

HEARING AID COMPATIBILITY

Applicant Name:
 Samsung Electronics Co., Ltd.
 129, Samsung-ro, Maetan dong,
 Yeongtong-gu, Suwon-si
 Gyeonggi-do 16677, Korea

Date of Testing:
 11/06/2017 - 12/11/2017
Test Site/Location:
 PCTEST Lab, Columbia, MD, USA
Test Report Serial No.:
 1M1711060289-13-R1.A3L

| | |
|-------------------|--------------------------------------|
| FCC ID: | A3LSMG965U |
| APPLICANT: | SAMSUNG ELECTRONICS CO., LTD. |

Scope of Test: RF Emissions Testing
Application Type: Certification
FCC Rule Part(s): CFR §20.19(b)
HAC Standard: ANSI C63.19-2011
 CTIA Test Plan for Hearing Aid Compatibility Rev 3.1, February 2017
 285076 D01 HAC Guidance v05
 285076 D02 T-Coil testing for CMRS IP v03

DUT Type: Portable Handset
Model: SM-G965U
Additional Model(s): SM-G965U1, SM-G965W
Test Device Serial No.: Pre-Production Sample [S/N: 37046]

| | |
|----------------------------------|-----------------------------------|
| C63.19-2011 HAC Category: | M4 (RF EMISSIONS CATEGORY) |
|----------------------------------|-----------------------------------|

Note: This revised Test Report (S/N: 1M1711060289-13-R1.A3L) supersedes and replaces the previously issued test report on the same subject device for the same type of testing as indicated. Please discard or destroy the previously issued test report(s) and dispose of it accordingly.

This wireless portable device has been shown to be hearing-aid compatible under the above rated category, specified in ANSI/IEEE Std. C63.19-2011 and has been tested in accordance with the specified measurement procedures. Hearing-Aid Compatibility is based on the assumption that all production units will be designed electrically identical to the device tested in this report. Test results reported herein relate only to the item(s) tested. North America bands only.

I attest to the accuracy of data. All measurements reported herein were performed by me or were made under my supervision and are correct to the best of my knowledge and belief. I assume full responsibility for the completeness of these measurements and vouch for the qualifications of all persons taking them.

 Randy Ortanez
 President

ctia AuthorizedTM
 Test Lab
 Lab Code: 20020221-00







| | | | | |
|--|---|---------------------------------------|---|--|
| FCC ID: A3LSMG965U |  | HAC (RF EMISSIONS) TEST REPORT |  | Approved by: Quality Manager |
| Filename: 1M1711060289-13-R1.A3L | Test Dates: 11/06/2017 - 12/11/2017 | DUT Type: Portable Handset | Page 1 of 108 | |

TABLE OF CONTENTS

| | | |
|-----|---|-----|
| 1. | INTRODUCTION | 3 |
| 2. | DUT DESCRIPTION..... | 4 |
| 3. | ANSI/IEEE C63.19 PERFORMANCE CATEGORIES | 7 |
| 4. | SYSTEM SPECIFICATIONS..... | 8 |
| 5. | TEST PROCEDURE | 13 |
| 6. | SYSTEM CHECK | 15 |
| 7. | MODULATION INTERFERENCE FACTOR..... | 18 |
| 8. | RF CONDUCTED POWER MEASUREMENTS..... | 26 |
| 9. | JUSTIFICATION OF HELD TO EAR MODES TESTED | 56 |
| 10. | LTE TDD UPLINK-DOWNLINK CONFIGURATION..... | 58 |
| 11. | OVERALL MEASUREMENT SUMMARY | 60 |
| 12. | EQUIPMENT LIST..... | 63 |
| 13. | MEASUREMENT UNCERTAINTY | 64 |
| 14. | TEST DATA..... | 65 |
| 15. | CALIBRATION CERTIFICATES..... | 75 |
| 16. | CONCLUSION..... | 103 |
| 17. | REFERENCES | 104 |
| 18. | TEST PHOTOGRAPHS | 106 |

| | | | | |
|--|--|---------------------------------------|---|--|
| FCC ID: A3LSMG965U |  PCTEST <small>TECHNOLOGICAL LABORATORY, INC.</small> | HAC (RF EMISSIONS) TEST REPORT |  | Approved by: Quality Manager |
| Filename: 1M1711060289-13-R1.A3L | Test Dates: 11/06/2017 - 12/11/2017 | DUT Type: Portable Handset | Page 2 of 108 | |

1. INTRODUCTION

On July 10, 2003, the Federal Communications Commission (FCC) adopted new rules requiring wireless manufacturers and service providers to provide digital wireless phones that are compatible with hearing aids. The FCC has modified the exemption for wireless phones under the Hearing Aid Compatibility Act of 1998 (HAC Act) in WT Docket 01-309 RM-8658¹ to extend the benefits of wireless telecommunications to individuals with hearing disabilities. These benefits encompass business, social and emergency communications, which increase the value of the wireless network for everyone. An estimated more than 10% of the population in the United States show signs of hearing impairment and of that fraction, almost 80% use hearing aids. Approximately 500 million people worldwide suffer from hearing loss.

Compatibility Tests Involved:

The standard calls for wireless communications devices to be measured for:

- RF Electric-field emissions
- T-coil mode, magnetic-signal strength in the audio band
- T-coil mode, magnetic-signal frequency response through the audio band
- T-coil mode, magnetic-signal and noise articulation index

The hearing aid must be measured for:

- RF immunity in microphone mode
- RF immunity in T-coil mode

In the following tests and results, this report includes the evaluation for a wireless communications device.

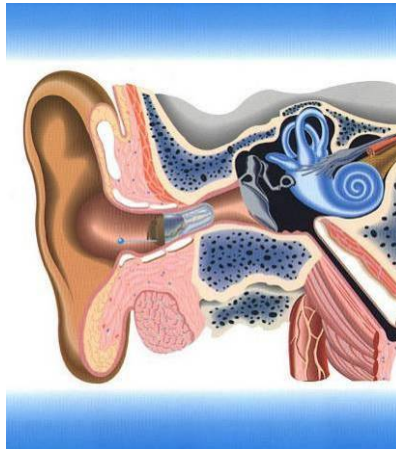



Figure 1-1 Hearing Aid *in-vitu*

¹ FCC Rule & Order, WT Docket 01-309 RM-8658

| | | | | |
|-------------------------------------|--|--------------------------------|---|---------------------------------|
| FCC ID: A3LSMG965U |  PCTEST ENGINEERING LABORATORY, INC. | HAC (RF EMISSIONS) TEST REPORT |  SAMSUNG | Approved by: Quality Manager |
| Filename: 1M1711060289-13-R1.A3L | Test Dates: 11/06/2017 - 12/11/2017 | DUT Type: Portable Handset | Page 3 of 108 | |

2. DUT DESCRIPTION



FCC ID: A3LSMG965U
Manufacturer: Samsung Electronics Co., Ltd.
129, Samsung-ro, Maetan dong,
Yeongtong-gu, Suwon-si
Gyeonggi-do 16677, Korea
Model: SM-G965U
Additional Model(s): SM-G965U1, SM-G965W
Serial Number: 37046
Antenna Configurations: Internal Antenna
HAC Test Configurations: Cell. CDMA, 564*, 1013, 384, 777, BT Off, WLAN Off, LTE Off
PCS CDMA, 25, 600, 1175, BT Off, WLAN Off, LTE Off
GSM 850, 128, 190, 251, BT Off, WLAN Off, LTE Off
GSM 1900, 512, 661, 810, BT Off, WLAN Off, LTE Off
LTE TDD B41 PC3; BW's: 20MHz; 39750, 40185, 40620, 41055, 41490; BT Off, WLAN Off
LTE TDD B41 PC2; BW's: 5MHz; 39750, 40185, 40620, 41055, 41490; BT Off, WLAN Off
*Note: Cell. CDMA Ch. 564 is the Part 90S test channel.
DUT Type: Portable Handset

I. Power Reduction for WIFI

This device uses an independent fixed level power reduction mechanism for all WIFI operations during voice or VoIP held to ear scenarios. Reduced powers were used to evaluate for low-power exemption in Section 9.II for WIFI. Detailed descriptions of the power reduction mechanism are included in the operational description.

II. LTE Band Selection

This device supports the following pairs of LTE bands with similar frequencies: LTE B12 & B17, LTE B5 & B26, LTE B4 & B66, LTE B2 & B25, and LTE B38 & B41. Each pair of LTE bands has the same target power and shares the same transmission path. Since the supported frequency spans for the smaller LTE bands are completely covered by the larger LTE bands, only the larger LTE bands (LTE B12, LTE B26, LTE B66, LTE B25, and LTE B41) were evaluated for hearing-aid compliance.



| | | | | |
|-------------------------------------|--|--------------------------------|---|---------------------------------|
| FCC ID: A3LSMG965U |  PCTEST TECHNOLOGICAL LABORATORY, INC. | HAC (RF EMISSIONS) TEST REPORT |  | Approved by: Quality Manager |
| Filename: 1M1711060289-13-R1.A3L | Test Dates: 11/06/2017 - 12/11/2017 | DUT Type: Portable Handset | Page 4 of 108 | |

Table 2-1: SM-G965U & SM-G965U1 HAC Air Interfaces

| Air-Interface | Band (MHz) | Type Transport | HAC Tested | Simultaneous But Not Tested | Name of Voice Service |
|--|-----------------|----------------|---|------------------------------|-----------------------|
| CDMA | 835 | VO | Yes | Yes: WIFI or BT | CMRS Voice |
| | 1900 | | | | |
| | EVDO | VD | No ¹ | Yes: WIFI or BT | Google Duo |
| GSM | 850 | VO | Yes | Yes: WIFI or BT | CMRS Voice |
| | 1900 | | | | |
| | GPRS/EDGE | VD | No ¹ | Yes: WIFI or BT | Google Duo |
| UMTS | 850 | VD | No ¹ | Yes: WIFI or BT | CMRS Voice |
| | 1700 | | | | |
| | 1900 | | | | |
| | HSPA | VD | No ¹ | Yes: WIFI or BT | Google Duo |
| LTE (FDD) | 680 (B71) | VD | No ¹ | Yes: WIFI or BT | VoLTE Google Duo |
| | 700 (B12) | | | | |
| | 700 (B17) | | | | |
| | 780 (B13) | | | | |
| | 790 (B14) | | | | |
| | 850 (B5) | | | | |
| | 850 (B26) | | | | |
| | 1700 (B4) | | | | |
| | 1700 (B66) | | | | |
| | 1900 (B2) | | | | |
| | 1900 (B25) | | | | |
| | 2300 (B30) | | | | |
| | 2500 (B7) | | | | |
| LTE (TDD) | 2600 (B38) | VD | Yes | Yes: WIFI or BT | Google Duo |
| | 2600 (B41) | | | | |
| WIFI | 2450 | VD | No ¹ | Yes: CDMA, GSM, UMTS, or LTE | VoWIFI Google Duo |
| | 5200 (U-NII 1) | | | | |
| | 5300 (U-NII 2A) | | | | |
| | 5500 (U-NII 2C) | | | | |
| | 5800 (U-NII 3) | | | | |
| BT | 2450 | DT | No | Yes: CDMA, GSM, UMTS, or LTE | N/A |
| Type Transport VO = Voice Only DT = Digital Data - Not intended for CMRS Service VD = CMRS and IP Voice over Data Transport | | | Notes: 1. Evaluated for MIF and low-power exemption. | | |





| | | | | | |
|-------------------------------------|--|--------------------------------|---|---------------------------------|--|
| FCC ID: A3LSMG965U |  PCTEST ENGINEERING LABORATORY, INC. | HAC (RF EMISSIONS) TEST REPORT |  | Approved by: Quality Manager | |
| Filename: 1M1711060289-13-R1.A3L | Test Dates: 11/06/2017 - 12/11/2017 | DUT Type: Portable Handset | Page 5 of 108 | | |

Table 2-2: SM-G965W HAC Air Interfaces

| Air-Interface | Band (MHz) | Type Transport | HAC Tested | Simultaneous But Not Tested | Name of Voice Service |
|--|-----------------|----------------|---|-----------------------------|-----------------------|
| GSM | 850 | VO | Yes | Yes: WIFI or BT | CMRS Voice |
| | 1900 | | | | |
| | GPRS/EDGE | VD | No ¹ | Yes: WIFI or BT | Google Duo |
| UMTS | 850 | VD | No ¹ | Yes: WIFI or BT | CMRS Voice |
| | 1700 | | | | |
| | 1900 | | | | |
| | HSPA | VD | No ¹ | Yes: WIFI or BT | Google Duo |
| LTE (FDD) | 700 (B12) | VD | No ¹ | Yes: WIFI or BT | VoLTE Google Duo |
| | 700 (B17) | | | | |
| | 780 (B13) | | | | |
| | 850 (B5) | | | | |
| | 1700 (B4) | | | | |
| | 1700 (B66) | | | | |
| | 1900 (B2) | | | | |
| | 1900 (B25) | | | | |
| | 2300 (B30) | | | | |
| | 2500 (B7) | | | | |
| LTE (TDD) | 2600 (B38) | VD | Yes | Yes: WIFI or BT | Google Duo |
| | 2600 (B41) | | | | |
| WIFI | 2450 | VD | No ¹ | Yes: GSM, UMTS, or LTE | VoWIFI Google Duo |
| | 5200 (U-NII 1) | | | | |
| | 5300 (U-NII 2A) | | | | |
| | 5500 (U-NII 2C) | | | | |
| | 5800 (U-NII 3) | | | | |
| BT | 2450 | DT | No | Yes: GSM, UMTS, or LTE | N/A |
| Type Transport VO = Voice Only DT = Digital Data - Not intended for CMRS Service VD = CMRS and IP Voice over Data Transport | | | Notes: 1. Evaluated for MIF and low-power exemption. | | |



| | | | | |
|-------------------------------------|--|--------------------------------|---|---------------------------------|
| FCC ID: A3LSMG965U |  PCTEST ENGINEERING LABORATORY, INC. | HAC (RF EMISSIONS) TEST REPORT |  | Approved by: Quality Manager |
| Filename: 1M1711060289-13-R1.A3L | Test Dates: 11/06/2017 - 12/11/2017 | DUT Type: Portable Handset | Page 6 of 108 | |

3. ANSI/IEEE C63.19 PERFORMANCE CATEGORIES

I. RF EMISSIONS

The ANSI Standard presents performance requirements for acceptable interoperability of hearing aids with wireless communications devices. When these parameters are met, a hearing aid operates acceptably in close proximity to a wireless communications device.

| Category | Telephone RF Parameters |
|--|---|
| Near field Category | E-field emissions CW dB(V/m) |
| f < 960 MHz | |
| M1 | 50 to 55 |
| M2 | 45 to 50 |
| M3 | 40 to 45 |
| M4 | < 40 |
| f > 960 MHz | |
| M1 | 40 to 45 |
| M2 | 35 to 40 |
| M3 | 30 to 35 |
| M4 | < 30 |
| Table 3-1 WD near-field categories as defined in ANSI C63.19-2011 | |

| | | | | |
|-------------------------------------|--|--------------------------------|---|---------------------------------|
| FCC ID: A3LSMG965U |  PCTEST ENGINEERING LABORATORY, INC. | HAC (RF EMISSIONS) TEST REPORT |  | Approved by: Quality Manager |
| Filename: 1M1711060289-13-R1.A3L | Test Dates: 11/06/2017 - 12/11/2017 | DUT Type: Portable Handset | Page 7 of 108 | |

4. SYSTEM SPECIFICATIONS

ER3DV6 E-Field Probe Description

| | |
|---------------|--|
| Construction: | One dipole parallel, two dipoles normal to probe axis Built-in shielding against static charges |
| Calibration: | In air from 100 MHz to 3.0 GHz (absolute accuracy $\pm 6.0\%$, $k=2$) |
| Frequency: | 100 MHz to > 6 GHz; Linearity: ± 0.2 dB (100 MHz to 3 GHz) |
| Directivity | ± 0.2 dB in air (rotation around probe axis) ± 0.4 dB in air (rotation normal to probe axis) |
| Dynamic Range | 2 V/m to > 1000 V/m (M3 or better device readings fall well below diode compression point) |
| Linearity: | ± 0.2 dB |
| Dimensions | Overall length: 330 mm (Tip: 16 mm) Tip diameter: 8 mm (Body: 12 mm) Distance from probe tip to dipole centers: 2.5 mm |

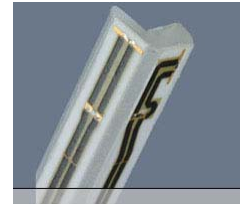
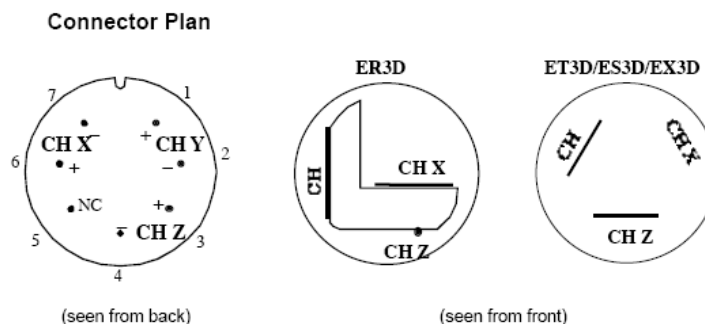

Figure 4-1
E-field Free-space Probe

Probe Tip Description

HAC field measurements take place in the close near field with high gradients. Increasing the measuring distance from the source will generally decrease the measured field values (in case of the validation dipole approx. 10% per mm).

The electric field probes have an irregular internal geometry because it is physically not possible to have the 3 orthogonal sensors situated with the same center. The effect of the different sensor centers is accounted for in the HAC uncertainty budget ("sensor displacement"). Their geometric center is at 2.5mm from the tip, and the element ends are 1.1mm closer to the tip.



The antistatic shielding inside the probe is connected to the probe connector case.

| | | | | |
|-------------------------------------|--|--------------------------------|---------------|---------------------------------|
| FCC ID: A3LSMG965U | PCTEST ENGINEERING LABORATORY, INC. | HAC (RF EMISSIONS) TEST REPORT | SAMSUNG | Approved by: Quality Manager |
| Filename: 1M1711060289-13-R1.A3L | Test Dates: 11/06/2017 - 12/11/2017 | DUT Type: Portable Handset | Page 8 of 108 | |

Instrumentation Chain

Equation 1

Conversion of Connector Voltage u_i to E-Field E_i

$$E_i = \sqrt{\frac{u_i + (u_i^2 \cdot CF)/(DCP)}{Norm_i \cdot ConvF}}$$

whereby

E_i : electric field in V/m
 u_i : voltage of channel i at the connector in μV
 $Norm_i$: sensitivity of channel i in $\mu\text{V}/(\text{V/m})^2$
 $ConvF$: enhancement factor in liquid ($ConvF=1$ for Air)
 DCP : diode compression point in μV
 CF : signal crest factor (peak power/average power)

Conditions of Calibration

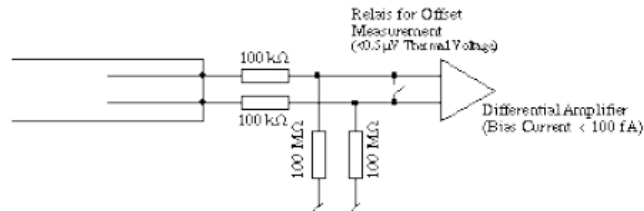

Please note:

- a lower input impedance of the amplifier will result in different sensitivity factors $Norm_i$ and DCP
- larger bias currents will cause higher offset

Probe Response to Frequency

The E-field sensors have inherently a very flat frequency response. They are calibrated with a number of frequencies resulting in a common calibration factor, with the frequency behavior documented in the calibration certificate (See also below).

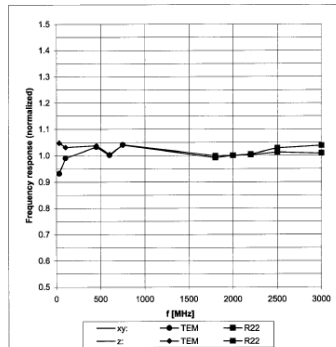

Frequency Response of E-Field

(TEM-Cell:if110 EXX, Waveguide R22)



Uncertainty of Frequency Response of E-field: $\pm 6.3\%$ ($k=2$)

Figure 4-2 E-Field Probe Frequency Response

| | | | | |
|-------------------------------------|--|--------------------------------|---|---------------------------------|
| FCC ID: A3LSMG965U |  PCTEST ENGINEERING LABORATORY, INC. | HAC (RF EMISSIONS) TEST REPORT |  | Approved by: Quality Manager |
| Filename: 1M1711060289-13-R1.A3L | Test Dates: 11/06/2017 - 12/11/2017 | DUT Type: Portable Handset | | Page 9 of 108 |

© 2017 PCTEST Engineering Laboratory, Inc.

REV 3.1.M

09/14/2017

© 2017 PCTEST Engineering Laboratory, Inc. All rights reserved. Unless otherwise specified, no part of this report may be reproduced or utilized in any part, form or by any means, electronic or mechanical, including photocopying and microfilm, without permission in writing from PCTEST Engineering Laboratory, Inc. If you have any questions about this international copyright or have an enquiry about obtaining additional rights to this report or assembly of contents thereof, please contact INFO@PCTEST.COM.

SPEAG Robotic System



E-field measurements are performed using the DASY5 automated dosimetric assessment system. The DASY5 is made by Schmid & Partner Engineering AG (SPEAG) in Zurich, Switzerland and consists of high precision robotics system (Staubli), robot controller, Intel CORE i7 computer, near-field probe, probe alignment sensor, and the HAC phantom. The robot is a six-axis industrial robot performing precise movements to position the probe to the location (points) of maximum electromagnetic field (EMF).



Figure 4-3
SPEAG Robotic System

System Hardware

A cell controller system contains the power supply, robot controller, teach pendant (Joystick), and a remote control used to drive the robot motors. The PC consists of the computer with operating system and RF Measurement Software DASY5 v52.8 (with HAC Extension), A/D interface card, monitor, mouse, and keyboard. The Staubli Robot is connected to the cell controller to allow software manipulation of the robot. A data acquisition electronic (DAE) circuit that performs the signal amplification, signal multiplexing, AD-conversion, offset measurements, mechanical surface detection, collision detection, etc. is connected to the Electro-optical coupler (EOC). The EOC performs the conversion from the optical into digital electric signal of the DAE and transfers data to the PC plug-in card.

| | | | | |
|--|---|---------------------------------------|---|--|
| FCC ID: A3LSMG965U |  PCTEST ENGINEERING LABORATORY, INC. | HAC (RF EMISSIONS) TEST REPORT |  | Approved by: Quality Manager |
| Filename: 1M1711060289-13-R1.A3L | Test Dates: 11/06/2017 - 12/11/2017 | DUT Type: Portable Handset | Page 10 of 108 | |

System Electronics

The DAE consists of a highly sensitive electrometer-grade preamplifier with auto-zeroing, a channel and gain-switching multiplexer, a fast 16 bit AD-converter and a command decoder and control logic unit. Transmission to the PC-card is accomplished through an optical downlink for data and status information and an optical uplink for commands and clock lines. The mechanical probe mounting device includes two different sensor systems for frontal and sidewise probe contacts. They are also used for mechanical surface detection and probe collision detection. The robot uses its own controller with a built in VME-bus computer.

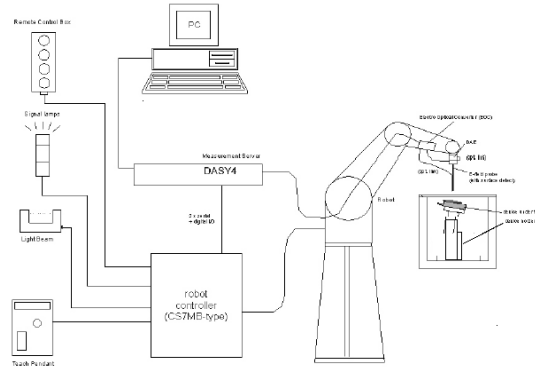



Figure 4-4
SPEAG Robotic System Diagram

DASY5 Instrumentation Chain

The first step of the evaluation is a linearization of the filtered input signal to account for the compression characteristics of the detector diode. The compensation depends on the input signal, the diode type and the DC-transmission factor from the diode to the evaluation electronics. If the exciting field is pulsed, the crest factor of the signal must be known to correctly compensate for peak power. The formula for each channel can be given as:

$$V_i = U_i + U_i^2 \cdot \frac{cf}{dcp_i}$$

| | | |
|------------|-----------------------------------|------------------|
| with V_i | = compensated signal of channel i | (i = x, y, z) |
| U_i | = input signal of channel i | (i = x, y, z) |
| cf | = crest factor of exciting field | (DASY parameter) |
| dcp_i | = diode compression point | (DASY parameter) |

| | | | | |
|-------------------------------------|--|--------------------------------|---|---------------------------------|
| FCC ID: A3LSMG965U |  PCTEST TECHNOLOGICAL LABORATORY, INC. | HAC (RF EMISSIONS) TEST REPORT |  | Approved by: Quality Manager |
| Filename: 1M1711060289-13-R1.A3L | Test Dates: 11/06/2017 - 12/11/2017 | DUT Type: Portable Handset | | Page 11 of 108 |

From the compensated input signals the primary field data for each channel can be evaluated:

$$E - \text{fieldprobes} : \quad E_i = \sqrt{\frac{V_i}{Norm_i \cdot ConvF}}$$

with V_i = compensated signal of channel i (i = x, y, z)
 $Norm_i$ = sensor sensitivity of channel i (i = x, y, z)
 $\mu\text{V}/(\text{V}/\text{m})^2$ for E-field Probes
 $ConvF$ = sensitivity enhancement in solution
 E_i = electric field strength of channel i in V/m

The RSS value of the field components gives the total field strength (Hermitian magnitude):



$$E_{tot} = \sqrt{E_x^2 + E_y^2 + E_z^2}$$

The primary field data are used to calculate the derived field units.

The measurement/integration time per point, as specified by the system manufacturer is >500ms.

The signal response time is evaluated as the time required by the system to reach 90% of the expected final value after an on/off switch of the power source with an integration time of 500ms and a probe response time of <5 ms. In the current implementation, DASY5 waits longer than 100ms after having reached the grid point before starting a measurement, i.e., the response time uncertainty is negligible.

If the device under test does not emit a CW signal, the integration time applied to measure the electric field at a specific point may introduce additional uncertainties due to the discretization. The tolerances for the different systems had the worst-case of 2.6%.

| | | | | |
|-------------------------------------|--|--------------------------------|---|---------------------------------|
| FCC ID: A3LSMG965U |  PCTEST ENGINEERING LABORATORY, INC. | HAC (RF EMISSIONS) TEST REPORT |  | Approved by: Quality Manager |
| Filename: 1M1711060289-13-R1.A3L | Test Dates: 11/06/2017 - 12/11/2017 | DUT Type: Portable Handset | Page 12 of 108 | |

5. TEST PROCEDURE

I. RF EMISSIONS

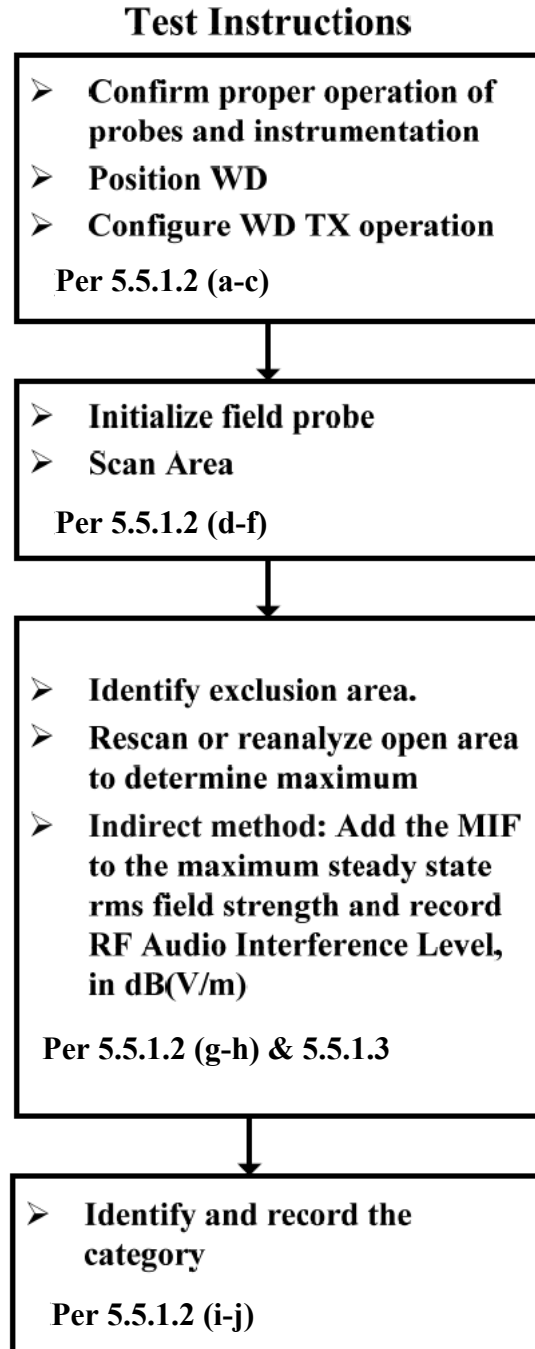



Figure 5-1 RF Emissions Flow Chart

| | | | | |
|-------------------------------------|--|--------------------------------|---|---------------------------------|
| FCC ID: A3LSMG965U |  PCTEST ENGINEERING LABORATORY, INC. | HAC (RF EMISSIONS) TEST REPORT |  | Approved by: Quality Manager |
| Filename: 1M1711060289-13-R1.A3L | Test Dates: 11/06/2017 - 12/11/2017 | DUT Type: Portable Handset | | Page 13 of 108 |

Test Setup

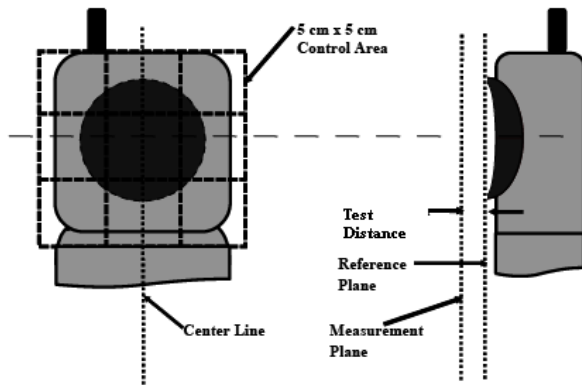

Figure 5-2

E-Field Emissions Test Setup Diagram (See Test Photographs for actual WD scan grid overlay)

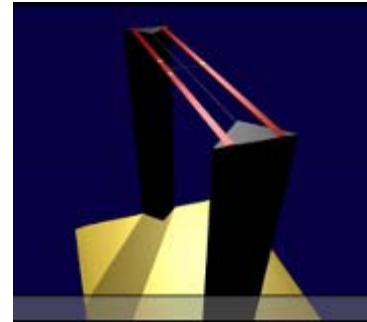



Figure 5-3
HAC Phantom

RF Emissions Test Procedure:

The following illustrate a typical RF emissions test scan over a wireless communications device:

1. Proper operation of the field probe, probe measurement system, other instrumentation, and the positioning system was confirmed.
2. WD is positioned in its intended test position, acoustic output point of the device perpendicular to the field probe.
3. The WD operation for maximum rated RF output power was configured and confirmed with the base station simulator, at the test channel and other normal operating parameters as intended for the test. The battery was ensured to be fully charged before each test.
4. The center sub-grid was centered over the center of the acoustic output (also audio band magnetic output, if applicable). The WD audio output was positioned tangent (as physically possible) to the measurement plane.
5. A surface calibration was performed before each setup change to ensure repeatable spacing and proper maintenance of the measurement plane using the HAC Phantom.
6. The measurement system measured the field strength at the reference location.
7. Measurements at 2mm or 5mm increments in the 5 x 5 cm region were performed at a distance 15 mm from the center point of the probe measurement element to the WD. A 360° rotation about the azimuth axis at the maximum interpolated position was measured. For the worst-case condition, the peak reading from this rotation was used in re-evaluating the HAC category.
8. The system performed a drift evaluation by measuring the field at the reference location. If the power drift deviated by more than 5%, the HAC test and drift measurements were repeated.

| | | | | |
|-------------------------------------|--|--------------------------------|---|---------------------------------|
| FCC ID: A3LSMG965U |  PCTEST ENGINEERING LABORATORY, INC. | HAC (RF EMISSIONS) TEST REPORT |  SAMSUNG | Approved by: Quality Manager |
| Filename: 1M1711060289-13-R1.A3L | Test Dates: 11/06/2017 - 12/11/2017 | DUT Type: Portable Handset | Page 14 of 108 | |

6. SYSTEM CHECK

I. System Check Parameters

The input signal was an un-modulated continuous wave. The following points were taken into consideration in performing this check:

- Average Input Power $P = 100\text{mW RMS}$ (20dBm RMS) after adjustment for return loss
- The test fixture must meet the 2 wavelength separation criterion
- The proper measurement of the 15 mm probe to dipole separation, which is measured from top surface of the dipole to the calibration reference point of the sensor, defined by the probe manufacturer is shown in the following diagram:

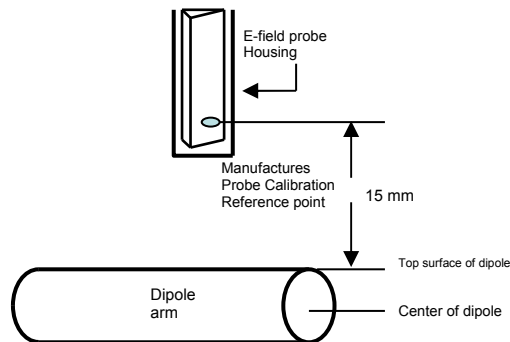

Figure 6-1
Separation Distance from Dipole to Field Probe

RF power was recorded using both an average reading meter and a peak reading meter. Readings of the probe are provided by the measurement system.

To assure proper operation of the near-field measurement probe the input power to the dipole shall be commensurate with the full rated output power of the wireless device [e.g. - for a cellular phone wireless device the average peak antenna input power will be on the order of 100mW (20dBm) RMS] after adjustment for any mismatch.



II. Validation Procedure

A dipole antenna meeting the requirements given in C63.19 was placed in the position normally occupied by the WD.

The length of the dipole was scanned, and the average peak value was recorded.

Measurement of CW

Using the near-field measurement system, scan the antenna over the radiating dipole and record the greatest field reading observed. Due to the nature of E-fields about free-space dipoles, the two E-field peaks measured over the dipole are averaged to compensate for non-parallelity of the setup (see manufacturer method on dipole calibration certificates, page 2). Field strength measurements shall be made only when the probe is stationary.

| | | | | |
|-------------------------------------|--|--------------------------------|---|---------------------------------|
| FCC ID: A3LSMG965U |  PCTEST ENGINEERING LABORATORY, INC. | HAC (RF EMISSIONS) TEST REPORT |  | Approved by: Quality Manager |
| Filename: 1M1711060289-13-R1.A3L | Test Dates: 11/06/2017 - 12/11/2017 | DUT Type: Portable Handset | | Page 15 of 108 |

RF power was recorded using both an average and a peak power reading meter.

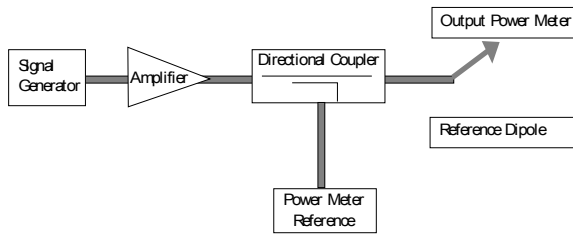

Figure 6-2
Setup for Desired Output Power to Dipole

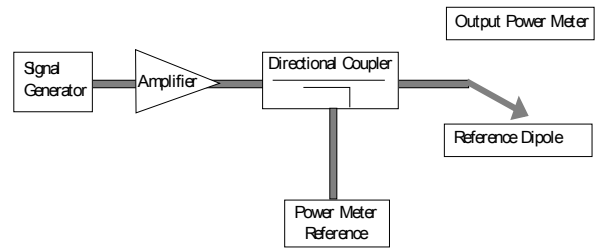

Figure 6-3
Setup to Dipole

Using this setup configuration, the signal generator was adjusted for the desired output power (100mW) at a specified frequency. The reference power from the coupled port of the directional coupler is recorded. Next, the output cable is connected to the reference dipole, as shown in Figure 6-3.

The input signal level was adjusted until the reference power from the coupled port of the directional coupler was the same as previously recorded, to compensate for the impedance mismatch between the output cable and the reference dipole. To assure proper operation of the near-field measurement probe the input power to the reference dipole was verified to the full rated output power of the wireless device. The dipole was secured in a holder in a manner to meet the 20 dB reflection. The near-field measurement probe was positioned over the dipole. The antenna was scanned over the appropriate sized area to cover the dipole from end to end. SPEAG uses 2D interpolation algorithms between the measured points. Please see below two dimensional plots showing that the interpolated values interpolate smoothly between 5mm steps for a free-space RF dipole:

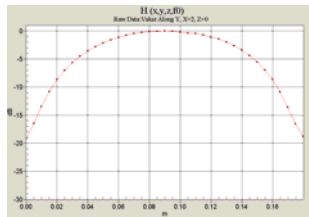

Figure 6-4
2-D Raw Data from scan along dipole axis

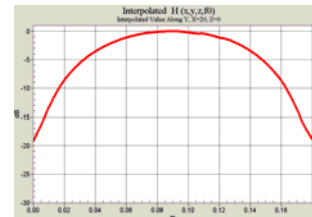

Figure 6-5
2-D Interpolated points from scan along dipole axis

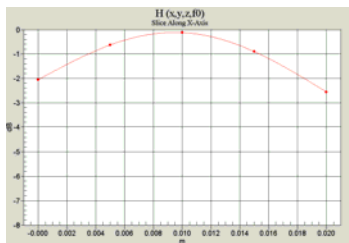

Figure 6-6
2-D Raw Data from scan along transverse axis

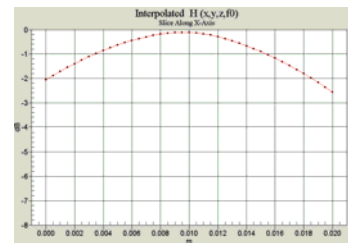

Figure 6-7
2-D Interpolated points from scan along transverse axis

| | | | | |
|-------------------------------------|--|--------------------------------|---------|---------------------------------|
| FCC ID: A3LSMG965U | PCTEST ENGINEERING LABORATORY, INC. | HAC (RF EMISSIONS) TEST REPORT | SAMSUNG | Approved by: Quality Manager |
| Filename: 1M1711060289-13-R1.A3L | Test Dates: 11/06/2017 - 12/11/2017 | DUT Type: Portable Handset | | Page 16 of 108 |

III. System Check Results

Validation Results

| Date | Frequency (MHz) | Probe S/N | DAE S/N | Dipole S/N | Input Power (dBm) | E-field Result (V/m) | Target Field (V/m) | % Deviation |
|------------|-----------------|-----------|---------|------------|-------------------|----------------------|--------------------|-------------|
| 11/6/2017 | 835 | 2353 | 859 | 1082 | 20.0 | 111.6 | 106.8 | 4.5% |
| 11/6/2017 | 1880 | 2353 | 859 | 1064 | 20.0 | 95.3 | 89.6 | 6.4% |
| 12/11/2017 | 2600 | 2353 | 859 | 1013 | 20.0 | 89.7 | 84.5 | 6.2% |

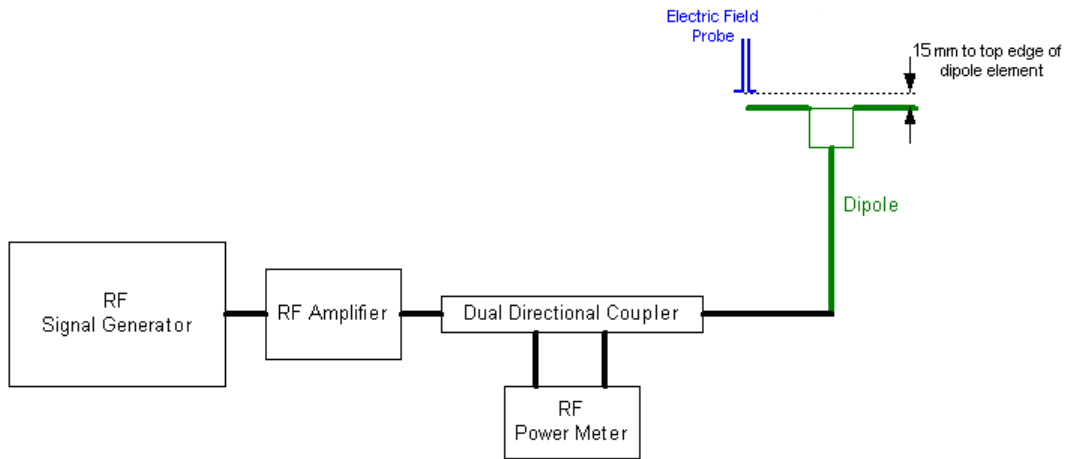



Figure 6-8
System Check Setup

| | | | | |
|-------------------------------------|--|--------------------------------|---|---------------------------------|
| FCC ID: A3LSMG965U |  PCTEST ENGINEERING LABORATORY, INC. | HAC (RF EMISSIONS) TEST REPORT |  SAMSUNG | Approved by: Quality Manager |
| Filename: 1M1711060289-13-R1.A3L | Test Dates: 11/06/2017 - 12/11/2017 | DUT Type: Portable Handset | Page 17 of 108 | |

7. MODULATION INTERFERENCE FACTOR

I. Measuring Modulation Interference Factors

For any specific fixed and repeatable modulated signal, a modulation interference factor (MIF, expressed in dB) may be determined that relates its interference potential to its steady-state RMS signal level or average power level. This factor is a function only of the audio-frequency amplitude modulation characteristics of the signal and is the same for field-strength and conducted power measurements. The MIF is valid only for a specific repeatable audio-frequency amplitude modulation characteristic; any change in modulation characteristic requires determination and application of a new MIF.

The MIF may be determined using a radiated RF field or a conducted RF signal:

- a. Using RF illumination or conducted coupling, apply the specific modulated signal in question to the measurement system at a level within its confirmed operating dynamic range.
- b. Measure the steady-state RMS level at the output of the fast probe or sensor.
- c. Measure the steady-state average level at the weighting output.
- d. Without changing the square-law detector or weighting system, and using RF illumination or conducted coupling, substitute for the specific modulated signal a 1 kHz, 80% amplitude modulated carrier at the same frequency and adjust its strength until the level at the weighting output equals the step c) measurement.
- e. Without changing the carrier level from step d), remove the 1 kHz modulation and again measure the steady-state RMS level indicated at the output of the fast probe or sensor.
- f. The MIF for the specific modulation characteristic is provided by the ratio of the step e) measurement to the step b) measurement, expressed in dB ($20 \times \log[(\text{step e})/(\text{step b})]$).



The following procedure was used to measure the MIF using the SPEAG Audio Interference Analyzer (AIA), Type No: SE UMS 170 CB, Serial No.: 1010:

1. The device was placed into a simulated call using a base station simulator or set to transmit using test software for a given mode.
2. The device was then set to continuously transmit at maximum power.
3. Using a coupler if needed, the device output signal was connected to the RF In port of the AIA, which was connected to a desktop computer. Alternatively, a radiated RF signal may be used with the AIA's built-in antenna.
4. The MIF measurement procedure in the DASY software was run, and the resulting MIF value was recorded.
5. Steps 1-4 were repeated for all CMRS air interfaces, frequency bands, and modulations.

The modulation interference factors obtained were applied to readings taken of the actual wireless device in order to obtain an accurate audio interference level reading using the formula:

$$\text{Audio Interference Level [dB(V/m)]} = 20 * \log[\text{Raw Field Value (V/m)}] + \text{MIF (dB)}$$

Because the MIF value is output power independent, MIF values for a given mode should be constant across all devices; however, per C63.19-2011 §D.7, MIF values should be measured for each device being evaluated. The voice modes for this device have been investigated in this section of the report.

| | | | | |
|-------------------------------------|--|--------------------------------|---|---------------------------------|
| FCC ID: A3LSMG965U |  PCTEST ENGINEERING LABORATORY, INC. | HAC (RF EMISSIONS) TEST REPORT |  | Approved by: Quality Manager |
| Filename: 1M1711060289-13-R1.A3L | Test Dates: 11/06/2017 - 12/11/2017 | DUT Type: Portable Handset | | Page 18 of 108 |

II. MIF Measurement Block Diagrams

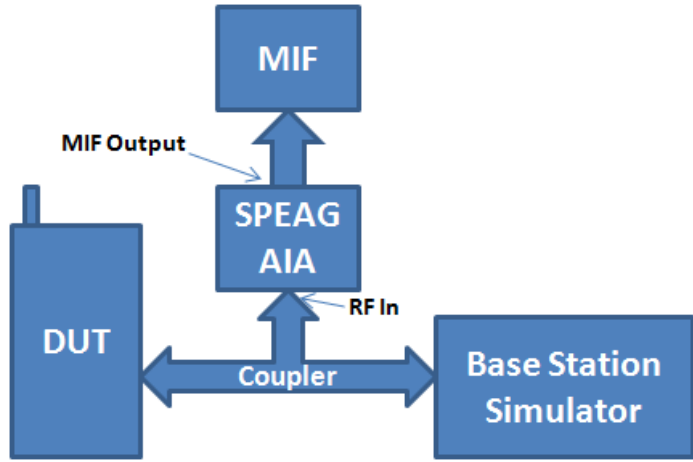

Figure 7-1
MIF Measurement Setup
for licensed modes

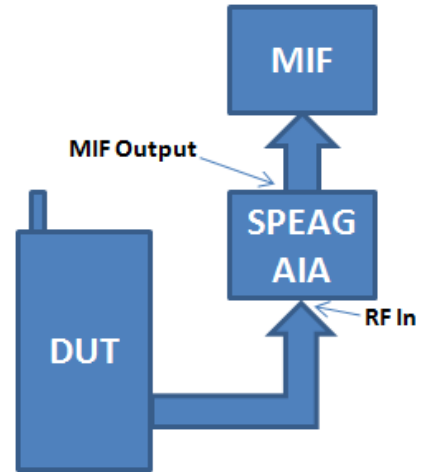

Figure 7-2
MIF Measurement Setup
for unlicensed modes

III. Measured Modulation Interference Factors:

Table 7-1
CDMA Modulation Interference Factors¹

| Mode | | Cell | | | | PCS | | |
|------|----------|--------|--------|--------|--------|--------|--------|--------|
| | | 90S | 22H | 22H | 22H | 24E | 24E | 24E |
| | | 564 | 1013 | 384 | 777 | 25 | 600 | 1175 |
| CDMA | RC1/SO3 | 3.07 | 3.03 | 3.04 | 3.06 | 3.06 | 3.04 | 3.06 |
| | RC1/SO55 | -19.66 | -19.91 | -19.68 | -19.35 | -19.80 | -19.85 | -19.88 |
| | EvDO | -19.41 | -19.57 | -19.40 | -19.05 | -19.40 | -19.43 | -19.75 |

Table 7-2
GSM Modulation Interference Factors¹

| Mode | | GSM850 | | | GSM1900 | | |
|------|-------|--------|------|------|---------|------|------|
| | | 128 | 190 | 251 | 512 | 661 | 810 |
| GSM | Voice | 3.56 | 3.56 | 3.56 | 3.56 | 3.56 | 3.56 |
| | EDGE | 3.76 | 3.76 | 3.76 | 3.53 | 3.39 | 3.23 |

¹ Note: Measured MIF values may be lower than sample MIF values provided in ANSI C63.19-2011 Annex D.7 Table D.5 due to manufacturing variations for each device, however per Annex D.7, the sample MIF values of Table D.5 are not intended to substitute for measurements of actual devices under test and their respective operating modes.

| | | | | |
|-------------------------------------|--|--------------------------------|--|---------------------------------|
| FCC ID: A3LSMG965U | PCTEST ENGINEERING LABORATORY, INC. | HAC (RF EMISSIONS) TEST REPORT | | Approved by: Quality Manager |
| Filename: 1M1711060289-13-R1.A3L | Test Dates: 11/06/2017 - 12/11/2017 | DUT Type: Portable Handset | | Page 19 of 108 |

© 2017 PCTEST Engineering Laboratory, Inc.

REV 3.1.M

09/14/2017

© 2017 PCTEST Engineering Laboratory, Inc. All rights reserved. Unless otherwise specified, no part of this report may be reproduced or utilized in any part, form or by any means, electronic or mechanical, including photocopying and microfilm, without permission in writing from PCTEST Engineering Laboratory, Inc. If you have any questions about this international copyright or have an enquiry about obtaining additional rights to this report or assembly of contents thereof, please contact INFO@PCTEST.COM.

Table 7-3
UMTS Modulation Interference Factors¹

| Mode | | UMTS V | | | UMTS IV | | | UMTS II | | |
|------|----------------|--------|--------|--------|---------|--------|--------|---------|--------|--------|
| | | 4132 | 4183 | 4233 | 1312 | 1412 | 1513 | 9262 | 9400 | 9538 |
| UMTS | 12.2 kbps RMC | -23.98 | -23.74 | -21.99 | -24.39 | -24.59 | -24.50 | -24.37 | -23.84 | -23.78 |
| | 12.2 kbps AMR | -15.66 | -15.11 | -15.18 | -15.05 | -15.10 | -15.02 | -15.07 | -15.02 | -15.07 |
| | HSUPA Subtest1 | -23.25 | -23.40 | -22.11 | -22.00 | -21.25 | -23.81 | -23.31 | -23.68 | -21.32 |

Table 7-4
LTE FDD Modulation Interference Factors^{1,2}

| LTE Band | Frequency [MHz] | Channel | Bandwidth [MHz] | Modulation | RB Size | RB Offset | MIF [dB] |
|----------|-----------------|---------|-----------------|------------|---------|-----------|----------|
| 71 | 680.5 | 133297 | 20 | 16QAM | 1 | 0 | -9.78 |
| 12 | 707.5 | 23095 | 10 | 16QAM | 1 | 0 | -9.80 |
| 13 | 782.0 | 23230 | 10 | 16QAM | 1 | 0 | -9.68 |
| 14 | 793.0 | 23330 | 10 | 16QAM | 1 | 0 | -9.83 |
| 26 | 831.5 | 26865 | 15 | 16QAM | 1 | 0 | -9.49 |
| 66 | 1745.0 | 132322 | 20 | 16QAM | 1 | 0 | -9.80 |
| 25 | 1882.5 | 26365 | 20 | 16QAM | 1 | 0 | -9.18 |
| 7 | 2535.0 | 21100 | 20 | 16QAM | 1 | 0 | -9.66 |
| 30 | 2310.0 | 27710 | 10 | 16QAM | 1 | 0 | -9.49 |
| 25 | 1882.5 | 26365 | 20 | QPSK | 1 | 0 | -14.10 |
| 25 | 1882.5 | 26365 | 20 | 64QAM | 1 | 0 | -9.84 |
| 25 | 1882.5 | 26365 | 20 | 16QAM | 1 | 50 | -9.03 |
| 25 | 1882.5 | 26365 | 20 | 16QAM | 1 | 99 | -9.15 |
| 25 | 1882.5 | 26365 | 20 | 16QAM | 50 | 0 | -16.85 |
| 25 | 1882.5 | 26365 | 20 | 16QAM | 100 | 0 | -17.36 |
| 25 | 1882.5 | 26365 | 15 | 16QAM | 1 | 36 | -8.96 |
| 25 | 1882.5 | 26365 | 10 | 16QAM | 1 | 25 | -9.01 |
| 25 | 1882.5 | 26365 | 5 | 16QAM | 1 | 12 | -9.00 |
| 25 | 1882.5 | 26365 | 3 | 16QAM | 1 | 7 | -9.30 |
| 25 | 1882.5 | 26365 | 1.4 | 16QAM | 1 | 2 | -9.22 |
| 25 | 1857.5 | 26115 | 15 | 16QAM | 1 | 36 | -9.14 |
| 25 | 1907.5 | 26615 | 15 | 16QAM | 1 | 36 | -9.36 |

¹ Note: Measured MIF values may be lower than sample MIF values provided in ANSI C63.19-2011 Annex D.7 Table D.5 due to manufacturing variations for each device, however per Annex D.7, the sample MIF values of Table D.5 are not intended to substitute for measurements of actual devices under test and their respective operating modes.

² Note: All FDD LTE bands were found to have substantially similar MIF values given similar RB, BW, and modulation configurations.



| | | | | |
|-------------------------------------|--|--------------------------------|---|---------------------------------|
| FCC ID: A3LSMG965U |  PCTEST ENGINEERING LABORATORY, INC. | HAC (RF EMISSIONS) TEST REPORT |  | Approved by: Quality Manager |
| Filename: 1M1711060289-13-R1.A3L | Test Dates: 11/06/2017 - 12/11/2017 | DUT Type: Portable Handset | Page 20 of 108 | |

Table 7-5
LTE TDD Power Class 3 Modulation Interference Factors^{1,2}

| LTE Band | Frequency [MHz] | Channel | Bandwidth [MHz] | Modulation | RB Size | RB Offset | MIF [dB] |
|----------|-----------------|---------|-----------------|------------|---------|-----------|----------|
| 41 | 2593.0 | 40620 | 20 | 16QAM | 1 | 0 | 1.63 |
| 41 | 2593.0 | 40620 | 20 | QPSK | 1 | 0 | 1.43 |
| 41 | 2593.0 | 40620 | 20 | 64QAM | 1 | 0 | 1.42 |
| 41 | 2593.0 | 40620 | 20 | 16QAM | 1 | 50 | 1.61 |
| 41 | 2593.0 | 40620 | 20 | 16QAM | 1 | 99 | 1.60 |
| 41 | 2593.0 | 40620 | 20 | 16QAM | 50 | 0 | 1.35 |
| 41 | 2593.0 | 40620 | 20 | 16QAM | 100 | 0 | 1.35 |
| 41 | 2593.0 | 40620 | 15 | 16QAM | 1 | 0 | 1.61 |
| 41 | 2593.0 | 40620 | 10 | 16QAM | 1 | 0 | 1.60 |
| 41 | 2593.0 | 40620 | 5 | 16QAM | 1 | 0 | 1.61 |
| 41 | 2506.0 | 39750 | 20 | 16QAM | 1 | 0 | 1.64 |
| 41 | 2549.5 | 40185 | 20 | 16QAM | 1 | 0 | 1.62 |
| 41 | 2636.5 | 41055 | 20 | 16QAM | 1 | 0 | 1.62 |
| 41 | 2680.0 | 41490 | 20 | 16QAM | 1 | 0 | 1.63 |

Table 7-6
LTE TDD Power Class 2 Modulation Interference Factors^{1,2}

| LTE Band | Frequency [MHz] | Channel | Bandwidth [MHz] | Modulation | RB Size | RB Offset | MIF [dB] |
|----------|-----------------|---------|-----------------|------------|---------|-----------|----------|
| 41 | 2593.0 | 40620 | 20 | 16QAM | 1 | 0 | 1.65 |
| 41 | 2593.0 | 40620 | 20 | QPSK | 1 | 0 | 1.45 |
| 41 | 2593.0 | 40620 | 20 | 64QAM | 1 | 0 | 1.47 |
| 41 | 2593.0 | 40620 | 20 | 16QAM | 1 | 50 | 1.64 |
| 41 | 2593.0 | 40620 | 20 | 16QAM | 1 | 99 | 1.62 |
| 41 | 2593.0 | 40620 | 20 | 16QAM | 50 | 0 | 1.40 |
| 41 | 2593.0 | 40620 | 20 | 16QAM | 100 | 0 | 1.40 |
| 41 | 2593.0 | 40620 | 15 | 16QAM | 1 | 0 | 1.66 |
| 41 | 2593.0 | 40620 | 10 | 16QAM | 1 | 0 | 1.64 |
| 41 | 2593.0 | 40620 | 5 | 16QAM | 1 | 0 | 1.67 |
| 41 | 2506.0 | 39750 | 5 | 16QAM | 1 | 0 | 1.66 |
| 41 | 2549.5 | 40185 | 5 | 16QAM | 1 | 0 | 1.67 |
| 41 | 2636.5 | 41055 | 5 | 16QAM | 1 | 0 | 1.65 |
| 41 | 2680.0 | 41490 | 5 | 16QAM | 1 | 0 | 1.65 |

Table 7-7
LTE TDD Uplink Carrier Aggregation Modulation Interference Factor^{1,3}

| Combination | PCC | | | | | | | SCC | | | | | | | MIF [dB] |
|-------------|----------|---------------------|---------------------|-----------------------------|------------|------------|------------------|----------|---------------------|---------------------|-----------------------------|------------|------------|------------------|----------|
| | PCC Band | PCC Bandwidth [MHz] | PCC (UL/DL) Channel | PCC (UL/DL) Frequency [MHz] | Modulation | PCC UL# RB | PCC UL RB Offset | SCC Band | SCC Bandwidth [MHz] | SCC (UL/DL) Channel | SCC (UL/DL) Frequency [MHz] | Modulation | SCC UL# RB | SCC UL RB Offset | |
| CA_41C | LTE B41 | 20 | 40185 | 2549.5 | 16QAM | 1 | 0 | LTE B41 | 20 | 39987 | 2529.7 | 16QAM | 1 | 99 | 1.36 |

¹ Note: Measured MIF values may be lower than sample MIF values provided in ANSI C63.19-2011 Annex D.7 Table D.5 due to manufacturing variations for each device, however per Annex D.7, the sample MIF values of Table D.5 are not intended to substitute for measurements of actual devices under test and their respective operating modes.

² Note: LTE TDD MIFs for both Power Class 3 and Power Class 2 were taken using UL-DL Configuration 2. More information about the chosen UL-DL Configuration can be found in Section 10.

³ Note: The configuration for LTE TDD ULCA was determined from the worst case configuration from Table 7-5. While channel 39750 was the worst case channel, channel 40185 was evaluated to ensure worst case modulation was evaluated for PCC due to the CA combination constraint of CA_41C.



| | | | | |
|-------------------------------------|--|--------------------------------|---|---------------------------------|
| FCC ID: A3LSMG965U |  PCTEST ENGINEERING LABORATORY, INC. | HAC (RF EMISSIONS) TEST REPORT |  | Approved by: Quality Manager |
| Filename: 1M1711060289-13-R1.A3L | Test Dates: 11/06/2017 - 12/11/2017 | DUT Type: Portable Handset | | Page 21 of 108 |

Table 7-8
802.11b (2.4GHz, SISO) Modulation Interference Factors^{1,2}

| Mode | 802.11b MIF Measurements [dB] | | | |
|---------|-------------------------------|-------|-------|-------|
| | Data Rate [Mbps] | | | |
| | 1 | 2 | 5.5 | 11 |
| 802.11b | -10.31 | -9.59 | -7.33 | -6.36 |

Table 7-9
802.11g (2.4GHz, SISO) Modulation Interference Factors^{1,2}

| Mode | 802.11g MIF Measurements [dB] | | | | | | | |
|---------|-------------------------------|-------|-------|-------|-------|-------|-------|-------|
| | Data Rate [Mbps] | | | | | | | |
| | 6 | 9 | 12 | 18 | 24 | 36 | 48 | 54 |
| 802.11g | -7.60 | -6.79 | -6.26 | -5.49 | -5.14 | -4.79 | -4.84 | -5.03 |

Table 7-10
802.11g (2.4GHz, MIMO) Modulation Interference Factors^{1,2}

| Mode | 802.11g MIF Measurements [dB] | | | | | | | |
|---------|-------------------------------|-------|-------|-------|-------|-------|-------|-------|
| | Data Rate [Mbps] | | | | | | | |
| | 12 | 18 | 24 | 36 | 48 | 72 | 96 | 108 |
| 802.11g | -7.53 | -6.75 | -6.23 | -5.46 | -5.11 | -4.76 | -4.82 | -5.01 |

Table 7-11
802.11n (2.4GHz, SISO) Modulation Interference Factors^{1,2}

| Mode | 802.11n (2.4GHz) MIF Measurements [dB] | | | | | | | |
|---------|--|-------|-------|-------|-------|-------|-------|-------|
| | Data Rate [Mbps] | | | | | | | |
| | 6.5 | 13 | 19.5 | 26 | 39 | 52 | 58.5 | 65 |
| 802.11n | -7.49 | -6.20 | -5.54 | -5.11 | -4.84 | -4.85 | -4.97 | -5.08 |

Table 7-12
802.11n (2.4GHz, MIMO) Modulation Interference Factors^{1,2}

| Mode | 802.11n (2.4GHz) MIF Measurements [dB] | | | | | | | |
|---------|--|-------|-------|-------|-------|-------|-------|-------|
| | Data Rate [Mbps] | | | | | | | |
| | 13 | 26 | 39 | 52 | 78 | 104 | 117 | 130 |
| 802.11n | -7.44 | -6.15 | -5.51 | -5.07 | -4.80 | -4.81 | -4.93 | -5.05 |

Table 7-13
802.11a (5GHz, 20MHz BW, SISO) Modulation Interference Factors^{1,2}

| Mode | 802.11a MIF Measurements [dB] | | | | | | | |
|---------|-------------------------------|--------|--------|--------|--------|--------|--------|--------|
| | Data Rate [Mbps] | | | | | | | |
| | 6 | 9 | 12 | 18 | 24 | 36 | 48 | 54 |
| 802.11a | -13.77 | -12.95 | -12.64 | -11.55 | -11.41 | -11.81 | -12.18 | -13.30 |

¹ Note: Measured MIF values may be lower than sample MIF values provided in ANSI C63.19-2011 Annex D.7 Table D.5 due to manufacturing variations for each device, however per Annex D.7, the sample MIF values of Table D.5 are not intended to substitute for measurements of actual devices under test and their respective operating modes.

² Note: WIFI MIF values were found to be independent of the transmit channel.



| | | | | |
|-------------------------------------|--|--------------------------------|---|---------------------------------|
| FCC ID: A3LSMG965U |  PCTEST ENGINEERING LABORATORY, INC. | HAC (RF EMISSIONS) TEST REPORT |  | Approved by: Quality Manager |
| Filename: 1M1711060289-13-R1.A3L | Test Dates: 11/06/2017 - 12/11/2017 | DUT Type: Portable Handset | | Page 22 of 108 |

Table 7-14
802.11a (5GHz, 20MHz BW, MIMO) Modulation Interference Factors^{1,2}

| Mode | 802.11a MIF Measurements [dB] | | | | | | | |
|---------|-------------------------------|--------|--------|--------|--------|--------|--------|--------|
| | Data Rate [Mbps] | | | | | | | |
| | 12 | 18 | 24 | 36 | 48 | 72 | 92 | 108 |
| 802.11a | -13.47 | -12.85 | -12.06 | -11.43 | -11.80 | -11.75 | -12.39 | -13.17 |

Table 7-15
802.11n (5GHz, 20MHz BW, SISO) Modulation Interference Factors^{1,2}

| Mode | 20MHz BW 802.11n (5GHz) MIF Measurements [dB] | | | | | | | |
|---------|---|--------|--------|--------|--------|--------|--------|--------|
| | Data Rate [Mbps] | | | | | | | |
| | 6.5 | 13 | 19.5 | 26 | 39 | 52 | 58.5 | 65 |
| 802.11n | -13.11 | -11.96 | -11.53 | -11.31 | -11.48 | -11.79 | -12.16 | -12.50 |

Table 7-16
802.11n (5GHz, 20MHz BW, MIMO) Modulation Interference Factors^{1,2}

| Mode | 20MHz BW 802.11n (5GHz) MIF Measurements [dB] | | | | | | | |
|---------|---|--------|--------|--------|--------|--------|--------|--------|
| | Data Rate [Mbps] | | | | | | | |
| | 13 | 26 | 39 | 52 | 78 | 104 | 117 | 130 |
| 802.11n | -13.17 | -12.04 | -11.92 | -11.31 | -11.61 | -12.10 | -12.44 | -12.91 |

Table 7-17
802.11ac (5GHz, 20MHz BW, SISO) Modulation Interference Factors^{1,2}

| Mode | 20MHz BW 802.11ac (5GHz) MIF Measurements [dB] | | | | | | | | | |
|----------|--|--------|--------|--------|--------|--------|--------|--------|--------|--|
| | Data Rate [Mbps] | | | | | | | | | |
| | 6.5 | 13 | 19.5 | 26 | 39 | 52 | 58.5 | 65 | 78 | |
| 802.11ac | -13.38 | -12.10 | -11.44 | -11.26 | -11.40 | -11.78 | -12.01 | -12.26 | -13.09 | |

Table 7-18
802.11ac (5GHz, 20MHz BW, MIMO) Modulation Interference Factors^{1,2}

| Mode | 20MHz BW 802.11ac (5GHz) MIF Measurements [dB] | | | | | | | | | |
|----------|--|--------|--------|--------|--------|--------|--------|--------|--------|--|
| | Data Rate [Mbps] | | | | | | | | | |
| | 13 | 26 | 39 | 52 | 78 | 104 | 117 | 130 | 156 | |
| 802.11ac | -12.49 | -11.63 | -11.80 | -12.25 | -12.89 | -13.95 | -13.88 | -14.16 | -14.96 | |

Table 7-19
802.11n (5GHz, 40MHz BW, SISO) Modulation Interference Factors^{1,2}

| Mode | 40MHz BW 802.11n (5GHz) MIF Measurements [dB] | | | | | | | |
|---------|---|--------|--------|--------|--------|--------|--------|--------|
| | Data Rate [Mbps] | | | | | | | |
| | 13.5 | 27 | 40.5 | 54 | 81 | 108 | 121.5 | 135 |
| 802.11n | -11.69 | -11.06 | -11.48 | -11.97 | -13.32 | -14.16 | -14.63 | -15.12 |

¹ Note: Measured MIF values may be lower than sample MIF values provided in ANSI C63.19-2011 Annex D.7 Table D.5 due to manufacturing variations for each device, however per Annex D.7, the sample MIF values of Table D.5 are not intended to substitute for measurements of actual devices under test and their respective operating modes.

² Note: WIFI MIF values were found to be independent of the transmit channel.



| | | | | |
|-------------------------------------|--|--------------------------------|---|---------------------------------|
| FCC ID: A3LSMG965U |  PCTEST TECHNOLOGICAL LABORATORY, INC. | HAC (RF EMISSIONS) TEST REPORT |  | Approved by: Quality Manager |
| Filename: 1M1711060289-13-R1.A3L | Test Dates: 11/06/2017 - 12/11/2017 | DUT Type: Portable Handset | Page 23 of 108 | |

Table 7-20
802.11n (5GHz, 40MHz BW, MIMO) Modulation Interference Factors^{1,2}

| Mode | 40MHz BW 802.11n (5GHz) MIF Measurements [dB] | | | | | | | |
|---------|---|--------|--------|--------|--------|--------|--------|--------|
| | Data Rate [Mbps] | | | | | | | |
| | 27 | 54 | 81 | 108 | 162 | 216 | 243 | 270 |
| 802.11n | -11.26 | -11.03 | -11.45 | -11.62 | -13.04 | -13.91 | -14.90 | -15.13 |

Table 7-21
802.11ac (5GHz, 40MHz BW, SISO) Modulation Interference Factors^{1,2}

| Mode | 40MHz BW 802.11ac (5GHz) MIF Measurements [dB] | | | | | | | | |
|----------|--|--------|--------|--------|--------|--------|--------|--------|--------|
| | Data Rate [Mbps] | | | | | | | | |
| | 13.5 | 27 | 40.5 | 54 | 81 | 108 | 121.5 | 135 | 180 |
| 802.11ac | -11.65 | -10.86 | -11.33 | -11.87 | -13.15 | -14.08 | -14.37 | -14.66 | -15.42 |

Table 7-22
802.11ac (5GHz, 40MHz BW, MIMO) Modulation Interference Factors^{1,2}

| Mode | 40MHz BW 802.11ac (5GHz) MIF Measurements [dB] | | | | | | | | |
|----------|--|--------|--------|--------|--------|--------|--------|--------|--------|
| | Data Rate [Mbps] | | | | | | | | |
| | 27 | 54 | 81 | 108 | 162 | 216 | 243 | 270 | 360 |
| 802.11ac | -10.65 | -11.86 | -12.79 | -13.79 | -14.89 | -16.27 | -16.63 | -16.43 | -16.66 |

Table 7-23
802.11ac (5GHz, 80MHz BW, SISO) Modulation Interference Factors^{1,2}

| Mode | 80MHz BW 802.11ac (5GHz) MIF Measurements [dB] | | | | | | | | | |
|----------|--|--------|--------|--------|--------|--------|--------|--------|--------|--------|
| | Data Rate [Mbps] | | | | | | | | | |
| | 29.3 | 58.5 | 87.8 | 117 | 175.5 | 234 | 263.3 | 292.5 | 351 | 390 |
| 802.11ac | -11.32 | -12.46 | -13.53 | -14.31 | -15.44 | -16.63 | -16.62 | -16.59 | -17.01 | -17.24 |

Table 7-24
802.11ac (5GHz, 80MHz BW, MIMO) Modulation Interference Factors^{1,2}

| Mode | 80MHz BW 802.11ac (5GHz) MIF Measurements [dB] | | | | | | | | | |
|----------|--|--------|--------|--------|--------|--------|--------|--------|--------|--------|
| | Data Rate [Mbps] | | | | | | | | | |
| | 58.5 | 117 | 175.5 | 234 | 351 | 468 | 526.5 | 585 | 702 | 780 |
| 802.11ac | -12.30 | -14.13 | -14.91 | -16.20 | -16.63 | -17.37 | -17.32 | -17.91 | -17.93 | -18.47 |

¹ Note: Measured MIF values may be lower than sample MIF values provided in ANSI C63.19-2011 Annex D.7 Table D.5 due to manufacturing variations for each device, however per Annex D.7, the sample MIF values of Table D.5 are not intended to substitute for measurements of actual devices under test and their respective operating modes.

² Note: WIFI MIF values were found to be independent of the transmit channel.



| | | | | |
|-------------------------------------|--|--------------------------------|---|---------------------------------|
| FCC ID: A3LSMG965U |  PCTEST ENGINEERING LABORATORY, INC. | HAC (RF EMISSIONS) TEST REPORT |  | Approved by: Quality Manager |
| Filename: 1M1711060289-13-R1.A3L | Test Dates: 11/06/2017 - 12/11/2017 | DUT Type: Portable Handset | Page 24 of 108 | |



Table 7-25
Simultaneous 2.4GHz and 5GHz WIFI Modulation Interference Factors^{1,2,3}

| # Tx | 5 GHz WIFI [dBm] | | 2.4 GHz WIFI [dBm] | | Measured MIF (dB) |
|------|------------------|------|--------------------|------|-------------------|
| | Ant1 | Ant2 | Ant1 | Ant2 | |
| 2 | x | - | - | x | -5.33 |
| 2 | - | x | x | - | -6.32 |
| 2 | x | - | x | - | -6.18 |
| 2 | - | x | - | x | -5.95 |
| 3 | x | x | x | - | -6.77 |
| 3 | x | x | - | x | -6.41 |
| 3 | x | - | x | x | -5.10 |
| 3 | - | x | x | x | -6.05 |
| 4 | x | x | x | x | -6.35 |

¹ Note: Measured MIF values may be lower than sample MIF values provided in ANSI C63.19-2011 Annex D.7 Table D.5 due to manufacturing variations for each device, however per Annex D.7, the sample MIF values of Table D.5 are not intended to substitute for measurements of actual devices under test and their respective operating modes.

² Note: WIFI MIF values were found to be independent of the transmit channel.

³ Note: The configuration for each scenario (e.g. bandwidth, data rate, etc.) was determined using the worst-case configuration from SISO and MIMO MIF measurements.

| | | | | |
|--|---|---------------------------------------|---|--|
| FCC ID: A3LSMG965U |  PCTEST ENGINEERING LABORATORY, INC. | HAC (RF EMISSIONS) TEST REPORT |  | Approved by: Quality Manager |
| Filename: 1M1711060289-13-R1.A3L | Test Dates: 11/06/2017 - 12/11/2017 | DUT Type: Portable Handset | | Page 25 of 108 |

8. RF CONDUCTED POWER MEASUREMENTS

I. Procedures Used to Establish RF Signal for HAC Testing

The handset was placed into a simulated call using a base station simulator in a shielded chamber. Such test signals offer a consistent means for testing HAC and are recommended for evaluating HAC. Measurements were taken with a fully charged battery. In order to verify that the device was tested and maintained at full power, this was configured with the base station simulator.

II. HAC Measurement Conditions

Output Power Verification

Maximum output power is verified on the High, Middle and Low channels for all applicable air interfaces. See Table 8-1 for air interface specific settings of transmit power parameters.

**Table 8-1
Power Control Parameters and Settings by Air Interface**

| Air Interface: | Parameter Name: | Parameter Set To: |
|----------------|--------------------|---------------------------|
| CDMA | Power Control Bits | "All Up" |
| GSM | PCL | GSM850: "5"; GSM1900: "0" |
| UMTS | TPC | "All 1's" |
| LTE | TPC | "Max Power" |
| WIFI | PLS | Mfr Specified |

III. Setup Used to Measure RF Conducted Powers

Power measurements for licensed modes were performed using a base station simulator under digital average power. Power measurements for unlicensed modes were performed using a power meter and power sensor.

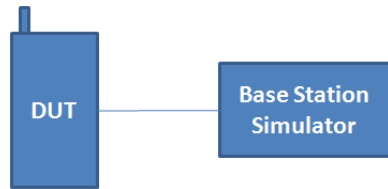

Figure 8-1
Power Measurement Setup for licensed modes

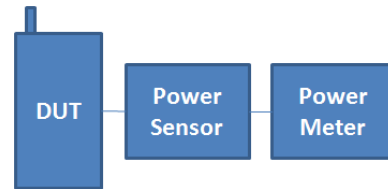

Figure 8-2
Power Measurement Setup for unlicensed modes

IV. CDMA Conducted Powers

| Band | Channel | Rule Part | Frequency | SO2 [dBm] | SO2 [dBm] | SO2 [dBm] | SO55 [dBm] | SO55 [dBm] | SO75 [dBm] | SO9 [dBm] | SO9 [dBm] | SO3 [dBm] | SO3 [dBm] | SO3 [dBm] | 1x EvDO Rev. A [dBm] |
|----------|---------|-----------|-----------|-----------|-----------|-----------|------------|------------|------------|-----------|-----------|-----------|-----------|-----------|----------------------|
| | F-RC | | MHz | RC1 | RC3 | RC4 | RC1 | RC3 | RC11 | RC2 | RC5 | RC1 | RC3 | RC4 | (RETAP) |
| Cellular | 564 | 90S | 820.1 | 25.10 | 25.07 | 25.07 | 25.12 | 25.08 | 25.12 | 25.11 | 25.08 | 25.06 | 25.08 | 25.07 | 25.15 |
| Cellular | 1013 | 22H | 824.7 | 24.56 | 24.51 | 24.54 | 24.57 | 24.52 | 24.57 | 24.56 | 24.53 | 24.54 | 24.51 | 24.53 | 24.55 |
| | 384 | 22H | 836.52 | 24.70 | 24.66 | 24.65 | 24.71 | 24.66 | 24.70 | 24.71 | 24.65 | 24.69 | 24.64 | 24.67 | 24.68 |
| | 777 | 22H | 848.31 | 24.74 | 24.69 | 24.70 | 24.75 | 24.69 | 24.74 | 24.75 | 24.71 | 24.73 | 24.70 | 24.71 | 24.71 |
| PCS | 25 | 24E | 1851.25 | 24.17 | 24.16 | 24.18 | 24.19 | 24.17 | 24.18 | 24.19 | 24.14 | 24.17 | 24.15 | 24.16 | 24.22 |
| | 600 | 24E | 1880 | 24.28 | 24.25 | 24.26 | 24.28 | 24.27 | 24.26 | 24.26 | 24.23 | 24.30 | 24.25 | 24.24 | 24.27 |
| | 1175 | 24E | 1908.75 | 24.08 | 24.12 | 24.13 | 24.15 | 24.11 | 24.17 | 24.14 | 24.13 | 24.22 | 24.14 | 24.18 | 24.07 |



| | | | | |
|-------------------------------------|--|--------------------------------|----------------|---------------------------------|
| FCC ID: A3LSMG965U | PCTEST ENGINEERING LABORATORY, INC. | HAC (RF EMISSIONS) TEST REPORT | SAMSUNG | Approved by: Quality Manager |
| Filename: 1M1711060289-13-R1.A3L | Test Dates: 11/06/2017 - 12/11/2017 | DUT Type: Portable Handset | Page 26 of 108 | |

V. GSM Conducted Powers

| Band | Channel | GSM [dBm] CS (1 Slot) | EDGE [dBm] 1 Tx Slot |
|-----------------|---------|-----------------------------|----------------------------|
| GSM 850 | 128 | 32.86 | 26.66 |
| | 190 | 32.81 | 26.60 |
| | 251 | 32.94 | 26.56 |
| GSM 1900 | 512 | 29.65 | 25.54 |
| | 661 | 29.72 | 25.74 |
| | 810 | 29.68 | 25.36 |

VI. UMTS Conducted Powers

| Mode | 3GPP 34.121 Subtest | Cellular Band [dBm] | | | AWS Band [dBm] | | | PCS Band [dBm] | | |
|-------|------------------------|---------------------|-------|-------|----------------|-------|-------|----------------|-------|-------|
| | | 4132 | 4183 | 4233 | 1312 | 1412 | 1513 | 9262 | 9400 | 9538 |
| WCDMA | 12.2 kbps RMC | 24.38 | 24.49 | 24.46 | 24.42 | 24.54 | 24.61 | 24.89 | 24.99 | 24.79 |
| | 12.2 kbps AMR | 24.40 | 24.48 | 24.47 | 24.40 | 24.51 | 24.59 | 24.84 | 24.97 | 24.73 |
| HSUPA | Subtest 1 | 23.40 | 23.57 | 23.56 | 22.95 | 23.06 | 23.06 | 23.17 | 23.29 | 23.05 |

| | | | | |
|--|---|---------------------------------------|---|--|
| FCC ID: A3LSMG965U |  PCTEST ENGINEERING LABORATORY, INC. | HAC (RF EMISSIONS) TEST REPORT |  | Approved by: Quality Manager |
| Filename: 1M1711060289-13-R1.A3L | Test Dates: 11/06/2017 - 12/11/2017 | DUT Type: Portable Handset | Page 27 of 108 | |

VII. LTE Conducted Powers

a. LTE Band 71

Table 8-2
LTE Band 71 (680.5MHz) Conducted Powers – 20MHz Bandwidth

| LTE Band 71 20 MHz Bandwidth | | | | | |
|---------------------------------|---------|-----------|--------------------------|------------------------------|----------|
| Modulation | RB Size | RB Offset | Mid Channel | MPR Allowed per 3GPP [dB] | MPR [dB] |
| | | | 133297 (680.5 MHz) | | |
| | | | Conducted Power [dBm] | | |
| QPSK | 1 | 0 | 24.52 | 0 | 0 |
| | 1 | 50 | 24.59 | | 0 |
| | 1 | 99 | 24.47 | | 0 |
| | 50 | 0 | 23.58 | 0-1 | 1 |
| | 50 | 25 | 23.61 | | 1 |
| | 50 | 50 | 23.47 | | 1 |
| 16QAM | 100 | 0 | 23.51 | 0-1 | 1 |
| | 1 | 0 | 23.88 | | 1 |
| | 1 | 50 | 23.90 | | 1 |
| | 1 | 99 | 23.83 | 0-2 | 1 |
| | 50 | 0 | 22.70 | | 2 |
| | 50 | 25 | 22.67 | | 2 |
| 64QAM | 50 | 50 | 22.55 | 0-2 | 2 |
| | 100 | 0 | 22.62 | | 2 |
| | 1 | 0 | 23.00 | | 0-2 |
| | 1 | 50 | 22.89 | 2 | |
| | 1 | 99 | 22.72 | 2 | |
| | 64QAM | 50 | 0 | 21.92 | 0-3 |
| 50 | | 25 | 21.85 | 3 | |
| 50 | | 50 | 21.68 | 3 | |
| 100 | | 0 | 21.78 | 3 | |

Note: Since LTE Band 71 at 20MHz bandwidth does not support 3 non-overlapping channels, conducted power measurements were made only on the middle channel.

Table 8-3
LTE Band 71 (680.5MHz) Conducted Powers – 15MHz Bandwidth

| LTE Band 71 15 MHz Bandwidth | | | | | |
|---------------------------------|---------|-----------|--------------------------|------------------------------|----------|
| Modulation | RB Size | RB Offset | Mid Channel | MPR Allowed per 3GPP [dB] | MPR [dB] |
| | | | 133297 (680.5 MHz) | | |
| | | | Conducted Power [dBm] | | |
| QPSK | 1 | 0 | 24.43 | 0 | 0 |
| | 1 | 36 | 24.45 | | 0 |
| | 1 | 74 | 24.34 | | 0 |
| | 36 | 0 | 23.55 | 0-1 | 1 |
| | 36 | 18 | 23.51 | | 1 |
| | 36 | 37 | 23.37 | | 1 |
| 16QAM | 75 | 0 | 23.44 | 0-1 | 1 |
| | 1 | 0 | 23.63 | | 1 |
| | 1 | 36 | 23.61 | | 1 |
| | 1 | 74 | 23.50 | 0-2 | 1 |
| | 36 | 0 | 22.58 | | 2 |
| | 36 | 18 | 22.54 | | 2 |
| 64QAM | 36 | 37 | 22.41 | 0-2 | 2 |
| | 75 | 0 | 22.52 | | 2 |
| | 1 | 0 | 22.72 | | 0-2 |
| | 1 | 36 | 22.66 | 2 | |
| | 1 | 74 | 22.54 | 2 | |
| | 64QAM | 36 | 0 | 21.65 | 0-3 |
| 36 | | 18 | 21.61 | 3 | |
| 36 | | 37 | 21.45 | 3 | |
| 75 | | 0 | 21.51 | 3 | |

Note: Since LTE Band 71 at 15MHz bandwidth does not support 3 non-overlapping channels, conducted power measurements were made only on the middle channel.





| | | | | |
|-------------------------------------|--|--------------------------------|---|---------------------------------|
| FCC ID: A3LSMG965U |  PCTEST TECHNICAL OPERATIONS, INC. | HAC (RF EMISSIONS) TEST REPORT |  | Approved by: Quality Manager |
| Filename: 1M1711060289-13-R1.A3L | Test Dates: 11/06/2017 - 12/11/2017 | DUT Type: Portable Handset | Page 28 of 108 | |

Table 8-4
LTE Band 71 (680.5MHz) Conducted Powers – 10MHz Bandwidth

| LTE Band 71 10 MHz Bandwidth | | | | | | | |
|---------------------------------|---------|-----------|-----------------------|-----------------------|-----------------------|------------------------------|----------|
| Modulation | RB Size | RB Offset | Low Channel | Mid Channel | High Channel | MPR Allowed per 3GPP [dB] | MPR [dB] |
| | | | 133172 (668.0 MHz) | 133297 (680.5 MHz) | 133422 (693.0 MHz) | | |
| | | | Conducted Power [dBm] | | | | |
| QPSK | 1 | 0 | 24.44 | 24.36 | 24.39 | 0 | 0 |
| | 1 | 25 | 24.41 | 24.38 | 24.28 | | 0 |
| | 1 | 49 | 24.33 | 24.34 | 24.27 | | 0 |
| | 25 | 0 | 23.59 | 23.49 | 23.35 | 0-1 | 1 |
| | 25 | 12 | 23.53 | 23.40 | 23.31 | | 1 |
| | 25 | 25 | 23.40 | 23.37 | 23.21 | | 1 |
| 16QAM | 50 | 0 | 23.49 | 23.39 | 23.28 | 0-1 | 1 |
| | 1 | 0 | 23.51 | 23.51 | 23.52 | | 1 |
| | 1 | 25 | 23.62 | 23.60 | 23.40 | | 1 |
| | 1 | 49 | 23.44 | 23.59 | 23.43 | 0-2 | 1 |
| | 25 | 0 | 22.62 | 22.55 | 22.40 | | 2 |
| | 25 | 12 | 22.60 | 22.47 | 22.41 | | 2 |
| 64QAM | 25 | 25 | 22.46 | 22.40 | 22.28 | 0-2 | 2 |
| | 50 | 0 | 22.57 | 22.52 | 22.39 | | 2 |
| | 1 | 0 | 22.69 | 22.57 | 22.61 | | 0-2 |
| | 1 | 25 | 22.67 | 22.66 | 22.52 | 2 | |
| | 1 | 49 | 22.57 | 22.63 | 22.50 | 0-3 | |
| | 25 | 0 | 21.63 | 21.55 | 21.45 | | 3 |
| 25 | 12 | 21.62 | 21.54 | 21.42 | 3 | | |
| 64QAM | 25 | 25 | 21.48 | 21.44 | 21.30 | 0-3 | 3 |
| | 50 | 0 | 21.59 | 21.53 | 21.38 | | 3 |

Table 8-5
LTE Band 71 (680.5MHz) Conducted Powers – 5MHz Bandwidth

| LTE Band 71 5 MHz Bandwidth | | | | | | | | |
|--------------------------------|---------|-----------|-----------------------|-----------------------|-----------------------|------------------------------|----------|---|
| Modulation | RB Size | RB Offset | Low Channel | Mid Channel | High Channel | MPR Allowed per 3GPP [dB] | MPR [dB] | |
| | | | 133147 (665.5 MHz) | 133297 (680.5 MHz) | 133447 (695.5 MHz) | | | |
| | | | Conducted Power [dBm] | | | | | |
| QPSK | 1 | 0 | 24.37 | 24.44 | 24.31 | 0 | 0 | |
| | 1 | 12 | 24.38 | 24.37 | 24.32 | | 0 | |
| | 1 | 24 | 24.42 | 24.33 | 24.25 | | 0 | |
| | 12 | 0 | 23.46 | 23.45 | 23.26 | 0-1 | 1 | |
| | 12 | 6 | 23.45 | 23.42 | 23.37 | | 1 | |
| | 12 | 13 | 23.49 | 23.36 | 23.33 | | 1 | |
| 16QAM | 25 | 0 | 23.50 | 23.39 | 23.24 | 0-1 | 1 | |
| | 1 | 0 | 23.49 | 23.56 | 23.39 | | 0-1 | 1 |
| | 1 | 12 | 23.57 | 23.54 | 23.46 | | | 1 |
| | 1 | 24 | 23.61 | 23.48 | 23.43 | 0-2 | | 1 |
| | 12 | 0 | 22.51 | 22.46 | 22.34 | | 2 | |
| | 12 | 6 | 22.52 | 22.52 | 22.45 | | 2 | |
| 64QAM | 12 | 13 | 22.59 | 22.43 | 22.38 | 0-2 | 2 | |
| | 25 | 0 | 22.58 | 22.45 | 22.33 | | 2 | |
| | 1 | 0 | 22.57 | 22.68 | 22.56 | | 0-2 | 2 |
| | 1 | 12 | 22.65 | 22.64 | 22.60 | 2 | | |
| | 1 | 24 | 22.67 | 22.56 | 22.57 | 0-3 | | 2 |
| | 12 | 0 | 21.56 | 21.56 | 21.40 | | 3 | |
| 12 | 6 | 21.55 | 21.57 | 21.49 | 3 | | | |
| 64QAM | 12 | 13 | 21.59 | 21.47 | 21.42 | 0-3 | 3 | |
| | 25 | 0 | 21.61 | 21.50 | 21.32 | | 3 | |

| | | | | |
|-------------------------------------|--|--------------------------------|---|---------------------------------|
| FCC ID: A3LSMG965U |  PCTEST Engineering Laboratory, Inc. | HAC (RF EMISSIONS) TEST REPORT |  | Approved by: Quality Manager |
| Filename: 1M1711060289-13-R1.A3L | Test Dates: 11/06/2017 - 12/11/2017 | DUT Type: Portable Handset | Page 29 of 108 | |

b. LTE Band 12



Table 8-6
LTE Band 12 (707.5MHz) Conducted Powers – 10MHz Bandwidth

| LTE Band 12 10 MHz Bandwidth | | | | | |
|---------------------------------|---------|-----------|--------------------------|------------------------------|----------|
| Modulation | RB Size | RB Offset | Mid Channel | MPR Allowed per 3GPP [dB] | MPR [dB] |
| | | | 23095 (707.5 MHz) | | |
| | | | Conducted Power [dBm] | | |
| QPSK | 1 | 0 | 24.13 | 0 | 0 |
| | 1 | 25 | 24.26 | | 0 |
| | 1 | 49 | 24.12 | | 0 |
| | 25 | 0 | 23.33 | 0-1 | 1 |
| | 25 | 12 | 23.35 | | 1 |
| | 25 | 25 | 23.31 | | 1 |
| 16QAM | 50 | 0 | 23.30 | 0-1 | 1 |
| | 1 | 0 | 23.43 | | 1 |
| | 1 | 25 | 23.50 | | 1 |
| | 1 | 49 | 23.46 | 0-2 | 1 |
| | 25 | 0 | 22.43 | | 2 |
| | 25 | 12 | 22.39 | | 2 |
| 64QAM | 25 | 25 | 22.38 | 0-2 | 2 |
| | 50 | 0 | 22.41 | | 2 |
| | 1 | 0 | 22.39 | | 2 |
| | 1 | 25 | 22.49 | 0-3 | 2 |
| | 1 | 49 | 22.46 | | 2 |
| | 25 | 0 | 21.46 | | 3 |
| 64QAM | 25 | 12 | 21.48 | 0-3 | 3 |
| | 25 | 25 | 21.42 | | 3 |
| | 50 | 0 | 21.44 | | 3 |
| | 50 | 0 | 21.44 | | 3 |

Note: Since LTE Band 12 at 10MHz bandwidth does not support 3 non-overlapping channels, conducted power measurements were made only on the middle channel.

Table 8-7
LTE Band 12 (707.5MHz) Conducted Powers – 5MHz Bandwidth

| LTE Band 12 5 MHz Bandwidth | | | | | | | |
|--------------------------------|---------|-----------|-----------------------|----------------------|----------------------|------------------------------|----------|
| Modulation | RB Size | RB Offset | Low Channel | Mid Channel | High Channel | MPR Allowed per 3GPP [dB] | MPR [dB] |
| | | | 23035 (701.5 MHz) | 23095 (707.5 MHz) | 23155 (713.5 MHz) | | |
| | | | Conducted Power [dBm] | | | | |
| QPSK | 1 | 0 | 24.26 | 24.26 | 24.19 | 0 | 0 |
| | 1 | 12 | 24.22 | 24.25 | 23.97 | | 0 |
| | 1 | 24 | 24.26 | 24.23 | 24.24 | | 0 |
| | 12 | 0 | 23.30 | 23.35 | 23.07 | 0-1 | 1 |
| | 12 | 6 | 23.28 | 23.36 | 23.10 | | 1 |
| | 12 | 13 | 23.35 | 23.33 | 23.25 | | 1 |
| 16QAM | 25 | 0 | 23.36 | 23.32 | 23.18 | 0-1 | 1 |
| | 1 | 0 | 23.43 | 23.47 | 23.32 | | 1 |
| | 1 | 12 | 23.37 | 23.46 | 23.28 | | 1 |
| | 1 | 24 | 23.46 | 23.41 | 23.36 | 0-2 | 1 |
| | 12 | 0 | 22.39 | 22.38 | 22.17 | | 2 |
| | 12 | 6 | 22.36 | 22.42 | 22.16 | | 2 |
| 64QAM | 12 | 13 | 22.43 | 22.36 | 22.32 | 0-2 | 2 |
| | 25 | 0 | 22.42 | 22.41 | 22.25 | | 2 |
| | 1 | 0 | 22.52 | 22.54 | 22.44 | | 0-3 |
| | 1 | 12 | 22.40 | 22.51 | 22.18 | 2 | |
| | 1 | 24 | 22.53 | 22.49 | 22.47 | 2 | |
| | 12 | 0 | 21.45 | 21.47 | 21.29 | 0-3 | 3 |
| 12 | 6 | 21.44 | 21.51 | 21.28 | 3 | | |
| 12 | 13 | 21.51 | 21.43 | 21.40 | 3 | | |
| 25 | 0 | 21.46 | 21.40 | 21.27 | 3 | | |



| | | | | |
|-------------------------------------|--|--------------------------------|---|---------------------------------|
| FCC ID: A3LSMG965U |  PCTEST ENGINEERING LABORATORY, INC. | HAC (RF EMISSIONS) TEST REPORT |  | Approved by: Quality Manager |
| Filename: 1M1711060289-13-R1.A3L | Test Dates: 11/06/2017 - 12/11/2017 | DUT Type: Portable Handset | Page 30 of 108 | |

**Table 8-8
LTE Band 12 (707.5MHz) Conducted Powers – 3MHz Bandwidth**

| LTE Band 12 3 MHz Bandwidth | | | | | | | |
|--------------------------------|---------|-----------|-----------------------|----------------------|----------------------|------------------------------|----------|
| Modulation | RB Size | RB Offset | Low Channel | Mid Channel | High Channel | MPR Allowed per 3GPP [dB] | MPR [dB] |
| | | | 23025 (700.5 MHz) | 23095 (707.5 MHz) | 23165 (714.5 MHz) | | |
| | | | Conducted Power [dBm] | | | | |
| QPSK | 1 | 0 | 24.31 | 24.31 | 24.00 | 0 | 0 |
| | 1 | 7 | 24.37 | 24.40 | 24.25 | | 0 |
| | 1 | 14 | 24.25 | 24.28 | 24.27 | | 0 |
| | 8 | 0 | 23.35 | 23.34 | 23.11 | 0-1 | 1 |
| | 8 | 4 | 23.36 | 23.36 | 23.28 | | 1 |
| | 8 | 7 | 23.29 | 23.31 | 23.35 | | 1 |
| 16QAM | 15 | 0 | 23.34 | 23.35 | 23.26 | 0-1 | 1 |
| | 1 | 0 | 23.43 | 23.48 | 23.15 | | 1 |
| | 1 | 7 | 23.52 | 23.58 | 23.44 | | 1 |
| | 8 | 14 | 23.40 | 23.45 | 23.41 | 0-2 | 1 |
| | 8 | 0 | 22.42 | 22.45 | 22.26 | | 2 |
| | 8 | 4 | 22.43 | 22.47 | 22.29 | | 2 |
| 64QAM | 8 | 7 | 22.36 | 22.43 | 22.36 | 0-2 | 2 |
| | 15 | 0 | 22.44 | 22.45 | 22.35 | | 2 |
| | 1 | 0 | 22.54 | 22.55 | 22.25 | | 0-3 |
| | 1 | 7 | 22.62 | 22.65 | 22.45 | 2 | |
| | 1 | 14 | 22.51 | 22.54 | 22.52 | 2 | |
| | 8 | 0 | 21.47 | 21.48 | 21.22 | 3 | |
| 8 | 4 | 21.48 | 21.51 | 21.34 | 3 | | |
| 8 | 7 | 21.40 | 21.48 | 21.48 | 3 | | |
| 15 | 0 | 21.44 | 21.46 | 21.36 | 3 | | |

**Table 8-9
LTE Band 12 (707.5MHz) Conducted Powers – 1.4MHz Bandwidth**

| LTE Band 12 1.4 MHz Bandwidth | | | | | | | | |
|----------------------------------|---------|-----------|-----------------------|----------------------|----------------------|------------------------------|----------|-----|
| Modulation | RB Size | RB Offset | Low Channel | Mid Channel | High Channel | MPR Allowed per 3GPP [dB] | MPR [dB] | |
| | | | 23017 (699.7 MHz) | 23095 (707.5 MHz) | 23173 (715.3 MHz) | | | |
| | | | Conducted Power [dBm] | | | | | |
| QPSK | 1 | 0 | 24.24 | 24.19 | 24.07 | 0 | 0 | |
| | 1 | 2 | 24.31 | 24.28 | 24.25 | | 0 | |
| | 1 | 5 | 24.21 | 24.19 | 24.17 | | 0 | |
| | 3 | 0 | 24.22 | 24.24 | 24.16 | 0-1 | 0 | |
| | 3 | 2 | 24.27 | 24.26 | 24.24 | | 0 | |
| | 3 | 3 | 24.21 | 24.25 | 24.20 | | 0 | |
| 16QAM | 6 | 0 | 23.26 | 23.26 | 23.25 | 0-1 | 1 | |
| | 1 | 0 | 23.36 | 23.40 | 23.29 | | 0-1 | 1 |
| | 1 | 2 | 23.43 | 23.47 | 23.38 | | | 1 |
| | 1 | 5 | 23.37 | 23.38 | 23.32 | 0-2 | | 1 |
| | 3 | 0 | 23.35 | 23.39 | 23.27 | | 1 | |
| | 3 | 2 | 23.36 | 23.42 | 23.35 | | 1 | |
| 64QAM | 3 | 3 | 23.32 | 23.36 | 23.31 | 0-2 | 1 | |
| | 6 | 0 | 22.38 | 22.39 | 22.36 | | 0-2 | 2 |
| | 1 | 0 | 22.46 | 22.47 | 22.37 | | | 0-2 |
| | 1 | 2 | 22.52 | 22.54 | 22.49 | 0-2 | | |
| | 1 | 5 | 22.43 | 22.46 | 22.42 | | 0-3 | |
| | 3 | 0 | 22.45 | 22.48 | 22.39 | | | 2 |
| 3 | 2 | 22.48 | 22.50 | 22.46 | 2 | | | |
| 3 | 3 | 22.43 | 22.45 | 22.44 | 2 | | | |
| 6 | 0 | 21.38 | 21.37 | 21.36 | 3 | | | |

| | | | | |
|-------------------------------------|--|--------------------------------|---|---------------------------------|
| FCC ID: A3LSMG965U |  PCTEST ENGINEERING LABORATORY, INC. | HAC (RF EMISSIONS) TEST REPORT |  | Approved by: Quality Manager |
| Filename: 1M1711060289-13-R1.A3L | Test Dates: 11/06/2017 - 12/11/2017 | DUT Type: Portable Handset | Page 31 of 108 | |

c. LTE Band 13



Table 8-10
LTE Band 13 (780.0MHz) Conducted Powers – 10MHz Bandwidth

| LTE Band 13 10 MHz Bandwidth | | | | | |
|---------------------------------|---------|-----------|--------------------------|------------------------------|----------|
| Modulation | RB Size | RB Offset | Mid Channel | MPR Allowed per 3GPP [dB] | MPR [dB] |
| | | | 23230 (782.0 MHz) | | |
| | | | Conducted Power [dBm] | | |
| QPSK | 1 | 0 | 24.58 | 0 | 0 |
| | 1 | 25 | 24.49 | | 0 |
| | 1 | 49 | 24.43 | | 0 |
| | 25 | 0 | 23.59 | 0-1 | 1 |
| | 25 | 12 | 23.69 | | 1 |
| | 25 | 25 | 23.62 | | 1 |
| 16QAM | 50 | 0 | 23.54 | 0-1 | 1 |
| | 1 | 0 | 23.77 | | 1 |
| | 1 | 25 | 23.79 | | 1 |
| | 1 | 49 | 23.84 | 0-1 | 1 |
| | 25 | 0 | 22.61 | | 2 |
| | 25 | 12 | 22.73 | | 2 |
| 64QAM | 25 | 25 | 22.70 | 0-2 | 2 |
| | 50 | 0 | 22.58 | | 2 |
| | 1 | 0 | 22.78 | | 0-2 |
| | 1 | 25 | 22.80 | 2 | |
| | 1 | 49 | 22.66 | 0-3 | |
| | 25 | 0 | 21.63 | | 3 |
| 25 | 12 | 21.76 | 3 | | |
| 64QAM | 25 | 25 | 21.72 | 0-3 | 3 |
| | 50 | 0 | 21.62 | | 3 |

Table 8-11
LTE Band 13 (780.0MHz) Conducted Powers – 5MHz Bandwidth

| LTE Band 13 5 MHz Bandwidth | | | | | | |
|--------------------------------|---------|-----------|--------------------------|------------------------------|----------|---|
| Modulation | RB Size | RB Offset | Mid Channel | MPR Allowed per 3GPP [dB] | MPR [dB] | |
| | | | 23230 (782.0 MHz) | | | |
| | | | Conducted Power [dBm] | | | |
| QPSK | 1 | 0 | 24.57 | 0 | 0 | |
| | 1 | 12 | 24.58 | | 0 | |
| | 1 | 24 | 24.26 | | 0 | |
| | 12 | 0 | 23.68 | 0-1 | 1 | |
| | 12 | 6 | 23.73 | | 1 | |
| | 12 | 13 | 23.70 | | 1 | |
| 16QAM | 25 | 0 | 23.74 | 0-1 | 1 | |
| | 1 | 0 | 23.73 | | 0-1 | 1 |
| | 1 | 12 | 23.70 | | | 1 |
| | 1 | 24 | 23.74 | 0-2 | | 1 |
| | 12 | 0 | 22.65 | | 2 | |
| | 12 | 6 | 22.67 | | 2 | |
| 64QAM | 12 | 13 | 22.66 | 0-2 | 2 | |
| | 25 | 0 | 22.68 | | 2 | |
| | 1 | 0 | 22.86 | | 0-2 | 2 |
| | 1 | 12 | 22.78 | 2 | | |
| | 1 | 24 | 22.79 | 0-3 | | 2 |
| | 12 | 0 | 21.78 | | 3 | |
| 12 | 6 | 21.84 | 0-3 | | 3 | |
| 12 | 13 | 21.85 | | 3 | | |
| 25 | 0 | 21.80 | | 3 | | |

Note: Since LTE Band 13 at 5MHz bandwidth does not support 3 non-overlapping channels, conducted power measurements were made only on the middle channel.

| | | | | |
|-------------------------------------|--|--------------------------------|---|---------------------------------|
| FCC ID: A3LSMG965U |  PCTEST TECHNICAL LABORATORY, INC. | HAC (RF EMISSIONS) TEST REPORT |  | Approved by: Quality Manager |
| Filename: 1M1711060289-13-R1.A3L | Test Dates: 11/06/2017 - 12/11/2017 | DUT Type: Portable Handset | | Page 32 of 108 |

d. LTE Band 14



Table 8-12
LTE Band 14 (793.0MHz) Conducted Powers – 10MHz Bandwidth

| LTE Band 14 10 MHz Bandwidth | | | | | |
|---------------------------------|---------|-----------|--------------------------|------------------------------|----------|
| Modulation | RB Size | RB Offset | Mid Channel | MPR Allowed per 3GPP [dB] | MPR [dB] |
| | | | 23330 (793.0 MHz) | | |
| | | | Conducted Power [dBm] | | |
| QPSK | 1 | 0 | 24.44 | 0 | 0 |
| | 1 | 25 | 24.57 | | 0 |
| | 1 | 49 | 24.45 | | 0 |
| | 25 | 0 | 23.66 | 0-1 | 1 |
| | 25 | 12 | 23.62 | | 1 |
| | 25 | 25 | 23.54 | | 1 |
| | 50 | 0 | 23.60 | | 1 |
| 16QAM | 1 | 0 | 23.73 | 0-1 | 1 |
| | 1 | 25 | 23.89 | | 1 |
| | 1 | 49 | 23.80 | | 1 |
| | 25 | 0 | 22.71 | 0-2 | 2 |
| | 25 | 12 | 22.73 | | 2 |
| | 25 | 25 | 22.63 | | 2 |
| | 50 | 0 | 22.65 | | 2 |
| 64QAM | 1 | 0 | 22.71 | 0-2 | 2 |
| | 1 | 25 | 22.81 | | 2 |
| | 1 | 49 | 22.67 | | 2 |
| | 25 | 0 | 21.76 | 0-3 | 3 |
| | 25 | 12 | 21.69 | | 3 |
| | 25 | 25 | 21.60 | | 3 |
| | 50 | 0 | 21.72 | | 3 |

Table 8-13
LTE Band 14 (793.0MHz) Conducted Powers – 5MHz Bandwidth

| LTE Band 14 5 MHz Bandwidth | | | | | |
|--------------------------------|---------|-----------|--------------------------|------------------------------|----------|
| Modulation | RB Size | RB Offset | Mid Channel | MPR Allowed per 3GPP [dB] | MPR [dB] |
| | | | 23330 (793.0 MHz) | | |
| | | | Conducted Power [dBm] | | |
| QPSK | 1 | 0 | 24.54 | 0 | 0 |
| | 1 | 12 | 24.60 | | 0 |
| | 1 | 24 | 24.55 | | 0 |
| | 12 | 0 | 23.67 | 0-1 | 1 |
| | 12 | 6 | 23.68 | | 1 |
| | 12 | 13 | 23.62 | | 1 |
| | 25 | 0 | 23.66 | | 1 |
| 16QAM | 1 | 0 | 23.70 | 0-1 | 1 |
| | 1 | 12 | 23.79 | | 1 |
| | 1 | 24 | 23.71 | | 1 |
| | 12 | 0 | 22.72 | 0-2 | 2 |
| | 12 | 6 | 22.73 | | 2 |
| | 12 | 13 | 22.70 | | 2 |
| | 25 | 0 | 22.71 | | 2 |
| 64QAM | 1 | 0 | 22.79 | 0-2 | 2 |
| | 1 | 12 | 22.87 | | 2 |
| | 1 | 24 | 22.81 | | 2 |
| | 12 | 0 | 21.82 | 0-3 | 3 |
| | 12 | 6 | 21.80 | | 3 |
| | 12 | 13 | 21.77 | | 3 |
| | 25 | 0 | 21.73 | | 3 |

Note: Since LTE Band 14 at 5MHz bandwidth does not support 3 non-overlapping channels, conducted power measurements were made only on the middle channel.

| | | | | |
|-------------------------------------|--|--------------------------------|---|---------------------------------|
| FCC ID: A3LSMG965U |  PCTEST TECHNICAL LABORATORY, INC. | HAC (RF EMISSIONS) TEST REPORT |  | Approved by: Quality Manager |
| Filename: 1M1711060289-13-R1.A3L | Test Dates: 11/06/2017 - 12/11/2017 | DUT Type: Portable Handset | | Page 33 of 108 |

e. LTE Band 26

Table 8-14
LTE Band 26 (836.5MHz) Conducted Powers – 15MHz Bandwidth

| LTE Band 26 (Cell) 15 MHz Bandwidth | | | | | |
|--|---------|-----------|--|------------------------------|----------|
| Modulation | RB Size | RB Offset | Mid Channel | MPR Allowed per 3GPP [dB] | MPR [dB] |
| | | | 26865 (831.5 MHz) Conducted Power [dBm] | | |
| QPSK | 1 | 0 | 24.45 | 0 | 0 |
| | 1 | 36 | 24.48 | | 0 |
| | 1 | 74 | 24.27 | | 0 |
| | 36 | 0 | 23.53 | 0-1 | 1 |
| | 36 | 18 | 23.58 | | 1 |
| | 36 | 37 | 23.51 | | 1 |
| 16QAM | 75 | 0 | 23.54 | 0-1 | 1 |
| | 1 | 0 | 23.81 | | 1 |
| | 1 | 36 | 23.78 | | 1 |
| | 1 | 74 | 23.56 | 0-2 | 1 |
| | 36 | 0 | 22.63 | | 2 |
| | 36 | 18 | 22.66 | | 2 |
| 64QAM | 36 | 37 | 22.56 | 0-2 | 2 |
| | 75 | 0 | 22.61 | | 2 |
| | 1 | 0 | 22.75 | | 2 |
| | 1 | 36 | 22.69 | 0-3 | 2 |
| | 1 | 74 | 22.48 | | 2 |
| | 36 | 0 | 21.66 | | 3 |
| 64QAM | 36 | 18 | 21.72 | 0-3 | 3 |
| | 36 | 37 | 21.59 | | 3 |
| | 75 | 0 | 21.61 | | 3 |

Note: Since LTE Band 26 at 15MHz bandwidth does not support 3 non-overlapping channels, conducted power measurements were made only on the middle channel.

Table 8-15
LTE Band 26 (831.5MHz) Conducted Powers – 10MHz Bandwidth

| LTE Band 26 (Cell) 10 MHz Bandwidth | | | | | | | | |
|--|---------|-----------|----------------------|----------------------|----------------------|------------------------------|----------|---|
| Modulation | RB Size | RB Offset | Low Channel | Mid Channel | High Channel | MPR Allowed per 3GPP [dB] | MPR [dB] | |
| | | | 26740 (819.0 MHz) | 26865 (831.5 MHz) | 26990 (844.0 MHz) | | | |
| Conducted Power [dBm] | | | | | | | | |
| QPSK | 1 | 0 | 24.25 | 24.31 | 24.33 | 0 | 0 | |
| | 1 | 25 | 24.24 | 24.37 | 24.37 | | 0 | |
| | 1 | 49 | 24.26 | 24.28 | 23.82 | | 0 | |
| | 25 | 0 | 23.30 | 23.35 | 23.36 | 0-1 | 1 | |
| | 25 | 12 | 23.40 | 23.30 | 23.30 | | 1 | |
| | 25 | 25 | 23.36 | 23.38 | 23.34 | | 1 | |
| 16QAM | 50 | 0 | 23.38 | 23.27 | 23.28 | 0-1 | 1 | |
| | 1 | 0 | 23.42 | 23.51 | 23.55 | | 0-1 | 1 |
| | 1 | 25 | 23.44 | 23.58 | 23.60 | | | 1 |
| | 1 | 49 | 23.46 | 23.47 | 22.78 | 0-2 | | 1 |
| | 25 | 0 | 22.40 | 22.43 | 22.43 | | 2 | |
| | 25 | 12 | 22.49 | 22.40 | 22.40 | | 2 | |
| 64QAM | 25 | 25 | 22.41 | 22.42 | 22.42 | 0-2 | 2 | |
| | 50 | 0 | 22.47 | 22.37 | 22.36 | | 2 | |
| | 1 | 0 | 22.45 | 22.59 | 22.62 | | 0-2 | 2 |
| | 1 | 25 | 22.50 | 22.63 | 22.65 | 0-3 | | 2 |
| | 1 | 49 | 22.51 | 22.55 | 22.07 | | | 2 |
| | 25 | 0 | 21.42 | 21.43 | 21.43 | | 0-3 | 3 |
| 25 | 12 | 21.50 | 21.42 | 21.41 | 3 | | | |
| 25 | 25 | 21.44 | 21.44 | 21.44 | 3 | | | |
| 50 | 0 | 21.49 | 21.39 | 21.40 | | 3 | | |



| | | | | |
|-------------------------------------|--|--------------------------------|---|---------------------------------|
| FCC ID: A3LSMG965U |  PCTEST TECHNOLOGICAL LABORATORY, INC. | HAC (RF EMISSIONS) TEST REPORT |  | Approved by: Quality Manager |
| Filename: 1M1711060289-13-R1.A3L | Test Dates: 11/06/2017 - 12/11/2017 | DUT Type: Portable Handset | | Page 34 of 108 |

Table 8-16
LTE Band 26 (831.5MHz) Conducted Powers – 5MHz Bandwidth

| LTE Band 26 (Cell) 5 MHz Bandwidth | | | | | | | |
|---------------------------------------|---------|-----------|-----------------------|----------------------|----------------------|------------------------------|----------|
| Modulation | RB Size | RB Offset | Low Channel | Mid Channel | High Channel | MPR Allowed per 3GPP [dB] | MPR [dB] |
| | | | 26715 (816.5 MHz) | 26865 (831.5 MHz) | 27015 (846.5 MHz) | | |
| | | | Conducted Power [dBm] | | | | |
| QPSK | 1 | 0 | 24.14 | 24.21 | 24.27 | 0 | 0 |
| | 1 | 12 | 24.21 | 24.32 | 24.22 | | 0 |
| | 1 | 24 | 24.16 | 24.26 | 23.66 | | 0 |
| | 12 | 0 | 23.26 | 23.24 | 23.38 | 0-1 | 1 |
| | 12 | 6 | 23.28 | 23.27 | 23.37 | | 1 |
| | 12 | 13 | 23.23 | 23.28 | 23.30 | | 1 |
| 16QAM | 25 | 0 | 23.24 | 23.18 | 23.32 | 0-1 | 1 |
| | 1 | 0 | 23.53 | 23.53 | 23.55 | | 1 |
| | 1 | 12 | 23.56 | 23.65 | 23.45 | | 1 |
| | 1 | 24 | 23.49 | 23.57 | 22.67 | 0-2 | 1 |
| | 12 | 0 | 22.41 | 22.37 | 22.47 | | 2 |
| | 12 | 6 | 22.41 | 22.35 | 22.44 | | 2 |
| 64QAM | 12 | 13 | 22.31 | 22.42 | 22.37 | 0-2 | 2 |
| | 25 | 0 | 22.33 | 22.30 | 22.43 | | 2 |
| | 1 | 0 | 22.38 | 22.49 | 22.60 | | 2 |
| | 1 | 12 | 22.47 | 22.57 | 22.57 | 0-3 | 2 |
| | 1 | 24 | 22.39 | 22.52 | 21.76 | | 2 |
| | 12 | 0 | 21.43 | 21.36 | 21.52 | | 3 |
| 64QAM | 12 | 6 | 21.40 | 21.38 | 21.50 | 0-3 | 3 |
| | 12 | 13 | 21.37 | 21.42 | 21.43 | | 3 |
| | 25 | 0 | 21.34 | 21.31 | 21.44 | | 3 |

Table 8-17
LTE Band 26 (831.5MHz) Conducted Powers – 3MHz Bandwidth

| LTE Band 26 (Cell) 3 MHz Bandwidth | | | | | | | |
|---------------------------------------|---------|-----------|-----------------------|----------------------|----------------------|------------------------------|----------|
| Modulation | RB Size | RB Offset | Low Channel | Mid Channel | High Channel | MPR Allowed per 3GPP [dB] | MPR [dB] |
| | | | 26705 (815.5 MHz) | 26865 (831.5 MHz) | 27025 (847.5 MHz) | | |
| | | | Conducted Power [dBm] | | | | |
| QPSK | 1 | 0 | 24.17 | 24.17 | 24.22 | 0 | 0 |
| | 1 | 7 | 24.21 | 24.39 | 24.28 | | 0 |
| | 1 | 14 | 24.20 | 24.26 | 23.54 | | 0 |
| | 8 | 0 | 23.18 | 23.19 | 23.31 | 0-1 | 1 |
| | 8 | 4 | 23.19 | 23.31 | 23.34 | | 1 |
| | 8 | 7 | 23.23 | 23.29 | 22.95 | | 1 |
| 16QAM | 15 | 0 | 23.27 | 23.19 | 23.31 | 0-1 | 1 |
| | 1 | 0 | 23.46 | 23.51 | 23.40 | | 1 |
| | 1 | 7 | 23.55 | 23.74 | 23.44 | | 1 |
| | 1 | 14 | 23.52 | 23.62 | 22.68 | 0-2 | 1 |
| | 8 | 0 | 22.27 | 22.34 | 22.42 | | 2 |
| | 8 | 4 | 22.29 | 22.46 | 22.43 | | 2 |
| 64QAM | 8 | 7 | 22.34 | 22.39 | 22.12 | 0-2 | 2 |
| | 15 | 0 | 22.32 | 22.24 | 22.38 | | 2 |
| | 1 | 0 | 22.38 | 22.42 | 22.49 | | 0-3 |
| | 1 | 7 | 22.47 | 22.65 | 22.53 | 2 | |
| | 1 | 14 | 22.42 | 22.50 | 21.88 | 2 | |
| | 64QAM | 8 | 0 | 21.31 | 21.36 | 21.46 | 0-3 |
| 8 | | 4 | 21.33 | 21.45 | 21.45 | 3 | |
| 8 | | 7 | 21.37 | 21.42 | 21.24 | 3 | |
| 15 | | 0 | 21.36 | 21.31 | 21.42 | 3 | |



| | | | | |
|-------------------------------------|--|--------------------------------|---|---------------------------------|
| FCC ID: A3LSMG965U |  PCTEST ENGINEERING LABORATORY, INC. | HAC (RF EMISSIONS) TEST REPORT |  | Approved by: Quality Manager |
| Filename: 1M1711060289-13-R1.A3L | Test Dates: 11/06/2017 - 12/11/2017 | DUT Type: Portable Handset | Page 35 of 108 | |

Table 8-18
LTE Band 26 (831.5MHz) Conducted Powers – 1.4MHz Bandwidth

| LTE Band 26 (Cell) 1.4 MHz Bandwidth | | | | | | | |
|---|---------|-----------|-----------------------|----------------------|----------------------|------------------------------|----------|
| Modulation | RB Size | RB Offset | Low Channel | Mid Channel | High Channel | MPR Allowed per 3GPP [dB] | MPR [dB] |
| | | | 26697 (814.7 MHz) | 26865 (831.5 MHz) | 27033 (848.3 MHz) | | |
| | | | Conducted Power [dBm] | | | | |
| QPSK | 1 | 0 | 24.06 | 24.18 | 24.22 | 0 | 0 |
| | 1 | 2 | 24.13 | 24.27 | 24.29 | | 0 |
| | 1 | 5 | 24.03 | 24.18 | 23.86 | | 0 |
| | 3 | 0 | 24.09 | 24.25 | 24.25 | | 0 |
| | 3 | 2 | 24.11 | 24.27 | 24.20 | | 0 |
| | 3 | 3 | 24.07 | 24.23 | 23.96 | | 0 |
| 16QAM | 6 | 0 | 23.11 | 23.24 | 23.23 | 0-1 | 1 |
| | 1 | 0 | 23.41 | 23.56 | 23.41 | 0-1 | 1 |
| | 1 | 2 | 23.47 | 23.63 | 23.44 | | 1 |
| | 1 | 5 | 23.40 | 23.54 | 23.08 | | 1 |
| | 3 | 0 | 23.31 | 23.48 | 23.37 | | 1 |
| | 3 | 2 | 23.34 | 23.49 | 23.38 | | 1 |
| 3 | 3 | 23.30 | 23.47 | 23.15 | 1 | | |
| 64QAM | 6 | 0 | 22.26 | 22.38 | 22.36 | 0-2 | 2 |
| | 1 | 0 | 22.37 | 22.54 | 22.49 | 0-2 | 2 |
| | 1 | 2 | 22.38 | 22.55 | 22.52 | | 2 |
| | 1 | 5 | 22.28 | 22.43 | 22.31 | | 2 |
| | 3 | 0 | 22.32 | 22.47 | 22.48 | | 2 |
| | 3 | 2 | 22.34 | 22.51 | 22.49 | | 2 |
| 3 | 3 | 22.30 | 22.45 | 22.41 | 2 | | |
| | 6 | 0 | 21.21 | 21.32 | 21.34 | 0-3 | 3 |

f. LTE Band 66

Table 8-19
LTE Band 66 (1745.0MHz) Conducted Powers – 20MHz Bandwidth

| LTE Band 66 (AWS) 20 MHz Bandwidth | | | | | | | |
|---------------------------------------|---------|-----------|------------------------|------------------------|------------------------|------------------------------|----------|
| Modulation | RB Size | RB Offset | Low Channel | Mid Channel | High Channel | MPR Allowed per 3GPP [dB] | MPR [dB] |
| | | | 132072 (1720.0 MHz) | 132322 (1745.0 MHz) | 132572 (1770.0 MHz) | | |
| | | | Conducted Power [dBm] | | | | |
| QPSK | 1 | 0 | 24.29 | 24.37 | 24.40 | 0 | 0 |
| | 1 | 50 | 24.09 | 24.12 | 24.12 | | 0 |
| | 1 | 99 | 24.02 | 24.18 | 24.16 | | 0 |
| | 50 | 0 | 23.04 | 23.35 | 23.28 | 0-1 | 1 |
| | 50 | 25 | 23.03 | 23.23 | 23.16 | | 1 |
| | 50 | 50 | 23.13 | 23.19 | 23.10 | | 1 |
| 16QAM | 100 | 0 | 23.19 | 23.24 | 23.19 | 0-1 | 1 |
| | 1 | 0 | 23.78 | 23.83 | 23.51 | | 1 |
| | 1 | 50 | 23.36 | 23.34 | 23.21 | | 1 |
| | 1 | 99 | 23.53 | 23.44 | 22.97 | 0-2 | 1 |
| | 50 | 0 | 22.23 | 22.36 | 22.34 | | 2 |
| | 50 | 25 | 22.20 | 22.26 | 22.26 | | 2 |
| 64QAM | 50 | 50 | 22.24 | 22.20 | 22.19 | 0-2 | 2 |
| | 100 | 0 | 22.28 | 22.27 | 22.27 | | 2 |
| | 1 | 0 | 22.66 | 22.70 | 22.69 | | 2 |
| | 1 | 50 | 22.44 | 22.45 | 22.41 | 0-3 | 2 |
| | 1 | 99 | 22.37 | 22.50 | 22.45 | | 2 |
| | 50 | 0 | 21.23 | 21.29 | 21.35 | | 3 |
| 64QAM | 50 | 25 | 21.23 | 21.24 | 21.27 | 0-3 | 3 |
| | 50 | 50 | 21.28 | 21.15 | 21.18 | | 3 |
| | 100 | 0 | 21.29 | 21.25 | 21.26 | | 3 |



| | | | | |
|-------------------------------------|--|--------------------------------|---|---------------------------------|
| FCC ID: A3LSMG965U |  PCTEST ENGINEERING LABORATORY, INC. | HAC (RF EMISSIONS) TEST REPORT |  | Approved by: Quality Manager |
| Filename: 1M1711060289-13-R1.A3L | Test Dates: 11/06/2017 - 12/11/2017 | DUT Type: Portable Handset | | Page 36 of 108 |

Table 8-20
LTE Band 66 (1745.0MHz) Conducted Powers – 15MHz Bandwidth

| LTE Band 66 (AWS) 15 MHz Bandwidth | | | | | | | |
|---------------------------------------|---------|-----------|------------------------|------------------------|------------------------|------------------------------|----------|
| Modulation | RB Size | RB Offset | Low Channel | Mid Channel | High Channel | MPR Allowed per 3GPP [dB] | MPR [dB] |
| | | | 132047 (1717.5 MHz) | 132322 (1745.0 MHz) | 132597 (1772.5 MHz) | | |
| | | | Conducted Power [dBm] | | | | |
| QPSK | 1 | 0 | 24.24 | 24.35 | 24.40 | 0 | 0 |
| | 1 | 36 | 23.80 | 24.12 | 24.31 | | 0 |
| | 1 | 74 | 24.09 | 24.07 | 24.23 | | 0 |
| | 36 | 0 | 22.95 | 23.24 | 23.32 | 0-1 | 1 |
| | 36 | 18 | 22.84 | 23.20 | 23.25 | | 1 |
| | 36 | 37 | 22.84 | 23.19 | 23.33 | | 1 |
| | 75 | 0 | 22.85 | 23.22 | 23.27 | | 1 |
| 16QAM | 1 | 0 | 23.42 | 23.51 | 23.50 | 0-1 | 1 |
| | 1 | 36 | 23.06 | 23.24 | 23.43 | | 1 |
| | 1 | 74 | 23.25 | 23.19 | 23.36 | | 1 |
| | 36 | 0 | 22.18 | 22.34 | 22.39 | 0-2 | 2 |
| | 36 | 18 | 22.04 | 22.30 | 22.32 | | 2 |
| | 36 | 37 | 21.96 | 22.26 | 22.39 | | 2 |
| | 75 | 0 | 21.99 | 22.30 | 22.32 | | 2 |
| 64QAM | 1 | 0 | 22.55 | 22.53 | 22.58 | 0-2 | 2 |
| | 1 | 36 | 22.39 | 22.34 | 22.54 | | 2 |
| | 1 | 74 | 22.45 | 22.36 | 22.49 | | 2 |
| | 36 | 0 | 21.10 | 21.39 | 21.41 | 0-3 | 3 |
| | 36 | 18 | 21.00 | 21.32 | 21.36 | | 3 |
| | 36 | 37 | 20.97 | 21.29 | 21.39 | | 3 |
| | 75 | 0 | 21.05 | 21.28 | 21.31 | | 3 |

Table 8-21
LTE Band 66 (1745.0MHz) Conducted Powers – 10MHz Bandwidth

| LTE Band 66 (AWS) 10 MHz Bandwidth | | | | | | | |
|---------------------------------------|---------|-----------|------------------------|------------------------|------------------------|------------------------------|----------|
| Modulation | RB Size | RB Offset | Low Channel | Mid Channel | High Channel | MPR Allowed per 3GPP [dB] | MPR [dB] |
| | | | 132022 (1715.0 MHz) | 132322 (1745.0 MHz) | 132622 (1775.0 MHz) | | |
| | | | Conducted Power [dBm] | | | | |
| QPSK | 1 | 0 | 24.13 | 24.18 | 24.26 | 0 | 0 |
| | 1 | 25 | 23.91 | 24.13 | 24.27 | | 0 |
| | 1 | 49 | 23.99 | 24.10 | 24.14 | | 0 |
| | 25 | 0 | 22.92 | 23.20 | 23.27 | 0-1 | 1 |
| | 25 | 12 | 22.80 | 23.19 | 23.25 | | 1 |
| | 25 | 25 | 22.76 | 23.15 | 23.13 | | 1 |
| | 50 | 0 | 22.73 | 23.23 | 23.18 | | 1 |
| 16QAM | 1 | 0 | 23.36 | 23.41 | 23.42 | 0-1 | 1 |
| | 1 | 25 | 23.00 | 23.32 | 23.19 | | 1 |
| | 1 | 49 | 23.13 | 23.20 | 23.28 | | 1 |
| | 25 | 0 | 22.09 | 22.28 | 22.33 | 0-2 | 2 |
| | 25 | 12 | 22.00 | 22.26 | 22.43 | | 2 |
| | 25 | 25 | 21.86 | 22.19 | 22.25 | | 2 |
| 64QAM | 50 | 0 | 21.88 | 22.29 | 22.29 | 2 | |
| | 1 | 0 | 22.61 | 22.46 | 22.55 | 0-2 | 2 |
| | 1 | 25 | 22.36 | 22.37 | 22.49 | | 2 |
| | 1 | 49 | 22.25 | 22.33 | 22.43 | | 2 |
| | 25 | 0 | 21.13 | 21.29 | 21.39 | 0-3 | 3 |
| | 25 | 12 | 20.92 | 21.30 | 21.44 | | 3 |
| | 25 | 25 | 20.81 | 21.26 | 21.37 | | 3 |
| 50 | 0 | 20.93 | 21.33 | 21.30 | 3 | | |



| | | | | |
|-------------------------------------|--|--------------------------------|---|---------------------------------|
| FCC ID: A3LSMG965U |  PCTEST ENGINEERING LABORATORY, INC. | HAC (RF EMISSIONS) TEST REPORT |  | Approved by: Quality Manager |
| Filename: 1M1711060289-13-R1.A3L | Test Dates: 11/06/2017 - 12/11/2017 | DUT Type: Portable Handset | Page 37 of 108 | |

Table 8-22
LTE Band 66 (1745.0MHz) Conducted Powers – 5MHz Bandwidth

| LTE Band 66 (AWS) 5 MHz Bandwidth | | | | | | | |
|--------------------------------------|---------|-----------|------------------------|------------------------|------------------------|------------------------------|----------|
| Modulation | RB Size | RB Offset | Low Channel | Mid Channel | High Channel | MPR Allowed per 3GPP [dB] | MPR [dB] |
| | | | 131997 (1712.5 MHz) | 132322 (1745.0 MHz) | 132647 (1777.5 MHz) | | |
| | | | Conducted Power [dBm] | | | | |
| QPSK | 1 | 0 | 24.11 | 24.09 | 24.06 | 0 | 0 |
| | 1 | 12 | 24.03 | 24.00 | 24.01 | | 0 |
| | 1 | 24 | 23.85 | 23.96 | 24.05 | | 0 |
| | 12 | 0 | 23.14 | 23.06 | 23.14 | 0-1 | 1 |
| | 12 | 6 | 23.12 | 23.07 | 23.17 | | 1 |
| | 12 | 13 | 22.97 | 23.03 | 23.18 | | 1 |
| 16QAM | 25 | 0 | 22.96 | 23.09 | 23.12 | 0-1 | 1 |
| | 1 | 0 | 23.31 | 23.24 | 23.28 | | 1 |
| | 1 | 12 | 23.21 | 23.14 | 23.30 | | 1 |
| | 1 | 24 | 23.13 | 23.11 | 23.33 | 0-2 | 1 |
| | 12 | 0 | 22.21 | 22.16 | 22.28 | | 2 |
| | 12 | 6 | 22.22 | 22.14 | 22.24 | | 2 |
| 64QAM | 12 | 13 | 22.02 | 22.07 | 22.21 | 0-2 | 2 |
| | 25 | 0 | 22.16 | 22.14 | 22.24 | | 2 |
| | 1 | 0 | 22.38 | 22.39 | 22.46 | | 0-2 |
| | 1 | 12 | 22.36 | 22.37 | 22.42 | 2 | |
| | 1 | 24 | 22.16 | 22.25 | 22.48 | 2 | |
| | 64QAM | 12 | 0 | 21.28 | 21.22 | 21.37 | 0-3 |
| 12 | | 6 | 21.24 | 21.20 | 21.33 | 3 | |
| 12 | | 13 | 21.21 | 21.14 | 21.28 | 3 | |
| 25 | | 0 | 21.24 | 21.12 | 21.27 | 3 | |

Table 8-23
LTE Band 66 (1745.0MHz) Conducted Powers – 3MHz Bandwidth

| LTE Band 66 (AWS) 3 MHz Bandwidth | | | | | | | | |
|--------------------------------------|---------|-----------|------------------------|------------------------|------------------------|------------------------------|----------|---|
| Modulation | RB Size | RB Offset | Low Channel | Mid Channel | High Channel | MPR Allowed per 3GPP [dB] | MPR [dB] | |
| | | | 131987 (1711.5 MHz) | 132322 (1745.0 MHz) | 132657 (1778.5 MHz) | | | |
| | | | Conducted Power [dBm] | | | | | |
| QPSK | 1 | 0 | 24.08 | 23.96 | 24.04 | 0 | 0 | |
| | 1 | 7 | 24.04 | 24.12 | 24.08 | | 0 | |
| | 1 | 14 | 23.95 | 24.09 | 24.13 | | 0 | |
| | 8 | 0 | 23.13 | 23.03 | 23.09 | 0-1 | 1 | |
| | 8 | 4 | 23.16 | 23.04 | 23.19 | | 1 | |
| | 8 | 7 | 23.05 | 23.00 | 23.11 | | 1 | |
| 16QAM | 15 | 0 | 23.17 | 23.04 | 23.06 | 0-1 | 1 | |
| | 1 | 0 | 23.20 | 23.28 | 23.26 | | 0-1 | 1 |
| | 1 | 7 | 23.29 | 23.36 | 23.32 | | | 1 |
| | 1 | 14 | 23.31 | 23.25 | 23.29 | 0-2 | | 1 |
| | 8 | 0 | 22.20 | 22.08 | 22.24 | | 2 | |
| | 8 | 4 | 22.23 | 22.14 | 22.23 | | 2 | |
| 64QAM | 8 | 7 | 22.19 | 22.12 | 22.26 | 0-2 | 2 | |
| | 15 | 0 | 22.24 | 22.14 | 22.22 | | 2 | |
| | 1 | 0 | 22.35 | 22.39 | 22.40 | | 0-2 | 2 |
| | 1 | 7 | 22.38 | 22.36 | 22.43 | 2 | | |
| | 1 | 14 | 22.33 | 22.29 | 22.36 | 0-3 | | 2 |
| | 8 | 0 | 21.24 | 21.21 | 21.27 | | 3 | |
| 8 | 4 | 21.20 | 21.19 | 21.34 | 3 | | | |
| 64QAM | 8 | 7 | 21.26 | 21.12 | 21.29 | 0-3 | 3 | |
| | 15 | 0 | 21.22 | 21.13 | 21.24 | | 3 | |



| | | | | |
|-------------------------------------|--|--------------------------------|---|---------------------------------|
| FCC ID: A3LSMG965U |  PCTEST ENGINEERING LABORATORY, INC. | HAC (RF EMISSIONS) TEST REPORT |  | Approved by: Quality Manager |
| Filename: 1M1711060289-13-R1.A3L | Test Dates: 11/06/2017 - 12/11/2017 | DUT Type: Portable Handset | Page 38 of 108 | |

Table 8-24
LTE Band 66 (1745.0MHz) Conducted Powers – 1.4MHz Bandwidth

| LTE Band 66 (AWS) 1.4 MHz Bandwidth | | | | | | | |
|--|---------|-----------|------------------------|------------------------|------------------------|---------------------------|----------|
| Modulation | RB Size | RB Offset | Low Channel | Mid Channel | High Channel | MPR Allowed per 3GPP [dB] | MPR [dB] |
| | | | 131979 (1710.7 MHz) | 132322 (1745.0 MHz) | 132665 (1779.3 MHz) | | |
| | | | Conducted Power [dBm] | | | | |
| QPSK | 1 | 0 | 23.99 | 24.00 | 23.96 | 0 | 0 |
| | 1 | 2 | 24.06 | 24.01 | 24.14 | | 0 |
| | 1 | 5 | 23.95 | 23.96 | 24.03 | | 0 |
| | 3 | 0 | 24.03 | 23.99 | 23.97 | | 0 |
| | 3 | 2 | 24.06 | 24.05 | 24.12 | | 0 |
| | 3 | 3 | 24.01 | 23.98 | 24.04 | | 0 |
| 16QAM | 6 | 0 | 23.06 | 22.99 | 23.09 | 0-1 | 1 |
| | 1 | 0 | 23.21 | 23.11 | 23.24 | 0-1 | 1 |
| | 1 | 2 | 23.16 | 23.16 | 23.30 | | 1 |
| | 1 | 5 | 23.09 | 23.13 | 23.23 | | 1 |
| | 3 | 0 | 23.15 | 23.05 | 23.19 | | 1 |
| | 3 | 2 | 23.19 | 23.06 | 23.26 | | 1 |
| 3 | 3 | 23.11 | 23.09 | 23.15 | 1 | | |
| 64QAM | 6 | 0 | 22.19 | 22.19 | 22.22 | 0-2 | 2 |
| | 1 | 0 | 22.26 | 22.20 | 22.36 | 0-2 | 2 |
| | 1 | 2 | 22.28 | 22.24 | 22.34 | | 2 |
| | 1 | 5 | 22.27 | 22.17 | 22.32 | | 2 |
| | 3 | 0 | 22.26 | 22.19 | 22.31 | | 2 |
| | 3 | 2 | 22.31 | 22.21 | 22.36 | | 2 |
| 3 | 3 | 22.23 | 22.16 | 22.31 | 2 | | |
| | 6 | 0 | 21.18 | 21.04 | 21.19 | 0-3 | 3 |

g. LTE Band 25

Table 8-25
LTE Band 25 (1882.5MHz) Conducted Powers – 20MHz Bandwidth

| LTE Band 25 (PCS) 20 MHz Bandwidth | | | | | | | | |
|---------------------------------------|---------|-----------|-----------------------|-----------------------|-----------------------|---------------------------|----------|---|
| Modulation | RB Size | RB Offset | Low Channel | Mid Channel | High Channel | MPR Allowed per 3GPP [dB] | MPR [dB] | |
| | | | 26140 (1860.0 MHz) | 26365 (1882.5 MHz) | 26590 (1905.0 MHz) | | | |
| | | | Conducted Power [dBm] | | | | | |
| QPSK | 1 | 0 | 24.72 | 24.77 | 24.69 | 0 | 0 | |
| | 1 | 50 | 24.31 | 24.31 | 24.41 | | 0 | |
| | 1 | 99 | 24.30 | 24.43 | 24.40 | | 0 | |
| | 16QAM | 50 | 0 | 23.65 | 23.49 | 23.56 | 0-1 | 1 |
| | | 50 | 25 | 23.42 | 23.38 | 23.49 | | 1 |
| | | 50 | 50 | 23.39 | 23.31 | 23.44 | | 1 |
| 100 | | 0 | 23.43 | 23.36 | 23.51 | 1 | | |
| 64QAM | 1 | 0 | 24.00 | 23.89 | 23.98 | 0-1 | 1 | |
| | 1 | 50 | 23.84 | 23.67 | 23.73 | | 1 | |
| | 1 | 99 | 23.85 | 23.74 | 23.63 | | 1 | |
| | 16QAM | 50 | 0 | 22.72 | 22.56 | 22.66 | 0-2 | 2 |
| | | 50 | 25 | 22.53 | 22.46 | 22.60 | | 2 |
| | | 50 | 50 | 22.47 | 22.38 | 22.51 | | 2 |
| 100 | | 0 | 22.53 | 22.44 | 22.62 | 2 | | |
| 100 | | 0 | 22.53 | 22.44 | 22.62 | 2 | | |
| 64QAM | 1 | 0 | 23.00 | 22.89 | 23.00 | 0-2 | 2 | |
| | 1 | 50 | 22.88 | 22.55 | 22.91 | | 2 | |
| | 1 | 99 | 22.93 | 22.69 | 22.87 | | 2 | |
| | 64QAM | 50 | 0 | 21.75 | 21.60 | 21.78 | 0-3 | 3 |
| | | 50 | 25 | 21.58 | 21.63 | 21.72 | | 3 |
| | | 50 | 50 | 21.57 | 21.60 | 21.69 | | 3 |
| | 100 | 0 | 21.55 | 21.59 | 21.63 | | 3 | |



| | | | | |
|-------------------------------------|--|--------------------------------|---|---------------------------------|
| FCC ID: A3LSMG965U |  PCTEST ENGINEERING LABORATORY, INC. | HAC (RF EMISSIONS) TEST REPORT |  | Approved by: Quality Manager |
| Filename: 1M1711060289-13-R1.A3L | Test Dates: 11/06/2017 - 12/11/2017 | DUT Type: Portable Handset | | Page 39 of 108 |

Table 8-26
LTE Band 25 (1882.5MHz) Conducted Powers – 15MHz Bandwidth

| LTE Band 25 (PCS) 15 MHz Bandwidth | | | | | | | |
|---------------------------------------|---------|-----------|-----------------------|-----------------------|-----------------------|------------------------------|----------|
| Modulation | RB Size | RB Offset | Low Channel | Mid Channel | High Channel | MPR Allowed per 3GPP [dB] | MPR [dB] |
| | | | 26115 (1857.5 MHz) | 26365 (1882.5 MHz) | 26615 (1907.5 MHz) | | |
| | | | Conducted Power [dBm] | | | | |
| QPSK | 1 | 0 | 24.62 | 24.46 | 24.56 | 0 | 0 |
| | 1 | 36 | 24.47 | 24.38 | 24.40 | | 0 |
| | 1 | 74 | 24.43 | 24.29 | 24.26 | | 0 |
| | 36 | 0 | 23.59 | 23.39 | 23.49 | 0-1 | 1 |
| | 36 | 18 | 23.55 | 23.34 | 23.45 | | 1 |
| | 36 | 37 | 23.35 | 23.28 | 23.40 | | 1 |
| | 75 | 0 | 23.41 | 23.40 | 23.46 | | 1 |
| 16QAM | 1 | 0 | 23.79 | 23.63 | 23.71 | 0-1 | 1 |
| | 1 | 36 | 23.64 | 23.53 | 23.67 | | 1 |
| | 1 | 74 | 23.57 | 23.42 | 23.59 | | 1 |
| | 36 | 0 | 22.64 | 22.46 | 22.58 | 0-2 | 2 |
| | 36 | 18 | 22.59 | 22.41 | 22.52 | | 2 |
| | 36 | 37 | 22.43 | 22.37 | 22.49 | | 2 |
| | 75 | 0 | 22.56 | 22.42 | 22.52 | | 2 |
| 64QAM | 1 | 0 | 22.92 | 22.65 | 22.76 | 0-2 | 2 |
| | 1 | 36 | 22.78 | 22.54 | 22.69 | | 2 |
| | 1 | 74 | 22.76 | 22.52 | 22.63 | | 2 |
| | 36 | 0 | 21.64 | 21.51 | 21.63 | 0-3 | 3 |
| | 36 | 18 | 21.67 | 21.47 | 21.58 | | 3 |
| | 36 | 37 | 21.52 | 21.39 | 21.53 | | 3 |
| | 75 | 0 | 21.53 | 21.44 | 21.59 | | 3 |

Table 8-27
LTE Band 25 (1882.5MHz) Conducted Powers – 10MHz Bandwidth

| LTE Band 25 (PCS) 10 MHz Bandwidth | | | | | | | |
|---------------------------------------|---------|-----------|-----------------------|-----------------------|-----------------------|------------------------------|----------|
| Modulation | RB Size | RB Offset | Low Channel | Mid Channel | High Channel | MPR Allowed per 3GPP [dB] | MPR [dB] |
| | | | 26090 (1855.0 MHz) | 26365 (1882.5 MHz) | 26640 (1910.0 MHz) | | |
| | | | Conducted Power [dBm] | | | | |
| QPSK | 1 | 0 | 24.78 | 24.58 | 24.44 | 0 | 0 |
| | 1 | 25 | 24.50 | 24.34 | 24.38 | | 0 |
| | 1 | 49 | 24.68 | 24.43 | 24.17 | | 0 |
| | 25 | 0 | 23.54 | 23.39 | 23.46 | 0-1 | 1 |
| | 25 | 12 | 23.53 | 23.33 | 23.44 | | 1 |
| | 25 | 25 | 23.47 | 23.31 | 23.43 | | 1 |
| | 50 | 0 | 23.54 | 23.35 | 23.47 | | 1 |
| 16QAM | 1 | 0 | 24.00 | 23.79 | 23.61 | 0-1 | 1 |
| | 1 | 25 | 23.89 | 23.56 | 23.56 | | 1 |
| | 1 | 49 | 23.82 | 23.59 | 23.49 | | 1 |
| | 25 | 0 | 22.60 | 22.45 | 22.57 | 0-2 | 2 |
| | 25 | 12 | 22.58 | 22.46 | 22.47 | | 2 |
| | 25 | 25 | 22.59 | 22.38 | 22.53 | | 2 |
| | 50 | 0 | 22.58 | 22.47 | 22.51 | | 2 |
| 64QAM | 1 | 0 | 22.88 | 22.74 | 22.69 | 0-2 | 2 |
| | 1 | 25 | 22.71 | 22.62 | 22.63 | | 2 |
| | 1 | 49 | 22.84 | 22.69 | 22.59 | | 2 |
| | 25 | 0 | 21.68 | 21.51 | 21.54 | 0-3 | 3 |
| | 25 | 12 | 21.62 | 21.47 | 21.53 | | 3 |
| | 25 | 25 | 21.57 | 21.42 | 21.46 | | 3 |
| | 50 | 0 | 21.64 | 21.44 | 21.55 | | 3 |



| | | | | |
|-------------------------------------|--|--------------------------------|---|---------------------------------|
| FCC ID: A3LSMG965U |  PCTEST ENGINEERING LABORATORY, INC. | HAC (RF EMISSIONS) TEST REPORT |  | Approved by: Quality Manager |
| Filename: 1M1711060289-13-R1.A3L | Test Dates: 11/06/2017 - 12/11/2017 | DUT Type: Portable Handset | | Page 40 of 108 |

Table 8-28
LTE Band 25 (1882.5MHz) Conducted Powers – 5MHz Bandwidth

| LTE Band 25 (PCS) 5 MHz Bandwidth | | | | | | | |
|--------------------------------------|---------|-----------|-----------------------|-----------------------|-----------------------|------------------------------|----------|
| Modulation | RB Size | RB Offset | Low Channel | Mid Channel | High Channel | MPR Allowed per 3GPP [dB] | MPR [dB] |
| | | | 26065 (1852.5 MHz) | 26365 (1882.5 MHz) | 26665 (1912.5 MHz) | | |
| | | | Conducted Power [dBm] | | | | |
| QPSK | 1 | 0 | 24.55 | 24.34 | 24.44 | 0 | 0 |
| | 1 | 12 | 24.43 | 24.25 | 24.39 | | 0 |
| | 1 | 24 | 24.47 | 24.23 | 24.13 | | 0 |
| | 12 | 0 | 23.52 | 23.27 | 23.47 | 0-1 | 1 |
| | 12 | 6 | 23.50 | 23.34 | 23.46 | | 1 |
| | 12 | 13 | 23.48 | 23.32 | 23.43 | | 1 |
| 16QAM | 25 | 0 | 23.49 | 23.29 | 23.39 | 0-1 | 1 |
| | 1 | 0 | 23.76 | 23.48 | 23.53 | | 1 |
| | 1 | 12 | 23.62 | 23.34 | 23.56 | | 1 |
| | 1 | 24 | 23.64 | 23.47 | 23.51 | 0-2 | 1 |
| | 12 | 0 | 22.61 | 22.44 | 22.49 | | 2 |
| | 12 | 6 | 22.59 | 22.37 | 22.51 | | 2 |
| 64QAM | 12 | 13 | 22.54 | 22.34 | 22.46 | 0-2 | 2 |
| | 25 | 0 | 22.56 | 22.36 | 22.49 | | 2 |
| | 1 | 0 | 22.77 | 22.58 | 22.66 | | 0-2 |
| | 1 | 12 | 22.74 | 22.55 | 22.68 | 2 | |
| | 1 | 24 | 22.71 | 22.53 | 22.62 | 2 | |
| | 64QAM | 12 | 0 | 21.66 | 21.48 | 21.63 | 0-3 |
| 12 | | 6 | 21.64 | 21.46 | 21.59 | 3 | |
| 12 | | 13 | 21.62 | 21.43 | 21.52 | 3 | |
| 25 | | 0 | 21.57 | 21.42 | 21.51 | 3 | |

Table 8-29
LTE Band 25 (1882.5MHz) Conducted Powers – 3MHz Bandwidth

| LTE Band 25 (PCS) 3 MHz Bandwidth | | | | | | | |
|--------------------------------------|---------|-----------|-----------------------|-----------------------|-----------------------|------------------------------|----------|
| Modulation | RB Size | RB Offset | Low Channel | Mid Channel | High Channel | MPR Allowed per 3GPP [dB] | MPR [dB] |
| | | | 26055 (1851.5 MHz) | 26365 (1882.5 MHz) | 26675 (1913.5 MHz) | | |
| | | | Conducted Power [dBm] | | | | |
| QPSK | 1 | 0 | 24.47 | 24.26 | 24.39 | 0 | 0 |
| | 1 | 7 | 24.55 | 24.40 | 24.41 | | 0 |
| | 1 | 14 | 24.43 | 24.23 | 24.12 | | 0 |
| | 8 | 0 | 23.50 | 23.30 | 23.33 | 0-1 | 1 |
| | 8 | 4 | 23.48 | 23.33 | 23.41 | | 1 |
| | 8 | 7 | 23.46 | 23.27 | 23.34 | | 1 |
| 16QAM | 15 | 0 | 23.49 | 23.30 | 23.39 | 0-1 | 1 |
| | 1 | 0 | 23.63 | 23.43 | 23.45 | | 1 |
| | 1 | 7 | 23.71 | 23.57 | 23.66 | | 1 |
| | 1 | 14 | 23.66 | 23.41 | 23.43 | 0-2 | 1 |
| | 8 | 0 | 22.55 | 22.44 | 22.47 | | 2 |
| | 8 | 4 | 22.54 | 22.41 | 22.53 | | 2 |
| 64QAM | 8 | 7 | 22.59 | 22.39 | 22.49 | 0-2 | 2 |
| | 15 | 0 | 22.56 | 22.38 | 22.47 | | 2 |
| | 1 | 0 | 22.73 | 22.50 | 22.56 | | 0-2 |
| | 1 | 7 | 22.74 | 22.59 | 22.66 | 2 | |
| | 1 | 14 | 22.67 | 22.51 | 22.51 | 2 | |
| | 64QAM | 8 | 0 | 21.62 | 21.43 | 21.49 | 0-3 |
| 8 | | 4 | 21.63 | 21.42 | 21.51 | 3 | |
| 8 | | 7 | 21.57 | 21.40 | 21.50 | 3 | |
| 15 | | 0 | 21.55 | 21.41 | 21.49 | 3 | |



| | | | | |
|-------------------------------------|--|--------------------------------|---|---------------------------------|
| FCC ID: A3LSMG965U |  PCTEST ENGINEERING LABORATORY, INC. | HAC (RF EMISSIONS) TEST REPORT |  | Approved by: Quality Manager |
| Filename: 1M1711060289-13-R1.A3L | Test Dates: 11/06/2017 - 12/11/2017 | DUT Type: Portable Handset | Page 41 of 108 | |



Table 8-30
LTE Band 25 (1882.5MHz) Conducted Powers – 1.4MHz Bandwidth

| LTE Band 25 (PCS) 1.4 MHz Bandwidth | | | | | | | |
|--|---------|-----------|-----------------------|-----------------------|-----------------------|---------------------------|----------|
| Modulation | RB Size | RB Offset | Low Channel | Mid Channel | High Channel | MPR Allowed per 3GPP [dB] | MPR [dB] |
| | | | 26047 (1850.7 MHz) | 26365 (1882.5 MHz) | 26683 (1914.3 MHz) | | |
| | | | Conducted Power [dBm] | | | | |
| QPSK | 1 | 0 | 24.38 | 24.44 | 24.29 | 0 | 0 |
| | 1 | 2 | 24.43 | 24.47 | 24.32 | | 0 |
| | 1 | 5 | 24.39 | 24.42 | 24.02 | | 0 |
| | 3 | 0 | 24.44 | 24.45 | 24.28 | | 0 |
| | 3 | 2 | 24.49 | 24.47 | 24.15 | | 0 |
| | 3 | 3 | 24.40 | 24.43 | 23.99 | | 0 |
| 16QAM | 6 | 0 | 23.42 | 23.47 | 23.24 | 0-1 | 1 |
| | 1 | 0 | 23.56 | 23.63 | 23.39 | 0-1 | 1 |
| | 1 | 2 | 23.49 | 23.68 | 23.47 | | 1 |
| | 1 | 5 | 23.51 | 23.59 | 23.35 | | 1 |
| | 3 | 0 | 23.51 | 23.58 | 23.37 | | 1 |
| | 3 | 2 | 23.54 | 23.67 | 23.38 | | 1 |
| | 3 | 3 | 23.53 | 23.50 | 23.32 | | 1 |
| 64QAM | 6 | 0 | 22.49 | 22.53 | 22.41 | 0-2 | 2 |
| | 1 | 0 | 22.68 | 22.68 | 22.47 | 0-2 | 2 |
| | 1 | 2 | 22.70 | 22.69 | 22.54 | | 2 |
| | 1 | 5 | 22.63 | 22.72 | 22.51 | | 2 |
| | 3 | 0 | 22.64 | 22.65 | 22.51 | | 2 |
| | 3 | 2 | 22.66 | 22.61 | 22.56 | | 2 |
| | 3 | 3 | 22.65 | 22.59 | 22.49 | | 2 |
| 6 | 0 | 21.49 | 21.57 | 21.54 | 0-3 | 3 | |

h. LTE Band 30

Table 8-31
LTE Band 30 (2310.0MHz) Conducted Powers – 10MHz Bandwidth

| LTE Band 30 10 MHz Bandwidth | | | | | | |
|---------------------------------|---------|-----------|-----------------------|---------------------------|----------|---|
| Modulation | RB Size | RB Offset | Mid Channel | MPR Allowed per 3GPP [dB] | MPR [dB] | |
| | | | 27710 (2310.0 MHz) | | | |
| | | | Conducted Power [dBm] | | | |
| QPSK | 1 | 0 | 23.70 | 0 | 0 | |
| | 1 | 25 | 23.69 | | 0 | |
| | 1 | 49 | 23.83 | | 0 | |
| | 16QAM | 25 | 0 | 22.81 | 0-1 | 1 |
| | | 25 | 12 | 22.78 | | 1 |
| | | 25 | 25 | 22.79 | | 1 |
| | | 50 | 0 | 22.75 | | 1 |
| 64QAM | 1 | 0 | 22.87 | 0-1 | 1 | |
| | 1 | 25 | 22.86 | | 1 | |
| | 1 | 49 | 22.97 | | 1 | |
| | 16QAM | 25 | 0 | 21.87 | 0-2 | 2 |
| | | 25 | 12 | 21.84 | | 2 |
| | | 25 | 25 | 21.86 | | 2 |
| 64QAM | 50 | 0 | 21.83 | 0-2 | 2 | |
| | 1 | 0 | 21.93 | | 2 | |
| | 1 | 25 | 21.96 | | 2 | |
| | 16QAM | 1 | 49 | 22.00 | 0-3 | 2 |
| | | 25 | 0 | 20.90 | | 3 |
| | | 25 | 12 | 20.86 | | 3 |
| 64QAM | 25 | 25 | 20.90 | 0-3 | 3 | |
| | 50 | 0 | 20.87 | | 3 | |

| | | | | |
|-------------------------------------|--|--------------------------------|---|---------------------------------|
| FCC ID: A3LSMG965U |  PCTEST ENGINEERING LABORATORY, INC. | HAC (RF EMISSIONS) TEST REPORT |  | Approved by: Quality Manager |
| Filename: 1M1711060289-13-R1.A3L | Test Dates: 11/06/2017 - 12/11/2017 | DUT Type: Portable Handset | | Page 42 of 108 |

**Table 8-32
LTE Band 30 (2310.0MHz) Conducted Powers – 5MHz Bandwidth**

| LTE Band 30 5 MHz Bandwidth | | | | | |
|--------------------------------|---------|-----------|--------------------------|------------------------------|----------|
| Modulation | RB Size | RB Offset | Mid Channel | MPR Allowed per 3GPP [dB] | MPR [dB] |
| | | | 27710 (2310.0 MHz) | | |
| | | | Conducted Power [dBm] | | |
| QPSK | 1 | 0 | 23.67 | 0 | 0 |
| | 1 | 12 | 23.66 | | 0 |
| | 1 | 24 | 23.73 | | 0 |
| | 12 | 0 | 22.72 | 0-1 | 1 |
| | 12 | 6 | 22.74 | | 1 |
| | 12 | 13 | 22.66 | | 1 |
| 16QAM | 25 | 0 | 22.67 | 0-1 | 1 |
| | 1 | 0 | 22.53 | | 1 |
| | 1 | 12 | 22.50 | | 1 |
| | 1 | 24 | 22.56 | 0-2 | 1 |
| | 12 | 0 | 21.75 | | 2 |
| | 12 | 6 | 21.74 | | 2 |
| 64QAM | 12 | 13 | 21.71 | 0-2 | 2 |
| | 25 | 0 | 21.75 | | 2 |
| | 1 | 0 | 21.62 | | 2 |
| | 1 | 12 | 21.55 | 0-2 | 2 |
| | 1 | 24 | 21.61 | | 2 |
| | 12 | 0 | 20.82 | | 0-3 |
| | 12 | 6 | 20.83 | 3 | |
| | 12 | 13 | 20.78 | 3 | |
| | 25 | 0 | 20.79 | | 3 |

Note: Since LTE Band 30 at 5MHz bandwidth does not support 3 non-overlapping channels, conducted power measurements were made only on the middle channel.

i. LTE Band 7

**Table 8-33
LTE Band 7 (2535.0MHz) Conducted Powers – 20MHz Bandwidth**

| LTE Band 7 20 MHz Bandwidth | | | | | | | | |
|--------------------------------|---------|-----------|-----------------------|-----------------------|-----------------------|------------------------------|----------|---|
| Modulation | RB Size | RB Offset | Low Channel | Mid Channel | High Channel | MPR Allowed per 3GPP [dB] | MPR [dB] | |
| | | | 20850 (2510.0 MHz) | 21100 (2535.0 MHz) | 21350 (2560.0 MHz) | | | |
| | | | Conducted Power [dBm] | | | | | |
| QPSK | 1 | 0 | 23.67 | 23.80 | 23.77 | 0 | 0 | |
| | 1 | 50 | 23.44 | 23.66 | 23.49 | | 0 | |
| | 1 | 99 | 23.57 | 23.71 | 23.64 | | 0 | |
| | 50 | 0 | 22.61 | 22.71 | 22.65 | 0-1 | 1 | |
| | 50 | 25 | 22.56 | 22.69 | 22.20 | | 1 | |
| | 50 | 50 | 22.58 | 22.66 | 22.53 | | 1 | |
| 16QAM | 100 | 0 | 22.65 | 22.64 | 22.57 | 0-1 | 1 | |
| | 1 | 0 | 22.52 | 22.68 | 22.99 | | 1 | |
| | 1 | 50 | 22.35 | 22.49 | 22.15 | | 0-1 | 1 |
| | 1 | 99 | 22.45 | 22.69 | 22.99 | 1 | | |
| | 50 | 0 | 21.67 | 21.77 | 21.73 | 0-2 | | 2 |
| | 50 | 25 | 21.62 | 21.73 | 21.35 | | 2 | |
| 50 | 50 | 21.66 | 21.71 | 21.62 | 2 | | | |
| 64QAM | 100 | 0 | 21.68 | 21.74 | 21.63 | 0-2 | 2 | |
| | 1 | 0 | 21.91 | 21.69 | 21.85 | | 0-2 | 2 |
| | 1 | 50 | 21.71 | 21.54 | 21.23 | | | 2 |
| | 1 | 99 | 21.78 | 21.66 | 21.71 | 0-3 | | 2 |
| | 50 | 0 | 20.64 | 20.82 | 20.75 | | 3 | |
| | 50 | 25 | 20.59 | 20.78 | 20.33 | | 3 | |
| | 50 | 50 | 20.65 | 20.73 | 20.65 | 0-3 | 3 | |
| | 100 | 0 | 20.74 | 20.75 | 20.68 | | 3 | |



| | | | | |
|-------------------------------------|--|--------------------------------|---|---------------------------------|
| FCC ID: A3LSMG965U |  PCTEST TECHNOLOGICAL LABORATORY, INC. | HAC (RF EMISSIONS) TEST REPORT |  | Approved by: Quality Manager |
| Filename: 1M1711060289-13-R1.A3L | Test Dates: 11/06/2017 - 12/11/2017 | DUT Type: Portable Handset | | Page 43 of 108 |

Table 8-34
LTE Band 7 (2535.0MHz) Conducted Powers – 15MHz Bandwidth

| LTE Band 7 15 MHz Bandwidth | | | | | | | |
|--------------------------------|---------|-----------|-----------------------|-----------------------|-----------------------|------------------------------|----------|
| Modulation | RB Size | RB Offset | Low Channel | Mid Channel | High Channel | MPR Allowed per 3GPP [dB] | MPR [dB] |
| | | | 20825 (2507.5 MHz) | 21100 (2535.0 MHz) | 21375 (2562.5 MHz) | | |
| | | | Conducted Power [dBm] | | | | |
| QPSK | 1 | 0 | 23.83 | 23.71 | 23.90 | 0 | 0 |
| | 1 | 36 | 23.59 | 23.56 | 23.79 | | 0 |
| | 1 | 74 | 23.50 | 23.58 | 23.74 | | 0 |
| | 36 | 0 | 22.72 | 22.64 | 22.71 | 0-1 | 1 |
| | 36 | 18 | 22.67 | 22.60 | 22.74 | | 1 |
| | 36 | 37 | 22.58 | 22.54 | 22.79 | | 1 |
| | 75 | 0 | 22.63 | 22.58 | 22.72 | | 1 |
| 16QAM | 1 | 0 | 22.91 | 22.93 | 22.99 | 0-1 | 1 |
| | 1 | 36 | 22.68 | 22.72 | 22.85 | | 1 |
| | 1 | 74 | 22.60 | 22.68 | 22.89 | | 1 |
| | 36 | 0 | 21.79 | 21.72 | 21.87 | 0-2 | 2 |
| | 36 | 18 | 21.74 | 21.70 | 21.81 | | 2 |
| | 36 | 37 | 21.64 | 21.61 | 21.84 | | 2 |
| | 75 | 0 | 21.68 | 21.66 | 21.78 | | 2 |
| 64QAM | 1 | 0 | 21.88 | 21.92 | 21.97 | 0-2 | 2 |
| | 1 | 36 | 21.66 | 21.87 | 21.87 | | 2 |
| | 1 | 74 | 21.70 | 21.85 | 21.94 | | 2 |
| | 36 | 0 | 20.82 | 20.78 | 20.84 | 0-3 | 3 |
| | 36 | 18 | 20.79 | 20.75 | 20.83 | | 3 |
| | 36 | 37 | 20.67 | 20.69 | 20.88 | | 3 |
| | 75 | 0 | 20.72 | 20.73 | 20.78 | | 3 |

Table 8-35
LTE Band 7 (2535.0MHz) Conducted Powers – 10MHz Bandwidth

| LTE Band 7 10 MHz Bandwidth | | | | | | | |
|--------------------------------|---------|-----------|-----------------------|-----------------------|-----------------------|------------------------------|----------|
| Modulation | RB Size | RB Offset | Low Channel | Mid Channel | High Channel | MPR Allowed per 3GPP [dB] | MPR [dB] |
| | | | 20800 (2505.0 MHz) | 21100 (2535.0 MHz) | 21400 (2565.0 MHz) | | |
| | | | Conducted Power [dBm] | | | | |
| QPSK | 1 | 0 | 23.71 | 23.76 | 23.53 | 0 | 0 |
| | 1 | 25 | 23.62 | 23.68 | 23.81 | | 0 |
| | 1 | 49 | 23.54 | 23.59 | 23.79 | | 0 |
| | 25 | 0 | 22.67 | 22.68 | 22.80 | 0-1 | 1 |
| | 25 | 12 | 22.65 | 22.69 | 22.86 | | 1 |
| | 25 | 25 | 22.59 | 22.66 | 22.79 | | 1 |
| | 50 | 0 | 22.63 | 22.67 | 22.75 | | 1 |
| 16QAM | 1 | 0 | 22.86 | 22.89 | 22.76 | 0-1 | 1 |
| | 1 | 25 | 22.78 | 22.78 | 22.91 | | 1 |
| | 1 | 49 | 22.72 | 22.83 | 22.90 | | 1 |
| | 25 | 0 | 21.78 | 21.80 | 21.83 | 0-2 | 2 |
| | 25 | 12 | 21.72 | 21.82 | 21.92 | | 2 |
| | 25 | 25 | 21.66 | 21.79 | 21.94 | | 2 |
| 64QAM | 50 | 0 | 21.75 | 21.78 | 21.82 | 2 | |
| | 1 | 0 | 21.86 | 22.00 | 21.79 | 0-2 | 2 |
| | 1 | 25 | 21.69 | 21.92 | 21.98 | | 2 |
| | 1 | 49 | 21.78 | 21.87 | 21.96 | | 2 |
| | 25 | 0 | 20.83 | 20.84 | 20.83 | 0-3 | 3 |
| | 25 | 12 | 20.78 | 20.83 | 20.87 | | 3 |
| | 25 | 25 | 20.76 | 20.79 | 20.86 | | 3 |
| 50 | 0 | 20.74 | 20.81 | 20.81 | 3 | | |



| | | | | |
|-------------------------------------|--|--------------------------------|---|---------------------------------|
| FCC ID: A3LSMG965U |  PCTEST ENGINEERING LABORATORY, INC. | HAC (RF EMISSIONS) TEST REPORT |  | Approved by: Quality Manager |
| Filename: 1M1711060289-13-R1.A3L | Test Dates: 11/06/2017 - 12/11/2017 | DUT Type: Portable Handset | Page 44 of 108 | |

Table 8-36
LTE Band 7 (2535.0MHz) Conducted Powers – 5MHz Bandwidth

| LTE Band 7 5 MHz Bandwidth | | | | | | | |
|-------------------------------|---------|-----------|-----------------------|-----------------------|-----------------------|------------------------------|----------|
| Modulation | RB Size | RB Offset | Low Channel | Mid Channel | High Channel | MPR Allowed per 3GPP [dB] | MPR [dB] |
| | | | 20775 (2502.5 MHz) | 21100 (2535.0 MHz) | 21425 (2567.5 MHz) | | |
| | | | Conducted Power [dBm] | | | | |
| QPSK | 1 | 0 | 23.75 | 23.71 | 23.84 | 0 | 0 |
| | 1 | 12 | 23.72 | 23.70 | 23.80 | | 0 |
| | 1 | 24 | 23.69 | 23.63 | 23.83 | | 0 |
| | 12 | 0 | 22.77 | 22.81 | 22.87 | 0-1 | 1 |
| | 12 | 6 | 22.81 | 22.72 | 22.89 | | 1 |
| | 12 | 13 | 22.78 | 22.70 | 22.86 | | 1 |
| 16QAM | 25 | 0 | 22.77 | 22.74 | 22.88 | 0-1 | 1 |
| | 1 | 0 | 22.93 | 22.77 | 23.00 | | 1 |
| | 1 | 12 | 22.87 | 22.89 | 22.94 | | 1 |
| | 1 | 24 | 22.82 | 22.85 | 22.92 | 0-2 | 1 |
| | 12 | 0 | 21.84 | 21.83 | 21.98 | | 2 |
| | 12 | 6 | 21.91 | 21.82 | 21.99 | | 2 |
| 64QAM | 12 | 13 | 21.85 | 21.74 | 21.91 | 0-2 | 2 |
| | 25 | 0 | 21.84 | 21.79 | 21.89 | | 2 |
| | 1 | 0 | 21.96 | 21.91 | 21.89 | | 0-2 |
| | 1 | 12 | 21.87 | 21.89 | 21.98 | 2 | |
| | 1 | 24 | 21.89 | 21.88 | 21.84 | 0-3 | |
| | 12 | 0 | 20.84 | 20.86 | 20.93 | | 3 |
| 12 | 6 | 20.91 | 20.87 | 20.91 | 3 | | |
| 64QAM | 12 | 13 | 20.85 | 20.80 | 20.85 | 0-3 | 3 |
| | 25 | 0 | 20.84 | 20.69 | 20.87 | | 3 |

j. LTE Band 41 – Power Class 3

Table 8-37
LTE Band 41 (2593.0MHz) Conducted Powers – 20MHz Bandwidth

| LTE Band 41 20 MHz Bandwidth | | | | | | | | | | | |
|---------------------------------|---------|-----------|-----------------------|-----------------------|-----------------------|-----------------------|-----------------------|------------------------------|----------|-----|---|
| Modulation | RB Size | RB Offset | Low Channel | Low-Mid Channel | Mid Channel | Mid-High Channel | High Channel | MPR Allowed per 3GPP [dB] | MPR [dB] | | |
| | | | 39750 (2506.0 MHz) | 40185 (2549.5 MHz) | 40620 (2593.0 MHz) | 41055 (2636.5 MHz) | 41490 (2680.0 MHz) | | | | |
| | | | Conducted Power [dBm] | | | | | | | | |
| QPSK | 1 | 0 | 24.38 | 24.41 | 24.02 | 23.95 | 24.05 | 0 | 0 | | |
| | 1 | 50 | 23.98 | 23.94 | 23.77 | 23.74 | 23.84 | | 0 | | |
| | 1 | 99 | 23.96 | 23.94 | 23.77 | 23.79 | 23.73 | | 0 | | |
| | 16QAM | 50 | 0 | 23.06 | 23.07 | 22.93 | 22.93 | 22.96 | 0-1 | 1 | |
| | | 50 | 25 | 23.01 | 23.01 | 22.86 | 22.85 | 22.84 | | 1 | |
| | | 50 | 50 | 22.96 | 22.92 | 22.76 | 22.77 | 22.81 | | 1 | |
| 64QAM | | 100 | 0 | 23.01 | 23.01 | 22.83 | 22.87 | 22.92 | 0-1 | 1 | |
| | | 1 | 0 | 23.50 | 23.50 | 23.20 | 23.45 | 23.50 | | 0-1 | 1 |
| | | 1 | 50 | 23.44 | 23.42 | 23.23 | 23.15 | 23.29 | | | 1 |
| | 16QAM | 1 | 99 | 23.38 | 23.44 | 23.20 | 23.19 | 23.20 | 0-2 | | 1 |
| | | 50 | 0 | 22.14 | 22.17 | 21.98 | 21.88 | 22.05 | | 2 | |
| | | 50 | 25 | 22.09 | 22.09 | 21.90 | 21.83 | 21.99 | | 2 | |
| 64QAM | | 50 | 50 | 22.01 | 22.00 | 21.79 | 21.74 | 21.91 | 0-2 | 2 | |
| | | 100 | 0 | 22.10 | 22.11 | 21.88 | 21.83 | 21.99 | | 2 | |
| | | 1 | 0 | 22.31 | 22.33 | 22.19 | 22.05 | 22.20 | | 0-2 | 2 |
| | 1 | 50 | 22.11 | 22.10 | 21.97 | 21.81 | 21.96 | 2 | | | |
| | 1 | 99 | 22.05 | 22.11 | 21.96 | 21.84 | 21.87 | 0-3 | 2 | | |
| | 64QAM | 50 | 0 | 21.15 | 21.19 | 21.05 | 20.92 | | 21.08 | 0-3 | 3 |
| 50 | | 25 | 21.11 | 21.13 | 21.02 | 20.84 | 21.00 | | 3 | | |
| 50 | | 50 | 21.04 | 21.04 | 20.93 | 20.76 | 20.93 | 0-3 | 3 | | |
| 100 | | 0 | 21.11 | 21.11 | 21.00 | 20.85 | 21.01 | | 3 | | |



| | | | | |
|-------------------------------------|--|--------------------------------|---|---------------------------------|
| FCC ID: A3LSMG965U |  PCTEST ENGINEERING LABORATORY, INC. | HAC (RF EMISSIONS) TEST REPORT |  | Approved by: Quality Manager |
| Filename: 1M1711060289-13-R1.A3L | Test Dates: 11/06/2017 - 12/11/2017 | DUT Type: Portable Handset | Page 45 of 108 | |

Table 8-38
LTE Band 41 (2593.0MHz) Conducted Powers – 15MHz Bandwidth

| LTE Band 41 15 MHz Bandwidth | | | | | | | | | | |
|---------------------------------|---------|-----------|-----------------------|-----------------------|-----------------------|-----------------------|-----------------------|------------------------------|----------|-----|
| Modulation | RB Size | RB Offset | Low Channel | Low-Mid Channel | Mid Channel | Mid-High Channel | High Channel | MPR Allowed per 3GPP [dB] | MPR [dB] | |
| | | | 39750 (2506.0 MHz) | 40185 (2549.5 MHz) | 40620 (2593.0 MHz) | 41055 (2636.5 MHz) | 41490 (2680.0 MHz) | | | |
| Conducted Power [dBm] | | | | | | | | | | |
| QPSK | 1 | 0 | 24.24 | 24.32 | 24.25 | 23.76 | 23.85 | 0 | 0 | |
| | 1 | 36 | 24.15 | 24.19 | 24.00 | 23.61 | 23.72 | | 0 | |
| | 1 | 74 | 24.06 | 24.21 | 23.95 | 23.62 | 23.63 | | 0 | |
| | QPSK | 36 | 0 | 23.15 | 23.27 | 23.12 | 22.73 | 22.82 | 0-1 | 1 |
| | | 36 | 18 | 23.17 | 23.21 | 23.11 | 22.68 | 22.78 | | 1 |
| | | 36 | 37 | 23.07 | 23.14 | 22.96 | 22.61 | 22.70 | | 1 |
| | | 75 | 0 | 23.11 | 23.19 | 23.04 | 22.66 | 22.75 | | 1 |
| 1 | | 0 | 23.50 | 23.50 | 23.50 | 23.25 | 23.31 | 1 | | |
| 16QAM | 1 | 36 | 23.50 | 23.49 | 23.49 | 23.09 | 23.21 | 0-1 | 1 | |
| | 1 | 74 | 23.49 | 23.49 | 23.47 | 23.11 | 23.11 | | 1 | |
| | 36 | 0 | 22.20 | 22.30 | 22.19 | 21.75 | 21.86 | | 2 | |
| | 16QAM | 36 | 18 | 22.20 | 22.30 | 22.14 | 21.73 | 21.83 | 0-2 | 2 |
| | | 36 | 37 | 22.16 | 22.21 | 22.02 | 21.69 | 21.76 | | 2 |
| | | 75 | 0 | 22.19 | 22.27 | 22.14 | 21.71 | 21.84 | | 2 |
| | | 1 | 0 | 22.39 | 22.46 | 22.37 | 21.92 | 22.01 | | 0-2 |
| 1 | 36 | 22.27 | 22.33 | 22.18 | 21.75 | 21.90 | 2 | | | |
| 1 | 74 | 22.26 | 22.37 | 22.14 | 21.80 | 21.83 | 2 | | | |
| 36 | 0 | 21.24 | 21.35 | 21.22 | 20.76 | 20.91 | 3 | | | |
| 36 | 18 | 21.23 | 21.30 | 21.15 | 20.77 | 20.86 | 0-3 | 3 | | |
| 36 | 37 | 21.20 | 21.27 | 21.05 | 20.68 | 20.82 | | 3 | | |
| 75 | 0 | 21.20 | 21.29 | 21.13 | 20.74 | 20.88 | | 3 | | |

Table 8-39
LTE Band 41 (2593.0MHz) Conducted Powers – 10MHz Bandwidth

| LTE Band 41 10 MHz Bandwidth | | | | | | | | | | |
|---------------------------------|---------|-----------|-----------------------|-----------------------|-----------------------|-----------------------|-----------------------|------------------------------|----------|---|
| Modulation | RB Size | RB Offset | Low Channel | Low-Mid Channel | Mid Channel | Mid-High Channel | High Channel | MPR Allowed per 3GPP [dB] | MPR [dB] | |
| | | | 39750 (2506.0 MHz) | 40185 (2549.5 MHz) | 40620 (2593.0 MHz) | 41055 (2636.5 MHz) | 41490 (2680.0 MHz) | | | |
| Conducted Power [dBm] | | | | | | | | | | |
| QPSK | 1 | 0 | 24.18 | 24.26 | 24.17 | 23.71 | 23.82 | 0 | 0 | |
| | 1 | 25 | 24.14 | 24.19 | 24.04 | 23.63 | 23.73 | | 0 | |
| | 1 | 49 | 24.11 | 24.23 | 23.89 | 23.67 | 23.65 | | 0 | |
| | QPSK | 25 | 0 | 23.15 | 23.21 | 23.08 | 22.68 | 22.83 | 0-1 | 1 |
| | | 25 | 12 | 23.17 | 23.22 | 23.08 | 22.71 | 22.78 | | 1 |
| | | 25 | 25 | 23.11 | 23.16 | 22.99 | 22.60 | 22.70 | | 1 |
| | | 50 | 0 | 23.14 | 23.22 | 23.05 | 22.69 | 22.76 | | 1 |
| 1 | | 0 | 23.50 | 23.49 | 23.49 | 23.21 | 23.31 | 0-1 | | 1 |
| 1 | 25 | 23.49 | 23.48 | 23.48 | 23.12 | 23.18 | 1 | | | |
| 1 | 49 | 23.49 | 23.50 | 23.40 | 23.16 | 23.14 | 1 | | | |
| 25 | 0 | 22.20 | 22.28 | 22.12 | 21.71 | 21.82 | 0-2 | | 2 | |
| 25 | 12 | 22.21 | 22.25 | 22.10 | 21.69 | 21.82 | | | 2 | |
| 25 | 25 | 22.12 | 22.21 | 22.02 | 21.66 | 21.75 | | | 2 | |
| 50 | 0 | 22.23 | 22.30 | 22.16 | 21.75 | 21.85 | | | 2 | |
| 64QAM | 1 | 0 | 22.35 | 22.40 | 22.30 | 21.88 | 21.98 | 0-2 | 2 | |
| | 1 | 25 | 22.30 | 22.37 | 22.21 | 21.80 | 21.90 | | 2 | |
| | 1 | 49 | 22.27 | 22.40 | 22.07 | 21.79 | 21.86 | | 2 | |
| | 25 | 0 | 21.34 | 21.39 | 21.30 | 20.84 | 20.94 | | 0-3 | 3 |
| | 25 | 12 | 21.30 | 21.39 | 21.25 | 20.88 | 20.95 | 3 | | |
| | 25 | 25 | 21.30 | 21.33 | 21.13 | 20.82 | 20.91 | 3 | | |
| | 50 | 0 | 21.23 | 21.31 | 21.19 | 20.81 | 20.88 | 3 | | |



| | | | | |
|-------------------------------------|--|---------------------------------------|---|---------------------------------|
| FCC ID: A3LSMG965U |  PCTEST Engineering Laboratory, Inc. | HAC (RF EMISSIONS) TEST REPORT |  | Approved by: Quality Manager |
| Filename: 1M1711060289-13-R1.A3L | Test Dates: 11/06/2017 - 12/11/2017 | DUT Type: Portable Handset | Page 46 of 108 | |

Table 8-40
LTE Band 41 (2593.0MHz) Conducted Powers – 5MHz Bandwidth

| LTE Band 41 5 MHz Bandwidth | | | | | | | | | | |
|--------------------------------|---------|-----------|-----------------------|-----------------------|-----------------------|-----------------------|-----------------------|---------------------------|----------|---|
| Modulation | RB Size | RB Offset | Low Channel | Low-Mid Channel | Mid Channel | Mid-High Channel | High Channel | MPR Allowed per 3GPP [dB] | MPR [dB] | |
| | | | 39750 (2506.0 MHz) | 40185 (2549.5 MHz) | 40620 (2593.0 MHz) | 41055 (2636.5 MHz) | 41490 (2680.0 MHz) | | | |
| Conducted Power [dBm] | | | | | | | | | | |
| QPSK | 1 | 0 | 24.14 | 24.27 | 24.14 | 23.73 | 23.76 | 0 | 0 | |
| | 1 | 12 | 24.15 | 24.23 | 24.10 | 23.70 | 23.77 | | 0 | |
| | 1 | 24 | 24.11 | 24.28 | 24.04 | 23.66 | 23.69 | | 0 | |
| | QPSK | 12 | 0 | 23.14 | 23.23 | 23.12 | 22.71 | 22.81 | 0-1 | 1 |
| | | 12 | 6 | 23.17 | 23.26 | 23.11 | 22.69 | 22.77 | | 1 |
| | | 12 | 13 | 23.11 | 23.21 | 23.06 | 22.70 | 22.73 | | 1 |
| 25 | | 0 | 23.14 | 23.22 | 23.10 | 22.70 | 22.78 | 1 | | |
| 1 | | 0 | 23.50 | 23.49 | 23.50 | 23.17 | 23.23 | 1 | | |
| 16QAM | 1 | 12 | 23.49 | 23.49 | 23.49 | 23.16 | 23.23 | 0-1 | 1 | |
| | 1 | 24 | 23.48 | 23.50 | 23.48 | 23.14 | 23.21 | | 1 | |
| | 12 | 0 | 22.26 | 22.32 | 22.20 | 21.82 | 21.88 | | 2 | |
| | 16QAM | 12 | 6 | 22.30 | 22.38 | 22.20 | 21.80 | 21.88 | 0-2 | 2 |
| | | 12 | 13 | 22.24 | 22.28 | 22.14 | 21.75 | 21.80 | | 2 |
| | | 25 | 0 | 22.19 | 22.28 | 22.12 | 21.73 | 21.80 | | 2 |
| 1 | | 0 | 22.34 | 22.41 | 22.26 | 21.84 | 21.91 | 2 | | |
| 64QAM | 1 | 12 | 22.34 | 22.39 | 22.24 | 21.83 | 21.92 | 0-2 | 2 | |
| | 1 | 24 | 22.28 | 22.46 | 22.20 | 21.82 | 21.84 | | 2 | |
| | 12 | 0 | 21.34 | 21.37 | 21.27 | 20.86 | 20.94 | | 3 | |
| | 64QAM | 12 | 6 | 21.35 | 21.43 | 21.26 | 20.88 | 20.92 | 0-3 | 3 |
| | | 12 | 13 | 21.28 | 21.35 | 21.18 | 20.85 | 20.86 | | 3 |
| | | 25 | 0 | 21.30 | 21.40 | 21.24 | 20.85 | 20.91 | | 3 |

k. LTE Band 41 – Power Class 2

Table 8-41
LTE Band 41 (2593.0MHz) Conducted Powers – 20MHz Bandwidth

| LTE Band 41 20 MHz Bandwidth | | | | | | | | | | |
|---------------------------------|---------|-----------|-----------------------|-----------------------|-----------------------|-----------------------|-----------------------|---------------------------|----------|---|
| Modulation | RB Size | RB Offset | Low Channel | Low-Mid Channel | Mid Channel | Mid-High Channel | High Channel | MPR Allowed per 3GPP [dB] | MPR [dB] | |
| | | | 39750 (2506.0 MHz) | 40185 (2549.5 MHz) | 40620 (2593.0 MHz) | 41055 (2636.5 MHz) | 41490 (2680.0 MHz) | | | |
| Conducted Power [dBm] | | | | | | | | | | |
| QPSK | 1 | 0 | 27.27 | 27.18 | 27.48 | 26.94 | 27.05 | 0 | 0 | |
| | 1 | 50 | 26.81 | 26.99 | 27.16 | 26.74 | 26.83 | | 0 | |
| | 1 | 99 | 26.60 | 27.06 | 27.05 | 26.65 | 26.71 | | 0 | |
| | QPSK | 50 | 0 | 25.81 | 26.21 | 26.39 | 25.88 | 26.01 | 0-1 | 1 |
| | | 50 | 25 | 25.91 | 26.25 | 26.27 | 25.87 | 25.94 | | 1 |
| | | 50 | 50 | 25.59 | 26.17 | 26.12 | 25.78 | 25.88 | | 1 |
| 100 | | 0 | 25.78 | 26.20 | 26.31 | 25.79 | 26.02 | 1 | | |
| 16QAM | 1 | 0 | 26.50 | 26.48 | 26.50 | 26.25 | 26.36 | 0-1 | 1 | |
| | 1 | 50 | 26.27 | 26.47 | 26.47 | 26.10 | 26.18 | | 1 | |
| | 1 | 99 | 26.02 | 26.42 | 26.41 | 25.99 | 26.08 | | 1 | |
| | 16QAM | 50 | 0 | 25.30 | 25.31 | 25.47 | 24.97 | 25.12 | 0-2 | 2 |
| | | 50 | 25 | 25.16 | 25.33 | 25.44 | 24.98 | 25.02 | | 2 |
| | | 50 | 50 | 24.85 | 25.26 | 25.29 | 24.87 | 24.94 | | 2 |
| 100 | | 0 | 24.68 | 25.24 | 25.38 | 24.88 | 25.03 | 2 | | |
| 64QAM | 1 | 0 | 25.35 | 25.36 | 25.46 | 25.05 | 25.17 | 0-2 | 2 | |
| | 1 | 50 | 25.14 | 25.27 | 25.37 | 24.88 | 24.97 | | 2 | |
| | 1 | 99 | 24.82 | 25.22 | 25.31 | 24.79 | 24.88 | | 2 | |
| | 64QAM | 50 | 0 | 24.02 | 24.32 | 24.48 | 23.96 | 24.12 | 0-3 | 3 |
| | | 50 | 25 | 24.16 | 24.35 | 24.46 | 24.02 | 24.07 | | 3 |
| | | 50 | 50 | 23.83 | 24.28 | 24.34 | 23.87 | 23.98 | | 3 |
| 100 | | 0 | 23.72 | 24.21 | 24.44 | 23.88 | 24.02 | 3 | | |



| | | | | |
|-------------------------------------|--|--------------------------------|---|---------------------------------|
| FCC ID: A3LSMG965U |  PCTEST Engineering Laboratory, Inc. | HAC (RF EMISSIONS) TEST REPORT |  | Approved by: Quality Manager |
| Filename: 1M1711060289-13-R1.A3L | Test Dates: 11/06/2017 - 12/11/2017 | DUT Type: Portable Handset | Page 47 of 108 | |

Table 8-42
LTE Band 41 (2593.0MHz) Conducted Powers – 15MHz Bandwidth

| LTE Band 41 15 MHz Bandwidth | | | | | | | | | | | |
|---------------------------------|---------|-----------|-----------------------|-----------------------|-----------------------|-----------------------|-----------------------|------------------------------|----------|-----|---|
| Modulation | RB Size | RB Offset | Low Channel | Low-Mid Channel | Mid Channel | Mid-High Channel | High Channel | MPR Allowed per 3GPP [dB] | MPR [dB] | | |
| | | | 39750 (2506.0 MHz) | 40185 (2549.5 MHz) | 40620 (2593.0 MHz) | 41055 (2636.5 MHz) | 41490 (2680.0 MHz) | | | | |
| Conducted Power [dBm] | | | | | | | | | | | |
| QPSK | 1 | 0 | 27.08 | 27.40 | 27.36 | 26.92 | 26.86 | 0 | 0 | | |
| | 1 | 36 | 27.07 | 27.28 | 27.18 | 26.76 | 26.73 | | 0 | | |
| | 1 | 74 | 26.87 | 27.23 | 27.04 | 26.73 | 26.63 | | 0 | | |
| | QPSK | 36 | 0 | 25.98 | 26.37 | 26.29 | 25.86 | 25.81 | 0-1 | 1 | |
| | | 36 | 18 | 26.04 | 26.36 | 26.26 | 25.83 | 25.79 | | 1 | |
| | | 36 | 37 | 25.88 | 26.28 | 26.16 | 25.80 | 25.71 | | 1 | |
| | | 75 | 0 | 25.77 | 26.32 | 26.20 | 25.80 | 25.75 | | 1 | |
| 1 | | 0 | 26.43 | 26.49 | 26.47 | 26.20 | 26.16 | 1 | | | |
| 1 | | 36 | 26.29 | 26.48 | 26.41 | 26.07 | 26.02 | 1 | | | |
| 16QAM | 1 | 74 | 26.19 | 26.44 | 26.36 | 26.05 | 25.92 | 0-1 | 1 | | |
| | 36 | 0 | 25.16 | 25.45 | 25.38 | 24.97 | 24.92 | | 2 | | |
| | 36 | 18 | 25.23 | 25.41 | 25.23 | 24.96 | 24.86 | | 2 | | |
| | 16QAM | 36 | 37 | 25.00 | 25.40 | 25.25 | 24.88 | 24.79 | 0-2 | 2 | |
| | | 75 | 0 | 24.87 | 25.40 | 25.28 | 24.89 | 24.83 | | 2 | |
| | | 1 | 0 | 25.48 | 25.49 | 25.46 | 25.19 | 25.12 | | 0-2 | 2 |
| | | 1 | 36 | 25.35 | 25.47 | 25.49 | 25.06 | 25.02 | | | 2 |
| 1 | | 74 | 25.28 | 25.43 | 25.34 | 25.04 | 24.91 | 2 | | | |
| 64QAM | 36 | 0 | 24.11 | 24.43 | 24.35 | 23.91 | 23.89 | 0-2 | 3 | | |
| | 36 | 18 | 24.24 | 24.42 | 24.31 | 23.89 | 23.83 | | 3 | | |
| | 36 | 37 | 24.18 | 24.34 | 24.21 | 23.82 | 23.76 | | 3 | | |
| | 75 | 0 | 24.12 | 24.43 | 24.31 | 23.89 | 23.90 | 0-3 | 3 | | |

Table 8-43
LTE Band 41 (2593.0MHz) Conducted Powers – 10MHz Bandwidth

| LTE Band 41 10 MHz Bandwidth | | | | | | | | | | |
|---------------------------------|---------|-----------|-----------------------|-----------------------|-----------------------|-----------------------|-----------------------|------------------------------|----------|-----|
| Modulation | RB Size | RB Offset | Low Channel | Low-Mid Channel | Mid Channel | Mid-High Channel | High Channel | MPR Allowed per 3GPP [dB] | MPR [dB] | |
| | | | 39750 (2506.0 MHz) | 40185 (2549.5 MHz) | 40620 (2593.0 MHz) | 41055 (2636.5 MHz) | 41490 (2680.0 MHz) | | | |
| Conducted Power [dBm] | | | | | | | | | | |
| QPSK | 1 | 0 | 26.85 | 27.34 | 27.26 | 26.84 | 26.81 | 0 | 0 | |
| | 1 | 25 | 26.95 | 27.31 | 27.17 | 26.79 | 26.73 | | 0 | |
| | 1 | 49 | 26.82 | 27.22 | 27.07 | 26.69 | 26.66 | | 0 | |
| | QPSK | 25 | 0 | 25.88 | 26.32 | 26.24 | 25.81 | 25.79 | 0-1 | 1 |
| | | 25 | 12 | 25.95 | 26.37 | 26.24 | 25.80 | 25.77 | | 1 |
| | | 25 | 25 | 25.74 | 26.26 | 26.14 | 25.76 | 25.71 | | 1 |
| | | 50 | 0 | 25.43 | 26.34 | 26.19 | 25.81 | 25.76 | | 1 |
| 1 | | 0 | 26.40 | 26.48 | 26.50 | 26.16 | 26.11 | 1 | | |
| 16QAM | 1 | 25 | 26.12 | 26.47 | 26.49 | 26.09 | 26.02 | 0-1 | 1 | |
| | 1 | 49 | 25.94 | 26.45 | 26.38 | 26.02 | 25.99 | | 1 | |
| | 25 | 0 | 24.95 | 25.37 | 25.32 | 24.85 | 24.86 | | 2 | |
| | 16QAM | 25 | 12 | 25.07 | 25.14 | 25.27 | 24.86 | 24.82 | 0-2 | 2 |
| | | 25 | 25 | 25.00 | 25.32 | 25.20 | 24.84 | 24.78 | | 2 |
| | | 50 | 0 | 24.75 | 25.43 | 25.32 | 24.91 | 24.84 | | 2 |
| | | 1 | 0 | 25.40 | 25.46 | 25.49 | 25.15 | 25.09 | | 0-2 |
| 1 | 25 | 25.30 | 25.44 | 25.49 | 25.08 | 25.00 | 2 | | | |
| 1 | 49 | 25.18 | 25.41 | 25.33 | 25.00 | 24.94 | 2 | | | |
| 64QAM | 25 | 0 | 24.12 | 24.19 | 24.41 | 23.92 | 23.95 | 0-2 | 3 | |
| | 25 | 12 | 24.22 | 24.48 | 24.34 | 23.92 | 23.89 | | 3 | |
| | 25 | 25 | 24.17 | 24.39 | 24.28 | 23.86 | 23.89 | | 3 | |
| | 64QAM | 50 | 0 | 23.47 | 24.47 | 24.37 | 23.90 | 23.89 | 0-3 | 3 |





| | | | | |
|-------------------------------------|--|---------------------------------------|---|---------------------------------|
| FCC ID: A3LSMG965U |  PCTEST Engineering Laboratory, Inc. | HAC (RF EMISSIONS) TEST REPORT |  | Approved by: Quality Manager |
| Filename: 1M1711060289-13-R1.A3L | Test Dates: 11/06/2017 - 12/11/2017 | DUT Type: Portable Handset | Page 48 of 108 | |

Table 8-44
LTE Band 41 (2593.0MHz) Conducted Powers – 5MHz Bandwidth

| LTE Band 41 5 MHz Bandwidth | | | | | | | | | |
|--------------------------------|---------|-----------|-----------------------|-----------------------|-----------------------|-----------------------|-----------------------|------------------------------|----------|
| Modulation | RB Size | RB Offset | Low Channel | Low-Mid Channel | Mid Channel | Mid-High Channel | High Channel | MPR Allowed per 3GPP [dB] | MPR [dB] |
| | | | 39750 (2506.0 MHz) | 40185 (2549.5 MHz) | 40620 (2593.0 MHz) | 41055 (2636.5 MHz) | 41490 (2680.0 MHz) | | |
| Conducted Power [dBm] | | | | | | | | | |
| QPSK | 1 | 0 | 26.91 | 27.28 | 27.19 | 26.74 | 26.72 | 0 | 0 |
| | 1 | 12 | 27.08 | 27.28 | 27.19 | 26.77 | 26.73 | | 0 |
| | 1 | 24 | 26.95 | 27.24 | 27.11 | 26.69 | 26.66 | | 0 |
| | 12 | 0 | 26.06 | 26.31 | 26.21 | 25.77 | 25.72 | 0-1 | 1 |
| | 12 | 6 | 25.97 | 26.35 | 26.25 | 25.80 | 25.74 | | 1 |
| | 12 | 13 | 25.92 | 26.26 | 26.16 | 25.74 | 25.71 | | 1 |
| 16QAM | 25 | 0 | 25.75 | 26.32 | 26.17 | 25.76 | 25.78 | 0-1 | 1 |
| | 1 | 0 | 26.27 | 26.47 | 26.49 | 26.12 | 26.02 | | 1 |
| | 1 | 12 | 26.36 | 26.48 | 26.50 | 26.09 | 26.02 | | 1 |
| | 1 | 24 | 26.23 | 26.44 | 26.43 | 26.03 | 25.99 | 0-2 | 1 |
| | 12 | 0 | 25.21 | 25.42 | 25.34 | 24.93 | 24.88 | | 2 |
| | 12 | 6 | 25.24 | 25.44 | 25.38 | 24.92 | 24.87 | | 2 |
| 64QAM | 12 | 13 | 25.23 | 25.41 | 25.31 | 24.89 | 24.94 | 0-2 | 2 |
| | 25 | 0 | 25.03 | 25.34 | 25.28 | 24.84 | 24.79 | | 2 |
| | 1 | 0 | 25.32 | 25.47 | 25.50 | 24.95 | 24.99 | | 0-2 |
| | 1 | 12 | 25.38 | 25.46 | 25.49 | 25.06 | 25.00 | 2 | |
| | 1 | 24 | 25.32 | 25.41 | 25.40 | 25.02 | 24.97 | 2 | |
| | 64QAM | 12 | 0 | 24.23 | 24.40 | 24.37 | 23.89 | 23.86 | 0-3 |
| 12 | | 6 | 24.25 | 24.43 | 24.36 | 23.92 | 23.83 | 3 | |
| 12 | | 13 | 24.20 | 24.41 | 24.28 | 23.86 | 23.79 | 3 | |
| 25 | | 0 | 24.01 | 24.41 | 24.32 | 23.90 | 23.84 | 0-3 | 3 |
| | | | | | | | | | 3 |

| | | | | |
|-------------------------------------|--|--------------------------------|---|---------------------------------|
| FCC ID: A3LSMG965U |  PCTEST ENGINEERING LABORATORY, INC. | HAC (RF EMISSIONS) TEST REPORT |  | Approved by: Quality Manager |
| Filename: 1M1711060289-13-R1.A3L | Test Dates: 11/06/2017 - 12/11/2017 | DUT Type: Portable Handset | | Page 49 of 108 |

VIII. WIFI Conducted Powers (SISO/MIMO)

Table 8-45
IEEE 802.11b/g/n (2.4GHz, SISO) Reduced Average RF Power¹

| 2.4GHz Conducted Power [dBm] | | | | |
|------------------------------|---------|------------------------|---------|---------|
| Freq [MHz] | Channel | IEEE Transmission Mode | | |
| | | 802.11b | 802.11g | 802.11n |
| | | Average | Average | Average |
| 2412 | 1 | 13.08 | 13.26 | 13.14 |
| 2437 | 6 | 13.22 | 13.49 | 13.31 |
| 2462 | 11 | 13.46 | 12.76 | 13.47 |

Table 8-46
IEEE 802.11g/n (2.4GHz, MIMO) Reduced Average RF Power¹

| 2.4GHz Conducted Power [dBm] | | | |
|------------------------------|---------|------------------------|---------|
| Freq [MHz] | Channel | IEEE Transmission mode | |
| | | 802.11g | 802.11n |
| 2412 | 1 | 16.08 | 15.92 |
| 2437 | 6 | 16.47 | 16.30 |
| 2462 | 11 | 15.99 | 16.31 |

Table 8-47
IEEE 802.11a/n/ac (5GHz, 20MHz BW, SISO) Reduced Average RF Power¹

| 5GHz (20MHz) Conducted Power [dBm] | | | | |
|------------------------------------|---------|------------------------|---------|----------|
| Freq [MHz] | Channel | IEEE Transmission Mode | | |
| | | 802.11a | 802.11n | 802.11ac |
| 5180 | 36 | 11.36 | 11.43 | 11.38 |
| 5200 | 40 | 11.70 | 11.48 | 11.45 |
| 5220 | 44 | 11.55 | 11.50 | 11.27 |
| 5240 | 48 | 11.49 | 11.38 | 11.43 |
| 5260 | 52 | 11.42 | 11.31 | 11.47 |
| 5280 | 56 | 11.53 | 11.28 | 11.36 |
| 5300 | 60 | 11.52 | 11.55 | 11.30 |
| 5320 | 64 | 11.40 | 11.57 | 11.55 |
| 5500 | 100 | 11.37 | 11.20 | 11.27 |
| 5580 | 116 | 11.45 | 11.48 | 11.24 |
| 5660 | 132 | 11.53 | 11.46 | 12.17 |
| 5700 | 140 | 11.41 | 11.34 | 11.97 |
| 5745 | 149 | 11.23 | 11.28 | 12.19 |
| 5785 | 157 | 11.18 | 11.13 | 12.28 |
| 5825 | 165 | 11.20 | 10.85 | 12.06 |

¹ Note: This device utilizes independent power reduction mechanisms for the WIFI transmitter in all WIFI modes for held-to-ear scenarios.



| | | | | |
|-------------------------------------|--|--------------------------------|---|---------------------------------|
| FCC ID: A3LSMG965U |  PCTEST ENGINEERING LABORATORY, INC. | HAC (RF EMISSIONS) TEST REPORT |  | Approved by: Quality Manager |
| Filename: 1M1711060289-13-R1.A3L | Test Dates: 11/06/2017 - 12/11/2017 | DUT Type: Portable Handset | Page 50 of 108 | |

Table 8-48
IEEE 802.11a/n/ac (5GHz, 20MHz BW, MIMO) Reduced Average RF Power¹

| 5GHz (20MHz) Conducted Power [dBm] | | | | |
|------------------------------------|---------|------------------------|---------|----------|
| Freq [MHz] | Channel | IEEE Transmission Mode | | |
| | | 802.11a | 802.11n | 802.11ac |
| 5180 | 36 | 14.62 | 14.72 | 14.57 |
| 5200 | 40 | 14.85 | 14.80 | 14.75 |
| 5220 | 44 | 14.89 | 14.85 | 14.73 |
| 5240 | 48 | 14.88 | 14.83 | 14.89 |
| 5260 | 52 | 14.83 | 14.74 | 14.95 |
| 5280 | 56 | 14.89 | 14.80 | 14.92 |
| 5300 | 60 | 14.97 | 14.91 | 14.95 |
| 5320 | 64 | 14.85 | 14.90 | 15.05 |
| 5500 | 100 | 14.88 | 14.83 | 14.48 |
| 5580 | 116 | 15.01 | 15.02 | 14.47 |
| 5700 | 140 | 14.58 | 14.47 | 14.89 |
| 5745 | 149 | 14.49 | 14.34 | 14.94 |
| 5785 | 157 | 14.44 | 14.21 | 15.01 |
| 5825 | 165 | 14.81 | 14.00 | 14.75 |

Table 8-49
IEEE 802.11n/ac (5GHz, 40MHz BW, SISO) Reduced Average RF Power¹

| 5GHz (40MHz) Conducted Power [dBm] | | | |
|------------------------------------|---------|------------------------|----------|
| Freq [MHz] | Channel | IEEE Transmission Mode | |
| | | 802.11n | 802.11ac |
| 5190 | 38 | 11.30 | 11.25 |
| 5230 | 46 | 11.22 | 11.38 |
| 5270 | 54 | 11.38 | 11.34 |
| 5310 | 62 | 11.47 | 11.36 |
| 5510 | 102 | 11.35 | 11.35 |
| 5590 | 118 | 11.48 | 11.36 |
| 5630 | 126 | 11.39 | 11.49 |
| 5710 | 142 | 11.42 | 11.40 |
| 5755 | 151 | 11.49 | 11.32 |
| 5795 | 159 | 11.21 | 11.36 |

¹ Note: This device utilizes independent power reduction mechanisms for the WIFI transmitter in all WIFI modes for held-to-ear scenarios.



| | | | | |
|-------------------------------------|--|--------------------------------|---|---------------------------------|
| FCC ID: A3LSMG965U |  PCTEST TECHNOLOGICAL LABORATORY, INC. | HAC (RF EMISSIONS) TEST REPORT |  | Approved by: Quality Manager |
| Filename: 1M1711060289-13-R1.A3L | Test Dates: 11/06/2017 - 12/11/2017 | DUT Type: Portable Handset | Page 51 of 108 | |

Table 8-50
IEEE 802.11n/ac (5GHz, 40MHz BW, MIMO) Reduced Average RF Power¹

| 5GHz (40MHz) Conducted Power [dBm] | | | |
|------------------------------------|---------|------------------------|----------|
| Freq [MHz] | Channel | IEEE Transmission Mode | |
| | | 802.11n | 802.11ac |
| 5190 | 38 | 14.25 | 14.19 |
| 5230 | 46 | 14.25 | 14.34 |
| 5270 | 54 | 14.38 | 14.42 |
| 5310 | 62 | 14.43 | 14.41 |
| 5510 | 102 | 14.55 | 14.44 |
| 5590 | 118 | 14.70 | 14.53 |
| 5630 | 126 | 14.60 | 14.65 |
| 5710 | 142 | 14.59 | 14.51 |
| 5755 | 151 | 14.55 | 14.46 |
| 5795 | 159 | 14.33 | 14.44 |



Table 8-51
IEEE 802.11ac (5GHz, 80MHz BW, SISO) Reduced Average RF Power¹

| 5GHz (80MHz) Conducted Power [dBm] | | |
|------------------------------------|---------|------------------------|
| Freq [MHz] | Channel | IEEE Transmission Mode |
| | | 802.11ac |
| 5210 | 42 | 11.61 |
| 5290 | 58 | 11.79 |
| 5530 | 106 | 11.81 |
| 5610 | 122 | 11.71 |
| 5690 | 138 | 12.32 |
| 5775 | 155 | 12.29 |

Table 8-52
IEEE 802.11ac (5GHz, 80MHz BW, MIMO) Reduced Average RF Power¹

| 5GHz (80MHz) Conducted Power [dBm] | | |
|------------------------------------|---------|------------------------|
| Freq [MHz] | Channel | IEEE Transmission Mode |
| | | 802.11ac |
| 5210 | 42 | 15.07 |
| 5290 | 58 | 15.11 |
| 5530 | 106 | 15.01 |
| 5610 | 122 | 14.99 |
| 5690 | 138 | 15.18 |
| 5775 | 155 | 15.40 |

¹ Note: This device utilizes independent power reduction mechanisms for the WIFI transmitter in all WIFI modes for held-to-ear scenarios.

| | | | | |
|-------------------------------------|---|---------------------------------------|---|---------------------------------|
| FCC ID: A3LSMG965U |  PCTEST ENGINEERING LABORATORY, INC. | HAC (RF EMISSIONS) TEST REPORT |  | Approved by: Quality Manager |
| Filename: 1M1711060289-13-R1.A3L | Test Dates: 11/06/2017 - 12/11/2017 | DUT Type: Portable Handset | Page 52 of 108 | |

IX. WIFI Conducted Powers for Operations with Simultaneous 2.4GHz and 5GHz

Table 8-53
IEEE 802.11b/g/n (2.4GHz, Ant1) Reduced Average RF Power¹

| 2.4GHz Conducted Power [dBm] | | | | |
|------------------------------|---------|------------------------|---------|---------|
| Freq [MHz] | Channel | IEEE Transmission Mode | | |
| | | 802.11b | 802.11g | 802.11n |
| 2412 | 1 | 13.08 | 13.26 | 13.14 |
| 2437 | 6 | 13.22 | 13.49 | 13.31 |
| 2462 | 11 | 13.46 | 12.76 | 13.47 |

Table 8-54
IEEE 802.11b/g/n (2.4GHz, Ant2) Reduced Average RF Power¹

| 2.4GHz Conducted Power [dBm] | | | | |
|------------------------------|---------|------------------------|---------|---------|
| Freq [MHz] | Channel | IEEE Transmission Mode | | |
| | | 802.11b | 802.11g | 802.11n |
| 2412 | 1 | 12.76 | 12.87 | 12.66 |
| 2437 | 6 | 13.20 | 13.43 | 13.27 |
| 2462 | 11 | 13.01 | 13.19 | 13.12 |

Table 8-55
IEEE 802.11a/n/ac (5GHz, 20MHz BW, Ant1) Reduced Average RF Power¹

| 5GHz (20MHz) Conducted Power [dBm] | | | | |
|------------------------------------|---------|------------------------|---------|----------|
| Freq [MHz] | Channel | IEEE Transmission Mode | | |
| | | 802.11a | 802.11n | 802.11ac |
| 5180 | 36 | 11.36 | 11.43 | 11.38 |
| 5200 | 40 | 11.70 | 11.48 | 11.45 |
| 5220 | 44 | 11.55 | 11.50 | 11.27 |
| 5240 | 48 | 11.49 | 11.38 | 11.43 |
| 5260 | 52 | 11.42 | 11.31 | 11.47 |
| 5280 | 56 | 11.53 | 11.28 | 11.36 |
| 5300 | 60 | 11.52 | 11.55 | 11.30 |
| 5320 | 64 | 11.40 | 11.57 | 11.55 |
| 5500 | 100 | 11.37 | 11.20 | 11.27 |
| 5580 | 116 | 11.45 | 11.48 | 11.24 |
| 5660 | 132 | 11.53 | 11.46 | 12.17 |
| 5700 | 140 | 11.41 | 11.34 | 11.97 |
| 5745 | 149 | 11.23 | 11.28 | 12.19 |
| 5785 | 157 | 11.18 | 11.13 | 12.28 |
| 5825 | 165 | 11.20 | 10.85 | 12.06 |

¹ Note: This device utilizes independent power reduction mechanisms for the WIFI transmitter in all WIFI modes for held-to-ear scenarios.



| | | | | |
|-------------------------------------|--|--------------------------------|---|---------------------------------|
| FCC ID: A3LSMG965U |  PCTEST TECHNOLOGICAL LABORATORY, INC. | HAC (RF EMISSIONS) TEST REPORT |  | Approved by: Quality Manager |
| Filename: 1M1711060289-13-R1.A3L | Test Dates: 11/06/2017 - 12/11/2017 | DUT Type: Portable Handset | Page 53 of 108 | |

Table 8-56
IEEE 802.11a/n/ac (5GHz, 20MHz BW, Ant2) Reduced Average RF Power¹

| 5GHz (20MHz) Conducted Power [dBm] | | | | |
|------------------------------------|---------|------------------------|---------|----------|
| Freq [MHz] | Channel | IEEE Transmission Mode | | |
| | | 802.11a | 802.11n | 802.11ac |
| 5180 | 36 | 11.84 | 11.97 | 11.74 |
| 5200 | 40 | 11.97 | 12.07 | 12.02 |
| 5220 | 44 | 12.19 | 12.16 | 12.12 |
| 5240 | 48 | 12.21 | 12.22 | 12.28 |
| 5260 | 52 | 12.18 | 12.12 | 12.36 |
| 5280 | 56 | 12.21 | 12.25 | 12.39 |
| 5300 | 60 | 12.36 | 12.23 | 12.49 |
| 5320 | 64 | 12.23 | 12.18 | 12.48 |
| 5500 | 100 | 12.32 | 12.37 | 11.66 |
| 5580 | 116 | 12.48 | 12.49 | 11.67 |
| 5660 | 132 | 12.49 | 11.58 | 11.92 |
| 5700 | 140 | 11.72 | 11.57 | 11.79 |
| 5745 | 149 | 11.71 | 11.38 | 11.65 |
| 5785 | 157 | 11.66 | 11.27 | 11.71 |
| 5825 | 165 | 12.33 | 11.13 | 11.40 |

Table 8-57
IEEE 802.11n/ac (5GHz, 40MHz BW, Ant1) Reduced Average RF Power¹

| 5GHz (40MHz) Conducted Power [dBm] | | | |
|------------------------------------|---------|------------------------|----------|
| Freq [MHz] | Channel | IEEE Transmission Mode | |
| | | 802.11n | 802.11ac |
| 5190 | 38 | 11.30 | 11.25 |
| 5230 | 46 | 11.22 | 11.38 |
| 5270 | 54 | 11.38 | 11.34 |
| 5310 | 62 | 11.47 | 11.36 |
| 5510 | 102 | 11.35 | 11.35 |
| 5590 | 118 | 11.48 | 11.36 |
| 5630 | 126 | 11.39 | 11.49 |
| 5710 | 142 | 11.42 | 11.40 |
| 5755 | 151 | 11.49 | 11.32 |
| 5795 | 159 | 11.21 | 11.36 |

¹ Note: This device utilizes independent power reduction mechanisms for the WIFI transmitter in all WIFI modes for held-to-ear scenarios.



| | | | | |
|-------------------------------------|--|--------------------------------|---|---------------------------------|
| FCC ID: A3LSMG965U |  PCTEST TECHNOLOGICAL LABORATORY, INC. | HAC (RF EMISSIONS) TEST REPORT |  | Approved by: Quality Manager |
| Filename: 1M1711060289-13-R1.A3L | Test Dates: 11/06/2017 - 12/11/2017 | DUT Type: Portable Handset | Page 54 of 108 | |

Table 8-58
IEEE 802.11n/ac (5GHz, 40MHz BW, Ant2) Reduced RF Power¹

| 5GHz (40MHz) Conducted Power [dBm] | | | |
|------------------------------------|---------|------------------------|----------|
| Freq [MHz] | Channel | IEEE Transmission Mode | |
| | | 802.11n | 802.11ac |
| 5190 | 38 | 11.18 | 11.11 |
| 5230 | 46 | 11.25 | 11.27 |
| 5270 | 54 | 11.36 | 11.47 |
| 5310 | 62 | 11.37 | 11.43 |
| 5510 | 102 | 11.73 | 11.50 |
| 5590 | 118 | 11.89 | 11.68 |
| 5630 | 126 | 11.79 | 11.79 |
| 5710 | 142 | 11.73 | 11.60 |
| 5755 | 151 | 11.59 | 11.58 |
| 5795 | 159 | 11.42 | 11.50 |



Table 8-59
IEEE 802.11ac (5GHz, 80MHz BW, Ant1) Reduced RF Power¹

| 5GHz (80MHz) Conducted Power [dBm] | | |
|------------------------------------|---------|------------------------|
| Freq [MHz] | Channel | IEEE Transmission Mode |
| | | 802.11ac |
| 5210 | 42 | 11.61 |
| 5290 | 58 | 11.79 |
| 5530 | 106 | 11.81 |
| 5610 | 122 | 11.71 |
| 5690 | 138 | 12.32 |
| 5775 | 155 | 12.29 |

Table 8-60
IEEE 802.11ac (5GHz, 80MHz BW, Ant2) Reduced RF Power¹

| 5GHz (80MHz) Conducted Power [dBm] | | |
|------------------------------------|---------|------------------------|
| Freq [MHz] | Channel | IEEE Transmission Mode |
| | | 802.11ac |
| | | Average |
| 5210 | 42 | 12.46 |
| 5290 | 58 | 12.38 |
| 5530 | 106 | 12.18 |
| 5610 | 122 | 12.24 |
| 5690 | 138 | 12.01 |
| 5775 | 155 | 12.49 |

¹ Note: This device utilizes independent power reduction mechanisms for the WIFI transmitter in all WIFI modes for held-to-ear scenarios.

| | | | | |
|-------------------------------------|---|---------------------------------------|---|---------------------------------|
| FCC ID: A3LSMG965U |  PCTEST ENGINEERING LABORATORY, INC. | HAC (RF EMISSIONS) TEST REPORT |  | Approved by: Quality Manager |
| Filename: 1M1711060289-13-R1.A3L | Test Dates: 11/06/2017 - 12/11/2017 | DUT Type: Portable Handset | Page 55 of 108 | |

9. JUSTIFICATION OF HELD TO EAR MODES TESTED

I. Analysis of RF Air Interface Technologies

An analysis was performed, following the guidance of §4.3 and §4.4 of the ANSI standard, of the RF air interface technologies being evaluated. The factors that will affect the RF interference potential were evaluated, and the worst case operating modes were identified and used in the evaluation. A WD's interference potential is a function both of the WD's average near-field field strength and of the signal's audio-frequency amplitude modulation characteristics. Per §4.4, RF air interface technologies that have low power have been found to produce sufficiently low RF interference potential, so it is possible to exempt them from the product testing specified in Clause 5 of the ANSI standard. An RF air interface technology of a device is exempt from testing when its average antenna input power plus its MIF is $\leq 17\text{dBm}$ for all of its operating modes. RF air interface technologies exempted from testing in this manner are automatically assigned an M4 rating to be used in determining the overall rating for the WD.



The worst case MIF plus the worst case average antenna input power for all modes are investigated below to determine the testing requirements for this device.

II. Individual Mode Evaluations

Table 9-1
Max Power + MIF calculations for Low Power Exemptions

| Air Interface | Maximum Average Power (dBm) | Worst Case MIF (dB) | Total (Power + MIF, dB) | C63.19 Testing Required |
|--|-----------------------------|---------------------|-------------------------|-------------------------|
| CDMA - RC1/SO55 Full Frame Rate | 25.12 | -19.35 | 5.77 | No |
| CDMA - RC1/SO3 1/8 th Frame Rate | 16.03* | 3.07 | 19.10 | Yes |
| CDMA - EVDO RevA | 25.15 | -19.05 | 6.10 | No |
| GSM850 | 23.91* | 3.56 | 27.47 | Yes |
| GSM1900 | 20.69* | 3.56 | 24.25 | Yes |
| EDGE850 | 17.63* | 3.76 | 21.39 | Yes*** |
| EDGE1900 | 16.71* | 3.53 | 20.24 | Yes*** |
| UMTS - RMC | 24.99 | -21.99 | 3.00 | No |
| UMTS - AMR | 24.97 | -15.02 | 9.95 | No |
| UMTS - HSUPA | 23.57 | -21.25 | 2.32 | No |
| LTE - FDD | 24.78 | -8.96 | 15.82 | No |
| LTE - TDD (PC3) | 17.72* | 1.64 | 19.36 | Yes |
| LTE - TDD (PC2) | 20.79* | 1.67 | 22.46 | Yes |
| 2.4GHz WIFI | 16.47 | -4.76 | 11.71 | No |
| 5GHz WIFI | 15.40 | -10.65 | 4.75 | No |
| Simultaneous 2.4GHz and 5GHz WIFI Operations | 18.99** | -5.10 | 13.89 | No |

* Note: ANSI C63.19-2011 Sec. 4.4 Footnote 20 indicates the use of a long averaging time for measuring the antenna input power when using this method of exclusion. Therefore, the frame averaged power was calculated for these modes in this investigation.



| | | | |
|---------------------------------|---|--|---|
| FCC ID: A3LSMG965U |  PCTEST ENGINEERING LABORATORY, INC. | HAC (RF EMISSIONS) TEST REPORT |  |
| Approved by: Quality Manager | Filename: 1M1711060289-13-R1.A3L | Test Dates: 11/06/2017 - 12/11/2017 | DUT Type: Portable Handset |

** Note: This value is calculated as the linear sum of the worst-case power for each band and antenna combination while in simultaneous 2.4GHz and 5GHz operation. This calculation is conservative and for use in this investigation only.

*** Note: GSM data modes were not evaluated as GSM voice modes were found to be the worst-case modes for the GSM air interface.

III. Low-Power Exemption Conclusions

Per ANSI C63.19-2011, RF Emissions testing for this device is required only for GSM and 1/8th Frame Rate CDMA voice modes as well as LTE TDD (Power Class 3 and Power Class 2) data modes. All other air interfaces are exempt.

| | | | | |
|-------------------------------------|---|--------------------------------|---|---------------------------------|
| FCC ID: A3LSMG965U |  | HAC (RF EMISSIONS) TEST REPORT |  | Approved by: Quality Manager |
| Filename: 1M1711060289-13-R1.A3L | Test Dates: 11/06/2017 - 12/11/2017 | DUT Type: Portable Handset | | Page 57 of 108 |

10. LTE TDD UPLINK-DOWNLINK CONFIGURATION

I. Uplink-Downlink Configuration Additional Testing

An investigation was performed on each supported power class for LTE TDD to determine the worst-case Uplink-Downlink configuration for RFE testing.

Per 3GPP TS 36.211, the total frame length for each TDD radio frame of length $T_f = 307200 \cdot T_s = 10$ ms, where T_s is a number of time units equal to $1/(15000 \times 2048)$ seconds. Additionally, each radio frame consists of 10 subframes, each of length $30720 \cdot T_s = 1$ ms, and subframes can be designated as uplink (U), downlink (D), or special subframe (S), depending on the Uplink-Downlink configuration as indicated in Table 4.2-2 of 3GPP TS 36.211. In the transmission duty factor calculation, the special subframe configuration with the shortest UpPTS duration within the special subframe is used and will be applied for measurement. From 3GPP TS 36.211 Table 4.2-1, the shortest UpPTS is $2192 \cdot T_s$ which occurs in the normal cyclic prefix and special subframe configuration 4.

See table below outlining the calculated transmission duty cycles for each Uplink-Downlink configuration:

Table 10-1
Uplink-Downlink Configurations for Type 2 Frame Structures



| Uplink-downlink configuration | Downlink-to-Uplink Switch-point periodicity | Subframe number | | | | | | | | | | Calculated Transmission Duty Cycle (%) |
|-------------------------------|---|-----------------|---|---|---|---|---|---|---|---|---|--|
| | | 0 | 1 | 2 | 3 | 4 | 5 | 6 | 7 | 8 | 9 | |
| 0 | 5 ms | D | S | U | U | U | D | S | U | U | U | 61.4% |
| 1 | 5 ms | D | S | U | U | D | D | S | U | U | D | 41.4% |
| 2 | 5 ms | D | S | U | D | D | D | S | U | D | D | 21.4% |
| 3 | 10 ms | D | S | U | U | U | D | D | D | D | D | 30.7% |
| 4 | 10 ms | D | S | U | U | D | D | D | D | D | D | 20.7% |
| 5 | 10 ms | D | S | U | D | D | D | D | D | D | D | 10.7% |
| 6 | 5 ms | D | S | U | U | U | D | S | U | U | D | 51.4% |

II. Power Class 3 Uplink-Downlink Configuration Additional Testing

Power Class 3 was evaluated with the following radio configuration: channel 40620, 20MHz BW, 16QAM, 1RB, 0RB Offset. For Power Class 3, all configurations (0-6) are supported. The configuration which resulted in the worst-case emissions was used for full testing. See Table 10-2 below for investigation results. The configuration determined in the investigation below was used to measure the MIF values in Table 7-5.

Table 10-2
LTE TDD Power Class 3 UL-DL Configuration Investigation Results

| Mode / Band | Power Class | Bandwidth | Channel | UL-DL Config. | Mod. | RB Size | RB Offset | Scan Center | Time Avg. Field (V/m) | Time Avg. Field [dB(V/m)] | MIF (dB) | Audio Interference Level [dB(V/m)] | FCC Limit (dBV/m) | FCC Margin (dB) | Result | Excl Blocks per 5.5 |
|--------------------------|-------------|-----------|---------|---------------|-------|---------|-----------|-------------|-----------------------|---------------------------|----------|------------------------------------|-------------------|-----------------|--------|---------------------|
| E-Field Emissions | | | | | | | | | | | | | | | | |
| LTE TDD / Band 41 | 3 | 20 | 40620 | 0 | 16QAM | 1 | 0 | Acoustic | 17.64 | 24.93 | -3.17 | 21.76 | 35.00 | -13.24 | M4 | none |
| | | 20 | 40620 | 1 | 16QAM | 1 | 0 | Acoustic | 14.13 | 23.00 | -1.57 | 21.43 | 35.00 | -13.67 | M4 | none |
| | | 20 | 40620 | 2 | 16QAM | 1 | 0 | Acoustic | 10.42 | 20.36 | 1.60 | 21.96 | 35.00 | -13.04 | M4 | none |
| | | 20 | 40620 | 3 | 16QAM | 1 | 0 | Acoustic | 12.96 | 22.25 | -1.29 | 20.96 | 35.00 | -14.04 | M4 | none |
| | | 20 | 40620 | 4 | 16QAM | 1 | 0 | Acoustic | 10.39 | 20.33 | 0.71 | 21.04 | 35.00 | -13.96 | M4 | none |
| | | 20 | 40620 | 5 | 16QAM | 1 | 0 | Acoustic | 7.62 | 17.63 | 3.58 | 21.21 | 35.00 | -13.79 | M4 | none |
| | | 20 | 40620 | 6 | 16QAM | 1 | 0 | Acoustic | 15.70 | 23.92 | -2.45 | 21.47 | 35.00 | -13.53 | M4 | none |

| | | | | |
|-------------------------------------|--|--------------------------------|---|---------------------------------|
| FCC ID: A3LSMG965U |  PCTEST ENGINEERING LABORATORY, INC. | HAC (RF EMISSIONS) TEST REPORT |  | Approved by: Quality Manager |
| Filename: 1M1711060289-13-R1.A3L | Test Dates: 11/06/2017 - 12/11/2017 | DUT Type: Portable Handset | Page 58 of 108 | |

III. Power Class 2 Uplink-Downlink Configuration Additional Testing



Power Class 2 was evaluated with the following radio configuration: channel 40620, 20MHz BW, 16QAM, 1RB, 0RB Offset. For Power Class 2, only configurations 1-5 are supported. The configuration which resulted in the worst-case emissions was used for full testing. See Table 10-3 below for investigation results. The configuration determined in the investigation below was used to measure the MIF values in Table 7-6.

Table 10-3
LTE TDD Power Class 2 UL-DL Configuration Investigation Results

| Mode / Band | Power Class | Bandwidth | Channel | UL-DL Config. | Mod. | RB Size | RB Offset | Scan Center | Time Avg. Field (V/m) | Time Avg. Field [dB(V/m)] | MIF (dB) | Audio Interference Level [dB(V/m)] | FCC Limit (dBV/m) | FCC Margin (dB) | Result | Excl Blocks per 5.5 |
|--------------------------|-------------|-----------|---------|---------------|-------|---------|-----------|-------------|-----------------------|---------------------------|----------|------------------------------------|-------------------|-----------------|--------|---------------------|
| E-Field Emissions | | | | | | | | | | | | | | | | |
| LTE TDD / Band 41 | 2 | 20 | 40620 | 1 | 16QAM | 1 | 0 | Acoustic | 15.61 | 23.87 | -1.55 | 22.32 | 35.00 | -12.68 | M4 | none |
| | | 20 | 40620 | 2 | 16QAM | 1 | 0 | Acoustic | 11.23 | 21.01 | 1.65 | 22.66 | 35.00 | -12.34 | M4 | none |
| | | 20 | 40620 | 3 | 16QAM | 1 | 0 | Acoustic | 13.31 | 22.48 | -1.28 | 21.20 | 35.00 | -13.80 | M4 | none |
| | | 20 | 40620 | 4 | 16QAM | 1 | 0 | Acoustic | 11.24 | 21.02 | 0.75 | 21.77 | 35.00 | -13.23 | M4 | none |
| | | 20 | 40620 | 5 | 16QAM | 1 | 0 | Acoustic | 7.94 | 18.00 | 3.69 | 21.69 | 35.00 | -13.31 | M4 | none |

IV. Conclusion

Per the investigations above, UL-DL Configuration 2 was used for both LTE TDD Power Class 3 and LTE TDD Power Class 2 testing.

| | | | | |
|-------------------------------------|--|--------------------------------|---|---------------------------------|
| FCC ID: A3LSMG965U |  PCTEST TECHNOLOGICAL LABORATORY, INC. | HAC (RF EMISSIONS) TEST REPORT |  | Approved by: Quality Manager |
| Filename: 1M1711060289-13-R1.A3L | Test Dates: 11/06/2017 - 12/11/2017 | DUT Type: Portable Handset | Page 59 of 108 | |

11. OVERALL MEASUREMENT SUMMARY

| | |
|---------|------------|
| FCC ID: | A3LSMG965U |
| S/N: | 37046 |

I. E-FIELD EMISSIONS:

Table 11-1
HAC Data Summary for CDMA E-field

| Mode | Channel | RC/SO | Scan Center | Conducted Power at BS (dBm) | Time Avg. Field (V/m) | Time Avg. Field [dB(V/m)] | MIF (dB) | Audio Interference Level [dB(V/m)] | FCC Limit (dBV/m) | FCC Margin (dB) | Result | Excl Blocks per 5.5 |
|--------------------------|---------|---------|-------------|-----------------------------|-----------------------|---------------------------|----------|------------------------------------|-------------------|-----------------|--------|---------------------|
| E-Field Emissions | | | | | | | | | | | | |
| Cellular CDMA | 564* | RC1/SO3 | Acoustic | 25.06 | 15.84 | 23.99 | 3.07 | 27.06 | 45.00 | -17.94 | M4 | none |
| | 1013 | RC1/SO3 | Acoustic | 24.54 | 14.43 | 23.19 | 3.03 | 26.22 | 45.00 | -18.78 | M4 | none |
| | 384 | RC1/SO3 | Acoustic | 24.69 | 14.44 | 23.19 | 3.04 | 26.23 | 45.00 | -18.77 | M4 | none |
| | 777 | RC1/SO3 | Acoustic | 24.73 | 13.92 | 22.87 | 3.06 | 25.93 | 45.00 | -19.07 | M4 | none |
| PCS CDMA | 25 | RC1/SO3 | Acoustic | 24.17 | 8.77 | 18.86 | 3.06 | 21.92 | 35.00 | -13.08 | M4 | none |
| | 600 | RC1/SO3 | Acoustic | 24.30 | 10.60 | 20.50 | 3.04 | 23.54 | 35.00 | -11.46 | M4 | none |
| | 1175 | RC1/SO3 | Acoustic | 24.22 | 7.63 | 17.65 | 3.06 | 20.71 | 35.00 | -14.29 | M4 | none |

* Note: Cell. CDMA ch.564 is the Part 90S test channel.

Table 11-2
HAC Data Summary for GSM E-field



| Mode | Channel | Scan Center | Conducted Power at BS (dBm) | Time Avg. Field (V/m) | Time Avg. Field [dB(V/m)] | MIF (dB) | Audio Interference Level [dB(V/m)] | FCC Limit (dBV/m) | FCC Margin (dB) | Result | Excl Blocks per 5.5 |
|--------------------------|---------|-------------|-----------------------------|-----------------------|---------------------------|----------|------------------------------------|-------------------|-----------------|--------|---------------------|
| E-Field Emissions | | | | | | | | | | | |
| GSM850 | 128 | Acoustic | 32.86 | 35.17 | 30.92 | 3.56 | 34.48 | 45.00 | -10.52 | M4 | none |
| | 190 | Acoustic | 32.81 | 37.96 | 31.59 | 3.56 | 35.15 | 45.00 | -9.85 | M4 | none |
| | 251 | Acoustic | 32.94 | 34.39 | 30.73 | 3.56 | 34.29 | 45.00 | -10.71 | M4 | none |
| GSM1900 | 512 | Acoustic | 29.65 | 13.31 | 22.48 | 3.56 | 26.04 | 35.00 | -8.96 | M4 | none |
| | 661 | Acoustic | 29.72 | 15.54 | 23.83 | 3.56 | 27.39 | 35.00 | -7.61 | M4 | none |
| | 810 | Acoustic | 29.68 | 12.42 | 21.88 | 3.56 | 25.44 | 35.00 | -9.56 | M4 | none |
| | 661 | T-Coil | 29.72 | 15.54 | 23.83 | 3.56 | 27.39 | 35.00 | -7.61 | M4 | none |

Table 11-3
HAC Data Summary for LTE TDD Power Class 3 E-field

| Mode / Band | Power Class | Bandwidth | Channel | UL-DL Config. | Mod. | RB Size | RB Offset | Scan Center | Conducted Power at BS (dBm) | Time Avg. Field (V/m) | Time Avg. Field [dB(V/m)] | MIF (dB) | Audio Interference Level [dB(V/m)] | FCC Limit (dBV/m) | FCC Margin (dB) | Result | Excl Blocks per 5.5 |
|--------------------------|-------------|-----------|---------|---------------|-------|---------|-----------|-------------|-----------------------------|-----------------------|---------------------------|----------|------------------------------------|-------------------|-----------------|--------|---------------------|
| E-Field Emissions | | | | | | | | | | | | | | | | | |
| LTE TDD / Band 41 | 3 | 20 | 39750 | 2 | 16QAM | 1 | 0 | Acoustic | 23.50 | 8.68 | 18.77 | 1.64 | 20.41 | 35.00 | -14.59 | M4 | none |
| | | 20 | 40185 | 2 | 16QAM | 1 | 0 | Acoustic | 23.50 | 8.89 | 18.98 | 1.62 | 20.60 | 35.00 | -14.40 | M4 | none |
| | | 20 | 40620 | 2 | 16QAM | 1 | 0 | Acoustic | 23.20 | 9.41 | 19.47 | 1.63 | 21.10 | 35.00 | -13.90 | M4 | none |
| | | 20 | 41055 | 2 | 16QAM | 1 | 0 | Acoustic | 23.45 | 8.42 | 18.51 | 1.62 | 20.13 | 35.00 | -14.87 | M4 | none |
| | | 20 | 41490 | 2 | 16QAM | 1 | 0 | Acoustic | 23.50 | 7.71 | 17.74 | 1.63 | 19.37 | 35.00 | -15.63 | M4 | none |

Table 11-4
HAC Data Summary for LTE TDD Power Class 2 E-field

| Mode / Band | Power Class | Bandwidth | Channel | UL-DL Config. | Mod. | RB Size | RB Offset | Scan Center | Conducted Power at BS (dBm) | Time Avg. Field (V/m) | Time Avg. Field [dB(V/m)] | MIF (dB) | Audio Interference Level [dB(V/m)] | FCC Limit (dBV/m) | FCC Margin (dB) | Result | Excl Blocks per 5.5 |
|--------------------------|-------------|-----------|---------|---------------|-------|---------|-----------|-------------|-----------------------------|-----------------------|---------------------------|----------|------------------------------------|-------------------|-----------------|--------|---------------------|
| E-Field Emissions | | | | | | | | | | | | | | | | | |
| LTE TDD / Band 41 | 2 | 5 | 39750 | 2 | 16QAM | 1 | 0 | Acoustic | 26.27 | 9.43 | 19.49 | 1.66 | 21.15 | 35.00 | -13.85 | M4 | none |
| | | 5 | 40185 | 2 | 16QAM | 1 | 0 | Acoustic | 26.47 | 9.56 | 19.60 | 1.67 | 21.27 | 35.00 | -13.73 | M4 | none |
| | | 5 | 40620 | 2 | 16QAM | 1 | 0 | Acoustic | 26.49 | 10.10 | 20.08 | 1.67 | 21.75 | 35.00 | -13.25 | M4 | none |
| | | 5 | 41055 | 2 | 16QAM | 1 | 0 | Acoustic | 26.12 | 8.70 | 18.79 | 1.65 | 20.44 | 35.00 | -14.56 | M4 | none |
| | | 5 | 41490 | 2 | 16QAM | 1 | 0 | Acoustic | 26.02 | 8.00 | 18.06 | 1.65 | 19.71 | 35.00 | -15.29 | M4 | none |

| | | | | |
|-------------------------------------|---|--------------------------------|---|---------------------------------|
| FCC ID: A3LSMG965U |  | HAC (RF EMISSIONS) TEST REPORT |  | Approved by: Quality Manager |
| Filename: 1M1711060289-13-R1.A3L | Test Dates: 11/06/2017 - 12/11/2017 | DUT Type: Portable Handset | Page 60 of 108 | |

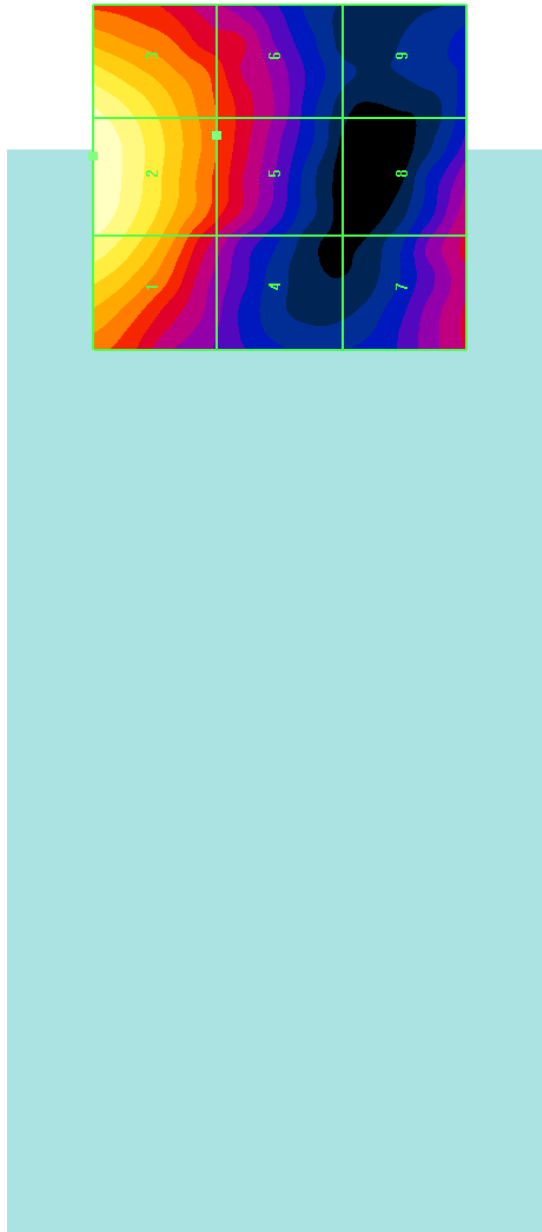



Figure 11-1
 Sample E-field Scan Overlay
 (See Test Setup Photographs for actual WD overlay)

| | | | | |
|-------------------------------------|---|--------------------------------|---|---------------------------------|
| FCC ID: A3LSMG965U |  | HAC (RF EMISSIONS) TEST REPORT |  | Approved by: Quality Manager |
| Filename: 1M1711060289-13-R1.A3L | Test Dates: 11/06/2017 - 12/11/2017 | DUT Type: Portable Handset | Page 61 of 108 | |

| | |
|---------|------------|
| FCC ID: | A3LSMG965U |
| S/N: | 37046 |



II. Worst-case Configuration Evaluation

Table 11-5
Peak Reading 360° Probe Rotation at Azimuth axis

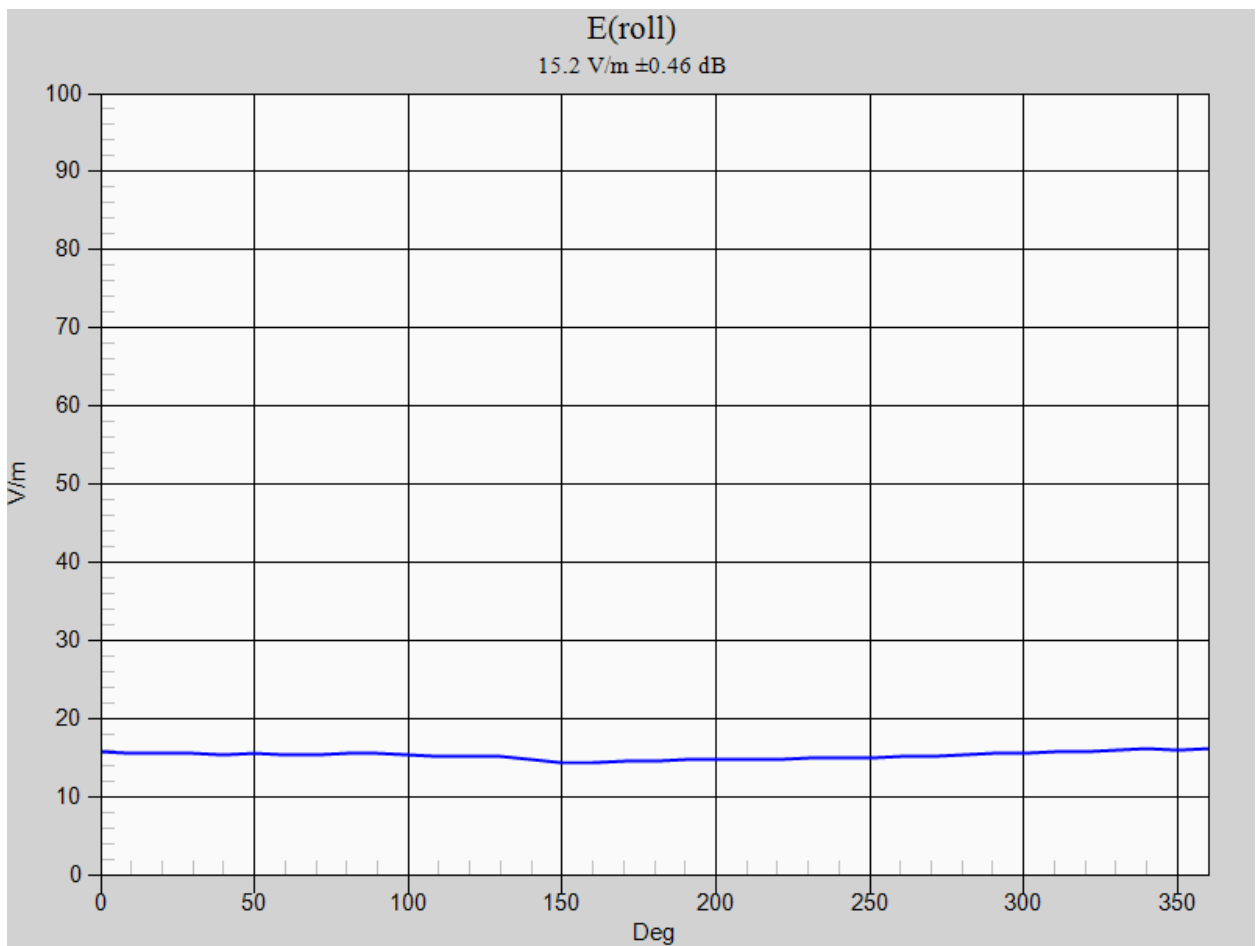
| Mode | Channel | Scan Center | Time Avg. Field (V/m) | Time Avg. Field [dB(V/m)] | MIF (dB) | Audio Interference Level [dB(V/m)] | FCC Limit (dBV/m) | FCC Margin (dB) | Result | Excl Blocks per 5.5 |
|-------------------------------------|---------|-------------|-----------------------|---------------------------|----------|------------------------------------|-------------------|-----------------|--------|---------------------|
| Probe Rotation at Worst-Case | | | | | | | | | | |
| GSM1900 | 661 | Acoustic | 16.05 | 24.11 | 3.56 | 27.67 | 35.00 | -7.33 | M4 | none |



* Note: Locations of probe rotation (with and without exclusions) are shown in Figure 11-1 denoted by the green square markers.

| | | | | |
|-------------------------------------|---|---------------------------------------|---|---------------------------------|
| FCC ID: A3LSMG965U |  PCTEST ENGINEERING LABORATORY, INC. | HAC (RF EMISSIONS) TEST REPORT |  | Approved by: Quality Manager |
| Filename: 1M1711060289-13-R1.A3L | Test Dates: 11/06/2017 - 12/11/2017 | DUT Type: Portable Handset | Page 62 of 108 | |



12. EQUIPMENT LIST

Table 12-1
Equipment List

| Manufacturer | Model | Description | Cal Date | Cal Interval | Cal Due | Serial Number |
|--------------------|-----------|-----------------------------------|------------|--------------|------------|---------------|
| Agilent | E4438C | ESG Vector Signal Generator | 3/24/2017 | Biennial | 3/24/2019 | MY42082385 |
| Agilent | E4432B | ESG-D Series Signal Generator | 3/24/2017 | Annual | 3/24/2018 | US40053896 |
| Agilent | N5182A | MXG Vector Signal Generator | 2/28/2017 | Annual | 2/28/2018 | MY47420800 |
| Amplifier Research | 15S1G6 | Amplifier | N/A | CBT* | N/A | 433978 |
| Anritsu | ML2496A | Power Meter | 4/20/2017 | Annual | 4/20/2018 | 1306009 |
| Anritsu | MA2411B | Pulse Power Sensor | 2/10/2017 | Annual | 2/10/2018 | 1207364 |
| Anritsu | MA2411B | Pulse Power Sensor | 2/10/2017 | Annual | 2/10/2018 | 1339018 |
| Anritsu | MA24106A | USB Power Sensor | 6/7/2017 | Annual | 6/7/2018 | 1244512 |
| Anritsu | MA24106A | USB Power Sensor | 6/7/2017 | Annual | 6/7/2018 | 1248508 |
| Anritsu | MT8821C | Radio Communication Analyzer | 8/15/2017 | Annual | 8/15/2018 | 6200901190 |
| Mini-Circuits | NLP-1200+ | Low Pass Filter DC to 1000 MHz | N/A | CBT* | N/A | N/A |
| Mini-Circuits | NLP-2950+ | Low Pass Filter DC to 2700 MHz | N/A | CBT* | N/A | N/A |
| Mini-Circuits | BW-N20W5 | Power Attenuator | N/A | CBT* | N/A | 1226 |
| Pasternack | PE2237-20 | Bidirectional Coupler | N/A | CBT* | N/A | N/A |
| Rohde & Schwarz | CMU200 | Base Station Simulator | 4/11/2017 | Annual | 4/11/2018 | 836371/0079 |
| Rohde & Schwarz | CMU200 | Base Station Simulator | 12/12/2016 | Annual | 12/12/2017 | 833855/0010 |
| Rohde & Schwarz | CMW500 | Radio Communication Tester | 4/12/2017 | Annual | 4/12/2018 | 128635 |
| Seekonk | NC-100 | Torque Wrench (8" lb) | 9/1/2016 | Biennial | 9/1/2018 | 21053 |
| SPEAG | AIA | Audio Interference Analyzer | N/A | CBT* | N/A | 1010 |
| SPEAG | DAE4 | Dasy Data Acquisition Electronics | 5/17/2017 | Annual | 5/17/2018 | 859 |
| SPEAG | CD1880V3 | Freespace 1880 MHz Dipole | 5/12/2016 | Biennial | 5/12/2018 | 1064 |
| SPEAG | CD2600V3 | Freespace 2600 MHz Dipole | 6/14/2017 | Biennial | 6/14/2019 | 1013 |
| SPEAG | CD835V3 | Freespace 835 MHz Dipole | 5/10/2016 | Biennial | 5/10/2018 | 1082 |
| SPEAG | ER3DV6 | Freespace E-field Probe | 1/16/2017 | Annual | 1/16/2018 | 2353 |

Calibration traceable to the National Institute of Standards and Technology (NIST).

***Note: CBT (Calibrated Before Testing).** Prior to testing, the measurement paths containing a cable, attenuator, coupler or filter were connected to a calibrated source (i.e. a signal generator) to determine the losses of the measurement path. The power meter offset was then adjusted to compensate for the measurement system losses. This level offset is stored within the power meter before measurements are made. This calibration verification procedure applies to the system verification and output power measurements. The calibrated reading is then taken directly from the power meter after compensation of the losses for all final power measurements.

| | | | | |
|-------------------------------------|---|--------------------------------|---|---------------------------------|
| FCC ID: A3LSMG965U |  PCTEST TECHNOLOGICAL CORPORATION, INC. | HAC (RF EMISSIONS) TEST REPORT |  | Approved by: Quality Manager |
| Filename: 1M1711060289-13-R1.A3L | Test Dates: 11/06/2017 - 12/11/2017 | DUT Type: Portable Handset | Page 63 of 108 | |

© 2017 PCTEST Engineering Laboratory, Inc.

REV 3.1.M
09/14/2017

© 2017 PCTEST Engineering Laboratory, Inc. All rights reserved. Unless otherwise specified, no part of this report may be reproduced or utilized in any part, form or by any means, electronic or mechanical, including photocopying and microfilm, without permission in writing from PCTEST Engineering Laboratory, Inc. If you have any questions about this international copyright or have an enquiry about obtaining additional rights to this report or assembly of contents thereof, please contact INFO@PCTEST.COM.

13. MEASUREMENT UNCERTAINTY



Table 13-1
Uncertainty Estimation Table

| Wireless Communications Device Near-Field Measurement Uncertainty Estimation | | | | | | | |
|---|-----------|-----------|-------------|---------|--------|-----------|---------------------------------|
| Uncertainty Component | Data (dB) | Data Type | Prob. Dist. | Divisor | Ci (E) | Unc. (dB) | Notes/Comments |
| Measurement System | | | | | | | |
| RF System Reflections | 0.50 | Tolerance | N | 1.00 | 1 | 0.50 | * Refl. < -20 dB |
| Field Probe Calibration | 0.21 | Tolerance | N | 1.00 | 1 | 0.21 | |
| Field Probe Isotropy | 0.01 | Tolerance | N | 1.00 | 1 | 0.01 | |
| Field Probe Frequency Response | 0.135 | Tolerance | N | 1.00 | 1 | 0.14 | |
| Field Probe Linearity | 0.013 | Tolerance | N | 1.00 | 1 | 0.01 | |
| Modulation Interference Factor | 0.20 | Tolerance | R | 1.73 | 1 | 0.12 | Applicable for M-rating testing |
| Boundary Effects | 0.105 | Accuracy | R | 1.73 | 1 | 0.06 | * |
| Probe Positioning Accuracy | 0.20 | Accuracy | R | 1.73 | 1 | 0.12 | * |
| Probe Positioner | 0.050 | Accuracy | R | 1.73 | 1 | 0.03 | * |
| Extrapolation/Interpolation | 0.045 | Tolerance | R | 1.73 | 1 | 0.03 | * |
| Resolution to 2mm error | 0.21 | Tolerance | N | 1.00 | 1 | 0.21 | |
| System Detection Limit | 0.05 | Tolerance | R | 1.73 | 1 | 0.03 | * |
| Readout Electronics | 0.015 | Tolerance | N | 1.00 | 1 | 0.02 | * |
| Integration Time | 0.11 | Tolerance | R | 1.73 | 1 | 0.06 | * |
| Response Time | 0.033 | Tolerance | R | 1.73 | 1 | 0.02 | * |
| Phantom Thickness | 0.10 | Tolerance | R | 1.73 | 1 | 0.06 | * |
| System Repeatability (Field x 2=power) | 0.17 | Tolerance | N | 1.00 | 1 | 0.17 | * |
| Test Sample Related | | | | | | | |
| Device Positioning Vertical | 0.2 | Tolerance | R | 1.73 | 1 | 0.12 | * |
| Device Positioning Lateral | 0.045 | Tolerance | R | 1.73 | 1 | 0.03 | * |
| Device Holder and Phantom | 0.1 | Tolerance | R | 1.73 | 1 | 0.06 | * |
| Power Drift | 0.21 | Tolerance | R | 1.73 | 1 | 0.12 | |
| <i>Combined Standard Uncertainty (k=1)</i> | | | | | | 0.66 | 16.3% |
| <i>Expanded Uncertainty [95% confidence]</i> | | | | | | 1.31 | 32.6% |
| <i>Expanded Uncertainty [95% confidence] on Field</i> | | | | | | 0.66 | 16.3% |

Notes:



1. Test equipments are calibrated according to techniques outlined in NIS81, NIS3003 and NIST Tech Note 1297. All equipments have traceability according to NIST. Measurement Uncertainties are defined in further detail in NIS 81 and NIST Tech Note 1297 and UKAS M3003.
2. * Uncertainty specifications from Schmidt & Partner Engineering AG (not site specific)

Measurement uncertainty reflects the quality and accuracy of a measured result as compared to the true value. Such statements are generally required when stating results of measurements so that it is clear to the intended audience that the results may differ when reproduced by different facilities. Measurement results vary due to the measurement uncertainty of the instrumentation, measurement technique, and test engineer. Most uncertainties are calculated using the tolerances of the instrumentation used in the measurement, the measurement setup variability, and the technique used in performing the test. While not generally included, the variability of the equipment under test also figures into the overall measurement uncertainty. Another component of the overall uncertainty is based on the variability of repeated measurements (so-called Type A uncertainty). This may mean that the Hearing Aid immunity tests may have to be repeated by taking down the test setup and resetting it up so that there are a statistically significant number of repeat measurements to identify the measurement uncertainty. By combining the repeat measurement results with that of the instrumentation chain using the technique contained in NIS 81 and NIS 3003, the overall measurement uncertainty was estimated.

| | | | | |
|-------------------------------------|--|--------------------------------|---|---------------------------------|
| FCC ID: A3LSMG965U |  PCTEST TECHNOLOGICAL LABORATORY, INC. | HAC (RF EMISSIONS) TEST REPORT |  | Approved by: Quality Manager |
| Filename: 1M1711060289-13-R1.A3L | Test Dates: 11/06/2017 - 12/11/2017 | DUT Type: Portable Handset | Page 64 of 108 | |

14. TEST DATA

See following Attached Pages for Test Data.

| | | | | |
|--|---|---------------------------------------|---|--|
| FCC ID: A3LSMG965U |  | HAC (RF EMISSIONS) TEST REPORT |  | Approved by: Quality Manager |
| Filename: 1M1711060289-13-R1.A3L | Test Dates: 11/06/2017 - 12/11/2017 | DUT Type: Portable Handset | Page 65 of 108 | |

© 2017 PCTEST Engineering Laboratory, Inc.

REV 3.1.M

09/14/2017

© 2017 PCTEST Engineering Laboratory, Inc. All rights reserved. Unless otherwise specified, no part of this report may be reproduced or utilized in any part, form or by any means, electronic or mechanical, including photocopying and microfilm, without permission in writing from PCTEST Engineering Laboratory, Inc. If you have any questions about this international copyright or have an enquiry about obtaining additional rights to this report or assembly of contents thereof, please contact INFO@PCTEST.COM.



DUT: CD835V3 - SN1082

Type: CD835V3
Serial: 1082

Communication System: CW; Frequency: 835 MHz;

Measurement Standard: DASYS (IEEE/IEC/ANSI C63.19-2011)

DASY5 Configuration:

- Probe: ER3DV6 - SN2353; Calibrated: 1/16/2017;
- Sensor-Surface: 0mm (Fix Surface)
- Electronics: DAE4 Sn859; Calibrated: 5/17/2017
- Phantom: HAC Test Arch with AMCC; Type: SD HAC P01 BA;
- Measurement SW: DASY52, Version 52.10 (0);

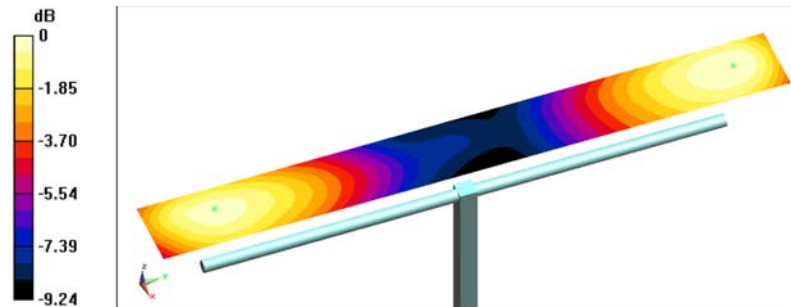

835 MHz / 100mW HAC Dipole Validation at 15mm/Hearing Aid Compatibility Test (41x361x1):

Interpolated grid: dx=0.5000 mm, dy=0.5000 mm
 Device Reference Point: 0, 0, -6.3 mm
 Reference Value = 120.4 V/m; Power Drift = -0.05 dB
 Applied MIF = 0.00 dB
 Average Value of Peak (interpolated) = 111.6 V/m



0 dB = 113.3 V/m = 41.08 dBV/m

PCTEST 2017

| | | | | |
|-------------------------------------|---|--------------------------------|---|---------------------------------|
| FCC ID: A3LSMG965U |  | HAC (RF EMISSIONS) TEST REPORT |  | Approved by: Quality Manager |
| Filename: 1M1711060289-13-R1.A3L | Test Dates: 11/06/2017 - 12/11/2017 | DUT Type: Portable Handset | Page 66 of 108 | |

© 2017 PCTEST Engineering Laboratory, Inc.

REV 3.1.M

09/14/2017

PCTEST Hearing-Aid Compatibility Facility

DUT: CD1880V3 - SN1064

Type: CD1880V3
Serial: 1064

Communication System: CW; Frequency: 1880 MHz;

Measurement Standard: DASYS (IEEE/IEC/ANSI C63.19-2011)

DASYS Configuration:



- Probe: ER3DV6 - SN2353; Calibrated: 1/16/2017;
- Sensor-Surface: 0mm (Fix Surface)
- Electronics: DAE4 Sn859; Calibrated: 7/21/2009
- Phantom: HAC Test Arch with AMCC; Type: SD HAC P01 BA;
- Measurement SW: DASYS2, Version 52.10 (0);

1880 MHz / 100mW HAC Dipole Validation at 15mm/Hearing Aid Compatibility Test (41x181x1):

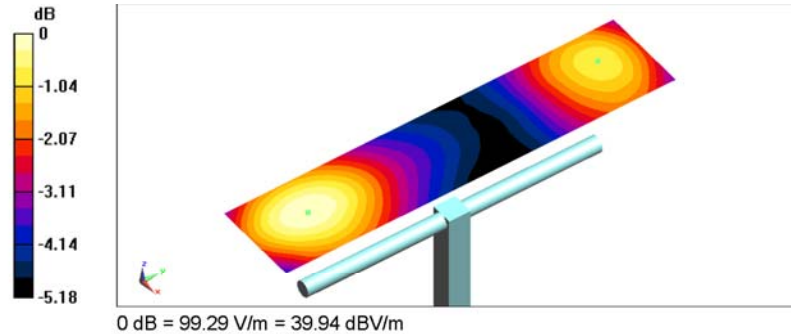
Interpolated grid: dx=0.5000 mm, dy=0.5000 mm
 Device Reference Point: 0, 0, -6.3 mm
 Reference Value = 161.3 V/m; Power Drift = 0.03 dB
 Applied MIF = 0.00 dB
 Average Value of Peak (interpolated) = 95.3 V/m



PCTEST 2017

| | | | | |
|--|---|---------------------------------------|---|--|
| FCC ID: A3LSMG965U |  | HAC (RF EMISSIONS) TEST REPORT |  | Approved by: Quality Manager |
| Filename: 1M1711060289-13-R1.A3L | Test Dates: 11/06/2017 - 12/11/2017 | DUT Type: Portable Handset | Page 67 of 108 | |

© 2017 PCTEST Engineering Laboratory, Inc.

REV 3.1.M

09/14/2017



DUT: CD2600V3 - SN1013

Type: CD2600V3
Serial: 1013

Communication System: CW; Frequency: 2600 MHz;

Measurement Standard: DASYS (IEEE/EC/ANSI C63.19-2011)

DASYS Configuration:



- Probe: ER3DV6 - SN2353; Calibrated: 1/16/2017;
- Sensor-Surface: 0mm (Fix Surface)
- Electronics: DAE4 Sn859; Calibrated: 7/21/2009
- Phantom: HAC Test Arch with AMCC; Type: SD HAC P01 BA;
- Measurement SW: DASYS2, Version 52.10 (0);

2600 MHz / 100mW HAC Dipole Validation at 15mm/Hearing Aid Compatibility Test (41x181x1):

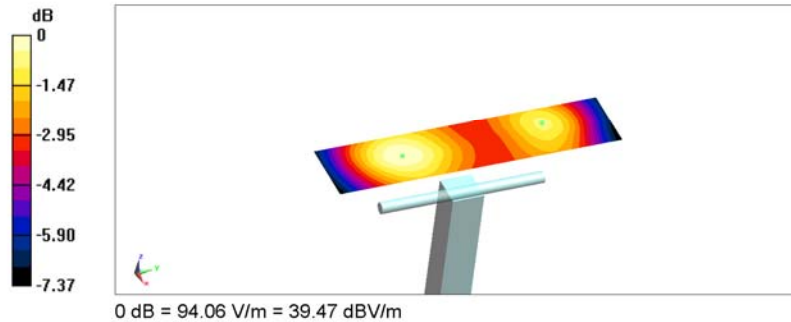
Interpolated grid: dx=0.5000 mm, dy=0.5000 mm
 Device Reference Point: 0, 0, -6.3 mm
 Reference Value = 68.38 V/m; Power Drift = 0.01 dB
 Applied MIF = 0.00 dB
 Average Value of Peak (interpolated) = 89.7 V/m



PCTEST 2017

| | | | | |
|-------------------------------------|---|--------------------------------|---|---------------------------------|
| FCC ID: A3LSMG965U |  | HAC (RF EMISSIONS) TEST REPORT |  | Approved by: Quality Manager |
| Filename: 1M1711060289-13-R1.A3L | Test Dates: 11/06/2017 - 12/11/2017 | DUT Type: Portable Handset | Page 68 of 108 | |

© 2017 PCTEST Engineering Laboratory, Inc.

REV 3.1.M

09/14/2017

**DUT: A3LSMG965U**

Type: Portable Handset
Serial: 37046
Backlight off
Duty Cycle: 1:8

Communication System: CDMA; Frequency: 820.1 MHz;

Measurement Standard: DASYS (IEEE/EC/ANSI C63.19-2011)

DASY5 Configuration:

- Probe: ER3DV6 - SN2353; Calibrated: 1/16/2017;
- Sensor-Surface: (Fix Surface)
- Electronics: DAE4 Sn859; Calibrated: 5/17/2017
- Phantom: HAC Test Arch with AMCC; Type: SD HAC P01 BA;
- Measurement SW: DASY52, Version 52.10 (0);

Extended Cellular CDMA Mid Channel / Hearing Aid Compatibility Test (101x101x1):

Interpolated grid: dx=0.5000 mm, dy=0.5000 mm
Device Reference Point: 0, 0, -6.3 mm
Reference Value = 20.01 V/m; Power Drift = -0.07 dB
Applied MIF = 3.07 dB
RF audio interference level = 27.06 dBV/m
Emission category: M4

MIF scaled E-field

| | | |
|--|--|--|
| Grid 1 M4 23.95 dBV/m | Grid 2 M4 26.56 dBV/m | Grid 3 M4 26.56 dBV/m |
| Grid 4 M4 24.84 dBV/m | Grid 5 M4 27.05 dBV/m | Grid 6 M4 27.02 dBV/m |
| Grid 7 M4 25.77 dBV/m | Grid 8 M4 27.06 dBV/m | Grid 9 M4 27.04 dBV/m |

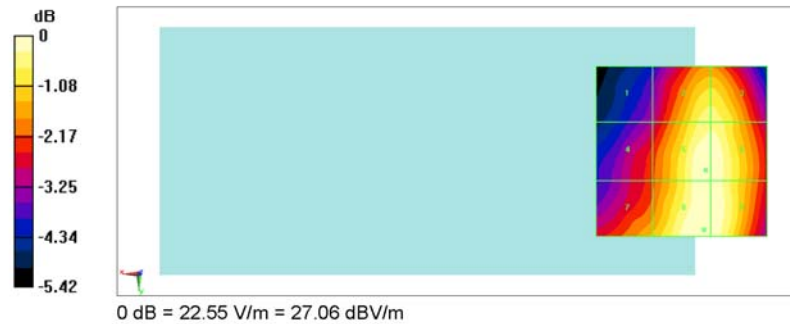

PCTEST 2017

| | | | | |
|--|---|---------------------------------------|----------------|--|
| FCC ID: A3LSMG965U | PCTEST ENGINEERING LABORATORY, INC. | HAC (RF EMISSIONS) TEST REPORT | SAMSUNG | Approved by: Quality Manager |
| Filename: 1M1711060289-13-R1.A3L | Test Dates: 11/06/2017 - 12/11/2017 | DUT Type: Portable Handset | Page 69 of 108 | |

© 2017 PCTEST Engineering Laboratory, Inc.

REV 3.1.M

09/14/2017

© 2017 PCTEST Engineering Laboratory, Inc. All rights reserved. Unless otherwise specified, no part of this report may be reproduced or utilized in any part, form or by any means, electronic or mechanical, including photocopying and microfilm, without permission in writing from PCTEST Engineering Laboratory, Inc. If you have any questions about this international copyright or have an enquiry about obtaining additional rights to this report or assembly of contents thereof, please contact INFO@PCTEST.COM.

**DUT: A3LSMG965U**

Type: Portable Handset
Serial: 37046
Backlight off
Duty Cycle: 1:8

Communication System: CDMA; Frequency: 1880 MHz;

Measurement Standard: DASYS (IEEE/EC/ANSI C63.19-2011)

DASYS Configuration:

- Probe: ER3DV6 - SN2353; Calibrated: 1/16/2017;
- Sensor-Surface: (Fix Surface)
- Electronics: DAE4 Sn859; Calibrated: 5/17/2017
- Phantom: HAC Test Arch with AMCC; Type: SD HAC P01 BA;
- Measurement SW: DASYS2, Version 52.10 (0);

PCS CDMA Mid Channel / Hearing Aid Compatibility Test (101x101x1):

Interpolated grid: dx=0.5000 mm, dy=0.5000 mm
Device Reference Point: 0, 0, -6.3 mm
Reference Value = 6.997 V/m; Power Drift = 0.03 dB
Applied MIF = 3.04 dB
RF audio interference level = 23.54 dBV/m
Emission category: M4

MIF scaled E-field

| | | |
|--|--|--|
| Grid 1 M4 22.62 dBV/m | Grid 2 M4 23.54 dBV/m | Grid 3 M4 22.01 dBV/m |
| Grid 4 M4 19.27 dBV/m | Grid 5 M4 19.65 dBV/m | Grid 6 M4 19.51 dBV/m |
| Grid 7 M4 20.04 dBV/m | Grid 8 M4 18.79 dBV/m | Grid 9 M4 17.76 dBV/m |

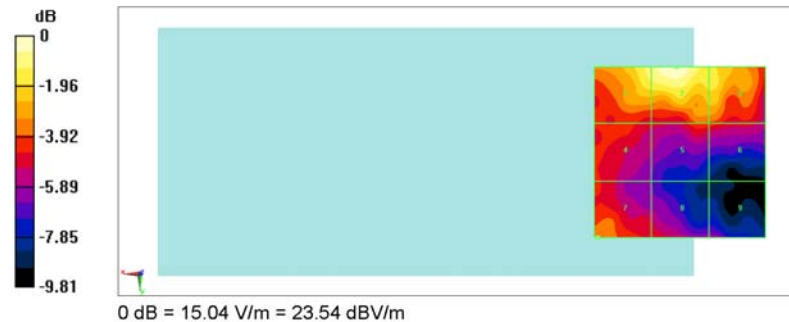

PCTEST 2017

| | | | |
|--|---|---------------------------------------|--|
| FCC ID: A3LSMG965U | PCTEST ENGINEERING LABORATORY, INC. | HAC (RF EMISSIONS) TEST REPORT | Approved by: Quality Manager |
| Filename: 1M1711060289-13-R1.A3L | Test Dates: 11/06/2017 - 12/11/2017 | DUT Type: Portable Handset | Page 70 of 108 |

© 2017 PCTEST Engineering Laboratory, Inc.

REV 3.1.M

09/14/2017

© 2017 PCTEST Engineering Laboratory, Inc. All rights reserved. Unless otherwise specified, no part of this report may be reproduced or utilized in any part, form or by any means, electronic or mechanical, including photocopying and microfilm, without permission in writing from PCTEST Engineering Laboratory, Inc. If you have any questions about this international copyright or have an enquiry about obtaining additional rights to this report or assembly of contents thereof, please contact INFO@PCTEST.COM.

**DUT: A3LSMG965U**

Type: Portable Handset
Serial: 37046
Backlight off
Duty Cycle: 1:8.3

Communication System: GSM; Frequency: 836.6 MHz;

Measurement Standard: DASYS (IEEE/EC/ANSI C63.19-2011)

DASY5 Configuration:

- Probe: ER3DV6 - SN2353; Calibrated: 1/16/2017;
- Sensor-Surface: (Fix Surface)
- Electronics: DAE4 Sn859; Calibrated: 5/17/2017
- Phantom: HAC Test Arch with AMCC; Type: SD HAC P01 BA;
- Measurement SW: DASY52, Version 52.10 (0);

GSM850 Mid Channel / Hearing Aid Compatibility Test (101x101x1):

Interpolated grid: dx=0.5000 mm, dy=0.5000 mm
Device Reference Point: 0, 0, -6.3 mm
Reference Value = 42.40 V/m; Power Drift = 0.07 dB
Applied MIF = 3.56 dB
RF audio interference level = 35.15 dBV/m
Emission category: M4

MIF scaled E-field

| | | |
|--|--|--|
| Grid 1 M4 32.95 dBV/m | Grid 2 M4 33.84 dBV/m | Grid 3 M4 33.65 dBV/m |
| Grid 4 M4 33.67 dBV/m | Grid 5 M4 34.51 dBV/m | Grid 6 M4 34.4 dBV/m |
| Grid 7 M4 34.54 dBV/m | Grid 8 M4 35.15 dBV/m | Grid 9 M4 34.94 dBV/m |

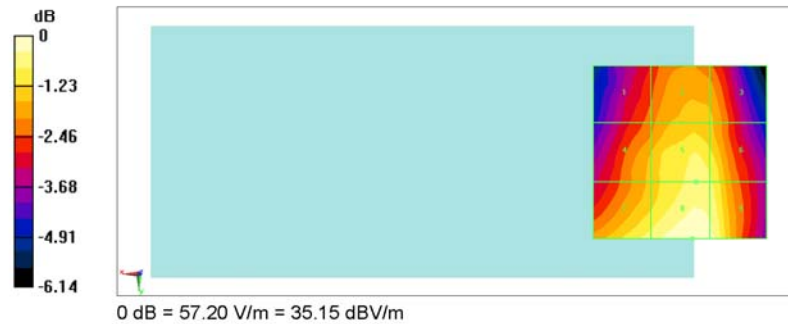

PCTEST 2017

| | | | | |
|--|---|---------------------------------------|----------------|--|
| FCC ID: A3LSMG965U | PCTEST ENGINEERING LABORATORY, INC. | HAC (RF EMISSIONS) TEST REPORT | SAMSUNG | Approved by: Quality Manager |
| Filename: 1M1711060289-13-R1.A3L | Test Dates: 11/06/2017 - 12/11/2017 | DUT Type: Portable Handset | Page 71 of 108 | |

© 2017 PCTEST Engineering Laboratory, Inc.

REV 3.1.M

09/14/2017

© 2017 PCTEST Engineering Laboratory, Inc. All rights reserved. Unless otherwise specified, no part of this report may be reproduced or utilized in any part, form or by any means, electronic or mechanical, including photocopying and microfilm, without permission in writing from PCTEST Engineering Laboratory, Inc. If you have any questions about this international copyright or have an enquiry about obtaining additional rights to this report or assembly of contents thereof, please contact INFO@PCTEST.COM.

**DUT: A3LSMG965U**

Type: Portable Handset
Serial: 37046
Backlight off
Duty Cycle: 1:8.3

Communication System: GSM; Frequency: 1880 MHz;

Measurement Standard: DASYS (IEEE/IEC/ANSI C63.19-2011)

DASYS Configuration:

- Probe: ER3DV6 - SN2353; Calibrated: 1/16/2017;
- Sensor-Surface: (Fix Surface)
- Electronics: DAE4 Sn859; Calibrated: 5/17/2017
- Phantom: HAC Test Arch with AMCC; Type: SD HAC P01 BA;
- Measurement SW: DASYS2, Version 52.10 (0);

GSM1900 Mid Channel / Hearing Aid Compatibility Test (101x101x1):

Interpolated grid: dx=0.5000 mm, dy=0.5000 mm
Device Reference Point: 0, 0, -6.3 mm
Reference Value = 10.24 V/m; Power Drift = -0.05 dB
Applied MIF = 3.56 dB
RF audio interference level = 27.39 dBV/m
Emission category: M4

MIF scaled E-field

| | | |
|--|--|--|
| Grid 1 M4 26.83 dBV/m | Grid 2 M4 27.39 dBV/m | Grid 3 M4 27.01 dBV/m |
| Grid 4 M4 22.3 dBV/m | Grid 5 M4 23.67 dBV/m | Grid 6 M4 23.63 dBV/m |
| Grid 7 M4 22.59 dBV/m | Grid 8 M4 22.51 dBV/m | Grid 9 M4 20.42 dBV/m |



PCTEST 2017

| | | | | |
|--|---|---------------------------------------|----------------|--|
| FCC ID: A3LSMG965U | PCTEST ENGINEERING LABORATORY, INC. | HAC (RF EMISSIONS) TEST REPORT | SAMSUNG | Approved by: Quality Manager |
| Filename: 1M1711060289-13-R1.A3L | Test Dates: 11/06/2017 - 12/11/2017 | DUT Type: Portable Handset | Page 72 of 108 | |

© 2017 PCTEST Engineering Laboratory, Inc.

REV 3.1.M

09/14/2017

© 2017 PCTEST Engineering Laboratory, Inc. All rights reserved. Unless otherwise specified, no part of this report may be reproduced or utilized in any part, form or by any means, electronic or mechanical, including photocopying and microfilm, without permission in writing from PCTEST Engineering Laboratory, Inc. If you have any questions about this international copyright or have an enquiry about obtaining additional rights to this report or assembly of contents thereof, please contact INFO@PCTEST.COM.



PCTEST Hearing-Aid Compatibility Facility

DUT: A3LSMG965U

Type: Portable Handset
Serial: 37046
Backlight off
Duty Cycle: 1:4.67

Communication System: LTE TDD41; Frequency: 2593 MHz;

Measurement Standard: DASYS (IEEE/IEC/ANSI C63.19-2011)

DASYS Configuration:

- Probe: ER3DV6 - SN2353; Calibrated: 1/16/2017;
- Sensor-Surface: (Fix Surface)
- Electronics: DAE4 Sn859; Calibrated: 5/17/2017
- Phantom: HAC Test Arch with AMCC; Type: SD HAC P01 BA;
- Measurement SW: DASYS2, Version 52.10 (0);

Power Class 3 TDD LTE Band 41 Mid Channel, 20MHz BW, 16QAM, 1RB, 0 RB Offset

Hearing Aid Compatibility Test (101x101x1):

Interpolated grid: dx=0.5000 mm, dy=0.5000 mm
Device Reference Point: 0, 0, -6.3 mm
Reference Value = 8.576 V/m; Power Drift = -0.09 dB
Applied MIF = 1.63 dB
RF audio interference level = 21.10 dBV/m
Emission category: M4

MIF scaled E-field

| | | |
|--|--|--|
| Grid 1 M4 20.92 dBV/m | Grid 2 M4 21.1 dBV/m | Grid 3 M4 21.02 dBV/m |
| Grid 4 M4 18.66 dBV/m | Grid 5 M4 20.42 dBV/m | Grid 6 M4 20.43 dBV/m |
| Grid 7 M4 16.44 dBV/m | Grid 8 M4 17.7 dBV/m | Grid 9 M4 17.55 dBV/m |

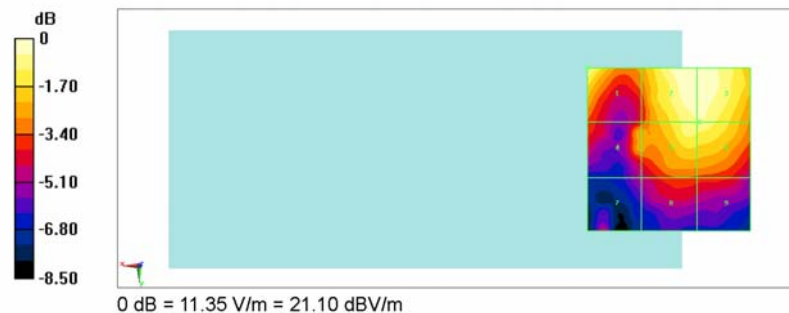

PCTEST 2017

| | | | | |
|--|---|---------------------------------------|----------------|--|
| FCC ID: A3LSMG965U | PCTEST ENGINEERING LABORATORY, INC. | HAC (RF EMISSIONS) TEST REPORT | SAMSUNG | Approved by: Quality Manager |
| Filename: 1M1711060289-13-R1.A3L | Test Dates: 11/06/2017 - 12/11/2017 | DUT Type: Portable Handset | Page 73 of 108 | |

© 2017 PCTEST Engineering Laboratory, Inc.

REV 3.1.M
09/14/2017



DUT: A3LSMG965U

Type: Portable Handset
 Serial: 37046
 Backlight off
 Duty Cycle: 1:4.67

Communication System: LTE TDD41; Frequency: 2593 MHz;

Measurement Standard: DASYS (IEEE/IEC/ANSI C63.19-2011)

DASY5 Configuration:

- Probe: ER3DV6 - SN2353; Calibrated: 1/16/2017;
- Sensor-Surface: (Fix Surface)
- Electronics: DAE4 Sn859; Calibrated: 5/17/2017
- Phantom: HAC Test Arch with AMCC; Type: SD HAC P01 BA;
- Measurement SW: DASY52, Version 52.10 (0);

Power Class 2 TDD LTE Band 41 Mid Channel, 5MHz BW, 16QAM, 1RB, 0 RB Offset

Hearing Aid Compatibility Test (101x101x1):

Interpolated grid: dx=0.5000 mm, dy=0.5000 mm
 Device Reference Point: 0, 0, -6.3 mm
 Reference Value = 9.502 V/m; Power Drift = -0.14 dB
 Applied MIF = 1.67 dB
 RF audio interference level = 21.75 dBV/m
Emission category: M4

MIF scaled E-field

| | | |
|--|--|--|
| Grid 1 M4 20.67 dBV/m | Grid 2 M4 21.75 dBV/m | Grid 3 M4 21.73 dBV/m |
| Grid 4 M4 17.02 dBV/m | Grid 5 M4 20.64 dBV/m | Grid 6 M4 20.64 dBV/m |
| Grid 7 M4 14.66 dBV/m | Grid 8 M4 17.43 dBV/m | Grid 9 M4 17.07 dBV/m |

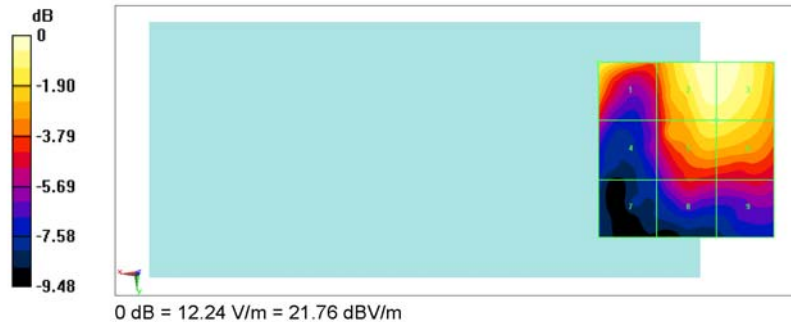

PCTEST 2017

| | | | | |
|--|---|---------------------------------------|----------------|--|
| FCC ID: A3LSMG965U | PCTEST ENGINEERING LABORATORY, INC. | HAC (RF EMISSIONS) TEST REPORT | SAMSUNG | Approved by: Quality Manager |
| Filename: 1M1711060289-13-R1.A3L | Test Dates: 11/06/2017 - 12/11/2017 | DUT Type: Portable Handset | Page 74 of 108 | |



© 2017 PCTEST Engineering Laboratory, Inc.

REV 3.1.M

09/14/2017

15. CALIBRATION CERTIFICATES

The following pages include the probe calibration used to evaluate HAC for the DUT.

| | | | | |
|--|---|---------------------------------------|---|--|
| FCC ID: A3LSMG965U |  PCTEST ENGINEERING LABORATORY, INC. | HAC (RF EMISSIONS) TEST REPORT |  | Approved by: Quality Manager |
| Filename: 1M1711060289-13-R1.A3L | Test Dates: 11/06/2017 - 12/11/2017 | DUT Type: Portable Handset | Page 75 of 108 | |

© 2017 PCTEST Engineering Laboratory, Inc.

REV 3.1.M

09/14/2017

© 2017 PCTEST Engineering Laboratory, Inc. All rights reserved. Unless otherwise specified, no part of this report may be reproduced or utilized in any part, form or by any means, electronic or mechanical, including photocopying and microfilm, without permission in writing from PCTEST Engineering Laboratory, Inc. If you have any questions about this international copyright or have an enquiry about obtaining additional rights to this report or assembly of contents thereof, please contact INFO@PCTEST.COM.

**Calibration Laboratory of
Schmid & Partner
Engineering AG**
Zeughausstrasse 43, 8004 Zurich, Switzerland



S Schweizerischer Kalibrierdienst
S Service suisse d'étalonnage
S Servizio svizzero di taratura
S Swiss Calibration Service

Accredited by the Swiss Accreditation Service (SAS)
The Swiss Accreditation Service is one of the signatories to the EA
Multilateral Agreement for the recognition of calibration certificates

Accreditation No.: **SCS 0108**

Client **PC Test**

Certificate No: **ER3-2353_Jan17**

CALIBRATION CERTIFICATE

Object **ER3DV6 - SN:2353**

Calibration procedure(s) **QA CAL-02.v8, QA CAL-25.v6
Calibration procedure for E-field probes optimized for close near field
evaluations in air**

Calibration date: **January 16, 2017**

This calibration certificate documents the traceability to national standards, which realize the physical units of measurements (SI).
The measurements and the uncertainties with confidence probability are given on the following pages and are part of the certificate.

All calibrations have been conducted in the closed laboratory facility: environment temperature (22 ± 3)°C and humidity < 70%.

Calibration Equipment used (M&TE critical for calibration)

| Primary Standards | ID | Cal Date (Certificate No.) | Scheduled Calibration |
|----------------------------|------------------|-----------------------------------|------------------------|
| Power meter NRP | SN: 104778 | 06-Apr-16 (No. 217-02288/02289) | Apr-17 |
| Power sensor NRP-Z91 | SN: 103244 | 06-Apr-16 (No. 217-02288) | Apr-17 |
| Power sensor NRP-Z91 | SN: 103245 | 06-Apr-16 (No. 217-02289) | Apr-17 |
| Reference 20 dB Attenuator | SN: S5277 (20x) | 05-Apr-16 (No. 217-02293) | Apr-17 |
| Reference Probe ER3DV6 | SN: 2328 | 14-Oct-16 (No. ER3-2328_Oct16) | Oct-17 |
| DAE4 | SN: 789 | 11-Nov-16 (No. DAE4-789_Nov16) | Nov-17 |
| Secondary Standards | ID | Check Date (in house) | Scheduled Check |
| Power meter E4419B | SN: GB41293874 | 06-Apr-16 (in house check Jun-16) | In house check: Jun-18 |
| Power sensor E4412A | SN: MY41498087 | 06-Apr-16 (in house check Jun-16) | In house check: Jun-18 |
| Power sensor E4412A | SN: 000110210 | 06-Apr-16 (in house check Jun-16) | In house check: Jun-18 |
| RF generator HP 8648C | SN: US3642U01700 | 04-Aug-99 (in house check Jun-16) | In house check: Jun-18 |
| Network Analyzer HP 8753E | SN: US37390585 | 18-Oct-01 (in house check Oct-16) | In house check: Oct-17 |

| | Name | Function | Signature |
|----------------|------------------|-----------------------|-----------|
| Calibrated by: | Johannes Kurikka | Laboratory Technician | |
| Approved by: | Katja Pokovic | Technical Manager | |

Issued: January 16, 2017

This calibration certificate shall not be reproduced except in full without written approval of the laboratory.

Certificate No: ER3-2353_Jan17

Page 1 of 10

| | | | | |
|-------------------------------------|--|--------------------------------|--|---------------------------------|
| FCC ID: A3LSMG965U | PCTEST TECHNICAL LABORATORY, INC. | HAC (RF EMISSIONS) TEST REPORT | | Approved by: Quality Manager |
| Filename: 1M1711060289-13-R1.A3L | Test Dates: 11/06/2017 - 12/11/2017 | DUT Type: Portable Handset | | Page 76 of 108 |

© 2017 PCTEST Engineering Laboratory, Inc.

REV 3.1.M
09/14/2017

© 2017 PCTEST Engineering Laboratory, Inc. All rights reserved. Unless otherwise specified, no part of this report may be reproduced or utilized in any part, form or by any means, electronic or mechanical, including photocopying and microfilm, without permission in writing from PCTEST Engineering Laboratory, Inc. If you have any questions about this international copyright or have an enquiry about obtaining additional rights to this report or assembly of contents thereof, please contact INFO@PCTEST.COM.

**Calibration Laboratory of
Schmid & Partner
Engineering AG**
Zeughausstrasse 43, 8004 Zurich, Switzerland



S Schweizerischer Kalibrierdienst
S Service suisse d'étalonnage
S Servizio svizzero di taratura
S Swiss Calibration Service

Accredited by the Swiss Accreditation Service (SAS)
The Swiss Accreditation Service is one of the signatories to the EA
Multilateral Agreement for the recognition of calibration certificates

Accreditation No.: **SCS 0108**

Glossary:

NORM_{x,y,z} sensitivity in free space
DCP diode compression point
CF crest factor (1/duty_cycle) of the RF signal
A, B, C, D modulation dependent linearization parameters
Polarization φ φ rotation around probe axis
Polarization ϑ ϑ rotation around an axis that is in the plane normal to probe axis (at measurement center),
i.e., $\vartheta = 0$ is normal to probe axis
Connector Angle information used in DASY system to align probe sensor X to the robot coordinate system

Calibration is Performed According to the Following Standards:

- a) IEEE Std 1309-2005, "IEEE Standard for calibration of electromagnetic field sensors and probes, excluding antennas, from 9 kHz to 40 GHz", December 2005
- b) CTIA Test Plan for Hearing Aid Compatibility, Rev 3.0, November 2013

Methods Applied and Interpretation of Parameters:

- **NORM_{x,y,z}**: Assessed for E-field polarization $\vartheta = 0$ for XY sensors and $\vartheta = 90$ for Z sensor ($f \leq 900$ MHz in TEM-cell; $f > 1800$ MHz: R22 waveguide).
- **NORM(f)_{x,y,z}** = **NORM_{x,y,z}** * *frequency_response* (see Frequency Response Chart).
- **DCP_{x,y,z}**: DCP are numerical linearization parameters assessed based on the data of power sweep with CW signal (no uncertainty required). DCP does not depend on frequency nor media.
- **PAR**: PAR is the Peak to Average Ratio that is not calibrated but determined based on the signal characteristics
- **A_{x,y,z}; B_{x,y,z}; C_{x,y,z}; D_{x,y,z}; VR_{x,y,z}**: A, B, C, D are numerical linearization parameters assessed based on the data of power sweep for specific modulation signal. The parameters do not depend on frequency nor media. VR is the maximum calibration range expressed in RMS voltage across the diode.
- **Spherical isotropy (3D deviation from isotropy)**: in a locally homogeneous field realized using an open waveguide setup.
- **Sensor Offset**: The sensor offset corresponds to the offset of virtual measurement center from the probe tip (on probe axis). No tolerance required.
- **Connector Angle**: The angle is assessed using the information gained by determining the **NORM_x** (no uncertainty required).



| | | | | |
|--|---|---------------------------------------|----------------|--|
| FCC ID: A3LSMG965U | PCTEST ENGINEERING LABORATORY, INC. | HAC (RF EMISSIONS) TEST REPORT | | Approved by: Quality Manager |
| Filename: 1M1711060289-13-R1.A3L | Test Dates: 11/06/2017 - 12/11/2017 | DUT Type: Portable Handset | Page 77 of 108 | |

Probe ER3DV6

SN:2353

Manufactured: March 8, 2005
Calibrated: January 16, 2017

Calibrated for DASY/EASY Systems
(Note: non-compatible with DASY2 system!)

| | | | | |
|-------------------------------------|---|--------------------------------|---|---------------------------------|
| FCC ID: A3LSMG965U |  | HAC (RF EMISSIONS) TEST REPORT |  | Approved by: Quality Manager |
| Filename: 1M1711060289-13-R1.A3L | Test Dates: 11/06/2017 - 12/11/2017 | DUT Type: Portable Handset | Page 78 of 108 | |

DASY/EASY - Parameters of Probe: ER3DV6 - SN:2353**Basic Calibration Parameters**

| | Sensor X | Sensor Y | Sensor Z | Unc (k=2) |
|--|----------|----------|----------|---------------|
| Norm ($\mu\text{V}/(\text{V}/\text{m})^2$) | 1.49 | 1.68 | 1.78 | $\pm 10.1 \%$ |
| DCP (mV) ^B | 99.3 | 98.2 | 100.1 | |



Modulation Calibration Parameters

| UID | Communication System Name | | A dB | B dB $\sqrt{\mu\text{V}}$ | C | D dB | VR mV | Unc ^E (k=2) |
|-----|---------------------------|---|---------|------------------------------|-----|---------|----------|---------------------------|
| 0 | CW | X | 0.0 | 0.0 | 1.0 | 0.00 | 210.4 | $\pm 3.8 \%$ |
| | | Y | 0.0 | 0.0 | 1.0 | | 207.1 | |
| | | Z | 0.0 | 0.0 | 1.0 | | 201.5 | |

The reported uncertainty of measurement is stated as the standard uncertainty of measurement multiplied by the coverage factor $k=2$, which for a normal distribution corresponds to a coverage probability of approximately 95%.

^B Numerical linearization parameter: uncertainty not required.

^E Uncertainty is determined using the max. deviation from linear response applying rectangular distribution and is expressed for the square of the field value.

| | | | | |
|-------------------------------------|--|--------------------------------|---|---------------------------------|
| FCC ID: A3LSMG965U |  PCTEST ENGINEERING LABORATORY, INC. | HAC (RF EMISSIONS) TEST REPORT |  | Approved by: Quality Manager |
| Filename: 1M1711060289-13-R1.A3L | Test Dates: 11/06/2017 - 12/11/2017 | DUT Type: Portable Handset | | Page 79 of 108 |

Frequency Response of E-Field (TEM-Cell:ifi110 EXX, Waveguide: R22)

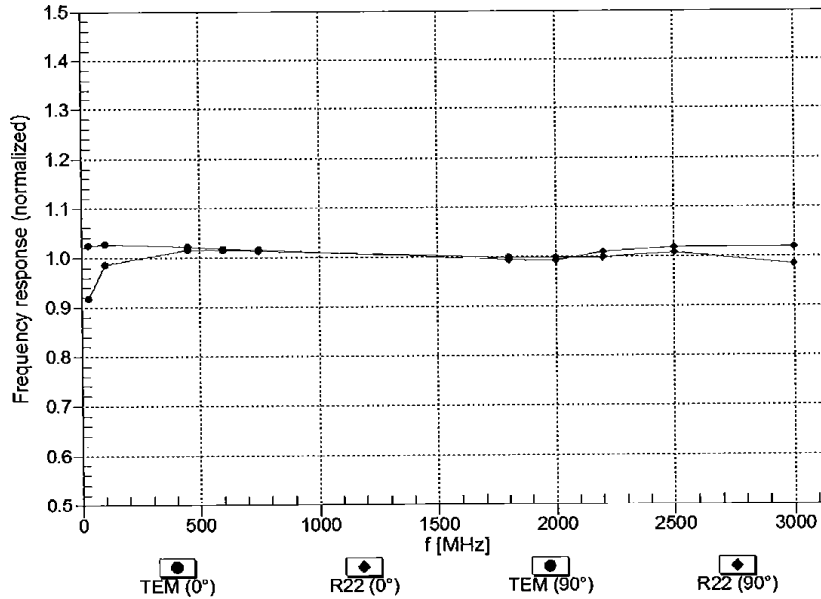

Uncertainty of Frequency Response of E-field: $\pm 6.3\%$ (k=2)

| | | | | |
|-------------------------------------|--|--------------------------------|---------|---------------------------------|
| FCC ID: A3LSMG965U | PCTEST TECHNOLOGICAL LABORATORY, INC. | HAC (RF EMISSIONS) TEST REPORT | SAMSUNG | Approved by: Quality Manager |
| Filename: 1M1711060289-13-R1.A3L | Test Dates: 11/06/2017 - 12/11/2017 | DUT Type: Portable Handset | | Page 80 of 108 |

Receiving Pattern (ϕ), $\vartheta = 0^\circ$

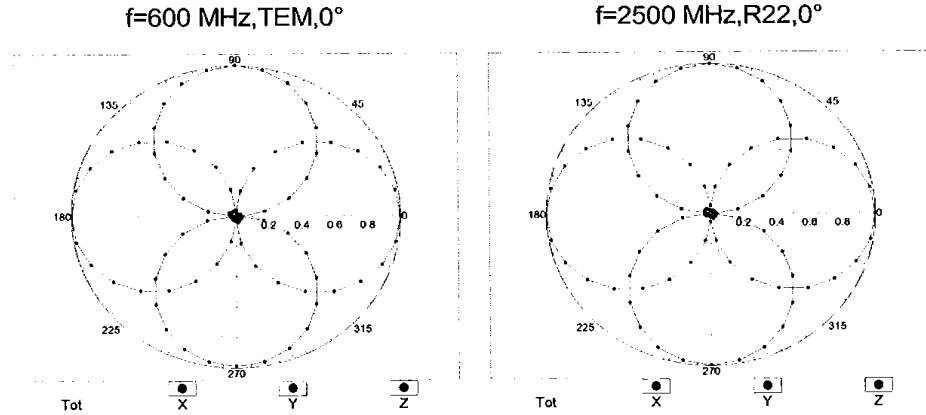

Receiving Pattern (ϕ), $\vartheta = 90^\circ$

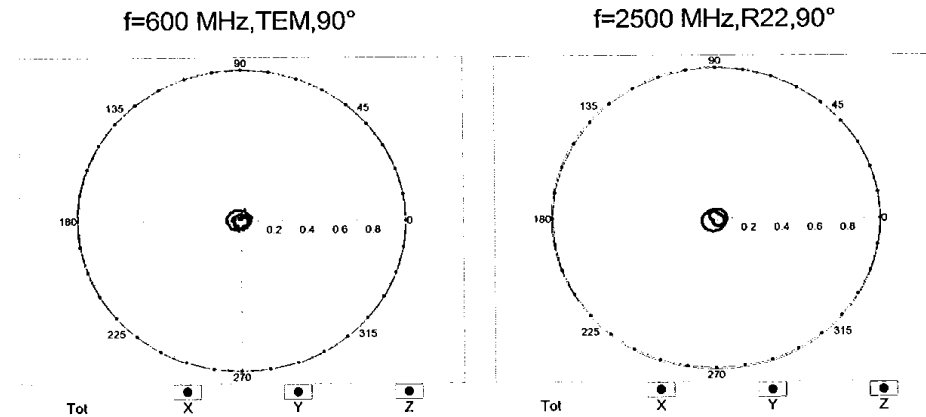

| | | | | |
|-------------------------------------|--|--------------------------------|---------|---------------------------------|
| FCC ID: A3LSMG965U | PCTEST TECHNOLOGICAL LABORATORY, INC. | HAC (RF EMISSIONS) TEST REPORT | SAMSUNG | Approved by: Quality Manager |
| Filename: 1M1711060289-13-R1.A3L | Test Dates: 11/06/2017 - 12/11/2017 | DUT Type: Portable Handset | | Page 81 of 108 |

Receiving Pattern (ϕ), $\theta = 0^\circ$

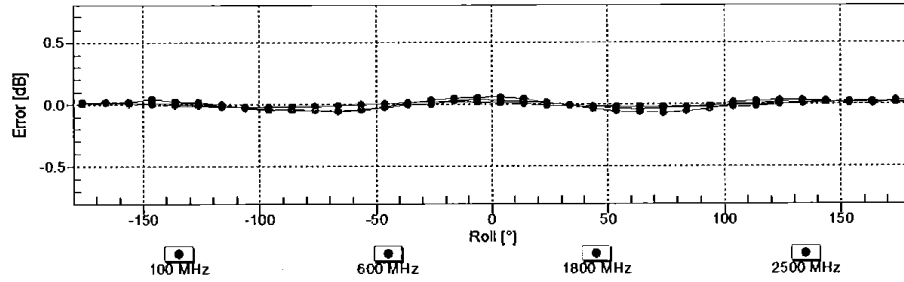

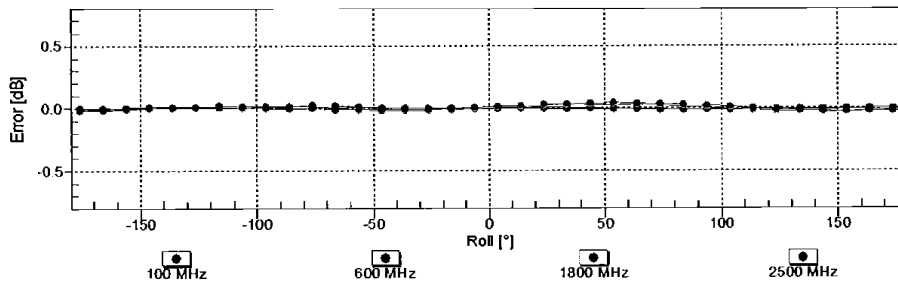

Uncertainty of Axial Isotropy Assessment: $\pm 0.5\%$ (k=2)

Receiving Pattern (ϕ), $\theta = 90^\circ$



Uncertainty of Axial Isotropy Assessment: $\pm 0.5\%$ (k=2)

| | | | | |
|-------------------------------------|--|--------------------------------|---|---------------------------------|
| FCC ID: A3LSMG965U |  PCTEST TECHNOLOGICAL LABORATORY, INC. | HAC (RF EMISSIONS) TEST REPORT |  SAMSUNG | Approved by: Quality Manager |
| Filename: 1M1711060289-13-R1.A3L | Test Dates: 11/06/2017 - 12/11/2017 | DUT Type: Portable Handset | Page 82 of 108 | |

Dynamic Range f(E-field) (TEM cell , f = 900 MHz)

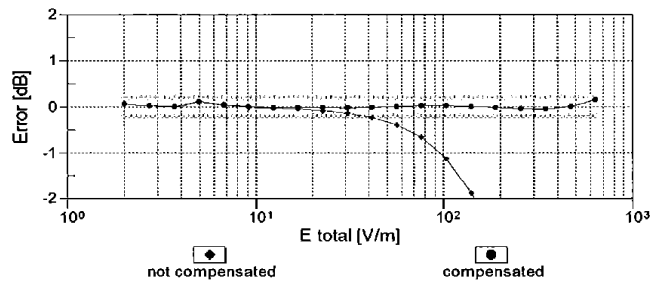
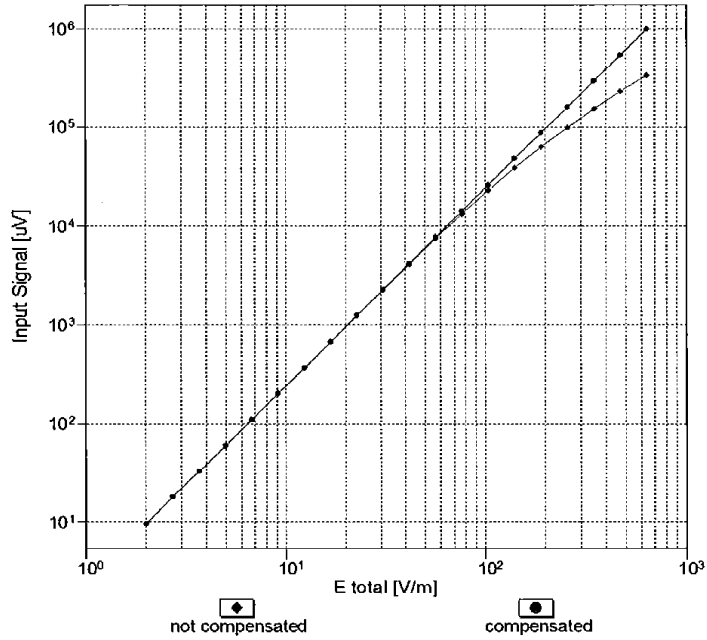



Uncertainty of Linearity Assessment: ± 0.6% (k=2)

| | | | | |
|-------------------------------------|--|--------------------------------|---------|---------------------------------|
| FCC ID: A3LSMG965U | PCTEST TECHNICAL LABORATORY, INC. | HAC (RF EMISSIONS) TEST REPORT | SAMSUNG | Approved by: Quality Manager |
| Filename: 1M1711060289-13-R1.A3L | Test Dates: 11/06/2017 - 12/11/2017 | DUT Type: Portable Handset | | Page 83 of 108 |

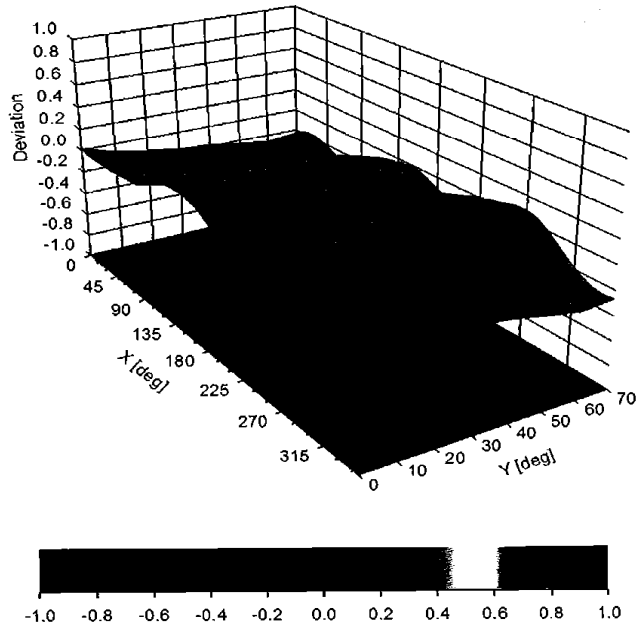
Deviation from Isotropy in Air Error (ϕ , θ), $f = 900$ MHz





Uncertainty of Spherical Isotropy Assessment: $\pm 2.6\%$ ($k=2$)

| | | | |
|--|--|---------------------------------------|--|
| FCC ID: A3LSMG965U |  PCTEST <small>ENGINEERING LABORATORY, INC.</small> | HAC (RF EMISSIONS) TEST REPORT |  Approved by: Quality Manager |
| Filename: 1M1711060289-13-R1.A3L | Test Dates: 11/06/2017 - 12/11/2017 | DUT Type: Portable Handset | Page 84 of 108 |

DASY/EASY - Parameters of Probe: ER3DV6 - SN:2353**Other Probe Parameters**

| | |
|---|-------------|
| Sensor Arrangement | Rectangular |
| Connector Angle (°) | 23.8 |
| Mechanical Surface Detection Mode | enabled |
| Optical Surface Detection Mode | disabled |
| Probe Overall Length | 337 mm |
| Probe Body Diameter | 10 mm |
| Tip Length | 10 mm |
| Tip Diameter | 8 mm |
| Probe Tip to Sensor X Calibration Point | 2.5 mm |
| Probe Tip to Sensor Y Calibration Point | 2.5 mm |
| Probe Tip to Sensor Z Calibration Point | 2.5 mm |

| | | | | |
|-------------------------------------|---|--------------------------------|---|---------------------------------|
| FCC ID: A3LSMG965U |  PCTEST ENGINEERING LABORATORY, INC. | HAC (RF EMISSIONS) TEST REPORT |  | Approved by: Quality Manager |
| Filename: 1M1711060289-13-R1.A3L | Test Dates: 11/06/2017 - 12/11/2017 | DUT Type: Portable Handset | Page 85 of 108 | |

**Calibration Laboratory of
Schmid & Partner
Engineering AG**
Zeughausstrasse 43, 8004 Zurich, Switzerland



S Schweizerischer Kalibrierdienst
C Service suisse d'étalonnage
S Servizio svizzero di taratura
S Swiss Calibration Service

Accredited by the Swiss Accreditation Service (SAS)
The Swiss Accreditation Service is one of the signatories to the EA
Multilateral Agreement for the recognition of calibration certificates

Accreditation No.: **SCS 0108**

Client **PC Test**

Certificate No: **CD835V3-1082_May16**

| CALIBRATION CERTIFICATE | | | |
|--|--|-----------------------------------|------------------------|
| Object | CD835V3 - SN: 1082 | | |
| Calibration procedure(s) | QA CAL-20.v6 Calibration procedure for dipoles in air | | |
| Calibration date: | May 10, 2016 | | |
| <p>This calibration certificate documents the traceability to national standards, which realize the physical units of measurements (SI). The measurements and the uncertainties with confidence probability are given on the following pages and are part of the certificate.</p> <p>All calibrations have been conducted in the closed laboratory facility: environment temperature (22 ± 3)°C and humidity < 70%.</p> | | | |
| Calibration Equipment used (M&TE critical for calibration) | | | |
| Primary Standards | ID # | Cal Date (Certificate No.) | Scheduled Calibration |
| Power meter NRP | SN: 104778 | 06-Apr-16 (No. 217-02288/02289) | Apr-17 |
| Power sensor NRP-Z91 | SN: 103244 | 06-Apr-16 (No. 217-02288) | Apr-17 |
| Power sensor NRP-Z91 | SN: 103245 | 06-Apr-16 (No. 217-02289) | Apr-17 |
| Reference 20 dB Attenuator | SN: 5058 (20k) | 05-Apr-16 (No. 217-02292) | Apr-17 |
| Type-N mismatch combination | SN: 5047.2 / 06327 | 05-Apr-16 (No. 217-02295) | Apr-17 |
| Probe ER3DV6 | SN: 2336 | 31-Dec-15 (No. ER3-2336_Dec15) | Dec-16 |
| Probe H3DV6 | SN: 6065 | 31-Dec-15 (No. H3-6065_Dec15) | Dec-16 |
| DAE4 | SN: 781 | 04-Sep-15 (No. DAE4-781_Sep15) | Sep-16 |
| Secondary Standards | ID # | Check Date (in house) | Scheduled Check |
| Power meter Agilent 4419B | SN: GB42420191 | 09-Oct-09 (in house check Sep-14) | In house check: Oct-17 |
| Power sensor HP E4412A | SN: US38485102 | 05-Jan-10 (in house check Sep-14) | In house check: Oct-17 |
| Power sensor HP 8482A | SN: US37295597 | 09-Oct-09 (in house check Sep-14) | In house check: Oct-17 |
| RF generator R&S SMT-06 | SN: 832283/011 | 27-Aug-12 (in house check Oct-15) | In house check: Oct-17 |
| Network Analyzer HP 8753E | SN: US37390585 | 18-Oct-01 (in house check Oct-15) | In house check: Oct-16 |
| Calibrated by: | Name Jeton Kastrati | Function Laboratory Technician | Signature |
| Approved by: | Name Katja Pokovic | Technical Manager | |
| | | | Issued: May 12, 2016 |
| This calibration certificate shall not be reproduced except in full without written approval of the laboratory. | | | |

Certificate No: CD835V3-1082_May16

Page 1 of 5

| | | | | |
|-------------------------------------|--|--------------------------------|----------------|---------------------------------|
| FCC ID: A3LSMG965U | PCTEST TECHNICAL LABORATORY, INC. | HAC (RF EMISSIONS) TEST REPORT | | Approved by: Quality Manager |
| Filename: 1M1711060289-13-R1.A3L | Test Dates: 11/06/2017 - 12/11/2017 | DUT Type: Portable Handset | Page 86 of 108 | |

© 2017 PCTEST Engineering Laboratory, Inc.

REV 3.1.M
09/14/2017

© 2017 PCTEST Engineering Laboratory, Inc. All rights reserved. Unless otherwise specified, no part of this report may be reproduced or utilized in any part, form or by any means, electronic or mechanical, including photocopying and microfilm, without permission in writing from PCTEST Engineering Laboratory, Inc. If you have any questions about this international copyright or have an enquiry about obtaining additional rights to this report or assembly of contents thereof, please contact INFO@PCTEST.COM.

**Calibration Laboratory of
Schmid & Partner
Engineering AG**
Zeughausstrasse 43, 8004 Zurich, Switzerland



S Schweizerischer Kalibrierdienst
C Service suisse d'étalonnage
S Servizio svizzero di taratura
S Swiss Calibration Service

Accredited by the Swiss Accreditation Service (SAS)
The Swiss Accreditation Service is one of the signatories to the EA
Multilateral Agreement for the recognition of calibration certificates

Accreditation No.: **SCS 0108**

References

- [1] ANSI-C63.19-2011
American National Standard, Methods of Measurement of Compatibility between Wireless Communications Devices and Hearing Aids.

Methods Applied and Interpretation of Parameters:

- *Coordinate System:* y-axis is in the direction of the dipole arms. z-axis is from the basis of the antenna (mounted on the table) towards its feed point between the two dipole arms. x-axis is normal to the other axes. In coincidence with the standards [1], the measurement planes (probe sensor center) are selected to be at a distance of 15 mm above the top metal edge of the dipole arms.
- *Measurement Conditions:* Further details are available from the hardcopies at the end of the certificate. All figures stated in the certificate are valid at the frequency indicated. The forward power to the dipole connector is set with a calibrated power meter connected and monitored with an auxiliary power meter connected to a directional coupler. While the dipole under test is connected, the forward power is adjusted to the same level.
- *Antenna Positioning:* The dipole is mounted on a HAC Test Arch phantom using the matching dipole positioner with the arms horizontal and the feeding cable coming from the floor. The measurements are performed in a shielded room with absorbers around the setup to reduce the reflections. It is verified before the mounting of the dipole under the Test Arch phantom, that its arms are perfectly in a line. It is installed on the HAC dipole positioner with its arms parallel below the dielectric reference wire and able to move elastically in vertical direction without changing its relative position to the top center of the Test Arch phantom. The vertical distance to the probe is adjusted after dipole mounting with a DASY5 Surface Check job. Before the measurement, the distance between phantom surface and probe tip is verified. The proper measurement distance is selected by choosing the matching section of the HAC Test Arch phantom with the proper device reference point (upper surface of the dipole) and the matching grid reference point (tip of the probe) considering the probe sensor offset. The vertical distance to the probe is essential for the accuracy.
- *Feed Point Impedance and Return Loss:* These parameters are measured using a HP 8753E Vector Network Analyzer. The impedance is specified at the SMA connector of the dipole. The influence of reflections was eliminating by applying the averaging function while moving the dipole in the air, at least 70cm away from any obstacles.
- *E-field distribution:* E field is measured in the x-y-plane with an isotropic ER3D-field probe with 100 mW forward power to the antenna feed point. In accordance with [1], the scan area is 20mm wide, its length exceeds the dipole arm length (180 or 90mm). The sensor center is 15 mm (in z) above the metal top of the dipole arms. Two 3D maxima are available near the end of the dipole arms. Assuming the dipole arms are perfectly in one line, the average of these two maxima (in subgrid 2 and subgrid 8) is determined to compensate for any non-parallelity to the measurement plane as well as the sensor displacement. The E-field value stated as calibration value represents the maximum of the interpolated 3D-E-field, in the plane above the dipole surface.

The reported uncertainty of measurement is stated as the standard uncertainty of measurement multiplied by the coverage factor k=2, which for a normal distribution corresponds to a coverage probability of approximately 95%.

| | | | | |
|--|---|---------------------------------------|----------------|--|
| FCC ID: A3LSMG965U | PCTEST ENGINEERING LABORATORY, INC. | HAC (RF EMISSIONS) TEST REPORT | | Approved by: Quality Manager |
| Filename: 1M1711060289-13-R1.A3L | Test Dates: 11/06/2017 - 12/11/2017 | DUT Type: Portable Handset | Page 87 of 108 | |

Measurement Conditions

DASY system configuration, as far as not given on page 1.

| | | |
|------------------------------------|---------------------|---------|
| DASY Version | DASY5 | V52.8.8 |
| Phantom | HAC Test Arch | |
| Distance Dipole Top - Probe Center | 15 mm | |
| Scan resolution | dx, dy = 5 mm | |
| Frequency | 835 MHz \pm 1 MHz | |
| Input power drift | < 0.05 dB | |

Maximum Field values at 835 MHz

| E-field 15 mm above dipole surface | condition | Interpolated maximum |
|------------------------------------|--------------------|------------------------------|
| Maximum measured above high end | 100 mW input power | 107.5 V/m = 40.63 dBV/m |
| Maximum measured above low end | 100 mW input power | 106.1 V/m = 40.51 dBV/m |
| Averaged maximum above arm | 100 mW input power | 106.8 V/m \pm 12.8 % (k=2) |

Appendix (Additional assessments outside the scope of SCS 0108)

Antenna Parameters

| Frequency | Return Loss | Impedance |
|-----------|-------------|---------------------------------|
| 800 MHz | 16.4 dB | 44.5 Ω - 13.4 j Ω |
| 835 MHz | 26.3 dB | 50.0 Ω + 4.9 j Ω |
| 900 MHz | 16.4 dB | 57.4 Ω - 14.7 j Ω |
| 950 MHz | 21.9 dB | 43.6 Ω + 4.0 j Ω |
| 960 MHz | 17.2 dB | 47.9 Ω + 13.5 j Ω |



3.2 Antenna Design and Handling

The calibration dipole has a symmetric geometry with a built-in two stub matching network, which leads to the enhanced bandwidth.

The dipole is built of standard semirigid coaxial cable. The internal matching line is open ended. The antenna is therefore open for DC signals.

Do not apply force to dipole arms, as they are liable to bend. The soldered connections near the feedpoint may be damaged. After excessive mechanical stress or overheating, check the impedance characteristics to ensure that the internal matching network is not affected.

After long term use with 40W radiated power, only a slight warming of the dipole near the feedpoint can be measured.

| | | | | |
|-------------------------------------|--|--------------------------------|---|---------------------------------|
| FCC ID: A3LSMG965U |  PCTEST ENGINEERING LABORATORY, INC. | HAC (RF EMISSIONS) TEST REPORT |  | Approved by: Quality Manager |
| Filename: 1M1711060289-13-R1.A3L | Test Dates: 11/06/2017 - 12/11/2017 | DUT Type: Portable Handset | Page 88 of 108 | |

Impedance Measurement Plot

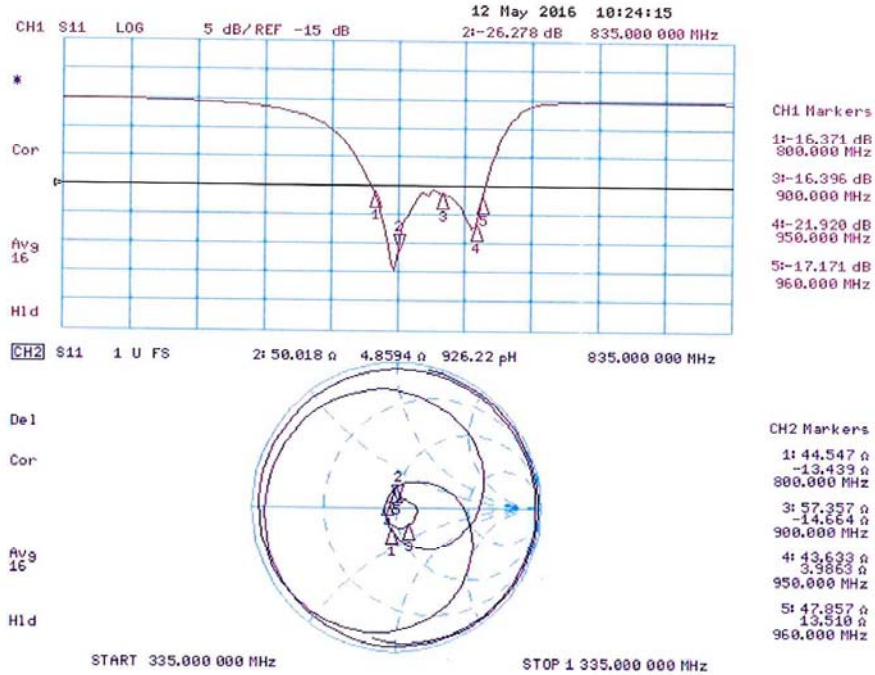

| | | | | |
|-------------------------------------|--|--------------------------------|---------|---------------------------------|
| FCC ID: A3LSMG965U | PCTEST ENGINEERING LABORATORY, INC. | HAC (RF EMISSIONS) TEST REPORT | SAMSUNG | Approved by: Quality Manager |
| Filename: 1M1711060289-13-R1.A3L | Test Dates: 11/06/2017 - 12/11/2017 | DUT Type: Portable Handset | | Page 89 of 108 |

DASY5 E-field Result

Date: 10.05.2016

Test Laboratory: SPEAG Lab2

DUT: HAC-Dipole 835 MHz; Type: CD835V3; Serial: CD835V3 - SN: 1082

Communication System: UID 0 - CW ; Frequency: 835 MHz
 Medium parameters used: $\sigma = 0 \text{ S/m}$, $\epsilon_r = 1$; $\rho = 1000 \text{ kg/m}^3$
 Phantom section: RF Section
 Measurement Standard: DASY5 (IEEE/IEC/ANSI C63.19-2011)

DASY52 Configuration:

- Probe: ER3DV6 - SN2336; ConvF(1, 1, 1); Calibrated: 31.12.2015;
- Sensor-Surface: (Fix Surface)
- Electronics: DAE4 Sn781; Calibrated: 04.09.2015
- Phantom: HAC Test Arch with AMCC; Type: SD HAC P01 BA; Serial: 1070
- DASY52 52.8.8(1258); SEMCAD X 14.6.10(7372)



Dipole E-Field measurement @ 835MHz/E-Scan - 835MHz d=15mm/Hearing Aid Compatibility Test (41x361x1):

Interpolated grid: dx=0.5000 mm, dy=0.5000 mm
 Device Reference Point: 0, 0, -6.3 mm
 Reference Value = 109.8 V/m; Power Drift = 0.02 dB
 Applied MIF = 0.00 dB
 RF audio interference level = 40.63 dBV/m
Emission category: M3

MIF scaled E-field

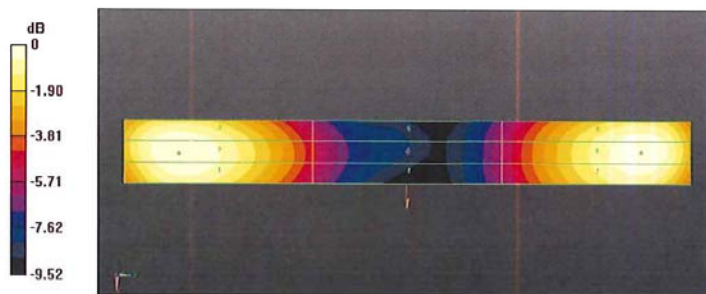
| | | |
|--------------------------|--------------------------|--------------------------|
| Grid 1 M3 40.52 dBV/m | Grid 2 M3 40.63 dBV/m | Grid 3 M3 40.46 dBV/m |
| Grid 4 M4 35.69 dBV/m | Grid 5 M4 35.78 dBV/m | Grid 6 M4 35.62 dBV/m |
| Grid 7 M3 40.38 dBV/m | Grid 8 M3 40.51 dBV/m | Grid 9 M3 40.37 dBV/m |



| | | | | |
|--|---|---------------------------------------|---|--|
| FCC ID: A3LSMG965U |  PCTEST ENGINEERING LABORATORY, INC. | HAC (RF EMISSIONS) TEST REPORT |  | Approved by: Quality Manager |
| Filename: 1M1711060289-13-R1.A3L | Test Dates: 11/06/2017 - 12/11/2017 | DUT Type: Portable Handset | Page 90 of 108 | |

**Calibration Laboratory of
Schmid & Partner
Engineering AG**
Zeughausstrasse 43, 8004 Zurich, Switzerland



S Schweizerischer Kalibrierdienst
C Service suisse d'étalonnage
S Servizio svizzero di taratura
S Swiss Calibration Service

Accredited by the Swiss Accreditation Service (SAS)
The Swiss Accreditation Service is one of the signatories to the EA
Multilateral Agreement for the recognition of calibration certificates

Accreditation No.: **SCS 0108**

Client **PC Test**

Certificate No: **CD1880V3-1064_May16**

| CALIBRATION CERTIFICATE | | | |
|---|--|-----------------------------------|------------------------|
| Object | CD1880V3 - SN: 1064 | | |
| Calibration procedure(s) | QA CAL-20.v6 Calibration procedure for dipoles in air | | |
| Calibration date: | May 12, 2016 | | |
| This calibration certificate documents the traceability to national standards, which realize the physical units of measurements (SI). The measurements and the uncertainties with confidence probability are given on the following pages and are part of the certificate. | | | |
| All calibrations have been conducted in the closed laboratory facility: environment temperature (22 ± 3)°C and humidity < 70%. | | | |
| Calibration Equipment used (M&TE critical for calibration) | | | |
| Primary Standards | ID # | Cal Date (Certificate No.) | Scheduled Calibration |
| Power meter NRP | SN: 104778 | 06-Apr-16 (No. 217-02288/02289) | Apr-17 |
| Power sensor NRP-Z91 | SN: 103244 | 06-Apr-16 (No. 217-02288) | Apr-17 |
| Power sensor NRP-Z91 | SN: 103245 | 06-Apr-16 (No. 217-02289) | Apr-17 |
| Reference 20 dB Attenuator | SN: 5058 (20k) | 05-Apr-16 (No. 217-02292) | Apr-17 |
| Type-N mismatch combination | SN: 5047.2 / 06327 | 05-Apr-16 (No. 217-02295) | Apr-17 |
| Probe ER3DV6 | SN: 2336 | 31-Dec-15 (No. ER3-2336_Dec15) | Dec-16 |
| Probe H3DV6 | SN: 6065 | 31-Dec-15 (No. H3-6065_Dec15) | Dec-16 |
| DAE4 | SN: 781 | 04-Sep-15 (No. DAE4-781_Sep15) | Sep-16 |
| Secondary Standards | ID # | Check Date (in house) | Scheduled Check |
| Power meter Agilent 4419B | SN: GB42420191 | 09-Oct-09 (in house check Sep-14) | In house check: Oct-17 |
| Power sensor HP E4412A | SN: US38485102 | 05-Jan-10 (in house check Sep-14) | In house check: Oct-17 |
| Power sensor HP 8482A | SN: US37295597 | 09-Oct-09 (in house check Sep-14) | In house check: Oct-17 |
| RF generator R&S SMT-06 | SN: 832283/011 | 27-Aug-12 (in house check Oct-15) | In house check: Oct-17 |
| Network Analyzer HP 8753E | SN: US37390585 | 18-Oct-01 (in house check Oct-15) | In house check: Oct-16 |
| Calibrated by: | Name Jeton Kastrati | Function Laboratory Technician | Signature |
| Approved by: | Name Katja Pokovic | Technical Manager | Signature |
| | | | Issued: May 12, 2016 |
| This calibration certificate shall not be reproduced except in full without written approval of the laboratory. | | | |

Certificate No: CD1880V3-1064_May16

Page 1 of 7

| | | | | |
|-------------------------------------|--|--------------------------------|--|---------------------------------|
| FCC ID: A3LSMG965U | PCTEST TECHNICAL LABORATORY, INC. | HAC (RF EMISSIONS) TEST REPORT | | Approved by: Quality Manager |
| Filename: 1M1711060289-13-R1.A3L | Test Dates: 11/06/2017 - 12/11/2017 | DUT Type: Portable Handset | | Page 91 of 108 |

© 2017 PCTEST Engineering Laboratory, Inc.

REV 3.1.M
09/14/2017

© 2017 PCTEST Engineering Laboratory, Inc. All rights reserved. Unless otherwise specified, no part of this report may be reproduced or utilized in any part, form or by any means, electronic or mechanical, including photocopying and microfilm, without permission in writing from PCTEST Engineering Laboratory, Inc. If you have any questions about this international copyright or have an enquiry about obtaining additional rights to this report or assembly of contents thereof, please contact INFO@PCTEST.COM.

**Calibration Laboratory of
Schmid & Partner
Engineering AG**
Zeughausstrasse 43, 8004 Zurich, Switzerland



S Schweizerischer Kalibrierdienst
C Service suisse d'étalonnage
S Servizio svizzero di taratura
S Swiss Calibration Service

Accredited by the Swiss Accreditation Service (SAS)
The Swiss Accreditation Service is one of the signatories to the EA
Multilateral Agreement for the recognition of calibration certificates

Accreditation No.: **SCS 0108**

References

- [1] ANSI-C63.19-2011
American National Standard, Methods of Measurement of Compatibility between Wireless Communications Devices and Hearing Aids.

Methods Applied and Interpretation of Parameters:

- *Coordinate System:* y-axis is in the direction of the dipole arms. z-axis is from the basis of the antenna (mounted on the table) towards its feed point between the two dipole arms. x-axis is normal to the other axes. In coincidence with the standards [1], the measurement planes (probe sensor center) are selected to be at a distance of 15 mm above the top metal edge of the dipole arms.
- *Measurement Conditions:* Further details are available from the hardcopies at the end of the certificate. All figures stated in the certificate are valid at the frequency indicated. The forward power to the dipole connector is set with a calibrated power meter connected and monitored with an auxiliary power meter connected to a directional coupler. While the dipole under test is connected, the forward power is adjusted to the same level.
- *Antenna Positioning:* The dipole is mounted on a HAC Test Arch phantom using the matching dipole positioner with the arms horizontal and the feeding cable coming from the floor. The measurements are performed in a shielded room with absorbers around the setup to reduce the reflections. It is verified before the mounting of the dipole under the Test Arch phantom, that its arms are perfectly in a line. It is installed on the HAC dipole positioner with its arms parallel below the dielectric reference wire and able to move elastically in vertical direction without changing its relative position to the top center of the Test Arch phantom. The vertical distance to the probe is adjusted after dipole mounting with a DASY5 Surface Check job. Before the measurement, the distance between phantom surface and probe tip is verified. The proper measurement distance is selected by choosing the matching section of the HAC Test Arch phantom with the proper device reference point (upper surface of the dipole) and the matching grid reference point (tip of the probe) considering the probe sensor offset. The vertical distance to the probe is essential for the accuracy.
- *Feed Point Impedance and Return Loss:* These parameters are measured using a HP 8753E Vector Network Analyzer. The impedance is specified at the SMA connector of the dipole. The influence of reflections was eliminating by applying the averaging function while moving the dipole in the air, at least 70cm away from any obstacles.
- *E-field distribution:* E field is measured in the x-y-plane with an isotropic ER3D-field probe with 100 mW forward power to the antenna feed point. In accordance with [1], the scan area is 20mm wide, its length exceeds the dipole arm length (180 or 90mm). The sensor center is 15 mm (in z) above the metal top of the dipole arms. Two 3D maxima are available near the end of the dipole arms. Assuming the dipole arms are perfectly in one line, the average of these two maxima (in subgrid 2 and subgrid 8) is determined to compensate for any non-parallelity to the measurement plane as well as the sensor displacement. The E-field value stated as calibration value represents the maximum of the interpolated 3D-E-field, in the plane above the dipole surface.

The reported uncertainty of measurement is stated as the standard uncertainty of measurement multiplied by the coverage factor k=2, which for a normal distribution corresponds to a coverage probability of approximately 95%.

| | | | | |
|-------------------------------------|---|--------------------------------|--|---------------------------------|
| FCC ID: A3LSMG965U | PCTEST PRECISIONS LABORATORIES, INC. | HAC (RF EMISSIONS) TEST REPORT | | Approved by: Quality Manager |
| Filename: 1M1711060289-13-R1.A3L | Test Dates: 11/06/2017 - 12/11/2017 | DUT Type: Portable Handset | | Page 92 of 108 |

Measurement Conditions

DASY system configuration, as far as not given on page 1.



| | | |
|------------------------------------|--------------------------------------|---------|
| DASY Version | DASY5 | V52.8.8 |
| Phantom | HAC Test Arch | |
| Distance Dipole Top - Probe Center | 15 mm | |
| Scan resolution | dx, dy = 5 mm | |
| Frequency | 1730 MHz ± 1 MHz 1880 MHz ± 1 MHz | |
| Input power drift | < 0.05 dB | |

Maximum Field values at 1730 MHz

| E-field 15 mm above dipole surface | condition | Interpolated maximum |
|------------------------------------|--------------------|-------------------------|
| Maximum measured above high end | 100 mW input power | 96.1 V/m = 39.66 dBV/m |
| Maximum measured above low end | 100 mW input power | 95.3 V/m = 39.58 dBV/m |
| Averaged maximum above arm | 100 mW input power | 95.7 V/m ± 12.8 % (k=2) |

Maximum Field values at 1880 MHz

| E-field 15 mm above dipole surface | condition | Interpolated maximum |
|------------------------------------|--------------------|-------------------------|
| Maximum measured above high end | 100 mW input power | 91.2 V/m = 39.20 dBV/m |
| Maximum measured above low end | 100 mW input power | 88.0 V/m = 38.89 dBV/m |
| Averaged maximum above arm | 100 mW Input power | 89.6 V/m ± 12.8 % (k=2) |

| | | | | |
|-------------------------------------|---|--------------------------------|---|---------------------------------|
| FCC ID: A3LSMG965U |  PCTEST ENGINEERING LABORATORY, INC. | HAC (RF EMISSIONS) TEST REPORT |  | Approved by: Quality Manager |
| Filename: 1M1711060289-13-R1.A3L | Test Dates: 11/06/2017 - 12/11/2017 | DUT Type: Portable Handset | Page 93 of 108 | |

Appendix (Additional assessments outside the scope of SCS 0108)

Antenna Parameters

Nominal Frequencies

| Frequency | Return Loss | Impedance |
|-----------|-------------|---------------------------------|
| 1730 MHz | 24.0 dB | 49.6 Ω + 6.3 j Ω |
| 1880 MHz | 19.8 dB | 49.5 Ω + 10.2 j Ω |
| 1900 MHz | 20.4 dB | 52.9 Ω + 9.4 j Ω |
| 1950 MHz | 26.8 dB | 54.4 Ω + 1.8 j Ω |
| 2000 MHz | 22.7 dB | 43.2 Ω + 0.8 j Ω |



3.2 Antenna Design and Handling

The calibration dipole has a symmetric geometry with a built-in two stub matching network, which leads to the enhanced bandwidth.

The dipole is built of standard semirigid coaxial cable. The internal matching line is open ended. The antenna is therefore open for DC signals.

Do not apply force to dipole arms, as they are liable to bend. The soldered connections near the feedpoint may be damaged. After excessive mechanical stress or overheating, check the impedance characteristics to ensure that the internal matching network is not affected.

After long term use with 40W radiated power, only a slight warming of the dipole near the feedpoint can be measured.

| | | | | |
|--|---|---------------------------------------|---|--|
| FCC ID: A3LSMG965U |  PCTEST TECHNOLOGICAL LABORATORY, INC. | HAC (RF EMISSIONS) TEST REPORT |  | Approved by: Quality Manager |
| Filename: 1M1711060289-13-R1.A3L | Test Dates: 11/06/2017 - 12/11/2017 | DUT Type: Portable Handset | Page 94 of 108 | |

Impedance Measurement Plot

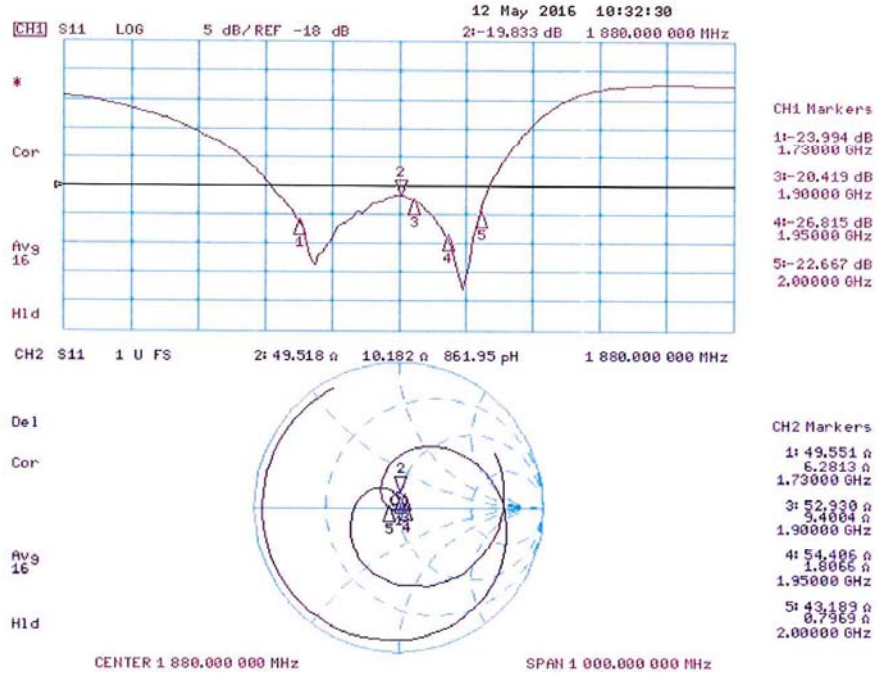

| | | | | |
|-------------------------------------|--|--------------------------------|---------|---------------------------------|
| FCC ID: A3LSMG965U | PCTEST ENGINEERING LABORATORY, INC. | HAC (RF EMISSIONS) TEST REPORT | SAMSUNG | Approved by: Quality Manager |
| Filename: 1M1711060289-13-R1.A3L | Test Dates: 11/06/2017 - 12/11/2017 | DUT Type: Portable Handset | | Page 95 of 108 |

DASY5 E-field Result

Date: 10.05.2016

Test Laboratory: SPEAG Lab2

DUT: HAC Dipole 1880 MHz; Type: CD1880V3; Serial: CD1880V3 - SN: 1064

Communication System: UID 0 - CW ; Frequency: 1880 MHz, Frequency: 1730 MHz
Medium parameters used: $\sigma = 0$ S/m, $\epsilon_r = 1$; $\rho = 1000$ kg/m³

Phantom section: RF Section

Measurement Standard: DASY5 (IEEE/IEC/ANSI C63.19-2011)

DASY52 Configuration:

- Probe: ER3DV6 - SN2336; ConvF(1, 1, 1); Calibrated: 31.12.2015;
- Sensor-Surface: (Fix Surface)
- Electronics: DAE4 Sn781; Calibrated: 04.09.2015
- Phantom: HAC Test Arch with AMCC; Type: SD HAC P01 BA; Serial: 1070
- DASY52 52.8.8(1258); SEMCAD X 14.6.10(7372)

Dipole E-Field measurement @ 1880MHz/E-Scan - 1880MHz d=15mm/Hearing Aid Compatibility Test (41x181x1):

Interpolated grid: dx=0.5000 mm, dy=0.5000 mm

Device Reference Point: 0, 0, -6.3 mm

Reference Value = 151.7 V/m; Power Drift = -0.01 dB

Applied MIF = 0.00 dB

RF audio interference level = 39.20 dBV/m



Emission category: M2

MIF scaled E-field

| | | |
|-------------|-------------|-------------|
| Grid 1 M2 | Grid 2 M2 | Grid 3 M2 |
| 39.04 dBV/m | 39.2 dBV/m | 39.08 dBV/m |
| Grid 4 M2 | Grid 5 M2 | Grid 6 M2 |
| 36.76 dBV/m | 36.86 dBV/m | 36.75 dBV/m |
| Grid 7 M2 | Grid 8 M2 | Grid 9 M2 |
| 38.68 dBV/m | 38.89 dBV/m | 38.8 dBV/m |

Certificate No: CD1880V3-1064_May16

Page 6 of 7

| | | | | |
|-------------------------------------|--|--------------------------------|---|---------------------------------|
| FCC ID: A3LSMG965U |  PCTEST ENGINEERING LABORATORY, INC. | HAC (RF EMISSIONS) TEST REPORT |  | Approved by: Quality Manager |
| Filename: 1M1711060289-13-R1.A3L | Test Dates: 11/06/2017 - 12/11/2017 | DUT Type: Portable Handset | | Page 96 of 108 |

© 2017 PCTEST Engineering Laboratory, Inc.

REV 3.1.M
09/14/2017

© 2017 PCTEST Engineering Laboratory, Inc. All rights reserved. Unless otherwise specified, no part of this report may be reproduced or utilized in any part, form or by any means, electronic or mechanical, including photocopying and microfilm, without permission in writing from PCTEST Engineering Laboratory, Inc. If you have any questions about this international copyright or have an enquiry about obtaining additional rights to this report or assembly of contents thereof, please contact INFO@PCTEST.COM.



Dipole E-Field measurement @ 1880MHz/E-Scan - 1730MHz d=15mm/Hearing Aid Compatibility Test (41x181x1):
 Interpolated grid: dx=0.5000 mm, dy=0.5000 mm
 Device Reference Point: 0, 0, -6.3 mm
 Reference Value = 168.3 V/m; Power Drift = 0.00 dB
 Applied MIF = 0.00 dB
 RF audio interference level = 39.66 dBV/m
Emission category: M2

MIF scaled E-field

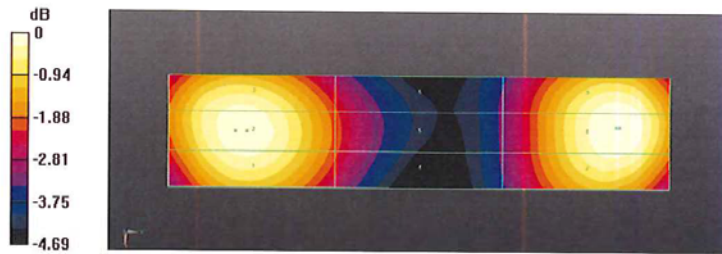
| | | |
|-------------|-------------|-------------|
| Grid 1 M2 | Grid 2 M2 | Grid 3 M2 |
| 39.43 dBV/m | 39.58 dBV/m | 39.44 dBV/m |
| Grid 4 M2 | Grid 5 M2 | Grid 6 M2 |
| 37.46 dBV/m | 37.56 dBV/m | 37.42 dBV/m |
| Grid 7 M2 | Grid 8 M2 | Grid 9 M2 |
| 39.44 dBV/m | 39.66 dBV/m | 39.57 dBV/m |



0 dB = 91.23 V/m = 39.20 dBV/m

| | | | | |
|--|---|---------------------------------------|---|--|
| FCC ID: A3LSMG965U |  | HAC (RF EMISSIONS) TEST REPORT |  | Approved by: Quality Manager |
| Filename: 1M1711060289-13-R1.A3L | Test Dates: 11/06/2017 - 12/11/2017 | DUT Type: Portable Handset | Page 97 of 108 | |

**Calibration Laboratory of
Schmid & Partner
Engineering AG**
Zeughausstrasse 43, 8004 Zurich, Switzerland



S Schweizerischer Kalibrierdienst
C Service suisse d'étalonnage
S Servizio svizzero di taratura
S Swiss Calibration Service

Accredited by the Swiss Accreditation Service (SAS)
The Swiss Accreditation Service is one of the signatories to the EA
Multilateral Agreement for the recognition of calibration certificates

Accreditation No.: **SCS 0108**

Client **PC Test**

Certificate No: **CD2600V3-1013_Jun17/2**

CALIBRATION CERTIFICATE (Replacement of No:CD2600V3-1013_Jun17)

Object **CD2600V3 - SN: 1013**

Calibration procedure(s) **QA CAL-20.v6
Calibration procedure for dipoles in air**

Calibration date: **June 14, 2017**

✓ AH
03/02/2017

This calibration certificate documents the traceability to national standards, which realize the physical units of measurements (SI).
The measurements and the uncertainties with confidence probability are given on the following pages and are part of the certificate.

All calibrations have been conducted in the closed laboratory facility: environment temperature (22 ± 3)°C and humidity < 70%.

Calibration Equipment used (M&TE critical for calibration)

| Primary Standards | ID # | Cal Date (Certificate No.) | Scheduled Calibration |
|-----------------------------|--------------------|---------------------------------|-----------------------|
| Power meter NRP | SN: 104778 | 04-Apr-17 (No. 217-02521/02522) | Apr-18 |
| Power sensor NRP-Z91 | SN: 103244 | 04-Apr-17 (No. 217-02521) | Apr-18 |
| Power sensor NRP-Z91 | SN: 103245 | 04-Apr-17 (No. 217-02522) | Apr-18 |
| Reference 20 dB Attenuator | SN: 5058 (20k) | 07-Apr-17 (No. 217-02528) | Apr-18 |
| Type-N mismatch combination | SN: 5047.2 / 06327 | 07-Apr-17 (No. 217-02529) | Apr-18 |
| Probe EF3DV6 | SN: 4013 | 21-Jun-16 (No. EF3-4013_Jun16) | Jun-17 |
| DAE4 | SN: 781 | 02-Sep-16 (No. DAE4-781_Sep16) | Sep-17 |

| Secondary Standards | ID # | Check Date (in house) | Scheduled Check |
|---------------------------|----------------|-----------------------------------|------------------------|
| Power meter Agilent 4419B | SN: GB42420191 | 09-Oct-09 (in house check Sep-14) | In house check: Oct-17 |
| Power sensor HP E4412A | SN: US38485102 | 05-Jan-10 (in house check Sep-14) | In house check: Oct-17 |
| Power sensor HP 8482A | SN: US37295597 | 09-Oct-09 (in house check Sep-14) | In house check: Oct-17 |
| RF generator R&S SMT-06 | SN: 832283/011 | 27-Aug-12 (in house check Oct-15) | In house check: Oct-17 |
| Network Analyzer HP 8753E | SN: US37390585 | 18-Oct-01 (in house check Oct-16) | In house check: Oct-17 |

| | | | |
|----------------|--------------------------|-----------------------------------|--------------------------------------|
| Calibrated by: | Name Johannes Kurikka | Function Laboratory Technician | Signature <i>Johannes Kurikka</i> |
| Approved by: | Name Katja Pokovic | Function Technical Manager | Signature <i>Katja Pokovic</i> |

Issued: July 20, 2017

This calibration certificate shall not be reproduced except in full without written approval of the laboratory.

Certificate No: CD2600V3-1013_Jun17/2

Page 1 of 5

| | | | | |
|-------------------------------------|--|--------------------------------|--|---------------------------------|
| FCC ID: A3LSMG965U | PCTEST TECHNOLOGICAL LABORATORY, INC. | HAC (RF EMISSIONS) TEST REPORT | | Approved by: Quality Manager |
| Filename: 1M1711060289-13-R1.A3L | Test Dates: 11/06/2017 - 12/11/2017 | DUT Type: Portable Handset | | Page 98 of 108 |

© 2017 PCTEST Engineering Laboratory, Inc.

REV 3.1.M
09/14/2017

© 2017 PCTEST Engineering Laboratory, Inc. All rights reserved. Unless otherwise specified, no part of this report may be reproduced or utilized in any part, form or by any means, electronic or mechanical, including photocopying and microfilm, without permission in writing from PCTEST Engineering Laboratory, Inc. If you have any questions about this international copyright or have an enquiry about obtaining additional rights to this report or assembly of contents thereof, please contact INFO@PCTEST.COM.

**Calibration Laboratory of
Schmid & Partner
Engineering AG**
Zeughausstrasse 43, 8004 Zurich, Switzerland



S Schweizerischer Kalibrierdienst
C Service suisse d'étalonnage
S Servizio svizzero di taratura
S Swiss Calibration Service

Accredited by the Swiss Accreditation Service (SAS)
The Swiss Accreditation Service is one of the signatories to the EA
Multilateral Agreement for the recognition of calibration certificates

Accreditation No.: **SCS 0108**

References

- [1] ANSI-C63.19-2011
American National Standard, Methods of Measurement of Compatibility between Wireless Communications Devices and Hearing Aids.

Methods Applied and Interpretation of Parameters:

- *Coordinate System:* y-axis is in the direction of the dipole arms. z-axis is from the basis of the antenna (mounted on the table) towards its feed point between the two dipole arms. x-axis is normal to the other axes. In coincidence with the standards [1], the measurement planes (probe sensor center) are selected to be at a distance of 15 mm above the top metal edge of the dipole arms.
- *Measurement Conditions:* Further details are available from the hardcopies at the end of the certificate. All figures stated in the certificate are valid at the frequency indicated. The forward power to the dipole connector is set with a calibrated power meter connected and monitored with an auxiliary power meter connected to a directional coupler. While the dipole under test is connected, the forward power is adjusted to the same level.
- *Antenna Positioning:* The dipole is mounted on a HAC Test Arch phantom using the matching dipole positioner with the arms horizontal and the feeding cable coming from the floor. The measurements are performed in a shielded room with absorbers around the setup to reduce the reflections. It is verified before the mounting of the dipole under the Test Arch phantom, that its arms are perfectly in a line. It is installed on the HAC dipole positioner with its arms parallel below the dielectric reference wire and able to move elastically in vertical direction without changing its relative position to the top center of the Test Arch phantom. The vertical distance to the probe is adjusted after dipole mounting with a DASY5 Surface Check job. Before the measurement, the distance between phantom surface and probe tip is verified. The proper measurement distance is selected by choosing the matching section of the HAC Test Arch phantom with the proper device reference point (upper surface of the dipole) and the matching grid reference point (tip of the probe) considering the probe sensor offset. The vertical distance to the probe is essential for the accuracy.
- *Feed Point Impedance and Return Loss:* These parameters are measured using a HP 8753E Vector Network Analyzer. The impedance is specified at the SMA connector of the dipole. The influence of reflections was eliminated by applying the averaging function while moving the dipole in the air, at least 70cm away from any obstacles.
- *E-field distribution:* E field is measured in the x-y-plane with an isotropic ER3D-field probe with 100 mW forward power to the antenna feed point. In accordance with [1], the scan area is 20mm wide, its length exceeds the dipole arm length (180 or 90mm). The sensor center is 15 mm (in z) above the metal top of the dipole arms. Two 3D maxima are available near the end of the dipole arms. Assuming the dipole arms are perfectly in one line, the average of these two maxima (in subgrid 2 and subgrid 8) is determined to compensate for any non-parallelity to the measurement plane as well as the sensor displacement. The E-field value stated as calibration value represents the maximum of the interpolated 3D-E-field, in the plane above the dipole surface.

The reported uncertainty of measurement is stated as the standard uncertainty of measurement multiplied by the coverage factor k=2, which for a normal distribution corresponds to a coverage probability of approximately 95%.

| | | | | |
|--|---|---------------------------------------|----------------|--|
| FCC ID: A3LSMG965U | PCTEST ENGINEERING LABORATORY, INC. | HAC (RF EMISSIONS) TEST REPORT | | Approved by: Quality Manager |
| Filename: 1M1711060289-13-R1.A3L | Test Dates: 11/06/2017 - 12/11/2017 | DUT Type: Portable Handset | Page 99 of 108 | |

Measurement Conditions

DASY system configuration, as far as not given on page 1.

| | | |
|------------------------------------|------------------|----------|
| DASY Version | DASY5 | V52.10.0 |
| Phantom | HAC Test Arch | |
| Distance Dipole Top - Probe Center | 15 mm | |
| Scan resolution | dx, dy = 5 mm | |
| Frequency | 2600 MHz ± 1 MHz | |
| Input power drift | < 0.05 dB | |

Maximum Field values at 2600 MHz

| E-field 15 mm above dipole surface | condition | Interpolated maximum |
|------------------------------------|--------------------|--------------------------------|
| Maximum measured above high end | 100 mW input power | 84.9 V/m = 38.58 dBV/m |
| Maximum measured above low end | 100 mW input power | 84.0 V/m = 38.48 dBV/m |
| Averaged maximum above arm | 100 mW input power | 84.5 V/m ± 12.8 % (k=2) |

Appendix (Additional assessments outside the scope of SCS 0108)

Antenna Parameters

| Frequency | Return Loss | Impedance |
|-----------|-------------|-----------------|
| 2450 MHz | 23.3 dB | 44.8 Ω - 3.8 jΩ |
| 2550 MHz | 32.2 dB | 51.0 Ω + 2.3 jΩ |
| 2600 MHz | 29.5 dB | 53.4 Ω - 0.3 jΩ |
| 2650 MHz | 27.0 dB | 53.2 Ω - 3.3 jΩ |
| 2750 MHz | 19.7 dB | 45.7 Ω - 8.9 jΩ |



3.2 Antenna Design and Handling

The calibration dipole has a symmetric geometry with a built-in two stub matching network, which leads to the enhanced bandwidth.

The dipole is built of standard semirigid coaxial cable. The internal matching line is open ended. The antenna is therefore open for DC signals.

Do not apply force to dipole arms, as they are liable to bend. The soldered connections near the feedpoint may be damaged. After excessive mechanical stress or overheating, check the impedance characteristics to ensure that the internal matching network is not affected.

After long term use with 40W radiated power, only a slight warming of the dipole near the feedpoint can be measured.

| | | | | |
|-------------------------------------|--|--------------------------------|---|---------------------------------|
| FCC ID: A3LSMG965U |  PCTEST ENGINEERING LABORATORY, INC. | HAC (RF EMISSIONS) TEST REPORT |  | Approved by: Quality Manager |
| Filename: 1M1711060289-13-R1.A3L | Test Dates: 11/06/2017 - 12/11/2017 | DUT Type: Portable Handset | | Page 100 of 108 |

Impedance Measurement Plot

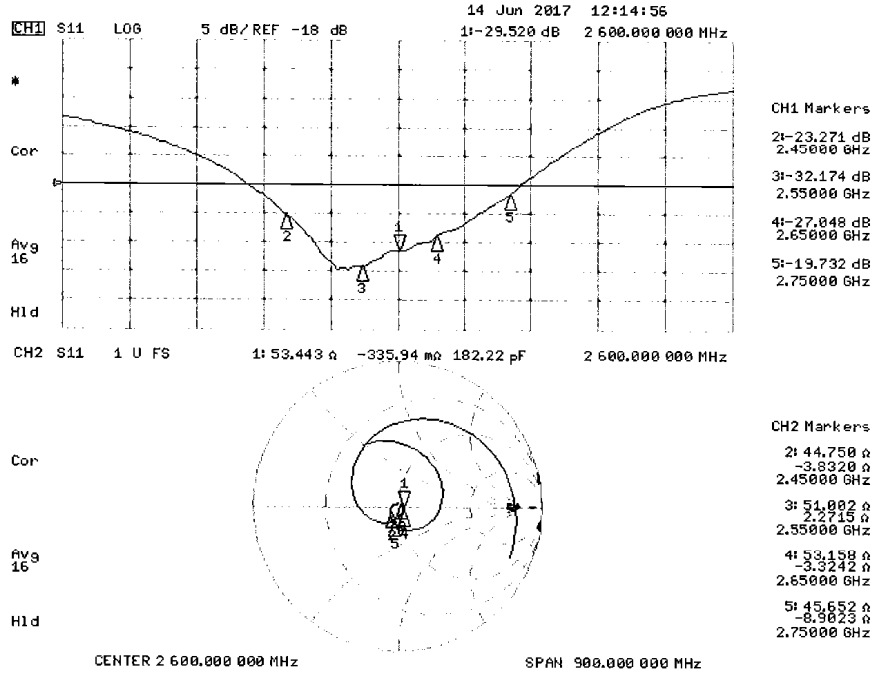

| | | | | |
|-------------------------------------|--|--------------------------------|-----------------|---------------------------------|
| FCC ID: A3LSMG965U | PCTEST TECHNOLOGICAL LABORATORY, INC. | HAC (RF EMISSIONS) TEST REPORT | SAMSUNG | Approved by: Quality Manager |
| Filename: 1M1711060289-13-R1.A3L | Test Dates: 11/06/2017 - 12/11/2017 | DUT Type: Portable Handset | Page 101 of 108 | |

DASY5 E-field Result

Date: 14.06.2017

Test Laboratory: SPEAG Lab2

DUT: HAC Dipole 2600 MHz; Type: CD2600V3; Serial: CD2600V3 - SN: 1013

Communication System: UID 0 - CW ; Frequency: 2600 MHz
 Medium parameters used: $\sigma = 0$ S/m, $\epsilon_r = 1$; $\rho = 1000$ kg/m³
 Phantom section: RF Section

DASY52 Configuration:

- Probe: EF3DV3 - SN4013; ConvF(1, 1, 1); Calibrated:21.06.2016 ;
- Sensor-Surface: (Fix Surface)
- Electronics: DAE4 Sn781; Calibrated: 02.09.2016
- Phantom: HAC Test Arch with AMCC; Type: SD HAC P01 BA; Serial: 1070
- DASY52 52.10.0(1444); SEMCAD X 14.6.10(7416)

Dipole E-Field measurement @ 2600MHz - with EF_4013/E-Scan - 2600MHz d=15mm/Hearing Aid Compatibility Test (41x181x1): Interpolated grid: dx=0.5000 mm, dy=0.5000 mm
 Device Reference Point: 0, 0, -6.3 mm
 Reference Value = 68.41 V/m; Power Drift = -0.01 dB
 PMR not calibrated. PMF = 1.000 is applied.
 E-field emissions = 84.92 V/m
Near-field category: M3 (AWF 0 dB)

PMF scaled E-field

| | | |
|-----------|-----------|-----------|
| Grid 1 M3 | Grid 2 M3 | Grid 3 M3 |
| 81.71 V/m | 83.99 V/m | 83.23 V/m |
| Grid 4 M3 | Grid 5 M3 | Grid 6 M3 |
| 77.39 V/m | 79.18 V/m | 78.75 V/m |
| Grid 7 M3 | Grid 8 M3 | Grid 9 M3 |
| 82.82 V/m | 84.92 V/m | 83.82 V/m |

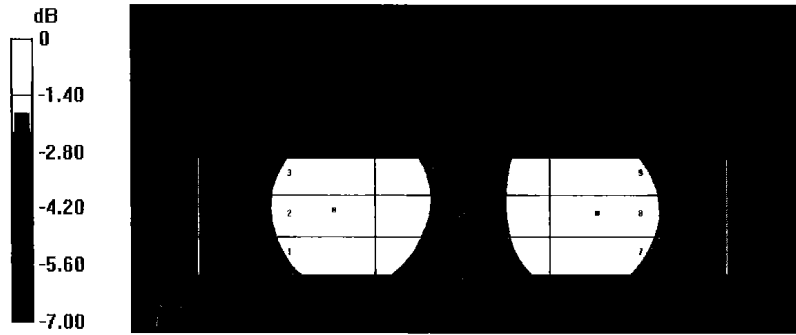



| | | | | |
|-------------------------------------|--|--------------------------------|-----------------|---------------------------------|
| FCC ID: A3LSMG965U | PCTEST ENGINEERING LABORATORY, INC. | HAC (RF EMISSIONS) TEST REPORT | SAMSUNG | Approved by: Quality Manager |
| Filename: 1M1711060289-13-R1.A3L | Test Dates: 11/06/2017 - 12/11/2017 | DUT Type: Portable Handset | Page 102 of 108 | |

16. CONCLUSION

The measurements, taken in accordance with the procedures provided in the CTIA Test Plan for Hearing Aid Compatibility Rev 3.1, February 2017, indicate that the wireless communications device complies with the HAC limits specified in the ANSI C63.19 Standard and FCC WT Docket No. 01-309 RM-8658. Precise laboratory measures were taken to assure repeatability of the tests. The tested device complies with the requirements in respect to all parameters specific to the test. The test results and statements relate only to the item(s) tested.

Please note that the M-rating for this equipment only represents the field interference possible against a hypothetical and typical hearing aid. The measurement system and techniques presented in this evaluation are proposed in the ANSI standard as a means of best approximating wireless device compatibility with a hearing-aid. The literature is under continual re-construction.

| | | | | |
|--|---|---------------------------------------|---|--|
| FCC ID: A3LSMG965U |  PCTEST ENGINEERING LABORATORY, INC. | HAC (RF EMISSIONS) TEST REPORT |  | Approved by: Quality Manager |
| Filename: 1M1711060289-13-R1.A3L | Test Dates: 11/06/2017 - 12/11/2017 | DUT Type: Portable Handset | Page 103 of 108 | |

© 2017 PCTEST Engineering Laboratory, Inc.



REV 3.1.M

09/14/2017



© 2017 PCTEST Engineering Laboratory, Inc. All rights reserved. Unless otherwise specified, no part of this report may be reproduced or utilized in any part, form or by any means, electronic or mechanical, including photocopying and microfilm, without permission in writing from PCTEST Engineering Laboratory, Inc. If you have any questions about this international copyright or have an enquiry about obtaining additional rights to this report or assembly of contents thereof, please contact INFO@PCTEST.COM.

17. REFERENCES

1. ANSI/IEEE C63.19-2011, "American National Standard for Methods of Measurement of Compatibility between Wireless Communication Devices and Hearing Aids.", New York, NY, IEEE, May 2011
2. CTIA Certification Program, "Test Plan for Hearing Aid Compatibility Rev 3.1", Washington, DC, CTIA, February 2017
3. FCC Office of Engineering and Technology KDB, "285076 D01 HAC Guidance v05," September 13, 2017
4. FCC Office of Engineering and Technology KDB, "285076 D02 T-Coil Testing for CMRS IP v03," September 13, 2017
5. FCC Public Notice DA 06-1215, *Wireless Telecommunications Bureau and Office of Engineering and Technology Clarify Use of Revised Wireless Phone Hearing Aid Compatibility Standard*, June 6, 2006
6. FCC 3G Review Guidance, Laboratory Division OET FCC, May/June 2006
7. Berger, H. S., "Compatibility Between Hearing Aids and Wireless Devices," Electronic Industries Forum, Boston, MA, May, 1997
8. Berger, H. S., "Hearing Aid and Cellular Phone Compatibility: Working Toward Solutions," *Wireless Telephones and Hearing Aids: New Challenges for Audiology*, Gallaudet University, Washington, D.C., May, 1997 (To be reprinted in the American Journal of Audiology).
9. Berger, H. S., "Hearing Aid Compatibility with Wireless Communications Devices," IEEE International Symposium on Electromagnetic Compatibility, Austin, TX, August, 1997.
10. Bronaugh, E. L., "Simplifying EMI Immunity (Susceptibility) Tests in TEM Cells," in the 1990 IEEE International Symposium on Electromagnetic Compatibility Symposium Record, Washington, D.C., August 1990, pp. 488-491
11. Byrne, D. and Dillon, H., The National Acoustics Laboratory (NAL) New Procedure for Selecting the Gain and Frequency Response of a Hearing Aid, *Ear and Hearing* 7:257-265, 1986.
12. Crawford, M. L., "Measurement of Electromagnetic Radiation from Electronic Equipment using TEM Transmission Cells," U.S. Department of Commerce, National Bureau of Standards, NBSIR 73-306, Feb. 1973.
13. Crawford, M. L., and Workman, J. L., "Using a TEM Cell for EMC Measurements of Electronic Equipment," U.S. Department of Commerce, National Bureau of Standards. Technical Note 1013, July 1981.
14. Decker, W. F., Crawford, M. L., and Wilson, W. A., "Construction of a Large Transverse Electromagnetic Cell", U.S. Department of Commerce, National Bureau of Standards, Technical Note 1011, Feb. 1979.
15. EHIMA GSM Project, Development phase, Project Report (1st part) Revision A. Technical-Audiological Laboratory and Telecom Denmark, October 1993.

| | | | | |
|-------------------------------------|--|--------------------------------|---|---------------------------------|
| FCC ID: A3LSMG965U |  PCTEST TECHNOLOGICAL LABORATORY, INC. | HAC (RF EMISSIONS) TEST REPORT |  | Approved by: Quality Manager |
| Filename: 1M1711060289-13-R1.A3L | Test Dates: 11/06/2017 - 12/11/2017 | DUT Type: Portable Handset | Page 104 of 108 | |

16. EHIMA GSM Project, Development phase, Part II Project Report. Technical-Audiological Laboratory and Telecom Denmark, June 1994.
17. EHIMA GSM Project Final Report, Hearing Aids and GSM Mobile Telephones: Interference Problems, Methods of Measurement and Levels of Immunity. Technical-Audiological Laboratory and Telecom Denmark, 1995.
18. HAMPIS Report, Comparison of Mobile phone electromagnetic near field with an upscaled electromagnetic far field, using hearing aid as reference, 21 October 1999.
19. Hearing Aids/GSM, Report from OTWIDAM, Technical-Audiological Laboratory and Telecom Denmark, April 1993.
20. IEEE 100, The Authoritative Dictionary of IEEE Standards Terms, Seventh Edition.
21. Joyner, K. H, et. al., Interference to Hearing Aids by the New Digital Mobile Telephone System, Global System for Mobile (GSM) Communication Standard, National Acoustic Laboratory, Australian Hearing Series, Sydney 1993.
22. Joyner, K. H., et. al., Interference to Hearing Aids by the Digital Mobile Telephone System, Global System for Mobile Communications (GSM), NAL Report #131, National Acoustic Laboratory, Australian Hearing Series, Sydney, 1995.
23. Konigstein, D., and Hansen, D., "A New Family of TEM Cells with enlarged bandwidth and Optimized working Volume," in the Proceedings of the 7th International Symposium on EMC, Zurich, Switzerland, March 1987; 50:9, pp. 127-132.
24. Kuk, F., and Hjorstgaard, N. K., "Factors affecting interference from digital cellular telephones," Hearing Journal, 1997; 50:9, pp 32-34.
25. Ma, M. A., and Kanda, M., "Electromagnetic Compatibility and Interference Metrology," U.S. Department of Commerce, National Bureau of Standards, Technical Note 1099, July 1986, pp. 17-43.
26. Ma, M. A., Sreenivashiah, I. , and Chang, D. C., "A Method of Determining the Emission and Susceptibility Levels of Electrically Small Objects Using a TEM Cell," U.S. Department of Commerce, National Bureau of Standards, Technial Note 1040, July 1981.
27. McCandless, G. A., and Lyregaard, P. E., Prescription of Gain/Output (POGO) for Hearing Aids, Hearing Instruments 1:16-21, 1983
28. Skopec, M., "Hearing Aid Electromagnetic Interference from Digital Wireless Telephones, "IEEE Transactions on Rehabilitation Engineering, vol. 6, no. 2, pp. 235-239, June 1998.
29. Technical Report, GSM 05.90, GSM EMC Considerations, European Telecommunications Standards Institute, January 1993.
30. Victorian, T. A., "Digital Cellular Telephone Interference and Hearing Aid Compatibility—an Update," Hearing Journal 1998; 51:10, pp. 53-60
31. Wong, G. S. K., and Embleton, T. F. W., eds., AIP Handbook of Condenser Microphones: Theory, Calibration and Measurements, AIP Press.

| | | | | |
|--|---|---------------------------------------|---|--|
| FCC ID: A3LSMG965U |  PCTEST ENGINEERING LABORATORY, INC. | HAC (RF EMISSIONS) TEST REPORT |  | Approved by: Quality Manager |
| Filename: 1M1711060289-13-R1.A3L | Test Dates: 11/06/2017 - 12/11/2017 | DUT Type: Portable Handset | Page 105 of 108 | |