



Accredited by the Swiss Accreditation Service (SAS)
The Swiss Accreditation Service is one of the signatories to the EA
Multilateral Agreement for the recognition of calibration certificates

Accreditation No.: **SCS 0108**

Client **PC Test**

Certificate No: **ES3-3319_Mar15**

CALIBRATION CERTIFICATE

Object **ES3DV3 - SN:3319**

Calibration procedure(s) **QA CAL-01.v9, QA CAL-23.v5, QA CAL-25.v6
Calibration procedure for dosimetric E-field probes**

Calibration date: **March 19, 2015**

*PM ✓
3/26/15*

This calibration certificate documents the traceability to national standards, which realize the physical units of measurements (SI).
The measurements and the uncertainties with confidence probability are given on the following pages and are part of the certificate.

All calibrations have been conducted in the closed laboratory facility: environment temperature (22 ± 3)°C and humidity < 70%.

Calibration Equipment used (M&TE critical for calibration)

Primary Standards	ID	Cal Date (Certificate No.)	Scheduled Calibration
Power meter E4419B	GB41293874	03-Apr-14 (No. 217-01911)	Apr-15
Power sensor E4412A	MY41498087	03-Apr-14 (No. 217-01911)	Apr-15
Reference 3 dB Attenuator	SN: S5054 (3c)	03-Apr-14 (No. 217-01915)	Apr-15
Reference 20 dB Attenuator	SN: S5277 (20x)	03-Apr-14 (No. 217-01919)	Apr-15
Reference 30 dB Attenuator	SN: S5129 (30b)	03-Apr-14 (No. 217-01920)	Apr-15
Reference Probe ES3DV2	SN: 3013	30-Dec-14 (No. ES3-3013_Dec14)	Dec-15
DAE4	SN: 660	14-Jan-15 (No. DAE4-660_Jan15)	Jan-16
Secondary Standards	ID	Check Date (in house)	Scheduled Check
RF generator HP 8648C	US3642U01700	4-Aug-99 (in house check Apr-13)	In house check: Apr-16
Network Analyzer HP 8753E	US37390585	18-Oct-01 (in house check Oct-14)	In house check: Oct-15

	Name	Function	Signature
Calibrated by:	Israe Elnaouq	Laboratory Technician	<i>Israe Elnaouq</i>
Approved by:	Katja Pokovic	Technical Manager	<i>Katja Pokovic</i>
			Issued: March 19, 2015
This calibration certificate shall not be reproduced except in full without written approval of the laboratory.			



Accredited by the Swiss Accreditation Service (SAS)

Accreditation No.: **SCS 0108**

The Swiss Accreditation Service is one of the signatories to the EA
Multilateral Agreement for the recognition of calibration certificates

Glossary:

TSL	tissue simulating liquid
NORM _{x,y,z}	sensitivity in free space
ConvF	sensitivity in TSL / NORM _{x,y,z}
DCP	diode compression point
CF	crest factor (1/duty_cycle) of the RF signal
A, B, C, D	modulation dependent linearization parameters
Polarization φ	φ rotation around probe axis
Polarization ϑ	ϑ rotation around an axis that is in the plane normal to probe axis (at measurement center), i.e., $\vartheta = 0$ is normal to probe axis
Connector Angle	information used in DASY system to align probe sensor X to the robot coordinate system

Calibration is Performed According to the Following Standards:

- a) IEEE Std 1528-2013, "IEEE Recommended Practice for Determining the Peak Spatial-Averaged Specific Absorption Rate (SAR) in the Human Head from Wireless Communications Devices: Measurement Techniques", June 2013
- b) IEC 62209-1, "Procedure to measure the Specific Absorption Rate (SAR) for hand-held devices used in close proximity to the ear (frequency range of 300 MHz to 3 GHz)", February 2005

Methods Applied and Interpretation of Parameters:

- *NORM_{x,y,z}*: Assessed for E-field polarization $\vartheta = 0$ ($f \leq 900$ MHz in TEM-cell; $f > 1800$ MHz: R22 waveguide). *NORM_{x,y,z}* are only intermediate values, i.e., the uncertainties of *NORM_{x,y,z}* does not affect the E^2 -field uncertainty inside TSL (see below *ConvF*).
- *NORM(f)_{x,y,z}* = *NORM_{x,y,z}* * *frequency_response* (see Frequency Response Chart). This linearization is implemented in DASY4 software versions later than 4.2. The uncertainty of the frequency response is included in the stated uncertainty of *ConvF*.
- *DCP_{x,y,z}*: DCP are numerical linearization parameters assessed based on the data of power sweep with CW signal (no uncertainty required). DCP does not depend on frequency nor media.
- *PAR*: PAR is the Peak to Average Ratio that is not calibrated but determined based on the signal characteristics
- *A_{x,y,z}*; *B_{x,y,z}*; *C_{x,y,z}*; *D_{x,y,z}*; *VR_{x,y,z}*: *A, B, C, D* are numerical linearization parameters assessed based on the data of power sweep for specific modulation signal. The parameters do not depend on frequency nor media. *VR* is the maximum calibration range expressed in RMS voltage across the diode.
- *ConvF and Boundary Effect Parameters*: Assessed in flat phantom using E-field (or Temperature Transfer Standard for $f \leq 800$ MHz) and inside waveguide using analytical field distributions based on power measurements for $f > 800$ MHz. The same setups are used for assessment of the parameters applied for boundary compensation (alpha, depth) of which typical uncertainty values are given. These parameters are used in DASY4 software to improve probe accuracy close to the boundary. The sensitivity in TSL corresponds to *NORM_{x,y,z}* * *ConvF* whereby the uncertainty corresponds to that given for *ConvF*. A frequency dependent *ConvF* is used in DASY version 4.4 and higher which allows extending the validity from ± 50 MHz to ± 100 MHz.
- *Spherical isotropy (3D deviation from isotropy)*: in a field of low gradients realized using a flat phantom exposed by a patch antenna.
- *Sensor Offset*: The sensor offset corresponds to the offset of virtual measurement center from the probe tip (on probe axis). No tolerance required.
- *Connector Angle*: The angle is assessed using the information gained by determining the *NORM_x* (no uncertainty required).

Probe ES3DV3

SN:3319

Manufactured: January 10, 2012
Calibrated: March 19, 2015

Calibrated for DASY/EASY Systems
(Note: non-compatible with DASY2 system!)

DASY/EASY - Parameters of Probe: ES3DV3 - SN:3319

Basic Calibration Parameters

	Sensor X	Sensor Y	Sensor Z	Unc (k=2)
Norm ($\mu V/(V/m)^2$) ^A	1.12	1.08	1.15	$\pm 10.1\%$
DCP (mV) ^B	104.4	106.0	104.4	

Modulation Calibration Parameters

UID	Communication System Name		A dB	B dB $\sqrt{\mu V}$	C	D dB	VR mV	Unc ^E (k=2)
0	CW	X	0.0	0.0	1.0	0.00	176.1	$\pm 3.3\%$
		Y	0.0	0.0	1.0		192.7	
		Z	0.0	0.0	1.0		174.6	
10010- CAA	SAR Validation (Square, 100ms, 10ms)	X	3.26	64.8	13.4	10.00	41.7	$\pm 1.9\%$
		Y	2.66	62.2	11.7		39.5	
		Z	3.51	64.8	13.2		42.1	
10011- CAB	UMTS-FDD (WCDMA)	X	3.47	68.1	19.1	2.91	142.9	$\pm 0.5\%$
		Y	3.37	67.9	19.1		133.0	
		Z	3.57	68.7	19.4		138.6	
10012- CAB	IEEE 802.11b WiFi 2.4 GHz (DSSS, 1 Mbps)	X	3.48	71.8	20.2	1.87	143.9	$\pm 0.7\%$
		Y	3.23	70.9	19.9		134.6	
		Z	3.68	72.8	20.6		140.5	
10013- CAB	IEEE 802.11g WiFi 2.4 GHz (DSSS-OFDM, 6 Mbps)	X	11.18	70.5	23.1	9.46	143.4	$\pm 3.3\%$
		Y	10.98	70.5	23.2		129.9	
		Z	11.19	70.6	23.1		138.8	
10021- DAB	GSM-FDD (TDMA, GMSK)	X	15.55	92.7	26.1	9.39	126.5	$\pm 1.7\%$
		Y	21.21	98.0	27.2		142.0	
		Z	19.50	96.1	27.0		125.4	
10023- DAB	GPRS-FDD (TDMA, GMSK, TN 0)	X	23.54	100.0	28.4	9.57	142.6	$\pm 2.2\%$
		Y	23.24	99.9	28.0		137.4	
		Z	23.57	99.6	28.2		139.7	
10024- DAB	GPRS-FDD (TDMA, GMSK, TN 0-1)	X	17.00	90.2	22.7	6.56	128.9	$\pm 2.2\%$
		Y	35.20	99.7	24.9		148.2	
		Z	33.12	99.6	25.4		123.8	
10027- DAB	GPRS-FDD (TDMA, GMSK, TN 0-1-2)	X	44.20	99.6	23.6	4.80	146.0	$\pm 1.9\%$
		Y	49.99	99.9	23.0		136.6	
		Z	41.43	99.6	23.9		141.4	
10028- DAB	GPRS-FDD (TDMA, GMSK, TN 0-1-2-3)	X	46.56	99.7	22.7	3.55	127.7	$\pm 2.2\%$
		Y	58.11	99.8	21.9		145.3	
		Z	55.65	99.6	22.2		124.3	
10032- CAA	IEEE 802.15.1 Bluetooth (GFSK, DH5)	X	34.25	99.4	21.1	1.16	140.3	$\pm 1.7\%$
		Y	40.72	100.0	20.6		135.7	
		Z	45.39	100.0	20.8		136.4	
10100- CAB	LTE-FDD (SC-FDMA, 100% RB, 20 MHz, QPSK)	X	6.30	67.1	19.5	5.67	127.4	$\pm 1.4\%$
		Y	6.58	68.4	20.3		149.0	
		Z	6.55	68.0	19.9		146.3	

10103-CAB	LTE-TDD (SC-FDMA, 100% RB, 20 MHz, QPSK)	X	10.47	75.6	25.8	9.29	146.6	±3.0 %
		Y	10.18	75.8	26.3		136.2	
		Z	10.38	75.3	25.6		140.8	
10108-CAC	LTE-FDD (SC-FDMA, 100% RB, 10 MHz, QPSK)	X	6.18	66.6	19.4	5.80	126.9	±1.4 %
		Y	6.40	67.8	20.1		147.0	
		Z	6.44	67.6	19.9		145.7	
10117-CAB	IEEE 802.11n (HT Mixed, 13.5 Mbps, BPSK)	X	10.24	69.0	21.3	8.07	142.7	±2.5 %
		Y	10.25	69.2	21.5		136.7	
		Z	10.16	68.8	21.2		136.6	
10151-CAB	LTE-TDD (SC-FDMA, 50% RB, 20 MHz, QPSK)	X	9.85	74.8	25.6	9.28	140.8	±3.0 %
		Y	9.49	74.7	25.9		130.5	
		Z	9.90	74.8	25.6		136.8	
10154-CAC	LTE-FDD (SC-FDMA, 50% RB, 10 MHz, QPSK)	X	6.13	67.1	19.7	5.75	146.6	±1.4 %
		Y	6.11	67.4	19.9		147.7	
		Z	6.12	67.1	19.7		142.3	
10160-CAB	LTE-FDD (SC-FDMA, 50% RB, 15 MHz, QPSK)	X	6.33	66.7	19.4	5.82	128.9	±1.4 %
		Y	6.33	67.1	19.7		128.7	
		Z	6.57	67.6	19.9		147.4	
10169-CAB	LTE-FDD (SC-FDMA, 1 RB, 20 MHz, QPSK)	X	4.89	66.4	19.5	5.73	127.5	±1.2 %
		Y	4.99	67.5	20.2		149.3	
		Z	5.09	67.3	20.0		145.1	
10172-CAB	LTE-TDD (SC-FDMA, 1 RB, 20 MHz, QPSK)	X	7.99	75.8	26.3	9.21	127.6	±2.7 %
		Y	9.29	81.7	29.6		149.8	
		Z	8.04	75.8	26.3		123.6	
10175-CAC	LTE-FDD (SC-FDMA, 1 RB, 10 MHz, QPSK)	X	5.08	67.3	20.0	5.72	149.3	±1.4 %
		Y	5.00	67.6	20.3		145.0	
		Z	5.09	67.3	20.0		145.0	
10181-CAB	LTE-FDD (SC-FDMA, 1 RB, 15 MHz, QPSK)	X	5.08	67.3	20.0	5.72	148.5	±1.4 %
		Y	5.06	67.9	20.4		147.1	
		Z	5.11	67.4	20.0		144.8	
10196-CAB	IEEE 802.11n (HT Mixed, 6.5 Mbps, BPSK)	X	9.89	68.7	21.2	8.10	134.6	±2.2 %
		Y	9.84	68.9	21.4		130.4	
		Z	9.82	68.5	21.1		130.4	
10225-CAB	UMTS-FDD (HSPA+)	X	7.02	67.1	19.5	5.97	138.0	±1.4 %
		Y	6.88	67.0	19.5		133.2	
		Z	7.01	67.1	19.5		134.6	
10237-CAB	LTE-TDD (SC-FDMA, 1 RB, 10 MHz, QPSK)	X	8.01	75.9	26.4	9.21	128.0	±2.7 %
		Y	9.39	82.1	29.9		149.7	
		Z	8.34	76.9	26.9		129.1	
10252-CAB	LTE-TDD (SC-FDMA, 50% RB, 10 MHz, QPSK)	X	9.05	73.6	25.1	9.24	130.6	±3.0 %
		Y	8.76	73.7	25.5		123.6	
		Z	9.10	73.6	25.1		127.8	
10267-CAB	LTE-TDD (SC-FDMA, 100% RB, 10 MHz, QPSK)	X	9.81	74.7	25.6	9.30	139.3	±3.0 %
		Y	9.50	74.8	25.9		130.7	
		Z	9.81	74.6	25.5		135.0	

10275-CAB	UMTS-FDD (HSUPA, Subtest 5, 3GPP Rel8.4)	X	4.49	67.1	18.9	3.96	140.1	±0.7 %
		Y	4.46	67.2	19.0		137.6	
		Z	4.52	67.1	18.9		137.1	
10291-AAB	CDMA2000, RC3, SO55, Full Rate	X	3.68	67.0	18.8	3.46	129.3	±0.7 %
		Y	3.64	67.3	19.0		130.3	
		Z	3.84	67.9	19.2		148.6	
10292-AAB	CDMA2000, RC3, SO32, Full Rate	X	3.64	67.2	18.8	3.39	131.8	±0.5 %
		Y	3.60	67.4	19.1		128.2	
		Z	3.71	67.5	19.0		128.0	
10297-AAA	LTE-FDD (SC-FDMA, 50% RB, 20 MHz, QPSK)	X	6.43	67.5	19.9	5.81	147.2	±1.7 %
		Y	6.39	67.7	20.0		145.4	
		Z	6.42	67.5	19.8		143.2	
10311-AAA	LTE-FDD (SC-FDMA, 100% RB, 15 MHz, QPSK)	X	6.73	67.1	19.7	6.06	129.7	±1.4 %
		Y	6.75	67.5	19.9		130.8	
		Z	6.75	67.3	19.7		126.2	
10400-AAB	IEEE 802.11ac WiFi (20MHz, 64-QAM, 99pc duty cycle)	X	10.14	68.9	21.5	8.37	136.7	±2.5 %
		Y	10.23	69.5	22.0		136.5	
		Z	10.13	68.9	21.5		132.8	
10403-AAB	CDMA2000 (1xEV-DO, Rev. 0)	X	4.97	69.2	19.3	3.76	143.5	±0.5 %
		Y	4.87	69.3	19.4		141.0	
		Z	5.02	69.2	19.3		139.6	
10404-AAB	CDMA2000 (1xEV-DO, Rev. A)	X	4.91	69.3	19.4	3.77	139.8	±0.7 %
		Y	4.67	68.9	19.1		138.9	
		Z	4.89	69.1	19.3		137.1	
10415-AAA	IEEE 802.11b WiFi 2.4 GHz (DSSS, 1 Mbps, 99pc duty cycle)	X	2.93	70.1	19.6	1.54	137.8	±0.7 %
		Y	2.84	69.8	19.6		138.2	
		Z	3.04	70.8	19.9		134.2	
10416-AAA	IEEE 802.11g WiFi 2.4 GHz (ERP-OFDM, 6 Mbps, 99pc duty cycle)	X	9.94	68.7	21.3	8.23	134.6	±2.2 %
		Y	10.00	69.1	21.7		134.1	
		Z	9.89	68.5	21.2		130.1	

The reported uncertainty of measurement is stated as the standard uncertainty of measurement multiplied by the coverage factor $k=2$, which for a normal distribution corresponds to a coverage probability of approximately 95%.

^A The uncertainties of NormX,Y,Z do not affect the E^2 -field uncertainty inside TSL (see Pages 7 and 8).

^B Numerical linearization parameter: uncertainty not required.

^E Uncertainty is determined using the max. deviation from linear response applying rectangular distribution and is expressed for the square of the field value.

DASY/EASY - Parameters of Probe: ES3DV3 - SN:3319

Calibration Parameter Determined in Head Tissue Simulating Media

f (MHz) ^C	Relative Permittivity ^F	Conductivity (S/m) ^F	ConvF X	ConvF Y	ConvF Z	Alpha ^G	Depth ^G (mm)	Unct. (k=2)
750	41.9	0.89	6.69	6.69	6.69	0.40	1.70	± 12.0 %
835	41.5	0.90	6.41	6.41	6.41	0.43	1.62	± 12.0 %
1750	40.1	1.37	5.29	5.29	5.29	0.80	1.16	± 12.0 %
1900	40.0	1.40	5.10	5.10	5.10	0.80	1.24	± 12.0 %
2300	39.5	1.67	4.77	4.77	4.77	0.64	1.38	± 12.0 %
2450	39.2	1.80	4.55	4.55	4.55	0.80	1.29	± 12.0 %
2600	39.0	1.96	4.39	4.39	4.39	0.80	1.31	± 12.0 %

^C Frequency validity above 300 MHz of ± 100 MHz only applies for DASY v4.4 and higher (see Page 2), else it is restricted to ± 50 MHz. The uncertainty is the RSS of the ConvF uncertainty at calibration frequency and the uncertainty for the indicated frequency band. Frequency validity below 300 MHz is ± 10, 25, 40, 50 and 70 MHz for ConvF assessments at 30, 64, 128, 150 and 220 MHz respectively. Above 5 GHz frequency validity can be extended to ± 110 MHz.

^F At frequencies below 3 GHz, the validity of tissue parameters (ϵ and σ) can be relaxed to ± 10% if liquid compensation formula is applied to measured SAR values. At frequencies above 3 GHz, the validity of tissue parameters (ϵ and σ) is restricted to ± 5%. The uncertainty is the RSS of the ConvF uncertainty for indicated target tissue parameters.

^G Alpha/Depth are determined during calibration. SPEAG warrants that the remaining deviation due to the boundary effect after compensation is always less than ± 1% for frequencies below 3 GHz and below ± 2% for frequencies between 3-6 GHz at any distance larger than half the probe tip diameter from the boundary.

DASY/EASY - Parameters of Probe: ES3DV3 - SN:3319

Calibration Parameter Determined in Body Tissue Simulating Media

f (MHz) ^C	Relative Permittivity ^F	Conductivity (S/m) ^F	ConvF X	ConvF Y	ConvF Z	Alpha ^G	Depth (mm) ^G	Unct. (k=2)
750	55.5	0.96	6.10	6.10	6.10	0.34	1.80	± 12.0 %
835	55.2	0.97	6.07	6.07	6.07	0.47	1.56	± 12.0 %
1750	53.4	1.49	4.83	4.83	4.83	0.70	1.36	± 12.0 %
1900	53.3	1.52	4.53	4.53	4.53	0.71	1.39	± 12.0 %
2300	52.9	1.81	4.24	4.24	4.24	0.80	1.26	± 12.0 %
2450	52.7	1.95	4.11	4.11	4.11	0.80	1.10	± 12.0 %
2600	52.5	2.16	3.90	3.90	3.90	0.80	1.11	± 12.0 %

^C Frequency validity above 300 MHz of ± 100 MHz only applies for DASY v4.4 and higher (see Page 2), else it is restricted to ± 50 MHz. The uncertainty is the RSS of the ConvF uncertainty at calibration frequency and the uncertainty for the indicated frequency band. Frequency validity below 300 MHz is ± 10, 25, 40, 50 and 70 MHz for ConvF assessments at 30, 64, 128, 150 and 220 MHz respectively. Above 5 GHz frequency validity can be extended to ± 110 MHz.

^F At frequencies below 3 GHz, the validity of tissue parameters (ϵ and σ) can be relaxed to ± 10% if liquid compensation formula is applied to measured SAR values. At frequencies above 3 GHz, the validity of tissue parameters (ϵ and σ) is restricted to ± 5%. The uncertainty is the RSS of the ConvF uncertainty for indicated target tissue parameters.

^G Alpha/Depth are determined during calibration. SPEAG warrants that the remaining deviation due to the boundary effect after compensation is always less than ± 1% for frequencies below 3 GHz and below ± 2% for frequencies between 3-6 GHz at any distance larger than half the probe tip diameter from the boundary.

Frequency Response of E-Field (TEM-Cell:ifi110 EXX, Waveguide: R22)

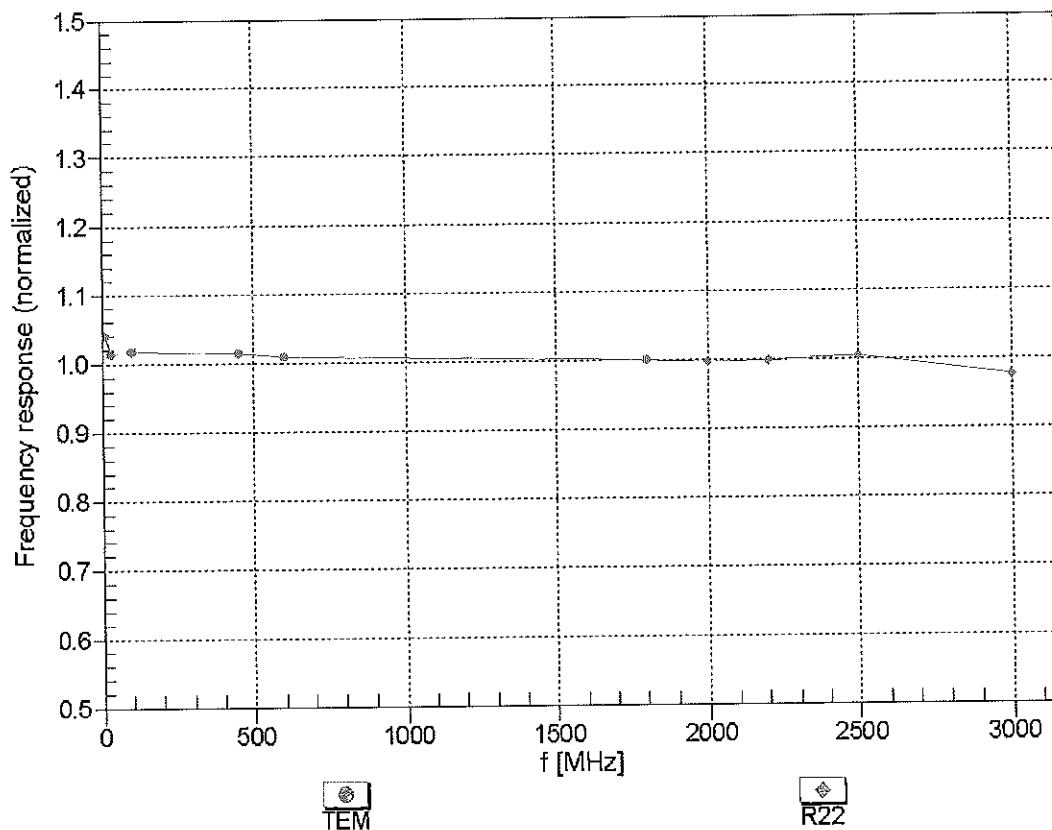

Uncertainty of Frequency Response of E-field: $\pm 6.3\%$ (k=2)

Receiving Pattern (ϕ), $\theta = 0^\circ$

f=600 MHz,TEM

f=1800 MHz,R22

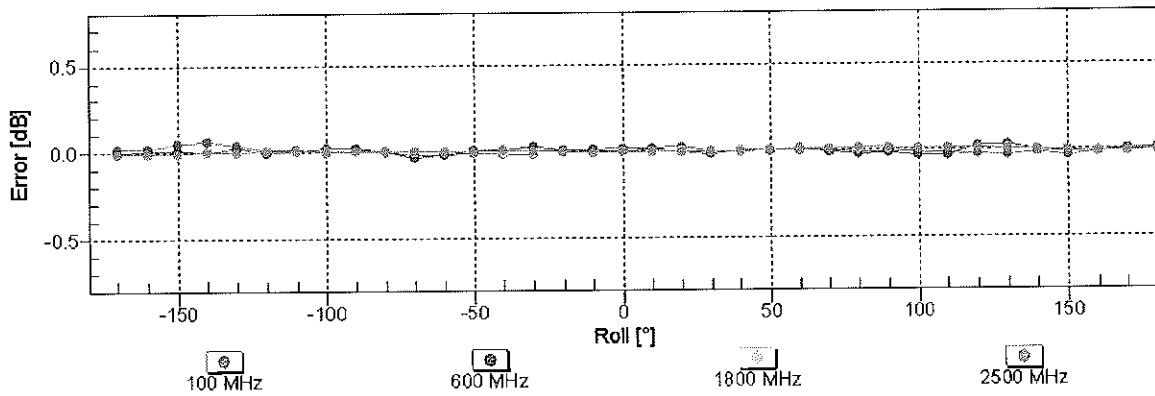
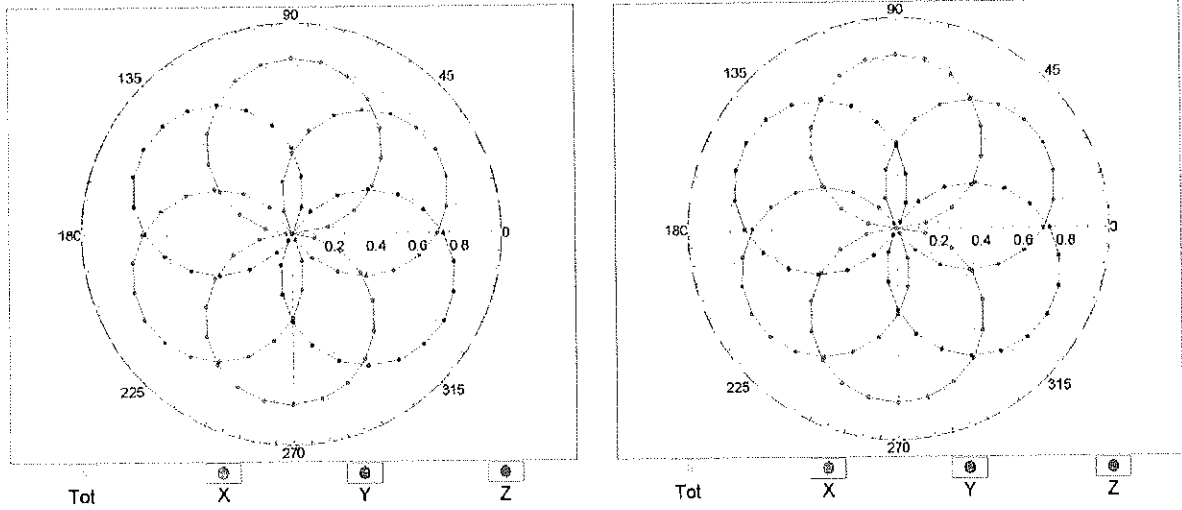

Uncertainty of Axial Isotropy Assessment: $\pm 0.5\%$ (k=2)

Dynamic Range $f(SAR_{head})$ (TEM cell , $f_{eval}= 1900$ MHz)

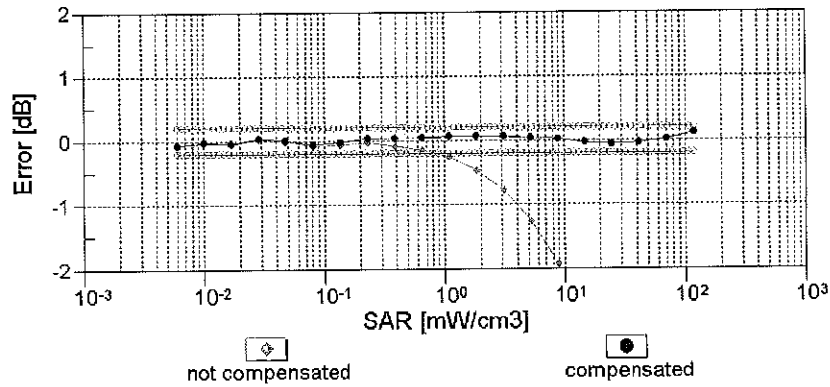
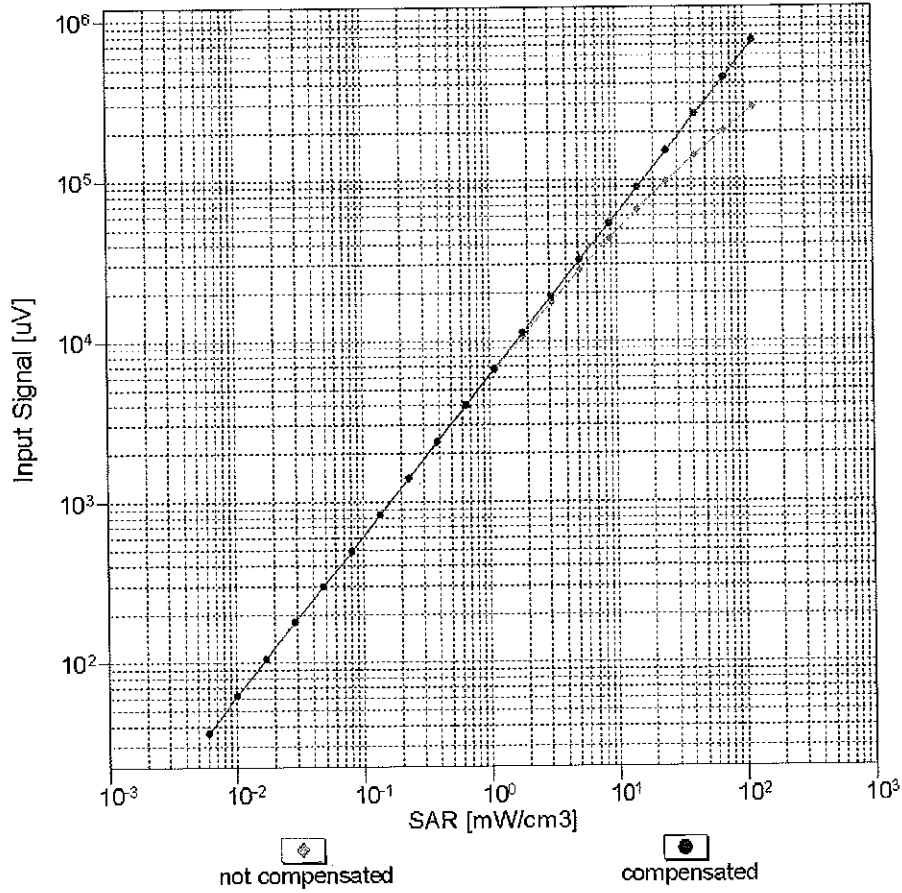

Uncertainty of Linearity Assessment: $\pm 0.6\%$ ($k=2$)

Conversion Factor Assessment

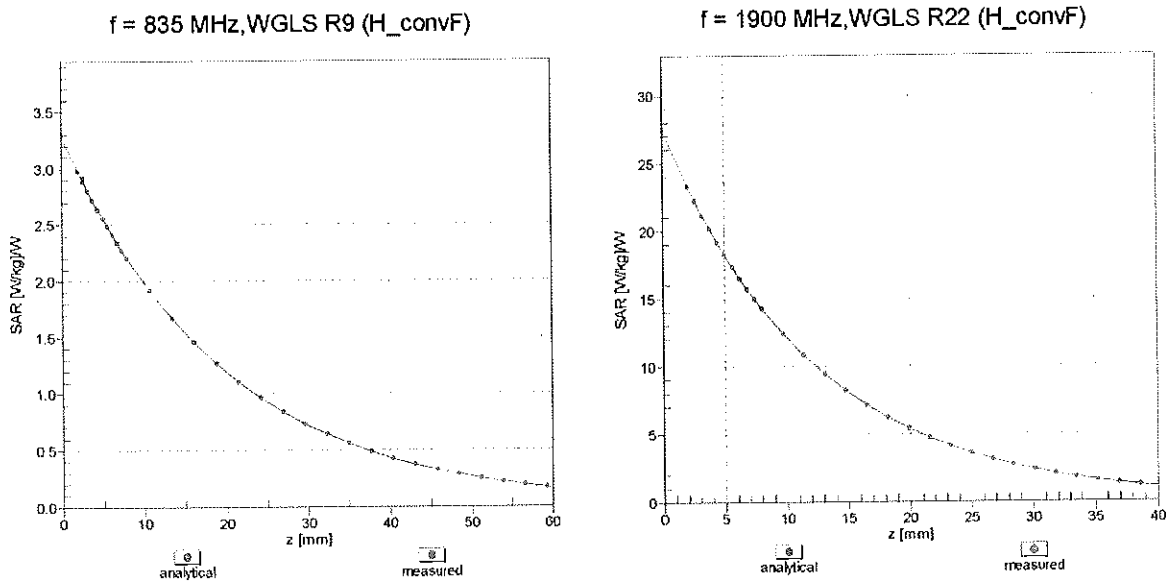

Deviation from Isotropy in Liquid Error (ϕ, θ), f = 900 MHz

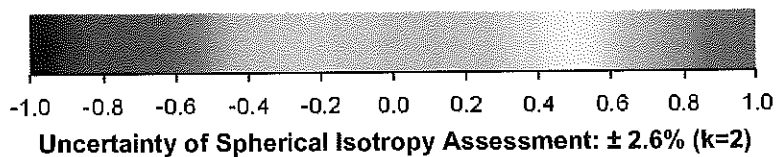
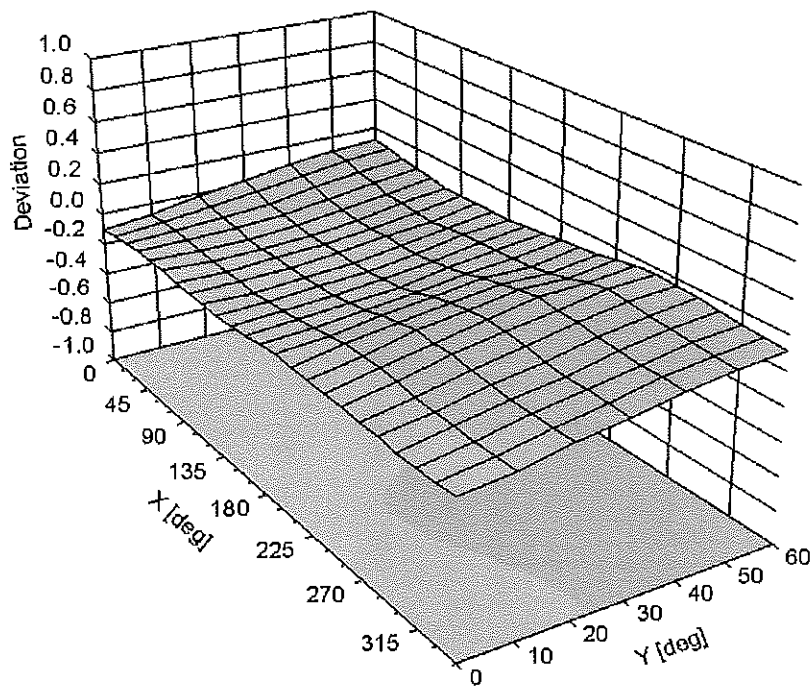

DASY/EASY - Parameters of Probe: ES3DV3 - SN:3319**Other Probe Parameters**

Sensor Arrangement	Triangular
Connector Angle (°)	-120.2
Mechanical Surface Detection Mode	enabled
Optical Surface Detection Mode	disabled
Probe Overall Length	337 mm
Probe Body Diameter	10 mm
Tip Length	10 mm
Tip Diameter	4 mm
Probe Tip to Sensor X Calibration Point	2 mm
Probe Tip to Sensor Y Calibration Point	2 mm
Probe Tip to Sensor Z Calibration Point	2 mm
Recommended Measurement Distance from Surface	3 mm



Accredited by the Swiss Accreditation Service (SAS)
The Swiss Accreditation Service is one of the signatories to the EA
Multilateral Agreement for the recognition of calibration certificates

Accreditation No.: **SCS 0108**

Client **PC Test**

Certificate No: **ES3-3263_May15**

CALIBRATION CERTIFICATE

Object **ES3DV3 - SN:3263**

Calibration procedure(s) **QA CAL-01.v9, QA CAL-23.v5, QA CAL-25.v6
Calibration procedure for dosimetric E-field probes**

Calibration date: **May 20, 2015**

*BN ✓
5/28/15*

This calibration certificate documents the traceability to national standards, which realize the physical units of measurements (SI).
The measurements and the uncertainties with confidence probability are given on the following pages and are part of the certificate.

All calibrations have been conducted in the closed laboratory facility: environment temperature (22 ± 3)°C and humidity < 70%.

Calibration Equipment used (M&TE critical for calibration)

Primary Standards	ID	Cal Date (Certificate No.)	Scheduled Calibration
Power meter E4419B	GB41293874	01-Apr-15 (No. 217-02128)	Mar-16
Power sensor E4412A	MY41498087	01-Apr-15 (No. 217-02128)	Mar-16
Reference 3 dB Attenuator	SN: S5054 (3c)	01-Apr-15 (No. 217-02129)	Mar-16
Reference 20 dB Attenuator	SN: S5277 (20x)	01-Apr-15 (No. 217-02132)	Mar-16
Reference 30 dB Attenuator	SN: S5129 (30b)	01-Apr-15 (No. 217-02133)	Mar-16
Reference Probe ES3DV2	SN: 3013	30-Dec-14 (No. ES3-3013_Dec14)	Dec-15
DAE4	SN: 660	14-Jan-15 (No. DAE4-660_Jan15)	Jan-16
Secondary Standards	ID	Check Date (in house)	Scheduled Check
RF generator HP 8648C	US3642U01700	4-Aug-99 (in house check Apr-13)	In house check: Apr-16
Network Analyzer HP 8753E	US37390585	18-Oct-01 (in house check Oct-14)	In house check: Oct-15

Calibrated by:	Name Leif Klysner	Function Laboratory Technician	Signature
Approved by:	Name Katja Pokovic	Function Technical Manager	
			Issued: May 19, 2015
This calibration certificate shall not be reproduced except in full without written approval of the laboratory.			



Accredited by the Swiss Accreditation Service (SAS)

Accreditation No.: **SCS 0108**

The Swiss Accreditation Service is one of the signatories to the EA
Multilateral Agreement for the recognition of calibration certificates

Glossary:

TSL	tissue simulating liquid
NORM _{x,y,z}	sensitivity in free space
ConvF	sensitivity in TSL / NORM _{x,y,z}
DCP	diode compression point
CF	crest factor (1/duty_cycle) of the RF signal
A, B, C, D	modulation dependent linearization parameters
Polarization φ	φ rotation around probe axis
Polarization ϑ	ϑ rotation around an axis that is in the plane normal to probe axis (at measurement center), i.e., ϑ = 0 is normal to probe axis
Connector Angle	information used in DASY system to align probe sensor X to the robot coordinate system

Calibration is Performed According to the Following Standards:

- a) IEEE Std 1528-2013, "IEEE Recommended Practice for Determining the Peak Spatial-Averaged Specific Absorption Rate (SAR) in the Human Head from Wireless Communications Devices: Measurement Techniques", June 2013
- b) IEC 62209-1, "Procedure to measure the Specific Absorption Rate (SAR) for hand-held devices used in close proximity to the ear (frequency range of 300 MHz to 3 GHz)", February 2005

Methods Applied and Interpretation of Parameters:

- *NORM_{x,y,z}*: Assessed for E-field polarization ϑ = 0 (f ≤ 900 MHz in TEM-cell; f > 1800 MHz: R22 waveguide). *NORM_{x,y,z}* are only intermediate values, i.e., the uncertainties of *NORM_{x,y,z}* does not affect the E²-field uncertainty inside TSL (see below *ConvF*).
- *NORM(f)_{x,y,z}* = *NORM_{x,y,z}* * *frequency_response* (see Frequency Response Chart). This linearization is implemented in DASY4 software versions later than 4.2. The uncertainty of the frequency response is included in the stated uncertainty of *ConvF*.
- *DCP_{x,y,z}*: DCP are numerical linearization parameters assessed based on the data of power sweep with CW signal (no uncertainty required). DCP does not depend on frequency nor media.
- *PAR*: PAR is the Peak to Average Ratio that is not calibrated but determined based on the signal characteristics
- *A_{x,y,z}*; *B_{x,y,z}*; *C_{x,y,z}*; *D_{x,y,z}*; *VR_{x,y,z}*; *A, B, C, D* are numerical linearization parameters assessed based on the data of power sweep for specific modulation signal. The parameters do not depend on frequency nor media. *VR* is the maximum calibration range expressed in RMS voltage across the diode.
- *ConvF* and *Boundary Effect Parameters*: Assessed in flat phantom using E-field (or Temperature Transfer Standard for f ≤ 800 MHz) and inside waveguide using analytical field distributions based on power measurements for f > 800 MHz. The same setups are used for assessment of the parameters applied for boundary compensation (alpha, depth) of which typical uncertainty values are given. These parameters are used in DASY4 software to improve probe accuracy close to the boundary. The sensitivity in TSL corresponds to *NORM_{x,y,z}* * *ConvF* whereby the uncertainty corresponds to that given for *ConvF*. A frequency dependent *ConvF* is used in DASY version 4.4 and higher which allows extending the validity from ± 50 MHz to ± 100 MHz.
- *Spherical isotropy (3D deviation from isotropy)*: in a field of low gradients realized using a flat phantom exposed by a patch antenna.
- *Sensor Offset*: The sensor offset corresponds to the offset of virtual measurement center from the probe tip (on probe axis). No tolerance required.
- *Connector Angle*: The angle is assessed using the information gained by determining the *NORM_x* (no uncertainty required).

Probe ES3DV3

SN:3263

Manufactured: January 25, 2010
Calibrated: May 20, 2015

Calibrated for DASY/EASY Systems
(Note: non-compatible with DASY2 system!)

DASY/EASY - Parameters of Probe: ES3DV3 - SN:3263

Basic Calibration Parameters

	Sensor X	Sensor Y	Sensor Z	Unc (k=2)
Norm ($\mu\text{V}/(\text{V}/\text{m})^2$) ^A	1.21	1.25	1.13	$\pm 10.1 \%$
DCP (mV) ^B	106.1	103.6	108.3	

Modulation Calibration Parameters

UID	Communication System Name		A dB	B dB $\sqrt{\mu\text{V}}$	C	D dB	VR mV	Unc ^E (k=2)
0	CW	X	0.0	0.0	1.0	0.00	205.3	$\pm 3.3 \%$
		Y	0.0	0.0	1.0		207.3	
		Z	0.0	0.0	1.0		199.5	
10010- CAA	SAR Validation (Square, 100ms, 10ms)	X	1.83	58.4	9.4	10.00	41.2	$\pm 1.4 \%$
		Y	3.88	63.3	12.9		47.5	
		Z	1.42	56.8	8.7		39.5	
10011- CAB	UMTS-FDD (WCDMA)	X	3.27	67.4	18.6	2.91	140.1	$\pm 0.7 \%$
		Y	3.39	67.5	18.7		142.7	
		Z	3.32	67.6	18.6		136.9	
10012- CAB	IEEE 802.11b WiFi 2.4 GHz (DSSS, 1 Mbps)	X	2.85	68.8	18.8	1.87	142.2	$\pm 0.7 \%$
		Y	3.38	70.7	19.5		144.8	
		Z	3.07	70.0	19.1		138.1	
10013- CAB	IEEE 802.11g WiFi 2.4 GHz (DSSS-OFDM, 6 Mbps)	X	10.99	70.8	23.4	9.46	135.9	$\pm 2.5 \%$
		Y	11.36	70.3	22.8		124.7	
		Z	10.57	70.0	22.9		129.4	
10021- DAB	GSM-FDD (TDMA, GMSK)	X	9.38	84.7	22.1	9.39	139.8	$\pm 1.9 \%$
		Y	27.79	100.0	28.7		129.4	
		Z	9.29	86.8	23.8		134.5	
10023- DAB	GPRS-FDD (TDMA, GMSK, TN 0)	X	9.63	84.9	22.1	9.57	134.1	$\pm 2.5 \%$
		Y	25.29	98.2	28.2		124.0	
		Z	9.65	87.7	24.3		128.2	
10024- DAB	GPRS-FDD (TDMA, GMSK, TN 0-1)	X	16.20	88.9	21.0	6.56	145.2	$\pm 1.4 \%$
		Y	41.82	99.7	25.6		128.5	
		Z	24.57	96.8	24.1		142.0	
10027- DAB	GPRS-FDD (TDMA, GMSK, TN 0-1-2)	X	55.77	99.6	22.1	4.80	138.5	$\pm 2.2 \%$
		Y	53.39	99.7	23.9		140.5	
		Z	40.28	99.6	23.2		134.3	
10028- DAB	GPRS-FDD (TDMA, GMSK, TN 0-1-2-3)	X	81.43	99.8	20.7	3.55	148.6	$\pm 1.7 \%$
		Y	60.49	99.7	22.9		146.0	
		Z	62.69	99.6	21.2		145.0	
10032- CAA	IEEE 802.15.1 Bluetooth (GFSK, DH5)	X	96.06	93.7	16.0	1.16	140.3	$\pm 1.9 \%$
		Y	77.08	99.9	20.1		149.0	
		Z	99.64	99.9	18.6		138.0	
10100- CAB	LTE-FDD (SC-FDMA, 100% RB, 20 MHz, QPSK)	X	6.24	67.2	19.6	5.67	131.7	$\pm 1.4 \%$
		Y	6.39	67.3	19.5		133.8	
		Z	6.19	67.2	19.6		126.8	

10103-CAB	LTE-TDD (SC-FDMA, 100% RB, 20 MHz, QPSK)	X	10.13	76.3	26.6	9.29	142.6	±2.7 %
		Y	12.07	77.9	26.6		138.9	
		Z	9.41	74.3	25.6		134.1	
10108-CAC	LTE-FDD (SC-FDMA, 100% RB, 10 MHz, QPSK)	X	6.13	66.9	19.5	5.80	129.6	±1.4 %
		Y	6.35	67.1	19.5		133.7	
		Z	6.39	68.0	20.1		150.0	
10117-CAB	IEEE 802.11n (HT Mixed, 13.5 Mbps, BPSK)	X	10.34	69.6	21.7	8.07	147.0	±1.9 %
		Y	10.05	68.3	20.9		123.4	
		Z	10.08	69.1	21.3		138.2	
10151-CAB	LTE-TDD (SC-FDMA, 50% RB, 20 MHz, QPSK)	X	9.44	75.3	26.3	9.28	137.0	±3.5 %
		Y	11.36	76.9	26.3		134.5	
		Z	8.85	73.5	25.3		130.3	
10154-CAC	LTE-FDD (SC-FDMA, 50% RB, 10 MHz, QPSK)	X	5.79	66.2	19.2	5.75	126.9	±1.2 %
		Y	6.05	66.5	19.3		130.9	
		Z	5.92	66.9	19.5		145.5	
10160-CAB	LTE-FDD (SC-FDMA, 50% RB, 15 MHz, QPSK)	X	6.25	66.9	19.5	5.82	131.8	±1.4 %
		Y	6.47	67.0	19.5		135.4	
		Z	6.09	66.5	19.3		127.5	
10169-CAB	LTE-FDD (SC-FDMA, 1 RB, 20 MHz, QPSK)	X	4.78	66.7	19.7	5.73	130.0	±1.2 %
		Y	5.14	66.7	19.5		135.0	
		Z	4.83	67.1	19.9		147.9	
10172-CAB	LTE-TDD (SC-FDMA, 1 RB, 20 MHz, QPSK)	X	8.63	80.4	29.1	9.21	147.7	±2.7 %
		Y	9.72	78.5	27.2		123.9	
		Z	7.63	76.7	27.2		142.5	
10175-CAC	LTE-FDD (SC-FDMA, 1 RB, 10 MHz, QPSK)	X	4.75	66.6	19.6	5.72	128.2	±1.2 %
		Y	5.12	66.6	19.5		134.3	
		Z	4.87	67.1	19.9		148.0	
10181-CAB	LTE-FDD (SC-FDMA, 1 RB, 15 MHz, QPSK)	X	4.76	66.6	19.6	5.72	127.9	±1.2 %
		Y	5.12	66.6	19.5		134.5	
		Z	4.87	67.3	20.0		147.0	
10196-CAB	IEEE 802.11n (HT Mixed, 6.5 Mbps, BPSK)	X	9.87	69.1	21.6	8.10	135.8	±2.2 %
		Y	10.19	69.1	21.4		145.3	
		Z	9.65	68.8	21.3		130.5	
10225-CAB	UMTS-FDD (HSPA+)	X	6.90	67.2	19.5	5.97	139.2	±1.7 %
		Y	7.22	67.3	19.6		148.0	
		Z	6.75	67.0	19.4		134.1	
10237-CAB	LTE-TDD (SC-FDMA, 1 RB, 10 MHz, QPSK)	X	8.68	80.6	29.2	9.21	148.0	±3.0 %
		Y	9.82	78.8	27.3		125.0	
		Z	7.85	77.6	27.7		143.5	
10252-CAB	LTE-TDD (SC-FDMA, 50% RB, 10 MHz, QPSK)	X	8.56	73.7	25.6	9.24	126.6	±3.5 %
		Y	10.58	76.0	25.9		126.3	
		Z	8.84	74.8	26.1		146.7	
10267-CAB	LTE-TDD (SC-FDMA, 100% RB, 10 MHz, QPSK)	X	9.24	74.6	25.9	9.30	133.6	±3.3 %
		Y	11.38	76.9	26.2		134.3	
		Z	8.79	73.2	25.1		128.6	

10275-CAB	UMTS-FDD (HSUPA, Subtest 5, 3GPP Rel8.4)	X	4.39	67.0	18.9	3.96	143.8	±0.9 %
		Y	4.55	67.1	18.8		147.3	
		Z	4.42	67.4	19.0		139.9	
10291-AAB	CDMA2000, RC3, SO55, Full Rate	X	3.59	67.2	18.9	3.46	132.2	±0.5 %
		Y	3.68	66.7	18.5		136.0	
		Z	3.57	67.1	18.6		128.5	
10292-AAB	CDMA2000, RC3, SO32, Full Rate	X	3.50	67.0	18.7	3.39	134.0	±0.7 %
		Y	3.62	66.6	18.4		138.6	
		Z	3.50	67.2	18.7		129.8	
10297-AAA	LTE-FDD (SC-FDMA, 50% RB, 20 MHz, QPSK)	X	6.11	66.8	19.4	5.81	127.7	±1.4 %
		Y	6.33	67.0	19.5		132.1	
		Z	6.28	67.6	19.9		146.6	
10311-AAA	LTE-FDD (SC-FDMA, 100% RB, 15 MHz, QPSK)	X	6.71	67.5	19.9	6.06	134.2	±1.7 %
		Y	6.93	67.7	19.9		138.0	
		Z	6.57	67.2	19.6		128.0	
10400-AAC	IEEE 802.11ac WiFi (20MHz, 64-QAM, 99pc duty cycle)	X	10.17	69.5	21.9	8.37	138.5	±2.5 %
		Y	10.55	69.5	21.8		148.0	
		Z	9.92	69.0	21.6		132.5	
10403-AAB	CDMA2000 (1xEV-DO, Rev. 0)	X	4.79	69.2	19.1	3.76	144.1	±0.7 %
		Y	4.71	67.0	18.2		129.2	
		Z	4.72	69.3	19.2		139.3	
10404-AAB	CDMA2000 (1xEV-DO, Rev. A)	X	4.69	69.2	19.2	3.77	142.1	±0.7 %
		Y	4.71	67.5	18.5		126.7	
		Z	4.51	68.6	18.8		137.3	
10415-AAA	IEEE 802.11b WiFi 2.4 GHz (DSSS, 1 Mbps, 99pc duty cycle)	X	2.55	68.0	18.5	1.54	141.7	±0.7 %
		Y	2.67	68.4	18.6		144.0	
		Z	2.98	70.8	19.5		138.0	
10416-AAA	IEEE 802.11g WiFi 2.4 GHz (ERP-OFDM, 6 Mbps, 99pc duty cycle)	X	10.01	69.3	21.8	8.23	137.3	±2.5 %
		Y	10.31	69.3	21.6		146.0	
		Z	9.69	68.8	21.4		129.9	

The reported uncertainty of measurement is stated as the standard uncertainty of measurement multiplied by the coverage factor $k=2$, which for a normal distribution corresponds to a coverage probability of approximately 95%.

^A The uncertainties of NormX,Y,Z do not affect the E²-field uncertainty inside TSL (see Pages 7 and 8).

^B Numerical linearization parameter: uncertainty not required.

^E Uncertainty is determined using the max. deviation from linear response applying rectangular distribution and is expressed for the square of the field value.

DASY/EASY - Parameters of Probe: ES3DV3 - SN:3263

Calibration Parameter Determined in Head Tissue Simulating Media

f (MHz) ^C	Relative Permittivity ^F	Conductivity (S/m) ^F	ConvF X	ConvF Y	ConvF Z	Alpha ^G	Depth (mm) ^G	Unct. (k=2)
750	41.9	0.89	6.27	6.27	6.27	0.29	1.87	± 12.0 %
835	41.5	0.90	6.18	6.18	6.18	0.49	1.42	± 12.0 %
1750	40.1	1.37	5.27	5.27	5.27	0.49	1.46	± 12.0 %
1900	40.0	1.40	4.96	4.96	4.96	0.66	1.28	± 12.0 %
2300	39.5	1.67	4.63	4.63	4.63	0.58	1.41	± 12.0 %
2450	39.2	1.80	4.40	4.40	4.40	0.71	1.34	± 12.0 %
2600	39.0	1.96	4.25	4.25	4.25	0.80	1.25	± 12.0 %

^C Frequency validity above 300 MHz of ± 100 MHz only applies for DASY v4.4 and higher (see Page 2), else it is restricted to ± 50 MHz. The uncertainty is the RSS of the ConvF uncertainty at calibration frequency and the uncertainty for the indicated frequency band. Frequency validity below 300 MHz is ± 10, 25, 40, 50 and 70 MHz for ConvF assessments at 30, 64, 128, 150 and 220 MHz respectively. Above 5 GHz frequency validity can be extended to ± 110 MHz.

^F At frequencies below 3 GHz, the validity of tissue parameters (ϵ and σ) can be relaxed to ± 10% if liquid compensation formula is applied to measured SAR values. At frequencies above 3 GHz, the validity of tissue parameters (ϵ and σ) is restricted to ± 5%. The uncertainty is the RSS of the ConvF uncertainty for indicated target tissue parameters.

^G Alpha/Depth are determined during calibration. SPEAG warrants that the remaining deviation due to the boundary effect after compensation is always less than ± 1% for frequencies below 3 GHz and below ± 2% for frequencies between 3-6 GHz at any distance larger than half the probe tip diameter from the boundary.

DASY/EASY - Parameters of Probe: ES3DV3 - SN:3263

Calibration Parameter Determined in Body Tissue Simulating Media

f (MHz) ^C	Relative Permittivity ^F	Conductivity (S/m) ^F	ConvF X	ConvF Y	ConvF Z	Alpha ^G	Depth (mm) ^G	Unct. (k=2)
750	55.5	0.96	6.07	6.07	6.07	0.53	1.42	± 12.0 %
835	55.2	0.97	6.08	6.08	6.08	0.57	1.36	± 12.0 %
1750	53.4	1.49	4.88	4.88	4.88	0.54	1.50	± 12.0 %
1900	53.3	1.52	4.66	4.66	4.66	0.56	1.51	± 12.0 %
2300	52.9	1.81	4.42	4.42	4.42	0.69	1.33	± 12.0 %
2450	52.7	1.95	4.28	4.28	4.28	0.80	1.08	± 12.0 %
2600	52.5	2.16	4.11	4.11	4.11	0.80	1.09	± 12.0 %

^C Frequency validity above 300 MHz of ± 100 MHz only applies for DASY v4.4 and higher (see Page 2), else it is restricted to ± 50 MHz. The uncertainty is the RSS of the ConvF uncertainty at calibration frequency and the uncertainty for the indicated frequency band. Frequency validity below 300 MHz is ± 10, 25, 40, 50 and 70 MHz for ConvF assessments at 30, 64, 128, 150 and 220 MHz respectively. Above 5 GHz frequency validity can be extended to ± 110 MHz.

^F At frequencies below 3 GHz, the validity of tissue parameters (ϵ and σ) can be relaxed to ± 10% if liquid compensation formula is applied to measured SAR values. At frequencies above 3 GHz, the validity of tissue parameters (ϵ and σ) is restricted to ± 5%. The uncertainty is the RSS of the ConvF uncertainty for indicated target tissue parameters.

^G Alpha/Depth are determined during calibration. SPEAG warrants that the remaining deviation due to the boundary effect after compensation is always less than ± 1% for frequencies below 3 GHz and below ± 2% for frequencies between 3-6 GHz at any distance larger than half the probe tip diameter from the boundary.

Frequency Response of E-Field (TEM-Cell:ifi110 EXX, Waveguide: R22)

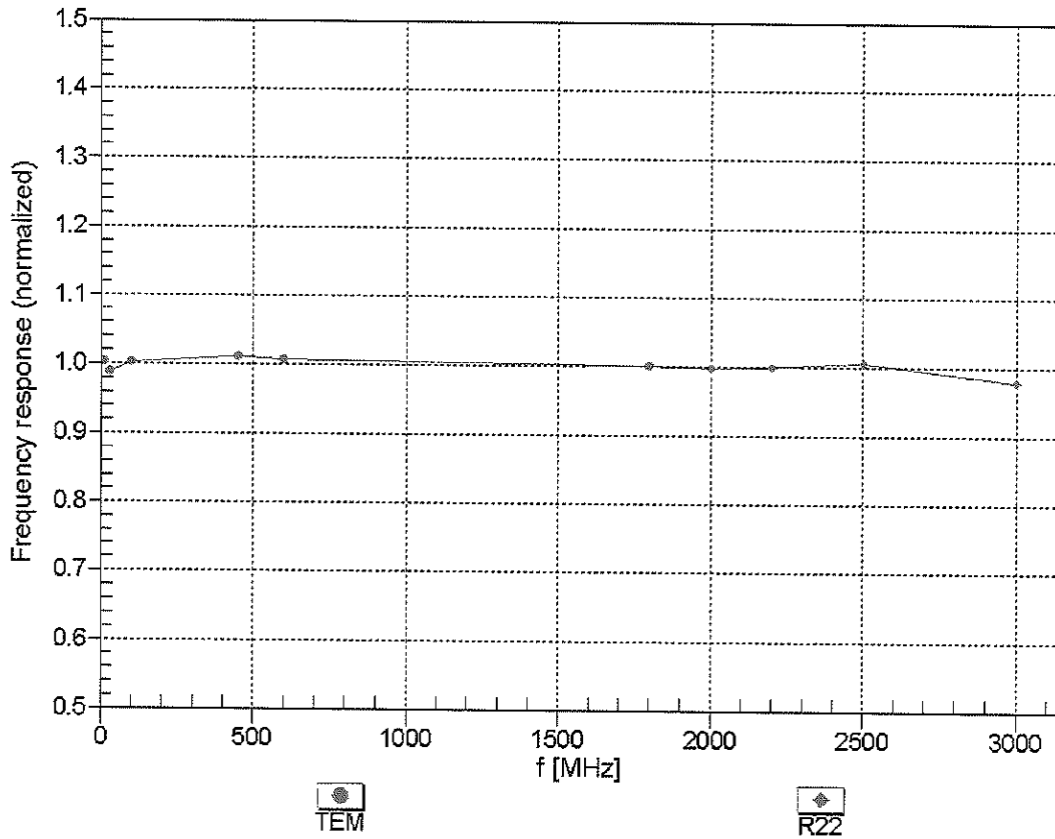

Uncertainty of Frequency Response of E-field: $\pm 6.3\%$ (k=2)

Receiving Pattern (ϕ), $\theta = 0^\circ$

f=600 MHz,TEM

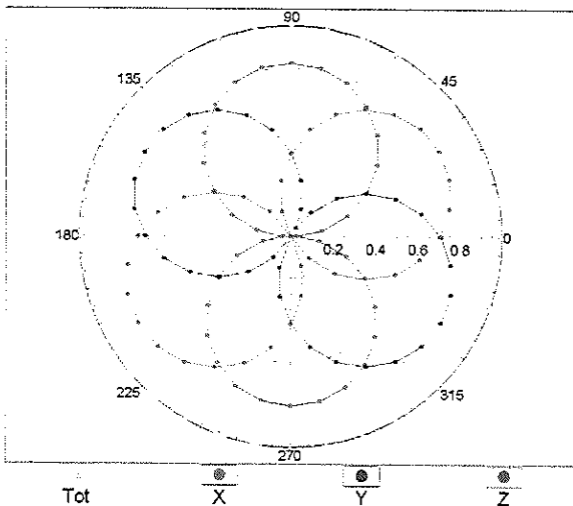

f=1800 MHz,R22

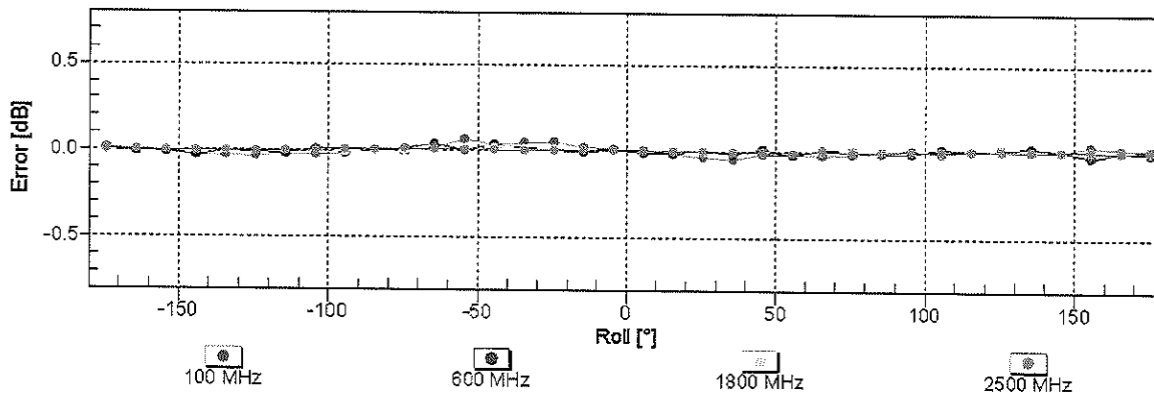
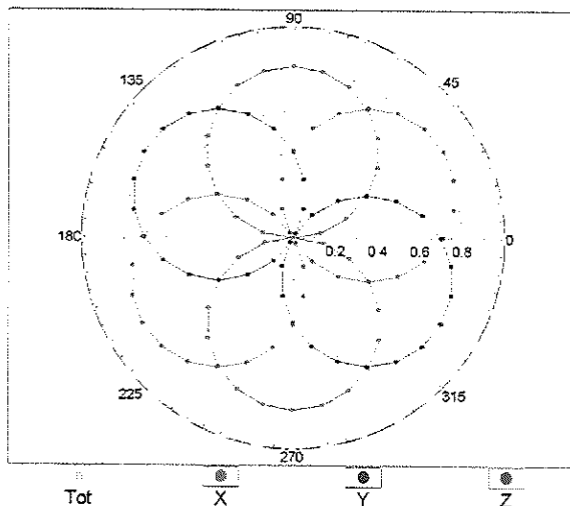

Uncertainty of Axial Isotropy Assessment: $\pm 0.5\%$ (k=2)

Dynamic Range $f(SAR_{head})$ (TEM cell, $f_{eval} = 1900$ MHz)

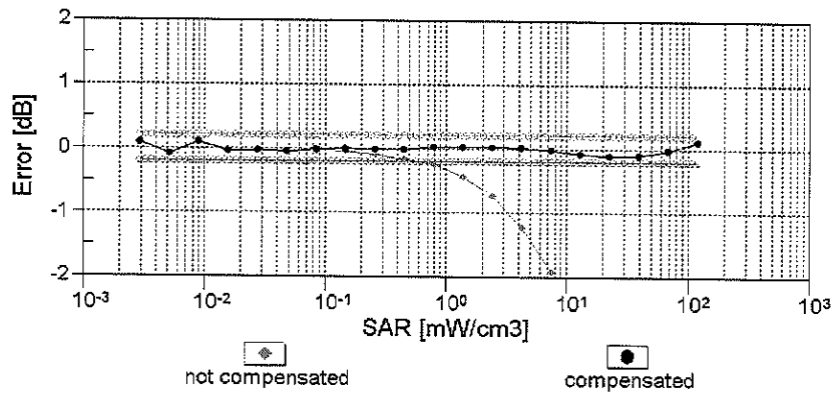
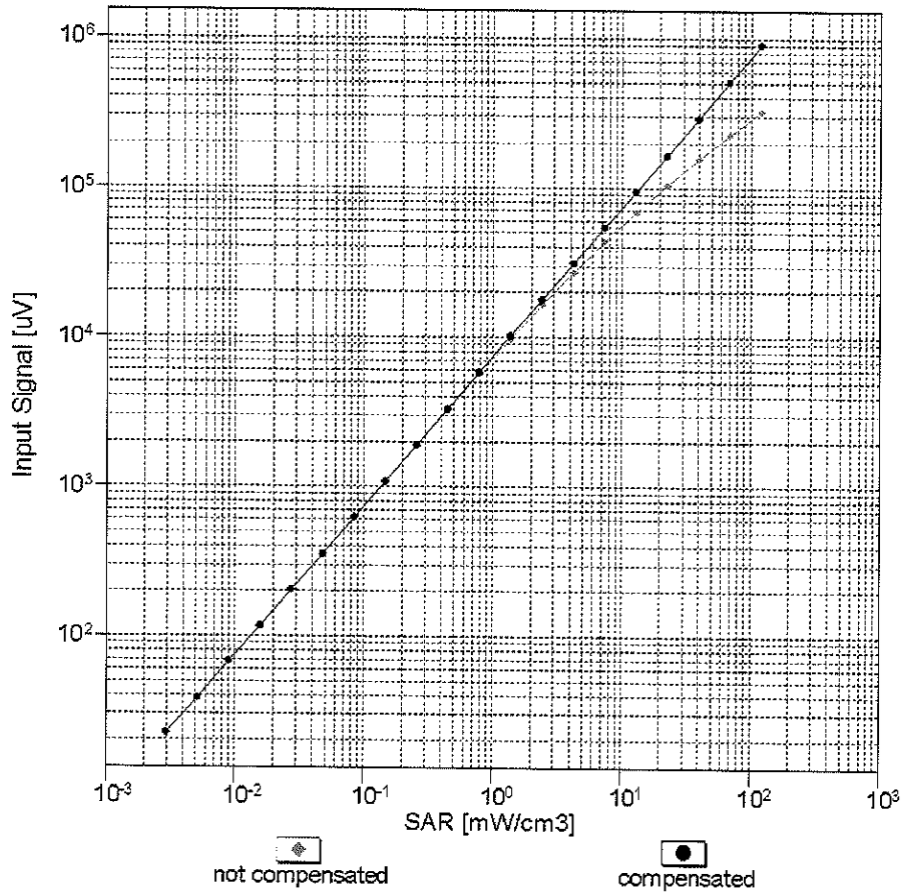

Uncertainty of Linearity Assessment: $\pm 0.6\%$ (k=2)

Conversion Factor Assessment

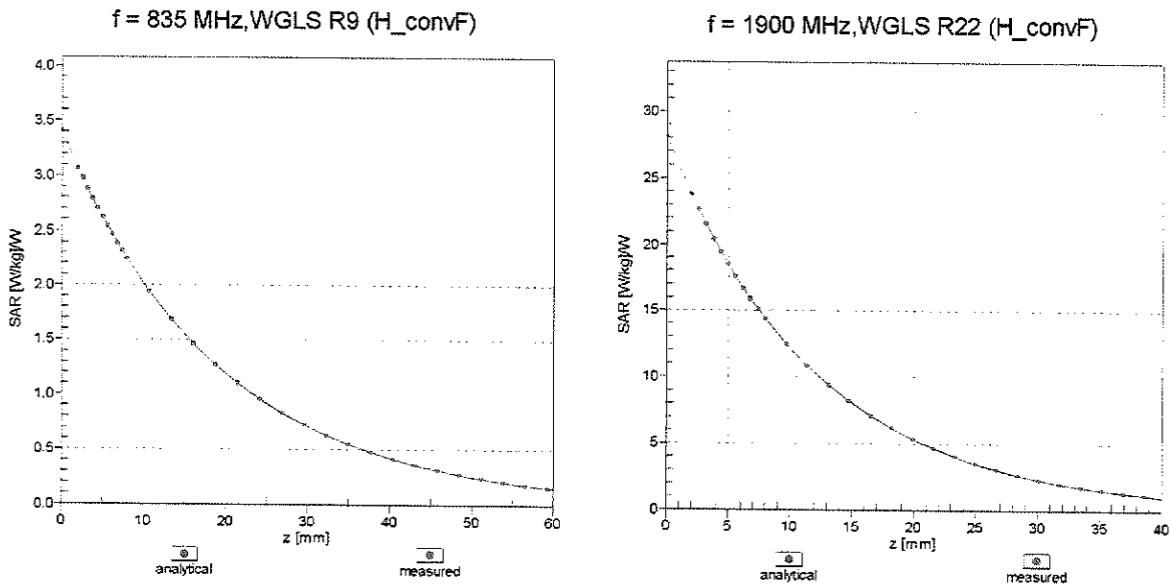

Deviation from Isotropy in Liquid Error (ϕ, θ), f = 900 MHz

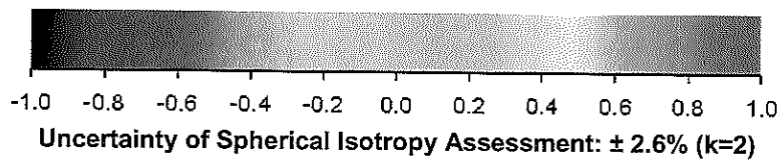
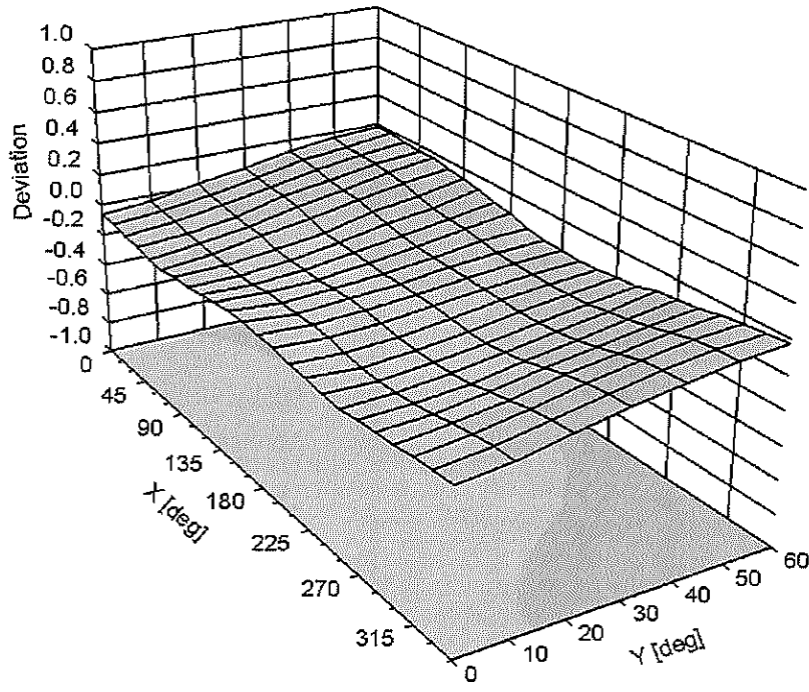

DASY/EASY - Parameters of Probe: ES3DV3 - SN:3263

Other Probe Parameters

Sensor Arrangement	Triangular
Connector Angle (°)	65.6
Mechanical Surface Detection Mode	enabled
Optical Surface Detection Mode	disabled
Probe Overall Length	337 mm
Probe Body Diameter	10 mm
Tip Length	10 mm
Tip Diameter	4 mm
Probe Tip to Sensor X Calibration Point	2 mm
Probe Tip to Sensor Y Calibration Point	2 mm
Probe Tip to Sensor Z Calibration Point	2 mm
Recommended Measurement Distance from Surface	3 mm



Accredited by the Swiss Accreditation Service (SAS)
The Swiss Accreditation Service is one of the signatories to the EA
Multilateral Agreement for the recognition of calibration certificates

Accreditation No.: **SCS 0108**

Client **PG Test**

Certificate No: **ES3-3334_Nov15**

CALIBRATION CERTIFICATE

Object **ES3DV3 - SN:3334**

Calibration procedure(s) **QA CAL-01.v9, QA CAL-12.v9, QA CAL-23.v5, QA CAL-25.v6**
Calibration procedure for dosimetric E-field probes

Calibration date: **November 17, 2015**

This calibration certificate documents the traceability to national standards, which realize the physical units of measurements (SI).
The measurements and the uncertainties with confidence probability are given on the following pages and are part of the certificate.

All calibrations have been conducted in the closed laboratory facility: environment temperature (22 ± 3)°C and humidity < 70%.

Calibration Equipment used (M&TE critical for calibration)

BV ✓
11/24/15

Primary Standards	ID	Cal Date (Certificate No.)	Scheduled Calibration
Power meter E4419B	GB41293874	01-Apr-15 (No. 217-02128)	Mar-16
Power sensor E4412A	MY41498087	01-Apr-15 (No. 217-02128)	Mar-16
Reference 3 dB Attenuator	SN: S5054 (3c)	01-Apr-15 (No. 217-02129)	Mar-16
Reference 20 dB Attenuator	SN: S5277 (20x)	01-Apr-15 (No. 217-02132)	Mar-16
Reference 30 dB Attenuator	SN: S5129 (30b)	01-Apr-15 (No. 217-02133)	Mar-16
Reference Probe ES3DV2	SN: 3013	30-Dec-14 (No. ES3-3013 Dec14)	Dec-15
DAE4	SN: 660	14-Jan-15 (No. DAE4-660_Jan15)	Jan-16
Secondary Standards	ID	Check Date (in house)	Scheduled Check
RF generator HP 8648C	US3642U01700	4-Aug-99 (in house check Apr-13)	In house check: Apr-16
Network Analyzer HP 8753E	US37393585	18-Oct-01 (in house check Oct-15)	In house check: Oct-16

	Name	Function	Signature
Calibrated by:	Jeton Kasrati	Laboratory Technician	<i>[Signature]</i>
Approved by:	Katja Pokovic	Technical Manager	<i>[Signature]</i>

Issued: November 17, 2015

This calibration certificate shall not be reproduced except in full without written approval of the laboratory.



Accredited by the Swiss Accreditation Service (SAS)

Accreditation No.: **SCS 0108**

The Swiss Accreditation Service is one of the signatories to the EA Multilateral Agreement for the recognition of calibration certificates

Glossary:

TSL	tissue simulating liquid
NORM _{x,y,z}	sensitivity in free space
ConvF	sensitivity in TSL / NORM _{x,y,z}
DCP	diode compression point
CF	crest factor (1/duty_cycle) of the RF signal
A, B, C, D	modulation dependent linearization parameters
Polarization ϕ	ϕ rotation around probe axis
Polarization ϑ	ϑ rotation around an axis that is in the plane normal to probe axis (at measurement center), i.e., $\vartheta = 0$ is normal to probe axis
Connector Angle	information used in DASY system to align probe sensor X to the robot coordinate system

Calibration is Performed According to the Following Standards:

- a) IEEE Std 1528-2013, "IEEE Recommended Practice for Determining the Peak Spatial-Averaged Specific Absorption Rate (SAR) in the Human Head from Wireless Communications Devices: Measurement Techniques", June 2013
- b) IEC 62209-1, "Procedure to measure the Specific Absorption Rate (SAR) for hand-held devices used in close proximity to the ear (frequency range of 300 MHz to 3 GHz)", February 2005
- c) IEC 62209-2, "Procedure to determine the Specific Absorption Rate (SAR) for wireless communication devices used in close proximity to the human body (frequency range of 30 MHz to 6 GHz)", March 2010
- d) KDB 865664, "SAR Measurement Requirements for 100 MHz to 6 GHz"

Methods Applied and Interpretation of Parameters:

- **NORM_{x,y,z}:** Assessed for E-field polarization $\vartheta = 0$ ($f \leq 900$ MHz in TEM-cell; $f > 1800$ MHz: R22 waveguide). NORM_{x,y,z} are only intermediate values, i.e., the uncertainties of NORM_{x,y,z} does not affect the E²-field uncertainty inside TSL (see below ConvF).
- **NORM(f)_{x,y,z} = NORM_{x,y,z} * frequency_response** (see Frequency Response Chart). This linearization is implemented in DASY4 software versions later than 4.2. The uncertainty of the frequency response is included in the stated uncertainty of ConvF.
- **DCP_{x,y,z}:** DCP are numerical linearization parameters assessed based on the data of power sweep with CW signal (no uncertainty required). DCP does not depend on frequency nor media.
- **PAR:** PAR is the Peak to Average Ratio that is not calibrated but determined based on the signal characteristics
- **A_{x,y,z}; B_{x,y,z}; C_{x,y,z}; D_{x,y,z}; VR_{x,y,z}:** A, B, C, D are numerical linearization parameters assessed based on the data of power sweep for specific modulation signal. The parameters do not depend on frequency nor media. VR is the maximum calibration range expressed in RMS voltage across the diode.
- **ConvF and Boundary Effect Parameters:** Assessed in flat phantom using E-field (or Temperature Transfer Standard for $f \leq 800$ MHz) and inside waveguide using analytical field distributions based on power measurements for $f > 800$ MHz. The same setups are used for assessment of the parameters applied for boundary compensation (alpha, depth) of which typical uncertainty values are given. These parameters are used in DASY4 software to improve probe accuracy close to the boundary. The sensitivity in TSL corresponds to NORM_{x,y,z} * ConvF whereby the uncertainty corresponds to that given for ConvF. A frequency dependent ConvF is used in DASY version 4.4 and higher which allows extending the validity from ± 50 MHz to ± 100 MHz.
- **Spherical isotropy (3D deviation from isotropy):** in a field of low gradients realized using a flat phantom exposed by a patch antenna.
- **Sensor Offset:** The sensor offset corresponds to the offset of virtual measurement center from the probe tip (on probe axis). No tolerance required.
- **Connector Angle:** The angle is assessed using the information gained by determining the NORM_x (no uncertainty required).

Probe ES3DV3

SN:3334

Manufactured: January 24, 2012
Calibrated: November 17, 2015

Calibrated for DASY/EASY Systems
(Note: non-compatible with DASY2 system!)

DASY/EASY - Parameters of Probe: ES3DV3 - SN:3334

Basic Calibration Parameters

	Sensor X	Sensor Y	Sensor Z	Unc (k=2)
Norm ($\mu\text{V}/(\text{V}/\text{m})^2$) ^A	1.03	1.03	0.99	$\pm 10.1\%$
DCP (mV) ^B	107.6	105.3	107.9	

Modulation Calibration Parameters

UID	Communication System Name		A dB	B dB $\sqrt{\mu\text{V}}$	C	D dB	VR mV	Unc ^E (k=2)
0	CW	X	0.0	0.0	1.0	0.00	192.1	$\pm 2.7\%$
		Y	0.0	0.0	1.0		183.6	
		Z	0.0	0.0	1.0		183.3	
10010- CAA	SAR Validation (Square, 100ms, 10ms)	X	2.27	60.1	10.2	10.00	38.6	$\pm 1.4\%$
		Y	1.99	59.3	10.2		38.4	
		Z	5.38	67.8	12.9		37.2	
10011- CAB	UMTS-FDD (WCDMA)	X	3.40	68.0	18.9	2.91	131.7	$\pm 0.5\%$
		Y	3.27	67.0	18.2		130.2	
		Z	3.41	68.3	19.1		148.5	
10012- CAB	IEEE 802.11b WiFi 2.4 GHz (DSSS, 1 Mbps)	X	2.93	68.9	18.7	1.87	132.9	$\pm 0.7\%$
		Y	3.12	69.6	18.8		130.2	
		Z	3.24	71.1	19.7		128.2	
10013- CAB	IEEE 802.11g WiFi 2.4 GHz (DSSS-OFDM, 6 Mbps)	X	10.90	70.3	23.0	9.46	133.5	$\pm 3.3\%$
		Y	10.53	69.0	22.1		124.6	
		Z	11.14	71.2	23.6		147.1	
10021- DAB	GSM-FDD (TDMA, GMSK)	X	15.05	91.0	24.4	9.39	139.5	$\pm 1.9\%$
		Y	10.11	85.5	23.3		131.9	
		Z	11.84	87.6	23.4		130.0	
10023- DAB	GPRS-FDD (TDMA, GMSK, TN 0)	X	10.42	84.9	22.6	9.57	131.5	$\pm 3.0\%$
		Y	13.29	89.7	24.6		141.1	
		Z	14.17	90.2	24.2		148.7	
10024- DAB	GPRS-FDD (TDMA, GMSK, TN 0-1)	X	11.26	83.1	19.4	6.56	140.7	$\pm 1.9\%$
		Y	26.29	95.5	23.8		134.7	
		Z	16.82	88.9	21.3		131.6	
10027- DAB	GPRS-FDD (TDMA, GMSK, TN 0-1-2)	X	64.74	99.9	22.2	4.80	131.5	$\pm 2.2\%$
		Y	56.71	99.8	22.7		124.7	
		Z	63.10	99.9	22.2		124.1	
10028- DAB	GPRS-FDD (TDMA, GMSK, TN 0-1-2-3)	X	62.11	99.6	21.6	3.55	146.1	$\pm 1.9\%$
		Y	77.61	99.8	21.2		132.0	
		Z	72.33	99.7	21.2		133.3	
10032- CAA	IEEE 802.15.1 Bluetooth (GFSK, DH5)	X	96.24	92.7	15.9	1.16	137.2	$\pm 1.7\%$
		Y	95.69	93.1	16.2		129.5	
		Z	98.67	94.1	16.4		149.7	
10100- CAB	LTE-FDD (SC-FDMA, 100% RB, 20 MHz, QPSK)	X	6.14	66.8	19.2	5.67	126.2	$\pm 1.7\%$
		Y	6.21	66.8	19.1		139.9	
		Z	6.41	67.9	19.9		145.9	

10103-CAB	LTE-TDD (SC-FDMA, 100% RB, 20 MHz, QPSK)	X	10.07	75.4	25.8	9.29	138.2	±2.5 %
		Y	9.54	73.3	24.5		130.5	
		Z	9.84	75.1	25.8		130.6	
10108-CAC	LTE-FDD (SC-FDMA, 100% RB, 10 MHz, QPSK)	X	6.34	67.6	19.8	5.80	149.5	±1.4 %
		Y	6.13	66.6	19.1		132.1	
		Z	6.19	67.2	19.7		137.8	
10117-CAB	IEEE 802.11n (HT Mixed, 13.5 Mbps, BPSK)	X	10.13	68.9	21.2	8.07	138.8	±2.7 %
		Y	10.16	68.9	21.1		149.6	
		Z	9.96	68.7	21.1		127.1	
10151-CAB	LTE-TDD (SC-FDMA, 50% RB, 20 MHz, QPSK)	X	9.42	74.4	25.5	9.28	132.9	±3.0 %
		Y	9.50	74.0	25.0		143.7	
		Z	9.01	73.4	25.0		126.5	
10154-CAC	LTE-FDD (SC-FDMA, 50% RB, 10 MHz, QPSK)	X	6.03	67.1	19.6	5.75	145.5	±1.4 %
		Y	5.81	66.0	18.9		128.9	
		Z	5.91	66.8	19.5		135.1	
10160-CAB	LTE-FDD (SC-FDMA, 50% RB, 15 MHz, QPSK)	X	6.19	66.5	19.2	5.82	126.7	±1.4 %
		Y	6.20	66.4	19.0		132.8	
		Z	6.39	67.5	19.8		141.1	
10169-CAB	LTE-FDD (SC-FDMA, 1 RB, 20 MHz, QPSK)	X	5.05	67.6	20.0	5.73	146.8	±1.4 %
		Y	4.82	66.2	19.2		132.2	
		Z	4.96	67.4	20.0		143.8	
10172-CAB	LTE-TDD (SC-FDMA, 1 RB, 20 MHz, QPSK)	X	8.88	79.7	28.3	9.21	147.9	±3.0 %
		Y	8.00	76.1	26.2		138.9	
		Z	8.39	78.5	27.8		141.5	
10175-CAC	LTE-FDD (SC-FDMA, 1 RB, 10 MHz, QPSK)	X	4.99	67.3	19.9	5.72	140.7	±1.2 %
		Y	4.80	66.2	19.1		131.3	
		Z	4.90	67.1	19.8		136.1	
10181-CAB	LTE-FDD (SC-FDMA, 1 RB, 15 MHz, QPSK)	X	4.99	67.3	19.9	5.72	145.4	±1.4 %
		Y	4.81	66.2	19.2		130.9	
		Z	4.89	67.1	19.8		136.0	
10196-CAB	IEEE 802.11n (HT Mixed, 6.5 Mbps, BPSK)	X	9.78	68.8	21.3	8.10	131.0	±2.5 %
		Y	9.73	68.4	21.0		140.7	
		Z	9.94	69.4	21.6		146.6	
10225-CAB	UMTS-FDD (HSPA+)	X	6.88	66.9	19.3	5.97	133.9	±1.7 %
		Y	6.96	67.1	19.3		144.8	
		Z	6.71	66.6	19.2		125.7	
10237-CAB	LTE-TDD (SC-FDMA, 1 RB, 10 MHz, QPSK)	X	9.00	80.2	28.5	9.21	148.2	±3.0 %
		Y	7.73	75.1	25.7		131.6	
		Z	8.27	78.2	27.7		136.1	
10252-CAB	LTE-TDD (SC-FDMA, 50% RB, 10 MHz, QPSK)	X	9.59	76.3	26.7	9.24	144.1	±2.7 %
		Y	8.74	72.9	24.5		133.4	
		Z	9.14	75.2	26.1		136.9	
10267-CAB	LTE-TDD (SC-FDMA, 100% RB, 10 MHz, QPSK)	X	9.25	73.9	25.3	9.30	124.8	±3.0 %
		Y	9.40	73.7	24.9		142.1	
		Z	9.86	76.1	26.5		145.3	

10275-CAB	UMTS-FDD (HSUPA, Subtest 5, 3GPP Rel8.4)	X	4.38	66.9	18.7	3.96	133.3	±0.9 %
		Y	4.44	66.9	18.6		148.2	
		Z	4.30	66.7	18.6		128.9	
10291-AAB	CDMA2000, RC3, SQ55, Full Rate	X	3.68	67.3	18.7	3.46	145.8	±0.7 %
		Y	3.58	66.6	18.2		136.3	
		Z	3.62	67.3	18.8		139.4	
10292-AAB	CDMA2000, RC3, SQ32, Full Rate	X	3.73	68.0	19.1	3.39	147.5	±0.7 %
		Y	3.55	66.7	18.3		138.5	
		Z	3.60	67.6	18.9		143.0	
10297-AAA	LTE-FDD (SC-FDMA, 50% RB, 20 MHz, QPSK)	X	6.30	67.4	19.7	5.81	141.4	±1.2 %
		Y	6.11	66.5	19.1		130.3	
		Z	6.17	67.0	19.5		138.8	
10311-AAA	LTE-FDD (SC-FDMA, 100% RB, 15 MHz, QPSK)	X	6.88	68.0	20.1	6.06	147.0	±1.7 %
		Y	6.68	67.1	19.5		136.0	
		Z	6.75	67.7	20.0		141.6	
10400-AAC	IEEE 802.11ac WiFi (20MHz, 64-QAM, 99pc duty cycle)	X	9.97	68.8	21.4	8.37	126.9	±2.7 %
		Y	10.07	68.9	21.4		143.6	
		Z	10.21	69.7	22.0		147.4	
10403-AAB	CDMA2000 (1xEV-DO, Rev. 0)	X	4.77	68.5	18.8	3.76	134.9	±0.5 %
		Y	4.69	68.1	18.5		126.7	
		Z	4.74	68.8	18.9		129.4	
10404-AAB	CDMA2000 (1xEV-DO, Rev. A)	X	4.72	68.7	18.8	3.77	132.9	±0.7 %
		Y	4.78	68.9	18.9		147.4	
		Z	4.63	68.7	18.9		127.1	
10415-AAA	IEEE 802.11b WiFi 2.4 GHz (DSSS, 1 Mbps, 99pc duty cycle)	X	2.72	68.9	18.8	1.54	131.9	±0.5 %
		Y	2.65	68.0	18.1		145.9	
		Z	2.72	69.3	19.0		127.3	
10416-AAA	IEEE 802.11g WiFi 2.4 GHz (ERP-OFDM, 6 Mbps, 99pc duty cycle)	X	9.81	68.6	21.2	8.23	131.6	±2.7 %
		Y	9.90	68.7	21.2		144.1	
		Z	9.97	69.3	21.7		146.0	

The reported uncertainty of measurement is stated as the standard uncertainty of measurement multiplied by the coverage factor $k=2$, which for a normal distribution corresponds to a coverage probability of approximately 95%.

^A The uncertainties of Norm X,Y,Z do not affect the E^2 -field uncertainty inside TSL (see Pages 7 and 8).

^B Numerical linearization parameter: uncertainty not required.

^C Uncertainty is determined using the max. deviation from linear response applying rectangular distribution and is expressed for the square of the field value.

DASY/EASY - Parameters of Probe: ES3DV3 - SN:3334

Calibration Parameter Determined in Head Tissue Simulating Media

f (MHz) ^c	Relative Permittivity ^e	Conductivity (S/m) ^e	ConvF X	ConvF Y	ConvF Z	Alpha ^g	Depth (mm) ^h	Unc (k=2)
6	55.5	0.75	6.13	6.13	6.13	0.00	1.00	± 13.3 %
13	55.5	0.75	5.76	5.76	5.76	0.00	1.00	± 13.3 %
750	41.9	0.89	6.56	6.56	6.56	0.24	2.36	± 12.0 %
835	41.5	0.90	6.37	6.37	6.37	0.37	1.70	± 12.0 %
1750	40.1	1.37	5.39	5.39	5.39	0.58	1.32	± 12.0 %
1900	40.0	1.40	5.18	5.18	5.18	0.77	1.20	± 12.0 %
2300	39.5	1.67	4.85	4.85	4.85	0.71	1.28	± 12.0 %
2450	39.2	1.80	4.58	4.58	4.58	0.79	1.17	± 12.0 %
2600	39.0	1.96	4.46	4.46	4.46	0.80	1.26	± 12.0 %

^c Frequency validity above 300 MHz of ± 100 MHz only applies for DASY v4.4 and higher (see Page 2), else it is restricted to ± 50 MHz. The uncertainty is the RSS of the ConvF uncertainty at calibration frequency and the uncertainty for the indicated frequency band. Frequency validity below 300 MHz is ± 10, 25, 40, 50 and 70 MHz for ConvF assessments at 30, 64, 128, 150 and 220 MHz respectively. Above 5 GHz frequency validity can be extended to ± 110 MHz.

^e At frequencies below 3 GHz, the validity of tissue parameters (ϵ and σ) can be relaxed to ± 10% if liquid compensation formula is applied to measured SAR values. At frequencies above 3 GHz, the validity of tissue parameters (ϵ and σ) is restricted to ± 5%. The uncertainty is the RSS of the ConvF uncertainty for indicated target tissue parameters.

^g Alpha/Depth are determined during calibration. SPEAG warrants that the remaining deviation due to the boundary effect after compensation is always less than ± 1% for frequencies below 3 GHz and below ± 2% for frequencies between 3-6 GHz at any distance larger than half the probe tip diameter from the boundary.

DASY/EASY - Parameters of Probe: ES3DV3 - SN:3334

Calibration Parameter Determined in Body Tissue Simulating Media

f (MHz) ^c	Relative Permittivity ^f	Conductivity (S/m) ^f	ConvF X	ConvF Y	ConvF Z	Alpha ^g	Depth ^g (mm)	Unc (k=2)
750	55.5	0.96	6.37	6.37	6.37	0.74	1.22	± 12.0 %
835	55.2	0.97	6.24	6.24	6.24	0.31	1.94	± 12.0 %
1750	53.4	1.49	5.03	5.03	5.03	0.50	1.57	± 12.0 %
1900	53.3	1.52	4.84	4.84	4.84	0.50	1.58	± 12.0 %
2300	52.9	1.81	4.61	4.61	4.61	0.74	1.23	± 12.0 %
2450	52.7	1.95	4.45	4.45	4.45	0.74	1.20	± 12.0 %
2600	52.5	2.16	4.29	4.29	4.29	0.80	1.20	± 12.0 %

^c Frequency validity above 300 MHz of ± 100 MHz only applies for DASY v4.4 and higher (see Page 2), else it is restricted to ± 50 MHz. The uncertainty is the RSS of the ConvF uncertainty at calibration frequency and the uncertainty for the indicated frequency band. Frequency validity below 300 MHz is ± 10, 25, 40, 50 and 70 MHz for ConvF assessments at 30, 64, 128, 150 and 220 MHz respectively. Above 5 GHz frequency validity can be extended to ± 110 MHz.

^f At frequencies below 3 GHz, the validity of tissue parameters (ϵ and σ) can be relaxed to ± 10% if liquid compensation formula is applied to measured SAR values. At frequencies above 3 GHz, the validity of tissue parameters (ϵ and σ) is restricted to ± 5%. The uncertainty is the RSS of the ConvF uncertainty for indicated target tissue parameters.

^g Alpha/Depth are determined during calibration. SPEAG warrants that the remaining deviation due to the boundary effect after compensation is always less than ± 1% for frequencies below 3 GHz and below ± 2% for frequencies between 3-6 GHz at any distance larger than half the probe tip diameter from the boundary.

Frequency Response of E-Field

(TEM-Cell:ifi110 EXX, Waveguide: R22)

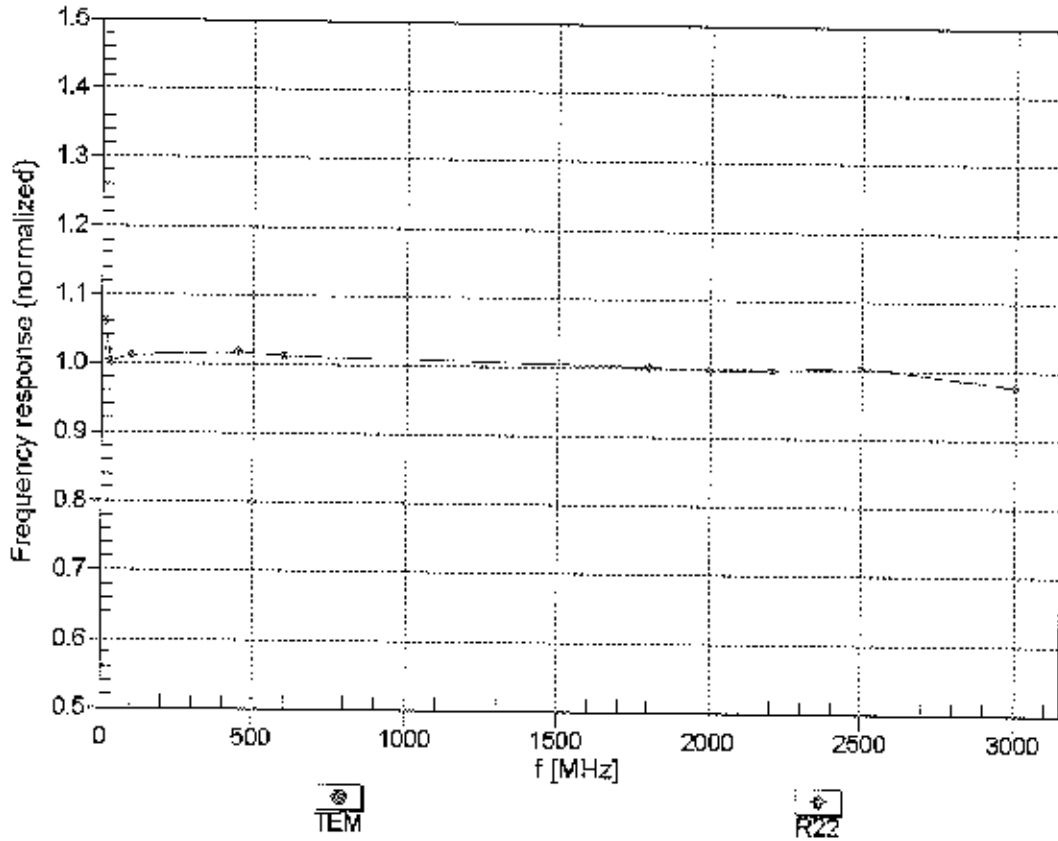

Uncertainty of Frequency Response of E-field: $\pm 6.3\%$ (k=2)

Receiving Pattern (ϕ), $\theta = 0^\circ$

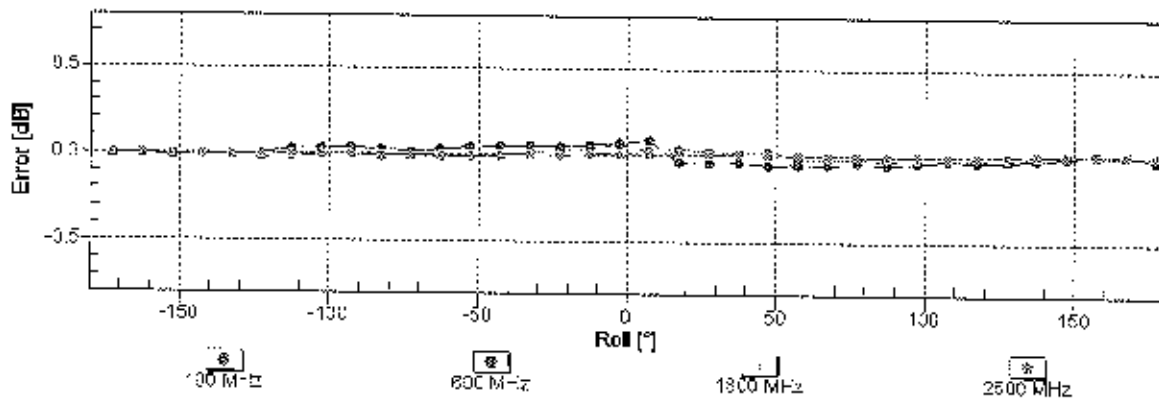
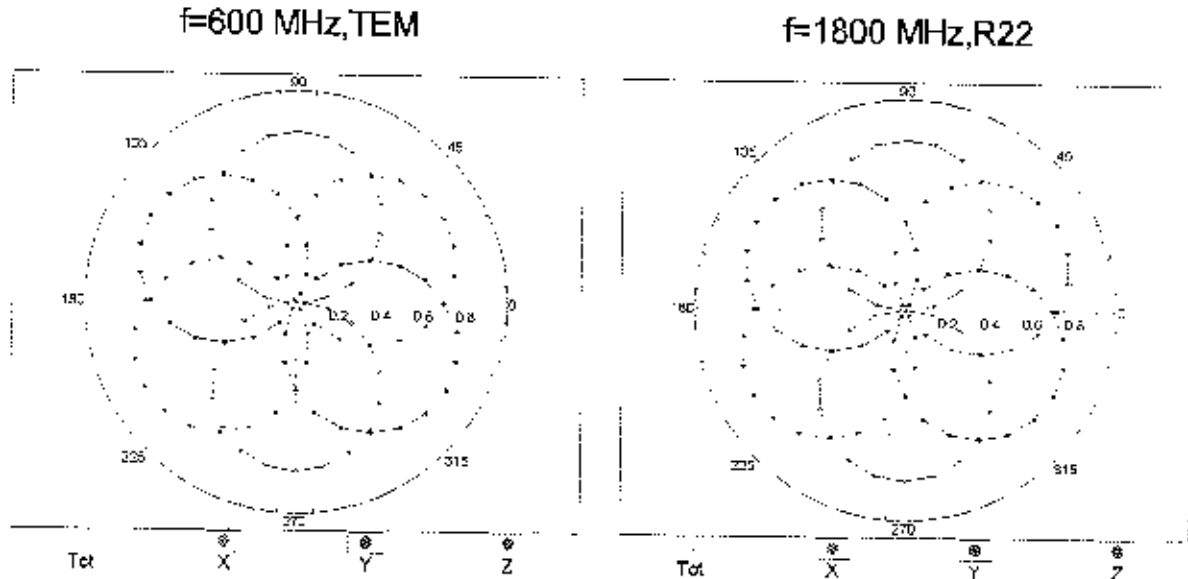

Uncertainty of Axial Isotropy Assessment: $\pm 0.5\%$ ($k=2$)

Dynamic Range $f(\text{SAR}_{\text{head}})$ (TEM cell, $f_{\text{eval}} = 1900 \text{ MHz}$)

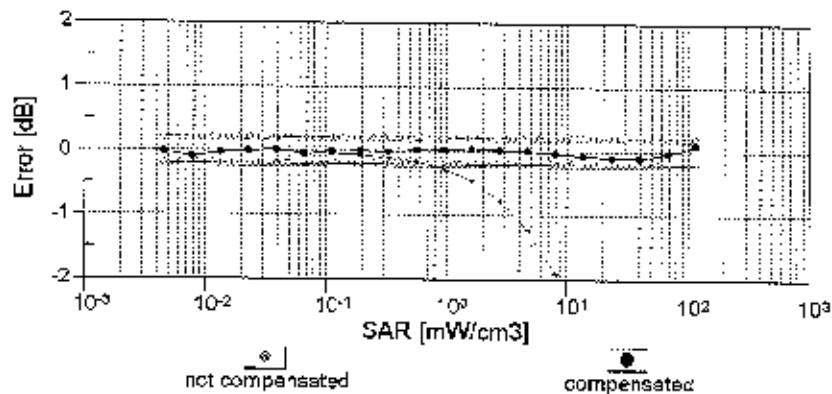
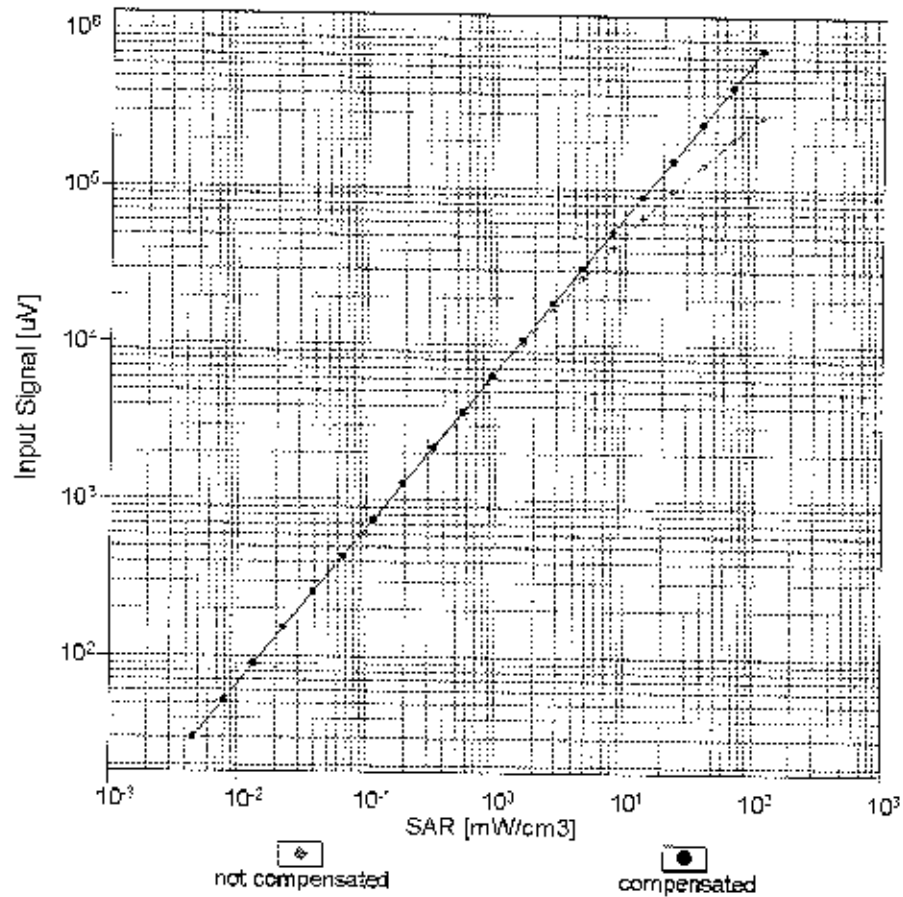

Uncertainty of Linearity Assessment: $\pm 0.6\%$ ($k=2$)

Conversion Factor Assessment

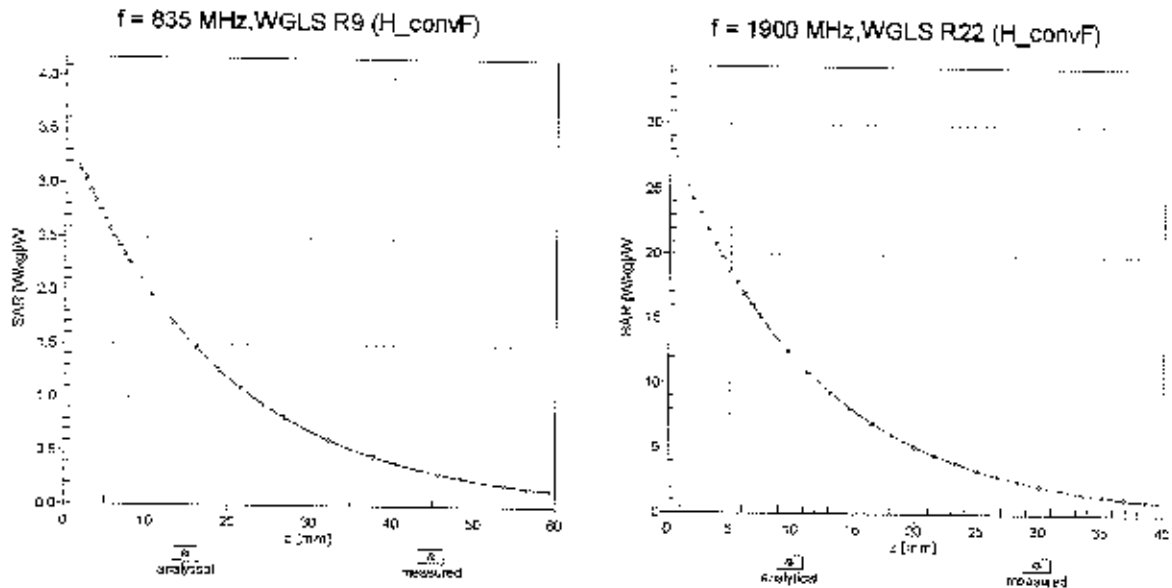

Deviation from Isotropy in Liquid Error (ϕ, θ), f = 900 MHz

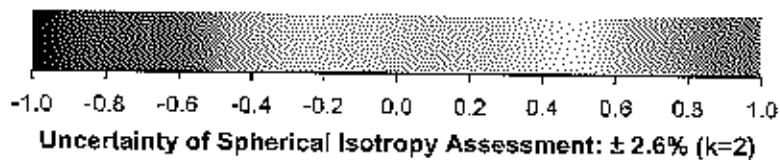
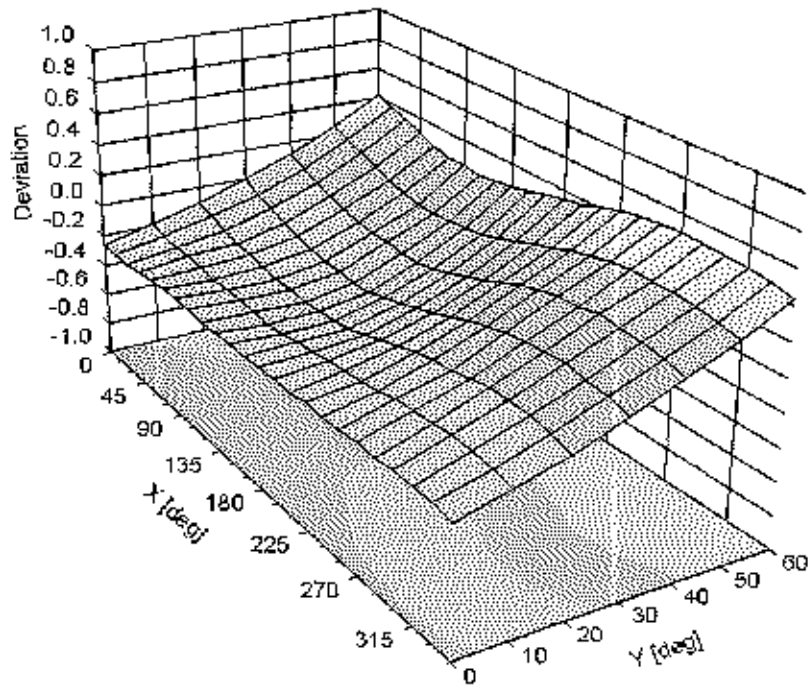

DASY/EASY - Parameters of Probe: ES3DV3 - SN:3334

Other Probe Parameters

Sensor Arrangement	Triangular
Connector Angle (°)	17.4
Mechanical Surface Detection Mode	enabled
Optical Surface Detection Mode	disabled
Probe Overall Length	337 mm
Probe Body Diameter	10 mm
Tip Length	10 mm
Tip Diameter	4 mm
Probe Tip to Sensor X Calibration Point	2 mm
Probe Tip to Sensor Y Calibration Point	2 mm
Probe Tip to Sensor Z Calibration Point	2 mm
Recommended Measurement Distance from Surface	3 mm



Accredited by the Swiss Accreditation Service (SAS)
The Swiss Accreditation Service is one of the signatories to the EA
Multilateral Agreement for the recognition of calibration certificates

Accreditation No.: **SCS 0108**

Client **PC Test**

Certificate No: **ES3-3333_Oct15**

CALIBRATION CERTIFICATE

Object: **ES3DV3 - SN:3333**

Calibration procedure(s): **QA CAL-01.v9, QA CAL-23.v5, QA CAL-25.v6**
Calibration procedure for dosimetric E-field probes

Calibration date: **October 29, 2015**

*BN ✓
11/03/15*

This calibration certificate documents the traceability to national standards, which realize the physical units of measurements (SI).
The measurements and the uncertainties with confidence probability are given on the following pages and are part of the certificate.

All calibrations have been conducted in the closed laboratory facility; environment temperature (22 ± 3)°C and humidity < 70%.

Calibration Equipment used (M&TE critical for calibration)

Primary Standards	ID	Cal Date (Certificate No.)	Scheduled Calibration
Power meter E4419B	GB41293874	01-Apr-15 (No. 217-02128)	Mar-16
Power sensor E4412A	MY41498087	01-Apr-15 (No. 217-02128)	Mar-16
Reference 3 dB Attenuator	SN: S5054 (3c)	01-Apr-15 (No. 217-02129)	Mar-16
Reference 20 dB Attenuator	SN: S5277 (20x)	01-Apr-15 (No. 217-02132)	Mar-16
Reference 30 dB Attenuator	SN: S5129 (30b)	01-Apr-15 (No. 217-02133)	Mar-16
Reference Probe ES3DV2	SN: 3013	30-Dec-14 (No. ES3-3013_Dec14)	Dec-15
DAE4	SN: 660	14-Jan-15 (No. DAE4-660_Jan15)	Jan-16
Secondary Standards	ID	Check Date (in house)	Scheduled Check
RF generator HP 8648C	US3642U01700	4-Aug-99 (In house check Apr-13)	In house check: Apr-16
Network Analyzer HP 8753E	US37390585	18-Oct-01 (in house check Oct-15)	In house check: Oct-16

Calibrated by:	Name Lutz Klysner	Function Laboratory Technician	Signature
Approved by:	Name Katja Pokovic	Function Technical Manager	

Issued: October 29, 2015

This calibration certificate shall not be reproduced except in full without written approval of the laboratory.



Accredited by the Swiss Accreditation Service (SAS)

Accreditation No.: **SCS 0108**

The Swiss Accreditation Service is one of the signatories to the EA
Multilateral Agreement for the recognition of calibration certificates

Glossary:

TSL	tissue simulating liquid
NORM _{x,y,z}	sensitivity in free space
ConvF	sensitivity in TSL / NORM _{x,y,z}
DCP	diode compression point
CF	crest factor (1/duty_cycle) of the RF signal
A, B, C, D	modulation dependent linearization parameters
Polarization ϕ	ϕ rotation around probe axis
Polarization θ	θ rotation around an axis that is in the plane normal to probe axis (at measurement center), i.e., $\theta = 0$ is normal to probe axis
Connector Angle	information used in DASY system to align probe sensor X to the robot coordinate system

Calibration is Performed According to the Following Standards:

- IEEE Std 1528-2013, "IEEE Recommended Practice for Determining the Peak Spatial-Averaged Specific Absorption Rate (SAR) in the Human Head from Wireless Communications Devices: Measurement Techniques", June 2013
- IEC 62209-1, "Procedure to measure the Specific Absorption Rate (SAR) for hand-held devices used in close proximity to the ear (frequency range of 300 MHz to 3 GHz)", February 2005
- IEC 62209-2, "Procedure to determine the Specific Absorption Rate (SAR) for wireless communication devices used in close proximity to the human body (frequency range of 30 MHz to 6 GHz)", March 2010
- KDB 865604, "SAR Measurement Requirements for 100 MHz to 6 GHz"

Methods Applied and Interpretation of Parameters:

- NORM_{x,y,z}**: Assessed for E-field polarization $\theta = 0$ ($f \leq 900$ MHz in TEM-cell; $f > 1800$ MHz: R22 waveguide). NORM_{x,y,z} are only intermediate values, i.e., the uncertainties of NORM_{x,y,z} does not affect the E²-field uncertainty inside TSL (see below ConvF).
- NORM(f)_{x,y,z}** = NORM_{x,y,z} * frequency_response (see Frequency Response Chart). This linearization is implemented in DASY4 software versions later than 4.2. The uncertainty of the frequency response is included in the stated uncertainty of ConvF.
- DCP_{x,y,z}**: DCP are numerical linearization parameters assessed based on the data of power sweep with CW signal (no uncertainty required). DCP does not depend on frequency nor media.
- PAR**: PAR is the Peak to Average Ratio that is not calibrated but determined based on the signal characteristics
- A_{x,y,z}; B_{x,y,z}; C_{x,y,z}; D_{x,y,z}; VR_{x,y,z}**: A, B, C, D are numerical linearization parameters assessed based on the data of power sweep for specific modulation signal. The parameters do not depend on frequency nor media. VR is the maximum calibration range expressed in RMS voltage across the diode.
- ConvF and Boundary Effect Parameters**: Assessed in flat phantom using E-field (or Temperature Transfer Standard for $f \leq 800$ MHz) and inside waveguide using analytical field distributions based on power measurements for $f > 800$ MHz. The same setups are used for assessment of the parameters applied for boundary compensation (alpha, depth) of which typical uncertainty values are given. These parameters are used in DASY4 software to improve probe accuracy close to the boundary. The sensitivity in TSL corresponds to NORM_{x,y,z} * ConvF whereby the uncertainty corresponds to that given for ConvF. A frequency dependent ConvF is used in DASY version 4.4 and higher which allows extending the validity from ± 50 MHz to ± 100 MHz.
- Spherical isotropy (3D deviation from isotropy)**: in a field of low gradients realized using a flat phantom exposed by a patch antenna.
- Sensor Offset**: The sensor offset corresponds to the offset of virtual measurement center from the probe tip (on probe axis). No tolerance required.
- Connector Angle**: The angle is assessed using the information gained by determining the NORM_x (no uncertainty required).

Probe ES3DV3

SN:3333

Manufactured: January 24, 2012
Calibrated: October 29, 2015

Calibrated for DASY/EASY Systems
(Note: non-compatible with DASY2 system!)

DASY/EASY - Parameters of Probe: ES3DV3 - SN:3333

Basic Calibration Parameters

	Sensor X	Sensor Y	Sensor Z	Unc (k=2)
Norm ($\mu\text{V}/(\text{V}/\text{m})^2$) ^A	1.07	0.90	0.88	$\pm 10.1\%$
DCP (mV) ^B	106.8	108.5	106.8	

Modulation Calibration Parameters

UID	Communication System Name		A dB	B dB $\sqrt{\mu\text{V}}$	C	D dB	VR mV	Unc ^E (k=2)
0	CW	X	0.0	0.0	1.0	0.00	201.0	$\pm 3.5\%$
		Y	0.0	0.0	1.0		187.1	
		Z	0.0	0.0	1.0		184.8	
10010- CAA	SAR Validation (Square, 100ms, 10ms)	X	2.43	80.7	11.4	10.00	41.6	$\pm 2.2\%$
		Y	4.35	67.4	13.2		35.6	
		Z	1.46	57.0	8.7		36.2	
10011- CAB	UMTS-FDD (WCDMA)	X	3.35	67.9	19.1	2.91	138.2	$\pm 0.5\%$
		Y	3.48	68.8	19.2		127.5	
		Z	3.37	67.6	18.6		149.0	
10012- CAB	IEEE 802.11b WiFi 2.4 GHz (DSSS, 1 Mbps)	X	3.80	72.8	20.8	1.87	141.0	$\pm 0.7\%$
		Y	3.68	73.3	20.8		128.0	
		Z	3.01	69.3	18.8		128.2	
10013- CAB	IEEE 802.11g WiFi 2.4 GHz (DSSS-OFDM, 6 Mbps)	X	11.52	71.7	23.9	9.46	139.3	$\pm 3.0\%$
		Y	10.94	70.4	22.9		147.1	
		Z	10.95	70.8	23.4		144.5	
10021- DAB	GSM-FDD (TDMA, GMSK)	X	21.45	95.2	26.5	9.39	139.9	$\pm 2.5\%$
		Y	9.12	82.9	21.9		142.0	
		Z	11.47	88.1	23.9		127.6	
10023- DAB	GPRS-FDD (TDMA, GMSK, TN 0)	X	20.81	95.6	27.0	9.57	135.8	$\pm 2.2\%$
		Y	9.78	84.4	22.7		135.3	
		Z	8.12	83.5	22.1		144.6	
10024- DAB	GPRS-FDD (TDMA, GMSK, TN 0-1)	X	39.84	99.8	25.2	6.56	140.9	$\pm 1.9\%$
		Y	35.07	100.0	25.0		128.4	
		Z	35.20	99.8	24.7		131.9	
10027- DAB	GPRS-FDD (TDMA, GMSK, TN 0-1-2)	X	47.16	99.8	23.9	4.80	124.9	$\pm 2.5\%$
		Y	49.75	99.6	22.8		145.4	
		Z	45.37	99.9	23.1		148.5	
10028- DAB	GPRS-FDD (TDMA, GMSK, TN 0-1-2-3)	X	56.24	99.6	22.6	3.55	140.4	$\pm 2.7\%$
		Y	56.95	99.7	21.9		129.1	
		Z	48.45	99.6	22.1		133.2	
10032- CAA	IEEE 802.15.1 Bluetooth (GFSK, DH5)	X	18.03	98.1	22.8	1.16	127.5	$\pm 1.9\%$
		Y	35.17	99.6	20.7		141.1	
		Z	21.08	99.9	21.9		127.5	
10100- CAB	LTE-FDD (SC-FDMA, 100% RB, 20 MHz, QPSK)	X	6.36	87.6	19.8	5.67	137.5	$\pm 1.2\%$
		Y	6.29	87.4	19.6		128.9	
		Z	6.35	87.5	19.7		139.5	

10103-CAB	LTE-TDD (SC-FDMA, 100% RB, 20 MHz, QPSK)	X	10.85	76.6	26.4	9.29	130.8	±2.7 %
		Y	9.58	73.7	24.8		143.0	
		Z	9.94	75.6	26.2		149.3	
10108-CAC	LTE-FDD (SC-FDMA, 100% RB, 10 MHz, QPSK)	X	6.21	67.0	19.7	5.80	128.9	±1.2 %
		Y	6.16	66.9	19.5		129.2	
		Z	6.22	67.2	19.7		138.0	
10117-CAB	IEEE 802.11n (HT Mixed, 13.5 Mbps, BPSK)	X	10.05	68.7	21.2	8.07	126.1	±2.5 %
		Y	10.13	69.0	21.3		146.1	
		Z	9.97	68.7	21.1		126.2	
10151-CAB	LTE-TDD (SC-FDMA, 50% RB, 20 MHz, QPSK)	X	10.11	75.5	26.0	9.28	125.8	±3.3 %
		Y	9.08	73.2	24.7		138.2	
		Z	9.32	74.8	26.0		143.1	
10154-CAC	LTE-FDD (SC-FDMA, 50% RB, 10 MHz, QPSK)	X	5.97	66.8	19.6	5.75	133.4	±1.2 %
		Y	5.92	66.7	19.5		127.0	
		Z	5.91	68.7	19.5		134.2	
10160-CAB	LTE-FDD (SC-FDMA, 50% RB, 15 MHz, QPSK)	X	6.40	67.3	19.9	5.82	137.8	±1.2 %
		Y	6.31	67.1	19.6		130.7	
		Z	6.32	67.1	19.6		139.8	
10169-CAB	LTE-FDD (SC-FDMA, 1 RB, 20 MHz, QPSK)	X	5.05	67.3	20.1	5.73	136.8	±1.2 %
		Y	4.89	67.0	19.9		131.1	
		Z	4.93	67.2	20.0		137.4	
10172-CAB	LTE-TDD (SC-FDMA, 1 RB, 20 MHz, QPSK)	X	10.74	83.9	30.3	9.21	136.8	±2.7 %
		Y	7.34	74.3	25.5		125.9	
		Z	7.74	76.6	27.1		131.2	
10175-CAC	LTE-FDD (SC-FDMA, 1 RB, 10 MHz, QPSK)	X	4.97	66.9	19.9	5.72	130.8	±1.2 %
		Y	4.86	66.9	19.8		128.5	
		Z	4.97	67.3	20.1		137.0	
10181-CAB	LTE-FDD (SC-FDMA, 1 RB, 15 MHz, QPSK)	X	4.99	67.0	19.9	5.72	130.1	±1.2 %
		Y	4.88	67.0	19.9		127.6	
		Z	4.95	67.2	20.0		136.2	
10196-CAB	IEEE 802.11n (HT Mixed, 6.5 Mbps, BPSK)	X	10.00	69.2	21.7	8.10	137.9	±2.2 %
		Y	9.75	68.7	21.2		137.5	
		Z	9.94	69.4	21.7		145.3	
10225-CAB	UMTS-FDD (HSPA+)	X	7.08	67.5	19.8	5.97	147.1	±1.4 %
		Y	7.06	67.7	19.8		142.3	
		Z	7.04	67.7	19.9		148.8	
10237-CAB	LTE-TDD (SC-FDMA, 1 RB, 10 MHz, QPSK)	X	10.66	83.5	30.1	9.21	144.0	±3.0 %
		Y	7.43	74.7	25.7		127.6	
		Z	7.86	77.1	27.4		132.3	
10252-CAB	LTE-TDD (SC-FDMA, 50% RB, 10 MHz, QPSK)	X	10.81	78.7	27.9	9.24	139.7	±3.0 %
		Y	8.48	72.4	24.4		130.1	
		Z	8.71	74.1	25.8		135.2	
10267-CAB	LTE-TDD (SC-FDMA, 100% RB, 10 MHz, QPSK)	X	11.73	79.9	28.3	9.30	148.6	±3.3 %
		Y	9.11	73.2	24.8		139.0	
		Z	9.38	74.9	26.1		142.7	

10275-CAB	UMTS-FDD (HSUPA, Subtest 5, 3GPP Rel8.4)	X	4.52	67.6	19.3	3.96	144.5	±0.7 %
		Y	4.67	68.3	19.6		146.0	
		Z	4.41	67.0	18.9		130.0	
10291-AAB	CDMA2000, RC3, SO55, Full Rate	X	3.68	67.2	19.0	3.46	134.5	±0.5 %
		Y	3.91	68.9	19.9		133.2	
		Z	3.86	68.5	19.6		146.9	
10292-AAB	CDMA2000, RC3, SO32, Full Rate	X	3.63	67.5	19.1	3.39	134.9	±0.5 %
		Y	3.93	69.3	20.0		136.0	
		Z	3.81	68.5	19.6		148.6	
10297-AAA	LTE-FDD (SC-FDMA, 50% RB, 20 MHz, QPSK)	X	6.20	67.1	19.7	5.81	129.0	±1.2 %
		Y	6.20	67.0	19.6		128.0	
		Z	6.32	67.5	19.9		142.7	
10311-AAA	LTE-FDD (SC-FDMA, 100% RB, 15 MHz, QPSK)	X	6.76	67.6	20.0	6.06	134.7	±1.4 %
		Y	6.75	67.5	19.9		133.5	
		Z	6.90	68.1	20.3		149.2	
10400-AAC	IEEE 802.11ac WiFi (20MHz, 64-QAM, 99pc duty cycle)	X	10.30	69.7	22.1	8.37	140.1	±2.5 %
		Y	10.05	69.0	21.5		141.2	
		Z	9.94	69.0	21.7		126.3	
10403-AAB	CDMA2000 (1xEV-DO, Rev. 0)	X	4.80	68.5	19.0	3.76	129.3	±0.5 %
		Y	5.30	71.1	20.2		148.4	
		Z	5.10	70.4	19.9		135.2	
10404-AAB	CDMA2000 (1xEV-DO, Rev. A)	X	4.77	68.8	19.2	3.77	127.3	±0.7 %
		Y	5.35	71.7	20.5		145.4	
		Z	5.03	70.6	20.1		133.3	
10415-AAA	IEEE 802.11b WiFi 2.4 GHz (DSSS, 1 Mbps, 99pc duty cycle)	X	2.77	69.7	19.7	1.54	147.0	±0.7 %
		Y	3.73	75.4	22.2		143.7	
		Z	3.25	72.2	20.7		133.9	
10416-AAA	IEEE 802.11g WiFi 2.4 GHz (ERP-OFDM, 6 Mbps, 99pc duty cycle)	X	10.11	69.4	21.8	8.23	144.7	±2.5 %
		Y	9.86	68.8	21.4		139.3	
		Z	9.72	68.6	21.3		126.0	

The reported uncertainty of measurement is stated as the standard uncertainty of measurement multiplied by the coverage factor $k=2$, which for a normal distribution corresponds to a coverage probability of approximately 95%.

^A The uncertainties of Norm X,Y,Z do not affect the E^2 -field uncertainty inside TSL (see Pages 7 and 8).

^B Numerical linearization parameter: uncertainty not required.

^E Uncertainty is determined using the max. deviation from linear response applying rectangular distribution and is expressed for the square of the field value.

DASY/EASY - Parameters of Probe: ES3DV3 - SN:3333

Calibration Parameter Determined In Head Tissue Simulating Media

f (MHz) ^c	Relative Permittivity ^F	Conductivity (S/m) ^F	ConvF X	ConvF Y	ConvF Z	Alpha ^G	Depth ^G (mm)	Unc (k=2)
750	41.9	0.89	6.46	6.46	6.46	0.75	1.22	± 12.0 %
835	41.5	0.90	6.16	6.16	6.16	0.36	1.67	± 12.0 %
1750	40.1	1.37	5.21	5.21	5.21	0.80	1.19	± 12.0 %
1900	40.0	1.40	5.03	5.03	5.03	0.73	1.25	± 12.0 %
2300	39.5	1.67	4.73	4.73	4.73	0.60	1.43	± 12.0 %
2450	39.2	1.80	4.53	4.53	4.53	0.80	1.28	± 12.0 %
2600	39.0	1.96	4.39	4.39	4.39	0.80	1.29	± 12.0 %

^c Frequency validity above 300 MHz of ± 100 MHz only applies for DASY v4.4 and higher (see Page 2), else it is restricted to ± 50 MHz. The uncertainty is the RSS of the ConvF uncertainty at calibration frequency and the uncertainty for the indicated frequency band. Frequency validity below 300 MHz is ± 10, 25, 40, 50 and 70 MHz for ConvF assessments at 30, 64, 128, 150 and 220 MHz respectively. Above 5 GHz frequency validity can be extended to ± 110 MHz.

^F At frequencies below 3 GHz, the validity of tissue parameters (ϵ and σ) can be relaxed to ± 10% if liquid compensation formula is applied to measured SAR values. At frequencies above 3 GHz, the validity of tissue parameters (ϵ and σ) is restricted to ± 5%. The uncertainty is the RSS of the ConvF uncertainty for indicated target tissue parameters.

^G Alpha/Depth are determined during calibration. SPEAG warrants that the remaining deviation due to the boundary effect after compensation is always less than ± 1% for frequencies below 3 GHz and below ± 2% for frequencies between 3-6 GHz at any distance larger than half the probe tip diameter from the boundary.

DASY/EASY - Parameters of Probe: ES3DV3 - SN:3333

Calibration Parameter Determined in Body Tissue Simulating Media

f (MHz) ^c	Relative Permittivity ^F	Conductivity (S/m) ^F	ConvF X	ConvF Y	ConvF Z	Alpha ^g	Depth ^g (mm)	Unc (k=2)
750	55.5	0.98	6.31	6.31	6.31	0.70	1.26	± 12.0 %
835	55.2	0.97	6.25	6.25	6.25	0.47	1.54	± 12.0 %
1750	53.4	1.49	4.90	4.90	4.90	0.49	1.63	± 12.0 %
1900	53.3	1.52	4.70	4.70	4.70	0.54	1.49	± 12.0 %
2300	52.9	1.81	4.51	4.51	4.51	0.80	1.15	± 12.0 %
2450	52.7	1.95	4.34	4.34	4.34	0.80	1.15	± 12.0 %
2600	52.5	2.16	4.23	4.23	4.23	0.80	1.03	± 12.0 %

^c Frequency validity above 300 MHz of ± 100 MHz only applies for DASY v4.4 and higher (see Page 2), else it is restricted to ± 50 MHz. The uncertainty is the RSS of the ConvF uncertainty at calibration frequency and the uncertainty for the indicated frequency band. Frequency validity below 300 MHz is ± 10, 25, 40, 50 and 70 MHz for ConvF assessments at 30, 64, 128, 160 and 220 MHz respectively. Above 5 GHz frequency validity can be extended to ± 110 MHz.

^F At frequencies below 3 GHz, the validity of tissue parameters (ϵ and σ) can be relaxed to ± 10% if liquid compensation formula is applied to measured SAR values. At frequencies above 3 GHz, the validity of tissue parameters (ϵ and σ) is restricted to ± 5%. The uncertainty is the RSS of the ConvF uncertainty for indicated target tissue parameters.

^g Alpha/Depth are determined during calibration. SPEAG warrants that the remaining deviation due to the boundary effect after compensation is always less than ± 1% for frequencies below 3 GHz and below ± 2% for frequencies between 3-6 GHz at any distance larger than half the probe tip diameter from the boundary.

Frequency Response of E-Field (TEM-Cell:ifi110 EXX, Waveguide: R22)

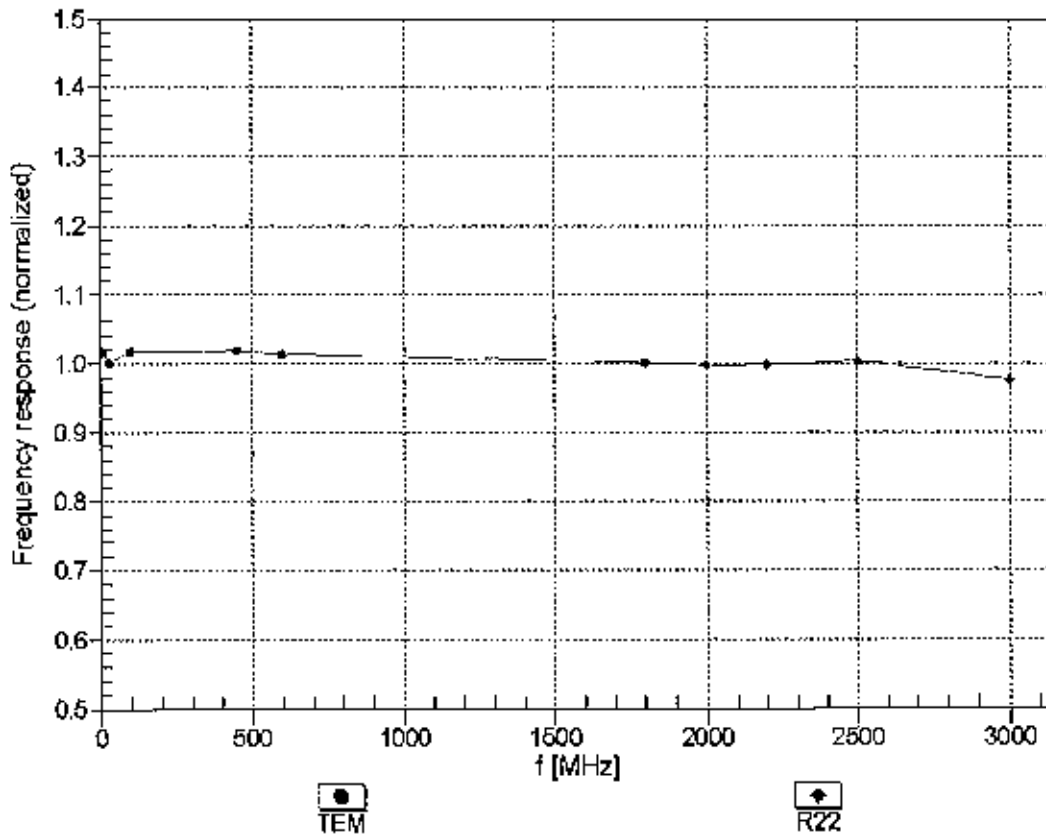

Uncertainty of Frequency Response of E-field: $\pm 6.3\%$ (k=2)

Receiving Pattern (ϕ), $\theta = 0^\circ$

f=600 MHz,TEM

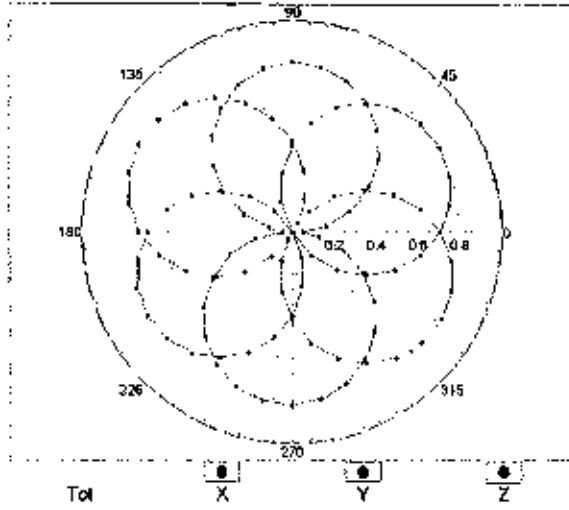

f=1800 MHz,R22

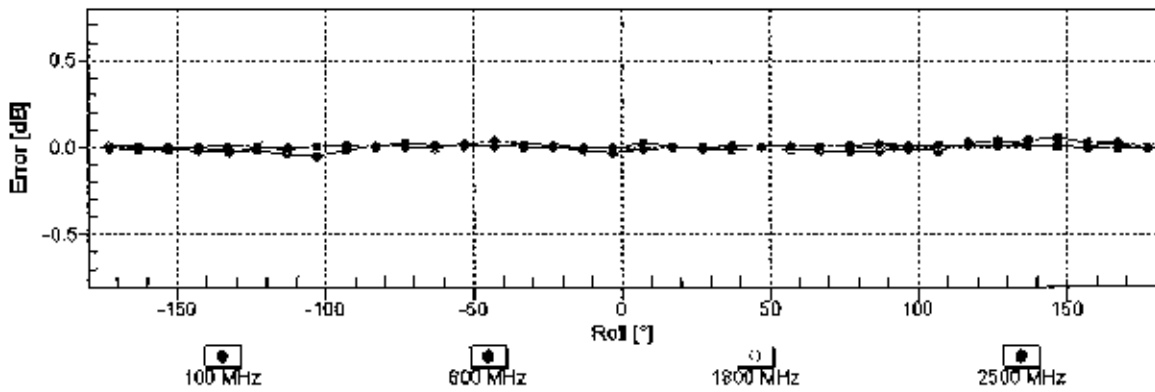
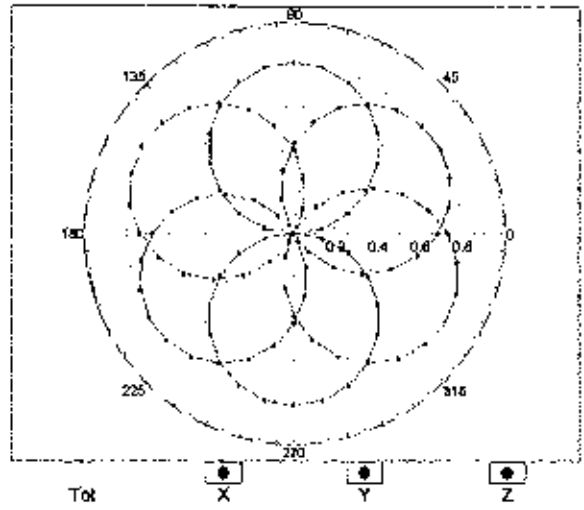

Uncertainty of Axial Isotropy Assessment: $\pm 0.5\%$ (k=2)

Dynamic Range f(SAR_{head}) (TEM cell , f_{eval}= 1900 MHz)

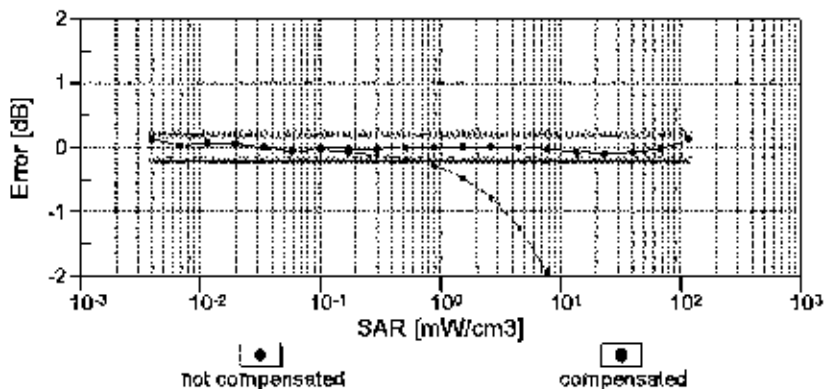
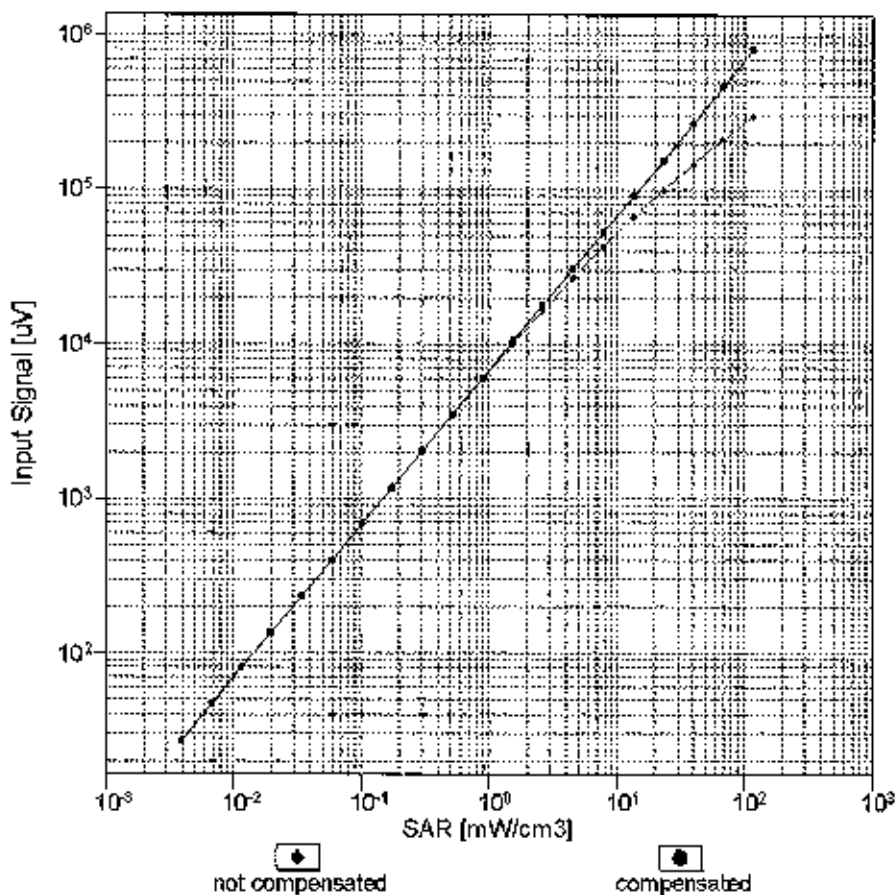

Uncertainty of Linearity Assessment: ± 0.6% (k=2)

Conversion Factor Assessment

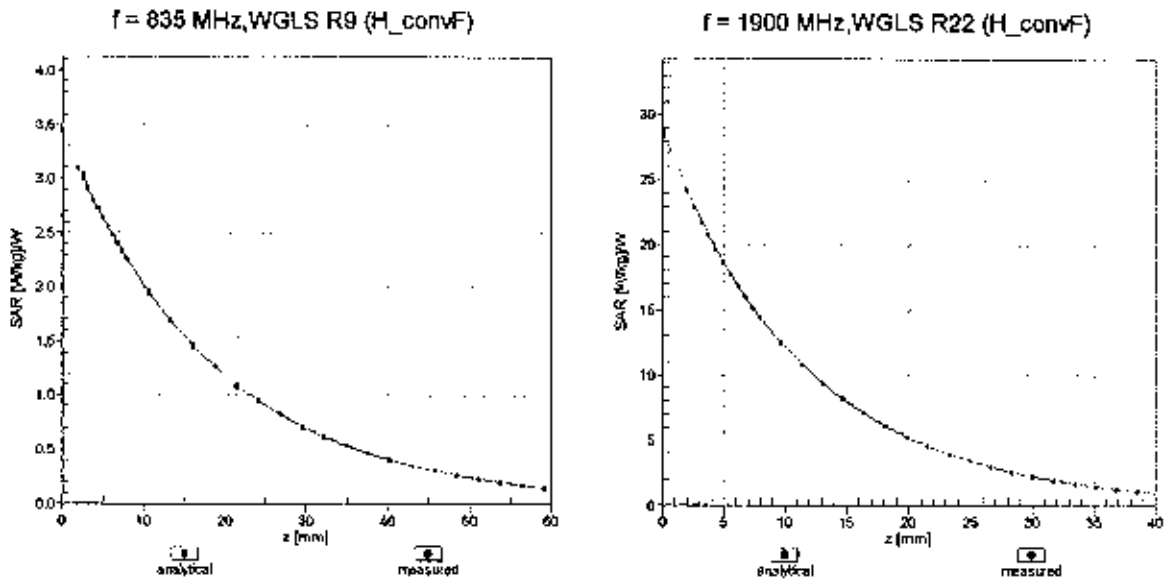

Deviation from Isotropy in Liquid Error (ϕ, θ), f = 900 MHz

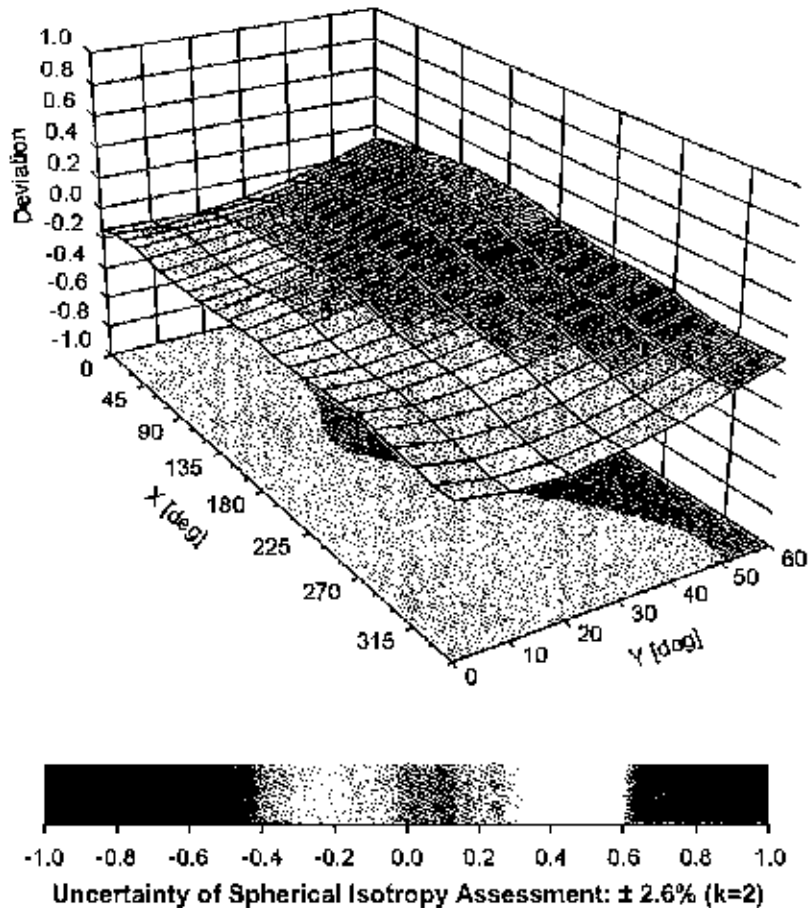

DASY/EASY - Parameters of Probe: ES3DV3 - SN:3333**Other Probe Parameters**

Sensor Arrangement	Triangular
Connector Angle (°)	-32.8
Mechanical Surface Detection Mode	enabled
Optical Surface Detection Mode	disabled
Probe Overall Length	337 mm
Probe Body Diameter	10 mm
Tip Length	10 mm
Tip Diameter	4 mm
Probe Tip to Sensor X Calibration Point	2 mm
Probe Tip to Sensor Y Calibration Point	2 mm
Probe Tip to Sensor Z Calibration Point	2 mm
Recommended Measurement Distance from Surface	3 mm



Accredited by the Swiss Accreditation Service (SAS)
The Swiss Accreditation Service is one of the signatories to the EA
Multilateral Agreement for the recognition of calibration certificates

Accreditation No.: **SCS 0108**

Client **PC Test**

Certificate No: **EX3-7308_Jul15**

CALIBRATION CERTIFICATE

Object **EX3DV4 - SN:7308**

Calibration procedure(s) **QA CAL-01.v9, QA CAL-14.v4, QA CAL-23.v5, QA CAL-25.v6
Calibration procedure for dosimetric E-field probes**

Calibration date: **July 21, 2015**

*BN ✓
08/04/15*

This calibration certificate documents the traceability to national standards, which realize the physical units of measurements (SI).
The measurements and the uncertainties with confidence probability are given on the following pages and are part of the certificate.

All calibrations have been conducted in the closed laboratory facility: environment temperature (22 ± 3)°C and humidity < 70%.

Calibration Equipment used (M&TE critical for calibration)

Primary Standards	ID	Cal Date (Certificate No.)	Scheduled Calibration
Power meter E4419B	GB41293874	01-Apr-15 (No. 217-02128)	Mar-16
Power sensor E4412A	MY41498087	01-Apr-15 (No. 217-02128)	Mar-16
Reference 3 dB Attenuator	SN: S5054 (3c)	01-Apr-15 (No. 217-02129)	Mar-16
Reference 20 dB Attenuator	SN: S5277 (20x)	01-Apr-15 (No. 217-02132)	Mar-16
Reference 30 dB Attenuator	SN: S5129 (30b)	01-Apr-15 (No. 217-02133)	Mar-16
Reference Probe ES3DV2	SN: 3013	30-Dec-14 (No. ES3-3013_Dec14)	Dec-15
DAE4	SN: 660	14-Jan-15 (No. DAE4-660_Jan15)	Jan-16
Secondary Standards	ID	Check Date (in house)	Scheduled Check
RF generator HP 8648C	US3642U01700	4-Aug-99 (in house check Apr-13)	In house check: Apr-16
Network Analyzer HP 8753E	US37390585	18-Oct-01 (in house check Oct-14)	In house check: Oct-15

Calibrated by: **Claudio Leubler** (Name) / **Laboratory Technician** (Function) / *[Signature]* (Signature)

Approved by: **Katja Pokovic** (Name) / **Technical Manager** (Function) / *[Signature]* (Signature)

Issued: July 22, 2015

This calibration certificate shall not be reproduced except in full without written approval of the laboratory.



Accredited by the Swiss Accreditation Service (SAS)
The Swiss Accreditation Service is one of the signatories to the EA
Multilateral Agreement for the recognition of calibration certificates

Accreditation No.: **SCS 0108**

Glossary:

TSL	tissue simulating liquid
NORM _{x,y,z}	sensitivity in free space
ConvF	sensitivity in TSL / NORM _{x,y,z}
DCP	diode compression point
CF	crest factor (1/duty_cycle) of the RF signal
A, B, C, D	modulation dependent linearization parameters
Polarization φ	φ rotation around probe axis
Polarization θ	θ rotation around an axis that is in the plane normal to probe axis (at measurement center), i.e., θ = 0 is normal to probe axis
Connector Angle	information used in DASY system to align probe sensor X to the robot coordinate system

Calibration is Performed According to the Following Standards:

- a) IEEE Std 1528-2013, "IEEE Recommended Practice for Determining the Peak Spatial-Averaged Specific Absorption Rate (SAR) in the Human Head from Wireless Communications Devices: Measurement Techniques", June 2013
- b) IEC 62209-1, "Procedure to measure the Specific Absorption Rate (SAR) for hand-held devices used in close proximity to the ear (frequency range of 300 MHz to 3 GHz)", February 2005
- c) IEC 62209-2, "Procedure to determine the Specific Absorption Rate (SAR) for wireless communication devices used in close proximity to the human body (frequency range of 30 MHz to 6 GHz)", March 2010
- d) KDB 865664, "SAR Measurement Requirements for 100 MHz to 6 GHz"

Methods Applied and Interpretation of Parameters:

- *NORM_{x,y,z}*: Assessed for E-field polarization θ = 0 (f ≤ 900 MHz in TEM-cell; f > 1800 MHz: R22 waveguide). *NORM_{x,y,z}* are only intermediate values, i.e., the uncertainties of *NORM_{x,y,z}* does not affect the E²-field uncertainty inside TSL (see below *ConvF*).
- *NORM(f)_{x,y,z}* = *NORM_{x,y,z}* * *frequency_response* (see Frequency Response Chart). This linearization is implemented in DASY4 software versions later than 4.2. The uncertainty of the frequency response is included in the stated uncertainty of *ConvF*.
- *DCP_{x,y,z}*: DCP are numerical linearization parameters assessed based on the data of power sweep with CW signal (no uncertainty required). DCP does not depend on frequency nor media.
- *PAR*: PAR is the Peak to Average Ratio that is not calibrated but determined based on the signal characteristics
- *A_{x,y,z}*; *B_{x,y,z}*; *C_{x,y,z}*; *D_{x,y,z}*; *VR_{x,y,z}*: *A, B, C, D* are numerical linearization parameters assessed based on the data of power sweep for specific modulation signal. The parameters do not depend on frequency nor media. *VR* is the maximum calibration range expressed in RMS voltage across the diode.
- *ConvF and Boundary Effect Parameters*: Assessed in flat phantom using E-field (or Temperature Transfer Standard for f ≤ 800 MHz) and inside waveguide using analytical field distributions based on power measurements for f > 800 MHz. The same setups are used for assessment of the parameters applied for boundary compensation (alpha, depth) of which typical uncertainty values are given. These parameters are used in DASY4 software to improve probe accuracy close to the boundary. The sensitivity in TSL corresponds to *NORM_{x,y,z}* * *ConvF* whereby the uncertainty corresponds to that given for *ConvF*. A frequency dependent *ConvF* is used in DASY version 4.4 and higher which allows extending the validity from ± 50 MHz to ± 100 MHz.
- *Spherical isotropy (3D deviation from isotropy)*: in a field of low gradients realized using a flat phantom exposed by a patch antenna.
- *Sensor Offset*: The sensor offset corresponds to the offset of virtual measurement center from the probe tip (on probe axis). No tolerance required.
- *Connector Angle*: The angle is assessed using the information gained by determining the *NORM_x* (no uncertainty required).

Probe EX3DV4

SN:7308

Manufactured: March 11, 2014
Calibrated: July 21, 2015

Calibrated for DASY/EASY Systems
(Note: non-compatible with DASY2 system!)

DASY/EASY - Parameters of Probe: EX3DV4 - SN:7308

Basic Calibration Parameters

	Sensor X	Sensor Y	Sensor Z	Unc (k=2)
Norm ($\mu\text{V}/(\text{V}/\text{m})^2$) ^A	0.50	0.60	0.45	$\pm 10.1\%$
DCP (mV) ^B	98.7	98.5	103.0	

Modulation Calibration Parameters

UID	Communication System Name		A dB	B dB $\sqrt{\mu\text{V}}$	C	D dB	VR mV	Unc ^E (k=2)
0	CW	X	0.0	0.0	1.0	0.00	157.9	$\pm 3.3\%$
		Y	0.0	0.0	1.0		152.7	
		Z	0.0	0.0	1.0		146.1	
10010-CAA	SAR Validation (Square, 100ms, 10ms)	X	1.57	63.2	12.0	10.00	44.9	$\pm 0.9\%$
		Y	4.80	74.9	16.5		43.8	
		Z	0.93	58.1	8.8		41.8	
10062-CAB	IEEE 802.11a/h WiFi 5 GHz (OFDM, 6 Mbps)	X	10.36	69.2	21.9	8.68	145.4	$\pm 3.3\%$
		Y	10.44	69.2	21.9		144.1	
		Z	9.89	68.5	21.5		130.2	
10117-CAB	IEEE 802.11n (HT Mixed, 13.5 Mbps, BPSK)	X	10.03	68.2	20.8	8.07	127.1	$\pm 3.0\%$
		Y	10.43	69.2	21.4		148.2	
		Z	10.05	68.6	21.1		138.2	
10196-CAB	IEEE 802.11n (HT Mixed, 6.5 Mbps, BPSK)	X	10.03	68.9	21.4	8.10	146.1	$\pm 3.0\%$
		Y	10.09	68.9	21.4		143.5	
		Z	9.59	68.3	21.1		131.0	
10317-AAB	IEEE 802.11a WiFi 5 GHz (OFDM, 6 Mbps, 96pc duty cycle)	X	10.17	69.0	21.6	8.36	144.5	$\pm 3.3\%$
		Y	10.23	69.0	21.6		141.8	
		Z	9.72	68.4	21.3		130.2	
10400-AAC	IEEE 802.11ac WiFi (20MHz, 64-QAM, 99pc duty cycle)	X	10.28	69.1	21.6	8.37	144.6	$\pm 3.3\%$
		Y	10.32	69.1	21.6		142.0	
		Z	9.81	68.5	21.3		129.4	
10401-AAC	IEEE 802.11ac WiFi (40MHz, 64-QAM, 99pc duty cycle)	X	10.70	68.8	21.5	8.60	129.8	$\pm 3.0\%$
		Y	10.55	68.4	21.2		123.2	
		Z	10.64	69.1	21.6		140.3	
10402-AAC	IEEE 802.11ac WiFi (80MHz, 64-QAM, 99pc duty cycle)	X	10.84	69.0	21.4	8.53	130.1	$\pm 3.0\%$
		Y	10.57	68.4	21.0		123.5	
		Z	10.91	69.6	21.7		142.7	

10417-AAA	IEEE 802.11a/h WiFi 5 GHz (OFDM, 6 Mbps, 99pc duty cycle)	X	10.10	68.9	21.5	8.23	145.0	±3.0 %
		Y	10.15	68.9	21.5		142.0	
		Z	9.64	68.3	21.1		130.3	

The reported uncertainty of measurement is stated as the standard uncertainty of measurement multiplied by the coverage factor $k=2$, which for a normal distribution corresponds to a coverage probability of approximately 95%.

^A The uncertainties of Norm X,Y,Z do not affect the E^2 -field uncertainty inside TSL (see Pages 6 and 7).

^B Numerical linearization parameter: uncertainty not required.

^E Uncertainty is determined using the max. deviation from linear response applying rectangular distribution and is expressed for the square of the field value.

DASY/EASY - Parameters of Probe: EX3DV4 - SN:7308

Calibration Parameter Determined in Head Tissue Simulating Media

f (MHz) ^C	Relative Permittivity ^F	Conductivity (S/m) ^F	ConvF X	ConvF Y	ConvF Z	Alpha ^G	Depth ^G (mm)	Unc (k=2)
5250	35.9	4.71	5.20	5.20	5.20	0.35	1.80	± 13.1 %
5600	35.5	5.07	4.65	4.65	4.65	0.40	1.80	± 13.1 %
5750	35.4	5.22	4.86	4.86	4.86	0.40	1.80	± 13.1 %

^C Frequency validity above 300 MHz of ± 100 MHz only applies for DASY v4.4 and higher (see Page 2), else it is restricted to ± 50 MHz. The uncertainty is the RSS of the ConvF uncertainty at calibration frequency and the uncertainty for the indicated frequency band. Frequency validity below 300 MHz is ± 10, 25, 40, 50 and 70 MHz for ConvF assessments at 30, 64, 128, 150 and 220 MHz respectively. Above 5 GHz frequency validity can be extended to ± 110 MHz.

^F At frequencies below 3 GHz, the validity of tissue parameters (ϵ and σ) can be relaxed to ± 10% if liquid compensation formula is applied to measured SAR values. At frequencies above 3 GHz, the validity of tissue parameters (ϵ and σ) is restricted to ± 5%. The uncertainty is the RSS of the ConvF uncertainty for indicated target tissue parameters.

^G Alpha/Depth are determined during calibration. SPEAG warrants that the remaining deviation due to the boundary effect after compensation is always less than ± 1% for frequencies below 3 GHz and below ± 2% for frequencies between 3-6 GHz at any distance larger than half the probe tip diameter from the boundary.

DASY/EASY - Parameters of Probe: EX3DV4 - SN:7308

Calibration Parameter Determined in Body Tissue Simulating Media

f (MHz) ^C	Relative Permittivity ^F	Conductivity (S/m) ^F	ConvF X	ConvF Y	ConvF Z	Alpha ^G	Depth ^G (mm)	Unc (k=2)
5250	48.9	5.36	4.63	4.63	4.63	0.40	1.90	± 13.1 %
5600	48.5	5.77	3.92	3.92	3.92	0.50	1.90	± 13.1 %
5750	48.3	5.94	4.24	4.24	4.24	0.50	1.90	± 13.1 %

^C Frequency validity above 300 MHz of ± 100 MHz only applies for DASY v4.4 and higher (see Page 2), else it is restricted to ± 50 MHz. The uncertainty is the RSS of the ConvF uncertainty at calibration frequency and the uncertainty for the indicated frequency band. Frequency validity below 300 MHz is ± 10, 25, 40, 50 and 70 MHz for ConvF assessments at 30, 64, 128, 150 and 220 MHz respectively. Above 5 GHz frequency validity can be extended to ± 110 MHz.

^F At frequencies below 3 GHz, the validity of tissue parameters (ϵ and σ) can be relaxed to ± 10% if liquid compensation formula is applied to measured SAR values. At frequencies above 3 GHz, the validity of tissue parameters (ϵ and σ) is restricted to ± 5%. The uncertainty is the RSS of the ConvF uncertainty for indicated target tissue parameters.

^G Alpha/Depth are determined during calibration. SPEAG warrants that the remaining deviation due to the boundary effect after compensation is always less than ± 1% for frequencies below 3 GHz and below ± 2% for frequencies between 3-6 GHz at any distance larger than half the probe tip diameter from the boundary.

Frequency Response of E-Field (TEM-Cell:ifi110 EXX, Waveguide: R22)

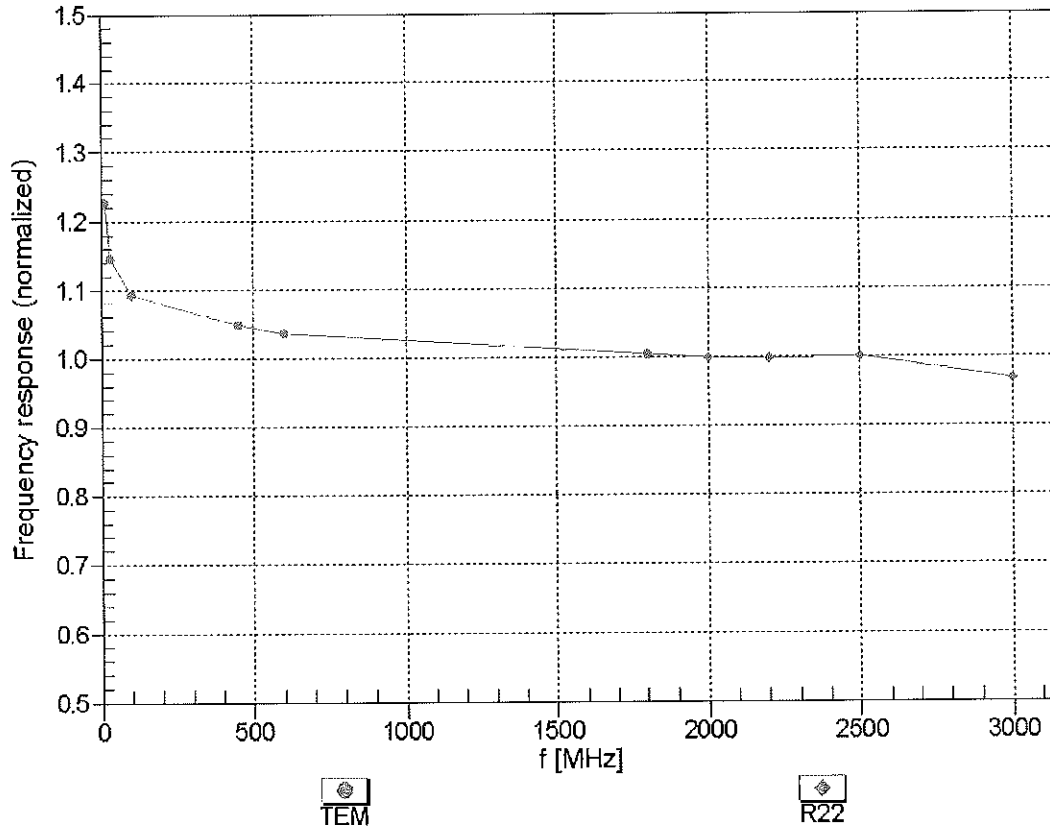

Uncertainty of Frequency Response of E-field: $\pm 6.3\%$ (k=2)

Receiving Pattern (ϕ), $\theta = 0^\circ$

f=600 MHz,TEM

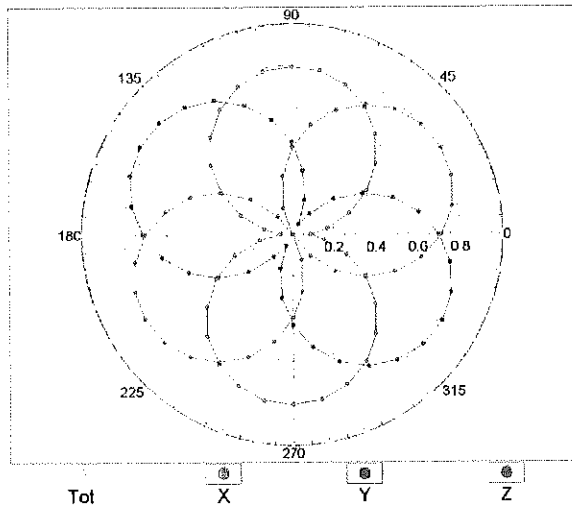

f=1800 MHz,R22

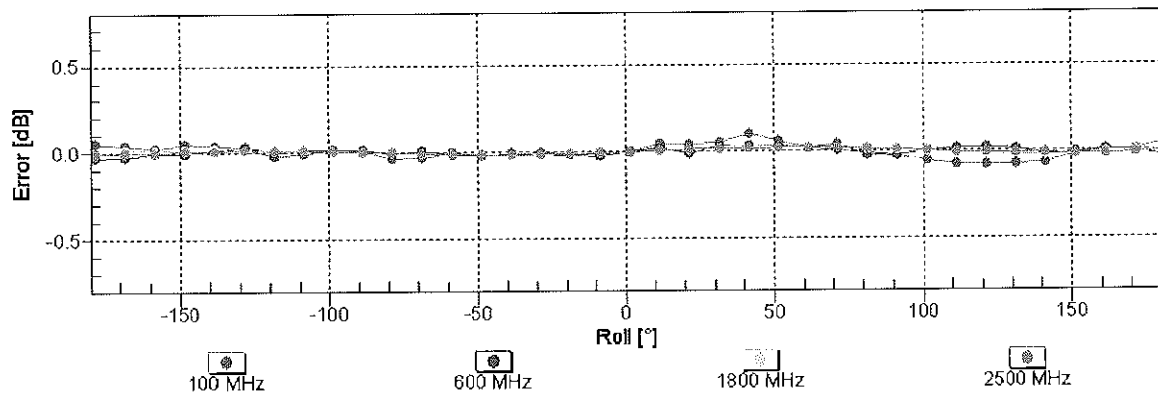
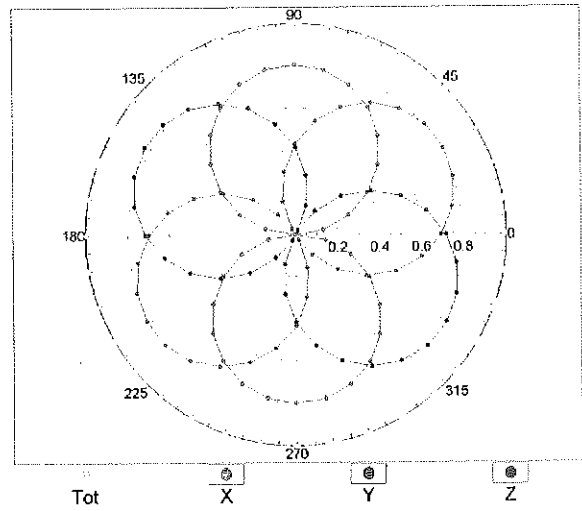

Uncertainty of Axial Isotropy Assessment: $\pm 0.5\%$ (k=2)

Dynamic Range f(SAR_{head}) (TEM cell , f_{eval}= 1900 MHz)

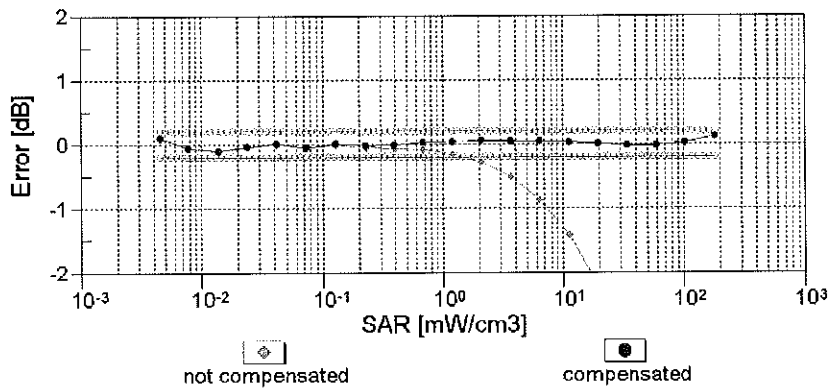
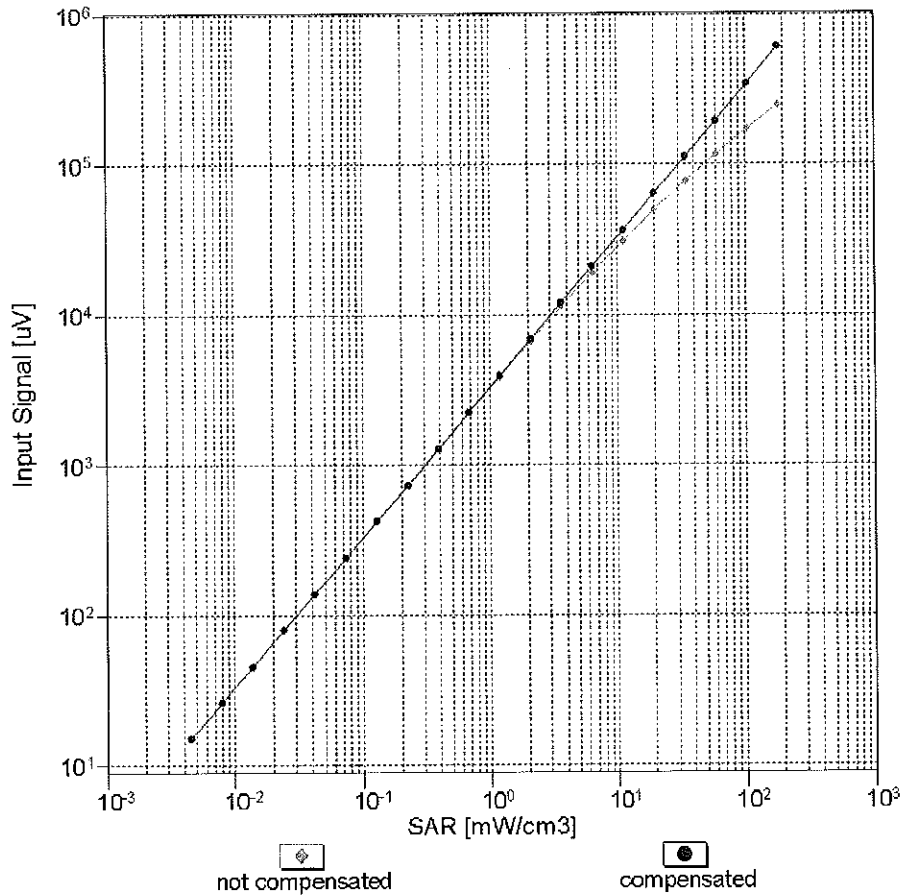

Uncertainty of Linearity Assessment: ± 0.6% (k=2)

Conversion Factor Assessment

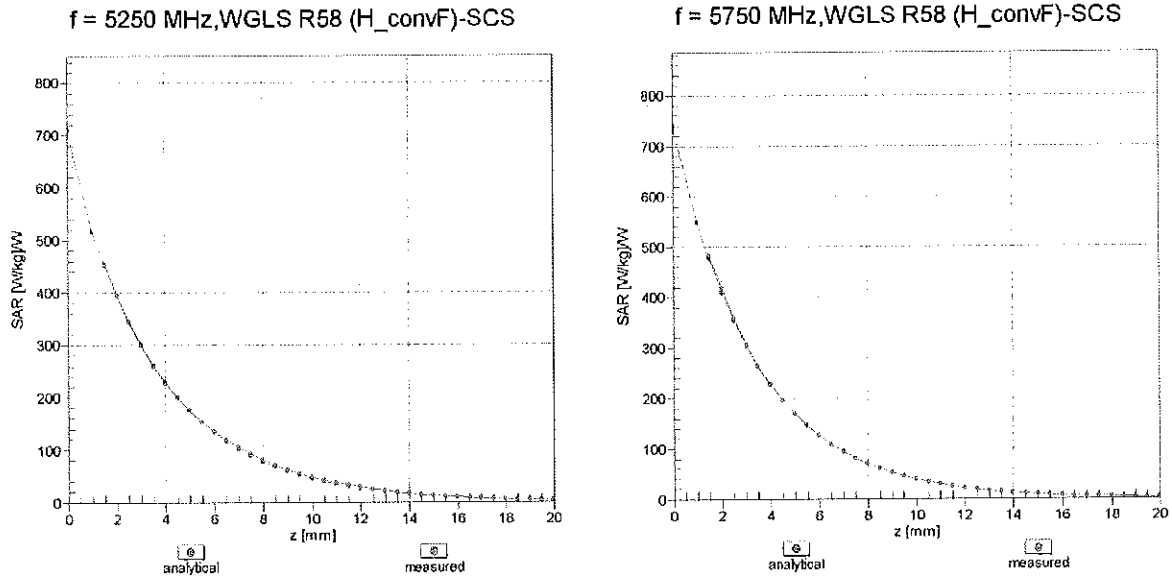

Deviation from Isotropy in Liquid Error (ϕ, ϑ), f = 900 MHz

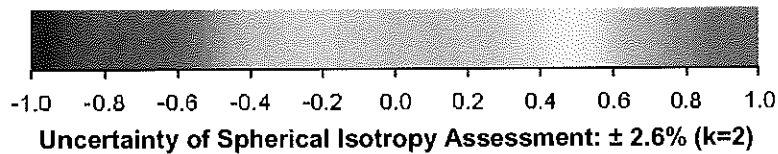
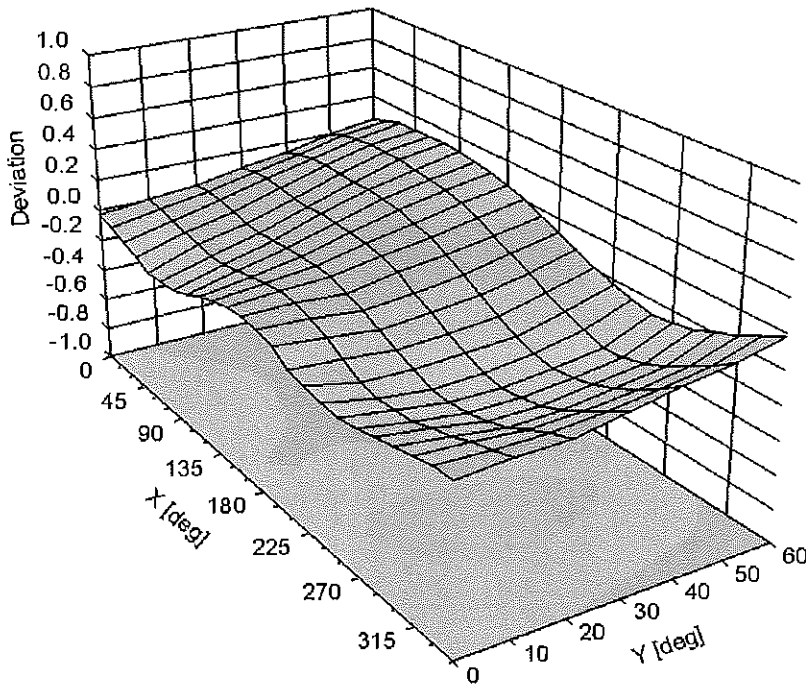

DASY/EASY - Parameters of Probe: EX3DV4 - SN:7308**Other Probe Parameters**

Sensor Arrangement	Triangular
Connector Angle (°)	111.5
Mechanical Surface Detection Mode	enabled
Optical Surface Detection Mode	disabled
Probe Overall Length	337 mm
Probe Body Diameter	10 mm
Tip Length	9 mm
Tip Diameter	2.5 mm
Probe Tip to Sensor X Calibration Point	1 mm
Probe Tip to Sensor Y Calibration Point	1 mm
Probe Tip to Sensor Z Calibration Point	1 mm
Recommended Measurement Distance from Surface	1.4 mm



Accredited by the Swiss Accreditation Service (SAS)
The Swiss Accreditation Service is one of the signatories to the EA
Multilateral Agreement for the recognition of calibration certificates

Accreditation No.: **SCS 0108**

Client **PC Test**

Certificate No: **EX3-7357_Apr15**

CALIBRATION CERTIFICATE

Object: **EX3DV4 - SN:7357**

Calibration procedure(s): **QA CAL-01.v9, QA CAL-14.v4, QA CAL-23.v5, QA CAL-25.v6
Calibration procedure for dosimetric E-field probes**

Calibration date: **April 23, 2015**

This calibration certificate documents the traceability to national standards, which realize the physical units of measurements (SI).
The measurements and the uncertainties with confidence probability are given on the following pages and are part of the certificate.

All calibrations have been conducted in the closed laboratory facility: environment temperature (22 ± 3)°C and humidity < 70%.

Calibration Equipment used (M&TE critical for calibration)

*PNV ✓
05/05/15*

Primary Standards	ID	Cal Date (Certificate No.)	Scheduled Calibration
Power meter E4419B	GB41293874	01-Apr-15 (No. 217-02128)	Mar-16
Power sensor E4412A	MY41498087	01-Apr-15 (No. 217-02128)	Mar-16
Reference 3 dB Attenuator	SN: S5054 (3c)	01-Apr-15 (No. 217-02129)	Mar-16
Reference 20 dB Attenuator	SN: S5277 (20x)	01-Apr-15 (No. 217-02132)	Mar-16
Reference 30 dB Attenuator	SN: S5129 (30b)	01-Apr-15 (No. 217-02133)	Mar-16
Reference Probe ES3DV2	SN: 3013	30-Dec-14 (No. ES3-3013_Dec14)	Dec-15
DAE4	SN: 660	14-Jan-15 (No. DAE4-660_Jan15)	Jan-16
Secondary Standards	ID	Check Date (in house)	Scheduled Check
RF generator HP 8648C	US3642U01700	4-Aug-99 (in house check Apr-13)	In house check: Apr-16
Network Analyzer HP 8753E	US37390585	18-Oct-01 (in house check Oct-14)	In house check: Oct-15

Calibrated by:	Claudio Leubler	Laboratory Technician	
Approved by:	Katja Pokovic	Technical Manager	

Issued: April 23, 2015

This calibration certificate shall not be reproduced except in full without written approval of the laboratory.



Accredited by the Swiss Accreditation Service (SAS)

Accreditation No.: **SCS 0108**

The Swiss Accreditation Service is one of the signatories to the EA Multilateral Agreement for the recognition of calibration certificates

Glossary:

TSL	tissue simulating liquid
NORM _{x,y,z}	sensitivity in free space
ConvF	sensitivity in TSL / NORM _{x,y,z}
DCP	diode compression point
CF	crest factor (1/duty_cycle) of the RF signal
A, B, C, D	modulation dependent linearization parameters
Polarization φ	φ rotation around probe axis
Polarization ϑ	ϑ rotation around an axis that is in the plane normal to probe axis (at measurement center), i.e., $\vartheta = 0$ is normal to probe axis
Connector Angle	information used in DASY system to align probe sensor X to the robot coordinate system

Calibration is Performed According to the Following Standards:

- IEEE Std 1528-2013, "IEEE Recommended Practice for Determining the Peak Spatial-Averaged Specific Absorption Rate (SAR) in the Human Head from Wireless Communications Devices: Measurement Techniques", June 2013
- IEC 62209-1, "Procedure to measure the Specific Absorption Rate (SAR) for hand-held devices used in close proximity to the ear (frequency range of 300 MHz to 3 GHz)", February 2005

Methods Applied and Interpretation of Parameters:

- NORM_{x,y,z}**: Assessed for E-field polarization $\vartheta = 0$ ($f \leq 900$ MHz in TEM-cell; $f > 1800$ MHz: R22 waveguide). NORM_{x,y,z} are only intermediate values, i.e., the uncertainties of NORM_{x,y,z} does not affect the E²-field uncertainty inside TSL (see below ConvF).
- NORM(f)_{x,y,z}** = NORM_{x,y,z} * frequency_response (see Frequency Response Chart). This linearization is implemented in DASY4 software versions later than 4.2. The uncertainty of the frequency response is included in the stated uncertainty of ConvF.
- DCP_{x,y,z}**: DCP are numerical linearization parameters assessed based on the data of power sweep with CW signal (no uncertainty required). DCP does not depend on frequency nor media.
- PAR**: PAR is the Peak to Average Ratio that is not calibrated but determined based on the signal characteristics
- A_{x,y,z}; B_{x,y,z}; C_{x,y,z}; D_{x,y,z}; VR_{x,y,z}; A, B, C, D** are numerical linearization parameters assessed based on the data of power sweep for specific modulation signal. The parameters do not depend on frequency nor media. VR is the maximum calibration range expressed in RMS voltage across the diode.
- ConvF and Boundary Effect Parameters**: Assessed in flat phantom using E-field (or Temperature Transfer Standard for $f \leq 800$ MHz) and inside waveguide using analytical field distributions based on power measurements for $f > 800$ MHz. The same setups are used for assessment of the parameters applied for boundary compensation (alpha, depth) of which typical uncertainty values are given. These parameters are used in DASY4 software to improve probe accuracy close to the boundary. The sensitivity in TSL corresponds to NORM_{x,y,z} * ConvF whereby the uncertainty corresponds to that given for ConvF. A frequency dependent ConvF is used in DASY version 4.4 and higher which allows extending the validity from ± 50 MHz to ± 100 MHz.
- Spherical isotropy (3D deviation from isotropy)**: in a field of low gradients realized using a flat phantom exposed by a patch antenna.
- Sensor Offset**: The sensor offset corresponds to the offset of virtual measurement center from the probe tip (on probe axis). No tolerance required.
- Connector Angle**: The angle is assessed using the information gained by determining the NORM_x (no uncertainty required).

Probe EX3DV4

SN:7357

Manufactured: February 5, 2015
Calibrated: April 23, 2015

Calibrated for DASY/EASY Systems
(Note: non-compatible with DASY2 system!)

DASY/EASY - Parameters of Probe: EX3DV4 - SN:7357

Basic Calibration Parameters

	Sensor X	Sensor Y	Sensor Z	Unc (k=2)
Norm ($\mu\text{V}/(\text{V}/\text{m})^2$) ^A	0.41	0.49	0.42	$\pm 10.1 \%$
DCP (mV) ^B	103.9	96.9	101.6	

Modulation Calibration Parameters

UID	Communication System Name		A dB	B dB $\sqrt{\mu\text{V}}$	C	D dB	VR mV	Unc ^E (k=2)
0	CW	X	0.0	0.0	1.0	0.00	146.9	$\pm 3.3 \%$
		Y	0.0	0.0	1.0		157.7	
		Z	0.0	0.0	1.0		138.2	
10010- CAA	SAR Validation (Square, 100ms, 10ms)	X	0.83	57.1	8.0	10.00	45.6	$\pm 0.7 \%$
		Y	1.12	59.0	9.6		45.6	
		Z	0.93	58.4	8.9		43.4	
10012- CAB	IEEE 802.11b WiFi 2.4 GHz (DSSS, 1 Mbps)	X	3.61	73.9	21.5	1.87	133.3	$\pm 0.9 \%$
		Y	2.64	66.3	17.3		127.2	
		Z	3.06	70.4	19.9		149.2	
10013- CAB	IEEE 802.11g WiFi 2.4 GHz (DSSS-OFDM, 6 Mbps)	X	10.42	68.9	22.1	9.46	142.7	$\pm 3.3 \%$
		Y	10.68	69.5	22.6		140.9	
		Z	10.33	68.6	21.9		134.3	
10032- CAA	IEEE 802.15.1 Bluetooth (GFSK, DH5)	X	0.06	0.0	100.0	1.16	149.4	$\pm 3.5 \%$
		Y	0.26	57.7	4.5		143.7	
		Z	0.05	0.6	100.0		143.3	
10062- CAB	IEEE 802.11a/h WiFi 5 GHz (OFDM, 6 Mbps)	X	10.19	68.8	21.5	8.68	144.0	$\pm 3.5 \%$
		Y	10.40	69.2	21.8		145.6	
		Z	10.11	68.5	21.4		138.3	
10103- CAB	LTE-TDD (SC-FDMA, 100% RB, 20 MHz, QPSK)	X	7.21	67.1	21.4	9.29	132.3	$\pm 1.9 \%$
		Y	7.94	69.4	22.8		136.4	
		Z	7.15	66.8	21.3		145.0	
10117- CAB	IEEE 802.11n (HT Mixed, 13.5 Mbps, BPSK)	X	10.10	68.5	20.9	8.07	131.3	$\pm 2.5 \%$
		Y	10.12	68.3	20.8		128.9	
		Z	9.95	68.0	20.6		124.4	
10151- CAB	LTE-TDD (SC-FDMA, 50% RB, 20 MHz, QPSK)	X	6.97	67.1	21.5	9.28	148.9	$\pm 1.9 \%$
		Y	7.50	68.7	22.5		130.8	
		Z	6.89	66.6	21.3		141.8	
10172- CAB	LTE-TDD (SC-FDMA, 1 RB, 20 MHz, QPSK)	X	5.57	68.9	22.9	9.21	141.8	$\pm 1.9 \%$
		Y	5.84	69.6	23.4		139.9	
		Z	5.43	68.1	22.5		134.4	
10196- CAB	IEEE 802.11n (HT Mixed, 6.5 Mbps, BPSK)	X	9.69	68.2	20.8	8.10	124.8	$\pm 3.3 \%$
		Y	10.09	69.0	21.4		148.5	
		Z	9.90	68.6	21.1		143.9	
10237- CAB	LTE-TDD (SC-FDMA, 1 RB, 10 MHz, QPSK)	X	5.57	69.0	22.9	9.21	140.3	$\pm 1.9 \%$
		Y	5.85	69.6	23.4		141.2	
		Z	5.43	68.0	22.4		133.8	

10252-CAB	LTE-TDD (SC-FDMA, 50% RB, 10 MHz, QPSK)	X	6.62	67.0	21.6	9.24	143.6	±2.2 %
		Y	7.21	68.9	22.9		144.8	
		Z	6.54	66.4	21.3		137.3	
10267-CAB	LTE-TDD (SC-FDMA, 100% RB, 10 MHz, QPSK)	X	7.00	67.1	21.6	9.30	149.1	±1.9 %
		Y	7.52	68.7	22.6		128.6	
		Z	6.91	66.6	21.3		142.7	
10317-AAB	IEEE 802.11a WiFi 5 GHz (OFDM, 6 Mbps, 96pc duty cycle)	X	9.81	68.2	21.0	8.36	123.5	±3.3 %
		Y	10.26	69.1	21.6		148.1	
		Z	10.06	68.7	21.3		144.2	
10400-AAB	IEEE 802.11ac WiFi (20MHz, 64-QAM, 99pc duty cycle)	X	9.88	68.2	21.0	8.37	123.6	±2.7 %
		Y	9.94	68.1	21.0		124.7	
		Z	10.15	68.8	21.3		144.7	
10401-AAB	IEEE 802.11ac WiFi (40MHz, 64-QAM, 99pc duty cycle)	X	10.61	68.7	21.2	8.60	132.4	±3.0 %
		Y	10.82	69.0	21.5		134.7	
		Z	10.54	68.4	21.1		126.8	
10402-AAB	IEEE 802.11ac WiFi (80MHz, 64-QAM, 99pc duty cycle)	X	10.66	68.6	21.1	8.53	133.5	±3.0 %
		Y	11.03	69.4	21.5		136.6	
		Z	10.56	68.3	20.9		126.5	
10415-AAA	IEEE 802.11b WiFi 2.4 GHz (DSSS, 1 Mbps, 99pc duty cycle)	X	4.15	76.8	22.5	1.54	130.0	±0.9 %
		Y	2.63	66.8	17.4		129.6	
		Z	3.25	72.3	20.7		147.1	
10416-AAA	IEEE 802.11g WiFi 2.4 GHz (ERP-OFDM, 6 Mbps, 99pc duty cycle)	X	9.99	68.7	21.2	8.23	146.6	±3.3 %
		Y	10.19	69.0	21.5		149.3	
		Z	9.96	68.6	21.2		141.2	
10417-AAA	IEEE 802.11a/h WiFi 5 GHz (OFDM, 6 Mbps, 99pc duty cycle)	X	10.02	68.8	21.3	8.23	148.2	±2.7 %
		Y	9.78	68.0	20.9		124.2	
		Z	9.96	68.6	21.2		142.5	

The reported uncertainty of measurement is stated as the standard uncertainty of measurement multiplied by the coverage factor $k=2$, which for a normal distribution corresponds to a coverage probability of approximately 95%.

^A The uncertainties of NormX,Y,Z do not affect the E^2 -field uncertainty inside TSL (see Pages 6 and 7).

^B Numerical linearization parameter: uncertainty not required.

^E Uncertainty is determined using the max. deviation from linear response applying rectangular distribution and is expressed for the square of the field value.

DASY/EASY - Parameters of Probe: EX3DV4 - SN:7357

Calibration Parameter Determined in Head Tissue Simulating Media

f (MHz) ^c	Relative Permittivity ^F	Conductivity (S/m) ^F	ConvF X	ConvF Y	ConvF Z	Alpha ^G	Depth ^G (mm)	Unct. (k=2)
2450	39.2	1.80	7.31	7.31	7.31	0.36	0.80	± 12.0 %
2600	39.0	1.96	7.06	7.06	7.06	0.38	0.80	± 12.0 %
5200	36.0	4.66	5.14	5.14	5.14	0.40	1.80	± 13.1 %
5300	35.9	4.76	4.93	4.93	4.93	0.40	1.80	± 13.1 %
5500	35.6	4.96	4.70	4.70	4.70	0.40	1.80	± 13.1 %
5600	35.5	5.07	4.38	4.38	4.38	0.45	1.80	± 13.1 %
5800	35.3	5.27	4.41	4.41	4.41	0.45	1.80	± 13.1 %

^c Frequency validity above 300 MHz of ± 100 MHz only applies for DASY v4.4 and higher (see Page 2), else it is restricted to ± 50 MHz. The uncertainty is the RSS of the ConvF uncertainty at calibration frequency and the uncertainty for the indicated frequency band. Frequency validity below 300 MHz is ± 10, 25, 40, 50 and 70 MHz for ConvF assessments at 30, 64, 128, 150 and 220 MHz respectively. Above 5 GHz frequency validity can be extended to ± 110 MHz.

^F At frequencies below 3 GHz, the validity of tissue parameters (ϵ and σ) can be relaxed to ± 10% if liquid compensation formula is applied to measured SAR values. At frequencies above 3 GHz, the validity of tissue parameters (ϵ and σ) is restricted to ± 5%. The uncertainty is the RSS of the ConvF uncertainty for indicated target tissue parameters.

^G Alpha/Depth are determined during calibration. SPEAG warrants that the remaining deviation due to the boundary effect after compensation is always less than ± 1% for frequencies below 3 GHz and below ± 2% for frequencies between 3-6 GHz at any distance larger than half the probe tip diameter from the boundary.

DASY/EASY - Parameters of Probe: EX3DV4 - SN:7357

Calibration Parameter Determined in Body Tissue Simulating Media

f (MHz) ^C	Relative Permittivity ^F	Conductivity (S/m) ^F	ConvF X	ConvF Y	ConvF Z	Alpha ^G	Depth ^G (mm)	Unct. (k=2)
2450	52.7	1.95	6.95	6.95	6.95	0.26	0.99	± 12.0 %
2600	52.5	2.16	6.68	6.68	6.68	0.28	0.99	± 12.0 %
5200	49.0	5.30	4.27	4.27	4.27	0.50	1.90	± 13.1 %
5300	48.9	5.42	4.11	4.11	4.11	0.50	1.90	± 13.1 %
5500	48.6	5.65	3.83	3.83	3.83	0.50	1.90	± 13.1 %
5600	48.5	5.77	3.72	3.72	3.72	0.55	1.90	± 13.1 %
5800	48.2	6.00	3.82	3.82	3.82	0.55	1.90	± 13.1 %

^C Frequency validity above 300 MHz of ± 100 MHz only applies for DASY v4.4 and higher (see Page 2), else it is restricted to ± 50 MHz. The uncertainty is the RSS of the ConvF uncertainty at calibration frequency and the uncertainty for the indicated frequency band. Frequency validity below 300 MHz is ± 10, 25, 40, 50 and 70 MHz for ConvF assessments at 30, 64, 128, 150 and 220 MHz respectively. Above 5 GHz frequency validity can be extended to ± 110 MHz.

^F At frequencies below 3 GHz, the validity of tissue parameters (ϵ and σ) can be relaxed to ± 10% if liquid compensation formula is applied to measured SAR values. At frequencies above 3 GHz, the validity of tissue parameters (ϵ and σ) is restricted to ± 5%. The uncertainty is the RSS of the ConvF uncertainty for indicated target tissue parameters.

^G Alpha/Depth are determined during calibration. SPEAG warrants that the remaining deviation due to the boundary effect after compensation is always less than ± 1% for frequencies below 3 GHz and below ± 2% for frequencies between 3-6 GHz at any distance larger than half the probe tip diameter from the boundary.

Frequency Response of E-Field

(TEM-Cell:ifi110 EXX, Waveguide: R22)

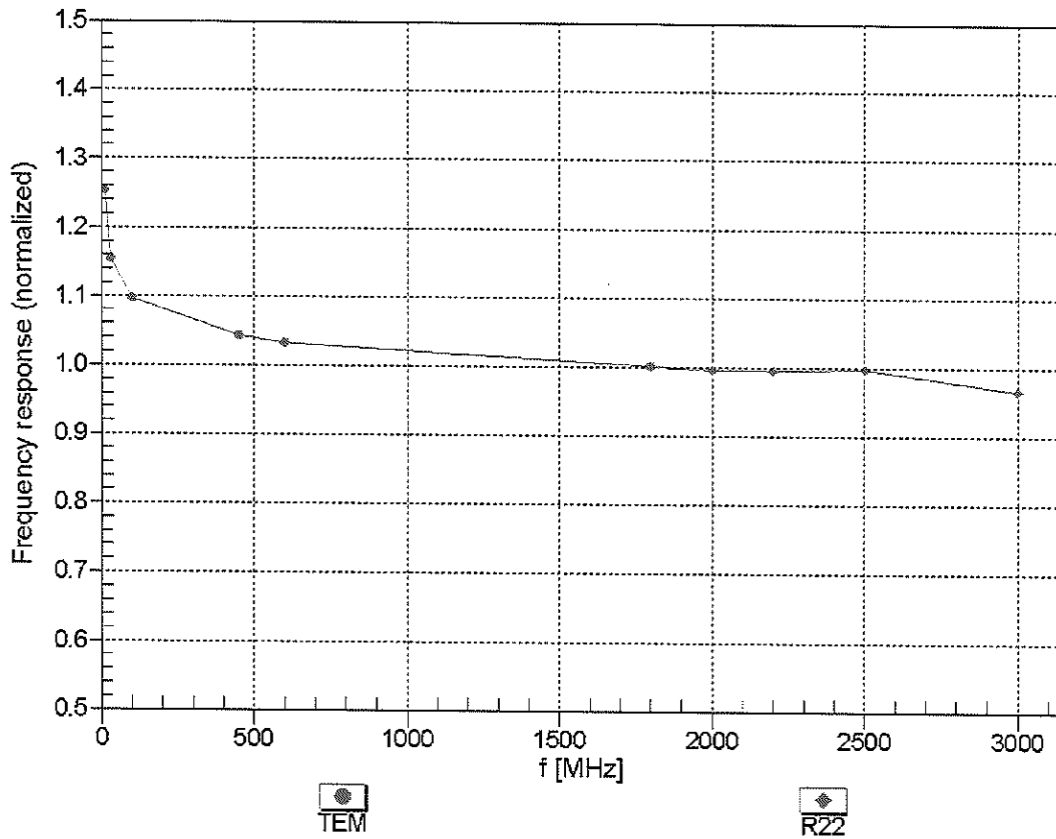

Uncertainty of Frequency Response of E-field: $\pm 6.3\%$ (k=2)

Receiving Pattern (ϕ), $\vartheta = 0^\circ$

f=600 MHz, TEM

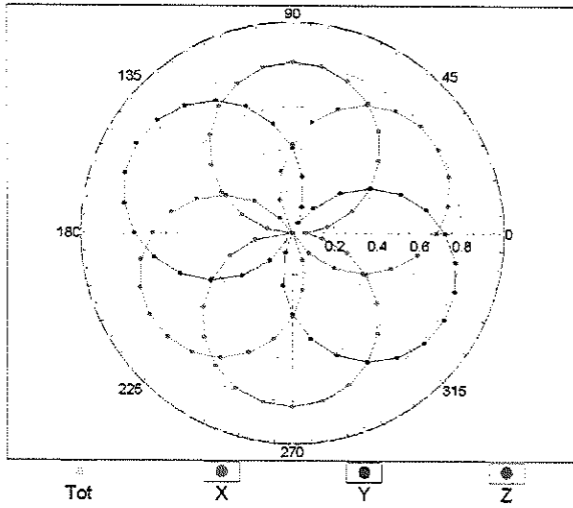

f=1800 MHz, R22

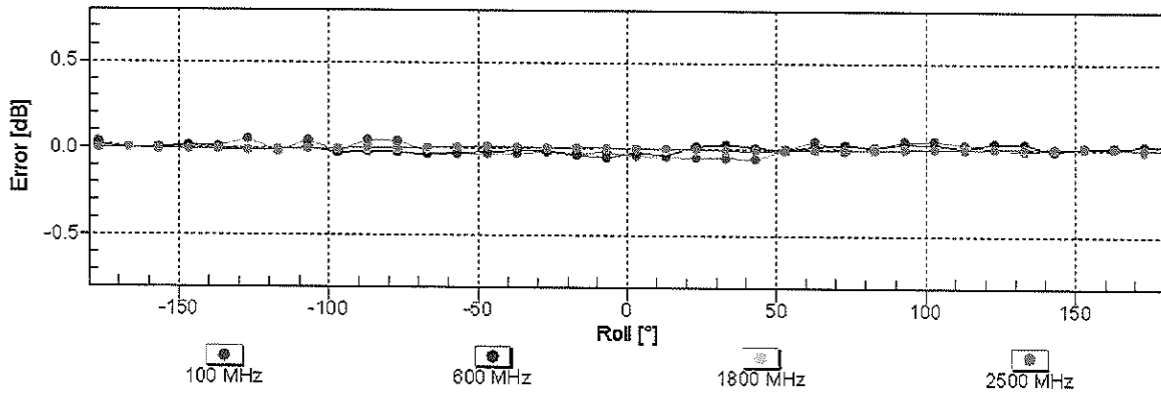
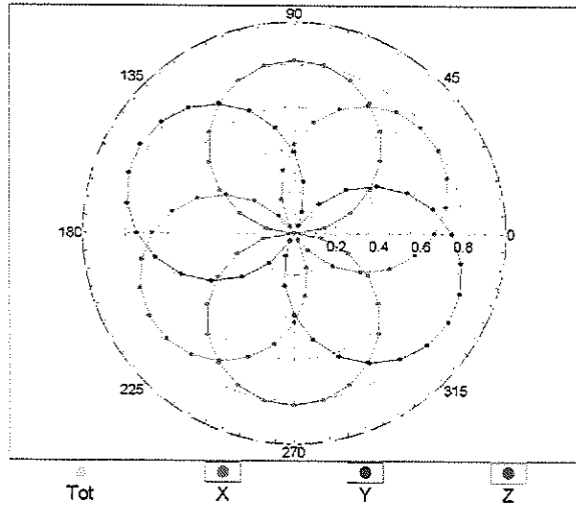

Uncertainty of Axial Isotropy Assessment: $\pm 0.5\%$ (k=2)

Dynamic Range $f(SAR_{head})$ (TEM cell , $f_{eval}= 1900$ MHz)

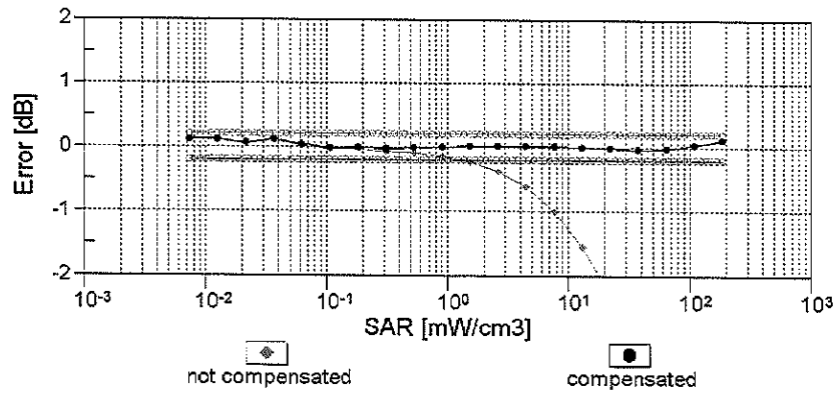
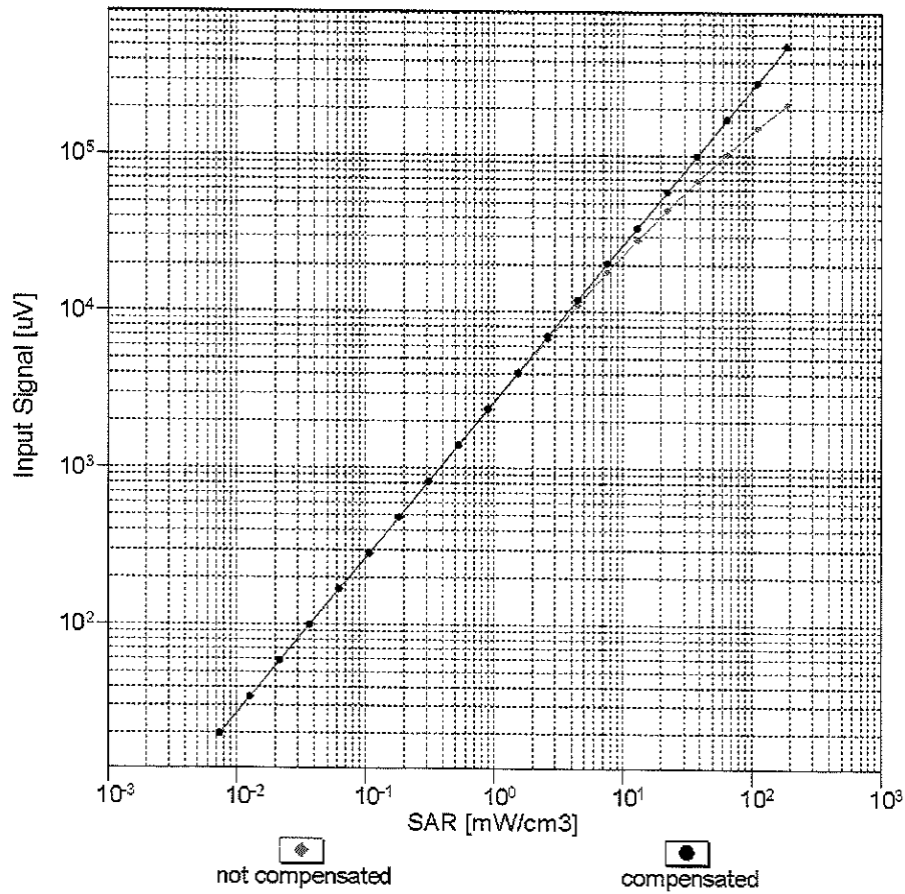

Uncertainty of Linearity Assessment: $\pm 0.6\%$ (k=2)

Conversion Factor Assessment

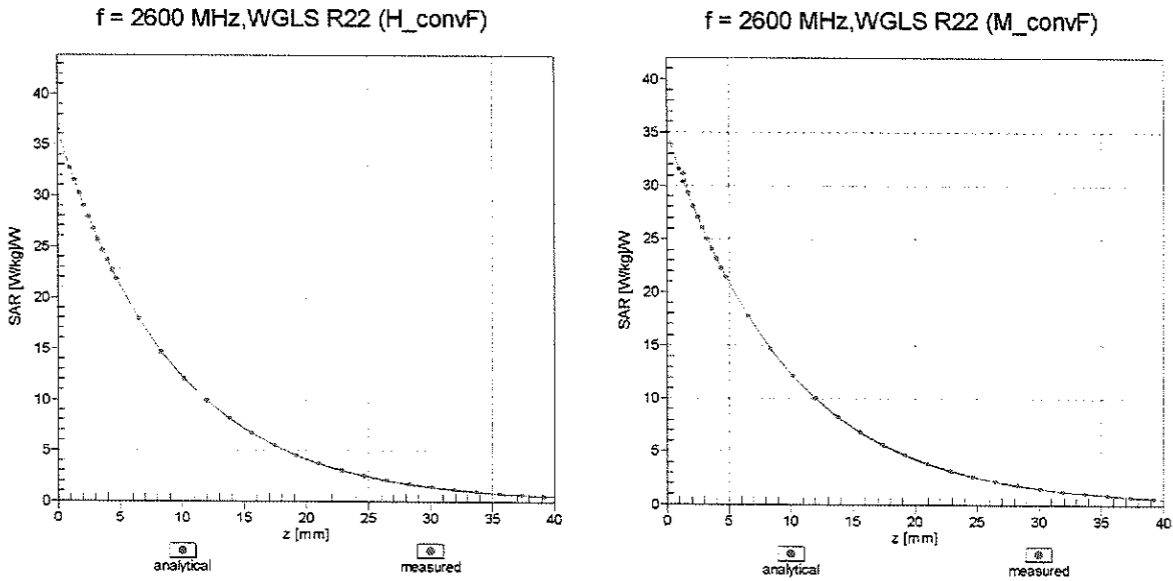

Deviation from Isotropy in Liquid Error (ϕ, ϑ), f = 900 MHz

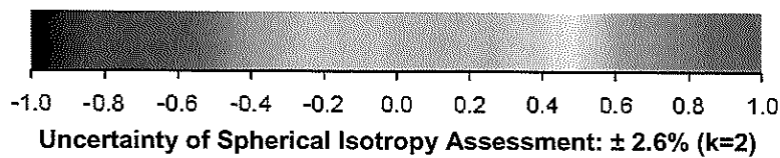
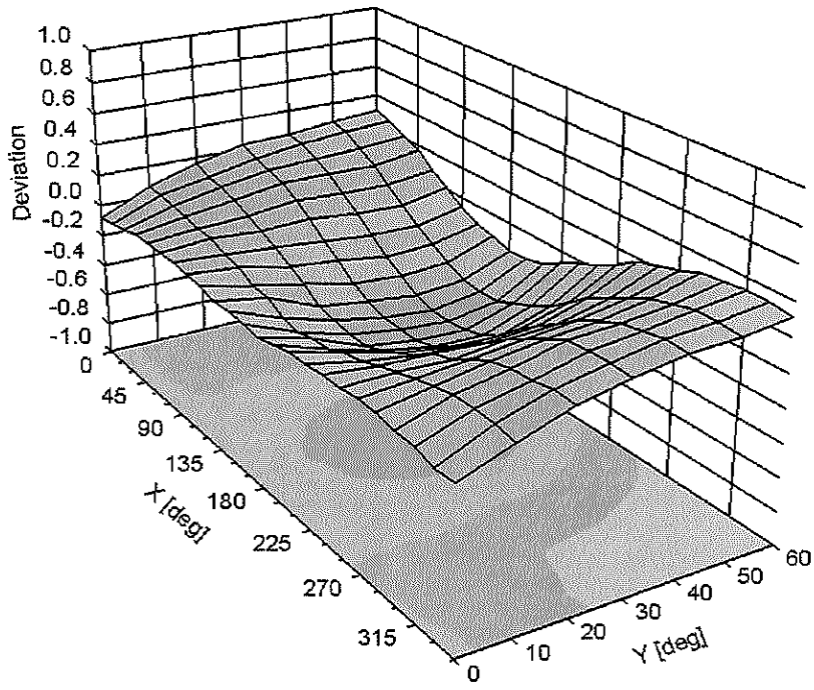

DASY/EASY - Parameters of Probe: EX3DV4 - SN:7357

Other Probe Parameters

Sensor Arrangement	Triangular
Connector Angle (°)	13.1
Mechanical Surface Detection Mode	enabled
Optical Surface Detection Mode	disabled
Probe Overall Length	337 mm
Probe Body Diameter	10 mm
Tip Length	9 mm
Tip Diameter	2.5 mm
Probe Tip to Sensor X Calibration Point	1 mm
Probe Tip to Sensor Y Calibration Point	1 mm
Probe Tip to Sensor Z Calibration Point	1 mm
Recommended Measurement Distance from Surface	1.4 mm

APPENDIX D: SAR TISSUE SPECIFICATIONS

Measurement Procedure for Tissue verification:

- 1) The network analyzer and probe system was configured and calibrated.
- 2) The probe was immersed in the tissue. The tissue was placed in a nonmetallic container. Trapped air bubbles beneath the flange were minimized by placing the probe at a slight angle.
- 3) The complex admittance with respect to the probe aperture was measured
- 4) The complex relative permittivity ϵ can be calculated from the below equation (Pournaropoulos and Misra):

$$Y = \frac{j2\omega\epsilon_r\epsilon_0}{[\ln(b/a)]^2} \int_a^b \int_a^b \int_0^\pi \cos\phi' \frac{\exp[-j\omega r(\mu_0\epsilon_r'\epsilon_0)^{1/2}]}{r} d\phi' d\rho' d\rho$$

where Y is the admittance of the probe in contact with the sample, the primed and unprimed coordinates refer to source and observation points, respectively, $r^2 = \rho^2 + \rho'^2 - 2\rho\rho'\cos\phi'$, ω is the angular frequency, and $j = \sqrt{-1}$.

Table D-I
Composition of the Tissue Equivalent Matter

Frequency (MHz)	750	750	835	835	1750	1750	1900	1900	2300-2600	2300-2600	5200-5800	5200-5800
Tissue	Head	Body	Head	Body	Head	Body	Head	Body	Head	Body	Head	Body
Ingredients (% by weight)												
Bactericide	See page 2-3	See page 2	0.1	0.1					See page 4		See page 5	
DGBE					47	31	44.92	29.44		26.7		
HEC			1	1								
NaCl			1.45	0.94	0.4	0.2	0.18	0.39		0.1		
Sucrose			57	44.9								
Polysorbate (Tween) 80												20
Water			40.45	53.06	52.6	68.8	54.9	70.17		73.2		80

FCC ID A3LSMG930US	PCTEST <small>ENGINEERING LABORATORY, INC.</small>	SAR EVALUATION REPORT		Reviewed by: Quality Manager
Test Dates: 12/04/15 - 01/04/16	DUT Type: Portable Handset	APPENDIX D: Page 1 of 5		

2 Composition / Information on ingredients

The Item is composed of the following ingredients:

H ₂ O	Water, 35 – 58%
Sucrose	Sugar, white, refined, 40 – 60%
NaCl	Sodium Chloride, 0 – 6%
Hydroxyethyl-cellulose	Medium Viscosity (CAS# 9004-62-0), <0.3%
Preventol-D7	Preservative: aqueous preparation, (CAS# 55965-84-9), containing 5-chloro-2-methyl-3(2H)-isothiazolone and 2-methyl-3(2H)-isothiazolone, 0.1 – 0.7%

Relevant for safety; Refer to the respective Safety Data Sheet*.

**Figure D-1
Composition of 750 MHz Head and Body Tissue Equivalent Matter**

Note: 750MHz liquid recipes are proprietary SPEAG. Since the composition is approximate to the actual liquids utilized, the manufacturer tissue-equivalent liquid data sheets are provided below.

Measurement Certificate / Material Test

Item Name	Body Tissue Simulating Liquid (MSL750V2)
Product No.	SL AAM 075 AA (Charge: 150223-3)
Manufacturer	SPEAG

Measurement Method

TSL dielectric parameters measured using calibrated OCP probe.

Setup Validation

Validation results were within $\pm 2.5\%$ towards the target values of Methanol.

Target Parameters

Target parameters as defined in the IEEE 1528 and IEC 62209 compliance standards.

Test Condition

Ambient	Environment temperatur (22 ± 3)°C and humidity < 70%.
TSL Temperature	22°C
Test Date	25-Feb-15
Operator	IEN



Additional Information

TSL Density	1.212 g/cm ³
TSL Heat-capacity	3.006 kJ/(kg*K)

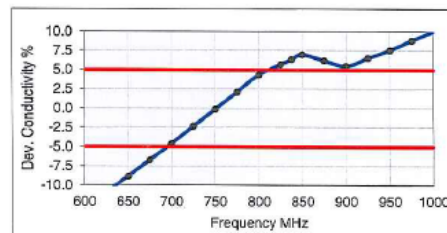
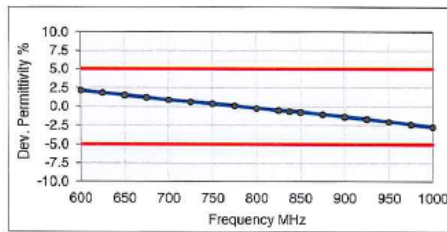
f [MHz]	Measured			Target		Diff.to Target [%]	
	HP-e'	HP-e''	sigma	eps	sigma	Δ-eps	Δ-sigma
600	57.3	24.76	0.83	56.1	0.95	2.2	-13.2
625	57.1	24.43	0.85	56.0	0.95	1.8	-11.0
650	56.8	24.09	0.87	55.9	0.96	1.5	-8.8
675	56.5	23.80	0.89	55.8	0.96	1.2	-6.7
700	56.2	23.51	0.92	55.7	0.96	0.9	-4.6
725	56.0	23.28	0.94	55.6	0.96	0.6	-2.4
750	55.7	23.06	0.96	55.5	0.96	0.4	-0.1
775	55.5	22.87	0.99	55.4	0.97	0.1	2.1
800	55.2	22.68	1.01	55.3	0.97	-0.2	4.4
825	55.0	22.52	1.03	55.2	0.98	-0.5	5.7
838	54.9	22.44	1.05	55.2	0.98	-0.6	6.3
850	54.8	22.36	1.06	55.2	0.99	-0.7	7.0
875	54.5	22.24	1.08	55.1	1.02	-1.0	6.2
900	54.3	22.12	1.11	55.0	1.05	-1.3	5.5
925	54.1	22.01	1.13	55.0	1.06	-1.6	6.5
950	53.9	21.89	1.16	54.9	1.08	-2.0	7.6
975	53.6	21.81	1.18	54.9	1.09	-2.3	8.8
1000	53.4	21.73	1.21	54.8	1.10	-2.7	10.1



**Figure D-2
750MHz Body Tissue Equivalent Matter**

FCC ID A3LSMG930US		SAR EVALUATION REPORT		Reviewed by: Quality Manager
Test Dates: 12/04/15 - 01/04/16	DUT Type: Portable Handset			APPENDIX D: Page 2 of 5

Measurement Certificate / Material Test

Item Name	Head Tissue Simulating Liquid (HSL750V2)
Product No.	SL AAH 075 AA (Charge: 150213-1)
Manufacturer	SPEAG

Measurement Method

TSL dielectric parameters measured using calibrated OCP probe.

Setup Validation

Validation results were within $\pm 2.5\%$ towards the target values of Methanol.

Target Parameters

Target parameters as defined in the IEEE 1528 and IEC 62209 compliance standards.

Test Condition

Ambient	Environment temperatur (22 ± 3)°C and humidity < 70%.
TSL Temperature	22°C
Test Date	18-Feb-15
Operator	IEN

Additional Information

TSL Density	1.284 g/cm ³
TSL Heat-capacity	2.701 kJ/(kg*K)

f [MHz]	Measured			Target		Diff.to Target [%]	
	HP-e'	HP-e''	sigma	eps	sigma	Δ-eps	Δ-sigma
600	44.6	22.42	0.75	42.7	0.88	4.5	-15.1
625	44.3	22.20	0.77	42.6	0.88	3.9	-12.7
650	43.9	21.98	0.79	42.5	0.89	3.3	-10.3
675	43.5	21.75	0.82	42.3	0.89	2.8	-8.0
700	43.1	21.53	0.84	42.2	0.89	2.2	-5.7
725	42.8	21.36	0.86	42.1	0.89	1.8	-3.3
750	42.5	21.22	0.89	41.9	0.89	1.3	-0.9
775	42.2	21.06	0.91	41.8	0.90	0.8	1.4
800	41.8	20.90	0.93	41.7	0.90	0.3	3.7
825	41.5	20.77	0.95	41.6	0.91	-0.2	5.1
838	41.4	20.71	0.96	41.5	0.91	-0.4	5.8
850	41.2	20.65	0.98	41.5	0.92	-0.7	6.6
875	40.9	20.53	1.00	41.5	0.94	-1.4	6.0
900	40.6	20.42	1.02	41.5	0.97	-2.1	5.4
925	40.4	20.32	1.05	41.5	0.98	-2.6	6.5
950	40.1	20.22	1.07	41.4	0.99	-3.2	7.5
975	39.8	20.14	1.09	41.4	1.00	-3.8	8.7
1000	39.5	20.05	1.12	41.3	1.01	-4.3	9.9

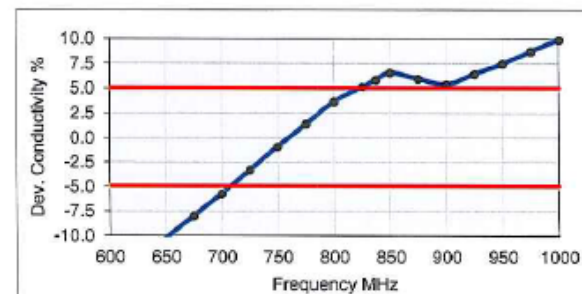
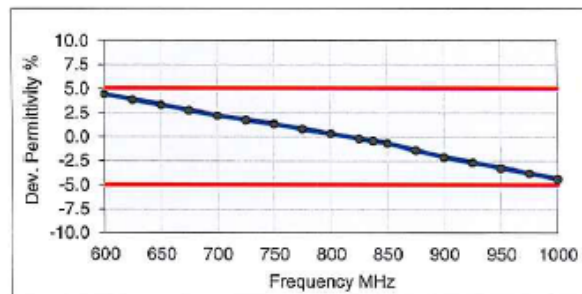



Figure D-3
750MHz Head Tissue Equivalent Matter

FCC ID A3LSMG930US		SAR EVALUATION REPORT		Reviewed by: Quality Manager
Test Dates: 12/04/15 - 01/04/16	DUT Type: Portable Handset			APPENDIX D: Page 3 of 5

2 Composition / Information on ingredients

The Item is composed of the following ingredients:

H2O	Water, 52 – 75%
C8H18O3	Diethylene glycol monobutyl ether (DGBE), 25 – 48% (CAS-No. 112-34-5, EC-No. 203-961-6, EC-index-No. 603-096-00-8) Relevant for safety; Refer to the respective Safety Data Sheet*.
NaCl	Sodium Chloride, <1.0%

Figure D-4
Composition of 2.3-2.6 GHz Head Tissue Equivalent Matter

Note: 2.3-2.6 GHz head liquid recipes are proprietary SPEAG. Since the composition is approximate to the actual liquids utilized, the manufacturer tissue-equivalent liquid data sheets are provided below.

Measurement Certificate / Material Test

Item Name	Head Tissue Simulating Liquid (HSL2450V2)
Product No.	SL AAH 245 BA (Charge: 150206-3)
Manufacturer	SPEAG

Measurement Method

TSL dielectric parameters measured using calibrated OCP probe.

Setup Validation

Validation results were within $\pm 2.5\%$ towards the target values of Methanol.

Target Parameters

Target parameters as defined in the IEEE 1528 and IEC 62209 compliance standards.

Test Condition

Ambient	Environment temperatur (22 ± 3)°C and humidity < 70%.
TSL Temperature	23°C
Test Date	11-Feb-15
Operator	IEN

Additional Information

TSL Density	0.988 g/cm ³
TSL Heat-capacity	3.680 kJ/(kg*K)

f (MHz)	Measured			Target		Diff.to Target (%)	
	HP-e'	HP-e''	sigma	eps	sigma	Δ-eps	Δ-sigma
1900	40.4	11.89	1.26	40.0	1.40	1.0	-10.2
1925	40.3	11.98	1.28	40.0	1.40	0.7	-8.3
1950	40.2	12.07	1.31	40.0	1.40	0.4	-6.4
1975	40.1	12.16	1.34	40.0	1.40	0.2	-4.6
2000	40.0	12.23	1.36	40.0	1.40	-0.1	-2.8
2025	39.9	12.32	1.39	40.0	1.42	-0.2	-2.4
2050	39.8	12.41	1.42	39.9	1.44	-0.3	-2.0
2075	39.7	12.50	1.44	39.9	1.47	-0.4	-1.6
2100	39.6	12.59	1.47	39.8	1.49	-0.5	-1.2
2125	39.5	12.66	1.50	39.8	1.51	-0.7	-0.9
2150	39.4	12.73	1.52	39.7	1.53	-0.8	-0.7
2175	39.3	12.83	1.55	39.7	1.56	-0.9	-0.2
2200	39.2	12.92	1.58	39.6	1.58	-1.1	0.2
2225	39.1	13.00	1.61	39.6	1.60	-1.2	0.6
2250	39.0	13.08	1.64	39.6	1.62	-1.3	0.9
2275	38.9	13.17	1.67	39.5	1.64	-1.5	1.4
2300	38.8	13.26	1.70	39.5	1.67	-1.7	1.8
2325	38.7	13.34	1.73	39.4	1.69	-1.8	2.2
2350	38.6	13.42	1.75	39.4	1.71	-2.0	2.5
2375	38.5	13.50	1.78	39.3	1.73	-2.1	2.9
2400	38.4	13.58	1.81	39.3	1.76	-2.3	3.3
2425	38.3	13.65	1.84	39.2	1.78	-2.4	3.6
2450	38.2	13.73	1.87	39.2	1.80	-2.6	3.9
2475	38.1	13.80	1.90	39.2	1.83	-2.8	4.0
2500	38.0	13.87	1.93	39.1	1.85	-3.0	4.0
2525	37.9	13.90	1.95	39.1	1.88	-3.1	3.8
2550	37.8	13.93	1.98	39.1	1.91	-3.2	3.5
2575	37.7	14.05	2.01	39.0	1.94	-3.5	4.0
2600	37.6	14.17	2.05	39.0	1.96	-3.7	4.4
2625	37.4	14.23	2.08	39.0	1.99	-3.9	4.4
2650	37.3	14.29	2.11	38.9	2.02	-4.1	4.4
2675	37.2	14.37	2.14	38.9	2.05	-4.3	4.6
2700	37.1	14.45	2.17	38.9	2.07	-4.5	4.7

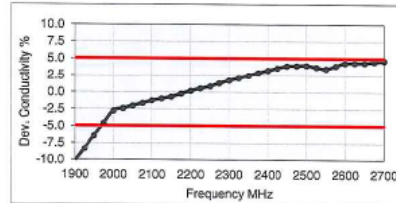
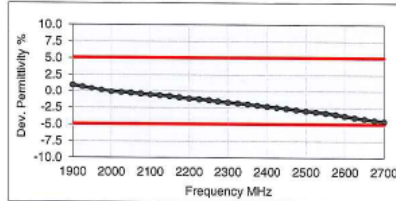

Figure D-5
2.3-2.6 GHz Head Tissue Equivalent Matter

FCC ID A3LSMG930US		SAR EVALUATION REPORT		Reviewed by: Quality Manager
Test Dates: 12/04/15 - 01/04/16	DUT Type: Portable Handset			APPENDIX D: Page 4 of 5

2 Composition / Information on ingredients

The Item is composed of the following ingredients:

Water	50 – 65%
Mineral oil	10 – 30%
Emulsifiers	8 – 25%
Sodium salt	0 – 1.5%

Figure D-6
Composition of 5 GHz Head Tissue Equivalent Matter

Note: 5GHz head liquid recipes are proprietary SPEAG. Since the composition is approximate to the actual liquids utilized, the manufacturer tissue-equivalent liquid data sheets are provided below.

Measurement Certificate / Material Test

Item Name	Head Tissue Simulating Liquid (HBBL3500-5800V5)
Product No.	SL AAH 502 AE (Charge: 141104-1)
Manufacturer	SPEAG

Measurement Method

TSL dielectric parameters measured using calibrated OCP probe.

Setup Validation

Validation results were within $\pm 2.5\%$ towards the target values of Methanol.

Target Parameters

Target parameters as defined in the IEEE 1528 and IEC 62209 compliance standards.

Test Condition

Ambient	Environment temperatur (22 ± 3)°C and humidity < 70%.
TSL Temperature	22°C
Test Date	25-Feb-15
Operator	IEN

Additional Information

TSL Density	0.985 g/cm ³
TSL Heat-capacity	3.383 kJ/(kg*K)

f [MHz]	Measured			Target		Diff.to Target [%]	
	HP-e'	HP-e''	sigma	eps	sigma	Δ-eps	Δ-sigma
3400	38.5	15.11	2.86	38.0	2.81	1.2	1.8
3500	38.4	15.08	2.94	37.9	2.91	1.2	0.9
3600	38.2	15.07	3.02	37.8	3.02	1.0	0.2
3700	38.1	15.05	3.10	37.7	3.12	1.1	-0.6
3800	38.0	15.04	3.18	37.6	3.22	1.1	-1.2
3900	37.9	15.05	3.27	37.5	3.32	1.1	-1.6
4000	37.8	15.07	3.35	37.4	3.43	1.2	-2.2
4100	37.6	15.09	3.44	37.2	3.53	1.0	-2.5
4200	37.5	15.14	3.54	37.1	3.63	1.0	-2.5
4300	37.4	15.18	3.63	37.0	3.73	1.0	-2.7
4400	37.3	15.24	3.73	36.9	3.84	1.1	-2.7
4500	37.1	15.29	3.83	36.8	3.94	0.9	-2.7
4600	37.0	15.37	3.93	36.7	4.04	0.9	-2.7
4700	36.8	15.42	4.03	36.6	4.14	0.7	-2.7
4800	36.7	15.47	4.13	36.4	4.25	0.7	-2.7
4850	36.6	15.50	4.18	36.4	4.30	0.6	-2.7
4900	36.5	15.54	4.24	36.3	4.35	0.5	-2.5
4950	36.5	15.55	4.28	36.3	4.40	0.6	-2.7
5000	36.4	15.59	4.34	36.2	4.45	0.5	-2.5
5050	36.3	15.62	4.39	36.2	4.50	0.4	-2.5
5100	36.2	15.66	4.44	36.1	4.55	0.3	-2.5
5150	36.2	15.67	4.49	36.0	4.60	0.4	-2.5
5200	36.1	15.71	4.55	36.0	4.66	0.3	-2.3
5250	36.0	15.73	4.59	35.9	4.71	0.2	-2.5
5300	35.9	15.76	4.65	35.9	4.76	0.1	-2.3
5350	35.9	15.78	4.70	35.8	4.81	0.2	-2.3
5400	35.8	15.81	4.75	35.8	4.86	0.1	-2.3
5450	35.7	15.82	4.80	35.7	4.91	0.0	-2.3
5500	35.6	15.84	4.85	35.6	4.96	-0.1	-2.3
5550	35.6	15.87	4.90	35.6	5.01	0.0	-2.3
5600	35.5	15.90	4.95	35.5	5.07	-0.1	-2.3
5650	35.4	15.94	5.01	35.5	5.12	-0.2	-2.1
5700	35.4	15.96	5.06	35.4	5.17	0.0	-2.1
5750	35.3	16.00	5.12	35.4	5.22	-0.2	-1.9
5800	35.2	16.01	5.16	35.3	5.27	-0.3	-2.1
5850	35.1	16.04	5.22	35.3	5.34	-0.6	-2.2
5900	35.1	16.06	5.27	35.3	5.40	-0.6	-2.4

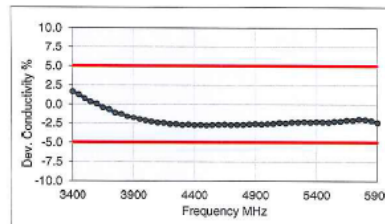
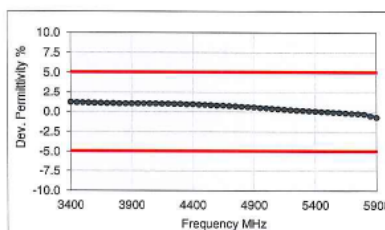



Figure D-7
5GHz Head Tissue Equivalent Matter

FCC ID A3LSMG930US		SAR EVALUATION REPORT		Reviewed by: Quality Manager
Test Dates: 12/04/15 - 01/04/16	DUT Type: Portable Handset			APPENDIX D: Page 5 of 5

APPENDIX E: SAR SYSTEM VALIDATION



Per FCC KDB Publication 865664 D02v01r02, SAR system validation status should be documented to confirm measurement accuracy. The SAR systems (including SAR probes, system components and software versions) used for this device were validated against its performance specifications prior to the SAR measurements. Reference dipoles were used with the required tissue- equivalent media for system validation, according to the procedures outlined in FCC KDB Publication 865664 D01v01r04 and IEEE 1528-2013. Since SAR probe calibrations are frequency dependent, each probe calibration point was validated at a frequency within the valid frequency range of the probe calibration point, using the system that normally operates with the probe for routine SAR measurements and according to the required tissue-equivalent media.

A tabulated summary of the system validation status including the validation date(s), measurement frequencies, SAR probes and tissue dielectric parameters has been included.

Table E-I
SAR System Validation Summary

SAR SYSTEM #	FREQ. [MHz]	DATE	PROBE SN	PROBE TYPE	PROBE CAL. POINT		COND. (σ)	PERM. (ϵ_r)	CW VALIDATION			MOD. VALIDATION		
									SENSITIVITY	PROBE LINEARITY	PROBE ISOTROPY	MOD. TYPE	DUTY FACTOR	PAR
K	750	9/17/2015	3022	ES3DV2	750	Head	0.894	42.461	PASS	PASS	PASS	N/A	N/A	N/A
J	835	5/19/2015	3319	ES3DV3	835	Head	0.911	41.529	PASS	PASS	PASS	GMSK	PASS	N/A
K	1750	9/13/2015	3022	ES3DV2	1750	Head	1.387	39.296	PASS	PASS	PASS	N/A	N/A	N/A
H	1750	7/15/2015	3263	ES3DV3	1750	Head	1.348	39.219	PASS	PASS	PASS	N/A	N/A	N/A
K	1900	9/14/2015	3022	ES3DV2	1900	Head	1.450	39.133	PASS	PASS	PASS	GMSK	PASS	N/A
G	1900	11/27/2015	3334	ES3DV3	1900	Head	1.448	38.541	PASS	PASS	PASS	GMSK	PASS	N/A
H	2300	7/20/2015	3263	ES3DV3	2300	Head	1.670	39.597	PASS	PASS	PASS	N/A	N/A	N/A
I	2450	11/16/2015	3333	ES3DV3	2450	Head	1.862	39.522	PASS	PASS	PASS	OFDM/TDD	PASS	PASS
I	2600	11/16/2015	3333	ES3DV3	2600	Head	2.040	24.200	PASS	PASS	PASS	TDD	PASS	N/A
E	5250	10/6/2015	7308	EX3DV4	5250	Head	4.621	36.087	PASS	PASS	PASS	OFDM	N/A	PASS
E	5600	10/6/2015	7308	EX3DV4	5600	Head	4.982	35.624	PASS	PASS	PASS	OFDM	N/A	PASS
E	5750	10/6/2015	7308	EX3DV4	5750	Head	5.151	35.406	PASS	PASS	PASS	OFDM	N/A	PASS
K	750	9/15/2015	3022	ES3DV2	750	Body	0.950	54.166	PASS	PASS	PASS	N/A	N/A	N/A
H	835	7/22/2015	3263	ES3DV3	835	Body	0.992	53.114	PASS	PASS	PASS	GMSK	PASS	N/A
K	1750	9/13/2015	3022	ES3DV2	1750	Body	1.491	52.532	PASS	PASS	PASS	N/A	N/A	N/A
G	1750	11/28/2015	3334	ES3DV3	1750	Body	1.508	51.635	PASS	PASS	PASS	N/A	N/A	N/A
I	1900	11/4/2015	3333	ES3DV3	1900	Body	1.579	51.524	PASS	PASS	PASS	GMSK	PASS	N/A
J	1900	5/18/2015	3319	ES3DV3	1900	Body	1.576	53.321	PASS	PASS	PASS	GMSK	PASS	N/A
J	2300	5/22/2015	3319	ES3DV3	2300	Body	1.888	51.751	PASS	PASS	PASS	N/A	N/A	N/A
G	2300	12/4/2015	3334	ES3DV3	2300	Body	1.778	52.277	PASS	PASS	PASS	N/A	N/A	N/A
J	2450	4/28/2015	3319	ES3DV3	2450	Body	2.028	51.126	PASS	PASS	PASS	OFDM/TDD	PASS	PASS
G	2450	12/4/2015	3334	ES3DV3	2450	Body	1.997	51.699	PASS	PASS	PASS	OFDM/TDD	PASS	PASS
G	2600	12/4/2015	3334	ES3DV3	2600	Body	2.198	51.174	PASS	PASS	PASS	TDD	PASS	N/A
D	5300	11/9/2015	7357	EX3DV4	5300	Body	5.568	47.186	PASS	PASS	PASS	OFDM	N/A	PASS
D	5600	11/9/2015	7357	EX3DV4	5600	Body	5.977	46.653	PASS	PASS	PASS	OFDM	N/A	PASS
D	5800	11/9/2015	7357	EX3DV4	5800	Body	6.257	46.285	PASS	PASS	PASS	OFDM	N/A	PASS

NOTE: While the probes have been calibrated for both CW and modulated signals, all measurements were performed using communication systems calibrated for CW signals only. Modulations in the table above represent test configurations for which the measurement system has been validated per FCC KDB Publication 865664 D01v01r04 for scenarios when CW probe calibrations are used with other signal types. SAR systems were validated for modulated signals with a periodic duty cycle, such as GMSK, or with a high peak to average ratio (>5 dB), such as OFDM according to FCC KDB Publication 865664 D01v01r04.

FCC ID A3LSMG930US		SAR EVALUATION REPORT		Reviewed by: Quality Manager
Test Dates: 12/04/15 - 01/04/16	DUT Type: Portable Handset			APPENDIX E: Page 1 of 1