

APPENDIX C: PROBE CALIBRATION



Accredited by the Swiss Accreditation Service (SAS)
The Swiss Accreditation Service is one of the signatories to the EA
Multilateral Agreement for the recognition of calibration certificates

Accreditation No.: **SCS 108**

Client **PC Test**

Certificate No: **D750V3-1003_Jan14**

CALIBRATION CERTIFICATE

Object **D750V3 - SN: 1003**

Calibration procedure(s) **QA CAL-05.v9
Calibration procedure for dipole validation kits above 700 MHz**

Calibration date: **January 20, 2014**

CC
21/14 ✓

This calibration certificate documents the traceability to national standards, which realize the physical units of measurements (SI).
The measurements and the uncertainties with confidence probability are given on the following pages and are part of the certificate.

All calibrations have been conducted in the closed laboratory facility: environment temperature (22 ± 3)°C and humidity < 70%.

Calibration Equipment used (M&TE critical for calibration)

Primary Standards	ID #	Cal Date (Certificate No.)	Scheduled Calibration
Power meter EPM-442A	GB37480704	09-Oct-13 (No. 217-01827)	Oct-14
Power sensor HP 8481A	US37292783	09-Oct-13 (No. 217-01827)	Oct-14
Power sensor HP 8481A	MY41092317	09-Oct-13 (No. 217-01828)	Oct-14
Reference 20 dB Attenuator	SN: 5058 (20k)	04-Apr-13 (No. 217-01736)	Apr-14
Type-N mismatch combination	SN: 5047.3 / 06327	04-Apr-13 (No. 217-01739)	Apr-14
Reference Probe ES3DV3	SN: 3205	30-Dec-13 (No. ES3-3205_Dec13)	Dec-14
DAE4	SN: 601	25-Apr-13 (No. DAE4-601_Apr13)	Apr-14
Secondary Standards	ID #	Check Date (in house)	Scheduled Check
RF generator R&S SMT-06	100005	04-Aug-99 (in house check Oct-13)	In house check: Oct-16
Network Analyzer HP 8753E	US37390585 S4206	18-Oct-01 (in house check Oct-13)	In house check: Oct-14

Calibrated by: **Israe El-Naouq** Laboratory Technician
Approved by: **Katja Pokovic** Technical Manager

Signature
Israe El-Naouq
Katja Pokovic

Issued: January 21, 2014

This calibration certificate shall not be reproduced except in full without written approval of the laboratory.



Accredited by the Swiss Accreditation Service (SAS)

The Swiss Accreditation Service is one of the signatories to the EA
Multilateral Agreement for the recognition of calibration certificates

Accreditation No.: **SCS 108**

Glossary:

TSL	tissue simulating liquid
ConvF	sensitivity in TSL / NORM x,y,z
N/A	not applicable or not measured

Calibration is Performed According to the Following Standards:

- IEEE Std 1528-2013, "IEEE Recommended Practice for Determining the Peak Spatial-Averaged Specific Absorption Rate (SAR) in the Human Head from Wireless Communications Devices: Measurement Techniques", June 2013
- IEC 62209-1, "Procedure to measure the Specific Absorption Rate (SAR) for hand-held devices used in close proximity to the ear (frequency range of 300 MHz to 3 GHz)", February 2005
- KDB 865664, "SAR Measurement Requirements for 100 MHz to 6 GHz"

Additional Documentation:

- DASY4/5 System Handbook

Methods Applied and Interpretation of Parameters:

- Measurement Conditions:** Further details are available from the Validation Report at the end of the certificate. All figures stated in the certificate are valid at the frequency indicated.
- Antenna Parameters with TSL:** The dipole is mounted with the spacer to position its feed point exactly below the center marking of the flat phantom section, with the arms oriented parallel to the body axis.
- Feed Point Impedance and Return Loss:** These parameters are measured with the dipole positioned under the liquid filled phantom. The impedance stated is transformed from the measurement at the SMA connector to the feed point. The Return Loss ensures low reflected power. No uncertainty required.
- Electrical Delay:** One-way delay between the SMA connector and the antenna feed point. No uncertainty required.
- SAR measured:** SAR measured at the stated antenna input power.
- SAR normalized:** SAR as measured, normalized to an input power of 1 W at the antenna connector.
- SAR for nominal TSL parameters:** The measured TSL parameters are used to calculate the nominal SAR result.

The reported uncertainty of measurement is stated as the standard uncertainty of measurement multiplied by the coverage factor $k=2$, which for a normal distribution corresponds to a coverage probability of approximately 95%.

Measurement Conditions

DASY system configuration, as far as not given on page 1.

DASY Version	DASY5	V52.8.7
Extrapolation	Advanced Extrapolation	
Phantom	Modular Flat Phantom	
Distance Dipole Center - TSL	15 mm	with Spacer
Zoom Scan Resolution	dx, dy, dz = 5 mm	
Frequency	750 MHz \pm 1 MHz	

Head TSL parameters

The following parameters and calculations were applied.

	Temperature	Permittivity	Conductivity
Nominal Head TSL parameters	22.0 °C	41.9	0.89 mho/m
Measured Head TSL parameters	(22.0 \pm 0.2) °C	40.8 \pm 6 %	0.92 mho/m \pm 6 %
Head TSL temperature change during test	< 0.5 °C	----	----

SAR result with Head TSL

SAR averaged over 1 cm³ (1 g) of Head TSL	Condition	
SAR measured	250 mW input power	2.16 W/kg
SAR for nominal Head TSL parameters	normalized to 1W	8.37 W/kg \pm 17.0 % (k=2)

SAR averaged over 10 cm³ (10 g) of Head TSL	condition	
SAR measured	250 mW input power	1.40 W/kg
SAR for nominal Head TSL parameters	normalized to 1W	5.46 W/kg \pm 16.5 % (k=2)

Body TSL parameters

The following parameters and calculations were applied.

	Temperature	Permittivity	Conductivity
Nominal Body TSL parameters	22.0 °C	55.5	0.96 mho/m
Measured Body TSL parameters	(22.0 \pm 0.2) °C	54.0 \pm 6 %	0.98 mho/m \pm 6 %
Body TSL temperature change during test	< 0.5 °C	----	----

SAR result with Body TSL

SAR averaged over 1 cm³ (1 g) of Body TSL	Condition	
SAR measured	250 mW input power	2.24 W/kg
SAR for nominal Body TSL parameters	normalized to 1W	8.77 W/kg \pm 17.0 % (k=2)

SAR averaged over 10 cm³ (10 g) of Body TSL	condition	
SAR measured	250 mW input power	1.47 W/kg
SAR for nominal Body TSL parameters	normalized to 1W	5.78 W/kg \pm 16.5 % (k=2)

Appendix

Antenna Parameters with Head TSL

Impedance, transformed to feed point	54.7 Ω - 0.2 j Ω
Return Loss	- 27.0 dB

Antenna Parameters with Body TSL

Impedance, transformed to feed point	49.5 Ω - 2.6 j Ω
Return Loss	- 31.4 dB

General Antenna Parameters and Design

Electrical Delay (one direction)	1.043 ns
----------------------------------	----------

After long term use with 100W radiated power, only a slight warming of the dipole near the feedpoint can be measured.

The dipole is made of standard semirigid coaxial cable. The center conductor of the feeding line is directly connected to the second arm of the dipole. The antenna is therefore short-circuited for DC-signals. On some of the dipoles, small end caps are added to the dipole arms in order to improve matching when loaded according to the position as explained in the "Measurement Conditions" paragraph. The SAR data are not affected by this change. The overall dipole length is still according to the Standard.

No excessive force must be applied to the dipole arms, because they might bend or the soldered connections near the feedpoint may be damaged.

Additional EUT Data

Manufactured by	SPEAG
Manufactured on	January 21, 2009

DASY5 Validation Report for Head TSL

Date: 20.01.2014

Test Laboratory: SPEAG, Zurich, Switzerland

DUT: Dipole 750 MHz; Type: D750V3; Serial: D750V3 - SN: 1003

Communication System: UID 0 - CW; Frequency: 750 MHz

Medium parameters used: $f = 750$ MHz; $\sigma = 0.92$ S/m; $\epsilon_r = 40.8$; $\rho = 1000$ kg/m³

Phantom section: Flat Section

Measurement Standard: DASY5 (IEEE/IEC/ANSI C63.19-2007)

DASY52 Configuration:

- Probe: ES3DV3 - SN3205; ConvF(6.37, 6.37, 6.37); Calibrated: 30.12.2013;
- Sensor-Surface: 3mm (Mechanical Surface Detection)
- Electronics: DAE4 Sn601; Calibrated: 25.04.2013
- Phantom: Flat Phantom 4.9L; Type: QD000P49AA; Serial: 1001
- DASY52 52.8.7(1137); SEMCAD X 14.6.10(7164)

Dipole Calibration for Head Tissue/Pin=250 mW, d=15mm/Zoom Scan (7x7x7)/Cube 0:

Measurement grid: dx=5mm, dy=5mm, dz=5mm

Reference Value = 53.711 V/m; Power Drift = 0.02 dB

Peak SAR (extrapolated) = 3.27 W/kg

SAR(1 g) = 2.16 W/kg; SAR(10 g) = 1.4 W/kg

Maximum value of SAR (measured) = 2.51 W/kg

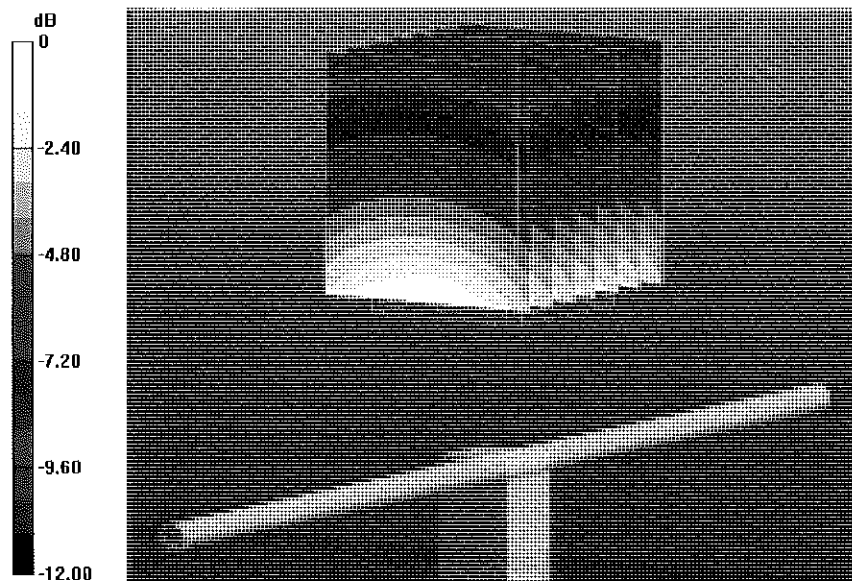

0 dB = 2.51 W/kg = 4.00 dBW/kg

Impedance Measurement Plot for Head TSL

20 Jan 2014 16:36:06

CH1 S11 1 U FS 1: 54.678 Ω -156.25 m \angle 1.3581 nF 750.000 000 MHz

*
De1

C Δ

Avg
16

H1d

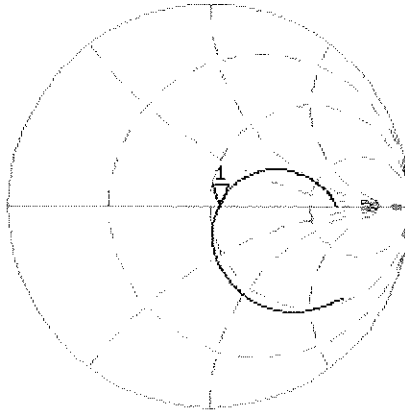

CH2 S11 LOG 5 dB/REF -20 dB 1: -26.992 dB 750.000 000 MHz

C Δ

Avg
16

H1d

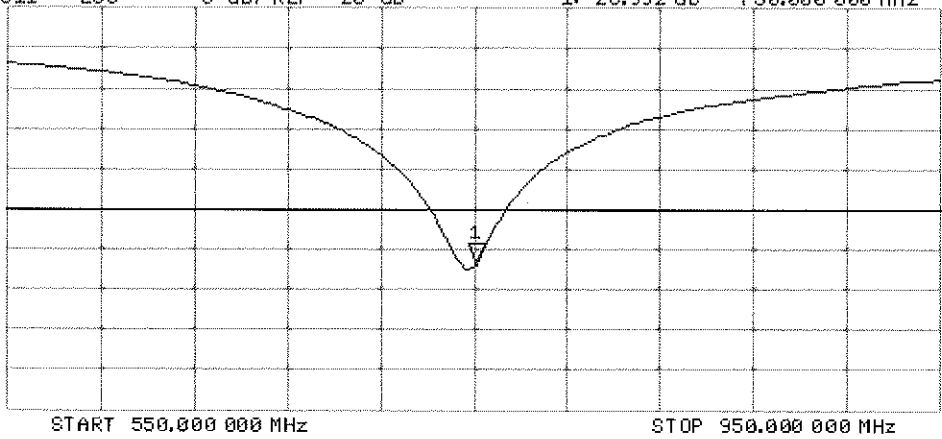

DASY5 Validation Report for Body TSL

Date: 20.01.2014

Test Laboratory: SPEAG, Zurich, Switzerland

DUT: Dipole 750 MHz; Type: D750V3; Serial: D750V3 - SN: 1003

Communication System: UID 0 - CW; Frequency: 750 MHz

Medium parameters used: $f = 750$ MHz; $\sigma = 0.98$ S/m; $\epsilon_r = 54$; $\rho = 1000$ kg/m³

Phantom section: Flat Section

Measurement Standard: DASY5 (IEEE/IEC/ANSI C63.19-2007)

DASY52 Configuration:

- Probe: ES3DV3 - SN3205; ConvF(6.13, 6.13, 6.13); Calibrated: 30.12.2013;
- Sensor-Surface: 3mm (Mechanical Surface Detection)
- Electronics: DAE4 Sn601; Calibrated: 25.04.2013
- Phantom: Flat Phantom 4.9L; Type: QD000P49AA; Serial: 1001
- DASY52 52.8.7(1137); SEMCAD X 14.6.10(7164)

Dipole Calibration for Body Tissue/Pin=250 mW, d=15mm/Zoom Scan (7x7x7)/Cube 0:

Measurement grid: dx=5mm, dy=5mm, dz=5mm

Reference Value = 53.082 V/m; Power Drift = 0.03 dB

Peak SAR (extrapolated) = 3.31 W/kg

SAR(1 g) = 2.24 W/kg; SAR(10 g) = 1.47 W/kg

Maximum value of SAR (measured) = 2.58 W/kg

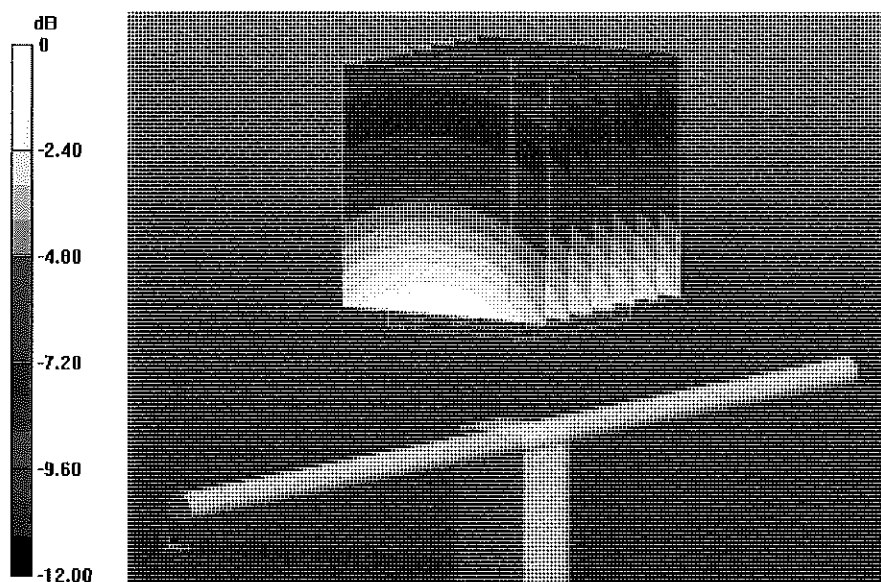

0 dB = 2.58 W/kg = 4.12 dBW/kg



Accredited by the Swiss Accreditation Service (SAS)
The Swiss Accreditation Service is one of the signatories to the EA
Multilateral Agreement for the recognition of calibration certificates

Accreditation No.: **SCS 108**

Client **PC Test**

Certificate No: **D835V2-4d133_Jul14**

CALIBRATION CERTIFICATE

Object **D835V2 - SN: 4d133**

Calibration procedure(s) **QA CAL-05.v9
Calibration procedure for dipole validation kits above 700 MHz**

CC
11/6/14

Calibration date: **July 24, 2014**

This calibration certificate documents the traceability to national standards, which realize the physical units of measurements (SI).
The measurements and the uncertainties with confidence probability are given on the following pages and are part of the certificate.

All calibrations have been conducted in the closed laboratory facility: environment temperature (22 ± 3)°C and humidity < 70%.

Calibration Equipment used (M&TE critical for calibration)

Primary Standards	ID #	Cal Date (Certificate No.)	Scheduled Calibration
Power meter EPM-442A	GB37480704	09-Oct-13 (No. 217-01827)	Oct-14
Power sensor HP 8481A	US37292783	09-Oct-13 (No. 217-01827)	Oct-14
Power sensor HP 8481A	MY41092317	09-Oct-13 (No. 217-01828)	Oct-14
Reference 20 dB Attenuator	SN: 5058 (20k)	03-Apr-14 (No. 217-01918)	Apr-15
Type-N mismatch combination	SN: 5047.2 / 06327	03-Apr-14 (No. 217-01921)	Apr-15
Reference Probe ES3DV3	SN: 3205	30-Dec-13 (No. ES3-3205_Dec13)	Dec-14
DAE4	SN: 601	30-Apr-14 (No. DAE4-601_Apr14)	Apr-15
Secondary Standards	ID #	Check Date (in house)	Scheduled Check
RF generator R&S SMT-06	100005	04-Aug-99 (in house check Oct-13)	In house check: Oct-16
Network Analyzer HP 8753E	US37390585 S4206	18-Oct-01 (in house check Oct-13)	In house check: Oct-14

Calibrated by: **Jeton Kastrati** Name: **Jeton Kastrati** Function: **Laboratory Technician**

Approved by: **Katja Pokovic** Name: **Katja Pokovic** Function: **Technical Manager**

Signature:

Signature:

Issued: July 24, 2014

This calibration certificate shall not be reproduced except in full without written approval of the laboratory.



Accredited by the Swiss Accreditation Service (SAS)
The Swiss Accreditation Service is one of the signatories to the EA
Multilateral Agreement for the recognition of calibration certificates

Accreditation No.: **SCS 108**

Glossary:

TSL	tissue simulating liquid
ConvF	sensitivity in TSL / NORM x,y,z
N/A	not applicable or not measured

Calibration is Performed According to the Following Standards:

- IEEE Std 1528-2013, "IEEE Recommended Practice for Determining the Peak Spatial-Averaged Specific Absorption Rate (SAR) in the Human Head from Wireless Communications Devices: Measurement Techniques", June 2013
- IEC 62209-1, "Procedure to measure the Specific Absorption Rate (SAR) for hand-held devices used in close proximity to the ear (frequency range of 300 MHz to 3 GHz)", February 2005
- KDB 865664, "SAR Measurement Requirements for 100 MHz to 6 GHz"

Additional Documentation:

- DASY4/5 System Handbook

Methods Applied and Interpretation of Parameters:

- Measurement Conditions:** Further details are available from the Validation Report at the end of the certificate. All figures stated in the certificate are valid at the frequency indicated.
- Antenna Parameters with TSL:** The dipole is mounted with the spacer to position its feed point exactly below the center marking of the flat phantom section, with the arms oriented parallel to the body axis.
- Feed Point Impedance and Return Loss:** These parameters are measured with the dipole positioned under the liquid filled phantom. The impedance stated is transformed from the measurement at the SMA connector to the feed point. The Return Loss ensures low reflected power. No uncertainty required.
- Electrical Delay:** One-way delay between the SMA connector and the antenna feed point. No uncertainty required.
- SAR measured:** SAR measured at the stated antenna input power.
- SAR normalized:** SAR as measured, normalized to an input power of 1 W at the antenna connector.
- SAR for nominal TSL parameters:** The measured TSL parameters are used to calculate the nominal SAR result.

The reported uncertainty of measurement is stated as the standard uncertainty of measurement multiplied by the coverage factor $k=2$, which for a normal distribution corresponds to a coverage probability of approximately 95%.

Measurement Conditions

DASY system configuration, as far as not given on page 1.

DASY Version	DASY5	V52.8.8
Extrapolation	Advanced Extrapolation	
Phantom	Modular Flat Phantom	
Distance Dipole Center - TSL	15 mm	with Spacer
Zoom Scan Resolution	dx, dy, dz = 5 mm	
Frequency	835 MHz \pm 1 MHz	

Head TSL parameters

The following parameters and calculations were applied.

	Temperature	Permittivity	Conductivity
Nominal Head TSL parameters	22.0 °C	41.5	0.90 mho/m
Measured Head TSL parameters	(22.0 \pm 0.2) °C	41.1 \pm 6 %	0.94 mho/m \pm 6 %
Head TSL temperature change during test	< 0.5 °C	----	----

SAR result with Head TSL

SAR averaged over 1 cm ³ (1 g) of Head TSL	Condition	
SAR measured	250 mW input power	2.38 W/kg
SAR for nominal Head TSL parameters	normalized to 1W	9.20 W/kg \pm 17.0 % (k=2)

SAR averaged over 10 cm ³ (10 g) of Head TSL	condition	
SAR measured	250 mW input power	1.53 W/kg
SAR for nominal Head TSL parameters	normalized to 1W	5.96 W/kg \pm 16.5 % (k=2)

Body TSL parameters

The following parameters and calculations were applied.

	Temperature	Permittivity	Conductivity
Nominal Body TSL parameters	22.0 °C	55.2	0.97 mho/m
Measured Body TSL parameters	(22.0 \pm 0.2) °C	53.8 \pm 6 %	1.02 mho/m \pm 6 %
Body TSL temperature change during test	< 0.5 °C	----	----

SAR result with Body TSL

SAR averaged over 1 cm ³ (1 g) of Body TSL	Condition	
SAR measured	250 mW input power	2.44 W/kg
SAR for nominal Body TSL parameters	normalized to 1W	9.35 W/kg \pm 17.0 % (k=2)

SAR averaged over 10 cm ³ (10 g) of Body TSL	condition	
SAR measured	250 mW input power	1.59 W/kg
SAR for nominal Body TSL parameters	normalized to 1W	6.15 W/kg \pm 16.5 % (k=2)

Appendix (Additional assessments outside the scope of SCS108)

Antenna Parameters with Head TSL

Impedance, transformed to feed point	51.6 Ω - 1.0 j Ω
Return Loss	- 34.7 dB

Antenna Parameters with Body TSL

Impedance, transformed to feed point	47.8 Ω - 3.3 j Ω
Return Loss	- 27.8 dB

General Antenna Parameters and Design

Electrical Delay (one direction)	1.395 ns
----------------------------------	----------

After long term use with 100W radiated power, only a slight warming of the dipole near the feedpoint can be measured.

The dipole is made of standard semirigid coaxial cable. The center conductor of the feeding line is directly connected to the second arm of the dipole. The antenna is therefore short-circuited for DC-signals. On some of the dipoles, small end caps are added to the dipole arms in order to improve matching when loaded according to the position as explained in the "Measurement Conditions" paragraph. The SAR data are not affected by this change. The overall dipole length is still according to the Standard.

No excessive force must be applied to the dipole arms, because they might bend or the soldered connections near the feedpoint may be damaged.

Additional EUT Data

Manufactured by	SPEAG
Manufactured on	July 22, 2011

DASY5 Validation Report for Head TSL

Date: 24.07.2014

Test Laboratory: SPEAG, Zurich, Switzerland

DUT: Dipole 835 MHz; Type: D835V2; Serial: D835V2 - SN: 4d133

Communication System: UID 0 - CW; Frequency: 835 MHz
Medium parameters used: $f = 835$ MHz; $\sigma = 0.94$ S/m; $\epsilon_r = 41.1$; $\rho = 1000$ kg/m³
Phantom section: Flat Section
Measurement Standard: DASY5 (IEEE/IEC/ANSI C63.19-2011)

DASY52 Configuration:

- Probe: ES3DV3 - SN3205; ConvF(6.22, 6.22, 6.22); Calibrated: 30.12.2013;
- Sensor-Surface: 3mm (Mechanical Surface Detection)
- Electronics: DAE4 Sn601; Calibrated: 30.04.2014
- Phantom: Flat Phantom 4.9L; Type: QD000P49AA; Serial: 1001
- DASY52 52.8.8(1222); SEMCAD X 14.6.10(7331)

Dipole Calibration for Head Tissue/Pin=250 mW, d=15mm/Zoom Scan (7x7x7)/Cube 0:

Measurement grid: dx=5mm, dy=5mm, dz=5mm
Reference Value = 56.07 V/m; Power Drift = 0.03 dB
Peak SAR (extrapolated) = 3.58 W/kg
SAR(1 g) = 2.38 W/kg; SAR(10 g) = 1.53 W/kg
Maximum value of SAR (measured) = 2.79 W/kg

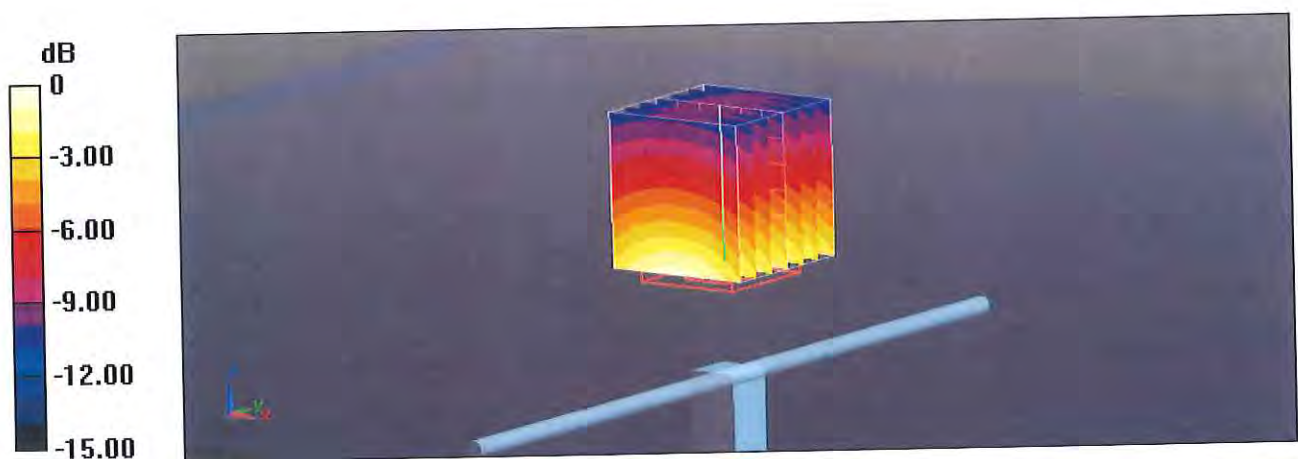

DASY5 Validation Report for Body TSL

Date: 17.07.2014

Test Laboratory: SPEAG, Zurich, Switzerland

DUT: Dipole 835 MHz; Type: D835V2; Serial: D835V2 - SN: 4d133

Communication System: UID 0 - CW; Frequency: 835 MHz

Medium parameters used: $f = 835 \text{ MHz}$; $\sigma = 1.02 \text{ S/m}$; $\epsilon_r = 53.8$; $\rho = 1000 \text{ kg/m}^3$

Phantom section: Flat Section

Measurement Standard: DASY5 (IEEE/IEC/ANSI C63.19-2011)

DASY52 Configuration:

- Probe: ES3DV3 - SN3205; ConvF(6.09, 6.09, 6.09); Calibrated: 30.12.2013;
- Sensor-Surface: 3mm (Mechanical Surface Detection)
- Electronics: DAE4 Sn601; Calibrated: 30.04.2014
- Phantom: Flat Phantom 4.9L; Type: QD000P49AA; Serial: 1001
- DASY52 52.8.8(1222); SEMCAD X 14.6.10(7331)

Dipole Calibration for Body Tissue/Pin=250 mW, d=15mm/Zoom Scan (7x7x7)/Cube 0:

Measurement grid: $dx=5\text{mm}$, $dy=5\text{mm}$, $dz=5\text{mm}$

Reference Value = 54.61 V/m; Power Drift = -0.01 dB

Peak SAR (extrapolated) = 3.59 W/kg

SAR(1 g) = 2.44 W/kg; SAR(10 g) = 1.59 W/kg

Maximum value of SAR (measured) = 2.84 W/kg

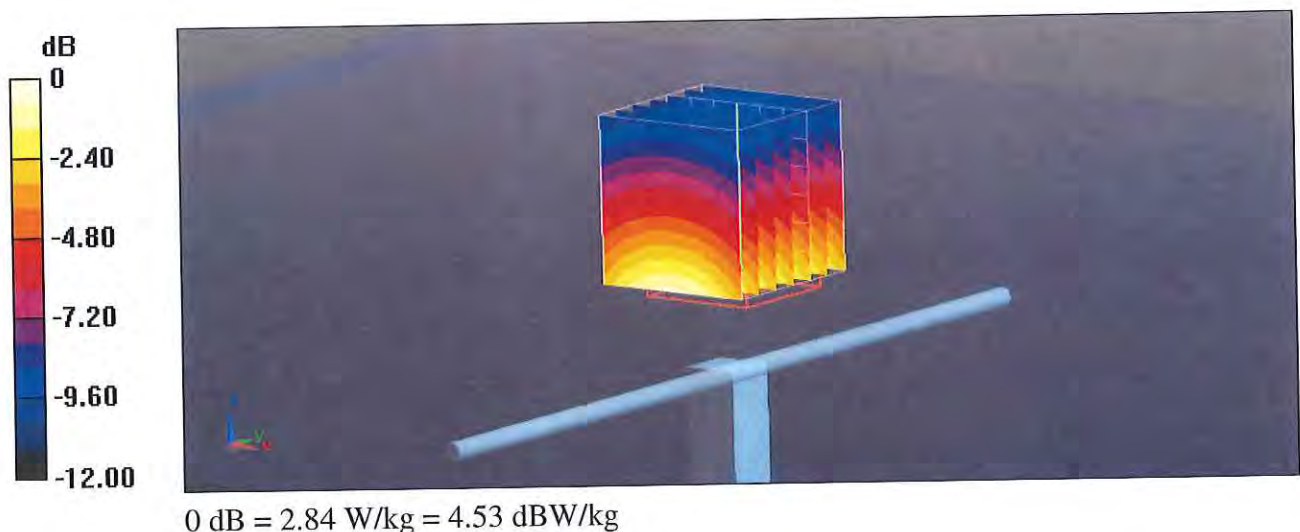

Impedance Measurement Plot for Body TSL

17 Jul 2014 13:43:24

[CH1] S11 1 U FS

1: 47.799 Ω -3.3184 Ω 57.439 pF

835.000 000 MHz

*

De l

Ca

Avg
16

H1 d

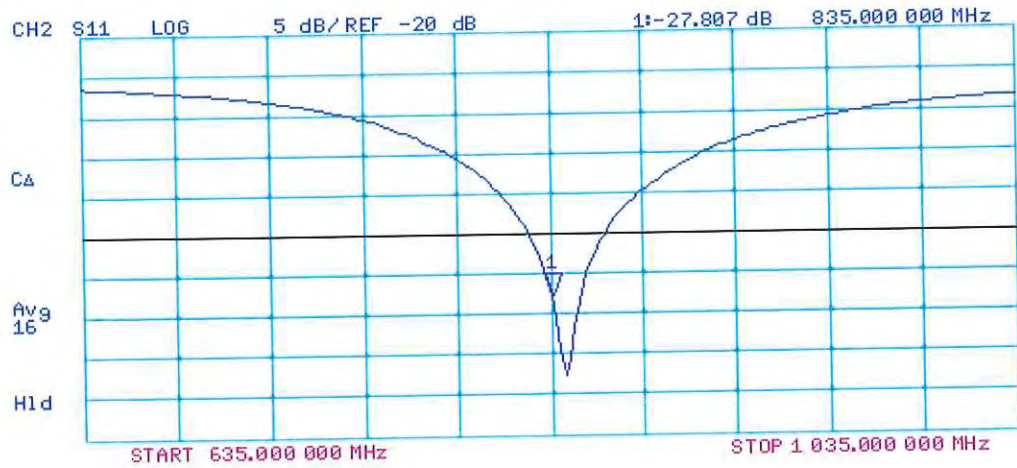
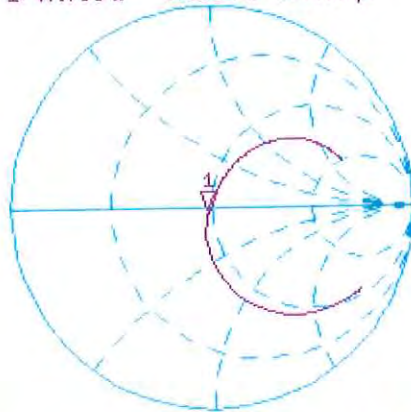



Accredited by the Swiss Accreditation Service (SAS)
The Swiss Accreditation Service is one of the signatories to the EA
Multilateral Agreement for the recognition of calibration certificates

Accreditation No.: **SCS 108**

Client **PC Test**

Certificate No: **D1900V2-5d141_Apr14**

CALIBRATION CERTIFICATE

Object **D1900V2 - SN: 5d141**

Calibration procedure(s) **QA CAL-05.v9
Calibration procedure for dipole validation kits above 700 MHz**

Calibration date: **April 09, 2014**

✓
Kok
5/7/14

This calibration certificate documents the traceability to national standards, which realize the physical units of measurements (SI).
The measurements and the uncertainties with confidence probability are given on the following pages and are part of the certificate.

All calibrations have been conducted in the closed laboratory facility: environment temperature (22 ± 3)°C and humidity < 70%.

Calibration Equipment used (M&TE critical for calibration)

Primary Standards	ID #	Cal Date (Certificate No.)	Scheduled Calibration
Power meter EPM-442A	GB37480704	09-Oct-13 (No. 217-01827)	Oct-14
Power sensor HP 8481A	US37292783	09-Oct-13 (No. 217-01827)	Oct-14
Power sensor HP 8481A	MY41092317	09-Oct-13 (No. 217-01828)	Oct-14
Reference 20 dB Attenuator	SN: 5058 (20k)	03-Apr-14 (No. 217-01918)	Apr-15
Type-N mismatch combination	SN: 5047.2 / 06327	03-Apr-14 (No. 217-01921)	Apr-15
Reference Probe ES3DV3	SN: 3205	30-Dec-13 (No. ES3-3205_Dec13)	Dec-14
DAE4	SN: 801	25-Apr-13 (No. DAE4-801_Apr13)	Apr-14

Secondary Standards	ID #	Check Date (in house)	Scheduled Check
RF generator R&S SMT-06	100005	04-Aug-99 (in house check Oct-13)	In house check: Oct-16
Network Analyzer HP 8753E	US37390585 S4206	18-Oct-01 (in house check Oct-13)	In house check: Oct-14

Calibrated by: **Claudio Leubler** Function: **Laboratory Technician**

Signature

Approved by: **Katja Pokovic** Technical Manager

Issued: April 9, 2014

This calibration certificate shall not be reproduced except in full without written approval of the laboratory.



Accredited by the Swiss Accreditation Service (SAS)
The Swiss Accreditation Service is one of the signatories to the EA
Multilateral Agreement for the recognition of calibration certificates

Accreditation No.: **SCS 108**

Glossary:

TSL	tissue simulating liquid
ConvF	sensitivity in TSL / NORM x,y,z
N/A	not applicable or not measured

Calibration is Performed According to the Following Standards:

- IEEE Std 1528-2013, "IEEE Recommended Practice for Determining the Peak Spatial-Averaged Specific Absorption Rate (SAR) in the Human Head from Wireless Communications Devices: Measurement Techniques", June 2013
- IEC 62209-1, "Procedure to measure the Specific Absorption Rate (SAR) for hand-held devices used in close proximity to the ear (frequency range of 300 MHz to 3 GHz)", February 2005
- KDB 865664, "SAR Measurement Requirements for 100 MHz to 6 GHz"

Additional Documentation:

- DASY4/5 System Handbook

Methods Applied and Interpretation of Parameters:

- Measurement Conditions:* Further details are available from the Validation Report at the end of the certificate. All figures stated in the certificate are valid at the frequency indicated.
- Antenna Parameters with TSL:* The dipole is mounted with the spacer to position its feed point exactly below the center marking of the flat phantom section, with the arms oriented parallel to the body axis.
- Feed Point Impedance and Return Loss:* These parameters are measured with the dipole positioned under the liquid filled phantom. The impedance stated is transformed from the measurement at the SMA connector to the feed point. The Return Loss ensures low reflected power. No uncertainty required.
- Electrical Delay:* One-way delay between the SMA connector and the antenna feed point. No uncertainty required.
- SAR measured:* SAR measured at the stated antenna input power.
- SAR normalized:* SAR as measured, normalized to an input power of 1 W at the antenna connector.
- SAR for nominal TSL parameters:* The measured TSL parameters are used to calculate the nominal SAR result.

The reported uncertainty of measurement is stated as the standard uncertainty of measurement multiplied by the coverage factor $k=2$, which for a normal distribution corresponds to a coverage probability of approximately 95%.

Measurement Conditions

DASY system configuration, as far as not given on page 1.

DASY Version	DASY5	V52.8.7
Extrapolation	Advanced Extrapolation	
Phantom	Modular Flat Phantom	
Distance Dipole Center - TSL	10 mm	with Spacer
Zoom Scan Resolution	dx, dy, dz = 5 mm	
Frequency	1900 MHz \pm 1 MHz	

Head TSL parameters

The following parameters and calculations were applied.

	Temperature	Permittivity	Conductivity
Nominal Head TSL parameters	22.0 °C	40.0	1.40 mho/m
Measured Head TSL parameters	(22.0 \pm 0.2) °C	39.1 \pm 6 %	1.36 mho/m \pm 6 %
Head TSL temperature change during test	< 0.5 °C	----	----

SAR result with Head TSL

SAR averaged over 1 cm ³ (1 g) of Head TSL	Condition	
SAR measured	250 mW input power	9.91 W/kg
SAR for nominal Head TSL parameters	normalized to 1W	40.1 W/kg \pm 17.0 % (k=2)

SAR averaged over 10 cm ³ (10 g) of Head TSL	condition	
SAR measured	250 mW input power	5.17 W/kg
SAR for nominal Head TSL parameters	normalized to 1W	20.8 W/kg \pm 16.5 % (k=2)

Body TSL parameters

The following parameters and calculations were applied.

	Temperature	Permittivity	Conductivity
Nominal Body TSL parameters	22.0 °C	53.3	1.52 mho/m
Measured Body TSL parameters	(22.0 \pm 0.2) °C	52.4 \pm 6 %	1.52 mho/m \pm 6 %
Body TSL temperature change during test	< 0.5 °C	----	----

SAR result with Body TSL

SAR averaged over 1 cm ³ (1 g) of Body TSL	Condition	
SAR measured	250 mW input power	10.2 W/kg
SAR for nominal Body TSL parameters	normalized to 1W	40.6 W/kg \pm 17.0 % (k=2)

SAR averaged over 10 cm ³ (10 g) of Body TSL	condition	
SAR measured	250 mW input power	5.41 W/kg
SAR for nominal Body TSL parameters	normalized to 1W	21.6 W/kg \pm 16.5 % (k=2)

Appendix

Antenna Parameters with Head TSL

Impedance, transformed to feed point	52.8 Ω + 5.5 j Ω
Return Loss	- 24.5 dB

Antenna Parameters with Body TSL

Impedance, transformed to feed point	48.8 Ω + 6.3 j Ω
Return Loss	- 23.7 dB

General Antenna Parameters and Design

Electrical Delay (one direction)	1.199 ns
----------------------------------	----------

After long term use with 100W radiated power, only a slight warming of the dipole near the feedpoint can be measured.

The dipole is made of standard semirigid coaxial cable. The center conductor of the feeding line is directly connected to the second arm of the dipole. The antenna is therefore short-circuited for DC-signals. On some of the dipoles, small end caps are added to the dipole arms in order to improve matching when loaded according to the position as explained in the "Measurement Conditions" paragraph. The SAR data are not affected by this change. The overall dipole length is still according to the Standard.

No excessive force must be applied to the dipole arms, because they might bend or the soldered connections near the feedpoint may be damaged.

Additional EUT Data

Manufactured by	SPEAG
Manufactured on	March 11, 2011

DASY5 Validation Report for Head TSL

Date: 09.04.2014

Test Laboratory: SPEAG, Zurich, Switzerland

DUT: Dipole 1900 MHz; Type: D1900V2; Serial: D1900V2 - SN: 5d141

Communication System: UID 0 - CW; Frequency: 1900 MHz

Medium parameters used: $f = 1900$ MHz; $\sigma = 1.36$ S/m; $\epsilon_r = 39.1$; $\rho = 1000$ kg/m³

Phantom section: Flat Section

Measurement Standard: DASY5 (IEEE/IEC/ANSI C63.19-2007)

DASY52 Configuration:

- Probe: ES3DV3 - SN3205; ConvF(5.06, 5.06, 5.06); Calibrated: 30.12.2013;
- Sensor-Surface: 3mm (Mechanical Surface Detection)
- Electronics: DAE4 Sn601; Calibrated: 25.04.2013
- Phantom: Flat Phantom 5.0 (front); Type: QD000P50AA; Serial: 1001
- DASY52 52.8.7(1137); SEMCAD X 14.6.10(7164)

Dipole Calibration for Head Tissue/ $P_{in}=250$ mW, $d=10$ mm/Zoom Scan (7x7x7)/Cube 0:

Measurement grid: $dx=5$ mm, $dy=5$ mm, $dz=5$ mm

Reference Value = 99.080 V/m; Power Drift = 0.01 dB

Peak SAR (extrapolated) = 18.2 W/kg

SAR(1 g) = 9.91 W/kg; SAR(10 g) = 5.17 W/kg

Maximum value of SAR (measured) = 12.5 W/kg

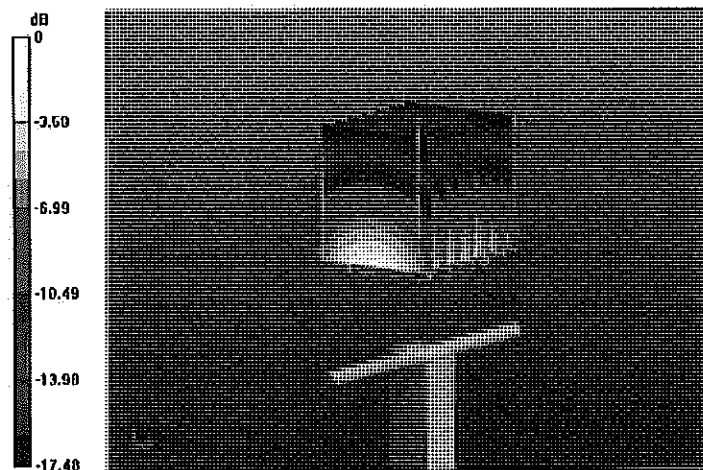

0 dB = 12.5 W/kg = 10.97 dBW/kg

Impedance Measurement Plot for Head TSL

9 Apr 2014 11:03:32

CH1 S11 1 U FS 1: 52.760 n 5.4512 n 456.62 pH 1 900.000 000 MHz

*
Del
CA

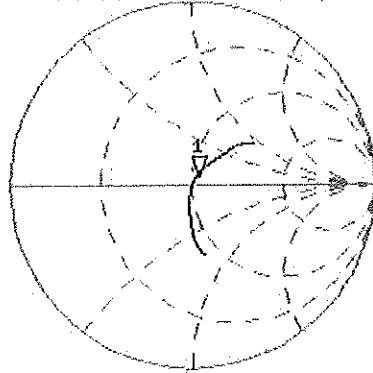

AVG
16

H1d

CH2 S11 LOG 5 dB/REF -20 dB 1: -24.525 dB 1 900.000 000 MHz

CA

AVG
16

H1d

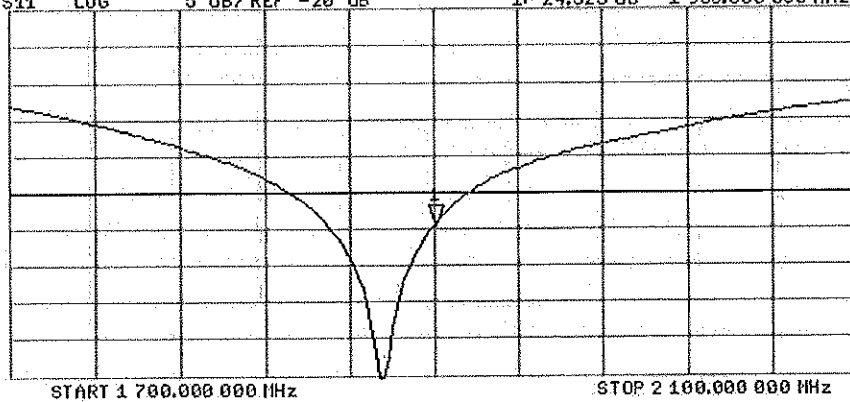

DASY5 Validation Report for Body TSL

Date: 09.04.2014

Test Laboratory: SPEAG, Zurich, Switzerland

DUT: Dipole 1900 MHz; Type: D1900V2; Serial: D1900V2 - SN: 5d141

Communication System: UID 0 - CW; Frequency: 1900 MHz

Medium parameters used: $f = 1900$ MHz; $\sigma = 1.52$ S/m; $\epsilon_r = 52.4$; $\rho = 1000$ kg/m³

Phantom section: Flat Section

Measurement Standard: DASY5 (IEEE/IEC/ANSI C63.19-2007)

DASY52 Configuration:

- Probe: ES3DV3 - SN3205; ConvF(4.76, 4.76, 4.76); Calibrated: 30.12.2013;
- Sensor-Surface: 3mm (Mechanical Surface Detection)
- Electronics: DAE4 Sn601; Calibrated: 25.04.2013
- Phantom: Flat Phantom 5.0 (back); Type: QD000P50AA; Serial: 1002
- DASY52 52.8.7(1137); SEMCAD X 14.6.10(7164)

Dipole Calibration for Body Tissue/Pin=250 mW, d=10mm/Zoom Scan (7x7x7)/Cube 0:

Measurement grid: dx=5mm, dy=5mm, dz=5mm

Reference Value = 95.820 V/m; Power Drift = -0.01 dB

Peak SAR (extrapolated) = 17.9 W/kg

SAR(1 g) = 10.2 W/kg; SAR(10 g) = 5.41 W/kg

Maximum value of SAR (measured) = 12.9 W/kg

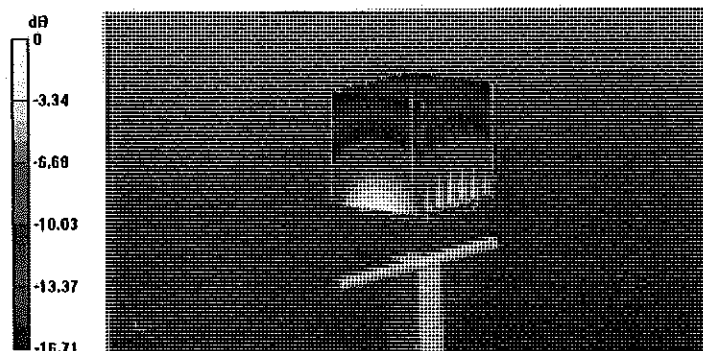

0 dB = 12.9 W/kg = 11.11 dBW/kg

Impedance Measurement Plot for Body TSL

9 Apr 2014 11:02:32

CH1 S11 1 U FS 1: 48.752 Ω 6.3320 Ω 530.41 μ H 1 900.000 000 MHz

*
Del
CA
Avg
16
↑

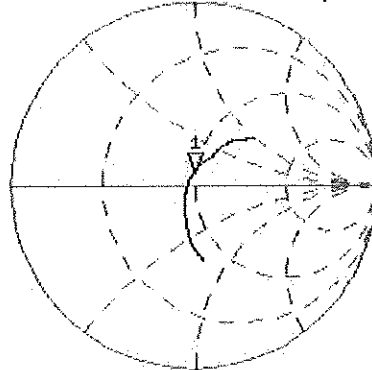

CH2 S11 LOG 5 dB/REF -20 dB 1: -23.715 dB 1 900.000 000 MHz

CA
Avg
16
↑

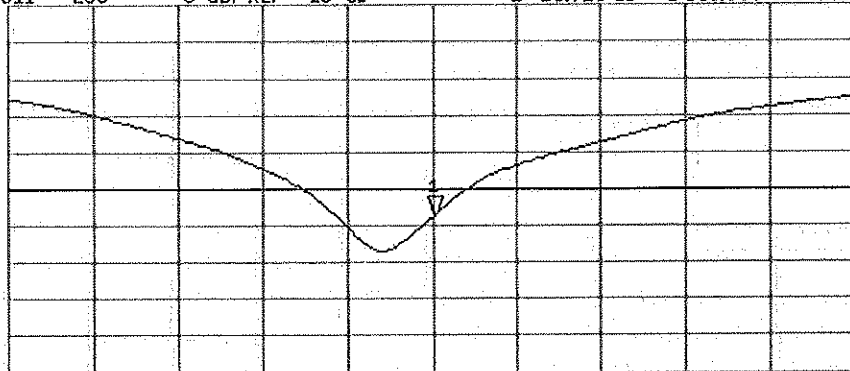



Accredited by the Swiss Accreditation Service (SAS)
The Swiss Accreditation Service is one of the signatories to the EA
Multilateral Agreement for the recognition of calibration certificates

Accreditation No.: **SCS 108**

Client **PC Test**

Certificate No: **D2450V2-797_Jan14**

CALIBRATION CERTIFICATE

Object **D2450V2 - SN: 797**

Calibration procedure(s) **QA CAL-05.v9
Calibration procedure for dipole validation kits above 700 MHz**

Calibration date: **January 21, 2014**

*CC ✓
2/5/14*

This calibration certificate documents the traceability to national standards, which realize the physical units of measurements (SI).
The measurements and the uncertainties with confidence probability are given on the following pages and are part of the certificate.

All calibrations have been conducted in the closed laboratory facility: environment temperature (22 ± 3)°C and humidity < 70%.

Calibration Equipment used (M&TE critical for calibration)

Primary Standards	ID #	Cal Date (Certificate No.)	Scheduled Calibration
Power meter EPM-442A	GB37480704	09-Oct-13 (No. 217-01827)	Oct-14
Power sensor HP 8481A	US37292783	09-Oct-13 (No. 217-01827)	Oct-14
Power sensor HP 8481A	MY41092317	09-Oct-13 (No. 217-01828)	Oct-14
Reference 20 dB Attenuator	SN: 5058 (20k)	04-Apr-13 (No. 217-01736)	Apr-14
Type-N mismatch combination	SN: 5047.3 / 06327	04-Apr-13 (No. 217-01739)	Apr-14
Reference Probe ES3DV3	SN: 3205	30-Dec-13 (No. ES3-3205_Dec13)	Dec-14
DAE4	SN: 601	25-Apr-13 (No. DAE4-601_Apr13)	Apr-14
Secondary Standards	ID #	Check Date (in house)	Scheduled Check
RF generator R&S SMT-06	100005	04-Aug-99 (in house check Oct-13)	In house check: Oct-16
Network Analyzer HP 8753E	US37390585 S4206	18-Oct-01 (in house check Oct-13)	In house check: Oct-14

Calibrated by:	Name Israe El-Naouq	Function Laboratory Technician	Signature
Approved by:	Katja Pokovic	Technical Manager	

Issued: January 21, 2014

This calibration certificate shall not be reproduced except in full without written approval of the laboratory.



Accredited by the Swiss Accreditation Service (SAS)

Accreditation No.: **SCS 108**

The Swiss Accreditation Service is one of the signatories to the EA
Multilateral Agreement for the recognition of calibration certificates

Glossary:

TSL	tissue simulating liquid
ConvF	sensitivity in TSL / NORM x,y,z
N/A	not applicable or not measured

Calibration is Performed According to the Following Standards:

- IEEE Std 1528-2013, "IEEE Recommended Practice for Determining the Peak Spatial-Averaged Specific Absorption Rate (SAR) in the Human Head from Wireless Communications Devices: Measurement Techniques", June 2013
- IEC 62209-1, "Procedure to measure the Specific Absorption Rate (SAR) for hand-held devices used in close proximity to the ear (frequency range of 300 MHz to 3 GHz)", February 2005
- KDB 865664, "SAR Measurement Requirements for 100 MHz to 6 GHz"

Additional Documentation:

- DASY4/5 System Handbook

Methods Applied and Interpretation of Parameters:

- Measurement Conditions:** Further details are available from the Validation Report at the end of the certificate. All figures stated in the certificate are valid at the frequency indicated.
- Antenna Parameters with TSL:** The dipole is mounted with the spacer to position its feed point exactly below the center marking of the flat phantom section, with the arms oriented parallel to the body axis.
- Feed Point Impedance and Return Loss:** These parameters are measured with the dipole positioned under the liquid filled phantom. The impedance stated is transformed from the measurement at the SMA connector to the feed point. The Return Loss ensures low reflected power. No uncertainty required.
- Electrical Delay:** One-way delay between the SMA connector and the antenna feed point. No uncertainty required.
- SAR measured:** SAR measured at the stated antenna input power.
- SAR normalized:** SAR as measured, normalized to an input power of 1 W at the antenna connector.
- SAR for nominal TSL parameters:** The measured TSL parameters are used to calculate the nominal SAR result.

The reported uncertainty of measurement is stated as the standard uncertainty of measurement multiplied by the coverage factor $k=2$, which for a normal distribution corresponds to a coverage probability of approximately 95%.

Measurement Conditions

DASY system configuration, as far as not given on page 1.

DASY Version	DASY5	V52.8.7
Extrapolation	Advanced Extrapolation	
Phantom	Modular Flat Phantom	
Distance Dipole Center - TSL	10 mm	with Spacer
Zoom Scan Resolution	dx, dy, dz = 5 mm	
Frequency	2450 MHz \pm 1 MHz	

Head TSL parameters

The following parameters and calculations were applied.

	Temperature	Permittivity	Conductivity
Nominal Head TSL parameters	22.0 °C	39.2	1.80 mho/m
Measured Head TSL parameters	(22.0 \pm 0.2) °C	38.7 \pm 6 %	1.86 mho/m \pm 6 %
Head TSL temperature change during test	< 0.5 °C	---	---

SAR result with Head TSL

SAR averaged over 1 cm³ (1 g) of Head TSL	Condition	
SAR measured	250 mW input power	13.2 W/kg
SAR for nominal Head TSL parameters	normalized to 1W	51.8 W/kg \pm 17.0 % (k=2)

SAR averaged over 10 cm³ (10 g) of Head TSL	condition	
SAR measured	250 mW input power	6.13 W/kg
SAR for nominal Head TSL parameters	normalized to 1W	24.3 W/kg \pm 16.5 % (k=2)

Body TSL parameters

The following parameters and calculations were applied.

	Temperature	Permittivity	Conductivity
Nominal Body TSL parameters	22.0 °C	52.7	1.95 mho/m
Measured Body TSL parameters	(22.0 \pm 0.2) °C	51.3 \pm 6 %	2.04 mho/m \pm 6 %
Body TSL temperature change during test	< 0.5 °C	---	---

SAR result with Body TSL

SAR averaged over 1 cm³ (1 g) of Body TSL	Condition	
SAR measured	250 mW input power	12.7 W/kg
SAR for nominal Body TSL parameters	normalized to 1W	49.4 W/kg \pm 17.0 % (k=2)

SAR averaged over 10 cm³ (10 g) of Body TSL	condition	
SAR measured	250 mW input power	5.86 W/kg
SAR for nominal Body TSL parameters	normalized to 1W	23.1 W/kg \pm 16.5 % (k=2)

Appendix

Antenna Parameters with Head TSL

Impedance, transformed to feed point	$53.5 \Omega + 3.2 j\Omega$
Return Loss	- 26.7 dB

Antenna Parameters with Body TSL

Impedance, transformed to feed point	$50.0 \Omega + 4.9 j\Omega$
Return Loss	- 26.2 dB

General Antenna Parameters and Design

Electrical Delay (one direction)	1.151 ns
----------------------------------	----------

After long term use with 100W radiated power, only a slight warming of the dipole near the feedpoint can be measured.

The dipole is made of standard semirigid coaxial cable. The center conductor of the feeding line is directly connected to the second arm of the dipole. The antenna is therefore short-circuited for DC-signals. On some of the dipoles, small end caps are added to the dipole arms in order to improve matching when loaded according to the position as explained in the "Measurement Conditions" paragraph. The SAR data are not affected by this change. The overall dipole length is still according to the Standard.

No excessive force must be applied to the dipole arms, because they might bend or the soldered connections near the feedpoint may be damaged.

Additional EUT Data

Manufactured by	SPEAG
Manufactured on	January 24, 2006

DASY5 Validation Report for Head TSL

Date: 21.01.2014

Test Laboratory: SPEAG, Zurich, Switzerland

DUT: Dipole 2450 MHz; Type: D2450V2; Serial: D2450V2 - SN: 797

Communication System: UID 0 - CW; Frequency: 2450 MHz

Medium parameters used: $f = 2450$ MHz; $\sigma = 1.86$ S/m; $\epsilon_r = 38.7$; $\rho = 1000$ kg/m³

Phantom section: Flat Section

Measurement Standard: DASY5 (IEEE/IEC/ANSI C63.19-2007)

DASY52 Configuration:

- Probe: ES3DV3 - SN3205; ConvF(4.53, 4.53, 4.53); Calibrated: 30.12.2013;
- Sensor-Surface: 3mm (Mechanical Surface Detection)
- Electronics: DAE4 Sn601; Calibrated: 25.04.2013
- Phantom: Flat Phantom 5.0 (front); Type: QD000P50AA; Serial: 1001
- DASY52 52.8.7(1137); SEMCAD X 14.6.10(7164)

Dipole Calibration for Head Tissue/Pin=250 mW, d=10mm/Zoom Scan (7x7x7)/Cube 0:

Measurement grid: dx=5mm, dy=5mm, dz=5mm

Reference Value = 99.151 V/m; Power Drift = 0.05 dB

Peak SAR (extrapolated) = 27.5 W/kg

SAR(1 g) = 13.2 W/kg; SAR(10 g) = 6.13 W/kg

Maximum value of SAR (measured) = 16.9 W/kg

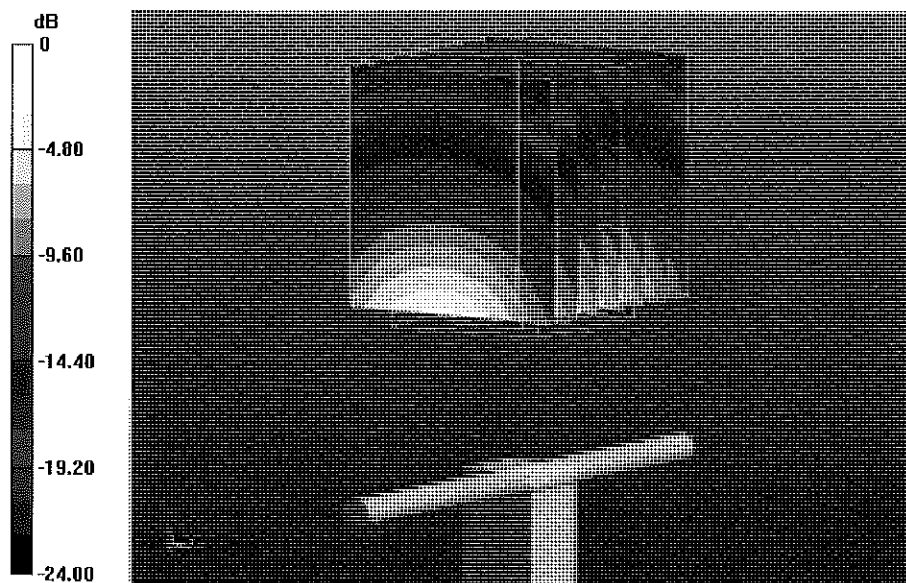

0 dB = 16.9 W/kg = 12.28 dBW/kg

Impedance Measurement Plot for Head TSL

21 Jan 2014 11:31:52

CHI S11 1 U FS 2: 53.512 Δ 3.2285 Δ 209.73 pH 2 450.000 000 MHz

*
De1
CA

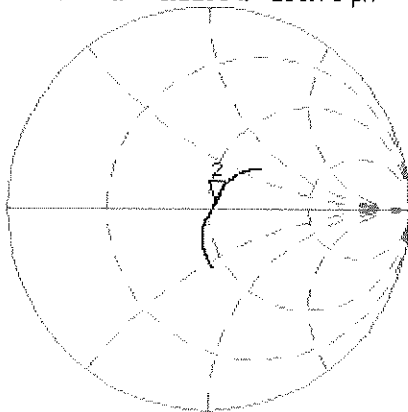

Avg
1E

H1d

CH2 S11 LOG 5 dB/REF -20 dB 2:-26.730 dB 2 450.000 000 MHz

CA

Avg
1E

H1d

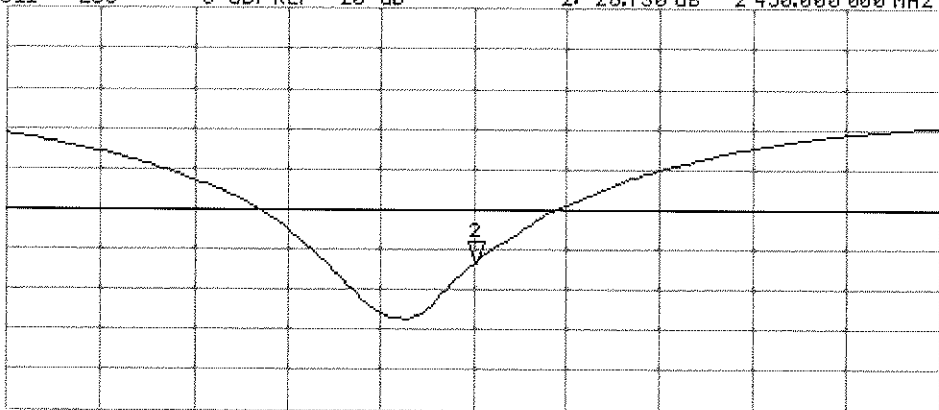

START 2 250.000 000 MHz

STOP 2 650.000 000 MHz

DASY5 Validation Report for Body TSL

Date: 21.01.2014

Test Laboratory: SPEAG, Zurich, Switzerland

DUT: Dipole 2450 MHz; Type: D2450V2; Serial: D2450V2 - SN: 797

Communication System: UID 0 - CW; Frequency: 2450 MHz

Medium parameters used: $f = 2450$ MHz; $\sigma = 2.04$ S/m; $\epsilon_r = 51.3$; $\rho = 1000$ kg/m³

Phantom section: Flat Section

Measurement Standard: DASY5 (IEEE/IEC/ANSI C63.19-2007)

DASY52 Configuration:

- Probe: ES3DV3 - SN3205; ConvF(4.35, 4.35, 4.35); Calibrated: 30.12.2013;
- Sensor-Surface: 3mm (Mechanical Surface Detection)
- Electronics: DAE4 Sn601; Calibrated: 25.04.2013
- Phantom: Flat Phantom 5.0 (back); Type: QD000P50AA; Serial: 1002
- DASY52 52.8.7(1137); SEMCAD X 14.6.10(7164)

Dipole Calibration for Body Tissue/Pin=250 mW, d=10mm/Zoom Scan (7x7x7)/Cube 0:

Measurement grid: dx=5mm, dy=5mm, dz=5mm

Reference Value = 93.709 V/m; Power Drift = 0.01 dB

Peak SAR (extrapolated) = 26.4 W/kg

SAR(1 g) = 12.7 W/kg; SAR(10 g) = 5.86 W/kg

Maximum value of SAR (measured) = 16.8 W/kg

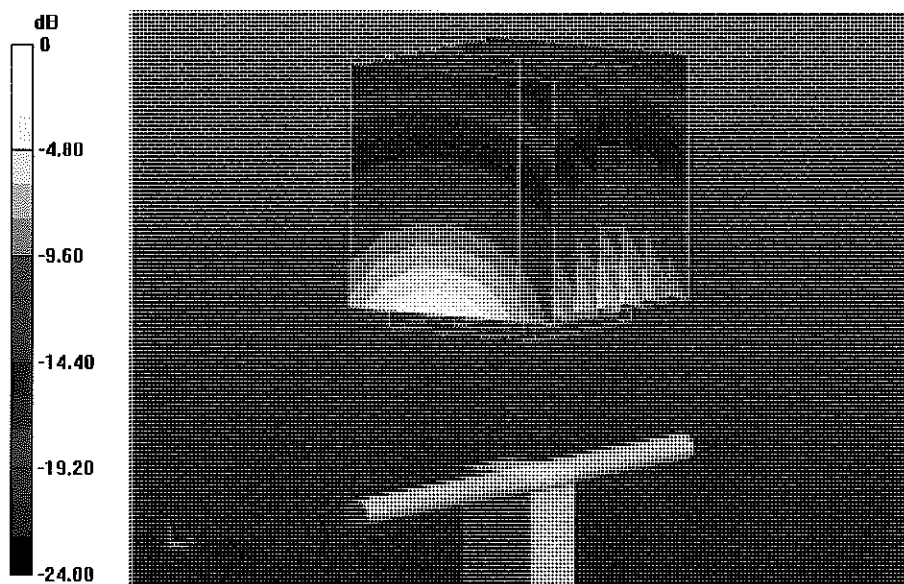

0 dB = 16.8 W/kg = 12.25 dBW/kg

Impedance Measurement Plot for Body TSL

21 Jan 2014 11:31:29

CH1 S11 1 U FS 2: 49.994 Ω 4.9258 Ω 319.98 μH 2 450.000 000 MHz

*
De l
C Δ

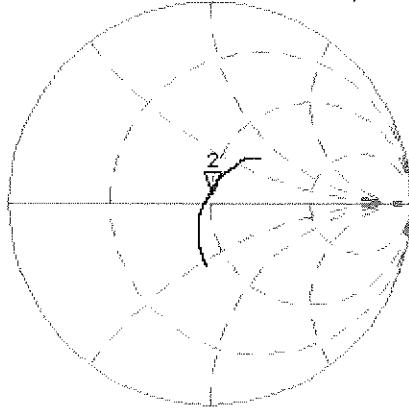

Avg
16

H1 d

CH2 S11 LOG 5 dB/REF -20 dB 2:-26.162 dB 2 450.000 000 MHz

C Δ

Avg
16

H1 d

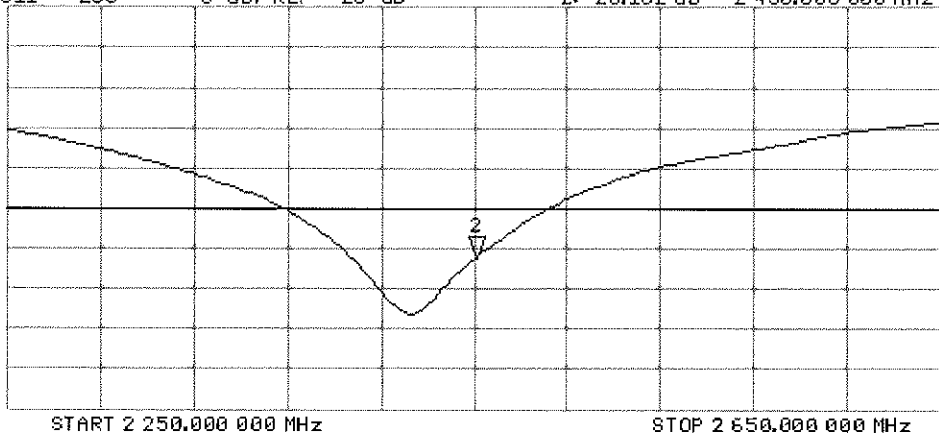



Accredited by the Swiss Accreditation Service (SAS)
The Swiss Accreditation Service is one of the signatories to the EA
Multilateral Agreement for the recognition of calibration certificates

Accreditation No.: **SCS 108**

Client **PC Test**

Certificate No: **D750V3-1054_Mar14**

CALIBRATION CERTIFICATE

Object **D750V3 - SN: 1054**

Calibration procedure(s) **QA CAL-05.v9**
Calibration procedure for dipole validation kits above 700 MHz

Calibration date: **March 17, 2014**

*CCV
3/28/14*

This calibration certificate documents the traceability to national standards, which realize the physical units of measurements (SI).
The measurements and the uncertainties with confidence probability are given on the following pages and are part of the certificate.

All calibrations have been conducted in the closed laboratory facility: environment temperature (22 ± 3)°C and humidity < 70%.

Calibration Equipment used (M&TE critical for calibration)

Primary Standards	ID #	Cal Date (Certificate No.)	Scheduled Calibration
Power meter EPM-442A	GB37480704	09-Oct-13 (No. 217-01827)	Oct-14
Power sensor HP 8481A	US37292783	09-Oct-13 (No. 217-01827)	Oct-14
Power sensor HP 8481A	MY41092317	09-Oct-13 (No. 217-01828)	Oct-14
Reference 20 dB Attenuator	SN: 5058 (20k)	04-Apr-13 (No. 217-01736)	Apr-14
Type-N mismatch combination	SN: 5047.3 / 06327	04-Apr-13 (No. 217-01739)	Apr-14
Reference Probe ES3DV3	SN: 3205	30-Dec-13 (No. ES3-3205_Dec13)	Dec-14
DAE4	SN: 601	25-Apr-13 (No. DAE4-601_Apr13)	Apr-14
Secondary Standards	ID #	Check Date (in house)	Scheduled Check
RF generator R&S SMT-06	100005	04-Aug-99 (in house check Oct-13)	In house check: Oct-16
Network Analyzer HP 8753E	US37390585 S4206	18-Oct-01 (in house check Oct-13)	In house check: Oct-14

Calibrated by: **Israe El-Naouq** Laboratory Technician

Signature

Israe El-Naouq

Approved by: **Katja Pokovic** Technical Manager

Katja Pokovic

Issued: March 17, 2014

This calibration certificate shall not be reproduced except in full without written approval of the laboratory.



Accredited by the Swiss Accreditation Service (SAS)
The Swiss Accreditation Service is one of the signatories to the EA
Multilateral Agreement for the recognition of calibration certificates

Accreditation No.: **SCS 108**

Glossary:

TSL	tissue simulating liquid
ConvF	sensitivity in TSL / NORM x,y,z
N/A	not applicable or not measured

Calibration is Performed According to the Following Standards:

- a) IEEE Std 1528-2013, "IEEE Recommended Practice for Determining the Peak Spatial-Averaged Specific Absorption Rate (SAR) in the Human Head from Wireless Communications Devices: Measurement Techniques", June 2013
- b) IEC 62209-1, "Procedure to measure the Specific Absorption Rate (SAR) for hand-held devices used in close proximity to the ear (frequency range of 300 MHz to 3 GHz)", February 2005
- c) KDB 865664, "SAR Measurement Requirements for 100 MHz to 6 GHz"

Additional Documentation:

- d) DASY4/5 System Handbook

Methods Applied and Interpretation of Parameters:

- *Measurement Conditions:* Further details are available from the Validation Report at the end of the certificate. All figures stated in the certificate are valid at the frequency indicated.
- *Antenna Parameters with TSL:* The dipole is mounted with the spacer to position its feed point exactly below the center marking of the flat phantom section, with the arms oriented parallel to the body axis.
- *Feed Point Impedance and Return Loss:* These parameters are measured with the dipole positioned under the liquid filled phantom. The impedance stated is transformed from the measurement at the SMA connector to the feed point. The Return Loss ensures low reflected power. No uncertainty required.
- *Electrical Delay:* One-way delay between the SMA connector and the antenna feed point. No uncertainty required.
- *SAR measured:* SAR measured at the stated antenna input power.
- *SAR normalized:* SAR as measured, normalized to an input power of 1 W at the antenna connector.
- *SAR for nominal TSL parameters:* The measured TSL parameters are used to calculate the nominal SAR result.

The reported uncertainty of measurement is stated as the standard uncertainty of measurement multiplied by the coverage factor $k=2$, which for a normal distribution corresponds to a coverage probability of approximately 95%.

Measurement Conditions

DASY system configuration, as far as not given on page 1.

DASY Version	DASY5	V52.8.7
Extrapolation	Advanced Extrapolation	
Phantom	Modular Flat Phantom	
Distance Dipole Center - TSL	15 mm	with Spacer
Zoom Scan Resolution	dx, dy, dz = 5 mm	
Frequency	750 MHz \pm 1 MHz	

Head TSL parameters

The following parameters and calculations were applied.

	Temperature	Permittivity	Conductivity
Nominal Head TSL parameters	22.0 °C	41.9	0.89 mho/m
Measured Head TSL parameters	(22.0 \pm 0.2) °C	40.6 \pm 6 %	0.92 mho/m \pm 6 %
Head TSL temperature change during test	< 0.5 °C	----	----

SAR result with Head TSL

SAR averaged over 1 cm³ (1 g) of Head TSL	Condition	
SAR measured	250 mW input power	2.15 W/kg
SAR for nominal Head TSL parameters	normalized to 1W	8.33 W/kg \pm 17.0 % (k=2)

SAR averaged over 10 cm³ (10 g) of Head TSL	condition	
SAR measured	250 mW input power	1.39 W/kg
SAR for nominal Head TSL parameters	normalized to 1W	5.42 W/kg \pm 16.5 % (k=2)

Body TSL parameters

The following parameters and calculations were applied.

	Temperature	Permittivity	Conductivity
Nominal Body TSL parameters	22.0 °C	55.5	0.96 mho/m
Measured Body TSL parameters	(22.0 \pm 0.2) °C	55.2 \pm 6 %	1.00 mho/m \pm 6 %
Body TSL temperature change during test	< 0.5 °C	----	----

SAR result with Body TSL

SAR averaged over 1 cm³ (1 g) of Body TSL	Condition	
SAR measured	250 mW input power	2.23 W/kg
SAR for nominal Body TSL parameters	normalized to 1W	8.64 W/kg \pm 17.0 % (k=2)

SAR averaged over 10 cm³ (10 g) of Body TSL	condition	
SAR measured	250 mW input power	1.46 W/kg
SAR for nominal Body TSL parameters	normalized to 1W	5.69 W/kg \pm 16.5 % (k=2)

Appendix

Antenna Parameters with Head TSL

Impedance, transformed to feed point	55.1 Ω + 0.7 j Ω
Return Loss	- 26.2 dB

Antenna Parameters with Body TSL

Impedance, transformed to feed point	48.5 Ω - 2.8 j Ω
Return Loss	- 29.8 dB

General Antenna Parameters and Design

Electrical Delay (one direction)	1.035 ns
----------------------------------	----------

After long term use with 100W radiated power, only a slight warming of the dipole near the feedpoint can be measured.

The dipole is made of standard semirigid coaxial cable. The center conductor of the feeding line is directly connected to the second arm of the dipole. The antenna is therefore short-circuited for DC-signals. On some of the dipoles, small end caps are added to the dipole arms in order to improve matching when loaded according to the position as explained in the "Measurement Conditions" paragraph. The SAR data are not affected by this change. The overall dipole length is still according to the Standard.

No excessive force must be applied to the dipole arms, because they might bend or the soldered connections near the feedpoint may be damaged.

Additional EUT Data

Manufactured by	SPEAG
Manufactured on	November 08, 2011

DASY5 Validation Report for Head TSL

Date: 17.03.2014

Test Laboratory: SPEAG, Zurich, Switzerland

DUT: Dipole 750 MHz; Type: D750V3; Serial: D750V3 - SN: 1054

Communication System: UID 0 - CW; Frequency: 750 MHz

Medium parameters used: $f = 750$ MHz; $\sigma = 0.92$ S/m; $\epsilon_r = 40.6$; $\rho = 1000$ kg/m³

Phantom section: Flat Section

Measurement Standard: DASY5 (IEEE/IEC/ANSI C63.19-2007)

DASY52 Configuration:

- Probe: ES3DV3 - SN3205; ConvF(6.37, 6.37, 6.37); Calibrated: 30.12.2013;
- Sensor-Surface: 3mm (Mechanical Surface Detection)
- Electronics: DAE4 Sn601; Calibrated: 25.04.2013
- Phantom: Flat Phantom 4.9L; Type: QD000P49AA; Serial: 1001
- DASY52 52.8.7(1137); SEMCAD X 14.6.10(7164)

Dipole Calibration for Head Tissue/Pin=250 mW, d=15mm/Zoom Scan (7x7x7)/Cube 0:

Measurement grid: dx=5mm, dy=5mm, dz=5mm

Reference Value = 53.851 V/m; Power Drift = 0.02 dB

Peak SAR (extrapolated) = 3.25 W/kg

SAR(1 g) = 2.15 W/kg; SAR(10 g) = 1.39 W/kg

Maximum value of SAR (measured) = 2.51 W/kg

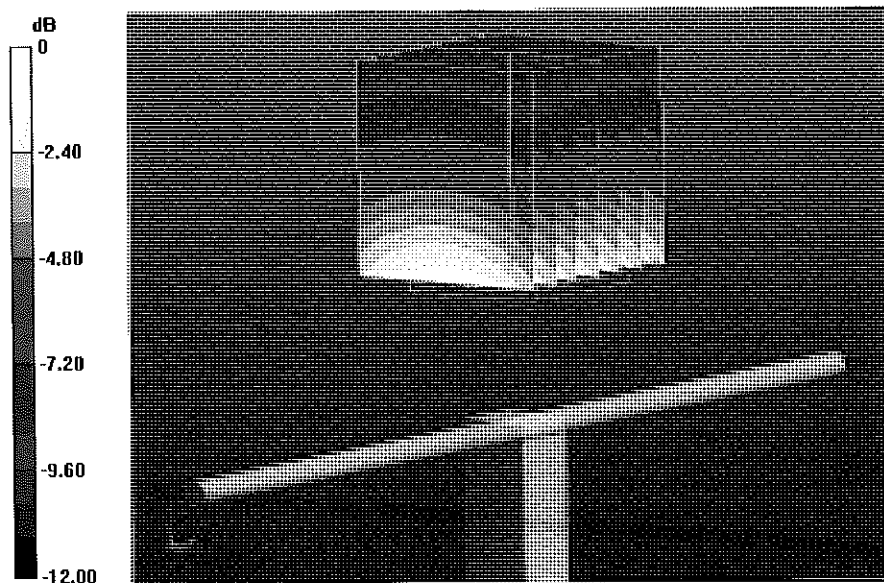

0 dB = 2.51 W/kg = 4.00 dBW/kg

Impedance Measurement Plot for Head TSL

17 Mar 2014 15:32:32

CH1 S11 1 U FS

2: 55.090 Ω 0.6895 Δ 146.31 pF

750.000 000 MHz

*
De1
CA

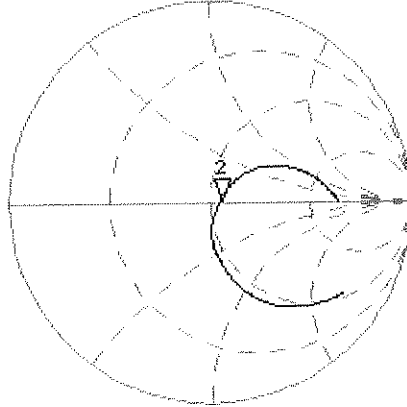

Avg
16

H1d

CH2 S11 LOG 5 dB/REF -20 dB 2:-26.216 dB 750.000 000 MHz

CA

Avg
16

H1d

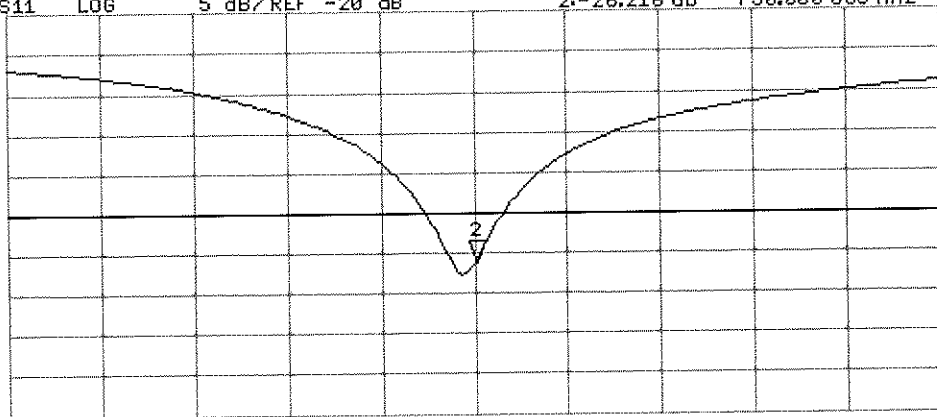

START 550.000 000 MHz

STOP 950.000 000 MHz

DASY5 Validation Report for Body TSL

Date: 14.03.2014

Test Laboratory: SPEAG, Zurich, Switzerland

DUT: Dipole 750 MHz; Type: D750V3; Serial: D750V3 - SN: 1054

Communication System: UID 0 - CW; Frequency: 750 MHz

Medium parameters used: $f = 750$ MHz; $\sigma = 1$ S/m; $\epsilon_r = 55.2$; $\rho = 1000$ kg/m³

Phantom section: Flat Section

Measurement Standard: DASY5 (IEEE/IEC/ANSI C63.19-2007)

DASY52 Configuration:

- Probe: ES3DV3 - SN3205; ConvF(6.13, 6.13, 6.13); Calibrated: 30.12.2013;
- Sensor-Surface: 3mm (Mechanical Surface Detection)
- Electronics: DAE4 Sn601; Calibrated: 25.04.2013
- Phantom: Flat Phantom 4.9L; Type: QD000P49AA; Serial: 1001
- DASY52 52.8.7(1137); SEMCAD X 14.6.10(7164)

Dipole Calibration for Body Tissue/Pin=250 mW, d=15mm/Zoom Scan (7x7x7)/Cube 0:

Measurement grid: dx=5mm, dy=5mm, dz=5mm

Reference Value = 52.788 V/m; Power Drift = -0.03 dB

Peak SAR (extrapolated) = 3.27 W/kg

SAR(1 g) = 2.23 W/kg; SAR(10 g) = 1.46 W/kg

Maximum value of SAR (measured) = 2.59 W/kg

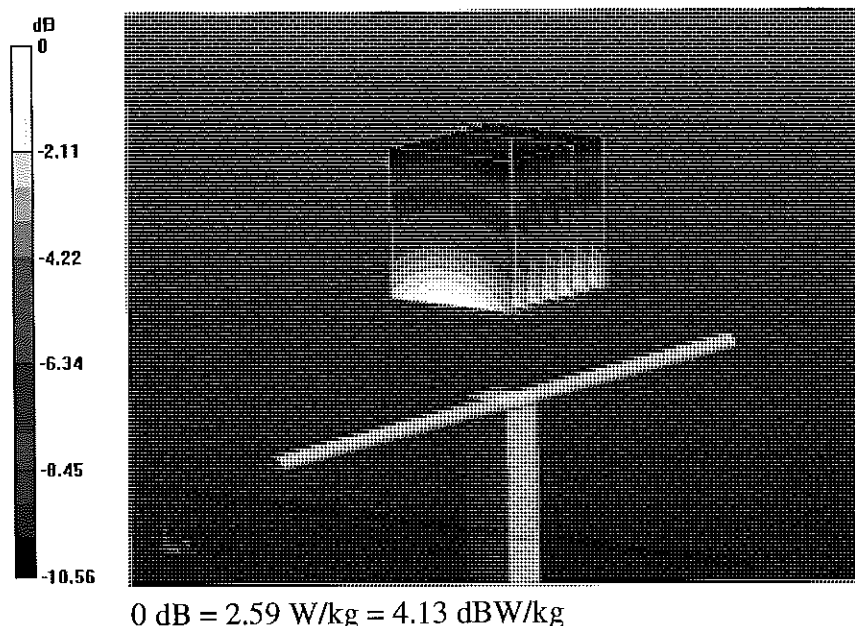

Impedance Measurement Plot for Body TSL

14 Mar 2014 17:44:13

CH1 S11 1 U FS 1: 48.496 Ω -2.8066 Ω 75.609 pF 750.000 000 MHz

*
Del
CA

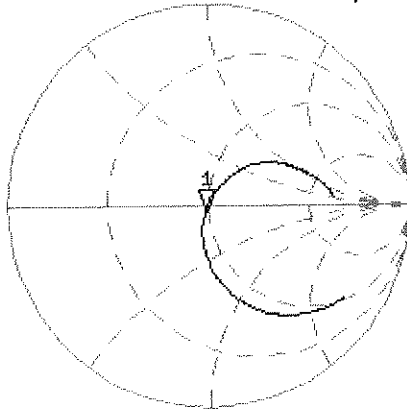

avg
16

H1 d

CH2 S11 LOG 5 dB/REF -20 dB 1: -29.812 dB 750.000 000 MHz

CA

avg
16

H1 d

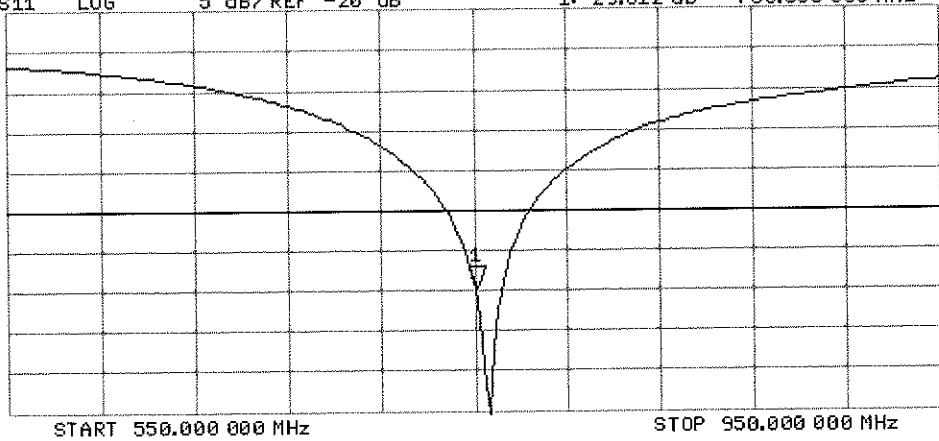



Accredited by the Swiss Accreditation Service (SAS)
The Swiss Accreditation Service is one of the signatories to the EA
Multilateral Agreement for the recognition of calibration certificates

Accreditation No.: SCS 108

Client **PC Test**

Certificate No: **D5GHzV2-1120_Feb14**

CALIBRATION CERTIFICATE

Object **D5GHzV2 - SN: 1120**

Calibration procedure(s) **QA CAL-22.v2
Calibration procedure for dipole validation kits between 3-6 GHz**

Calibration date: **February 26, 2014**

CCV
3/16/14

This calibration certificate documents the traceability to national standards, which realize the physical units of measurements (SI).
The measurements and the uncertainties with confidence probability are given on the following pages and are part of the certificate.

All calibrations have been conducted in the closed laboratory facility: environment temperature (22 ± 3)°C and humidity < 70%.

Calibration Equipment used (M&TE critical for calibration)

Primary Standards	ID #	Cal Date (Certificate No.)	Scheduled Calibration
Power meter EPM-442A	GB37480704	09-Oct-13 (No. 217-01827)	Oct-14
Power sensor HP 8481A	US37292783	09-Oct-13 (No. 217-01827)	Oct-14
Power sensor HP 8481A	MY41092317	09-Oct-13 (No. 217-01828)	Oct-14
Reference 20 dB Attenuator	SN: 5058 (20k)	04-Apr-13 (No. 217-01736)	Apr-14
Type-N mismatch combination	SN: 5047.3 / 06327	04-Apr-13 (No. 217-01739)	Apr-14
Reference Probe EX3DV4	SN: 3503	30-Dec-13 (No. EX3-3503_Dec13)	Dec-14
DAE4	SN: 601	25-Apr-13 (No. DAE4-601_Apr13)	Apr-14
Secondary Standards	ID #	Check Date (in house)	Scheduled Check
RF generator R&S SMT-06	100005	04-Aug-99 (in house check Oct-13)	In house check: Oct-16
Network Analyzer HP 8753E	US37390585 S4206	18-Oct-01 (in house check Oct-13)	In house check: Oct-14

Calibrated by: **Claudio Leubler** Laboratory Technician

Signature

Approved by: **Katja Pokovic** Technical Manager

Issued: February 27, 2014

This calibration certificate shall not be reproduced except in full without written approval of the laboratory.



Accredited by the Swiss Accreditation Service (SAS)

The Swiss Accreditation Service is one of the signatories to the EA
Multilateral Agreement for the recognition of calibration certificates

Glossary:

TSL	tissue simulating liquid
ConvF	sensitivity in TSL / NORM x,y,z
N/A	not applicable or not measured

Calibration is Performed According to the Following Standards:

- IEC 62209-2, "Evaluation of Human Exposure to Radio Frequency Fields from Handheld and Body-Mounted Wireless Communication Devices in the Frequency Range of 30 MHz to 6 GHz: Human models, Instrumentation, and Procedures"; Part 2: "Procedure to determine the Specific Absorption Rate (SAR) for including accessories and multiple transmitters", March 2010
- KDB 865664, "SAR Measurement Requirements for 100 MHz to 6 GHz"
- IEEE Std 1528-2013, "IEEE Recommended Practice for Determining the Peak Spatial-Averaged Specific Absorption Rate (SAR) in the Human Head from Wireless Communications Devices: Measurement Techniques", June 2013

Additional Documentation:

- DASY4/5 System Handbook

Methods Applied and Interpretation of Parameters:

- Measurement Conditions:** Further details are available from the Validation Report at the end of the certificate. All figures stated in the certificate are valid at the frequency indicated.
- Antenna Parameters with TSL:** The dipole is mounted with the spacer to position its feed point exactly below the center marking of the flat phantom section, with the arms oriented parallel to the body axis.
- Feed Point Impedance and Return Loss:** These parameters are measured with the dipole positioned under the liquid filled phantom. The impedance stated is transformed from the measurement at the SMA connector to the feed point. The Return Loss ensures low reflected power. No uncertainty required.
- Electrical Delay:** One-way delay between the SMA connector and the antenna feed point. No uncertainty required.
- SAR measured:** SAR measured at the stated antenna input power.
- SAR normalized:** SAR as measured, normalized to an input power of 1 W at the antenna connector.
- SAR for nominal TSL parameters:** The measured TSL parameters are used to calculate the nominal SAR result.

The reported uncertainty of measurement is stated as the standard uncertainty of measurement multiplied by the coverage factor $k=2$, which for a normal distribution corresponds to a coverage probability of approximately 95%.

Measurement Conditions

DASY system configuration, as far as not given on page 1.

DASY Version	DASY5	V52.8.7
Extrapolation	Advanced Extrapolation	
Phantom	Modular Flat Phantom V5.0	
Distance Dipole Center - TSL	10 mm	with Spacer
Zoom Scan Resolution	dx, dy = 4.0 mm, dz = 1.4 mm	Graded Ratio = 1.4 (Z direction)
Frequency	5200 MHz ± 1 MHz 5300 MHz ± 1 MHz 5500 MHz ± 1 MHz 5600 MHz ± 1 MHz 5800 MHz ± 1 MHz	

Head TSL parameters at 5200 MHz

The following parameters and calculations were applied.

	Temperature	Permittivity	Conductivity
Nominal Head TSL parameters	22.0 °C	36.0	4.66 mho/m
Measured Head TSL parameters	(22.0 ± 0.2) °C	37.1 ± 6 %	4.52 mho/m ± 6 %
Head TSL temperature change during test	< 0.5 °C	----	----

SAR result with Head TSL at 5200 MHz

SAR averaged over 1 cm³ (1 g) of Head TSL	Condition	
SAR measured	100 mW input power	7.87 W/kg
SAR for nominal Head TSL parameters	normalized to 1W	79.1 W/kg ± 19.9 % (k=2)

SAR averaged over 10 cm³ (10 g) of Head TSL	condition	
SAR measured	100 mW input power	2.24 W/kg
SAR for nominal Head TSL parameters	normalized to 1W	22.5 W/kg ± 19.5 % (k=2)

Head TSL parameters at 5300 MHz

The following parameters and calculations were applied.

	Temperature	Permittivity	Conductivity
Nominal Head TSL parameters	22.0 °C	35.9	4.76 mho/m
Measured Head TSL parameters	(22.0 ± 0.2) °C	36.9 ± 6 %	4.63 mho/m ± 6 %
Head TSL temperature change during test	< 0.5 °C	----	----

SAR result with Head TSL at 5300 MHz

SAR averaged over 1 cm ³ (1 g) of Head TSL	Condition	
SAR measured	100 mW input power	8.30 W/kg
SAR for nominal Head TSL parameters	normalized to 1W	83.4 W / kg ± 19.9 % (k=2)

SAR averaged over 10 cm ³ (10 g) of Head TSL	condition	
SAR measured	100 mW input power	2.37 W/kg
SAR for nominal Head TSL parameters	normalized to 1W	23.8 W/kg ± 19.5 % (k=2)

Head TSL parameters at 5500 MHz

The following parameters and calculations were applied.

	Temperature	Permittivity	Conductivity
Nominal Head TSL parameters	22.0 °C	35.6	4.96 mho/m
Measured Head TSL parameters	(22.0 ± 0.2) °C	36.7 ± 6 %	4.84 mho/m ± 6 %
Head TSL temperature change during test	< 0.5 °C	----	----

SAR result with Head TSL at 5500 MHz

SAR averaged over 1 cm ³ (1 g) of Head TSL	Condition	
SAR measured	100 mW input power	8.45 W/kg
SAR for nominal Head TSL parameters	normalized to 1W	84.9 W/kg ± 19.9 % (k=2)

SAR averaged over 10 cm ³ (10 g) of Head TSL	condition	
SAR measured	100 mW input power	2.40 W/kg
SAR for nominal Head TSL parameters	normalized to 1W	24.1 W/kg ± 19.5 % (k=2)

Head TSL parameters at 5600 MHz

The following parameters and calculations were applied.

	Temperature	Permittivity	Conductivity
Nominal Head TSL parameters	22.0 °C	35.5	5.07 mho/m
Measured Head TSL parameters	(22.0 ± 0.2) °C	36.6 ± 6 %	4.95 mho/m ± 6 %
Head TSL temperature change during test	< 0.5 °C	----	----

SAR result with Head TSL at 5600 MHz

SAR averaged over 1 cm ³ (1 g) of Head TSL	Condition	
SAR measured	100 mW input power	8.18 W/kg
SAR for nominal Head TSL parameters	normalized to 1W	82.2 W/kg ± 19.9 % (k=2)

SAR averaged over 10 cm ³ (10 g) of Head TSL	condition	
SAR measured	100 mW input power	2.33 W/kg
SAR for nominal Head TSL parameters	normalized to 1W	23.5 W/kg ± 19.5 % (k=2)

Head TSL parameters at 5800 MHz

The following parameters and calculations were applied.

	Temperature	Permittivity	Conductivity
Nominal Head TSL parameters	22.0 °C	35.3	5.27 mho/m
Measured Head TSL parameters	(22.0 ± 0.2) °C	36.3 ± 6 %	5.16 mho/m ± 6 %
Head TSL temperature change during test	< 0.5 °C	----	----

SAR result with Head TSL at 5800 MHz

SAR averaged over 1 cm ³ (1 g) of Head TSL	Condition	
SAR measured	100 mW input power	7.87 W/kg
SAR for nominal Head TSL parameters	normalized to 1W	79.1 W/kg ± 19.9 % (k=2)

SAR averaged over 10 cm ³ (10 g) of Head TSL	condition	
SAR measured	100 mW input power	2.23 W/kg
SAR for nominal Head TSL parameters	normalized to 1W	22.4 W/kg ± 19.5 % (k=2)

Body TSL parameters at 5200 MHz

The following parameters and calculations were applied.

	Temperature	Permittivity	Conductivity
Nominal Body TSL parameters	22.0 °C	49.0	5.30 mho/m
Measured Body TSL parameters	(22.0 ± 0.2) °C	47.8 ± 6 %	5.40 mho/m ± 6 %
Body TSL temperature change during test	< 0.5 °C	----	----

SAR result with Body TSL at 5200 MHz

SAR averaged over 1 cm ³ (1 g) of Body TSL	Condition	
SAR measured	100 mW input power	7.43 W/kg
SAR for nominal Body TSL parameters	normalized to 1W	74.0 W/kg ± 19.9 % (k=2)

SAR averaged over 10 cm ³ (10 g) of Body TSL	condition	
SAR measured	100 mW input power	2.08 W/kg
SAR for nominal Body TSL parameters	normalized to 1W	20.7 W/kg ± 19.5 % (k=2)

Body TSL parameters at 5300 MHz

The following parameters and calculations were applied.

	Temperature	Permittivity	Conductivity
Nominal Body TSL parameters	22.0 °C	48.9	5.42 mho/m
Measured Body TSL parameters	(22.0 ± 0.2) °C	47.6 ± 6 %	5.53 mho/m ± 6 %
Body TSL temperature change during test	< 0.5 °C	----	----

SAR result with Body TSL at 5300 MHz

SAR averaged over 1 cm ³ (1 g) of Body TSL	Condition	
SAR measured	100 mW input power	7.62 W/kg
SAR for nominal Body TSL parameters	normalized to 1W	75.8 W/kg ± 19.9 % (k=2)

SAR averaged over 10 cm ³ (10 g) of Body TSL	condition	
SAR measured	100 mW input power	2.14 W/kg
SAR for nominal Body TSL parameters	normalized to 1W	21.3 W/kg ± 19.5 % (k=2)

Body TSL parameters at 5500 MHz

The following parameters and calculations were applied.

	Temperature	Permittivity	Conductivity
Nominal Body TSL parameters	22.0 °C	48.6	5.65 mho/m
Measured Body TSL parameters	(22.0 ± 0.2) °C	47.3 ± 6 %	5.80 mho/m ± 6 %
Body TSL temperature change during test	< 0.5 °C	----	----

SAR result with Body TSL at 5500 MHz

SAR averaged over 1 cm ³ (1 g) of Body TSL	Condition	
SAR measured	100 mW input power	7.96 W/kg
SAR for nominal Body TSL parameters	normalized to 1W	79.2 W/kg ± 19.9 % (k=2)

SAR averaged over 10 cm ³ (10 g) of Body TSL	condition	
SAR measured	100 mW input power	2.21 W/kg
SAR for nominal Body TSL parameters	normalized to 1W	22.0 W/kg ± 19.5 % (k=2)

Body TSL parameters at 5600 MHz

The following parameters and calculations were applied.

	Temperature	Permittivity	Conductivity
Nominal Body TSL parameters	22.0 °C	48.5	5.77 mho/m
Measured Body TSL parameters	(22.0 ± 0.2) °C	47.1 ± 6 %	5.94 mho/m ± 6 %
Body TSL temperature change during test	< 0.5 °C	----	----

SAR result with Body TSL at 5600 MHz

SAR averaged over 1 cm ³ (1 g) of Body TSL	Condition	
SAR measured	100 mW input power	7.98 W/kg
SAR for nominal Body TSL parameters	normalized to 1W	79.4 W/kg ± 19.9 % (k=2)

SAR averaged over 10 cm ³ (10 g) of Body TSL	condition	
SAR measured	100 mW input power	2.21 W/kg
SAR for nominal Body TSL parameters	normalized to 1W	22.0 W/kg ± 19.5 % (k=2)

Body TSL parameters at 5800 MHz

The following parameters and calculations were applied.

	Temperature	Permittivity	Conductivity
Nominal Body TSL parameters	22.0 °C	48.2	6.00 mho/m
Measured Body TSL parameters	(22.0 ± 0.2) °C	46.8 ± 6 %	6.21 mho/m ± 6 %
Body TSL temperature change during test	< 0.5 °C	----	----

SAR result with Body TSL at 5800 MHz

SAR averaged over 1 cm ³ (1 g) of Body TSL	Condition	
SAR measured	100 mW input power	7.47 W/kg
SAR for nominal Body TSL parameters	normalized to 1W	74.4 W/kg ± 19.9 % (k=2)

SAR averaged over 10 cm ³ (10 g) of Body TSL	condition	
SAR measured	100 mW input power	2.07 W/kg
SAR for nominal Body TSL parameters	normalized to 1W	20.6 W/kg ± 19.5 % (k=2)

Appendix

Antenna Parameters with Head TSL at 5200 MHz

Impedance, transformed to feed point	54.0 Ω - 5.6 j Ω
Return Loss	- 23.6 dB

Antenna Parameters with Head TSL at 5300 MHz

Impedance, transformed to feed point	51.1 Ω + 1.6 j Ω
Return Loss	- 34.6 dB

Antenna Parameters with Head TSL at 5500 MHz

Impedance, transformed to feed point	51.1 Ω - 2.3 j Ω
Return Loss	- 31.9 dB

Antenna Parameters with Head TSL at 5600 MHz

Impedance, transformed to feed point	58.4 Ω - 0.2 j Ω
Return Loss	- 22.2 dB

Antenna Parameters with Head TSL at 5800 MHz

Impedance, transformed to feed point	52.9 Ω + 2.8 j Ω
Return Loss	- 28.2 dB

Antenna Parameters with Body TSL at 5200 MHz

Impedance, transformed to feed point	52.3 Ω - 5.9 j Ω
Return Loss	- 24.2 dB

Antenna Parameters with Body TSL at 5300 MHz

Impedance, transformed to feed point	51.1 Ω + 1.2 j Ω
Return Loss	- 35.8 dB

Antenna Parameters with Body TSL at 5500 MHz

Impedance, transformed to feed point	50.5 Ω - 2.6 j Ω
Return Loss	- 31.6 dB

Antenna Parameters with Body TSL at 5600 MHz

Impedance, transformed to feed point	59.5 Ω - 2.9 j Ω
Return Loss	- 20.9 dB

Antenna Parameters with Body TSL at 5800 MHz

Impedance, transformed to feed point	54.2 Ω + 1.1 j Ω
Return Loss	- 27.7 dB

General Antenna Parameters and Design

Electrical Delay (one direction)	1.206 ns
----------------------------------	----------

After long term use with 100W radiated power, only a slight warming of the dipole near the feedpoint can be measured.

The dipole is made of standard semirigid coaxial cable. The center conductor of the feeding line is directly connected to the second arm of the dipole. The antenna is therefore short-circuited for DC-signals. On some of the dipoles, small end caps are added to the dipole arms in order to improve matching when loaded according to the position as explained in the "Measurement Conditions" paragraph. The SAR data are not affected by this change. The overall dipole length is still according to the Standard.

No excessive force must be applied to the dipole arms, because they might bend or the soldered connections near the feedpoint may be damaged.

Additional EUT Data

Manufactured by	SPEAG
Manufactured on	September 08, 2011

DASY5 Validation Report for Head TSL

Date: 26.02.2014

Test Laboratory: SPEAG, Zurich, Switzerland

DUT: Dipole 5GHz; Type: D5GHzV2; Serial: D5GHzV2 - SN: 1120

Communication System: UID 0 - CW; Frequency: 5200 MHz, Frequency: 5300 MHz, Frequency: 5500 MHz, Frequency: 5600 MHz, Frequency: 5800 MHz

Medium parameters used: $f = 5200$ MHz; $\sigma = 4.52$ S/m; $\epsilon_r = 37.1$; $\rho = 1000$ kg/m³,

Medium parameters used: $f = 5300$ MHz; $\sigma = 4.63$ S/m; $\epsilon_r = 36.9$; $\rho = 1000$ kg/m³,

Medium parameters used: $f = 5500$ MHz; $\sigma = 4.84$ S/m; $\epsilon_r = 36.7$; $\rho = 1000$ kg/m³,

Medium parameters used: $f = 5600$ MHz; $\sigma = 4.95$ S/m; $\epsilon_r = 36.6$; $\rho = 1000$ kg/m³,

Medium parameters used: $f = 5800$ MHz; $\sigma = 5.16$ S/m; $\epsilon_r = 36.3$; $\rho = 1000$ kg/m³

Phantom section: Flat Section

Measurement Standard: DASY5 (IEEE/IEC/ANSI C63.19-2007)

DASY52 Configuration:

- Probe: EX3DV4 - SN3503; ConvF(5.52, 5.52, 5.52); Calibrated: 30.12.2013, ConvF(5.2, 5.2, 5.2); Calibrated: 30.12.2013, ConvF(5.01, 5.01, 5.01); Calibrated: 30.12.2013, ConvF(4.86, 4.86, 4.86); Calibrated: 30.12.2013, ConvF(4.91, 4.91, 4.91); Calibrated: 30.12.2013;
- Sensor-Surface: 1.4mm (Mechanical Surface Detection)
- Electronics: DAE4 Sn601; Calibrated: 25.04.2013
- Phantom: Flat Phantom 5.0 (front); Type: QD000P50AA; Serial: 1001
- DASY52 52.8.7(1137); SEMCAD X 14.6.10(7164)

Dipole Calibration for Head Tissue/Pin=100mW, dist=10mm, f=5200 MHz/Zoom Scan,

dist=1.4mm (8x8x7)/Cube 0: Measurement grid: dx=4mm, dy=4mm, dz=1.4mm

Reference Value = 62.794 V/m; Power Drift = 0.06 dB

Peak SAR (extrapolated) = 28.6 W/kg

SAR(1 g) = 7.87 W/kg; SAR(10 g) = 2.24 W/kg

Maximum value of SAR (measured) = 18.0 W/kg

Dipole Calibration for Head Tissue/Pin=100mW, dist=10mm, f=5300 MHz/Zoom Scan,

dist=1.4mm (8x8x7)/Cube 0: Measurement grid: dx=4mm, dy=4mm, dz=1.4mm

Reference Value = 63.390 V/m; Power Drift = 0.05 dB

Peak SAR (extrapolated) = 31.5 W/kg

SAR(1 g) = 8.3 W/kg; SAR(10 g) = 2.37 W/kg

Maximum value of SAR (measured) = 19.2 W/kg

Dipole Calibration for Head Tissue/Pin=100mW, dist=10mm, f=5500 MHz/Zoom Scan,

dist=1.4mm (8x8x7)/Cube 0: Measurement grid: dx=4mm, dy=4mm, dz=1.4mm

Reference Value = 63.321 V/m; Power Drift = 0.08 dB

Peak SAR (extrapolated) = 33.6 W/kg

SAR(1 g) = 8.45 W/kg; SAR(10 g) = 2.4 W/kg

Maximum value of SAR (measured) = 20.0 W/kg

Dipole Calibration for Head Tissue/Pin=100mW, dist=10mm, f=5600 MHz/Zoom Scan, dist=1.4mm (8x8x7)/Cube 0: Measurement grid: dx=4mm, dy=4mm, dz=1.4mm
Reference Value = 62.007 V/m; Power Drift = 0.07 dB
Peak SAR (extrapolated) = 32.7 W/kg
SAR(1 g) = 8.18 W/kg; SAR(10 g) = 2.33 W/kg
Maximum value of SAR (measured) = 19.4 W/kg

Dipole Calibration for Head Tissue/Pin=100mW, dist=10mm, f=5800 MHz/Zoom Scan, dist=1.4mm (8x8x7)/Cube 0: Measurement grid: dx=4mm, dy=4mm, dz=1.4mm
Reference Value = 59.638 V/m; Power Drift = 0.07 dB
Peak SAR (extrapolated) = 33.0 W/kg
SAR(1 g) = 7.87 W/kg; SAR(10 g) = 2.23 W/kg
Maximum value of SAR (measured) = 19.0 W/kg

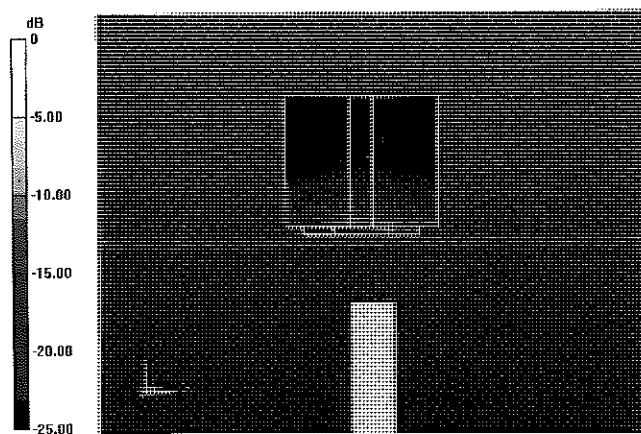

0 dB = 19.0 W/kg = 12.79 dBW/kg

Impedance Measurement Plot for Head TSL

26 Feb 2014 10:12:36

[CH1] S11 1 U FS 1: 53.980 Ω -5.5879 Ω 5.4773 pF 5 200.000 000 MHz

*
Del
Cor
Avg
16
H1d

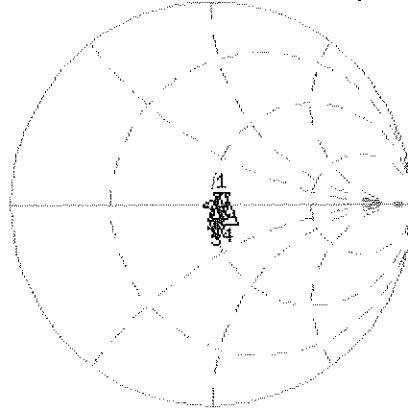

CH1 Markers
2: 51.086 Ω
1.5508 Ω
5.30000 GHz
3: 51.148 Ω
-2.3066 Ω
5.50000 GHz
4: 50.436 Ω
-153.20 m Ω
5.60000 GHz
5: 52.877 Ω
2.8086 Ω
5.80000 GHz

CH2 S11 LOG 5 dB/REF -20 dB 1:-23.625 dB 5 200.000 000 MHz

Cor
Avg
16
H1d

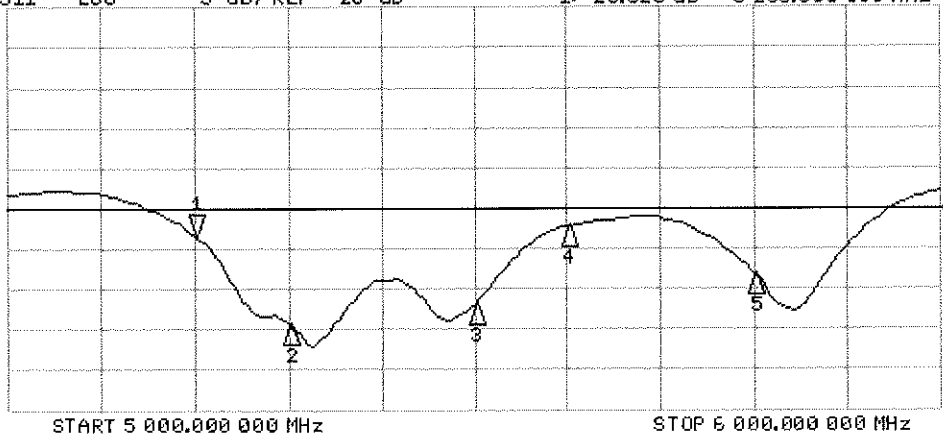

CH2 Markers
2:-34.550 dB
5.30000 GHz
3:-31.869 dB
5.50000 GHz
4:-22.182 dB
5.60000 GHz
5:-28.164 dB
5.80000 GHz

DASY5 Validation Report for Body TSL

Date: 25.02.2014

Test Laboratory: SPEAG, Zurich, Switzerland

DUT: Dipole 5GHz; Type: D5GHzV2; Serial: D5GHzV2 - SN: 1120

Communication System: UID 0 - CW; Frequency: 5200 MHz, Frequency: 5300 MHz, Frequency: 5500 MHz, Frequency: 5600 MHz, Frequency: 5800 MHz

Medium parameters used: $f = 5200$ MHz; $\sigma = 5.4$ S/m; $\epsilon_r = 47.8$; $\rho = 1000$ kg/m³,

Medium parameters used: $f = 5300$ MHz; $\sigma = 5.53$ S/m; $\epsilon_r = 47.6$; $\rho = 1000$ kg/m³,

Medium parameters used: $f = 5500$ MHz; $\sigma = 5.8$ S/m; $\epsilon_r = 47.3$; $\rho = 1000$ kg/m³,

Medium parameters used: $f = 5600$ MHz; $\sigma = 5.94$ S/m; $\epsilon_r = 47.1$; $\rho = 1000$ kg/m³,

Medium parameters used: $f = 5800$ MHz; $\sigma = 6.21$ S/m; $\epsilon_r = 46.8$; $\rho = 1000$ kg/m³

Phantom section: Flat Section

Measurement Standard: DASY5 (IEEE/IEC/ANSI C63.19-2007)

DASY52 Configuration:

- Probe: EX3DV4 - SN3503; ConvF(5.01, 5.01, 5.01); Calibrated: 30.12.2013, ConvF(4.76, 4.76, 4.76); Calibrated: 30.12.2013, ConvF(4.52, 4.52, 4.52); Calibrated: 30.12.2013, ConvF(4.3, 4.3, 4.3); Calibrated: 30.12.2013, ConvF(4.47, 4.47, 4.47); Calibrated: 30.12.2013;
- Sensor-Surface: 1.4mm (Mechanical Surface Detection)
- Electronics: DAE4 Sn601; Calibrated: 25.04.2013
- Phantom: Flat Phantom 5.0 (back); Type: QD000P50AA; Serial: 1002
- DASY52 52.8.7(1137); SEMCAD X 14.6.10(7164)

Dipole Calibration for Body Tissue/Pin=100mW, dist=10mm, f=5200 MHz/Zoom Scan, dist=1.4mm (8x8x7)/Cube 0: Measurement grid: dx=4mm, dy=4mm, dz=1.4mm

Reference Value = 59.562 V/m; Power Drift = 0.03 dB

Peak SAR (extrapolated) = 29.5 W/kg

SAR(1 g) = 7.43 W/kg; SAR(10 g) = 2.08 W/kg

Maximum value of SAR (measured) = 17.7 W/kg

Dipole Calibration for Body Tissue/Pin=100mW, dist=10mm, f=5300 MHz/Zoom Scan, dist=1.4mm (8x8x7)/Cube 0: Measurement grid: dx=4mm, dy=4mm, dz=1.4mm

Reference Value = 58.903 V/m; Power Drift = -0.02 dB

Peak SAR (extrapolated) = 31.1 W/kg

SAR(1 g) = 7.62 W/kg; SAR(10 g) = 2.14 W/kg

Maximum value of SAR (measured) = 18.4 W/kg

Dipole Calibration for Body Tissue/Pin=100mW, dist=10mm, f=5500 MHz/Zoom Scan, dist=1.4mm (8x8x7)/Cube 0: Measurement grid: dx=4mm, dy=4mm, dz=1.4mm

Reference Value = 59.015 V/m; Power Drift = -0.00 dB

Peak SAR (extrapolated) = 34.5 W/kg

SAR(1 g) = 7.96 W/kg; SAR(10 g) = 2.21 W/kg

Maximum value of SAR (measured) = 19.5 W/kg

Dipole Calibration for Body Tissue/Pin=100mW, dist=10mm, f=5600 MHz/Zoom Scan, dist=1.4mm (8x8x7)/Cube 0: Measurement grid: dx=4mm, dy=4mm, dz=1.4mm

Reference Value = 58.626 V/m; Power Drift = -0.02 dB

Peak SAR (extrapolated) = 35.6 W/kg

SAR(1 g) = 7.98 W/kg; SAR(10 g) = 2.21 W/kg

Maximum value of SAR (measured) = 19.8 W/kg

Dipole Calibration for Body Tissue/Pin=100mW, dist=10mm, f=5800 MHz/Zoom Scan, dist=1.4mm (8x8x7)/Cube 0: Measurement grid: dx=4mm, dy=4mm, dz=1.4mm

Reference Value = 55.428 V/m; Power Drift = -0.01 dB

Peak SAR (extrapolated) = 34.9 W/kg

SAR(1 g) = 7.47 W/kg; SAR(10 g) = 2.07 W/kg

Maximum value of SAR (measured) = 18.8 W/kg

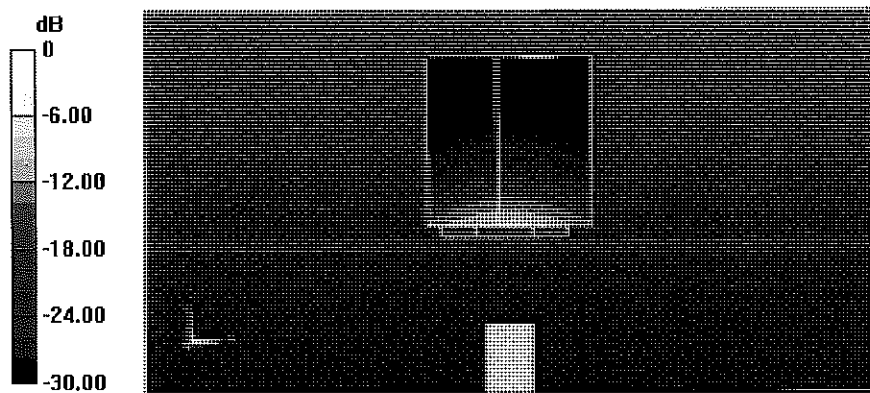

Impedance Measurement Plot for Body TSL

25 Feb 2014 15:49:48

CH1 S11 1 U FS 1: 52.344 Ω -5.8965 Ω 5.1907 pF 5 200.000 000 MHz

*
Del
Cor
Avg
16
H1d

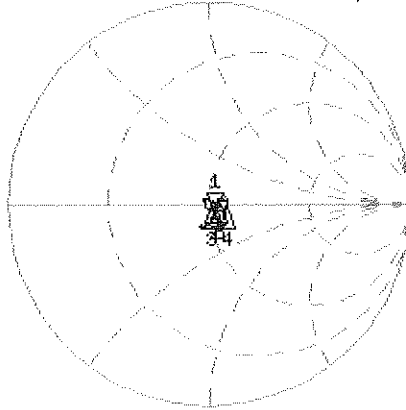

CH1 Markers
2: 51.105 Ω
1.1973 Ω
5.30000 GHz
3: 50.543 Ω
-2.5781 Ω
5.50000 GHz
4: 59.457 Ω
-2.9082 Ω
5.60000 GHz
5: 54.162 Ω
1.1016 Ω
5.80000 GHz

CH2 S11 LOG 5 dB/REF -20 dB 1: -24.165 dB 5 200.000 000 MHz

Cor
Avg
16
H1d

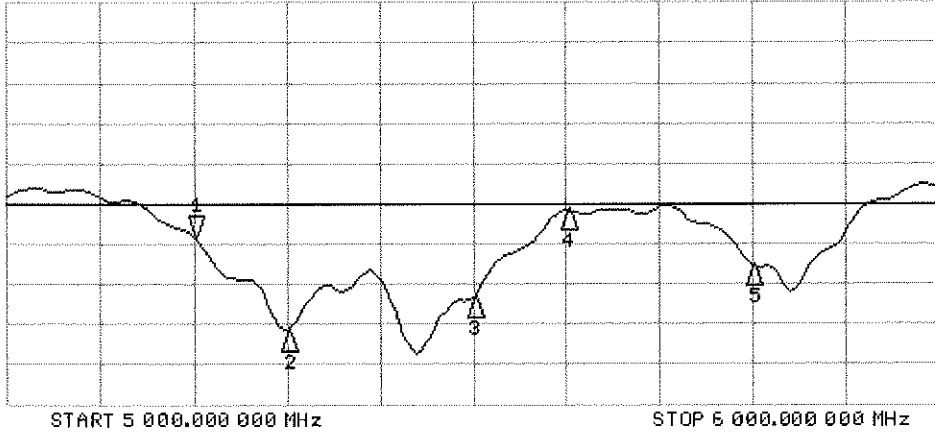

CH2 Markers
2: -35.830 dB
5.30000 GHz
3: -31.626 dB
5.50000 GHz
4: -20.878 dB
5.60000 GHz
5: -27.672 dB
5.80000 GHz



Accredited by the Swiss Accreditation Service (SAS)
The Swiss Accreditation Service is one of the signatories to the EA
Multilateral Agreement for the recognition of calibration certificates

Accreditation No.: **SCS 108**

Client **PC Test**

Certificate No: **D5GHzV2-1057_Jan14**

CALIBRATION CERTIFICATE

Object **D5GHzV2 - SN: 1057**

Calibration procedure(s) **QA CAL-22.v2
Calibration procedure for dipole validation kits between 3-6 GHz**

Calibration date: **January 27, 2014**

CC
2/5/14 ✓

This calibration certificate documents the traceability to national standards, which realize the physical units of measurements (SI).
The measurements and the uncertainties with confidence probability are given on the following pages and are part of the certificate.

All calibrations have been conducted in the closed laboratory facility: environment temperature (22 ± 3)°C and humidity < 70%.

Calibration Equipment used (M&TE critical for calibration)

Primary Standards	ID #	Cal Date (Certificate No.)	Scheduled Calibration
Power meter EPM-442A	GB37480704	09-Oct-13 (No. 217-01827)	Oct-14
Power sensor HP 8481A	US37292783	09-Oct-13 (No. 217-01827)	Oct-14
Power sensor HP 8481A	MY41092317	09-Oct-13 (No. 217-01828)	Oct-14
Reference 20 dB Attenuator	SN: 5058 (20k)	04-Apr-13 (No. 217-01736)	Apr-14
Type-N mismatch combination	SN: 5047.3 / 06327	04-Apr-13 (No. 217-01739)	Apr-14
Reference Probe EX3DV4	SN: 3503	30-Dec-13 (No. EX3-3503_Dec13)	Dec-14
DAE4	SN: 601	25-Apr-13 (No. DAE4-601_Apr13)	Apr-14
Secondary Standards	ID #	Check Date (in house)	Scheduled Check
RF generator R&S SMT-06	100005	04-Aug-99 (in house check Oct-13)	In house check: Oct-16
Network Analyzer HP 8753E	US37390585 S4206	18-Oct-01 (in house check Oct-13)	In house check: Oct-14

Calibrated by: **Israe El-Naouq** Name: **Israe El-Naouq** Function: **Laboratory Technician**

Approved by: **Kalja Pokovic** Name: **Kalja Pokovic** Technical Manager

Signature: *Israe El-Naouq*

Signature: *Kalja Pokovic*

Issued: January 27, 2014

This calibration certificate shall not be reproduced except in full without written approval of the laboratory.



Accredited by the Swiss Accreditation Service (SAS)

The Swiss Accreditation Service is one of the signatories to the EA
Multilateral Agreement for the recognition of calibration certificates

Glossary:

TSL	tissue simulating liquid
ConvF	sensitivity in TSL / NORM x,y,z
N/A	not applicable or not measured

Calibration is Performed According to the Following Standards:

- IEC 62209-2, "Evaluation of Human Exposure to Radio Frequency Fields from Handheld and Body-Mounted Wireless Communication Devices in the Frequency Range of 30 MHz to 6 GHz: Human models, Instrumentation, and Procedures"; Part 2: "Procedure to determine the Specific Absorption Rate (SAR) for including accessories and multiple transmitters", March 2010
- KDB 865664, "SAR Measurement Requirements for 100 MHz to 6 GHz"
- IEEE Std 1528-2013, "IEEE Recommended Practice for Determining the Peak Spatial-Averaged Specific Absorption Rate (SAR) in the Human Head from Wireless Communications Devices: Measurement Techniques", June 2013

Additional Documentation:

- DASY4/5 System Handbook

Methods Applied and Interpretation of Parameters:

- Measurement Conditions:** Further details are available from the Validation Report at the end of the certificate. All figures stated in the certificate are valid at the frequency indicated.
- Antenna Parameters with TSL:** The dipole is mounted with the spacer to position its feed point exactly below the center marking of the flat phantom section, with the arms oriented parallel to the body axis.
- Feed Point Impedance and Return Loss:** These parameters are measured with the dipole positioned under the liquid filled phantom. The impedance stated is transformed from the measurement at the SMA connector to the feed point. The Return Loss ensures low reflected power. No uncertainty required.
- Electrical Delay:** One-way delay between the SMA connector and the antenna feed point. No uncertainty required.
- SAR measured:** SAR measured at the stated antenna input power.
- SAR normalized:** SAR as measured, normalized to an input power of 1 W at the antenna connector.
- SAR for nominal TSL parameters:** The measured TSL parameters are used to calculate the nominal SAR result.

The reported uncertainty of measurement is stated as the standard uncertainty of measurement multiplied by the coverage factor $k=2$, which for a normal distribution corresponds to a coverage probability of approximately 95%.

Measurement Conditions

DASY system configuration, as far as not given on page 1.

DASY Version	DASY5	V52.8.7
Extrapolation	Advanced Extrapolation	
Phantom	Modular Flat Phantom V5.0	
Distance Dipole Center - TSL	10 mm	with Spacer
Zoom Scan Resolution	dx, dy = 4.0 mm, dz = 1.4 mm	Graded Ratio = 1.4 (Z direction)
Frequency	5200 MHz ± 1 MHz 5300 MHz ± 1 MHz 5500 MHz ± 1 MHz 5600 MHz ± 1 MHz 5800 MHz ± 1 MHz	

Head TSL parameters at 5200 MHz

The following parameters and calculations were applied.

	Temperature	Permittivity	Conductivity
Nominal Head TSL parameters	22.0 °C	36.0	4.66 mho/m
Measured Head TSL parameters	(22.0 ± 0.2) °C	35.0 ± 6 %	4.45 mho/m ± 6 %
Head TSL temperature change during test	< 0.5 °C	----	----

SAR result with Head TSL at 5200 MHz

SAR averaged over 1 cm³ (1 g) of Head TSL	Condition	
SAR measured	100 mW input power	7.85 W/kg
SAR for nominal Head TSL parameters	normalized to 1W	78.0 W/kg ± 19.9 % (k=2)

SAR averaged over 10 cm³ (10 g) of Head TSL	condition	
SAR measured	100 mW input power	2.25 W/kg
SAR for nominal Head TSL parameters	normalized to 1W	22.3 W/kg ± 19.5 % (k=2)

Head TSL parameters at 5300 MHz

The following parameters and calculations were applied.

	Temperature	Permittivity	Conductivity
Nominal Head TSL parameters	22.0 °C	35.9	4.76 mho/m
Measured Head TSL parameters	(22.0 ± 0.2) °C	34.9 ± 6 %	4.54 mho/m ± 6 %
Head TSL temperature change during test	< 0.5 °C	----	----

SAR result with Head TSL at 5300 MHz

SAR averaged over 1 cm ³ (1 g) of Head TSL	Condition	
SAR measured	100 mW input power	8.36 W/kg
SAR for nominal Head TSL parameters	normalized to 1W	83.0 W / kg ± 19.9 % (k=2)

SAR averaged over 10 cm ³ (10 g) of Head TSL	condition	
SAR measured	100 mW input power	2.40 W/kg
SAR for nominal Head TSL parameters	normalized to 1W	23.8 W/kg ± 19.5 % (k=2)

Head TSL parameters at 5500 MHz

The following parameters and calculations were applied.

	Temperature	Permittivity	Conductivity
Nominal Head TSL parameters	22.0 °C	35.6	4.96 mho/m
Measured Head TSL parameters	(22.0 ± 0.2) °C	34.6 ± 6 %	4.74 mho/m ± 6 %
Head TSL temperature change during test	< 0.5 °C	----	----

SAR result with Head TSL at 5500 MHz

SAR averaged over 1 cm ³ (1 g) of Head TSL	Condition	
SAR measured	100 mW input power	8.50 W/kg
SAR for nominal Head TSL parameters	normalized to 1W	84.3 W/kg ± 19.9 % (k=2)

SAR averaged over 10 cm ³ (10 g) of Head TSL	condition	
SAR measured	100 mW input power	2.42 W/kg
SAR for nominal Head TSL parameters	normalized to 1W	24.0 W/kg ± 19.5 % (k=2)

Head TSL parameters at 5600 MHz

The following parameters and calculations were applied.

	Temperature	Permittivity	Conductivity
Nominal Head TSL parameters	22.0 °C	35.5	5.07 mho/m
Measured Head TSL parameters	(22.0 ± 0.2) °C	34.5 ± 6 %	4.86 mho/m ± 6 %
Head TSL temperature change during test	< 0.5 °C	----	----

SAR result with Head TSL at 5600 MHz

SAR averaged over 1 cm ³ (1 g) of Head TSL	Condition	
SAR measured	100 mW input power	8.42 W/kg
SAR for nominal Head TSL parameters	normalized to 1W	83.5 W/kg ± 19.9 % (k=2)

SAR averaged over 10 cm ³ (10 g) of Head TSL	condition	
SAR measured	100 mW input power	2.40 W/kg
SAR for nominal Head TSL parameters	normalized to 1W	23.8 W/kg ± 19.5 % (k=2)

Head TSL parameters at 5800 MHz

The following parameters and calculations were applied.

	Temperature	Permittivity	Conductivity
Nominal Head TSL parameters	22.0 °C	35.3	5.27 mho/m
Measured Head TSL parameters	(22.0 ± 0.2) °C	34.2 ± 6 %	5.07 mho/m ± 6 %
Head TSL temperature change during test	< 0.5 °C	----	----

SAR result with Head TSL at 5800 MHz

SAR averaged over 1 cm ³ (1 g) of Head TSL	Condition	
SAR measured	100 mW input power	8.00 W/kg
SAR for nominal Head TSL parameters	normalized to 1W	79.3 W/kg ± 19.9 % (k=2)

SAR averaged over 10 cm ³ (10 g) of Head TSL	condition	
SAR measured	100 mW input power	2.28 W/kg
SAR for nominal Head TSL parameters	normalized to 1W	22.6 W/kg ± 19.5 % (k=2)

Body TSL parameters at 5200 MHz

The following parameters and calculations were applied.

	Temperature	Permittivity	Conductivity
Nominal Body TSL parameters	22.0 °C	49.0	5.30 mho/m
Measured Body TSL parameters	(22.0 ± 0.2) °C	47.3 ± 6 %	5.44 mho/m ± 6 %
Body TSL temperature change during test	< 0.5 °C	----	----

SAR result with Body TSL at 5200 MHz

SAR averaged over 1 cm ³ (1 g) of Body TSL	Condition	
SAR measured	100 mW input power	7.58 W/kg
SAR for nominal Body TSL parameters	normalized to 1W	75.3 W/kg ± 19.9 % (k=2)

SAR averaged over 10 cm ³ (10 g) of Body TSL	condition	
SAR measured	100 mW input power	2.12 W/kg
SAR for nominal Body TSL parameters	normalized to 1W	21.0 W/kg ± 19.5 % (k=2)

Body TSL parameters at 5300 MHz

The following parameters and calculations were applied.

	Temperature	Permittivity	Conductivity
Nominal Body TSL parameters	22.0 °C	48.9	5.42 mho/m
Measured Body TSL parameters	(22.0 ± 0.2) °C	47.2 ± 6 %	5.57 mho/m ± 6 %
Body TSL temperature change during test	< 0.5 °C	----	----

SAR result with Body TSL at 5300 MHz

SAR averaged over 1 cm ³ (1 g) of Body TSL	Condition	
SAR measured	100 mW input power	7.79 W/kg
SAR for nominal Body TSL parameters	normalized to 1W	77.4 W/kg ± 19.9 % (k=2)

SAR averaged over 10 cm ³ (10 g) of Body TSL	condition	
SAR measured	100 mW input power	2.17 W/kg
SAR for nominal Body TSL parameters	normalized to 1W	21.5 W/kg ± 19.5 % (k=2)

Body TSL parameters at 5500 MHz

The following parameters and calculations were applied.

	Temperature	Permittivity	Conductivity
Nominal Body TSL parameters	22.0 °C	48.6	5.65 mho/m
Measured Body TSL parameters	(22.0 ± 0.2) °C	46.8 ± 6 %	5.84 mho/m ± 6 %
Body TSL temperature change during test	< 0.5 °C	----	----

SAR result with Body TSL at 5500 MHz

SAR averaged over 1 cm ³ (1 g) of Body TSL	Condition	
SAR measured	100 mW input power	7.96 W/kg
SAR for nominal Body TSL parameters	normalized to 1W	79.1 W/kg ± 19.9 % (k=2)

SAR averaged over 10 cm ³ (10 g) of Body TSL	condition	
SAR measured	100 mW input power	2.22 W/kg
SAR for nominal Body TSL parameters	normalized to 1W	22.0 W/kg ± 19.5 % (k=2)

Body TSL parameters at 5600 MHz

The following parameters and calculations were applied.

	Temperature	Permittivity	Conductivity
Nominal Body TSL parameters	22.0 °C	48.5	5.77 mho/m
Measured Body TSL parameters	(22.0 ± 0.2) °C	46.6 ± 6 %	5.98 mho/m ± 6 %
Body TSL temperature change during test	< 0.5 °C	----	----

SAR result with Body TSL at 5600 MHz

SAR averaged over 1 cm ³ (1 g) of Body TSL	Condition	
SAR measured	100 mW input power	8.07 W/kg
SAR for nominal Body TSL parameters	normalized to 1W	80.2 W/kg ± 19.9 % (k=2)

SAR averaged over 10 cm ³ (10 g) of Body TSL	condition	
SAR measured	100 mW input power	2.24 W/kg
SAR for nominal Body TSL parameters	normalized to 1W	22.2 W/kg ± 19.5 % (k=2)

Body TSL parameters at 5800 MHz

The following parameters and calculations were applied.

	Temperature	Permittivity	Conductivity
Nominal Body TSL parameters	22.0 °C	48.2	6.00 mho/m
Measured Body TSL parameters	(22.0 ± 0.2) °C	46.3 ± 6 %	6.23 mho/m ± 6 %
Body TSL temperature change during test	< 0.5 °C	----	----

SAR result with Body TSL at 5800 MHz

SAR averaged over 1 cm ³ (1 g) of Body TSL	Condition	
SAR measured	100 mW input power	7.48 W/kg
SAR for nominal Body TSL parameters	normalized to 1W	74.3 W/kg ± 19.9 % (k=2)

SAR averaged over 10 cm ³ (10 g) of Body TSL	condition	
SAR measured	100 mW input power	2.06 W/kg
SAR for nominal Body TSL parameters	normalized to 1W	20.4 W/kg ± 19.5 % (k=2)

Appendix

Antenna Parameters with Head TSL at 5200 MHz

Impedance, transformed to feed point	43.1 Ω - 4.6 j Ω
Return Loss	- 21.0 dB

Antenna Parameters with Head TSL at 5300 MHz

Impedance, transformed to feed point	46.5 Ω - 1.3 j Ω
Return Loss	- 28.1 dB

Antenna Parameters with Head TSL at 5500 MHz

Impedance, transformed to feed point	46.2 Ω - 2.5 j Ω
Return Loss	- 26.4 dB

Antenna Parameters with Head TSL at 5600 MHz

Impedance, transformed to feed point	48.9 Ω - 5.7 j Ω
Return Loss	- 24.6 dB

Antenna Parameters with Head TSL at 5800 MHz

Impedance, transformed to feed point	48.7 Ω - 3.1 j Ω
Return Loss	- 29.5 dB

Antenna Parameters with Body TSL at 5200 MHz

Impedance, transformed to feed point	49.4 Ω - 7.7 j Ω
Return Loss	- 22.2 dB

Antenna Parameters with Body TSL at 5300 MHz

Impedance, transformed to feed point	49.6 Ω - 3.0 j Ω
Return Loss	- 30.3 dB

Antenna Parameters with Body TSL at 5500 MHz

Impedance, transformed to feed point	50.8 Ω - 3.9 j Ω
Return Loss	- 28.0 dB

Antenna Parameters with Body TSL at 5600 MHz

Impedance, transformed to feed point	55.4 Ω - 2.5 j Ω
Return Loss	- 25.0 dB

Antenna Parameters with Body TSL at 5800 MHz

Impedance, transformed to feed point	52.3 Ω - 0.7 j Ω
Return Loss	- 32.5 dB

General Antenna Parameters and Design

Electrical Delay (one direction)	1.186 ns
----------------------------------	----------

After long term use with 100W radiated power, only a slight warming of the dipole near the feedpoint can be measured.

The dipole is made of standard semirigid coaxial cable. The center conductor of the feeding line is directly connected to the second arm of the dipole. The antenna is therefore short-circuited for DC-signals. On some of the dipoles, small end caps are added to the dipole arms in order to improve matching when loaded according to the position as explained in the "Measurement Conditions" paragraph. The SAR data are not affected by this change. The overall dipole length is still according to the Standard.

No excessive force must be applied to the dipole arms, because they might bend or the soldered connections near the feedpoint may be damaged.

Additional EUT Data

Manufactured by	SPEAG
Manufactured on	November 27, 2006

DASY5 Validation Report for Head TSL

Date: 27.01.2014

Test Laboratory: SPEAG, Zurich, Switzerland

DUT: Dipole 5GHz; Type: D5GHzV2; Serial: D5GHzV2 - SN: 1057

Communication System: UID 0 - CW; Frequency: 5200 MHz, Frequency: 5300 MHz, Frequency: 5500 MHz, Frequency: 5600 MHz, Frequency: 5800 MHz

Medium parameters used: $f = 5200$ MHz; $\sigma = 4.45$ S/m; $\epsilon_r = 35$; $\rho = 1000$ kg/m³, Medium parameters used: $f = 5300$ MHz; $\sigma = 4.54$ S/m; $\epsilon_r = 34.9$; $\rho = 1000$ kg/m³, Medium parameters used: $f = 5500$ MHz; $\sigma = 4.74$ S/m; $\epsilon_r = 34.6$; $\rho = 1000$ kg/m³, Medium parameters used: $f = 5600$ MHz; $\sigma = 4.86$ S/m; $\epsilon_r = 34.5$; $\rho = 1000$ kg/m³, Medium parameters used: $f = 5800$ MHz; $\sigma = 5.07$ S/m; $\epsilon_r = 34.2$; $\rho = 1000$ kg/m³

Phantom section: Flat Section

Measurement Standard: DASY5 (IEEE/IEC/ANSI C63.19-2007)

DASY52 Configuration:

- Probe: EX3DV4 - SN3503; ConvF(5.52, 5.52, 5.52); Calibrated: 30.12.2013, ConvF(5.2, 5.2, 5.2); Calibrated: 30.12.2013, ConvF(5.01, 5.01, 5.01); Calibrated: 30.12.2013, ConvF(4.86, 4.86, 4.86); Calibrated: 30.12.2013, ConvF(4.91, 4.91, 4.91); Calibrated: 30.12.2013;
- Sensor-Surface: 1.4mm (Mechanical Surface Detection)
- Electronics: DAE4 Sn601; Calibrated: 25.04.2013
- Phantom: Flat Phantom 5.0 (front); Type: QD000P50AA; Serial: 1001
- DASY52 52.8.7(1137); SEMCAD X 14.6.10(7164)

Dipole Calibration for Head Tissue/Pin=100mW, dist=10mm, f=5200 MHz/Zoom Scan, dist=1.4mm (8x8x7)/Cube 0: Measurement grid: dx=4mm, dy=4mm, dz=1.4mm

Reference Value = 63.497 V/m; Power Drift = 0.04 dB

Peak SAR (extrapolated) = 28.2 W/kg

SAR(1 g) = 7.85 W/kg; SAR(10 g) = 2.25 W/kg

Maximum value of SAR (measured) = 18.6 W/kg

Dipole Calibration for Head Tissue/Pin=100mW, dist=10mm, f=5300 MHz/Zoom Scan, dist=1.4mm (8x8x7)/Cube 0: Measurement grid: dx=4mm, dy=4mm, dz=1.4mm

Reference Value = 64.444 V/m; Power Drift = 0.07 dB

Peak SAR (extrapolated) = 31.2 W/kg

SAR(1 g) = 8.36 W/kg; SAR(10 g) = 2.4 W/kg

Maximum value of SAR (measured) = 20.1 W/kg

Dipole Calibration for Head Tissue/Pin=100mW, dist=10mm, f=5500 MHz/Zoom Scan, dist=1.4mm (8x8x7)/Cube 0: Measurement grid: dx=4mm, dy=4mm, dz=1.4mm

Reference Value = 63.807 V/m; Power Drift = 0.07 dB

Peak SAR (extrapolated) = 33.0 W/kg

SAR(1 g) = 8.5 W/kg; SAR(10 g) = 2.42 W/kg

Maximum value of SAR (measured) = 20.8 W/kg

Dipole Calibration for Head Tissue/Pin=100mW, dist=10mm, f=5600 MHz/Zoom Scan, dist=1.4mm (8x8x7)/Cube 0: Measurement grid: dx=4mm, dy=4mm, dz=1.4mm
Reference Value = 63.194 V/m; Power Drift = 0.06 dB
Peak SAR (extrapolated) = 33.2 W/kg
SAR(1 g) = 8.42 W/kg; SAR(10 g) = 2.4 W/kg

Dipole Calibration for Head Tissue/Pin=100mW, dist=10mm, f=5800 MHz/Zoom Scan, dist=1.4mm (8x8x7)/Cube 0: Measurement grid: dx=4mm, dy=4mm, dz=1.4mm
Reference Value = 60.646 V/m; Power Drift = 0.08 dB
Peak SAR (extrapolated) = 32.9 W/kg
SAR(1 g) = 8 W/kg; SAR(10 g) = 2.28 W/kg
Maximum value of SAR (measured) = 19.9 W/kg

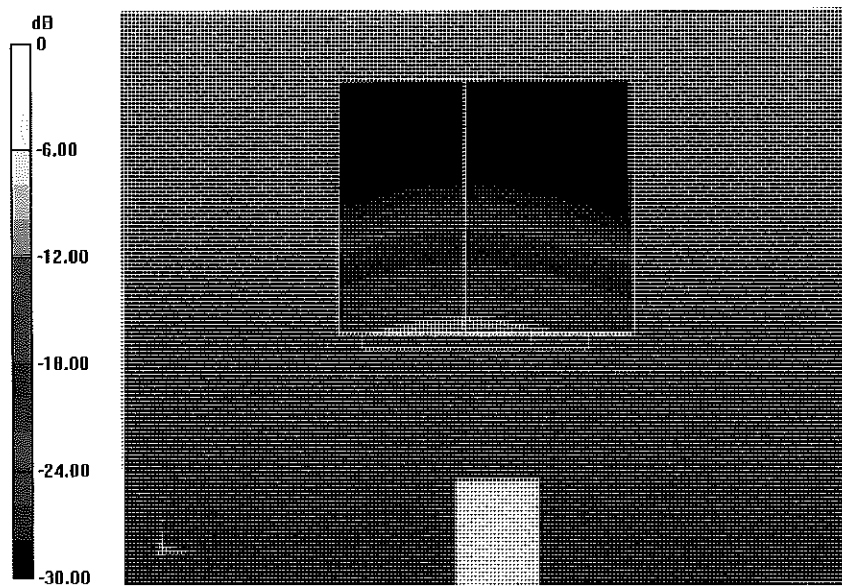

0 dB = 19.9 W/kg = 12.99 dBW/kg

Impedance Measurement Plot for Head TSL

27 Jan 2014 17:12:04

CH1 S11 1 U FS

1: 43.092 Ω -4.5938 Ω 6.6627 pF

5 200.000 000 MHz

*
De1
Cor
Avg
16
H1d

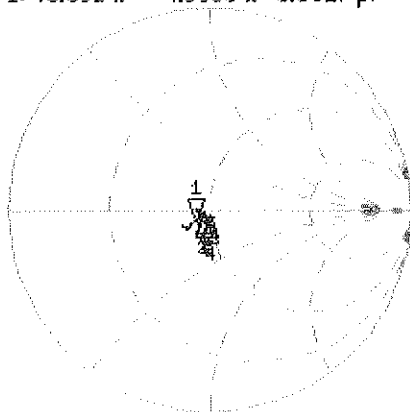

CH1 Markers

2: 46.475 Ω
-1.3496 Ω
5.30000 GHz
3: 46.150 Ω
-2.5078 Ω
5.50000 GHz
4: 48.900 Ω
-5.6992 Ω
5.60000 GHz
5: 48.734 Ω
-3.0762 Ω
5.80000 GHz

CH2 S11 LOG 5 dB/REF -20 dB 1: -21.014 dB 5 200.000 000 MHz

De1
Cor
Avg
16
H1d

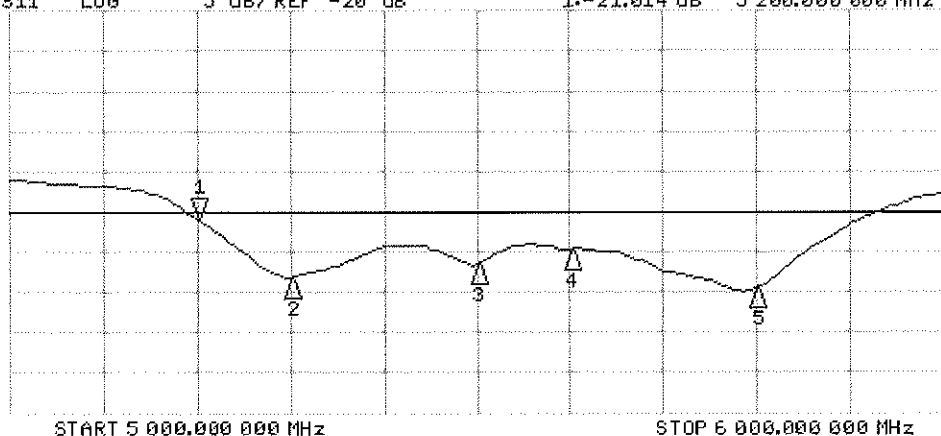

CH2 Markers

2: -28.145 dB
5.30000 GHz
3: -26.415 dB
5.50000 GHz
4: -24.640 dB
5.60000 GHz
5: -29.464 dB
5.80000 GHz

DASY5 Validation Report for Body TSL

Date: 24.01.2014

Test Laboratory: SPEAG, Zurich, Switzerland

DUT: Dipole 5GHz; Type: D5GHzV2; Serial: D5GHzV2 - SN: 1057

Communication System: UID 0 - CW; Frequency: 5200 MHz, Frequency: 5300 MHz, Frequency: 5500 MHz, Frequency: 5600 MHz, Frequency: 5800 MHz

Medium parameters used: $f = 5200$ MHz; $\sigma = 5.44$ S/m; $\epsilon_r = 47.3$; $\rho = 1000$ kg/m³, Medium parameters used: $f = 5300$ MHz; $\sigma = 5.57$ S/m; $\epsilon_r = 47.2$; $\rho = 1000$ kg/m³, Medium parameters used: $f = 5500$ MHz; $\sigma = 5.84$ S/m; $\epsilon_r = 46.8$; $\rho = 1000$ kg/m³, Medium parameters used: $f = 5600$ MHz; $\sigma = 5.98$ S/m; $\epsilon_r = 46.6$; $\rho = 1000$ kg/m³, Medium parameters used: $f = 5800$ MHz; $\sigma = 6.23$ S/m; $\epsilon_r = 46.3$; $\rho = 1000$ kg/m³

Phantom section: Flat Section

Measurement Standard: DASY5 (IEEE/IEC/ANSI C63.19-2007)

DASY52 Configuration:

- Probe: EX3DV4 - SN3503; ConvF(5.01, 5.01, 5.01); Calibrated: 30.12.2013, ConvF(4.76, 4.76, 4.76); Calibrated: 30.12.2013, ConvF(4.52, 4.52, 4.52); Calibrated: 30.12.2013, ConvF(4.3, 4.3, 4.3); Calibrated: 30.12.2013, ConvF(4.47, 4.47, 4.47); Calibrated: 30.12.2013;
- Sensor-Surface: 1.4mm (Mechanical Surface Detection)
- Electronics: DAE4 Sn601; Calibrated: 25.04.2013
- Phantom: Flat Phantom 5.0 (back); Type: QD000P50AA; Serial: 1002
- DASY52 52.8.7(1137); SEMCAD X 14.6.10(7164)

Dipole Calibration for Body Tissue/Pin=100mW, dist=10mm, f=5200 MHz/Zoom Scan, dist=1.4mm (8x8x7)/Cube 0: Measurement grid: dx=4mm, dy=4mm, dz=1.4mm

Reference Value = 58.809 V/m; Power Drift = -0.05 dB

Peak SAR (extrapolated) = 30.1 W/kg

SAR(1 g) = 7.58 W/kg; SAR(10 g) = 2.12 W/kg

Maximum value of SAR (measured) = 18.2 W/kg

Dipole Calibration for Body Tissue/Pin=100mW, dist=10mm, f=5300 MHz/Zoom Scan, dist=1.4mm (8x8x7)/Cube 0: Measurement grid: dx=4mm, dy=4mm, dz=1.4mm

Reference Value = 58.585 V/m; Power Drift = -0.00 dB

Peak SAR (extrapolated) = 32.2 W/kg

SAR(1 g) = 7.79 W/kg; SAR(10 g) = 2.17 W/kg

Maximum value of SAR (measured) = 19.1 W/kg

Dipole Calibration for Body Tissue/Pin=100mW, dist=10mm, f=5500 MHz/Zoom Scan, dist=1.4mm (8x8x7)/Cube 0: Measurement grid: dx=4mm, dy=4mm, dz=1.4mm

Reference Value = 58.364 V/m; Power Drift = -0.01 dB

Peak SAR (extrapolated) = 34.4 W/kg

SAR(1 g) = 7.96 W/kg; SAR(10 g) = 2.22 W/kg

Maximum value of SAR (measured) = 19.4 W/kg

Dipole Calibration for Body Tissue/Pin=100mW, dist=10mm, f=5600 MHz/Zoom Scan, dist=1.4mm (8x8x7)/Cube 0: Measurement grid: dx=4mm, dy=4mm, dz=1.4mm

Reference Value = 57.864 V/m; Power Drift = 0.01 dB

Peak SAR (extrapolated) = 35.8 W/kg

SAR(1 g) = 8.07 W/kg; SAR(10 g) = 2.24 W/kg

Maximum value of SAR (measured) = 19.8 W/kg

Dipole Calibration for Body Tissue/Pin=100mW, dist=10mm, f=5800 MHz/Zoom Scan, dist=1.4mm (8x8x7)/Cube 0: Measurement grid: dx=4mm, dy=4mm, dz=1.4mm

Reference Value = 54.817 V/m; Power Drift = -0.01 dB

Peak SAR (extrapolated) = 35.1 W/kg

SAR(1 g) = 7.48 W/kg; SAR(10 g) = 2.06 W/kg

Maximum value of SAR (measured) = 18.8 W/kg

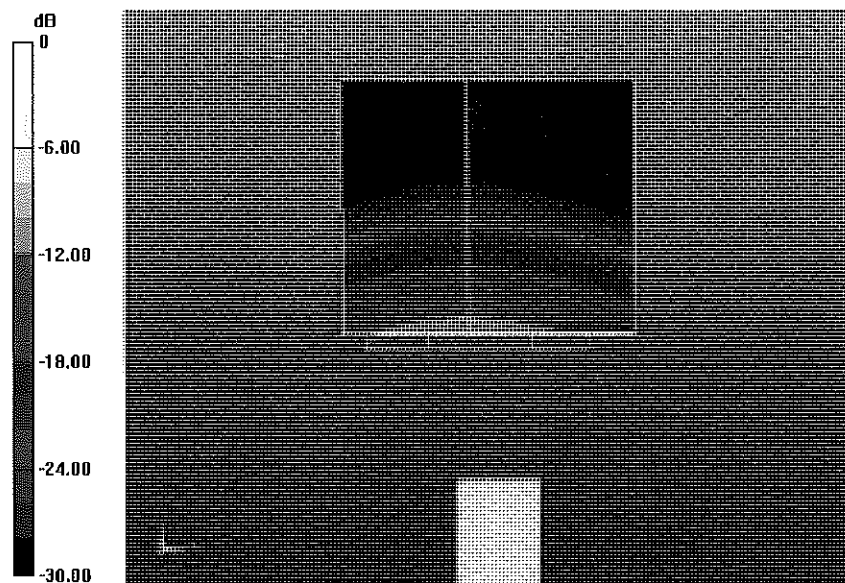

0 dB = 18.8 W/kg = 12.74 dBW/kg

Impedance Measurement Plot for Body TSL

24 Jan 2014 15:50:22

CH1 S11 1 U FS 1: 49.354 Ω -7.7188 Ω 3.9652 pF 5 200.000 000 MHz

*
De1
Cor
Avg
16
H1d

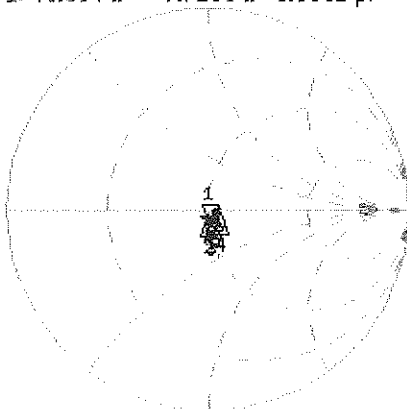

CH1 Markers
2: 49.559 Ω
-3.0176 Ω
5.30000 GHz
3: 50.793 Ω
-3.9160 Ω
5.50000 GHz
4: 55.393 Ω
-2.5176 Ω
5.60000 GHz
5: 52.320 Ω
-716.80 m Ω
5.80000 GHz

CH2 S11 L06 5 dB/REF -20 dB 1:-22.190 dB 5 200.000 000 MHz

Cor
Avg
16
H1d

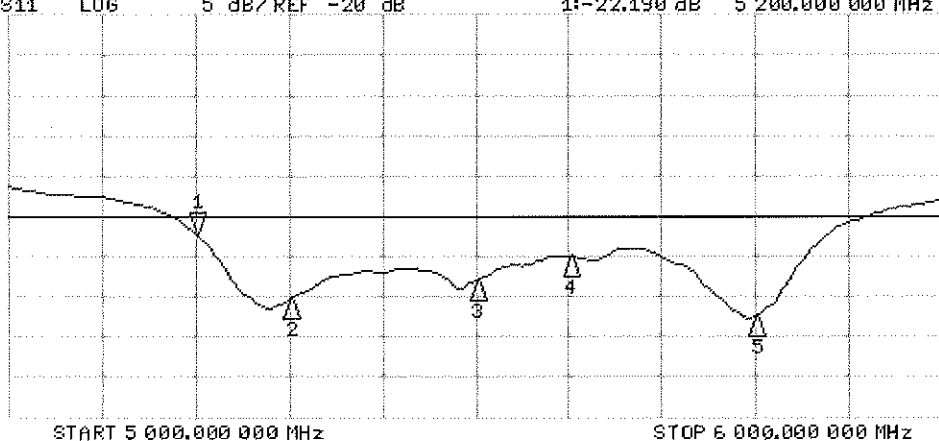

CH2 Markers
2:-30.277 dB
5.30000 GHz
3:-28.039 dB
5.50000 GHz
4:-24.950 dB
5.60000 GHz
5:-32.401 dB
5.80000 GHz

START 5 000.000 000 MHz

STOP 6 000.000 000 MHz



Accredited by the Swiss Accreditation Service (SAS)
The Swiss Accreditation Service is one of the signatories to the EA
Multilateral Agreement for the recognition of calibration certificates

Accreditation No.: **SCS 108**

Client **PC Test**

Certificate No: **ES3-3263_May14**

CALIBRATION CERTIFICATE

Object **ES3DV3 - SN:3263**

Calibration procedure(s) **QA CAL-01.v9, QA CAL-23.v5, QA CAL-25.v6
Calibration procedure for dosimetric E-field probes**

OCV
7/17/14

Calibration date: **May 15, 2014**

This calibration certificate documents the traceability to national standards, which realize the physical units of measurements (SI).
The measurements and the uncertainties with confidence probability are given on the following pages and are part of the certificate.

All calibrations have been conducted in the closed laboratory facility: environment temperature (22 ± 3)°C and humidity < 70%.

Calibration Equipment used (M&TE critical for calibration)

Primary Standards	ID	Cal Date (Certificate No.)	Scheduled Calibration
Power meter E4419B	GB41293874	03-Apr-14 (No. 217-01911)	Apr-15
Power sensor E4412A	MY41498087	03-Apr-14 (No. 217-01911)	Apr-15
Reference 3 dB Attenuator	SN: S5054 (3c)	03-Apr-14 (No. 217-01915)	Apr-15
Reference 20 dB Attenuator	SN: S5277 (20x)	03-Apr-14 (No. 217-01919)	Apr-15
Reference 30 dB Attenuator	SN: S5129 (30b)	03-Apr-14 (No. 217-01920)	Apr-15
Reference Probe ES3DV2	SN: 3013	30-Dec-13 (No. ES3-3013_Dec13)	Dec-14
DAE4	SN: 660	13-Dec-13 (No. DAE4-660_Dec13)	Dec-14
Secondary Standards	ID	Check Date (in house)	Scheduled Check
RF generator HP 8648C	US3642U01700	4-Aug-99 (in house check Apr-13)	In house check: Apr-16
Network Analyzer HP 8753E	US37390585	18-Oct-01 (in house check Oct-13)	In house check: Oct-14

	Name	Function	Signature
Calibrated by:	Jeton Kastrati	Laboratory Technician	
Approved by:	Katja Pokovic	Technical Manager	
			Issued: May 15, 2014

This calibration certificate shall not be reproduced except in full without written approval of the laboratory.



Accredited by the Swiss Accreditation Service (SAS)

Accreditation No.: **SCS 108**

The Swiss Accreditation Service is one of the signatories to the EA
Multilateral Agreement for the recognition of calibration certificates

Glossary:

TSL	tissue simulating liquid
NORM _{x,y,z}	sensitivity in free space
ConvF	sensitivity in TSL / NORM _{x,y,z}
DCP	diode compression point
CF	crest factor (1/duty_cycle) of the RF signal
A, B, C, D	modulation dependent linearization parameters
Polarization φ	φ rotation around probe axis
Polarization ϑ	ϑ rotation around an axis that is in the plane normal to probe axis (at measurement center), i.e., $\vartheta = 0$ is normal to probe axis
Connector Angle	information used in DASY system to align probe sensor X to the robot coordinate system

Calibration is Performed According to the Following Standards:

- IEEE Std 1528-2013, "IEEE Recommended Practice for Determining the Peak Spatial-Averaged Specific Absorption Rate (SAR) in the Human Head from Wireless Communications Devices: Measurement Techniques", June 2013
- IEC 62209-1, "Procedure to measure the Specific Absorption Rate (SAR) for hand-held devices used in close proximity to the ear (frequency range of 300 MHz to 3 GHz)", February 2005

Methods Applied and Interpretation of Parameters:

- NORM_{x,y,z}**: Assessed for E-field polarization $\vartheta = 0$ ($f \leq 900$ MHz in TEM-cell; $f > 1800$ MHz: R22 waveguide). NORM_{x,y,z} are only intermediate values, i.e., the uncertainties of NORM_{x,y,z} does not affect the E²-field uncertainty inside TSL (see below *ConvF*).
- NORM(*f*)_{x,y,z} = NORM_{x,y,z} * frequency_response** (see Frequency Response Chart). This linearization is implemented in DASY4 software versions later than 4.2. The uncertainty of the frequency response is included in the stated uncertainty of *ConvF*.
- DCP_{x,y,z}**: DCP are numerical linearization parameters assessed based on the data of power sweep with CW signal (no uncertainty required). DCP does not depend on frequency nor media.
- PAR**: PAR is the Peak to Average Ratio that is not calibrated but determined based on the signal characteristics
- A_{x,y,z}; B_{x,y,z}; C_{x,y,z}; D_{x,y,z}; VR_{x,y,z}**: A, B, C, D are numerical linearization parameters assessed based on the data of power sweep for specific modulation signal. The parameters do not depend on frequency nor media. VR is the maximum calibration range expressed in RMS voltage across the diode.
- ConvF and Boundary Effect Parameters**: Assessed in flat phantom using E-field (or Temperature Transfer Standard for $f \leq 800$ MHz) and inside waveguide using analytical field distributions based on power measurements for $f > 800$ MHz. The same setups are used for assessment of the parameters applied for boundary compensation (alpha, depth) of which typical uncertainty values are given. These parameters are used in DASY4 software to improve probe accuracy close to the boundary. The sensitivity in TSL corresponds to NORM_{x,y,z} * ConvF whereby the uncertainty corresponds to that given for ConvF. A frequency dependent ConvF is used in DASY version 4.4 and higher which allows extending the validity from ± 50 MHz to ± 100 MHz.
- Spherical isotropy (3D deviation from isotropy)**: in a field of low gradients realized using a flat phantom exposed by a patch antenna.
- Sensor Offset**: The sensor offset corresponds to the offset of virtual measurement center from the probe tip (on probe axis). No tolerance required.
- Connector Angle**: The angle is assessed using the information gained by determining the NORM_x (no uncertainty required).

Probe ES3DV3

SN:3263

Manufactured: January 25, 2010
Calibrated: May 15, 2014

Calibrated for DASY/EASY Systems
(Note: non-compatible with DASY2 system!)

DASY/EASY - Parameters of Probe: ES3DV3 - SN:3263

Basic Calibration Parameters

	Sensor X	Sensor Y	Sensor Z	Unc (k=2)
Norm ($\mu\text{V}/(\text{V}/\text{m})^2$) ^A	1.21	1.24	1.13	$\pm 10.1\%$
DCP (mV) ^B	103.8	102.3	104.7	

Modulation Calibration Parameters

UID	Communication System Name		A dB	B dB $\sqrt{\mu\text{V}}$	C	D dB	VR mV	Unc ^E (k=2)
0	CW	X	0.0	0.0	1.0	0.00	156.3	$\pm 3.5\%$
		Y	0.0	0.0	1.0		203.1	
		Z	0.0	0.0	1.0		197.2	
10010- CAA	SAR Validation (Square, 100ms, 10ms)	X	2.33	59.4	10.8	10.00	46.4	$\pm 1.4\%$
		Y	4.39	63.4	13.6		50.8	
		Z	1.35	55.5	7.8		39.6	
10011- CAB	UMTS-FDD (WCDMA)	X	3.49	68.2	19.1	2.91	126.7	$\pm 0.7\%$
		Y	3.28	66.9	18.5		120.7	
		Z	2.74	63.1	15.1		113.5	
10012- CAA	IEEE 802.11b WiFi 2.4 GHz (DSSS, 1 Mbps)	X	3.51	72.0	20.3	1.87	127.9	$\pm 0.7\%$
		Y	3.21	69.4	18.8		124.1	
		Z	1.93	60.6	12.6		113.3	
10013- CAA	IEEE 802.11g WiFi 2.4 GHz (DSSS-OFDM, 6 Mbps)	X	11.30	70.8	23.3	9.46	125.2	$\pm 2.5\%$
		Y	12.42	72.7	24.4		129.4	
		Z	10.03	67.8	21.1		105.5	
10021- DAB	GSM-FDD (TDMA, GMSK)	X	24.45	99.1	27.6	9.39	141.4	$\pm 1.4\%$
		Y	29.93	99.5	29.0		124.5	
		Z	4.53	73.0	18.1		111.6	
10023- DAB	GPRS-FDD (TDMA, GMSK, TN 0)	X	25.10	99.7	27.9	9.57	134.2	$\pm 1.9\%$
		Y	24.85	96.1	28.0		120.2	
		Z	5.99	76.5	19.1		142.5	
10024- DAB	GPRS-FDD (TDMA, GMSK, TN 0-1)	X	24.34	93.0	23.0	6.56	117.1	$\pm 1.4\%$
		Y	26.49	92.6	24.2		148.7	
		Z	4.00	69.6	13.8		136.6	
10027- DAB	GPRS-FDD (TDMA, GMSK, TN 0-1-2)	X	51.24	99.9	23.5	4.80	131.1	$\pm 1.9\%$
		Y	56.83	99.5	24.3		101.8	
		Z	1.70	61.4	9.1		107.7	
10028- DAB	GPRS-FDD (TDMA, GMSK, TN 0-1-2-3)	X	60.12	99.6	22.2	3.55	138.7	$\pm 1.9\%$
		Y	64.73	99.9	23.4		105.5	
		Z	1.13	58.4	6.0		116.0	
10032- CAA	IEEE 802.15.1 Bluetooth (GFSK, DH5)	X	77.27	99.6	19.6	1.16	149.5	$\pm 2.5\%$
		Y	60.44	99.7	21.0		109.4	
		Z	0.34	55.9	2.9		131.4	
10039- CAB	CDMA2000 (1xRTT, RC1)	X	4.79	66.8	19.0	4.57	124.5	$\pm 0.9\%$
		Y	4.85	66.4	18.8		125.6	
		Z	4.06	63.4	16.1		108.1	

10081-CAB	CDMA2000 (1xRTT, RC3)	X	3.93	66.1	18.5	3.97	119.8	±0.7 %
		Y	3.90	65.5	18.2		120.1	
		Z	3.29	62.4	15.3		108.5	
10098-CAB	UMTS-FDD (HSUPA, Subtest 2)	X	4.68	66.9	18.7	3.98	131.2	±0.7 %
		Y	4.64	66.6	18.6		130.5	
		Z	4.15	64.5	16.5		118.8	
10100-CAB	LTE-FDD (SC-FDMA, 100% RB, 20 MHz, QPSK)	X	6.61	68.1	20.0	5.67	137.5	±1.7 %
		Y	6.70	68.4	20.2		137.7	
		Z	5.90	65.6	17.9		124.0	
10108-CAB	LTE-FDD (SC-FDMA, 100% RB, 10 MHz, QPSK)	X	6.44	67.5	19.8	5.80	135.1	±1.7 %
		Y	6.60	68.0	20.1		135.4	
		Z	5.75	64.9	17.6		121.8	
10110-CAB	LTE-FDD (SC-FDMA, 100% RB, 5 MHz, QPSK)	X	6.14	67.1	19.7	5.75	131.6	±1.2 %
		Y	6.28	67.4	19.9		132.7	
		Z	5.62	65.5	18.2		118.4	
10114-CAA	IEEE 802.11n (HT Greenfield, 13.5 Mbps, BPSK)	X	10.18	68.8	21.2	8.10	124.3	±1.9 %
		Y	10.60	69.7	21.8		126.2	
		Z	9.38	67.0	19.8		108.4	
10117-CAA	IEEE 802.11n (HT Mixed, 13.5 Mbps, BPSK)	X	10.23	68.9	21.3	8.07	125.0	±1.9 %
		Y	10.56	69.6	21.7		127.1	
		Z	9.37	67.1	19.8		109.1	
10151-CAB	LTE-TDD (SC-FDMA, 50% RB, 20 MHz, QPSK)	X	10.23	75.7	26.0	9.28	125.0	±2.7 %
		Y	14.60	83.3	29.5		147.3	
		Z	8.05	69.7	22.3		106.3	
10154-CAB	LTE-FDD (SC-FDMA, 50% RB, 10 MHz, QPSK)	X	6.12	67.0	19.6	5.75	131.6	±1.4 %
		Y	6.28	67.4	19.9		132.4	
		Z	5.49	64.7	17.4		117.9	
10160-CAB	LTE-FDD (SC-FDMA, 50% RB, 15 MHz, QPSK)	X	6.57	67.5	19.8	5.82	136.0	±1.4 %
		Y	6.71	67.9	20.1		137.1	
		Z	5.89	65.2	17.8		122.4	
10169-CAB	LTE-FDD (SC-FDMA, 1 RB, 20 MHz, QPSK)	X	4.82	66.0	19.3	5.73	113.5	±1.4 %
		Y	5.12	66.3	19.4		116.6	
		Z	4.75	65.9	18.3		142.7	
10172-CAB	LTE-TDD (SC-FDMA, 1 RB, 20 MHz, QPSK)	X	9.53	80.6	28.6	9.21	136.5	±2.2 %
		Y	11.32	81.6	28.8		109.2	
		Z	6.84	72.0	23.8		117.3	
10175-CAB	LTE-FDD (SC-FDMA, 1 RB, 10 MHz, QPSK)	X	4.86	66.2	19.4	5.72	112.9	±1.2 %
		Y	5.10	66.2	19.4		115.9	
		Z	4.55	64.9	17.8		137.7	
10181-CAB	LTE-FDD (SC-FDMA, 1 RB, 15 MHz, QPSK)	X	4.81	66.0	19.2	5.72	111.6	±1.2 %
		Y	5.13	66.4	19.5		116.1	
		Z	4.70	65.7	18.3		137.1	
10193-CAA	IEEE 802.11n (HT Greenfield, 6.5 Mbps, BPSK)	X	9.80	68.3	21.0	8.09	117.2	±2.2 %
		Y	10.23	69.1	21.6		121.5	
		Z	9.85	68.9	20.8		148.4	

10196-CAA	IEEE 802.11n (HT Mixed, 6.5 Mbps, BPSK)	X	9.81	68.4	21.1	8.10	117.7	±2.2 %
		Y	10.23	69.2	21.6		121.7	
		Z	9.87	69.0	20.9		149.9	
10219-CAA	IEEE 802.11n (HT Mixed, 7.2 Mbps, BPSK)	X	9.71	68.3	21.0	8.03	117.8	±2.2 %
		Y	10.12	69.1	21.6		121.0	
		Z	8.90	66.6	19.6		104.1	
10222-CAA	IEEE 802.11n (HT Mixed, 15 Mbps, BPSK)	X	10.14	68.7	21.2	8.06	122.3	±1.9 %
		Y	10.52	69.5	21.7		125.4	
		Z	9.28	66.8	19.6		108.5	
10225-CAB	UMTS-FDD (HSPA+)	X	7.25	67.8	19.9	5.97	146.3	±1.7 %
		Y	7.32	67.5	19.8		149.3	
		Z	6.52	65.7	18.0		130.7	
10237-CAB	LTE-TDD (SC-FDMA, 1 RB, 10 MHz, QPSK)	X	9.55	80.7	28.7	9.21	137.2	±2.5 %
		Y	11.34	81.7	28.9		109.9	
		Z	6.98	72.5	24.0		119.5	
10252-CAB	LTE-TDD (SC-FDMA, 50% RB, 10 MHz, QPSK)	X	9.26	74.1	25.3	9.24	115.6	±3.3 %
		Y	13.72	82.5	29.3		137.9	
		Z	8.83	73.3	24.4		144.1	
10267-CAB	LTE-TDD (SC-FDMA, 100% RB, 10 MHz, QPSK)	X	10.06	75.2	25.8	9.30	122.9	±2.7 %
		Y	14.69	83.4	29.6		147.6	
		Z	8.02	69.6	22.3		103.4	
10274-CAB	UMTS-FDD (HSUPA, Subtest 5, 3GPP Rel8.10)	X	6.08	67.2	19.0	4.87	140.2	±1.2 %
		Y	6.23	67.5	19.2		143.5	
		Z	5.52	65.4	17.4		125.1	
10275-CAB	UMTS-FDD (HSUPA, Subtest 5, 3GPP Rel8.4)	X	4.44	66.7	18.7	3.96	122.1	±0.7 %
		Y	4.39	66.3	18.5		124.4	
		Z	3.83	63.7	16.0		114.0	
10291-AAB	CDMA2000, RC3, SO55, Full Rate	X	3.64	66.7	18.6	3.46	115.7	±0.7 %
		Y	3.60	66.0	18.2		118.0	
		Z	3.17	64.2	16.3		108.4	
10292-AAB	CDMA2000, RC3, SO32, Full Rate	X	3.62	67.0	18.8	3.39	116.9	±0.9 %
		Y	3.54	66.1	18.2		119.1	
		Z	3.24	64.2	15.8		145.6	
10297-AAA	LTE-FDD (SC-FDMA, 50% RB, 20 MHz, QPSK)	X	6.43	67.5	19.8	5.81	132.0	±1.4 %
		Y	6.60	68.0	20.1		134.9	
		Z	5.81	65.4	18.0		115.0	
10311-AAA	LTE-FDD (SC-FDMA, 100% RB, 15 MHz, QPSK)	X	7.04	68.1	20.2	6.06	137.5	±1.4 %
		Y	7.19	68.6	20.5		140.3	
		Z	6.26	65.7	18.2		119.6	
10315-AAA	IEEE 802.11b WiFi 2.4 GHz (DSSS, 1 Mbps, 96pc duty cycle)	X	3.05	70.0	19.4	1.71	121.7	±0.7 %
		Y	2.91	68.7	18.7		123.4	
		Z	1.83	60.2	12.3		108.4	
10316-AAA	IEEE 802.11g WiFi 2.4 GHz (ERP-OFDM, 6 Mbps, 96pc duty cycle)	X	10.05	68.7	21.4	8.36	117.3	±1.9 %
		Y	10.57	69.7	22.0		122.8	
		Z	9.11	66.5	19.7		103.1	

10403-AAB	CDMA2000 (1xEV-DO, Rev. 0)	X	4.81	68.3	18.8	3.76	125.8	±0.7 %
		Y	4.65	66.5	18.1		130.8	
		Z	3.98	64.7	16.0		114.7	
10404-AAB	CDMA2000 (1xEV-DO, Rev. A)	X	4.91	69.1	19.2	3.77	123.3	±0.7 %
		Y	4.60	66.6	18.1		128.5	
		Z	3.73	64.0	15.4		112.0	
10415-AAA	IEEE 802.11b WiFi 2.4 GHz (DSSS, 1 Mbps, 99pc duty cycle)	X	2.78	69.0	19.0	1.54	121.9	±0.7 %
		Y	2.46	66.8	17.9		122.5	
		Z	1.83	60.9	13.0		112.4	
10416-AAA	IEEE 802.11g WiFi 2.4 GHz (ERP-OFDM, 6 Mbps, 99pc duty cycle)	X	9.88	68.4	21.2	8.23	116.6	±1.7 %
		Y	10.29	69.2	21.7		121.5	
		Z	9.25	67.3	20.2		103.4	

The reported uncertainty of measurement is stated as the standard uncertainty of measurement multiplied by the coverage factor $k=2$, which for a normal distribution corresponds to a coverage probability of approximately 95%.

^A The uncertainties of NormX,Y,Z do not affect the E^2 -field uncertainty inside TSL (see Pages 8 and 9).

^B Numerical linearization parameter: uncertainty not required.

^E Uncertainty is determined using the max. deviation from linear response applying rectangular distribution and is expressed for the square of the field value.

DASY/EASY - Parameters of Probe: ES3DV3 - SN:3263

Calibration Parameter Determined in Head Tissue Simulating Media

f (MHz) ^C	Relative Permittivity ^F	Conductivity (S/m) ^F	ConvF X	ConvF Y	ConvF Z	Alpha ^G	Depth ^G (mm)	Unct. (k=2)
750	41.9	0.89	6.42	6.42	6.42	0.72	1.18	± 12.0 %
835	41.5	0.90	6.23	6.23	6.23	0.27	2.02	± 12.0 %
1750	40.1	1.37	5.41	5.41	5.41	0.74	1.23	± 12.0 %
1900	40.0	1.40	5.08	5.08	5.08	0.80	1.16	± 12.0 %
2450	39.2	1.80	4.47	4.47	4.47	0.80	1.22	± 12.0 %
2600	39.0	1.96	4.33	4.33	4.33	0.66	1.41	± 12.0 %

^C Frequency validity of ± 100 MHz only applies for DASY v4.4 and higher (see Page 2), else it is restricted to ± 50 MHz. The uncertainty is the RSS of the ConvF uncertainty at calibration frequency and the uncertainty for the indicated frequency band.

^F At frequencies below 3 GHz, the validity of tissue parameters (ϵ and σ) can be relaxed to ± 10% if liquid compensation formula is applied to measured SAR values. At frequencies above 3 GHz, the validity of tissue parameters (ϵ and σ) is restricted to ± 5%. The uncertainty is the RSS of the ConvF uncertainty for indicated target tissue parameters.

^G Alpha/Depth are determined during calibration. SPEAG warrants that the remaining deviation due to the boundary effect after compensation is always less than ± 1% for frequencies below 3 GHz and below ± 2% for frequencies between 3-6 GHz at any distance larger than half the probe tip diameter from the boundary.

DASY/EASY - Parameters of Probe: ES3DV3 - SN:3263

Calibration Parameter Determined in Body Tissue Simulating Media

f (MHz) ^C	Relative Permittivity ^F	Conductivity (S/m) ^F	ConvF X	ConvF Y	ConvF Z	Alpha ^G	Depth (mm) ^G	Unct. (k=2)
750	55.5	0.96	6.19	6.19	6.19	0.52	1.41	± 12.0 %
835	55.2	0.97	6.16	6.16	6.16	0.68	1.28	± 12.0 %
1750	53.4	1.49	4.98	4.98	4.98	0.38	1.91	± 12.0 %
1900	53.3	1.52	4.78	4.78	4.78	0.66	1.35	± 12.0 %
2450	52.7	1.95	4.27	4.27	4.27	0.72	1.13	± 12.0 %
2600	52.5	2.16	4.11	4.11	4.11	0.74	1.07	± 12.0 %

^C Frequency validity of ± 100 MHz only applies for DASY v4.4 and higher (see Page 2), else it is restricted to ± 50 MHz. The uncertainty is the RSS of the ConvF uncertainty at calibration frequency and the uncertainty for the indicated frequency band.

^F At frequencies below 3 GHz, the validity of tissue parameters (ϵ and σ) can be relaxed to ± 10% if liquid compensation formula is applied to measured SAR values. At frequencies above 3 GHz, the validity of tissue parameters (ϵ and σ) is restricted to ± 5%. The uncertainty is the RSS of the ConvF uncertainty for indicated target tissue parameters.

^G Alpha/Depth are determined during calibration. SPEAG warrants that the remaining deviation due to the boundary effect after compensation is always less than ± 1% for frequencies below 3 GHz and below ± 2% for frequencies between 3-6 GHz at any distance larger than half the probe tip diameter from the boundary.

Frequency Response of E-Field (TEM-Cell:ifi110 EXX, Waveguide: R22)

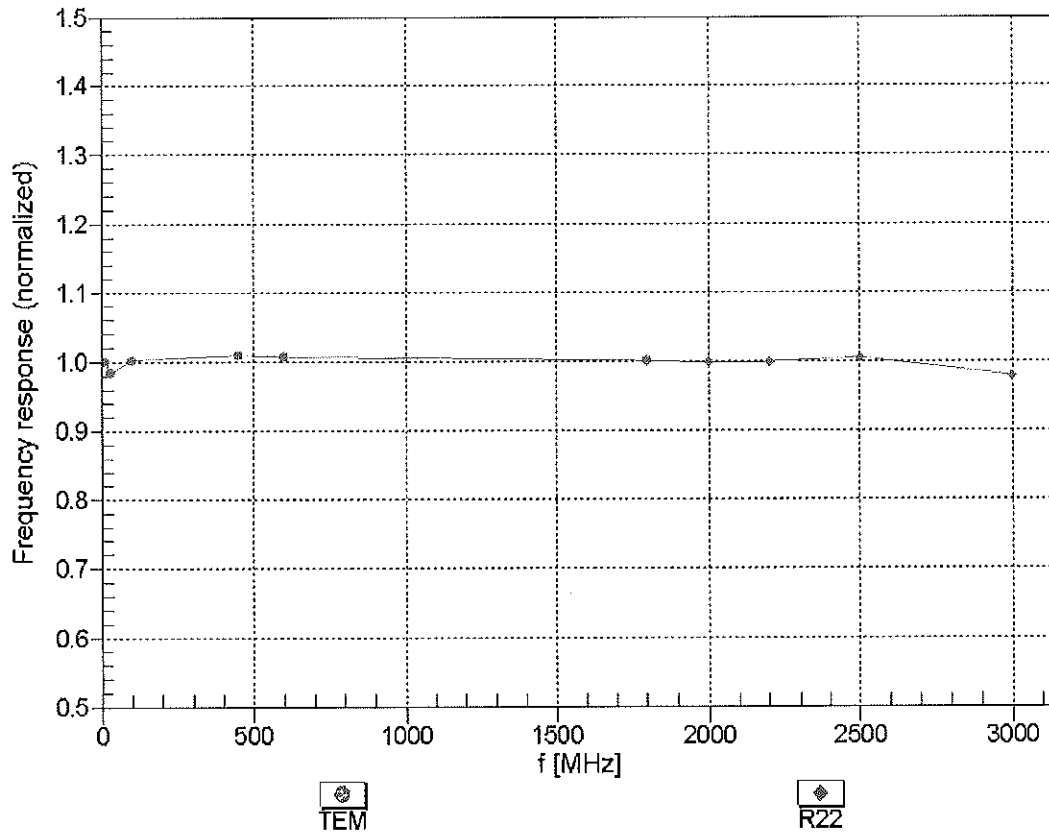

Uncertainty of Frequency Response of E-field: $\pm 6.3\%$ (k=2)

Receiving Pattern (ϕ), $\theta = 0^\circ$

f=600 MHz,TEM

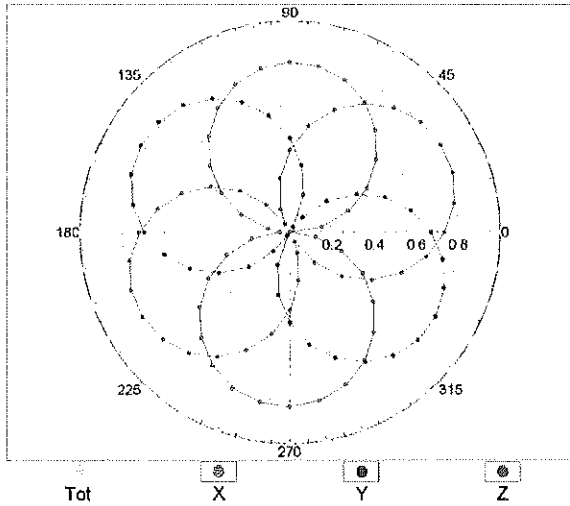

f=1800 MHz,R22

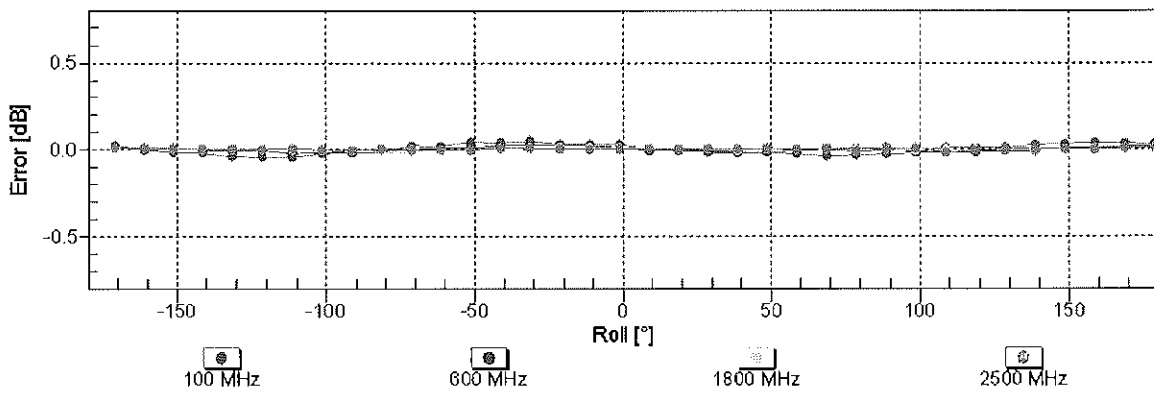
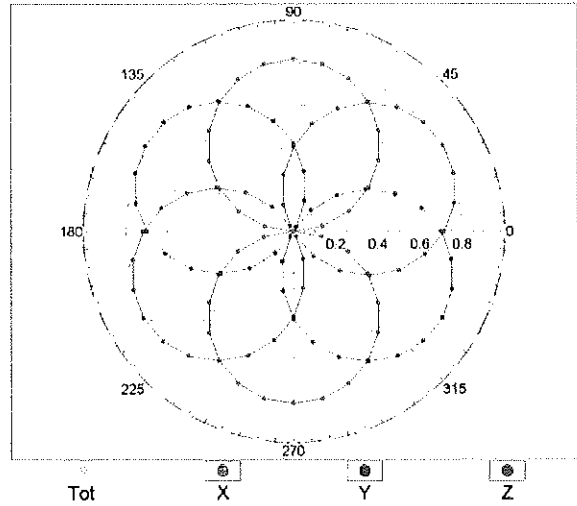

Uncertainty of Axial Isotropy Assessment: $\pm 0.5\%$ (k=2)

Dynamic Range $f(\text{SAR}_{\text{head}})$ (TEM cell , $f_{\text{eval}}=1900 \text{ MHz}$)

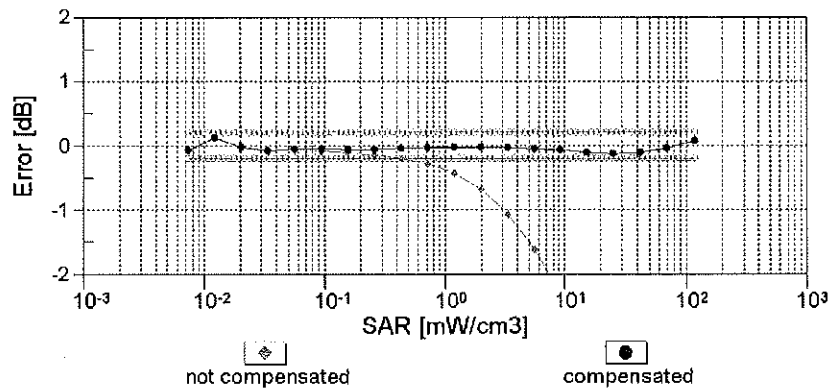
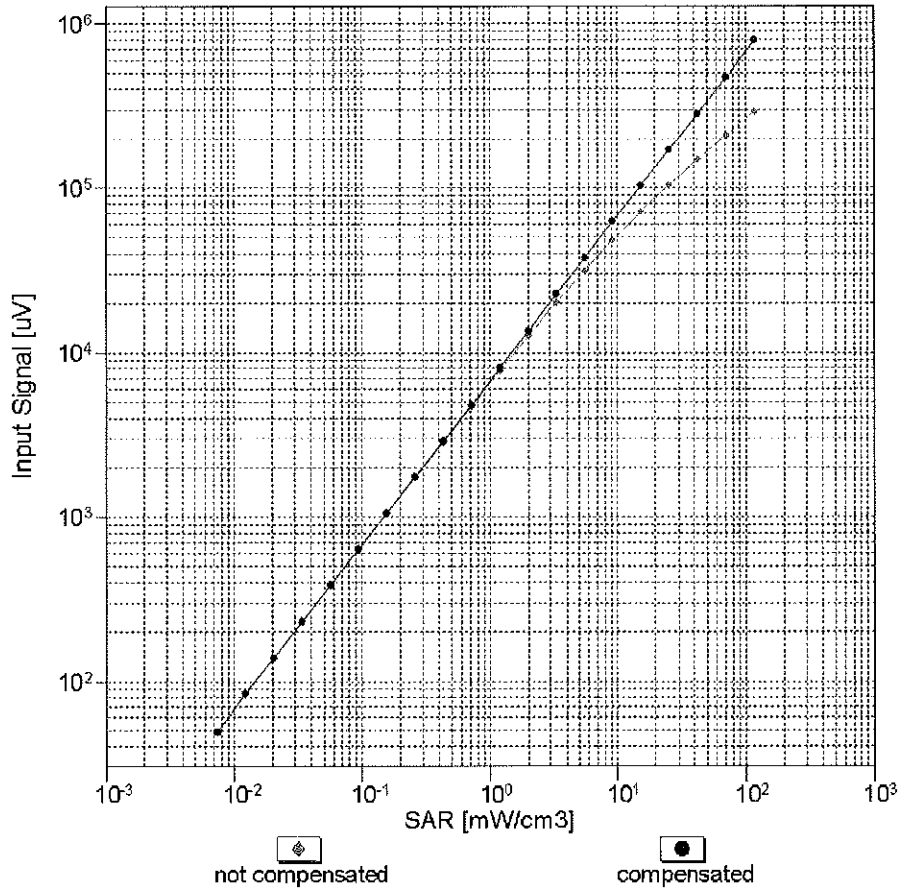

Uncertainty of Linearity Assessment: $\pm 0.6\%$ ($k=2$)

Conversion Factor Assessment

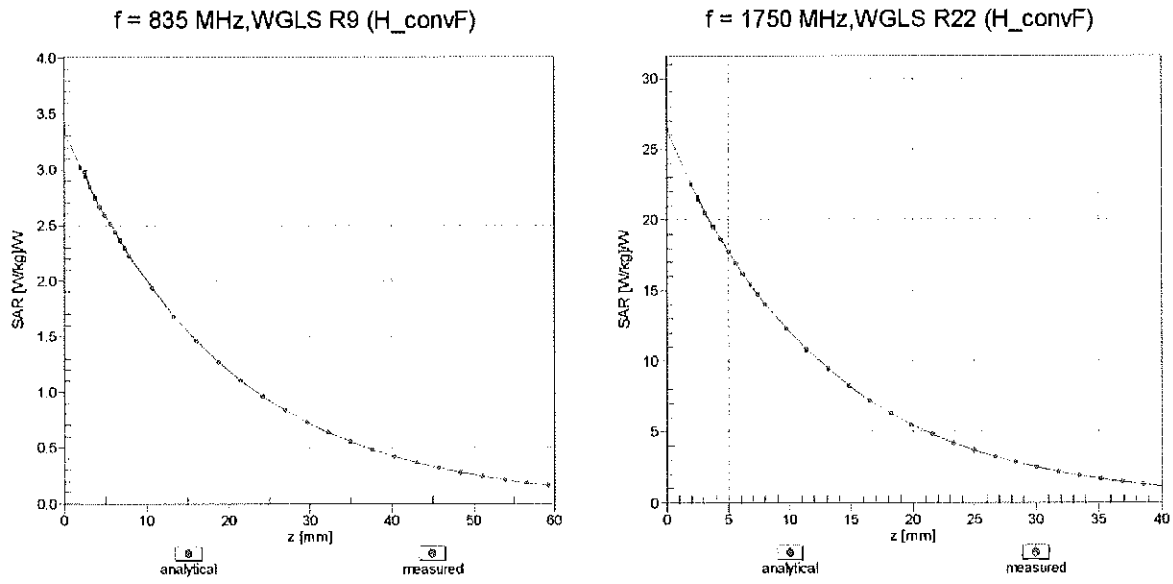

Deviation from Isotropy in Liquid Error (ϕ, ϑ), f = 900 MHz

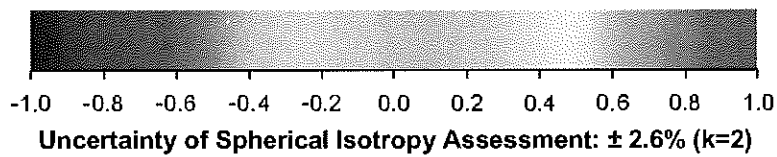
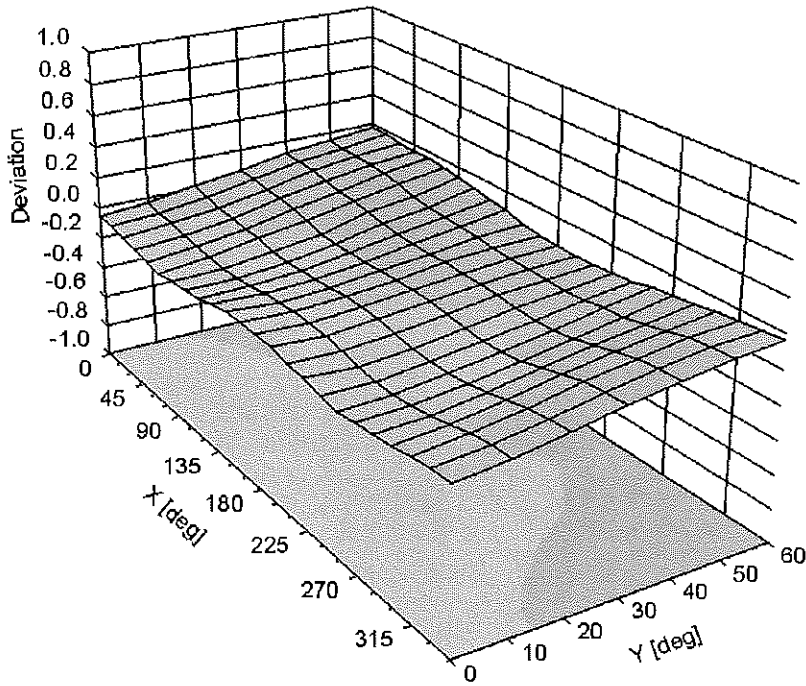

DASY/EASY - Parameters of Probe: ES3DV3 - SN:3263

Other Probe Parameters

Sensor Arrangement	Triangular
Connector Angle (°)	-111.2
Mechanical Surface Detection Mode	enabled
Optical Surface Detection Mode	disabled
Probe Overall Length	337 mm
Probe Body Diameter	10 mm
Tip Length	10 mm
Tip Diameter	4 mm
Probe Tip to Sensor X Calibration Point	2 mm
Probe Tip to Sensor Y Calibration Point	2 mm
Probe Tip to Sensor Z Calibration Point	2 mm
Recommended Measurement Distance from Surface	3 mm

**Calibration Laboratory of
Schmid & Partner
Engineering AG**
Zeughausstrasse 43, 8004 Zurich, Switzerland



S S C S Schweizerischer Kalibrierdienst
Service suisse d'étalonnage
Servizio svizzero di taratura
Swiss Calibration Service

Accredited by the Swiss Accreditation Service (SAS)
The Swiss Accreditation Service is one of the signatories to the EA
Multilateral Agreement for the recognition of calibration certificates

Accreditation No.: **SCS 108**

Client **PC Test**

Certificate No: **ES3-3288_Sep14/2**

CALIBRATION CERTIFICATE (Replacement of No:ES3-3288_Sep14)

Object **ES3DV3 - SN:3288**

Calibration procedure(s) **QA CAL-01.v9, QA CAL-23.v5, QA CAL-25.v6
Calibration procedure for dosimetric E-field probes** CC
11/12/14

Calibration date: **September 24, 2014**

This calibration certificate documents the traceability to national standards, which realize the physical units of measurements (SI).
The measurements and the uncertainties with confidence probability are given on the following pages and are part of the certificate.

All calibrations have been conducted in the closed laboratory facility: environment temperature (22 ± 3)°C and humidity < 70%.

Calibration Equipment used (M&TE critical for calibration)

Primary Standards	ID	Cal Date (Certificate No.)	Scheduled Calibration
Power meter E4419B	GB41293874	03-Apr-14 (No. 217-01911)	Apr-15
Power sensor E4412A	MY41498087	03-Apr-14 (No. 217-01911)	Apr-15
Reference 3 dB Attenuator	SN: S5054 (3c)	03-Apr-14 (No. 217-01915)	Apr-15
Reference 20 dB Attenuator	SN: S5277 (20x)	03-Apr-14 (No. 217-01919)	Apr-15
Reference 30 dB Attenuator	SN: S5129 (30b)	03-Apr-14 (No. 217-01920)	Apr-15
Reference Probe ES3DV2	SN: 3013	30-Dec-13 (No. ES3-3013_Dec13)	Dec-14
DAE4	SN: 660	13-Dec-13 (No. DAE4-660_Dec13)	Dec-14
Secondary Standards	ID	Check Date (in house)	Scheduled Check
RF generator HP 8648C	US3642U01700	4-Aug-99 (in house check Apr-13)	In house check: Apr-16
Network Analyzer HP 8753E	US37390585	18-Oct-01 (in house check Oct-13)	In house check: Oct-14

Calibrated by:	Name Leif Klysner	Function Laboratory Technician	Signature
Approved by:	Name Katja Pokovic	Function Technical Manager	

Issued: November 3, 2014

This calibration certificate shall not be reproduced except in full without written approval of the laboratory.



Accredited by the Swiss Accreditation Service (SAS)
The Swiss Accreditation Service is one of the signatories to the EA
Multilateral Agreement for the recognition of calibration certificates

Accreditation No.: **SCS 108**

Glossary:

TSL	tissue simulating liquid
NORM _{x,y,z}	sensitivity in free space
ConvF	sensitivity in TSL / NORM _{x,y,z}
DCP	diode compression point
CF	crest factor (1/duty_cycle) of the RF signal
A, B, C, D	modulation dependent linearization parameters
Polarization ϕ	ϕ rotation around probe axis
Polarization ϑ	ϑ rotation around an axis that is in the plane normal to probe axis (at measurement center), i.e., $\vartheta = 0$ is normal to probe axis
Connector Angle	information used in DASY system to align probe sensor X to the robot coordinate system

Calibration is Performed According to the Following Standards:

- a) IEEE Std 1528-2013, "IEEE Recommended Practice for Determining the Peak Spatial-Averaged Specific Absorption Rate (SAR) in the Human Head from Wireless Communications Devices: Measurement Techniques", June 2013
- b) IEC 62209-1, "Procedure to measure the Specific Absorption Rate (SAR) for hand-held devices used in close proximity to the ear (frequency range of 300 MHz to 3 GHz)", February 2005

Methods Applied and Interpretation of Parameters:

- *NORM_{x,y,z}*: Assessed for E-field polarization $\vartheta = 0$ ($f \leq 900$ MHz in TEM-cell; $f > 1800$ MHz: R22 waveguide). *NORM_{x,y,z}* are only intermediate values, i.e., the uncertainties of *NORM_{x,y,z}* does not affect the E^2 -field uncertainty inside TSL (see below *ConvF*).
- *NORM(f)_{x,y,z}* = *NORM_{x,y,z}* * *frequency_response* (see Frequency Response Chart). This linearization is implemented in DASY4 software versions later than 4.2. The uncertainty of the frequency response is included in the stated uncertainty of *ConvF*.
- *DCP_{x,y,z}*: DCP are numerical linearization parameters assessed based on the data of power sweep with CW signal (no uncertainty required). DCP does not depend on frequency nor media.
- *PAR*: PAR is the Peak to Average Ratio that is not calibrated but determined based on the signal characteristics
- *A_{x,y,z}*; *B_{x,y,z}*; *C_{x,y,z}*; *D_{x,y,z}*; *VR_{x,y,z}*; *A*, *B*, *C*, *D* are numerical linearization parameters assessed based on the data of power sweep for specific modulation signal. The parameters do not depend on frequency nor media. *VR* is the maximum calibration range expressed in RMS voltage across the diode.
- *ConvF and Boundary Effect Parameters*: Assessed in flat phantom using E-field (or Temperature Transfer Standard for $f \leq 800$ MHz) and inside waveguide using analytical field distributions based on power measurements for $f > 800$ MHz. The same setups are used for assessment of the parameters applied for boundary compensation (alpha, depth) of which typical uncertainty values are given. These parameters are used in DASY4 software to improve probe accuracy close to the boundary. The sensitivity in TSL corresponds to *NORM_{x,y,z}* * *ConvF* whereby the uncertainty corresponds to that given for *ConvF*. A frequency dependent *ConvF* is used in DASY version 4.4 and higher which allows extending the validity from ± 50 MHz to ± 100 MHz.
- *Spherical isotropy (3D deviation from isotropy)*: in a field of low gradients realized using a flat phantom exposed by a patch antenna.
- *Sensor Offset*: The sensor offset corresponds to the offset of virtual measurement center from the probe tip (on probe axis). No tolerance required.
- *Connector Angle*: The angle is assessed using the information gained by determining the *NORM_x* (no uncertainty required).

Probe ES3DV3

SN:3288

Manufactured:	July 6, 2010
Repaired:	September 18, 2014
Calibrated:	September 24, 2014

Calibrated for DASY/EASY Systems
(Note: non-compatible with DASY2 system!)

DASY/EASY - Parameters of Probe: ES3DV3 - SN:3288

Basic Calibration Parameters

	Sensor X	Sensor Y	Sensor Z	Unc (k=2)
Norm ($\mu\text{V}/(\text{V}/\text{m})^2$) ^A	1.05	1.16	0.92	$\pm 10.1 \%$
DCP (mV) ^B	105.1	104.6	106.7	

Modulation Calibration Parameters

UID	Communication System Name		A dB	B dB $\sqrt{\mu\text{V}}$	C	D dB	VR mV	Unc ^E (k=2)
0	CW	X	0.0	0.0	1.0	0.00	195.8	$\pm 3.5 \%$
		Y	0.0	0.0	1.0		175.9	
		Z	0.0	0.0	1.0		177.1	
10010- CAA	SAR Validation (Square, 100ms, 10ms)	X	2.71	61.9	11.4	10.00	40.3	$\pm 2.2 \%$
		Y	2.37	60.2	11.2		42.6	
		Z	1.54	56.6	8.9		41.2	
10011- CAB	UMTS-FDD (WCDMA)	X	3.29	67.1	18.4	2.91	133.8	$\pm 0.5 \%$
		Y	3.43	67.9	18.9		139.5	
		Z	3.45	68.1	18.9		141.3	
10012- CAA	IEEE 802.11b WiFi 2.4 GHz (DSSS, 1 Mbps)	X	2.99	68.9	18.6	1.87	135.1	$\pm 0.7 \%$
		Y	3.59	72.4	20.4		140.7	
		Z	3.54	72.4	20.3		143.0	
10013- CAA	IEEE 802.11g WiFi 2.4 GHz (DSSS-OFDM, 6 Mbps)	X	11.15	70.8	23.3	9.46	132.3	$\pm 3.5 \%$
		Y	11.29	70.8	23.2		141.1	
		Z	11.07	70.7	23.2		139.2	
10021- DAB	GSM-FDD (TDMA, GMSK)	X	14.71	90.5	24.5	9.39	149.0	$\pm 1.9 \%$
		Y	16.40	92.8	26.0		131.3	
		Z	11.34	87.2	23.6		126.1	
10023- DAB	GPRS-FDD (TDMA, GMSK, TN 0)	X	15.91	92.2	25.3	9.57	138.9	$\pm 2.5 \%$
		Y	21.25	96.9	27.2		142.0	
		Z	11.68	87.2	23.5		145.9	
10024- DAB	GPRS-FDD (TDMA, GMSK, TN 0-1)	X	38.62	99.8	24.7	6.56	123.8	$\pm 2.2 \%$
		Y	36.71	99.7	25.2		128.1	
		Z	36.56	99.4	24.5		129.5	
10027- DAB	GPRS-FDD (TDMA, GMSK, TN 0-1-2)	X	56.60	99.6	22.6	4.80	138.8	$\pm 1.9 \%$
		Y	46.94	99.9	23.7		149.9	
		Z	51.17	99.8	22.9		144.9	
10028- DAB	GPRS-FDD (TDMA, GMSK, TN 0-1-2-3)	X	70.88	100.0	21.6	3.55	147.5	$\pm 1.9 \%$
		Y	52.58	99.8	22.6		129.4	
		Z	76.98	99.8	21.2		128.7	
10032- CAA	IEEE 802.15.1 Bluetooth (GFSK, DH5)	X	98.89	99.5	18.9	1.16	135.8	$\pm 1.4 \%$
		Y	78.39	99.6	19.5		141.7	
		Z	95.21	95.5	17.1		143.4	
10039- CAB	CDMA2000 (1xRTT, RC1)	X	4.72	66.7	18.9	4.57	133.7	$\pm 0.9 \%$
		Y	4.85	67.1	19.1		137.7	
		Z	4.81	67.4	19.2		141.9	

10081-CAB	CDMA2000 (1xRTT, RC3)	X	3.91	66.3	18.6	3.97	129.5	±0.7 %
		Y	4.00	66.6	18.7		133.7	
		Z	3.99	66.8	18.8		137.5	
10098-CAB	UMTS-FDD (HSUPA, Subtest 2)	X	4.63	66.9	18.7	3.98	141.4	±0.7 %
		Y	4.78	67.5	19.0		147.7	
		Z	4.57	66.8	18.6		127.8	
10100-CAB	LTE-FDD (SC-FDMA, 100% RB, 20 MHz, QPSK)	X	6.59	68.2	20.1	5.67	149.2	±1.4 %
		Y	6.36	67.3	19.6		130.7	
		Z	6.36	67.5	19.6		133.6	
10108-CAB	LTE-FDD (SC-FDMA, 100% RB, 10 MHz, QPSK)	X	6.44	67.8	20.0	5.80	146.6	±1.4 %
		Y	6.23	66.8	19.4		128.8	
		Z	6.24	67.1	19.6		131.4	
10110-CAB	LTE-FDD (SC-FDMA, 100% RB, 5 MHz, QPSK)	X	6.08	67.1	19.6	5.75	143.2	±1.4 %
		Y	6.20	67.4	19.8		148.0	
		Z	5.92	66.6	19.3		128.5	
10114-CAA	IEEE 802.11n (HT Greenfield, 13.5 Mbps, BPSK)	X	10.32	69.3	21.5	8.10	137.0	±2.2 %
		Y	10.31	69.1	21.4		143.5	
		Z	10.37	69.5	21.6		146.1	
10117-CAA	IEEE 802.11n (HT Mixed, 13.5 Mbps, BPSK)	X	10.35	69.4	21.6	8.07	138.3	±2.2 %
		Y	10.36	69.3	21.4		146.4	
		Z	10.42	69.6	21.6		149.0	
10151-CAB	LTE-TDD (SC-FDMA, 50% RB, 20 MHz, QPSK)	X	9.95	75.7	26.2	9.28	134.9	±3.3 %
		Y	10.37	76.0	26.1		146.6	
		Z	9.77	75.4	26.0		142.5	
10154-CAB	LTE-FDD (SC-FDMA, 50% RB, 10 MHz, QPSK)	X	6.12	67.2	19.7	5.75	144.9	±1.4 %
		Y	6.21	67.4	19.8		148.8	
		Z	5.91	66.5	19.3		128.7	
10160-CAB	LTE-FDD (SC-FDMA, 50% RB, 15 MHz, QPSK)	X	6.28	66.7	19.4	5.82	125.5	±1.2 %
		Y	6.37	66.8	19.4		129.7	
		Z	6.36	67.1	19.6		132.9	
10169-CAB	LTE-FDD (SC-FDMA, 1 RB, 20 MHz, QPSK)	X	5.08	67.6	20.2	5.73	147.0	±1.2 %
		Y	4.95	66.6	19.6		128.6	
		Z	4.91	66.9	19.8		131.2	
10172-CAB	LTE-TDD (SC-FDMA, 1 RB, 20 MHz, QPSK)	X	8.18	77.2	27.2	9.21	123.4	±2.7 %
		Y	8.37	76.6	26.6		129.5	
		Z	7.97	76.7	26.9		128.7	
10175-CAB	LTE-FDD (SC-FDMA, 1 RB, 10 MHz, QPSK)	X	5.05	67.4	20.1	5.72	146.2	±1.4 %
		Y	5.10	67.3	20.0		142.8	
		Z	4.87	66.7	19.6		129.6	
10181-CAB	LTE-FDD (SC-FDMA, 1 RB, 15 MHz, QPSK)	X	5.04	67.4	20.0	5.72	145.5	±1.2 %
		Y	5.12	67.4	20.0		143.4	
		Z	4.87	66.7	19.6		129.9	
10193-CAA	IEEE 802.11n (HT Greenfield, 6.5 Mbps, BPSK)	X	9.92	68.9	21.4	8.09	131.0	±2.2 %
		Y	9.84	68.5	21.1		130.0	
		Z	9.94	69.0	21.4		138.6	

10196-CAA	IEEE 802.11n (HT Mixed, 6.5 Mbps, BPSK)	X	9.90	68.9	21.4	8.10	130.8	±2.2 %
		Y	9.81	68.4	21.0		131.4	
		Z	9.95	69.1	21.5		140.5	
10219-CAA	IEEE 802.11n (HT Mixed, 7.2 Mbps, BPSK)	X	9.81	68.8	21.3	8.03	130.0	±2.2 %
		Y	9.89	68.9	21.3		138.1	
		Z	9.89	69.1	21.5		140.5	
10222-CAA	IEEE 802.11n (HT Mixed, 15 Mbps, BPSK)	X	10.25	69.2	21.4	8.06	137.1	±2.2 %
		Y	10.30	69.2	21.4		144.4	
		Z	10.38	69.6	21.6		148.4	
10225-CAB	UMTS-FDD (HSPA+)	X	6.90	66.8	19.3	5.97	132.8	±1.4 %
		Y	7.09	67.3	19.6		142.0	
		Z	7.04	67.4	19.6		143.5	
10237-CAB	LTE-TDD (SC-FDMA, 1 RB, 10 MHz, QPSK)	X	9.61	81.9	29.6	9.21	149.3	±2.7 %
		Y	8.66	77.6	27.1		133.7	
		Z	8.20	77.5	27.3		132.2	
10252-CAB	LTE-TDD (SC-FDMA, 50% RB, 10 MHz, QPSK)	X	9.16	74.5	25.8	9.24	126.3	±3.0 %
		Y	9.62	75.0	25.8		137.4	
		Z	9.16	74.8	25.9		135.2	
10267-CAB	LTE-TDD (SC-FDMA, 100% RB, 10 MHz, QPSK)	X	9.97	75.7	26.3	9.30	133.7	±3.3 %
		Y	10.38	75.9	26.1		146.1	
		Z	9.91	75.7	26.3		143.8	
10274-CAB	UMTS-FDD (HSUPA, Subtest 5, 3GPP Rel8.10)	X	5.86	66.6	18.7	4.87	129.9	±0.9 %
		Y	6.01	67.1	19.0		135.7	
		Z	5.95	67.1	19.0		139.4	
10275-CAB	UMTS-FDD (HSUPA, Subtest 5, 3GPP Rel8.4)	X	4.40	66.7	18.6	3.96	136.4	±0.7 %
		Y	4.55	67.3	19.0		138.3	
		Z	4.56	67.6	19.1		144.3	
10291-AAB	CDMA2000, RC3, SO55, Full Rate	X	3.64	66.9	18.7	3.46	127.4	±0.5 %
		Y	3.77	67.6	19.1		130.2	
		Z	3.72	67.5	19.0		134.4	
10292-AAB	CDMA2000, RC3, SO32, Full Rate	X	3.58	67.0	18.7	3.39	128.4	±0.5 %
		Y	3.73	67.7	19.1		132.7	
		Z	3.69	67.8	19.1		136.1	
10297-AAA	LTE-FDD (SC-FDMA, 50% RB, 20 MHz, QPSK)	X	6.43	67.7	19.9	5.81	145.5	±1.4 %
		Y	6.49	67.7	19.9		149.5	
		Z	6.23	67.0	19.6		129.5	
10311-AAA	LTE-FDD (SC-FDMA, 100% RB, 15 MHz, QPSK)	X	6.74	67.3	19.8	6.06	126.7	±1.4 %
		Y	6.83	67.5	19.8		132.9	
		Z	6.81	67.6	19.9		135.8	
10315-AAA	IEEE 802.11b WiFi 2.4 GHz (DSSS, 1 Mbps, 96pc duty cycle)	X	3.00	69.9	19.4	1.71	133.9	±0.5 %
		Y	3.30	71.5	20.1		141.0	
		Z	3.22	71.4	20.0		142.9	
10316-AAA	IEEE 802.11g WiFi 2.4 GHz (ERP-OFDM, 6 Mbps, 96pc duty cycle)	X	10.17	69.2	21.8	8.36	130.5	±2.5 %
		Y	10.20	69.1	21.6		138.4	
		Z	10.20	69.4	21.8		140.7	

10403-AAB	CDMA2000 (1xEV-DO, Rev. 0)	X	4.75	68.3	18.8	3.76	138.5	±0.7 %
		Y	5.00	69.1	19.2		146.7	
		Z	4.92	69.2	19.1		148.5	
10404-AAB	CDMA2000 (1xEV-DO, Rev. A)	X	4.73	68.6	18.9	3.77	136.3	±0.7 %
		Y	4.97	69.4	19.4		143.7	
		Z	4.91	69.6	19.3		146.0	
10415-AAA	IEEE 802.11b WiFi 2.4 GHz (DSSS, 1 Mbps, 99pc duty cycle)	X	2.65	68.1	18.5	1.54	135.2	±0.5 %
		Y	3.05	70.8	19.9		140.7	
		Z	2.87	69.8	19.3		144.8	
10416-AAA	IEEE 802.11g WiFi 2.4 GHz (ERP-OFDM, 6 Mbps, 99pc duty cycle)	X	10.00	69.0	21.5	8.23	130.8	±2.2 %
		Y	10.06	68.9	21.4		138.6	
		Z	10.08	69.3	21.7		141.6	

The reported uncertainty of measurement is stated as the standard uncertainty of measurement multiplied by the coverage factor $k=2$, which for a normal distribution corresponds to a coverage probability of approximately 95%.

^A The uncertainties of NormX,Y,Z do not affect the E²-field uncertainty inside TSL (see Pages 8 and 9).

^B Numerical linearization parameter: uncertainty not required.

^E Uncertainty is determined using the max. deviation from linear response applying rectangular distribution and is expressed for the square of the field value.

DASY/EASY - Parameters of Probe: ES3DV3 - SN:3288

Calibration Parameter Determined in Head Tissue Simulating Media

f (MHz) ^C	Relative Permittivity ^F	Conductivity (S/m) ^F	ConvF X	ConvF Y	ConvF Z	Alpha ^G	Depth ^G (mm)	Unct. (k=2)
750	41.9	0.89	6.81	6.81	6.81	0.37	1.70	± 12.0 %
835	41.5	0.90	6.51	6.51	6.51	0.45	1.52	± 12.0 %
1750	40.1	1.37	5.38	5.38	5.38	0.44	1.58	± 12.0 %
1900	40.0	1.40	5.17	5.17	5.17	0.80	1.18	± 12.0 %
2450	39.2	1.80	4.56	4.56	4.56	0.80	1.21	± 12.0 %
2600	39.0	1.96	4.44	4.44	4.44	0.80	1.22	± 12.0 %

^C Frequency validity above 300 MHz of ± 100 MHz only applies for DASY v4.4 and higher (see Page 2), else it is restricted to ± 50 MHz. The uncertainty is the RSS of the ConvF uncertainty at calibration frequency and the uncertainty for the indicated frequency band. Frequency validity below 300 MHz is ± 10, 25, 40, 50 and 70 MHz for ConvF assessments at 30, 64, 128, 150 and 220 MHz respectively. Above 5 GHz frequency validity can be extended to ± 110 MHz.

^F At frequencies below 3 GHz, the validity of tissue parameters (ϵ and σ) can be relaxed to ± 10% if liquid compensation formula is applied to measured SAR values. At frequencies above 3 GHz, the validity of tissue parameters (ϵ and σ) is restricted to ± 5%. The uncertainty is the RSS of the ConvF uncertainty for indicated target tissue parameters.

^G Alpha/Depth are determined during calibration. SPEAG warrants that the remaining deviation due to the boundary effect after compensation is always less than ± 1% for frequencies below 3 GHz and below ± 2% for frequencies between 3-6 GHz at any distance larger than half the probe tip diameter from the boundary.

DASY/EASY - Parameters of Probe: ES3DV3 - SN:3288

Calibration Parameter Determined in Body Tissue Simulating Media

f (MHz) ^C	Relative Permittivity ^F	Conductivity (S/m) ^F	ConvF X	ConvF Y	ConvF Z	Alpha ^G	Depth ^G (mm)	Unct. (k=2)
750	55.5	0.96	6.38	6.38	6.38	0.31	1.89	± 12.0 %
835	55.2	0.97	6.32	6.32	6.32	0.55	1.39	± 12.0 %
1750	53.4	1.49	5.03	5.03	5.03	0.57	1.44	± 12.0 %
1900	53.3	1.52	4.82	4.82	4.82	0.51	1.54	± 12.0 %
2450	52.7	1.95	4.36	4.36	4.36	0.71	1.07	± 12.0 %
2600	52.5	2.16	4.22	4.22	4.22	0.80	1.07	± 12.0 %

^C Frequency validity above 300 MHz of ± 100 MHz only applies for DASY v4.4 and higher (see Page 2), else it is restricted to ± 50 MHz. The uncertainty is the RSS of the ConvF uncertainty at calibration frequency and the uncertainty for the indicated frequency band. Frequency validity below 300 MHz is ± 10, 25, 40, 50 and 70 MHz for ConvF assessments at 30, 64, 128, 150 and 220 MHz respectively. Above 5 GHz frequency validity can be extended to ± 110 MHz.

^F At frequencies below 3 GHz, the validity of tissue parameters (ϵ and σ) can be relaxed to ± 10% if liquid compensation formula is applied to measured SAR values. At frequencies above 3 GHz, the validity of tissue parameters (ϵ and σ) is restricted to ± 5%. The uncertainty is the RSS of the ConvF uncertainty for indicated target tissue parameters.

^G Alpha/Depth are determined during calibration. SPEAG warrants that the remaining deviation due to the boundary effect after compensation is always less than ± 1% for frequencies below 3 GHz and below ± 2% for frequencies between 3-6 GHz at any distance larger than half the probe tip diameter from the boundary.

Frequency Response of E-Field

(TEM-Cell:ifi1110 EXX, Waveguide: R22)

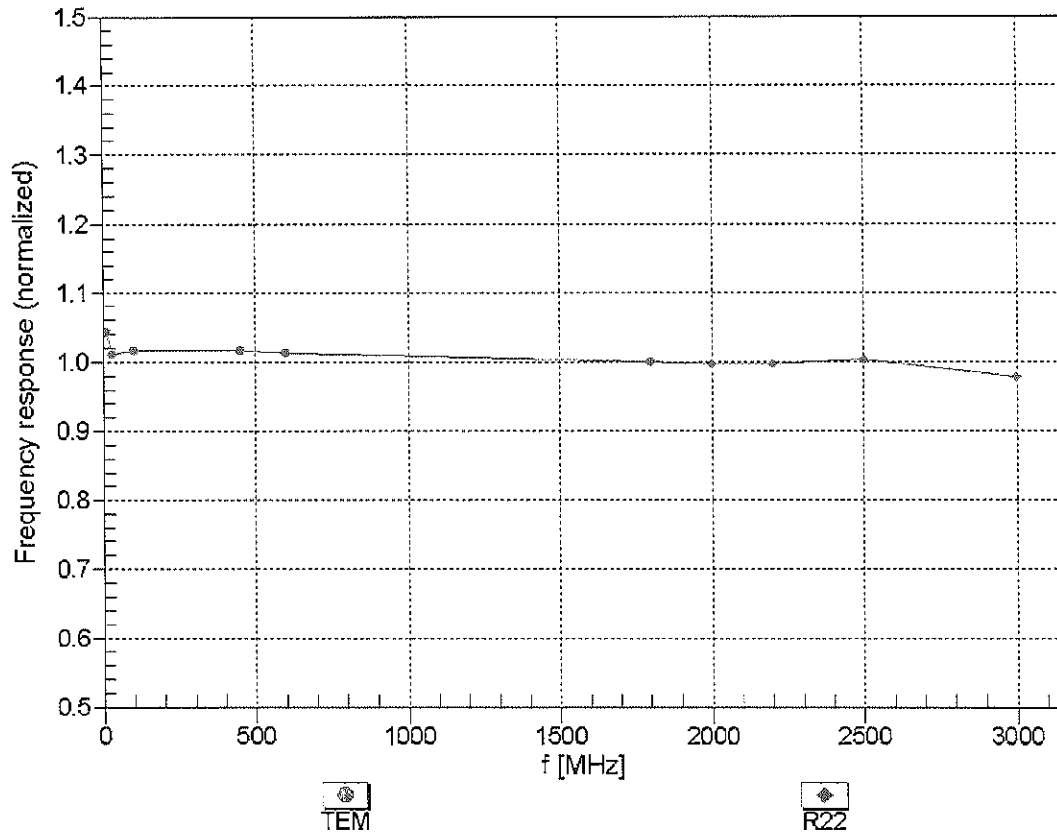

Uncertainty of Frequency Response of E-field: $\pm 6.3\%$ (k=2)

Receiving Pattern (ϕ), $\vartheta = 0^\circ$

f=600 MHz,TEM

f=1800 MHz,R22

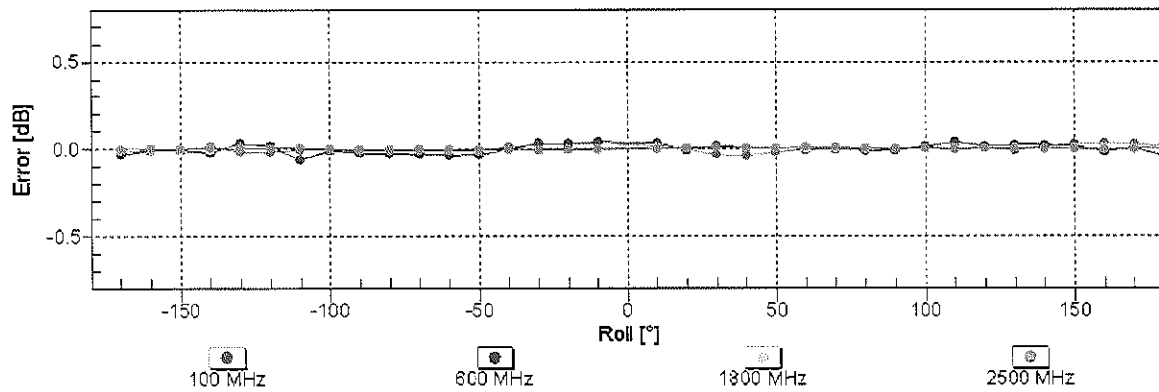
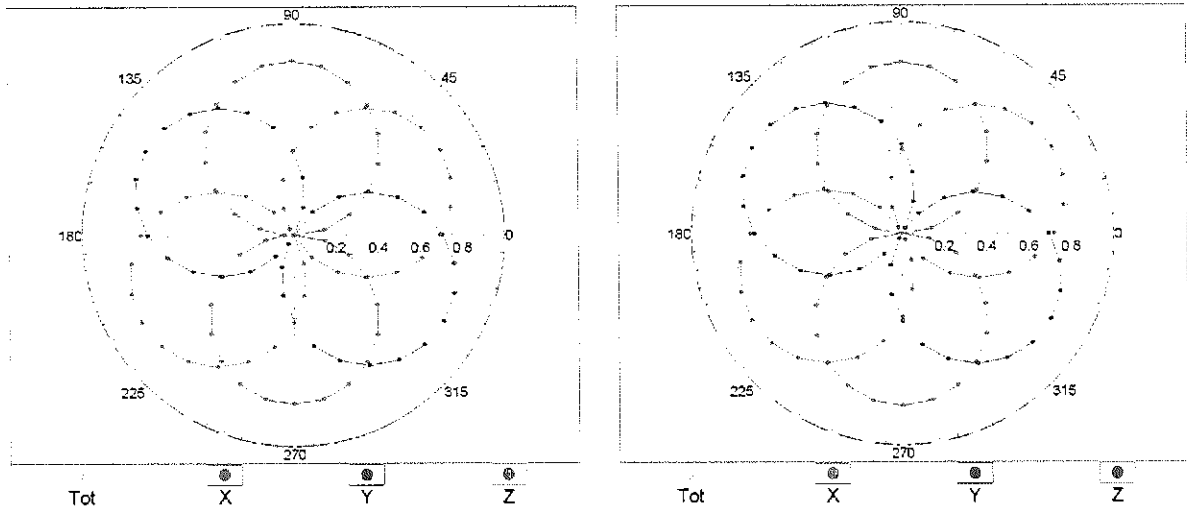

Uncertainty of Axial Isotropy Assessment: $\pm 0.5\%$ (k=2)

Dynamic Range $f(\text{SAR}_{\text{head}})$ (TEM cell , $f_{\text{eval}}= 1900 \text{ MHz}$)

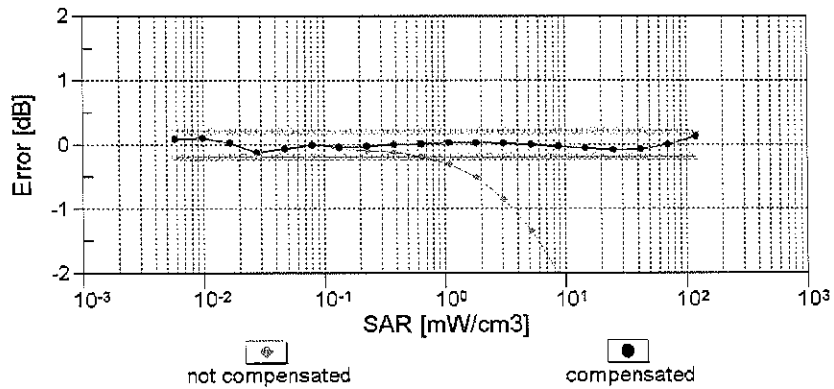
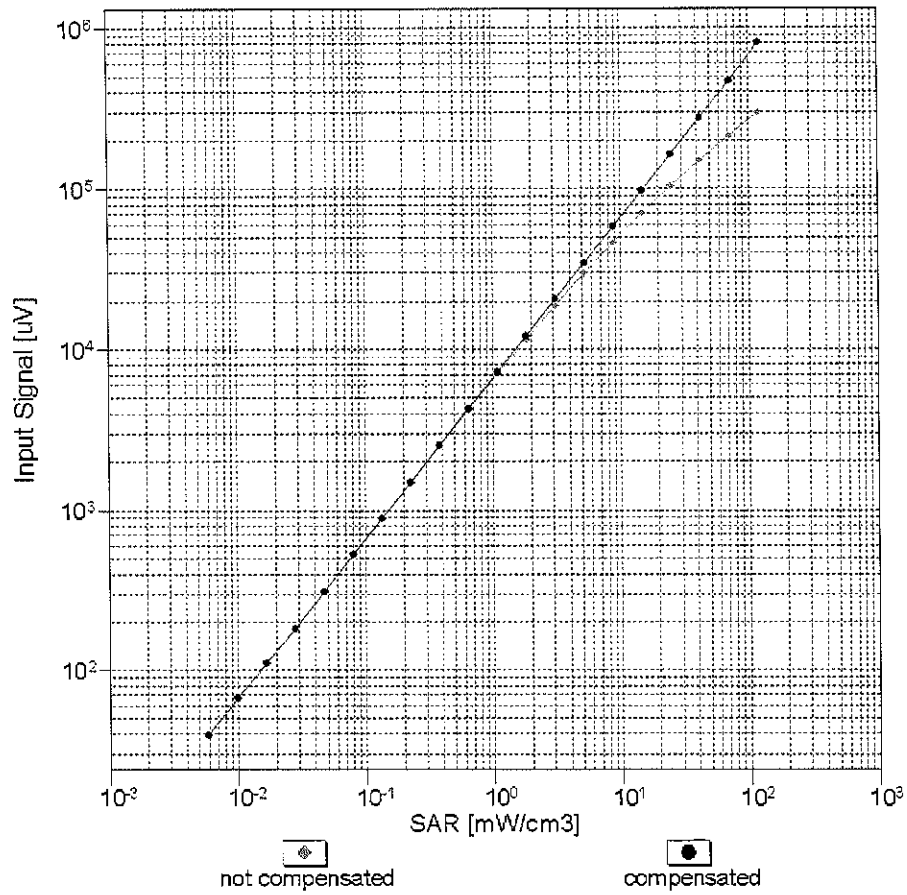

Uncertainty of Linearity Assessment: $\pm 0.6\%$ ($k=2$)

Conversion Factor Assessment

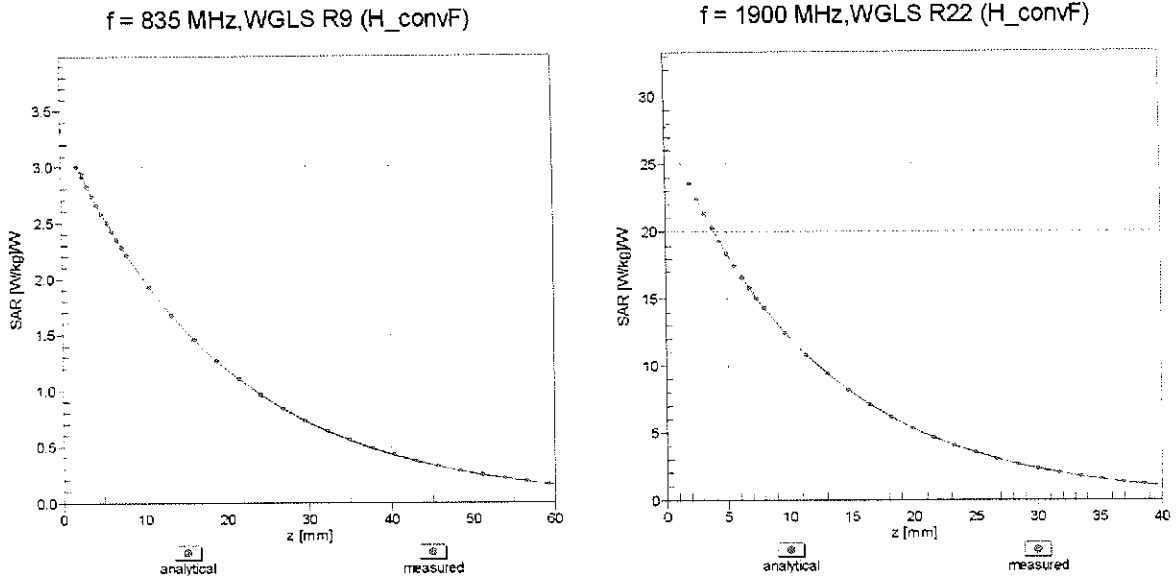

Deviation from Isotropy in Liquid

Error (ϕ, θ), f = 900 MHz

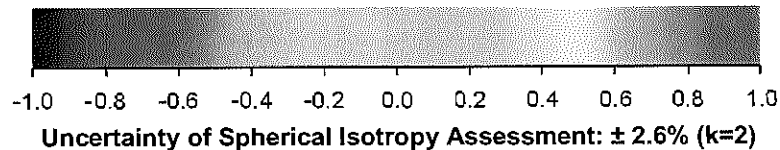
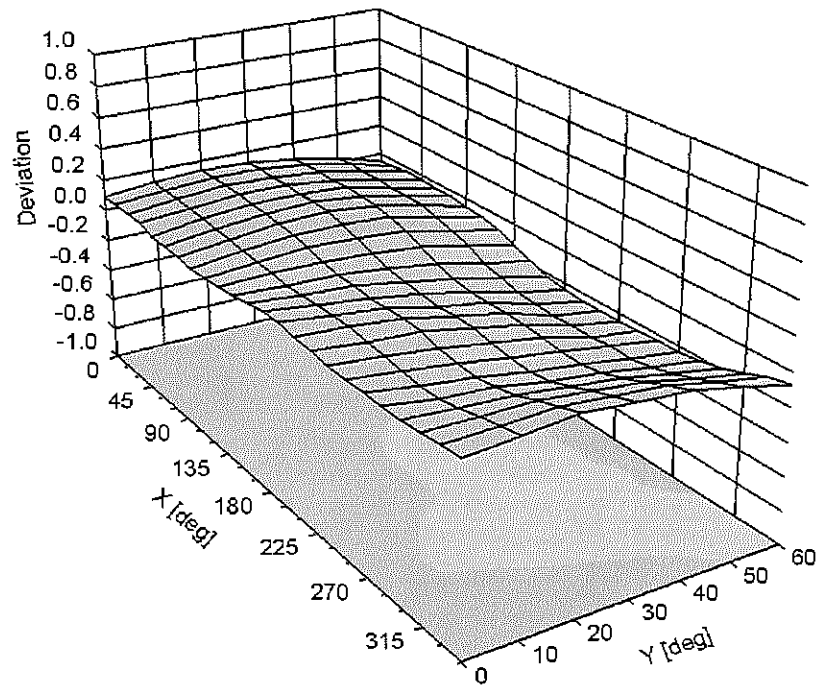

DASY/EASY - Parameters of Probe: ES3DV3 - SN:3288**Other Probe Parameters**

Sensor Arrangement	Triangular
Connector Angle (°)	-110
Mechanical Surface Detection Mode	enabled
Optical Surface Detection Mode	disabled
Probe Overall Length	337 mm
Probe Body Diameter	10 mm
Tip Length	10 mm
Tip Diameter	4 mm
Probe Tip to Sensor X Calibration Point	2 mm
Probe Tip to Sensor Y Calibration Point	2 mm
Probe Tip to Sensor Z Calibration Point	2 mm
Recommended Measurement Distance from Surface	3 mm



Accredited by the Swiss Accreditation Service (SAS)
The Swiss Accreditation Service is one of the signatories to the EA
Multilateral Agreement for the recognition of calibration certificates

Accreditation No.: **SCS 108**

Client **PC Test**

Certificate No: **ES3-3258_Feb14**

CALIBRATION CERTIFICATE

Object **ES3DV3 - SN:3258**

Calibration procedure(s) **QA CAL-01.v9, QA CAL-23.v5, QA CAL-25.v6
Calibration procedure for dosimetric E-field probes** *CCV
3/16/14*

Calibration date: **February 25, 2014**

This calibration certificate documents the traceability to national standards, which realize the physical units of measurements (SI).
The measurements and the uncertainties with confidence probability are given on the following pages and are part of the certificate.

All calibrations have been conducted in the closed laboratory facility: environment temperature (22 ± 3)°C and humidity < 70%.

Calibration Equipment used (M&TE critical for calibration)

Primary Standards	ID	Cal Date (Certificate No.)	Scheduled Calibration
Power meter E4419B	GB41293874	04-Apr-13 (No. 217-01733)	Apr-14
Power sensor E4412A	MY41498087	04-Apr-13 (No. 217-01733)	Apr-14
Reference 3 dB Attenuator	SN: S5054 (3c)	04-Apr-13 (No. 217-01737)	Apr-14
Reference 20 dB Attenuator	SN: S5277 (20x)	04-Apr-13 (No. 217-01735)	Apr-14
Reference 30 dB Attenuator	SN: S5129 (30b)	04-Apr-13 (No. 217-01738)	Apr-14
Reference Probe ES3DV2	SN: 3013	30-Dec-13 (No. ES3-3013_Dec13)	Dec-14
DAE4	SN: 660	13-Dec-13 (No. DAE4-660_Dec13)	Dec-14
Secondary Standards	ID	Check Date (in house)	Scheduled Check
RF generator HP 8648C	US3642U01700	4-Aug-99 (in house check Apr-13)	In house check: Apr-16
Network Analyzer HP 8753E	US37390585	18-Oct-01 (in house check Oct-13)	In house check: Oct-14

Calibrated by:	Name Israe El-Naouq	Function Laboratory Technician	Signature <i>Israe El-Naouq</i>
Approved by:	Name Katja Pokovic	Function Technical Manager	Signature <i>Katja Pokovic</i>

Issued: February 27, 2014

This calibration certificate shall not be reproduced except in full without written approval of the laboratory.

PCT# 80615



Accredited by the Swiss Accreditation Service (SAS)

Accreditation No.: **SCS 108**

The Swiss Accreditation Service is one of the signatories to the EA Multilateral Agreement for the recognition of calibration certificates

Glossary:

TSL	tissue simulating liquid
NORM _{x,y,z}	sensitivity in free space
ConvF	sensitivity in TSL / NORM _{x,y,z}
DCP	diode compression point
CF	crest factor (1/duty_cycle) of the RF signal
A, B, C, D	modulation dependent linearization parameters
Polarization φ	φ rotation around probe axis
Polarization ϑ	ϑ rotation around an axis that is in the plane normal to probe axis (at measurement center), i.e., $\vartheta = 0$ is normal to probe axis
Connector Angle	information used in DASY system to align probe sensor X to the robot coordinate system

Calibration is Performed According to the Following Standards:

- a) IEEE Std 1528-2013, "IEEE Recommended Practice for Determining the Peak Spatial-Averaged Specific Absorption Rate (SAR) in the Human Head from Wireless Communications Devices: Measurement Techniques", June 2013
- b) IEC 62209-1, "Procedure to measure the Specific Absorption Rate (SAR) for hand-held devices used in close proximity to the ear (frequency range of 300 MHz to 3 GHz)", February 2005

Methods Applied and Interpretation of Parameters:

- *NORM_{x,y,z}*: Assessed for E-field polarization $\vartheta = 0$ ($f \leq 900$ MHz in TEM-cell; $f > 1800$ MHz: R22 waveguide). *NORM_{x,y,z}* are only intermediate values, i.e., the uncertainties of *NORM_{x,y,z}* does not affect the E^2 -field uncertainty inside TSL (see below *ConvF*).
- *NORM(f)_{x,y,z}* = *NORM_{x,y,z}* * *frequency_response* (see Frequency Response Chart). This linearization is implemented in DASY4 software versions later than 4.2. The uncertainty of the frequency response is included in the stated uncertainty of *ConvF*.
- *DCP_{x,y,z}*: DCP are numerical linearization parameters assessed based on the data of power sweep with CW signal (no uncertainty required). DCP does not depend on frequency nor media.
- *PAR*: PAR is the Peak to Average Ratio that is not calibrated but determined based on the signal characteristics
- *A_{x,y,z}*; *B_{x,y,z}*; *C_{x,y,z}*; *D_{x,y,z}*; *VR_{x,y,z}*: *A, B, C, D* are numerical linearization parameters assessed based on the data of power sweep for specific modulation signal. The parameters do not depend on frequency nor media. *VR* is the maximum calibration range expressed in RMS voltage across the diode.
- *ConvF and Boundary Effect Parameters*: Assessed in flat phantom using E-field (or Temperature Transfer Standard for $f \leq 800$ MHz) and inside waveguide using analytical field distributions based on power measurements for $f > 800$ MHz. The same setups are used for assessment of the parameters applied for boundary compensation (alpha, depth) of which typical uncertainty values are given. These parameters are used in DASY4 software to improve probe accuracy close to the boundary. The sensitivity in TSL corresponds to *NORM_{x,y,z}* * *ConvF* whereby the uncertainty corresponds to that given for *ConvF*. A frequency dependent *ConvF* is used in DASY version 4.4 and higher which allows extending the validity from ± 50 MHz to ± 100 MHz.
- *Spherical isotropy (3D deviation from isotropy)*: in a field of low gradients realized using a flat phantom exposed by a patch antenna.
- *Sensor Offset*: The sensor offset corresponds to the offset of virtual measurement center from the probe tip (on probe axis). No tolerance required.
- *Connector Angle*: The angle is assessed using the information gained by determining the *NORM_x* (no uncertainty required).

Probe ES3DV3

SN:3258

Manufactured: January 25, 2010
Calibrated: February 25, 2014

Calibrated for DASY/EASY Systems
(Note: non-compatible with DASY2 system!)

DASY/EASY - Parameters of Probe: ES3DV3 - SN:3258

Basic Calibration Parameters

	Sensor X	Sensor Y	Sensor Z	Unc (k=2)
Norm ($\mu V/(V/m)^2$) ^A	1.29	1.19	1.23	± 10.1 %
DCP (mV) ^B	104.5	107.0	103.0	

Modulation Calibration Parameters

UID	Communication System Name		A dB	B dB√μV	C	D dB	VR mV	Unc ^E (k=2)
0	CW	X	0.0	0.0	1.0	0.00	222.4	±3.8 %
		Y	0.0	0.0	1.0		202.2	
		Z	0.0	0.0	1.0		207.1	
10010-CAA	SAR Validation (Square, 100ms, 10ms)	X	5.09	65.6	14.1	10.00	44.8	±1.9 %
		Y	1.68	57.4	9.3		40.7	
		Z	4.01	62.4	13.0		51.1	
10011-CAB	UMTS-FDD (WCDMA)	X	3.34	67.5	18.9	2.91	131.2	±0.5 %
		Y	3.43	67.9	18.7		137.1	
		Z	3.42	67.8	19.0		146.0	
10012-CAA	IEEE 802.11b WiFi 2.4 GHz (DSSS, 1 Mbps)	X	3.40	70.9	19.8	1.87	134.2	±0.7 %
		Y	3.19	70.2	19.2		137.9	
		Z	3.46	70.8	19.6		149.6	
10021-DAB	GSM-FDD (TDMA, GMSK)	X	30.24	99.7	28.7	9.39	131.2	±1.4 %
		Y	12.91	88.5	23.9		147.5	
		Z	30.37	99.5	28.9		128.0	
10023-DAB	GPRS-FDD (TDMA, GMSK, TN 0)	X	29.88	100.0	29.0	9.57	123.0	±1.9 %
		Y	16.02	92.5	25.4		140.7	
		Z	30.01	100.0	29.4		125.8	
10024-DAB	GPRS-FDD (TDMA, GMSK, TN 0-1)	X	44.57	99.7	25.9	6.56	119.6	±1.7 %
		Y	28.97	95.3	23.2		127.6	
		Z	43.72	99.8	26.3		120.1	
10027-DAB	GPRS-FDD (TDMA, GMSK, TN 0-1-2)	X	53.52	99.7	24.4	4.80	129.4	±2.2 %
		Y	54.55	99.9	22.9		143.3	
		Z	51.63	99.7	24.8		127.5	
10028-DAB	GPRS-FDD (TDMA, GMSK, TN 0-1-2-3)	X	58.93	99.8	23.4	3.55	133.4	±2.2 %
		Y	77.54	99.7	21.3		125.3	
		Z	56.64	99.8	23.8		130.8	
10032-CAA	IEEE 802.15.1 Bluetooth (GFSK, DH5)	X	47.03	99.5	21.3	1.16	136.3	±1.7 %
		Y	95.86	95.2	17.1		138.2	
		Z	39.68	100.0	22.2		132.3	
10039-CAB	CDMA2000 (1xRTT, RC1)	X	4.84	66.8	19.1	4.57	131.3	±0.9 %
		Y	4.75	67.0	18.9		135.2	
		Z	4.86	66.7	19.0		127.2	

10081-CAB	CDMA2000 (1xRTT, RC3)	X	4.06	66.8	19.0	3.97	148.4	±0.7 %
		Y	3.96	66.6	18.6		134.7	
		Z	4.13	66.9	19.1		143.4	
10098-CAB	UMTS-FDD (HSUPA, Subtest 2)	X	4.63	66.8	18.7	3.98	137.3	±0.7 %
		Y	4.75	67.5	18.8		148.4	
		Z	4.65	66.7	18.7		133.2	
10100-CAB	LTE-FDD (SC-FDMA, 100% RB, 20 MHz, QPSK)	X	6.66	68.5	20.3	5.67	144.0	±1.2 %
		Y	6.27	67.1	19.3		130.6	
		Z	6.62	68.2	20.1		140.5	
10108-CAB	LTE-FDD (SC-FDMA, 100% RB, 10 MHz, QPSK)	X	6.53	68.0	20.2	5.80	142.6	±1.4 %
		Y	6.17	66.8	19.3		129.2	
		Z	6.52	67.8	20.1		139.0	
10110-CAB	LTE-FDD (SC-FDMA, 100% RB, 5 MHz, QPSK)	X	6.19	67.3	19.9	5.75	137.9	±1.4 %
		Y	6.12	67.3	19.6		149.5	
		Z	6.19	67.1	19.8		136.1	
10114-CAA	IEEE 802.11n (HT Greenfield, 13.5 Mbps, BPSK)	X	10.49	69.5	21.7	8.10	132.4	±2.5 %
		Y	10.23	69.1	21.3		144.3	
		Z	10.45	69.3	21.6		129.5	
10117-CAA	IEEE 802.11n (HT Mixed, 13.5 Mbps, BPSK)	X	10.46	69.5	21.7	8.07	133.9	±2.5 %
		Y	10.26	69.2	21.3		147.4	
		Z	10.47	69.4	21.7		130.5	
10151-CAB	LTE-TDD (SC-FDMA, 50% RB, 20 MHz, QPSK)	X	11.61	77.4	26.8	9.28	118.8	±3.0 %
		Y	9.89	75.2	25.7		144.9	
		Z	12.01	77.8	26.9		119.6	
10154-CAB	LTE-FDD (SC-FDMA, 50% RB, 10 MHz, QPSK)	X	6.20	67.3	19.9	5.75	139.2	±1.2 %
		Y	5.86	66.2	19.0		128.5	
		Z	6.22	67.3	19.9		136.3	
10160-CAB	LTE-FDD (SC-FDMA, 50% RB, 15 MHz, QPSK)	X	6.63	67.8	20.1	5.82	144.1	±1.4 %
		Y	6.31	66.8	19.3		133.1	
		Z	6.66	67.7	20.0		140.9	
10169-CAB	LTE-FDD (SC-FDMA, 1 RB, 20 MHz, QPSK)	X	5.25	67.5	20.2	5.73	143.6	±1.2 %
		Y	4.92	66.7	19.5		131.0	
		Z	5.29	67.4	20.2		140.7	
10172-CAB	LTE-TDD (SC-FDMA, 1 RB, 20 MHz, QPSK)	X	13.49	87.5	31.6	9.21	139.0	±2.7 %
		Y	7.83	75.5	26.0		124.9	
		Z	13.47	86.5	31.1		137.8	
10175-CAB	LTE-FDD (SC-FDMA, 1 RB, 10 MHz, QPSK)	X	5.22	67.4	20.1	5.72	144.3	±1.4 %
		Y	5.08	67.5	19.9		147.9	
		Z	5.26	67.2	20.0		139.6	
10181-CAB	LTE-FDD (SC-FDMA, 1 RB, 15 MHz, QPSK)	X	5.24	67.5	20.1	5.72	144.5	±1.2 %
		Y	5.06	67.4	19.8		147.0	
		Z	5.29	67.3	20.1		139.2	

10193-CAA	IEEE 802.11n (HT Greenfield, 6.5 Mbps, BPSK)	X	10.12	69.1	21.6	8.09	128.8	±2.2 %
		Y	9.76	68.4	21.0		132.8	
		Z	10.08	68.9	21.5		123.4	
10196-CAA	IEEE 802.11n (HT Mixed, 6.5 Mbps, BPSK)	X	10.15	69.2	21.7	8.10	130.2	±2.2 %
		Y	9.77	68.5	21.0		134.1	
		Z	10.10	69.0	21.5		124.0	
10219-CAA	IEEE 802.11n (HT Mixed, 7.2 Mbps, BPSK)	X	10.02	69.0	21.5	8.03	128.7	±2.2 %
		Y	9.67	68.5	21.0		133.3	
		Z	10.02	68.9	21.5		123.9	
10222-CAA	IEEE 802.11n (HT Mixed, 15 Mbps, BPSK)	X	10.46	69.6	21.7	8.06	134.0	±2.2 %
		Y	10.09	68.8	21.1		139.7	
		Z	10.40	69.3	21.6		128.7	
10225-CAB	UMTS-FDD (HSPA+)	X	7.09	67.1	19.6	5.97	131.2	±1.4 %
		Y	6.98	67.2	19.4		138.0	
		Z	7.06	66.8	19.4		127.2	
10237-CAB	LTE-TDD (SC-FDMA, 1 RB, 10 MHz, QPSK)	X	13.63	87.8	31.7	9.21	141.6	±3.0 %
		Y	7.85	75.5	26.0		126.5	
		Z	13.99	87.7	31.6		141.4	
10252-CAB	LTE-TDD (SC-FDMA, 50% RB, 10 MHz, QPSK)	X	12.86	81.4	28.9	9.24	142.1	±3.0 %
		Y	8.91	73.4	24.8		129.9	
		Z	13.15	81.4	28.8		142.0	
10267-CAB	LTE-TDD (SC-FDMA, 100% RB, 10 MHz, QPSK)	X	11.63	77.5	26.8	9.30	118.7	±3.0 %
		Y	9.62	74.3	25.2		138.4	
		Z	11.96	77.7	26.9		119.3	
10274-CAB	UMTS-FDD (HSUPA, Subtest 5, 3GPP Rel8.10)	X	6.14	67.4	19.3	4.87	149.9	±0.9 %
		Y	5.90	66.9	18.7		132.8	
		Z	6.20	67.5	19.3		146.6	
10275-CAB	UMTS-FDD (HSUPA, Subtest 5, 3GPP Rel8.4)	X	4.45	66.9	18.9	3.96	130.1	±0.7 %
		Y	4.50	67.2	18.8		137.9	
		Z	4.64	67.6	19.3		149.2	
10291-AAB	CDMA2000, RC3, SO55, Full Rate	X	3.79	67.5	19.2	3.46	145.3	±0.7 %
		Y	3.74	67.5	18.9		128.2	
		Z	3.78	67.3	19.1		139.1	
10292-AAB	CDMA2000, RC3, SO32, Full Rate	X	3.77	67.8	19.3	3.39	147.0	±0.5 %
		Y	3.69	67.7	18.9		130.1	
		Z	3.73	67.3	19.0		141.3	
10297-AAA	LTE-FDD (SC-FDMA, 50% RB, 20 MHz, QPSK)	X	6.52	67.9	20.1	5.81	141.4	±1.4 %
		Y	6.41	67.6	19.7		147.4	
		Z	6.51	67.7	20.1		135.4	
10311-AAA	LTE-FDD (SC-FDMA, 100% RB, 15 MHz, QPSK)	X	7.17	68.7	20.7	6.06	147.7	±1.4 %
		Y	6.69	67.2	19.6		128.6	
		Z	7.12	68.4	20.5		142.0	

10315-AAA	IEEE 802.11b WiFi 2.4 GHz (DSSS, 1 Mbps, 96pc duty cycle)	X	3.04	70.0	19.6	1.71	129.8	±0.5 %
		Y	3.25	71.3	19.7		136.9	
		Z	3.09	69.9	19.5		148.7	
10403-AAB	CDMA2000 (1xEV-DO, Rev. 0)	X	4.73	67.3	18.6	3.76	135.7	±0.5 %
		Y	4.93	69.1	19.0		141.5	
		Z	4.73	67.1	18.4		132.7	
10404-AAB	CDMA2000 (1xEV-DO, Rev. A)	X	4.67	67.5	18.6	3.77	134.0	±0.5 %
		Y	4.92	69.4	19.1		139.8	
		Z	4.65	67.1	18.5		130.7	

The reported uncertainty of measurement is stated as the standard uncertainty of measurement multiplied by the coverage factor k=2, which for a normal distribution corresponds to a coverage probability of approximately 95%.

^A The uncertainties of NormX,Y,Z do not affect the E²-field uncertainty inside TSL (see Pages 8 and 9).
^B Numerical linearization parameter: uncertainty not required.
^E Uncertainty is determined using the max. deviation from linear response applying rectangular distribution and is expressed for the square of the field value.

DASY/EASY - Parameters of Probe: ES3DV3 - SN:3258

Calibration Parameter Determined in Head Tissue Simulating Media

f (MHz) ^C	Relative Permittivity ^F	Conductivity (S/m) ^F	ConvF X	ConvF Y	ConvF Z	Alpha ^G	Depth (mm) ^G	Unct. (k=2)
750	41.9	0.89	6.53	6.53	6.53	0.40	1.60	± 12.0 %
835	41.5	0.90	6.27	6.27	6.27	0.80	1.17	± 12.0 %
1750	40.1	1.37	5.19	5.19	5.19	0.80	1.10	± 12.0 %
1900	40.0	1.40	5.04	5.04	5.04	0.68	1.27	± 12.0 %
2450	39.2	1.80	4.52	4.52	4.52	0.78	1.23	± 12.0 %
2600	39.0	1.96	4.34	4.34	4.34	0.76	1.33	± 12.0 %

^C Frequency validity of ± 100 MHz only applies for DASY v4.4 and higher (see Page 2), else it is restricted to ± 50 MHz. The uncertainty is the RSS of the ConvF uncertainty at calibration frequency and the uncertainty for the indicated frequency band.

^F At frequencies below 3 GHz, the validity of tissue parameters (ϵ and σ) can be relaxed to ± 10% if liquid compensation formula is applied to measured SAR values. At frequencies above 3 GHz, the validity of tissue parameters (ϵ and σ) is restricted to ± 5%. The uncertainty is the RSS of the ConvF uncertainty for indicated target tissue parameters.

^G Alpha/Depth are determined during calibration. SPEAG warrants that the remaining deviation due to the boundary effect after compensation is always less than ± 1% for frequencies below 3 GHz and below ± 2% for frequencies between 3-6 GHz at any distance larger than half the probe tip diameter from the boundary.

DASY/EASY - Parameters of Probe: ES3DV3 - SN:3258

Calibration Parameter Determined in Body Tissue Simulating Media

f (MHz) ^c	Relative Permittivity ^F	Conductivity (S/m) ^F	ConvF X	ConvF Y	ConvF Z	Alpha ^G	Depth ^G (mm)	Unct. (k=2)
750	55.5	0.96	6.15	6.15	6.15	0.61	1.32	± 12.0 %
835	55.2	0.97	6.11	6.11	6.11	0.80	1.15	± 12.0 %
1750	53.4	1.49	4.83	4.83	4.83	0.47	1.74	± 12.0 %
1900	53.3	1.52	4.61	4.61	4.61	0.55	1.59	± 12.0 %
2450	52.7	1.95	4.14	4.14	4.14	0.80	1.11	± 12.0 %
2600	52.5	2.16	3.91	3.91	3.91	0.80	1.00	± 12.0 %

^c Frequency validity of ± 100 MHz only applies for DASY v4.4 and higher (see Page 2), else it is restricted to ± 50 MHz. The uncertainty is the RSS of the ConvF uncertainty at calibration frequency and the uncertainty for the indicated frequency band.

^F At frequencies below 3 GHz, the validity of tissue parameters (ϵ and σ) can be relaxed to ± 10% if liquid compensation formula is applied to measured SAR values. At frequencies above 3 GHz, the validity of tissue parameters (ϵ and σ) is restricted to ± 5%. The uncertainty is the RSS of the ConvF uncertainty for indicated target tissue parameters.

^G Alpha/Depth are determined during calibration. SPEAG warrants that the remaining deviation due to the boundary effect after compensation is always less than ± 1% for frequencies below 3 GHz and below ± 2% for frequencies between 3-6 GHz at any distance larger than half the probe tip diameter from the boundary.

Frequency Response of E-Field (TEM-Cell: ifi110 EXX, Waveguide: R22)

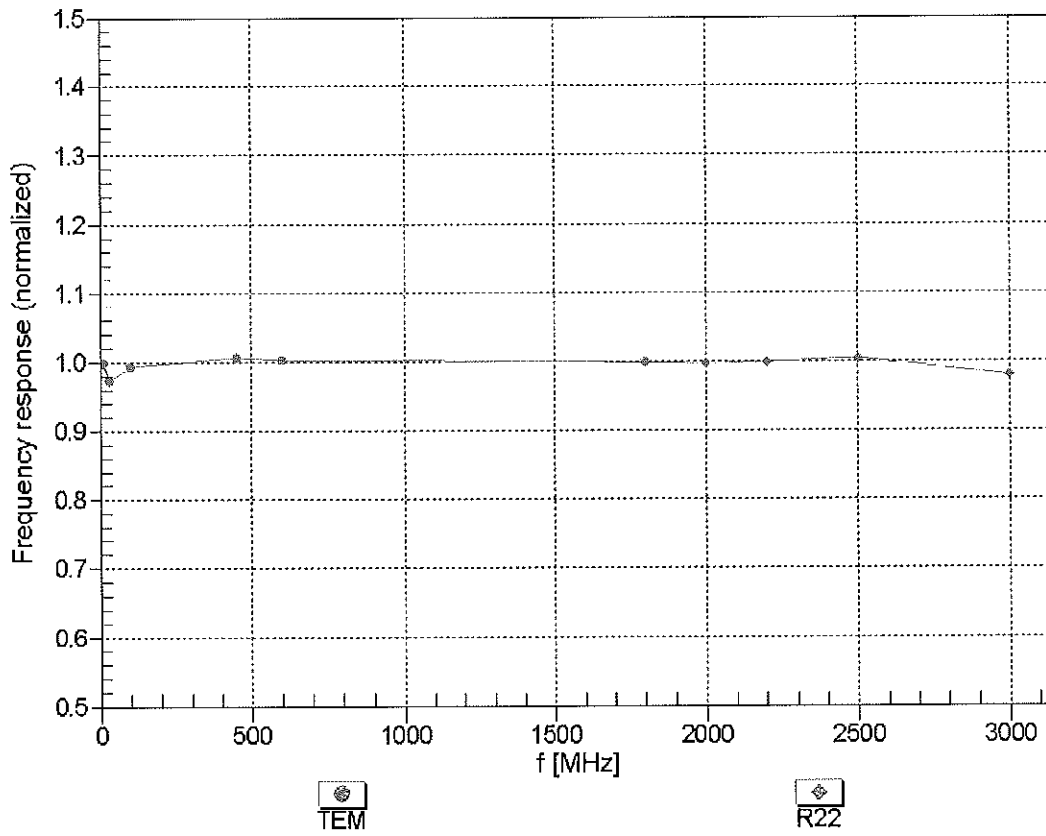

Uncertainty of Frequency Response of E-field: $\pm 6.3\%$ (k=2)

Receiving Pattern (ϕ), $\theta = 0^\circ$

f=600 MHz,TEM

f=1800 MHz,R22

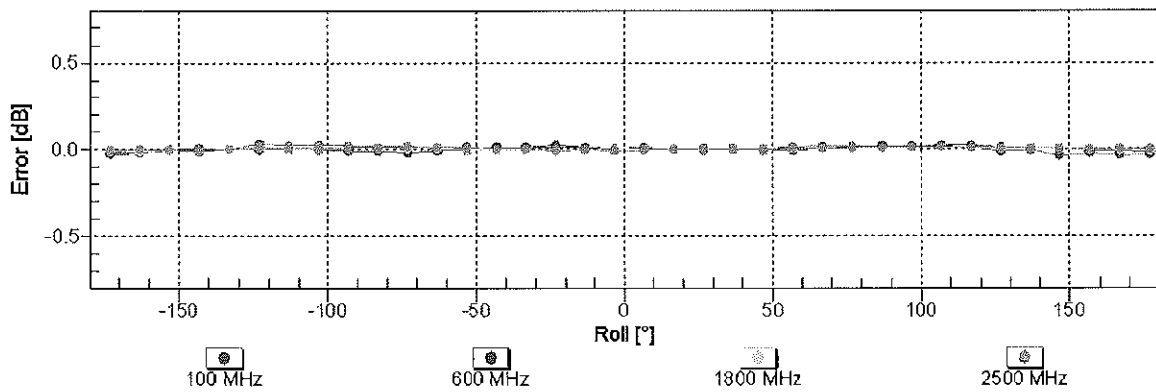
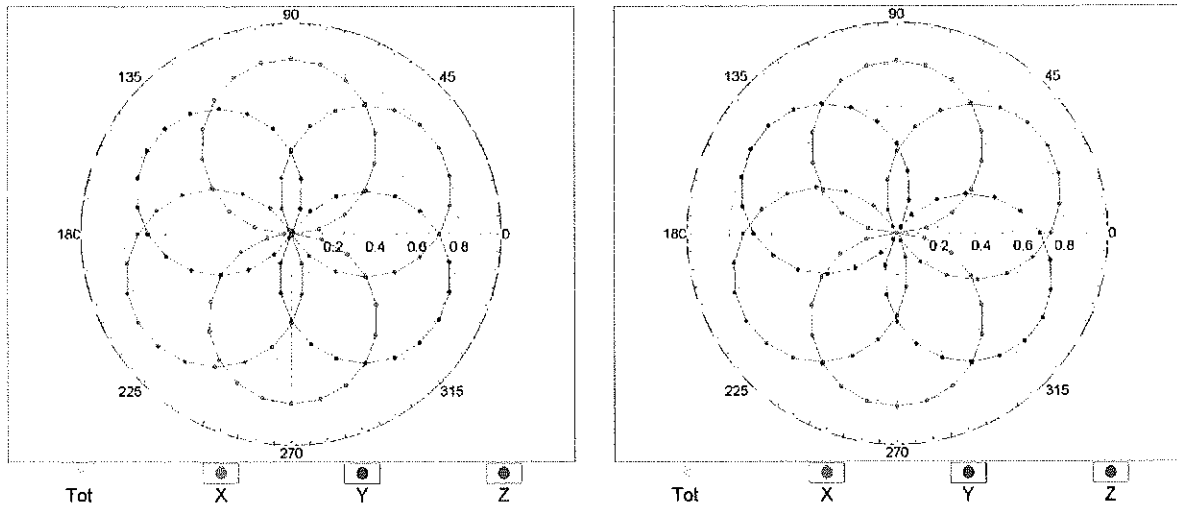

Uncertainty of Axial Isotropy Assessment: $\pm 0.5\%$ ($k=2$)

Dynamic Range f(SAR_{head}) (TEM cell , f_{eval}= 1900 MHz)

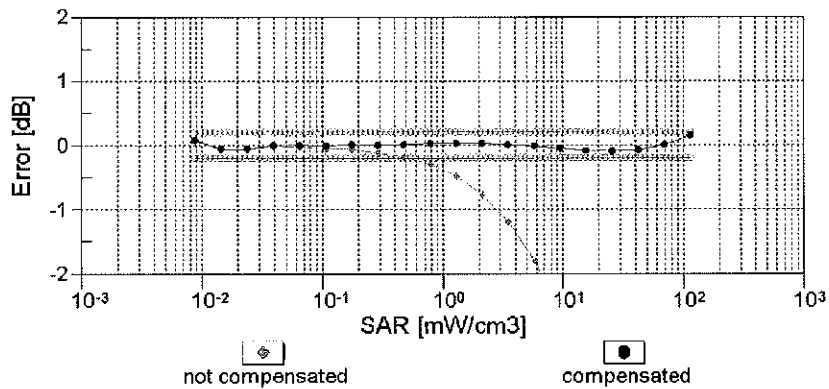
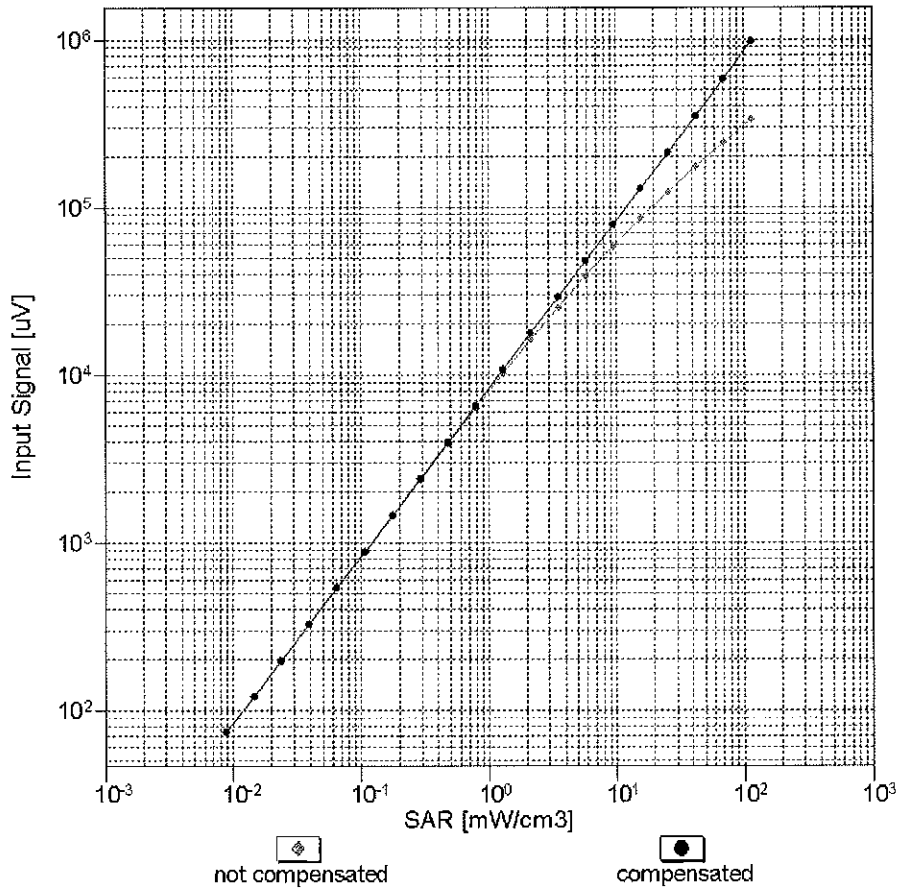

Uncertainty of Linearity Assessment: ± 0.6% (k=2)

Conversion Factor Assessment

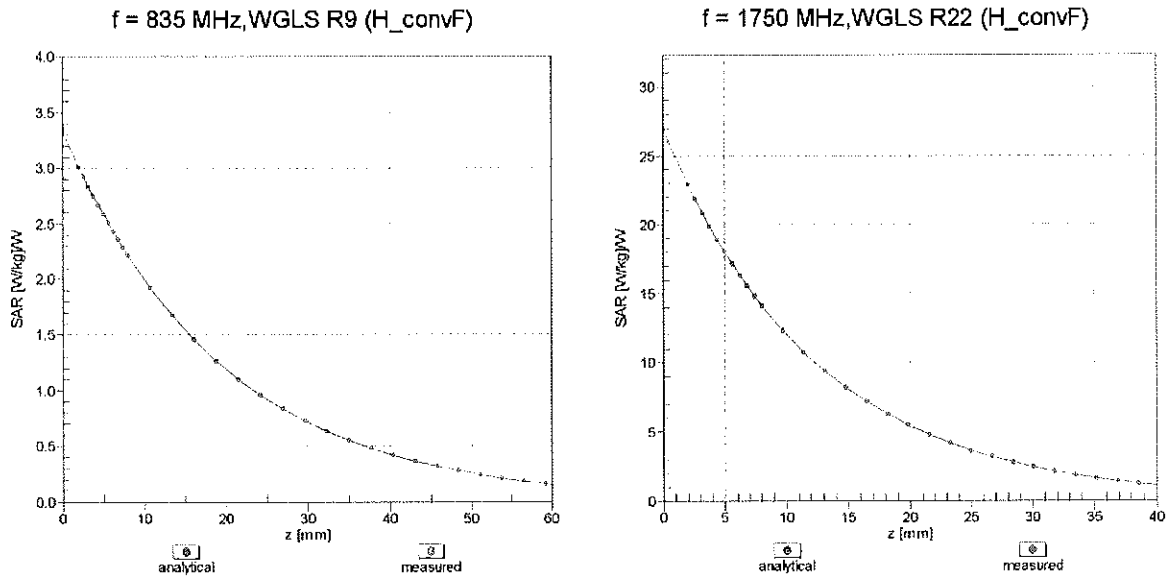

Deviation from Isotropy in Liquid Error (ϕ, ϑ), f = 900 MHz

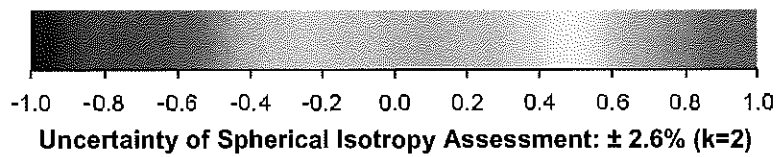
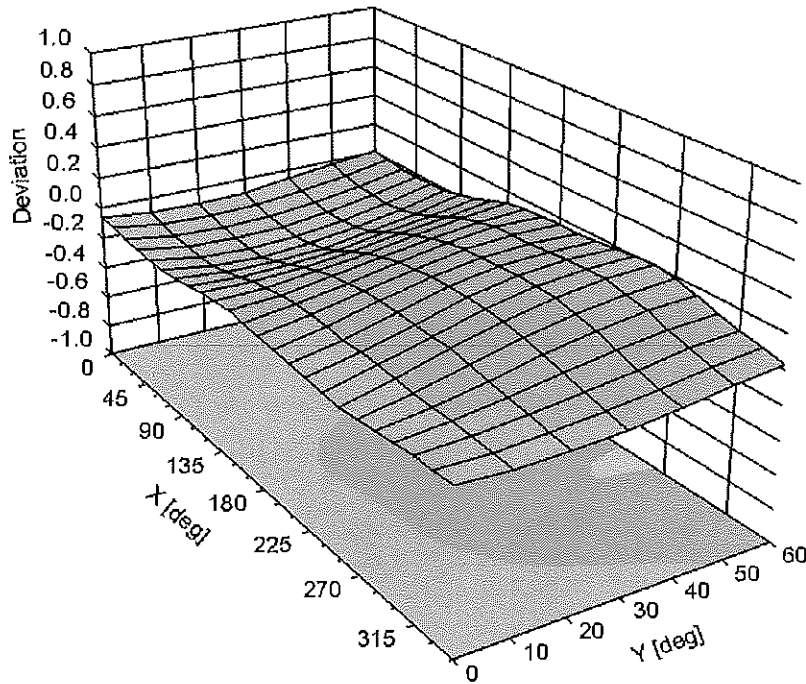

DASY/EASY - Parameters of Probe: ES3DV3 - SN:3258

Other Probe Parameters

Sensor Arrangement	Triangular
Connector Angle (°)	-123.1
Mechanical Surface Detection Mode	enabled
Optical Surface Detection Mode	disabled
Probe Overall Length	337 mm
Probe Body Diameter	10 mm
Tip Length	10 mm
Tip Diameter	4 mm
Probe Tip to Sensor X Calibration Point	2 mm
Probe Tip to Sensor Y Calibration Point	2 mm
Probe Tip to Sensor Z Calibration Point	2 mm
Recommended Measurement Distance from Surface	3 mm



Accredited by the Swiss Accreditation Service (SAS)
The Swiss Accreditation Service is one of the signatories to the EA
Multilateral Agreement for the recognition of calibration certificates

Accreditation No.: **SCS 108**

Client **PC Test**

Certificate No: **EX3-7308_Jul14**

CALIBRATION CERTIFICATE

Object **EX3DV4 - SN:7308**

Calibration procedure(s) **QA CAL-01.v9, QA CAL-14.v4, QA CAL-23.v5, QA CAL-25.v6
Calibration procedure for dosimetric E-field probes**

CC
w/4m

Calibration date: **July 16, 2014**

This calibration certificate documents the traceability to national standards, which realize the physical units of measurements (SI).
The measurements and the uncertainties with confidence probability are given on the following pages and are part of the certificate.

All calibrations have been conducted in the closed laboratory facility: environment temperature (22 ± 3)°C and humidity < 70%.

Calibration Equipment used (M&TE critical for calibration)

Primary Standards	ID	Cal Date (Certificate No.)	Scheduled Calibration
Power meter E4419B	GB41293874	03-Apr-14 (No. 217-01911)	Apr-15
Power sensor E4412A	MY41498087	03-Apr-14 (No. 217-01911)	Apr-15
Reference 3 dB Attenuator	SN: S5054 (3c)	03-Apr-14 (No. 217-01915)	Apr-15
Reference 20 dB Attenuator	SN: S5277 (20x)	03-Apr-14 (No. 217-01919)	Apr-15
Reference 30 dB Attenuator	SN: S5129 (30b)	03-Apr-14 (No. 217-01920)	Apr-15
Reference Probe ES3DV2	SN: 3013	30-Dec-13 (No. ES3-3013_Dec13)	Dec-14
DAE4	SN: 660	13-Dec-13 (No. DAE4-660_Dec13)	Dec-14
Secondary Standards	ID	Check Date (in house)	Scheduled Check
RF generator HP 8648C	US3642U01700	4-Aug-99 (in house check Apr-13)	In house check: Apr-16
Network Analyzer HP 8753E	US37390585	18-Oct-01 (in house check Oct-13)	In house check: Oct-14

Calibrated by:	Name Jeton Kastrati	Function Laboratory Technician	Signature
Approved by:	Name Katja Pokovic	Function Technical Manager	Signature

Issued: July 21, 2014

This calibration certificate shall not be reproduced except in full without written approval of the laboratory.



Accredited by the Swiss Accreditation Service (SAS)
The Swiss Accreditation Service is one of the signatories to the EA
Multilateral Agreement for the recognition of calibration certificates

Accreditation No.: **SCS 108**

Glossary:

TSL	tissue simulating liquid
NORM _{x,y,z}	sensitivity in free space
ConvF	sensitivity in TSL / NORM _{x,y,z}
DCP	diode compression point
CF	crest factor (1/duty_cycle) of the RF signal
A, B, C, D	modulation dependent linearization parameters
Polarization φ	φ rotation around probe axis
Polarization ϑ	ϑ rotation around an axis that is in the plane normal to probe axis (at measurement center), i.e., ϑ = 0 is normal to probe axis
Connector Angle	information used in DASY system to align probe sensor X to the robot coordinate system

Calibration is Performed According to the Following Standards:

- a) IEEE Std 1528-2013, "IEEE Recommended Practice for Determining the Peak Spatial-Averaged Specific Absorption Rate (SAR) in the Human Head from Wireless Communications Devices: Measurement Techniques", June 2013
- b) IEC 62209-1, "Procedure to measure the Specific Absorption Rate (SAR) for hand-held devices used in close proximity to the ear (frequency range of 300 MHz to 3 GHz)", February 2005

Methods Applied and Interpretation of Parameters:

- *NORM_{x,y,z}*: Assessed for E-field polarization ϑ = 0 (f ≤ 900 MHz in TEM-cell; f > 1800 MHz: R22 waveguide). *NORM_{x,y,z}* are only intermediate values, i.e., the uncertainties of *NORM_{x,y,z}* does not affect the E²-field uncertainty inside TSL (see below *ConvF*).
- *NORM(f)_{x,y,z}* = *NORM_{x,y,z}* * *frequency_response* (see Frequency Response Chart). This linearization is implemented in DASY4 software versions later than 4.2. The uncertainty of the frequency response is included in the stated uncertainty of *ConvF*.
- *DCP_{x,y,z}*: DCP are numerical linearization parameters assessed based on the data of power sweep with CW signal (no uncertainty required). DCP does not depend on frequency nor media.
- *PAR*: PAR is the Peak to Average Ratio that is not calibrated but determined based on the signal characteristics
- *A_{x,y,z}*; *B_{x,y,z}*; *C_{x,y,z}*; *D_{x,y,z}*; *VR_{x,y,z}*; *A*, *B*, *C*, *D* are numerical linearization parameters assessed based on the data of power sweep for specific modulation signal. The parameters do not depend on frequency nor media. *VR* is the maximum calibration range expressed in RMS voltage across the diode.
- *ConvF and Boundary Effect Parameters*: Assessed in flat phantom using E-field (or Temperature Transfer Standard for f ≤ 800 MHz) and inside waveguide using analytical field distributions based on power measurements for f > 800 MHz. The same setups are used for assessment of the parameters applied for boundary compensation (alpha, depth) of which typical uncertainty values are given. These parameters are used in DASY4 software to improve probe accuracy close to the boundary. The sensitivity in TSL corresponds to *NORM_{x,y,z}* * *ConvF* whereby the uncertainty corresponds to that given for *ConvF*. A frequency dependent *ConvF* is used in DASY version 4.4 and higher which allows extending the validity from ± 50 MHz to ± 100 MHz.
- *Spherical isotropy (3D deviation from isotropy)*: in a field of low gradients realized using a flat phantom exposed by a patch antenna.
- *Sensor Offset*: The sensor offset corresponds to the offset of virtual measurement center from the probe tip (on probe axis). No tolerance required.
- *Connector Angle*: The angle is assessed using the information gained by determining the *NORM_x* (no uncertainty required).

Probe EX3DV4

SN:7308

Manufactured: March 11, 2014
Calibrated: July 16, 2014

Calibrated for DASY/EASY Systems
(Note: non-compatible with DASY2 system!)

DASY/EASY - Parameters of Probe: EX3DV4 - SN:7308

Basic Calibration Parameters

	Sensor X	Sensor Y	Sensor Z	Unc (k=2)
Norm ($\mu\text{V}/(\text{V}/\text{m})^2$) ^A	0.50	0.60	0.45	$\pm 10.1\%$
DCP (mV) ^B	100.8	98.6	99.9	

Modulation Calibration Parameters

UID	Communication System Name		A dB	B dB $\sqrt{\mu\text{V}}$	C	D dB	VR mV	Unc ^E (k=2)
0	CW	X	0.0	0.0	1.0	0.00	160.9	$\pm 2.5\%$
		Y	0.0	0.0	1.0		132.5	
		Z	0.0	0.0	1.0		154.1	
10012-CAA	IEEE 802.11b WiFi 2.4 GHz (DSSS, 1 Mbps)	X	2.79	68.0	18.3	1.87	125.2	$\pm 0.5\%$
		Y	2.74	67.3	17.9		142.6	
		Z	2.74	67.2	17.7		119.7	
10062-CAA	IEEE 802.11a/h WiFi 5 GHz (OFDM, 6 Mbps)	X	10.26	68.8	21.6	8.68	124.2	$\pm 2.5\%$
		Y	10.73	69.7	22.0		144.6	
		Z	9.98	68.3	21.3		116.1	
10114-CAA	IEEE 802.11n (HT Greenfield, 13.5 Mbps, BPSK)	X	10.24	68.6	21.0	8.10	125.1	$\pm 2.2\%$
		Y	9.68	67.1	20.1		99.7	
		Z	10.17	68.5	21.0		122.8	
10117-CAA	IEEE 802.11n (HT Mixed, 13.5 Mbps, BPSK)	X	10.27	68.7	21.0	8.07	126.1	$\pm 2.2\%$
		Y	9.67	67.0	20.1		100.6	
		Z	10.12	68.4	20.9		123.9	
10193-CAA	IEEE 802.11n (HT Greenfield, 6.5 Mbps, BPSK)	X	9.83	68.2	20.9	8.09	120.3	$\pm 2.5\%$
		Y	10.37	69.4	21.5		147.5	
		Z	9.71	68.2	20.9		116.9	
10196-CAA	IEEE 802.11n (HT Mixed, 6.5 Mbps, BPSK)	X	9.80	68.2	20.9	8.10	120.4	$\pm 1.9\%$
		Y	9.54	67.2	20.3		102.9	
		Z	9.65	68.0	20.8		116.5	
10219-CAA	IEEE 802.11n (HT Mixed, 7.2 Mbps, BPSK)	X	9.67	68.0	20.8	8.03	119.1	$\pm 1.9\%$
		Y	9.41	67.1	20.2		102.5	
		Z	9.54	68.0	20.8		116.0	
10222-CAA	IEEE 802.11n (HT Mixed, 15 Mbps, BPSK)	X	10.21	68.6	21.0	8.06	125.9	$\pm 2.2\%$
		Y	9.84	67.5	20.4		106.4	
		Z	10.09	68.4	20.9		122.3	
10315-AAA	IEEE 802.11b WiFi 2.4 GHz (DSSS, 1 Mbps, 96pc duty cycle)	X	2.92	69.3	18.9	1.71	123.4	$\pm 0.5\%$
		Y	2.80	68.0	18.2		107.9	
		Z	2.85	68.3	18.3		122.3	
10317-AAA	IEEE 802.11a WiFi 5 GHz (OFDM, 6 Mbps, 96pc duty cycle)	X	9.98	68.4	21.2	8.36	119.4	$\pm 1.9\%$
		Y	9.66	67.3	20.5		101.7	
		Z	9.79	68.1	21.0		115.6	

10400-AAA	IEEE 802.11ac WiFi (20MHz, 64-QAM, 99pc duty cycle)	X	10.10	68.5	21.2	8.37	121.3	±2.2 %
		Y	9.82	67.5	20.6		103.5	
		Z	9.90	68.2	21.1		116.6	
10402-AAA	IEEE 802.11ac WiFi (80MHz, 64-QAM, 99pc duty cycle)	X	11.17	69.7	21.7	8.53	131.0	±2.2 %
		Y	10.57	68.2	20.8		110.9	
		Z	11.01	69.4	21.5		128.1	

The reported uncertainty of measurement is stated as the standard uncertainty of measurement multiplied by the coverage factor $k=2$, which for a normal distribution corresponds to a coverage probability of approximately 95%.

^A The uncertainties of NormX,Y,Z do not affect the E^2 -field uncertainty inside TSL (see Pages 6 and 7).

^B Numerical linearization parameter: uncertainty not required.

^E Uncertainty is determined using the max. deviation from linear response applying rectangular distribution and is expressed for the square of the field value.

DASY/EASY - Parameters of Probe: EX3DV4 - SN:7308

Calibration Parameter Determined in Head Tissue Simulating Media

f (MHz) ^C	Relative Permittivity ^F	Conductivity (S/m) ^F	ConvF X	ConvF Y	ConvF Z	Alpha ^G	Depth ^G (mm)	Unct. (k=2)
5250	35.9	4.71	5.37	5.37	5.37	0.30	1.80	± 13.1 %
5600	35.5	5.07	4.64	4.64	4.64	0.35	1.80	± 13.1 %
5750	35.4	5.22	4.81	4.81	4.81	0.40	1.80	± 13.1 %

^C Frequency validity above 300 MHz of ± 100 MHz only applies for DASY v4.4 and higher (see Page 2), else it is restricted to ± 50 MHz. The uncertainty is the RSS of the ConvF uncertainty at calibration frequency and the uncertainty for the indicated frequency band. Frequency validity below 300 MHz is ± 10, 25, 40, 50 and 70 MHz for ConvF assessments at 30, 64, 128, 150 and 220 MHz respectively. Above 5 GHz frequency validity can be extended to ± 110 MHz.

^F At frequencies below 3 GHz, the validity of tissue parameters (ϵ and σ) can be relaxed to ± 10% if liquid compensation formula is applied to measured SAR values. At frequencies above 3 GHz, the validity of tissue parameters (ϵ and σ) is restricted to ± 5%. The uncertainty is the RSS of the ConvF uncertainty for indicated target tissue parameters.

^G Alpha/Depth are determined during calibration. SPEAG warrants that the remaining deviation due to the boundary effect after compensation is always less than ± 1% for frequencies below 3 GHz and below ± 2% for frequencies between 3-6 GHz at any distance larger than half the probe tip diameter from the boundary.

DASY/EASY - Parameters of Probe: EX3DV4 - SN:7308

Calibration Parameter Determined in Body Tissue Simulating Media

f (MHz) ^C	Relative Permittivity ^F	Conductivity (S/m) ^F	ConvF X	ConvF Y	ConvF Z	Alpha ^G	Depth ^G (mm)	Unct. (k=2)
5250	48.9	5.36	4.60	4.60	4.60	0.35	1.90	± 13.1 %
5600	48.5	5.77	4.09	4.09	4.09	0.40	1.90	± 13.1 %
5750	48.3	5.94	4.22	4.22	4.22	0.50	1.90	± 13.1 %

^C Frequency validity above 300 MHz of ± 100 MHz only applies for DASY v4.4 and higher (see Page 2), else it is restricted to ± 50 MHz. The uncertainty is the RSS of the ConvF uncertainty at calibration frequency and the uncertainty for the indicated frequency band. Frequency validity below 300 MHz is ± 10, 25, 40, 50 and 70 MHz for ConvF assessments at 30, 64, 128, 150 and 220 MHz respectively. Above 5 GHz frequency validity can be extended to ± 110 MHz.

^F At frequencies below 3 GHz, the validity of tissue parameters (ϵ and σ) can be relaxed to ± 10% if liquid compensation formula is applied to measured SAR values. At frequencies above 3 GHz, the validity of tissue parameters (ϵ and σ) is restricted to ± 5%. The uncertainty is the RSS of the ConvF uncertainty for indicated target tissue parameters.

^G Alpha/Depth are determined during calibration. SPEAG warrants that the remaining deviation due to the boundary effect after compensation is always less than ± 1% for frequencies below 3 GHz and below ± 2% for frequencies between 3-6 GHz at any distance larger than half the probe tip diameter from the boundary.

Frequency Response of E-Field (TEM-Cell:ifi110 EXX, Waveguide: R22)

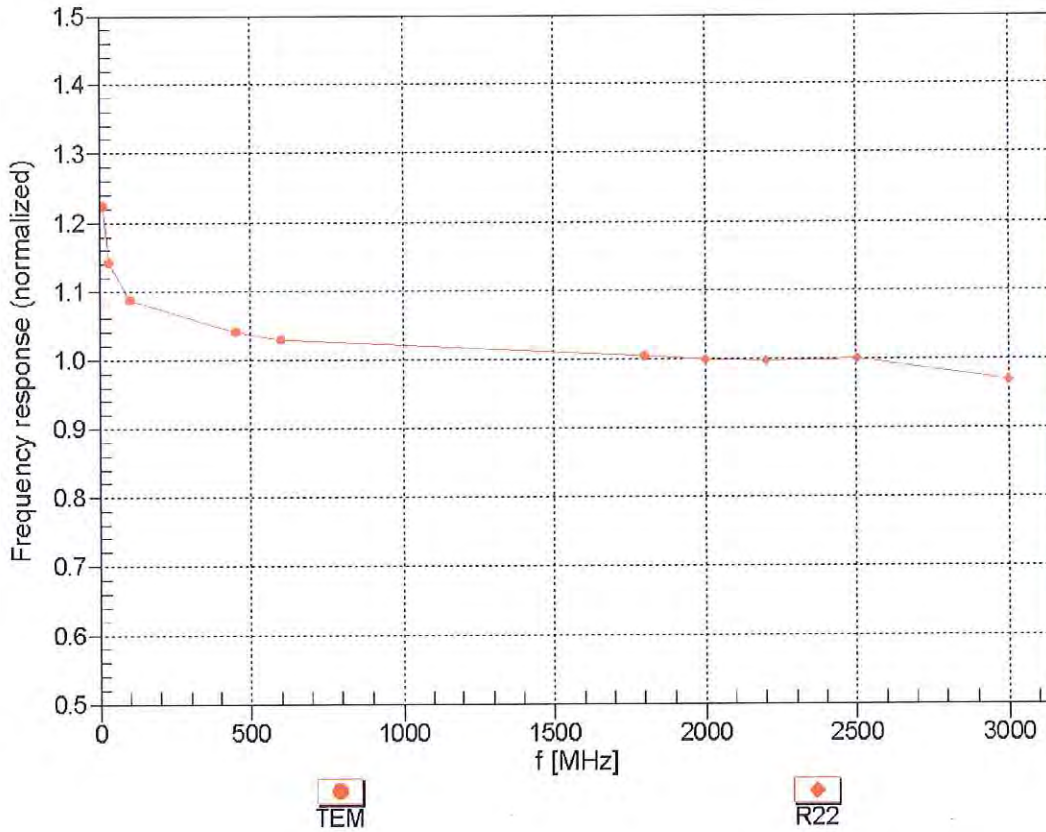

Uncertainty of Frequency Response of E-field: $\pm 6.3\%$ (k=2)

Receiving Pattern (ϕ), $\vartheta = 0^\circ$

f=600 MHz,TEM

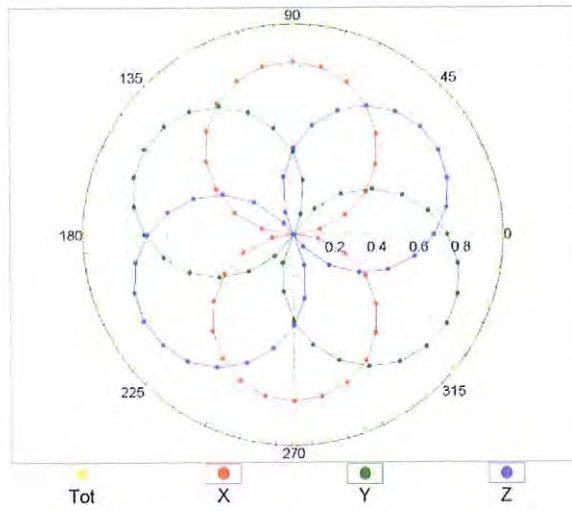

f=1800 MHz,R22

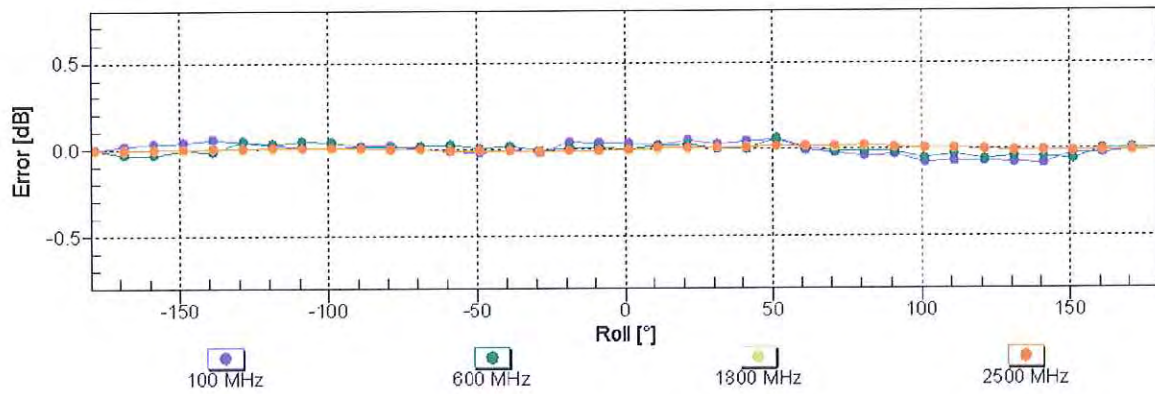
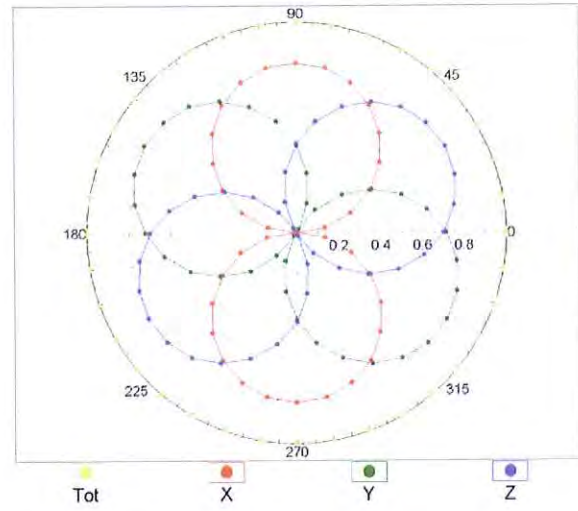

Uncertainty of Axial Isotropy Assessment: $\pm 0.5\%$ ($k=2$)

Dynamic Range f(SAR_{head}) (TEM cell , f_{eval}= 1900 MHz)

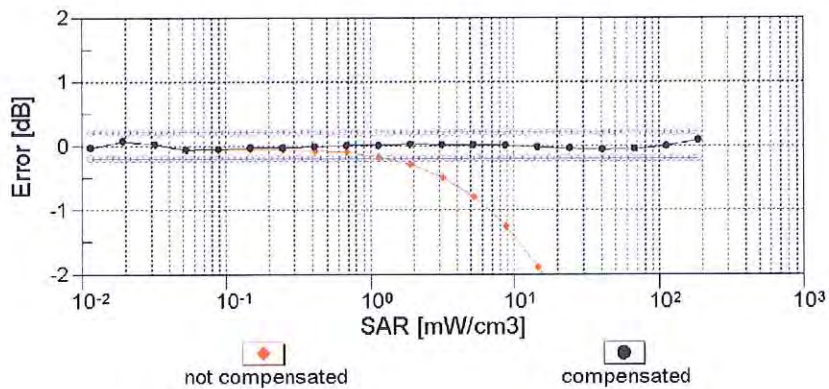
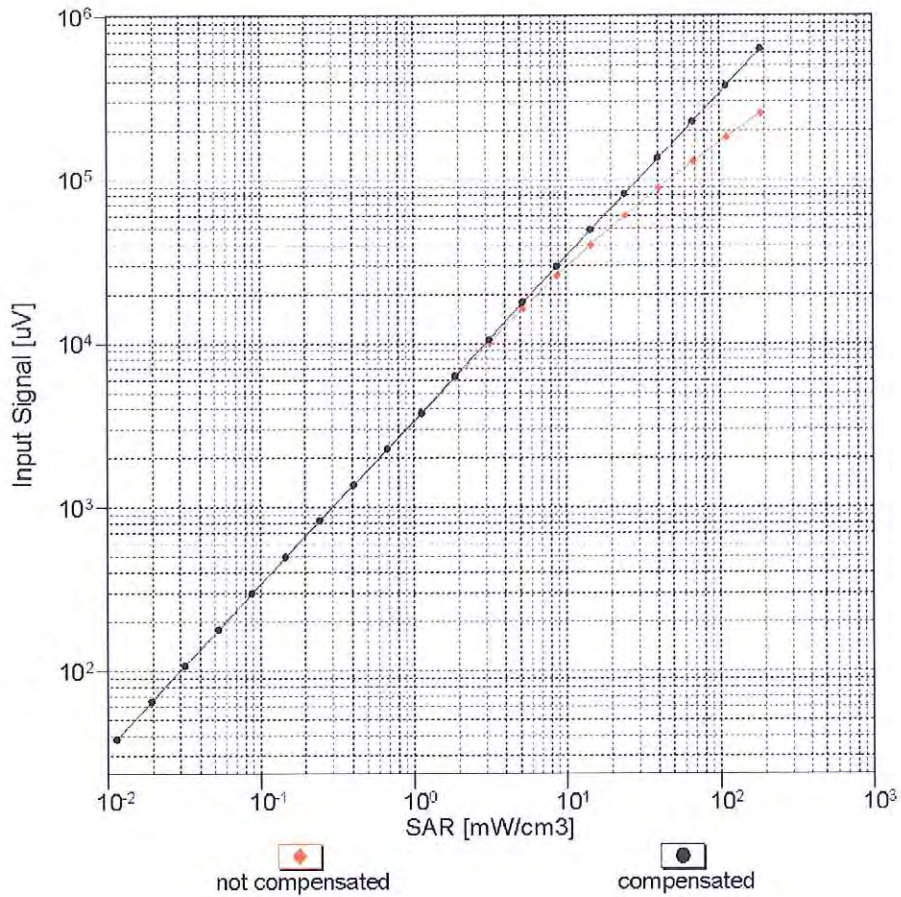

Uncertainty of Linearity Assessment: ± 0.6% (k=2)

Conversion Factor Assessment

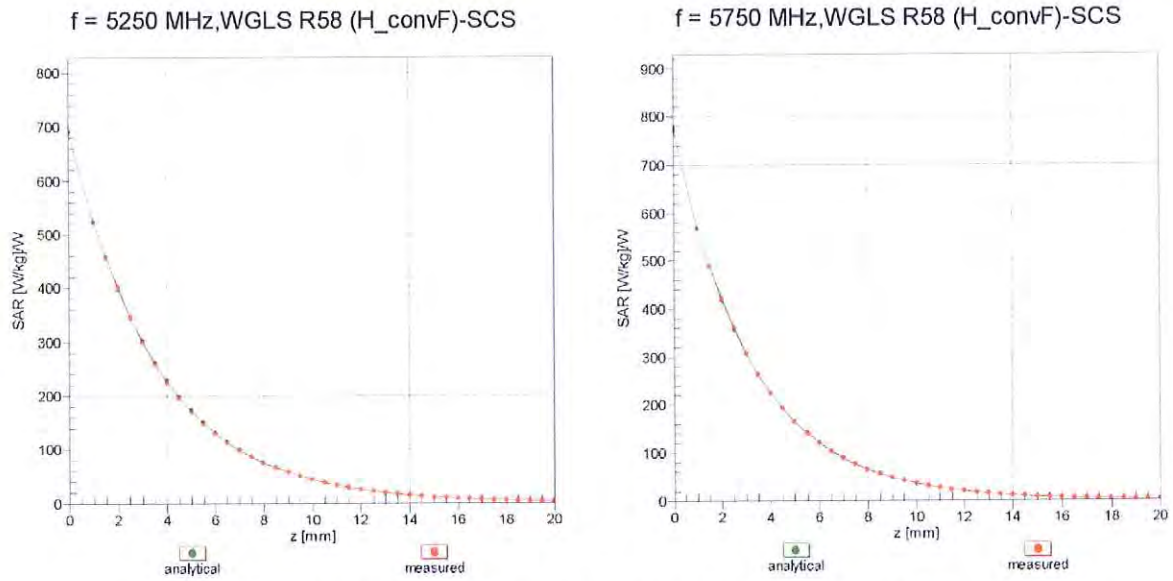

Deviation from Isotropy in Liquid Error (ϕ, ϑ), f = 900 MHz

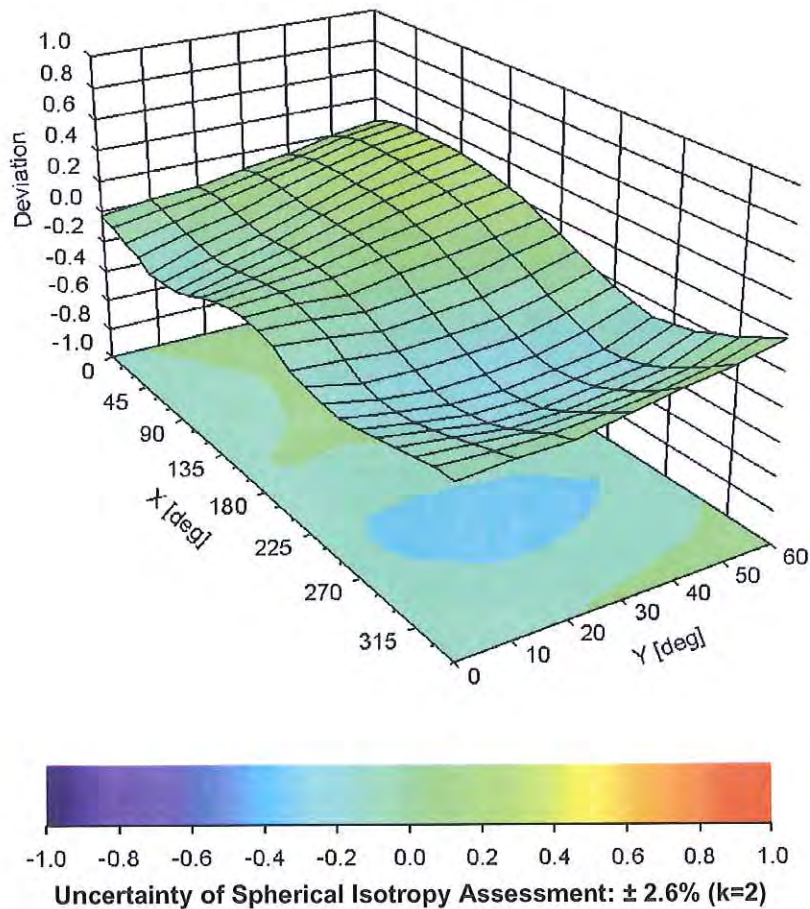

DASY/EASY - Parameters of Probe: EX3DV4 - SN:7308

Other Probe Parameters

Sensor Arrangement	Triangular
Connector Angle (°)	-68.9
Mechanical Surface Detection Mode	enabled
Optical Surface Detection Mode	disabled
Probe Overall Length	337 mm
Probe Body Diameter	10 mm
Tip Length	9 mm
Tip Diameter	2.5 mm
Probe Tip to Sensor X Calibration Point	1 mm
Probe Tip to Sensor Y Calibration Point	1 mm
Probe Tip to Sensor Z Calibration Point	1 mm
Recommended Measurement Distance from Surface	1.4 mm

**Calibration Laboratory of
Schmid & Partner
Engineering AG**
Zeughausstrasse 43, 8004 Zurich, Switzerland



S Schweizerischer Kalibrierdienst
C Service suisse d'étalonnage
S Servizio svizzero di taratura
Swiss Calibration Service

Accredited by the Swiss Accreditation Service (SAS)
The Swiss Accreditation Service is one of the signatories to the EA
Multilateral Agreement for the recognition of calibration certificates

Accreditation No.: **SCS 108**

Client **PC Test**

Certificate No: **ES3-3022_Aug14/2**

CALIBRATION CERTIFICATE (Replacement of No: ES3-3022_Aug14)

Object **ES3DV2 - SN:3022**

Calibration procedure(s) **QA CAL-01.v9, QA CAL-12.v9, QA CAL-23.v5, QA CAL-25.v6
Calibration procedure for dosimetric E-field probes** CC
D/M/14

Calibration date: **August 19, 2014**

This calibration certificate documents the traceability to national standards, which realize the physical units of measurements (SI).
The measurements and the uncertainties with confidence probability are given on the following pages and are part of the certificate.

All calibrations have been conducted in the closed laboratory facility: environment temperature (22 ± 3)°C and humidity < 70%.

Calibration Equipment used (M&TE critical for calibration)

Primary Standards	ID	Cal Date (Certificate No.)	Scheduled Calibration
Power meter E4419B	GB41293874	03-Apr-14 (No. 217-01911)	Apr-15
Power sensor E4412A	MY41498087	03-Apr-14 (No. 217-01911)	Apr-15
Reference 3 dB Attenuator	SN: S5054 (3c)	03-Apr-14 (No. 217-01915)	Apr-15
Reference 20 dB Attenuator	SN: S5277 (20x)	03-Apr-14 (No. 217-01919)	Apr-15
Reference 30 dB Attenuator	SN: S5129 (30b)	03-Apr-14 (No. 217-01920)	Apr-15
Reference Probe ES3DV2	SN: 3013	30-Dec-13 (No. ES3-3013_Dec13)	Dec-14
DAE4	SN: 660	13-Dec-13 (No. DAE4-660_Dec13)	Dec-14
Secondary Standards	ID	Check Date (in house)	Scheduled Check
RF generator HP 8648C	US3642U01700	4-Aug-99 (in house check Apr-13)	In house check: Apr-16
Network Analyzer HP 8753E	US37390585	18-Oct-01 (in house check Oct-13)	In house check: Oct-14

Calibrated by:	Name Jeton Kastrali	Function Laboratory Technician	Signature
Approved by:	Name Katja Pokovic	Function Technical Manager	

Issued: November 3, 2014

This calibration certificate shall not be reproduced except in full without written approval of the laboratory.



Accredited by the Swiss Accreditation Service (SAS)
The Swiss Accreditation Service is one of the signatories to the EA
Multilateral Agreement for the recognition of calibration certificates

Accreditation No.: **SCS 108**

Glossary:

TSL	tissue simulating liquid
NORM _{x,y,z}	sensitivity in free space
ConvF	sensitivity in TSL / NORM _{x,y,z}
DCP	diode compression point
CF	crest factor (1/duty_cycle) of the RF signal
A, B, C, D	modulation dependent linearization parameters
Polarization φ	φ rotation around probe axis
Polarization ϑ	ϑ rotation around an axis that is in the plane normal to probe axis (at measurement center), i.e., $\vartheta = 0$ is normal to probe axis
Connector Angle	information used in DASY system to align probe sensor X to the robot coordinate system

Calibration is Performed According to the Following Standards:

- IEEE Std 1528-2013, "IEEE Recommended Practice for Determining the Peak Spatial-Averaged Specific Absorption Rate (SAR) in the Human Head from Wireless Communications Devices: Measurement Techniques", June 2013
- IEC 62209-1, "Procedure to measure the Specific Absorption Rate (SAR) for hand-held devices used in close proximity to the ear (frequency range of 300 MHz to 3 GHz)", February 2005

Methods Applied and Interpretation of Parameters:

- NORM_{x,y,z}**: Assessed for E-field polarization $\vartheta = 0$ ($f \leq 900$ MHz in TEM-cell; $f > 1800$ MHz: R22 waveguide). NORM_{x,y,z} are only intermediate values, i.e., the uncertainties of NORM_{x,y,z} does not affect the E²-field uncertainty inside TSL (see below ConvF).
- NORM(f)_{x,y,z}** = NORM_{x,y,z} * frequency_response (see Frequency Response Chart). This linearization is implemented in DASY4 software versions later than 4.2. The uncertainty of the frequency response is included in the stated uncertainty of ConvF.
- DCP_{x,y,z}**: DCP are numerical linearization parameters assessed based on the data of power sweep with CW signal (no uncertainty required). DCP does not depend on frequency nor media.
- PAR**: PAR is the Peak to Average Ratio that is not calibrated but determined based on the signal characteristics
- A_{x,y,z}; B_{x,y,z}; C_{x,y,z}; D_{x,y,z}; VR_{x,y,z}; A, B, C, D** are numerical linearization parameters assessed based on the data of power sweep for specific modulation signal. The parameters do not depend on frequency nor media. VR is the maximum calibration range expressed in RMS voltage across the diode.
- ConvF and Boundary Effect Parameters**: Assessed in flat phantom using E-field (or Temperature Transfer Standard for $f \leq 800$ MHz) and inside waveguide using analytical field distributions based on power measurements for $f > 800$ MHz. The same setups are used for assessment of the parameters applied for boundary compensation (alpha, depth) of which typical uncertainty values are given. These parameters are used in DASY4 software to improve probe accuracy close to the boundary. The sensitivity in TSL corresponds to NORM_{x,y,z} * ConvF whereby the uncertainty corresponds to that given for ConvF. A frequency dependent ConvF is used in DASY version 4.4 and higher which allows extending the validity from ± 50 MHz to ± 100 MHz.
- Spherical isotropy (3D deviation from isotropy)**: in a field of low gradients realized using a flat phantom exposed by a patch antenna.
- Sensor Offset**: The sensor offset corresponds to the offset of virtual measurement center from the probe tip (on probe axis). No tolerance required.
- Connector Angle**: The angle is assessed using the information gained by determining the NORM_x (no uncertainty required).

Probe ES3DV2

SN:3022

Manufactured: April 15, 2003
Calibrated: August 19, 2014

Calibrated for DASY/EASY Systems
(Note: non-compatible with DASY2 system!)

DASY/EASY - Parameters of Probe: ES3DV2 - SN:3022

Basic Calibration Parameters

	Sensor X	Sensor Y	Sensor Z	Unc (k=2)
Norm ($\mu\text{V}/(\text{V}/\text{m})^2$) ^A	1.00	1.04	0.96	$\pm 10.1\%$
DCP (mV) ^B	103.0	96.3	101.6	

Modulation Calibration Parameters

UID	Communication System Name		A dB	B dB $\sqrt{\mu\text{V}}$	C	D dB	VR mV	Unc ^E (k=2)
0	CW	X	0.0	0.0	1.0	0.00	181.8	$\pm 2.7\%$
		Y	0.0	0.0	1.0		183.0	
		Z	0.0	0.0	1.0		192.3	
10010- CAA	SAR Validation (Square, 100ms, 10ms)	X	2.51	63.1	12.7	10.00	42.6	$\pm 1.9\%$
		Y	2.62	63.1	12.9		42.7	
		Z	3.12	65.7	13.6		40.4	
10011- CAB	UMTS-FDD (WCDMA)	X	3.33	67.8	19.2	2.91	145.9	$\pm 0.9\%$
		Y	3.13	64.9	16.9		147.4	
		Z	3.20	66.4	18.2		139.6	
10012- CAA	IEEE 802.11b WiFi 2.4 GHz (DSSS, 1 Mbps)	X	3.05	70.1	19.8	1.87	147.2	$\pm 0.9\%$
		Y	2.62	65.1	16.2		147.4	
		Z	2.85	68.2	18.4		141.7	
10013- CAA	IEEE 802.11g WiFi 2.4 GHz (DSSS-OFDM, 6 Mbps)	X	11.10	70.9	23.6	9.46	143.9	$\pm 3.0\%$
		Y	11.04	70.2	22.9		144.2	
		Z	10.77	70.2	23.1		134.7	
10021- DAB	GSM-FDD (TDMA, GMSK)	X	19.66	99.7	28.6	9.39	126.0	$\pm 1.9\%$
		Y	11.04	89.6	25.5		138.9	
		Z	10.45	88.8	24.9		137.5	
10023- DAB	GPRS-FDD (TDMA, GMSK, TN 0)	X	20.19	99.6	28.5	9.57	142.0	$\pm 2.5\%$
		Y	10.53	88.4	25.0		145.5	
		Z	15.52	96.5	27.8		147.6	
10024- DAB	GPRS-FDD (TDMA, GMSK, TN 0-1)	X	31.93	99.6	25.2	6.56	149.5	$\pm 1.9\%$
		Y	12.70	87.9	22.2		148.0	
		Z	27.00	99.8	25.7		135.3	
10027- DAB	GPRS-FDD (TDMA, GMSK, TN 0-1-2)	X	38.32	99.8	23.8	4.80	148.1	$\pm 2.2\%$
		Y	9.80	83.2	19.3		138.8	
		Z	31.96	99.9	24.2		128.9	
10028- DAB	GPRS-FDD (TDMA, GMSK, TN 0-1-2-3)	X	40.03	99.5	22.8	3.55	130.5	$\pm 2.2\%$
		Y	40.27	99.6	23.0		148.1	
		Z	43.09	99.7	22.5		140.1	
10032- CAA	IEEE 802.15.1 Bluetooth (GFSK, DH5)	X	38.93	99.4	20.4	1.16	146.7	$\pm 1.9\%$
		Y	32.83	92.5	17.9		139.2	
		Z	31.94	99.5	20.8		133.1	
10039- CAB	CDMA2000 (1xRTT, RC1)	X	4.66	66.8	19.3	4.57	144.5	$\pm 1.2\%$
		Y	4.56	65.3	17.9		137.2	
		Z	4.52	66.1	18.7		131.7	

10081-CAB	CDMA2000 (1xRTT, RC3)	X	3.82	66.0	18.7	3.97	140.3	±0.9 %
		Y	3.77	64.5	17.3		133.6	
		Z	3.79	65.7	18.4		128.2	
10098-CAB	UMTS-FDD (HSUPA, Subtest 2)	X	4.40	66.2	18.5	3.98	130.9	±1.2 %
		Y	4.39	65.0	17.4		131.1	
		Z	4.47	66.3	18.4		140.0	
10100-CAB	LTE-FDD (SC-FDMA, 100% RB, 20 MHz, QPSK)	X	6.30	67.3	19.8	5.67	137.4	±1.7 %
		Y	6.25	66.3	18.9		135.9	
		Z	6.36	67.4	19.7		147.5	
10108-CAB	LTE-FDD (SC-FDMA, 100% RB, 10 MHz, QPSK)	X	6.14	66.8	19.6	5.80	134.6	±1.7 %
		Y	6.17	66.1	18.9		133.9	
		Z	6.24	67.0	19.7		144.5	
10110-CAB	LTE-FDD (SC-FDMA, 100% RB, 6 MHz, QPSK)	X	5.82	66.3	19.4	5.75	131.2	±1.7 %
		Y	5.82	65.4	18.6		130.3	
		Z	5.91	66.5	19.4		140.4	
10114-CAA	IEEE 802.11n (HT Greenfield, 13.5 Mbps, BPSK)	X	10.00	68.5	21.2	8.10	124.3	±2.5 %
		Y	9.89	67.9	20.6		124.0	
		Z	10.05	68.6	21.2		133.2	
10117-CAA	IEEE 802.11n (HT Mixed, 13.5 Mbps, BPSK)	X	10.01	68.6	21.2	8.07	125.8	±2.5 %
		Y	9.91	67.9	20.7		125.8	
		Z	10.09	68.8	21.3		134.7	
10151-CAB	LTE-TDD (SC-FDMA, 50% RB, 20 MHz, QPSK)	X	9.69	75.5	26.4	9.28	144.7	±3.3 %
		Y	9.09	72.7	24.6		143.2	
		Z	8.54	72.0	24.5		124.8	
10154-CAB	LTE-FDD (SC-FDMA, 50% RB, 10 MHz, QPSK)	X	5.82	66.2	19.4	5.75	131.3	±1.9 %
		Y	6.06	66.3	19.1		149.2	
		Z	5.91	66.5	19.4		140.7	
10160-CAB	LTE-FDD (SC-FDMA, 50% RB, 15 MHz, QPSK)	X	6.27	66.9	19.7	5.82	136.5	±1.4 %
		Y	6.19	65.8	18.7		128.4	
		Z	6.33	67.0	19.6		145.4	
10169-CAB	LTE-FDD (SC-FDMA, 1 RB, 20 MHz, QPSK)	X	4.81	66.4	19.7	5.73	134.8	±1.7 %
		Y	4.92	66.1	19.1		149.9	
		Z	4.78	66.4	19.6		141.2	
10172-CAB	LTE-TDD (SC-FDMA, 1 RB, 20 MHz, QPSK)	X	7.83	76.6	27.2	9.21	131.4	±3.5 %
		Y	7.54	74.5	25.8		147.8	
		Z	7.71	76.7	27.4		145.3	
10175-CAB	LTE-FDD (SC-FDMA, 1 RB, 10 MHz, QPSK)	X	4.90	66.9	20.0	5.72	147.6	±1.4 %
		Y	4.90	66.0	19.1		148.0	
		Z	4.78	66.4	19.6		141.6	
10181-CAB	LTE-FDD (SC-FDMA, 1 RB, 15 MHz, QPSK)	X	4.90	66.9	20.0	5.72	148.1	±1.4 %
		Y	4.89	65.9	19.0		146.9	
		Z	4.80	66.5	19.7		142.1	
10193-CAA	IEEE 802.11n (HT Greenfield, 6.5 Mbps, BPSK)	X	9.80	68.7	21.4	8.09	135.1	±2.7 %
		Y	9.78	68.2	20.9		135.5	
		Z	9.70	68.5	21.2		130.2	

10196-CAA	IEEE 802.11n (HT Mixed, 6.5 Mbps, BPSK)	X	9.79	68.7	21.4	8.10	136.4	±2.7 %
		Y	9.81	68.3	20.9		138.0	
		Z	9.72	68.6	21.3		132.8	
10219-CAA	IEEE 802.11n (HT Mixed, 7.2 Mbps, BPSK)	X	9.68	68.6	21.3	8.03	136.0	±2.7 %
		Y	9.74	68.3	21.0		137.4	
		Z	9.62	68.5	21.2		132.6	
10222-CAA	IEEE 802.11n (HT Mixed, 15 Mbps, BPSK)	X	10.20	69.1	21.5	8.06	143.4	±2.5 %
		Y	9.91	60.0	20.7		125.8	
		Z	10.27	69.4	21.6		148.4	
10225-CAB	UMTS-FDD (HSPA+)	X	6.87	66.9	19.6	5.97	139.5	±1.9 %
		Y	7.04	66.9	19.3		149.3	
		Z	6.89	67.0	19.5		143.5	
10237-CAB	LTE-TDD (SC-FDMA, 1 RB, 10 MHz, QPSK)	X	7.66	75.9	26.9	9.21	126.1	±3.0 %
		Y	7.17	73.1	25.1		132.1	
		Z	7.18	74.6	26.3		128.0	
10252-CAB	LTE-TDD (SC-FDMA, 50% RB, 10 MHz, QPSK)	X	8.58	73.1	25.3	9.24	127.6	±3.3 %
		Y	8.22	71.0	23.7		126.9	
		Z	8.83	74.3	26.0		149.8	
10267-CAB	LTE-TDD (SC-FDMA, 100% RB, 10 MHz, QPSK)	X	9.69	75.5	26.5	9.30	143.8	±3.3 %
		Y	8.88	72.0	24.2		135.2	
		Z	8.83	72.9	25.1		131.3	
10274-CAB	UMTS-FDD (HSUPA, Subtest 5, 3GPP Rel8.10)	X	5.87	67.0	19.2	4.87	141.2	±1.4 %
		Y	5.77	65.8	18.1		136.0	
		Z	5.71	66.3	18.6		132.7	
10275-CAB	UMTS-FDD (HSUPA, Subtest 5, 3GPP Rel8.4)	X	4.44	67.2	19.2	3.96	147.3	±0.9 %
		Y	4.29	65.3	17.6		139.2	
		Z	4.31	66.3	18.5		139.6	
10291-AAB	CDMA2000, RC3, SO55, Full Rate	X	3.60	67.1	19.1	3.46	137.8	±0.7 %
		Y	3.44	64.8	17.2		129.6	
		Z	3.48	66.2	18.4		130.5	
10292-AAB	CDMA2000, RC3, SO32, Full Rate	X	3.50	66.9	18.9	3.39	139.5	±0.7 %
		Y	3.38	64.8	17.2		132.0	
		Z	3.48	66.5	18.5		133.1	
10297-AAA	LTE-FDD (SC-FDMA, 50% RB, 20 MHz, QPSK)	X	6.12	66.7	19.6	5.81	133.3	±1.9 %
		Y	6.35	66.7	19.3		149.3	
		Z	6.17	66.8	19.5		132.7	
10311-AAA	LTE-FDD (SC-FDMA, 100% RB, 15 MHz, QPSK)	X	6.72	67.4	20.0	6.06	138.7	±1.7 %
		Y	6.63	66.3	19.1		131.4	
		Z	6.72	67.3	19.9		138.7	
10315-AAA	IEEE 802.11b WiFi 2.4 GHz (DSSS, 1 Mbps, 96pc duty cycle)	X	2.90	69.9	19.8	1.71	146.4	±0.5 %
		Y	2.54	65.2	16.5		139.3	
		Z	2.75	68.1	18.5		146.4	
10316-AAA	IEEE 802.11g WiFi 2.4 GHz (ERP-OFDM, 6 Mbps, 96pc duty cycle)	X	10.12	69.3	21.9	8.36	142.9	±3.0 %
		Y	10.01	68.5	21.3		135.2	
		Z	10.11	69.3	21.9		141.7	

10403-AAB	CDMA2000 (1xEV-DO, Rev. 0)	X	4.59	68.2	19.0	3.76	126.7	±0.7 %
		Y	4.59	67.2	18.0		142.4	
		Z	4.64	68.5	19.0		143.0	
10404-AAB	CDMA2000 (1xEV-DO, Rev. A)	X	4.64	68.8	19.3	3.77	147.1	±0.9 %
		Y	4.47	67.1	17.9		139.6	
		Z	4.54	68.4	18.9		147.2	
10415-AAA	IEEE 802.11b WiFi 2.4 GHz (DSSS, 1 Mbps, 99pc duty cycle)	X	2.66	69.0	19.4	1.54	145.8	±0.5 %
		Y	2.40	64.8	16.2		140.0	
		Z	2.62	67.8	18.4		147.2	
10416-AAA	IEEE 802.11g WiFi 2.4 GHz (ERP-OFDM, 6 Mbps, 99pc duty cycle)	X	9.97	69.1	21.7	8.23	142.0	±3.0 %
		Y	10.08	68.9	21.4		145.8	
		Z	10.01	69.2	21.8		143.3	

The reported uncertainty of measurement is stated as the standard uncertainty of measurement multiplied by the coverage factor $k=2$, which for a normal distribution corresponds to a coverage probability of approximately 95%.

[^] The uncertainties of NormX,Y,Z do not affect the E^2 -field uncertainty inside TSL (see Pages 8 and 9).

[^] Numerical linearization parameter: uncertainty not required.

[^] Uncertainty is determined using the max. deviation from linear response applying rectangular distribution and is expressed for the square of the field value.

DASY/EASY - Parameters of Probe: ES3DV2 - SN:3022

Calibration Parameter Determined in Head Tissue Simulating Media

f (MHz) ^c	Relative Permittivity ^F	Conductivity (S/m) ^F	ConvF X	ConvF Y	ConvF Z	Alpha ^G	Depth ^G (mm)	Unct. (k=2)
750	41.9	0.89	6.39	6.39	6.39	0.20	2.24	± 12.0 %
835	41.5	0.90	6.18	6.18	6.18	0.23	1.98	± 12.0 %
1750	40.1	1.37	5.04	5.04	5.04	0.51	1.35	± 12.0 %
1900	40.0	1.40	4.85	4.85	4.85	0.38	1.66	± 12.0 %
2450	39.2	1.80	4.31	4.31	4.31	0.66	1.28	± 12.0 %
2600	39.0	1.96	4.13	4.13	4.13	0.76	1.28	± 12.0 %

^c Frequency validity above 300 MHz of ± 100 MHz only applies for DASY v4.4 and higher (see Page 2), else it is restricted to ± 50 MHz. The uncertainty is the RSS of the ConvF uncertainty at calibration frequency and the uncertainty for the indicated frequency band. Frequency validity below 300 MHz is ± 10, 25, 40, 50 and 70 MHz for ConvF assessments at 30, 64, 128, 150 and 220 MHz respectively. Above 5 GHz frequency validity can be extended to ± 110 MHz.

^F At frequencies below 3 GHz, the validity of tissue parameters (ϵ and σ) can be relaxed to ± 10% if liquid compensation formula is applied to measured SAR values. At frequencies above 3 GHz, the validity of tissue parameters (ϵ and σ) is restricted to ± 5%. The uncertainty is the RSS of the ConvF uncertainty for indicated target tissue parameters.

^G Alpha/Depth are determined during calibration. SPEAG warrants that the remaining deviation due to the boundary effect after compensation is always less than ± 1% for frequencies below 3 GHz and below ± 2% for frequencies between 3-6 GHz at any distance larger than half the probe tip diameter from the boundary.

DASY/EASY - Parameters of Probe: ES3DV2 - SN:3022

Calibration Parameter Determined in Body Tissue Simulating Media

f (MHz) ^c	Relative Permittivity ^F	Conductivity (S/m) ^F	ConvF X	ConvF Y	ConvF Z	Alpha ^g	Depth ^g (mm)	Unct. (k=2)
450	56.7	0.94	6.78	6.78	6.78	0.12	1.30	± 13.3 %
600	56.1	0.95	6.72	6.72	6.72	0.05	1.20	± 13.3 %
750	55.5	0.96	6.02	6.02	6.02	0.23	2.05	± 12.0 %
835	55.2	0.97	5.98	5.98	5.98	0.29	1.85	± 12.0 %
1750	53.4	1.49	4.70	4.70	4.70	0.66	1.25	± 12.0 %
1900	53.3	1.52	4.49	4.49	4.49	0.33	2.02	± 12.0 %
2450	52.7	1.95	4.05	4.05	4.05	0.80	1.01	± 12.0 %
2600	52.5	2.16	3.94	3.94	3.94	0.68	1.03	± 12.0 %

^c Frequency validity above 300 MHz of ± 100 MHz only applies for DASY v4.4 and higher (see Page 2), else it is restricted to ± 50 MHz. The uncertainty is the RSS of the ConvF uncertainty at calibration frequency and the uncertainty for the indicated frequency band. Frequency validity below 300 MHz is ± 10, 25, 40, 50 and 70 MHz for ConvF assessments at 30, 64, 128, 150 and 220 MHz respectively. Above 5 GHz frequency validity can be extended to ± 110 MHz.

^F At frequencies below 3 GHz, the validity of tissue parameters (ϵ and σ) can be relaxed to ± 10% if liquid compensation formula is applied to measured SAR values. At frequencies above 3 GHz, the validity of tissue parameters (ϵ and σ) is restricted to ± 5%. The uncertainty is the RSS of the ConvF uncertainty for indicated target tissue parameters.

^g Alpha/Depth are determined during calibration. SPEAG warrants that the remaining deviation due to the boundary effect after compensation is always less than ± 1% for frequencies below 3 GHz and below ± 2% for frequencies between 3-6 GHz at any distance larger than half the probe tip diameter from the boundary.

Frequency Response of E-Field (TEM-Cell:ifi110 EXX, Waveguide: R22)

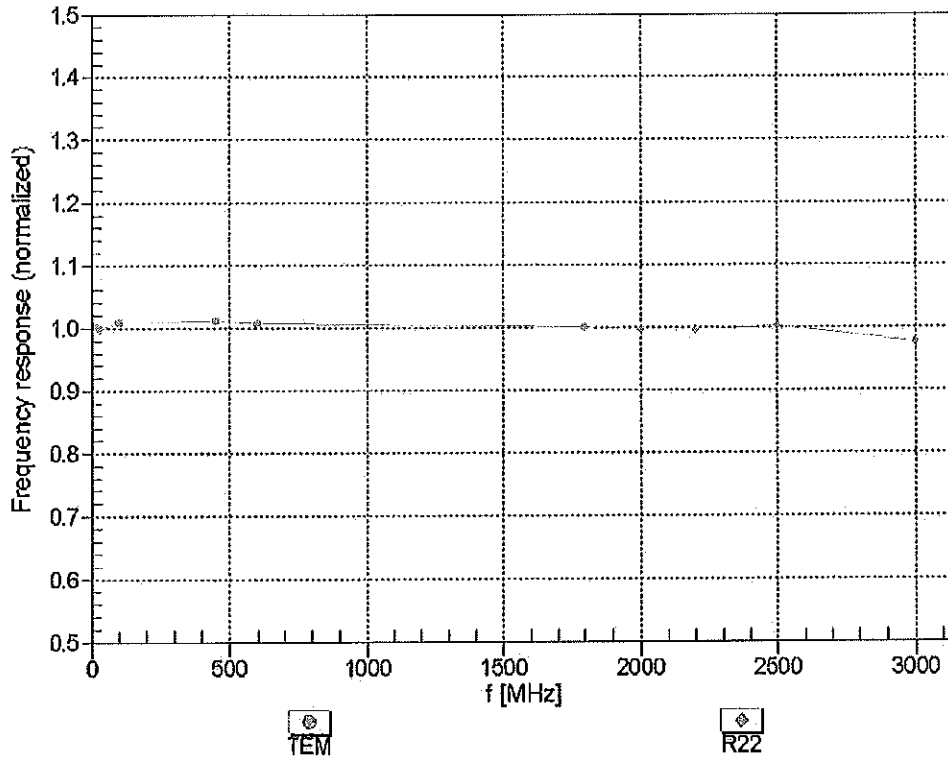

Uncertainty of Frequency Response of E-field: $\pm 6.3\%$ (k=2)

Receiving Pattern (ϕ), $\theta = 0^\circ$

f=600 MHz,TEM

f=1800 MHz,R22

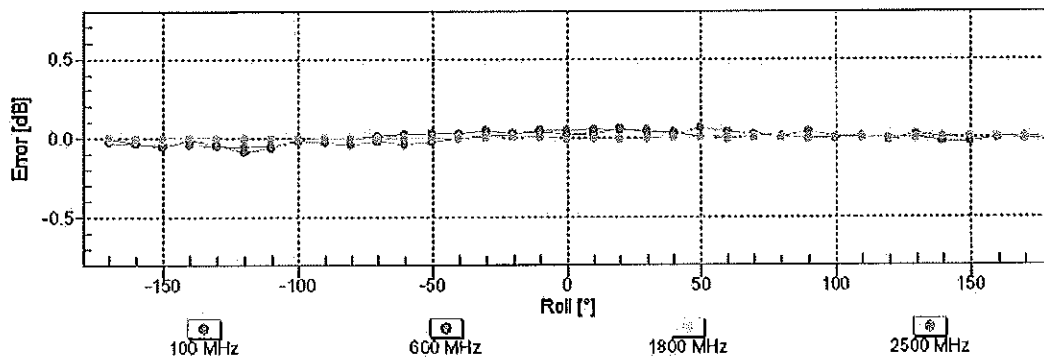
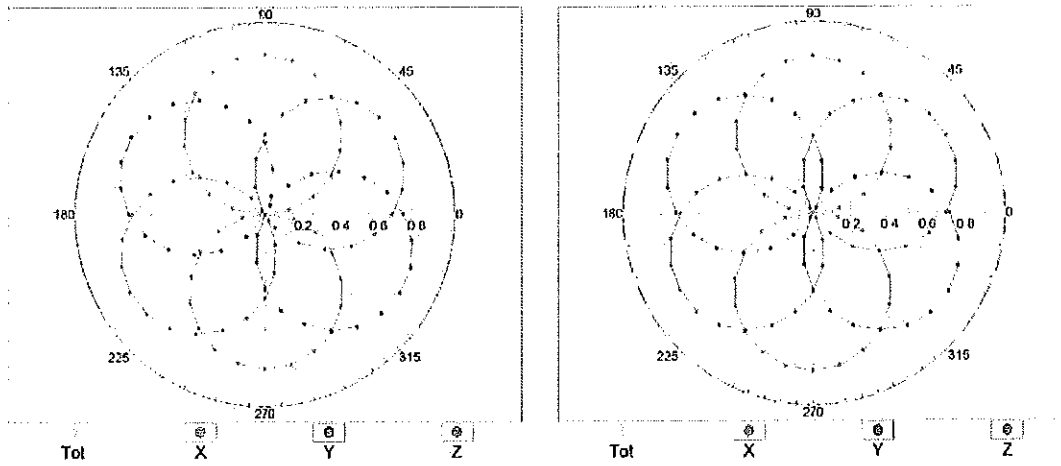

Uncertainty of Axial Isotropy Assessment: $\pm 0.5\%$ (k=2)

Dynamic Range $f(SAR_{head})$ (TEM cell, $f_{eval} = 1900$ MHz)

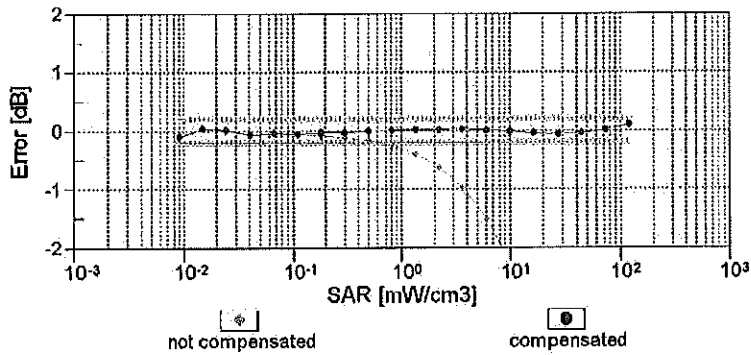
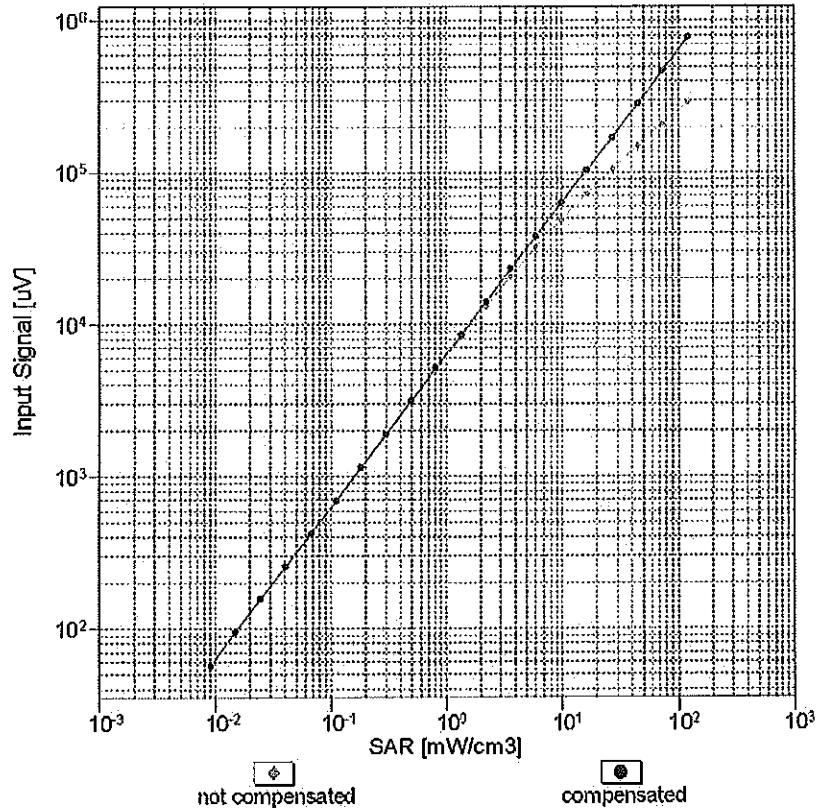

Uncertainty of Linearity Assessment: $\pm 0.6\%$ ($k=2$)

Conversion Factor Assessment

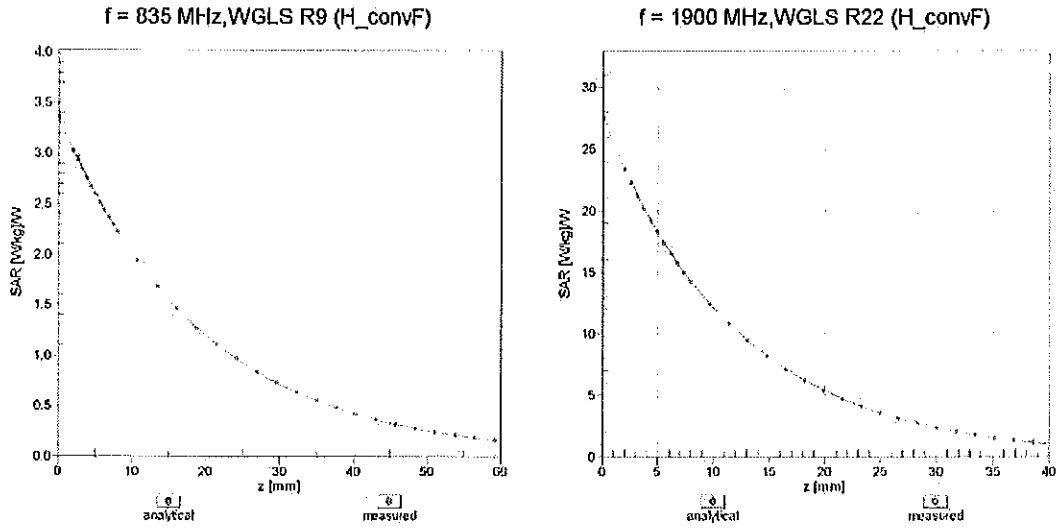

Deviation from Isotropy in Liquid Error (ϕ, θ), f = 900 MHz

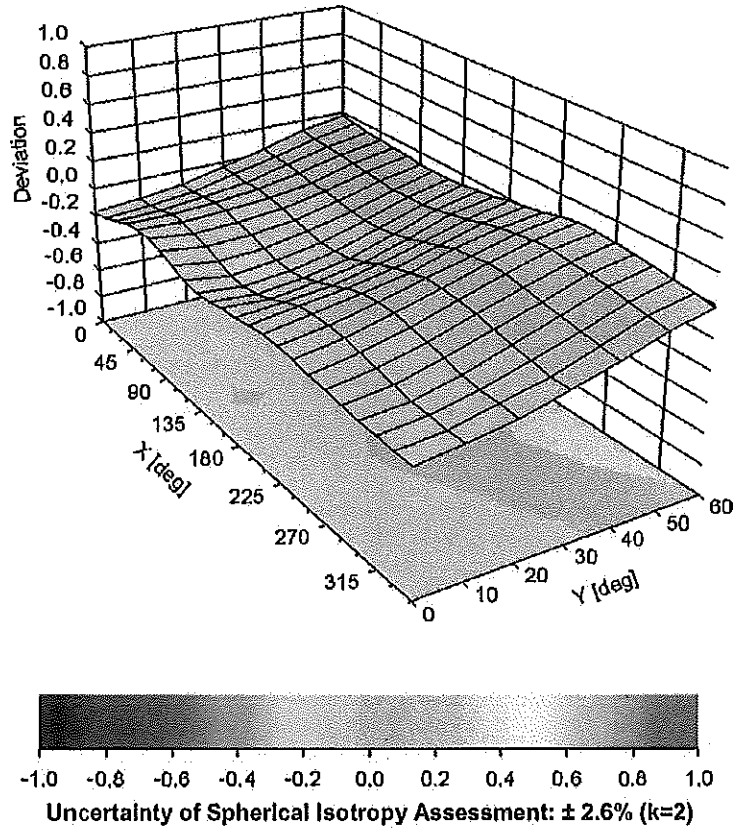

DASY/EASY - Parameters of Probe: ES3DV2 - SN:3022**Other Probe Parameters**

Sensor Arrangement	Triangular
Connector Angle (°)	-80,3
Mechanical Surface Detection Mode	enabled
Optical Surface Detection Mode	disabled
Probe Overall Length	337 mm
Probe Body Diameter	10 mm
Tip Length	10 mm
Tip Diameter	4 mm
Probe Tip to Sensor X Calibration Point	2 mm
Probe Tip to Sensor Y Calibration Point	2 mm
Probe Tip to Sensor Z Calibration Point	2 mm
Recommended Measurement Distance from Surface	3 mm



Accredited by the Swiss Accreditation Service (SAS)
The Swiss Accreditation Service is one of the signatories to the EA
Multilateral Agreement for the recognition of calibration certificates

Accreditation No.: **SCS 108**

Client **PC Test**

Certificate No: **EX3-3920_Dec14**

CALIBRATION CERTIFICATE

Object **EX3DV4 - SN:3920**

Calibration procedure(s) **QA CAL-01.v9, QA CAL-14.v4, QA CAL-23.v5, QA CAL-25.v6
Calibration procedure for dosimetric E-field probes**

CC
RIS/19

Calibration date: **December 12, 2014**

This calibration certificate documents the traceability to national standards, which realize the physical units of measurements (SI).
The measurements and the uncertainties with confidence probability are given on the following pages and are part of the certificate.

All calibrations have been conducted in the closed laboratory facility: environment temperature (22 ± 3)°C and humidity < 70%.

Calibration Equipment used (M&TE critical for calibration)

Primary Standards	ID	Cal Date (Certificate No.)	Scheduled Calibration
Power meter E4419B	GB41293874	03-Apr-14 (No. 217-01911)	Apr-15
Power sensor E4412A	MY41498087	03-Apr-14 (No. 217-01911)	Apr-15
Reference 3 dB Attenuator	SN: S5054 (3c)	03-Apr-14 (No. 217-01915)	Apr-15
Reference 20 dB Attenuator	SN: S5277 (20x)	03-Apr-14 (No. 217-01919)	Apr-15
Reference 30 dB Attenuator	SN: S5129 (30b)	03-Apr-14 (No. 217-01920)	Apr-15
Reference Probe ES3DV2	SN: 3013	30-Dec-13 (No. ES3-3013_Dec13)	Dec-14
DAE4	SN: 660	13-Dec-13 (No. DAE4-660_Dec13)	Dec-14
Secondary Standards	ID	Check Date (in house)	Scheduled Check
RF generator HP 8648C	US3642U01700	4-Aug-99 (in house check Apr-13)	In house check: Apr-16
Network Analyzer HP 8753E	US37390585	18-Oct-01 (in house check Oct-14)	In house check: Oct-15

Calibrated by:	Name Israe El-Naoug	Function Laboratory Technician	Signature
Approved by:	Name Katja Pokovic	Function Technical Manager	Signature
			Issued: December 13, 2014
This calibration certificate shall not be reproduced except in full without written approval of the laboratory.			



Accredited by the Swiss Accreditation Service (SAS)

Accreditation No.: **SCS 108**

The Swiss Accreditation Service is one of the signatories to the EA
Multilateral Agreement for the recognition of calibration certificates

Glossary:

TSL	tissue simulating liquid
NORM _{x,y,z}	sensitivity in free space
ConvF	sensitivity in TSL / NORM _{x,y,z}
DCP	diode compression point
CF	crest factor (1/duty_cycle) of the RF signal
A, B, C, D	modulation dependent linearization parameters
Polarization φ	φ rotation around probe axis
Polarization ϑ	ϑ rotation around an axis that is in the plane normal to probe axis (at measurement center), i.e., $\vartheta = 0$ is normal to probe axis
Connector Angle	information used in DASY system to align probe sensor X to the robot coordinate system

Calibration is Performed According to the Following Standards:

- IEEE Std 1528-2013, "IEEE Recommended Practice for Determining the Peak Spatial-Averaged Specific Absorption Rate (SAR) in the Human Head from Wireless Communications Devices: Measurement Techniques", June 2013
- IEC 62209-1, "Procedure to measure the Specific Absorption Rate (SAR) for hand-held devices used in close proximity to the ear (frequency range of 300 MHz to 3 GHz)", February 2005

Methods Applied and Interpretation of Parameters:

- NORM_{x,y,z}**: Assessed for E-field polarization $\vartheta = 0$ ($f \leq 900$ MHz in TEM-cell; $f > 1800$ MHz: R22 waveguide). NORM_{x,y,z} are only intermediate values, i.e., the uncertainties of NORM_{x,y,z} does not affect the E²-field uncertainty inside TSL (see below ConvF).
- NORM(f)_{x,y,z}** = NORM_{x,y,z} * frequency_response (see Frequency Response Chart). This linearization is implemented in DASY4 software versions later than 4.2. The uncertainty of the frequency response is included in the stated uncertainty of ConvF.
- DCP_{x,y,z}**: DCP are numerical linearization parameters assessed based on the data of power sweep with CW signal (no uncertainty required). DCP does not depend on frequency nor media.
- PAR**: PAR is the Peak to Average Ratio that is not calibrated but determined based on the signal characteristics
- A_{x,y,z}; B_{x,y,z}; C_{x,y,z}; D_{x,y,z}; VR_{x,y,z}; A, B, C, D** are numerical linearization parameters assessed based on the data of power sweep for specific modulation signal. The parameters do not depend on frequency nor media. VR is the maximum calibration range expressed in RMS voltage across the diode.
- ConvF and Boundary Effect Parameters**: Assessed in flat phantom using E-field (or Temperature Transfer Standard for $f \leq 800$ MHz) and inside waveguide using analytical field distributions based on power measurements for $f > 800$ MHz. The same setups are used for assessment of the parameters applied for boundary compensation (alpha, depth) of which typical uncertainty values are given. These parameters are used in DASY4 software to improve probe accuracy close to the boundary. The sensitivity in TSL corresponds to NORM_{x,y,z} * ConvF whereby the uncertainty corresponds to that given for ConvF. A frequency dependent ConvF is used in DASY version 4.4 and higher which allows extending the validity from ± 50 MHz to ± 100 MHz.
- Spherical isotropy (3D deviation from isotropy)**: in a field of low gradients realized using a flat phantom exposed by a patch antenna.
- Sensor Offset**: The sensor offset corresponds to the offset of virtual measurement center from the probe tip (on probe axis). No tolerance required.
- Connector Angle**: The angle is assessed using the information gained by determining the NORM_x (no uncertainty required).

Probe EX3DV4

SN:3920

Manufactured: December 18, 2012
Calibrated: December 12, 2014

Calibrated for DASY/EASY Systems
(Note: non-compatible with DASY2 system!)

DASY/EASY - Parameters of Probe: EX3DV4 - SN:3920

Basic Calibration Parameters

	Sensor X	Sensor Y	Sensor Z	Unc (k=2)
Norm ($\mu\text{V}/(\text{V}/\text{m})^2$) ^A	0.35	0.50	0.50	$\pm 10.1\%$
DCP (mV) ^B	104.2	98.5	97.7	

Modulation Calibration Parameters

UID	Communication System Name		A dB	B dB $\sqrt{\mu\text{V}}$	C	D dB	VR mV	Unc ^E (k=2)
0	CW	X	0.0	0.0	1.0	0.00	131.7	$\pm 3.5\%$
		Y	0.0	0.0	1.0		140.3	
		Z	0.0	0.0	1.0		136.8	
10010- CAA	SAR Validation (Square, 100ms, 10ms)	X	0.94	56.5	8.3	10.00	38.1	$\pm 0.7\%$
		Y	2.14	63.7	12.2		41.6	
		Z	3.89	70.9	15.1		40.9	
10012- CAB	IEEE 802.11b WiFi 2.4 GHz (DSSS, 1 Mbps)	X	2.91	68.2	18.0	1.87	142.7	$\pm 0.7\%$
		Y	2.48	64.3	15.8		132.6	
		Z	2.61	65.8	16.8		129.2	
10013- CAB	IEEE 802.11g WiFi 2.4 GHz (DSSS-OFDM, 6 Mbps)	X	10.41	69.4	22.2	9.46	149.3	$\pm 3.5\%$
		Y	10.78	69.4	22.2		146.4	
		Z	10.76	69.7	22.6		141.9	
10032- CAA	IEEE 802.15.1 Bluetooth (GFSK, DH5)	X	0.29	58.3	5.2	1.16	136.2	$\pm 0.7\%$
		Y	0.52	61.5	7.4		149.5	
		Z	0.99	66.7	9.6		146.5	
10062- CAB	IEEE 802.11a/h WiFi 5 GHz (OFDM, 6 Mbps)	X	9.78	68.2	21.1	8.68	126.2	$\pm 3.3\%$
		Y	10.40	68.9	21.4		145.8	
		Z	10.43	69.3	21.9		146.6	
10103- CAB	LTE-TDD (SC-FDMA, 100% RB, 20 MHz, QPSK)	X	7.49	68.0	21.7	9.29	145.0	$\pm 2.2\%$
		Y	7.76	68.0	21.7		137.3	
		Z	8.12	69.7	22.9		139.5	
10117- CAB	IEEE 802.11n (HT Mixed, 13.5 Mbps, BPSK)	X	10.08	68.6	20.8	8.07	140.7	$\pm 3.0\%$
		Y	10.01	67.8	20.3		129.1	
		Z	10.13	68.3	20.8		130.9	
10151- CAB	LTE-TDD (SC-FDMA, 50% RB, 20 MHz, QPSK)	X	7.12	67.7	21.7	9.28	140.0	$\pm 2.2\%$
		Y	7.42	67.6	21.5		133.0	
		Z	7.70	69.2	22.8		135.2	
10172- CAB	LTE-TDD (SC-FDMA, 1 RB, 20 MHz, QPSK)	X	5.55	68.8	22.5	9.21	129.9	$\pm 2.7\%$
		Y	6.01	69.1	22.6		144.5	
		Z	6.16	70.6	23.9		146.7	
10196- CAB	IEEE 802.11n (HT Mixed, 6.5 Mbps, BPSK)	X	9.56	68.2	20.7	8.10	132.3	$\pm 3.0\%$
		Y	10.09	68.7	20.9		149.9	
		Z	10.08	69.0	21.3		147.9	
10237- CAB	LTE-TDD (SC-FDMA, 1 RB, 10 MHz, QPSK)	X	5.60	69.2	22.8	9.21	133.6	$\pm 2.7\%$
		Y	6.05	69.3	22.7		145.6	
		Z	6.15	70.5	23.9		147.8	

10252-CAB	LTE-TDD (SC-FDMA, 50% RB, 10 MHz, QPSK)	X	6.68	67.3	21.6	9.24	133.4	±2.7 %
		Y	7.19	68.0	21.9		147.8	
		Z	7.38	69.3	23.0		147.7	
10267-CAB	LTE-TDD (SC-FDMA, 100% RB, 10 MHz, QPSK)	X	7.14	67.7	21.8	9.30	139.9	±2.2 %
		Y	7.44	67.6	21.5		133.0	
		Z	7.68	69.1	22.7		131.5	
10317-AAB	IEEE 802.11a WiFi 5 GHz (OFDM, 6 Mbps, 96pc duty cycle)	X	9.72	68.3	21.0	8.36	132.1	±3.3 %
		Y	10.25	68.8	21.2		148.1	
		Z	10.27	69.2	21.6		148.7	
10400-AAB	IEEE 802.11ac WiFi (20MHz, 64-QAM, 99pc duty cycle)	X	9.78	68.3	20.9	8.37	131.9	±3.3 %
		Y	9.97	67.9	20.7		125.1	
		Z	10.36	69.3	21.7		148.4	
10401-AAB	IEEE 802.11ac WiFi (40MHz, 64-QAM, 99pc duty cycle)	X	10.63	68.9	21.2	8.60	142.5	±3.0 %
		Y	10.72	68.6	21.0		133.5	
		Z	10.74	68.8	21.4		133.0	
10402-AAB	IEEE 802.11ac WiFi (80MHz, 64-QAM, 99pc duty cycle)	X	10.89	69.3	21.2	8.53	145.0	±3.3 %
		Y	10.70	68.4	20.8		133.2	
		Z	10.95	69.2	21.4		134.0	
10415-AAA	IEEE 802.11b WiFi 2.4 GHz (DSSS, 1 Mbps, 99pc duty cycle)	X	2.84	68.2	17.9	1.54	141.1	±0.5 %
		Y	2.39	64.2	15.6		130.2	
		Z	2.63	66.6	17.2		128.6	
10416-AAA	IEEE 802.11g WiFi 2.4 GHz (ERP-OFDM, 6 Mbps, 99pc duty cycle)	X	9.67	68.3	20.9	8.23	131.6	±3.3 %
		Y	10.14	68.6	21.0		147.9	
		Z	10.17	69.1	21.5		148.5	
10417-AAA	IEEE 802.11a/h WiFi 5 GHz (OFDM, 6 Mbps, 99pc duty cycle)	X	9.67	68.3	20.9	8.23	133.0	±3.3 %
		Y	9.78	67.7	20.5		124.4	
		Z	10.21	69.1	21.5		149.4	

The reported uncertainty of measurement is stated as the standard uncertainty of measurement multiplied by the coverage factor $k=2$, which for a normal distribution corresponds to a coverage probability of approximately 95%.

^A The uncertainties of NormX,Y,Z do not affect the E^2 -field uncertainty inside TSL (see Pages 6 and 7).

^B Numerical linearization parameter: uncertainty not required.

^E Uncertainty is determined using the max. deviation from linear response applying rectangular distribution and is expressed for the square of the field value.

DASY/EASY - Parameters of Probe: EX3DV4 - SN:3920

Calibration Parameter Determined in Head Tissue Simulating Media

f (MHz) ^C	Relative Permittivity ^F	Conductivity (S/m) ^F	ConvF X	ConvF Y	ConvF Z	Alpha ^G	Depth ^G (mm)	Unct. (k=2)
2450	39.2	1.80	7.12	7.12	7.12	0.62	0.65	± 12.0 %
2600	39.0	1.96	6.85	6.85	6.85	0.36	0.86	± 12.0 %
5200	36.0	4.66	4.87	4.87	4.87	0.35	1.80	± 13.1 %
5300	35.9	4.76	4.69	4.69	4.69	0.35	1.80	± 13.1 %
5500	35.6	4.96	4.44	4.44	4.44	0.40	1.80	± 13.1 %
5600	35.5	5.07	4.35	4.35	4.35	0.40	1.80	± 13.1 %
5800	35.3	5.27	4.27	4.27	4.27	0.40	1.80	± 13.1 %

^C Frequency validity above 300 MHz of ± 100 MHz only applies for DASY v4.4 and higher (see Page 2), else it is restricted to ± 50 MHz. The uncertainty is the RSS of the ConvF uncertainty at calibration frequency and the uncertainty for the indicated frequency band. Frequency validity below 300 MHz is ± 10, 25, 40, 50 and 70 MHz for ConvF assessments at 30, 64, 128, 150 and 220 MHz respectively. Above 5 GHz frequency validity can be extended to ± 110 MHz.

^F At frequencies below 3 GHz, the validity of tissue parameters (ϵ and σ) can be relaxed to ± 10% if liquid compensation formula is applied to measured SAR values. At frequencies above 3 GHz, the validity of tissue parameters (ϵ and σ) is restricted to ± 5%. The uncertainty is the RSS of the ConvF uncertainty for indicated target tissue parameters.

^G Alpha/Depth are determined during calibration. SPEAG warrants that the remaining deviation due to the boundary effect after compensation is always less than ± 1% for frequencies below 3 GHz and below ± 2% for frequencies between 3-6 GHz at any distance larger than half the probe tip diameter from the boundary.

DASY/EASY - Parameters of Probe: EX3DV4 - SN:3920

Calibration Parameter Determined in Body Tissue Simulating Media

f (MHz) ^C	Relative Permittivity ^F	Conductivity (S/m) ^F	ConvF X	ConvF Y	ConvF Z	Alpha ^G	Depth ^G (mm)	Unct. (k=2)
2450	52.7	1.95	7.02	7.02	7.02	0.80	0.50	± 12.0 %
2600	52.5	2.16	6.78	6.78	6.78	0.80	0.50	± 12.0 %
5200	49.0	5.30	4.33	4.33	4.33	0.45	1.90	± 13.1 %
5300	48.9	5.42	4.16	4.16	4.16	0.45	1.90	± 13.1 %
5500	48.6	5.65	3.79	3.79	3.79	0.50	1.90	± 13.1 %
5600	48.5	5.77	3.66	3.66	3.66	0.50	1.90	± 13.1 %
5800	48.2	6.00	3.93	3.93	3.93	0.50	1.90	± 13.1 %

^C Frequency validity above 300 MHz of ± 100 MHz only applies for DASY v4.4 and higher (see Page 2), else it is restricted to ± 50 MHz. The uncertainty is the RSS of the ConvF uncertainty at calibration frequency and the uncertainty for the indicated frequency band. Frequency validity below 300 MHz is ± 10, 25, 40, 50 and 70 MHz for ConvF assessments at 30, 64, 128, 150 and 220 MHz respectively. Above 5 GHz frequency validity can be extended to ± 110 MHz.

^F At frequencies below 3 GHz, the validity of tissue parameters (ϵ and σ) can be relaxed to ± 10% if liquid compensation formula is applied to measured SAR values. At frequencies above 3 GHz, the validity of tissue parameters (ϵ and σ) is restricted to ± 5%. The uncertainty is the RSS of the ConvF uncertainty for indicated target tissue parameters.

^G Alpha/Depth are determined during calibration. SPEAG warrants that the remaining deviation due to the boundary effect after compensation is always less than ± 1% for frequencies below 3 GHz and below ± 2% for frequencies between 3-6 GHz at any distance larger than half the probe tip diameter from the boundary.

Frequency Response of E-Field

(TEM-Cell:ifi110 EXX, Waveguide: R22)

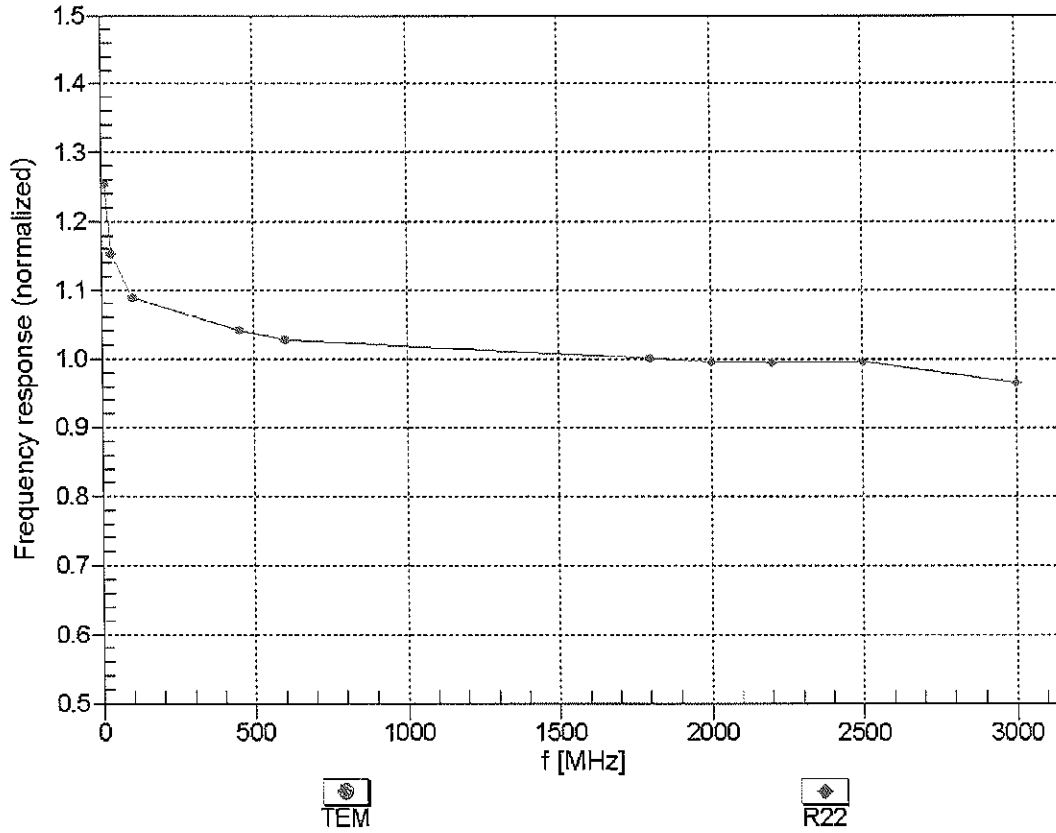

Uncertainty of Frequency Response of E-field: $\pm 6.3\%$ (k=2)

Receiving Pattern (ϕ), $\vartheta = 0^\circ$

f=600 MHz,TEM

f=1800 MHz,R22

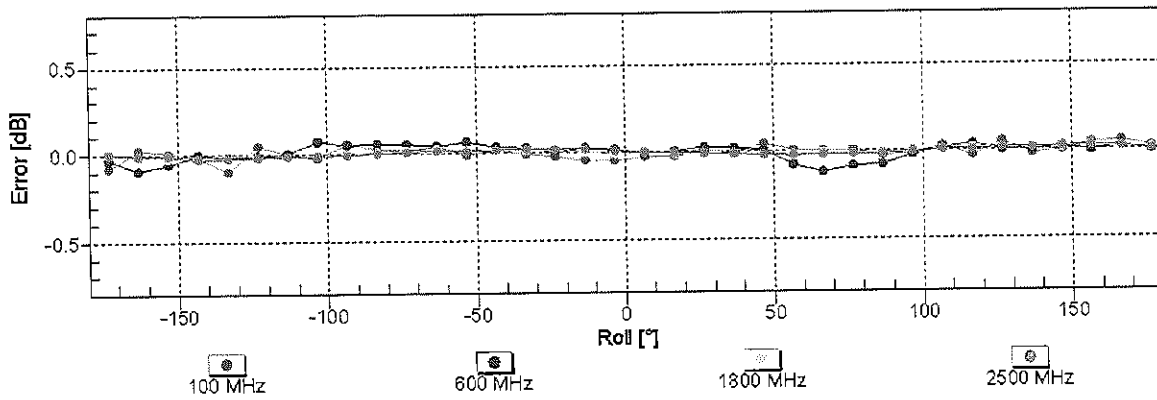
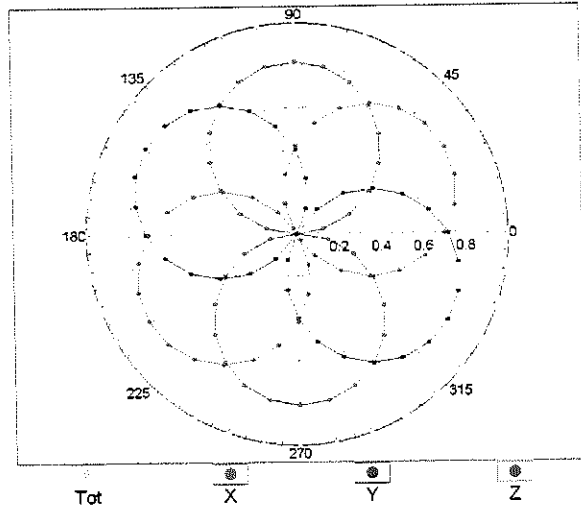
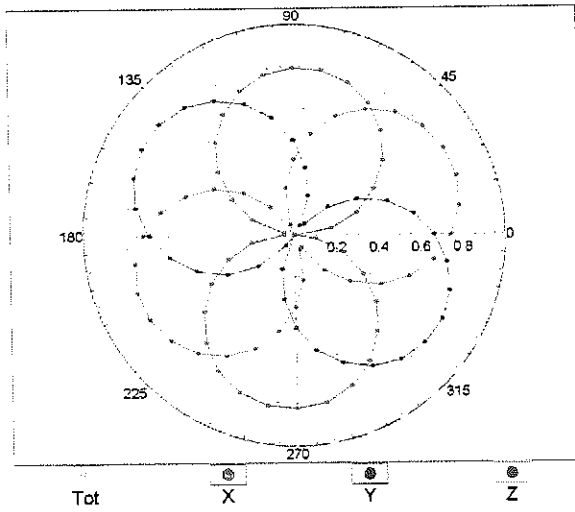

Uncertainty of Axial Isotropy Assessment: $\pm 0.5\%$ (k=2)

Dynamic Range f(SAR_{head})

(TEM cell , f_{eval}= 1900 MHz)

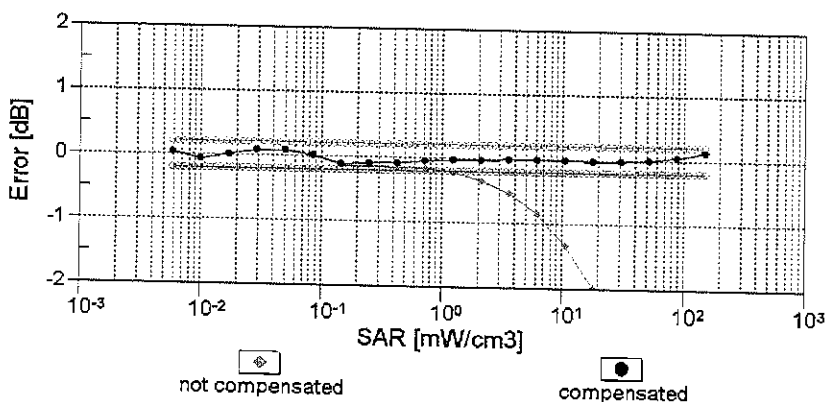
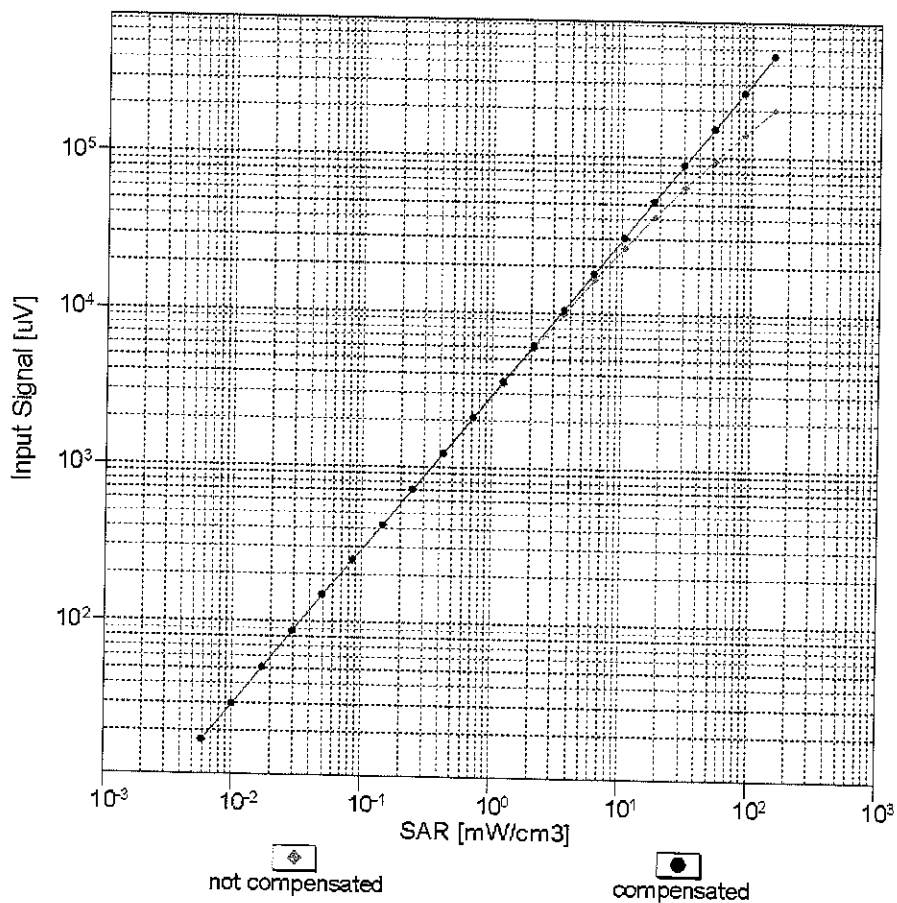

Uncertainty of Linearity Assessment: ± 0.6% (k=2)

Conversion Factor Assessment

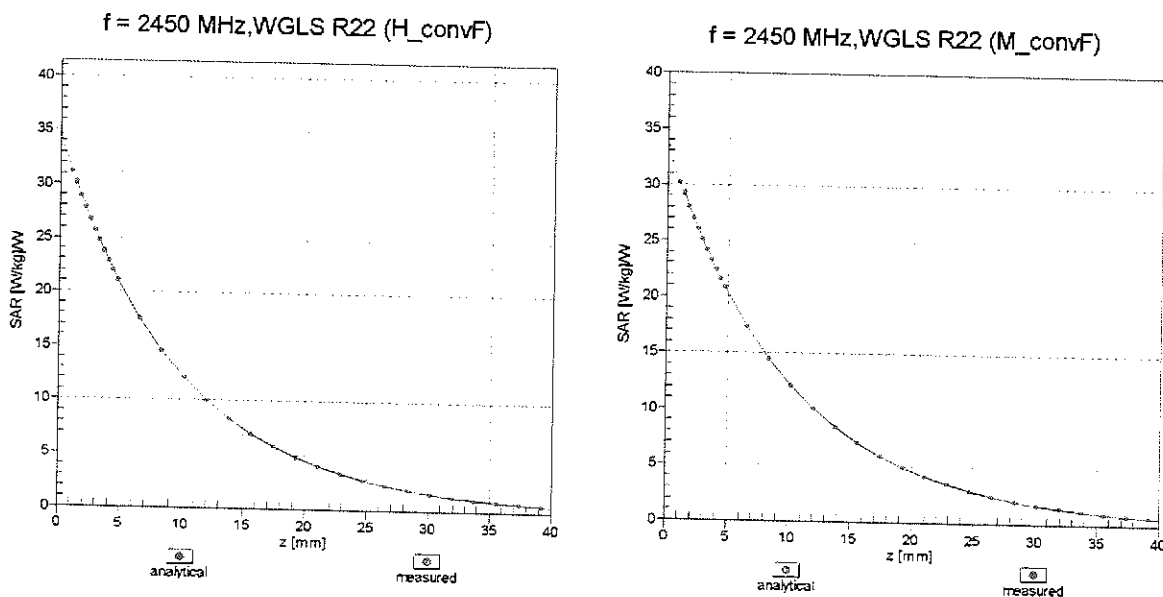

Deviation from Isotropy in Liquid

Error (ϕ, θ), $f = 900 \text{ MHz}$

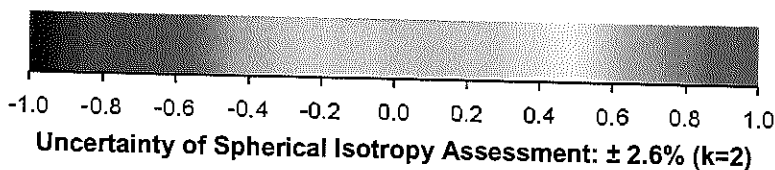
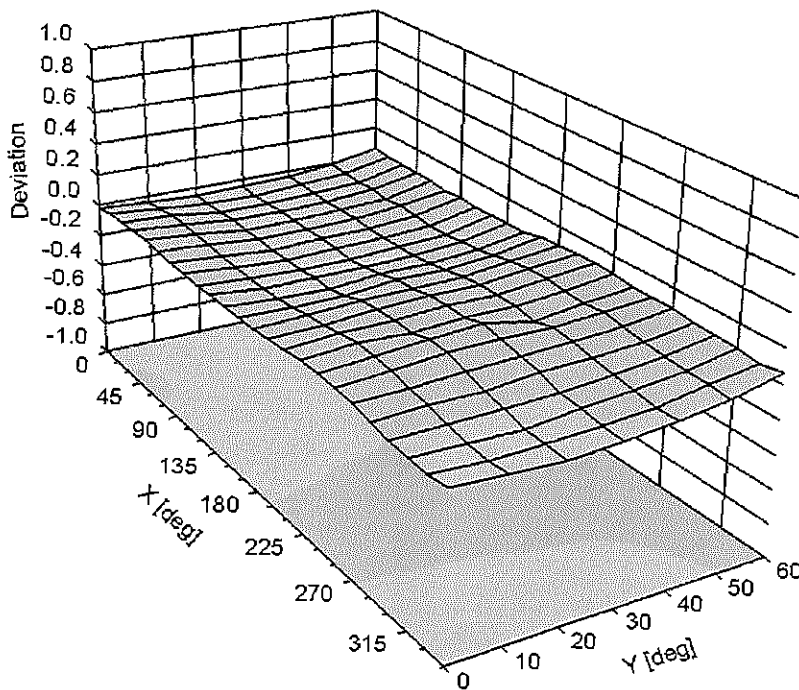

DASY/EASY - Parameters of Probe: EX3DV4 - SN:3920

Other Probe Parameters

Sensor Arrangement	Triangular
Connector Angle (°)	-23.3
Mechanical Surface Detection Mode	enabled
Optical Surface Detection Mode	disabled
Probe Overall Length	337 mm
Probe Body Diameter	10 mm
Tip Length	9 mm
Tip Diameter	2.5 mm
Probe Tip to Sensor X Calibration Point	1 mm
Probe Tip to Sensor Y Calibration Point	1 mm
Probe Tip to Sensor Z Calibration Point	1 mm
Recommended Measurement Distance from Surface	1.4 mm

APPENDIX D: SAR TISSUE SPECIFICATIONS

Measurement Procedure for Tissue verification:

- 3) The network analyzer and probe system was configured and calibrated.
- 4) The probe was immersed in the tissue. The tissue was placed in a nonmetallic container. Trapped air bubbles beneath the flange were minimized by placing the probe at a slight angle.
- 5) The complex admittance with respect to the probe aperture was measured
- 6) The complex relative permittivity ϵ can be calculated from the below equation (Pournaropoulos and Misra):

$$Y = \frac{j2\omega\epsilon_r\epsilon_0}{[\ln(b/a)]^2} \int_a^b \int_a^b \int_0^\pi \cos\phi' \frac{\exp[-j\omega r(\mu_0\epsilon_r\epsilon_0)^{1/2}]}{r} d\phi' d\rho' d\rho$$

where Y is the admittance of the probe in contact with the sample, the primed and unprimed coordinates refer to source and observation points, respectively, $r^2 = \rho^2 + \rho'^2 - 2\rho\rho' \cos\phi'$, ω is the angular frequency, and $j = \sqrt{-1}$.

**Table D-1
Composition of the Tissue Equivalent Matter**

Frequency (MHz)	750	750	835	835	1900	1900	2450	2450	5200-5800	5200-5800	
Tissue	Head	Body	Head	Body	Head	Body	Head	Body	Head	Body	
Ingredients (% by weight)											
Bactericide	See page 2-3	See page 2	0.1	0.1			See page 4		See page 5		
DGBE					44.92	29.44				26.7	
HEC			1	1							
NaCl			1.45	0.94	0.18	0.39				0.1	
Sucrose			57	44.9							
Polysorbate (Tween) 80											20
Water					40.45	53.06		54.9		70.17	

FCC ID: A3LSMG925KOR	PCTEST <small>PROFESSIONAL LABORATORY, INC.</small>	SAR EVALUATION REPORT		Reviewed by: Quality Manager
Test Dates: 12/29/14 - 01/12/15	DUT Type: Portable Handset			APPENDIX D: Page 1 of 5

2 Composition / Information on ingredients

The Item is composed of the following ingredients:

H ₂ O	Water, 35 – 58%
Sucrose	Sugar, white, refined, 40 – 60%
NaCl	Sodium Chloride, 0 – 6%
Hydroxyethyl-cellulose	Medium Viscosity (CAS# 9004-62-0), <0.3%
Preventol-D7	Preservative: aqueous preparation, (CAS# 55965-84-9), containing 5-chloro-2-methyl-3(2H)-isothiazolone and 2-methyl-3(2H)-isothiazolone, 0.1 – 0.7%

Relevant for safety; Refer to the respective Safety Data Sheet*.

Figure D-1
Composition of 750 MHz Head and Body Tissue Equivalent Matter

Note: 750MHz liquid recipes are proprietary SPEAG. Since the composition is approximate to the actual liquids utilized, the manufacturer tissue-equivalent liquid data sheets are provided below.

Measurement Certificate / Material Test

Item Name	Body Tissue Simulating Liquid (MSL750V2)
Product No.	SL AAM 075 AA (Charge: 130313-1)
Manufacturer	SPEAG

Measurement Method

TSL dielectric parameters measured using calibrated OCP probe.

Setup Validation

Validation results were within $\pm 2.5\%$ towards the target values of Methanol.

Target Parameters

Target parameters as defined in the IEEE 1528 and IEC 62209 compliance standards.

Test Condition

Ambient Environment temperature (22 ± 3)°C and humidity < 70%.
 TSL Temperature 22°C
 Test Date 13-Mar-13
 Operator IEN

Additional Information

TSL Density 1.212 g/cm³
 TSL Heat-capacity 3.006 kJ/(kg*K)

f [MHz]	Measured			Target		Diff. to Target [%]	
	HP-e'	HP-e''	sigma	eps	sigma	Δ-eps	Δ-sigma
600	57.5	24.64	0.82	56.1	0.95	2.5	-13.6
625	57.2	24.31	0.84	56.0	0.95	2.1	-11.4
650	57.0	23.99	0.87	55.9	0.96	1.8	-9.2
675	56.7	23.69	0.89	55.8	0.96	1.5	-7.1
700	56.4	23.39	0.91	55.7	0.96	1.2	-5.1
725	56.2	23.18	0.93	55.6	0.96	1.0	-2.8
750	55.9	22.97	0.96	55.5	0.96	0.7	-0.5
775	55.7	22.78	0.98	55.4	0.97	0.4	1.7
800	55.4	22.60	1.01	55.3	0.97	0.1	4.0
825	55.2	22.44	1.03	55.2	0.98	-0.2	5.3
850	55.0	22.36	1.04	55.2	0.98	-0.3	5.9
875	54.9	22.28	1.05	55.2	0.99	-0.4	6.6
900	54.7	22.16	1.08	55.1	1.02	-0.7	5.8
925	54.5	22.03	1.10	55.0	1.05	-1.0	5.1
950	54.2	21.93	1.13	55.0	1.06	-1.3	6.2
975	54.0	21.82	1.15	54.9	1.08	-1.7	7.2
1000	53.8	21.74	1.18	54.9	1.09	-2.0	8.5
1000	53.6	21.66	1.21	54.8	1.10	-2.3	9.7

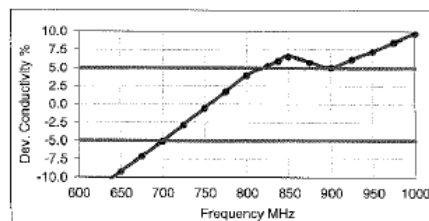
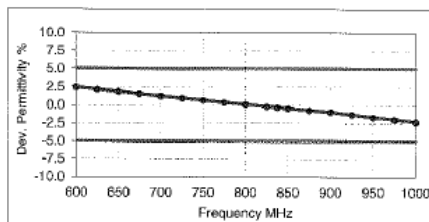



Figure D-2
750MHz Body Tissue Equivalent Matter

FCC ID: A3LSMG925KOR		SAR EVALUATION REPORT		Reviewed by: Quality Manager
Test Dates: 12/29/14 - 01/12/15	DUT Type: Portable Handset			APPENDIX D: Page 2 of 5

Measurement Certificate / Material Test

Item Name	Head Tissue Simulating Liquid (HSL750V2)
Product No.	SL AAH 075 AA (Charge: 130312-4)
Manufacturer	SPEAG

Measurement Method

TSL dielectric parameters measured using calibrated OCP probe.

Setup Validation

Validation results were within $\pm 2.5\%$ towards the target values of Methanol.

Target Parameters

Target parameters as defined in the IEEE 1528 and IEC 62209 compliance standards.

Test Condition

Ambient	Environment temperatur (22 ± 3)°C and humidity < 70%.
TSL Temperature	22°C
Test Date	13-Mar-13
Operator	IEN

Additional Information

TSL Density	1.284 g/cm ³
TSL Heat-capacity	2.701 kJ/(kg*K)

f [MHz]	Measured			Target		Diff. to Target [%]	
	HP-e'	HP-e''	sigma	eps	sigma	Δ-eps	Δ-sigma
600	44.6	23.25	0.78	42.7	0.88	4.3	-12.0
625	44.2	23.00	0.80	42.6	0.88	3.8	-9.5
650	43.8	22.76	0.82	42.5	0.89	3.2	-7.1
675	43.4	22.50	0.84	42.3	0.89	2.6	-4.9
700	43.1	22.24	0.87	42.2	0.89	2.1	-2.6
725	42.7	22.06	0.89	42.1	0.89	1.6	-0.2
750	42.4	21.88	0.91	41.9	0.89	1.1	2.2
775	42.1	21.72	0.94	41.8	0.90	0.6	4.6
800	41.7	21.55	0.96	41.7	0.90	0.1	6.9
825	41.4	21.40	0.98	41.6	0.91	-0.4	8.3
838	41.3	21.32	0.99	41.5	0.91	-0.8	9.0
850	41.1	21.24	1.00	41.5	0.92	-0.9	9.6
875	40.8	21.11	1.03	41.5	0.94	-1.6	9.0
900	40.6	20.99	1.05	41.5	0.97	-2.3	8.3
925	40.3	20.87	1.07	41.5	0.98	-2.9	9.4
950	40.0	20.76	1.10	41.4	0.99	-3.5	10.3
975	39.7	20.66	1.12	41.4	1.00	-4.0	11.5
1000	39.5	20.57	1.14	41.3	1.01	-4.5	12.7

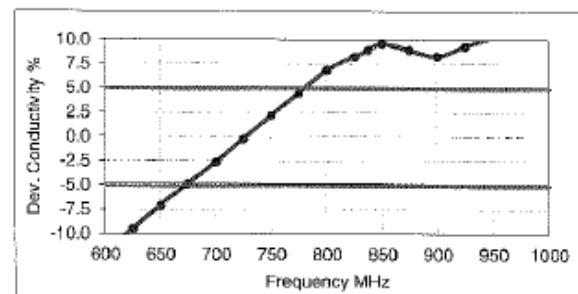
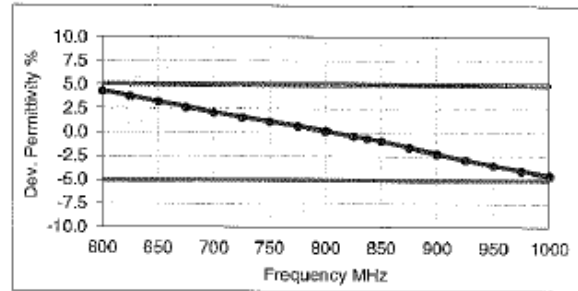



Figure D-3
750MHz Head Tissue Equivalent Matter

FCC ID: A3LSMG925KOR		SAR EVALUATION REPORT		Reviewed by: Quality Manager
Test Dates: 12/29/14 - 01/12/15	DUT Type: Portable Handset			APPENDIX D: Page 3 of 5

2 Composition / Information on ingredients

The Item is composed of the following ingredients:

H2O	Water, 52 – 75%
C8H18O3	Diethylene glycol monobutyl ether (DGBE), 25 – 48% (CAS-No. 112-34-5, EC-No. 203-961-6, EC-index-No. 603-096-00-8) Relevant for safety; Refer to the respective Safety Data Sheet*.
NaCl	Sodium Chloride, <1.0%

Figure D-4
Composition of 2.4 GHz Head Tissue Equivalent Matter

Note: 2.4 GHz head liquid recipes are proprietary SPEAG. Since the composition is approximate to the actual liquids utilized, the manufacturer tissue-equivalent liquid data sheets are provided below.

Measurement Certificate / Material Test

Item Name	Head Tissue Simulating Liquid (HSL2450V2)
Product No.	SL AAH 245 BA (Charge: 130212-2)
Manufacturer	SPEAG

Measurement Method

TSL dielectric parameters measured using calibrated OCP probe.

Setup Validation

Validation results were within $\pm 2.5\%$ towards the target values of Methanol.

Target Parameters

Target parameters as defined in the IEEE 1528 and IEC 62209 compliance standards.

Test Condition

Ambient	Environment temperatur (22 ± 3)°C and humidity < 70%.
TSL Temperature	23°C
Test Date	13-Feb-13
Operator	DI

Additional Information

TSL Density	0.988 g/cm ³
TSL Heat-capacity	3.680 kJ/(kg*K)

f (MHz)	Measured			Target		Diff. to Target [%]	
	HP-ε'	HP-ε''	sigma	eps	sigma	Δ-eps	Δ-sigma
1900	40.4	11.94	1.26	40.0	1.40	1.0	-9.9
1925	40.3	12.02	1.29	40.0	1.40	0.7	-8.0
1950	40.2	12.11	1.31	40.0	1.40	0.5	-6.2
1975	40.1	12.20	1.34	40.0	1.40	0.2	-4.2
2000	40.0	12.29	1.37	40.0	1.40	-0.1	-2.3
2025	39.9	12.39	1.40	40.0	1.42	-0.2	-1.9
2050	39.8	12.49	1.42	39.9	1.44	-0.4	-1.4
2075	39.6	12.57	1.45	39.9	1.47	-0.6	-1.1
2100	39.5	12.65	1.48	39.8	1.49	-0.7	-0.7
2125	39.4	12.74	1.51	39.8	1.51	-0.9	-0.4
2150	39.3	12.82	1.53	39.7	1.53	-1.0	0.0
2175	39.2	12.89	1.56	39.7	1.56	-1.2	0.3
2200	39.1	12.97	1.59	39.6	1.58	-1.3	0.6
2225	39.0	13.04	1.61	39.6	1.60	-1.5	0.9
2250	38.9	13.11	1.64	39.6	1.62	-1.7	1.2
2275	38.8	13.20	1.67	39.5	1.64	-1.8	1.6
2300	38.7	13.28	1.70	39.5	1.67	-2.0	2.0
2325	38.6	13.35	1.73	39.4	1.69	-2.1	2.3
2350	38.5	13.42	1.75	39.4	1.71	-2.3	2.6
2375	38.4	13.50	1.78	39.3	1.73	-2.4	2.9
2400	38.3	13.58	1.81	39.3	1.76	-2.6	3.3
2425	38.2	13.65	1.84	39.2	1.78	-2.7	3.6
2450	38.1	13.73	1.87	39.2	1.80	-2.9	4.0
2475	38.0	13.79	1.90	39.2	1.83	-3.1	3.9
2500	37.9	13.85	1.93	39.1	1.85	-3.3	3.9
2525	37.8	13.94	1.96	39.1	1.88	-3.4	4.0
2550	37.7	14.02	1.99	39.1	1.91	-3.6	4.2
2575	37.6	14.09	2.02	39.0	1.94	-3.8	4.3
2600	37.5	14.17	2.05	39.0	1.96	-4.0	4.4
2625	37.4	14.23	2.08	39.0	1.99	-4.2	4.4
2650	37.3	14.29	2.11	38.9	2.02	-4.3	4.4
2675	37.1	14.36	2.14	38.9	2.05	-4.5	4.5
2700	37.0	14.43	2.17	38.9	2.07	-4.8	4.6

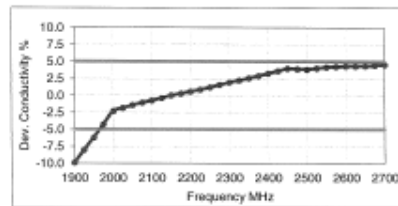
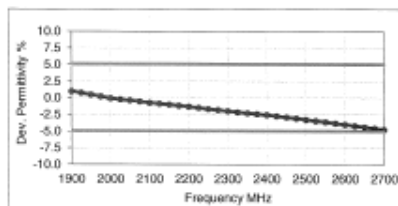



Figure D-5
2.4 GHz Head Tissue Equivalent Matter

FCC ID: A3LSMG925KOR		SAR EVALUATION REPORT		Reviewed by: Quality Manager
Test Dates: 12/29/14 - 01/12/15	DUT Type: Portable Handset			APPENDIX D: Page 4 of 5

2 Composition / Information on ingredients

The Item is composed of the following ingredients:

Water	50 – 65%
Mineral oil	10 – 30%
Emulsifiers	8 – 25%
Sodium salt	0 – 1.5%

Figure D-6

Composition of 5 GHz Head Tissue Equivalent Matter

Note: 5GHz head liquid recipes are proprietary SPEAG. Since the composition is approximate to the actual liquids utilized, the manufacturer tissue-equivalent liquid data sheets are provided below.

Measurement Certificate / Material Test

Item Name	Head Tissue Simulating Liquid (HBBL3500-5800V5)
Product No.	SL AAH 502 AC (Charge: 130903-1)
Manufacturer	SPEAG

Measurement Method

TSL dielectric parameters measured using calibrated OCP probe.

Setup Validation

Validation results were within $\pm 2.5\%$ towards the target values of Methanol.

Target Parameters

Target parameters as defined in the IEEE 1528 and IEC 62209 compliance standards.

Test Condition

Ambient Environment temperatur (22 ± 3)°C and humidity < 70%.
 TSL Temperature 22°C
 Test Date 4-Sep-13
 Operator IEN

Additional information

TSL Density 0.985 g/cm³
 TSL Heat-capacity 3.383 kJ/(kg*K)

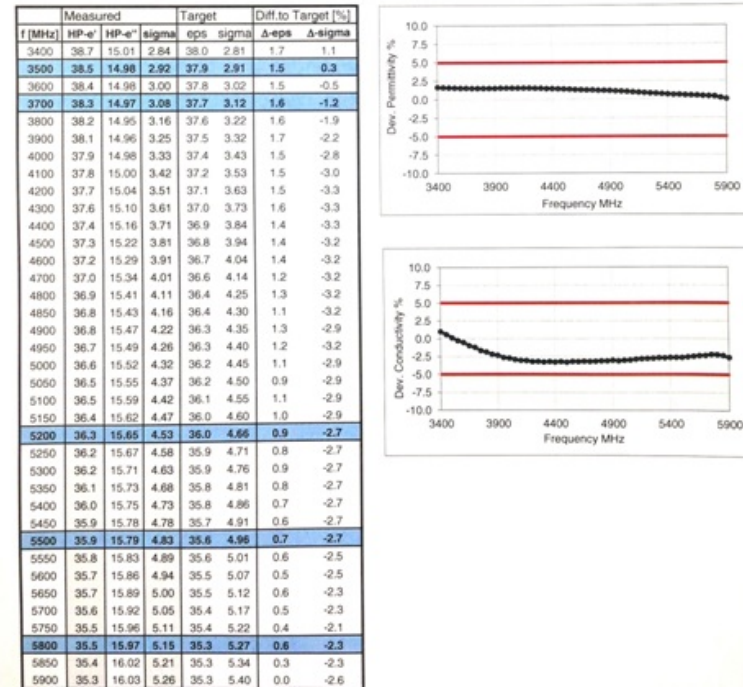



Figure D-7

5GHz Head Tissue Equivalent Matter

FCC ID: A3LSMG925KOR		SAR EVALUATION REPORT		Reviewed by: Quality Manager
Test Dates: 12/29/14 - 01/12/15	DUT Type: Portable Handset			APPENDIX D: Page 5 of 5

APPENDIX E: SAR SYSTEM VALIDATION



Per FCC KDB 865664 D02v01, SAR system validation status should be documented to confirm measurement accuracy. The SAR systems (including SAR probes, system components and software versions) used for this device were validated against its performance specifications prior to the SAR measurements. Reference dipoles were used with the required tissue- equivalent media for system validation, according to the procedures outlined in FCC KDB 865664 D01 v01 and IEEE 1528-2013. Since SAR probe calibrations are frequency dependent, each probe calibration point was validated at a frequency within the valid frequency range of the probe calibration point, using the system that normally operates with the probe for routine SAR measurements and according to the required tissue-equivalent media.

A tabulated summary of the system validation status including the validation date(s), measurement frequencies, SAR probes and tissue dielectric parameters has been included.

Table E-I
SAR System Validation Summary

SAR SYSTEM #	FREQ. [MHz]	DATE	PROBE SN	PROBE TYPE	PROBE CAL. POINT		COND.	PERM.	CW VALIDATION			MOD. VALIDATION		
							(σ)	(ε _r)	SENSI-TIVITY	PROBE LINEARITY	PROBE ISOTROPY	MOD. TYPE	DUTY FACTOR	PAR
D	750	8/28/2014	3263	ES3DV3	750	Head	0.911	40.71	PASS	PASS	PASS	N/A	N/A	N/A
K	835	10/13/2014	3288	ES3DV3	835	Head	0.926	41.94	PASS	PASS	PASS	GMSK	PASS	N/A
G	1900	6/27/2014	3258	ES3DV3	1900	Head	1.400	39.22	PASS	PASS	PASS	GMSK	PASS	N/A
G	2450	3/6/2014	3258	ES3DV3	2450	Head	1.736	38.36	PASS	PASS	PASS	OFDM/TDD	PASS	PASS
E	5300	10/28/2014	7308	EX3DV4	5250	Head	4.617	36.20	PASS	PASS	PASS	OFDM	N/A	PASS
E	5500	10/28/2014	7308	EX3DV4	5600	Head	4.828	35.97	PASS	PASS	PASS	OFDM	N/A	PASS
E	5800	10/28/2014	7308	EX3DV4	5750	Head	5.113	35.53	PASS	PASS	PASS	OFDM	N/A	PASS
D	750	10/20/2014	3263	ES3DV3	750	Body	0.971	55.55	PASS	PASS	PASS	N/A	N/A	N/A
K	835	10/13/2014	3288	ES3DV3	835	Body	0.998	52.95	PASS	PASS	PASS	GMSK	PASS	N/A
J	1900	9/4/2014	3022	ES3DV2	1900	Body	1.555	52.66	PASS	PASS	PASS	GMSK	PASS	N/A
G	1900	6/25/2014	3258	ES3DV3	1900	Body	1.534	51.23	PASS	PASS	PASS	GMSK	PASS	N/A
G	2450	3/5/2014	3258	ES3DV3	2450	Body	2.044	51.30	PASS	PASS	PASS	OFDM/TDD	PASS	PASS
H	5300	12/30/2014	3920	EX3DV4	5300	Body	5.523	47.80	PASS	PASS	PASS	OFDM	N/A	PASS
H	5500	12/30/2014	3920	EX3DV4	5500	Body	5.800	47.43	PASS	PASS	PASS	OFDM	N/A	PASS
H	5800	12/30/2014	3920	EX3DV4	5800	Body	6.191	46.98	PASS	PASS	PASS	OFDM	N/A	PASS

NOTE: While the probes have been calibrated for both CW and modulated signals, all measurements were performed using communication systems calibrated for CW signals only. Modulations in the table above represent test configurations for which the measurement system has been validated per FCC KDB Publication 865664 D01v01 for scenarios when CW probe calibrations are used with other signal types. SAR systems were validated for modulated signals with a periodic duty cycle, such as GMSK, or with a high peak to average ratio (>5 dB), such as OFDM according to KDB 865664.

FCC ID: A3LSMG925KOR		SAR EVALUATION REPORT		Reviewed by: Quality Manager
Test Dates: 12/29/14 - 01/12/15	DUT Type: Portable Handset	APPENDIX E: Page 1 of 1		