

## HEARING AID COMPATIBILITY

**Applicant Name:**

Samsung Electronics Co., Ltd.  
129, Samsung-ro, Maetan dong,  
Yeongtong-gu, Suwon-si  
Gyeonggi-do 443-742, Korea

**Date of Testing:**

04/06/2015 - 04/11/2015

**Test Site/Location:**

PCTEST Lab, Columbia, MD, USA

**Test Report Serial No.:**

0Y1504030668.A3L

**FCC ID:**

**A3LSMG890A**

**APPLICANT:**

**SAMSUNG ELECTRONICS CO., LTD.**

**Scope of Test:**

Audio Band Magnetic Testing (T-Coil)

**Application Type:**

Certification

**FCC Rule Part(s):**

CFR §20.19(b)

**HAC Standard:**

ANSI C63.19-2011

**EUT Type:**

Portable Handset

**Model(s):**

SM-G890A

**Test Device Serial No.:**

*Pre-Production Sample* [S/N: 359356060056390]

**C63.19-2011 HAC Category:**

**T3 (SIGNAL TO NOISE CATEGORY)**



This wireless portable device has been shown to be hearing-aid compatible under the above rated category, specified in ANSI/IEEE Std. C63.19-2011 and has been tested in accordance with the specified measurement procedures. Test results reported herein relate only to the item(s) tested. Hearing-Aid Compatibility is based on the assumption that all production units will be designed electrically identical to the device tested in this report. North American Bands only.

I attest to the accuracy of data. All measurements reported herein were performed by me or were made under my supervision and are correct to the best of my knowledge and belief. I assume full responsibility for the completeness of these measurements and vouch for the qualifications of all persons taking them.



Randy Ortanez  
President





FCC ID: A3LSMG890A		HAC (T-COIL) TEST REPORT		Reviewed by: Quality Manager
Filename: 0Y1504030668.A3L	Test Dates: 04/06/2015 - 04/11/2015	EUT Type: Portable Handset		Page 1 of 57

# TABLE OF CONTENTS

---

1.	INTRODUCTION .....	3
2.	EUT DESCRIPTION .....	4
3.	ANSI C63.19-2011 PERFORMANCE CATEGORIES .....	5
4.	METHOD OF MEASUREMENT .....	7
5.	VOLTE TEST SYSTEM SETUP AND DUT CONFIGURATION .....	17
6.	FCC 3G MEASUREMENTS .....	19
7.	TEST SUMMARY .....	20
8.	MEASUREMENT UNCERTAINTY .....	43
9.	EQUIPMENT LIST .....	44
10.	CALIBRATION CERTIFICATES.....	45
11.	CONCLUSION.....	52
12.	REFERENCES .....	53
13.	TEST SETUP PHOTOGRAPHS .....	55

<b>FCC ID:</b> A3LSMG890A	 <small>ENGINEERING LABORATORY, INC.</small>	<b>HAC (T-COIL) TEST REPORT</b>		<b>Reviewed by:</b> Quality Manager
<b>Filename:</b> 0Y1504030668.A3L	<b>Test Dates:</b> 04/06/2015 - 04/11/2015	<b>EUT Type:</b> Portable Handset		Page 2 of 57

# 1. INTRODUCTION

On July 10, 2003, the Federal Communications Commission (FCC) adopted new rules requiring wireless manufacturers and service providers to provide digital wireless phones that are compatible with hearing aids. The FCC has modified the exemption for wireless phones under the Hearing Aid Compatibility Act of 1998 (HAC Act) in WT Docket 01-309 RM-8658<sup>1</sup> to extend the benefits of wireless telecommunications to individuals with hearing disabilities. These benefits encompass business, social and emergency communications, which increase the value of the wireless network for everyone. An estimated more than 10% of the population in the United States show signs of hearing impairment and of that fraction, almost 80% use hearing aids. Approximately 500 million people worldwide and 30 million people in the United States suffer from hearing loss.

## Compatibility Tests Involved:

The standard calls for wireless communications devices to be measured for:

- RF Electric-field emissions
- T-coil mode, magnetic-signal strength in the audio band
- T-coil mode, magnetic-signal frequency response through the audio band
- T-coil mode, magnetic-signal and noise articulation index

The hearing aid must be measured for:

- RF immunity in microphone mode
- RF immunity in T-coil mode

In the following tests and results, this report includes the evaluation for a wireless communications device.

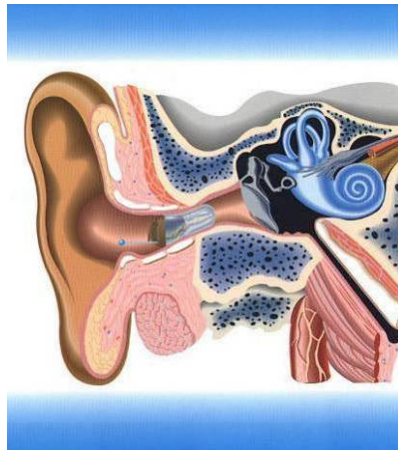



Figure 1-1 Hearing Aid *in-vitu*

<sup>1</sup> FCC Rule & Order, WT Docket 01-309 RM-8658

FCC ID: A3LSMG890A	 PCTEST ENGINEERING LABORATORY, INC.	HAC (T-COIL) TEST REPORT	 SAMSUNG	Reviewed by: Quality Manager
Filename: 0Y1504030668.A3L	Test Dates: 04/06/2015 - 04/11/2015	EUT Type: Portable Handset		Page 3 of 57

## 2. EUT DESCRIPTION



FCC ID: A3LSMG890A  
 Applicant: Samsung Electronics Co., Ltd.  
 129, Samsung-ro, Maetan dong,  
 Yeongtong-gu, Suwon-si  
 Gyeonggi-do 443-742, Korea

Model(s): SM-G890A  
 Serial Number: 359356060056390  
 HW Version: REV0.0  
 SW Version: G890A.000  
 Antenna: Internal Antenna

HAC Test Configurations: GSM 850, 128, 190, 251, BT Off, WLAN Off, LTE Off  
 GSM 1900, 512, 661, 810, BT Off, WLAN Off, LTE Off  
 UMTS V, 4132, 4183, 4233, BT Off, WLAN Off, LTE Off  
 UMTS II, 9262, 9400, 9538, BT Off, WLAN Off, LTE Off  
 LTE FDD B2; BW's: 20MHz, 15MHz, 10MHz, 5MHz, 3MHz, 1.4MHz; BT Off, WLAN Off  
 LTE FDD B4; BW's: 20MHz, 15MHz, 10MHz, 5MHz, 3MHz, 1.4MHz; BT Off, WLAN Off  
 LTE FDD B5; BW's: 10MHz, 5MHz, 3MHz, 1.4MHz; BT Off, WLAN Off  
 LTE FDD B12; BW's: 10MHz, 5MHz; BT Off, WLAN Off  
 LTE FDD B17; BW's: 10MHz, 5MHz; BT Off, WLAN Off  
 LTE FDD B30; BW's: 10MHz, 5MHz, 3MHz, 1.4MHz; BT Off, WLAN Off

\* Note: LTE test channels for different bands and bandwidths can be found in Sect. 7.II

EUT Type: Portable Handset

Air-Interface	Band (MHz)	Type Transport	HAC Tested	Simultaneous But Not Tested	Voice over Digital Transport OTT Capability	WiFi Low Power	Additional GSM Power Reduction
GSM	850	VO	Yes	Yes: WiFi or BT	N/A	N/A	No
	1900						
	GPRS/EDGE	DT	No	Yes: WiFi or BT	Yes	N/A	No
UMTS	850	VD	Yes	Yes: WiFi or BT	N/A	N/A	N/A
	1900						
	HSPA	DT	No	Yes: WiFi or BT	Yes	N/A	N/A
LTE	700 (B12)	VD <sup>1</sup>	Yes	Yes: WiFi or BT	Yes	N/A	N/A
	700 (B17)						
	850 (B5)						
	1700 (B4)						
	1900 (B2)						
	2300 (B30)						
WiFi	2450	VD	No <sup>2</sup>	Yes: GSM, UMTS or LTE	Yes	N/A	N/A
	5200						
	5300						
	5500						
	5800						
BT	2450	DT	No	Yes: GSM, UMTS or LTE	N/A	N/A	N/A

Type Transport  
 VO = Voice Only  
 DT = Digital Data - Not intended for CMRS Service  
 VD = CMRS and Data Transport

Notes:  
 1. The 3GPP VoLTE CMRS service is defined by GSMA in PRD IR.92 for IP Voice Service and Digital Transport.  
 2. Not tested in accordance with the guidance issued by OET in KDB publication 285076 D02 T-Coil testing for CMRS IP.

Table 2-1: A3LSMG890A HAC Air Interfaces

FCC ID: A3LSMG890A	PCTEST ENGINEERING LABORATORY, INC.	HAC (T-COIL) TEST REPORT		Reviewed by: Quality Manager
Filename: 0Y1504030668.A3L	Test Dates: 04/06/2015 - 04/11/2015	EUT Type: Portable Handset		Page 4 of 57

### 3. ANSI C63.19-2011 PERFORMANCE CATEGORIES

#### I. MAGNETIC COUPLING

##### Axial and Radial Field Intensity

All orientations of the magnetic field, in the axial and radial position along the measurement plane shall be  $\geq -18$  dB(A/m) at 1 kHz in a 1/3 octave band filter per §8.3.1.

##### Frequency Response

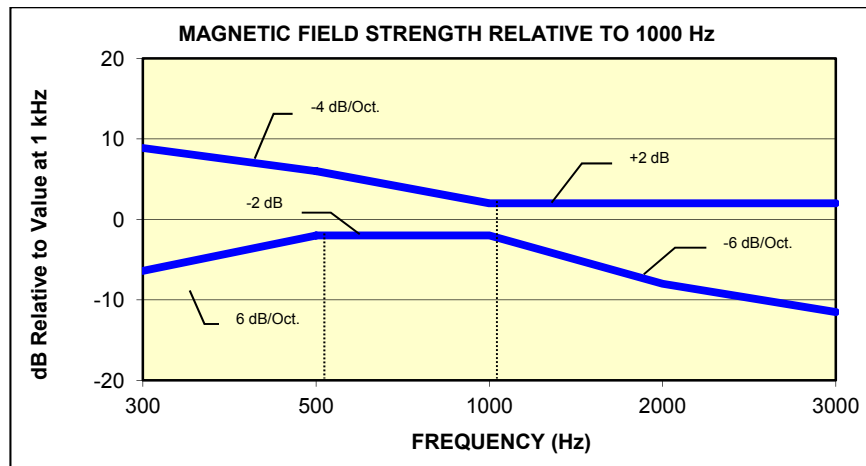

The frequency response of the axial component of the magnetic field shall follow the response curve specified in EIA RS-504-1983, over the frequency range 300 Hz – 3000 Hz per §8.3.2.

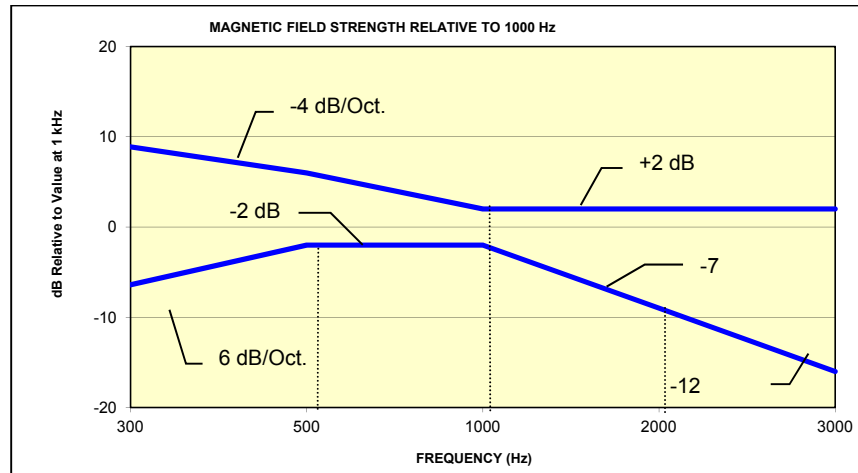

**Figure 3-1**  
Magnetic field frequency response for Wireless Devices with an axial field  $\leq -15$  dB (A/m) at 1 kHz



**Figure 3-2**  
Magnetic Field frequency response for wireless devices with an axial field that exceeds -15 dB(A/m) at 1 kHz

FCC ID: A3LSMG890A	 PCTEST ENGINEERING LABORATORY, INC.	HAC (T-COIL) TEST REPORT	 SAMSUNG	Reviewed by: Quality Manager
Filename: 0Y1504030668.A3L	Test Dates: 04/06/2015 - 04/11/2015	EUT Type: Portable Handset		Page 5 of 57



## Signal Quality

The table below provides the signal quality requirement for the intended audio magnetic signal from a wireless device. Only the RF immunity of the hearing aid is measured in T-coil mode. It is assumed that a hearing aid can have no immunity to an interference signal in the audio band, which is the intended reception band for this mode. The only criterion that can be measured is the RF immunity in T-coil mode. This is measured using the same procedure as the audio coupling mode at the same levels.

The signal quality of the axial and radial components of the magnetic field was used to determine the T-coil mode category.

Category	Telephone RF Parameters
	Wireless Device Signal Quality [(Signal + Noise)-to-noise ratio in dB]
T1	0 to 10 dB
T2	10 to 20 dB
T3	20 to 30 dB
T4	> 30 dB

Table 3-1  
**Magnetic Coupling Parameters**

FCC ID: A3LSMG890A	 PCTEST ENGINEERING LABORATORY, INC.	HAC (T-COIL) TEST REPORT	 SAMSUNG	Reviewed by: Quality Manager
Filename: 0Y1504030668.A3L	Test Dates: 04/06/2015 - 04/11/2015	EUT Type: Portable Handset		Page 6 of 57

## 4. METHOD OF MEASUREMENT

### I. Test Setup

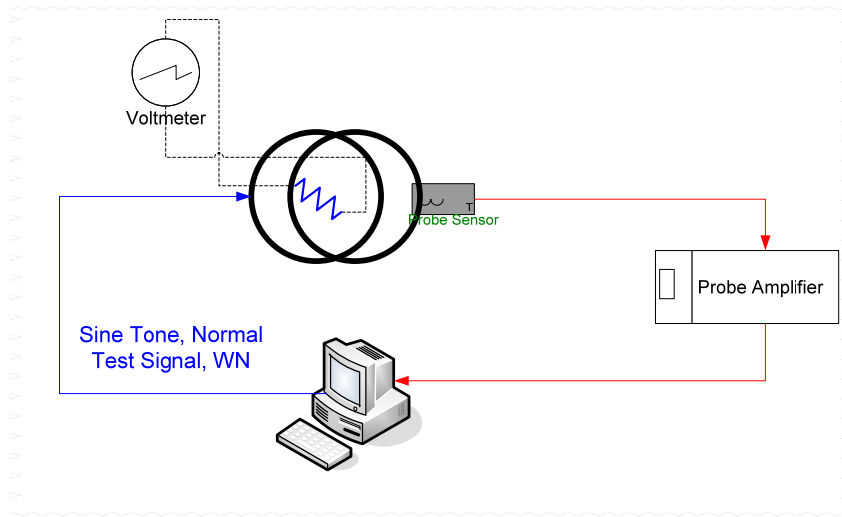

The equipment was connected as shown in an acoustic/RF hemi-anechoic chamber:

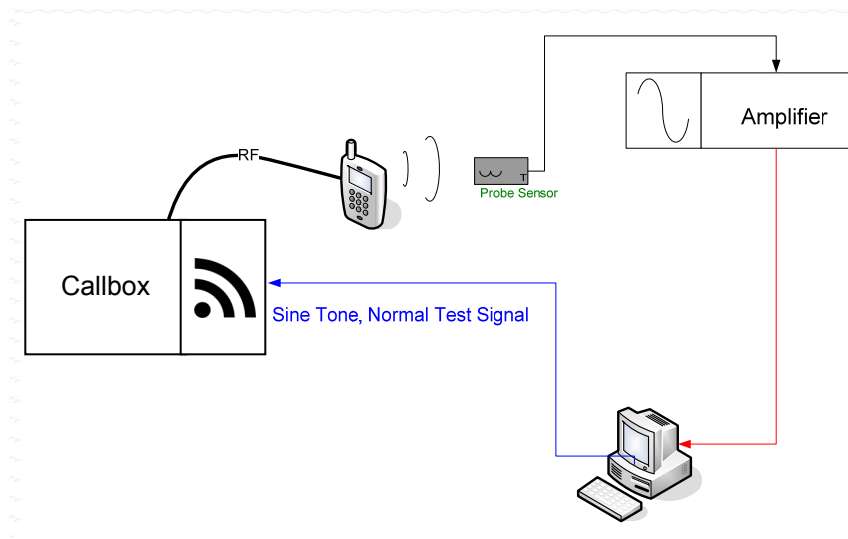

**Figure 4-1**  
**Validation Setup with Helmholtz Coil**

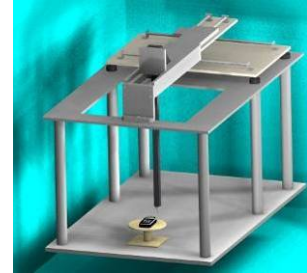

**Figure 4-2**  
**T-Coil Test Setup**

FCC ID: A3LSMG890A	 PCTEST ENGINEERING LABORATORY, INC.	HAC (T-COIL) TEST REPORT	 SAMSUNG	Reviewed by: Quality Manager
Filename: 0Y1504030668.A3L	Test Dates: 04/06/2015 - 04/11/2015	EUT Type: Portable Handset		Page 7 of 57

## II. Scanning Mechanism

Manufacturer:	TEM
Accuracy:	± 0.83 cm/meter
Minimum Step Size:	0.1 mm
Maximum speed	6.1 cm/sec
Line Voltage:	115 VAC
Line Frequency:	60 Hz
Material Composite:	Delrin (Acetal)
Data Control:	Parallel Port
Dynamic Range (X-Y-Z):	45 x 31.75 x 47 cm
Dimensions:	36" x 25" x 38"
Operating Area:	36" x 49" x 55"
Reflections:	< -20 dB (in anechoic chamber)





**Figure 4-3**  
**RF Near-Field Scanner**

## III. 3GPP2 Normal Test Signal (Speech)

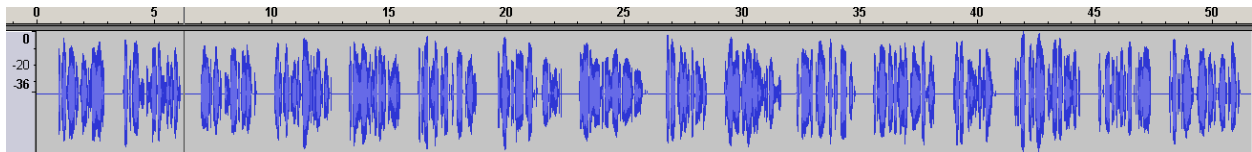
Manufacturer:	3GPP2 (TIA 1042 §3.3.1) Modified-IRS weighted, multi-talker speech signal, 4 Male and 4
Stimulus Type:	Female speakers (alternating)
Single Sample Duration:	51.62 seconds
Activity Level:	77.4%



**Figure 4-4**  
**Temporal Characteristic of Normal Test Signal**

FCC ID: A3LSMG890A		HAC (T-COIL) TEST REPORT		Reviewed by: Quality Manager
Filename: 0Y1504030668.A3L	Test Dates: 04/06/2015 - 04/11/2015	EUT Type: Portable Handset		Page 8 of 57

ABM1 Measurement Block Diagram:

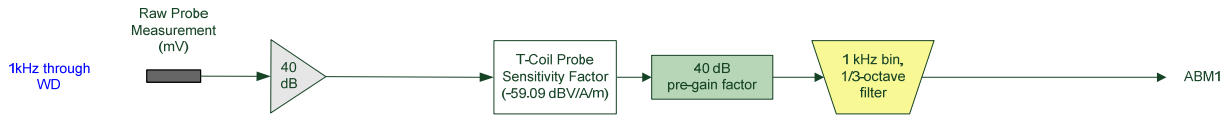

ABM2 Measurement Block Diagram:

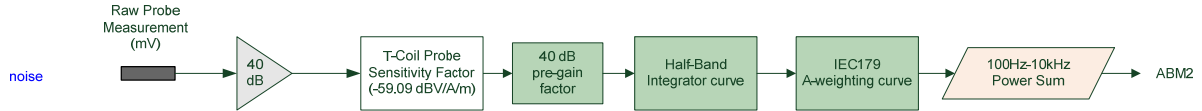

**Figure 4-5 Magnetic Measurement Processing Steps**

#### IV. Test Procedure

1. Ambient Noise Check per C63.19 §7.3.1
  - a. Ambient interference was monitored using a Real-Time Analyzer between 100-10,000 Hz with 1/3 octave filtering.
  - b. “A-weighting” and Half-Band Integration was applied to the measurements.
  - c. Since this measurement was measured in the same method as ABM2 measurements, this level was verified to be more than 10 dB below the lowest measurement signal (which is the highest ABM2 measurement for a T4 WD). Therefore the maximum noise level for a T4 WD with an ABM1 = -18 dBA/m is:  
 $-18 - 30 - 10 = -58 \text{ dBA/m}$
2. Measurement System Validation(See Figure 4-1)
  - a. The measurement system including the probe, pre-amplifier and acquisition system were validated as an entire system to ensure the reliability of test measurements.
  - b. ABM1 Validation  
 The magnetic field at the center of the Helmholtz coil is given by the equation (per C63.19 Annex D.10.1):



$$H_c = \frac{NI}{r\sqrt{1.25^3}} = \frac{N\left(\frac{V}{R}\right)}{r\sqrt{1.25^3}}$$

Where  $H_c$  = magnetic field strength in amperes per meter  
 $N$  = number of turns per coil

For the Helmholtz Coil,  $N=20$ ;  $r=0.13\text{m}$ ;  $R=10.193\Omega$  and using  $V=29\text{mV}$ :

$$H_c = \frac{20 \cdot \left(\frac{0.029}{10.193}\right)}{0.13 \cdot \sqrt{1.25^3}} = 0.31623 \text{ A/m} \approx -10 \text{ dB(A/m)}$$

Therefore a pure tone of 1kHz was applied into the coils such that 29 mV was observed across the 10 Ω resistor. The voltmeter used for measurement was verified to be capable of measurements in the audio band range. This theoretically generates an expected field of -10 dB(A/m) in the center of the Helmholtz coil which was used to validate the probe measurement at -10dB(A/m). This was verified to be within ± 0.5 dB of the -10dB(A/m) value (see Page 42).

FCC ID: A3LSMG890A	 PCTEST ENGINEERING LABORATORY, INC.	HAC (T-COIL) TEST REPORT		Reviewed by: Quality Manager
Filename: 0Y1504030668.A3L	Test Dates: 04/06/2015 - 04/11/2015	EUT Type: Portable Handset		Page 9 of 57

c. Frequency Response Validation

The frequency response through the Helmholtz Coil was verified to be within 0.5 dB relative to 1kHz, between 300 – 3000 Hz using the Normal speech signal as shown below:

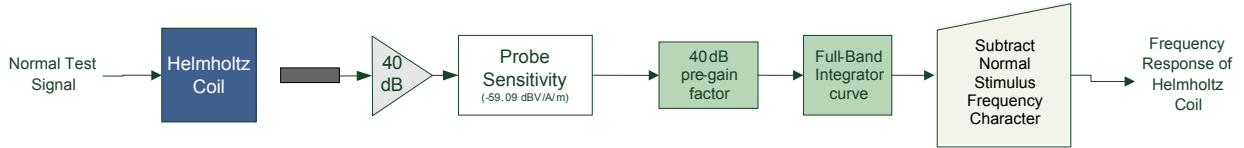

**Figure 4-6 Frequency Response Validation**

d. ABM2 Measurement Validation

WD noise measurements are filtered with A-weighting and Half-Band Integration over a frequency range of 100Hz – 10kHz to process ABM2 measurements. Below is the verification of the system processing A-weighting and Half-Band integration between system input to output within 0.5 dB of the theoretical result:

**Table 4-1  
ABM2 Frequency Response Validation**

f (Hz)	HBI, A - Measured (dB re 1kHz)	HBI, A - Theoretical (dB re 1kHz)	dB Var.
100	-16.180	-16.170	-0.010
125	-13.257	-13.250	-0.007
160	-10.347	-10.340	-0.007
200	-8.017	-8.010	-0.007
250	-5.925	-5.920	-0.005
315	-4.045	-4.040	-0.005
400	-2.405	-2.400	-0.005
500	-1.212	-1.210	-0.002
630	-0.349	-0.350	0.001
800	0.071	0.070	0.001
1000	0.000	0.000	0.000
1250	-0.503	-0.500	-0.003
1600	-1.513	-1.510	-0.003
2000	-2.778	-2.780	0.002
2500	-4.316	-4.320	0.004
3150	-6.166	-6.170	0.004
4000	-8.322	-8.330	0.008
5000	-10.573	-10.590	0.017
6300	-13.178	-13.200	0.022
8000	-16.241	-16.270	0.029
10000	-19.495	-19.520	0.025

FCC ID: A3LSMG890A	PCTEST ENGINEERING LABORATORY, INC.	HAC (T-COIL) TEST REPORT	SAMSUNG	Reviewed by: Quality Manager
Filename: 0Y1504030668.A3L	Test Dates: 04/06/2015 - 04/11/2015	EUT Type: Portable Handset		Page 10 of 57

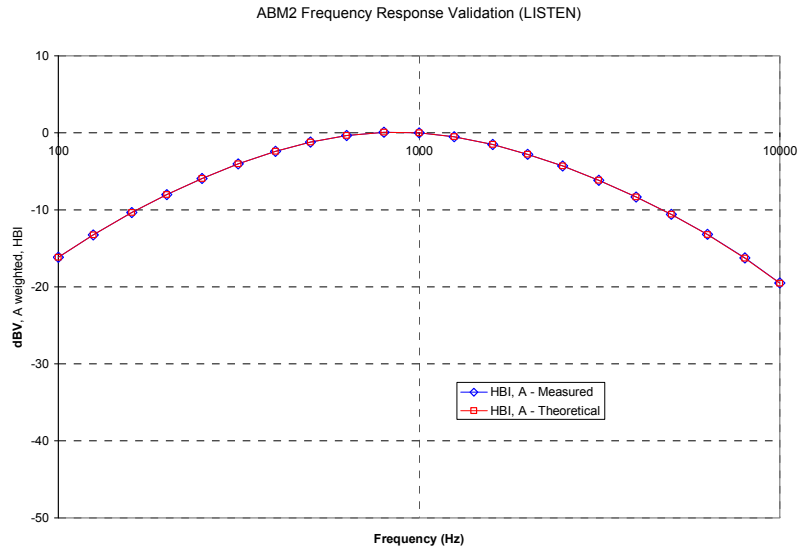

**Figure 4-7**  
**ABM2 Frequency Response Validation**

The ABM2 result is a power sum from 100Hz to 10kHz with half-band integration and A-weighting. To verify the power sum measurement, a power sum over the full band was measured and verified to track with the source level (See Figure 4-9). Therefore the setup in this step was used to verify the power sum post-processing for ABM2 measurements. See below block diagram:

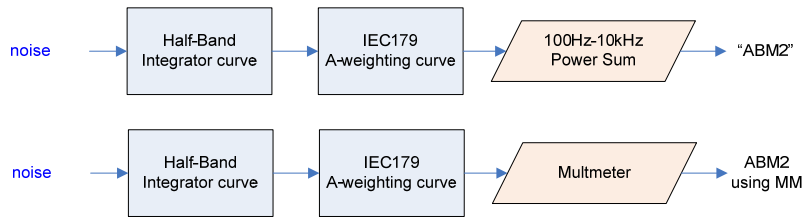

**Figure 4-8**  
**ABM2 Validation Block Diagram**

The power summed output results for a known input were compared to the multi-meter results to verify any deviation in the post-processing implemented with the power-sum.

**Table 4-2**  
**ABM2 Power Sum Validation**

WN Input (dBV)	Power Sum (dBV)	Multimeter-Full (dBV)	Dev (dB)
-60	-60.36	-60.2	0.16
-50	-50.19	-50.13	0.06
-40	-40.14	-40.03	0.11
-30	-30.13	-30.01	0.12
-20	-20.12	-20	0.12
-10	-10.14	-10	0.14

FCC ID: A3LSMG890A	PCTEST ENGINEERING LABORATORY, INC.	HAC (T-COIL) TEST REPORT	SAMSUNG	Reviewed by: Quality Manager
Filename: 0Y1504030668.A3L	Test Dates: 04/06/2015 - 04/11/2015	EUT Type: Portable Handset		Page 11 of 57

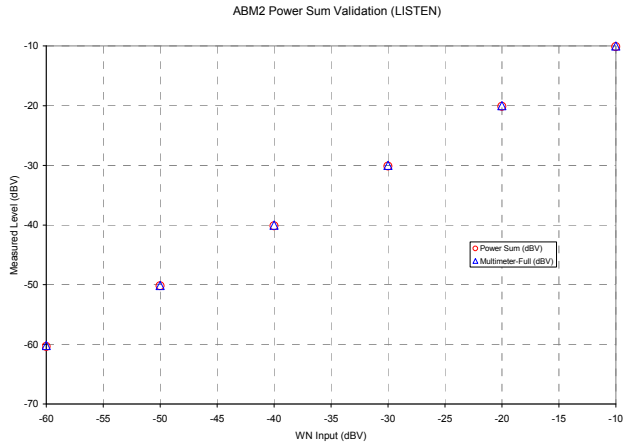
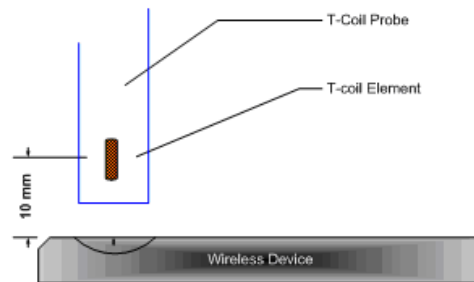

**Figure 4-9**  
**ABM2 Power Sum Validation**

3. Measurement Test Setup

a. Fine scan above the WD (TEM)

- i. A multitone signal was applied to the handset such that the phone acoustic output was stable within 1dB over the probe settling time and with the acoustic output level at the C63.19 specified levels (below). The measurement step size was in 2 mm increments at a distance of 10 mm between the surface of the wireless device as shown below:





**Figure 4-10**  
**Measurement Distance**

- ii. After scanning, the planar field maximum point was determined. The position of the probe was moved to this location to setup the test using the SoundCheck system.
- iii. These steps were repeated for all T-coil orientations (axial and radial) per Figure 4-15 after a T-coil orientation was fully measured with the SoundCheck system.

b. Speech Signal Setup to Base Station Simulator

- i. C63.19 Table 7-1 states audio reference input levels for various technologies:

Standard	Technology	Input Level (dBm0)
TIA/EIA/IS-2000	CDMA	-18
J-STD-007	GSM (217)	-16
T1/T1P1/3GPP	UMTS (WCDMA)	-16
iDEN™	TDMA (22 and 11 Hz)	-18

FCC ID: A3LSMG890A	 PCTEST ENGINEERING LABORATORY, INC.	HAC (T-COIL) TEST REPORT	 SAMSUNG	Reviewed by: Quality Manager
Filename: 0Y1504030668.A3L	Test Dates: 04/06/2015 - 04/11/2015	EUT Type: Portable Handset	Page 12 of 57	

The CMU200 audio levels were determined using base station simulator manufacturer calibration procedures resulting in the below corresponding voltages relative to handset test point level (in dBm0):

**Table 4-3  
CMU200 Voltage Input Levels for Audio**

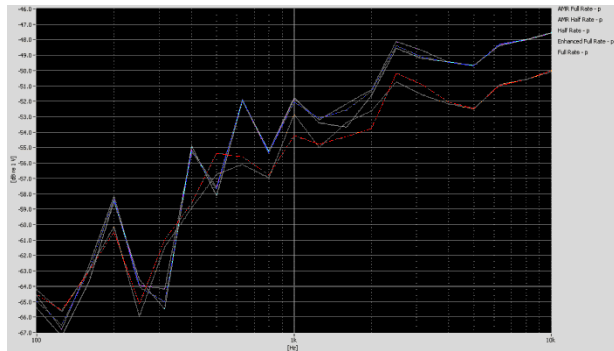

dBm0 Ref.	Voltage		Notes
3.14 dBm0	990.5 mV	-0.08 dBV	From GSM "DECODER CAL". (What is needed through Encoder for FS)
-16 dBm0	109.4 mV	-19.2 dBV	For Speechcod/Handset Low
dBm0 Ref.	Voltage		Notes
3.14 dBm0	1068.5 mV	0.58 dBV	From UMTS "DECODER CAL". (What is needed through Encoder for FS)
-16 dBm0	118.0 mV	-18.6 dBV	For Handset Low

- ii. According to the C63 Committee, a speech input level of -16dBm0 shall be used for LTE T-Coil testing.
- iii. See Section 5 for more information regarding CMW500 audio level settings for Voice Over LTE (VoLTE) testing.
- c. Real-Time Analyzer (RTA)
  - i. The Real-Time Analyzer was configured to analyze measurements using 1/3 Octave band weighted filtering.
- d. WD Radio Configuration Selection
  - i. The device was chosen to be tested in the worst-case ABM2 condition (see below for GSM, see Section 6 for more information regarding worst-case configurations for UMTS. LTE configuration information can be found in Section 5):



**Figure 4-11  
Vocoder Analysis for ABM Noise for GSM**

- 4. Signal Quality Data Analysis
  - a. Narrow-band Magnetic Intensity
    - i. The standard specifies a 1kHz 1/3 octave band minimum field intensity for a sine tone. The ABM1 measurements were evaluated at 1kHz with 1/3 octave band filtering over an averaged period of 10 seconds.
  - b. Frequency Response
    - i. The appropriate frequency response curve was measured to curves in Figure 3-1 or Figure 3-2 between 300 – 3000 Hz using digital linear averaging (limit lines

<b>FCC ID:</b> A3LSMG890A		<b>HAC (T-COIL) TEST REPORT</b>		<b>Reviewed by:</b> Quality Manager
<b>Filename:</b> 0Y1504030668.A3L	<b>Test Dates:</b> 04/06/2015 - 04/11/2015	<b>EUT Type:</b> Portable Handset	Page 13 of 57	

chosen according to measurement found in step 4a). A linear average over 3x the length of the artificial voice signal (3x sampling) was performed. A 10 second delay was configured in the measurement process of the stimulus to ensure handset vocoder latency effects and echo cancellation devices (if any) were appropriately stabilized during measurements.

- ii. The appropriate post-processing was applied according to the system processing chain illustrated in Figure 4-13. All R10 frequencies were plotted with respect to 0dB at 1kHz value and aligned with respect to the EIA-504 mask.

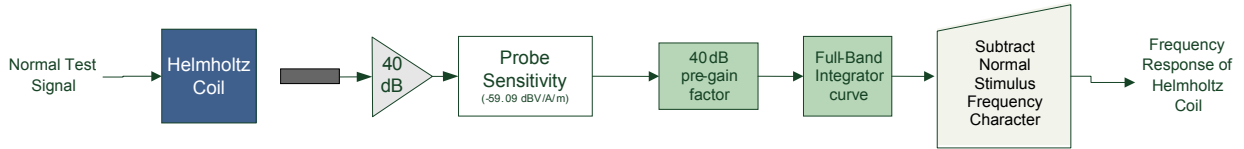

**Figure 4-12 Frequency Response Block Diagram**

- iii. The margin is represented by the closest measured data point on the curve to the EIA-504 limit lines, in dB.
- c. Signal Quality Index
- i. Ensuring the WD was at maximum RF power, maximum volume, backlight on, display on, maximum contrast setting, keypad lights on (when possible) with no audio signal through the vocoder, the WD was measured over at least 100 Hz – 10,000 Hz, maximized over 5 seconds with a 50ms sample time for the ABM2 measurement (5 second time period is used in noise measurements under standards such as IEEE 269, etc.).
  - ii. After applying half-band integration and A-weighting to the result, a power sum was applied over each 1/3 octave bandwidth frequency for an ABM2 value
  - iii. This result was subtracted from the ABM1 result in step a, to obtain the Signal Quality.

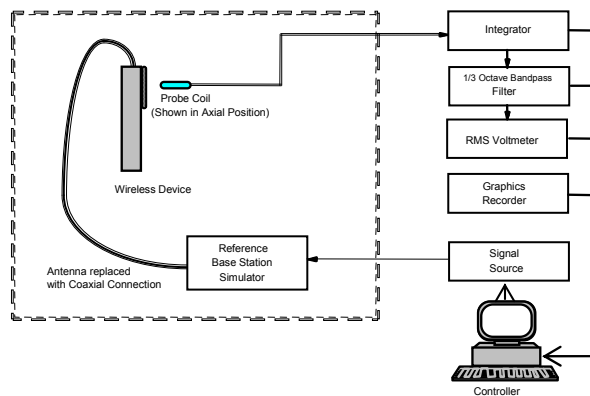

## V. Test Setup



**Figure 4-13 Audio Magnetic Field Test Setup**

## VI. Deviation from C63.19 Test Procedure

Non-conducted RF connection due to RF port being located underneath the front screen.

FCC ID: A3LSMG890A	 PCTEST ENGINEERING LABORATORY, INC.	HAC (T-COIL) TEST REPORT	 SAMSUNG	Reviewed by: Quality Manager
Filename: 0Y1504030668.A3L	Test Dates: 04/06/2015 - 04/11/2015	EUT Type: Portable Handset		Page 14 of 57

## VII. Air Interface Technologies Tested

According to the April 2013 TCB workshop slides, OTT data services are outside the current definition of a managed CMRS service and are currently not required to be evaluated.

VoIP over WIFI CMRS air interfaces were not tested in accordance with the guidance issued by OET in KDB publication 285076 D02 T-Coil testing for CMRS IP.

## VIII. Wireless Device Channels and Frequencies

### 1. 2G/3G Modes

The frequencies listed in the table below are those that lie in the center of the bands used for cellular telephony. Low, middle and high channels were tested in each band for FCC compliance evaluation to ensure the maximum emission is captured across the entire band.

To facilitate setting of a base station simulator for ABM measurements, specific band plan channel numbers are listed that may be used in lieu of the band center frequencies.

**Table 4-4  
Center Channels and Frequencies**

Test frequencies & associated channels	
Channel	Frequency (MHz)
<b>Cellular 850</b>	
190 (GSM)	836.60
4183 (UMTS)	836.60
<b>PCS 1900</b>	
661 (GSM)	1880
9400 (UMTS)	1880



### 2. 4G (LTE) Modes

The middle channel for every band and bandwidth combination was tested for each probe orientation. The band and bandwidth combination from each probe orientation resulting in the worst-case SNNR was additionally tested using low and high channels for that band and bandwidth combination. See Tables 7-10 through 7-19 for LTE bandwidths and channels.

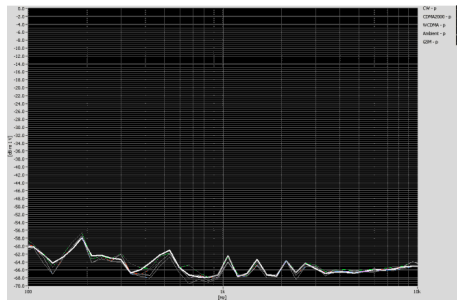
## IX. RF Emission Effect on T-coil Measurements

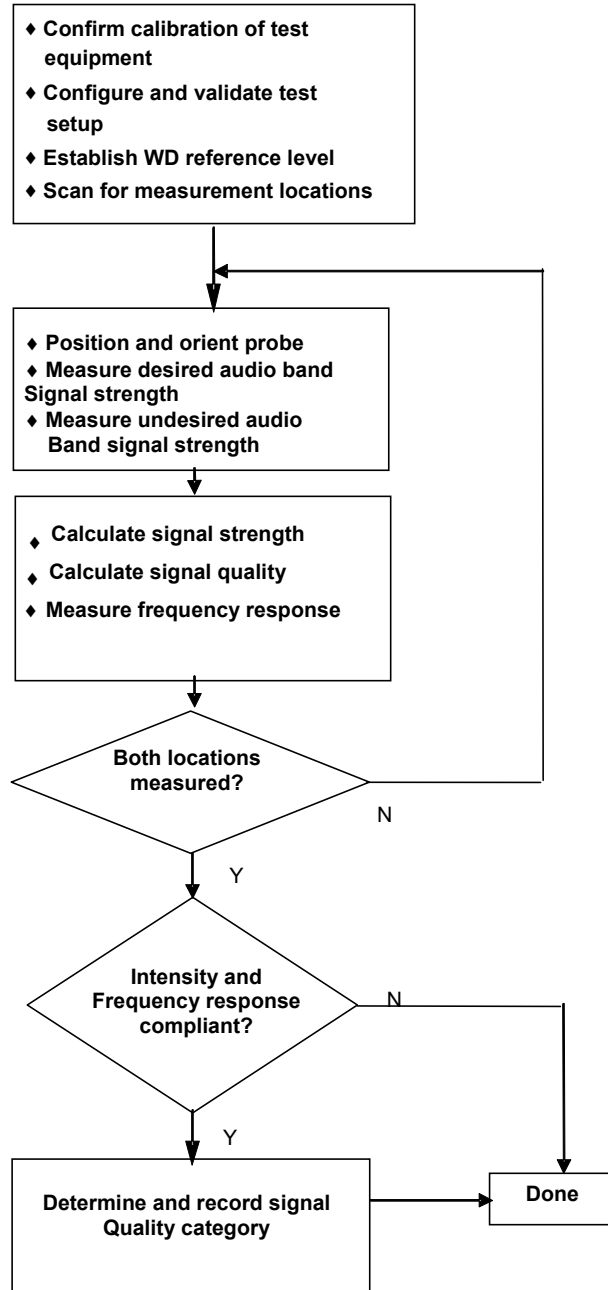

**Figure 4-14  
High power RF Emissions Effect with HAC Dipole on the T-coil Probe System 10mm between dipole maximum and magnetic probe**



FCC ID: A3LSMG890A	 PCTEST ENGINEERING LABORATORY, INC.	HAC (T-COIL) TEST REPORT	 SAMSUNG	Reviewed by: Quality Manager
Filename: 0Y1504030668.A3L	Test Dates: 04/06/2015 - 04/11/2015	EUT Type: Portable Handset		Page 15 of 57

## X. Test Flow

The flow diagram below was followed (From C63.19):



**Figure 4-15**  
**C63.19 T-Coil Signal Test Process**

FCC ID: A3LSMG890A	 PCTEST ENGINEERING LABORATORY, INC.	HAC (T-COIL) TEST REPORT	 SAMSUNG	Reviewed by: Quality Manager
Filename: 0Y1504030668.A3L	Test Dates: 04/06/2015 - 04/11/2015	EUT Type: Portable Handset	Page 16 of 57	

## 5. VOLTE TEST SYSTEM SETUP AND DUT CONFIGURATION

### I. Test System Setup for VoLTE T-coil Testing

#### 1. Equipment Setup

The general test setup used for VoLTE is shown below (adopted from FCC KDB 285076 D02). The callbox used when performing VoLTE T-coil measurements is a CMW500. The Data Application Unit (DAU) of the CMW500 was used to simulate the IP Multimedia Subsystem (IMS) server.

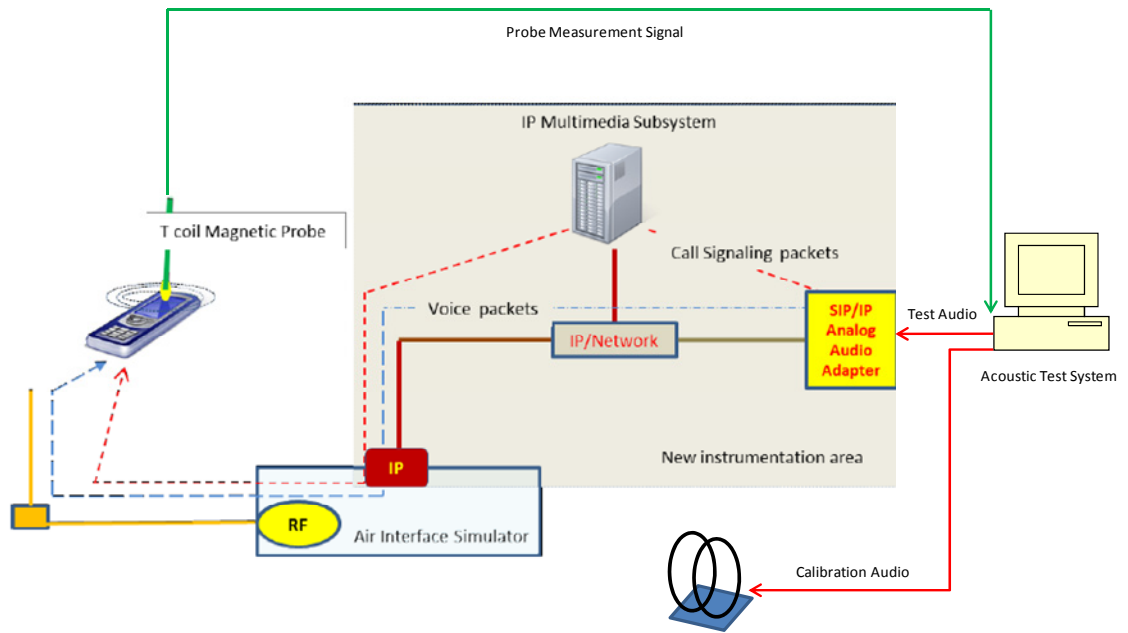



**Figure 5-1**  
**Test Setup for VoLTE T-Coil Measurements**

#### 2. Audio Level Settings

According to the July 2012 interpretations by the C63 Committee regarding the appropriate audio levels to be used for LTE T-coil testing, -16dBm0 shall be used for the normal speech input level. The CMW500 base station simulator was manually configured to ensure that the settings for speech input and full scale levels resulted in the -16dBm0 speech input level to the DUT for the VoLTE connection.

\* [http://c63.org/documents/misc/posting/new\\_interpretations.htm](http://c63.org/documents/misc/posting/new_interpretations.htm)

FCC ID: A3LSMG890A	 PCTEST ENGINEERING LABORATORY, INC.	HAC (T-COIL) TEST REPORT	 SAMSUNG	Reviewed by: Quality Manager
Filename: 0Y1504030668.A3L	Test Dates: 04/06/2015 - 04/11/2015	EUT Type: Portable Handset		Page 17 of 57

## II. DUT Configuration for VoLTE T-coil Testing

### 1. Radio Configuration

An investigation was performed on the highest bandwidth of the worst-case LTE Band to determine the modulation and RB configuration to be used for testing. 16QAM, 1RB, 0RB offset was used for the testing as the worst-case configuration for the handset. See below table for SNNR comparison between different radio configurations:

Frequency [MHz]	Channel	Bandwidth [MHz]	Modulation	RB Size	RB Offset	ABM1 [dB(A/m)]	ABM2 [dB(A/m)]	SNNR [dB]
2310.0	27710	10	QPSK	1	0	-5.67	-41.98	36.31
2310.0	27710	10	QPSK	1	25	-5.48	-43.02	37.54
2310.0	27710	10	QPSK	1	49	-5.37	-42.73	37.36
2310.0	27710	10	QPSK	25	0	-5.64	-48.27	42.63
2310.0	27710	10	QPSK	25	12	-5.50	-48.84	43.34
2310.0	27710	10	QPSK	25	25	-5.12	-48.87	43.75
2310.0	27710	10	QPSK	50	0	-5.59	-49.20	43.61
2310.0	27710	10	16QAM	1	0	-5.43	-34.61	29.18
2310.0	27710	10	16QAM	1	25	-5.65	-38.07	32.42
2310.0	27710	10	16QAM	1	49	-5.52	-37.81	32.29
2310.0	27710	10	16QAM	25	0	-5.65	-47.30	41.65
2310.0	27710	10	16QAM	25	12	-5.17	-47.24	42.07
2310.0	27710	10	16QAM	25	25	-5.54	-47.01	41.47
2310.0	27710	10	16QAM	50	0	-5.20	-48.83	43.63

**Table 5-1**  
**LTE SNNR by Radio Configuration**

### 2. Codec Configuration

An investigation was performed on the highest bandwidth of the worst-case LTE Band to determine the audio codec configuration to be used for testing. The WB AMR 6.60kbps setting was used for the audio codec on the CMW500 for VoLTE T-coil testing. See below table for ABM1 and ABM2 comparisons between different codecs and codec data rates:



Codec Setting:	WB AMR 23.85kbps	WB AMR 6.60kbps	NB AMR 12.2kbps	NB AMR 4.75kbps	Orientation	Channel
ABM1 Pre-test (dBA/m)	-4.38	-6.37	7.6	2.71	Axial	27710
ABM2 Pre-test (dBA/m) (A-weight, Half-Band Int.)	-35.96	-36.12	-35.23	-36.14		
S+N/N (dB)	31.58	29.75	42.83	38.85		

**Table 5-2**  
**FCC 4G ABM Measurements for A3LSMG890A**

- Mute on; Backlight on; Max Volume; Max Contrast
- TPC = "Max Power"



**Figure 5-2**  
**Audio Band Magnetic Curve Measurement Block Diagram**

FCC ID: A3LSMG890A	 PCTEST ENGINEERING LABORATORY, INC.	HAC (T-COIL) TEST REPORT	 SAMSUNG	Reviewed by: Quality Manager
Filename: 0Y1504030668.A3L	Test Dates: 04/06/2015 - 04/11/2015	EUT Type: Portable Handset		Page 18 of 57

## 6. FCC 3G MEASUREMENTS

### I. UMTS Test Configurations

AMR at 12.2kbps, 13.6kbps SRB was used for the testing as the worst-case configuration for the handset. See below plot for ABM noise comparison between vocoder rates:

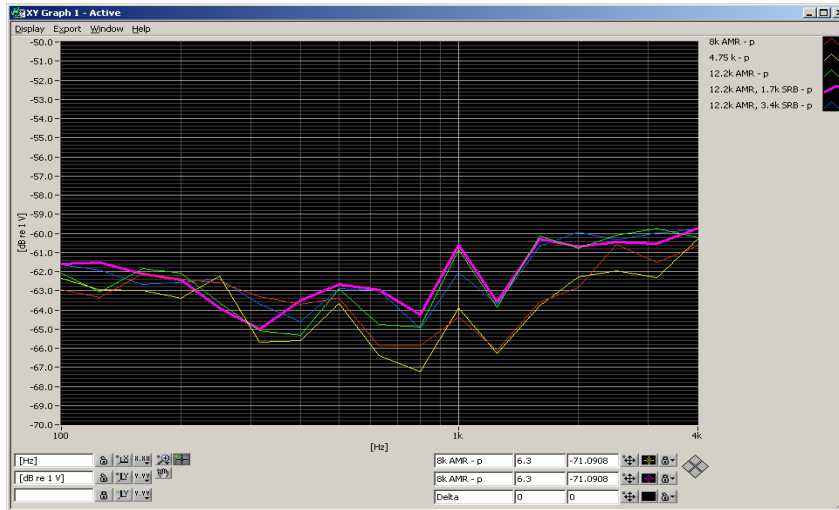

Figure 6-1  
UMTS Audio Band Magnetic Noise

### II. ABM Measurements

Table 6-1  
FCC 3G ABM Measurements for A3LSMG890A (UMTS)

Codec Setting:	AMR 12.2kbps	AMR 7.95kbp	AMR 4.75kbps	Orientation	Channel
ABM1 Pre-test (dBA/m)	7.44	7.41	7.14	Axial	9262
ABM2 Pre-test (dBA/m) (A-weight, Half-Band Int.)	-44.86	-46.69	-47.14		
S+N/N (dB)	52.30	54.10	54.28		

- Mute on; Backlight on; Max Volume; Max Contrast
- TPC="All 1s"



Figure 6-2  
Audio Band Magnetic Curve Measurement Block Diagram

FCC ID: A3LSMG890A	PCTEST ENGINEERING LABORATORY, INC.	HAC (T-COIL) TEST REPORT	SAMSUNG	Reviewed by: Quality Manager
Filename: 0Y1504030668.A3L	Test Dates: 04/06/2015 - 04/11/2015	EUT Type: Portable Handset		Page 19 of 57

## 7. TEST SUMMARY

### I. T-Coil Test Summary

**Table 7-1**  
**Table of Results for GSM**



C63.19 Sec.	Mode	Band	Test Description	Minimum Limit*	Measured	Verdict
				<i>dBa/m</i>	<i>dBa/m</i>	<i>PASS/FAIL</i>
8.3.1	GSM	Cellular	Intensity, Axial	-18	7.4	PASS
8.3.1			Intensity, Radial	-18	0.6	PASS
8.3.4			Signal-to-Noise/Noise, Axial	20	26.2	PASS
8.3.4			Signal-to-Noise/Noise, Radial	20	33.4	PASS
8.3.2			Frequency Response, Axial	0	1.9	PASS
8.3.1	GSM	PCS	Intensity, Axial	-18	6.8	PASS
8.3.1			Intensity, Radial	-18	0.3	PASS
8.3.4			Signal-to-Noise/Noise, Axial	20	29.4	PASS
8.3.4			Signal-to-Noise/Noise, Radial	20	35.9	PASS
8.3.2			Frequency Response, Axial	0	2.0	PASS

Note: The above summary table represents the worst-case numerical values according to configurations in Table 7-10.

**Table 7-2**  
**Table of Results for UMTS**

C63.19 Sec.	Mode	Band	Test Description	Minimum Limit*	Measured	Verdict
				<i>dBa/m</i>	<i>dBa/m</i>	<i>PASS/FAIL</i>
8.3.1	UMTS	Cellular	Intensity, Axial	-18	7.6	PASS
8.3.1			Intensity, Radial	-18	0.7	PASS
8.3.4			Signal-to-Noise/Noise, Axial	20	52.3	PASS
8.3.4			Signal-to-Noise/Noise, Radial	20	60.1	PASS
8.3.2			Frequency Response, Axial	0	1.8	PASS
8.3.1	UMTS	PCS	Intensity, Axial	-18	7.6	PASS
8.3.1			Intensity, Radial	-18	0.7	PASS
8.3.4			Signal-to-Noise/Noise, Axial	20	52.1	PASS
8.3.4			Signal-to-Noise/Noise, Radial	20	60.2	PASS
8.3.2			Frequency Response, Axial	0	1.6	PASS

Note: The above summary table represents the worst-case numerical values according to configurations in Table 7-11.

FCC ID: A3LSMG890A	 PCTEST ENGINEERING LABORATORY, INC.	HAC (T-COIL) TEST REPORT		Reviewed by: Quality Manager
Filename: 0Y1504030668.A3L	Test Dates: 04/06/2015 - 04/11/2015	EUT Type: Portable Handset		Page 20 of 57

**Table 7-3**  
**Table of Results for LTE B12**



C63.19 Sec.	Mode	BW/Band	Test Description	Minimum Limit*	Measured	Verdict
				<i>dBa/m</i>	<i>dBa/m</i>	<i>PASS/FAIL</i>
8.3.1	LTE	5MHz/ Band 12	Intensity, Axial	-18	-6.4	PASS
8.3.1			Intensity, Radial	-18	-10.8	PASS
8.3.4			Signal-to-Noise/Noise, Axial	20	32.7	PASS
8.3.4			Signal-to-Noise/Noise, Radial	20	39.2	PASS
8.3.2			Frequency Response, Axial	0	1.4	PASS
8.3.1	LTE	10MHz/ Band 12	Intensity, Axial	-18	-6.4	PASS
8.3.1			Intensity, Radial	-18	-10.8	PASS
8.3.4			Signal-to-Noise/Noise, Axial	20	33.6	PASS
8.3.4			Signal-to-Noise/Noise, Radial	20	40.3	PASS
8.3.2			Frequency Response, Axial	0	1.4	PASS

Note: The above summary table represents the worst-case numerical values according to configurations in Table 7-12.

**Table 7-4**  
**Table of Results for LTE B17**

C63.19 Sec.	Mode	BW/Band	Test Description	Minimum Limit*	Measured	Verdict
				<i>dBa/m</i>	<i>dBa/m</i>	<i>PASS/FAIL</i>
8.3.1	LTE	5MHz/ Band 17	Intensity, Axial	-18	-6.6	PASS
8.3.1			Intensity, Radial	-18	-10.5	PASS
8.3.4			Signal-to-Noise/Noise, Axial	20	31.4	PASS
8.3.4			Signal-to-Noise/Noise, Radial	20	39.5	PASS
8.3.2			Frequency Response, Axial	0	1.5	PASS
8.3.1	LTE	10MHz/ Band 17	Intensity, Axial	-18	-6.5	PASS
8.3.1			Intensity, Radial	-18	-11.2	PASS
8.3.4			Signal-to-Noise/Noise, Axial	20	32.4	PASS
8.3.4			Signal-to-Noise/Noise, Radial	20	39.2	PASS
8.3.2			Frequency Response, Axial	0	1.3	PASS



Note: The above summary table represents the worst-case numerical values according to configurations in Table 7-13.

<b>FCC ID:</b> A3LSMG890A	 <b>PCTEST</b> ENGINEERING LABORATORY, INC.	<b>HAC (T-COIL) TEST REPORT</b>		<b>Reviewed by:</b> Quality Manager
<b>Filename:</b> 0Y1504030668.A3L	<b>Test Dates:</b> 04/06/2015 - 04/11/2015	<b>EUT Type:</b> Portable Handset	Page 21 of 57	

**Table 7-5  
Table of Results for LTE B5**

C63.19 Sec.	Mode	BW/Band	Test Description	Minimum Limit*	Measured	Verdict
				<i>dBA/m</i>	<i>dBA/m</i>	<i>PASS/FAIL</i>
8.3.1	LTE	1.4MHz/ Band 5	Intensity, Axial	-18	-6.6	PASS
8.3.1			Intensity, Radial	-18	-11.2	PASS
8.3.4			Signal-to-Noise/Noise, Axial	20	36.1	PASS
8.3.4			Signal-to-Noise/Noise, Radial	20	41.1	PASS
8.3.2			Frequency Response, Axial	0	1.4	PASS
8.3.1	LTE	3MHz/ Band 5	Intensity, Axial	-18	-6.4	PASS
8.3.1			Intensity, Radial	-18	-10.8	PASS
8.3.4			Signal-to-Noise/Noise, Axial	20	35.6	PASS
8.3.4			Signal-to-Noise/Noise, Radial	20	41.9	PASS
8.3.2			Frequency Response, Axial	0	1.3	PASS
8.3.1	LTE	5MHz/ Band 5	Intensity, Axial	-18	-6.6	PASS
8.3.1			Intensity, Radial	-18	-11.0	PASS
8.3.4			Signal-to-Noise/Noise, Axial	20	35.0	PASS
8.3.4			Signal-to-Noise/Noise, Radial	20	42.1	PASS
8.3.2			Frequency Response, Axial	0	1.3	PASS
8.3.1	LTE	10MHz/ Band 5	Intensity, Axial	-18	-6.7	PASS
8.3.1			Intensity, Radial	-18	-11.2	PASS
8.3.4			Signal-to-Noise/Noise, Axial	20	34.1	PASS
8.3.4			Signal-to-Noise/Noise, Radial	20	40.6	PASS
8.3.2			Frequency Response, Axial	0	1.2	PASS



Note: The above summary table represents the worst-case numerical values according to configurations in Table 7-14 and Table 7-15.

FCC ID: A3LSMG890A	 PCTEST ENGINEERING LABORATORY, INC.	HAC (T-COIL) TEST REPORT		Reviewed by: Quality Manager
Filename: 0Y1504030668.A3L	Test Dates: 04/06/2015 - 04/11/2015	EUT Type: Portable Handset	Page 22 of 57	

**Table 7-6  
Table of Results for LTE B4**

C63.19 Sec.	Mode	BW/Band	Test Description	Minimum Limit*	Measured	Verdict
				<i>dBA/m</i>	<i>dBA/m</i>	<i>PASS/FAIL</i>
8.3.1	LTE	1.4MHz/ Band 4	Intensity, Axial	-18	-6.9	PASS
8.3.1			Intensity, Radial	-18	-11.2	PASS
8.3.4			Signal-to-Noise/Noise, Axial	20	33.6	PASS
8.3.4			Signal-to-Noise/Noise, Radial	20	41.5	PASS
8.3.2			Frequency Response, Axial	0	1.4	PASS
8.3.1	LTE	3MHz/ Band 4	Intensity, Axial	-18	-6.8	PASS
8.3.1			Intensity, Radial	-18	-10.8	PASS
8.3.4			Signal-to-Noise/Noise, Axial	20	34.6	PASS
8.3.4			Signal-to-Noise/Noise, Radial	20	42.7	PASS
8.3.2			Frequency Response, Axial	0	1.3	PASS
8.3.1	LTE	5MHz/ Band 4	Intensity, Axial	-18	-6.6	PASS
8.3.1			Intensity, Radial	-18	-10.9	PASS
8.3.4			Signal-to-Noise/Noise, Axial	20	33.9	PASS
8.3.4			Signal-to-Noise/Noise, Radial	20	42.2	PASS
8.3.2			Frequency Response, Axial	0	1.3	PASS
8.3.1	LTE	10MHz/ Band 4	Intensity, Axial	-18	-6.4	PASS
8.3.1			Intensity, Radial	-18	-10.8	PASS
8.3.4			Signal-to-Noise/Noise, Axial	20	34.6	PASS
8.3.4			Signal-to-Noise/Noise, Radial	20	40.9	PASS
8.3.2			Frequency Response, Axial	0	1.3	PASS
8.3.1	LTE	15MHz/ Band 4	Intensity, Axial	-18	-6.5	PASS
8.3.1			Intensity, Radial	-18	-10.9	PASS
8.3.4			Signal-to-Noise/Noise, Axial	20	33.4	PASS
8.3.4			Signal-to-Noise/Noise, Radial	20	41.2	PASS
8.3.2			Frequency Response, Axial	0	1.4	PASS
8.3.1	LTE	20MHz/ Band 4	Intensity, Axial	-18	-6.5	PASS
8.3.1			Intensity, Radial	-18	-10.7	PASS
8.3.4			Signal-to-Noise/Noise, Axial	20	32.1	PASS
8.3.4			Signal-to-Noise/Noise, Radial	20	40.2	PASS
8.3.2			Frequency Response, Axial	0	1.4	PASS



Note: The above summary table represents the worst-case numerical values according to configurations in Table 7-16 through Table 7-18.

FCC ID: A3LSMG890A	 PCTEST ENGINEERING LABORATORY, INC.	HAC (T-COIL) TEST REPORT		Reviewed by: Quality Manager
Filename: 0Y1504030668.A3L	Test Dates: 04/06/2015 - 04/11/2015	EUT Type: Portable Handset	Page 23 of 57	

**Table 7-7**  
**Table of Results for LTE B2**

C63.19 Sec.	Mode	BW/Band	Test Description	Minimum Limit*	Measured	Verdict
				<i>dB</i> A/m	<i>dB</i> A/m	<i>PASS/FAIL</i>
8.3.1	LTE	1.4MHz/ Band 2	Intensity, Axial	-18	-7.4	PASS
8.3.1			Intensity, Radial	-18	-11.1	PASS
8.3.4			Signal-to-Noise/Noise, Axial	20	31.3	PASS
8.3.4			Signal-to-Noise/Noise, Radial	20	41.3	PASS
8.3.2			Frequency Response, Axial	0	1.4	PASS
8.3.1	LTE	3MHz/ Band 2	Intensity, Axial	-18	-6.5	PASS
8.3.1			Intensity, Radial	-18	-11.1	PASS
8.3.4			Signal-to-Noise/Noise, Axial	20	32.9	PASS
8.3.4			Signal-to-Noise/Noise, Radial	20	41.9	PASS
8.3.2			Frequency Response, Axial	0	1.3	PASS
8.3.1	LTE	5MHz/ Band 2	Intensity, Axial	-18	-6.5	PASS
8.3.1			Intensity, Radial	-18	-11.2	PASS
8.3.4			Signal-to-Noise/Noise, Axial	20	32.4	PASS
8.3.4			Signal-to-Noise/Noise, Radial	20	41.3	PASS
8.3.2			Frequency Response, Axial	0	1.3	PASS
8.3.1	LTE	10MHz/ Band 2	Intensity, Axial	-18	-6.5	PASS
8.3.1			Intensity, Radial	-18	-10.4	PASS
8.3.4			Signal-to-Noise/Noise, Axial	20	32.9	PASS
8.3.4			Signal-to-Noise/Noise, Radial	20	41.5	PASS
8.3.2			Frequency Response, Axial	0	1.4	PASS
8.3.1	LTE	15MHz/ Band 2	Intensity, Axial	-18	-6.5	PASS
8.3.1			Intensity, Radial	-18	-11.2	PASS
8.3.4			Signal-to-Noise/Noise, Axial	20	31.9	PASS
8.3.4			Signal-to-Noise/Noise, Radial	20	39.8	PASS
8.3.2			Frequency Response, Axial	0	1.4	PASS
8.3.1	LTE	20MHz/ Band 2	Intensity, Axial	-18	-6.8	PASS
8.3.1			Intensity, Radial	-18	-10.4	PASS
8.3.4			Signal-to-Noise/Noise, Axial	20	30.4	PASS
8.3.4			Signal-to-Noise/Noise, Radial	20	38.7	PASS
8.3.2			Frequency Response, Axial	0	1.3	PASS

Note: The above summary table represents the worst-case numerical values according to configurations in Table 7-19 through Table 7-21.

FCC ID: A3LSMG890A	 PCTEST ENGINEERING LABORATORY, INC.	<b>HAC (T-COIL) TEST REPORT</b>		Reviewed by: Quality Manager
Filename: 0Y1504030668.A3L	Test Dates: 04/06/2015 - 04/11/2015	EUT Type: Portable Handset	Page 24 of 57	

**Table 7-8**  
**Table of Results for LTE B30**



C63.19 Sec.	Mode	BW/Band	Test Description	Minimum Limit*	Measured	Verdict
				<i>dBA/m</i>	<i>dBA/m</i>	<i>PASS/FAIL</i>
8.3.1	LTE	1.4MHz/ Band 30	Intensity, Axial	-18	-6.4	PASS
8.3.1			Intensity, Radial	-18	-10.8	PASS
8.3.4			Signal-to-Noise/Noise, Axial	20	32.2	PASS
8.3.4			Signal-to-Noise/Noise, Radial	20	39.4	PASS
8.3.2			Frequency Response, Axial	0	1.4	PASS
8.3.1	LTE	3MHz/ Band 30	Intensity, Axial	-18	-6.0	PASS
8.3.1			Intensity, Radial	-18	-10.6	PASS
8.3.4			Signal-to-Noise/Noise, Axial	20	32.2	PASS
8.3.4			Signal-to-Noise/Noise, Radial	20	39.1	PASS
8.3.2			Frequency Response, Axial	0	1.3	PASS
8.3.1	LTE	5MHz/ Band 30	Intensity, Axial	-18	-6.5	PASS
8.3.1			Intensity, Radial	-18	-10.8	PASS
8.3.4			Signal-to-Noise/Noise, Axial	20	30.6	PASS
8.3.4			Signal-to-Noise/Noise, Radial	20	40.1	PASS
8.3.2			Frequency Response, Axial	0	1.3	PASS
8.3.1	LTE	10MHz/ Band 30	Intensity, Axial	-18	-6.3	PASS
8.3.1			Intensity, Radial	-18	-11.9	PASS
8.3.4			Signal-to-Noise/Noise, Axial	20	29.6	PASS
8.3.4			Signal-to-Noise/Noise, Radial	20	38.6	PASS
8.3.2			Frequency Response, Axial	0	1.3	PASS

Note: The above summary table represents the worst-case numerical values according to configurations in Table 7-22 and Table 7-23.

**Table 7-9**  
**Consolidated Tabled Results**

		Freq. Response Margin		Magnetic Intensity Verdict		FCC SNR Verdict	
		Axial	Radial	Axial	Radial	Axial	Radial
GSM	Cellular	PASS	NA	PASS	PASS	PASS	PASS
	PCS	PASS	NA	PASS	PASS	PASS	PASS
UMTS	Cellular	PASS	NA	PASS	PASS	PASS	PASS
	PCS	PASS	NA	PASS	PASS	PASS	PASS
LTE	B12	PASS	NA	PASS	PASS	PASS	PASS
	B17	PASS	NA	PASS	PASS	PASS	PASS
	B5	PASS	NA	PASS	PASS	PASS	PASS
	B4	PASS	NA	PASS	PASS	PASS	PASS
	B2	PASS	NA	PASS	PASS	PASS	PASS
	B30	PASS	NA	PASS	PASS	PASS	PASS

Note: Result shown is for T-coil category only.

FCC ID: A3LSMG890A	 PCTEST ENGINEERING LABORATORY, INC.	HAC (T-COIL) TEST REPORT		Reviewed by: Quality Manager
Filename: 0Y1504030668.A3L	Test Dates: 04/06/2015 - 04/11/2015	EUT Type: Portable Handset		Page 25 of 57



## II. Raw Handset Data

**Table 7-10**  
**Raw Data Results for GSM**

	Volume	Cellular Band					
		Axial			Radial		
		128	190	251	128	190	251
ABM1, dBA/m	Maximum	7.58	7.53	7.35	0.59	0.59	0.56
ABM2, dBA/m		-21.31	-19.87	-18.86	-34.95	-32.86	-32.81
Ambient Noise, dBA/m		-61.09	-61.09	-61.09	-61.59	-61.59	-61.59
Freq. Response Margin (dB)		1.99	1.94	1.96	N/A	N/A	N/A
S+N/N (dB)		28.89	27.40	26.21	35.54	33.45	33.37
S+N/N per orientation (dB)		26.21			33.37		
C63.19-2011 Rating per orientation		<b>T3</b>			<b>T4</b>		
	Volume	PCS Band					
		Axial			Radial		
		512	661	810	512	661	810
ABM1, dBA/m	Maximum	6.82	7.50	7.55	0.51	0.33	0.48
ABM2, dBA/m		-22.56	-24.01	-23.55	-35.39	-37.09	-36.28
Ambient Noise, dBA/m		-61.09	-61.09	-61.09	-61.59	-61.59	-61.59
Freq. Response Margin (dB)		1.99	2.00	2.00	N/A	N/A	N/A
S+N/N (dB)		29.38	31.51	31.10	35.90	37.42	36.76
S+N/N per orientation (dB)		29.38			35.90		
C63.19-2011 Rating per orientation		<b>T3</b>			<b>T4</b>		
T-coil Coordinates (cm)	[x,y] from bottom left	2.6, 2.6			2.6, 3.4		

### Notes:

1. Power Configuration: GSM850: PCL=5, GSM1900: PCL=0;
2. Phone Condition: Mute on; Backlight on; Max Volume; Max Contrast
3. Vocoder Configuration: EFR (GSM);
4. 'Radial' orientation refers to radial transverse.
5. Speech Signal: 3GPP2 Normal Test Signal



FCC ID: A3LSMG890A	 PCTEST ENGINEERING LABORATORY, INC.	HAC (T-COIL) TEST REPORT		Reviewed by: Quality Manager
Filename: 0Y1504030668.A3L	Test Dates: 04/06/2015 - 04/11/2015	EUT Type: Portable Handset	Page 26 of 57	

**Table 7-11  
Raw Data Results for UMTS**

	Volume	Cellular Band					
		Axial			Radial		
		4132	4183	4233	4132	4183	4233
ABM1, dBA/m	Maximum	7.59	7.59	7.59	0.70	0.69	0.69
ABM2, dBA/m		-44.66	-44.82	-44.76	-59.59	-59.53	-59.41
Ambient Noise, dBA/m		-61.09	-61.09	-61.09	-61.59	-61.59	-61.59
Freq. Response Margin (dB)		1.81	1.76	1.84	N/A	N/A	N/A
S+N/N (dB)		52.25	52.41	52.35	60.29	60.22	60.10
S+N/N per orientation (dB)		52.25			60.10		
C63.19-2011 Rating per orientation		<b>T4</b>			<b>T4</b>		
	Volume	PCS Band					
		Axial			Radial		
		9262	9400	9538	9262	9400	9538
ABM1, dBA/m	Maximum	7.59	7.60	7.59	0.69	0.67	0.67
ABM2, dBA/m		-44.48	-45.02	-44.90	-59.48	-59.87	-59.73
Ambient Noise, dBA/m		-61.09	-61.09	-61.09	-61.59	-61.59	-61.59
Freq. Response Margin (dB)		1.60	1.84	1.78	N/A	N/A	N/A
S+N/N (dB)		52.07	52.62	52.49	60.17	60.54	60.40
S+N/N per orientation (dB)		52.07			60.17		
C63.19-2011 Rating per orientation		<b>T4</b>			<b>T4</b>		
T-coil Coordinates (cm)		[x,y] from bottom left	2.6, 2.6			2.6, 3.4	

**Notes:**

1. Power Configuration: UMTS: TPC="All 1s";
2. Phone Condition: Mute on; Backlight on; Max Volume; Max Contrast
3. Vocoder Configuration: AMR 12.2 kbps (UMTS);
4. 'Radial' orientation refers to radial transverse.
5. Speech Signal: 3GPP2 Normal Test Signal.



FCC ID: A3LSMG890A	 PCTEST ENGINEERING LABORATORY, INC.	HAC (T-COIL) TEST REPORT		Reviewed by: Quality Manager
Filename: 0Y1504030668.A3L	Test Dates: 04/06/2015 - 04/11/2015	EUT Type: Portable Handset		Page 27 of 57

**Table 7-12  
Raw Data Results for LTE B12 (5MHz and 10MHz BW's)**

		5MHz BW	
		Axial	Radial
Volume		23095	23095
ABM1, dBA/m	Maximum	-6.41	-10.83
ABM2, dBA/m		-39.06	-50.06
Ambient Noise, dBA/m		-61.09	-61.59
Freq. Response Margin (dB)		1.43	N/A
S+N/N (dB)		32.65	39.23
S+N/N per orientation (dB)		32.65	39.23
C63.19-2011 Rating per orientation		<b>T4</b>	<b>T4</b>
		10MHz BW	
Volume		23095	23095
		Axial	Radial
ABM1, dBA/m	Maximum	-6.43	-10.78
ABM2, dBA/m		-39.98	-51.08
Ambient Noise, dBA/m		-61.09	-61.59
Freq. Response Margin (dB)		1.38	N/A
S+N/N (dB)		33.55	40.30
S+N/N per orientation (dB)		33.55	40.30
C63.19-2011 Rating per orientation		<b>T4</b>	<b>T4</b>
T-coil Coordinates (cm)		[x,y] from bottom left	2.6, 2.6

**Notes:**

1. Power Configuration: TPC="Max Power";
2. Radio Configuration: 16QAM, 1RB, 0RB Offset
3. Phone Condition: Mute on; Backlight on; Max Volume, Max Contrast
4. Vocoder Configuration: WB AMR 6.60kbps (LTE)
5. 'Radial' orientation refers to radial transverse.
6. Speech Signal: 3GPP2 Normal Test Signal.



FCC ID: A3LSMG890A	 PCTEST ENGINEERING LABORATORY, INC.	HAC (T-COIL) TEST REPORT	 SAMSUNG	Reviewed by: Quality Manager
Filename: 0Y1504030668.A3L	Test Dates: 04/06/2015 - 04/11/2015	EUT Type: Portable Handset	Page 28 of 57	

**Table 7-13  
Raw Data Results for LTE B17 (5MHz and 10MHz BW's)**

		5MHz BW	
		Axial	Radial
Volume		23790	23790
ABM1, dBA/m	Maximum	-6.55	-10.47
ABM2, dBA/m		-37.91	-49.94
Ambient Noise, dBA/m		-61.09	-61.59
Freq. Response Margin (dB)		1.45	N/A
S+N/N (dB)		31.36	39.47
S+N/N per orientation (dB)		31.36	39.47
C63.19-2011 Rating per orientation		<b>T4</b>	<b>T4</b>
		10MHz BW	
		Axial	Radial
Volume		23790	23790
ABM1, dBA/m	Maximum	-6.51	-11.15
ABM2, dBA/m		-38.92	-50.33
Ambient Noise, dBA/m		-61.09	-61.59
Freq. Response Margin (dB)		1.31	N/A
S+N/N (dB)		32.41	39.18
S+N/N per orientation (dB)		32.41	39.18
C63.19-2011 Rating per orientation		<b>T4</b>	<b>T4</b>
T-coil Coordinates (cm)	[x,y] from bottom left	2.6, 2.6	2.6, 3.4

**Notes:**

1. Power Configuration: TPC="Max Power";
2. Radio Configuration: 16QAM, 1RB, 0RB Offset
3. Phone Condition: Mute on; Backlight on; Max Volume, Max Contrast
4. Vocoder Configuration: WB AMR 6.60kbps (LTE)
5. 'Radial' orientation refers to radial transverse.
6. Speech Signal: 3GPP2 Normal Test Signal.



FCC ID: A3LSMG890A	 PCTEST ENGINEERING LABORATORY, INC.	HAC (T-COIL) TEST REPORT		Reviewed by: Quality Manager
Filename: 0Y1504030668.A3L	Test Dates: 04/06/2015 - 04/11/2015	EUT Type: Portable Handset	Page 29 of 57	

**Table 7-14  
Raw Data Results for LTE B5 (1.4MHz and 3MHz BW's)**

		1.4MHz BW	
		Axial	Radial
Volume		20525	20525
ABM1, dBA/m	Maximum	-6.55	-11.21
ABM2, dBA/m		-42.64	-52.30
Ambient Noise, dBA/m		-61.09	-61.59
Freq. Response Margin (dB)		1.42	N/A
S+N/N (dB)		36.09	41.09
S+N/N per orientation (dB)		36.09	41.09
C63.19-2011 Rating per orientation		<b>T4</b>	<b>T4</b>
		3MHz BW	
		Axial	Radial
Volume		20525	20525
ABM1, dBA/m	Maximum	-6.38	-10.78
ABM2, dBA/m		-41.94	-52.67
Ambient Noise, dBA/m		-61.09	-61.59
Freq. Response Margin (dB)		1.32	N/A
S+N/N (dB)		35.56	41.89
S+N/N per orientation (dB)		35.56	41.89
C63.19-2011 Rating per orientation		<b>T4</b>	<b>T4</b>
T-coil Coordinates (cm)		[x,y] from bottom left	2.6, 2.6

**Notes:**

1. Power Configuration: TPC="Max Power";
2. Radio Configuration: 16QAM, 1RB, 0RB Offset
3. Phone Condition: Mute on; Backlight on; Max Volume, Max Contrast
4. Vocoder Configuration: WB AMR 6.60kbps (LTE)
5. 'Radial' orientation refers to radial transverse.
6. Speech Signal: 3GPP2 Normal Test Signal.



FCC ID: A3LSMG890A	 PCTEST ENGINEERING LABORATORY, INC.	HAC (T-COIL) TEST REPORT		Reviewed by: Quality Manager
Filename: 0Y1504030668.A3L	Test Dates: 04/06/2015 - 04/11/2015	EUT Type: Portable Handset	Page 30 of 57	

**Table 7-15  
Raw Data Results for LTE B5 (5MHz and 10MHz BW's)**

		5MHz BW	
		Axial	Radial
Volume		20525	20525
ABM1, dBA/m	Maximum	-6.60	-10.96
ABM2, dBA/m		-41.57	-53.10
Ambient Noise, dBA/m		-61.09	-61.59
Freq. Response Margin (dB)		1.32	N/A
S+N/N (dB)		34.97	42.14
S+N/N per orientation (dB)		34.97	42.14
C63.19-2011 Rating per orientation		<b>T4</b>	<b>T4</b>
		10MHz BW	
Volume		20525	20525
		Axial	Radial
ABM1, dBA/m	Maximum	-6.66	-11.20
ABM2, dBA/m		-40.75	-51.82
Ambient Noise, dBA/m		-61.09	-61.59
Freq. Response Margin (dB)		1.21	N/A
S+N/N (dB)		34.09	40.62
S+N/N per orientation (dB)		34.09	40.62
C63.19-2011 Rating per orientation		<b>T4</b>	<b>T4</b>
T-coil Coordinates (cm)		[x,y] from bottom left	2.6, 2.6

**Notes:**

1. Power Configuration: TPC="Max Power";
2. Radio Configuration: 16QAM, 1RB, 0RB Offset
3. Phone Condition: Mute on; Backlight on; Max Volume, Max Contrast
4. Vocoder Configuration: WB AMR 6.60kbps (LTE)
5. 'Radial' orientation refers to radial transverse.
6. Speech Signal: 3GPP2 Normal Test Signal.



FCC ID: A3LSMG890A	 PCTEST ENGINEERING LABORATORY, INC.	HAC (T-COIL) TEST REPORT	 SAMSUNG	Reviewed by: Quality Manager
Filename: 0Y1504030668.A3L	Test Dates: 04/06/2015 - 04/11/2015	EUT Type: Portable Handset	Page 31 of 57	

**Table 7-16  
Raw Data Results for LTE B4 (1.4MHz and 3MHz BW's)**

		1.4MHz BW	
		Axial	Radial
Volume		20175	20175
ABM1, dBA/m	Maximum	-6.85	-11.22
ABM2, dBA/m		-40.48	-52.67
Ambient Noise, dBA/m		-61.09	-61.59
Freq. Response Margin (dB)		1.41	N/A
S+N/N (dB)		33.63	41.45
S+N/N per orientation (dB)		33.63	41.45
C63.19-2011 Rating per orientation		<b>T4</b>	<b>T4</b>
		3MHz BW	
Volume		20175	20175
		Axial	Radial
ABM1, dBA/m	Maximum	-6.79	-10.84
ABM2, dBA/m		-41.40	-53.53
Ambient Noise, dBA/m		-61.09	-61.59
Freq. Response Margin (dB)		1.34	N/A
S+N/N (dB)		34.61	42.69
S+N/N per orientation (dB)		34.61	42.69
C63.19-2011 Rating per orientation		<b>T4</b>	<b>T4</b>
T-coil Coordinates (cm)		[x,y] from bottom left	2.6, 2.6

**Notes:**

1. Power Configuration: TPC="Max Power";
2. Radio Configuration: 16QAM, 1RB, 0RB Offset
3. Phone Condition: Mute on; Backlight on; Max Volume, Max Contrast
4. Vocoder Configuration: WB AMR 6.60kbps (LTE)
5. 'Radial' orientation refers to radial transverse.
6. Speech Signal: 3GPP2 Normal Test Signal.



FCC ID: A3LSMG890A	 PCTEST ENGINEERING LABORATORY, INC.	HAC (T-COIL) TEST REPORT	 SAMSUNG	Reviewed by: Quality Manager
Filename: 0Y1504030668.A3L	Test Dates: 04/06/2015 - 04/11/2015	EUT Type: Portable Handset	Page 32 of 57	

**Table 7-17  
Raw Data Results for LTE B4 (5MHz and 10MHz BW's)**

		5MHz BW	
		Axial	Radial
Volume		20175	20175
ABM1, dBA/m	Maximum	-6.58	-10.86
ABM2, dBA/m		-40.50	-53.10
Ambient Noise, dBA/m		-61.09	-61.59
Freq. Response Margin (dB)		1.33	N/A
S+N/N (dB)		33.92	42.24
S+N/N per orientation (dB)		33.92	42.24
C63.19-2011 Rating per orientation		<b>T4</b>	<b>T4</b>
		10MHz BW	
		Axial	Radial
Volume		20175	20175
ABM1, dBA/m	Maximum	-6.42	-10.82
ABM2, dBA/m		-41.02	-51.74
Ambient Noise, dBA/m		-61.09	-61.59
Freq. Response Margin (dB)		1.31	N/A
S+N/N (dB)		34.60	40.92
S+N/N per orientation (dB)		34.60	40.92
C63.19-2011 Rating per orientation		<b>T4</b>	<b>T4</b>
T-coil Coordinates (cm)		[x,y] from bottom left	2.6, 2.6

**Notes:**

1. Power Configuration: TPC="Max Power";
2. Radio Configuration: 16QAM, 1RB, 0RB Offset
3. Phone Condition: Mute on; Backlight on; Max Volume, Max Contrast
4. Vocoder Configuration: WB AMR 6.60kbps (LTE)
5. 'Radial' orientation refers to radial transverse.
6. Speech Signal: 3GPP2 Normal Test Signal.



FCC ID: A3LSMG890A	 PCTEST ENGINEERING LABORATORY, INC.	HAC (T-COIL) TEST REPORT		Reviewed by: Quality Manager
Filename: 0Y1504030668.A3L	Test Dates: 04/06/2015 - 04/11/2015	EUT Type: Portable Handset	Page 33 of 57	

**Table 7-18  
Raw Data Results for LTE B4 (15MHz and 20MHz BW's)**

		15MHz BW	
		Axial	Radial
Volume		20175	20175
ABM1, dBA/m	Maximum	-6.52	-10.88
ABM2, dBA/m		-39.87	-52.10
Ambient Noise, dBA/m		-61.09	-61.59
Freq. Response Margin (dB)		1.35	N/A
S+N/N (dB)		33.35	41.22
S+N/N per orientation (dB)		33.35	41.22
C63.19-2011 Rating per orientation		<b>T4</b>	<b>T4</b>
		20MHz BW	
		Axial	Radial
Volume		20175	20175
ABM1, dBA/m	Maximum	-6.54	-10.69
ABM2, dBA/m		-38.60	-50.93
Ambient Noise, dBA/m		-61.09	-61.59
Freq. Response Margin (dB)		1.38	N/A
S+N/N (dB)		32.06	40.24
S+N/N per orientation (dB)		32.06	40.24
C63.19-2011 Rating per orientation		<b>T4</b>	<b>T4</b>
T-coil Coordinates (cm)	[x,y] from bottom left	2.6, 2.6	2.6, 3.4

**Notes:**

1. Power Configuration: TPC="Max Power";
2. Radio Configuration: 16QAM, 1RB, 0RB Offset
3. Phone Condition: Mute on; Backlight on; Max Volume, Max Contrast
4. Vocoder Configuration: WB AMR 6.60kbps (LTE)
5. 'Radial' orientation refers to radial transverse.
6. Speech Signal: 3GPP2 Normal Test Signal.



FCC ID: A3LSMG890A	 PCTEST ENGINEERING LABORATORY, INC.	HAC (T-COIL) TEST REPORT		Reviewed by: Quality Manager
Filename: 0Y1504030668.A3L	Test Dates: 04/06/2015 - 04/11/2015	EUT Type: Portable Handset	Page 34 of 57	

**Table 7-19  
Raw Data Results for LTE B2 (1.4MHz and 3MHz BW's)**

		1.4MHz BW	
		Axial	Radial
Volume		18900	18900
ABM1, dBA/m	Maximum	-7.36	-11.05
ABM2, dBA/m		-38.68	-52.31
Ambient Noise, dBA/m		-61.09	-61.59
Freq. Response Margin (dB)		1.35	N/A
S+N/N (dB)		31.32	41.26
S+N/N per orientation (dB)		31.32	41.26
C63.19-2011 Rating per orientation		<b>T4</b>	<b>T4</b>
		3MHz BW	
Volume		18900	18900
		Axial	
		Radial	
ABM1, dBA/m	Maximum	-6.52	-11.09
ABM2, dBA/m		-39.44	-53.01
Ambient Noise, dBA/m		-61.09	-61.59
Freq. Response Margin (dB)		1.33	N/A
S+N/N (dB)		32.92	41.92
S+N/N per orientation (dB)		32.92	41.92
C63.19-2011 Rating per orientation		<b>T4</b>	<b>T4</b>
T-coil Coordinates (cm)		[x,y] from bottom left	2.6, 2.6

**Notes:**

1. Power Configuration: TPC="Max Power";
2. Radio Configuration: 16QAM, 1RB, 0RB Offset
3. Phone Condition: Mute on; Backlight on; Max Volume, Max Contrast
4. Vocoder Configuration: WB AMR 6.60kbps (LTE)
5. 'Radial' orientation refers to radial transverse.
6. Speech Signal: 3GPP2 Normal Test Signal.



FCC ID: A3LSMG890A	 PCTEST ENGINEERING LABORATORY, INC.	HAC (T-COIL) TEST REPORT	 SAMSUNG	Reviewed by: Quality Manager
Filename: 0Y1504030668.A3L	Test Dates: 04/06/2015 - 04/11/2015	EUT Type: Portable Handset	Page 35 of 57	

**Table 7-20  
Raw Data Results for LTE B2 (5MHz and 10MHz BW's)**

		5MHz BW	
		Axial	Radial
Volume		18900	18900
ABM1, dBA/m	Maximum	-6.51	-11.19
ABM2, dBA/m		-38.94	-52.51
Ambient Noise, dBA/m		-61.09	-61.59
Freq. Response Margin (dB)		1.32	N/A
S+N/N (dB)		32.43	41.32
S+N/N per orientation (dB)		32.43	41.32
C63.19-2011 Rating per orientation		<b>T4</b>	<b>T4</b>
		10MHz BW	
Volume		18900	18900
		Axial	Radial
ABM1, dBA/m	Maximum	-6.45	-10.42
ABM2, dBA/m		-39.37	-51.95
Ambient Noise, dBA/m		-61.09	-61.59
Freq. Response Margin (dB)		1.42	N/A
S+N/N (dB)		32.92	41.53
S+N/N per orientation (dB)		39.92	41.53
C63.19-2011 Rating per orientation		<b>T4</b>	<b>T4</b>
T-coil Coordinates (cm)		[x,y] from bottom left	2.6, 2.6

**Notes:**

1. Power Configuration: TPC="Max Power";
2. Radio Configuration: 16QAM, 1RB, 0RB Offset
3. Phone Condition: Mute on; Backlight on; Max Volume, Max Contrast
4. Vocoder Configuration: WB AMR 6.60kbps (LTE)
5. 'Radial' orientation refers to radial transverse.
6. Speech Signal: 3GPP2 Normal Test Signal.



FCC ID: A3LSMG890A	 PCTEST ENGINEERING LABORATORY, INC.	HAC (T-COIL) TEST REPORT	 SAMSUNG	Reviewed by: Quality Manager
Filename: 0Y1504030668.A3L	Test Dates: 04/06/2015 - 04/11/2015	EUT Type: Portable Handset	Page 36 of 57	

**Table 7-21  
Raw Data Results for LTE B2 (15MHz and 20MHz BW's)**

		15MHz BW	
		Axial	Radial
Volume		18900	18900
	ABM1, dBA/m	-6.49	-11.16
	ABM2, dBA/m	-38.42	-50.95
	Ambient Noise, dBA/m	-61.09	-61.59
	Freq. Response Margin (dB)	1.38	N/A
	S+N/N (dB)	31.93	39.79
	S+N/N per orientation (dB)	31.93	39.79
	C63.19-2011 Rating per orientation	<b>T4</b>	<b>T4</b>
		20MHz BW	
		Axial	Radial
Volume		18900	18900
	ABM1, dBA/m	-6.78	-10.42
	ABM2, dBA/m	-37.13	-49.15
	Ambient Noise, dBA/m	-61.09	-61.59
	Freq. Response Margin (dB)	1.27	N/A
	S+N/N (dB)	30.35	38.73
	S+N/N per orientation (dB)	30.35	38.73
	C63.19-2011 Rating per orientation	<b>T4</b>	<b>T4</b>
T-coil Coordinates (cm)	[x,y] from bottom left	2.6, 2.6	2.6, 3.4

**Notes:**

1. Power Configuration: TPC="Max Power";
2. Radio Configuration: 16QAM, 1RB, 0RB Offset
3. Phone Condition: Mute on; Backlight on; Max Volume, Max Contrast
4. Vocoder Configuration: WB AMR 6.60kbps (LTE)
5. 'Radial' orientation refers to radial transverse.
6. Speech Signal: 3GPP2 Normal Test Signal.



FCC ID: A3LSMG890A	 PCTEST ENGINEERING LABORATORY, INC.	HAC (T-COIL) TEST REPORT	 SAMSUNG	Reviewed by: Quality Manager
Filename: 0Y1504030668.A3L	Test Dates: 04/06/2015 - 04/11/2015	EUT Type: Portable Handset	Page 37 of 57	

**Table 7-22**  
**Raw Data Results for LTE B30 (1.4MHz and 3MHz BW's)**

		1.4MHz BW	
		Axial	Radial
Volume		27710	27710
	ABM1, dBA/m	-6.38	-10.75
	ABM2, dBA/m	-38.59	-50.19
	Ambient Noise, dBA/m	-61.09	-61.59
	Freq. Response Margin (dB)	1.42	N/A
	S+N/N (dB)	32.21	39.44
	S+N/N per orientation (dB)	32.21	39.44
	C63.19-2011 Rating per orientation	<b>T4</b>	<b>T4</b>
		3MHz BW	
		Axial	Radial
Volume		27710	27710
	ABM1, dBA/m	-6.03	-10.64
	ABM2, dBA/m	-38.18	-49.72
	Ambient Noise, dBA/m	-61.09	-61.59
	Freq. Response Margin (dB)	1.25	N/A
	S+N/N (dB)	32.15	39.08
	S+N/N per orientation (dB)	32.15	39.08
	C63.19-2011 Rating per orientation	<b>T4</b>	<b>T4</b>
T-coil Coordinates (cm)	[x,y] from bottom left	2.6, 2.6	2.6, 3.4

**Notes:**

1. Power Configuration: TPC="Max Power";
2. Radio Configuration: 16QAM, 1RB, 0RB Offset
3. Phone Condition: Mute on; Backlight on; Max Volume, Max Contrast
4. Vocoder Configuration: WB AMR 6.60kbps (LTE)
5. 'Radial' orientation refers to radial transverse.
6. Speech Signal: 3GPP2 Normal Test Signal.



FCC ID: A3LSMG890A	 PCTEST ENGINEERING LABORATORY, INC.	HAC (T-COIL) TEST REPORT	 SAMSUNG	Reviewed by: Quality Manager
Filename: 0Y1504030668.A3L	Test Dates: 04/06/2015 - 04/11/2015	EUT Type: Portable Handset	Page 38 of 57	

**Table 7-23  
Raw Data Results for LTE B30 (5MHz and 10MHz BW's)**

		Volume	5MHz BW	
			Axial	Radial
			27710	27710
ABM1, dBA/m			-6.51	-10.75
ABM2, dBA/m			-37.14	-50.87
Ambient Noise, dBA/m			-61.09	-61.59
Freq. Response Margin (dB)			1.31	N/A
S+N/N (dB)		Maximum	30.63	40.12
S+N/N per orientation (dB)			30.63	40.12
C63.19-2011 Rating per orientation			<b>T4</b>	<b>T4</b>
		Volume	10MHz BW	
			Axial	Radial
			27710	27710
ABM1, dBA/m			-6.34	-11.89
ABM2, dBA/m			-35.95	-50.46
Ambient Noise, dBA/m			-61.09	-61.59
Freq. Response Margin (dB)			1.28	N/A
S+N/N (dB)		Maximum	29.61	38.57
S+N/N per orientation (dB)			29.61	38.57
C63.19-2011 Rating per orientation			<b>T3</b>	<b>T4</b>
T-coil Coordinates (cm)	[x,y] from bottom left		2.6, 2.6	2.6, 3.4

**Notes:**

1. Power Configuration: TPC="Max Power";
2. Radio Configuration: 16QAM, 1RB, 0RB Offset
3. Phone Condition: Mute on; Backlight on; Max Volume, Max Contrast
4. Vocoder Configuration: WB AMR 6.60kbps (LTE)
5. 'Radial' orientation refers to radial transverse.
6. Speech Signal: 3GPP2 Normal Test Signal.
7. The worst case band and bandwidth combination for each probe orientation is additionally tested on the low and high channels for those combinations. However, since LTE Band 30 at 10MHz bandwidth (as the worst case for both Axial and Radial probe orientations) does not support 3 non-overlapping channels, only the middle channel was selected for testing.

FCC ID: A3LSMG890A	 PCTEST ENGINEERING LABORATORY, INC.	HAC (T-COIL) TEST REPORT		Reviewed by: Quality Manager
Filename: 0Y1504030668.A3L	Test Dates: 04/06/2015 - 04/11/2015	EUT Type: Portable Handset	Page 39 of 57	

### III. Frequency Response Graph

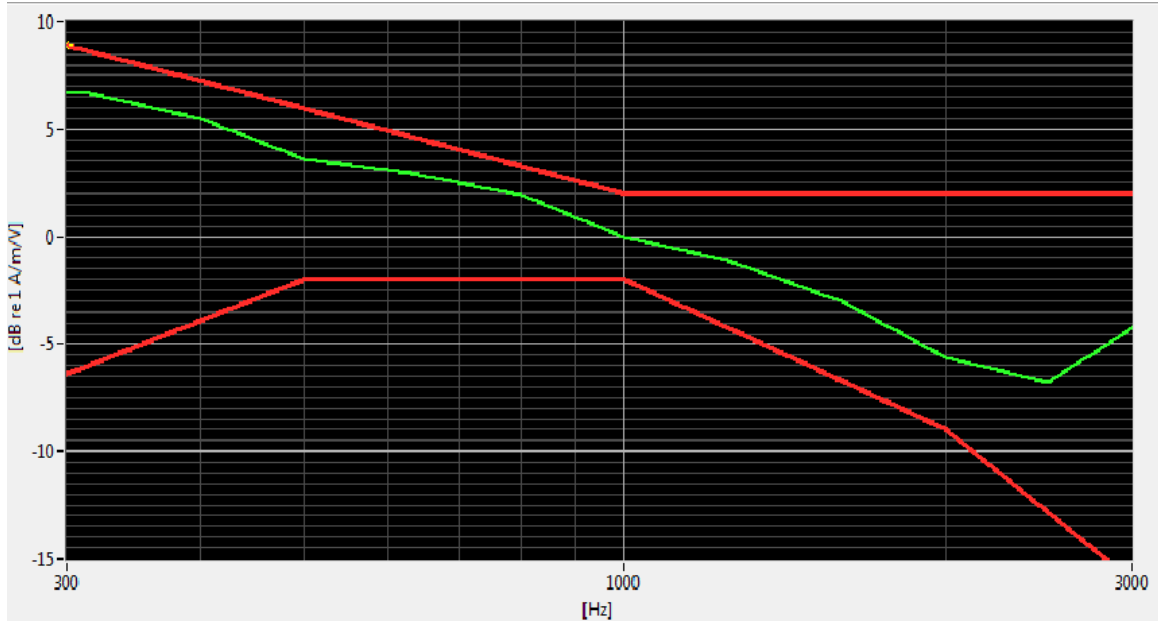
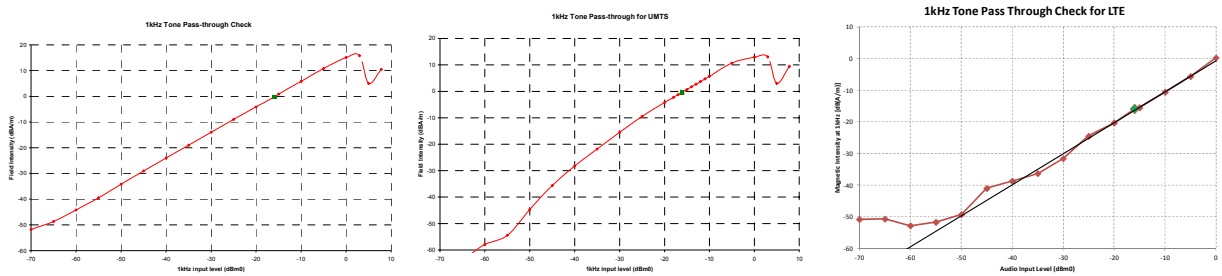



Figure 7-1  
Axial Frequency Response

Note: User T-coil Mode (**Settings**→**Call** → **More Settings**→**Hearing aids**) was set to ON for Frequency Response compliance. This frequency response represents the worst-case ABM2 test configuration according to Table 7-10 to Table 7-23.

### IV. 1 kHz Vocoder Application Check



This model was verified to be within the linear region for ABM1 measurements at -16 dBm0 for GSM, UMTS, and VoLTE. This measurement was taken in the axial configuration above the maximum location.

FCC ID: A3LSMG890A	 PCTEST ENGINEERING LABORATORY, INC.	HAC (T-COIL) TEST REPORT	 SAMSUNG	Reviewed by: Quality Manager
Filename: 0Y1504030668.A3L	Test Dates: 04/06/2015 - 04/11/2015	EUT Type: Portable Handset		Page 40 of 57

## V. Undesirable Audio Magnetic Band Plots (ABM2)

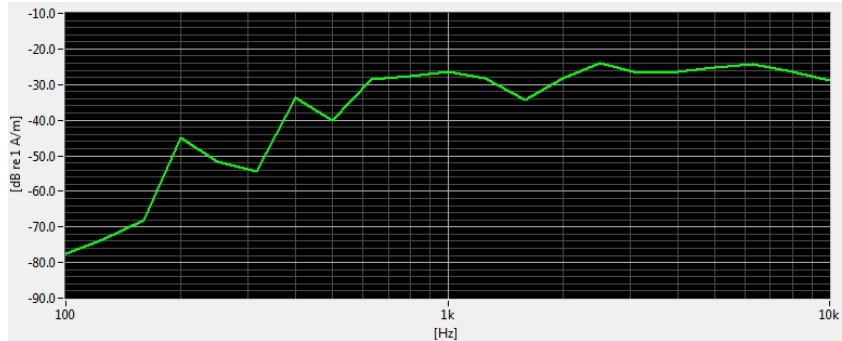

**Figure 7-2**

### Worst-case ABM2 Plot for GSM

Note: This plot represents the data from the location/configuration resulting in the highest ABM2 result shown in Table 7-10

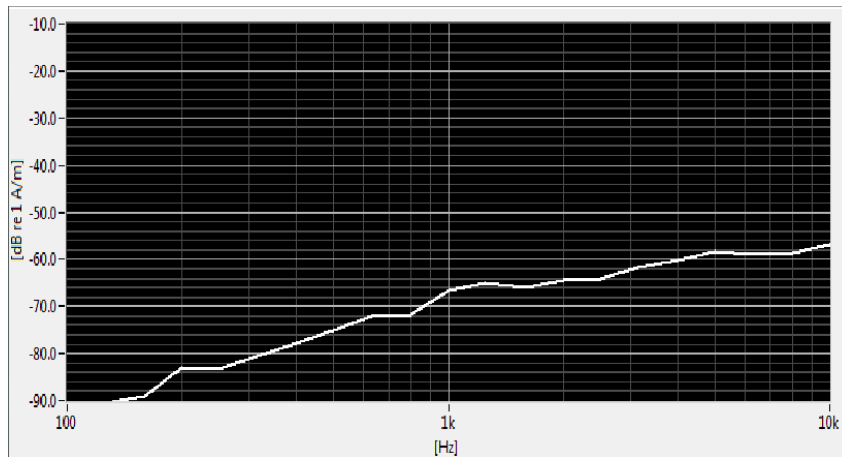

**Figure 7-3**

### Worst-case ABM2 Plot for UMTS

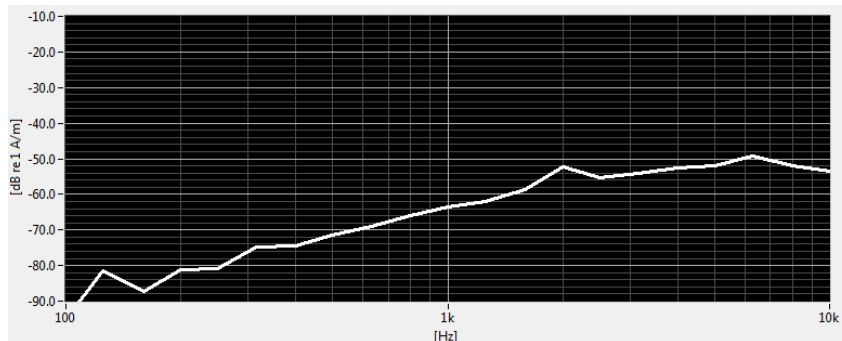

Note: This plot represents the data from the location/configuration resulting in the highest ABM2 result shown in Table 7-11.



**Figure 7-4**

### Worst-case ABM2 Plot for LTE

Note: This plot represents the data from the location/configuration resulting in the highest ABM2 result shown in Table 7-12 through Table 7-23.

FCC ID: A3LSMG890A	 PCTEST ENGINEERING LABORATORY, INC.	HAC (T-COIL) TEST REPORT	 SAMSUNG	Reviewed by: Quality Manager
Filename: 0Y1504030668.A3L	Test Dates: 04/06/2015 - 04/11/2015	EUT Type: Portable Handset		Page 41 of 57

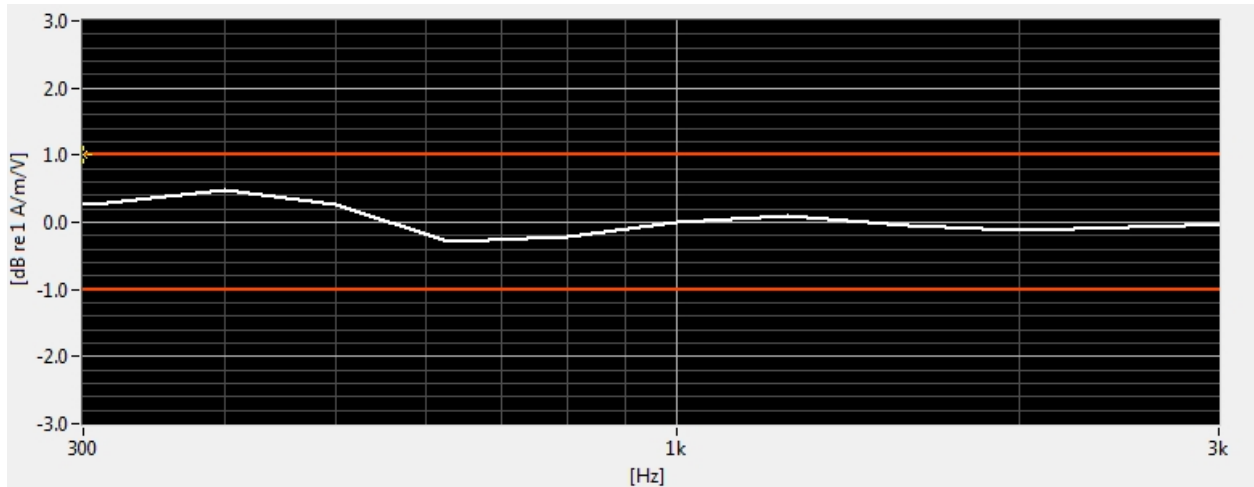

## VI. T-Coil Validation Test Results



**Figure 7-5**  
Helmholtz Coil Validation for Frequency Response

**Table 7-24**  
Helmholtz Coil Validation Table of Results

Item	Target	Result	Verdict
Signal Validation			
Frequency Response, from limits	> 0 dB	0.50	PASS
Magnetic Intensity, -10 dBA/m	-10 ± 0.5 dB	-9.751	PASS
Noise Validation			
Axial Environmental Noise	< - 58 dBA/m	-61.09	PASS
Radial Environmental Noise	< - 58 dBA/m	-61.59	PASS

FCC ID: A3LSMG890A	 PCTEST ENGINEERING LABORATORY, INC.	HAC (T-COIL) TEST REPORT	 SAMSUNG	Reviewed by: Quality Manager
Filename: 0Y1504030668.A3L	Test Dates: 04/06/2015 - 04/11/2015	EUT Type: Portable Handset		Page 42 of 57

## 8. MEASUREMENT UNCERTAINTY



**Table 8-1  
Uncertainty Estimation Table**

Contribution	Data +/- %	Data +/- dB	Data Type	Probability distribution	Divisor	Standard uncertainty	Standard Uncertainty (dB)
ABM Noise	7.0%	0.29	Std. Dev.	Normal k=1	1.00	7.0%	
RF Reflections	4.7%	0.20	Specification	Rectangular	1.73	2.7%	
Reference Signal Level	12.2%	0.50	Specification	Rectangular	1.73	7.0%	
Positioning Accuracy	10.0%	0.41	Uncertainty	Rectangular	1.73	5.8%	
Probe Coil Sensitivity	12.2%	0.50	Specification	Rectangular	1.73	7.0%	
Probe Linearity	2.4%	0.10	Std. Dev.	Normal k=1	1.00	2.4%	
Cable Loss	2.8%	0.12	Specification	Rectangular	1.73	1.6%	
Frequency Analyzer	5.0%	0.21	Specification	Rectangular	1.73	2.9%	
System Repeatability	5.0%	0.21	Std. Dev.	Normal k=1	1.00	5.0%	
WD Repeatability	9.0%	0.37	Std. Dev.	Normal k=1	1.00	9.0%	
Positioner Accuracy	1.0%	0.04	Specification	Rectangular	1.73	0.6%	
<b>Combined standard uncertainty, uc (k=1)</b>						<b>17.7%</b>	<b>0.71</b>
<b>Expanded uncertainty (k=2), 95% confidence level</b>						<b>35.3%</b>	<b>1.31</b>

**Notes:**

1. Test equipments are calibrated according to techniques outlined in NIS81, NIS3003 and NIST Tech Note 1297.
2. All equipments have traceability according to NIST. Measurement Uncertainties are defined in further detail in NIS 81 and NIST Tech Note 1297 and UKAS M3003.



Measurement uncertainty reflects the quality and accuracy of a measured result as compared to the true value. Such statements are generally required when stating results of measurements so that it is clear to the intended audience that the results may differ when reproduced by different facilities. Measurement results vary due to the measurement uncertainty of the instrumentation, measurement technique, and test engineer. Most uncertainties are calculated using the tolerances of the instrumentation used in the measurement, the measurement setup variability, and the technique used in performing the test. While not generally included, the variability of the equipment under test also figures into the overall measurement uncertainty. Another component of the overall uncertainty is based on the variability of repeated measurements (so-called Type A uncertainty). This may mean that the Hearing Aid compatibility tests may have to be repeated by taking down the test setup and resetting it up so that there are a statistically significant number of repeat measurements to identify the measurement uncertainty. By combining the repeat measurement results with that of the instrumentation chain using the technique contained in NIS 81 and NIS 3003, the overall measurement uncertainty was estimated.

<b>FCC ID:</b> A3LSMG890A		<b>HAC (T-COIL) TEST REPORT</b>		<b>Reviewed by:</b> Quality Manager
<b>Filename:</b> 0Y1504030668.A3L	<b>Test Dates:</b> 04/06/2015 - 04/11/2015	<b>EUT Type:</b> Portable Handset	Page 43 of 57	



## 9. EQUIPMENT LIST

**Table 9-1  
Equipment List**

Manufacturer	Model	Description	Cal Date	Cal Interval	Cal Due	Serial Number
Control Company	36934-158	Wall-Mounted Thermometer	4/29/2014	Biennial	4/29/2016	122014488
Listen	SoundCheck	Acoustic Analyzer System	10/17/2014	Annual	10/17/2015	01-20-03368
Listen	SoundConnect	Microphone Power Supply	1/22/2015	Annual	1/22/2016	0899-PS150
NI	4474	Data Acquisition Card	N/A		N/A	N/A
Rohde & Schwarz	CMU200	Base Station Simulator	12/4/2014	Annual	12/4/2015	833855/0010
Rohde & Schwarz	CMU200	Base Station Simulator	4/24/2014	Annual	4/24/2015	836371/0079
Rohde & Schwarz	CMW500	Radio Communication Tester	10/4/2013	Biennial	10/4/2015	103962
TEM	Axial T-Coil Probe	Axial T-Coil Probe	9/16/2014	Annual	9/16/2015	TEM-1124
TEM	Radial T-Coil Probe	Radial T-Coil Probe	9/16/2014	Annual	9/16/2015	TEM-1130
TEM	C63.19	Helmholtz Coil	1/29/2015	Annual	1/29/2016	925
TEM		HAC Positioner	N/A		N/A	N/A
TEM		HAC System Controller with Software	N/A		N/A	N/A

<b>FCC ID:</b> A3LSMG890A		<b>HAC (T-COIL) TEST REPORT</b>		<b>Reviewed by:</b> Quality Manager
<b>Filename:</b> 0Y1504030668.A3L	<b>Test Dates:</b> 04/06/2015 - 04/11/2015	<b>EUT Type:</b> Portable Handset		Page 44 of 57

## 10. CALIBRATION CERTIFICATES

<b>FCC ID:</b> A3LSMG890A	 <b>PCTEST</b> ENGINEERING LABORATORY, INC.	<b>HAC (T-COIL) TEST REPORT</b>		<b>Reviewed by:</b> Quality Manager
<b>Filename:</b> 0Y1504030668.A3L	<b>Test Dates:</b> 04/06/2015 - 04/11/2015	<b>EUT Type:</b> Portable Handset		Page 45 of 57

West Caldwell Calibration Laboratories Inc.

# Certificate of Calibration

for

**AXIAL T COIL PROBE**

Manufactured by: TEM CONSULTING  
Model No: AXIAL T COIL PROBE  
Serial No: TEM-1124  
Calibration Recall No: 24538

Submitted By:

Customer: JUSTIN CHAO  
Company: PCTEST ENGINEERING LAB  
Address: 6660-B DOBBIN ROAD  
COLUMBIA MD 21045

The subject instrument was calibrated to the indicated specification using standards traceable to the National Institute of Standards and Technology or to accepted values of natural physical constants. This document certifies that the instrument met the following specification upon its return to the submitter.

West Caldwell Calibration Laboratories Procedure No. AXIAL T C TEM

Upon receipt for Calibration, the instrument was found to be:

Within ( X ) see attached Report of Calibration.

the tolerance of the indicated specification.

*QA*  
*9/19/2014*

West Caldwell Calibration Laboratories' calibration control system meets the requirements, ISO 10012-1 MIL-STD-45662A, ANSI/NCSL Z540-1, IEC Guide 25, ISO 9001:2008 and ISO 17025.

Note: With this Certificate, Report of Calibration is included.

Approved by:

Calibration Date: 16-Sep-14

*FC*

Certificate No: 24538 - 1

Felix Christopher (QA Mgr.)  
ISO/IEC 17025:2005



QA Doc. #1051 Rev. 2.0 10/1/01

Certificate Page 1 of 1

**West Caldwell Calibration Laboratories, Inc.**  
uncompromised calibration  
1575 State Route 96, Victor, NY 14564, U.S.A.



Calibration Lab. Cert. # 1533.01

FCC ID: A3LSMG890A	 PCTEST ENGINEERING LABORATORY, INC.	HAC (T-COIL) TEST REPORT	 SAMSUNG	Reviewed by: Quality Manager
Filename: 0Y1504030668.A3L	Test Dates: 04/06/2015 - 04/11/2015	EUT Type: Portable Handset		Page 46 of 57



ISO/IEC 17025: 2005



Calibration Lab. Cert. # 1533.01

## REPORT OF CALIBRATION

TEM Consulting LP Axial T Coil Probe

for  
Model No.: Axial T Coil Probe

Serial No.: TEM-1124

Company : PCTEST Engineering Lab.

I. D. No: 80578

Calibration results:		Before data: .....	After data: .....
<b>Probe Sensitivity measured with Helmholtz Coil</b>			
<i>Helmholtz Coil;</i>			
the number of turns on each coil;	10	No.	
the radius of each coil, in meters;	0.204	m	
the current in the coils, in amperes.;	0.09	A	
<i>Helmholtz Coil Constant;</i>	7.09	A/m/V	
<i>Helmholtz Coil magnetic field;</i>	5.97	A/m	
<b>Probe Sensitivity at</b>	1000	Hz.	
<b>was</b>	-60.22	dBV/A/m	
	0.975	mV/A/m	
<b>Probe resistance</b>	901	Ohms	
		Before & after data same: ...X.....	
Laboratory Environment:			
Ambient Temperature:	22.2	°C	
Ambient Humidity:	45.9	% RH	
Ambient Pressure:	99.5	kPa	
Calibration Date:	16-Sep-14		
Re-calibration Due:	16-Sep-15		
Report Number:	24538	-1	
Control Number:	24538		

The above listed instrument meets or exceeds the tested manufacturer's specifications.

This Calibration is traceable through NIST test numbers: ,287708

The expanded uncertainty of calibration: 0.30dB at 95% confidence level with a coverage factor of k=2.

Graph represents Probes Frequency Response.

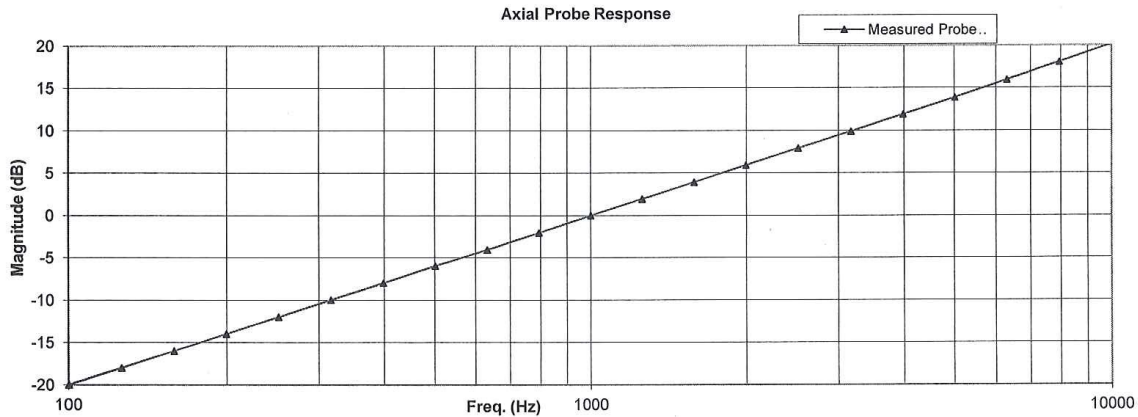

The above listed instrument was checked using calibration procedure documented in West Caldwell

Calibration Laboratories Inc. procedure :

Rev. 7.0 Jan. 24, 2014 Doc. # 1038 HCATEMC

Calibration was performed by West Caldwell Calibration Laboratories Inc. under Operating Procedures

intended to implement the requirements of ISO10012-1, IEC Guide 25, ANSI/NCCL Z540-1, (MIL-STD-45662A) and ISO 9001:2008, ISO 17025

Cal. Date: 16-Sep-2014

Measurements performed by: *[Signature]*

Calibrated on WCCL system type 9700

Felix Christopher

This document shall not be reproduced, except in full, without the written approval from West Caldwell Cal. Labs. Inc.

Rev. 7.0 Jan. 24, 2014 Doc. # 1038 HCATEMC

FCC ID: A3LSMG890A	PCTEST ENGINEERING LABORATORY, INC.	HAC (T-COIL) TEST REPORT	SAMSUNG	Reviewed by: Quality Manager
Filename: OY1504030668.A3L	Test Dates: 04/06/2015 - 04/11/2015	EUT Type: Portable Handset		Page 47 of 57

HCATEMC\_TEM-1124\_Sep-16-2014

**West Caldwell Calibration Laboratories Inc.**

1575 State Route 96, Victor NY 14564  
Tel. (585) 586-3900 FAX (585) 586-4327

**Calibration Data Record**

for  
TEM Consulting LP Axial T Coil Probe      Model No.: Axial T Coil Probe      Serial No.: TEM-1124  
Company : PCTEST Engineering Lab.

Test	Function	Tolerance	Measured values			
			Before	Out	Remarks	
1.0	Probe Sensitivity at	1000 Hz.      dBV/A/m	-60.22			
2.0	Probe Level Linearity					
			dB			
			6	6.00		
		Ref. (0 dB)	0	0.00		
			-6	-6.00		
		-12	-12.10			
3.0	Probe Frequency Response		Hz			
			100	-20.0		
			126	-18.0		
			158	-16.0		
			200	-14.0		
			251	-12.0		
			316	-10.0		
			398	-8.0		
			501	-6.0		
			631	-4.1		
			794	-2.0		
			Ref. (0 dB)	1000	0.0	
				1259	1.9	
				1585	3.9	
				1995	5.9	
				2512	7.9	
				3162	9.9	
		3981	11.9			
		5012	13.9			
		6310	15.9			
		7943	18.0			
		10000	20.2			



Instruments used for calibration:			Date of Cal.	Traceability No.	Due Date
HP	34401A	S/N 36064102	8-Oct-2013	,287708	8-Oct-2014
HP	34401A	S/N 36102471	8-Oct-2013	,287708	8-Oct-2014
HP	33120A	S/N 36043716	8-Oct-2013	,287708	8-Oct-2014
B&K	2133	S/N 1583254	6-Jan-2014	683/284413-14	7-Jan-2015

Cal. Date: 16-Sep-2014  
Calibrated on WCCL system type 9700

Tested by: Felix Christopher

This document shall not be reproduced, except in full, without the written approval from West Caldwell Cal. Labs. Inc.

Rev. 7.0 Jan. 24, 2014 Doc. # 1038 HCATEMC

FCC ID: A3LSMG890A	 PCTEST ENGINEERING LABORATORY, INC.	HAC (T-COIL) TEST REPORT		Reviewed by: Quality Manager
Filename: 0Y1504030668.A3L	Test Dates: 04/06/2015 - 04/11/2015	EUT Type: Portable Handset		Page 48 of 57

West Caldwell Calibration Laboratories Inc.

# Certificate of Calibration

for

**RADIAL T COIL PROBE**

Manufactured by: TEM CONSULTING  
Model No: RADIAL T COIL PROBE  
Serial No: TEM-1130  
Calibration Recall No: 24538

Submitted By:

Customer: JUSTIN CHAO  
Company: PCTEST ENGINEERING LAB  
Address: 6660-B DOBBIN ROAD  
COLUMBIA MD 21045

The subject instrument was calibrated to the indicated specification using standards traceable to the National Institute of Standards and Technology or to accepted values of natural physical constants. This document certifies that the instrument met the following specification upon its return to the submitter.

West Caldwell Calibration Laboratories Procedure No. RADIAL T TEM

Upon receipt for Calibration, the instrument was found to be:

Within ( X ) see attached Report of Calibration.

the tolerance of the indicated specification.

West Caldwell Calibration Laboratories' calibration control system meets the requirements, ISO 10012-1 MIL-STD-45662A, ANSI/NCSL Z540-1, IEC Guide 25, ISO 9001:2008 and ISO 17025.

Note: With this Certificate, Report of Calibration is included.

Approved by:

Calibration Date: 16-Sep-14

*FC*

Certificate No: 24538 - 2

Felix Christopher (QA Mgr.)  
ISO/IEC 17025:2005

QA Doc. #1051 Rev. 2.0 10/1/01

Certificate Page 1 of 1

**West Caldwell Calibration Laboratories, Inc.**  
uncompromised calibration  
1575 State Route 96, Victor, NY 14564, U.S.A.



Calibration Lab. Cert. # 1533.01

FCC ID: A3LSMG890A	PCTEST ENGINEERING LABORATORY, INC.	HAC (T-COIL) TEST REPORT		Reviewed by: Quality Manager
Filename: 0Y1504030668.A3L	Test Dates: 04/06/2015 - 04/11/2015	EUT Type: Portable Handset		Page 49 of 57



ISO/IEC 17025: 2005



Calibration Lab. Cert. # 1533.01

## REPORT OF CALIBRATION

TEM Consulting LP Radial T Coil Probe

Model No.: Radial T Coil Probe

Serial No.: TEM-1130

Company : PCTEST Engineering Lab.

I. D. No: 80579

Calibration results:		Before data: .....	After data: .....
<b>Probe Sensitivity measured with Helmholtz Coil</b>			
<i>Helmholtz Coil;</i>			
the number of turns on each coil;	10	No.	Before & after data same: ...X.....
the radius of each coil, in meters;	0.204	m	
the current in the coils, in amperes.;	0.09	A	
<i>Helmholtz Coil Constant;</i>	7.09	A/m/V	Laboratory Environment:
<i>Helmholtz Coil magnetic field;</i>	5.97	A/m	Ambient Temperature: 22.2 °C
			Ambient Humidity: 45.9 % RH
			Ambient Pressure: 99.5 kPa
			Calibration Date: 16-Sep-14
Probe Sensitivity at	1000	Hz.	Re-calibration Due: 16-Sep-15
was	-60.58	dBV/A/m	Report Number: 24538 -2
	0.936	mV/A/m	Control Number: 24538
Probe resistance	907	Ohms	

The above listed instrument meets or exceeds the tested manufacturer's specifications.

This Calibration is traceable through NIST test numbers: ,287708

The expanded uncertainty of calibration: 0.30dB at 95% confidence level with a coverage factor of k=2.

Graph represents Probes Frequency Response.

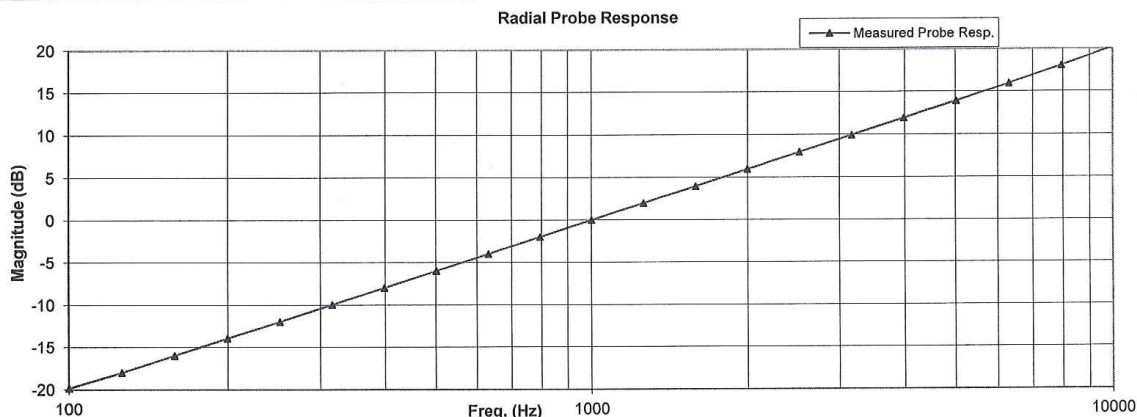

The above listed instrument was checked using calibration procedure documented in West Caldwell Calibration Laboratories Inc. procedure : **Rev. 7.0 Jan. 24, 2014 Doc. # 1038 HCRTEMC**  
 Calibration was performed by West Caldwell Calibration Laboratories Inc. under Operating Procedures intended to implement the requirements of ISO10012-1, IEC Guide 25, ANSI/NCCL Z540-1, (MIL-STD-45662A) and ISO 9001:2008, ISO 17025

Cal. Date: 16-Sep-2014

Measurements performed by: *[Signature]*

Calibrated on WCCL system type 9700

**Felix Christopher**

This document shall not be reproduced, except in full, without the written approval from West Caldwell Cal. Labs. Inc.

Rev. 7.0 Jan. 24, 2014 Doc. # 1038 HCRTEMC

FCC ID: A3LSMG890A	PCTEST ENGINEERING LABORATORY, INC.	HAC (T-COIL) TEST REPORT	SAMSUNG	Reviewed by: Quality Manager
Filename: 0Y1504030668.A3L	Test Dates: 04/06/2015 - 04/11/2015	EUT Type: Portable Handset		Page 50 of 57

**West Caldwell Calibration Laboratories Inc.**

1575 State Route 96, Victor NY 14564  
Tel. (585) 586-3900 FAX (585) 586-4327

**Calibration Data Record**

for  
TEM Consulting LP Radial T Coil Probe      Model No.: Radial T Coil Probe      Serial No.: TEM-1130  
Company : PCTEST Engineering Lab.

Test	Function	Tolerance	Measured values		
			Before	Out	Remarks
1.0	Probe Sensitivity at	1000 Hz.      dBV/A/m	-60.58		
2.0	Probe Level Linearity	Ref. (0 dB)	6	6.03	
			0	0.00	
			-6	-6.03	
			-12	-12.05	
3.0	Probe Frequency Response	Ref. (0 dB)	100	-19.8	
			126	-18.0	
			158	-16.0	
			200	-13.9	
			251	-12.0	
			316	-10.0	
			398	-8.0	
			501	-6.0	
			631	-4.0	
			794	-2.0	
			1000	0.0	
			1259	2.0	
			1585	4.0	
			1995	6.0	
			2512	7.9	
			3162	9.9	
3981	11.9				
5012	13.9				
6310	16.0				
7943	18.0				
10000	20.2				



Instruments used for calibration:			Date of Cal.	Traceability No.	Due Date
HP	34401A	S/N 36064102	8-Oct-2013	,287708	8-Oct-2014
HP	34401A	S/N 36102471	8-Oct-2013	,287708	8-Oct-2014
HP	33120A	S/N 36043716	8-Oct-2013	,287708	8-Oct-2014
B&K	2133	S/N 1583254	6-Jan-2014	683/284413-14	7-Jan-2015

Cal. Date: 16-Sep-2014  
Calibrated on WCCL system type 9700

Tested by: Felix Christopher

This document shall not be reproduced, except in full, without the written approval from West Caldwell Cal. Labs. Inc.



Rev. 7.0 Jan. 24, 2014 Doc. # 1038 HCRTEMC

FCC ID: A3LSMG890A	 PCTEST ENGINEERING LABORATORY, INC.	HAC (T-COIL) TEST REPORT		Reviewed by: Quality Manager
Filename: 0Y1504030668.A3L	Test Dates: 04/06/2015 - 04/11/2015	EUT Type: Portable Handset		Page 51 of 57

## 11. CONCLUSION



The measurements indicate that the wireless communications device complies with the HAC limits specified in accordance with the ANSI C63.19 Standard and FCC WT Docket No. 01-309 RM-8658. Precise laboratory measures were taken to assure repeatability of the tests. The tested device complies with the requirements in respect to all parameters specific to the test. The test results and statements relate only to the item(s) tested.

The measurement system and techniques presented in this evaluation are proposed in the ANSI standard as a means of best approximating wireless device compatibility with a hearing-aid. The literature is under continual re-construction.



<b>FCC ID:</b> A3LSMG890A	 <b>PCTEST</b> ENGINEERING LABORATORY, INC.	<b>HAC (T-COIL) TEST REPORT</b>		<b>Reviewed by:</b> Quality Manager
<b>Filename:</b> 0Y1504030668.A3L	<b>Test Dates:</b> 04/06/2015 - 04/11/2015	<b>EUT Type:</b> Portable Handset		Page 52 of 57

## 12. REFERENCES

1. ANSI C63.19-2011, American National Standard for Methods of Measurement of Compatibility between Wireless communication devices and Hearing Aids.", New York, NY, IEEE, May 2011
2. FCC Office of Engineering and Technology KDB, "285076 D01 HAC Guidance v04," October 31, 2013
3. FCC Office of Engineering and Technology KDB, "285076 D02 T-Coil Testing for CMRS IP v01r01," October 31, 2013
4. FCC Public Notice DA 06-1215, *Wireless Telecommunications Bureau and Office of Engineering and Technology Clarify Use of Revised Wireless Phone Hearing Aid Compatibility Standard*, June 6, 2006
5. FCC 3G Review Guidance, Laboratory Division OET FCC, May/June 2006
6. Berger, H. S., "Compatibility Between Hearing Aids and Wireless Devices," Electronic Industries Forum, Boston, MA, May, 1997
7. Berger, H. S., "Hearing Aid and Cellular Phone Compatibility: Working Toward Solutions," *Wireless Telephones and Hearing Aids: New Challenges for Audiology*, Gallaudet University, Washington, D.C., May, 1997 (To be reprinted in the American Journal of Audiology).
8. Berger, H. S., "Hearing Aid Compatibility with Wireless Communications Devices," IEEE International Symposium on Electromagnetic Compatibility, Austin, TX, August, 1997.
9. Bronaugh, E. L., "Simplifying EMI Immunity (Susceptibility) Tests in TEM Cells," in the 1990 IEEE International Symposium on Electromagnetic Compatibility Symposium Record, Washington, D.C., August 1990, pp. 488-491
10. Byrne, D. and Dillon, H., The National Acoustics Laboratory (NAL) New Procedure for Selecting the Gain and Frequency Response of a Hearing Aid, *Ear and Hearing* 7:257-265, 1986.
11. Crawford, M. L., "Measurement of Electromagnetic Radiation from Electronic Equipment using TEM Transmission Cells," U.S. Department of Commerce, National Bureau of Standards, NBSIR 73-306, Feb. 1973.
12. Crawford, M. L., and Workman, J. L., "Using a TEM Cell for EMC Measurements of Electronic Equipment," U.S. Department of Commerce, National Bureau of Standards. Technical Note 1013, July 1981.
13. EHIMA GSM Project, Development phase, Project Report (1<sup>st</sup> part) Revision A. Technical-Audiological Laboratory and Telecom Denmark, October 1993.
14. EHIMA GSM Project, Development phase, Part II Project Report. Technical-Audiological Laboratory and Telecom Denmark, June 1994.
15. EHIMA GSM Project Final Report, Hearing Aids and GSM Mobile Telephones: Interference Problems, Methods of Measurement and Levels of Immunity. Technical-Audiological Laboratory and Telecom Denmark, 1995.

FCC ID: A3LSMG890A		HAC (T-COIL) TEST REPORT		Reviewed by: Quality Manager
Filename: 0Y1504030668.A3L	Test Dates: 04/06/2015 - 04/11/2015	EUT Type: Portable Handset		Page 53 of 57

16. HAMPIS Report, Comparison of Mobile phone electromagnetic near field with an upscaled electromagnetic far field, using hearing aid as reference, 21 October 1999.
17. Hearing Aids/GSM, Report from OTWIDAM, Technical-Audiological Laboratory and Telecom Denmark, April 1993.
18. IEEE 100, The Authoritative Dictionary of IEEE Standards Terms, Seventh Edition.
19. Joyner, K. H., et. al., Interference to Hearing Aids by the New Digital Mobile Telephone System, Global System for Mobile (GSM) Communication Standard, National Acoustic Laboratory, Australian Hearing Series, Sydney 1993.
20. Joyner, K. H., et. al., Interference to Hearing Aids by the Digital Mobile Telephone System, Global System for Mobile Communications (GSM), NAL Report #131, National Acoustic Laboratory, Australian Hearing Series, Sydney, 1995.
21. Kecker, W. T., Crawford, M. L., and Wilson, W. A., "Construction of a Transverse Electromagnetic Cell", U.S. Department of Commerce, National Bureau of Standards, Technical Note 1011, Nov. 1978.
22. Konigstein, D., and Hansen, D., "A New Family of TEM Cells with enlarged bandwidth and Optimized working Volume," in the Proceedings of the 7<sup>th</sup> International Symposium on EMC, Zurich, Switzerland, March 1987; 50:9, pp. 127-132.
23. Kuk, F., and Hjorstgaard, N. K., "Factors affecting interference from digital cellular telephones," Hearing Journal, 1997; 50:9, pp 32-34.
24. Ma, M. A., and Kanda, M., "Electromagnetic Compatibility and Interference Metrology," U.S. Department of Commerce, National Bureau of Standards, Technical Note 1099, July 1986, pp. 17-43.
25. Ma, M. A., Sreenivashiah, I. , and Chang, D. C., "A Method of Determining the Emission and Susceptibility Levels of Electrically Small Objects Using a TEM Cell," U.S. Department of Commerce, National Bureau of Standards, Technical Note 1040, July 1981.
26. McCandless, G. A., and Lyregaard, P. E., Prescription of Gain/Output (POGO) for Hearing Aids, Hearing Instruments 1:16-21, 1983
27. Skopec, M., "Hearing Aid Electromagnetic Interference from Digital Wireless Telephones," IEEE Transactions on Rehabilitation Engineering, vol. 6, no. 2, pp. 235-239, June 1998.
28. Technical Report, GSM 05.90, GSM EMC Considerations, European Telecommunications Standards Institute, January 1993.
29. Victorian, T. A., "Digital Cellular Telephone Interference and Hearing Aid Compatibility—an Update," Hearing Journal 1998; 51:10, pp. 53-60
30. Wong, G. S. K., and Embleton, T. F. W., eds., AIP Handbook of Condenser Microphones: Theory, Calibration and Measurements, AIP Press.

<b>FCC ID:</b> A3LSMG890A		<b>HAC (T-COIL) TEST REPORT</b>		<b>Reviewed by:</b> Quality Manager
<b>Filename:</b> 0Y1504030668.A3L	<b>Test Dates:</b> 04/06/2015 - 04/11/2015	<b>EUT Type:</b> Portable Handset	Page 54 of 57	