



HCT Co., Ltd.

74, Seoicheon-ro 578beon-gil, Majang-myeon, Icheon-si, Gyeonggi-do, 17383 KOREA

Tel. +82 31 645 6300 Fax. +82 31 645 6401

HAC T-COIL Test Report

Applicant Name:

SAMSUNG Electronics Co., Ltd.

129, Samsung-ro, Yeongtong-gu, Suwon-Si, Gyeonggi-do,
16677 Rep. of Korea

Date of Issue: May. 26, 2022

Test Report No.: HCT-SR-2204-FC003-R2

Test Site: HCT CO., LTD.

FCC ID

A3LSMG736U

Equipment Type:

Mobile Phone

Application Type

Certification

FCC Rule Part(s):

CFR §20.19 , ANSI C63.19-2011

Model Name:

SM-G736U

Additional Model Name:

SM-G736U1

Date of Test:

Mar. 28, 2022 ~ Apr 25, 2022

**C63.19-2011
HAC Category**

T3 (T-COIL CATEGORY)

This wireless portable device has been shown to be hearing-aid compatible under the above rated category, specified in ANSI/IEEE Std. C63.19-2011 and had been tested in accordance with the specified measurement procedures. Hearing-Aid Compatibility is based on the assumption that all production units will be designed electrically identical to the device tested in this report.

I attest to the accuracy of data. All measurements reported herein were performed by me or were made under my supervision and are correct to the best of my knowledge and belief. I assume full responsibility for the completeness of these measurements and vouch for the qualifications of all persons taking them.

Tested By

**Hui-Jun, Yun
Test Engineer
SAR Team
Certification Division**

Reviewed By

**Yun-jeang, Heo
Technical Manager
SAR Team
Certification Division**

This report only responds to the tested sample and may not be reproduced, except in full, without written approval of the HCT Co., Ltd.

REVISION HISTORY

The revision history for this test report is shown in table.

Revision No.	Date of Issue	Description
0	May. 16, 2022	Initial Release
1	May 20, 2022	Revised Page 6.
2	May 26, 2022	Revised Page 11, 12

This test results were applied only to the test methods required by the standard.

The above Test Report is not related to the accredited test result by (KS Q) ISO/IEC 17025 and KOLAS(Korea Laboratory Accreditation Scheme), which signed the ILAC-MRA.

Table of Contents

1. Test Regulations	4
2. ATTESTATION OF TEST RESULT OF DEVICE UNDER TEST	5
3. DEVICE UNDER TEST DESCRIPTION.....	6
4. Test Methodology	7
5. Measuring Instrument Calibraion	8
6. Measurement Uncertainty.....	9
7. Test Procedures for all Technologies	10
8. Audio Level and Gain Measurements.....	14
9 T-coil Measurement Criteria	16
10. Device Under Test.....	18
11. Air Interfaces and Operating Mode	19
12. HAC (T-coil) Test Results	19
Attachment 1. HAC T-COIL Test Plots	38
Attachment 2. HAC T-Coil Probe Certificates	213

1. Test Regulations

The tests were performed according to the following regulations:

Test Standard	FCC 47 CFR §20.19 ANSI C63.19-2011
Test Method	<ul style="list-style-type: none">• FCC CFR47 Part 20.19• ANSI C63.19 2011-version• FCC KDB 285076 D01 HAC Guidance v06• FCC KDB 285076 D02 T Coil testing v04• FCC KDB 285076 D03 HAC FAQ v01r05

2. ATTESTATION OF TEST RESULT OF DEVICE UNDER TEST

Test Laboratory	
Company Name:	HCT Co., LTD
Address:	74, Seoicheon-ro 578beon-gil, Majang-myeon, Icheon-si, Gyeonggi-do, 17383, Rep. of Korea
Telephone:	+82 31 645 6300
Fax.:	+82 31 645 6401

Attestation of SAR test result	
Applicant Name:	SAMSUNG Electronics Co., Ltd.
Model Name:	SM-G736U
Additional Model Name:	SM-G736U1
EUT Type:	Mobile Phone
Application Type:	Certification

2.1 Test Methodology

The Tests document in this report were performed in accordance with ANSI C63.19-2011 method of Measurement of Compatibility between Wireless Communication Devices and Hearing Aids, FCC published KDB 285076 D01 HAC Guidance v06, FCC published KDB 285076 D02 HAC T-Coil Testing v04, FCC Published KDB285076 D03 HAC FAQ v01r05 and TCB Workshop updates .

3. DEVICE UNDER TEST DESCRIPTION

3.1 DUT specification

Device Wireless specification overview		
Band & Mode	Operating Mode	Tx Frequency
GSM850	Voice / Data	824.2 MHz ~ 848.8 MHz
GSM1900	Voice / Data	1 850.2 MHz ~ 1 909.8 MHz
UMTS Band 5	Voice / Data	826.4 MHz ~ 846.6 MHz
UMTS Band 4	Voice / Data	1 712.4 MHz ~ 1 752.6 MHz
UMTS Band 2	Voice / Data	1 852.4 MHz ~ 1 907.6 MHz
LTE Band 2 (PCS)	Voice / Data	1 850.7 MHz ~ 1 909.3 MHz
LTE Band 4 (AWS)	Voice / Data	1 710.7 MHz ~ 1 754.3 MHz
LTE Band 5 (Cell)	Voice / Data	824.7 MHz ~ 848.3 MHz
LTE Band 7	Voice / Data	2 502.5 MHz ~ 2 567.5 MHz
LTE Band 12	Voice / Data	699.7 MHz ~ 715.3 MHz
LTE Band 13	Voice / Data	779.5 MHz ~ 784.5 MHz
LTE Band 14	Voice / Data	790.5 MHz ~ 795.5 MHz
LTE Band 25	Voice / Data	1 850.7 MHz ~ 1 914.3 MHz
LTE Band 26	Voice / Data	814.7 MHz ~ 848.3 MHz
LTE Band 30	Voice / Data	2 307.5 MHz ~ 2 312.5 MHz
LTE TDD Band 38	Voice / Data	2 572.5 MHz ~ 2 617.5 MHz
LTE TDD Band 40	Voice / Data	2 302.5 MHz ~ 2 397.5 MHz
LTE TDD Band 41	Voice / Data	2 498.5 MHz ~ 2 687.5 MHz
LTE TDD Band 48	Voice / Data	3 552.5 MHz ~ 3 697.5 MHz
LTE Band 66 (AWS)	Voice / Data	1 710.7 MHz ~ 1 779.3 MHz
LTE Band 71	Voice / Data	665.5 MHz ~ 695.5 MHz
NR Band n2	Voice / Data	1 852.5 MHz ~ 1 907.5 MHz
NR Band n5	Voice / Data	826.5 MHz ~ 846.5 MHz
NR Band n12	Voice / Data	701.5 MHz ~ 713.5 MHz
NR Band n25	Voice / Data	1 852.5 MHz ~ 1 912.5 MHz
NR Band n30	Voice / Data	2 307.5 MHz ~ 2 312.5 MHz
NR Band n41	Voice / Data	2 506.02 MHz ~ 2 679.99 MHz
NR Band n66	Voice / Data	1 712.5 MHz ~ 1 777.5 MHz
NR Band n71	Voice / Data	665.5 MHz ~ 695.5 MHz
NR Band n77	Voice / Data	3 705 MHz ~ 3 975 MHz
NR Band n77 (DoD)	Voice / Data	3 455.04 MHz ~ 3 544.98 MHz
U-NII-1	Voice / Data	5 180 MHz ~ 5 240 MHz
U-NII-2A	Voice / Data	5 260 MHz ~ 5 320 MHz
U-NII-2C	Voice / Data	5 500 MHz ~ 5 720 MHz
U-NII-3	Voice / Data	5 745 MHz ~ 5 825 MHz
U-NII-5	Data	5 955 MHz ~ 6 425 MHz
U-NII-6	Data	6 425 MHz ~ 6 525 MHz
U-NII-7	Data	6 525 MHz ~ 6 875 MHz
U-NII-8	Data	6 875 MHz ~ 7 115 MHz
2.4 GHz WLAN	Voice / Data	2 412 MHz ~ 2 462 MHz
Bluetooth / LE 5.2	Data	2 402 MHz ~ 2 480 MHz
NFC	Data	13.56 MHz

4. Test Methodology

The tests documented in this report were performed in accordance with ANSI C63.19-2011 Methods of Measurement of Compatibility between Wireless Communications Devices and Hearing Aids and FCC published procedure

KDB 285076 D01 HAC Guidance v06

KDB 285076 D03 HAC FAQ v01r05

TCB workshop updates

KDB 285076 D02 T-Coil testing v04

5. Measuring Instrument Calibraion

The measuring equipment used to perform the tests documented in this report has been calibrated in accordance with the manufacturers' recommendations and is traceable to recognized national standards.

Name of Equipment	Manufacturer	Type/Model	Serial No.	Cal. Due Date
ABM Probe	SPEAG	AM1DV3	3050	11/23/2022
ABM Probe	SPEAG	AM1DV3	3049	06/01/2022
Data Acquisition Electronics	SPEAG	DAE4	652	01/24/2023
Data Acquisition Electronics	SPEAG	DAE4	1417	02/24/2023
DAC	Sound Devices	USBPre 2	HB1318341009	N/A
Radio Communication Tester	R & S	CMW 500	167916	10/22/2022
Radio Communication Tester	R & S	CMW 500	167918	04/15/2023
Radio Communication Tester	R & S	CMW 500	127521	05/03/2022
USB Audio Module	KEYSIGHT	U8903B-UAM	101006	N/A
UXM 5G Wireless Test Set	KEYSIGHT	E7515B	MY58460166	08/11/2022

6. Measurement Uncertainty

Measurement Uncertainty for Audio Band Magnetic Measurement

Error Description	Uncertainty values (±%)	Probe Dist.	Div.	C _i ABM1	C _i ABM2	Std. Unc.	
						ABM1 (±%)	ABM2 (±%)
Probe Sensitivity							
ReFeRence Level	3.00	N	1	1	1	3.00	3.00
AMCC Geometry	0.40	R	1.73	1	1	0.23	0.23
AMCC Current	1.00	R	1.73	1	1	0.58	0.58
Porbe Positioning during Calibr.	0.10	R	1.73	1	1	0.06	0.06
Noise Contribution	0.70	R	1.73	0.0143	1	0.01	0.40
Frequency Slope	5.90	R	1.73	0.1	1	0.34	3.41
Probe System							
Repeatability / Drift	1.00	R	1.73	1	1	0.58	0.58
Linearity / Dynamic Range	0.60	R	1.73	1	1	0.35	0.35
Acoustic Noise	1.00	R	1.73	0.1	1	0.06	0.58
Probe Angle	2.30	R	1.73	1	1	1.33	1.33
Spectral Processing	0.90	R	1.73	1	1	0.52	0.52
Integration Time	0.60	N	1.00	1	5	0.60	3.00
Field Disturbation	0.20	R	1.73	1	1	0.12	0.12
Test Signal							
Ref. Signal Spectral Response	0.60	R	1.73	0	1	0.00	0.35
Positioning							
Probe Positioning	1.90	R	1.73	1	1	1.10	1.10
Phantom Thickness	0.90	R	1.73	1	1	0.52	0.52
DUT Positioning	1.90	R	1.73	1	1	1.10	1.10
External Contributions							
RF Interference	0.00	R	1.73	1	0.3	0.00	0.00
Test Signal Variation	2.00	R	1.73	1	1	1.2	1.2
Combined Std. Uncertainty (ABM field)						4.1	6.1
Expanded Std. Uncertainty (%)						8.1	12.3
Notes for table N - Nomal R - Rectangular Div. - Divisor used to obtain standard uncertainty							

7. Test Procedures for all Technologies

7.1 General Procedures C63.19-2011, Section 7

ANSI C63.19-2011, Section 7

This document describes the procedures used to measure the ABM (T-Coil) performance of the WD.

In addition to measuring the absolute signal levels, the A-weighted magnitude of the unintended signal shall also be determined. In order to assure that the required signal quality is measured, the measurement of the intended signal and the measurement of the unintended signal must be made at the same location for all measurement positions. In addition, the RF field strength at each measurement location must be at or below that required for the assigned category.

Measurements shall not include undesired properties from the WD's RF field; therefore, use of a coaxial connection to a base station simulator or non-radiating load may be necessary. However, even then with a coaxial connection to a base station simulator or non-radiating load there may still be RF leakage from the WD, which may interfere with the desired measurement. Pre-measurement checks should be made to avoid this possibility. All measurements shall be done with the WD operating on battery power with an appropriate normal speech audio signal input level given in Table 7.1. If the device display can be turned off during a phone call then that may be done during the measurement as well.

Measurements shall be performed at two locations specified in A.3, with the correct probe orientation for a particular location, in a multistage sequence by first measuring the field intensity of the desired T-Coil signal (ABM1) that is useful to a hearing aid T-Coil. The undesired magnetic components (ABM2) must be measured at the same location as the desired ABM or T-Coil signal (ABM1), and the ratio of desired to undesired ABM signals must be calculated. For the perpendicular field location, only the ABM1 frequency response shall be determined in a third measurement stage. The flow chart in Figure 7.3 illustrates this three-stage, two orientation process.

The following steps summarize the basic test flow for determining ABM1 and ABM2. These steps assume that a sine wave or narrowband 1/3 octave signal can be used for the measurement of ABM1.

A validation of the test setup and instrumentation may be performed using a TMFS or Helmholtz coil. Measure the emissions and confirm that they are within the specified tolerance.

Position the WD in the test setup and connect the WD RF connector to a base station simulator or a non-radiating load as shown in Figure 7.1 or Figure 7.2. Confirm that equipment that requires calibration has been calibrated, and that the noise level meets the requirements given in 7.3.1.

The drive level to the WD is set such that the reference input level specified in Table 7.1 is input to the base station simulator (or manufacturer's test mode equivalent) in the 1 kHz, 1/3 octave band. This drive level shall be used for the T-Coil signal test (ABM1) at $f = 1$ kHz. Either a sine wave at 1025 Hz or a voice-like signal, band-limited to the 1 kHz 1/3 octave, as defined in 7.4.2, shall be used for the reference audio signal.

If interference is found at 1025 Hz an alternative nearby reference audio signal frequency may be used.

The same drive level will be used for the ABM1 frequency response measurements at each 1/3 octave band center frequency. The WD volume control may be set at any level up to maximum, provided that a signal at any frequency at maximum modulation would not result in clipping or signal overload.

Determine the magnetic measurement locations for the WD device (A.3), if not already specified by the manufacturer, as described in 7.4.4.1.1 and 7.4.4.2.

At each measurement location, measure and record the desired T-Coil magnetic signals (ABM1 at f_i) as described in 7.4.4.2 in each individual ISO 266-1975 R10 standard 1/3 octave band. The desired audio band input frequency (f_i) shall be centered in each 1/3 octave band maintaining the same drive level as determined in item c) and the reading taken for that band.

Equivalent methods of determining the frequency response may also be employed, such as fast Fourier transform (FFT) analysis using noise excitation or input-output comparison using simulated speech.

The full-band integrated or half-band integrated probe output, as specified in D.9, may be used, as long as the appropriate calibration curve is applied to the measured result, so as to yield an accurate measurement of the field magnitude. (The resulting measurement shall be an accurate measurement in dB A/m.)

All measurements of the desired signal shall be shown to be of the desired signal and not of an undesired signal. This may be shown by turning the desired signal ON and OFF with the probe measuring the same location. If the scanning method is used the scans shall show that all measurement points selected for the ABM1 measurement meet the ambient and test system noise criteria in 7.3.1.

At the measurement location for each orientation, measure and record the undesired broadband audio magnetic signal (ABM2) as specified in 7.4.4.4 with no audio signal applied (or digital zero applied, if appropriate) using A-weighting and the half-band integrator. Calculate the ratio of the desired to undesired signal strength (i.e., signal quality).

Obtain the data from the postprocessor, SEMCAD, and determine the category that properly classifies the signal quality based on Table 8.5.

Test Setup Diagram

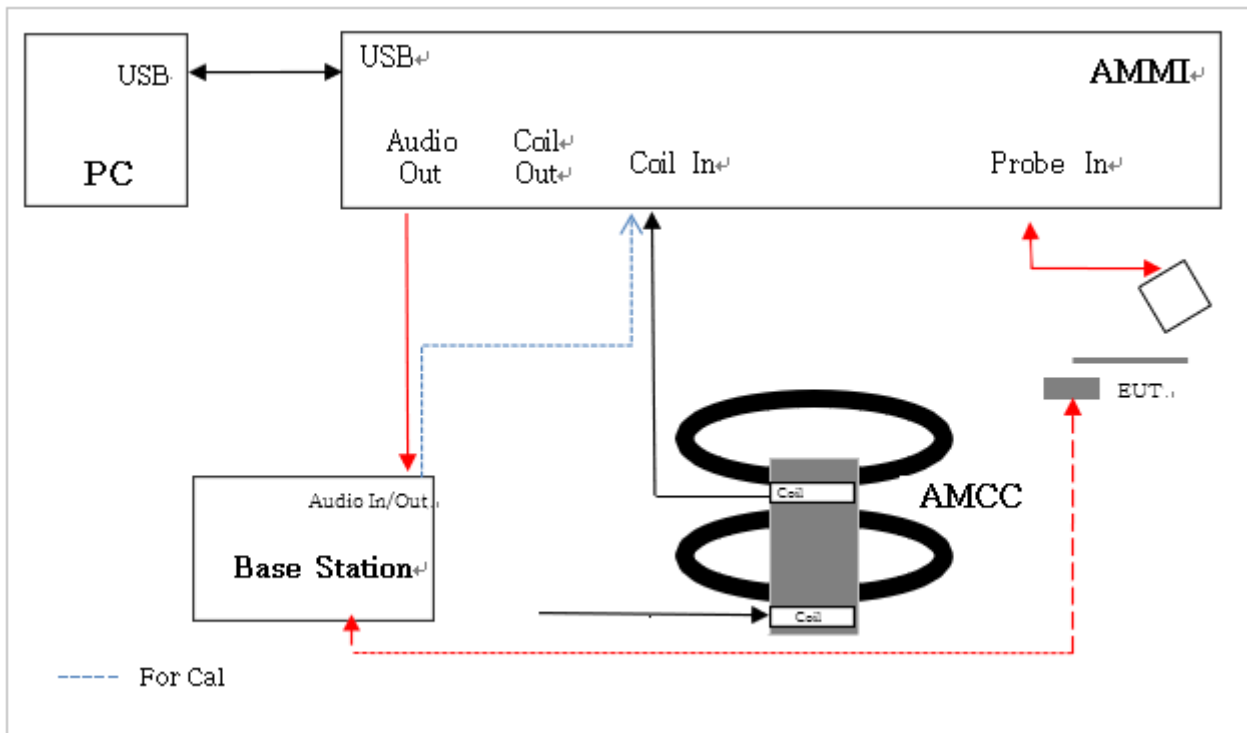

7.2 VoWiFi

This device supports Wi-Fi calling (aka Voice over Wi-Fi or VoWiFi) which is an extended feature of the carriers CMRS service to offload VoLTE calls onto local area networks over WI-FI via the internet and subject to HAC assessment for phones with a HAC rating.

The set up for VoWiFi uses the Base station as described in section 7.1 with the exception that the reference audio level is set at -20dBm0. The reference level is calibrated using the standard call box calibration procedures with the exception of the -20dBm0 reference level being used (refer to section 8.4).

An investigation was performed to determine worst case codec, bit rate and air interface configuration (refer to sections 12.5 and 12.6).

7.3 Over the Top(OTT)

This device supports VoIP via a preinstalled application that uses the Google Duo service, using OPUS as its only codec (refer to §11 for air interface details and §12.7 for codec bit rates). VoIP capabilities require HAC assessment when voice calls are supported over the cellular data connection via pre-installed VoIP applications.

The equipment is set up as shown below with a support device used to originate the call using the IP transport. The support device connects to the cloud-based Google Duo service via Wi-Fi access point and router, or RJ45. The DUT connects to the VoIP service via a cellular/unlicensed air interface to the call box and an Ethernet connection from call box to Internet. The various codec bit rate and air interface configurations are evaluated to determine the worst-case configuration (refer to §12.7).

Test Setup configuration for OTT calls

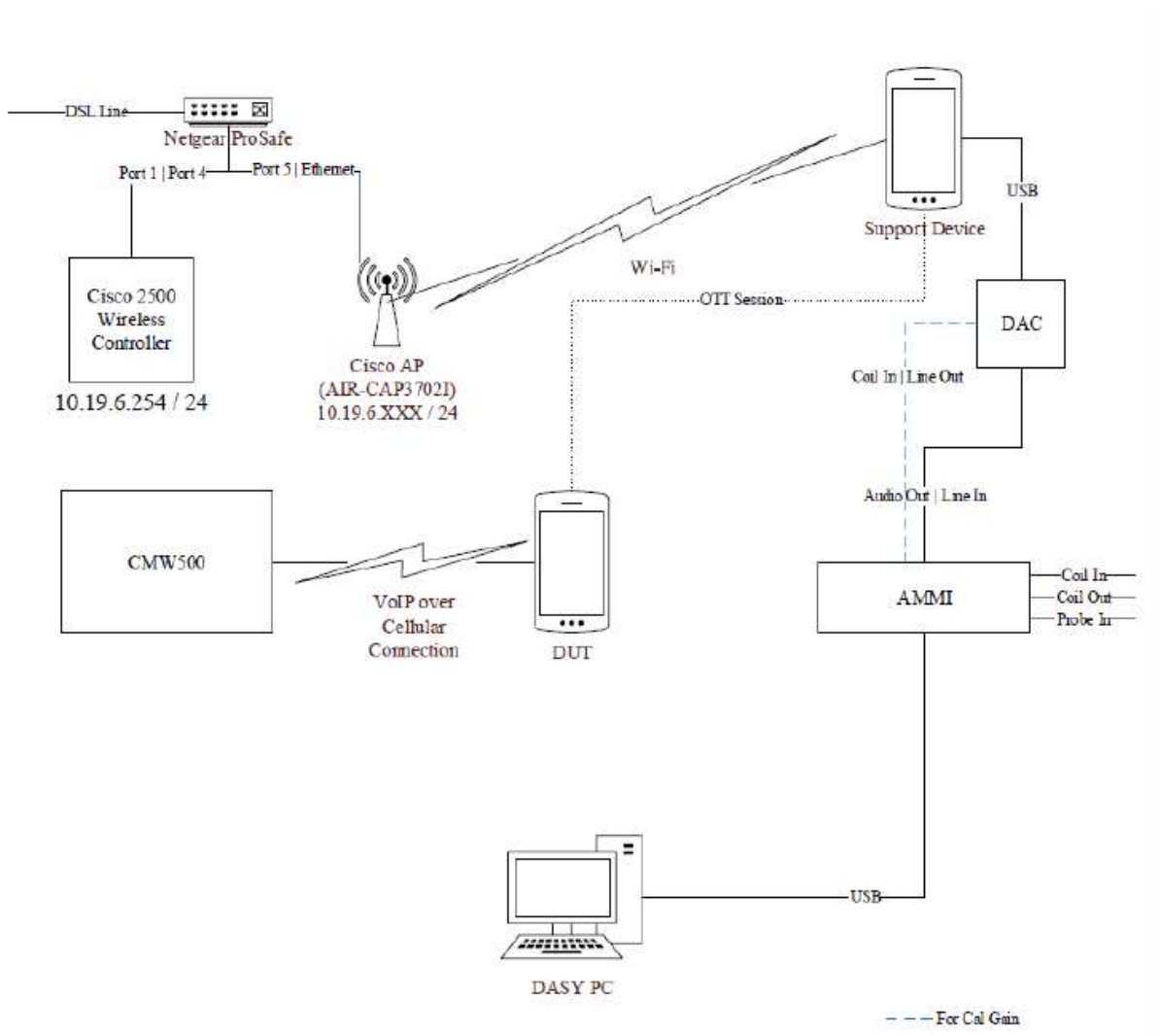

For the OTT call, the calibrated audio card within the CMW500 cannot be used so the AMMI is connected to an external Digital-Analog Converter (DAC) and the DAC is connected to the Support Device via USB. The test signal is sent from the DASY PC to the AMMI, from the AMMI to the DAC, from the DAC to the Support Device, and, via the VoIP call, to the DUT.

As this test set up uses an external DAC between the AMMI's audio output and support device, the appropriate gain factor for the OTT call needs be determined. This is done by connecting the DAC between the AMMI Audio output and Coil input as shown below.

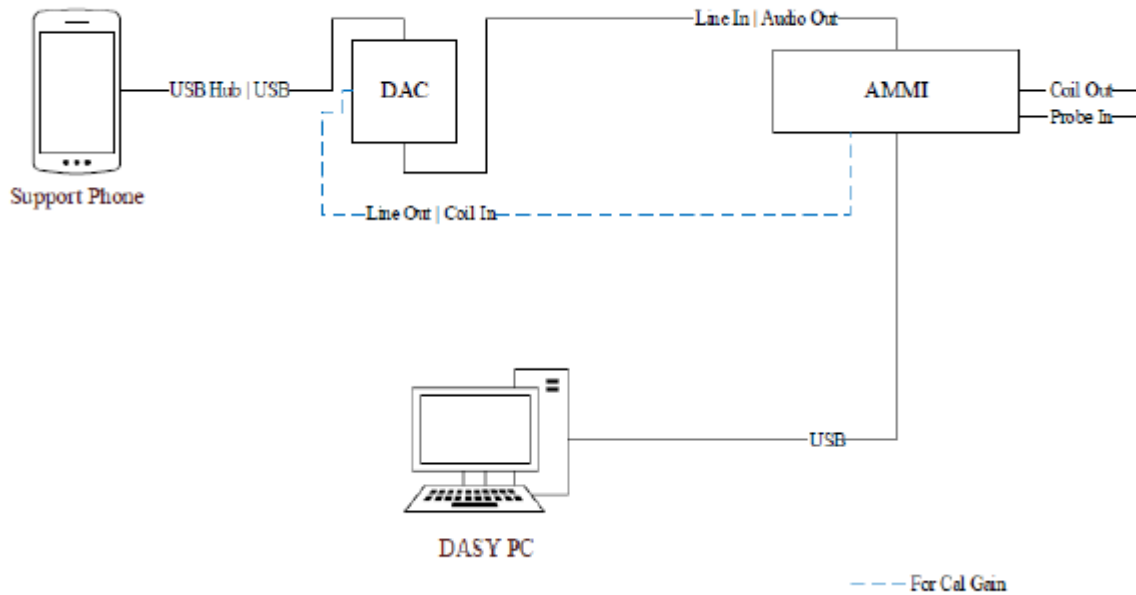

Using the metering function on the DAC, the DAC gain is adjusted until the volume reaches 0 dBFS (3.14 dBm0 based on TIA/EIA 810-A). SPEAG's "TN-LK-05042018-C-T-Coil_Levels" document (Appendix E) steps E through H are then followed to determine the adjusted gain values as detailed in §8.5 so that the reference level is set to 23.14dB below full scale, i.e. at -20dBm0. A verification of the DAC's output is performed prior to testing

8. Audio Level and Gain Measurements

8.1 GSM

Refer to the below table for the gains used to measure GSM.

Signal Type	Audio Level [dBm]	Gain [dB]	Gain [linear]
Voice 1 kHz	-16	27.75	24.35
Voice 300 - 3 kHz	-19	34.46	52.32

8.2 W-CDMA

Refer to the below table for the gains used to measure W-CDMA.

Signal Type	Audio Level [dBm]	Gain [dB]	Gain [linear]
Voice 1 kHz	-16	27.75	24.35
Voice 300 - 3 kHz	-19	34.46	52.32

8.3 VOLTE

Refer to the below table for the gains used to measure VoLTE.

The following software/firmware was used to simulate the VoLTE server for testing:

Firmware	License Keys	Software Name
V3.7.30 for LTE	KS500 KS550	LTE FDD R8 SIG BASIC LTE TDD R8 SIG BASIC
V3.7.20 for Audio	KA100 KA150 KAA20 KM050 KS104	IP APPL ENABLING IPv4 IP APPL ENABLING IPv6 IP APPL IMS BASIC DATA APPL MEAS EVS SPEECH CODEC

Signal Type	Audio Level [dBm]	Gain [dB]	Gain [linear]
Voice 1 kHz	-16	27.76	24.38
Voice 300 - 3 kHz	-19	34.47	52.36

8.4 VoWi-Fi

Refer to the below table for the gains used to measure VoWi-Fi.

Firmware	License Keys	Software Name
V3.7.40 for WLAN	KS650	WLAN A/B/G SIG BASIC
	KS651	WLAN N SIG BASIC
	KS656	WLAN IEEE 802.11ac
	KS657	WLAN IEEE 802.11ax
V3.7.20 for Audio	KA100	IP APPL ENABLING IPv4
	KA150	IP APPL ENABLING IPv4
	KAA20	IP APPL IMS BASIC
	KM050	DATA APPL MEAS
	KS104	EVS SPEECH CODEC

Signal Type	Audio Level [dBm]	Gain [dB]	Gain [linear]
Voice 1 kHz	-20	24.13	16.04
Voice 300 - 3 kHz	-20	33.84	48.75

8.5 Over the Top(OTT)

For EDGE, HSPA, LTE, NR and Wi-Fi the linear gain levels listed below were used. The results below are based on a reference input level of -20 dBm.

To calibrate the DAC (refer §7.3), three. Way audio files (sine wave, 1 kHz voice, and 300 to 3 kHz voice) are sent from the DASY5 PC to the AMMI, then to the DAC. The Helmholtz resonator measures the field strength, which represents the AMMI to DAC input sensitivity. After determining the input sensitivity, the adjusted linear gain values can then be calculated.

Signal Type	Audio Level [dBm]	Gain [dB]	Gain [linear]
Voice 1 kHz	-20	25.66	19.15
Voice 300-3 kHz	-20	35.37	58.25

9 T-coil Measurement Criteria

9.1 Frequency Responses

The frequency response of the axial component of the magnetic field, measured in 1/3 octave bands, shall follow the response curve, over the frequency range 300 Hz to 3000 Hz.

Figure 8.1 and Figure 8.2 provide the boundaries for the specified frequency. These response curves are for true field strength measurements of the T-Coil signal. Thus the 6 dB/octave probe response has been corrected from the raw readings.

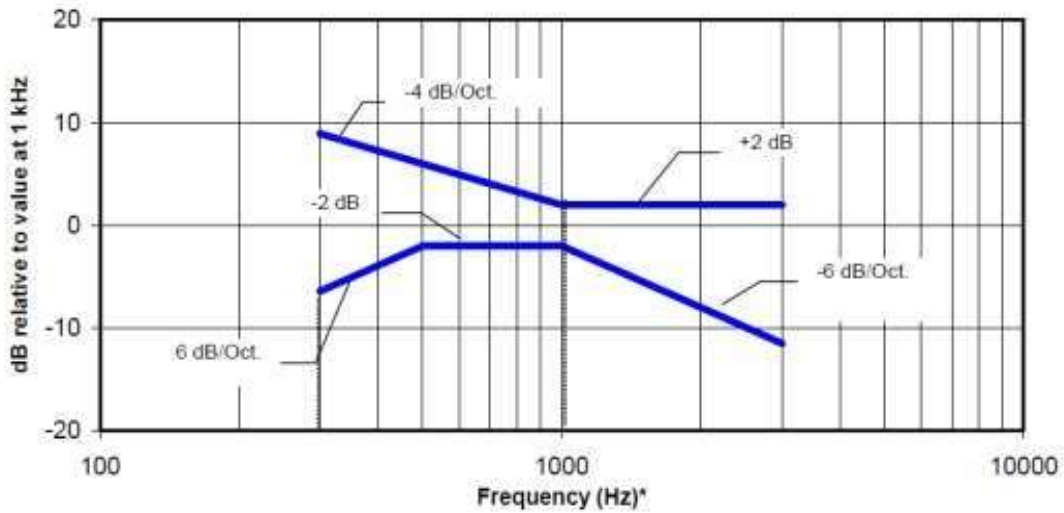

NOTE—The frequency response is between 300 Hz and 3000 Hz.

Figure 8.1—Magnetic field frequency response for WDs with field strength ≤ -15 dB (A/m) at 1 kHz

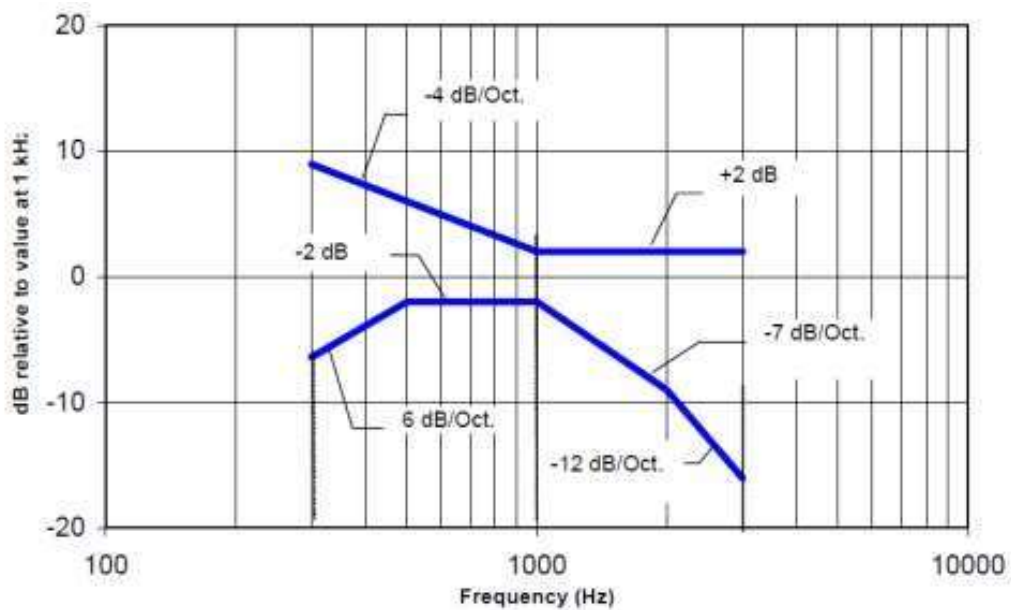

NOTE—The frequency response is between 300 Hz and 3000 Hz.

Figure 8.2—Magnetic field frequency response for WDs with a field that exceeds -15 dB(A/m) at 1 kHz

9.2 Signal to Noise

This specifies the signal-to-noise quality requirement for the intended T-Coil signal from a WD. The worst signal to noise of the two T-Coil signal measurements, as determined in Clause 7, shall be used to determine the T-Coil mode category per Table 8.5.

Only the RF immunity of the hearing aid is measured in T-Coil mode. It is assumed that a hearing aid can have no immunity to an interference signal in the audio band, which is the intended reception band for this mode. So, the only criterion that can be measured is the RF immunity in T-Coil Mode. This is measured using the same procedure as for the audio coupling mode and at the same levels as specified in 6.4.

Category	Telephone parameters WD signal quality [(signal+noise)-to-noise ratio in decibels]
Category T1	0 dB to 10 dB
Category T2	10 dB to 20 dB
Category T3	20 dB to 30 dB
Category T4	> 30 dB

Table 8.5- T-Coil signal-to-noise categories

Measurement locations and reference plane to be used for the T-coil measurements.

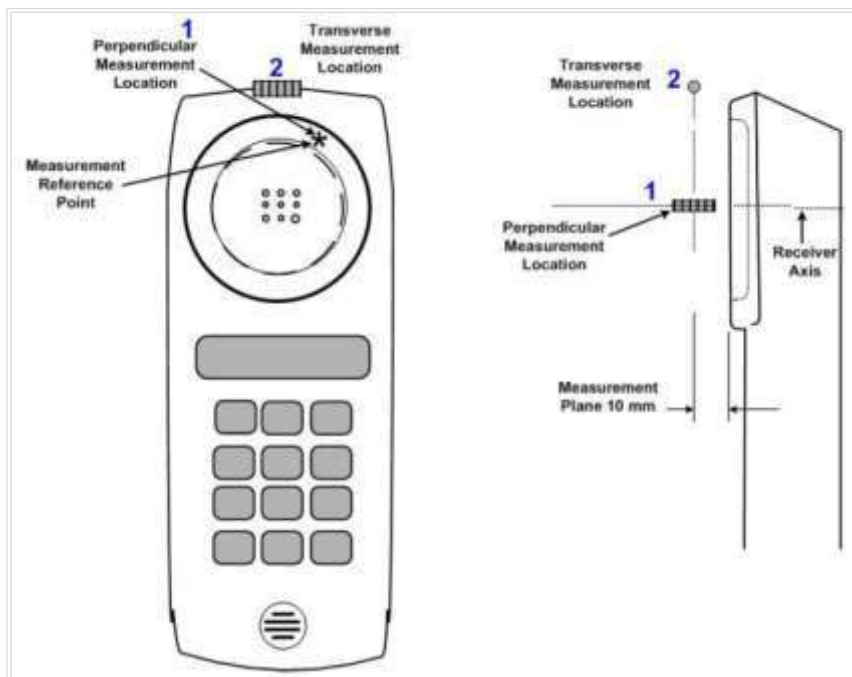

10. Device Under Test

Normal operation	Held to head	
Back Cover	The Back Cover is removable	
Test sample information	S/N	Notes
	VCO1256M	T-coil Test
	VCO1310M	T-coil Test
	VDB1837M	T-coil Test

11. Air Interfaces and Operating Mode

Air Interface	Bands (MHz)	Type	C63.19 Tested	Simultaneous Transmitter	Audio Codecs Evaluated	
GSM	850	VO	Yes	Wi-Fi, BT	EFR	
	1900					
	GPRS/EDGE	VD	Yes	Wi-Fi, BT	OPUS ²	
UMTS (UMTS)	850	VO	Yes	Wi-Fi, BT	AMR-NB & AMR-WB	
	1700					
	1900					
	HSPA	VD	Yes	Wi-Fi, BT	OPUS ²	
LTE - FDD	680(B71)	VD	Yes	Wi-Fi, BT	(AMR-NB, AMR-WB, EVS-NB, EVS-WB) 1 & OPUS ²	
	700 (B12/13/14)					
	850 (B5/26)					
	1700 (B4/66)					
	1900 (B2/25)					
	2300 (B30)					
	2500 (B7)					
LTE - TDD	2600 (B41)	VD	Yes	Wi-Fi, BT	(AMR-NB, AMR-WB, EVS-NB, EVS-WB) 1 & OPUS ²	
	3600 (B48)					
	2600 (B38)					
	2300 (B40)					
NR -FDD	700(B12)	VD	Yes	Wi-Fi, BT	OPUS ²	
	680(B71)					
	850(B5)					
	1700(B66)					
	1900(B2, B25)					
	2300(B30)					
NR -TDD	2600(B41)	VD	Yes	Wi-Fi, BT	OPUS ²	
	3800(B77)		Yes			
	28000 (n261)		No ³			
	39000 (n260)		No ³			
Wi-Fi	2450	VD	Yes	WWAN, Wifi 5GHz	AMR-NB, AMR-WB, EVS-NB, EVS-WB & OPUS ²	
	5200 (U-NII-1)			WWAN and Wifi 2.4GHz, BT		
	5300 (U-NII-2A)					
	5500 (U-NII-2C)			No ³		WWAN and BT
	5800 (U-NII-3)					
	6200(UNII 5)					
	6500(UNII 6)					
	6700(UNII 7)			No ³		WWAN and BT
	7000(UNII 8)					
BT	2450	DT	NA	WWAN and Wifi 5GHz	N/A	
Type: VO: Legacy Cellular Voice Service DT: Digital Transport only (no voice) CMRS: Commercial Mobile Radio Service VD: IP Voice service over Digital Transport				Note: 1. Ref Lev in accordance with the July 2012 VoLTE interpretation 2. Ref Lev -20 dBm0 3. Wifi 6E, n260,n261 are currently outside the scope of ANSI C63.19 and FCC HAC regulations. This DUT dose not support VOmmWave for n260,n261		

12. HAC (T-coil) Test Results

12.1 Codec Investigation

An investigation between the various codec configurations (Low/High bit rates for Narrowband, Wideband) and specific parameters are documented (ABM1, ABM2, S+N/N, frequency response) to determine the worst-case bit rates for each voice service type. The table below compares the varying codec configurations. A codec investigation was performed on one band of each CDMA, GSM, W-CDMA, LTE FDD/TDD.

The highlighted results below were determined to be the worst case codec configuration(s) for CDMA,GSM, W- CDMA and LTE.

Codec Investigation				
Codec State	AMR-NB (kbit/s)		Orientation	Band/ Channel
	FR V1	HR V1		
ABM1 (dB/m)	1.91	1.89	z (Axial)	GSM 850 CH.190
ABM2 (dBA/m)	-23.1	-24.21		
S+N/N (dB)	25.00	26.10		
Freq. Resposne (dB)	1.68	1.45		
ABM1 (dB/m)	-12.96	-12.35	y (Transversal)	
ABM2 (dBA/m)	-38.46	-36.11		
S+N/N (dB)	25.49	23.76		

Codec Investigation								
Codec State	AMR-NB (kbit/s)			AMR-WB (kbit/s)			Orientation	Band/ Bandwidth/ Channel
	4.75	7.4	12.2	6.6	15.85	23.85		
ABM1 (dB/m)	-3.2	0.63	0.37	-0.18	-0.59	1.02	z (Axial)	UMTS Band II Rel.99 CH.9400
ABM2 (dBA/m)	-31.83	-27.88	-27.33	-34.07	-34.00	-32.15		
S+N/N (dB)	28.63	28.51	27.69	33.9	33.42	33.17		
Freq. Resposne (dB)	1.43	1.96	1.92	2.0	2.0	2.0		
ABM1 (dB/m)	-10.65	-9.73	-13.44	-8.17	-7.88	-11.35	y (Transversal)	
ABM2 (dBA/m)	-39.10	-38.09	-40.93	-41.46	-40.92	-44.16		
S+N/N (dB)	28.45	28.36	27.48	33.29	33.04	32.81		

Codec Investigation											
Codec State	AMR-NB (kbit/s)			AMR-WB (kbit/s)			Orientation	Band/ Bandwidth/ Channel			
	4.75	7.4	12.2	6.6	15.85	23.85					
ABM1 (dB/m)	-10.25	-3.28	0.38	-1.95	-3.96	-0.12	z (Axial)	LTE Band 66 132322Ch QPSK 20MHz 1RB 0offset			
ABM2 (dBA/m)	-38.60	-31.80	-27.23	-35.45	-37.26	-33.48					
S+N/N (dB)	28.35	28.53	27.61	33.50	33.31	33.37					
Freq. Resposne(dB)	1.74	1.84	1.89	2.0	2.0	2.0					
ABM1 (dB/m)	-10.76	-13.51	-6.81	-8.02	-8.01	-7.76	y (Transversal)				
ABM2 (dBA/m)	-39.03	-41.70	-34.35	-41.23	-40.98	-40.69					
S+N/N (dB)	28.27	28.19	27.54	33.21	32.97	32.93					

Codec Investigation												
Codec State	EVS-NB (kbit/s)			EVS-WB (kbit/s)			EVS-SWB (kbit/s)			Orientation	Band/ BandWidth/ Channel	
	5.9	13.2	24.4	5.9	24.4	128	9.6	24.4	128			
ABM1 (dB/m)	-5.24	-10.71	-11.06	-4.15	0.90	1.26	-1.47	-4.64	-2.74	z (Axial)	LTE Band 66 132322Ch QPSK 20MHz 1RB 0offset	
ABM2 (dBA/m)	-28.68	-35.71	-36.98	-37.11	-34.41	-33.31	-35.25	-37.90	-35.61			
S+N/N (dB)	23.44	25.00	25.92	32.95	35.31	34.57	33.79	33.22	32.87			
Freq.Resposne(dB)	1.94	2.0	1.94	2.0	2.0	2.0	1.92	2.0	2.0			
ABM1 (dB/m)	-9.44	-9.48	-7.12	-14.37	-7.39	-6.61	-14.18	-9.66	-10.66	y (Transversal)		
ABM2 (dBA/m)	-33.43	-34.26	-32.83	-46.89	-42.29	-40.95	-45.83	-42.40	-43.03			
S+N/N (dB)	23.99	24.79	25.72	32.53	34.91	34.34	31.65	32.74	32.37			

Codec Investigation											
Codec State	AMR-NB (kbit/s)			AMR-WB (kbit/s)			Orientation	Band/ Bandwidth/ Channel			
	4.75	7.4	12.2	6.6	15.85	23.85					
ABM1 (dB/m)	0.16	1.40	1.50	-1.11	-0.74	-0.71	z (Axial)	LTE Band 41 QPSK 20MHz 1RB 0offset 40620ch			
ABM2 (dBA/m)	-27.80	-26.66	-25.90	-33.31	-32.89	-32.74					
S+N/N (dB)	27.95	28.06	27.40	32.20	32.14	32.03					
Freq. Resposne(dB)	1.43	1.92	1.91	2.0	2.0	2.0					
ABM1 (dB/m)	-10.26	-7.78	-7.78	-10.96	-8.65	-10.81	y (Transversal)				
ABM2 (dBA/m)	-38.56	-35.95	-35.15	-43.53	-40.85	-43.03					
S+N/N (dB)	28.30	28.17	27.37	32.57	32.20	32.22					

Codec Investigation												
Codec State	EVS-NB (kbit/s)			EVS-WB (kbit/s)			EVS-SWB (kbit/s)			Orientation	Band/ BandWidth/ Channel	
	5.9	13.2	24.4	5.9	24.4	128	9.6	24.4	128			
ABM1 (dB/m)	-1.14	-0.97	-0.20	-0.88	-0.41	-0.15	-2.86	-1.87	-2.70	z (Axial))	LTE Band 41 QPSK 20MHz 1RB 0offset 40620ch	
ABM2 (dBA/m)	-24.82	-25.64	-25.94	-32.64	-34.24	-33.96	-35.53	-32.78	-35.93			
S+N/N (dB)	23.68	24.67	25.74	31.76	33.83	33.81	32.66	30.91	33.23			
Freq.Resposne(dB)	1.85	1.92	1.97	2.0	2.0	2.0	1.88	2.0	2.0			
ABM1 (dB/m)	-11.91	-7.02	-9.41	-8.57	-10.85	-11.00	-13.67	-13.61	-13.32	y (Transversal)		
ABM2 (dBA/m)	-35.59	-31.62	-35.08	-40.11	-44.64	-44.41	-46.52	-46.79	-46.81			
S+N/N (dB)	23.69	24.59	25.67	31.54	33.80	33.40	32.85	33.17	33.49			

12.2 TDD Configuration

LTE TDD Uplink-Downlink Configuration Investigation for VoLTE over IMS

An investigation was performed to determine the worst-case Uplink-Downlink configuration for VoLTE over IMS T-Coil testing. The effects of UL-DL configuration were found to be independent of band and bandwidth; therefore, only one band and bandwidth were used for this investigation.

Per 3GPP TS 36.211, the total frame length for each TDD radio frame of length $T_f = 307200 \cdot T_s = 10$ ms, where T_s is a number of time units equal to $1/(15000 \times 2048)$ seconds. Additionally, each radio frame consists of 10 subframes, each of length $30720 \cdot T_s = 1$ ms, and subframes can be designated as uplink (U), downlink (D), or special subframe (S), depending on the Uplink-Downlink configuration as indicated in Table 4.2-2 of 3GPP TS 36.211. In the transmission duty factor calculation, the special subframe configuration with the shortest UpPTS duration within the special subframe is used and will be applied for measurement. From 3GPP TS 36.211 Table 4.2-1, the shortest UpPTS is $2192 \cdot T_s$ which occurs in the normal cyclic prefix and special subframe configuration 4.

See table below outlining the calculated transmission duty cycles for each Uplink-Downlink configuration:

Uplink-Downlink Configurations for Type 2 Frame Structures

Uplink-downlink configuration	Downlink-to-Uplink Switch-point periodicity	Subframe number										Calculated Transmission Duty Cycle (%)
		0	1	2	3	4	5	6	7	8	9	
0	5 ms	D	S	U	U	U	D	S	U	U	U	61.4%
1	5 ms	D	S	U	U	D	D	S	U	U	D	41.4%
2	5 ms	D	S	U	D	D	D	S	U	D	D	21.4%
3	10 ms	D	S	U	U	U	D	D	D	D	D	30.7%
4	10 ms	D	S	U	U	D	D	D	D	D	D	20.7%
5	10 ms	D	S	U	D	D	D	D	D	D	D	10.7%
6	5 ms	D	S	U	U	U	D	S	U	U	D	51.4%

Power Class 3 Uplink-Downlink Configuration Investigation

VoLTE over IMS was evaluated with the following radio configuration → channel 40620, 20MHz BW, QPSK, 1RB, 0Offset. all configurations (0-6) are supported. The configuration which resulted in the worst z (Axial), y(Transversal) SNR was used for full testing. Uplink-Downlink configuration 1 was used as the worst-case configuration for VoLTE over IMS T-Coil testing. See table below for the SNR comparison between each Uplink-Downlink configuration:

VoLTE over IMS SNNR by UL-DL Configuration

Frequency [MHz]	Channel	Bandwidth [MHz]	Modulation	RB Size	RB Offset	UL-DL Configuration	ABM1 [dB(A/m)]	ABM2 [dB(A/m)]	Orientation	Freq. Response (dB)	SNR [dB]
2593	40620	20	QPSK	1	0	0	-1.14	-24.82	z (Axial)	1.85	23.68
2593	40620	20	QPSK	1	0	1	-0.92	-24.45		1.87	23.53
2593	40620	20	QPSK	1	0	2	-3.04	-29.56		2.00	26.52
2593	40620	20	QPSK	1	0	3	-0.06	-26.59		1.89	26.53
2593	40620	20	QPSK	1	0	4	-4.78	-31.25		2.00	26.47
2593	40620	20	QPSK	1	0	5	0.67	-26.13		2.00	26.80
2593	40620	20	QPSK	1	0	6	0.12	-26.57		1.88	26.69
2593	40620	20	QPSK	1	0	0	-11.91	-35.59	y (Transversal)		23.69
2593	40620	20	QPSK	1	0	1	-6.34	-30.52			24.18
2593	40620	20	QPSK	1	0	2	-9.07	-33.34			24.27
2593	40620	20	QPSK	1	0	3	-9.46	-33.84			24.38
2593	40620	20	QPSK	1	0	4	-10.13	-34.25			24.12
2593	40620	20	QPSK	1	0	5	-6.87	-31.12			24.25
2593	40620	20	QPSK	1	0	6	-6.79	-31.24		24.46	

Per the investigations above, UL-DL Configuration 1 was used to evaluate VoLTE over IMS

12.3 Air Interface Investigation

Use the worst-case codec test and document a limited set of bands/modulations/channels/bandwidth.

Observe the effect of changing the band and bandwidth to ensure that there are no unexpected variations.

GSM / UMTS

Mode	Ch. Freq.	Orientation	ABM1 dB (A/m)	ABM2 dB (A/m)	Ambient Noise dB(A/m)	Freq. Response (dB)	ABM SNR (dB)	T-Rating	Plot No.
GSM 850 Voice Coder Speech Codec: HR V1	CH.128 824.2 MHz	z(Axial)	2.39	-23.94	-55.42	1.11	26.33	T3	
		y(Transversal)	-12.04	-35.82	-55.40		23.79	T3	
	CH.190 836.6 MHz	z(Axial)	1.89	-24.21	-55.42	1.45	26.10	T3	
		y(Transversal)	-12.35	-36.11	-55.40		23.76	T3	
	CH.251 848.8 MHz	z(Axial)	2.21	-24.01	-55.42	1.48	26.22	T3	1/ 2
		y(Transversal)	-6.77	-30.45	-55.40		23.68	T3	3
GSM 1900 Voice Coder Speech Codec: HR V1	CH.661 1880.0 MHz	z(Axial)	0.88	-25.82	-55.42	1.23	26.70	T3	4/ 5
		y(Transversal)	-13.24	-39.89	-55.40		26.65	T3	6
UMTS Band II Voice AMR NB Codec: 12.2 kbit/s	CH.9262 1850.4 MHz	z(Axial)	-4.54	-32.37	-55.42	1.94	27.83	T3	
		y(Transversal)	-9.81	-37.59	-55.40		27.79	T3	
	CH.9400 1880.0 MHz	z(Axial)	0.37	-27.33	-55.42	1.92	27.69	T3	7/ 8
		y(Transversal)	-13.44	-40.93	-55.40		27.48	T3	9
	CH.9538 1907.6 MHz	z(Axial)	-0.88	-28.66	-55.42	1.85	27.77	T3	
		y(Transversal)	-7.03	-34.78	-55.40		27.74	T3	
UMTS Band IV Voice AMR NB Codec: 12.2 kbit/s	CH.1412 1732.4 MHz	z(Axial)	-1.51	-29.33	-55.42	2.00	27.82	T3	10/11
		y(Transversal)	-8.78	-36.57	-55.40		27.79	T3	12
UMTS Band V Voice AMR NB Codec: 12.2 kbit/s	CH.4183 836.6 MHz	z(Axial)	0.95	-26.88	-55.42	1.97	27.84	T3	13/14
		y(Transversal)	-6.90	-34.71	-55.40		27.81	T3	15

Air Interface Investigation (Contiued)

LTE-FDD

Mode	Ch. Freq.	BW	BW/ Modulation	RB Config.	Orientation	ABM1 dB(A/m)	ABM2 dB(A/m)	Ambient Noise dB(A/m)	Freq. Response (dB)	ABM SNR (dB)	T- Rating	Plot No.
LTE Band 66 Voice EVS-NB Codec: 5.9 kbit/s	CH.132322 1745 MHz	20 MHz	QPSK	1/0	z(Axial)	-5.24	-28.68	-55.36	1.94	23.44	T3	16/17
					y(Transversal)	-9.44	-33.43	-55.37		23.99	T3	18
				1/49	z(Axial)	-4.36	-29.41	-55.36	1.81	25.04	T3	
					y(Transversal)	-7.77	-31.45	-55.37		24.69	T3	
				1/99	z(Axial)	-1.36	-26.09	-55.36	2.00	24.73	T3	
					y(Transversal)	-14.35	-39.12	-55.37		24.77	T3	
				50/0	z(Axial)	-8.25	-32.90	-55.36	2.00	24.64	T3	
					y(Transversal)	-12.96	-36.92	-55.37		23.96	T3	
				50/25	z(Axial)	1.49	-23.04	-55.36	2.00	24.53	T3	
					y(Transversal)	-8.68	-33.07	-55.37		24.40	T3	
				50/49	z(Axial)	-12.38	-36.88	-55.36	2.00	24.49	T3	
					y(Transversal)	-8.80	-33.21	-55.37		24.41	T3	
				100/0	z(Axial)	-4.24	-28.99	-55.36	1.99	24.75	T3	
					y(Transversal)	-6.39	-30.90	-55.37		24.51	T3	
		16QAM	1/0	z(Axial)	-1.28	-25.35	-55.36	2.00	24.07	T3		
				y(Transversal)	-12.89	-37.20	-55.37		24.31	T3		
		64QAM	1/0	z(Axial)	-4.19	-28.86	-55.36	2.00	24.68	T3		
				y(Transversal)	-11.33	-36.18	-55.37		24.85	T3		
		256QAM	1/0	z(Axial)	-3.62	-28.07	-55.36	2.00	24.45	T3		
				y(Transversal)	-9.65	-34.56	-55.37		24.91	T3		
		15 MHz	QPSK	1/0	z(Axial)	2.38	-22.69	-55.36	2.00	25.06	T3	
		y(Transversal)			-12.22	-37.19	-55.37		24.97	T3		
		10 MHz		1/0	z(Axial)	-4.95	-29.54	-55.36	2.00	24.59	T3	
					y(Transversal)	-14.44	-39.07	-55.37		24.62	T3	
		5 MHz		1/0	z(Axial)	-5.79	-30.53	-55.36	2.00	24.74	T3	
					y(Transversal)	-9.92	-34.60	-55.37		24.69	T3	
		3 MHz		1/0	z(Axial)	-8.81	-33.79	-55.36	1.74	24.98	T3	
					y(Transversal)	-6.19	-30.80	-55.37		24.61	T3	
		1.4 MHz		1/0	z(Axial)	-1.85	-26.48	-55.36	2.00	24.63	T3	
					y(Transversal)	-9.82	-34.75	-55.37		24.93	T3	

Air Interface Investigation(Contiued)

LTE-FDD

Mode	Ch. Freq.	Band width	BW/ Mode	RB Config.	Orientation	ABM1 dB(A/m)	ABM2 dB(A/m)	Ambient Noise dB(A/m)	Freq. Response (dB)	ABM SNR (dB)	T-Rating	Plot No.
LTE Band 7 Voice EVS NB Codec: 5.9 kbit/s	CH.21100 2535 MHz	20 MHz	QPSK	1/0	z(Axial)	-8.94	-33.43	-55.36	1.92	24.49	T3	19/20
					y(Transversal)	-10.05	-34.83	-55.37		24.79	T3	21
LTE Band 12 Voice EVS NB Codec: 5.9 kbit/s	CH.23095 707.5 MHz	10 MHz	QPSK	1/0	z(Axial)	-4.04	-28.91	-55.36	2.00	24.88	T3	22/23
					y(Transversal)	-9.38	-34.15	-55.37		24.77	T3	24
LTE Band 13 Voice EVS NB Codec: 5.9 kbit/s	CH.23230 782	10 MHz	QPSK	1/0	z(Axial)	-4.43	-27.79	-55.36	2.00	23.36	T3	25/ 26
					y(Transversal)	-5.56	-30.16	-55.37		24.60	T3	27
LTE Band 14 Voice EVS NB Codec: 5.9 kbit/s	CH.23330 793 MHz	10 MHz	QPSK	1/0	z(Axial)	-0.33	-24.69	-55.34	2.00	24.36	T3	28/ 29
					y(Transversal)	-7.08	-31.64	-55.29		24.55	T3	30
LTE Band 25 Voice EVS NB Codec: 5.9 kbit/s	CH.26365 1882.5	20 MHz	QPSK	1/0	z(Axial)	0.11	-24.36	-55.34	2.00	24.47	T3	31/ 32
					y(Transversal)	-11.07	-35.67	-55.29		24.60	T3	33
LTE Band 26 Voice EVS NB Codec: 5.9 kbit/s	CH.26865 831.5 MHz	15 MHz	QPSK	1/0	z(Axial)	1.91	-22.96	-55.34	2.00	24.87	T3	34/ 35
					y(Transversal)	-5.73	-30.59	-55.29		24.86	T3	36
LTE Band 30 Voice EVS NB Codec: 5.9 kbit/s	CH.27710 2310 MHz	10 MHz	QPSK	1/0	z(Axial)	0.18	-24.51	-55.34	1.80	24.69	T3	37/ 38
					y(Transversal)	-5.52	29.35	-55.29		23.83	T3	39
LTE Band 71 Voice EVS NB Codec: 5.9 kbit/s	CH.133297 680.5 MHz	10 MHz	QPSK	1/0	z(Axial)	-1.89	-26.52	-55.34	1.92	24.64	T3	40/ 41
					y(Transversal)	-5.97	-30.96	-55.29		24.99	T3	42

Air Interface Investigation(Contiued)

LTE-TDD

Mode	Ch. Freq.	BW	BW/ Modulation	RB Config.	Orientation	ABM1 dB(A/m)	ABM2 dB(A/m)	Ambient Noise dB(A/m)	Freq. Response (dB)	ABM SNR (dB)	T-Rating	Plot No.
LTE Band 41 Voice EVS-NB Codec: 59kbit/s	CH.40620 2593 MHz	20 MHz	QPSK	1/0	z(Axial)	-0.92	-24.45	-55.19	2.00	23.53	T3	
					y(Transversal)	-6.34	-30.52	-55.00		24.18	T3	
				1/49	z(Axial)	0.19	-24.09	-55.19	2.00	24.28	T3	
					y(Transversal)	-9.68	-33.85	-55.00		24.16	T3	
				1/99	z(Axial)	-0.16	-24.47	-55.19	2.00	24.31	T3	43/ 44
					y(Transversal)	-10.36	-33.56	-55.00		23.19	T3	45
				50/0	z(Axial)	-0.58	-24.90	-55.19	2.00	24.33	T3	
					y(Transversal)	-7.54	-31.78	-55.00		24.24	T3	
				50/25	z(Axial)	-3.35	-27.34	-55.19	2.00	23.99	T3	
					y(Transversal)	-7.50	-31.75	-55.00		24.25	T3	
				50/49	z(Axial)	2.34	-21.76	-55.19	1.91	24.10	T3	
					y(Transversal)	-8.84	-33.43	-55.00		24.58	T3	
		100/0	z(Axial)	1.32	-22.91	-55.19	2.00	24.23	T3			
			y(Transversal)	-5.74	-29.87	-55.00		24.13	T3			
		16QAM	1/99	z(Axial)	2.51	-22.60	-55.19	2.00	25.11	T3		
				y(Transversal)	-7.64	-31.83	-55.00		24.20	T3		
		64QAM	1/99	z(Axial)	-0.13	-24.66	-55.19	2.00	24.52	T3		
				y(Transversal)	-13.63	-37.14	-55.00		23.51	T3		
		256QAM	1/99	z(Axial)	-4.77	-28.61	-55.19	2.00	23.85	T3		
				y(Transversal)	-12.84	-37.13	-55.00		24.29	T3		
		15 MHz	QPSK	1/74	z(Axial)	-9.51	-33.63	-55.19	2.00	24.12	T3	
		y(Transversal)			-5.44	-30.06	-55.00		24.62	T3		
		10 MHz		1/49	z(Axial)	1.19	-22.21	-55.19	1.93	23.40	T3	
					y(Transversal)	-6.40	-29.81	-55.00		23.41	T3	
5 MHz	1/24	z(Axial)		-0.13	-23.61	-55.19	1.84	23.47	T3			
		y(Transversal)		-6.69	-30.29	-55.00		23.60	T3			

Mode	Ch. Freq.	BW	BW/ Modulation	RB Config.	Orientation	ABM1 dB(A/m)	ABM2 dB(A/m)	Ambient Noise dB(A/m)	Freq. Response (dB)	ABM SNR (dB)	T-Rating	Plot No.
LTE Band 38 Voice EVS-NB Codec: 5.9kbit/s	CH.38000 2595 MHz	20 MHz	QPSK	1/99	z(Axial)	2.28	-26.71	-55.32	2.00	28.99	T3	46/ 47
					y(Transversal)	-12.30	-41.55	-55.27		29.25	T3	48
LTE Band 40 Voice Lower EVS-NB Codec: 5.9kbit/s	CH.38750 2310 MHz	10 MHz	QPSK	1/49	z(Axial)	-4.49	-28.00	-55.32	2.00	23.51	T3	49/ 50
					y(Transversal)	-9.83	-33.89	-55.27		24.06	T3	51
LTE Band 40 Voice Upper EVS-NB Codec: 5.9kbit/s	CH.39200 2355 MHz	10 MHz	QPSK	1/49	z(Axial)	-10.31	-34.52	-55.32	2.00	24.21	T3	
					y(Transversal)	-8.37	-32.55	-55.27		24.18	T3	
LTE Band 48 Voice EVS-NB Codec: 5.9kbit/s	CH.55990 3625 MHz	20 MHz	QPSK	1/49	z(Axial)	-0.66	-25.05	-55.32	2.00	24.39	T3	52/ 53
					y(Transversal)	-11.21	-35.36	-55.27		24.15	T3	54
LTE Band 41 Voice EVS-NB Codec: 5.9kbit/s s	CH.39750 2506 MHz	20 MHz	QPSK	1/99	z(Axial)	-0.26	-24.21	-55.32	2.00	23.95	T3	
					y(Transversal)	-7.11	-30.65	-55.27		23.54	T3	
	z(Axial)				1.78	-22.31	-55.32	1.90	24.10	T3		
	y(Transversal)				-10.24	-34.20	-55.27		23.96	T3		
	z(Axial)				1.77	-25.12	-55.32	2.00	26.89	T3		
	y(Transversal)				-9.84	-36.06	-55.27		26.22	T3		
CH.41490 2680 MHz	z(Axial)	-3.09	-27.35	-55.32	1.87	24.26	T3					
	y(Transversal)	-13.01	-37.53	-55.27		24.52	T3					

12.4 VoWi-Fi Codec Investigation

An investigation between the various codec configurations (Low/High bit rates for Narrowband, Wideband) and specific parameters are documented (ABM1, ABM2, S+N/N, frequency response) to determine the worst-case bit rates for each voice service type. The table below compares the varying codec configurations. A codec investigation was performed for each Wi-Fi 2.4 GHz and 5 GHz.

The highlighted results below were determined to be the worst case codec configuration(s) for Wi-Fi 2.4 GHz and 5 GHz.

Codec Investigation								
Codec State	AMR-NB (kbit/s)			AMR-WB (kbit/s)			Orientation	Band/ Bandwidth/ Channel
	4.75	7.4	12.2	6.6	15.85	23.85		
ABM1 (dB/m)	-3.72	-2.06	-1.67	-3.34	-1.85	-1.74	z (Axial)	802.11b CH.6 2437 MHz DSSS 1 Mbps
ABM2 (dBA/m)	-29.27	-27.67	-26.67	-31.12	-30.76	-30.61		
S+N/N (dB)	25.54	25.61	25.01	27.77	28.92	28.87		
Freq. Resposne(dB)	1.58	1.70	1.98	2.00	2.00	2.00		
ABM1 (dB/m)	-9.42	-9.00	-14.90	-10.50	-11.91	-8.88	y (Transversal)	
ABM2 (dBA/m)	-35.34	-34.99	-40.17	-39.13	-41.83	-38.91		
S+N/N (dB)	25.92	25.99	25.27	28.63	29.92	30.03		

Codec Investigation											
Codec State	EVS-NB (kbit/s)			EVS-WB (kbit/s)			EVS-SWB (kbit/s)			Orientation	Band/ BandWidth/ Channel
	5.9	13.2	24.4	5.9	24.4	128	9.6	24.4	128		
ABM1 (dB/m)	-2.83	0.23	-1.59	-7.44	-2.29	-1.73	-6.25	-6.64	-6.22	z (Axial)	802.11b CH.6 2437 MHz DSSS 1 Mbps
ABM2 (dBA/m)	-28.36	-24.98	-26.83	-32.99	-32.02	-31.58	-31.90	-31.76	-32.42		
S+N/N (dB)	25.53	25.22	25.23	25.55	29.73	29.85	25.65	25.12	26.20		
Freq.Resposne(dB)	1.95	1.89	1.99	2.00	2.00	2.00	2.00	2.00	1.98		
ABM1 (dB/m)	-14.94	-8.96	-11.38	-11.84	-12.04	-11.73	-13.46	-13.79	-12.50	y (Transversal)	
ABM2 (dBA/m)	-40.53	-34.19	-36.82	-37.91	-42.78	-41.94	-40.67	-40.35	-38.76		
S+N/N (dB)	25.59	25.23	25.43	26.07	30.74	30.21	27.21	26.56	26.26		

Codec Investigation								
Codec State	AMR-NB (kbit/s)			AMR-WB (kbit/s)			Orientation	Band/ Bandwidth/ Channel
	4.75	7.4	12.2	6.6	15.85	23.85		
ABM1 (dB/m)	-7.75	-7.46	-2.91	-3.03	-3.23	-1.58	z (Axial)	802.11a CH.40 5200 MHz BPSK 6 Mbps
ABM2 (dBA/m)	-33.51	-33.45	-28.71	-32.57	-33.49	-31.99		
S+N/N (dB)	25.76	25.99	25.8	29.54	30.26	30.41		
Freq. Resposne(dB)	1.65	1.81	1.95	2.00	2.00	2.00		
ABM1 (dB/m)	-12.41	-9.32	-11.54	-11.46	-10.31	-10.29	y (Transversal)	
ABM2 (dBA/m)	-38.26	-35.33	-37.10	-40.92	-40.40	-40.40		
S+N/N (dB)	25.85	26.01	25.56	29.46	30.10	30.11		

Codec Investigation											
Codec State	EVS-NB (kbit/s)			EVS-WB (kbit/s)			EVS-SWB (kbit/s)			Orientation	Band/ BandWidth/ Channel
	5.9	13.2	24.4	5.9	24.4	128	9.6	24.4	128		
ABM1 (dB/m)	-6.43	-1.72	-1.58	-6.35	-0.18	-1.72	-5.3	-6.74	-6.48	z (Axial)	802.11a CH.40 5200 MHz BPSK 6 Mbps
ABM2 (dBA/m)	-30.48	-27.23	-27.2	-33.9	-31.63	-32.13	-33.79	-34.42	-33.92		
S+N/N (dB)	24.06	25.51	25.62	27.54	31.45	30.41	28.48	27.68	27.44		
Freq.Resposne(dB)	2.00	1.98	2.00	2.00	2.00	2.00	1.91	2.00	1.96		
ABM1 (dB/m)	-11.75	-11.36	-8.72	-14.78	-11.39	-8.94	-14.54	-14.19	-13.57	y (Transversal)	
ABM2 (dBA/m)	-35.45	-36.87	-34.26	-43.59	-42.86	-39.52	-42.39	-41.70	-41.24		
S+N/N (dB)	23.71	25.51	25.55	28.81	31.47	30.58	27.86	27.51	27.67		

12.5 VoWi-Fi Antennas Investigation

EVS-NB 5.9 kbit/s was the worst case bit-rates for 802.11b, 802.11a. The secondary antenna was investigated to determine which antennas yields a worse SNNR. The worst case codec and bit-rate from Antenna 1 was used to determine Antenna 2's exclusion. Since Antenna 2 yielded a better SNNR than Antenna 1, all subsequent measurements were measured using Antenna 1.

Antenna	Mode	Ch. Freq.	BW	BW /Modulation	Orientation	ABM1 dB(A/m)	ABM2 dB(A/m)	Ambient Noise dB(A/m)	Freq. Response (dB)	ABM SNR (dB)	T- Rating
WiFi Ant 1	802.11a CH.40 Voice EVS-NB Codec: 5.9 kbit/s	CH.40 5200 MHz	20 MHz	BPSK 6 Mbps	z(Axial)	-6.43	-30.48	-55.03	2.00	24.06	T3
					y(Transversal)	-11.75	-35.45	-54.82		23.71	T3
z(Axial)					-0.79	-26.27	-55.03	2.00	25.47	T3	
y(Transversal)					-11.86	-36.21	-54.82		24.34	T3	

12.6 VoWi-Fi Air Interface Investigation

Using the data from §9.4, further testing was performed on the remaining 802.11 modes. The objective of these measurements is to ensure that changing the modulation, bandwidth, and data rate, whilst using the worst case codec configuration measured in §9.4, yields no unexpected variations.

Moe	Ch. Freq.	BW	BW/ Modulation	Orientation	ABM1 dB(A/m)	ABM2 dB(A/m)	Ambient Noise dB(A/m)	Freq. Response (dB)	ABM SNR (dB)	T-Rating	Plot No.
802.11b Voice AMR-NB Codec: 12.2 kbit/s	CH.6 2437 MHz	20 MHz	DSSS 1 Mbps	z(Axial)	-1.67	-26.67	-55.37	1.98	25.01	T3	55/ 56
				y(Transversal)	-14.90	-40.17	-55.21		25.27	T3	57
			CCK 5.5 Mbps	z(Axial)	-5.48	-31.04	-55.37	1.97	25.56	T3	
				y(Transversal)	-8.65	-34.73	-55.21		26.08	T3	
	CCK 11 Mbps		z(Axial)	-5.02	-31.69	-55.37	1.94	26.67	T3		
			y(Transversal)	-9.52	-35.47	-55.21		25.95	T3		
	CH.1 2412 MHz		DSSS 1 Mbps	z(Axial)	-1.02	-26.71	-55.37	1.91	25.70	T3	
				y(Transversal)	-10.67	-36.66	-55.21		25.98	T3	
CH.11 2462 MHz	DSSS 1 Mbps	z(Axial)	0.36	-25.16	-55.37	1.90	25.52	T3			
y(Transversal)		-10.59	-36.63	-55.21		26.04	T3				
802.11g Voice AMR-NB Codec: 12.2 kbit/s	CH.6 2437 MHz	20 MHz	64QAM 54 Mbps	z(Axial)	-1.07	-27.15	-55.37	1.94	26.08	T3	
				y(Transversal)	-8.16	-34.45	-55.21		26.30	T3	
802.11n HT20 Voice AMR-NB Codec: 12.2 kbit/s	CH.6 2437 MHz	20 MHz	MCS 7 135 Mbps	z(Axial)	-1.03	-27.25	-55.37	1.89	26.23	T3	
				y(Transversal)	-11.08	-37.30	-55.21		26.22	T3	
802.11ax HE20 Voice AMR-NB Codec: 12.2 kbit/s	CH.6 2437 MHz	20 MHz	MCS 0 8.6 Mbps	z(Axial)	-0.99	-27.04	-55.37	1.91	26.05	T3	
				y(Transversal)	-10.65	-36.71	-55.21		26.06	T3	

VoWi-Fi Air Interface Investigation (Continued)

Mode	Ch. Freq.	BW	BW /Modulation	Orientation	ABM1 dB(A/m)	ABM2 dB(A/m)	Ambient Noise dB(A/m)	Freq. Response (dB)	ABM SNR (dB)	T- Rating	Plot No.
802.11a Voice EVS-NB Codec: 5.9kbit/s	CH.40 5200 MHz	20 MHz	BPSK 6 Mbps	z(Axial)	-6.43	-30.48	-55.03	2	24.04	T3	
				y(Transversal)	-11.75	-35.45	-54.82		23.71	T3	
			QPSK 18 Mbps	z(Axial)	-2.14	-27.64	-55.03	2	25.50	T3	
				y(Transversal)	-14.00	-39.43	-54.82		25.42	T3	
			64QAM 54 Mbps	z(Axial)	-6.97	-30.34	-54.75	2	23.37	T3	58/ 59
				y(Transversal)	-10.74	-34.7	-55.05		23.95	T3	60
802.11n HT20 Voice EVS-NB Codec: 5.9kbit/s	CH.40 5200 MHz	20 MHz	MCS 0 6.5 Mbps	z(Axial)	0.21	-25.41	-55.03	2	25.62	T3	
				y(Transversal)	-11.57	-37.17	-54.82		25.60	T3	
			MCS 3 26 Mbps	z(Axial)	-0.96	-26.51	-55.03	2	25.55	T3	
				y(Transversal)	-11.47	-36.89	-54.82		25.42	T3	
			MCS 7 65 Mbps	z(Axial)	-0.85	-26.36	-55.03	2	25.52	T3	
				y(Transversal)	-11.73	-37.15	-54.82		25.42	T3	
802.11n HT40 Voice EVS-NB Codec: 5.9kbit/s	CH.38 5190 MHz	40 MHz	MCS 0 13.5 Mbps	z(Axial)	-1.60	-27	-54.75	2	25.40	T3	
				y(Transversal)	-8.40	-33.72	-55.05		25.32	T3	
			MCS 3 54 Mbps	z(Axial)	0.16	-25.36	-54.75	2	25.51	T3	
				y(Transversal)	-11.34	-36.85	-55.05		25.51	T3	
			MCS 7 135 Mbps	z(Axial)	0.18	-25.39	-54.75	2	25.56	T3	
				y(Transversal)	-11.24	-36.74	-55.05		25.49	T3	
802.11ac VHT20 Voice EVS-NB Codec: 5.9kbit/s	CH.40 5200 MHz	20 MHz	MCS 0 6.5 Mbps	z(Axial)	-1.55	-26.94	-54.75	1.97	25.40	T3	
				y(Transversal)	-9.11	-34.44	-55.05		25.34	T3	
			MCS 4 39 Mbps	z(Axial)	-3.06	-28.37	-54.75	2	25.31	T3	
				y(Transversal)	-14.87	-40.28	-55.05		25.41	T3	
			MCS 8 78 Mbps	z(Axial)	0.13	-25.29	-54.75	1.98	25.42	T3	
				y(Transversal)	-11.30	-36.71	-55.05		25.40	T3	
802.11ac VHT40 Voice EVS-NB Codec: 5.9kbit/s	CH.38 5190 MHz	40 MHz	MCS 0 13.5 Mbps	z(Axial)	-2.80	-26.62	-54.75	2	23.82	T3	
				y(Transversal)	-11.52	-35.23	-55.05		23.71	T3	
			MCS 4 81 Mbps	z(Axial)	-2.62	-26.2	-54.75	2	23.58	T3	
				y(Transversal)	-14.64	-38.5	-55.05		23.87	T3	
			MCS 9 180 Mbps	z(Axial)	-0.46	-24.71	-54.75	2	24.25	T3	
				y(Transversal)	-9.09	-33.24	-55.05		24.15	T3	
802.11ac VHT80 Voice EVS-NB Codec: 5.9kbit/s	CH.42 5210 MHz	80 MHz	MCS 0 29.3 Mbps	z(Axial)	-2.06	-25.86	-54.75	2	23.81	T3	
				y(Transversal)	-10.90	-34.7	-55.05		23.80	T3	
			MCS 4 175.5Mbps	z(Axial)	-0.82	-24.51	-54.75	2	23.69	T3	
				y(Transversal)	-14.62	-38.45	-55.05		23.83	T3	
			MCS 9 390 Mbps	z(Axial)	-7.04	-30.87	-54.75	1.71	23.84	T3	
				y(Transversal)	-13.76	-37.4	-55.05		23.64	T3	

Mode	Ch. Freq.	BW	BW /Modulation	Orientation	ABM1 dB(A/m)	ABM2 dB(A/m)	Ambient Noise dB(A/m)	Freq. Response (dB)	ABM SNR (dB)	T-Rating	Plot No.
802.11ax HE20 Voice EVS-NB Codec: 5.9kbit/s	CH.40 5200 MHz	20 MHz	MCS 0 8.6 Mbps	z(Axial)	-2.27	-25.87	-54.75	2	23.60	T3	
				y(Transversal)	-10.70	-34.33	-55.05		23.63	T3	
			MCS 6 77.4 Mbps	z(Axial)	-6.93	-30.69	-55.03	2	23.76	T3	
				y(Transversal)	-11.70	-35.43	-54.82		23.73	T3	
MCS 11 143.4Mbps	z(Axial)	-0.70	-24.86	-54.75	2	24.17	T3				
	y(Transversal)	-11.27	-34.91	-55.05		23.65	T3				
802.11ax HE40 Voice EVS-NB Codec: 5.9kbit/s	CH.38 5190 MHz	40 MHz	MCS 0 17.2 Mbps	z(Axial)	-1.25	-26.47	-55.57	2	25.22	T3	
				y(Transversal)	-10.47	-35.79	-55.32		25.33	T3	
			MCS 6 154.9Mbps	z(Axial)	-5.33	-31.14	-55.57	2	25.81	T3	
				y(Transversal)	-10.58	-36.39	-55.32		25.81	T3	
MCS 11 286.8Mbps	z(Axial)	-1.59	-27.53	-55.57	2	25.94	T3				
	y(Transversal)	-10.54	-36.51	-55.32		25.98	T3				
802.11ax HE80 Voice EVS-NB Codec: 5.9kbit/s	CH.42 5210 MHz	80 MHz	MCS 0 36.05Mbps	z(Axial)	0.29	-24.92	-55.57	2	25.20	T3	
				y(Transversal)	-10.88	-36.08	-55.32		25.20	T3	
			MCS 6 324.3Mbps	z(Axial)	0.27	-25.06	-55.57	2	25.33	T3	
				y(Transversal)	-8.33	-33.54	-55.32		25.21	T3	
MCS 11 600.5Mbps	z(Axial)	-1.21	-26.58	-55.57	1.98	25.37	T3				
	y(Transversal)	-8.46	-33.63	-55.32		25.17	T3				
802.11ax VHT160 Voice EVS-NB Codec: 5.9 kbit/s	CH.50 5250 MHz	160 MHz	MCS 0 36.05Mbps	z(Axial)	0.57	-23.59	-55.57	2	24.16	T3	
				y(Transversal)	-9.25	-33.55	-55.32		24.29	T3	
			MCS 6 324.3Mbps	z(Axial)	-2.21	-26.59	-55.57	2	24.38	T3	
				y(Transversal)	-9.38	-34.21	-55.32		24.83	T3	
MCS 11 600.5Mbps	z(Axial)	-1.29	-25.48	-55.57	2	24.2	T3				
	y(Transversal)	-8.44	-32.51	-55.32		24.07	T3				
802.11a Voice EVS-NB Codec: 5.9 kbit/s	CH.60 5300 MHz	20 MHz	64QAM 54 Mbps	z(Axial)	-2.19	-27.37	-55.57	2	25.18	T3	61/ 62
				y(Transversal)	-14.20	-39.36	-55.32		25.16	T3	63
	CH.120 5600 MHz	20 MHz	64QAM 54 Mbps	z(Axial)	-0.41	-25.63	-55.57	2	25.22	T3	64/65
				y(Transversal)	-10.86	-36.11	-55.32		25.25	T3	66
	CH.157 5785 MHz	20 MHz	64QAM 54 Mbps	z(Axial)	-0.39	-25.61	-55.57	2	25.22	T3	67/68
				y(Transversal)	-7.64	-33.39	-55.32		25.75	T3	69
802.11a Voice EVS-NB Codec: 5.9kbit/s	CH.36 5180 MHz	20 MHz	64QAM 54 Mbps	z(Axial)	-3.20	-27.49	-55.57	2	24.29	T3	70/71
				y(Transversal)	-9.90	-33.83	-55.32		23.93	T3	72
	CH.48 5240 MHz	20 MHz	64QAM 54 Mbps	z(Axial)	-4.06	-28.16	-55.57	2	24.09	T3	73/74
				y(Transversal)	-10.01	-34.43	-55.32		24.41	T3	75

12.7 OTT Codec Investigation

The DUT's nested OTT application supports range of codec bit rate 6 – 75 kbit/s, thus an investigation between the various codec configurations (6/75 as Low/High bit rates) and specific parameters are documented (ABM1, ABM2, S+N/N, frequency response) to determine the worst-case bit rates for each service type.

The table below compares the varying codec configurations.

Codec Investigation					
Codec State	codec bit rate (kbit/s)			Orientation	Band/ BandWidth/ Channel
	6	40	75		
ABM1 (dB/m)	-2.12	-1.93	0.85	z (Axial)	GSM 850 EDGE 2 slots CH.251 848.8 MHz
ABM2 (dBA/m)	-35.12	-34.53	-34.66		
S+N/N (dB)	33.00	32.59	35.51		
Freq.Resposne (dB)	2.00	1.62	2.00		
ABM1 (dB/m)	-10.79	-13.11	-10.85	y(Transversal)	
ABM2 (dBA/m)	-40.66	-40.94	-41.74		
S+N/N (dB)	29.87	27.83	30.89		
ABM1 (dB/m)	0.78	0.71	-4.01	z (Axial)	
ABM2 (dBA/m)	-36.68	-34.21	-38.48		
S+N/N (dB)	37.45	34.92	34.47		
Freq.Resposne (dB)	2.00	2.00	2.00		
ABM1 (dB/m)	-9.63	-10.65	-10.50	y(Transversal)	
ABM2 (dBA/m)	-46.77	-45.42	-44.56		
S+N/N (dB)	37.14	34.76	34.06		
ABM1 (dB/m)	-8.31	-2.60	-1.05	z (Axial)	LTE Band 13 10 MHz QPSK 1RB Offset CH.23230 782 MHz
ABM2 (dBA/m)	-44.04	-37.21	-35.10		
S+N/N (dB)	35.72	34.61	34.05		
Freq.Resposne (dB)	2.00	2.00	2.00		
ABM1 (dB/m)	-9.97	-11.05	-10.62	y(Transversal)	
ABM2 (dBA/m)	-45.52	-45.26	-43.84		
S+N/N (dB)	35.56	34.21	33.23		
ABM1 (dB/m)	-0.55	-0.84	-0.88	z (Axial)	
ABM2 (dBA/m)	-36.24	-34.77	-34.02		
S+N/N (dB)	35.69	33.93	33.14		
Freq.Resposne (dB)	2.00	2.00	2.00		
ABM1 (dB/m)	-7.71	-8.78	-14.53	y(Transversal)	
ABM2 (dBA/m)	-41.77	-41.31	-46.92		
S+N/N (dB)	34.06	32.53	32.40		

Codec Investigation					
Codec State	codec bit rate (kbit/s)			Orientation	Band/ BandWidth/ Channel
	6	40	75		
ABM1 (dB/m)	0.28	0.88	0.51	z (Axial)	NR Band 66 40 MHz DFT-s QPSK 1RB 1offset CH.349000 1745 MHz
ABM2 (dBA/m)	-34.81	-33.57	-32.92		
S+N/N (dB)	35.09	34.45	33.43		
Freq.Resposne (dB)	2.00	2.00	2.00		
ABM1 (dB/m)	-10.65	-10.89	-8.03	y(Transversal)	
ABM2 (dBA/m)	-42.94	-42.11	-39.84		
S+N/N (dB)	32.29	31.22	31.81		
ABM1 (dB/m)	0.31	0.08	1.52	z (Axial)	
ABM2 (dBA/m)	-35.89	-31.76	-29.08		
S+N/N (dB)	36.19	31.85	30.60		
Freq.Resposne (dB)	2.00	2.00	2.00		
ABM1 (dB/m)	-11.02	-12.82	-8.23	y(Transversal)	
ABM2 (dBA/m)	-40.41	-44.12	-39.99		
S+N/N (dB)	29.39	31.29	31.76		
ABM1 (dB/m)	0.23	0.01	0.28	z (Axial)	802.11b 2.4GHz 1Mbps CH.6 2437 MHz
ABM2 (dBA/m)	-29.40	-29.30	-29.27		
S+N/N (dB)	29.63	29.31	29.55		
Freq.Resposne (dB)	2.00	2.00	2.00		
ABM1 (dB/m)	-13.46	-10.00	-9.78	y(Transversal)	
ABM2 (dBA/m)	-47.20	-42.67	-42.26		
S+N/N (dB)	33.74	32.66	32.48		
ABM1 (dB/m)	0.17	1.88	-1.00	z (Axial)	
ABM2 (dBA/m)	-35.00	-32.34	-34.30		
S+N/N (dB)	35.16	34.22	33.30		
Freq.Resposne (dB)	2.00	2.00	2.00		
ABM1 (dB/m)	-10.32	-12.05	-13.84	y(Transversal)	
ABM2 (dBA/m)	-46.47	-46.54	-47.50		
S+N/N (dB)	35.15	34.49	33.66		

12.8 OTT Air Interface Investigation

Mode	Ch. Freq.	BW	BW/ Mode	RB Config.	Orientation	ABM1 dB(A/m)	ABM2 dB(A/m)	Ambient Noise dB(A/m)	Freq. Response (dB)	ABM SNR (dB)	T-Rating	Plot No.
GSM850 EDGE 2 slots Duo Codec: 40 kbit/s	CH.251 848.8 MHz				z(Axial)	-1.93	-34.53	-55.47	1.62	32.59	T4	76/77
					y(Transversal)	-13.11	-40.94	-55.34		27.83	T3	78
GSM1900 EDGE 2 slots Duo Codec: 40 kbit/s	CH.661 1880.0 MHz				z(Axial)	-0.22	-35.24	-55.47	1.63	35.01	T4	79/80
					y(Transversal)	-11.97	-45.62	-55.34		33.65	T4	81
UMTS Band II HSUPA subtest1 Duo Codec: 75 kbit/s	CH.9400 1880.0 MHz				z(Axial)	-4.01	-38.48	-55.50	2.00	34.47	T4	82/ 83
					y(Transversal)	-10.50	-44.56	-55.37		34.06	T4	84
UMTS Band IV HSUPA subtest1 Duo Codec: 75 kbit/s	CH.1412 1732.4 MHz				z(Axial)	-5.49	-39.84	-55.50	2.00	34.36	T4	85/ 86
					y(Transversal)	-10.31	-44.22	-55.37		33.91	T4	87
UMTS Band V HSUPA subtest1 Duo Codec: 75 kbit/s	CH.4183 836.6 MHz				z(Axial)	-6.25	-40.89	-55.50	2.00	34.63	T4	88/89
					y(Transversal)	-10.36	-44.44	-55.37		34.08	T4	90
LTE Band 7 Google Duo Codec: 75 kbit/s	CH.21100 2535 MHz	20 MHz	QPSK	1/0	z(Axial)	-0.91	-35.69	-54.07	2.00	34.78	T4	91/ 92
					y(Transversal)	-8.22	-42.42	-54.45		34.19	T4	93
LTE Band 12 Google Duo Codec: 75 kbit/s	CH.23095 707.5 MHz	10 MHz	QPSK	1/0	z(Axial)	0.40	-33.76	-54.07	2.00	34.16	T4	94/ 95
					y(Transversal)	-7.20	-40.77	-54.45		33.58	T4	96
LTE Band 13 Google Duo Codec: 75 kbit/s	CH.23230 782.0 MHz	10 MHz	QPSK	1/0	z(Axial)	-1.05	-35.10	-54.07	2.00	34.05	T4	97/ 98
					y(Transversal)	-10.62	-43.84	-54.45		33.23	T4	99
LTE Band 14 Google Duo Codec: 75 kbit/s	CH.23330 793 MHz	10 MHz	QPSK	1/0	z(Axial)	0.04	-33.82	-54.07	2.00	33.86	T4	100/ 101
					y(Transversal)	-10.71	-44.24	-54.45		33.53	T4	102
LTE Band 25 Google Duo Codec: 75 kbit/s	CH.26365 1882.5 MHz	20 MHz	QPSK	1/0	z(Axial)	-0.59	-35.21	-54.07	2.00	34.62	T4	103/ 104
					y(Transversal)	-8.08	-42.39	-54.45		34.31	T4	105
LTE Band 26 Google Duo Codec: 75 kbit/s	CH.26865 831.5 MHz	15 MHz	QPSK	1/0	z(Axial)	0.32	-33.59	-54.07	2.00	33.91	T4	106/ 107
					y(Transversal)	-10.77	-44.36	-54.45		33.59	T4	108
LTE Band 30 Google Duo Codec: 75 kbit/s	CH.27710 2310 MHz	10 MHz	QPSK	1/0	z(Axial)	-0.55	-34.98	-54.07	2.00	34.43	T4	109/ 110
					y(Transversal)	-8.16	-41.95	-54.45		33.79	T4	111
LTE Band 66 Google Duo Codec: 75 kbit/s	CH.132322 1745 MHz	20 MHz	QPSK	1/0	z(Axial)	-5.80	-40.12	-54.07	2.00	34.31	T4	112/ 113
					y(Transversal)	-11.35	-45.25	-54.45		33.90	T4	114
LTE Band 71 Google Duo Codec: 75 kbit/s	CH.133297 680.5 MHz	20 MHz	QPSK	1/0	z(Axial)	-5.66	-40.01	-54.07	2.00	34.35	T4	115/ 116
					y(Transversal)	-10.85	-44.82	-54.45		33.98	T4	117

Mode:	Ch./ Freq.	BW/ Data Rate	BW/ Modulation	RB Config.	Orientation	ABM1 dB(A/m)	ABM2 dB(A/m)	Ambient Noise dB(A/m)	Freq. Response (dB)	ABM SNR(dB)	T-Rating	Plot No.
LTE Band 38 Google Duo Codec: 75 kbit/s	CH.38000 2595 MHz	20 MHz	QPSK	1/99	z(Axial)	-0.19	-34.02	-54.07	2.00	33.83	T4	118/ 119
					y(Transversal)	-10.96	-43.83	-54.45		32.87	T4	120
LTE Band 40 Google Duo Codec: 75 kbit/s	CH.38750 2310 MHz	10 MHz	QPSK	1/49	z(Axial)	-2.17	-36.15	-54.07	2.00	33.98	T4	121/ 122
					y(Transversal)	-7.84	-41.39	-54.45		33.55	T4	123
LTE Band 40 Google Duo Codec: 75 kbit/s	CH.39200 2355 MHz	10 MHz	QPSK	1/49	z(Axial)	-0.14	-34.51	-54.07	2.00	34.37	T4	124/ 125
					y(Transversal)	-8.11	-41.53	-54.45		33.42	T4	126
LTE Band 41 Google Duo Codec: 75 kbit/s	CH.40620 2593 MHz	20 MHz	QPSK	1/99	z(Axial)	-0.88	-34.02	-54.07	2.00	33.14	T4	127/ 128
					y(Transversal)	-14.53	-46.92	-54.45		32.40	T4	129
LTE Band 48 Google Duo Codec: 75 kbit/s	CH.55990 3625 MHz	20 MHz	QPSK	1/99	z(Axial)	0.85	-33.75	-54.07	2.00	34.60	T4	130/ 131
					y(Transversal)	-13.25	-46.19	-54.45		32.94	T4	132
Wi-Fi 2.4 GHz 802.11b Google Duo Codec: 40 kbit/s	CH.6 2437 MHz	20 MHz	1 Mbps		z(Axial)	0.01	-29.30	-55.42	2.00	29.31	T3	133/ 134
					y(Transversal)	-10.00	-42.67	-55.37		32.66	T4	135
U-NII 5.2 GHz 802.11ac HT20 Google Duo Codec: 75 kbit/s	CH.40 5200 MHz	20 MHz	54 Mbps		z(Axial)	-1.00	-34.30	-55.44	2.00	33.30	T4	136/ 137
					y(Transversal)	-13.84	-47.50	-55.44		33.66	T4	138
U-NII 5.3 GHz 802.11ac HT20 Google Duo Codec: 75 kbit/s	CH.60 5300 MHz	20 MHz	54 Mbps		z(Axial)	0.39	-33.14	-55.44	2.00	33.54	T4	139/ 140
					y(Transversal)	-6.92	-40.98	-55.44		34.06	T4	141
U-NII 5.6 GHz 802.11ac HT20 Google Duo Codec: 75 kbit/s	CH.120 5600 MHz	20 MHz	54 Mbps		z(Axial)	-1.24	-34.32	-55.44	2.00	33.07	T4	142/ 143
					y(Transversal)	-8.50	-42.00	-55.44		33.50	T4	144
U-NII 5.8 GHz 802.11ac HT20 Google Duo Codec: 75 kbit/s	CH.157 5785 MHz	20 MHz	54 Mbps		z(Axial)	-1.36	-34.37	-55.44	2.00	33.02	T4	145/ 146
					y(Transversal)	-11.80	-44.61	-55.44		32.81	T4	147
GSM850 EDGE 2 slots Duo Codec: 40 kbit/s	CH.128 824.2 MHz				z(Axial)	-0.25	-35.33	-55.47	2.00	35.08	T4	
					y(Transversal)	-8.48	-38.84	-55.34		30.36	T4	
GSM850 EDGE 2 slots Duo Codec: 40 kbit/s	CH.190 836.6 MHz				z(Axial)	-5.58	-35.28	-55.47	1.71	29.70	T3	
					y(Transversal)	-13.73	-44.52	-55.34		30.79	T4	

NR

Mode	Ch. Freq.	BW	Waveform	BW/ Modulation	RB Config.	Orientation	ABM1 dB(A/m)	ABM2 dB(A/m)	Ambient Noise dB(A/m)	Freq. Response (dB)	ABM SNR (dB)	T-Rating	Plot No.
NR Band n5 Google Duo Codec: 40 kbit/s	CH.167300 836.5 MHz	20 MHz	DFTs	QPSK	1/1	z(Axial)	-0.04	-36.41	-55.47	2	36.36	T4	148/ 149
						y(Transversal)	-10.46	-51.91	-55.34		41.46	T4	150
NR Band n12 Google Duo Codec: 40 kbit/s	CH.141500 707.5 MHz	15 MHz	DFTs	QPSK	1/1	z(Axial)	-0.23	-36.15	-55.47	2	35.92	T4	151/ 152
						y(Transversal)	-7.42	-40.91	-55.34		33.5	T4	153
NR Band n25 Google Duo Codec: 40 kbit/s	CH.376500 1882.5 MHz	40 MHz	DFTs	QPSK	1/1	z(Axial)	1.54	-35.16	-55.47	2	36.71	T4	154/155
						y(Transversal)	-6.88	-42.93	-55.34		36.05	T4	156
NR Band n30 Google Duo Codec: 40 kbit/s	CH.462000 2310 MHz	10 MHz	DFTs	QPSK	1/1	z(Axial)	1.40	-35.26	-55.47	2	36.65	T4	157/158
						y(Transversal)	-10.04	-46.44	-55.34		36.40	T4	159
NR Band n66 Google Duo Codec: 40 kbit/s	CH.349000 1745 MHz	40 MHz	DFTs	QPSK	1/1	z(Axial)	0.88	-33.57	-55.47	2	34.45	T4	160/161
						y(Transversal)	-10.89	-42.11	-55.34		31.22	T4	162
NR Band n71 Google Duo Codec: 40 kbit/s	CH.136100 680.5 MHz	20 MHz	DFTs	QPSK	1/1	z(Axial)	-0.76	-36.35	-55.47	2	35.59	T4	163/164
						y(Transversal)	-9.90	-44.2	-55.34		34.30	T4	165
NR Band n41 Google Duo Codec: 6 kbit/s	CH. 518598 2592.99 MHz	100 MHz	DFTs	QPSK	1/271	z(Axial)	0.31	-35.89	-55.42	2	36.19	T4	166/ 167
						y(Transversal)	-11.02	-40.41	-55.32		29.39	T3	168
NR Band n77 Google Duo Codec: 6 kbit/s	CH. 656000 3840 MHz	100 MHz	DFTs	QPSK	1/271	z(Axial)	0.13	-30.85	-55.42	2	30.98	T4	169/ 170
						y(Transversal)	-14.47	-43.89	-55.32		29.43	T3	171
NR Band n77 DoD Google Duo Codec: 6 kbit/s	CH. 633334 3500.01 MHz	100 MHz	DFTs	QPSK	1/271	z(Axial)	-1.07	-32.3	-55.42	2	31.23	T4	172 /173
						y(Transversal)	-11.19	-40.40	-55.32		29.21	T3	174

Attachment 1. HAC T-COIL Test Plots

Plot No.1

GSM850 HR V1 251ch z(axial)

Communication System: UID 0, GSM 850 (0); Frequency: 848.8 MHz;Duty Cycle: 1:8.30042
Medium parameters used: $\sigma = 0$ S/m, $\epsilon_r = 1$; $\rho = 0$ kg/m³
Phantom section: TCoil Section

DASY5 Configuration:

- Probe: AM1DV3 - 3049; ; Calibrated: 6/1/2021
- Sensor-Surface: 0mm (Fix Surface)
- Electronics: DAE4 Sn652; Calibrated: 1/24/2022
- Phantom: HAC Test Arch with AMCC TCOIL
- Measurement SW: DASY52, Version 52.10 (4); SEMCAD X Version 14.6.14 (7483)

T-Coil scan (scan for ANSI C63.19-2007 & 2011 compliance)/General Scans/z (axial) 4.2mm 50 x 50/ABM Signal(x,y,z) (13x13x1): Measurement grid: dx=10mm, dy=10mm

Signal Type: Audio File (.wav) 48k_voice_1kHz_1s.wav
Output Gain: 24.35
Measure Window Start: 300ms
Measure Window Length: 1000ms
BWC applied: -0.19 dB
Device Reference Point: 0, 0, -6.3 mm

Cursor:

ABM1 comp = 2.21 dBA/m
BWC Factor = -0.19 dB
Location: 8.3, -8.3, 3.7 mm

Cursor:

ABM2 = -24.01 dBA/m
Location: 8.3, -8.3, 3.7 mm

Cursor:

ABM1/ABM2 = 26.22 dB
ABM1 comp = 2.21 dBA/m
BWC Factor = -0.19 dB
Location: 8.3, -8.3, 3.7 mm

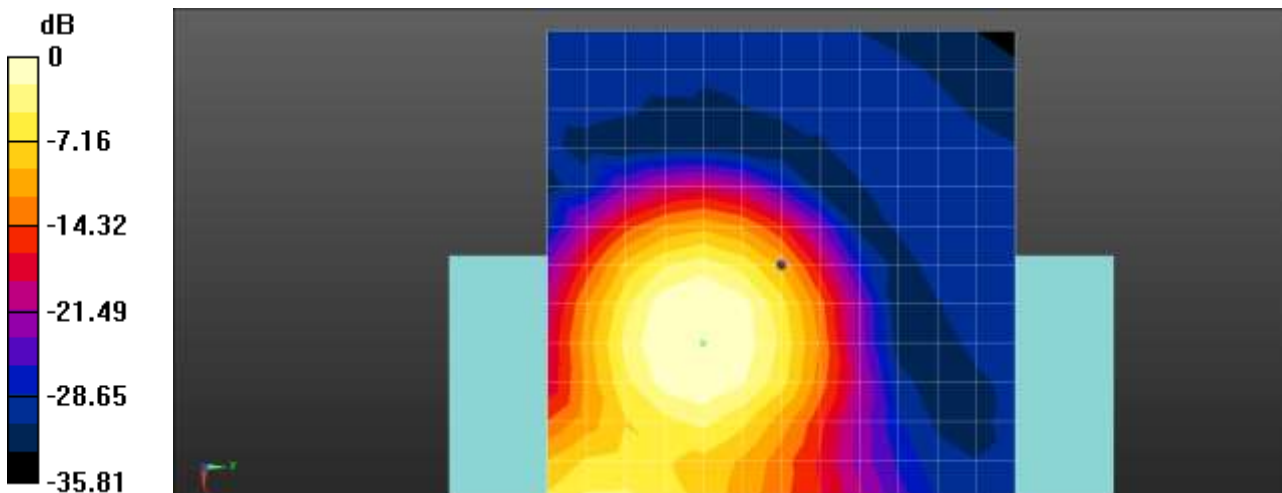

0 dB = 1.000 A/m = 0.00 dBA/m

Plot No.2

GSM850 190ch HR V1 251ch Freq. Response

Communication System: UID 0, GSM 850 (0); Frequency: 848.8 MHz;Duty Cycle: 1:8.30042
 Medium parameters used: $\sigma = 0$ S/m, $\epsilon_r = 1$; $\rho = 0$ kg/m³
 Phantom section: TCoil Section

T-Coil scan (scan for ANSI C63.19-2007 & 2011 compliance)/General Scans/z (axial) wideband at best S/N/ABM Freq Resp(x,y,z,f) (1x1x1): Measurement grid: dx=10mm, dy=10mm

Signal Type: Audio File (.wav) 48k_Normal_51s new.wav

Output Gain: 52.32

Measure Window Start: 300ms

Measure Window Length: 51000ms

BWC applied: 9.12 dB

Device Reference Point: 0, 0, -6.3 mm

Category	Telephone parameters WD signal quality [(signal+noise)-to-noise ratio in decibels]
Category T1	0 dB to 10 dB
Category T2	10 dB to 20 dB
Category T3	20 dB to 30 dB
Category T4	> 30 dB

Cursor:

Diff = 1.48 dB

BWC Factor = 9.12 dB

Location: 8, -8.8, 3.7 mm

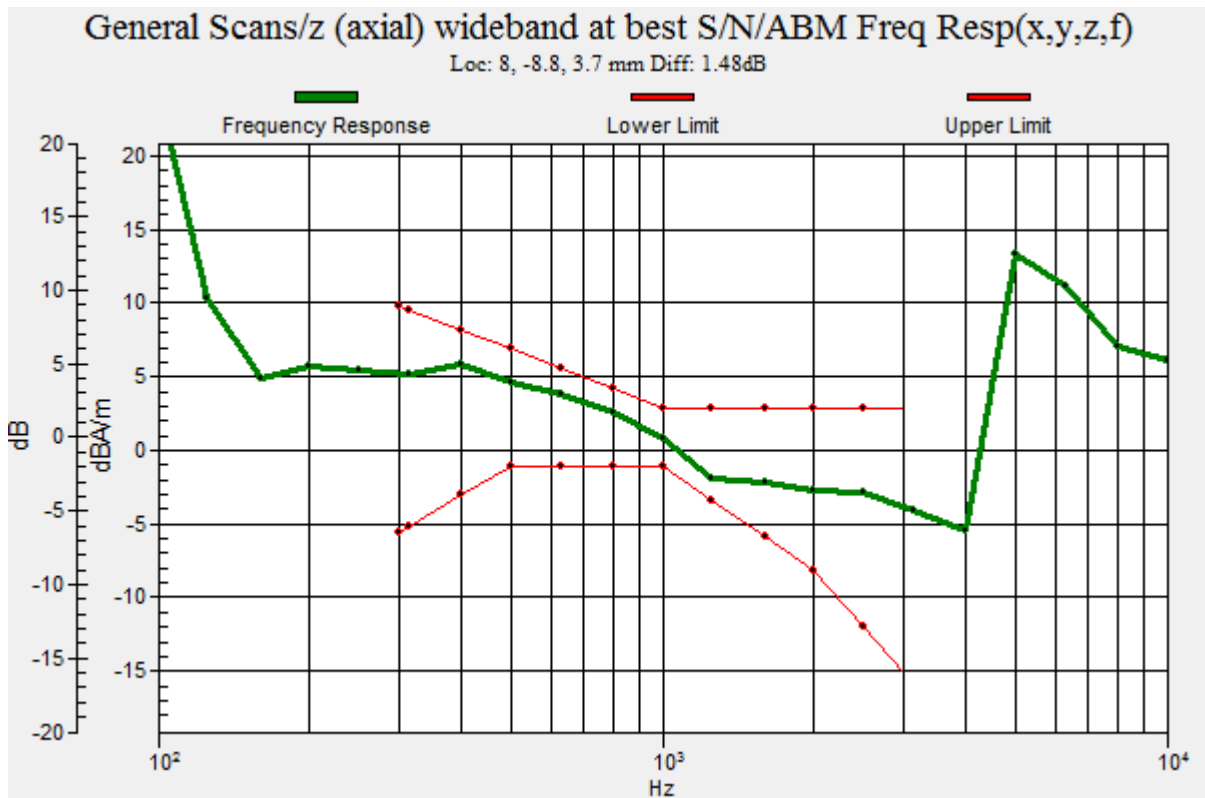

Plot No.3

GSM850 251ch HR V1 190ch y(transversal)

Communication System: UID 0, GSM 850 (0); Frequency: 848.8 MHz;Duty Cycle: 1:8.30042
Medium parameters used: $\sigma = 0$ S/m, $\epsilon_r = 1$; $\rho = 0$ kg/m³
Phantom section: TCoil Section

DASY5 Configuration:

- Probe: AM1DV3 - 3049; ; Calibrated: 6/1/2021
- Sensor-Surface: 0mm (Fix Surface)
- Electronics: DAE4 Sn652; Calibrated: 1/24/2022
- Phantom: HAC Test Arch with AMCC TCOIL
- Measurement SW: DASY52, Version 52.10 (4); SEMCAD X Version 14.6.14 (7483)

T-Coil scan (scan for ANSI C63.19-2007 & 2011 compliance)/General Scans/y (transversal) 4.2mm 50

x 50/ABM Signal(x,y,z) (13x13x1): Measurement grid: dx=10mm, dy=10mm

Signal Type: Audio File (.wav) 48k_voice_1kHz_1s.wav

Output Gain: 24.35

Measure Window Start: 300ms

Measure Window Length: 1000ms

BWC applied: -0.19 dB

Device Reference Point: 0, 0, -6.3 mm

Cursor:

ABM1 comp = -6.77 dBA/m

BWC Factor = -0.19 dB

Location: 4.2, -16.7, 3.7 mm

Cursor:

ABM2 = -30.45 dBA/m

Location: 4.2, -16.7, 3.7 mm

Cursor:

ABM1/ABM2 = 23.68 dB

ABM1 comp = -6.77 dBA/m

BWC Factor = -0.19 dB

Location: 4.2, -16.7, 3.7 mm

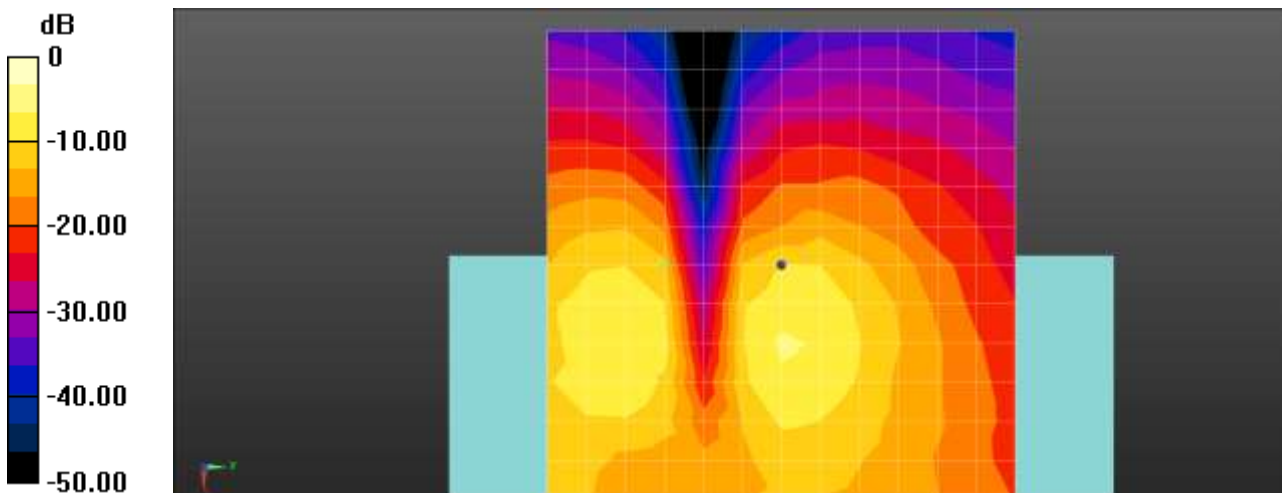

0 dB = 1.000 A/m = 0.00 dBA/m

Plot No.4

GSM1900 HR V1 661ch z(axial)

Communication System: UID 0, GSM 1900 (0); Frequency: 1880 MHz;Duty Cycle: 1:8.30042
Medium parameters used: $\sigma = 0$ S/m, $\epsilon_r = 1$; $\rho = 0$ kg/m³
Phantom section: TCoil Section

DASY5 Configuration:

- Probe: AM1DV3 - 3049; ; Calibrated: 6/1/2021
- Sensor-Surface: 0mm (Fix Surface)
- Electronics: DAE4 Sn652; Calibrated: 1/24/2022
- Phantom: HAC Test Arch with AMCC TCOIL
- Measurement SW: DASY52, Version 52.10 (4); SEMCAD X Version 14.6.14 (7483)

T-Coil scan (scan for ANSI C63.19-2007 & 2011 compliance)/General Scans/z (axial) 4.2mm 50 x

50/ABM Signal(x,y,z) (13x13x1): Measurement grid: dx=10mm, dy=10mm

Signal Type: Audio File (.wav) 48k_voice_1kHz_1s.wav

Output Gain: 24.35

Measure Window Start: 300ms

Measure Window Length: 1000ms

BWC applied: -0.19 dB

Device Reference Point: 0, 0, -6.3 mm

Cursor:

ABM1 comp = 0.88 dBA/m

BWC Factor = -0.19 dB

Location: 8.3, -12.5, 3.7 mm

Cursor:

ABM2 = -25.82 dBA/m

Location: 8.3, -12.5, 3.7 mm

Cursor:

ABM1/ABM2 = 26.70 dB

ABM1 comp = 0.88 dBA/m

BWC Factor = -0.19 dB

Location: 8.3, -12.5, 3.7 mm

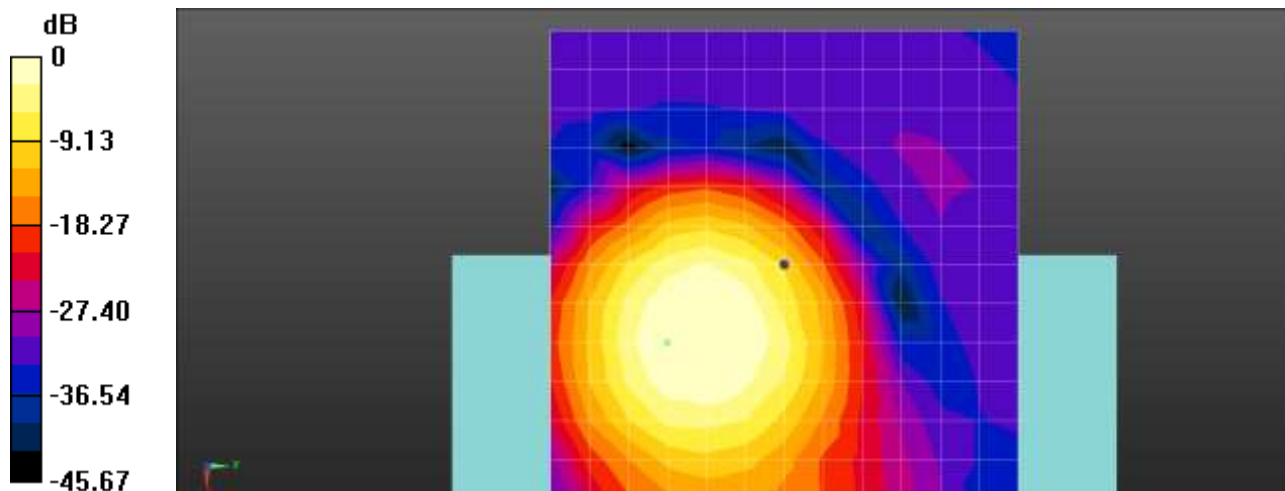

0 dB = 1.000 A/m = 0.00 dBA/m

Plot No.5

GSM1900 HR V1 661ch Freq. Response

Communication System: UID 0, GSM 1900 (0); Frequency: 1880 MHz; Duty Cycle: 1:8.30042
 Medium parameters used: $\sigma = 0$ S/m, $\epsilon_r = 1$; $\rho = 0$ kg/m³
 Phantom section: TCoil Section

T-Coil scan (scan for ANSI C63.19-2007 & 2011 compliance)/General Scans/z (axial) wideband at best

S/N/ABM Freq Resp(x,y,z,f) (1x1x1): Measurement grid: dx=10mm, dy=10mm

Signal Type: Audio File (.wav) 48k_Normal_51s new.wav

Output Gain: 52.32

Measure Window Start: 300ms

Measure Window Length: 51000ms

BWC applied: 9.13 dB

Device Reference Point: 0, 0, -6.3 mm

Category	Telephone parameters WD signal quality [(signal+noise)-to-noise ratio in decibels]
Category T1	0 dB to 10 dB
Category T2	10 dB to 20 dB
Category T3	20 dB to 30 dB
Category T4	> 30 dB

Cursor:

Diff = 1.23 dB

BWC Factor = 9.13 dB

Location: 8, -13.6, 3.7 mm

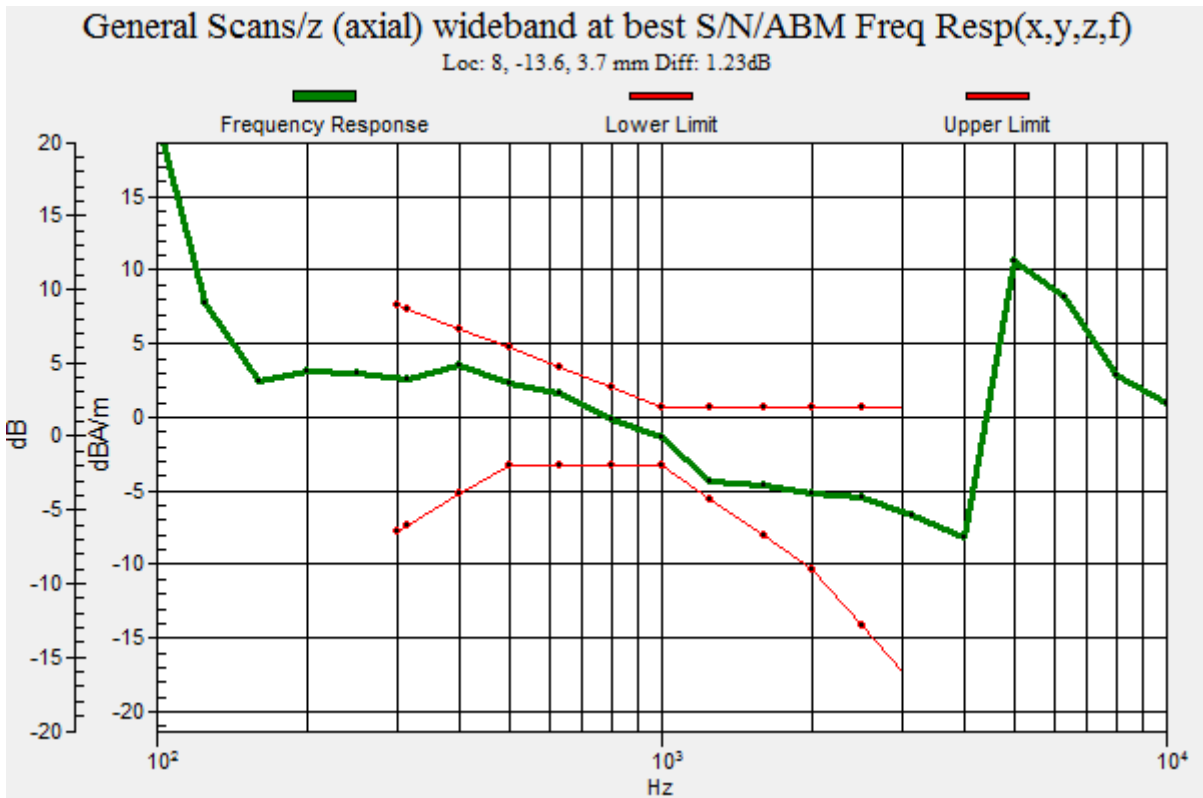

Plot No.6

GSM1900 HR V1 661ch y(transversal)

Communication System: UID 0, GSM 1900 (0); Frequency: 1880 MHz;Duty Cycle: 1:8.30042
Medium parameters used: $\sigma = 0$ S/m, $\epsilon_r = 1$; $\rho = 0$ kg/m³
Phantom section: TCoil Section

DASY5 Configuration:

- Probe: AM1DV3 - 3049; ; Calibrated: 6/1/2021
- Sensor-Surface: 0mm (Fix Surface)
- Electronics: DAE4 Sn652; Calibrated: 1/24/2022
- Phantom: HAC Test Arch with AMCC TCOIL
- Measurement SW: DASY52, Version 52.10 (4); SEMCAD X Version 14.6.14 (7483)

T-Coil scan (scan for ANSI C63.19-2007 & 2011 compliance)/General Scans/y (transversal) 4.2mm 50

x 50/ABM Signal(x,y,z) (13x13x1): Measurement grid: dx=10mm, dy=10mm

Signal Type: Audio File (.wav) 48k_voice_1kHz_1s.wav

Output Gain: 24.35

Measure Window Start: 300ms

Measure Window Length: 1000ms

BWC applied: -0.19 dB

Device Reference Point: 0, 0, -6.3 mm

Cursor:

ABM1 comp = -13.24 dBA/m

BWC Factor = -0.19 dB

Location: -4.2, 4.2, 3.7 mm

Cursor:

ABM2 = -39.89 dBA/m

Location: -4.2, 4.2, 3.7 mm

Cursor:

ABM1/ABM2 = 26.65 dB

ABM1 comp = -13.24 dBA/m

BWC Factor = -0.19 dB

Location: -4.2, 4.2, 3.7 mm

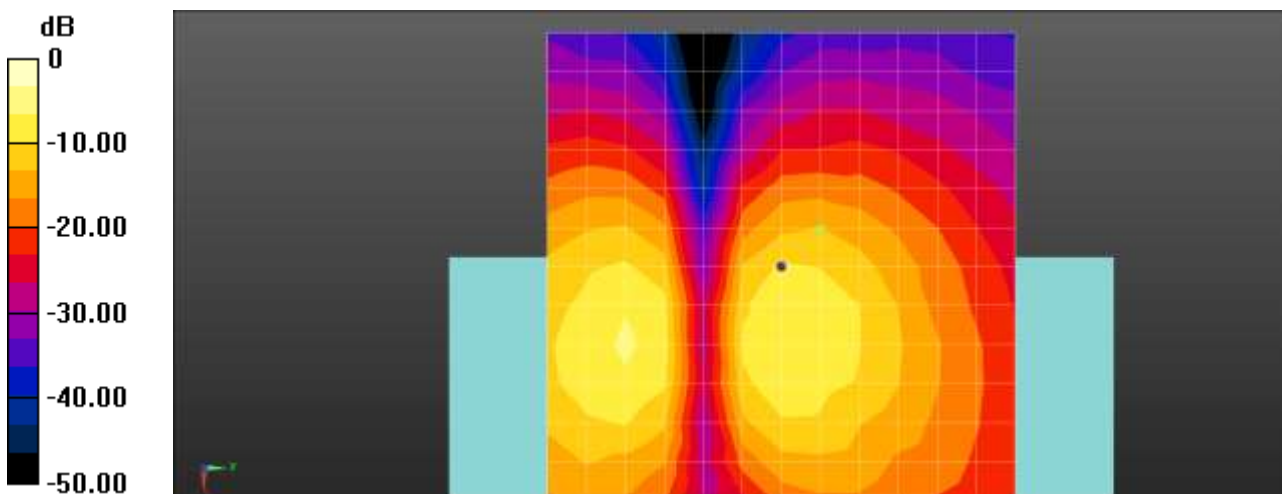

0 dB = 1.000 A/m = 0.00 dBA/m

Plot No.7

UMTS Band 2 9400ch AMR NB 12_2 z(axial)

Communication System: UID 0, UMTS1900 (0); Frequency: 1880 MHz;Duty Cycle: 1:1
Medium parameters used: $\sigma = 0$ S/m, $\epsilon_r = 1$; $\rho = 0$ kg/m³
Phantom section: TCoil Section

DASY5 Configuration:

- Probe: AM1DV3 - 3049; ; Calibrated: 6/1/2021
- Sensor-Surface: 0mm (Fix Surface)
- Electronics: DAE4 Sn652; Calibrated: 1/24/2022
- Phantom: HAC Test Arch with AMCC TCOIL
- Measurement SW: DASY52, Version 52.10 (4); SEMCAD X Version 14.6.14 (7483)

T-Coil scan (scan for ANSI C63.19-2007 & 2011 compliance)/General Scans/z (axial) 4.2mm 50 x 50/ABM Signal(x,y,z) (13x13x1): Measurement grid: dx=10mm, dy=10mm

Signal Type: Audio File (.wav) 48k_voice_1kHz_1s.wav
Output Gain: 24.35
Measure Window Start: 300ms
Measure Window Length: 1000ms
BWC applied: -0.19 dB
Device Reference Point: 0, 0, -6.3 mm

Cursor:

ABM1 comp = 0.37 dBA/m
BWC Factor = -0.19 dB
Location: 8.3, -12.5, 3.7 mm

Cursor:

ABM2 = -27.33 dBA/m
Location: 8.3, -12.5, 3.7 mm

Cursor:

ABM1/ABM2 = 27.69 dB
ABM1 comp = 0.37 dBA/m
BWC Factor = -0.19 dB
Location: 8.3, -12.5, 3.7 mm

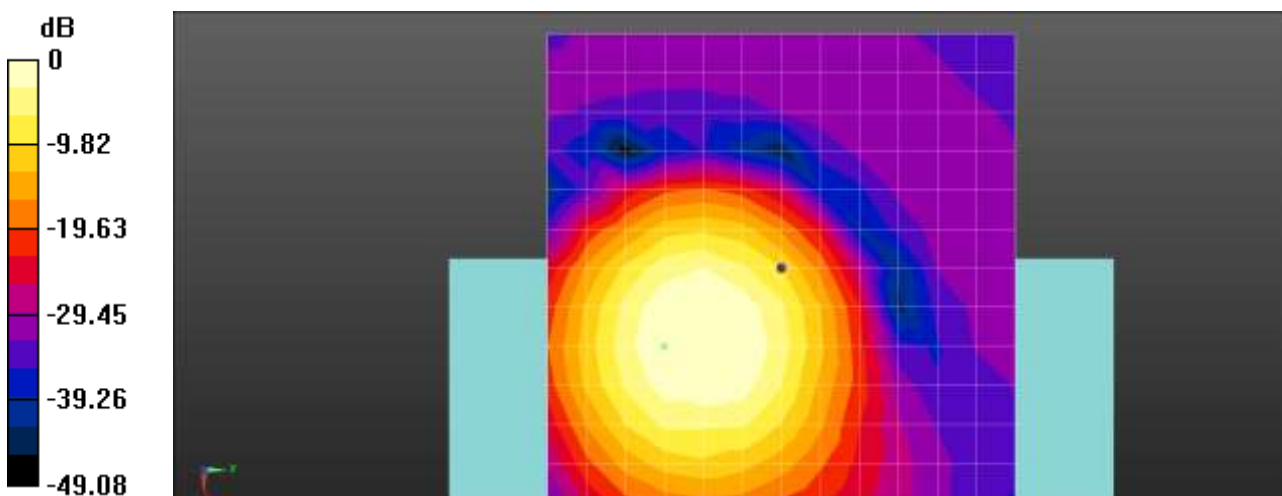

0 dB = 1.000 A/m = 0.00 dBA/m

Plot No.8

UMTS Band 2 9400ch AMR NB 12_2 Freq. Response

Communication System: UID 0, UMTS1900 (0); Frequency: 1880 MHz;Duty Cycle: 1:1
 Medium parameters used: $\sigma = 0$ S/m, $\epsilon_r = 1$; $\rho = 0$ kg/m³
 Phantom section: TCoil Section

T-Coil scan (scan for ANSI C63.19-2007 & 2011 compliance)/General Scans/z (axial) wideband at best S/N/ABM Freq Resp(x,y,z,f) (1x1x1): Measurement grid: dx=10mm, dy=10mm

Signal Type: Audio File (.wav) 48k_Normal_51s new.wav

Output Gain: 52.32

Measure Window Start: 300ms

Measure Window Length: 51000ms

BWC applied: 9.12 dB

Device Reference Point: 0, 0, -6.3 mm

Category	Telephone parameters WD signal quality [(signal+noise)-to-noise ratio in decibels]
Category T1	0 dB to 10 dB
Category T2	10 dB to 20 dB
Category T3	20 dB to 30 dB
Category T4	> 30 dB

Cursor:

Diff = 1.92 dB

BWC Factor = 9.12 dB

Location: 7.6, -12.3, 3.7 mm

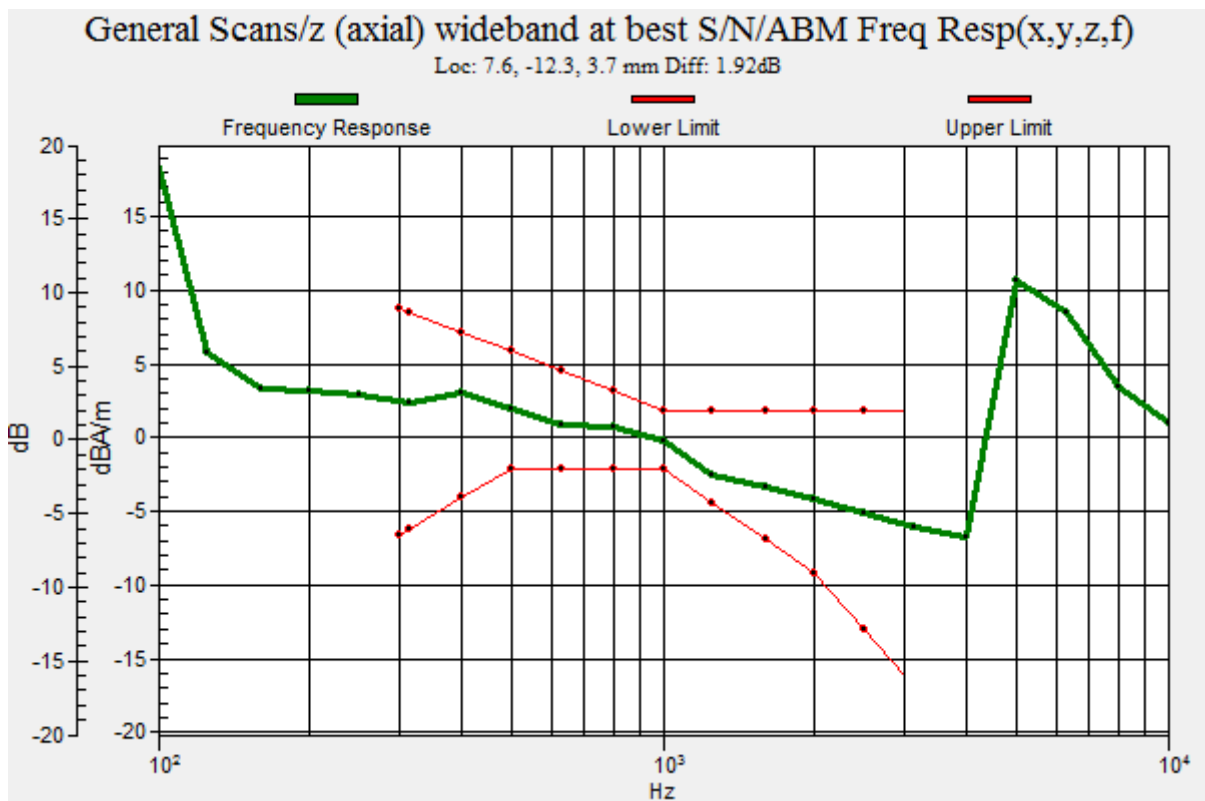

Plot No.9

UMTS Band 2 9400ch AMR NB 12_2 y(transversal)

Communication System: UID 0, UMTS1900 (0); Frequency: 1880 MHz;Duty Cycle: 1:1
Medium parameters used: $\sigma = 0$ S/m, $\epsilon_r = 1$; $\rho = 0$ kg/m³
Phantom section: TCoil Section

DASY5 Configuration:

- Probe: AM1DV3 - 3049; ; Calibrated: 6/1/2021
- Sensor-Surface: 0mm (Fix Surface)
- Electronics: DAE4 Sn652; Calibrated: 1/24/2022
- Phantom: HAC Test Arch with AMCC TCOIL
- Measurement SW: DASY52, Version 52.10 (4); SEMCAD X Version 14.6.14 (7483)

T-Coil scan (scan for ANSI C63.19-2007 & 2011 compliance)/General Scans/y (transversal) 4.2mm 50

x 50/ABM Signal(x,y,z) (13x13x1): Measurement grid: dx=10mm, dy=10mm

Signal Type: Audio File (.wav) 48k_voice_1kHz_1s.wav

Output Gain: 24.35

Measure Window Start: 300ms

Measure Window Length: 1000ms

BWC applied: -0.19 dB

Device Reference Point: 0, 0, -6.3 mm

Cursor:

ABM1 comp = -13.44 dBA/m

BWC Factor = -0.19 dB

Location: -4.2, -16.7, 3.7 mm

Cursor:

ABM2 = -40.93 dBA/m

Location: -4.2, -16.7, 3.7 mm

Cursor:

ABM1/ABM2 = 27.48 dB

ABM1 comp = -13.44 dBA/m

BWC Factor = -0.19 dB

Location: -4.2, -16.7, 3.7 mm

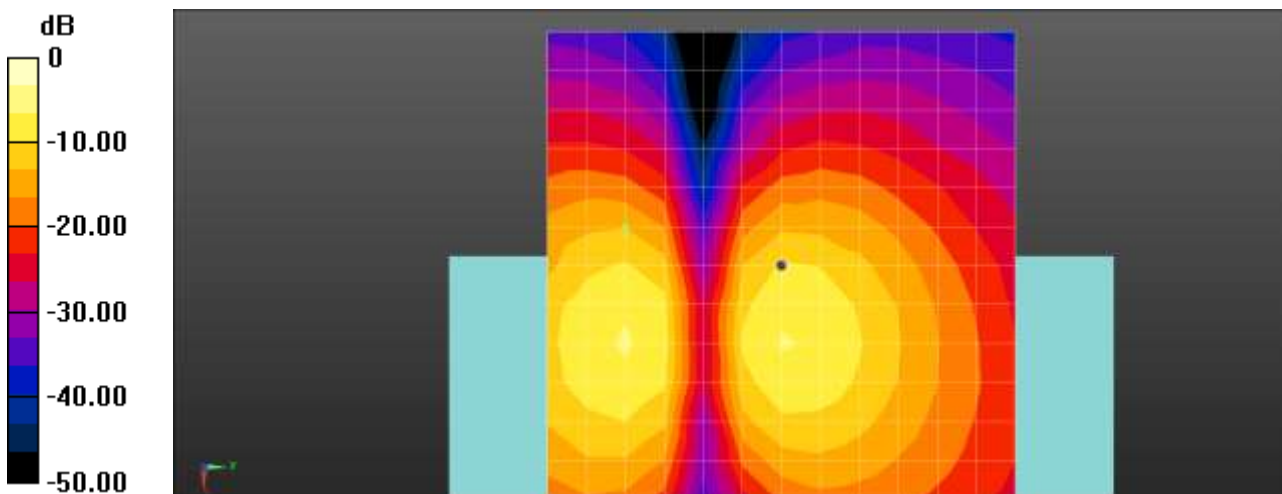

0 dB = 1.000 A/m = 0.00 dBA/m

Plot No.10

UMTS Band 4 1412ch AMR NB 12_2 z(axial)

Communication System: UID 0, UMTS IV (0); Frequency: 1732.4 MHz;Duty Cycle: 1:1
Medium parameters used: $\sigma = 0$ S/m, $\epsilon_r = 1$; $\rho = 0$ kg/m³
Phantom section: TCoil Section

DASY5 Configuration:

- Probe: AM1DV3 - 3049; ; Calibrated: 6/1/2021
- Sensor-Surface: 0mm (Fix Surface)
- Electronics: DAE4 Sn652; Calibrated: 1/24/2022
- Phantom: HAC Test Arch with AMCC TCOIL
- Measurement SW: DASY52, Version 52.10 (4); SEMCAD X Version 14.6.14 (7483)

T-Coil scan (scan for ANSI C63.19-2007 & 2011 compliance)/General Scans/z (axial) 4.2mm 50 x 50/ABM Signal(x,y,z) (13x13x1): Measurement grid: dx=10mm, dy=10mm

Signal Type: Audio File (.wav) 48k_voice_1kHz_1s.wav
Output Gain: 24.35
Measure Window Start: 300ms
Measure Window Length: 1000ms
BWC applied: -0.20 dB
Device Reference Point: 0, 0, -6.3 mm

Cursor:

ABM1 comp = -1.51 dBA/m
BWC Factor = -0.20 dB
Location: 12.5, -12.5, 3.7 mm

Cursor:

ABM2 = -29.33 dBA/m
Location: 12.5, -12.5, 3.7 mm

Cursor:

ABM1/ABM2 = 27.82 dB
ABM1 comp = -1.51 dBA/m
BWC Factor = -0.20 dB
Location: 12.5, -12.5, 3.7 mm

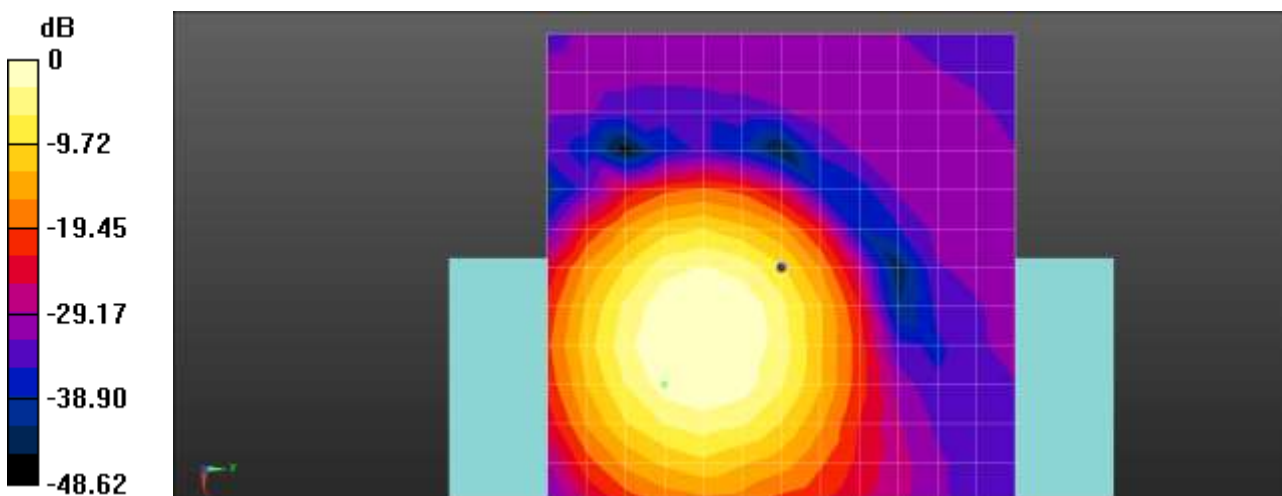

0 dB = 1.000 A/m = 0.00 dBA/m

Plot No.11

UMTS Band 4 1412ch AMR NB 12_2 Freq. Response

Communication System: UID 0, UMTS IV (0); Frequency: 1732.4 MHz; Duty Cycle: 1:1
 Medium parameters used: $\sigma = 0$ S/m, $\epsilon_r = 1$; $\rho = 0$ kg/m³
 Phantom section: TCoil Section

T-Coil scan (scan for ANSI C63.19-2007 & 2011 compliance)/General Scans/z (axial) wideband at best

S/N/ABM Freq Resp(x,y,z,f) (1x1x1): Measurement grid: dx=10mm, dy=10mm

Signal Type: Audio File (.wav) 48k_Normal_51s new.wav

Output Gain: 52.32

Measure Window Start: 300ms

Measure Window Length: 51000ms

BWC applied: 9.12 dB

Device Reference Point: 0, 0, -6.3 mm

Category	Telephone parameters WD signal quality [(signal+noise)-to-noise ratio in decibels]
Category T1	0 dB to 10 dB
Category T2	10 dB to 20 dB
Category T3	20 dB to 30 dB
Category T4	> 30 dB

Cursor:

Diff = 2.00 dB

BWC Factor = 9.12 dB

Location: 11.1, -12.4, 3.7 mm

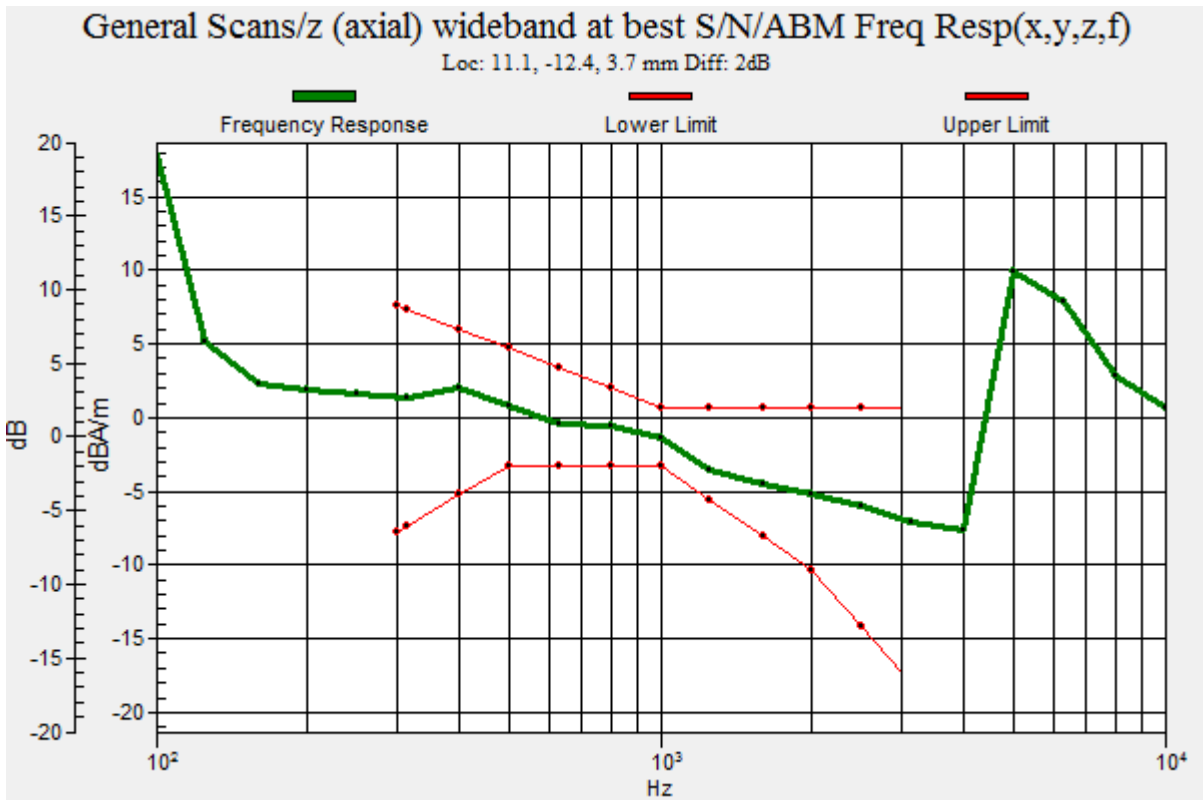

Plot No.12

UMTS Band 4 1412ch AMR NB 12_2 y(transversal)

Communication System: UID 0, UMTS IV (0); Frequency: 1732.4 MHz;Duty Cycle: 1:1
Medium parameters used: $\sigma = 0$ S/m, $\epsilon_r = 1$; $\rho = 0$ kg/m³
Phantom section: TCoil Section

DASY5 Configuration:

- Probe: AM1DV3 - 3049; ; Calibrated: 6/1/2021
- Sensor-Surface: 0mm (Fix Surface)
- Electronics: DAE4 Sn652; Calibrated: 1/24/2022
- Phantom: HAC Test Arch with AMCC TCOIL
- Measurement SW: DASY52, Version 52.10 (4); SEMCAD X Version 14.6.14 (7483)

T-Coil scan (scan for ANSI C63.19-2007 & 2011 compliance)/General Scans/y (transversal) 4.2mm 50

x 50/ABM Signal(x,y,z) (13x13x1): Measurement grid: dx=10mm, dy=10mm

Signal Type: Audio File (.wav) 48k_voice_1kHz_1s.wav

Output Gain: 24.35

Measure Window Start: 300ms

Measure Window Length: 1000ms

BWC applied: -0.20 dB

Device Reference Point: 0, 0, -6.3 mm

Cursor:

ABM1 comp = -8.78 dBA/m

BWC Factor = -0.20 dB

Location: 4.2, -12.5, 3.7 mm

Cursor:

ABM2 = -36.57 dBA/m

Location: 4.2, -12.5, 3.7 mm

Cursor:

ABM1/ABM2 = 27.79 dB

ABM1 comp = -8.78 dBA/m

BWC Factor = -0.20 dB

Location: 4.2, -12.5, 3.7 mm

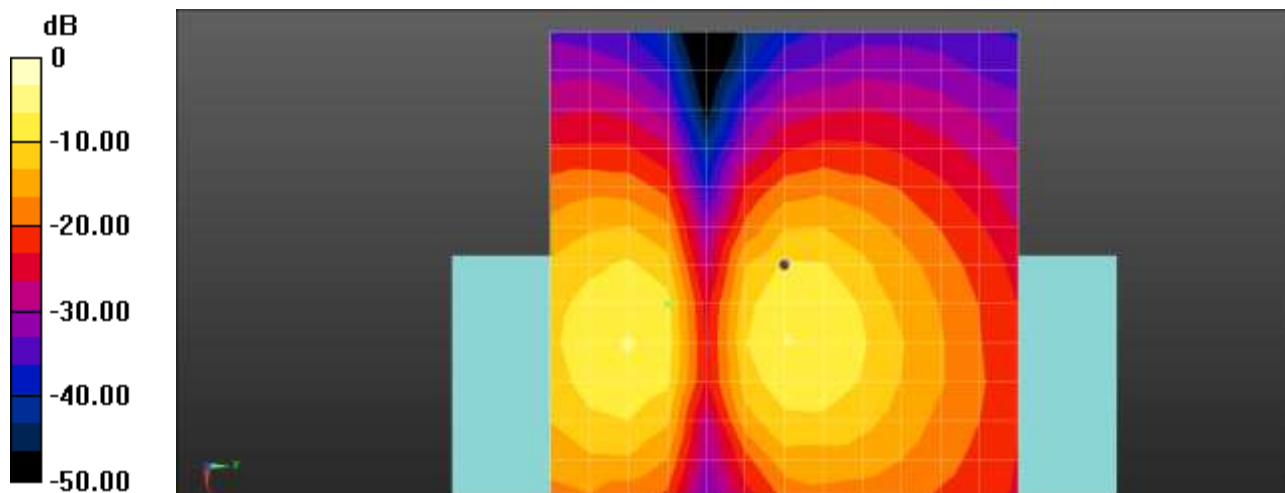

0 dB = 1.000 A/m = 0.00 dBA/m

Plot No.13
UMTS Band 5 4183ch AMR NB 12_2 z(axial)

Communication System: UID 0, UMTS850 (0); Frequency: 836.6 MHz;Duty Cycle: 1:1
Medium parameters used: $\sigma = 0$ S/m, $\epsilon_r = 1$; $\rho = 0$ kg/m³
Phantom section: TCoil Section

DASY5 Configuration:

- Probe: AM1DV3 - 3049; ; Calibrated: 6/1/2021
- Sensor-Surface: 0mm (Fix Surface)
- Electronics: DAE4 Sn652; Calibrated: 1/24/2022
- Phantom: HAC Test Arch with AMCC TCOIL
- Measurement SW: DASY52, Version 52.10 (4); SEMCAD X Version 14.6.14 (7483)

T-Coil scan (scan for ANSI C63.19-2007 & 2011 compliance)/General Scans/z (axial) 4.2mm 50 x 50/ABM Signal(x,y,z) (13x13x1): Measurement grid: dx=10mm, dy=10mm

Signal Type: Audio File (.wav) 48k_voice_1kHz_1s.wav
Output Gain: 24.35
Measure Window Start: 300ms
Measure Window Length: 1000ms
BWC applied: -0.19 dB
Device Reference Point: 0, 0, -6.3 mm

Cursor:

ABM1 comp = 0.95 dBA/m
BWC Factor = -0.19 dB
Location: 4.2, -8.3, 3.7 mm

Cursor:

ABM2 = -26.88 dBA/m
Location: 4.2, -8.3, 3.7 mm

Cursor:

ABM1/ABM2 = 27.84 dB
ABM1 comp = 0.95 dBA/m
BWC Factor = -0.19 dB
Location: 4.2, -8.3, 3.7 mm

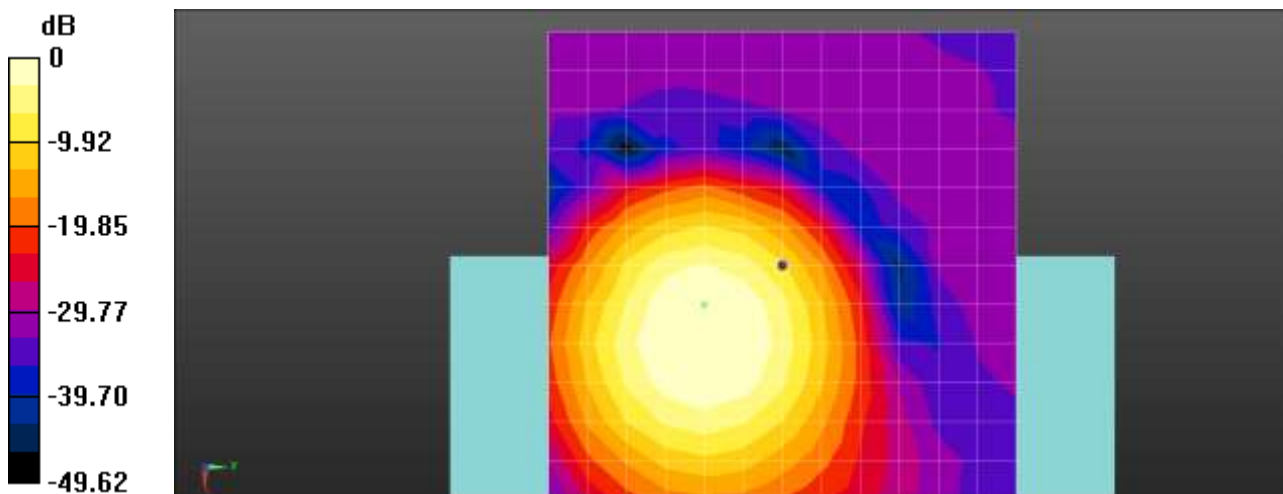

0 dB = 1.000 A/m = 0.00 dBA/m

Plot No.14

UMTS Band 5 4183ch AMR NB 12_2 Freq. Response

Communication System: UID 0, UMTS850 (0); Frequency: 836.6 MHz;Duty Cycle: 1:1
 Medium parameters used: $\sigma = 0$ S/m, $\epsilon_r = 1$; $\rho = 0$ kg/m³
 Phantom section: TCoil Section

T-Coil scan (scan for ANSI C63.19-2007 & 2011 compliance)/General Scans/z (axial) wideband at best S/N/ABM Freq Resp(x,y,z,f) (1x1x1): Measurement grid: dx=10mm, dy=10mm

Signal Type: Audio File (.wav) 48k_Normal_51s new.wav

Output Gain: 52.32

Measure Window Start: 300ms

Measure Window Length: 51000ms

BWC applied: 9.13 dB

Device Reference Point: 0, 0, -6.3 mm

Category	Telephone parameters WD signal quality [(signal+noise)-to-noise ratio in decibels]
Category T1	0 dB to 10 dB
Category T2	10 dB to 20 dB
Category T3	20 dB to 30 dB
Category T4	> 30 dB

Cursor:

Diff = 1.97 dB

BWC Factor = 9.13 dB

Location: 3.8, -8.1, 3.7 mm

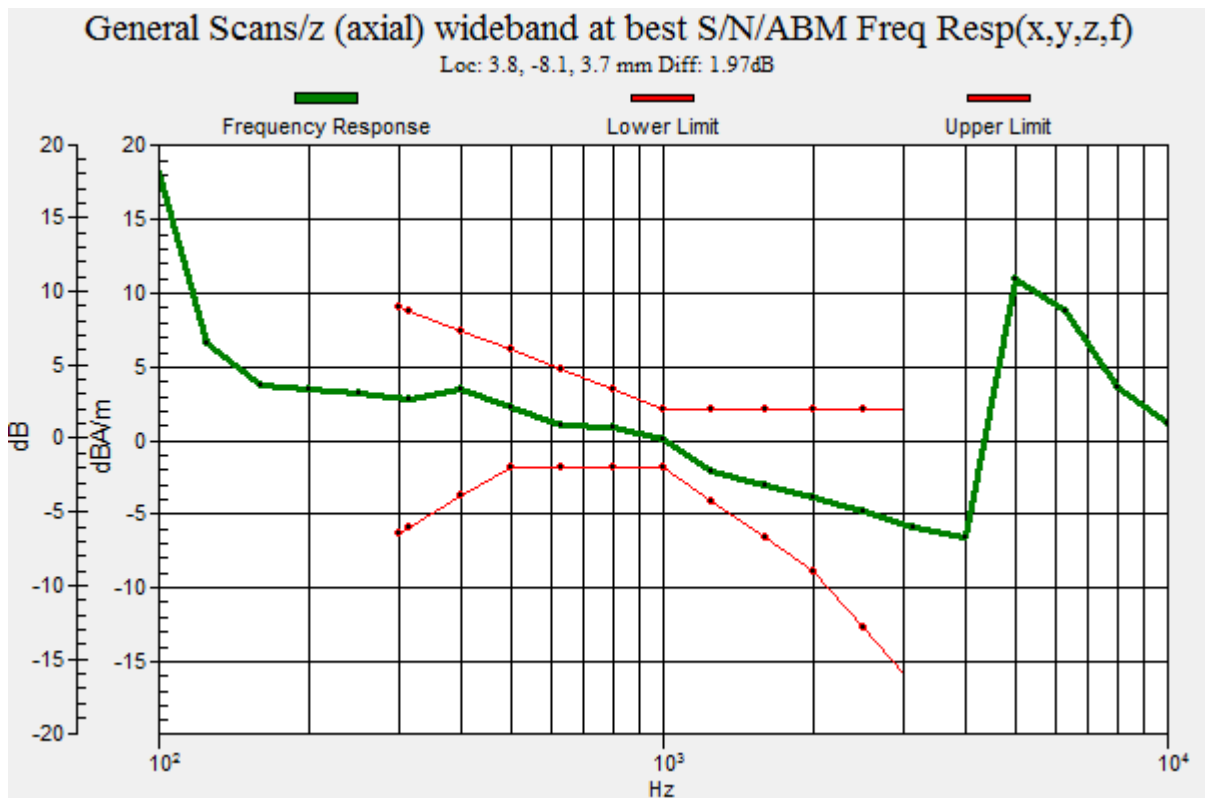

Plot No.15

UMTS Band 5 4183ch AMR NB 12_2 y(transversal)

Communication System: UID 0, UMTS850 (0); Frequency: 836.6 MHz;Duty Cycle: 1:1
Medium parameters used: $\sigma = 0$ S/m, $\epsilon_r = 1$; $\rho = 0$ kg/m³
Phantom section: TCoil Section

DASY5 Configuration:

- Probe: AM1DV3 - 3049; ; Calibrated: 6/1/2021
- Sensor-Surface: 0mm (Fix Surface)
- Electronics: DAE4 Sn652; Calibrated: 1/24/2022
- Phantom: HAC Test Arch with AMCC TCOIL
- Measurement SW: DASY52, Version 52.10 (4); SEMCAD X Version 14.6.14 (7483)

T-Coil scan (scan for ANSI C63.19-2007 & 2011 compliance)/General Scans/y (transversal) 4.2mm 50

x 50/ABM Signal(x,y,z) (13x13x1): Measurement grid: dx=10mm, dy=10mm

Signal Type: Audio File (.wav) 48k_voice_1kHz_1s.wav

Output Gain: 24.35

Measure Window Start: 300ms

Measure Window Length: 1000ms

BWC applied: -0.19 dB

Device Reference Point: 0, 0, -6.3 mm

Cursor:

ABM1 comp = -6.90 dBA/m

BWC Factor = -0.19 dB

Location: 4.2, -16.7, 3.7 mm

Cursor:

ABM2 = -34.71 dBA/m

Location: 4.2, -16.7, 3.7 mm

Cursor:

ABM1/ABM2 = 27.81 dB

ABM1 comp = -6.90 dBA/m

BWC Factor = -0.19 dB

Location: 4.2, -16.7, 3.7 mm

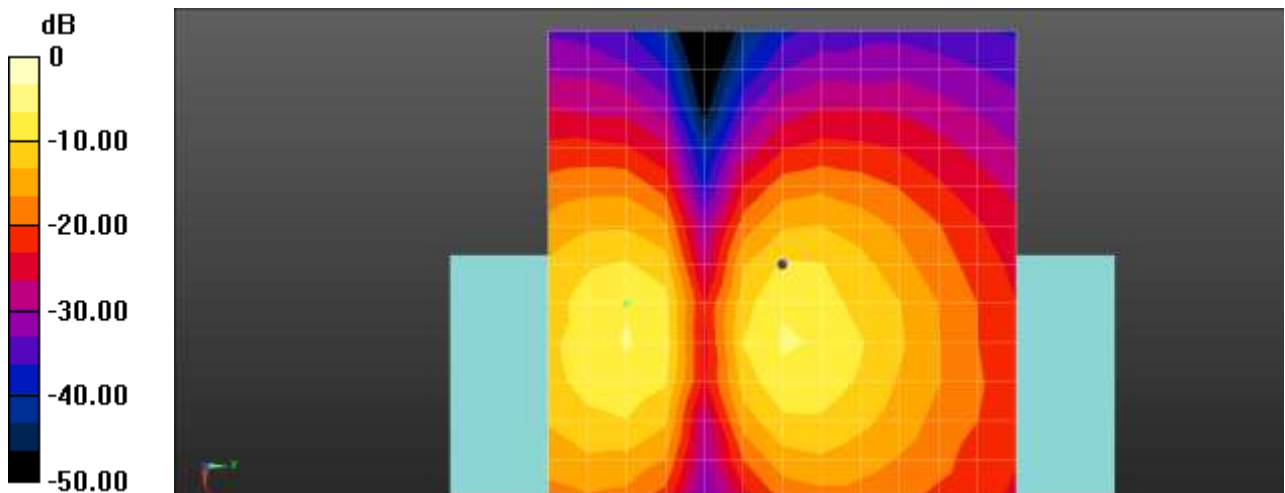

0 dB = 1.000 A/m = 0.00 dBA/m

Plot No.16

LTE Band 66 QPSK 20MHz 1RB 0offset 132322ch EVS NB 5.9 z(axial)

Communication System: UID 0, LTE Band66 (0); Frequency: 1745 MHz;Duty Cycle: 1:1
Medium parameters used: $\sigma = 0$ S/m, $\epsilon_r = 1$; $\rho = 0$ kg/m³
Phantom section: TCoil Section

DASY5 Configuration:

- Probe: AM1DV3 - 3049; ; Calibrated: 2021-06-01
- Sensor-Surface: 0mm (Fix Surface)
- Electronics: DAE4 Sn652; Calibrated: 2022-01-24
- Phantom: HAC Test Arch with AMCC TCOIL
- Measurement SW: DASY52, Version 52.10 (4)

T-Coil scan (scan for ANSI C63.19-2007 & 2011 compliance)/General Scans/z (axial) 4.2mm 50 x

50/ABM Signal(x,y,z) (13x13x1): Measurement grid: dx=10mm, dy=10mm
Signal Type: Audio File (.wav) 48k_voice_1kHz_1s.wav
Output Gain: 24.38
Measure Window Start: 300ms
Measure Window Length: 1000ms
BWC applied: -0.17 dB
Device Reference Point: 0, 0, -6.3 mm

Cursor:

ABM1 comp = -5.24 dBA/m
BWC Factor = -0.17 dB
Location: 4.2, -16.7, 3.7 mm

Cursor:

ABM2 = -28.68 dBA/m
Location: 4.2, -16.7, 3.7 mm

Cursor:

ABM1/ABM2 = 23.44 dB
ABM1 comp = -5.24 dBA/m
BWC Factor = -0.17 dB
Location: 4.2, -16.7, 3.7 mm

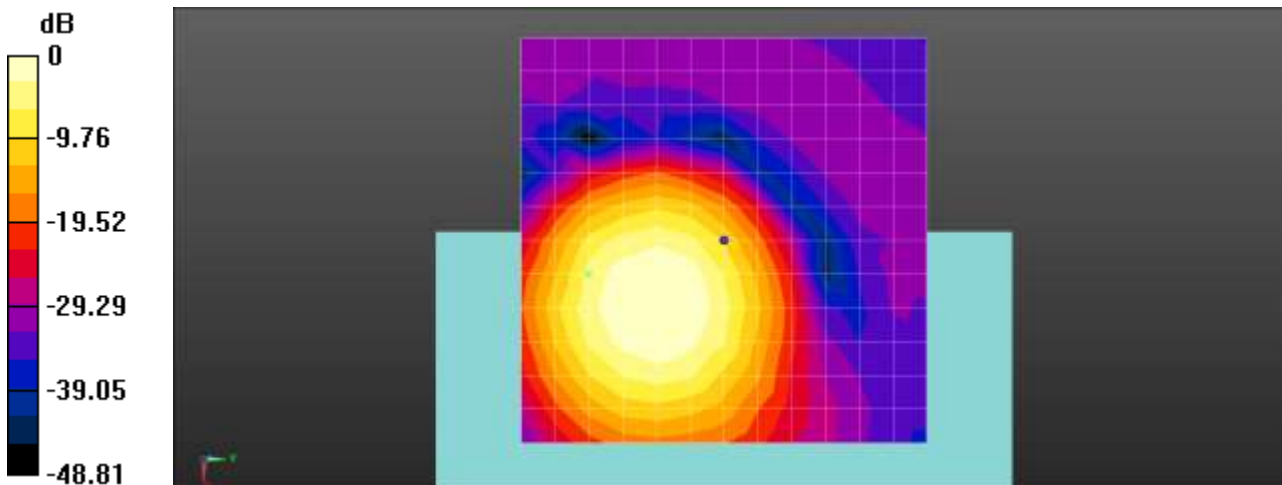

0 dB = 1.000 A/m = 0.00 dBA/m

Plot No.17

LTE Band 66 QPSK 20MHz 1RB 0offset 132322ch EVS NB 5.9 Freq. Response

Communication System: UID 0, LTE Band66 (0); Frequency: 1745 MHz;Duty Cycle: 1:1

Medium parameters used: $\sigma = 0$ S/m, $\epsilon_r = 1$; $\rho = 0$ kg/m³

Phantom section: TCoil Section

T-Coil scan (scan for ANSI C63.19-2007 & 2011 compliance)/General Scans/z (axial) wideband at best

S/N/ABM Freq Resp(x,y,z,f) (1x1x1): Measurement grid: dx=10mm, dy=10mm

Signal Type: Audio File (.wav) 48k_Normal_51s new.wav

Output Gain: 52.36

Measure Window Start: 300ms

Measure Window Length: 51000ms

BWC applied: 9.14 dB

Device Reference Point: 0, 0, -6.3 mm

Category	Telephone parameters WD signal quality [(signal+noise)-to-noise ratio in decibels]
Category T1	0 dB to 10 dB
Category T2	10 dB to 20 dB
Category T3	20 dB to 30 dB
Category T4	> 30 dB

Cursor:

Diff = 1.94 dB

BWC Factor = 9.14 dB

Location: 4.5, -16.2, 3.7 mm

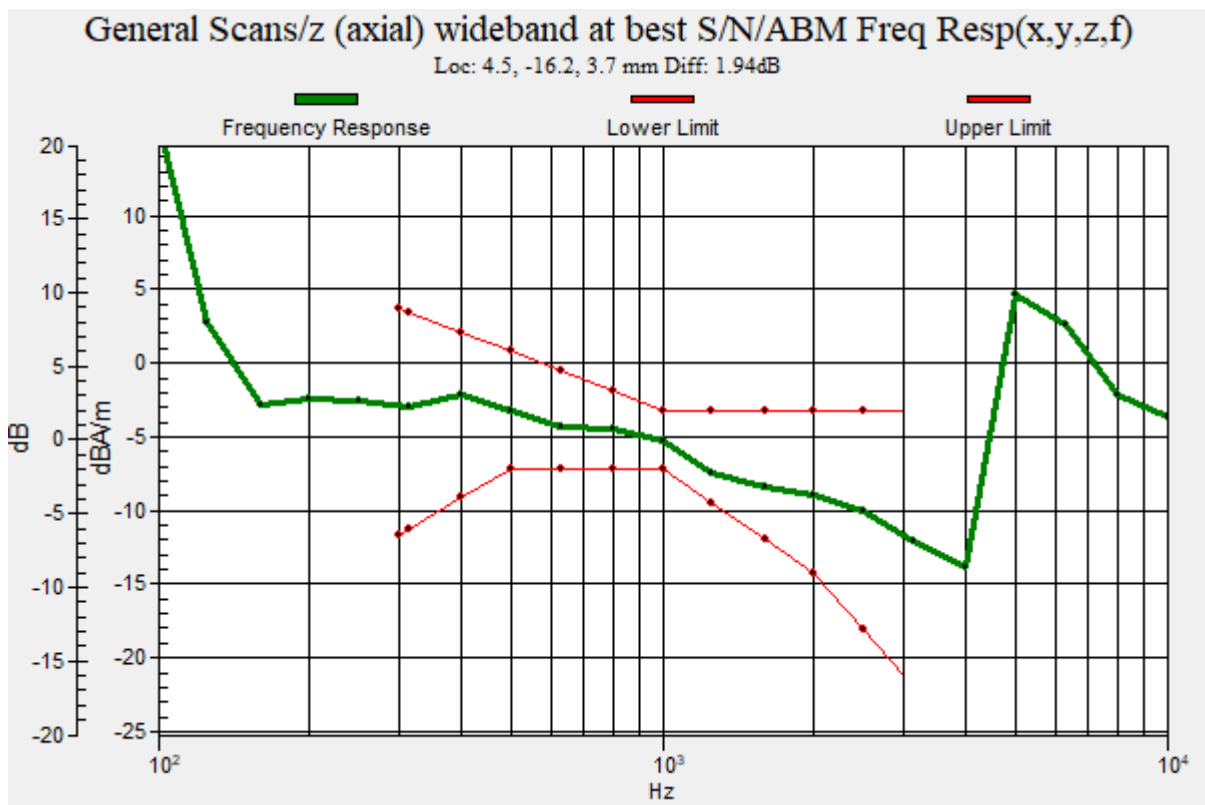

Plot No.18

LTE Band 66 QPSK 20MHz 1RB 0offset 132322ch EVS NB 5.9 y(transversal)

Communication System: UID 0, LTE Band66 (0); Frequency: 1745 MHz;Duty Cycle: 1:1

Medium parameters used: $\sigma = 0$ S/m, $\epsilon_r = 1$; $\rho = 0$ kg/m³

Phantom section: TCoil Section

DASY5 Configuration:

- Probe: AM1DV3 - 3049; ; Calibrated: 2021-06-01
- Sensor-Surface: 0mm (Fix Surface)
- Electronics: DAE4 Sn652; Calibrated: 2022-01-24
- Phantom: HAC Test Arch with AMCC TCOIL
- Measurement SW: DASY52, Version 52.10 (4)

T-Coil scan (scan for ANSI C63.19-2007 & 2011 compliance)/General Scans/y (transversal) 4.2mm 50

x 50/ABM Signal(x,y,z) (13x13x1): Measurement grid: dx=10mm, dy=10mm

Signal Type: Audio File (.wav) 48k_voice_1kHz_1s.wav

Output Gain: 24.38

Measure Window Start: 300ms

Measure Window Length: 1000ms

BWC applied: -0.17 dB

Device Reference Point: 0, 0, -6.3 mm

Cursor:

ABM1 comp = -9.44 dBA/m

BWC Factor = -0.17 dB

Location: 8.3, 8.3, 3.7 mm

Cursor:

ABM2 = -33.43 dBA/m

Location: 8.3, 8.3, 3.7 mm

Cursor:

ABM1/ABM2 = 23.99 dB

ABM1 comp = -9.44 dBA/m

BWC Factor = -0.17 dB

Location: 8.3, 8.3, 3.7 mm

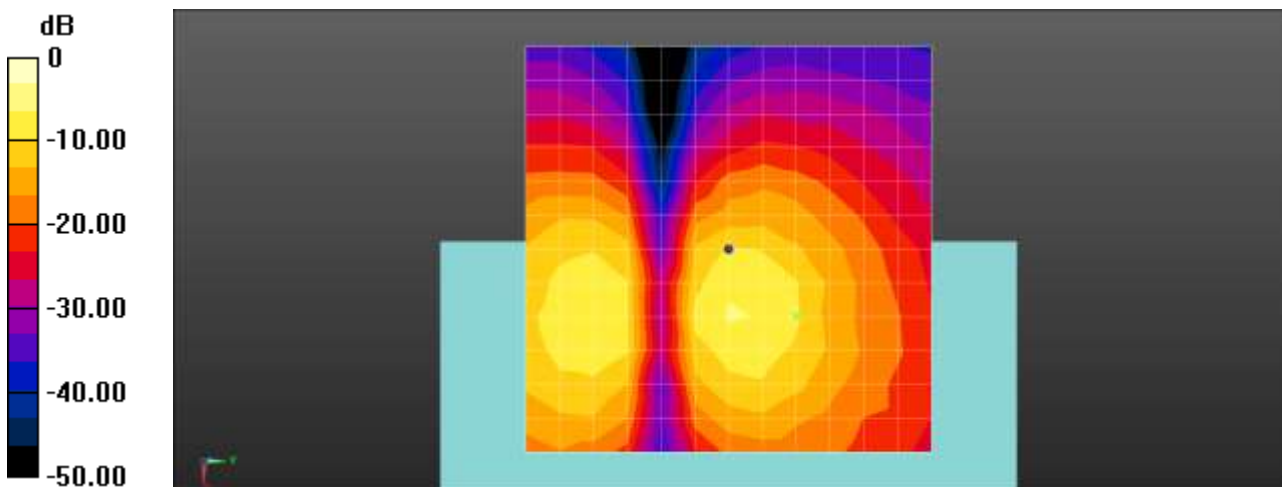

0 dB = 1.000 A/m = 0.00 dBA/m

Plot No.19

LTE Band 7 QPSK 20MHz 1RB 0offset 21100ch EVS NB 5.9 z(axial)

Communication System: UID 0, LTE Band 7 (0); Frequency: 2535 MHz;Duty Cycle: 1:1
Medium parameters used: $\sigma = 0$ S/m, $\epsilon_r = 1$; $\rho = 0$ kg/m³
Phantom section: TCoil Section

DASY5 Configuration:

- Probe: AM1DV3 - 3049; ; Calibrated: 2021-06-01
- Sensor-Surface: 0mm (Fix Surface)
- Electronics: DAE4 Sn652; Calibrated: 2022-01-24
- Phantom: HAC Test Arch with AMCC TCOIL
- Measurement SW: DASY52, Version 52.10 (4)

T-Coil scan (scan for ANSI C63.19-2007 & 2011 compliance)/General Scans/z (axial) 4.2mm 50 x 50/ABM Signal(x,y,z) (13x13x1): Measurement grid: dx=10mm, dy=10mm

Signal Type: Audio File (.wav) 48k_voice_1kHz_1s.wav
Output Gain: 24.38
Measure Window Start: 300ms
Measure Window Length: 1000ms
BWC applied: -0.20 dB
Device Reference Point: 0, 0, -6.3 mm

Cursor:

ABM1 comp = -8.94 dBA/m
BWC Factor = -0.20 dB
Location: -4.2, -8.3, 3.7 mm

Cursor:

ABM2 = -33.43 dBA/m
Location: -4.2, -8.3, 3.7 mm

Cursor:

ABM1/ABM2 = 24.49 dB
ABM1 comp = -8.94 dBA/m
BWC Factor = -0.20 dB
Location: -4.2, -8.3, 3.7 mm

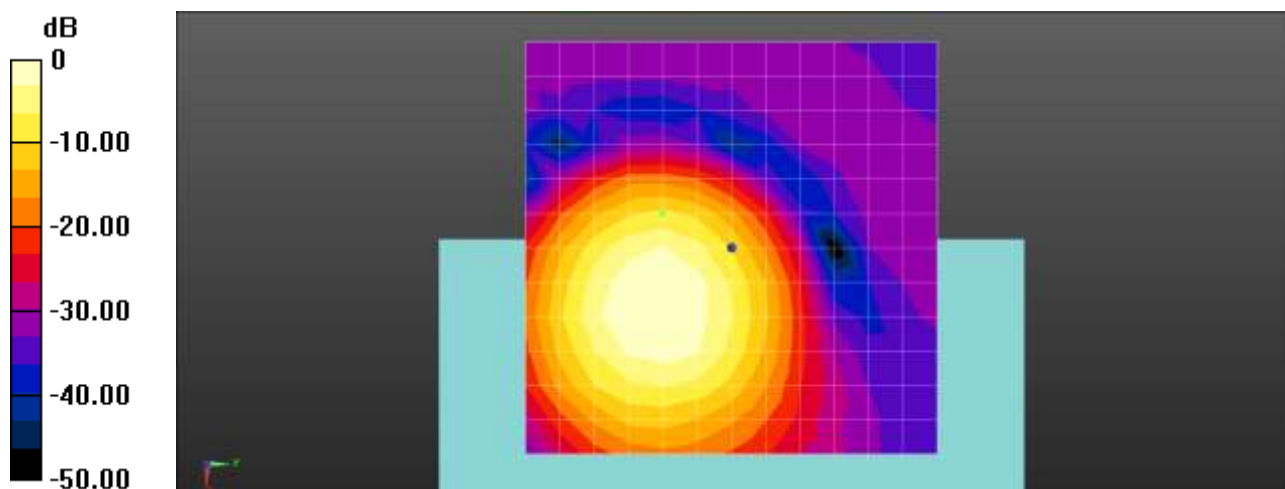

0 dB = 1.000 A/m = 0.00 dBA/m

Plot No.20

LTE Band 7 QPSK 20MHz 1RB 0offset 21100ch EVS NB 5.9 Freq. Response

Communication System: UID 0, LTE Band 7 (0); Frequency: 2535 MHz;Duty Cycle: 1:1
 Medium parameters used: $\sigma = 0$ S/m, $\epsilon_r = 1$; $\rho = 0$ kg/m³
 Phantom section: TCoil Section

T-Coil scan (scan for ANSI C63.19-2007 & 2011 compliance)/General Scans/z (axial) wideband at best S/N/ABM Freq Resp(x,y,z,f) (1x1x1):

Measurement grid: dx=10mm, dy=10mm

Signal Type: Audio File (.wav) 48k_Normal_51s new.wav

Output Gain: 52.36

Measure Window Start: 300ms

Measure Window Length: 51000ms

BWC applied: 9.12 dB

Device Reference Point: 0, 0, -6.3 mm

Category	Telephone parameters WD signal quality [(signal+noise)-to-noise ratio in decibels]
Category T1	0 dB to 10 dB
Category T2	10 dB to 20 dB
Category T3	20 dB to 30 dB
Category T4	> 30 dB

Cursor:

Diff = 1.92 dB

BWC Factor = 9.12 dB

Location: -3.8, -7.2, 3.7 mm

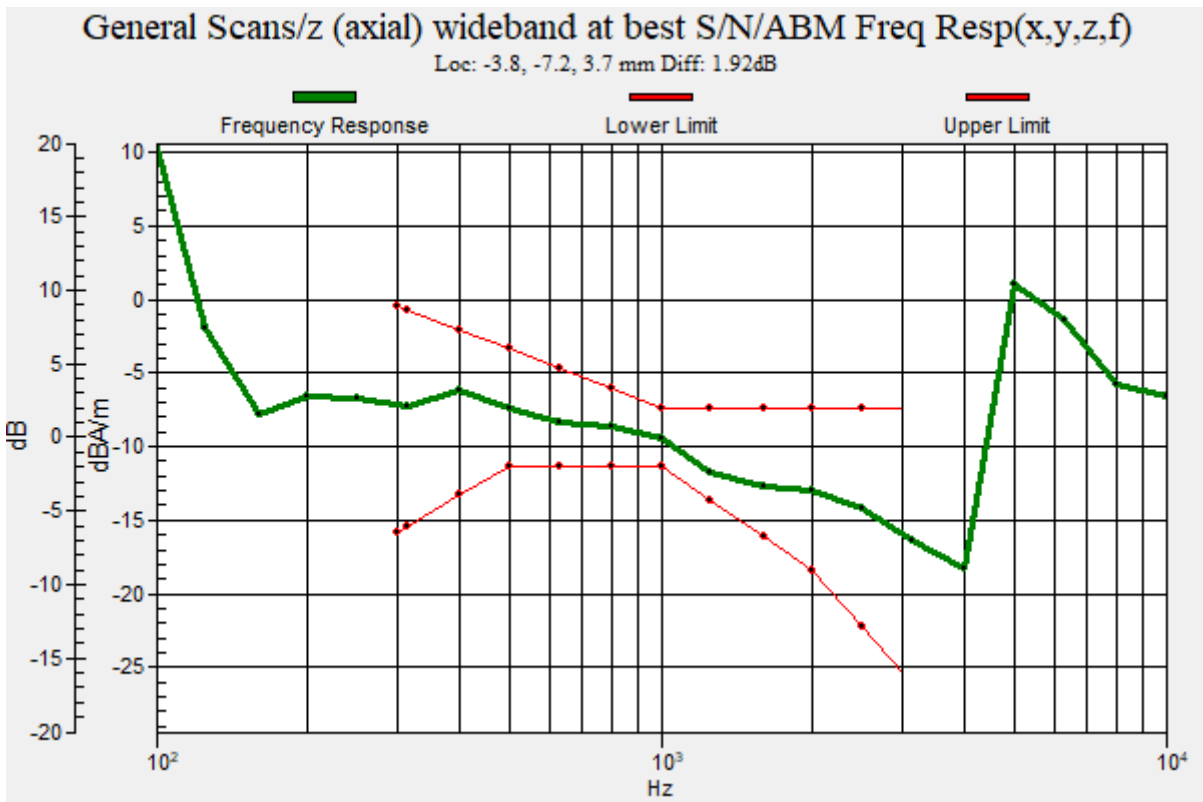

Plot No.21

LTE Band 7 QPSK 20MHz 1RB 0offset 21100ch EVS NB 5.9 y(transversal)

Communication System: UID 0, LTE Band 7 (0); Frequency: 2535 MHz;Duty Cycle: 1:1

Medium parameters used: $\sigma = 0$ S/m, $\epsilon_r = 1$; $\rho = 0$ kg/m³

Phantom section: TCoil Section

DASY5 Configuration:

- Probe: AM1DV3 - 3049; ; Calibrated: 2021-06-01
- Sensor-Surface: 0mm (Fix Surface)
- Electronics: DAE4 Sn652; Calibrated: 2022-01-24
- Phantom: HAC Test Arch with AMCC TCOIL
- Measurement SW: DASY52, Version 52.10 (4)

T-Coil scan (scan for ANSI C63.19-2007 & 2011 compliance)/General Scans/y (transversal) 4.2mm 50

x 50/ABM Signal(x,y,z) (13x13x1): Measurement grid: dx=10mm, dy=10mm

Signal Type: Audio File (.wav) 48k_voice_1kHz_1s.wav

Output Gain: 24.38

Measure Window Start: 300ms

Measure Window Length: 1000ms

BWC applied: -0.20 dB

Device Reference Point: 0, 0, -6.3 mm

Cursor:

ABM1 comp = -10.05 dBA/m

BWC Factor = -0.20 dB

Location: 12.5, -4.2, 3.7 mm

Cursor:

ABM2 = -34.83 dBA/m

Location: 12.5, -4.2, 3.7 mm

Cursor:

ABM1/ABM2 = 24.79 dB

ABM1 comp = -10.05 dBA/m

BWC Factor = -0.20 dB

Location: 12.5, -4.2, 3.7 mm

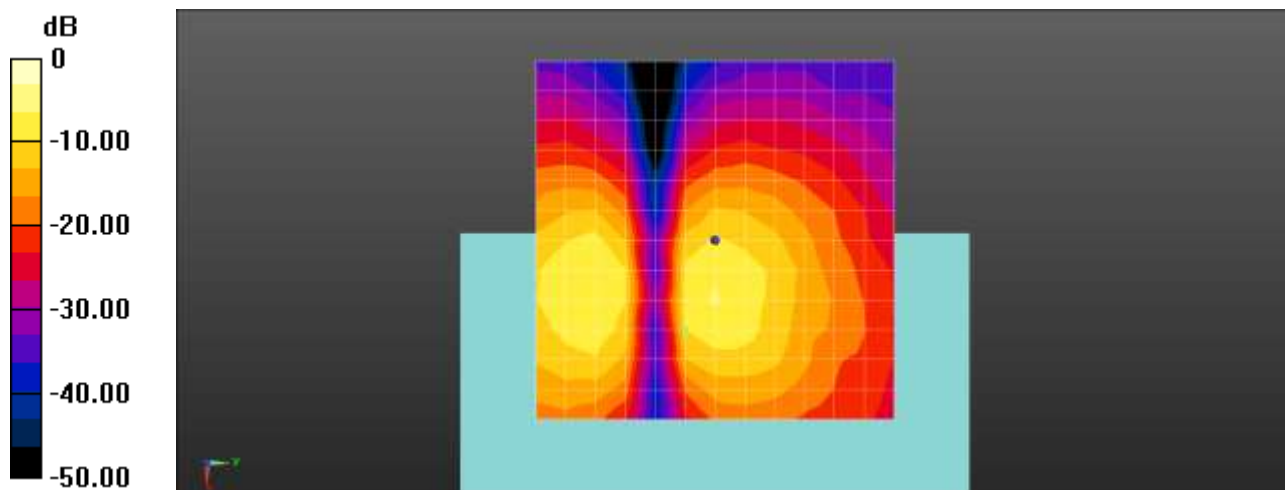

0 dB = 1.000 A/m = 0.00 dBA/m

Plot No.22

LTE Band 12 QPSK 10MHz 1RB 0offset 23095ch EVS NB 5.9 z(axial)

Communication System: UID 0, LTE Band12 (0); Frequency: 707.5 MHz;Duty Cycle: 1:1

Medium parameters used: $\sigma = 0$ S/m, $\epsilon_r = 1$; $\rho = 0$ kg/m³

Phantom section: TCoil Section

DASY5 Configuration:

- Probe: AM1DV3 - 3049; ; Calibrated: 2021-06-01
- Sensor-Surface: 0mm (Fix Surface)
- Electronics: DAE4 Sn652; Calibrated: 2022-01-24
- Phantom: HAC Test Arch with AMCC TCOIL
- Measurement SW: DASY52, Version 52.10 (4)

T-Coil scan (scan for ANSI C63.19-2007 & 2011 compliance)/General Scans/z (axial) 4.2mm 50 x

50/ABM Signal(x,y,z) (13x13x1): Measurement grid: dx=10mm, dy=10mm

Signal Type: Audio File (.wav) 48k_voice_1kHz_1s.wav

Output Gain: 24.38

Measure Window Start: 300ms

Measure Window Length: 1000ms

BWC applied: -0.20 dB

Device Reference Point: 0, 0, -6.3 mm

Cursor:

ABM1 comp = -4.04 dBA/m

BWC Factor = -0.20 dB

Location: 8.3, -16.7, 3.7 mm

Cursor:

ABM2 = -28.91 dBA/m

Location: 8.3, -16.7, 3.7 mm

Cursor:

ABM1/ABM2 = 24.88 dB

ABM1 comp = -4.04 dBA/m

BWC Factor = -0.20 dB

Location: 8.3, -16.7, 3.7 mm

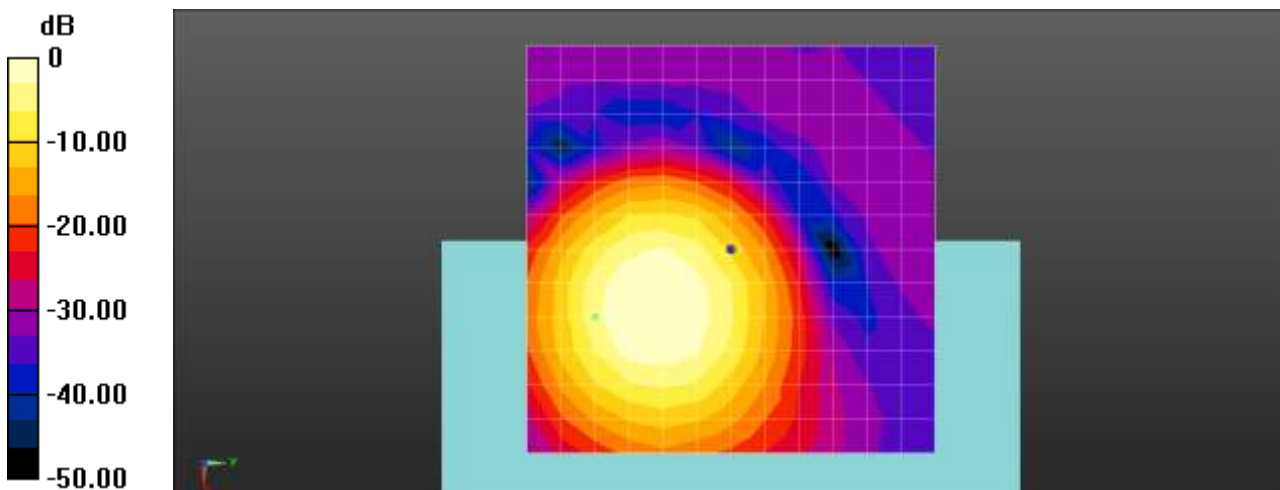

0 dB = 1.000 A/m = 0.00 dBA/m

Plot No.23

LTE Band 12 QPSK 10MHz 1RB 0offset 23095ch EVS NB 5.9 Freq. Response

Communication System: UID 0, LTE Band12 (0); Frequency: 707.5 MHz;Duty Cycle: 1:1
 Medium parameters used: $\sigma = 0$ S/m, $\epsilon_r = 1$; $\rho = 0$ kg/m³
 Phantom section: TCoil Section

T-Coil scan (scan for ANSI C63.19-2007 & 2011 compliance)/General Scans/z (axial) wideband at best S/N/ABM Freq Resp(x,y,z,f) (1x1x1): Measurement grid: dx=10mm, dy=10mm

Signal Type: Audio File (.wav) 48k_Normal_51s new.wav
 Output Gain: 52.36
 Measure Window Start: 300ms
 Measure Window Length: 51000ms
 BWC applied: 9.12 dB
 Device Reference Point: 0, 0, -6.3 mm

Category	Telephone parameters WD signal quality [(signal+noise)-to-noise ratio in decibels]
Category T1	0 dB to 10 dB
Category T2	10 dB to 20 dB
Category T3	20 dB to 30 dB
Category T4	> 30 dB

Cursor:

Diff = 2.00 dB
 BWC Factor = 9.12 dB
 Location: 7.5, -16.2, 3.7 mm

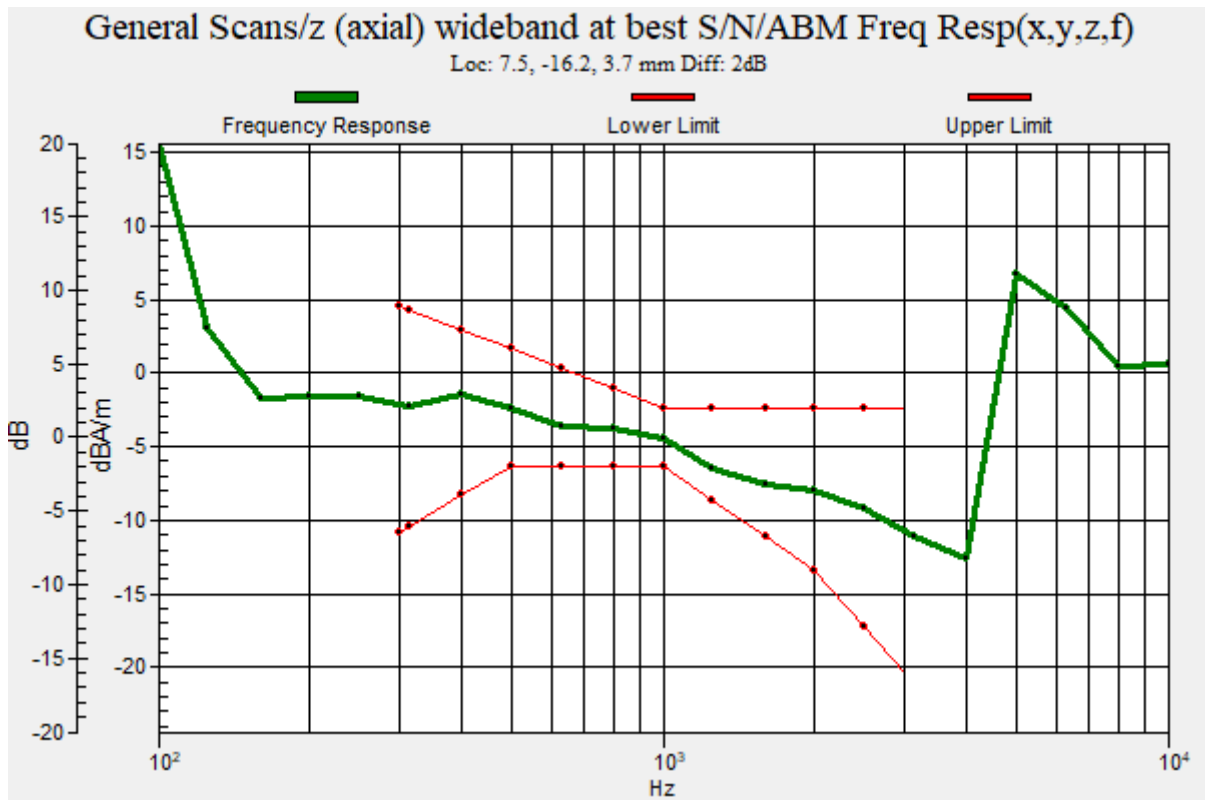

Plot No.24

LTE Band 12 QPSK 10MHz 1RB 0offset 23095ch EVS NB 5.9 y(transversal)

Communication System: UID 0, LTE Band12 (0); Frequency: 707.5 MHz;Duty Cycle: 1:1

Medium parameters used: $\sigma = 0$ S/m, $\epsilon_r = 1$; $\rho = 0$ kg/m³

Phantom section: TCoil Section

DASY5 Configuration:

- Probe: AM1DV3 - 3049; ; Calibrated: 2021-06-01
- Sensor-Surface: 0mm (Fix Surface)
- Electronics: DAE4 Sn652; Calibrated: 2022-01-24
- Phantom: HAC Test Arch with AMCC TCOIL
- Measurement SW: DASY52, Version 52.10 (4)

T-Coil scan (scan for ANSI C63.19-2007 & 2011 compliance)/General Scans/y (transversal) 4.2mm 50

x 50/ABM Signal(x,y,z) (13x13x1): Measurement grid: dx=10mm, dy=10mm

Signal Type: Audio File (.wav) 48k_voice_1kHz_1s.wav

Output Gain: 24.38

Measure Window Start: 300ms

Measure Window Length: 1000ms

BWC applied: -0.20 dB

Device Reference Point: 0, 0, -6.3 mm

Cursor:

ABM1 comp = -9.38 dBA/m

BWC Factor = -0.20 dB

Location: 8.3, -12.5, 3.7 mm

Cursor:

ABM2 = -34.15 dBA/m

Location: 8.3, -12.5, 3.7 mm

Cursor:

ABM1/ABM2 = 24.77 dB

ABM1 comp = -9.38 dBA/m

BWC Factor = -0.20 dB

Location: 8.3, -12.5, 3.7 mm

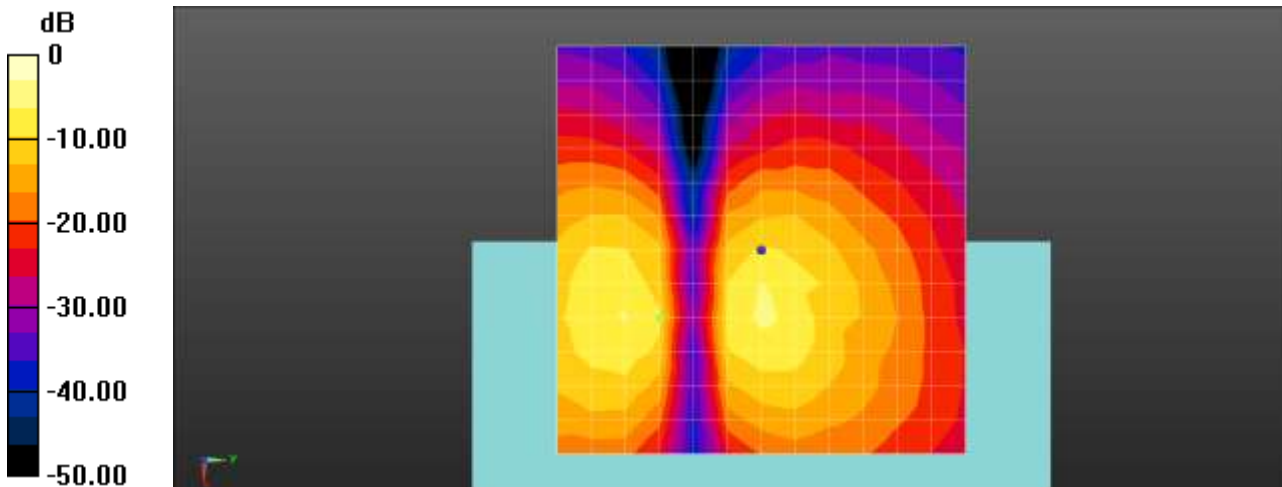

0 dB = 1.000 A/m = 0.00 dBA/m

Plot No.25

LTE Band 13 QPSK 10MHz 1RB 0offset 23230ch EVS NB 5.9 z(axial)

Communication System: UID 0, LTE Band 13 (0); Frequency: 782 MHz;Duty Cycle: 1:1

Medium parameters used: $\sigma = 0$ S/m, $\epsilon_r = 1$; $\rho = 0$ kg/m³

Phantom section: TCoil Section

DASY5 Configuration:

- Probe: AM1DV3 - 3049; ; Calibrated: 2021-06-01
- Sensor-Surface: 0mm (Fix Surface)
- Electronics: DAE4 Sn652; Calibrated: 2022-01-24
- Phantom: HAC Test Arch with AMCC TCOIL
- Measurement SW: DASY52, Version 52.10 (4)

T-Coil scan (scan for ANSI C63.19-2007 & 2011 compliance)/General Scans/z (axial) 4.2mm 50 x

50/ABM Signal(x,y,z) (13x13x1): Measurement grid: dx=10mm, dy=10mm

Signal Type: Audio File (.wav) 48k_voice_1kHz_1s.wav

Output Gain: 24.38

Measure Window Start: 300ms

Measure Window Length: 1000ms

BWC applied: -0.20 dB

Device Reference Point: 0, 0, -6.3 mm

Cursor:

ABM1 comp = -4.43 dBA/m

BWC Factor = -0.20 dB

Location: 8.3, -16.7, 3.7 mm

Cursor:

ABM2 = -27.79 dBA/m

Location: 8.3, -16.7, 3.7 mm

Cursor:

ABM1/ABM2 = 23.36 dB

ABM1 comp = -4.43 dBA/m

BWC Factor = -0.20 dB

Location: 8.3, -16.7, 3.7 mm

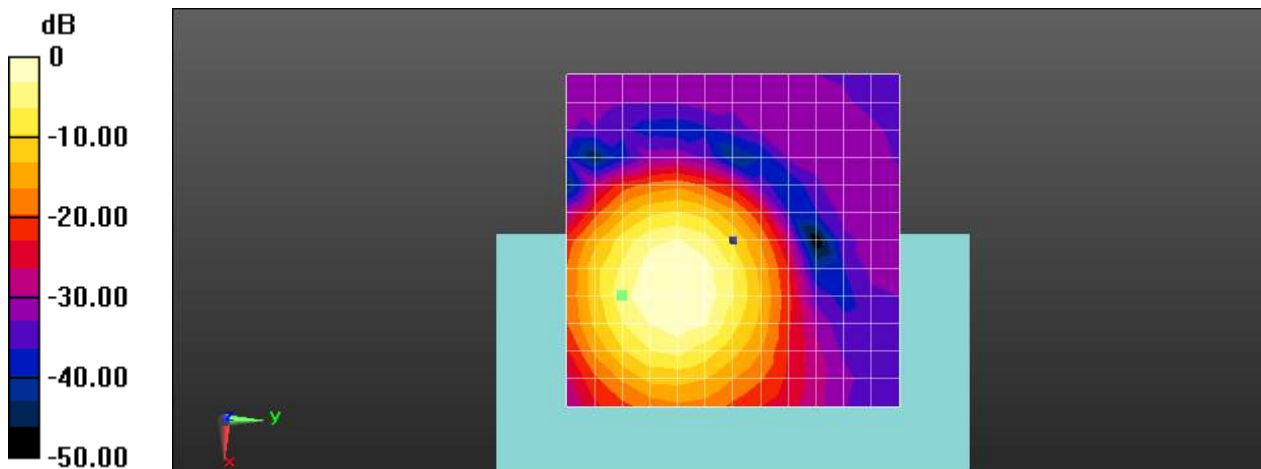

0 dB = 1.000 A/m = 0.00 dBA/m

Plot No.26

LTE Band 13 QPSK 10MHz 1RB 0offset 23230ch EVS NB 5.9 Freq. Response

Communication System: UID 0, LTE Band 13 (0); Frequency: 782 MHz;Duty Cycle: 1:1
 Medium parameters used: $\sigma = 0$ S/m, $\epsilon_r = 1$; $\rho = 0$ kg/m³
 Phantom section: TCoil Section

T-Coil scan (scan for ANSI C63.19-2007 & 2011 compliance)/General Scans/z (axial) wideband at best

S/N/ABM Freq Resp(x,y,z,f) (1x1x1): Measurement grid: dx=10mm, dy=10mm

Signal Type: Audio File (.wav) 48k_Normal_51s new.wav

Output Gain: 52.36

Measure Window Start: 300ms

Measure Window Length: 51000ms

BWC applied: 9.12 dB

Device Reference Point: 0, 0, -6.3 mm

Category	Telephone parameters WD signal quality [(signal+noise)-to-noise ratio in decibels]
Category T1	0 dB to 10 dB
Category T2	10 dB to 20 dB
Category T3	20 dB to 30 dB
Category T4	> 30 dB

Cursor:

Diff = 2.00 dB

BWC Factor = 9.12 dB

Location: 4.5, -8.4, 3.7 mm

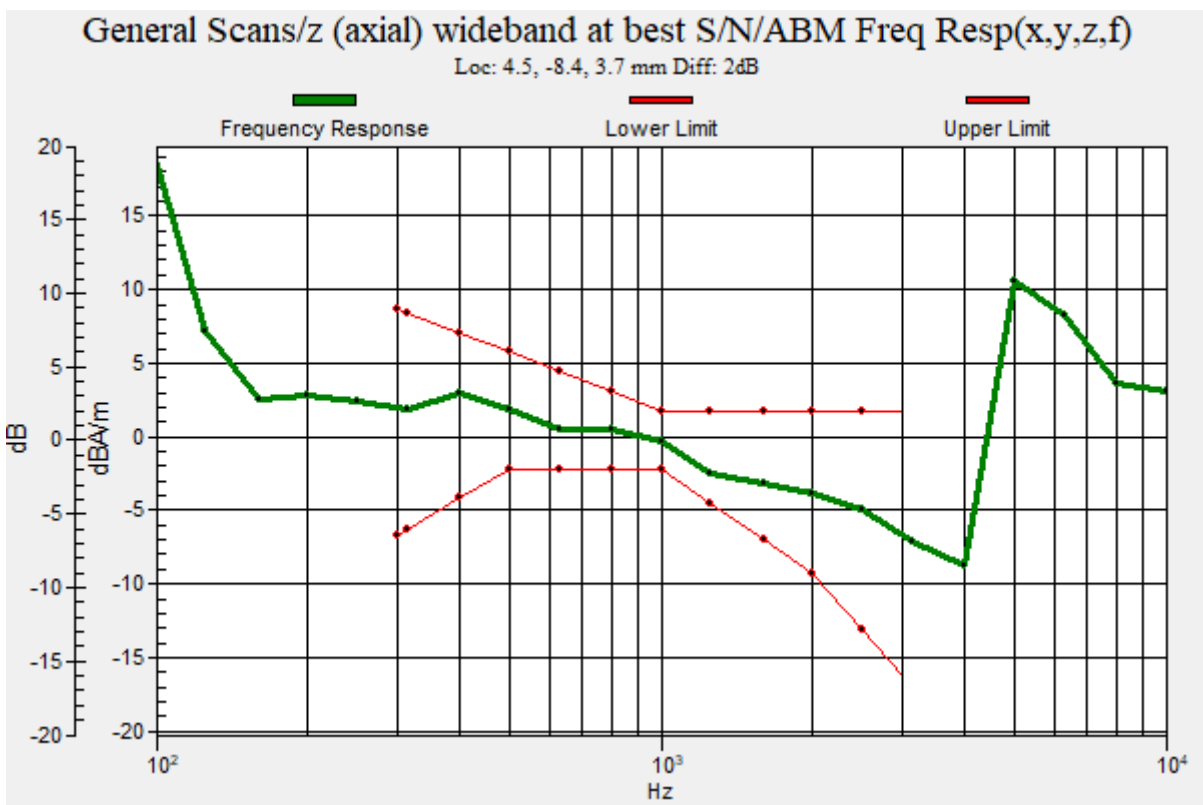

Plot No.27

LTE Band 13 QPSK 10MHz 1RB 0offset 23230ch EVS NB 5.9y(transversal)

Communication System: UID 0, LTE Band 13 (0); Frequency: 782 MHz;Duty Cycle: 1:1
Medium parameters used: $\sigma = 0$ S/m, $\epsilon_r = 1$; $\rho = 0$ kg/m³
Phantom section: TCoil Section

DASY5 Configuration:

- Probe: AM1DV3 - 3049; ; Calibrated: 2021-06-01
- Sensor-Surface: 0mm (Fix Surface)
- Electronics: DAE4 Sn652; Calibrated: 2022-01-24
- Phantom: HAC Test Arch with AMCC TCOIL
- Measurement SW: DASY52, Version 52.10 (4)

T-Coil scan (scan for ANSI C63.19-2007 & 2011 compliance)/General Scans/y (transversal) 4.2mm 50 x 50/ABM Signal(x,y,z) (13x13x1): Measurement grid: dx=10mm, dy=10mm

Signal Type: Audio File (.wav) 48k_voice_1kHz_1s.wav
Output Gain: 24.38
Measure Window Start: 300ms
Measure Window Length: 1000ms
BWC applied: -0.20 dB
Device Reference Point: 0, 0, -6.3 mm

Cursor:

ABM1 comp = -5.56 dBA/m
BWC Factor = -0.20 dB
Location: 8.3, -16.7, 3.7 mm

Cursor:

ABM2 = -30.16 dBA/m
Location: 8.3, -16.7, 3.7 mm

Cursor:

ABM1/ABM2 = 24.60 dB
ABM1 comp = -5.56 dBA/m
BWC Factor = -0.20 dB
Location: 8.3, -16.7, 3.7 mm

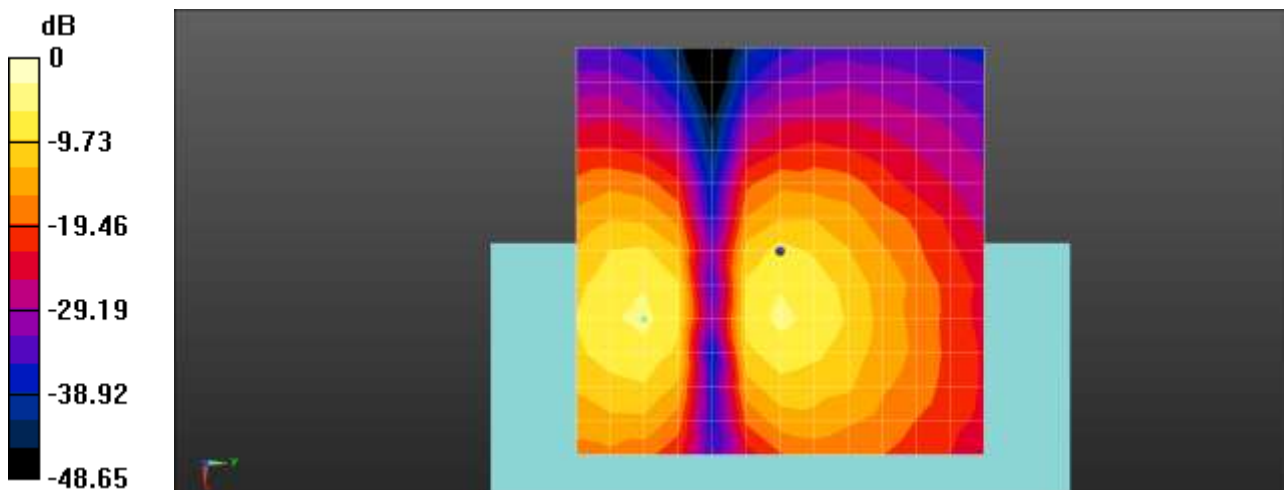

0 dB = 1.000 A/m = 0.00 dBA/m

Plot No.28

LTE Band 14 QPSK 10MHz 1RB 0offset 23330ch EVS NB 5.9z(axial)

Communication System: UID 0, LTE Band 14 (0); Frequency: 793 MHz;Duty Cycle: 1:1

Medium parameters used: $\sigma = 0$ S/m, $\epsilon_r = 1$; $\rho = 0$ kg/m³

Phantom section: TCoil Section

DASY5 Configuration:

- Probe: AM1DV3 - 3049; ; Calibrated: 2021-06-01
- Sensor-Surface: 0mm (Fix Surface)
- Electronics: DAE4 Sn652; Calibrated: 2022-01-24
- Phantom: HAC Test Arch with AMCC TCOIL
- Measurement SW: DASY52, Version 52.10 (4)

T-Coil scan (scan for ANSI C63.19-2007 & 2011 compliance)/General Scans/z (axial) 4.2mm 50 x

50/ABM Signal(x,y,z) (13x13x1): Measurement grid: dx=10mm, dy=10mm

Signal Type: Audio File (.wav) 48k_voice_1kHz_1s.wav

Output Gain: 24.38

Measure Window Start: 300ms

Measure Window Length: 1000ms

BWC applied: -0.19 dB

Device Reference Point: 0, 0, -6.3 mm

Cursor:

ABM1 comp = -0.33 dBA/m

BWC Factor = -0.19 dB

Location: 8.3, -4.2, 3.7 mm

Cursor:

ABM2 = -24.69 dBA/m

Location: 8.3, -4.2, 3.7 mm

Cursor:

ABM1/ABM2 = 24.36 dB

ABM1 comp = -0.33 dBA/m

BWC Factor = -0.19 dB

Location: 8.3, -4.2, 3.7 mm

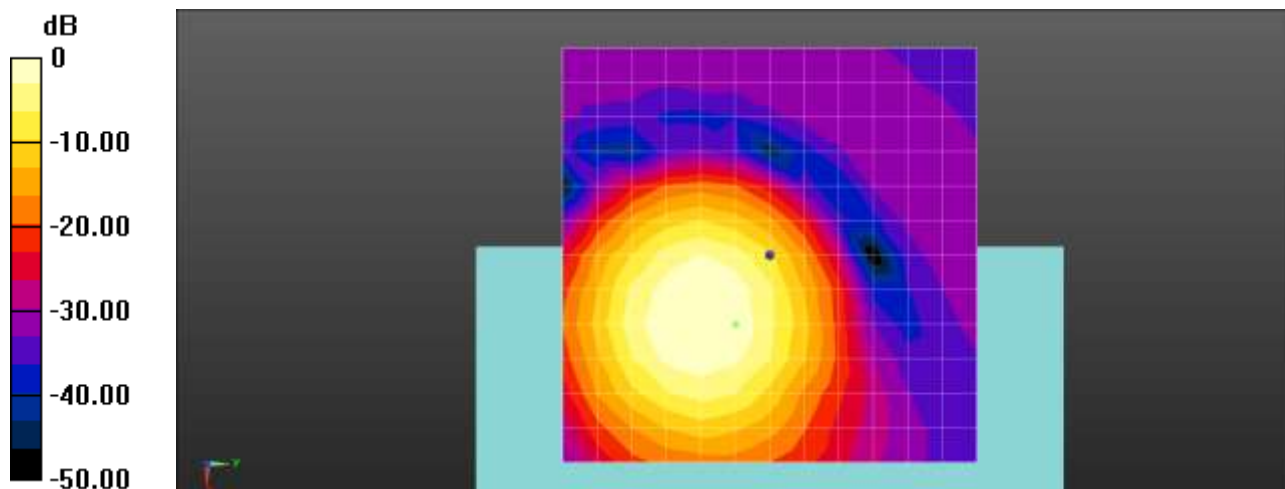

0 dB = 1.000 A/m = 0.00 dBA/m

Plot No.29

LTE Band 14 QPSK 10MHz 1RB 0offset 23330ch EVS NB 5.9 Freq. Response

Communication System: UID 0, LTE Band 14 (0); Frequency: 793 MHz;Duty Cycle: 1:1
 Medium parameters used: $\sigma = 0$ S/m, $\epsilon_r = 1$; $\rho = 0$ kg/m³
 Phantom section: TCoil Section

T-Coil scan (scan for ANSI C63.19-2007 & 2011 compliance)/General Scans/z (axial) wideband at best S/N/ABM Freq Resp(x,y,z,f) (1x1x1): Measurement grid: dx=10mm, dy=10mm

Signal Type: Audio File (.wav) 48k_Normal_51s new.wav
 Output Gain: 52.36
 Measure Window Start: 300ms
 Measure Window Length: 51000ms
 BWC applied: 9.13 dB
 Device Reference Point: 0, 0, -6.3 mm

Category	Telephone parameters WD signal quality [(signal+noise)-to-noise ratio in decibels]
Category T1	0 dB to 10 dB
Category T2	10 dB to 20 dB
Category T3	20 dB to 30 dB
Category T4	> 30 dB

Cursor:

Diff = 2.00 dB
 BWC Factor = 9.13 dB
 Location: 9.1, -4.1, 3.7 mm

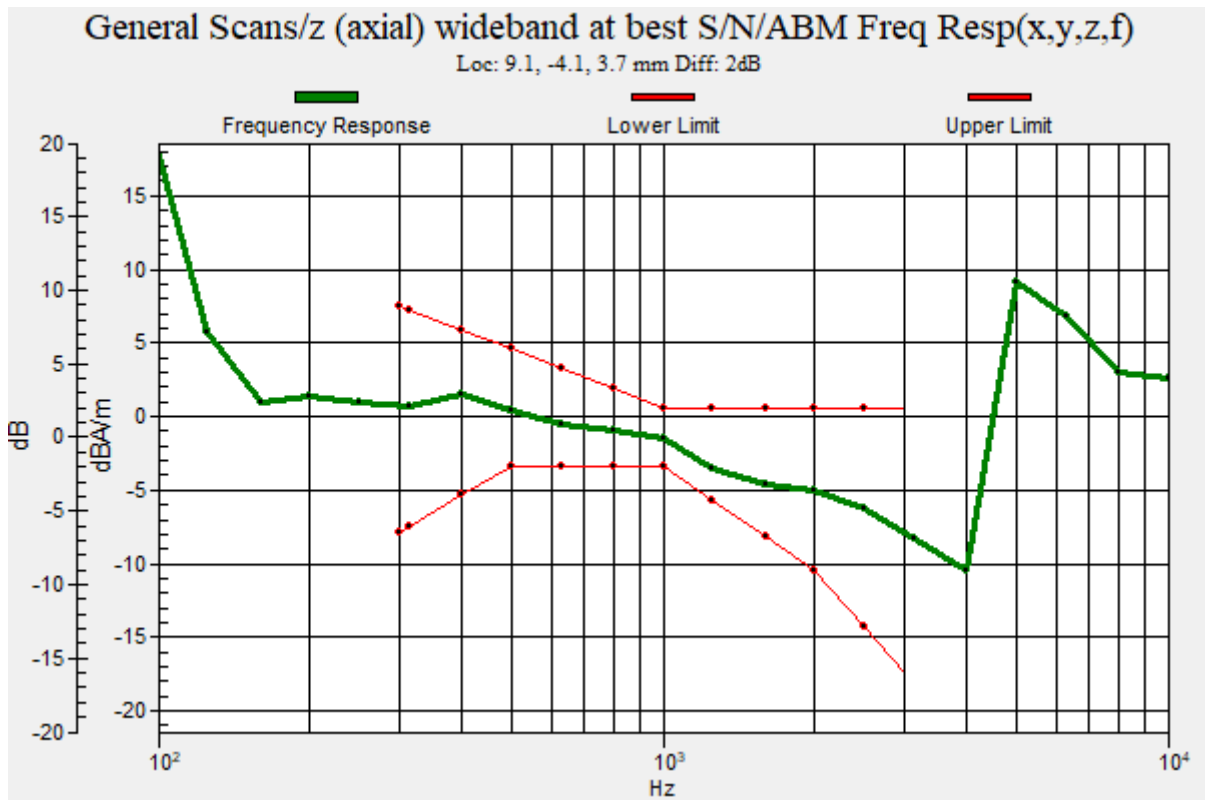

Plot No.30

LTE Band 14 QPSK 10MHz 1RB 0offset 23330ch EVS NB 5.9 y(transversal)

Communication System: UID 0, LTE Band 14 (0); Frequency: 793 MHz;Duty Cycle: 1:1
Medium parameters used: $\sigma = 0$ S/m, $\epsilon_r = 1$; $\rho = 0$ kg/m³
Phantom section: TCoil Section

DASY5 Configuration:

- Probe: AM1DV3 - 3049; ; Calibrated: 2021-06-01
- Sensor-Surface: 0mm (Fix Surface)
- Electronics: DAE4 Sn652; Calibrated: 2022-01-24
- Phantom: HAC Test Arch with AMCC TCOIL
- Measurement SW: DASY52, Version 52.10 (4)

T-Coil scan (scan for ANSI C63.19-2007 & 2011 compliance)/General Scans/y (transversal) 4.2mm 50

x 50/ABM Signal(x,y,z) (13x13x1): Measurement grid: dx=10mm, dy=10mm

Signal Type: Audio File (.wav) 48k_voice_1kHz_1s.wav

Output Gain: 24.38

Measure Window Start: 300ms

Measure Window Length: 1000ms

BWC applied: -0.19 dB

Device Reference Point: 0, 0, -6.3 mm

Cursor:

ABM1 comp = -7.08 dBA/m

BWC Factor = -0.19 dB

Location: 4.2, -20.8, 3.7 mm

Cursor:

ABM2 = -31.64 dBA/m

Location: 4.2, -20.8, 3.7 mm

Cursor:

ABM1/ABM2 = 24.55 dB

ABM1 comp = -7.08 dBA/m

BWC Factor = -0.19 dB

Location: 4., -20.8, 3.7 mm

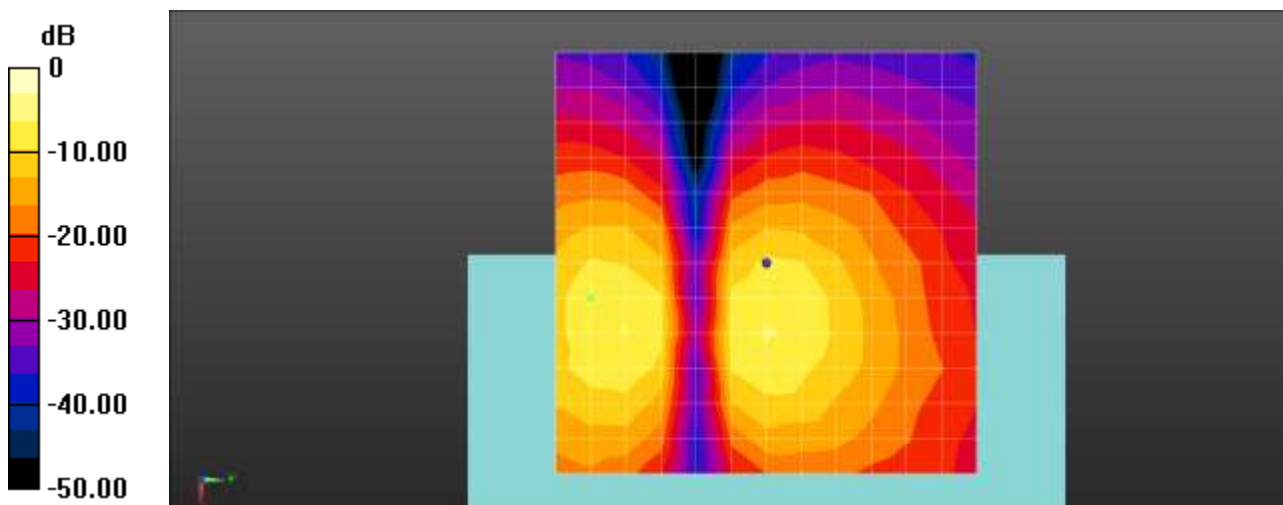

0 dB = 1.000 A/m = 0.00 dBA/m

Plot No.31

LTE Band 25 QPSK 20MHz 1RB 0offset 26365ch EVS NB 5.9 z(axial)

Communication System: UID 0, LTE Band 25 (0); Frequency: 1882.5 MHz;Duty Cycle: 1:1

Medium parameters used: $\sigma = 0$ S/m, $\epsilon_r = 1$; $\rho = 0$ kg/m³

Phantom section: TCoil Section

DASY5 Configuration:

- Probe: AM1DV3 - 3049; ; Calibrated: 2021-06-01
- Sensor-Surface: 0mm (Fix Surface)
- Electronics: DAE4 Sn652; Calibrated: 2022-01-24
- Phantom: HAC Test Arch with AMCC TCOIL
- Measurement SW: DASY52, Version 52.10 (4)

T-Coil scan (scan for ANSI C63.19-2007 & 2011 compliance)/General Scans/z (axial) 4.2mm 50 x

50/ABM Signal(x,y,z) (13x13x1): Measurement grid: dx=10mm, dy=10mm

Signal Type: Audio File (.wav) 48k_voice_1kHz_1s.wav

Output Gain: 24.38

Measure Window Start: 300ms

Measure Window Length: 1000ms

BWC applied: -0.19 dB

Device Reference Point: 0, 0, -6.3 mm

Cursor:

ABM1 comp = 0.11 dBA/m

BWC Factor = -0.19 dB

Location: 8.3, -4.2, 3.7 mm

Cursor:

ABM2 = -24.36 dBA/m

Location: 8.3, -4.2, 3.7 mm

Cursor:

ABM1/ABM2 = 24.47 dB

ABM1 comp = 0.11 dBA/m

BWC Factor = -0.19 dB

Location: 8.3, -4.2, 3.7 mm

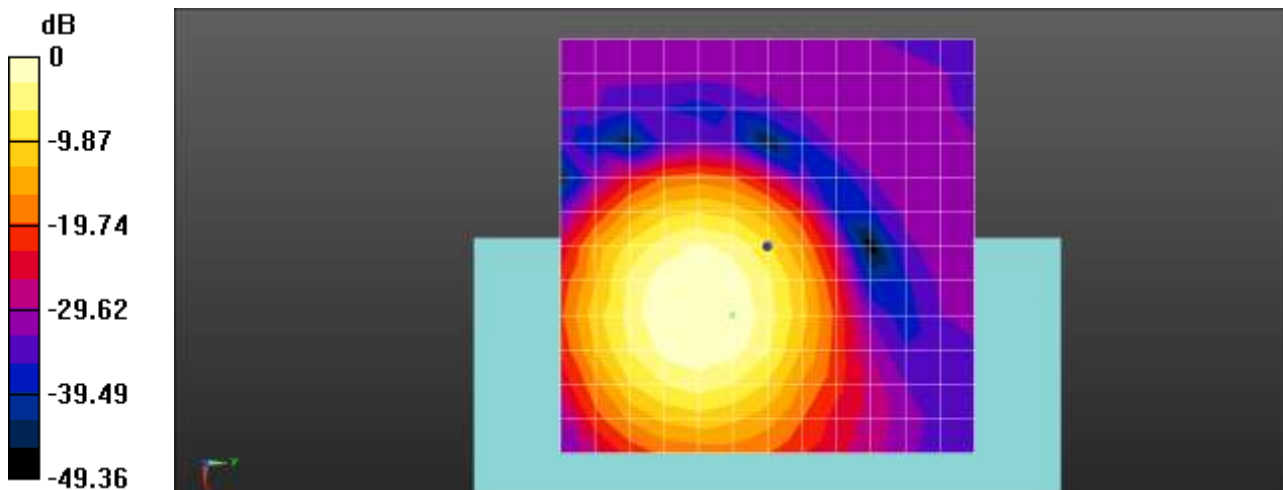

0 dB = 1.000 A/m = 0.00 dBA/m

Plot No.32

LTE Band 25 QPSK 20MHz 1RB 0offset 26365ch EVS NB 5.9 Freq.Response

Communication System: UID 0, LTE Band 25 (0); Frequency: 1882.5 MHz;Duty Cycle: 1:1

Medium parameters used: $\sigma = 0$ S/m, $\epsilon_r = 1$; $\rho = 0$ kg/m³

Phantom section: TCoil Section

T-Coil scan (scan for ANSI C63.19-2007 & 2011 compliance)/General Scans/z (axial) wideband at best

S/N/ABM Freq Resp(x,y,z,f) (1x1x1): Measurement grid: dx=10mm, dy=10mm

Signal Type: Audio File (.wav) 48k_Normal_51s new.wav

Output Gain: 52.36

Measure Window Start: 300ms

Measure Window Length: 51000ms

BWC applied: 9.12 dB

Device Reference Point: 0, 0, -6.3 mm

Category	Telephone parameters WD signal quality [(signal+noise)-to-noise ratio in decibels]
Category T1	0 dB to 10 dB
Category T2	10 dB to 20 dB
Category T3	20 dB to 30 dB
Category T4	> 30 dB

Cursor:

Diff = 2.00 dB

BWC Factor = 9.12 dB

Location: 9.2, -4.2, 3.7 mm

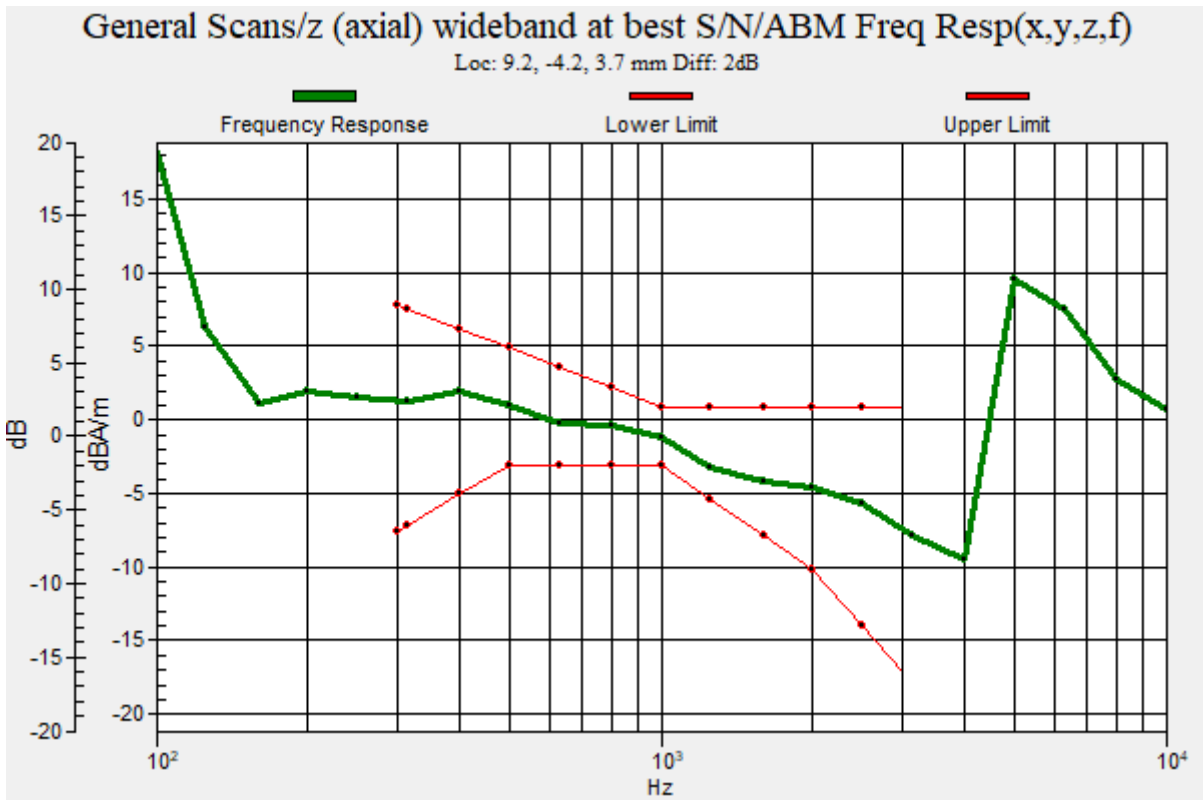

Plot No.33

LTE Band 25 QPSK 20MHz 1RB 0offset 26365ch EVS NB 5.9 y(transversal)

Communication System: UID 0, LTE Band 25 (0); Frequency: 1882.5 MHz;Duty Cycle: 1:1
Medium parameters used: $\sigma = 0$ S/m, $\epsilon_r = 1$; $\rho = 0$ kg/m³
Phantom section: TCoil Section

DASY5 Configuration:

- Probe: AM1DV3 - 3049; ; Calibrated: 2021-06-01
- Sensor-Surface: 0mm (Fix Surface)
- Electronics: DAE4 Sn652; Calibrated: 2022-01-24
- Phantom: HAC Test Arch with AMCC TCOIL
- Measurement SW: DASY52, Version 52.10 (4)

T-Coil scan (scan for ANSI C63.19-2007 & 2011 compliance)/General Scans/y (transversal) 4.2mm 50

x 50/ABM Signal(x,y,z) (13x13x1): Measurement grid: dx=10mm, dy=10mm

Signal Type: Audio File (.wav) 48k_voice_1kHz_1s.wav

Output Gain: 24.38

Measure Window Start: 300ms

Measure Window Length: 1000ms

BWC applied: -0.19 dB

Device Reference Point: 0, 0, -6.3 mm

Cursor:

ABM1 comp = -11.07 dBA/m

BWC Factor = -0.19 dB

Location: 0, -4.2, 3.7 mm

Cursor:

ABM2 = -35.67 dBA/m

Location: 0, -4.2, 3.7 mm

Cursor:

ABM1/ABM2 = 24.60 dB

ABM1 comp = -11.07 dBA/m

BWC Factor = -0.19 dB

Location: 0, -4.2, 3.7 mm

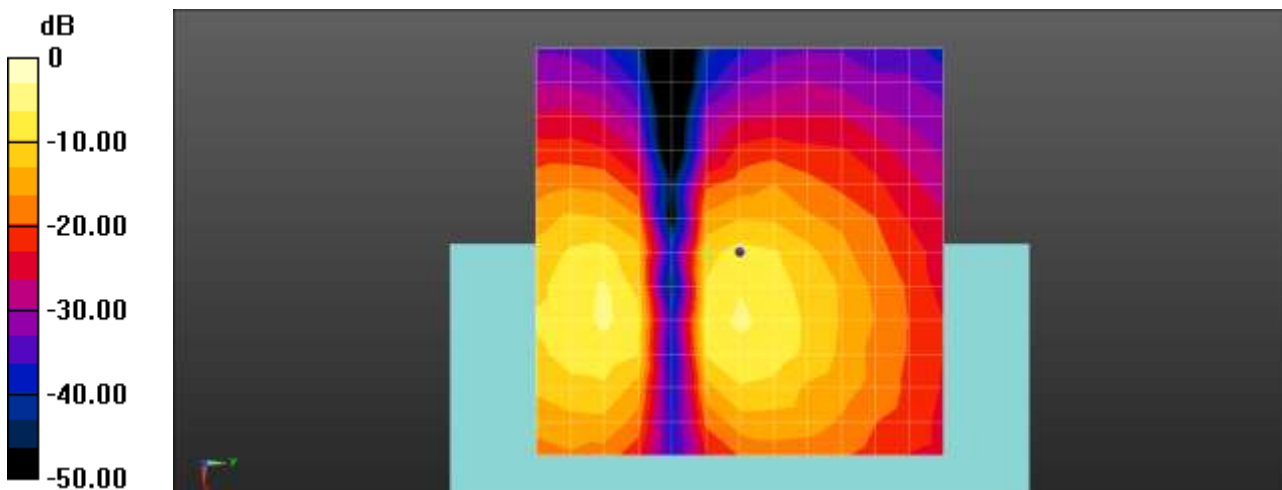

0 dB = 1.000 A/m = 0.00 dBA/m

Plot No.34

LTE Band 26 QPSK 15MHz 1RB 0offset 26865ch EVS NB 5.9 z(axial)

Communication System: UID 0, LTE Band 26 (0); Frequency: 831.5 MHz;Duty Cycle: 1:1

Medium parameters used: $\sigma = 0$ S/m, $\epsilon_r = 1$; $\rho = 0$ kg/m³

Phantom section: TCoil Section

DASY5 Configuration:

- Probe: AM1DV3 - 3049; ; Calibrated: 2021-06-01
- Sensor-Surface: 0mm (Fix Surface)
- Electronics: DAE4 Sn652; Calibrated: 2022-01-24
- Phantom: HAC Test Arch with AMCC TCOIL
- Measurement SW: DASY52, Version 52.10 (4)

T-Coil scan (scan for ANSI C63.19-2007 & 2011 compliance)/General Scans/z (axial) 4.2mm 50 x

50/ABM Signal(x,y,z) (13x13x1): Measurement grid: dx=10mm, dy=10mm

Signal Type: Audio File (.wav) 48k_voice_1kHz_1s.wav

Output Gain: 24.38

Measure Window Start: 300ms

Measure Window Length: 1000ms

BWC applied: -0.19 dB

Device Reference Point: 0, 0, -6.3 mm

Cursor:

ABM1 comp = 1.91 dBA/m

BWC Factor = -0.19 dB

Location: 8.3, -8.3, 3.7 mm

Cursor:

ABM2 = -22.96 dBA/m

Location: 8.3, -8.3, 3.7 mm

Cursor:

ABM1/ABM2 = 24.87 dB

ABM1 comp = 1.91 dBA/m

BWC Factor = -0.19 dB

Location: 8.3, -8.3, 3.7 mm

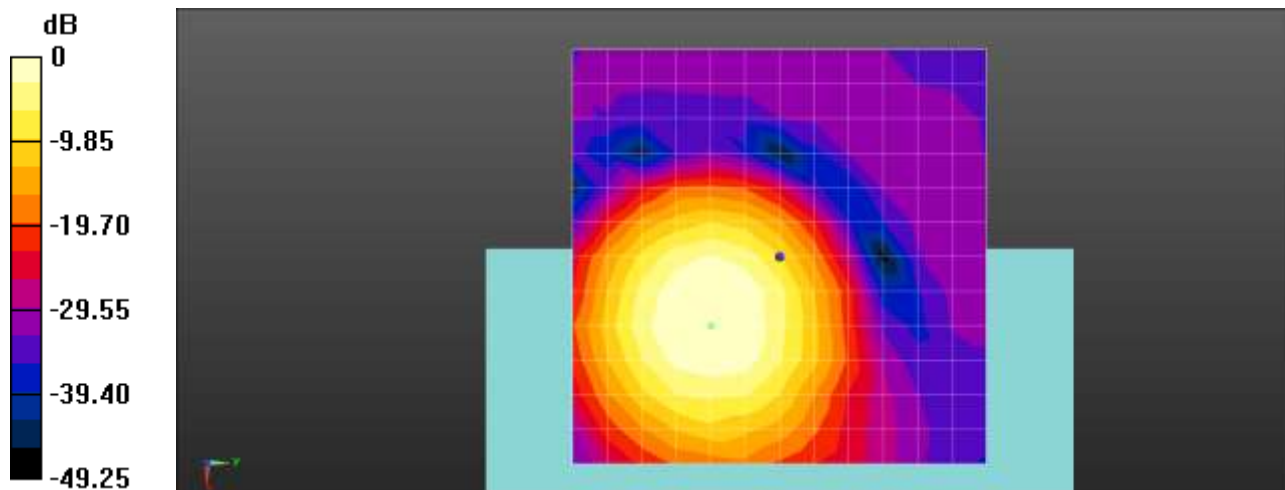

0 dB = 1.000 A/m = 0.00 dBA/m

Plot No.35

LTE Band 26 QPSK 15MHz 1RB 0offset 26865ch EVS NB 5.9 Freq.Response

Communication System: UID 0, LTE Band 26 (0); Frequency: 831.5 MHz;Duty Cycle: 1:1

Medium parameters used: $\sigma = 0$ S/m, $\epsilon_r = 1$; $\rho = 0$ kg/m³

Phantom section: TCoil Section

T-Coil scan (scan for ANSI C63.19-2007 & 2011 compliance)/General Scans/z (axial) wideband at best

S/N/ABM Freq Resp(x,y,z,f) (1x1x1): Measurement grid: dx=10mm, dy=10mm

Signal Type: Audio File (.wav) 48k_Normal_51s new.wav

Output Gain: 52.36

Measure Window Start: 300ms

Measure Window Length: 51000ms

BWC applied: 9.13 dB

Device Reference Point: 0, 0, -6.3 mm

Category	Telephone parameters WD signal quality [(signal+noise)-to-noise ratio in decibels]
Category T1	0 dB to 10 dB
Category T2	10 dB to 20 dB
Category T3	20 dB to 30 dB
Category T4	> 30 dB

Cursor:

Diff = 2.00 dB

BWC Factor = 9.13 dB

Location: 8.2, -7.8, 3.7 mm

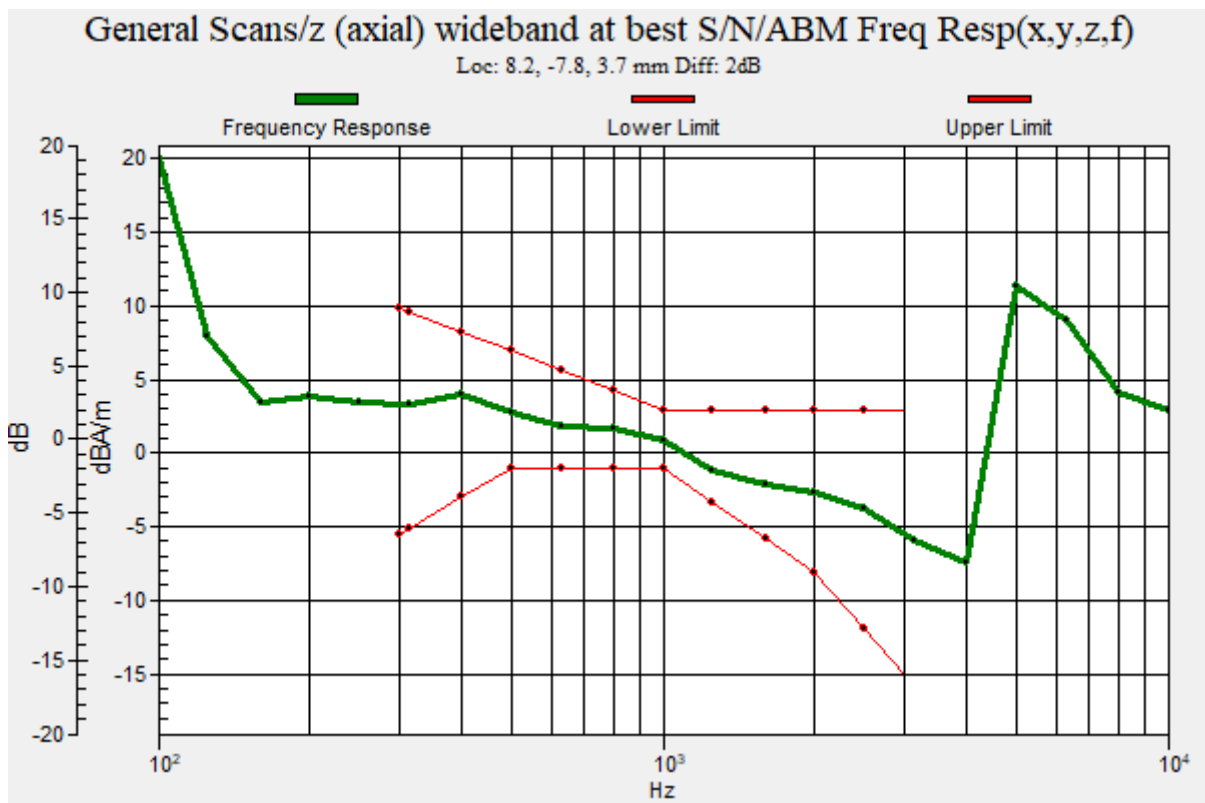

Plot No.36

LTE Band 26 QPSK 15MHz 1RB 0offset 26865ch EVS NB 5.9 y(transversal)

Communication System: UID 0, LTE Band 26 (0); Frequency: 831.5 MHz;Duty Cycle: 1:1
Medium parameters used: $\sigma = 0$ S/m, $\epsilon_r = 1$; $\rho = 0$ kg/m³
Phantom section: TCoil Section

DASY5 Configuration:

- Probe: AM1DV3 - 3049; ; Calibrated: 2021-06-01
- Sensor-Surface: 0mm (Fix Surface)
- Electronics: DAE4 Sn652; Calibrated: 2022-01-24
- Phantom: HAC Test Arch with AMCC TCOIL
- Measurement SW: DASY52, Version 52.10 (4)

T-Coil scan (scan for ANSI C63.19-2007 & 2011 compliance)/General Scans/y (transversal) 4.2mm 50

x 50/ABM Signal(x,y,z) (13x13x1): Measurement grid: dx=10mm, dy=10mm
Signal Type: Audio File (.wav) 48k_voice_1kHz_1s.wav
Output Gain: 24.38
Measure Window Start: 300ms
Measure Window Length: 1000ms
BWC applied: -0.19 dB
Device Reference Point: 0, 0, -6.3 mm

Cursor:

ABM1 comp = -5.73 dBA/m
BWC Factor = -0.19 dB
Location: 4.2, -16.7, 3.7 mm

Cursor:

ABM2 = -30.59 dBA/m
Location: 4.2, -16.7, 3.7 mm

Cursor:

ABM1/ABM2 = 24.86 dB
ABM1 comp = -5.73 dBA/m
BWC Factor = -0.19 dB
Location: 4.2, -16.7, 3.7 mm

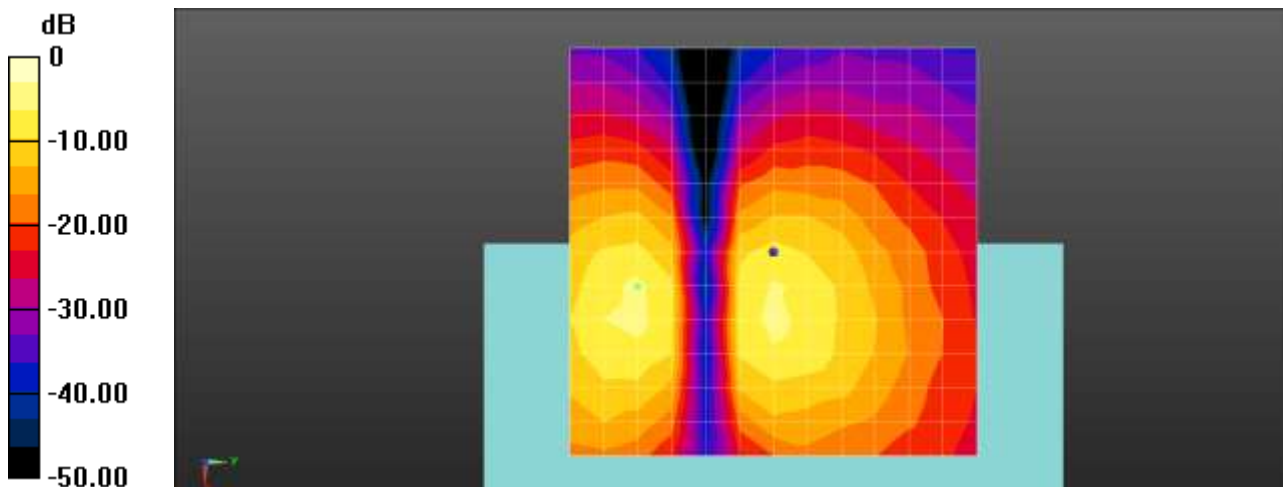

0 dB = 1.000 A/m = 0.00 dBA/m

Plot No.37

LTE Band 30 QPSK 10MHz 1RB 0offset 27710ch EVS NB 5.9 z(axial)

Communication System: UID 0, LTE Band30 (0); Frequency: 2310 MHz;Duty Cycle: 1:1
Medium parameters used: $\sigma = 0$ S/m, $\epsilon_r = 1$; $\rho = 0$ kg/m³
Phantom section: TCoil Section

DASY5 Configuration:

- Probe: AM1DV3 - 3049; ; Calibrated: 2021-06-01
- Sensor-Surface: 0mm (Fix Surface)
- Electronics: DAE4 Sn652; Calibrated: 2022-01-24
- Phantom: HAC Test Arch with AMCC TCOIL
- Measurement SW: DASY52, Version 52.10 (4)

T-Coil scan (scan for ANSI C63.19-2007 & 2011 compliance)/General Scans/z (axial) 4.2mm 50 x

50/ABM Signal(x,y,z) (13x13x1): Measurement grid: dx=10mm, dy=10mm

Signal Type: Audio File (.wav) 48k_voice_1kHz_1s.wav

Output Gain: 24.38

Measure Window Start: 300ms

Measure Window Length: 1000ms

BWC applied: -0.19 dB

Device Reference Point: 0, 0, -6.3 mm

Cursor:

ABM1 comp = 0.18 dBA/m

BWC Factor = -0.19 dB

Location: 8.3, -12.5, 3.7 mm

Cursor:

ABM2 = -24.51 dBA/m

Location: 8.3, -12.5, 3.7 mm

Cursor:

ABM1/ABM2 = 24.69 dB

ABM1 comp = 0.18 dBA/m

BWC Factor = -0.19 dB

Location: 8.3, -12.5, 3.7 mm

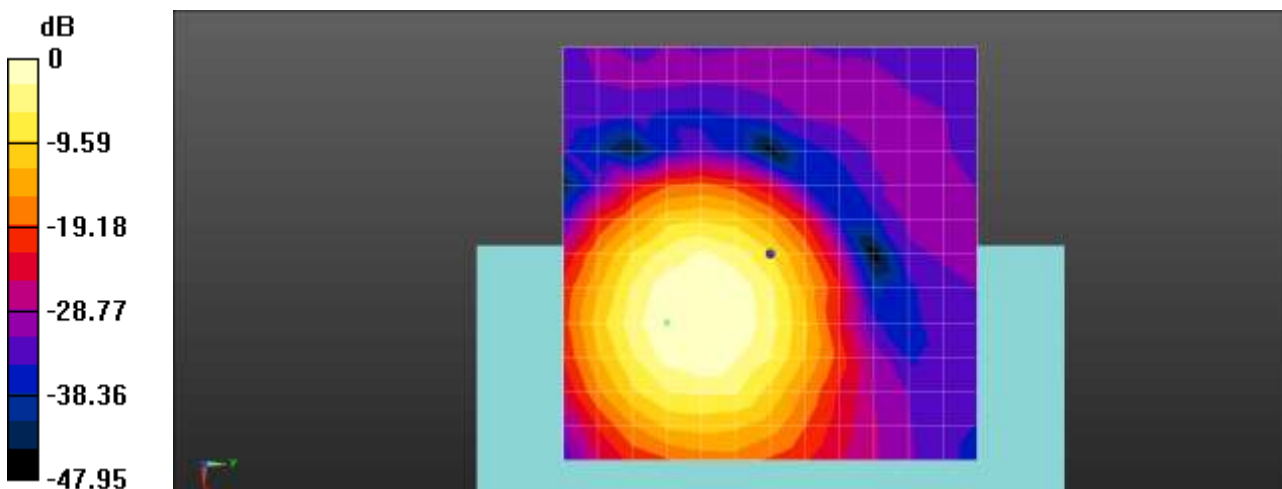

0 dB = 1.000 A/m = 0.00 dBA/m

Plot No.38

LTE Band 30 QPSK 10MHz 1RB 0offset 27710ch EVS NB 5.9 Freq.Response

Communication System: UID 0, LTE Band30 (0); Frequency: 2310 MHz;Duty Cycle: 1:1
 Medium parameters used: $\sigma = 0$ S/m, $\epsilon_r = 1$; $\rho = 0$ kg/m³
 Phantom section: TCoil Section

T-Coil scan (scan for ANSI C63.19-2007 & 2011 compliance)/General Scans/z (axial) wideband at best S/N/ABM Freq Resp(x,y,z,f) (1x1x1): Measurement grid: dx=10mm, dy=10mm

Signal Type: Audio File (.wav) 48k_Normal_51s new.wav

Output Gain: 52.36

Measure Window Start: 300ms

Measure Window Length: 51000ms

BWC applied: 9.13 dB

Device Reference Point: 0, 0, -6.3 mm

Category	Telephone parameters WD signal quality [(signal+noise)-to-noise ratio in decibels]
Category T1	0 dB to 10 dB
Category T2	10 dB to 20 dB
Category T3	20 dB to 30 dB
Category T4	> 30 dB

Cursor:

Diff = 1.80 dB

BWC Factor = 9.13 dB

Location: 8.9, -13.2, 3.7 mm

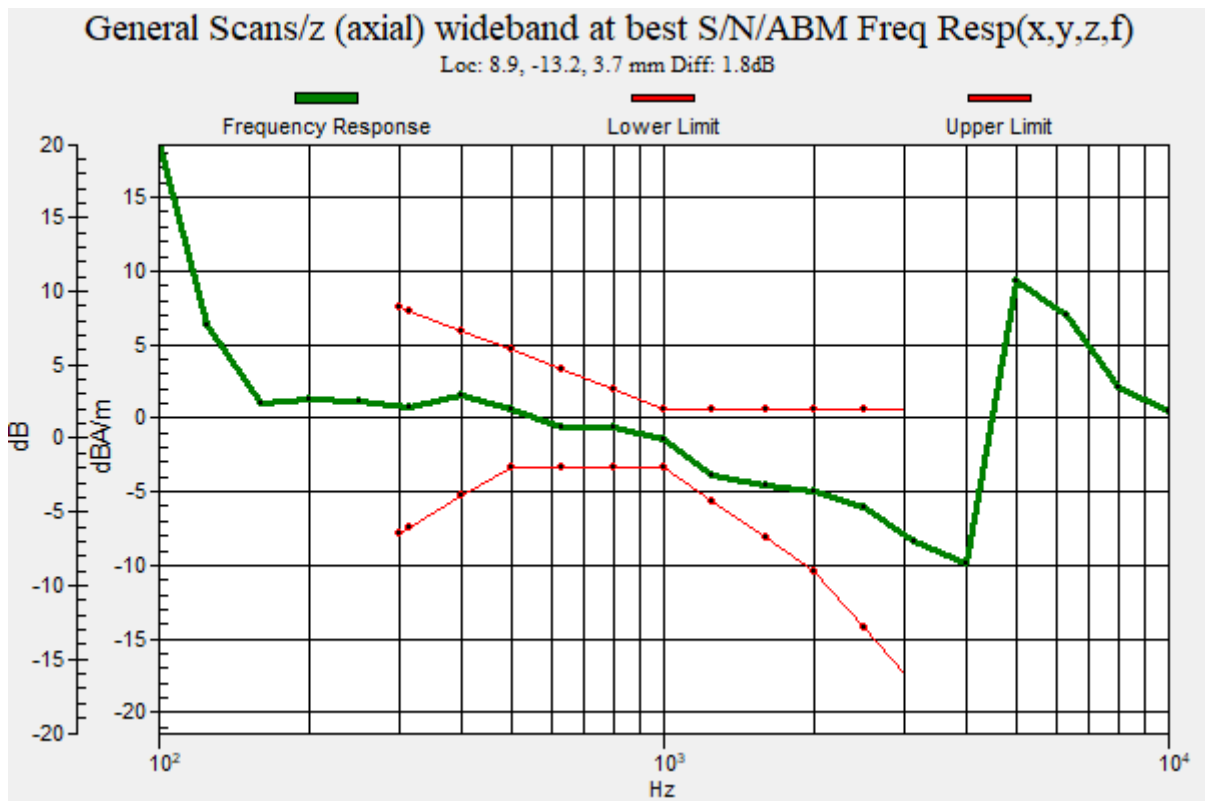

Plot No.39

LTE Band 30 QPSK 10MHz 1RB 0offset 27710ch EVS NB 5.9 y(transversal)

Communication System: UID 0, LTE Band30 (0); Frequency: 2310 MHz;Duty Cycle: 1:1
Medium parameters used: $\sigma = 0$ S/m, $\epsilon_r = 1$; $\rho = 0$ kg/m³
Phantom section: TCoil Section

DASY5 Configuration:

- Probe: AM1DV3 - 3049; ; Calibrated: 2021-06-01
- Sensor-Surface: 0mm (Fix Surface)
- Electronics: DAE4 Sn652; Calibrated: 2022-01-24
- Phantom: HAC Test Arch with AMCC TCOIL
- Measurement SW: DASY52, Version 52.10 (4)

T-Coil scan (scan for ANSI C63.19-2007 & 2011 compliance)/General Scans/y (transversal) 4.2mm 50

x 50/ABM Signal(x,y,z) (13x13x1): Measurement grid: dx=10mm, dy=10mm

Signal Type: Audio File (.wav) 48k_voice_1kHz_1s.wav

Output Gain: 24.38

Measure Window Start: 300ms

Measure Window Length: 1000ms

BWC applied: -0.19 dB

Device Reference Point: 0, 0, -6.3 mm

Cursor:

ABM1 comp = -5.52 dBA/m

BWC Factor = -0.19 dB

Location: 8.3, 0, 3.7 mm

Cursor:

ABM2 = -29.35 dBA/m

Location: 8.3, 0, 3.7 mm

Cursor:

ABM1/ABM2 = 23.83 dB

ABM1 comp = -5.52 dBA/m

BWC Factor = -0.19 dB

Location: 8.3, 0, 3.7 mm

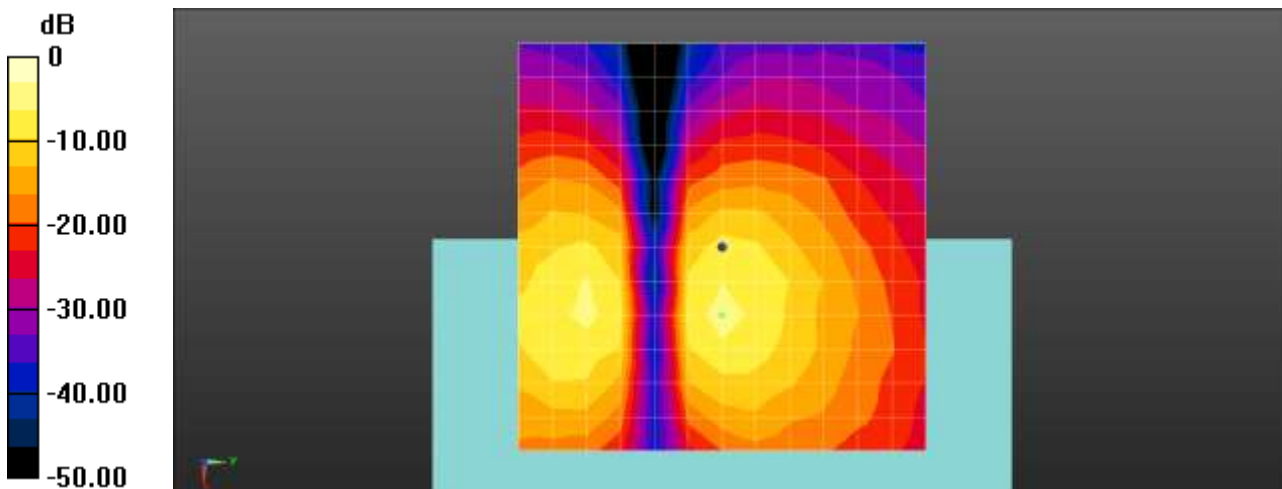

0 dB = 1.000 A/m = 0.00 dBA/m

Plot No.40

LTE Band 71 QPSK 10MHz 1RB 0offset 133297ch EVS NB 5.9 z(axial)

Communication System: UID 0, LTE Band 71 (0); Frequency: 680.5 MHz;Duty Cycle: 1:1
Medium parameters used: $\sigma = 0$ S/m, $\epsilon_r = 1$; $\rho = 0$ kg/m³
Phantom section: TCoil Section

DASY5 Configuration:

- Probe: AM1DV3 - 3049; ; Calibrated: 2021-06-01
- Sensor-Surface: 0mm (Fix Surface)
- Electronics: DAE4 Sn652; Calibrated: 2022-01-24
- Phantom: HAC Test Arch with AMCC TCOIL
- Measurement SW: DASY52, Version 52.10 (4)

T-Coil scan (scan for ANSI C63.19-2007 & 2011 compliance)/General Scans/z (axial) 4.2mm 50 x

50/ABM Signal(x,y,z) (13x13x1): Measurement grid: dx=10mm, dy=10mm

Signal Type: Audio File (.wav) 48k_voice_1kHz_1s.wav

Output Gain: 24.38

Measure Window Start: 300ms

Measure Window Length: 1000ms

BWC applied: -0.19 dB

Device Reference Point: 0, 0, -6.3 mm

Cursor:

ABM1 comp = -1.89 dBA/m

BWC Factor = -0.19 dB

Location: 12.5, -4.2, 3.7 mm

Cursor:

ABM2 = -26.52 dBA/m

Location: 12.5, -4.2, 3.7 mm

Cursor:

ABM1/ABM2 = 24.64 dB

ABM1 comp = -1.89 dBA/m

BWC Factor = -0.19 dB

Location: 12.5, -4.2, 3.7 mm

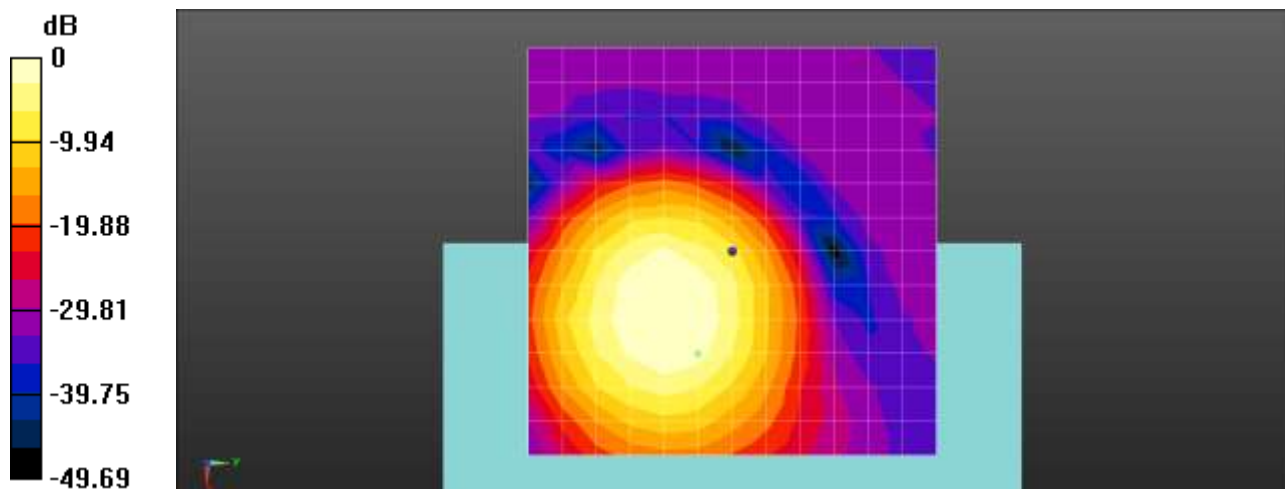

0 dB = 1.000 A/m = 0.00 dBA/m

Plot No.41

LTE Band 71 QPSK 10MHz 1RB 0offset 133297ch EVS NB 5.9 Freq.Response

Communication System: UID 0, LTE Band 71 (0); Frequency: 680.5 MHz;Duty Cycle: 1:1

Medium parameters used: $\sigma = 0$ S/m, $\epsilon_r = 1$; $\rho = 0$ kg/m³

Phantom section: TCoil Section

T-Coil scan (scan for ANSI C63.19-2007 & 2011 compliance)/General Scans/z (axial) wideband at best

S/N/ABM Freq Resp(x,y,z,f) (1x1x1): Measurement grid: dx=10mm, dy=10mm

Signal Type: Audio File (.wav) 48k_Normal_51s new.wav

Output Gain: 52.36

Measure Window Start: 300ms

Measure Window Length: 51000ms

BWC applied: 9.12 dB

Device Reference Point: 0, 0, -6.3 mm

Category	Telephone parameters WD signal quality [(signal+noise)-to-noise ratio in decibels]
Category T1	0 dB to 10 dB
Category T2	10 dB to 20 dB
Category T3	20 dB to 30 dB
Category T4	> 30 dB

Cursor:

Diff = 1.92 dB

BWC Factor = 9.12 dB

Location: 11.8, -5.3, 3.7 mm

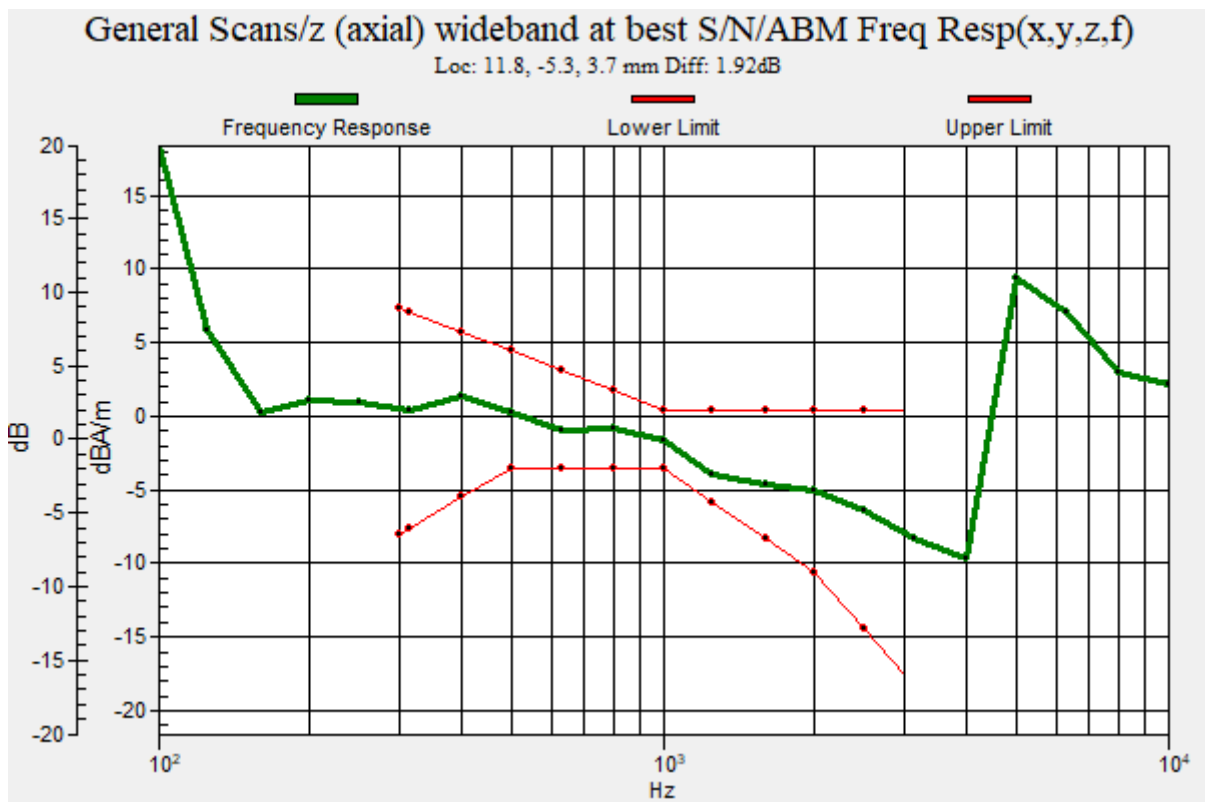

Plot No.42

LTE Band 71 QPSK 10MHz 1RB 0offset 133297ch EVS NB 5.9 133297ch y(transversal)

Communication System: UID 0, LTE Band 71 (0); Frequency: 680.5 MHz;Duty Cycle: 1:1
Medium parameters used: $\sigma = 0$ S/m, $\epsilon_r = 1$; $\rho = 0$ kg/m³
Phantom section: TCoil Section

DASY5 Configuration:

- Probe: AM1DV3 - 3049; ; Calibrated: 2021-06-01
- Sensor-Surface: 0mm (Fix Surface)
- Electronics: DAE4 Sn652; Calibrated: 2022-01-24
- Phantom: HAC Test Arch with AMCC TCOIL
- Measurement SW: DASY52, Version 52.10 (4)

T-Coil scan (scan for ANSI C63.19-2007 & 2011 compliance)/General Scans/y (transversal) 4.2mm 50

x 50/ABM Signal(x,y,z) (13x13x1): Measurement grid: dx=10mm, dy=10mm
Signal Type: Audio File (.wav) 48k_voice_1kHz_1s.wav
Output Gain: 24.38
Measure Window Start: 300ms
Measure Window Length: 1000ms
BWC applied: -0.19 dB
Device Reference Point: 0, 0, -6.3 mm

Cursor:

ABM1 comp = -5.97 dBA/m
BWC Factor = -0.19 dB

Cursor:

ABM2 = -30.96 dBA/m
Location: 4.2, 0, 3.7 mm

Cursor:

ABM1/ABM2 = 24.99 dB
ABM1 comp = -5.97 dBA/m
BWC Factor = -0.19 dB
Location: 4.2, 0, 3.7 mm

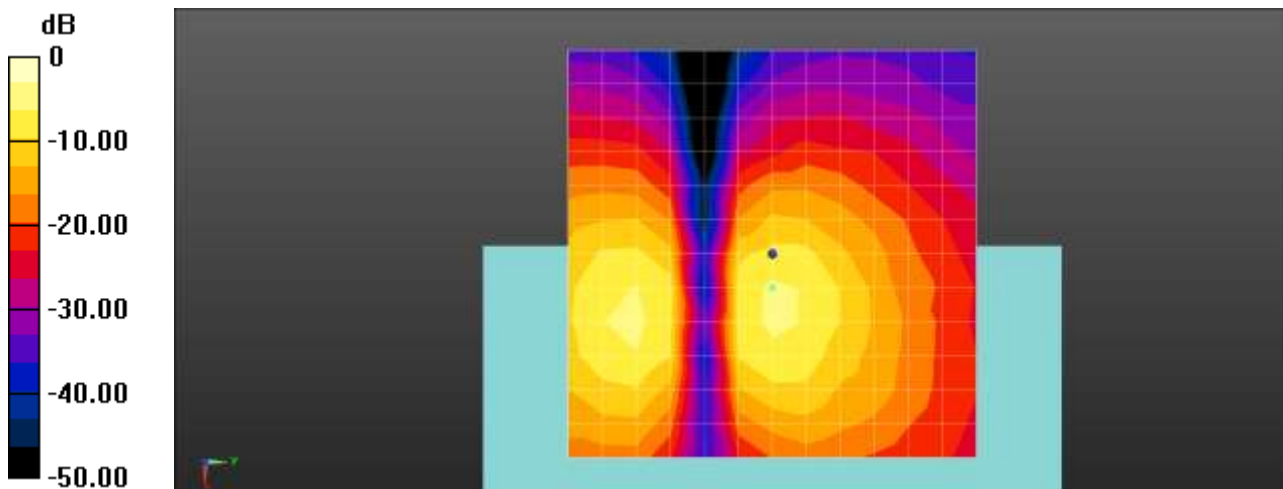

0 dB = 1.000 A/m = 0.00 dBA/m

Plot No.43

LTE Band 41 QPSK 20MHz 1RB 99offset EVS NB 5.9 40620ch z(axial)

Communication System: UID 0, LTE Band 41 (0); Frequency: 2593 MHz;Duty Cycle: 1:2.30728

Medium parameters used: $\sigma = 0$ S/m, $\epsilon_r = 1$; $\rho = 0$ kg/m³

Phantom section: TCoil Section

DASY5 Configuration:

- Probe: AM1DV3 - 3049; ; Calibrated: 2021-06-01
- Sensor-Surface: 0mm (Fix Surface)
- Electronics: DAE4 Sn652; Calibrated: 2022-01-24
- Phantom: HAC Test Arch with AMCC TCOIL
- Measurement SW: DASY52, Version 52.10 (4)

T-Coil scan (scan for ANSI C63.19-2007 & 2011 compliance)/General Scans/z (axial) 4.2mm 50 x

50/ABM Signal(x,y,z) (13x13x1): Measurement grid: dx=10mm, dy=10mm

Signal Type: Audio File (.wav) 48k_voice_1kHz_1s.wav

Output Gain: 24.38

Measure Window Start: 300ms

Measure Window Length: 1000ms

BWC applied: -0.20 dB

Device Reference Point: 0, 0, -6.3 mm

Cursor:

ABM1 comp = -0.16 dBA/m

BWC Factor = -0.19 dB

Location: 4.2, -12.5, 3.7 mm

Cursor:

ABM2 = -24.47 dBA/m

Location: 4.2, -12.5, 3.7 mm

Cursor:

ABM1/ABM2 = 24.31 dB

ABM1 comp = 1.19 dBA/m

BWC Factor = -0.19 dB

Location: 4.2, -12.5, 3.7 mm

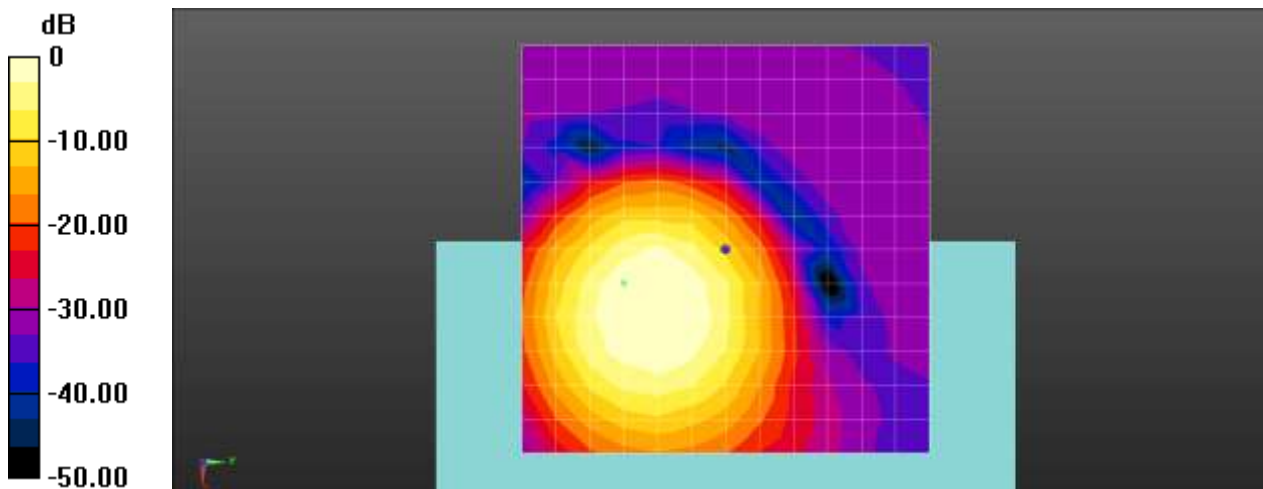

0 dB = 1.000 A/m = 0.00 dBA/m

Plot No.44

LTE Band 41 QPSK 20MHz 1RB 99offset EVS NB 5.9 40620ch Freq. Response

Communication System: UID 0, LTE Band 41 (0); Frequency: 2593 MHz;Duty Cycle: 1:2.30728
 Medium parameters used: $\sigma = 0$ S/m, $\epsilon_r = 1$; $\rho = 0$ kg/m³
 Phantom section: TCoil Section

T-Coil scan (scan for ANSI C63.19-2007 & 2011 compliance)/General Scans/z (axial) wideband at best

S/N/ABM Freq Resp(x,y,z,f) (1x1x1): Measurement grid: dx=10mm, dy=10mm
 Signal Type: Audio File (.wav) 48k_Normal_51s new.wav
 Output Gain: 52.36
 Measure Window Start: 300ms
 Measure Window Length: 51000ms
 BWC applied: 9.12 dB
 Device Reference Point: 0, 0, -6.3 mm

Category	Telephone parameters WD signal quality [(signal+noise)-to-noise ratio in decibels]
Category T1	0 dB to 10 dB
Category T2	10 dB to 20 dB
Category T3	20 dB to 30 dB
Category T4	> 30 dB

Cursor:

Diff = 2.00 dB
 BWC Factor = 9.13 dB
 Location: 4.2, -10.3, 3.7 mm

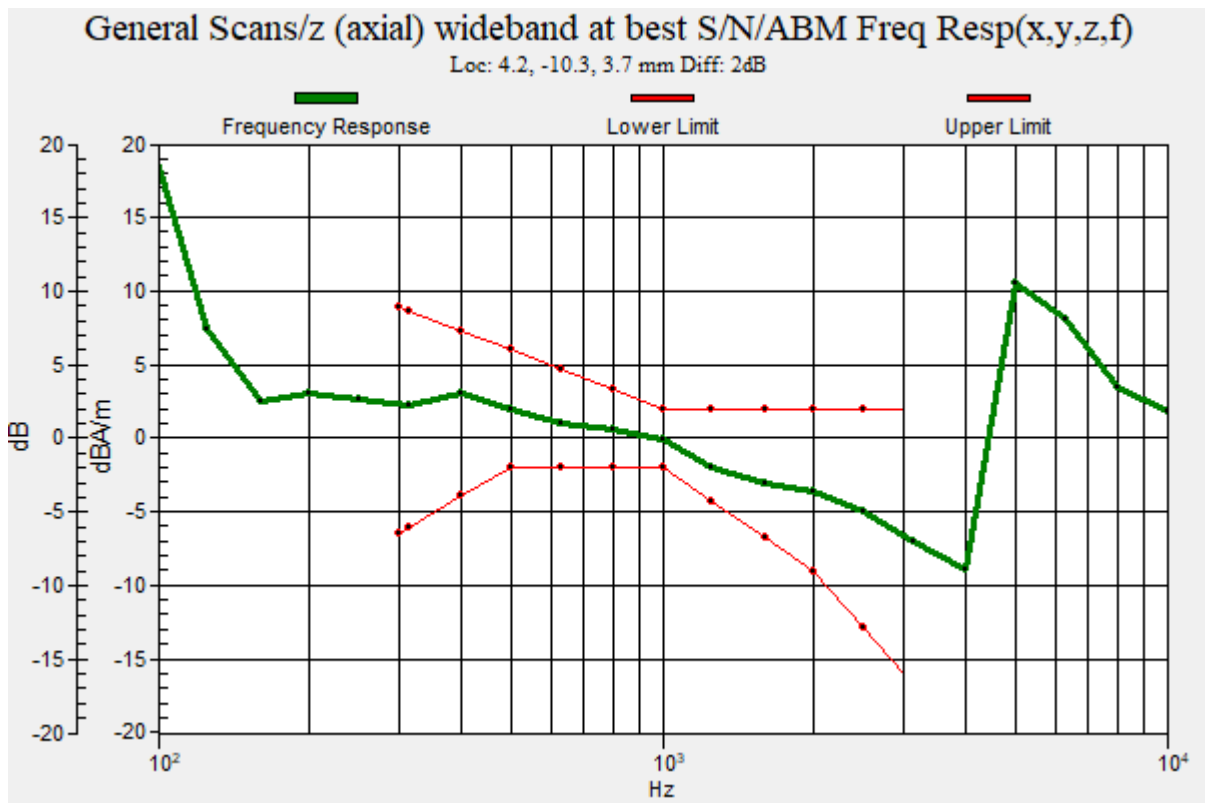

Plot No.45

LTE Band 41 QPSK 10MHz 1RB 49offset EVS NB 5.9 40620ch y(transversal)

Communication System: UID 0, LTE Band 41 (0); Frequency: 2593 MHz;Duty Cycle: 1:2.30728
Medium parameters used: $\sigma = 0$ S/m, $\epsilon_r = 1$; $\rho = 0$ kg/m³
Phantom section: TCoil Section

DASY5 Configuration:

- Probe: AM1DV3 - 3049; ; Calibrated: 2021-06-01
- Sensor-Surface: 0mm (Fix Surface)
- Electronics: DAE4 Sn652; Calibrated: 2022-01-24
- Phantom: HAC Test Arch with AMCC TCOIL
- Measurement SW: DASY52, Version 52.10 (4)

T-Coil scan (scan for ANSI C63.19-2007 & 2011 compliance)/General Scans/y (transversal) 4.2mm 50

x 50/ABM Signal(x,y,z) (13x13x1): Measurement grid: dx=10mm, dy=10mm

Signal Type: Audio File (.wav) 48k_voice_1kHz_1s.wav

Output Gain: 24.38

Measure Window Start: 300ms

Measure Window Length: 1000ms

BWC applied: -0.20 dB

Device Reference Point: 0, 0, -6.3 mm

Cursor:

ABM1 comp = -10.36 dBA/m

BWC Factor = -0.19 dB

Location: 0, 4.2, 3.7 mm

Cursor:

ABM2 = -33.56 dBA/m

Location: 0, 4.2, 3.7 mm

Cursor:

ABM1/ABM2 = 23.19 dB

ABM1 comp = -10.36 dBA/m

BWC Factor = -0.19 dB

Location: 0, 4.2, 3.7 mm

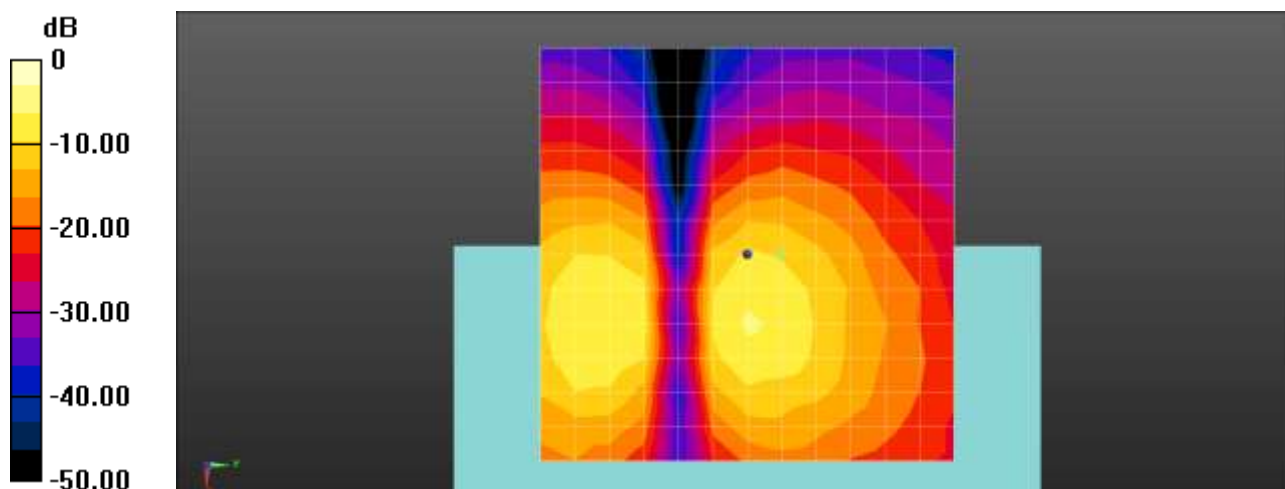

0 dB = 1.000 A/m = 0.00 dBA/m

Plot No.46

LTE Band 38 QPSK 20MHz 1RB 99offset EVS NB 5.9 40620ch z(axial)

Communication System: UID 0, LTE38 (0); Frequency: 2595 MHz;Duty Cycle: 1:2.30728

Medium parameters used: $\sigma = 0$ S/m, $\epsilon_r = 1$; $\rho = 0$ kg/m³

Phantom section: TCoil Section

DASY5 Configuration:

- Probe: AM1DV3 - 3049; ; Calibrated: 2021-06-01
- Sensor-Surface: 0mm (Fix Surface)
- Electronics: DAE4 Sn652; Calibrated: 2022-01-24
- Phantom: HAC Test Arch with AMCC TCOIL
- Measurement SW: DASY52, Version 52.10 (4)

T-Coil scan (scan for ANSI C63.19-2007 & 2011 compliance)/General Scans/z (axial) 4.2mm 50 x

50/ABM Signal(x,y,z) (13x13x1): Measurement grid: dx=10mm, dy=10mm

Signal Type: Audio File (.wav) 48k_voice_1kHz_1s.wav

Output Gain: 24.38

Measure Window Start: 300ms

Measure Window Length: 1000ms

BWC applied: -0.18 dB

Device Reference Point: 0, 0, -6.3 mm

Cursor:

ABM1 comp = 2.28 dBA/m

BWC Factor = -0.18 dB

Location: 8.3, -8.3, 3.7 mm

Cursor:

ABM2 = -26.71 dBA/m

Location: 8.3, -8.3, 3.7 mm

Cursor:

ABM1/ABM2 = 28.99 dB

ABM1 comp = 2.28 dBA/m

BWC Factor = -0.18 dB

Location: 8.3, -8.3, 3.7 mm

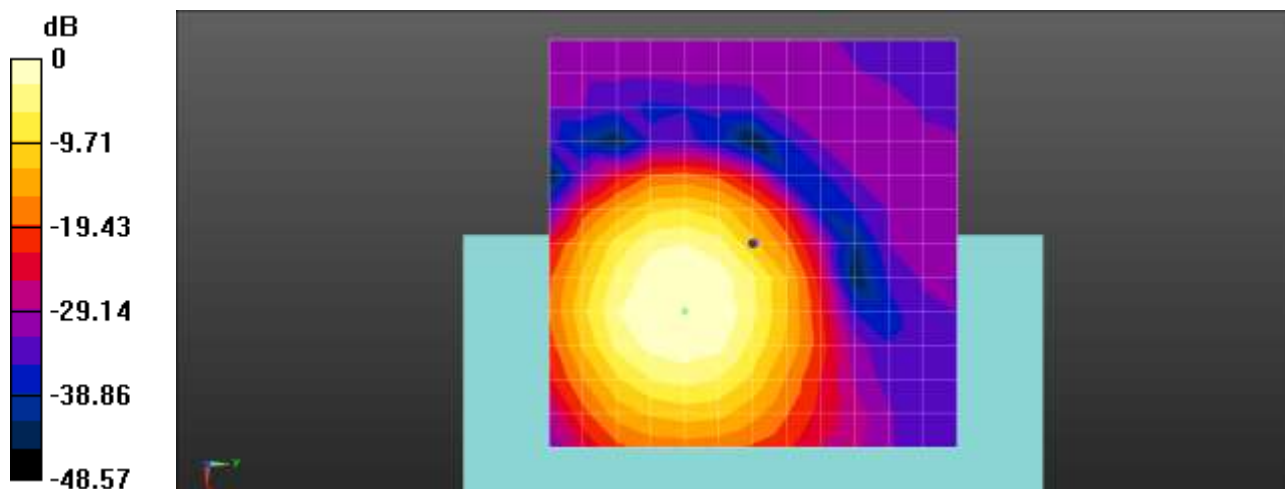

0 dB = 1.000 A/m = 0.00 dBA/m

Plot No.47

LTE Band 38 QPSK 20MHz 1RB 99offset EVS NB 5.9 40620ch Freq.Response

Communication System: UID 0, LTE38 (0); Frequency: 2595 MHz;Duty Cycle: 1:2.30728

Medium parameters used: $\sigma = 0$ S/m, $\epsilon_r = 1$; $\rho = 0$ kg/m³

Phantom section: TCoil Section

T-Coil scan (scan for ANSI C63.19-2007 & 2011 compliance)/General Scans/z (axial) wideband at best

S/N/ABM Freq Resp(x,y,z,f) (1x1x1): Measurement grid: dx=10mm, dy=10mm

Signal Type: Audio File (.wav) 48k_Normal_51s new.wav

Output Gain: 52.36

Measure Window Start: 300ms

Measure Window Length: 51000ms

BWC applied: 9.13 dB

Device Reference Point: 0, 0, -6.3 mm

Category	Telephone parameters WD signal quality [(signal+noise)-to-noise ratio in decibels]
Category T1	0 dB to 10 dB
Category T2	10 dB to 20 dB
Category T3	20 dB to 30 dB
Category T4	> 30 dB

Cursor:

Diff = 2.00 dB

BWC Factor = 9.13 dB

Location: 7.8, -7.7, 3.7 mm

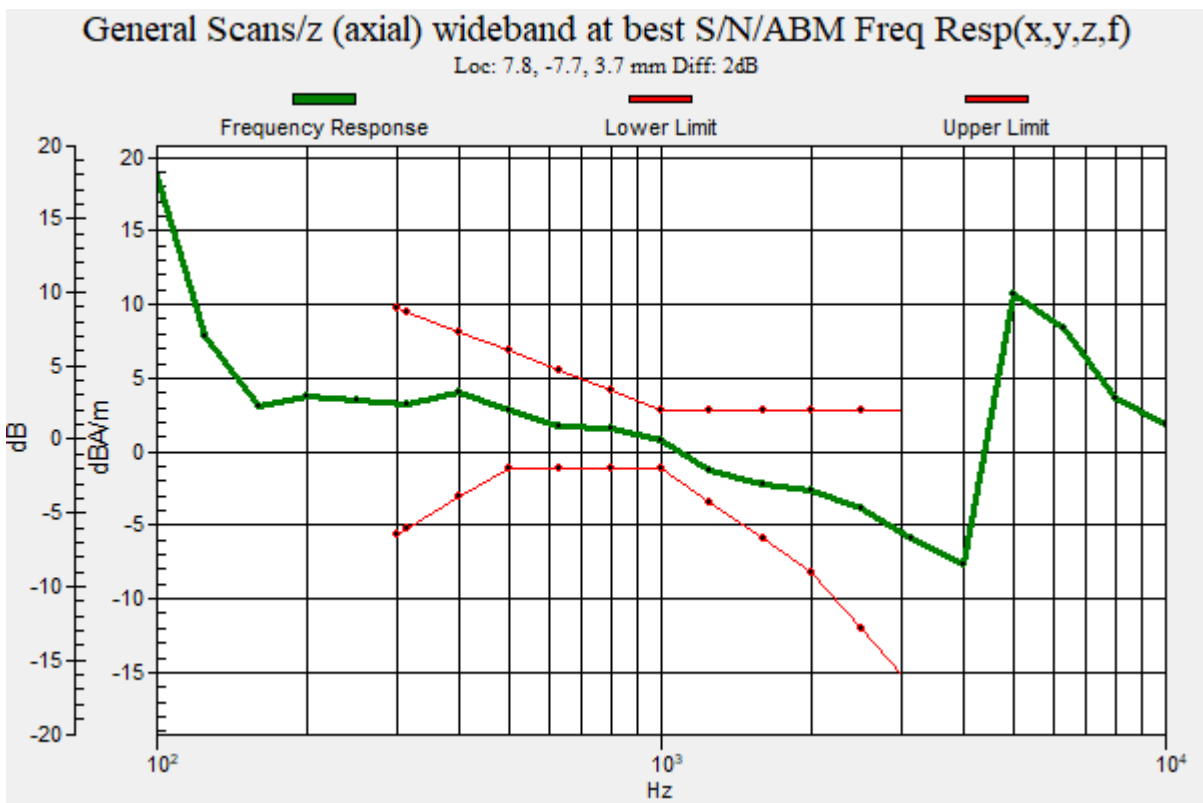

Plot No.48

LTE Band 38 QPSK 20MHz 1RB 99offset EVS NB 5.9 40620chy (transversal)

Communication System: UID 0, LTE38 (0); Frequency: 2595 MHz;Duty Cycle: 1:2.30728

Medium parameters used: $\sigma = 0$ S/m, $\epsilon_r = 1$; $\rho = 0$ kg/m³

Phantom section: TCoil Section

DASY5 Configuration:

- Probe: AM1DV3 - 3049; ; Calibrated: 2021-06-01
- Sensor-Surface: 0mm (Fix Surface)
- Electronics: DAE4 Sn652; Calibrated: 2022-01-24
- Phantom: HAC Test Arch with AMCC TCOIL
- Measurement SW: DASY52, Version 52.10 (4)

T-Coil scan (scan for ANSI C63.19-2007 & 2011 compliance)/General Scans/y (transversal) 4.2mm 50

x 50/ABM Signal(x,y,z) (13x13x1): Measurement grid: dx=10mm, dy=10mm

Signal Type: Audio File (.wav) 48k_voice_1kHz_1s.wav

Output Gain: 24.38

Measure Window Start: 300ms

Measure Window Length: 1000ms

BWC applied: -0.18 dB

Device Reference Point: 0, 0, -6.3 mm

Cursor:

ABM1 comp = -12.30 dBA/m

BWC Factor = -0.18 dB

Location: -4.2, 0, 3.7 mm

Cursor:

ABM2 = -41.55 dBA/m

Location: -4.2, 0, 3.7 mm

Cursor:

ABM1/ABM2 = 29.25 dB

ABM1 comp = -12.30 dBA/m

BWC Factor = -0.18 dB

Location: -4.2, 0, 3.7 mm

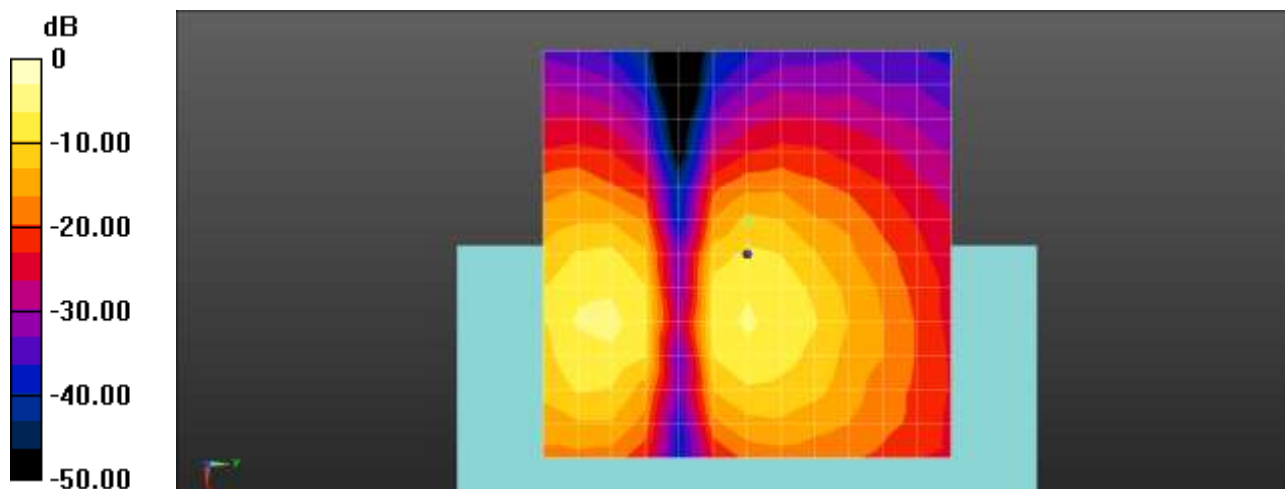

0 dB = 1.000 A/m = 0.00 dBA/m

Plot No.49

LTE Band 40 QPSK 10MHz 1RB 49offset EVS NB 5.9 38750ch z(axial)

Communication System: UID 0, LTE40 (0); Frequency: 2310 MHz;Duty Cycle: 1:2.30728

Medium parameters used: $\sigma = 0$ S/m, $\epsilon_r = 1$; $\rho = 0$ kg/m³

Phantom section: TCoil Section

DASY5 Configuration:

- Probe: AM1DV3 - 3049; ; Calibrated: 2021-06-01
- Sensor-Surface: 0mm (Fix Surface)
- Electronics: DAE4 Sn652; Calibrated: 2022-01-24
- Phantom: HAC Test Arch with AMCC TCOIL
- Measurement SW: DASY52, Version 52.10 (4)

T-Coil scan (scan for ANSI C63.19-2007 & 2011 compliance)/General Scans/z (axial) 4.2mm 50 x

50/ABM Signal(x,y,z) (13x13x1): Measurement grid: dx=10mm, dy=10mm

Signal Type: Audio File (.wav) 48k_voice_1kHz_1s.wav

Output Gain: 24.38

Measure Window Start: 300ms

Measure Window Length: 1000ms

BWC applied: -0.19 dB

Device Reference Point: 0, 0, -6.3 mm

Cursor:

ABM1 comp = -4.49 dBA/m

BWC Factor = -0.19 dB

Location: 8.3, -16.7, 3.7 mm

Cursor:

ABM2 = -28.00 dBA/m

Location: 8.3, -16.7, 3.7 mm

Cursor:

ABM1/ABM2 = 23.51 dB

ABM1 comp = -4.49 dBA/m

BWC Factor = -0.19 dB

Location: 8.3, -16.7, 3.7 mm

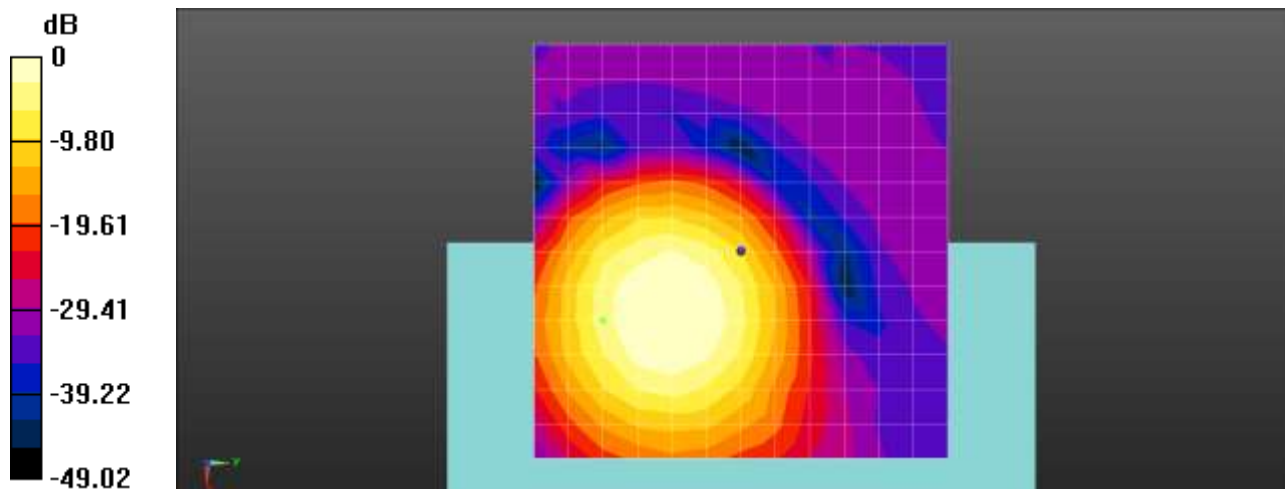

0 dB = 1.000 A/m = 0.00 dBA/m

Plot No.50

LTE Band 40 QPSK 10MHz 1RB 49offset EVS NB 5.9 38750ch Freq.Response

Communication System: UID 0, LTE40 (0); Frequency: 2310 MHz;Duty Cycle: 1:2.30728

Medium parameters used: $\sigma = 0$ S/m, $\epsilon_r = 1$; $\rho = 0$ kg/m³

Phantom section: TCoil Section

T-Coil scan (scan for ANSI C63.19-2007 & 2011 compliance)/General Scans/z (axial) wideband at best

S/N/ABM Freq Resp(x,y,z,f) (1x1x1): Measurement grid: dx=10mm, dy=10mm

Signal Type: Audio File (.wav) 48k_Normal_51s new.wav

Output Gain: 52.36

Measure Window Start: 300ms

Measure Window Length: 51000ms

BWC applied: 9.13 dB

Device Reference Point: 0, 0, -6.3 mm

Category	Telephone parameters WD signal quality [(signal+noise)-to-noise ratio in decibels]
Category T1	0 dB to 10 dB
Category T2	10 dB to 20 dB
Category T3	20 dB to 30 dB
Category T4	> 30 dB

Cursor:

Diff = 2.00 dB

BWC Factor = 9.13 dB

Location: 5.9, -1.2, 3.7 mm

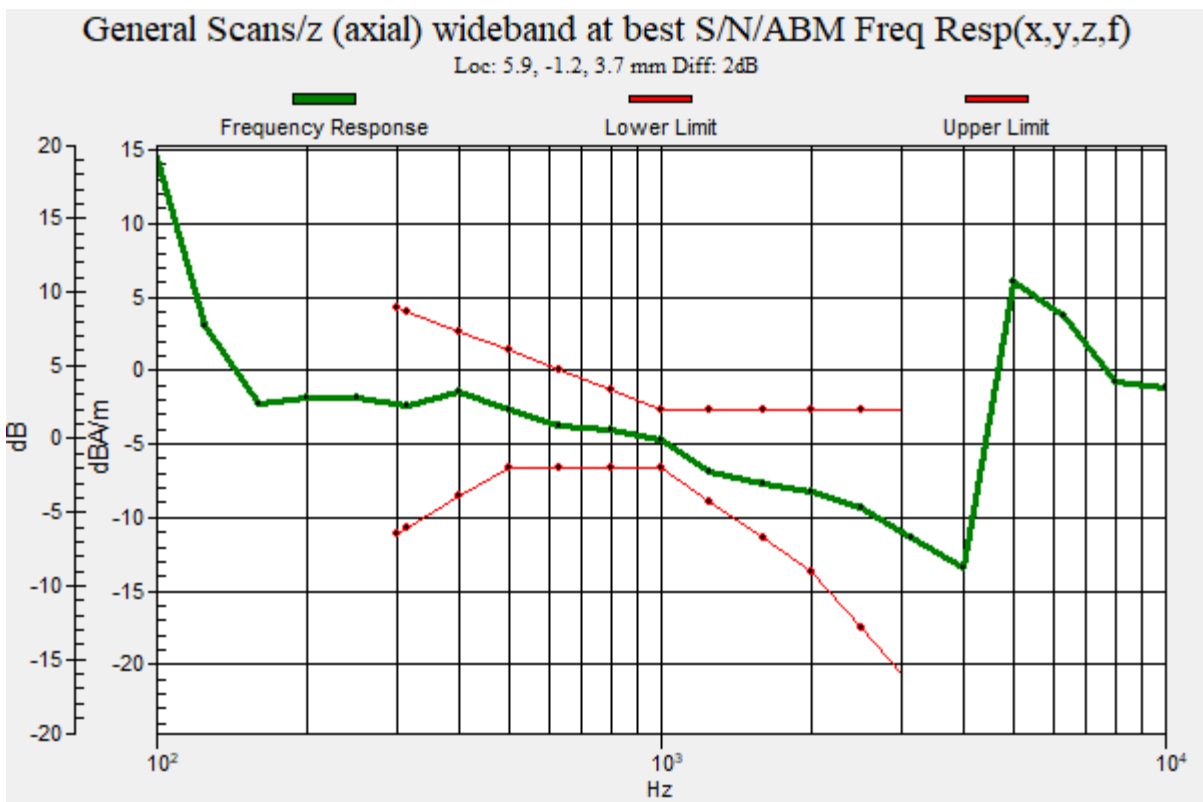

Plot No.51

LTE Band 40 QPSK 10MHz 1RB 49offset EVS NB 5.9 38750chy(transversal)

Communication System: UID 0, LTE40 (0); Frequency: 2310 MHz;Duty Cycle: 1:2.30728
Medium parameters used: $\sigma = 0$ S/m, $\epsilon_r = 1$; $\rho = 0$ kg/m³
Phantom section: TCoil Section

DASY5 Configuration:

- Probe: AM1DV3 - 3049; ; Calibrated: 2021-06-01
- Sensor-Surface: 0mm (Fix Surface)
- Electronics: DAE4 Sn652; Calibrated: 2022-01-24
- Phantom: HAC Test Arch with AMCC TCOIL
- Measurement SW: DASY52, Version 52.10 (4)

T-Coil scan (scan for ANSI C63.19-2007 & 2011 compliance)/General Scans/y (transversal) 4.2mm 50

x 50/ABM Signal(x,y,z) (13x13x1): Measurement grid: dx=10mm, dy=10mm

Signal Type: Audio File (.wav) 48k_voice_1kHz_1s.wav

Output Gain: 24.38

Measure Window Start: 300ms

Measure Window Length: 1000ms

BWC applied: -0.19 dB

Device Reference Point: 0, 0, -6.3 mm

Cursor:

ABM1 comp = -9.83 dBA/m

BWC Factor = -0.19 dB

Location: 0, 4.2, 3.7 mm

Cursor:

ABM2 = -33.89 dBA/m

Location: 0, 4.2, 3.7 mm

Cursor:

ABM1/ABM2 = 24.06 dB

ABM1 comp = -9.83 dBA/m

BWC Factor = -0.19 dB

Location: 0, 4.2, 3.7 mm

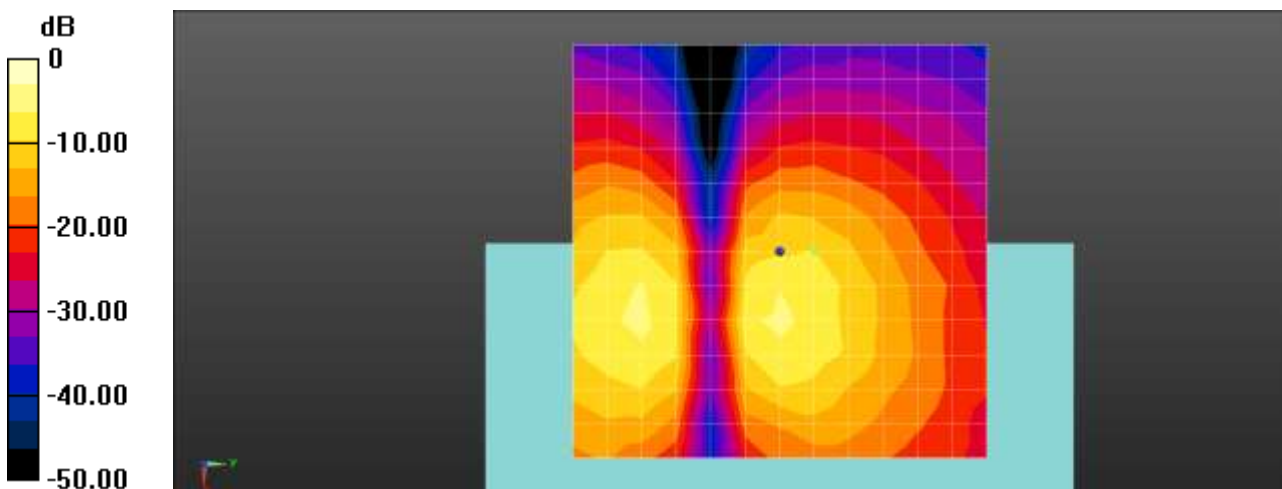

0 dB = 1.000 A/m = 0.00 dBA/m

Plot No.52

LTE Band 48 QPSK 20MHz 1RB 99offset EVS NB 5.9 55990ch z(axial)

Communication System: UID 0, LTE 48 (0); Frequency: 3625 MHz;Duty Cycle: 1:2.30728

Medium parameters used: $\sigma = 0$ S/m, $\epsilon_r = 1$; $\rho = 0$ kg/m³

Phantom section: TCoil Section

DASY5 Configuration:

- Probe: AM1DV3 - 3049; ; Calibrated: 2021-06-01
- Sensor-Surface: 0mm (Fix Surface)
- Electronics: DAE4 Sn652; Calibrated: 2022-01-24
- Phantom: HAC Test Arch with AMCC TCOIL
- Measurement SW: DASY52, Version 52.10 (4)

T-Coil scan (scan for ANSI C63.19-2007 & 2011 compliance)/General Scans/z (axial) 4.2mm 50 x 50/ABM Signal(x,y,z) (13x13x1): Measurement grid: dx=10mm, dy=10mm

Signal Type: Audio File (.wav) 48k_voice_1kHz_1s.wav

Output Gain: 24.38

Measure Window Start: 300ms

Measure Window Length: 1000ms

BWC applied: -0.19 dB

Device Reference Point: 0, 0, -6.3 mm

Cursor:

ABM1 comp = -0.66 dBA/m

BWC Factor = -0.19 dB

Location: 8.3, -4.2, 3.7 mm

Cursor:

ABM2 = -25.05 dBA/m

Location: 8.3, -4.2, 3.7 mm

Cursor:

ABM1/ABM2 = 24.39 dB

ABM1 comp = -0.66 dBA/m

BWC Factor = -0.19 dB

Location: 8.3, -4.2, 3.7 mm

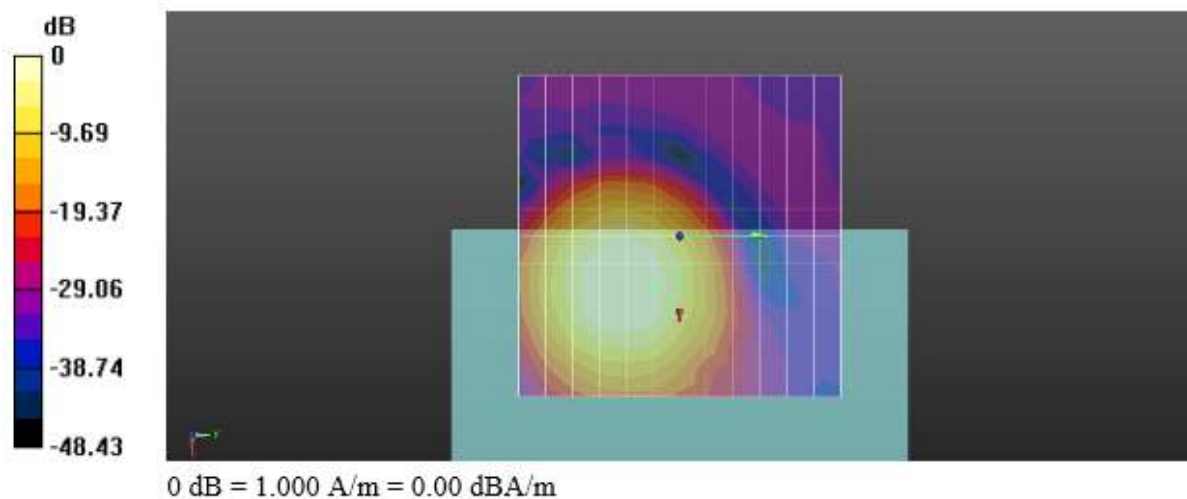

Plot No.53

LTE Band 48 QPSK 20MHz 1RB 99offset EVS NB 5.9 55990ch Freq.Response

Communication System: UID 0, LTE 48 (0); Frequency: 3625 MHz;Duty Cycle: 1:2.30728

Medium parameters used: $\sigma = 0$ S/m, $\epsilon_r = 1$; $\rho = 0$ kg/m³

Phantom section: TCoil Section

T-Coil scan (scan for ANSI C63.19-2007 & 2011 compliance)/General Scans/z (axial) wideband at best

S/N/ABM Freq Resp(x,y,z,f) (1x1x1): Measurement grid: dx=10mm, dy=10mm

Signal Type: Audio File (.wav) 48k_Normal_51s new.wav

Output Gain: 52.36

Measure Window Start: 300ms

Measure Window Length: 51000ms

BWC applied: 9.12 dB

Device Reference Point: 0, 0, -6.3 mm

Category	Telephone parameters WD signal quality [(signal+noise)-to-noise ratio in decibels]
Category T1	0 dB to 10 dB
Category T2	10 dB to 20 dB
Category T3	20 dB to 30 dB
Category T4	> 30 dB

Cursor:

Diff = 2.00 dB

BWC Factor = 9.12 dB

Location: 8.4, -4.7, 3.7 mm

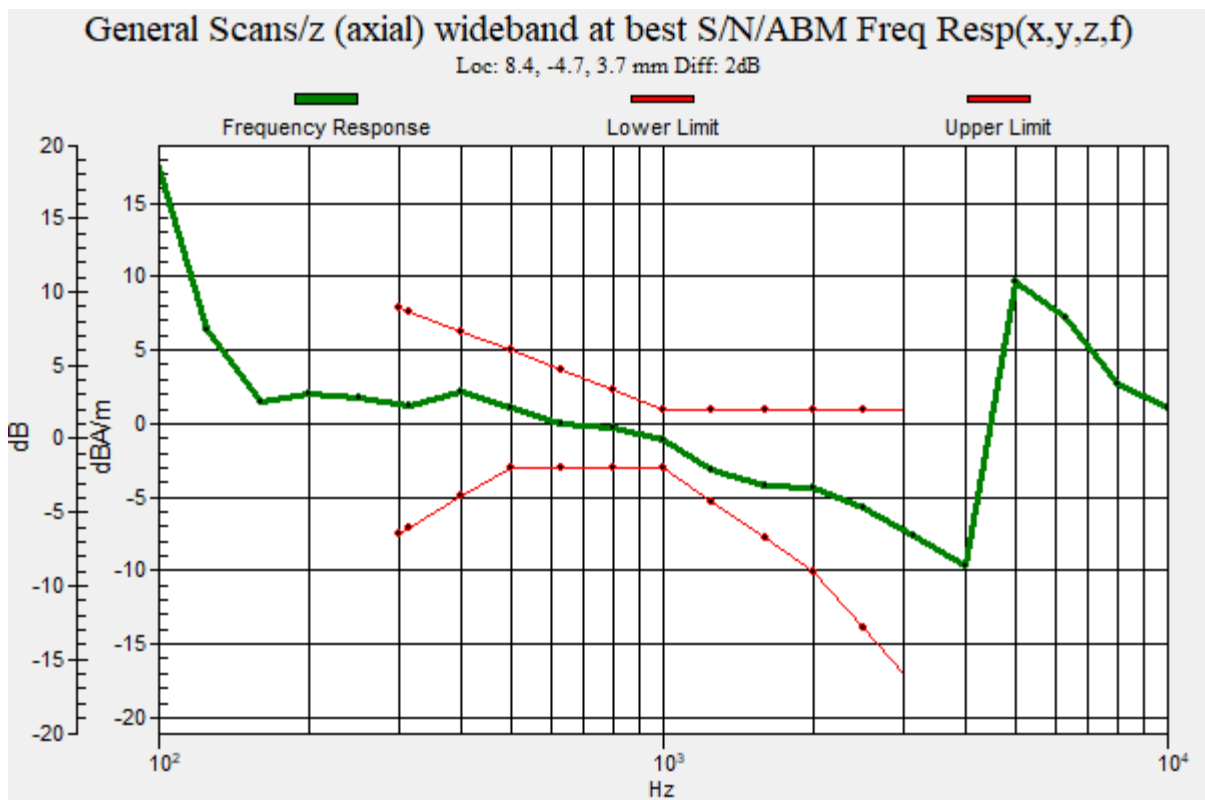

Plot No.54

LTE Band 48 QPSK 20MHz 1RB 99offset EVS NB 5.9 55990ch y(transversal)

Communication System: UID 0, LTE 48 (0); Frequency: 3625 MHz;Duty Cycle: 1:2.30728
Medium parameters used: $\sigma = 0$ S/m, $\epsilon_r = 1$; $\rho = 0$ kg/m³
Phantom section: TCoil Section

DASY5 Configuration:

- Probe: AM1DV3 - 3049; ; Calibrated: 2021-06-01
- Sensor-Surface: 0mm (Fix Surface)
- Electronics: DAE4 Sn652; Calibrated: 2022-01-24
- Phantom: HAC Test Arch with AMCC TCOIL
- Measurement SW: DASY52, Version 52.10 (4)

T-Coil scan (scan for ANSI C63.19-2007 & 2011 compliance)/General Scans/y (transversal) 4.2mm 50

x 50/ABM Signal(x,y,z) (13x13x1): Measurement grid: dx=10mm, dy=10mm

Signal Type: Audio File (.wav) 48k_voice_1kHz_1s.wav

Output Gain: 24.38

Measure Window Start: 300ms

Measure Window Length: 1000ms

BWC applied: -0.19 dB

Device Reference Point: 0, 0, -6.3 mm

Cursor:

ABM1 comp = -11.21 dBA/m

BWC Factor = -0.19 dB

Location: 0, -12.5, 3.7 mm

Cursor:

ABM2 = -35.36 dBA/m

Location: 0, -12.5, 3.7 mm

Cursor:

ABM1/ABM2 = 24.15 dB

ABM1 comp = -11.21 dBA/m

BWC Factor = -0.19 dB

Location: 0, -12.5, 3.7 mm

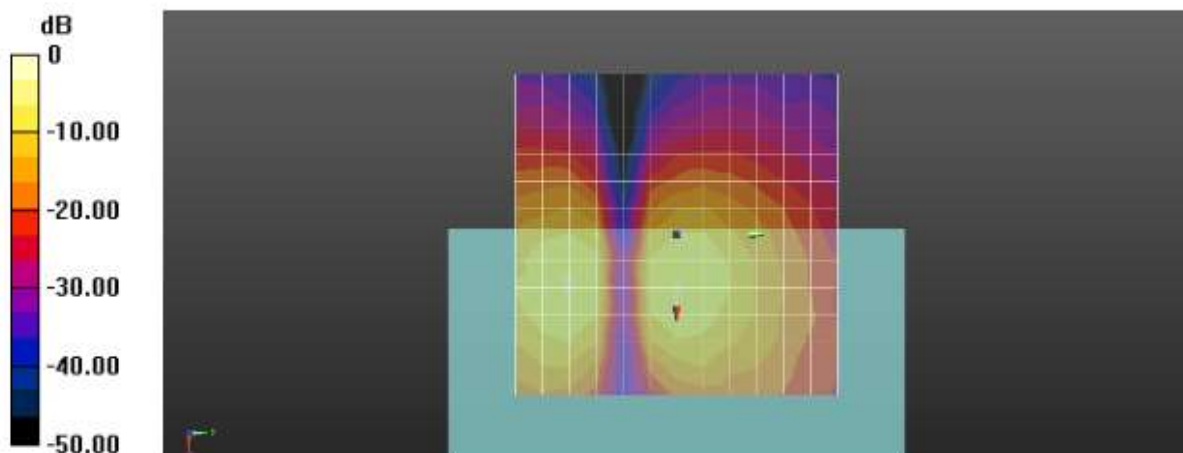

0 dB = 1.000 A/m = 0.00 dBA/m

Plot No.55
802.11b AMR-NB 12.2 1Mbps 6ch z(axial)

Communication System: UID 0, 2450MHz FCC (0); Frequency: 2437 MHz;Duty Cycle: 1:1
Medium parameters used: $\sigma = 0$ S/m, $\epsilon_r = 1$; $\rho = 0$ kg/m³
Phantom section: TCoil Section

DASY5 Configuration:

- Probe: AM1DV3 - 3050; ; Calibrated: 2021-11-23
- Sensor-Surface: 0mm (Fix Surface)
- Electronics: DAE4 Sn1417; Calibrated: 2022-02-24
- Phantom: HAC Test Arch with AMCC
- Measurement SW: DASY52, Version 52.10 (4); SEMCAD X Version 14.6.14 (7483)

T-Coil scan (scan for ANSI C63.19-2007 & 2011 compliance)/General Scans/z (axial) 4.2mm 50 x 50/ABM Signal(x,y,z) (13x13x1): Measurement grid: dx=10mm, dy=10mm

Signal Type: Audio File (.wav) 48k_voice_1kHz_1s.wav
Output Gain: 16.04
Measure Window Start: 300ms
Measure Window Length: 1000ms
BWC applied: 0.16 dB
Device Reference Point: 0, 0, -6.3 mm

Cursor:

ABM1 comp = -1.67 dBA/m
BWC Factor = 0.16 dB
Location: 4.2, -8.3, 3.7 mm

Cursor:

ABM2 = -26.67 dBA/m
Location: 4.2, -8.3, 3.7 mm

Cursor:

ABM1/ABM2 = 25.01 dB
ABM1 comp = -1.67 dBA/m
BWC Factor = 0.16 dB
Location: 4.2, -8.3, 3.7 mm

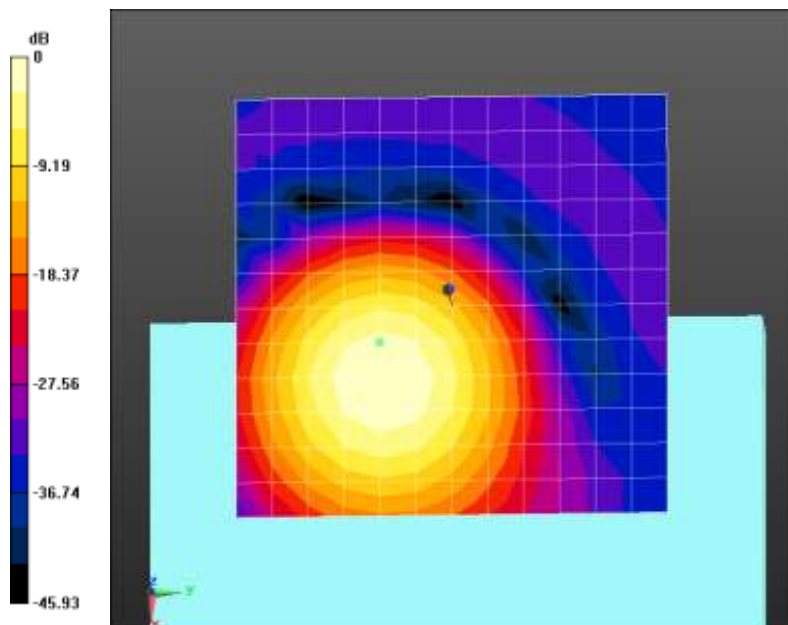

0 dB = 1.000 A/m = 0.00 dBA/m

Plot No.56
802.11b AMR-NB 12.2 1Mbps 6ch Freq.Response

Communication System: UID 0, 2450MHz FCC (0); Frequency: 2437 MHz;Duty Cycle: 1:1
 Medium parameters used: $\sigma = 0$ S/m, $\epsilon_r = 1$; $\rho = 0$ kg/m³
 Phantom section: TCoil Section

T-Coil scan (scan for ANSI C63.19-2007 & 2011 compliance)/General Scans/z (axial) wideband at best S/N/ABM Freq Resp(x,y,z,f) (1x1x1): Measurement grid: dx=10mm, dy=10mm
 Signal Type: Audio File (.wav) 48k_Normal_51s new.wav
 Output Gain: 48.75
 Measure Window Start: 300ms
 Measure Window Length: 51000ms
 BWC applied: 9.48 dB
 Device Reference Point: 0, 0, -6.3 mm

Category	Telephone parameters WD signal quality [(signal+noise)-to-noise ratio in decibels]
Category T1	0 dB to 10 dB
Category T2	10 dB to 20 dB
Category T3	20 dB to 30 dB
Category T4	> 30 dB

Cursor:
 Diff = 1.98 dB
 BWC Factor = 9.48 dB
 Location: 7.5, -11.1, 3.7 mm

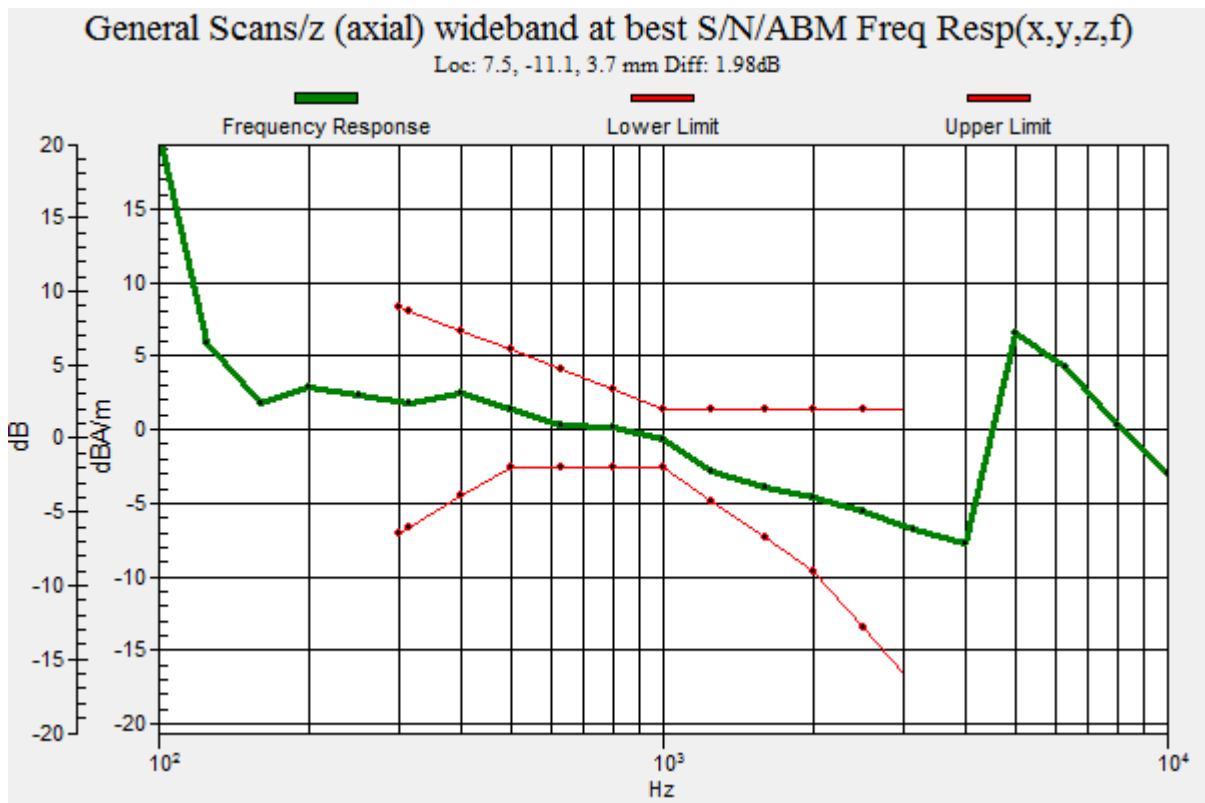

Plot No.57
802.11b AMR-NB 12.2 1Mbps 6ch y(transversal)

Communication System: UID 0, 2450MHz FCC (0); Frequency: 2437 MHz;Duty Cycle: 1:1
Medium parameters used: $\sigma = 0$ S/m, $\epsilon_r = 1$; $\rho = 0$ kg/m³
Phantom section: TCoil Section

DASY5 Configuration:

- Probe: AM1DV3 - 3050; ; Calibrated: 2021-11-23
- Sensor-Surface: 0mm (Fix Surface)
- Electronics: DAE4 Sn1417; Calibrated: 2022-02-24
- Phantom: HAC Test Arch with AMCC
- Measurement SW: DASY52, Version 52.10 (4); SEMCAD X Version 14.6.14 (7483)

T-Coil scan (scan for ANSI C63.19-2007 & 2011 compliance)/General Scans/y (transversal) 4.2mm 50 x 50/ABM Signal(x,y,z) (13x13x1): Measurement grid: dx=10mm, dy=10mm

Signal Type: Audio File (.wav) 48k_voice_1kHz_1s.wav
Output Gain: 16.04
Measure Window Start: 300ms
Measure Window Length: 1000ms
BWC applied: 0.16 dB
Device Reference Point: 0, 0, -6.3 mm

Cursor:

ABM1 comp = -14.90 dBA/m
BWC Factor = 0.16 dB
Location: -4.2, -16.7, 3.7 mm

Cursor:

ABM2 = -40.17 dBA/m
Location: -4.2, -16.7, 3.7 mm

Cursor:

ABM1/ABM2 = 25.27 dB
ABM1 comp = -14.90 dBA/m
BWC Factor = 0.16 dB
Location: -4.2, -16.7, 3.7 mm

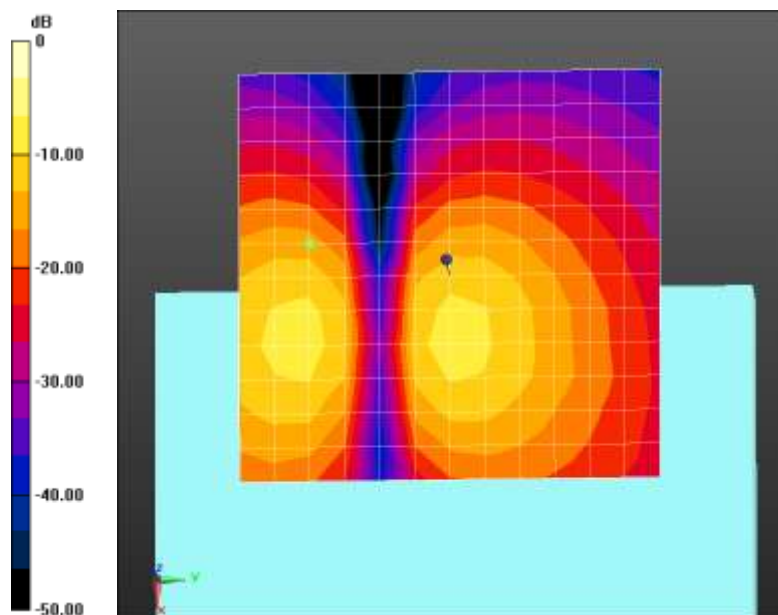

0 dB = 1.000 A/m = 0.00 dBA/m

Plot No.58
802.11a EVS-NB 5.9 54Mbps 40ch z(axial)

Communication System: UID 0, WIFI 5GHz (0); Frequency: 5200 MHz;Duty Cycle: 1:1
Medium parameters used: $\sigma = 0$ S/m, $\epsilon_r = 1$; $\rho = 0$ kg/m³
Phantom section: TCoil Section

DASY5 Configuration:

- Probe: AM1DV3 - 3050; ; Calibrated: 2021-11-23
- Sensor-Surface: 0mm (Fix Surface)
- Electronics: DAE4 Sn1417; Calibrated: 2022-02-24
- Phantom: HAC Test Arch with AMCC
- Measurement SW: DASY52, Version 52.10 (4)

T-Coil scan (scan for ANSI C63.19-2007 & 2011 compliance)/General Scans/z (axial) 4.2mm 50 x 50/ABM Signal(x,y,z) (13x13x1): Measurement grid: dx=10mm, dy=10mm

Signal Type: Audio File (.wav) 48k_voice_1kHz_1s.wav
Output Gain: 16.04
Measure Window Start: 300ms
Measure Window Length: 1000ms
BWC applied: 0.16 dB
Device Reference Point: 0, 0, -6.3 mm

Cursor:

ABM1 comp = -6.97 dBA/m
BWC Factor = 0.16 dB
Location: 4.2, 0, 3.7 mm

Cursor:

ABM2 = -30.34 dBA/m
Location: 4.2, 0, 3.7 mm

Cursor:

ABM1/ABM2 = 23.37 dB
ABM1 comp = -6.97 dBA/m
BWC Factor = 0.16 dB
Location: 4.2, 0, 3.7 mm

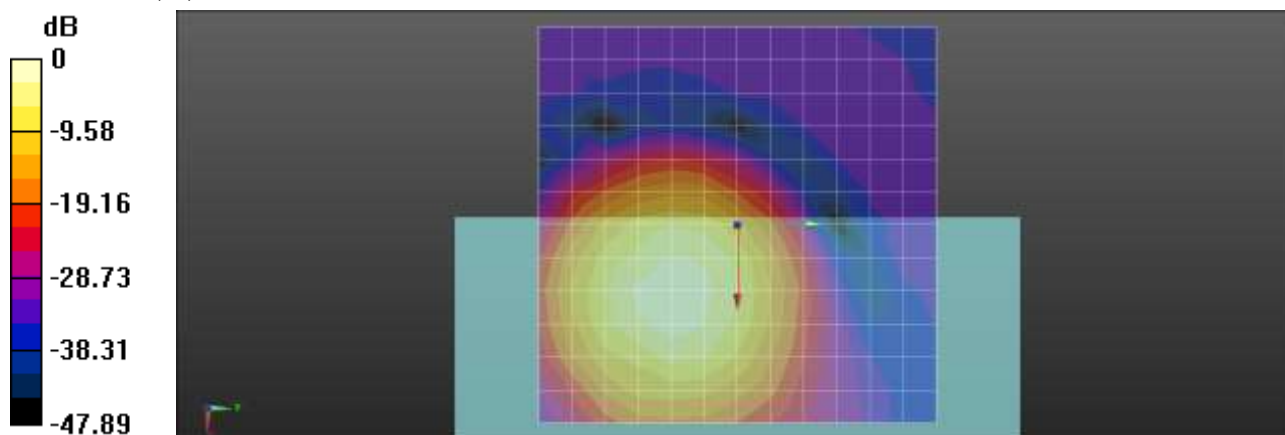

0 dB = 1.000 A/m = 0.00 dBA/m

Plot No.59
802.11a EVS-NB 5.9 54Mbps 40ch Freq.Response

Communication System: UID 0, WIFI 5GHz (0); Frequency: 5200 MHz;Duty Cycle: 1:1
 Medium parameters used: $\sigma = 0$ S/m, $\epsilon_r = 1$; $\rho = 0$ kg/m³
 Phantom section: TCoil Section

T-Coil scan (scan for ANSI C63.19-2007 & 2011 compliance)/General Scans/z (axial) wideband at best

S/N/ABM Freq Resp(x,y,z,f) (1x1x1): Measurement grid: dx=10mm, dy=10mm

Signal Type: Audio File (.wav) 48k_Normal_51s new.wav

Output Gain: 48.75

Measure Window Start: 300ms

Measure Window Length: 51000ms

BWC applied: 9.48 dB

Device Reference Point: 0, 0, -6.3 mm

Category	Telephone parameters WD signal quality [(signal+noise)-to-noise ratio in decibels]
Category T1	0 dB to 10 dB
Category T2	10 dB to 20 dB
Category T3	20 dB to 30 dB
Category T4	> 30 dB

Cursor:

Diff = 2.00 dB

BWC Factor = 9.48 dB

Location: 4.1, -0.5, 3.7 mm

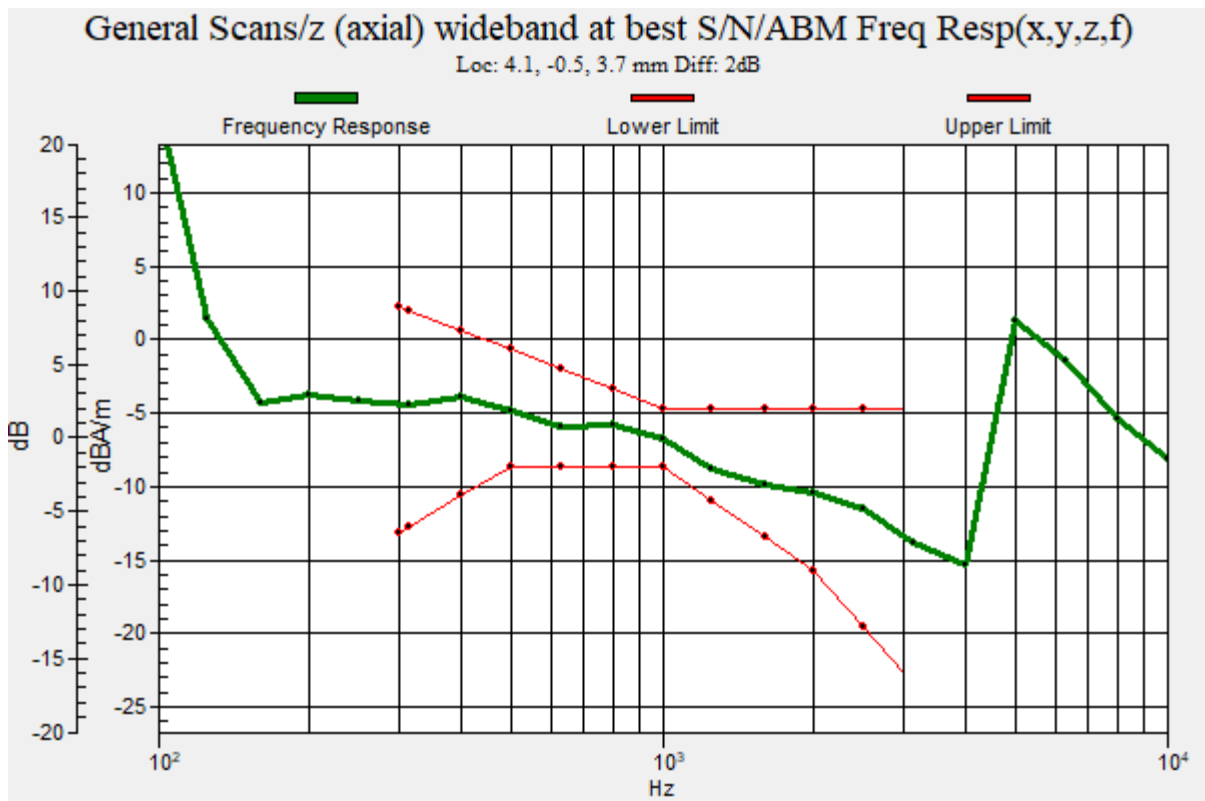

Plot No.60
802.11a EVS-NB 5.9 54Mbps 40ch y(transversal)

Communication System: UID 0, WIFI 5GHz (0); Frequency: 5200 MHz;Duty Cycle: 1:1
Medium parameters used: $\sigma = 0$ S/m, $\epsilon_r = 1$; $\rho = 0$ kg/m³
Phantom section: TCoil Section

DASY5 Configuration:

- Probe: AM1DV3 - 3050; ; Calibrated: 2021-11-23
- Sensor-Surface: 0mm (Fix Surface)
- Electronics: DAE4 Sn1417; Calibrated: 2022-02-24
- Phantom: HAC Test Arch with AMCC
- Measurement SW: DASY52, Version 52.10 (4)

T-Coil scan (scan for ANSI C63.19-2007 & 2011 compliance)/General Scans/y (transversal) 4.2mm 50 x 50/ABM Signal(x,y,z) (13x13x1): Measurement grid: dx=10mm, dy=10mm

Signal Type: Audio File (.wav) 48k_voice_1kHz_1s.wav
Output Gain: 16.04
Measure Window Start: 300ms
Measure Window Length: 1000ms
BWC applied: 0.16 dB
Device Reference Point: 0, 0, -6.3 mm

Cursor:

ABM1 comp = -10.74 dBA/m
BWC Factor = 0.16 dB
Location: 0, -16.7, 3.7 mm

Cursor:

ABM2 = -34.70 dBA/m
Location: 0, -16.7, 3.7 mm

Cursor:

ABM1/ABM2 = 23.95 dB
ABM1 comp = -10.74 dBA/m
BWC Factor = 0.16 dB
Location: 0, -16.7, 3.7 mm

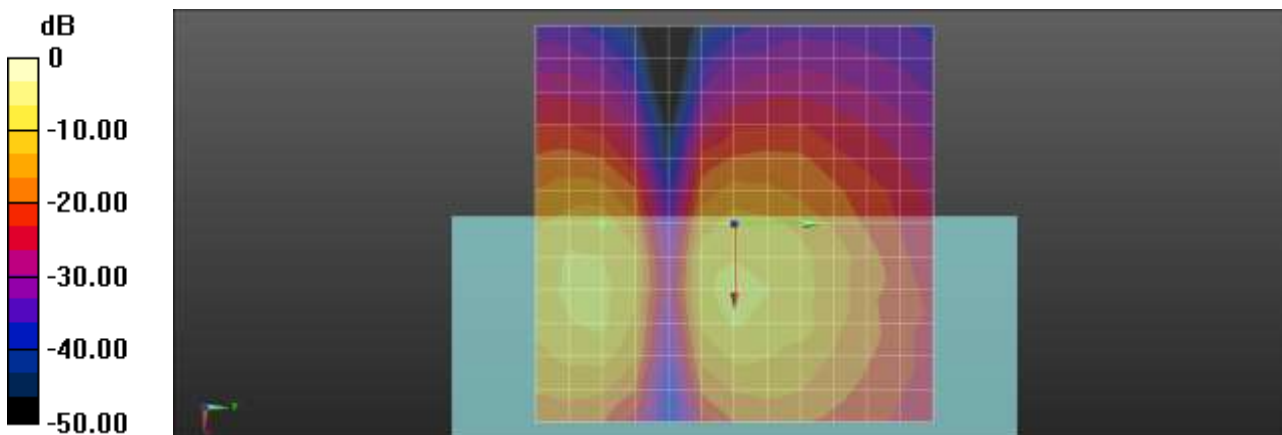

0 dB = 1.000 A/m = 0.00 dBA/m

Plot No.61

802.11a EVS-NB 5.9 54Mbps 60ch z(axial)

Communication System: UID 0, WIFI 5GHz (0); Frequency: 5300 MHz;Duty Cycle: 1:1
Medium parameters used: $\sigma = 0$ S/m, $\epsilon_r = 1$; $\rho = 0$ kg/m³
Phantom section: TCoil Section

DASY5 Configuration:

- Probe: AM1DV3 - 3050; ; Calibrated: 2021-11-23
- Sensor-Surface: 0mm (Fix Surface)
- Electronics: DAE4 Sn1417; Calibrated: 2022-02-24
- Phantom: HAC Test Arch with AMCC
- Measurement SW: DASY52, Version 52.10 (4)

T-Coil scan (scan for ANSI C63.19-2007 & 2011 compliance)/General Scans/z (axial) 4.2mm 50 x

50/ABM Signal(x,y,z) (13x13x1): Measurement grid: dx=10mm, dy=10mm

Signal Type: Audio File (.wav) 48k_voice_1kHz_1s.wav

Output Gain: 16.04

Measure Window Start: 300ms

Measure Window Length: 1000ms

BWC applied: 0.16 dB

Device Reference Point: 0, 0, -6.3 mm

Cursor:

ABM1 comp = -2.19 dBA/m

BWC Factor = 0.16 dB

Location: 8.3, -12.5, 3.7 mm

Cursor:

ABM2 = -27.37 dBA/m

Location: 8.3, -12.5, 3.7 mm

Cursor:

ABM1/ABM2 = 25.18 dB

ABM1 comp = -2.19 dBA/m

BWC Factor = 0.16 dB

Location: 8.3, -12.5, 3.7 mm

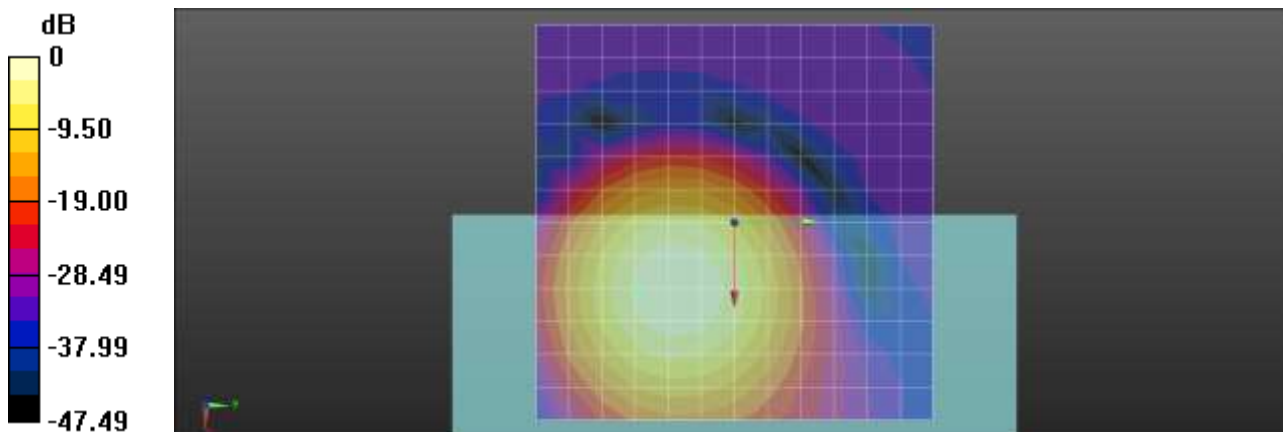

0 dB = 1.000 A/m = 0.00 dBA/m

Plot No.62
802.11a EVS-NB 5.9 54Mbps 60ch Freq.Response

Communication System: UID 0, WIFI 5GHz (0); Frequency: 5300 MHz;Duty Cycle: 1:1
 Medium parameters used: $\sigma = 0$ S/m, $\epsilon_r = 1$; $\rho = 0$ kg/m³
 Phantom section: TCoil Section

T-Coil scan (scan for ANSI C63.19-2007 & 2011 compliance)/General Scans/z (axial) wideband at best S/N/ABM Freq Resp(x,y,z,f) (1x1x1): Measurement grid: dx=10mm, dy=10mm
 Signal Type: Audio File (.wav) 48k_Normal_51s new.wav
 Output Gain: 48.75
 Measure Window Start: 300ms
 Measure Window Length: 51000ms
 BWC applied: 9.48 dB
 Device Reference Point: 0, 0, -6.3 mm

Category	Telephone parameters WD signal quality [(signal+noise)-to-noise ratio in decibels]
Category T1	0 dB to 10 dB
Category T2	10 dB to 20 dB
Category T3	20 dB to 30 dB
Category T4	> 30 dB

Cursor:
 Diff = 2.00 dB
 BWC Factor = 9.48 dB
 Location: 6.5, -11.7, 3.7 mm

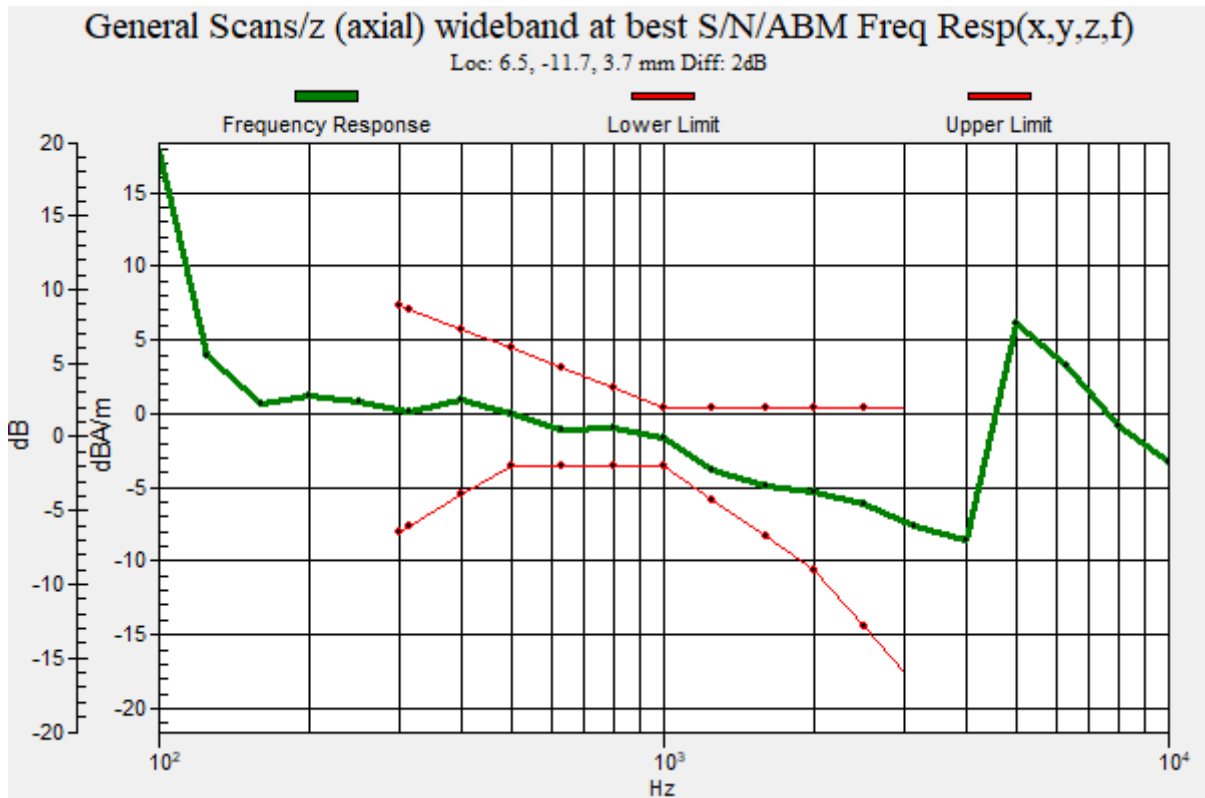

Plot No.63
802.11a EVS-NB 5.9 54Mbps 60ch y(transversal)

Communication System: UID 0, WIFI 5GHz (0); Frequency: 5300 MHz;Duty Cycle: 1:1
Medium parameters used: $\sigma = 0$ S/m, $\epsilon_r = 1$; $\rho = 0$ kg/m³
Phantom section: TCoil Section

DASY5 Configuration:

- Probe: AM1DV3 - 3050; ; Calibrated: 2021-11-23
- Sensor-Surface: 0mm (Fix Surface)
- Electronics: DAE4 Sn1417; Calibrated: 2022-02-24
- Phantom: HAC Test Arch with AMCC
- Measurement SW: DASY52, Version 52.10 (4)

T-Coil scan (scan for ANSI C63.19-2007 & 2011 compliance)/General Scans/y (transversal) 4.2mm 50 x 50/ABM Signal(x,y,z) (13x13x1): Measurement grid: dx=10mm, dy=10mm

Signal Type: Audio File (.wav) 48k_voice_1kHz_1s.wav
Output Gain: 16.04
Measure Window Start: 300ms
Measure Window Length: 1000ms
BWC applied: 0.16 dB
Device Reference Point: 0, 0, -6.3 mm

Cursor:

ABM1 comp = -14.20 dBA/m
BWC Factor = 0.16 dB
Location: -4.2, 4.2, 3.7 mm

Cursor:

ABM2 = -39.36 dBA/m
Location: -4.2, 4.2, 3.7 mm

Cursor:

ABM1/ABM2 = 25.16 dB
ABM1 comp = -14.20 dBA/m
BWC Factor = 0.16 dB
Location: -4.2, 4.2, 3.7 mm

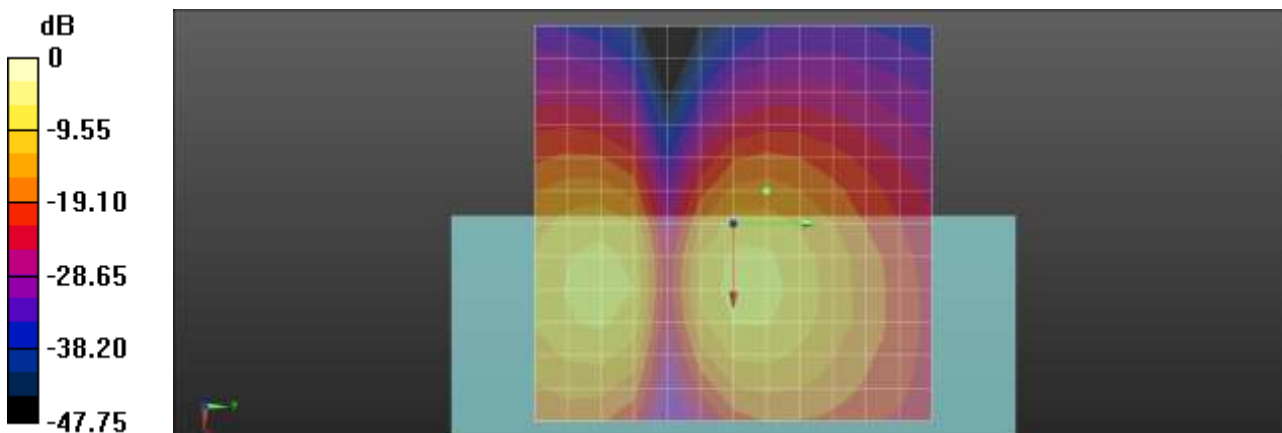

0 dB = 1.000 A/m = 0.00 dBA/m

Plot No.64
802.11a EVS-NB 5.9 54Mbps 120ch z(axial)

Communication System: UID 0, WIFI 5GHz (0); Frequency: 5600 MHz;Duty Cycle: 1:1
Medium parameters used: $\sigma = 0$ S/m, $\epsilon_r = 1$; $\rho = 0$ kg/m³
Phantom section: TCoil Section

DASY5 Configuration:

- Probe: AM1DV3 - 3050; ; Calibrated: 2021-11-23
- Sensor-Surface: 0mm (Fix Surface)
- Electronics: DAE4 Sn1417; Calibrated: 2022-02-24
- Phantom: HAC Test Arch with AMCC
- Measurement SW: DASY52, Version 52.10 (4)

T-Coil scan (scan for ANSI C63.19-2007 & 2011 compliance)/General Scans/z (axial) 4.2mm 50 x 50/ABM Signal(x,y,z) (13x13x1): Measurement grid: dx=10mm, dy=10mm

Signal Type: Audio File (.wav) 48k_voice_1kHz_1s.wav
Output Gain: 16.04
Measure Window Start: 300ms
Measure Window Length: 1000ms
BWC applied: 0.16 dB
Device Reference Point: 0, 0, -6.3 mm

Cursor:

ABM1 comp = -0.41 dBA/m
BWC Factor = 0.16 dB
Location: 8.3, -4.2, 3.7 mm

Cursor:

ABM2 = -25.63 dBA/m
Location: 8.3, -4.2, 3.7 mm

Cursor:

ABM1/ABM2 = 25.22 dB
ABM1 comp = -0.41 dBA/m
BWC Factor = 0.16 dB
Location: 8.3, -4.2, 3.7 mm

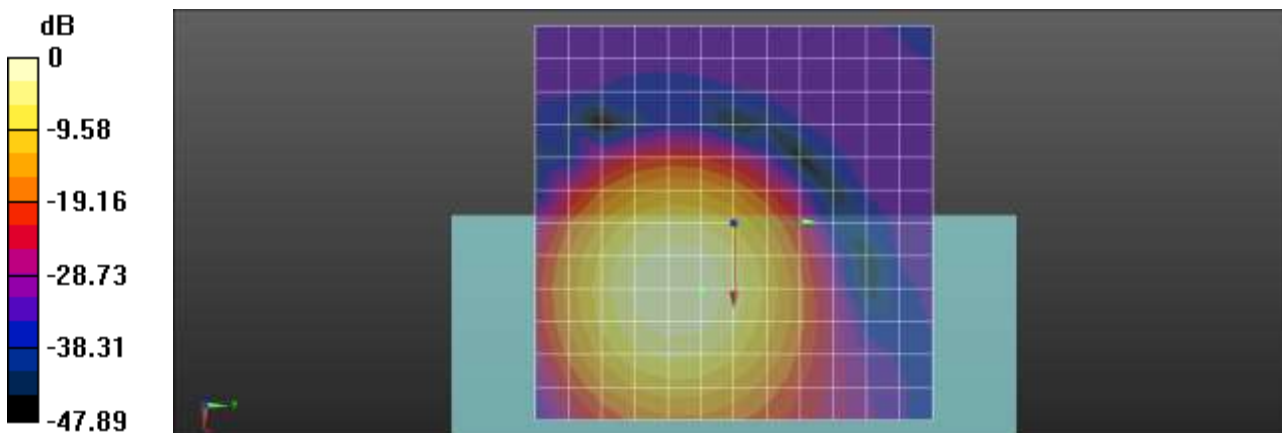

0 dB = 1.000 A/m = 0.00 dBA/m

Plot No.65
802.11a EVS-NB 5.9 54Mbps 120ch Freq.Response

Communication System: UID 0, WIFI 5GHz (0); Frequency: 5600 MHz;Duty Cycle: 1:1
 Medium parameters used: $\sigma = 0$ S/m, $\epsilon_r = 1$; $\rho = 0$ kg/m³
 Phantom section: TCoil Section

T-Coil scan (scan for ANSI C63.19-2007 & 2011 compliance)/General Scans/z (axial) wideband at best S/N/ABM Freq Resp(x,y,z,f) (1x1x1): Measurement grid: dx=10mm, dy=10mm
 Signal Type: Audio File (.wav) 48k_Normal_51s new.wav
 Output Gain: 48.75
 Measure Window Start: 300ms
 Measure Window Length: 51000ms
 BWC applied: 9.48 dB
 Device Reference Point: 0, 0, -6.3 mm

Category	Telephone parameters WD signal quality [(signal+noise)-to-noise ratio in decibels]
Category T1	0 dB to 10 dB
Category T2	10 dB to 20 dB
Category T3	20 dB to 30 dB
Category T4	> 30 dB

Cursor:
 Diff = 2.00 dB
 BWC Factor = 9.48 dB
 Location: 7.5, -4.9, 3.7 mm

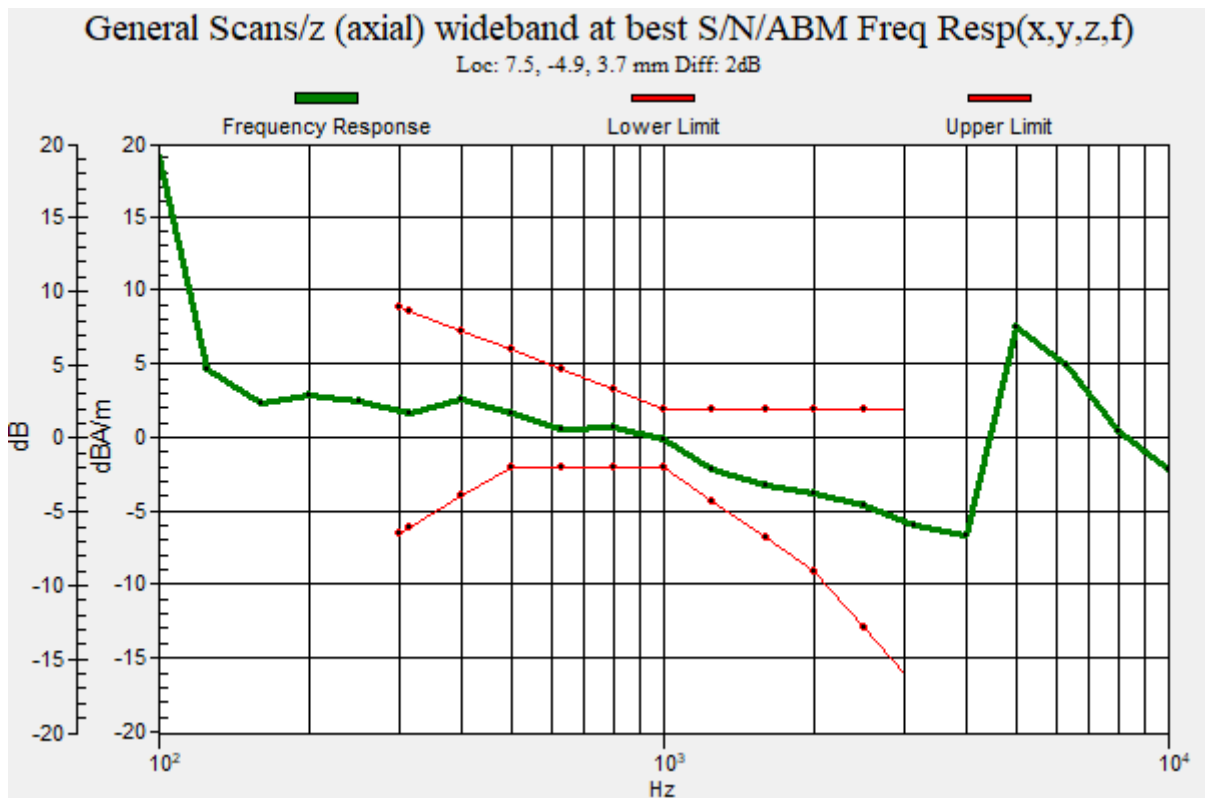

Plot No.66

802.11a EVS-NB 5.9 54Mbps 120ch y(transversal)

Communication System: UID 0, WIFI 5GHz (0); Frequency: 5600 MHz;Duty Cycle: 1:1
Medium parameters used: $\sigma = 0$ S/m, $\epsilon_r = 1$; $\rho = 0$ kg/m³
Phantom section: TCoil Section

DASY5 Configuration:

- Probe: AM1DV3 - 3050; ; Calibrated: 2021-11-23
- Sensor-Surface: 0mm (Fix Surface)
- Electronics: DAE4 Sn1417; Calibrated: 2022-02-24
- Phantom: HAC Test Arch with AMCC
- Measurement SW: DASY52, Version 52.10 (4)

T-Coil scan (scan for ANSI C63.19-2007 & 2011 compliance)/General Scans/y (transversal) 4.2mm 50

x 50/ABM Signal(x,y,z) (13x13x1): Measurement grid: dx=10mm, dy=10mm

Signal Type: Audio File (.wav) 48k_voice_1kHz_1s.wav

Output Gain: 16.04

Measure Window Start: 300ms

Measure Window Length: 1000ms

BWC applied: 0.16 dB

Device Reference Point: 0, 0, -6.3 mm

Cursor:

ABM1 comp = -10.86 dBA/m

BWC Factor = 0.16 dB

Location: 0, 4.2, 3.7 mm

Cursor:

ABM2 = -36.11 dBA/m

Location: 0, 4.2, 3.7 mm

Cursor:

ABM1/ABM2 = 25.25 dB

ABM1 comp = -10.86 dBA/m

BWC Factor = 0.16 dB

Location: 0, 4.2, 3.7 mm

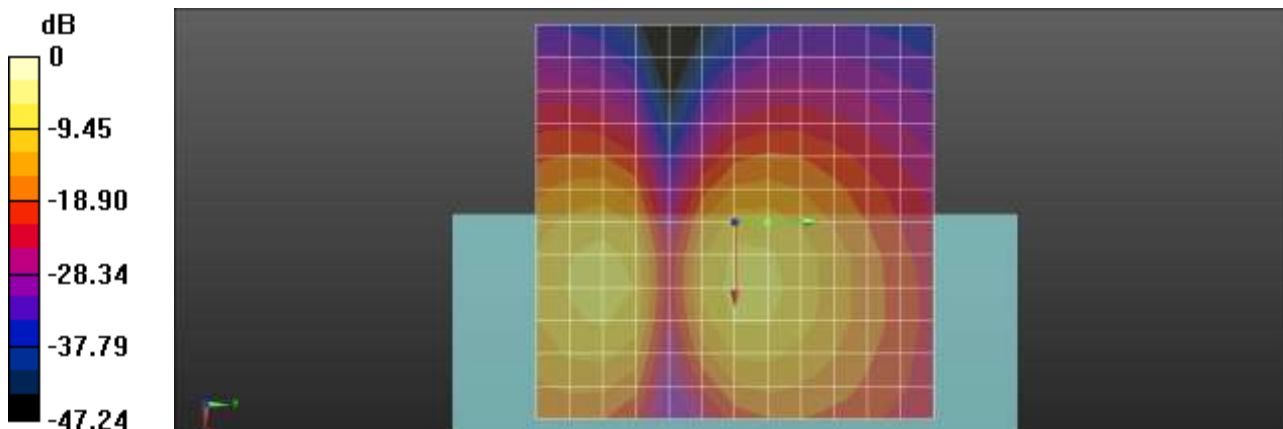

0 dB = 1.000 A/m = 0.00 dBA/m

Plot No.67
802.11a EVS-NB 5.9 54Mbps 157ch z(axial)

Communication System: UID 0, WIFI 5GHz (0); Frequency: 5785 MHz;Duty Cycle: 1:1
Medium parameters used: $\sigma = 0$ S/m, $\epsilon_r = 1$; $\rho = 0$ kg/m³
Phantom section: TCoil Section

DASY5 Configuration:

- Probe: AM1DV3 - 3050; ; Calibrated: 2021-11-23
- Sensor-Surface: 0mm (Fix Surface)
- Electronics: DAE4 Sn1417; Calibrated: 2022-02-24
- Phantom: HAC Test Arch with AMCC
- Measurement SW: DASY52, Version 52.10 (4)

T-Coil scan (scan for ANSI C63.19-2007 & 2011 compliance)/General Scans/z (axial) 4.2mm 50 x 50/ABM Signal(x,y,z) (13x13x1): Measurement grid: dx=10mm, dy=10mm

Signal Type: Audio File (.wav) 48k_voice_1kHz_1s.wav
Output Gain: 16.04
Measure Window Start: 300ms
Measure Window Length: 1000ms
BWC applied: 0.16 dB
Device Reference Point: 0, 0, -6.3 mm

Cursor:

ABM1 comp = -0.39 dBA/m
BWC Factor = 0.16 dB
Location: 8.3, -4.2, 3.7 mm

Cursor:

ABM2 = -25.61 dBA/m
Location: 8.3, -4.2, 3.7 mm

Cursor:

ABM1/ABM2 = 25.22 dB
ABM1 comp = -0.39 dBA/m
BWC Factor = 0.16 dB
Location: 8.3, -4.2, 3.7 mm

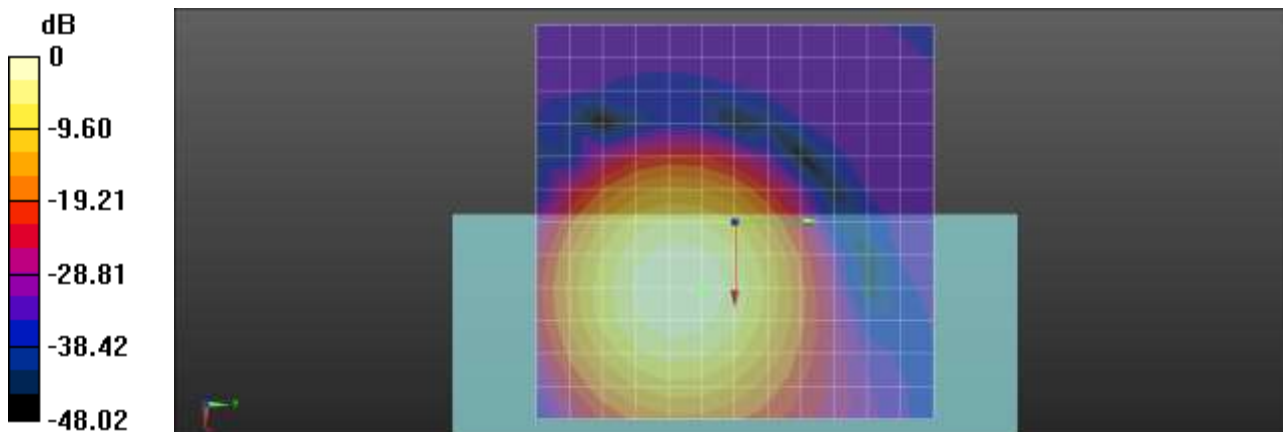

0 dB = 1.000 A/m = 0.00 dBA/m

Plot No.68
802.11a EVS-NB 5.9 54Mbps 157ch Freq.Response

Communication System: UID 0, WIFI 5GHz (0); Frequency: 5785 MHz;Duty Cycle: 1:1
 Medium parameters used: $\sigma = 0$ S/m, $\epsilon_r = 1$; $\rho = 0$ kg/m³
 Phantom section: TCoil Section

T-Coil scan (scan for ANSI C63.19-2007 & 2011 compliance)/General Scans/z (axial) wideband at best S/N/ABM Freq Resp(x,y,z,f) (1x1x1): Measurement grid: dx=10mm, dy=10mm
 Signal Type: Audio File (.wav) 48k_Normal_51s new.wav
 Output Gain: 48.75
 Measure Window Start: 300ms
 Measure Window Length: 51000ms
 BWC applied: 9.48 dB
 Device Reference Point: 0, 0, -6.3 mm

Category	Telephone parameters WD signal quality [(signal+noise)-to-noise ratio in decibels]
Category T1	0 dB to 10 dB
Category T2	10 dB to 20 dB
Category T3	20 dB to 30 dB
Category T4	> 30 dB

Cursor:
 Diff = 2.00 dB
 BWC Factor = 9.48 dB
 Location: 7.3, -5.1, 3.7 mm

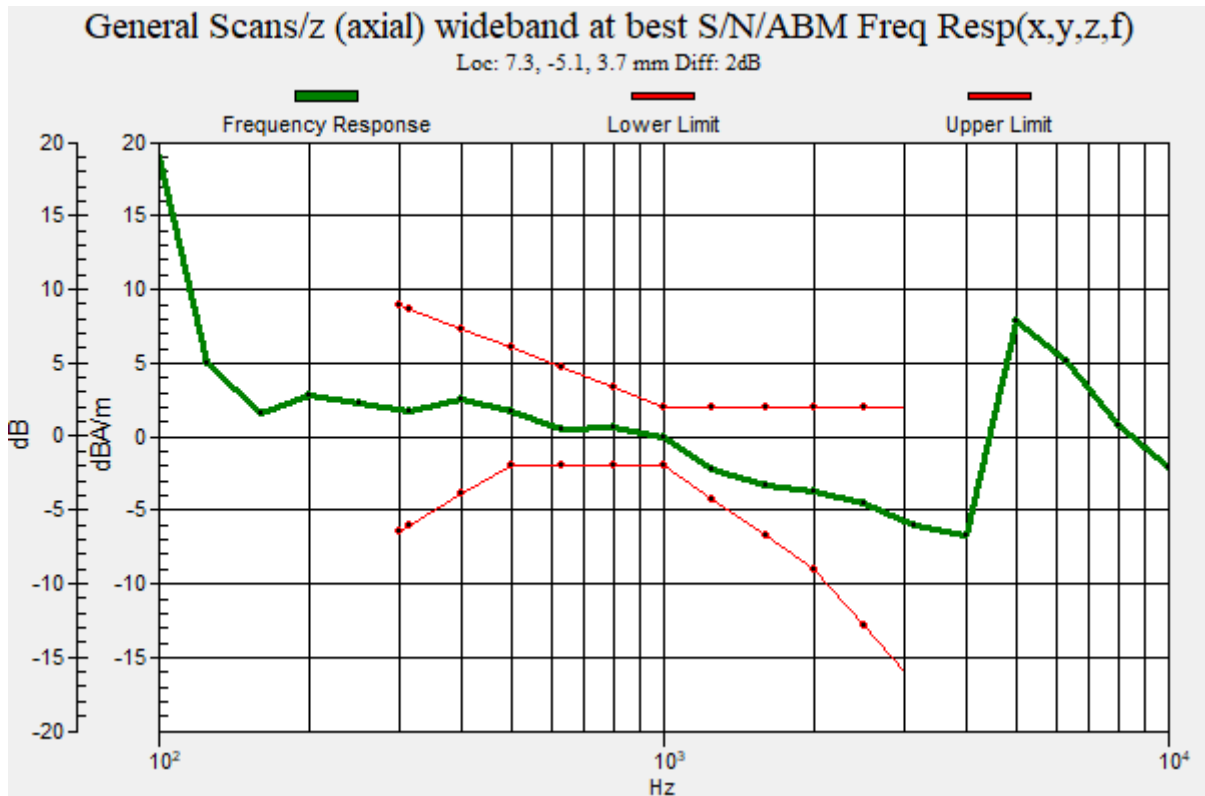

Plot No.69
802.11a EVS-NB 5.9 54Mbps 157ch y(transversal)

Communication System: UID 0, WIFI 5GHz (0); Frequency: 5785 MHz;Duty Cycle: 1:1
Medium parameters used: $\sigma = 0$ S/m, $\epsilon_r = 1$; $\rho = 0$ kg/m³
Phantom section: TCoil Section

DASY5 Configuration:

- Probe: AM1DV3 - 3050; ; Calibrated: 2021-11-23
- Sensor-Surface: 0mm (Fix Surface)
- Electronics: DAE4 Sn1417; Calibrated: 2022-02-24
- Phantom: HAC Test Arch with AMCC
- Measurement SW: DASY52, Version 52.10 (4)

T-Coil scan (scan for ANSI C63.19-2007 & 2011 compliance)/General Scans/y (transversal) 4.2mm 50 x 50/ABM Signal(x,y,z) (13x13x1): Measurement grid: dx=10mm, dy=10mm

Signal Type: Audio File (.wav) 48k_voice_1kHz_1s.wav
Output Gain: 16.04
Measure Window Start: 300ms
Measure Window Length: 1000ms
BWC applied: 0.16 dB
Device Reference Point: 0, 0, -6.3 mm

Cursor:

ABM1 comp = -7.64 dBA/m
BWC Factor = 0.16 dB
Location: 8.3, -16.7, 3.7 mm

Cursor:

ABM2 = -33.39 dBA/m
Location: 8.3, -16.7, 3.7 mm

Cursor:

ABM1/ABM2 = 25.75 dB
ABM1 comp = -7.64 dBA/m
BWC Factor = 0.16 dB
Location: 8.3, -16.7, 3.7 mm

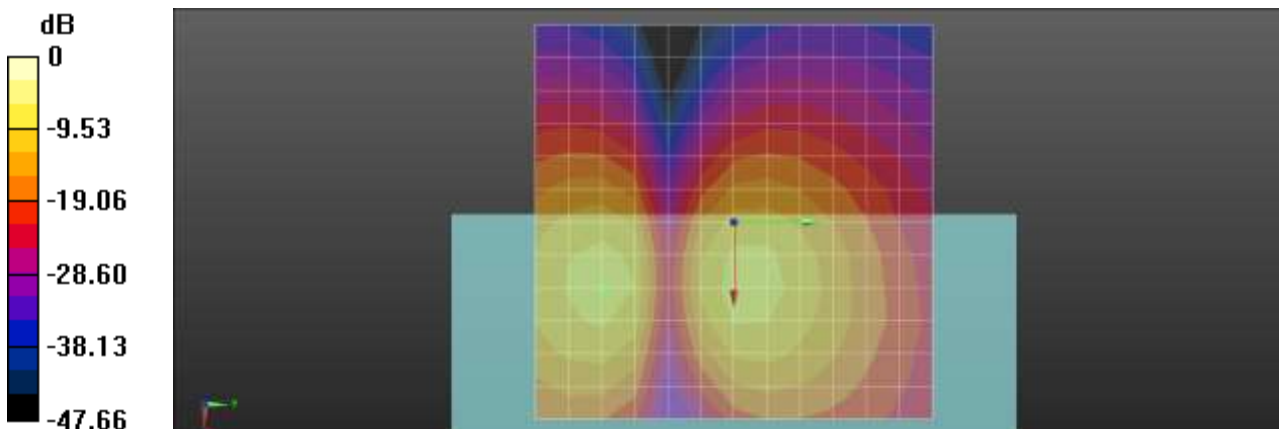

0 dB = 1.000 A/m = 0.00 dBA/m

Plot No.70
802.11a EVS-NB 5.9 54Mbps 36ch z(axial)

Communication System: UID 0, WIFI 5GHz (0); Frequency: 5180 MHz;Duty Cycle: 1:1
Medium parameters used: $\sigma = 0$ S/m, $\epsilon_r = 1$; $\rho = 0$ kg/m³
Phantom section: TCoil Section

DASY5 Configuration:

- Probe: AM1DV3 - 3050; ; Calibrated: 2021-11-23
- Sensor-Surface: 0mm (Fix Surface)
- Electronics: DAE4 Sn1417; Calibrated: 2022-02-24
- Phantom: HAC Test Arch with AMCC
- Measurement SW: DASY52, Version 52.10 (4)

T-Coil scan (scan for ANSI C63.19-2007 & 2011 compliance)/General Scans/z (axial) 4.2mm 50 x 50/ABM Signal(x,y,z) (13x13x1): Measurement grid: dx=10mm, dy=10mm

Signal Type: Audio File (.wav) 48k_voice_1kHz_1s.wav
Output Gain: 16.04
Measure Window Start: 300ms
Measure Window Length: 1000ms
BWC applied: 0.16 dB
Device Reference Point: 0, 0, -6.3 mm

Cursor:

ABM1 comp = -3.20 dBA/m
BWC Factor = 0.16 dB
Location: 12.5, -12.5, 3.7 mm

Cursor:

ABM2 = -27.49 dBA/m
Location: 12.5, -12.5, 3.7 mm

Cursor:

ABM1/ABM2 = 24.29 dB
ABM1 comp = -3.20 dBA/m
BWC Factor = 0.16 dB
Location: 12.5, -12.5, 3.7 mm

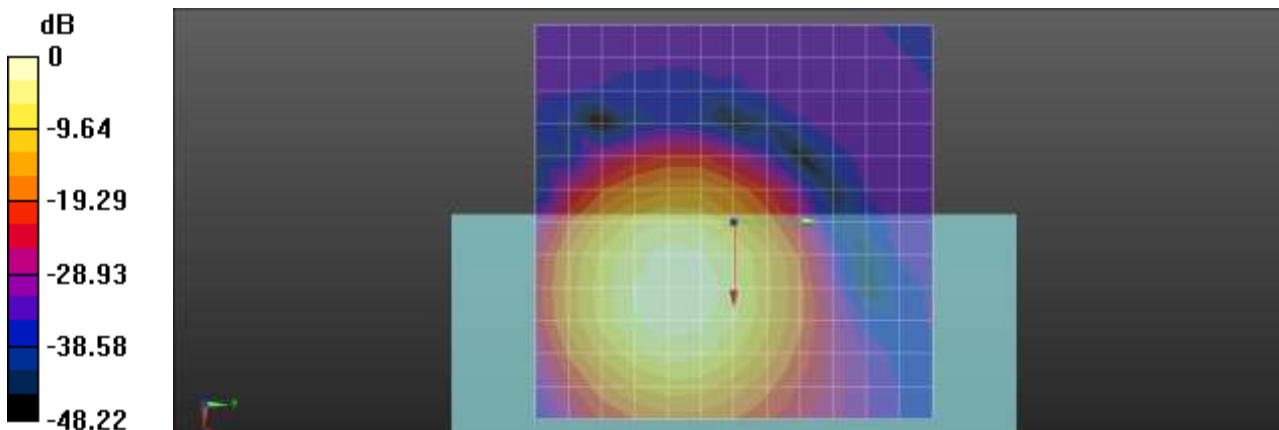

0 dB = 1.000 A/m = 0.00 dBA/m

Plot No.71

802.11a EVS-NB 5.9 54Mbps 36ch Freq.Response

Communication System: UID 0, WIFI 5GHz (0); Frequency: 5180 MHz;Duty Cycle: 1:1
 Medium parameters used: $\sigma = 0$ S/m, $\epsilon_r = 1$; $\rho = 0$ kg/m³
 Phantom section: TCoil Section

T-Coil scan (scan for ANSI C63.19-2007 & 2011 compliance)/General Scans/z (axial) wideband at best

S/N/ABM Freq Resp(x,y,z,f) (1x1x1): Measurement grid: dx=10mm, dy=10mm

Signal Type: Audio File (.wav) 48k_Normal_51s new.wav

Output Gain: 48.75

Measure Window Start: 300ms

Measure Window Length: 51000ms

BWC applied: 9.48 dB

Device Reference Point: 0, 0, -6.3 mm

Category	Telephone parameters WD signal quality [(signal+noise)-to-noise ratio in decibels]
Category T1	0 dB to 10 dB
Category T2	10 dB to 20 dB
Category T3	20 dB to 30 dB
Category T4	> 30 dB

Cursor:

Diff = 2.00 dB

BWC Factor = 9.48 dB

Location: 12.5, -12.7, 3.7 mm

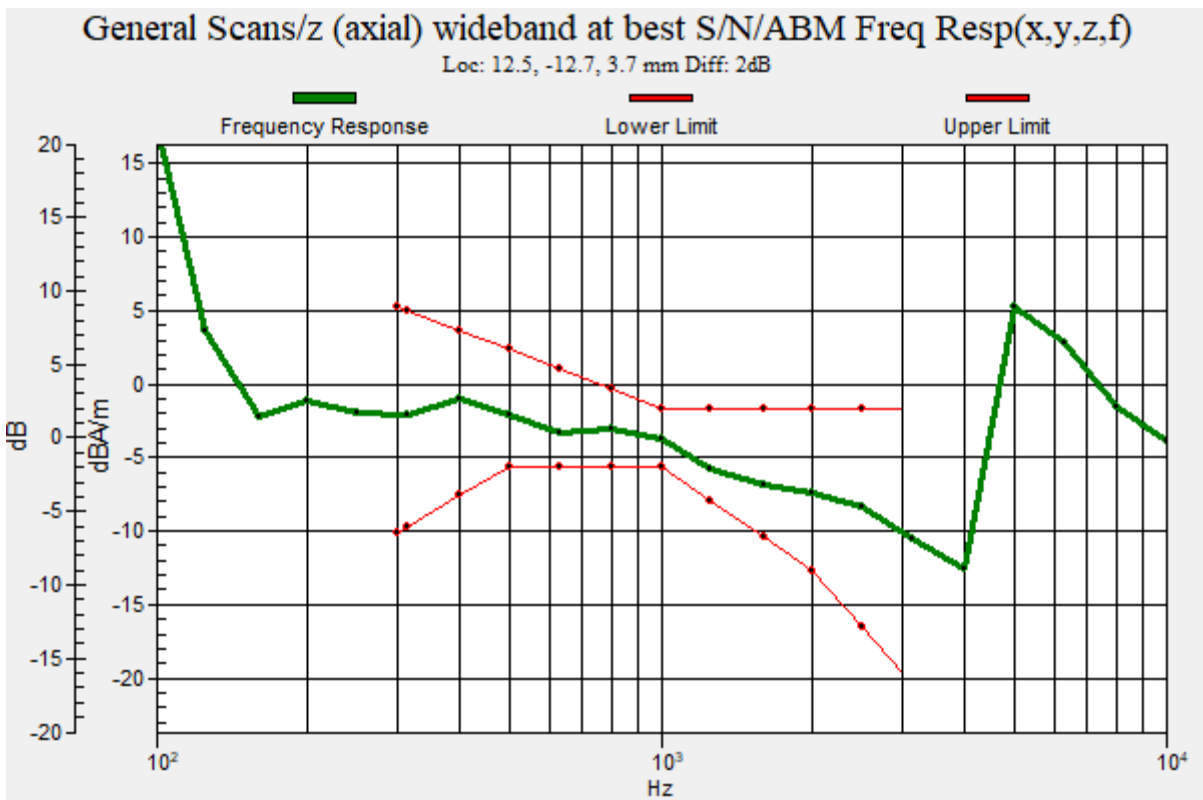

Plot No.72
802.11a EVS-NB 5.9 54Mbps 36ch y(transversal)

Communication System: UID 0, WIFI 5GHz (0); Frequency: 5180 MHz;Duty Cycle: 1:1
Medium parameters used: $\sigma = 0$ S/m, $\epsilon_r = 1$; $\rho = 0$ kg/m³
Phantom section: TCoil Section

DASY5 Configuration:

- Probe: AM1DV3 - 3050; ; Calibrated: 2021-11-23
- Sensor-Surface: 0mm (Fix Surface)
- Electronics: DAE4 Sn1417; Calibrated: 2022-02-24
- Phantom: HAC Test Arch with AMCC
- Measurement SW: DASY52, Version 52.10 (4)

T-Coil scan (scan for ANSI C63.19-2007 & 2011 compliance)/General Scans/y (transversal) 4.2mm 50

x 50/ABM Signal(x,y,z) (13x13x1): Measurement grid: dx=10mm, dy=10mm

Signal Type: Audio File (.wav) 48k_voice_1kHz_1s.wav

Output Gain: 16.04

Measure Window Start: 300ms

Measure Window Length: 1000ms

BWC applied: 0.16 dB

Device Reference Point: 0, 0, -6.3 mm

Cursor:

ABM1 comp = -9.90 dBA/m

BWC Factor = 0.16 dB

Location: 4.2, -20.8, 3.7 mm

Cursor:

ABM2 = -33.83 dBA/m

Location: 4.2, -20.8, 3.7 mm

Cursor:

ABM1/ABM2 = 23.93 dB

ABM1 comp = -9.90 dBA/m

BWC Factor = 0.16 dB

Location: 4.2, -20.8, 3.7 mm

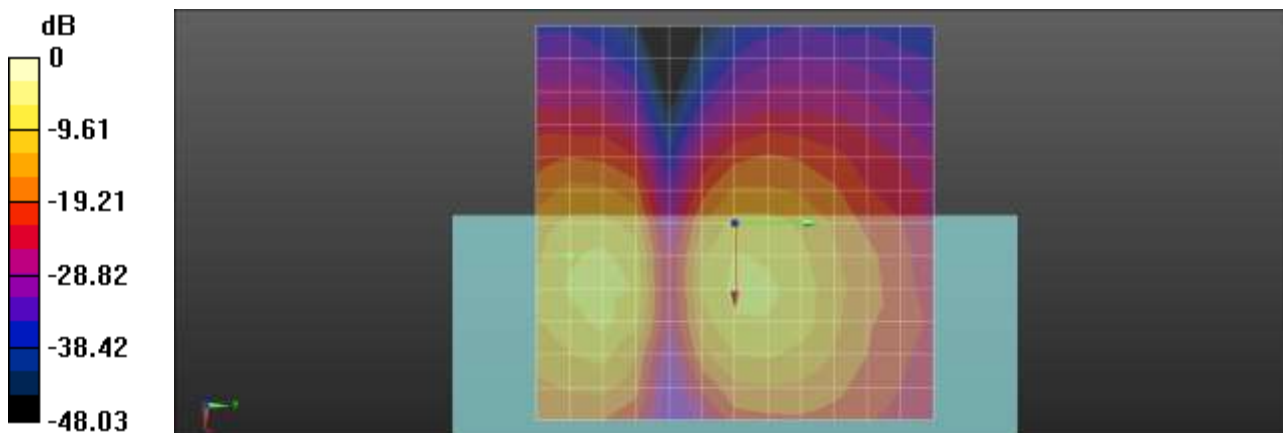

0 dB = 1.000 A/m = 0.00 dBA/m

Plot No.73

802.11a EVS-NB 5.9 54Mbps 48ch z(axial)

Communication System: UID 0, WIFI 5GHz (0); Frequency: 5240 MHz;Duty Cycle: 1:1
Medium parameters used: $\sigma = 0$ S/m, $\epsilon_r = 1$; $\rho = 0$ kg/m³
Phantom section: TCoil Section

DASY5 Configuration:

- Probe: AM1DV3 - 3050; ; Calibrated: 2021-11-23
- Sensor-Surface: 0mm (Fix Surface)
- Electronics: DAE4 Sn1417; Calibrated: 2022-02-24
- Phantom: HAC Test Arch with AMCC
- Measurement SW: DASY52, Version 52.10 (4)

T-Coil scan (scan for ANSI C63.19-2007 & 2011 compliance)/General Scans/z (axial) 4.2mm 50 x

50/ABM Signal(x,y,z) (13x13x1): Measurement grid: dx=10mm, dy=10mm

Signal Type: Audio File (.wav) 48k_voice_1kHz_1s.wav

Output Gain: 16.04

Measure Window Start: 300ms

Measure Window Length: 1000ms

BWC applied: 0.16 dB

Device Reference Point: 0, 0, -6.3 mm

Cursor:

ABM1 comp = -4.06 dBA/m

BWC Factor = 0.16 dB

Location: 8.3, 0, 3.7 mm

Cursor:

ABM2 = -28.16 dBA/m

Location: 8.3, 0, 3.7 mm

Cursor:

ABM1/ABM2 = 24.09 dB

ABM1 comp = -4.06 dBA/m

BWC Factor = 0.16 dB

Location: 8.3, 0, 3.7 mm

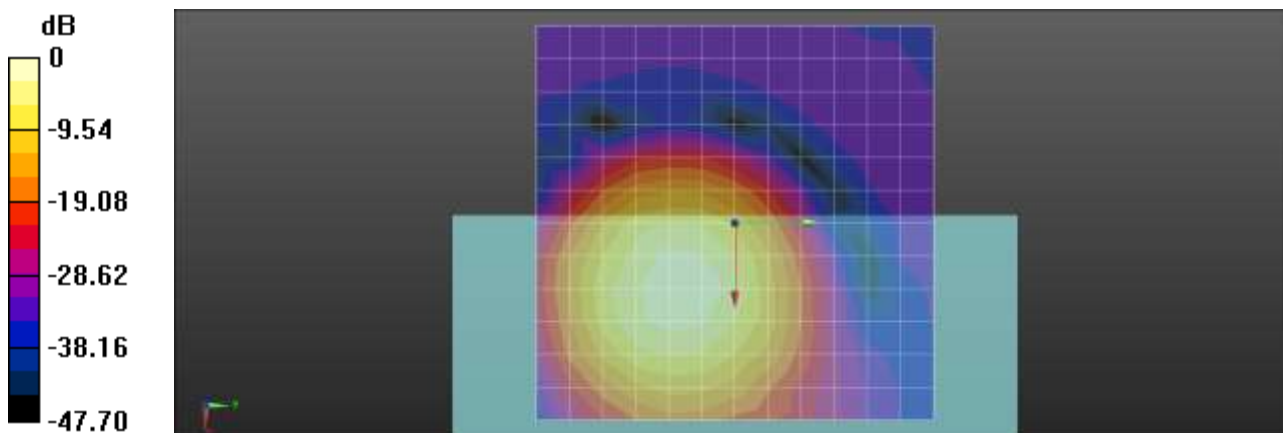

0 dB = 1.000 A/m = 0.00 dBA/m

Plot No.74
802.11a EVS-NB 5.9 54Mbps 48ch Freq.Response

Communication System: UID 0, WIFI 5GHz (0); Frequency: 5240 MHz;Duty Cycle: 1:1
 Medium parameters used: $\sigma = 0$ S/m, $\epsilon_r = 1$; $\rho = 0$ kg/m³
 Phantom section: TCoil Section

T-Coil scan (scan for ANSI C63.19-2007 & 2011 compliance)/General Scans/z (axial) wideband at best S/N/ABM Freq Resp(x,y,z,f) (1x1x1): Measurement grid: dx=10mm, dy=10mm
 Signal Type: Audio File (.wav) 48k_Normal_51s new.wav
 Output Gain: 48.75
 Measure Window Start: 300ms
 Measure Window Length: 51000ms
 BWC applied: 9.48 dB
 Device Reference Point: 0, 0, -6.3 mm

Category	Telephone parameters WD signal quality [(signal+noise)-to-noise ratio in decibels]
Category T1	0 dB to 10 dB
Category T2	10 dB to 20 dB
Category T3	20 dB to 30 dB
Category T4	> 30 dB

Cursor:
 Diff = 2.00 dB
 BWC Factor = 9.48 dB
 Location: 8, -0.5, 3.7 mm

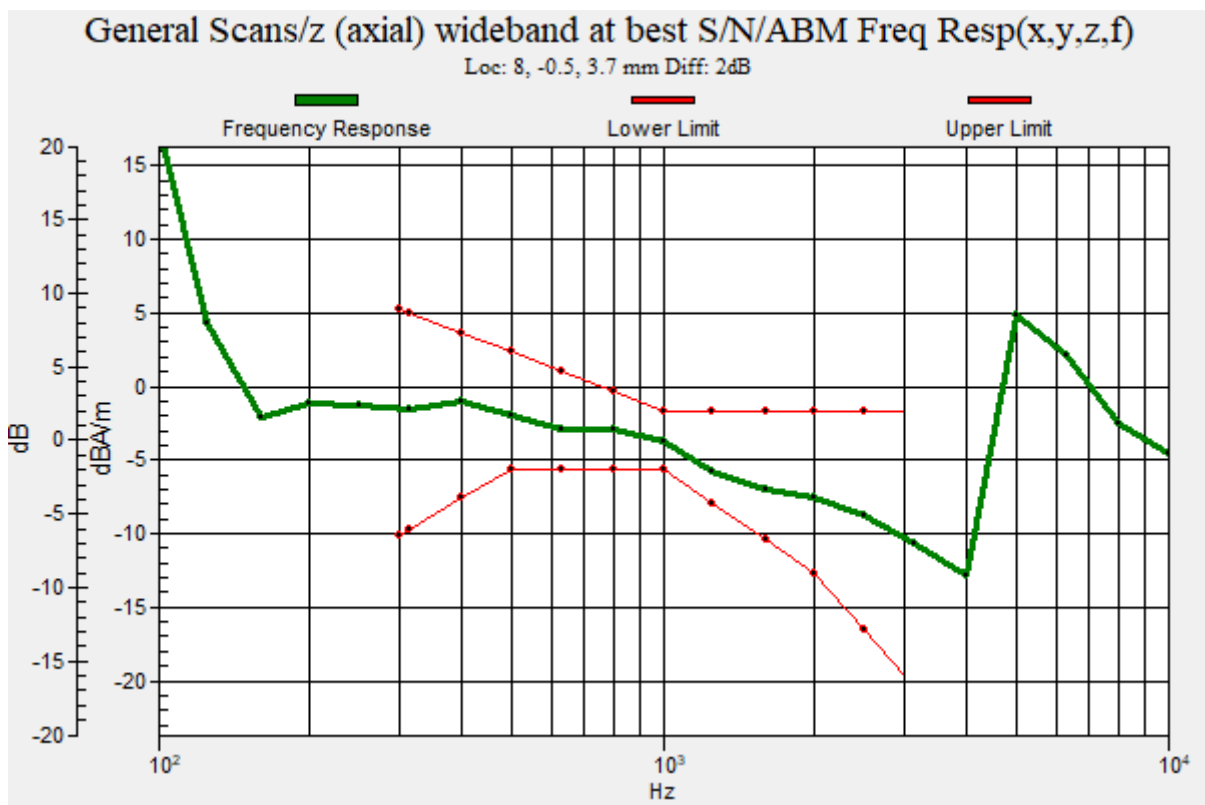

Plot No.75
802.11a EVS-NB 5.9 54Mbps 48ch y(transversal)

Communication System: UID 0, WIFI 5GHz (0); Frequency: 5240 MHz;Duty Cycle: 1:1
Medium parameters used: $\sigma = 0$ S/m, $\epsilon_r = 1$; $\rho = 0$ kg/m³
Phantom section: TCoil Section

DASY5 Configuration:

- Probe: AM1DV3 - 3050; ; Calibrated: 2021-11-23
- Sensor-Surface: 0mm (Fix Surface)
- Electronics: DAE4 Sn1417; Calibrated: 2022-02-24
- Phantom: HAC Test Arch with AMCC
- Measurement SW: DASY52, Version 52.10 (4)

T-Coil scan (scan for ANSI C63.19-2007 & 2011 compliance)/General Scans/y (transversal) 4.2mm 50 x 50/ABM Signal(x,y,z) (13x13x1): Measurement grid: dx=10mm, dy=10mm

Signal Type: Audio File (.wav) 48k_voice_1kHz_1s.wav
Output Gain: 16.04
Measure Window Start: 300ms
Measure Window Length: 1000ms
BWC applied: 0.16 dB
Device Reference Point: 0, 0, -6.3 mm

Cursor:

ABM1 comp = -10.01 dBA/m
BWC Factor = 0.16 dB
Location: 4.2, -12.5, 3.7 mm

Cursor:

ABM2 = -34.43 dBA/m
Location: 4.2, -12.5, 3.7 mm

Cursor:

ABM1/ABM2 = 24.41 dB
ABM1 comp = -10.01 dBA/m
BWC Factor = 0.16 dB
Location: 4.2, -12.5, 3.7 mm

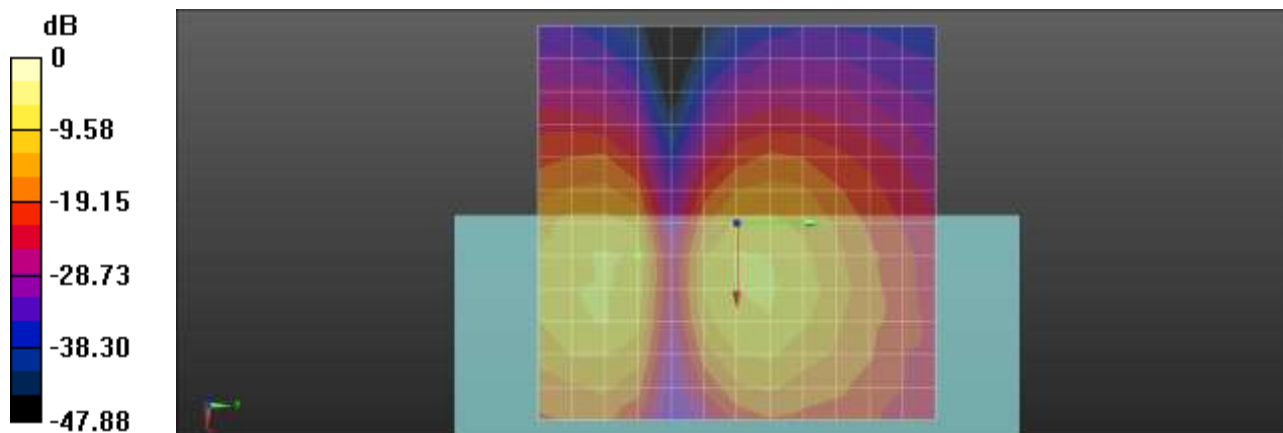

0 dB = 1.000 A/m = 0.00 dBA/m

Plot No.76

GSM850 251ch EDGE 2Tx bitrate 40 kbits z(axial)

Communication System: UID 0, GSM850 GPRS 2TX (0); Frequency: 848.8 MHz;Duty Cycle: 1:4.14954
Medium parameters used: $\sigma = 0$ S/m, $\epsilon_r = 1$; $\rho = 0$ kg/m³
Phantom section: TCoil Section

DASY5 Configuration:

- Probe: AM1DV3 - 3049; ; Calibrated: 2021-06-01
- Sensor-Surface: 0mm (Fix Surface)
- Electronics: DAE4 Sn652; Calibrated: 2022-01-24
- Phantom: HAC Test Arch with AMCC TCOIL
- Measurement SW: DASY52, Version 52.10 (4)

T-Coil scan (scan for ANSI C63.19-2007 & 2011 compliance)/General Scans/z (axial) 4.2mm 50 x 50/ABM Signal(x,y,z) (13x13x1): Measurement grid: dx=10mm, dy=10mm

Signal Type: Audio File (.wav) 48k_voice_1kHz_1s.wav
Output Gain: 19.15
Measure Window Start: 300ms
Measure Window Length: 3000ms
BWC applied: -0.18 dB
Device Reference Point: 0, 0, -6.3 mm

Cursor:

ABM1 comp = -1.93 dBA/m
BWC Factor = -0.18 dB
Location: 8.3, -12.5, 3.7 mm

Cursor:

ABM2 = -34.53 dBA/m
Location: 8.3, -12.5, 3.7 mm

Cursor:

ABM1/ABM2 = 32.59 dB
ABM1 comp = -1.93 dBA/m
BWC Factor = -0.18 dB
Location: 8.3, -12.5, 3.7 mm

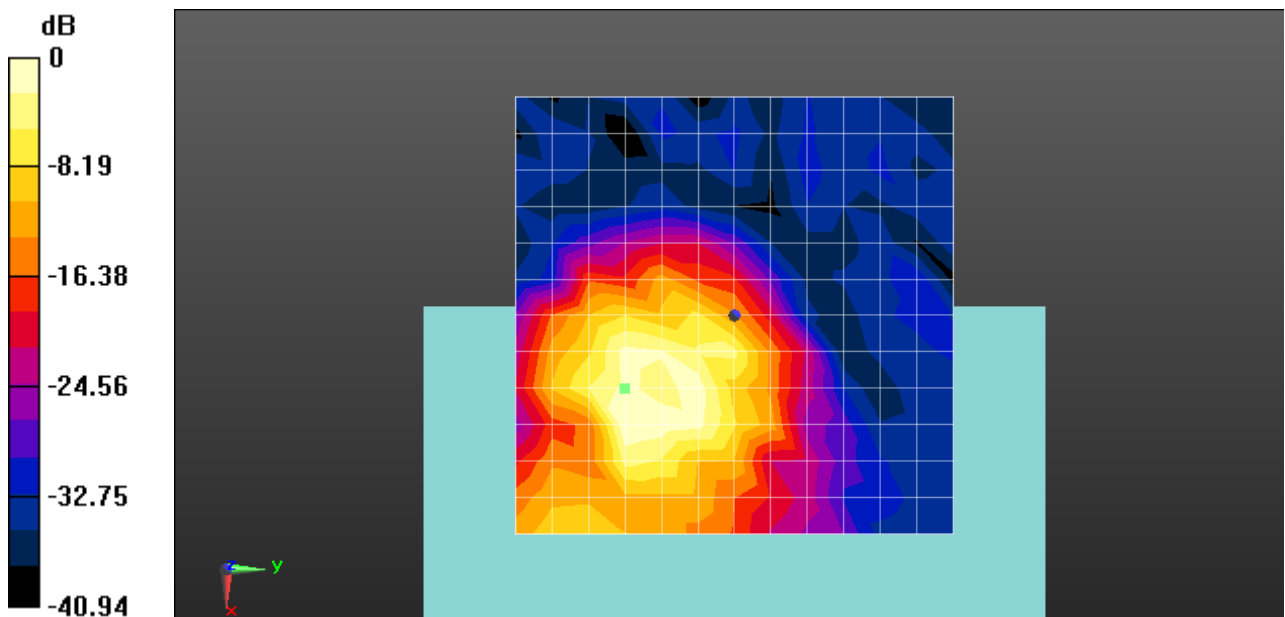

0 dB = 1.000 A/m = 0.00 dBA/m

Plot No.77
GSM850 251ch EDGE 2Tx bitrate 40 kbits Freq.Response

Communication System: UID 0, GSM850 GPRS 2TX (0); Frequency: 848.8 MHz;Duty Cycle: 1:4.14954
 Medium parameters used: $\sigma = 0$ S/m, $\epsilon_r = 1$; $\rho = 0$ kg/m³
 Phantom section: TCoil Section

T-Coil scan (scan for ANSI C63.19-2007 & 2011 compliance)/General Scans/z (axial) wideband at best S/N/ABM Freq Resp(x,y,z,f) (1x1x1): Measurement grid: dx=10mm, dy=10mm
 Signal Type: Audio File (.wav) 48k_Normal_51s new.wav
 Output Gain: 58.25
 Measure Window Start: 300ms
 Measure Window Length: 51000ms
 BWC applied: 9.14 dB
 Device Reference Point: 0, 0, -6.3 mm

Category	Telephone parameters WD signal quality [(signal+noise)-to-noise ratio in decibels]
Category T1	0 dB to 10 dB
Category T2	10 dB to 20 dB
Category T3	20 dB to 30 dB
Category T4	> 30 dB

Cursor:
 Diff = 1.62 dB
 BWC Factor = 9.14 dB
 Location: 8, -12.3, 3.7 mm

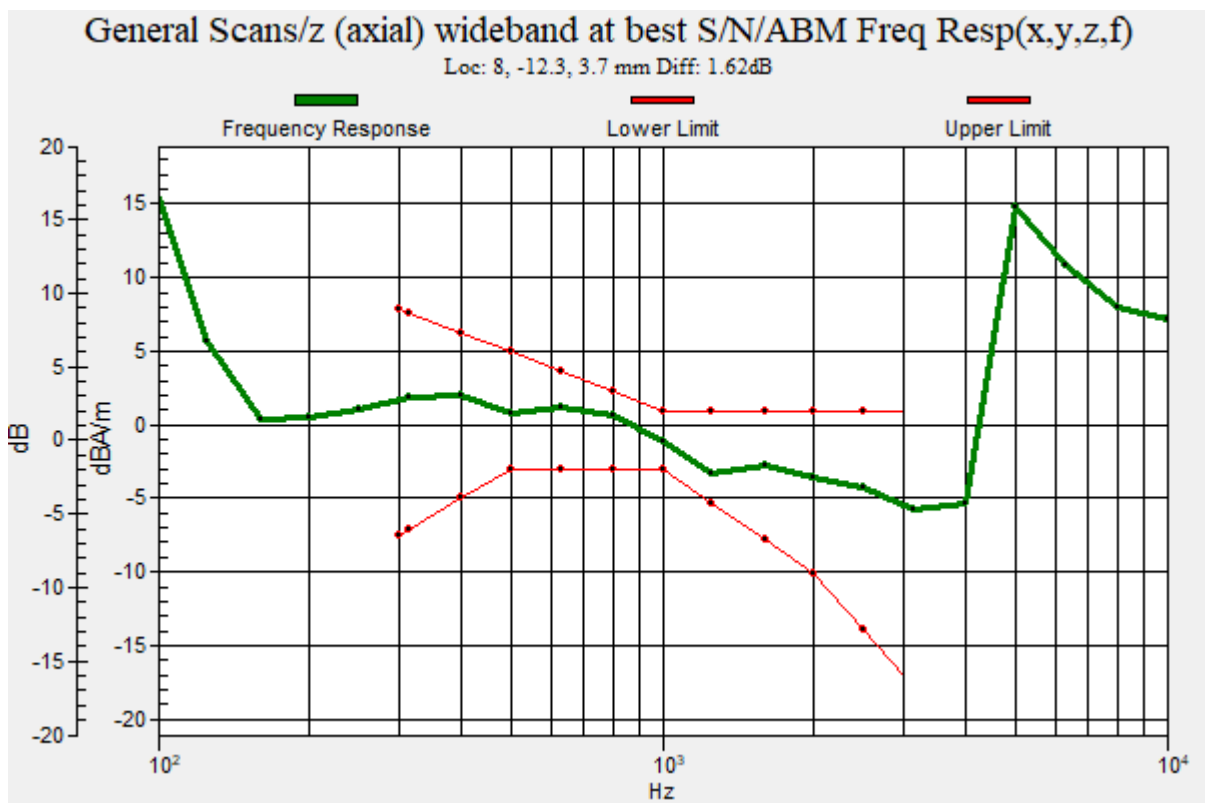

Plot No.78
GSM850 251ch EDGE 2Tx bitrate 40 kbits y(transversal)

Communication System: UID 0, GSM850 GPRS 2TX (0); Frequency: 848.8 MHz;Duty Cycle: 1:4.14954
Medium parameters used: $\sigma = 0$ S/m, $\epsilon_r = 1$; $\rho = 0$ kg/m³
Phantom section: TCoil Section

DASY5 Configuration:

- Probe: AM1DV3 - 3049; ; Calibrated: 2021-06-01
- Sensor-Surface: 0mm (Fix Surface)
- Electronics: DAE4 Sn652; Calibrated: 2022-01-24
- Phantom: HAC Test Arch with AMCC TCOIL
- Measurement SW: DASY52, Version 52.10 (4)

T-Coil scan (scan for ANSI C63.19-2007 & 2011 compliance)/General Scans/y (transversal) 4.2mm 50 x 50/ABM Signal(x,y,z) (13x13x1): Measurement grid: dx=10mm, dy=10mm

Signal Type: Audio File (.wav) 48k_voice_1kHz_1s.wav
Output Gain: 19.15
Measure Window Start: 300ms
Measure Window Length: 3000ms
BWC applied: -0.18 dB
Device Reference Point: 0, 0, -6.3 mm

Cursor:

ABM1 comp = -13.11 dBA/m
BWC Factor = -0.18 dB
Location: 0, -12.5, 3.7 mm

Cursor:

ABM2 = -40.94 dBA/m
Location: 0, -12.5, 3.7 mm

Cursor:

ABM1/ABM2 = 27.83 dB
ABM1 comp = -13.11 dBA/m
BWC Factor = -0.18 dB
Location: 0, -12.5, 3.7 mm

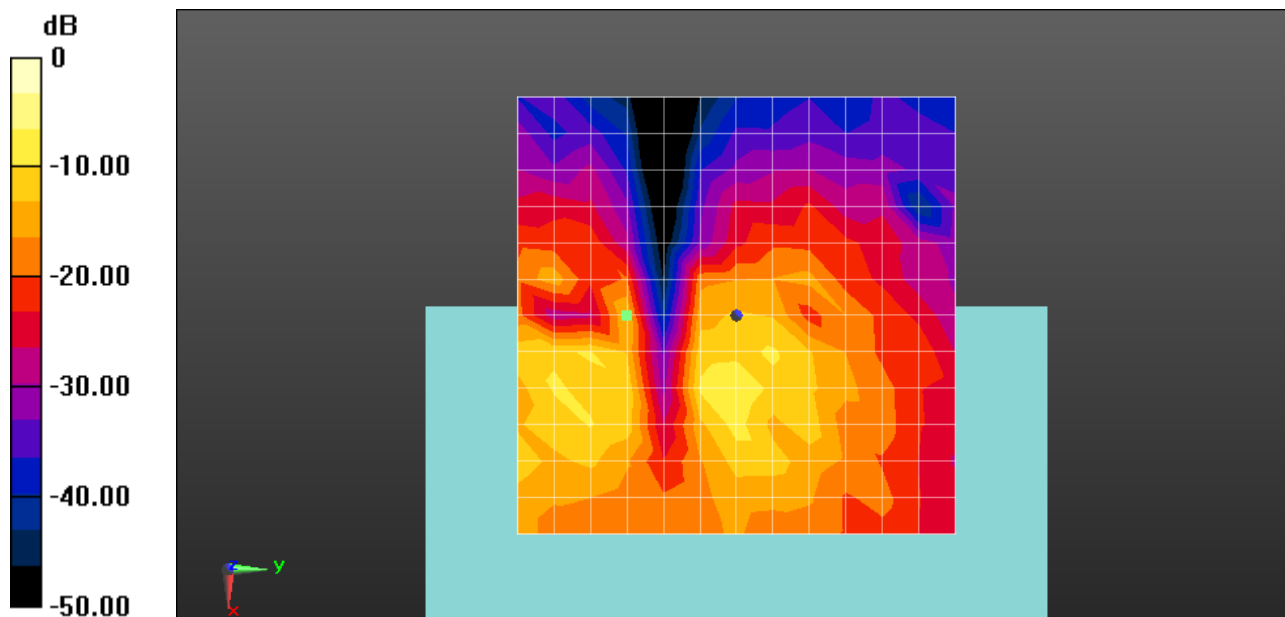

0 dB = 1.000 A/m = 0.00 dBA/m

Plot No.79
GSM1900 661ch EDGE 2Tx bitrate 40 kbits z(axial)

Communication System: UID 0, GSM 1900 2TX (0); Frequency: 1880 MHz;Duty Cycle: 1:4.14954
Medium parameters used: $\sigma = 0$ S/m, $\epsilon_r = 1$; $\rho = 0$ kg/m³
Phantom section: TCoil Section

DASY5 Configuration:

- Probe: AM1DV3 - 3049; ; Calibrated: 2021-06-01
- Sensor-Surface: 0mm (Fix Surface)
- Electronics: DAE4 Sn652; Calibrated: 2022-01-24
- Phantom: HAC Test Arch with AMCC TCOIL
- Measurement SW: DASY52, Version 52.10 (4)

T-Coil scan (scan for ANSI C63.19-2007 & 2011 compliance)/General Scans/z (axial) 4.2mm 50 x 50/ABM Signal(x,y,z) (13x13x1): Measurement grid: dx=10mm, dy=10mm

Signal Type: Audio File (.wav) 48k_voice_1kHz_1s.wav
Output Gain: 19.15
Measure Window Start: 300ms
Measure Window Length: 3000ms
BWC applied: -0.18 dB
Device Reference Point: 0, 0, -6.3 mm

Cursor:

ABM1 comp = -0.22 dBA/m
BWC Factor = -0.18 dB
Location: 4.2, -8.3, 3.7 mm

Cursor:

ABM2 = -35.24 dBA/m
Location: 4.2, -8.3, 3.7 mm

Cursor:

ABM1/ABM2 = 35.01 dB
ABM1 comp = -0.22 dBA/m
BWC Factor = -0.18 dB
Location: 4.2, -8.3, 3.7 mm

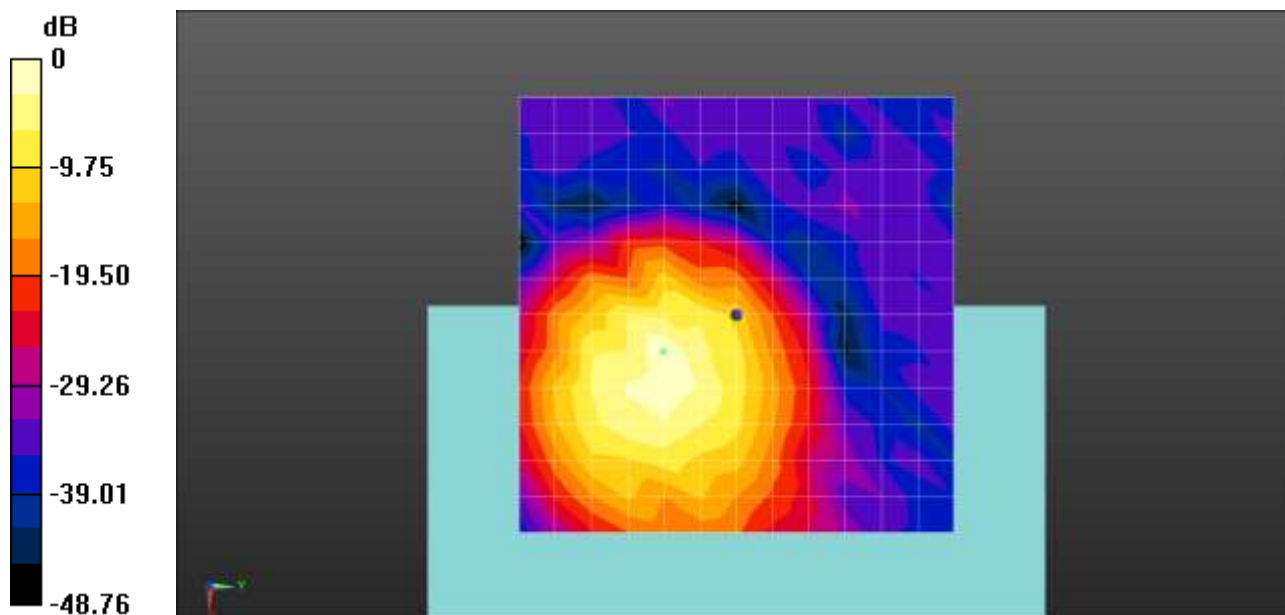

0 dB = 1.000 A/m = 0.00 dBA/m

Plot No.80
GSM1900 661ch EDGE 2Tx bitrate 40 kbits Freq.Response

Communication System: UID 0, GSM 1900 2TX (0); Frequency: 1880 MHz;Duty Cycle: 1:4.14954
 Medium parameters used: $\sigma = 0$ S/m, $\epsilon_r = 1$; $\rho = 0$ kg/m³
 Phantom section: TCoil Section

T-Coil scan (scan for ANSI C63.19-2007 & 2011 compliance)/General Scans/z (axial) wideband at best S/N/ABM Freq Resp(x,y,z,f) (1x1x1): Measurement grid: dx=10mm, dy=10mm
 Signal Type: Audio File (.wav) 48k_Normal_51s new.wav
 Output Gain: 58.25
 Measure Window Start: 300ms
 Measure Window Length: 51000ms
 BWC applied: 9.14 dB
 Device Reference Point: 0, 0, -6.3 mm

Category	Telephone parameters WD signal quality [(signal+noise)-to-noise ratio in decibels]
Category T1	0 dB to 10 dB
Category T2	10 dB to 20 dB
Category T3	20 dB to 30 dB
Category T4	> 30 dB

Cursor:
 Diff = 1.63 dB
 BWC Factor = 9.14 dB
 Location: 4.5, -8.3, 3.7 mm

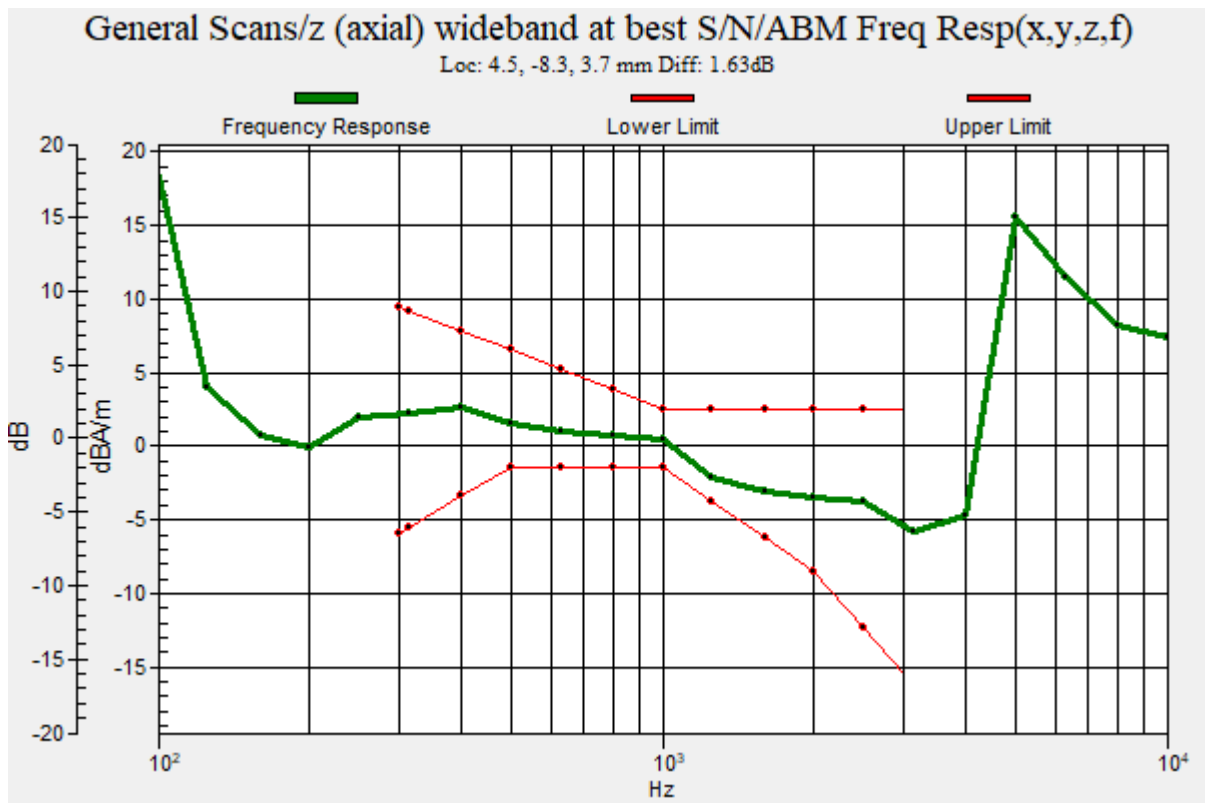

Plot No.81
GSM1900 661ch EDGE 2Tx bitrate 40 kbits y(transversal)

Communication System: UID 0, GSM 1900 2TX (0); Frequency: 1880 MHz;Duty Cycle: 1:4.14954
Medium parameters used: $\sigma = 0$ S/m, $\epsilon_r = 1$; $\rho = 0$ kg/m³
Phantom section: TCoil Section

DASY5 Configuration:

- Probe: AM1DV3 - 3049; ; Calibrated: 2021-06-01
- Sensor-Surface: 0mm (Fix Surface)
- Electronics: DAE4 Sn652; Calibrated: 2022-01-24
- Phantom: HAC Test Arch with AMCC TCOIL
- Measurement SW: DASY52, Version 52.10 (4)

T-Coil scan (scan for ANSI C63.19-2007 & 2011 compliance)/General Scans/y (transversal) 4.2mm 50 x 50/ABM Signal(x,y,z) (13x13x1): Measurement grid: dx=10mm, dy=10mm

Signal Type: Audio File (.wav) 48k_voice_1kHz_1s.wav
Output Gain: 19.15
Measure Window Start: 300ms
Measure Window Length: 3000ms
BWC applied: -0.18 dB
Device Reference Point: 0, 0, -6.3 mm

Cursor:

ABM1 comp = -11.97 dBA/m
BWC Factor = -0.18 dB
Location: 0, 4.2, 3.7 mm

Cursor:

ABM2 = -45.62 dBA/m
Location: 0, 4.2, 3.7 mm

Cursor:

ABM1/ABM2 = 33.65 dB
ABM1 comp = -11.97 dBA/m
BWC Factor = -0.18 dB
Location: 0, 4.2, 3.7 mm

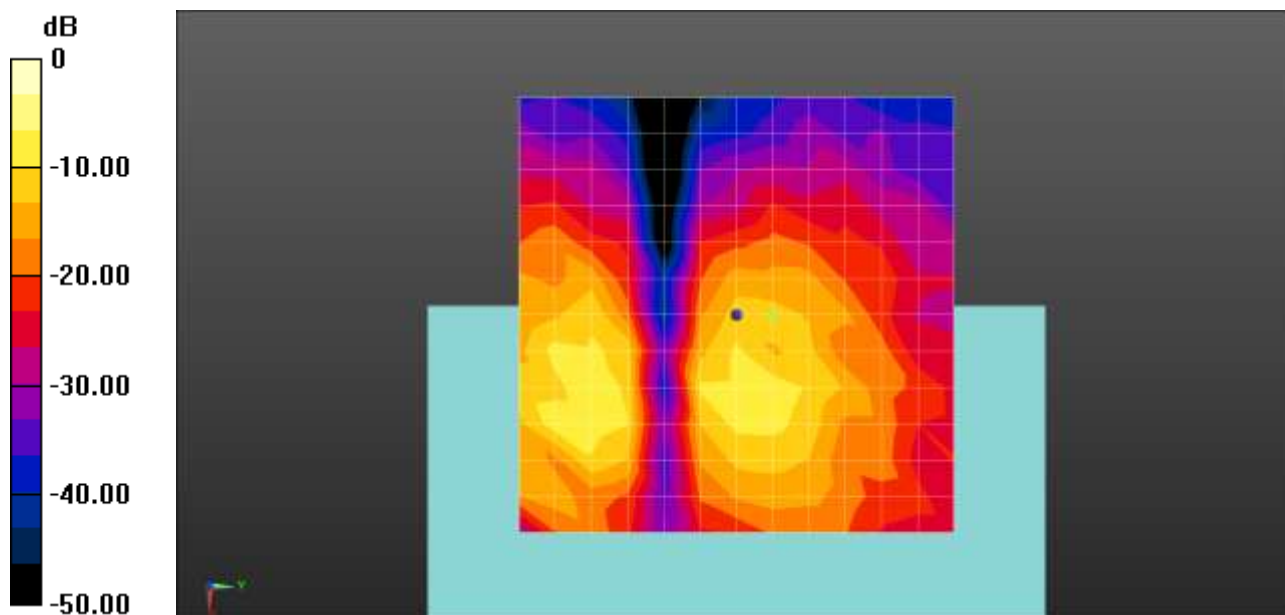

0 dB = 1.000 A/m = 0.00 dBA/m

Plot No.82
UMTS Band 2 9400ch bitrate 75 kbits z(axial)

Communication System: UID 0, UMTS1900 (0); Frequency: 1880 MHz;Duty Cycle: 1:1
Medium parameters used: $\sigma = 0$ S/m, $\epsilon_r = 1$; $\rho = 0$ kg/m³
Phantom section: TCoil Section

DASY5 Configuration:

- Probe: AM1DV3 - 3049; ; Calibrated: 2021-06-01
- Sensor-Surface: 0mm (Fix Surface)
- Electronics: DAE4 Sn652; Calibrated: 2022-01-24
- Phantom: HAC Test Arch with AMCC TCOIL
- Measurement SW: DASY52, Version 52.10 (4)

T-Coil scan (scan for ANSI C63.19-2007 & 2011 compliance)/General Scans/z (axial) 4.2mm 50 x 50/ABM Signal(x,y,z) (13x13x1): Measurement grid: dx=10mm, dy=10mm

Signal Type: Audio File (.wav) 48k_voice_1kHz_1s.wav
Output Gain: 19.15
Measure Window Start: 300ms
Measure Window Length: 1000ms
BWC applied: -0.18 dB
Device Reference Point: 0, 0, -6.3 mm

Cursor:

ABM1 comp = -4.01 dBA/m
BWC Factor = -0.18 dB
Location: 0, -8.3, 3.7 mm

Cursor:

ABM2 = -38.48 dBA/m
Location: 0, -8.3, 3.7 mm

Cursor:

ABM1/ABM2 = 34.47 dB
ABM1 comp = -4.01 dBA/m
BWC Factor = -0.18 dB
Location: 0, -8.3, 3.7 mm

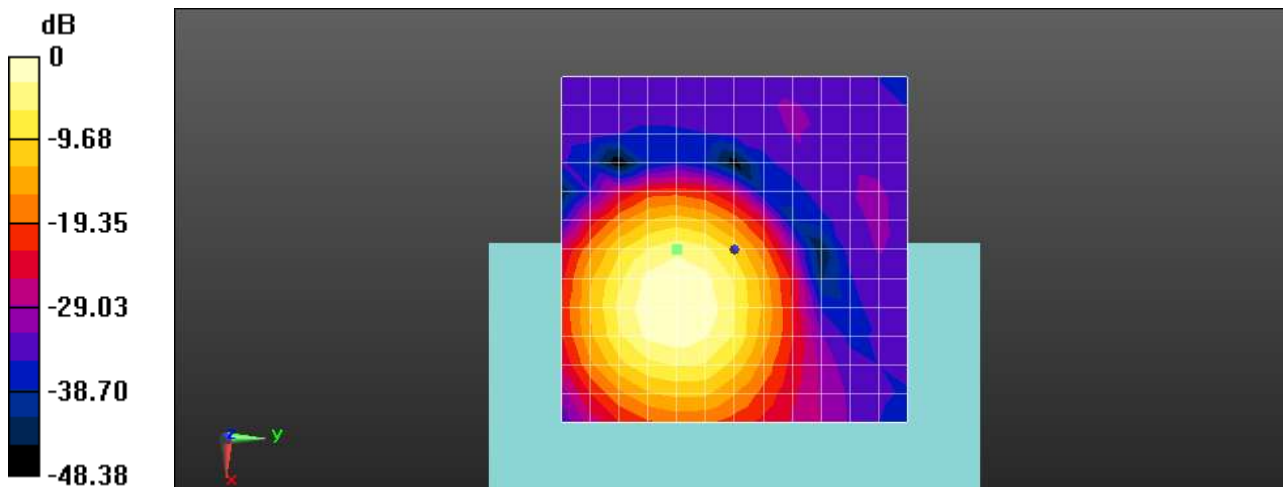

0 dB = 1.000 A/m = 0.00 dBA/m

Plot No.83
UMTS Band 2 9400ch bitrate 75 kbits Freq.Response

Communication System: UID 0, UMTS1900 (0); Frequency: 1880 MHz;Duty Cycle: 1:1
 Medium parameters used: $\sigma = 0$ S/m, $\epsilon_r = 1$; $\rho = 0$ kg/m³
 Phantom section: TCoil Section

T-Coil scan (scan for ANSI C63.19-2007 & 2011 compliance)/General Scans/z (axial) wideband at best S/N/ABM Freq Resp(x,y,z,f) (1x1x1): Measurement grid: dx=10mm, dy=10mm
 Signal Type: Audio File (.wav) 48k_Normal_51s new.wav
 Output Gain: 58.25
 Measure Window Start: 300ms
 Measure Window Length: 51000ms
 BWC applied: 9.14 dB
 Device Reference Point: 0, 0, -6.3 mm

Category	Telephone parameters WD signal quality [(signal+noise)-to-noise ratio in decibels]
Category T1	0 dB to 10 dB
Category T2	10 dB to 20 dB
Category T3	20 dB to 30 dB
Category T4	> 30 dB

Cursor:
 Diff = 2.00 dB
 BWC Factor = 9.14 dB
 Location: 0.5, -6.6, 3.7 mm

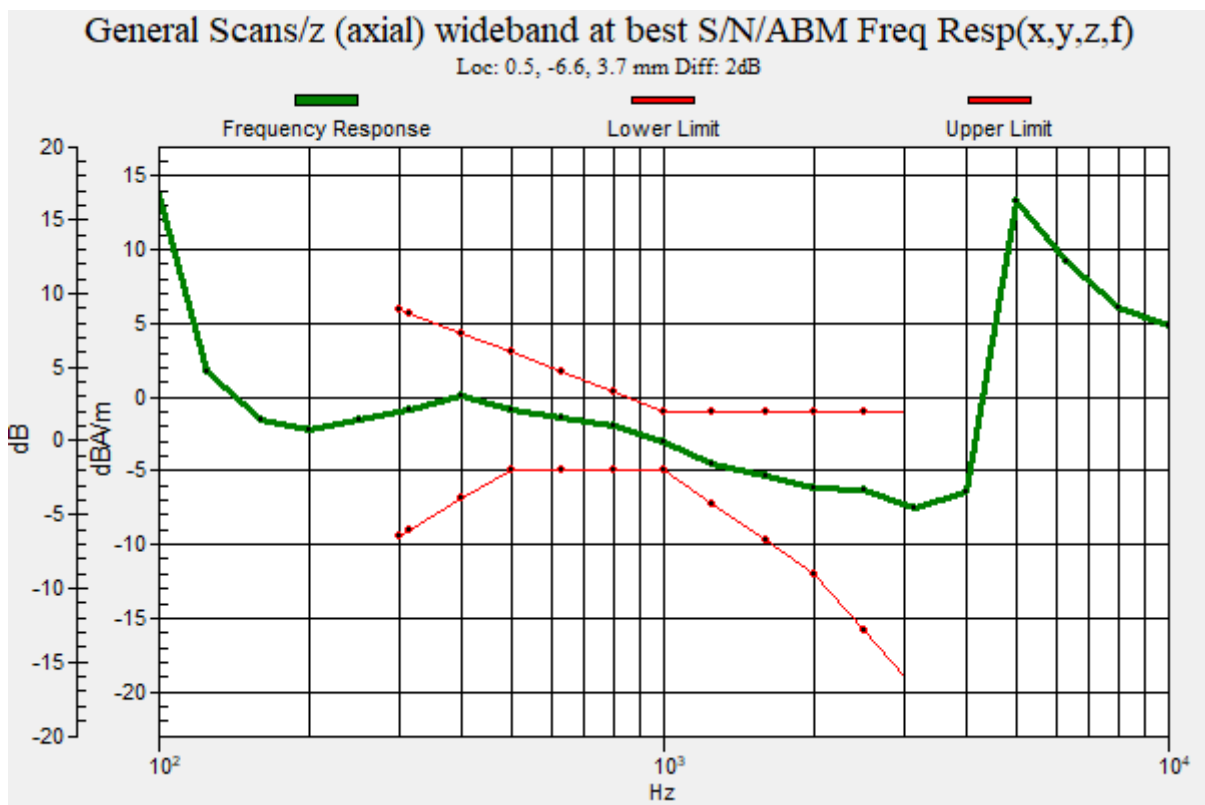

Plot No.84
UMTS Band 2 9400ch bitrate 75 kbits y(transversal)

Communication System: UID 0, UMTS1900 (0); Frequency: 1880 MHz;Duty Cycle: 1:1
Medium parameters used: $\sigma = 0$ S/m, $\epsilon_r = 1$; $\rho = 0$ kg/m³
Phantom section: TCoil Section

DASY5 Configuration:

- Probe: AM1DV3 - 3049; ; Calibrated: 2021-06-01
- Sensor-Surface: 0mm (Fix Surface)
- Electronics: DAE4 Sn652; Calibrated: 2022-01-24
- Phantom: HAC Test Arch with AMCC TCOIL
- Measurement SW: DASY52, Version 52.10 (4)

T-Coil scan (scan for ANSI C63.19-2007 & 2011 compliance)/General Scans/y (transversal) 4.2mm 50

x 50/ABM Signal(x,y,z) (13x13x1): Measurement grid: dx=10mm, dy=10mm

Signal Type: Audio File (.wav) 48k_voice_1kHz_1s.wav

Output Gain: 19.15

Measure Window Start: 300ms

Measure Window Length: 1000ms

BWC applied: -0.18 dB

Device Reference Point: 0, 0, -6.3 mm

Cursor:

ABM1 comp = -10.50 dBA/m

BWC Factor = -0.18 dB

Location: 0, 4.2, 3.7 mm

Cursor:

ABM2 = -44.56 dBA/m

Location: 0, 4.2, 3.7 mm

Cursor:

ABM1/ABM2 = 34.06 dB

ABM1 comp = -10.50 dBA/m

BWC Factor = -0.18 dB

Location: 0, 4.2, 3.7 mm

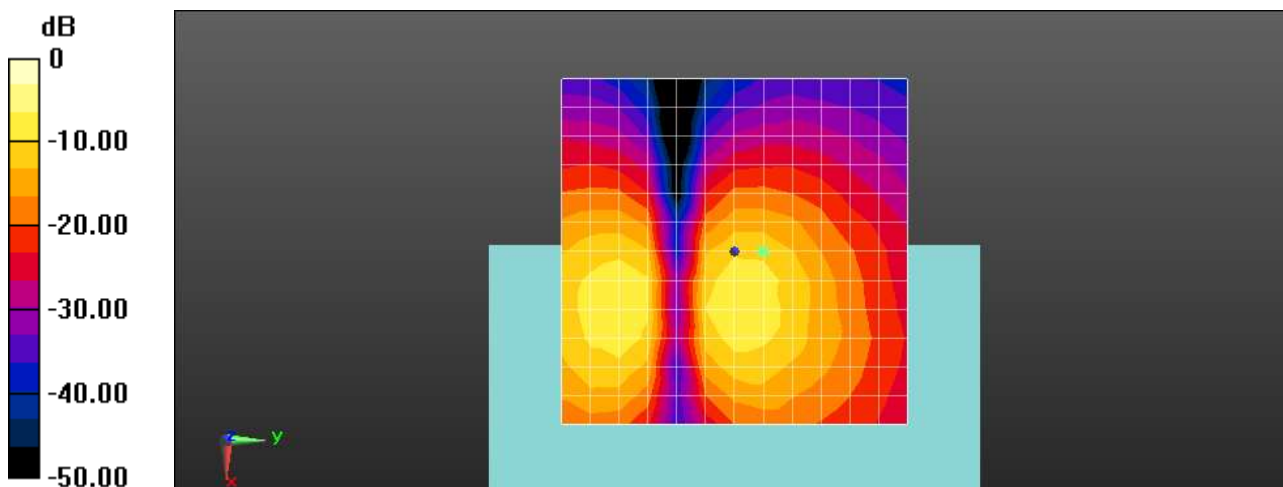

0 dB = 1.000 A/m = 0.00 dBA/m

Plot No.85
LTE Band 4 1412ch bitrate 75 kbits z(axial)

Communication System: UID 0, UMTS IV (0); Frequency: 1732.4 MHz;Duty Cycle: 1:1
Medium parameters used: $\sigma = 0$ S/m, $\epsilon_r = 1$; $\rho = 0$ kg/m³
Phantom section: TCoil Section

DASY5 Configuration:

- Probe: AM1DV3 - 3049; ; Calibrated: 2021-06-01
- Sensor-Surface: 0mm (Fix Surface)
- Electronics: DAE4 Sn652; Calibrated: 2022-01-24
- Phantom: HAC Test Arch with AMCC TCOIL
- Measurement SW: DASY52, Version 52.10 (4)

T-Coil scan (scan for ANSI C63.19-2007 & 2011 compliance)/General Scans/z (axial) 4.2mm 50 x 50/ABM Signal(x,y,z) (13x13x1): Measurement grid: dx=10mm, dy=10mm

Signal Type: Audio File (.wav) 48k_voice_1kHz_1s.wav
Output Gain: 19.15
Measure Window Start: 300ms
Measure Window Length: 1000ms
BWC applied: -0.17 dB
Device Reference Point: 0, 0, -6.3 mm

Cursor:

ABM1 comp = -5.49 dBA/m
BWC Factor = -0.17 dB
Location: 0, -12.5, 3.7 mm

Cursor:

ABM2 = -39.84 dBA/m
Location: 0, -12.5, 3.7 mm

Cursor:

ABM1/ABM2 = 34.36 dB
ABM1 comp = -5.49 dBA/m
BWC Factor = -0.17 dB
Location: 0, -12.5, 3.7 mm

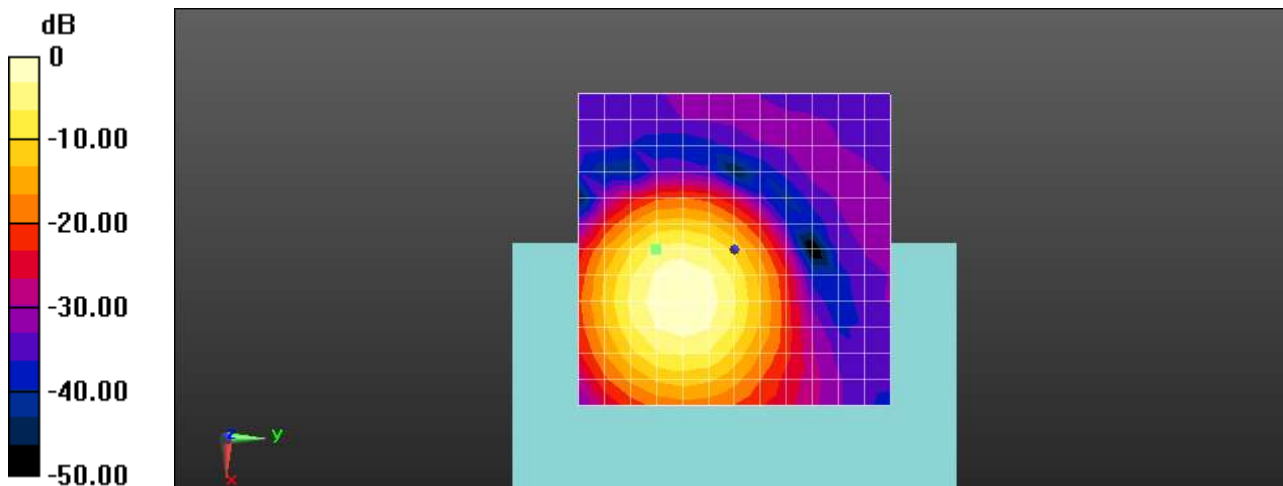

0 dB = 1.000 A/m = 0.00 dBA/m

Plot No.86
LTE Band 4 1412ch bitrate 75 kbits Freq.Response

Communication System: UID 0, UMTS IV (0); Frequency: 1732.4 MHz;Duty Cycle: 1:1
 Medium parameters used: $\sigma = 0$ S/m, $\epsilon_r = 1$; $\rho = 0$ kg/m³
 Phantom section: TCoil Section

T-Coil scan (scan for ANSI C63.19-2007 & 2011 compliance)/General Scans/z (axial) wideband at best S/N/ABM Freq Resp(x,y,z,f) (1x1x1): Measurement grid: dx=10mm, dy=10mm
 Signal Type: Audio File (.wav) 48k_Normal_51s new.wav
 Output Gain: 58.25
 Measure Window Start: 300ms
 Measure Window Length: 51000ms
 BWC applied: 9.15 dB
 Device Reference Point: 0, 0, -6.3 mm

Category	Telephone parameters WD signal quality [(signal+noise)-to-noise ratio in decibels]
Category T1	0 dB to 10 dB
Category T2	10 dB to 20 dB
Category T3	20 dB to 30 dB
Category T4	> 30 dB

Cursor:
 Diff = 2.00 dB
 BWC Factor = 9.15 dB
 Location: -0.1, -12.4, 3.7 mm

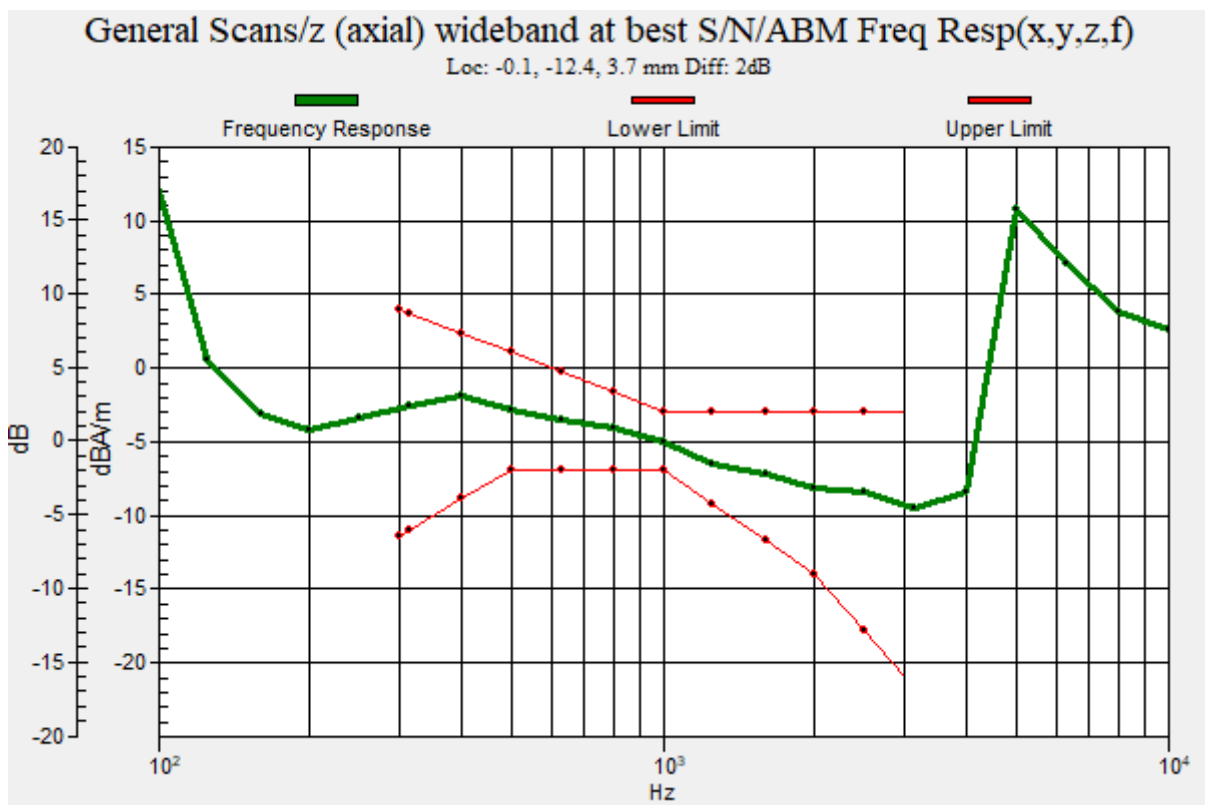

Plot No.87
LTE Band 4 1412ch bitrate 75 kbits y(transversal)

Communication System: UID 0, UMTS IV (0); Frequency: 1732.4 MHz;Duty Cycle: 1:1
Medium parameters used: $\sigma = 0$ S/m, $\epsilon_r = 1$; $\rho = 0$ kg/m³
Phantom section: TCoil Section

DASY5 Configuration:

- Probe: AM1DV3 - 3049; ; Calibrated: 2021-06-01
- Sensor-Surface: 0mm (Fix Surface)
- Electronics: DAE4 Sn652; Calibrated: 2022-01-24
- Phantom: HAC Test Arch with AMCC TCOIL
- Measurement SW: DASY52, Version 52.10 (4)

T-Coil scan (scan for ANSI C63.19-2007 & 2011 compliance)/General Scans/y (transversal) 4.2mm 50

x 50/ABM Signal(x,y,z) (13x13x1): Measurement grid: dx=10mm, dy=10mm

Signal Type: Audio File (.wav) 48k_voice_1kHz_1s.wav

Output Gain: 19.15

Measure Window Start: 300ms

Measure Window Length: 1000ms

BWC applied: -0.17 dB

Device Reference Point: 0, 0, -6.3 mm

Cursor:

ABM1 comp = -10.31 dBA/m

BWC Factor = -0.17 dB

Location: 0, -16.7, 3.7 mm

Cursor:

ABM2 = -44.22 dBA/m

Location: 0, -16.7, 3.7 mm

Cursor:

ABM1/ABM2 = 33.91 dB

ABM1 comp = -10.31 dBA/m

BWC Factor = -0.17 dB

Location: 0, -16.7, 3.7 mm

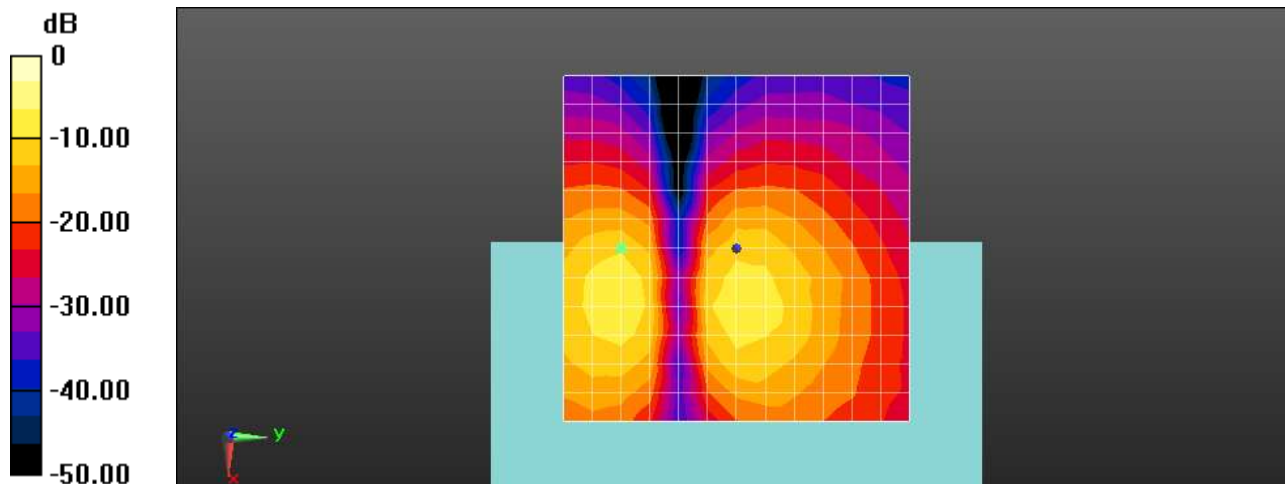

0 dB = 1.000 A/m = 0.00 dBA/m

Plot No.88
UMTS Band 5 4183ch bitrate 75 kbits z(axial)

Communication System: UID 0, UMTS850 (0); Frequency: 836.6 MHz;Duty Cycle: 1:1
Medium parameters used: $\sigma = 0$ S/m, $\epsilon_r = 1$; $\rho = 0$ kg/m³
Phantom section: TCoil Section

DASY5 Configuration:

- Probe: AM1DV3 - 3049; ; Calibrated: 2021-06-01
- Sensor-Surface: 0mm (Fix Surface)
- Electronics: DAE4 Sn652; Calibrated: 2022-01-24
- Phantom: HAC Test Arch with AMCC TCOIL
- Measurement SW: DASY52, Version 52.10 (4)

T-Coil scan (scan for ANSI C63.19-2007 & 2011 compliance)/General Scans/z (axial) 4.2mm 50 x 50/ABM Signal(x,y,z) (13x13x1): Measurement grid: dx=10mm, dy=10mm

Signal Type: Audio File (.wav) 48k_voice_1kHz_1s.wav
Output Gain: 19.15
Measure Window Start: 300ms
Measure Window Length: 1000ms
BWC applied: -0.18 dB
Device Reference Point: 0, 0, -6.3 mm

Cursor:

ABM1 comp = -6.25 dBA/m
BWC Factor = -0.18 dB
Location: 4.2, -16.7, 3.7 mm

Cursor:

ABM2 = -40.89 dBA/m
Location: 4.2, -16.7, 3.7 mm

Cursor:

ABM1/ABM2 = 34.63 dB
ABM1 comp = -6.25 dBA/m
BWC Factor = -0.18 dB
Location: 4.2, -16.7, 3.7 mm

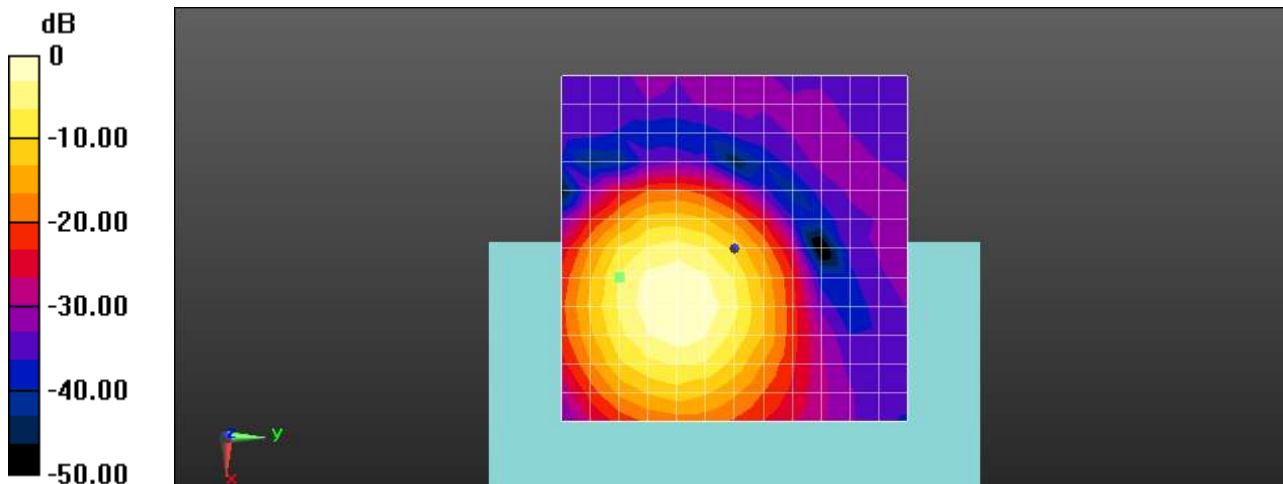

0 dB = 1.000 A/m = 0.00 dBA/m

Plot No.89
UMTS Band 5 4183ch bitrate 75 kbits Freq.Response

Communication System: UID 0, UMTS850 (0); Frequency: 836.6 MHz;Duty Cycle: 1:1
 Medium parameters used: $\sigma = 0$ S/m, $\epsilon_r = 1$; $\rho = 0$ kg/m³
 Phantom section: TCoil Section

T-Coil scan (scan for ANSI C63.19-2007 & 2011 compliance)/General Scans/z (axial) wideband at best S/N/ABM Freq Resp(x,y,z,f) (1x1x1): Measurement grid: dx=10mm, dy=10mm
 Signal Type: Audio File (.wav) 48k_Normal_51s new.wav
 Output Gain: 58.25
 Measure Window Start: 300ms
 Measure Window Length: 51000ms
 BWC applied: 9.14 dB
 Device Reference Point: 0, 0, -6.3 mm

Category	Telephone parameters WD signal quality [(signal+noise)-to-noise ratio in decibels]
Category T1	0 dB to 10 dB
Category T2	10 dB to 20 dB
Category T3	20 dB to 30 dB
Category T4	> 30 dB

Cursor:
 Diff = 2.00 dB
 BWC Factor = 9.14 dB
 Location: 3.6, -15.5, 3.7 mm

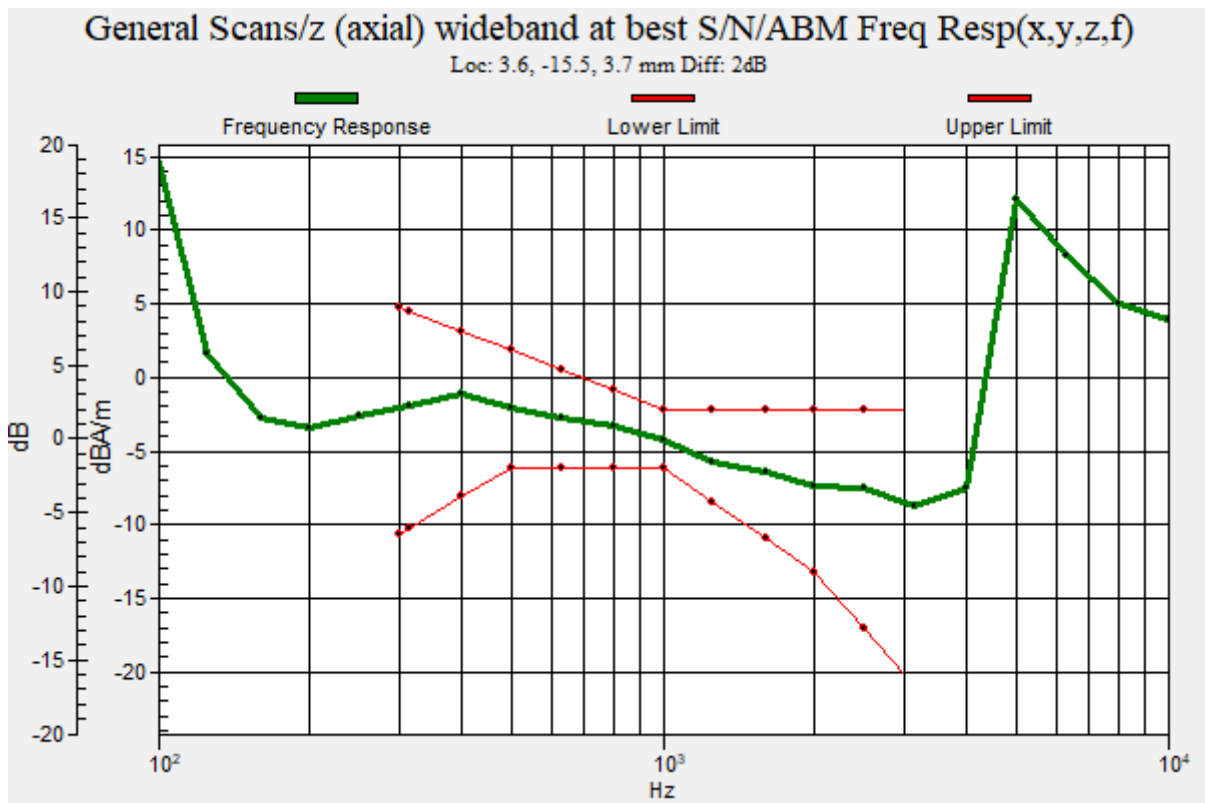

Plot No.90

UMTS Band 5 4183ch bitrate 75 kbits y(transversal)

Communication System: UID 0, UMTS850 (0); Frequency: 836.6 MHz;Duty Cycle: 1:1
Medium parameters used: $\sigma = 0$ S/m, $\epsilon_r = 1$; $\rho = 0$ kg/m³
Phantom section: TCoil Section

DASY5 Configuration:

- Probe: AM1DV3 - 3049; ; Calibrated: 2021-06-01
- Sensor-Surface: 0mm (Fix Surface)
- Electronics: DAE4 Sn652; Calibrated: 2022-01-24
- Phantom: HAC Test Arch with AMCC TCOIL
- Measurement SW: DASY52, Version 52.10 (4)

T-Coil scan (scan for ANSI C63.19-2007 & 2011 compliance)/General Scans/y (transversal) 4.2mm 50

x 50/ABM Signal(x,y,z) (13x13x1): Measurement grid: dx=10mm, dy=10mm

Signal Type: Audio File (.wav) 48k_voice_1kHz_1s.wav

Output Gain: 19.15

Measure Window Start: 300ms

Measure Window Length: 1000ms

BWC applied: -0.18 dB

Device Reference Point: 0, 0, -6.3 mm

Cursor:

ABM1 comp = -10.36 dBA/m

BWC Factor = -0.18 dB

Location: 0, -16.7, 3.7 mm

Cursor:

ABM2 = -44.44 dBA/m

Location: 0, -16.7, 3.7 mm

Cursor:

ABM1/ABM2 = 34.08 dB

ABM1 comp = -10.36 dBA/m

BWC Factor = -0.18 dB

Location: 0, -16.7, 3.7 mm

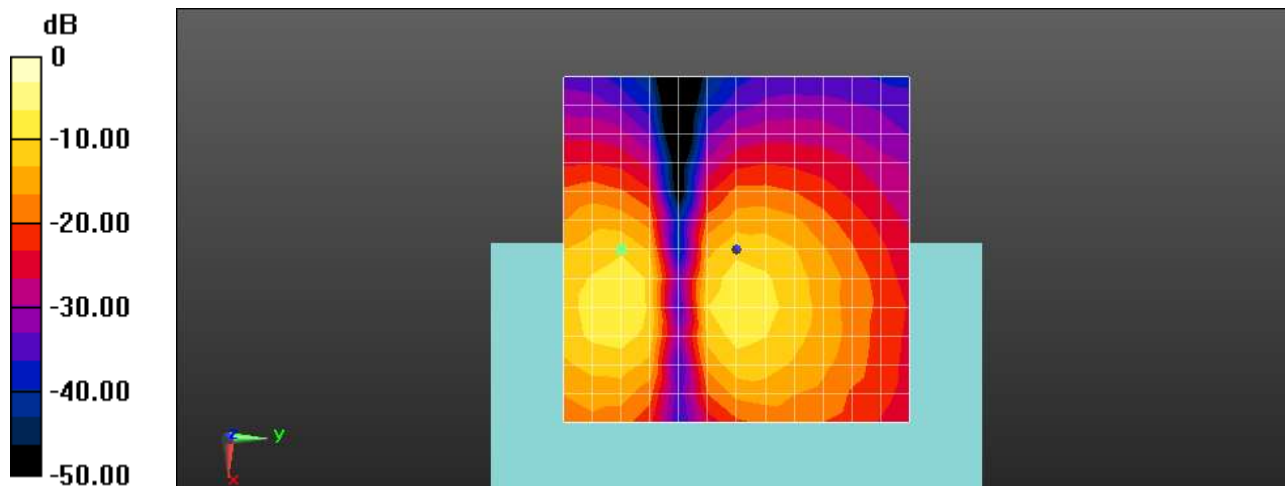

0 dB = 1.000 A/m = 0.00 dBA/m

Plot No.91
LTE 7 QPSK 20MHz 1RB 0offset 21100ch bitrate 75 kbits z(axial)

Communication System: UID 0, LTE Band 7 (0); Frequency: 2535 MHz;Duty Cycle: 1:1
Medium parameters used: $\sigma = 0$ S/m, $\epsilon_r = 1$; $\rho = 0$ kg/m³
Phantom section: TCoil Section

DASY5 Configuration:

- Probe: AM1DV3 - 3049; ; Calibrated: 2021-06-01
- Sensor-Surface: 0mm (Fix Surface)
- Electronics: DAE4 Sn652; Calibrated: 2022-01-24
- Phantom: HAC Test Arch with AMCC TCOIL
- Measurement SW: DASY52, Version 52.10 (4)

T-Coil scan (scan for ANSI C63.19-2007 & 2011 compliance)/General Scans/y (transversal) 4.2mm 50

x 50/ABM Signal(x,y,z) (13x13x1): Measurement grid: dx=10mm, dy=10mm

Signal Type: Audio File (.wav) 48k_voice_1kHz_1s.wav

Output Gain: 19.15

Measure Window Start: 300ms

Measure Window Length: 1000ms

BWC applied: -0.19 dB

Device Reference Point: 0, 0, -6.3 mm

Cursor:

ABM1 comp = -0.91BA/m

BWC Factor = -0.19 dB

Location: 8.3, -12.5, 3.7 mm

Cursor:

ABM2 = -35.69 dBA/m

Location: 8.3, -12.5, 3.7 mm

Cursor:

ABM1/ABM2 = 34.78 dB

ABM1 comp = -0.91 dBA/m

BWC Factor = -0.19 dB

Location: 8.3, -12.5, 3.7 mm

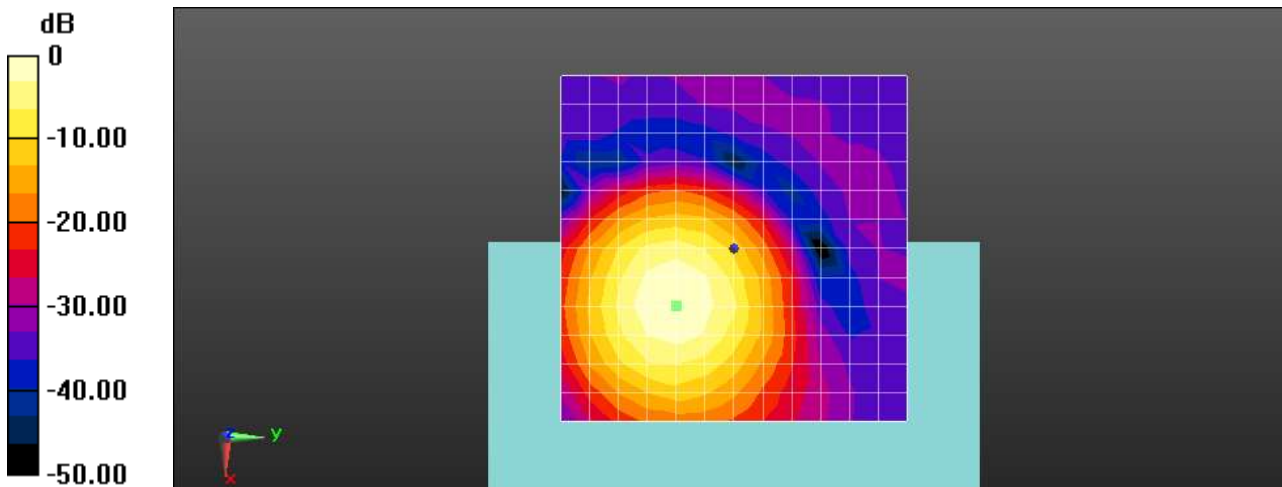

0 dB = 1.000 A/m = 0.00 dBA/m

Plot No.92

LTE 7 QPSK 20MHz 1RB 0offset 21100ch bitrate 75 kbits Freq.Response

Communication System: UID 0, LTE Band 7 (0); Frequency: 2535 MHz;Duty Cycle: 1:1
 Medium parameters used: $\sigma = 0$ S/m, $\epsilon_r = 1$; $\rho = 0$ kg/m³
 Phantom section: TCoil Section

T-Coil scan (scan for ANSI C63.19-2007 & 2011 compliance)/General Scans/z (axial) wideband at best

S/N/ABM Freq Resp(x,y,z,f) (1x1x1): Measurement grid: dx=10mm, dy=10mm

Signal Type: Audio File (.wav) 48k_Normal_51s new.wav

Output Gain: 58.25

Measure Window Start: 300ms

Measure Window Length: 51000ms

BWC applied: 9.13 dB

Device Reference Point: 0, 0, -6.3 mm

Category	Telephone parameters WD signal quality [(signal+noise)-to-noise ratio in decibels]
Category T1	0 dB to 10 dB
Category T2	10 dB to 20 dB
Category T3	20 dB to 30 dB
Category T4	> 30 dB

Cursor:

Diff = 2.00 dB

BWC Factor = 9.13 dB

Location: 7.5, -12.2, 3.7 mm

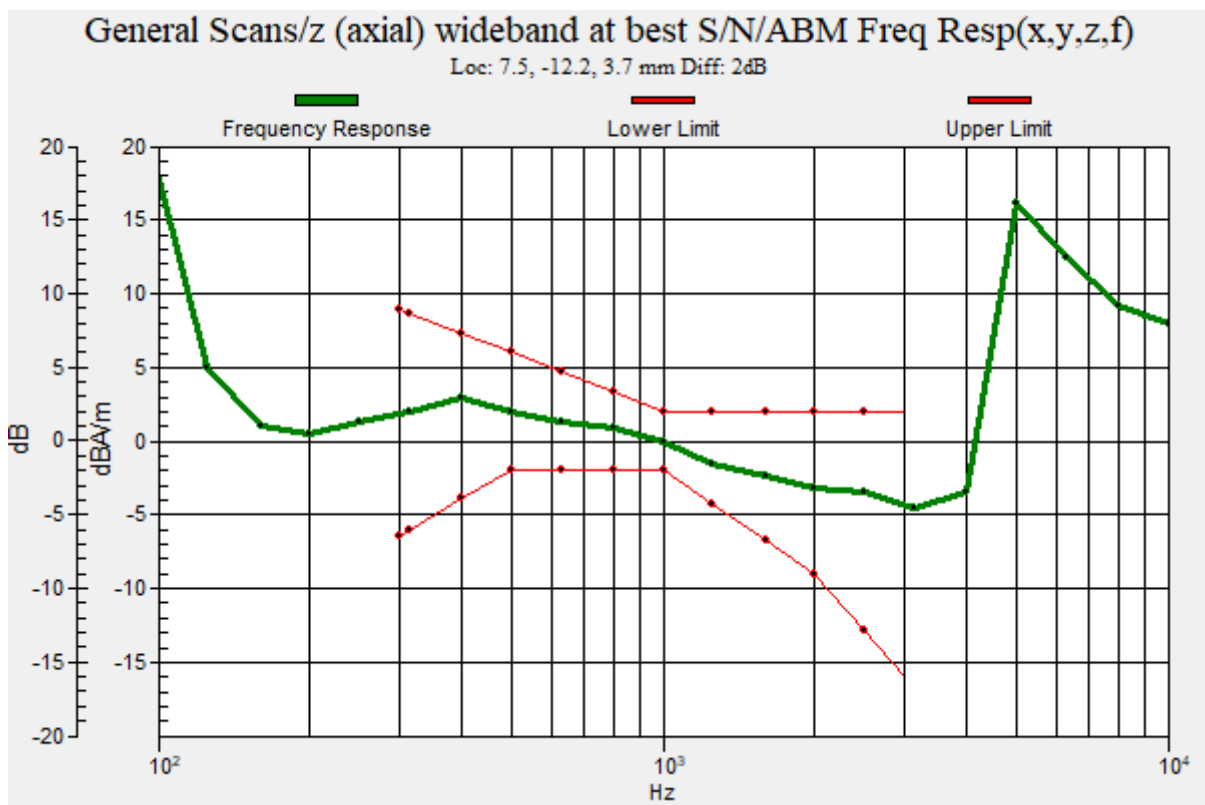

Plot No.93

LTE 7 QPSK 20MHz 1RB 0offset 21100ch bitrate 75 kbits y(transversal)

Communication System: UID 0, LTE Band 7 (0); Frequency: 2535 MHz;Duty Cycle: 1:1
Medium parameters used: $\sigma = 0$ S/m, $\epsilon_r = 1$; $\rho = 0$ kg/m³
Phantom section: TCoil Section

DASY5 Configuration:

- Probe: AM1DV3 - 3049; ; Calibrated: 2021-06-01
- Sensor-Surface: 0mm (Fix Surface)
- Electronics: DAE4 Sn652; Calibrated: 2022-01-24
- Phantom: HAC Test Arch with AMCC TCOIL
- Measurement SW: DASY52, Version 52.10 (4)

T-Coil scan (scan for ANSI C63.19-2007 & 2011 compliance)/General Scans/y (transversal) 4.2mm 50 x 50/ABM Signal(x,y,z) (13x13x1): Measurement grid: dx=10mm, dy=10mm

Signal Type: Audio File (.wav) 48k_voice_1kHz_1s.wav
Output Gain: 19.15
Measure Window Start: 300ms
Measure Window Length: 1000ms
BWC applied: -0.19 dB
Device Reference Point: 0, 0, -6.3 mm

Cursor:

ABM1 comp = -8.22 dBA/m
BWC Factor = -0.19 dB
Location: 4.2, 0, 3.7 mm

Cursor:

ABM2 = -42.42 dBA/m
Location: 4.2, 0, 3.7 mm

Cursor:

ABM1/ABM2 = 34.19 dB
ABM1 comp = -8.22 dBA/m
BWC Factor = -0.19 dB
Location: 4.2, 0, 3.7 mm

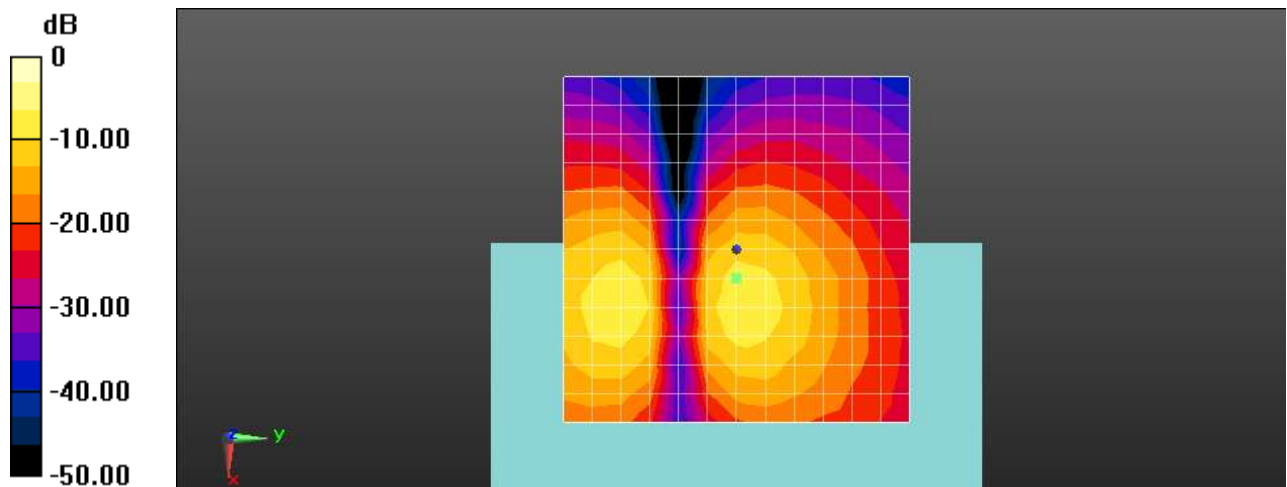

0 dB = 1.000 A/m = 0.00 dBA/m

Plot No.94

LTE 12 QPSK 10MHz 1RB 0offset 23095ch bitrate 75 kbits z(axial)

Communication System: UID 0, LTE Band12 (0); Frequency: 707.5 MHz;Duty Cycle: 1:1

Medium parameters used: $\sigma = 0$ S/m, $\epsilon_r = 1$; $\rho = 0$ kg/m³

Phantom section: TCoil Section

DASY5 Configuration:

- Probe: AM1DV3 - 3049; ; Calibrated: 2021-06-01
- Sensor-Surface: 0mm (Fix Surface)
- Electronics: DAE4 Sn652; Calibrated: 2022-01-24
- Phantom: HAC Test Arch with AMCC TCOIL
- Measurement SW: DASY52, Version 52.10 (4)

T-Coil scan (scan for ANSI C63.19-2007 & 2011 compliance)/General Scans/z (axial) 4.2mm 50 x

50/ABM Signal(x,y,z) (13x13x1): Measurement grid: dx=10mm, dy=10mm

Signal Type: Audio File (.wav) 48k_voice_1kHz_1s.wav

Output Gain: 19.15

Measure Window Start: 300ms

Measure Window Length: 1000ms

BWC applied: -0.19 dB

Device Reference Point: 0, 0, -6.3 mm

Cursor:

ABM1 comp = 0.40 dBA/m

BWC Factor = -0.19 dB

Location: 8.3, -8.3, 3.7 mm

Cursor:

ABM2 = -33.76 dBA/m

Location: 8.3, -8.3, 3.7 mm

Cursor:

ABM1/ABM2 = 34.16 dB

ABM1 comp = 0.40 dBA/m

BWC Factor = -0.19 dB

Location: 8.3, -8.3, 3.7 mm

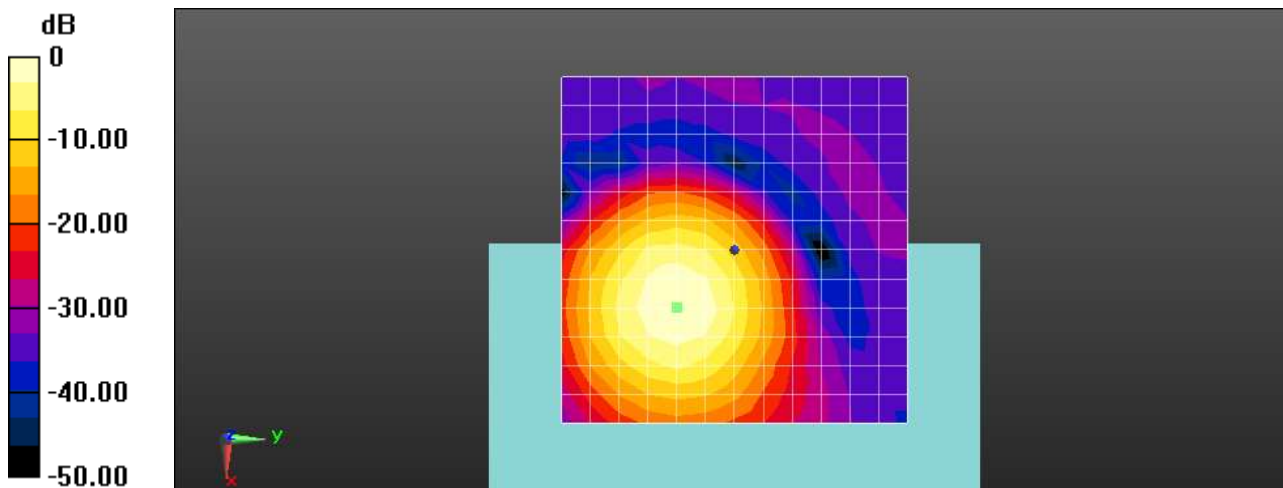

0 dB = 1.000 A/m = 0.00 dBA/m

Plot No.95

LTE 12 QPSK 10MHz 1RB 0offset 23095ch bitrate 75 kbits Freq.Response

Communication System: UID 0, LTE Band12 (0); Frequency: 707.5 MHz;Duty Cycle: 1:1
 Medium parameters used: $\sigma = 0$ S/m, $\epsilon_r = 1$; $\rho = 0$ kg/m³
 Phantom section: TCoil Section

T-Coil scan (scan for ANSI C63.19-2007 & 2011 compliance)/General Scans/z (axial) wideband at best

S/N/ABM Freq Resp(x,y,z,f) (1x1x1): Measurement grid: dx=10mm, dy=10mm

Signal Type: Audio File (.wav) 48k_Normal_51s new.wav

Output Gain: 58.25

Measure Window Start: 300ms

Measure Window Length: 51000ms

BWC applied: 9.13 dB

Device Reference Point: 0, 0, -6.3 mm

Category	Telephone parameters WD signal quality [(signal+noise)-to-noise ratio in decibels]
Category T1	0 dB to 10 dB
Category T2	10 dB to 20 dB
Category T3	20 dB to 30 dB
Category T4	> 30 dB

Cursor:

Diff = 2.00 dB

BWC Factor = 9.13 dB

Location: 7.4, -6.3, 3.7 mm

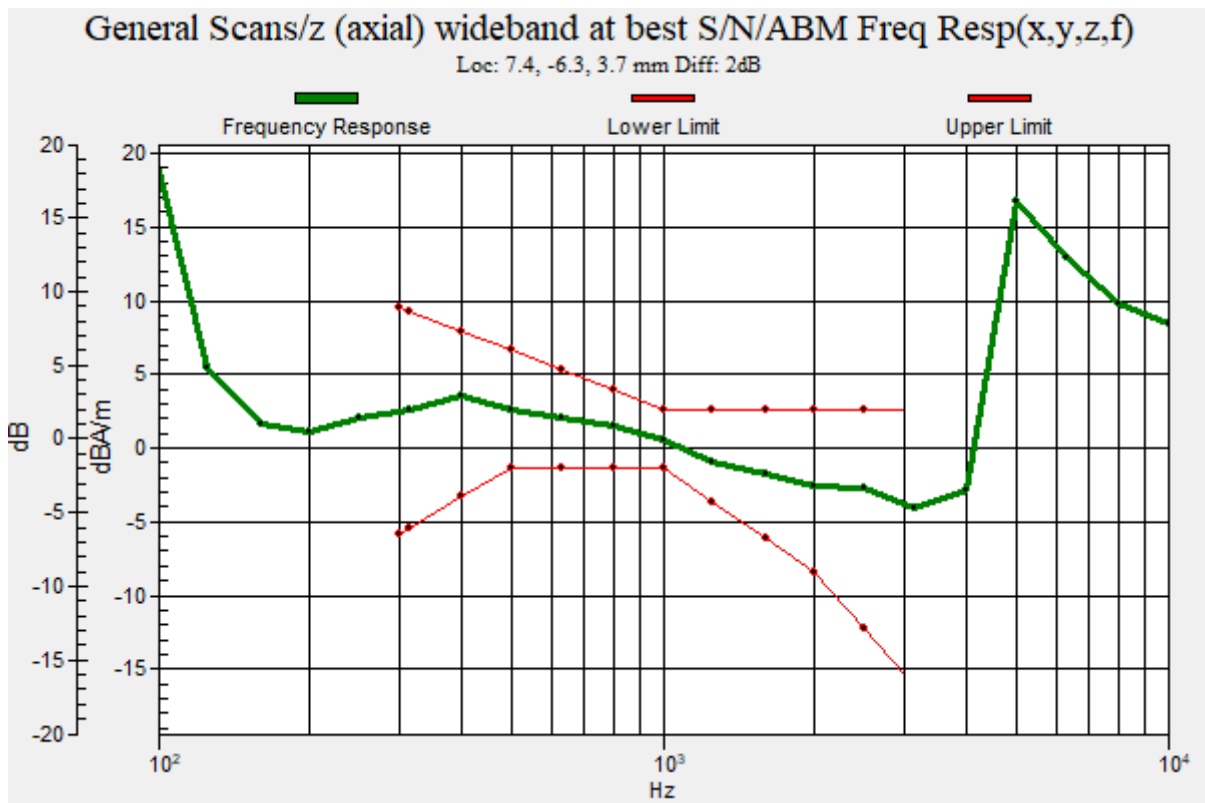

Plot No.96
LTE 12 QPSK 10MHz 1RB 0offset 23095ch bitrate 75 kbits y(transversal)

Communication System: UID 0, LTE Band12 (0); Frequency: 707.5 MHz;Duty Cycle: 1:1
Medium parameters used: $\sigma = 0$ S/m, $\epsilon_r = 1$; $\rho = 0$ kg/m³
Phantom section: TCoil Section

DASY5 Configuration:

- Probe: AM1DV3 - 3049; ; Calibrated: 2021-06-01
- Sensor-Surface: 0mm (Fix Surface)
- Electronics: DAE4 Sn652; Calibrated: 2022-01-24
- Phantom: HAC Test Arch with AMCC TCOIL
- Measurement SW: DASY52, Version 52.10 (4)

T-Coil scan (scan for ANSI C63.19-2007 & 2011 compliance)/General Scans/y (transversal) 4.2mm 50

x 50/ABM Signal(x,y,z) (13x13x1): Measurement grid: dx=10mm, dy=10mm

Signal Type: Audio File (.wav) 48k_voice_1kHz_1s.wav

Output Gain: 19.15

Measure Window Start: 300ms

Measure Window Length: 1000ms

BWC applied: -0.19 dB

Device Reference Point: 0, 0, -6.3 mm

Cursor:

ABM1 comp = -7.20 dBA/m

BWC Factor = -0.19 dB

Location: 8.3, -16.7, 3.7 mm

Cursor:

ABM2 = -40.77 dBA/m

Location: 8.3, -16.7, 3.7 mm

Cursor:

ABM1/ABM2 = 33.58 dB

ABM1 comp = -7.20 dBA/m

BWC Factor = -0.19 dB

Location: 8.3, -16.7, 3.7 mm

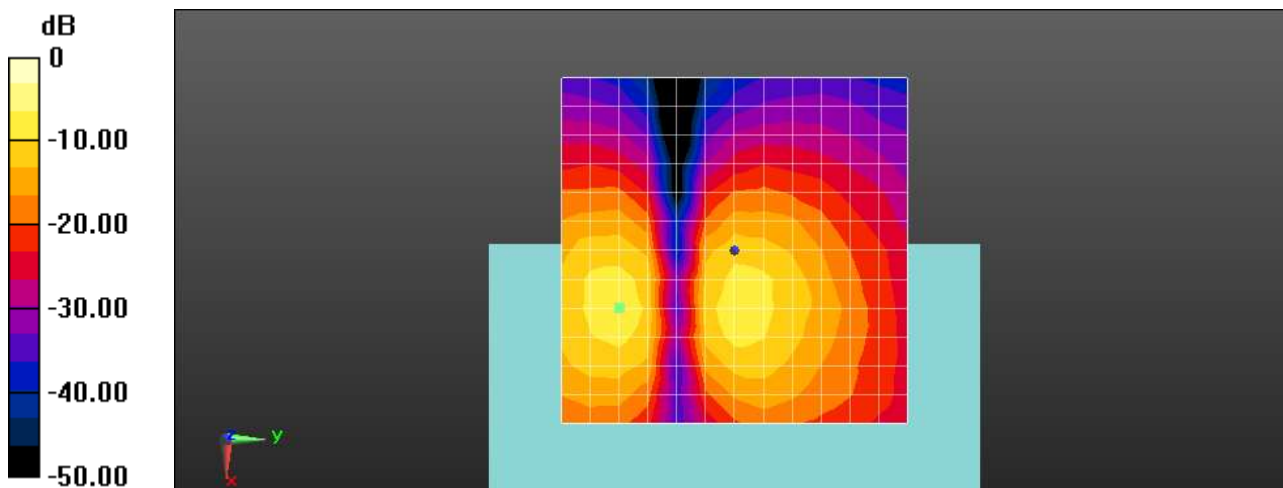

0 dB = 1.000 A/m = 0.00 dBA/m

Plot No.97
LTE 13 QPSK 10MHz 1RB 0offset 23230ch bitrate 75 kbits z(axial)

Communication System: UID 0, LTE Band 13 (0); Frequency: 782 MHz;Duty Cycle: 1:1
Medium parameters used: $\sigma = 0$ S/m, $\epsilon_r = 1$; $\rho = 0$ kg/m³
Phantom section: TCoil Section

DASY5 Configuration:

- Probe: AM1DV3 - 3049; ; Calibrated: 2021-06-01
- Sensor-Surface: 0mm (Fix Surface)
- Electronics: DAE4 Sn652; Calibrated: 2022-01-24
- Phantom: HAC Test Arch with AMCC TCOIL
- Measurement SW: DASY52, Version 52.10 (4)

T-Coil scan (scan for ANSI C63.19-2007 & 2011 compliance)/General Scans/z (axial) 4.2mm 50 x

50/ABM Signal(x,y,z) (13x13x1): Measurement grid: dx=10mm, dy=10mm

Signal Type: Audio File (.wav) 48k_voice_1kHz_1s.wav

Output Gain: 19.15

Measure Window Start: 300ms

Measure Window Length: 1000ms

BWC applied: -0.19 dB

Device Reference Point: 0, 0, -6.3 mm

Cursor:

ABM1 comp = -1.05 dBA/m

BWC Factor = -0.19 dB

Location: 8.3, -12.5, 3.7 mm

Cursor:

ABM2 = -35.10 dBA/m

Location: 8.3, -12.5, 3.7 mm

Cursor:

ABM1/ABM2 = 34.05 dB

ABM1 comp = -1.05 dBA/m

BWC Factor = -0.19 dB

Location: 8.3, -12.5, 3.7 mm

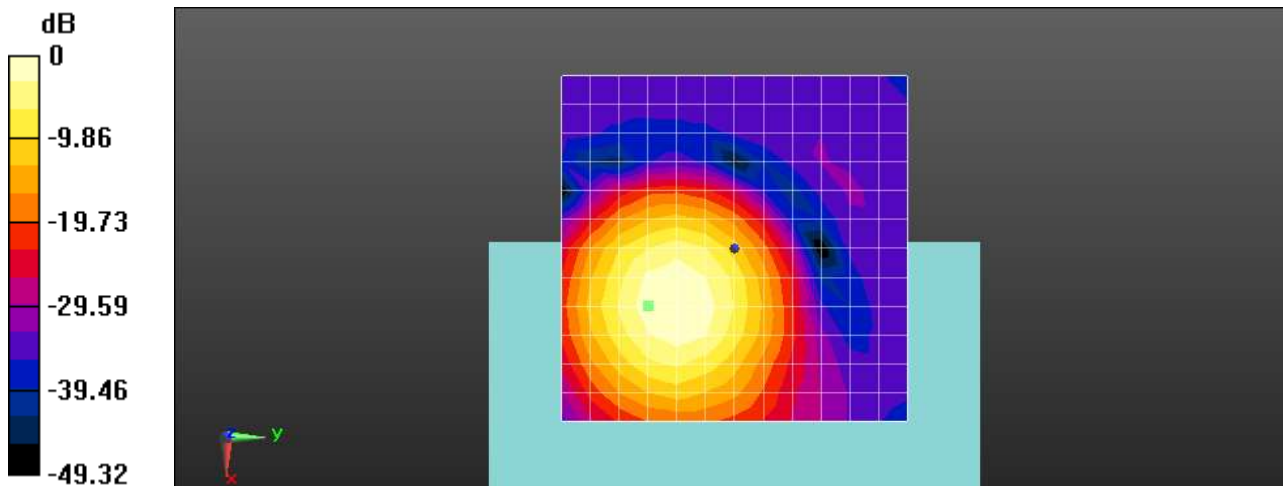

0 dB = 1.000 A/m = 0.00 dBA/m

Plot No.98
LTE 13 QPSK 10MHz 1RB 0offset 23230ch bitrate 75 kbits Freq.Response

Communication System: UID 0, LTE Band 13 (0); Frequency: 782 MHz;Duty Cycle: 1:1
 Medium parameters used: $\sigma = 0$ S/m, $\epsilon_r = 1$; $\rho = 0$ kg/m³
 Phantom section: TCoil Section

T-Coil scan (scan for ANSI C63.19-2007 & 2011 compliance)/General Scans/z (axial) wideband at best S/N/ABM Freq Resp(x,y,z,f) (1x1x1): Measurement grid: dx=10mm, dy=10mm
 Signal Type: Audio File (.wav) 48k_Normal_51s new.wav
 Output Gain: 58.25
 Measure Window Start: 300ms
 Measure Window Length: 51000ms
 BWC applied: 9.13 dB
 Device Reference Point: 0, 0, -6.3 mm

Category	Telephone parameters WD signal quality [(signal+noise)-to-noise ratio in decibels]
Category T1	0 dB to 10 dB
Category T2	10 dB to 20 dB
Category T3	20 dB to 30 dB
Category T4	> 30 dB

Cursor:
 Diff = 2.00 dB
 BWC Factor = 9.13 dB
 Location: 6.9, -11.8, 3.7 mm

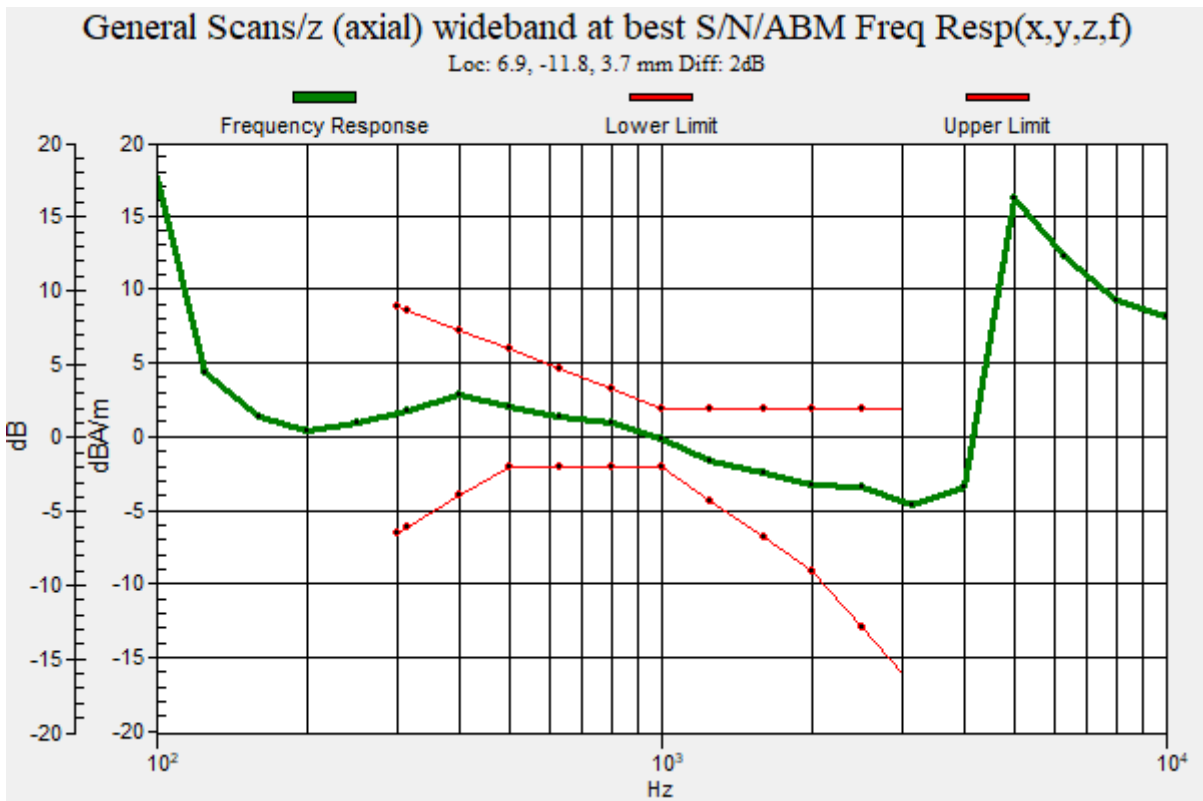

Plot No.99

LTE 13 QPSK 10MHz 1RB 0offset 23230ch bitrate 75 kbits y(transversal)

Communication System: UID 0, LTE Band 13 (0); Frequency: 782 MHz;Duty Cycle: 1:1
Medium parameters used: $\sigma = 0$ S/m, $\epsilon_r = 1$; $\rho = 0$ kg/m³
Phantom section: TCoil Section

DASY5 Configuration:

- Probe: AM1DV3 - 3049; ; Calibrated: 2021-06-01
- Sensor-Surface: 0mm (Fix Surface)
- Electronics: DAE4 Sn652; Calibrated: 2022-01-24
- Phantom: HAC Test Arch with AMCC TCOIL
- Measurement SW: DASY52, Version 52.10 (4)

T-Coil scan (scan for ANSI C63.19-2007 & 2011 compliance)/General Scans/y (transversal) 4.2mm 50

x 50/ABM Signal(x,y,z) (13x13x1): Measurement grid: dx=10mm, dy=10mm

Signal Type: Audio File (.wav) 48k_voice_1kHz_1s.wav

Output Gain: 19.15

Measure Window Start: 300ms

Measure Window Length: 1000ms

BWC applied: -0.19 dB

Device Reference Point: 0, 0, -6.3 mm

Cursor:

ABM1 comp = -10.62 dBA/m

BWC Factor = -0.19 dB

Location: 0, 0, 3.7 mm

Cursor:

ABM2 = -43.84 dBA/m

Location: 0, 0, 3.7 mm

Cursor:

ABM1/ABM2 = 33.23 dB

ABM1 comp = -10.62 dBA/m

BWC Factor = -0.19 dB

Location: 0, 0, 3.7 mm

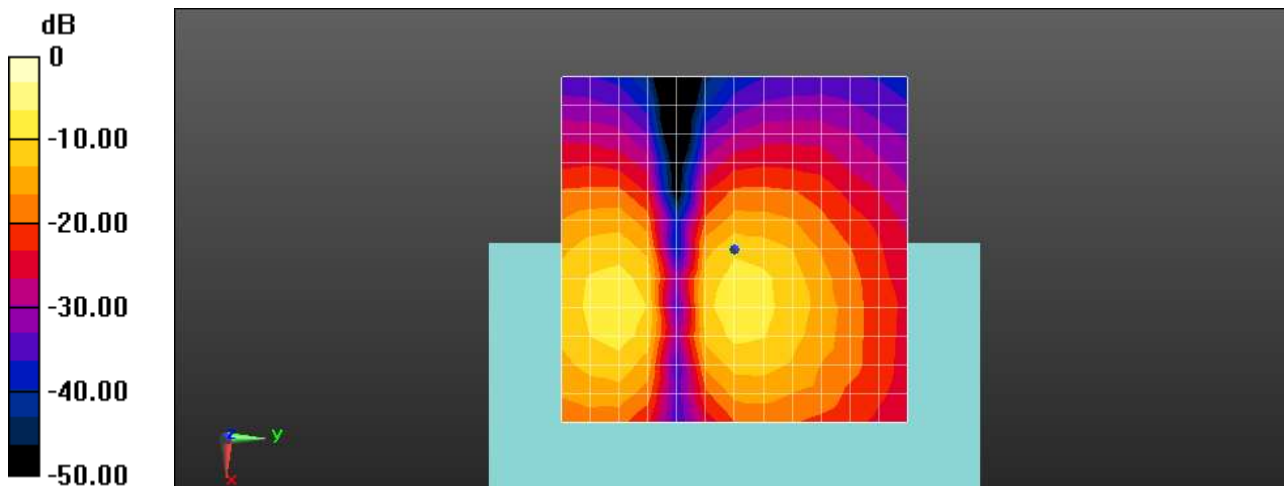

0 dB = 1.000 A/m = 0.00 dBA/m

Plot No.100

LTE 14 QPSK 10MHz 1RB 0offset 23330ch bitrate 75 kbits z(axial)

Communication System: UID 0, LTE Band 14 (0); Frequency: 793 MHz;Duty Cycle: 1:1

Medium parameters used: $\sigma = 0$ S/m, $\epsilon_r = 1$; $\rho = 0$ kg/m³

Phantom section: TCoil Section

DASY5 Configuration:

- Probe: AM1DV3 - 3049; ; Calibrated: 2021-06-01
- Sensor-Surface: 0mm (Fix Surface)
- Electronics: DAE4 Sn652; Calibrated: 2022-01-24
- Phantom: HAC Test Arch with AMCC TCOIL
- Measurement SW: DASY52, Version 52.10 (4)

T-Coil scan (scan for ANSI C63.19-2007 & 2011 compliance)/General Scans/z (axial) 4.2mm 50 x

50/ABM Signal(x,y,z) (13x13x1): Measurement grid: dx=10mm, dy=10mm

Signal Type: Audio File (.wav) 48k_voice_1kHz_1s.wav

Output Gain: 19.15

Measure Window Start: 300ms

Measure Window Length: 1000ms

BWC applied: -0.18 dB

Device Reference Point: 0, 0, -6.3 mm

Cursor:

ABM1 comp = 0.04 dBA/m

BWC Factor = -0.18 dB

Location: 8.3, -8.3, 3.7 mm

Cursor:

ABM2 = -33.82 dBA/m

Location: 8.3, -8.3, 3.7 mm

Cursor:

ABM1/ABM2 = 33.86 dB

ABM1 comp = 0.04 dBA/m

BWC Factor = -0.18 dB

Location: 8.3, -8.3, 3.7 mm

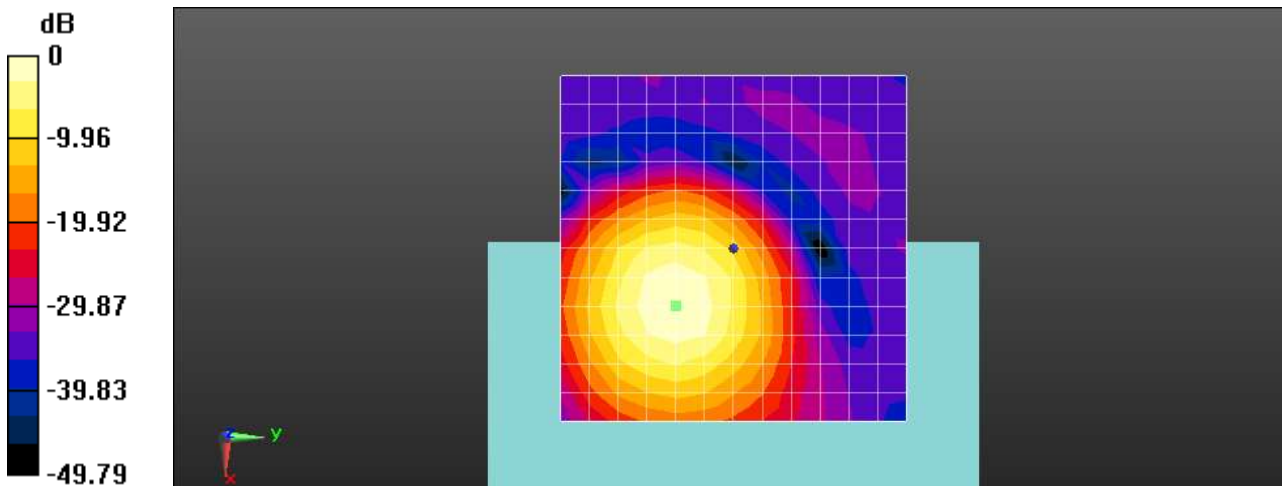

0 dB = 1.000 A/m = 0.00 dBA/m

Plot No.101

LTE 14 QPSK 10MHz 1RB 0offset 23330ch bitrate 75 kbits Freq.Response

Communication System: UID 0, LTE Band 14 (0); Frequency: 793 MHz;Duty Cycle: 1:1

Medium parameters used: $\sigma = 0$ S/m, $\epsilon_r = 1$; $\rho = 0$ kg/m³

Phantom section: TCoil Section

T-Coil scan (scan for ANSI C63.19-2007 & 2011 compliance)/General Scans/z (axial) wideband at best

S/N/ABM Freq Resp(x,y,z,f) (1x1x1): Measurement grid: dx=10mm, dy=10mm

Signal Type: Audio File (.wav) 48k_Normal_51s new.wav

Output Gain: 58.25

Measure Window Start: 300ms

Measure Window Length: 51000ms

BWC applied: 9.13 dB

Device Reference Point: 0, 0, -6.3 mm

Category	Telephone parameters WD signal quality [(signal+noise)-to-noise ratio in decibels]
Category T1	0 dB to 10 dB
Category T2	10 dB to 20 dB
Category T3	20 dB to 30 dB
Category T4	> 30 dB

Cursor:

Diff = 2.00 dB

BWC Factor = 9.13 dB

Location: 7.2, -8.8, 3.7 mm

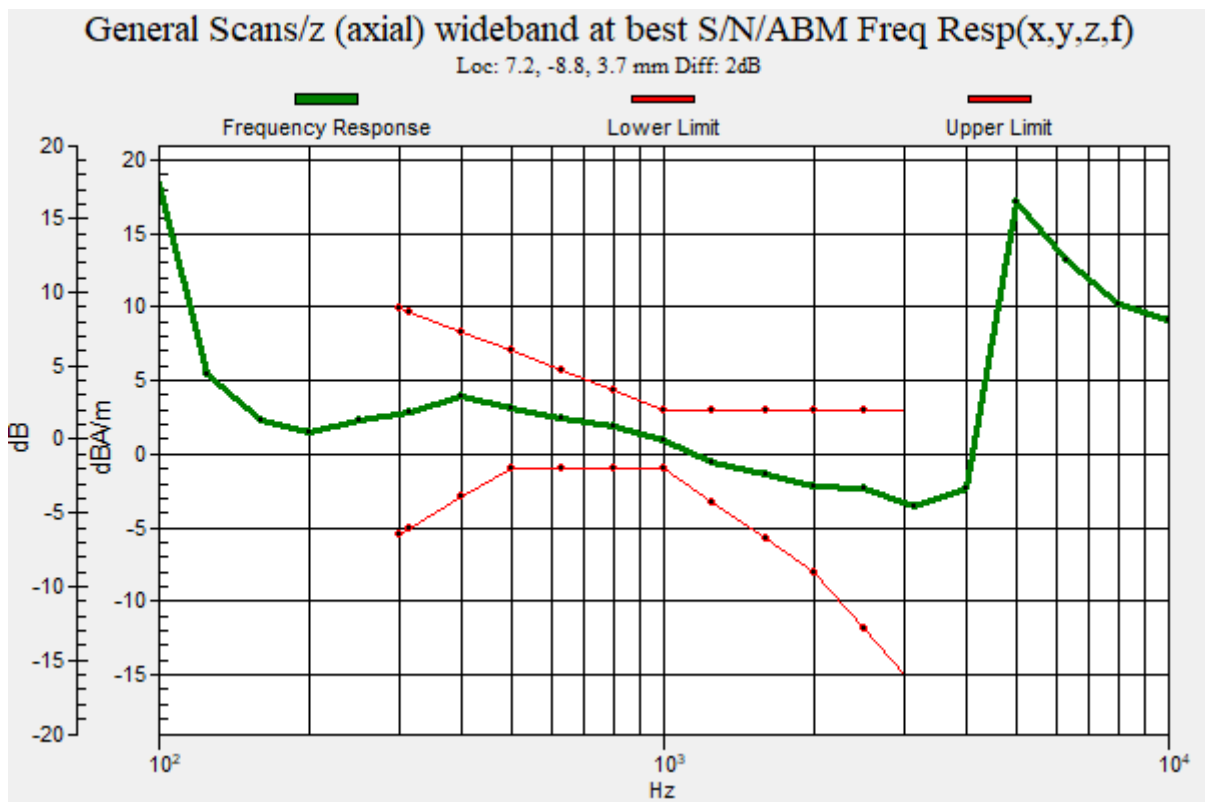

Plot No.102

LTE 14 QPSK 10MHz 1RB 0offset 23330ch bitrate 75 kbits y(transversal)

Communication System: UID 0, LTE Band 14 (0); Frequency: 793 MHz;Duty Cycle: 1:1

Medium parameters used: $\sigma = 0$ S/m, $\epsilon_r = 1$; $\rho = 0$ kg/m³

Phantom section: TCoil Section

DASY5 Configuration:

- Probe: AM1DV3 - 3049; ; Calibrated: 2021-06-01
- Sensor-Surface: 0mm (Fix Surface)
- Electronics: DAE4 Sn652; Calibrated: 2022-01-24
- Phantom: HAC Test Arch with AMCC TCOIL
- Measurement SW: DASY52, Version 52.10 (4)

T-Coil scan (scan for ANSI C63.19-2007 & 2011 compliance)/General Scans/y (transversal) 4.2mm 50

x 50/ABM Signal(x,y,z) (13x13x1): Measurement grid: dx=10mm, dy=10mm

Signal Type: Audio File (.wav) 48k_voice_1kHz_1s.wav

Output Gain: 19.15

Measure Window Start: 300ms

Measure Window Length: 1000ms

BWC applied: -0.18 dB

Device Reference Point: 0, 0, -6.3 mm

Cursor:

ABM1 comp = -10.71 dBA/m

BWC Factor = -0.18 dB

Location: 0, -16.7, 3.7 mm

Cursor:

ABM2 = -44.24 dBA/m

Location: 0, -16.7, 3.7 mm

Cursor:

ABM1/ABM2 = 33.53 dB

ABM1 comp = -10.71 dBA/m

BWC Factor = -0.18 dB

Location: 0, -16.7, 3.7 mm

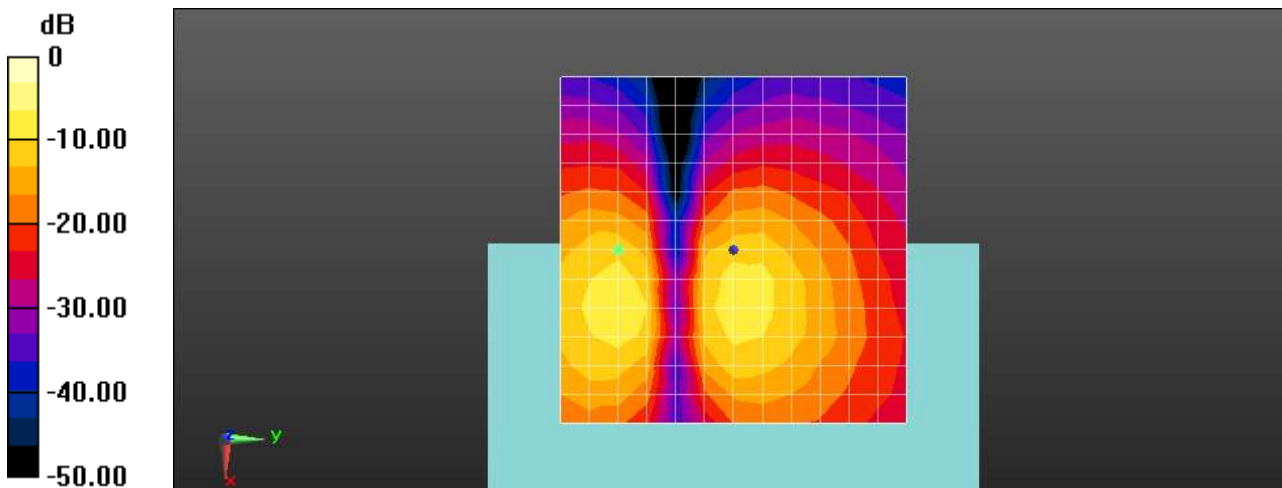

0 dB = 1.000 A/m = 0.00 dBA/m

Plot No.103

LTE 25 QPSK 20MHz 1RB 0offset 26365ch bitrate 75 kbits z(axial)

Communication System: UID 0, LTE Band 25 (0); Frequency: 1882.5 MHz;Duty Cycle: 1:1

Medium parameters used: $\sigma = 0$ S/m, $\epsilon_r = 1$; $\rho = 0$ kg/m³

Phantom section: TCoil Section

DASY5 Configuration:

- Probe: AM1DV3 - 3049; ; Calibrated: 2021-06-01
- Sensor-Surface: 0mm (Fix Surface)
- Electronics: DAE4 Sn652; Calibrated: 2022-01-24
- Phantom: HAC Test Arch with AMCC TCOIL
- Measurement SW: DASY52, Version 52.10 (4)

T-Coil scan (scan for ANSI C63.19-2007 & 2011 compliance)/General Scans/z (axial) 4.2mm 50 x

50/ABM Signal(x,y,z) (13x13x1): Measurement grid: dx=10mm, dy=10mm

Signal Type: Audio File (.wav) 48k_voice_1kHz_1s.wav

Output Gain: 19.15

Measure Window Start: 300ms

Measure Window Length: 1000ms

BWC applied: -0.19 dB

Device Reference Point: 0, 0, -6.3 mm

Cursor:

ABM1 comp = -0.59 dBA/m

BWC Factor = -0.19 dB

Location: 4.2, -8.3, 3.7 mm

Cursor:

ABM2 = -35.21 dBA/m

Location: 4.2, -8.3, 3.7 mm

Cursor:

ABM1/ABM2 = 34.62 dB

ABM1 comp = -0.59 dBA/m

BWC Factor = -0.19 dB

Location: 4.2, -8.3, 3.7 mm

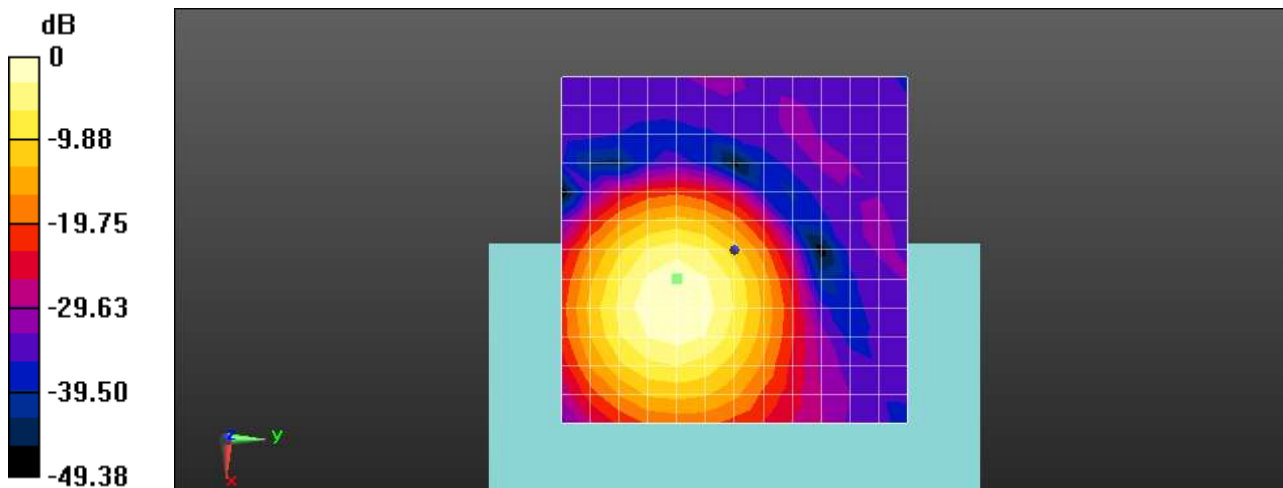

0 dB = 1.000 A/m = 0.00 dBA/m

Plot No.104

LTE 25 QPSK 20MHz 1RB 0offset 26365ch bitrate 75 kbits Freq.Response

Communication System: UID 0, LTE Band 25 (0); Frequency: 1882.5 MHz;Duty Cycle: 1:1

Medium parameters used: $\sigma = 0$ S/m, $\epsilon_r = 1$; $\rho = 0$ kg/m³

Phantom section: TCoil Section

T-Coil scan (scan for ANSI C63.19-2007 & 2011 compliance)/General Scans/z (axial) wideband at best

S/N/ABM Freq Resp(x,y,z,f) (1x1x1): Measurement grid: dx=10mm, dy=10mm

Signal Type: Audio File (.wav) 48k_Normal_51s new.wav

Output Gain: 58.25

Measure Window Start: 300ms

Measure Window Length: 51000ms

BWC applied: 9.13 dB

Device Reference Point: 0, 0, -6.3 mm

Category	Telephone parameters WD signal quality [(signal+noise)-to-noise ratio in decibels]
Category T1	0 dB to 10 dB
Category T2	10 dB to 20 dB
Category T3	20 dB to 30 dB
Category T4	> 30 dB

Cursor:

Diff = 2.00 dB

BWC Factor = 9.13 dB

Location: 3.8, -8.2, 3.7 mm

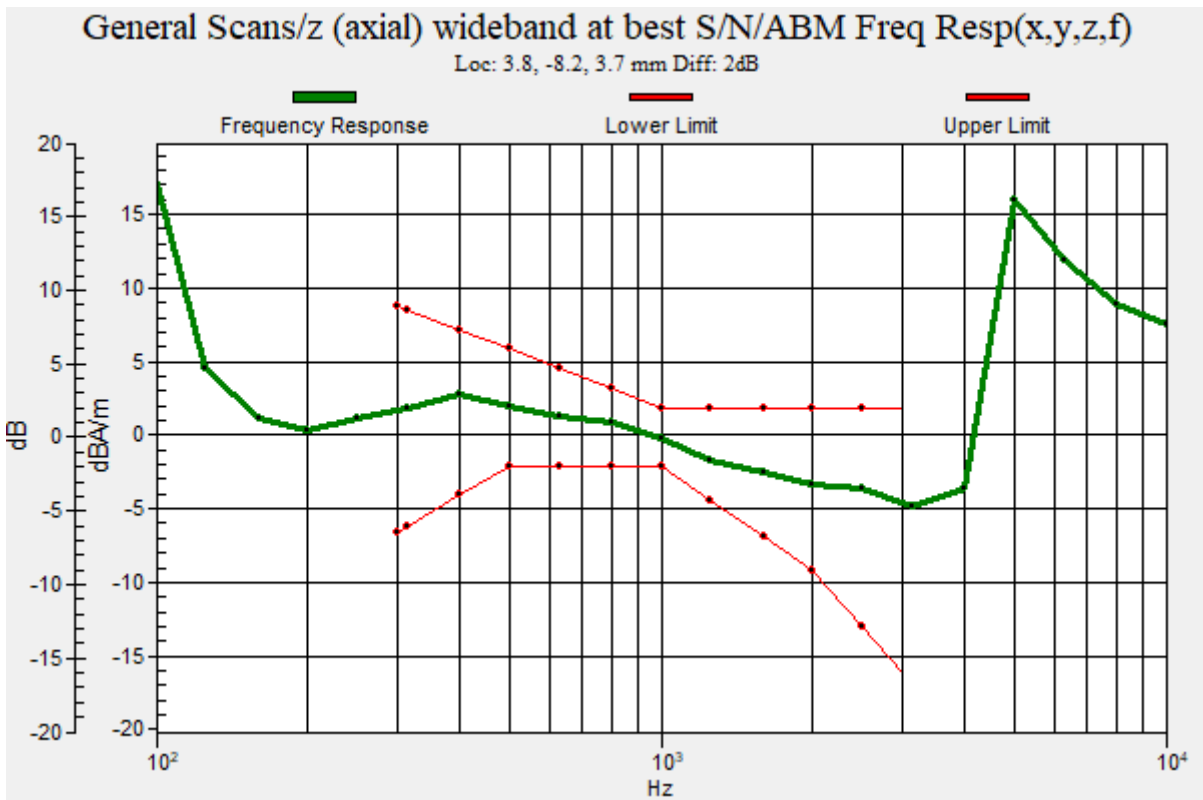

Plot No.105
LTE 25 QPSK 20MHz 1RB 0offset 26365ch bitrate 75 kbits y(transversal)

Communication System: UID 0, LTE Band 25 (0); Frequency: 1882.5 MHz;Duty Cycle: 1:1
Medium parameters used: $\sigma = 0$ S/m, $\epsilon_r = 1$; $\rho = 0$ kg/m³
Phantom section: TCoil Section

DASY5 Configuration:

- Probe: AM1DV3 - 3049; ; Calibrated: 2021-06-01
- Sensor-Surface: 0mm (Fix Surface)
- Electronics: DAE4 Sn652; Calibrated: 2022-01-24
- Phantom: HAC Test Arch with AMCC TCOIL
- Measurement SW: DASY52, Version 52.10 (4)

T-Coil scan (scan for ANSI C63.19-2007 & 2011 compliance)/General Scans/y (transversal) 4.2mm 50

x 50/ABM Signal(x,y,z) (13x13x1): Measurement grid: dx=10mm, dy=10mm

Signal Type: Audio File (.wav) 48k_voice_1kHz_1s.wav

Output Gain: 19.15

Measure Window Start: 300ms

Measure Window Length: 1000ms

BWC applied: -0.19 dB

Device Reference Point: 0, 0, -6.3 mm

Cursor:

ABM1 comp = -8.08 dBA/m

BWC Factor = -0.19 dB

Location: 4.2, 0, 3.7 mm

Cursor:

ABM2 = -42.39 dBA/m

Location: 4.2, 0, 3.7 mm

Cursor:

ABM1/ABM2 = 34.31 dB

ABM1 comp = -8.08 dBA/m

BWC Factor = -0.19 dB

Location: 4.2, 0, 3.7 mm

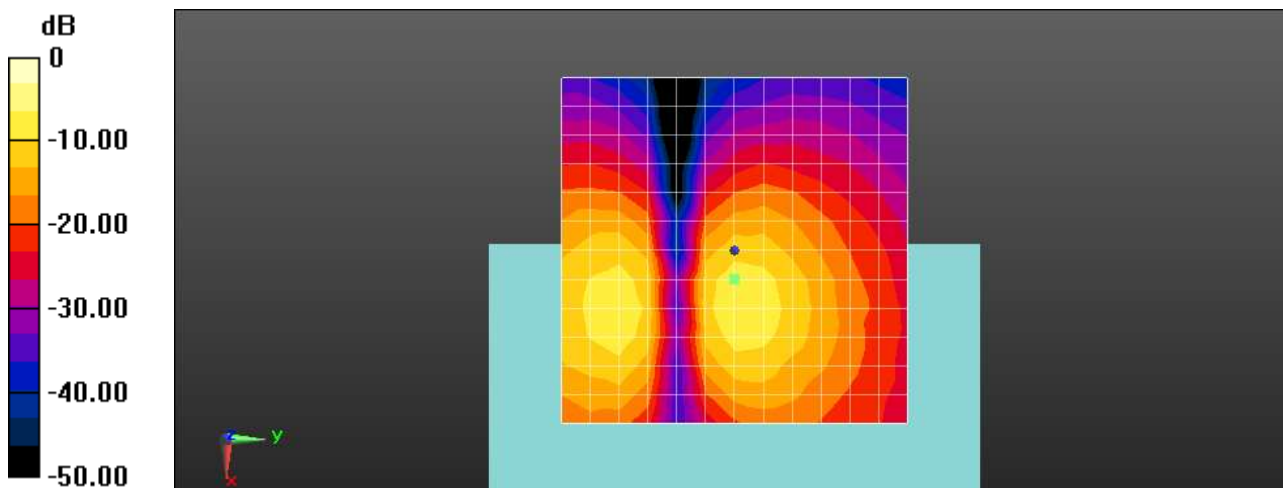

0 dB = 1.000 A/m = 0.00 dBA/m

Plot No.106

LTE 26 QPSK 15MHz 1RB 0offset 26865ch bitrate 75 kbits z (axial)

Communication System: UID 0, LTE Band 26 (0); Frequency: 831.5 MHz;Duty Cycle: 1:1
Medium parameters used: $\sigma = 0$ S/m, $\epsilon_r = 1$; $\rho = 0$ kg/m³
Phantom section: TCoil Section

DASY5 Configuration:

- Probe: AM1DV3 - 3049; ; Calibrated: 2021-06-01
- Sensor-Surface: 0mm (Fix Surface)
- Electronics: DAE4 Sn652; Calibrated: 2022-01-24
- Phantom: HAC Test Arch with AMCC TCOIL
- Measurement SW: DASY52, Version 52.10 (4)

T-Coil scan (scan for ANSI C63.19-2007 & 2011 compliance)/General Scans/z (axial) 4.2mm 50 x 50/ABM Signal(x,y,z) (13x13x1): Measurement grid: dx=10mm, dy=10mm

Signal Type: Audio File (.wav) 48k_voice_1kHz_1s.wav
Output Gain: 19.15
Measure Window Start: 300ms
Measure Window Length: 1000ms
BWC applied: -0.18 dB
Device Reference Point: 0, 0, -6.3 mm

Cursor:

ABM1 comp = 0.32 dBA/m
BWC Factor = -0.18 dB
Location: 8.3, -8.3, 3.7 mm

Cursor:

ABM2 = -33.59 dBA/m
Location: 8.3, -8.3, 3.7 mm

Cursor:

ABM1/ABM2 = 33.91 dB
ABM1 comp = 0.32 dBA/m
BWC Factor = -0.18 dB
Location: 8.3, -8.3, 3.7 mm

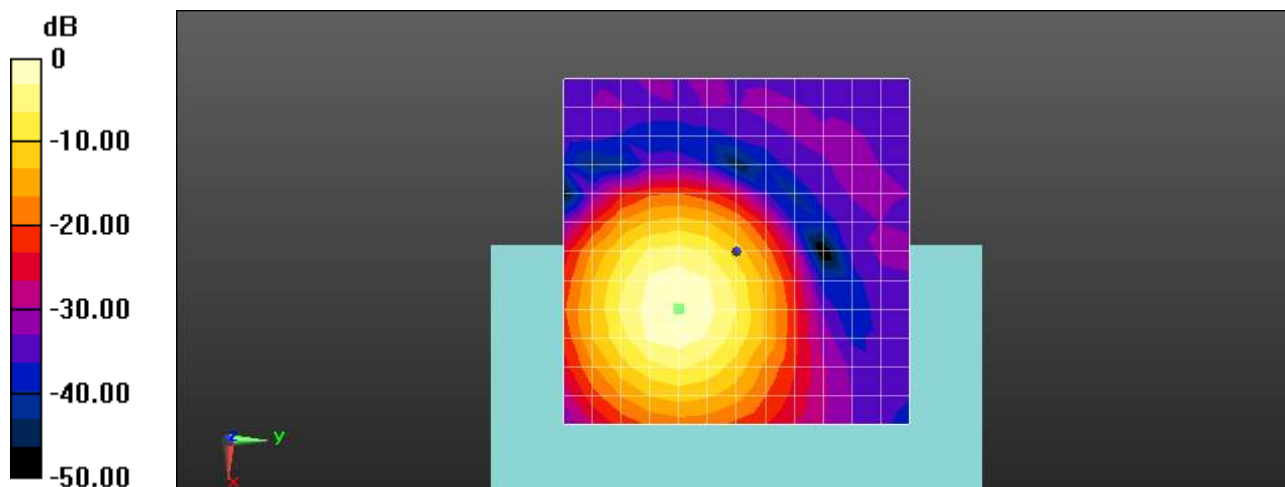

0 dB = 1.000 A/m = 0.00 dBA/m

Plot No.107

LTE 26 QPSK 15MHz 1RB 0offset 26865ch bitrate 75 kbits Freq.Response

Communication System: UID 0, LTE Band 26 (0); Frequency: 831.5 MHz;Duty Cycle: 1:1

Medium parameters used: $\sigma = 0$ S/m, $\epsilon_r = 1$; $\rho = 0$ kg/m³

Phantom section: TCoil Section

T-Coil scan (scan for ANSI C63.19-2007 & 2011 compliance)/General Scans/z (axial) wideband at best

S/N/ABM Freq Resp(x,y,z,f) (1x1x1): Measurement grid: dx=10mm, dy=10mm

Signal Type: Audio File (.wav) 48k_Normal_51s new.wav

Output Gain: 58.25

Measure Window Start: 300ms

Measure Window Length: 51000ms

BWC applied: 9.14 dB

Device Reference Point: 0, 0, -6.3 mm

Category	Telephone parameters WD signal quality [(signal+noise)-to-noise ratio in decibels]
Category T1	0 dB to 10 dB
Category T2	10 dB to 20 dB
Category T3	20 dB to 30 dB
Category T4	> 30 dB

Cursor:

Diff = 2.00 dB

BWC Factor = 9.14 dB

Location: 7.6, -8.5, 3.7 mm

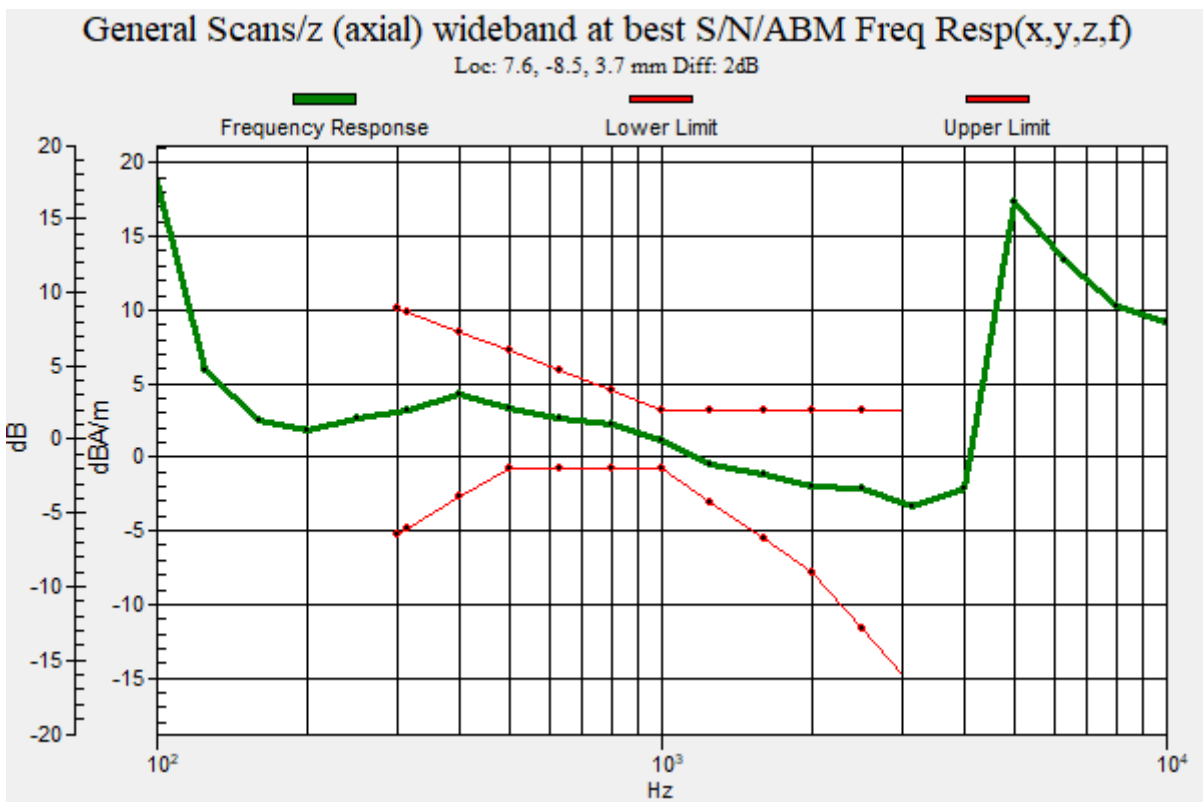

Plot No.108

LTE 26 QPSK 15MHz 1RB 0offset 26865ch bitrate 75 kbits y(transversal)

Communication System: UID 0, LTE Band 26 (0); Frequency: 831.5 MHz;Duty Cycle: 1:1

Medium parameters used: $\sigma = 0$ S/m, $\epsilon_r = 1$; $\rho = 0$ kg/m³

Phantom section: TCoil Section

DASY5 Configuration:

- Probe: AM1DV3 - 3049; ; Calibrated: 2021-06-01
- Sensor-Surface: 0mm (Fix Surface)
- Electronics: DAE4 Sn652; Calibrated: 2022-01-24
- Phantom: HAC Test Arch with AMCC TCOIL
- Measurement SW: DASY52, Version 52.10 (4)

T-Coil scan (scan for ANSI C63.19-2007 & 2011 compliance)/General Scans/y (transversal) 4.2mm 50

x 50/ABM Signal(x,y,z) (13x13x1): Measurement grid: dx=10mm, dy=10mm

Signal Type: Audio File (.wav) 48k_voice_1kHz_1s.wav

Output Gain: 19.15

Measure Window Start: 300ms

Measure Window Length: 1000ms

BWC applied: -0.18 dB

Device Reference Point: 0, 0, -6.3 mm

Cursor:

ABM1 comp = -10.77 dBA/m

BWC Factor = -0.18 dB

Location: 0, 0, 3.7 mm

Cursor:

ABM2 = -44.36 dBA/m

Location: 0, 0, 3.7 mm

Cursor:

ABM1/ABM2 = 33.59 dB

ABM1 comp = -10.77 dBA/m

BWC Factor = -0.18 dB

Location: 0, 0, 3.7 mm

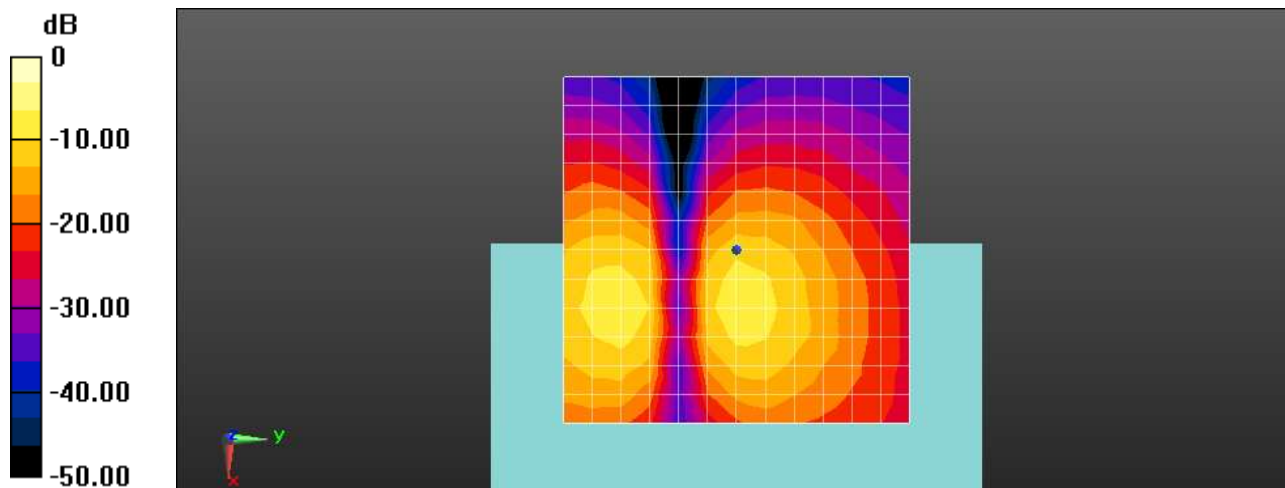

0 dB = 1.000 A/m = 0.00 dBA/m

Plot No.109

LTE 30 QPSK 10MHz 1RB 0offset 27710ch bitrate 75 kbits z(axial)

Communication System: UID 0, LTE Band30 (0); Frequency: 2310 MHz;Duty Cycle: 1:1

Medium parameters used: $\sigma = 0$ S/m, $\epsilon_r = 1$; $\rho = 0$ kg/m³

Phantom section: TCoil Section

DASY5 Configuration:

- Probe: AM1DV3 - 3049; ; Calibrated: 2021-06-01
- Sensor-Surface: 0mm (Fix Surface)
- Electronics: DAE4 Sn652; Calibrated: 2022-01-24
- Phantom: HAC Test Arch with AMCC TCOIL
- Measurement SW: DASY52, Version 52.10 (4)

T-Coil scan (scan for ANSI C63.19-2007 & 2011 compliance)/General Scans/z (axial) 4.2mm 50 x

50/ABM Signal(x,y,z) (13x13x1): Measurement grid: dx=10mm, dy=10mm

Signal Type: Audio File (.wav) 48k_voice_1kHz_1s.wav

Output Gain: 19.15

Measure Window Start: 300ms

Measure Window Length: 1000ms

BWC applied: -0.18 dB

Device Reference Point: 0, 0, -6.3 mm

Cursor:

ABM1 comp = -0.55 dBA/m

BWC Factor = -0.18 dB

Location: 4.2, -8.3, 3.7 mm

Cursor:

ABM2 = -34.98 dBA/m

Location: 4.2, -8.3, 3.7 mm

Cursor:

ABM1/ABM2 = 34.43 dB

ABM1 comp = -0.55 dBA/m

BWC Factor = -0.18 dB

Location: 4.2, -8.3, 3.7 mm

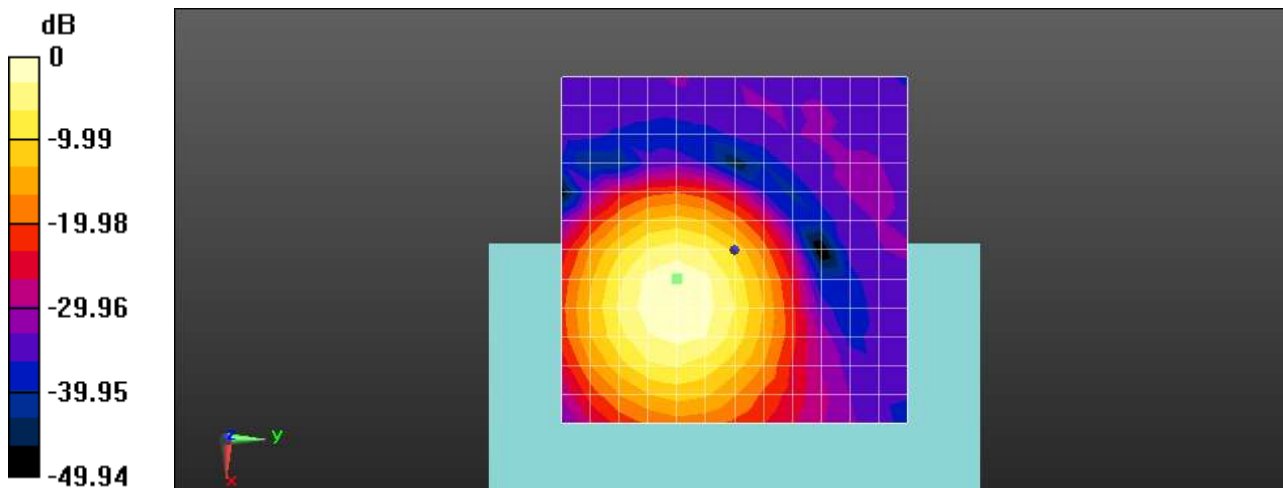

0 dB = 1.000 A/m = 0.00 dBA/m

Plot No.110
LTE 30 QPSK 10MHz 1RB 0offset 27710ch bitrate 75 kbits Freq.Response

Communication System: UID 0, LTE Band30 (0); Frequency: 2310 MHz;Duty Cycle: 1:1
 Medium parameters used: $\sigma = 0$ S/m, $\epsilon_r = 1$; $\rho = 0$ kg/m³
 Phantom section: TCoil Section

T-Coil scan (scan for ANSI C63.19-2007 & 2011 compliance)/General Scans/z (axial) wideband at best S/N/ABM Freq Resp(x,y,z,f) (1x1x1): Measurement grid: dx=10mm, dy=10mm
 Signal Type: Audio File (.wav) 48k_Normal_51s new.wav
 Output Gain: 58.25
 Measure Window Start: 300ms
 Measure Window Length: 51000ms
 BWC applied: 9.13 dB
 Device Reference Point: 0, 0, -6.3 mm

Category	Telephone parameters WD signal quality [(signal+noise)-to-noise ratio in decibels]
Category T1	0 dB to 10 dB
Category T2	10 dB to 20 dB
Category T3	20 dB to 30 dB
Category T4	> 30 dB

Cursor:
 Diff = 2.00 dB
 BWC Factor = 9.13 dB
 Location: 4, -9.3, 3.7 mm

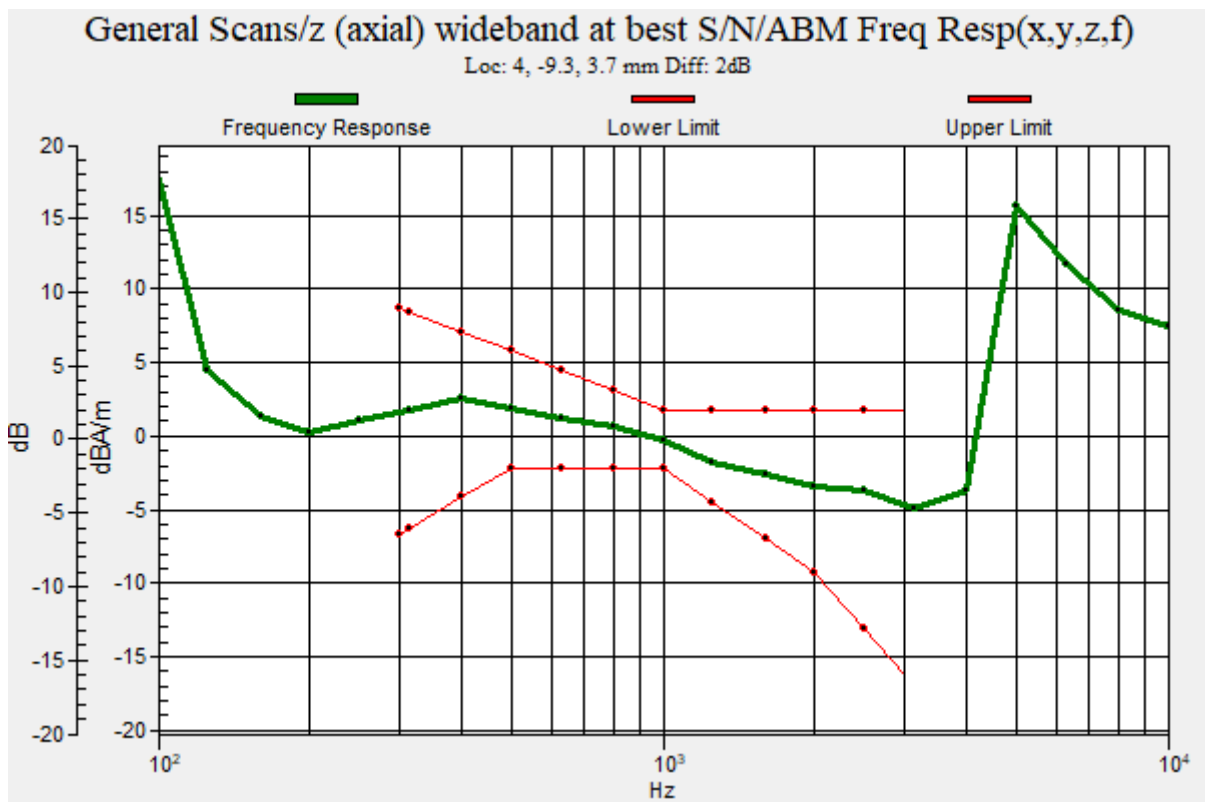

Plot No.111

LTE 30 QPSK 10MHz 1RB 0offset 27710ch bitrate 75 kbits y(transversal)

Communication System: UID 0, LTE Band30 (0); Frequency: 2310 MHz;Duty Cycle: 1:1

Medium parameters used: $\sigma = 0$ S/m, $\epsilon_r = 1$; $\rho = 0$ kg/m³

Phantom section: TCoil Section

DASY5 Configuration:

- Probe: AM1DV3 - 3049; ; Calibrated: 2021-06-01
- Sensor-Surface: 0mm (Fix Surface)
- Electronics: DAE4 Sn652; Calibrated: 2022-01-24
- Phantom: HAC Test Arch with AMCC TCOIL
- Measurement SW: DASY52, Version 52.10 (4)

T-Coil scan (scan for ANSI C63.19-2007 & 2011 compliance)/General Scans/y (transversal) 4.2mm 50

x 50/ABM Signal(x,y,z) (13x13x1): Measurement grid: dx=10mm, dy=10mm

Signal Type: Audio File (.wav) 48k_voice_1kHz_1s.wav

Output Gain: 19.15

Measure Window Start: 300ms

Measure Window Length: 1000ms

BWC applied: -0.18 dB

Device Reference Point: 0, 0, -6.3 mm

Cursor:

ABM1 comp = -8.16 dBA/m

BWC Factor = -0.18 dB

Location: 4.2, 0, 3.7 mm

Cursor:

ABM2 = -41.95 dBA/m

Location: 4.2, 0, 3.7 mm

Cursor:

ABM1/ABM2 = 33.79 dB

ABM1 comp = -8.16 dBA/m

BWC Factor = -0.18 dB

Location: 4.2, 0, 3.7 mm

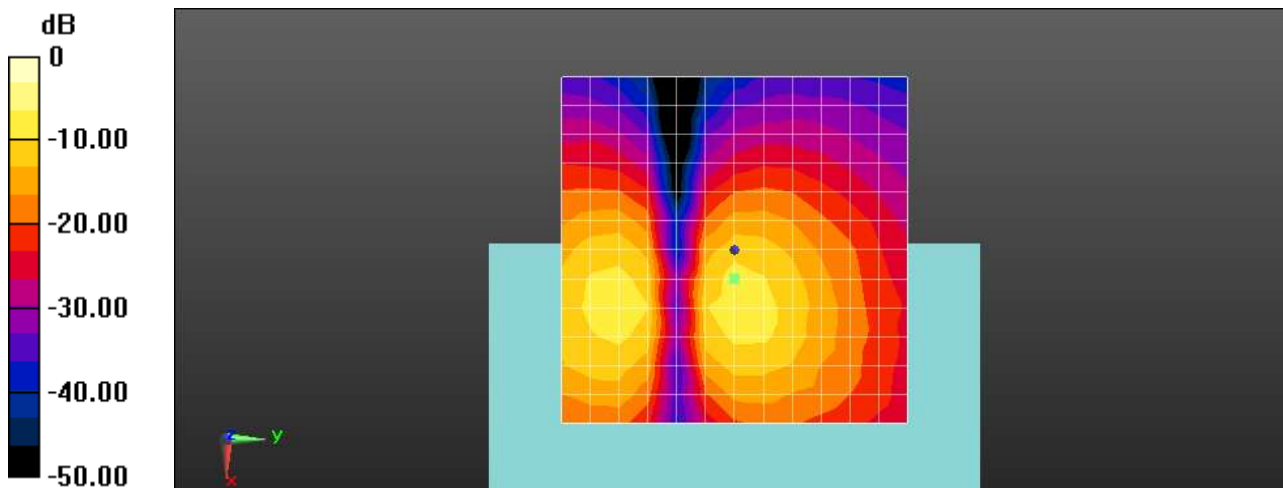

0 dB = 1.000 A/m = 0.00 dBA/m

Plot No.112

LTE 66 QPSK 20MHz 1RB 0offset 132322ch bitrate 75 kbits z(axial)

Communication System: UID 0, LTE Band66 (0); Frequency: 1745 MHz;Duty Cycle: 1:1

Medium parameters used: $\sigma = 0$ S/m, $\epsilon_r = 1$; $\rho = 0$ kg/m³

Phantom section: TCoil Section

DASY5 Configuration:

- Probe: AM1DV3 - 3049; ; Calibrated: 2021-06-01
- Sensor-Surface: 0mm (Fix Surface)
- Electronics: DAE4 Sn652; Calibrated: 2022-01-24
- Phantom: HAC Test Arch with AMCC TCOIL
- Measurement SW: DASY52, Version 52.10 (4)

T-Coil scan (scan for ANSI C63.19-2007 & 2011 compliance)/General Scans/z (axial) 4.2mm 50 x

50/ABM Signal(x,y,z) (13x13x1): Measurement grid: dx=10mm, dy=10mm

Signal Type: Audio File (.wav) 48k_voice_1kHz_1s.wav

Output Gain: 19.15

Measure Window Start: 300ms

Measure Window Length: 1000ms

BWC applied: -0.19 dB

Device Reference Point: 0, 0, -6.3 mm

Cursor:

ABM1 comp = -5.80 dBA/m

BWC Factor = -0.19 dB

Location: 0, -12.5, 3.7 mm

Cursor:

ABM2 = -40.12 dBA/m

Location: 0, -12.5, 3.7 mm

Cursor:

ABM1/ABM2 = 34.31 dB

ABM1 comp = -5.80 dBA/m

BWC Factor = -0.19 dB

Location: 0, -12.5, 3.7 mm

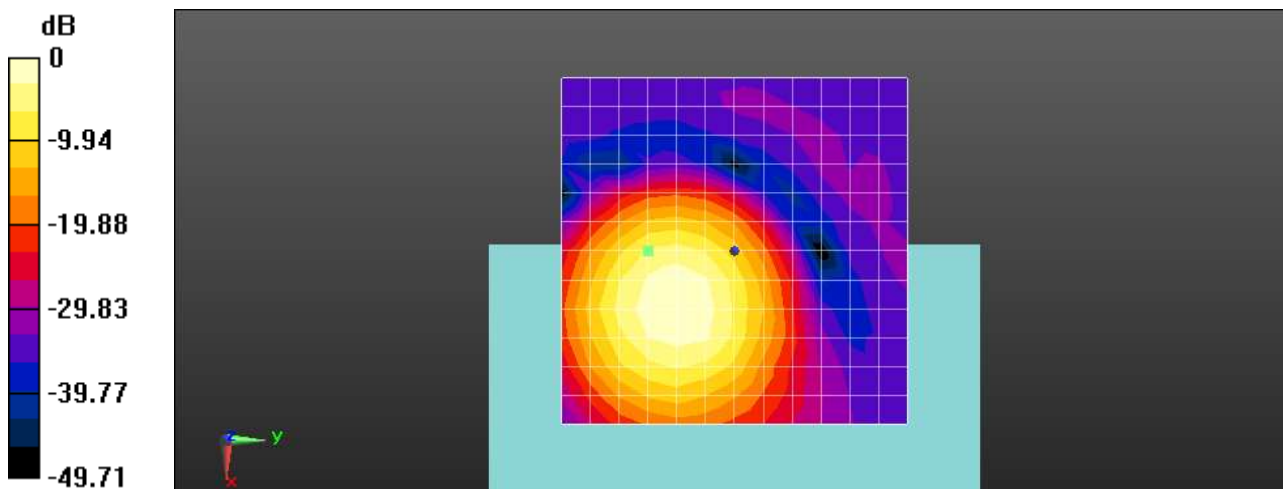

0 dB = 1.000 A/m = 0.00 dBA/m

Plot No.113
LTE 66 QPSK 20MHz 1RB 0offset 132322ch bitrate 75 kbits Freq.Response

Communication System: UID 0, LTE Band66 (0); Frequency: 1745 MHz;Duty Cycle: 1:1
 Medium parameters used: $\sigma = 0$ S/m, $\epsilon_r = 1$; $\rho = 0$ kg/m³
 Phantom section: TCoil Section

T-Coil scan (scan for ANSI C63.19-2007 & 2011 compliance)/General Scans/z (axial) wideband at best S/N/ABM Freq Resp(x,y,z,f) (1x1x1): Measurement grid: dx=10mm, dy=10mm
 Signal Type: Audio File (.wav) 48k_Normal_51s new.wav
 Output Gain: 58.25
 Measure Window Start: 300ms
 Measure Window Length: 51000ms
 BWC applied: 9.13 dB
 Device Reference Point: 0, 0, -6.3 mm

Category	Telephone parameters WD signal quality [(signal+noise)-to-noise ratio in decibels]
Category T1	0 dB to 10 dB
Category T2	10 dB to 20 dB
Category T3	20 dB to 30 dB
Category T4	> 30 dB

Cursor:
 Diff = 2.00 dB
 BWC Factor = 9.13 dB
 Location: 0.3, -11.9, 3.7 mm

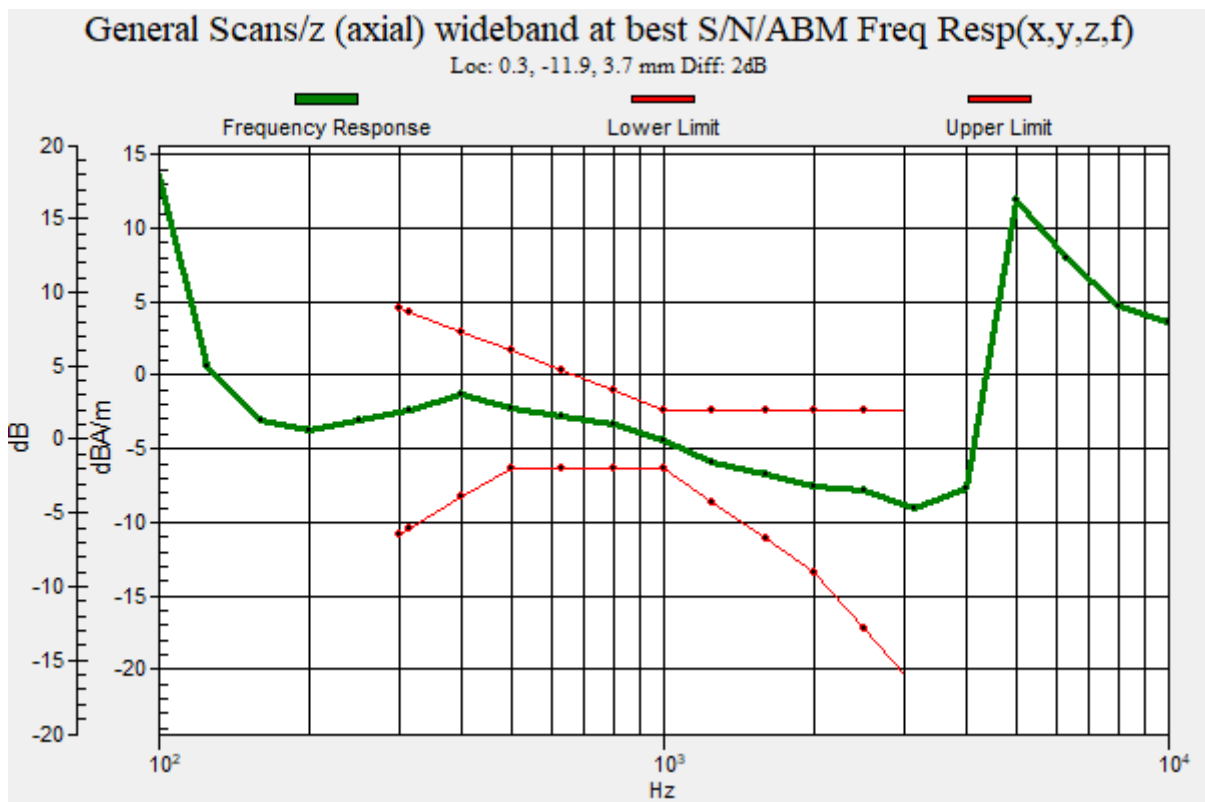

Plot No.114
LTE 66 QPSK 20MHz 1RB 0offset 132322ch bitrate 75 kbits y(transversal)

Communication System: UID 0, LTE Band66 (0); Frequency: 1745 MHz;Duty Cycle: 1:1
Medium parameters used: $\sigma = 0$ S/m, $\epsilon_r = 1$; $\rho = 0$ kg/m³
Phantom section: TCoil Section

DASY5 Configuration:

- Probe: AM1DV3 - 3049; ; Calibrated: 2021-06-01
- Sensor-Surface: 0mm (Fix Surface)
- Electronics: DAE4 Sn652; Calibrated: 2022-01-24
- Phantom: HAC Test Arch with AMCC TCOIL
- Measurement SW: DASY52, Version 52.10 (4)

T-Coil scan (scan for ANSI C63.19-2007 & 2011 compliance)/General Scans/y (transversal) 4.2mm 50 x 50/ABM Signal(x,y,z) (13x13x1): Measurement grid: dx=10mm, dy=10mm

Signal Type: Audio File (.wav) 48k_voice_1kHz_1s.wav
Output Gain: 19.15
Measure Window Start: 300ms
Measure Window Length: 1000ms
BWC applied: -0.19 dB
Device Reference Point: 0, 0, -6.3 mm

Cursor:

ABM1 comp = -11.35 dBA/m
BWC Factor = -0.19 dB
Location: 0, -20.8, 3.7 mm

Cursor:

ABM2 = -45.25 dBA/m
Location: 0, -20.8, 3.7 mm

Cursor:

ABM1/ABM2 = 33.90 dB
ABM1 comp = -11.35 dBA/m
BWC Factor = -0.19 dB
Location: 0, -20.8, 3.7 mm

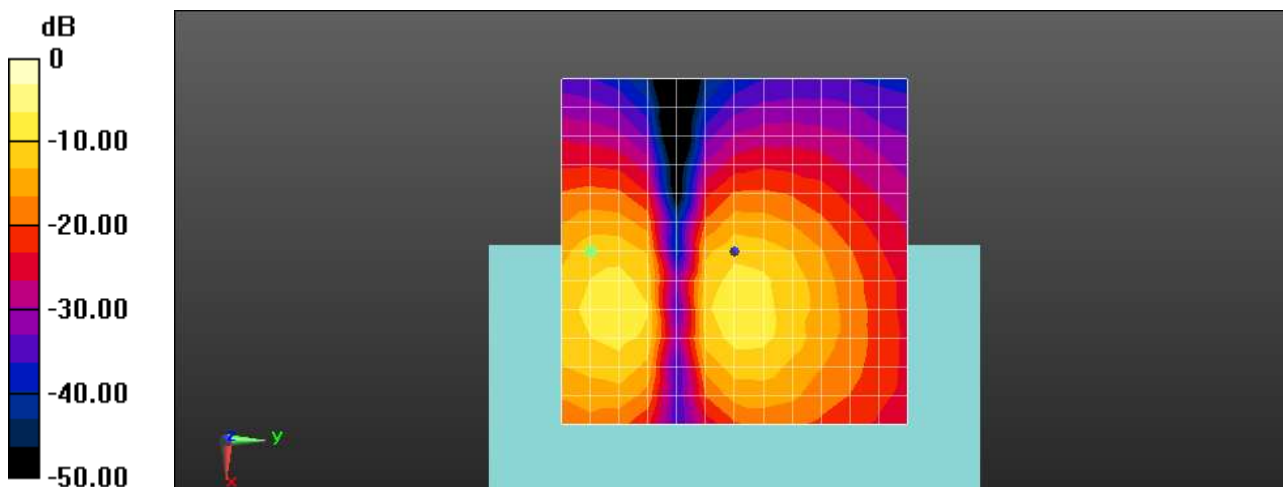

0 dB = 1.000 A/m = 0.00 dBA/m

Plot No.115

LTE Band 71 QPSK 20MHz 1RB 0offset 133297ch bitrate 75 kbits z(axial)

Communication System: UID 0, LTE Band 71 (0); Frequency: 680.5 MHz;Duty Cycle: 1:1

Medium parameters used: $\sigma = 0$ S/m, $\epsilon_r = 1$; $\rho = 0$ kg/m³

Phantom section: TCoil Section

DASY5 Configuration:

- Probe: AM1DV3 - 3049; ; Calibrated: 2021-06-01
- Sensor-Surface: 0mm (Fix Surface)
- Electronics: DAE4 Sn652; Calibrated: 2022-01-24
- Phantom: HAC Test Arch with AMCC TCOIL
- Measurement SW: DASY52, Version 52.10 (4)

T-Coil scan (scan for ANSI C63.19-2007 & 2011 compliance)/General Scans/z (axial) 4.2mm 50 x

50/ABM Signal(x,y,z) (13x13x1): Measurement grid: dx=10mm, dy=10mm

Signal Type: Audio File (.wav) 48k_voice_1kHz_1s.wav

Output Gain: 19.15

Measure Window Start: 300ms

Measure Window Length: 1000ms

BWC applied: -0.19 dB

Device Reference Point: 0, 0, -6.3 mm

Cursor:

ABM1 comp = -5.66 dBA/m

BWC Factor = -0.19 dB

Location: 0, -12.5, 3.7 mm

Cursor:

ABM2 = -40.01 dBA/m

Location: 0, -12.5, 3.7 mm

Cursor:

ABM1/ABM2 = 34.35 dB

ABM1 comp = -5.66 dBA/m

BWC Factor = -0.19 dB

Location: 0, -12.5, 3.7 mm

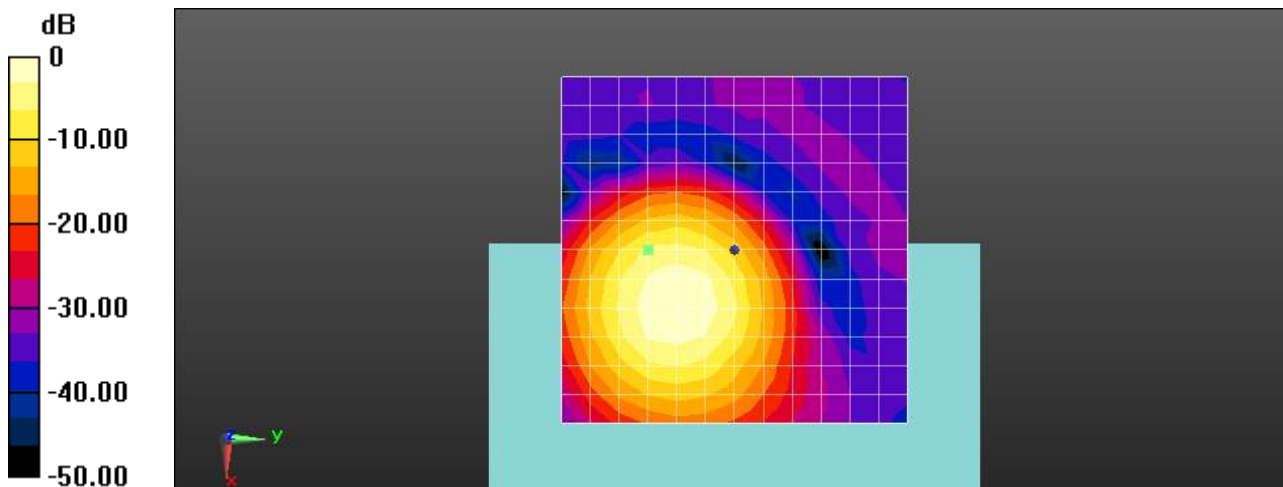

0 dB = 1.000 A/m = 0.00 dBA/m

Plot No.116

LTE Band 71 QPSK 20MHz 1RB 0offset 133297ch bitrate 75 kbits Freq.Response

Communication System: UID 0, LTE Band 71 (0); Frequency: 680.5 MHz;Duty Cycle: 1:1

Medium parameters used: $\sigma = 0$ S/m, $\epsilon_r = 1$; $\rho = 0$ kg/m³

Phantom section: TCoil Section

T-Coil scan (scan for ANSI C63.19-2007 & 2011 compliance)/General Scans/z (axial) wideband at best

S/N/ABM Freq Resp(x,y,z,f) (1x1x1): Measurement grid: dx=10mm, dy=10mm

Signal Type: Audio File (.wav) 48k_Normal_51s new.wav

Output Gain: 58.25

Measure Window Start: 300ms

Measure Window Length: 51000ms

BWC applied: 9.13 dB

Device Reference Point: 0, 0, -6.3 mm

Category	Telephone parameters WD signal quality [(signal+noise)-to-noise ratio in decibels]
Category T1	0 dB to 10 dB
Category T2	10 dB to 20 dB
Category T3	20 dB to 30 dB
Category T4	> 30 dB

Cursor:

Diff = 2.00 dB

BWC Factor = 9.13 dB

Location: 0.5, -12.5, 3.7 mm

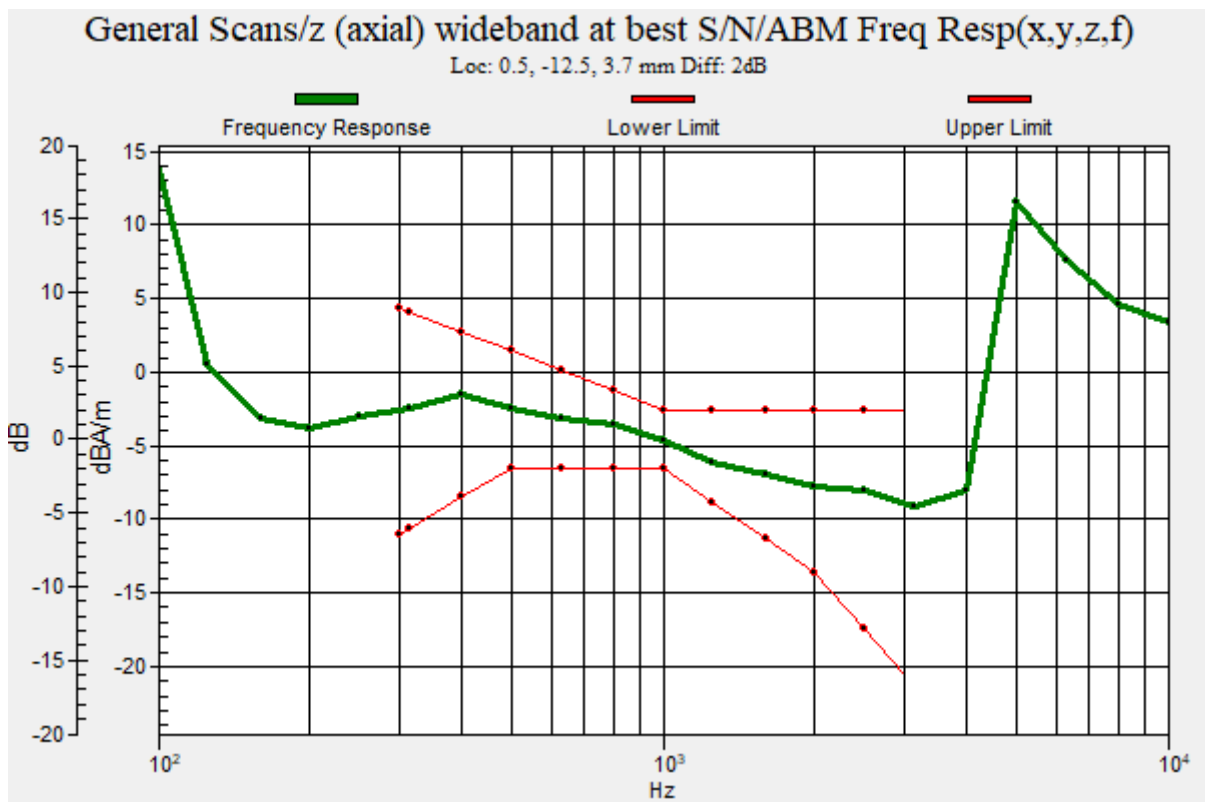

Plot No.117

LTE Band 71 QPSK 20MHz 1RB 0offset 133297ch bitrate 75 kbits y(transversal)

Communication System: UID 0, LTE Band 71 (0); Frequency: 680.5 MHz;Duty Cycle: 1:1
Medium parameters used: $\sigma = 0$ S/m, $\epsilon_r = 1$; $\rho = 0$ kg/m³
Phantom section: TCoil Section

DASY5 Configuration:

- Probe: AM1DV3 - 3049; ; Calibrated: 2021-06-01
- Sensor-Surface: 0mm (Fix Surface)
- Electronics: DAE4 Sn652; Calibrated: 2022-01-24
- Phantom: HAC Test Arch with AMCC TCOIL
- Measurement SW: DASY52, Version 52.10 (4)

T-Coil scan (scan for ANSI C63.19-2007 & 2011 compliance)/General Scans/y (transversal) 4.2mm 50 x 50/ABM Signal(x,y,z) (13x13x1): Measurement grid: dx=10mm, dy=10mm

Signal Type: Audio File (.wav) 48k_voice_1kHz_1s.wav
Output Gain: 19.15
Measure Window Start: 300ms
Measure Window Length: 1000ms
BWC applied: -0.19 dB
Device Reference Point: 0, 0, -6.3 mm

Cursor:

ABM1 comp = -10.85 dBA/m
BWC Factor = -0.19 dB
Location: 0, 4.2, 3.7 mm

Cursor:

ABM2 = -44.82 dBA/m
Location: 0, 4.2, 3.7 mm

Cursor:

ABM1/ABM2 = 33.98 dB
ABM1 comp = -10.85 dBA/m
BWC Factor = -0.19 dB
Location: 0, 4.2, 3.7 mm

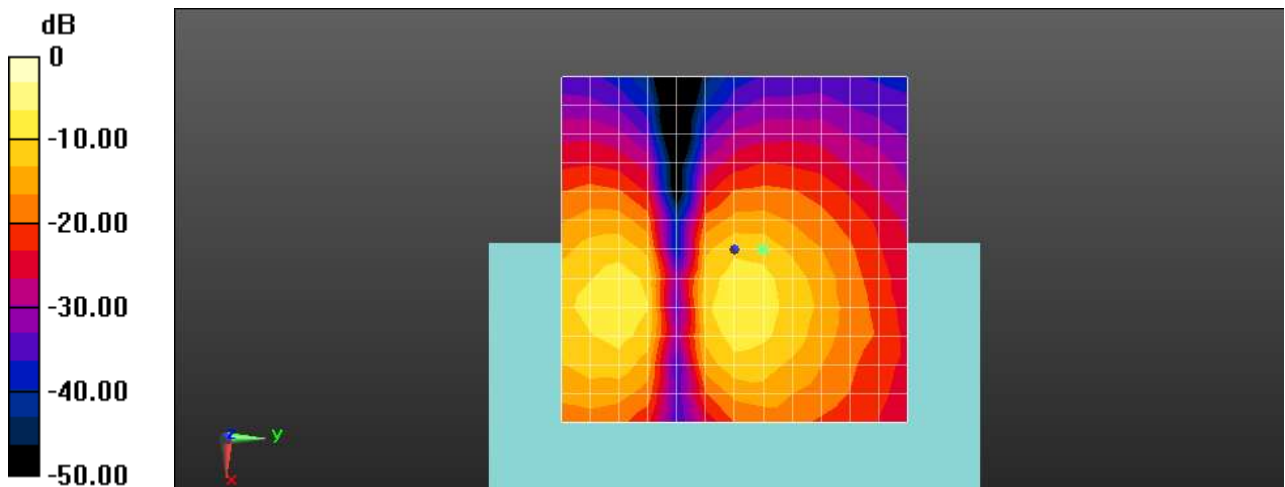

0 dB = 1.000 A/m = 0.00 dBA/m

Plot No.118

LTE 38 QPSK 20MHz 1RB 99offset 38000ch bitrate 75 kbits z(axial)

Communication System: UID 0, LTE Band 38 (0); Frequency: 2595 MHz;Duty Cycle: 1:2.30728

Medium parameters used: $\sigma = 0$ S/m, $\epsilon_r = 1$; $\rho = 0$ kg/m³

Phantom section: TCoil Section

DASY5 Configuration:

- Probe: AM1DV3 - 3049; ; Calibrated: 2021-06-01
- Sensor-Surface: 0mm (Fix Surface)
- Electronics: DAE4 Sn652; Calibrated: 2022-01-24
- Phantom: HAC Test Arch with AMCC TCOIL
- Measurement SW: DASY52, Version 52.10 (4)

T-Coil scan (scan for ANSI C63.19-2007 & 2011 compliance)/General Scans/z (axial) 4.2mm 50 x

50/ABM Signal(x,y,z) (13x13x1): Measurement grid: dx=10mm, dy=10mm

Signal Type: Audio File (.wav) 48k_voice_1kHz_1s.wav

Output Gain: 19.15

Measure Window Start: 300ms

Measure Window Length: 1000ms

BWC applied: -0.20 dB

Device Reference Point: 0, 0, -6.3 mm

Cursor:

ABM1 comp = -0.19 dBA/m

BWC Factor = -0.20 dB

Location: 4.2, -8.3, 3.7 mm

Cursor:

ABM2 = -34.02 dBA/m

Location: 4.2, -8.3, 3.7 mm

Cursor:

ABM1/ABM2 = 33.83 dB

ABM1 comp = -0.19 dBA/m

BWC Factor = -0.20 dB

Location: 4.2, -8.3, 3.7 mm

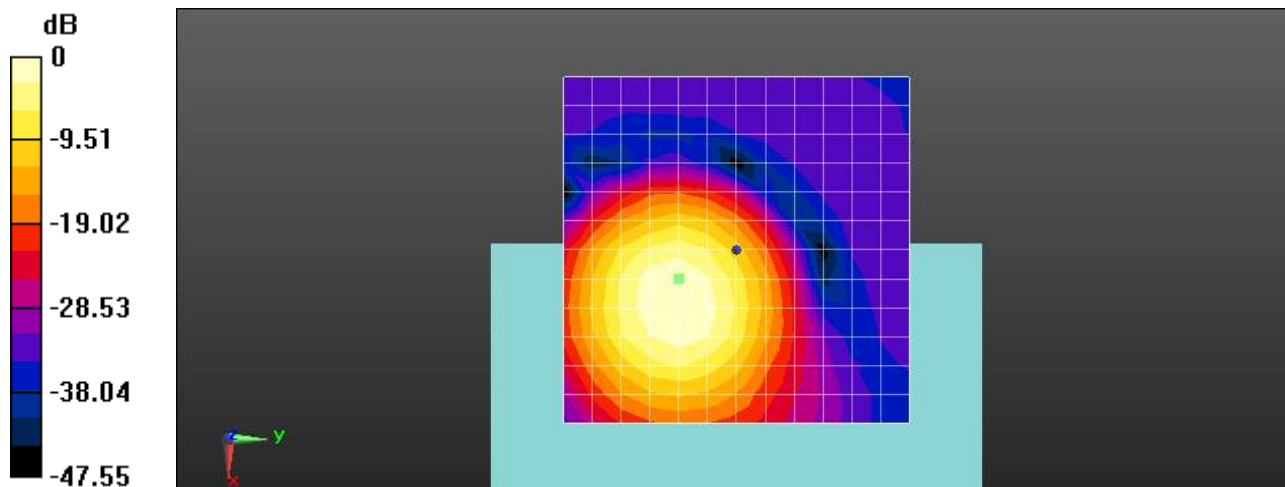

0 dB = 1.000 A/m = 0.00 dBA/m

Plot No.119
LTE 38 QPSK 20MHz 1RB 99offset 38000ch bitrate 75 kbits Freq.Response

Communication System: UID 0, LTE Band 38 (0); Frequency: 2595 MHz;Duty Cycle: 1:2.30728
 Medium parameters used: $\sigma = 0$ S/m, $\epsilon_r = 1$; $\rho = 0$ kg/m³
 Phantom section: TCoil Section

T-Coil scan (scan for ANSI C63.19-2007 & 2011 compliance)/General Scans/z (axial) wideband at best S/N/ABM Freq Resp(x,y,z,f) (1x1x1): Measurement grid: dx=10mm, dy=10mm
 Signal Type: Audio File (.wav) 48k_Normal_51s new.wav
 Output Gain: 58.25
 Measure Window Start: 300ms
 Measure Window Length: 51000ms
 BWC applied: 9.12 dB
 Device Reference Point: 0, 0, -6.3 mm

Category	Telephone parameters WD signal quality [(signal+noise)-to-noise ratio in decibels]
Category T1	0 dB to 10 dB
Category T2	10 dB to 20 dB
Category T3	20 dB to 30 dB
Category T4	> 30 dB

Cursor:
 Diff = 2.00 dB
 BWC Factor = 9.12 dB
 Location: 6, -11.1, 3.7 mm

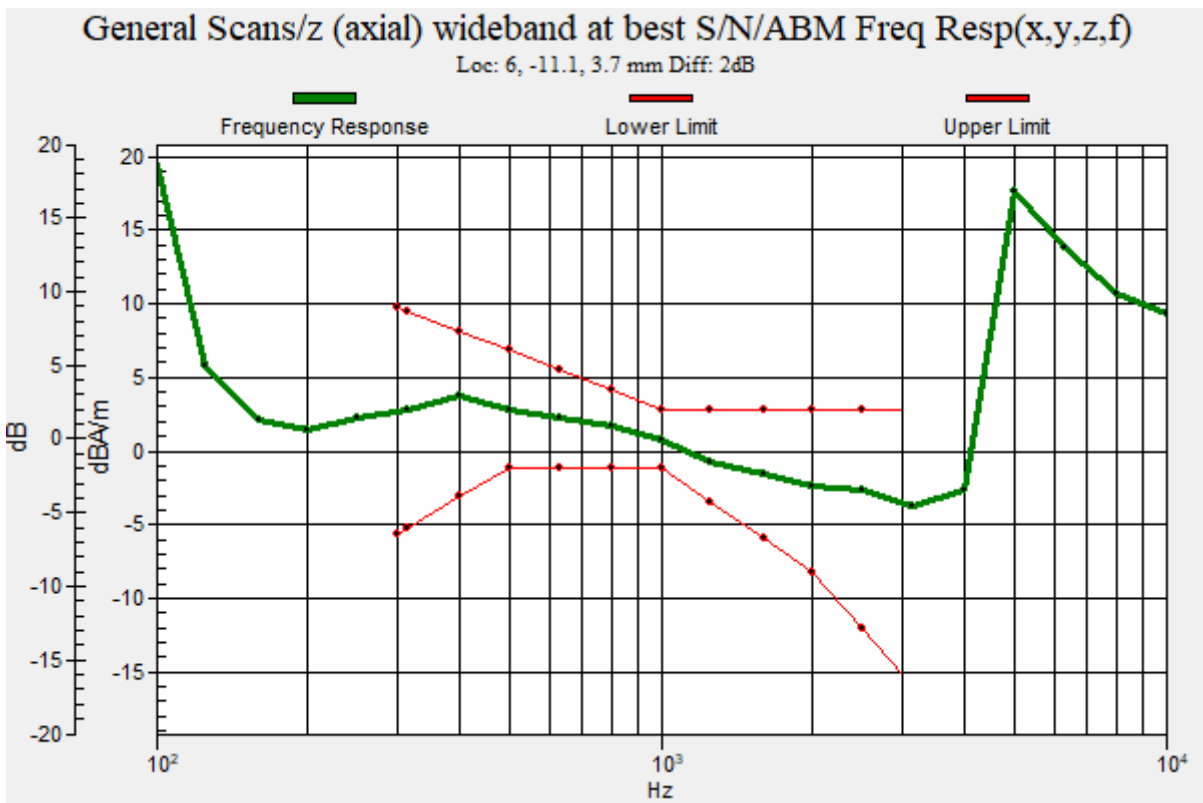

Plot No.120
LTE 38 QPSK 20MHz 1RB 99offset 38000ch bitrate 75 kbits y(transversal)

Communication System: UID 0, LTE Band 38 (0); Frequency: 2595 MHz;Duty Cycle: 1:2.30728
Medium parameters used: $\sigma = 0$ S/m, $\epsilon_r = 1$; $\rho = 0$ kg/m³
Phantom section: TCoil Section

DASY5 Configuration:

- Probe: AM1DV3 - 3049; ; Calibrated: 2021-06-01
- Sensor-Surface: 0mm (Fix Surface)
- Electronics: DAE4 Sn652; Calibrated: 2022-01-24
- Phantom: HAC Test Arch with AMCC TCOIL
- Measurement SW: DASY52, Version 52.10 (4)

T-Coil scan (scan for ANSI C63.19-2007 & 2011 compliance)/General Scans/y (transversal) 4.2mm 50

x 50/ABM Signal(x,y,z) (13x13x1): Measurement grid: dx=10mm, dy=10mm
Signal Type: Audio File (.wav) 48k_voice_1kHz_1s.wav
Output Gain: 19.15
Measure Window Start: 300ms
Measure Window Length: 1000ms
BWC applied: -0.20 dB
Device Reference Point: 0, 0, -6.3 mm

Cursor:

ABM1 comp = -10.96 dBA/m
BWC Factor = -0.20 dB
Location: 0, 4.2, 3.7 mm

Cursor:

ABM2 = -43.83 dBA/m
Location: 0, 4.2, 3.7 mm

Cursor:

ABM1/ABM2 = 32.87 dB
ABM1 comp = -10.96 dBA/m
BWC Factor = -0.20 dB
Location: 0, 4.2, 3.7 mm

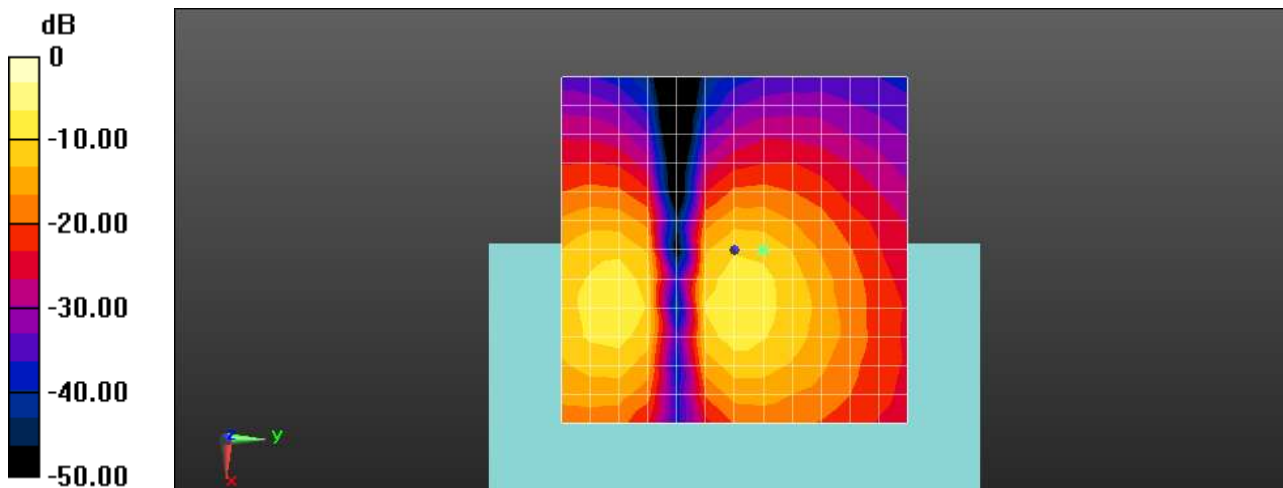

0 dB = 1.000 A/m = 0.00 dBA/m

Plot No.121
LTE 40 QPSK 10MHz 1RB 49offset 38750ch bitrate 75 kbits z(axial)

Communication System: UID 0, LTE Band40 (0); Frequency: 2310 MHz;Duty Cycle: 1:2.30728
 Medium parameters used: $\sigma = 0$ S/m, $\epsilon_r = 1$; $\rho = 0$ kg/m³
 Phantom section: TCoil Section

DASY5 Configuration:

- Probe: AM1DV3 - 3049; ; Calibrated: 2021-06-01
- Sensor-Surface: 0mm (Fix Surface)
- Electronics: DAE4 Sn652; Calibrated: 2022-01-24
- Phantom: HAC Test Arch with AMCC TCOIL
- Measurement SW: DASY52, Version 52.10 (4)

T-Coil scan (scan for ANSI C63.19-2007 & 2011 compliance)/General Scans/z (axial) 4.2mm 50 x 50/ABM Signal(x,y,z) (13x13x1): Measurement grid: dx=10mm, dy=10mm

Signal Type: Audio File (.wav) 48k_voice_1kHz_1s.wav
 Output Gain: 19.15
 Measure Window Start: 300ms
 Measure Window Length: 1000ms
 BWC applied: -0.19 dB
 Device Reference Point: 0, 0, -6.3 mm

Cursor:

ABM1 comp = -2.17 dBA/m
 BWC Factor = -0.19 dB
 Location: 4.2, -4.2, 3.7 mm

Cursor:

ABM2 = -36.15 dBA/m
 Location: 4.2, -4.2, 3.7 mm

Cursor:

ABM1/ABM2 = 33.98 dB
 ABM1 comp = -2.17 dBA/m
 BWC Factor = -0.19 dB
 Location: 4.2, -4.2, 3.7 mm

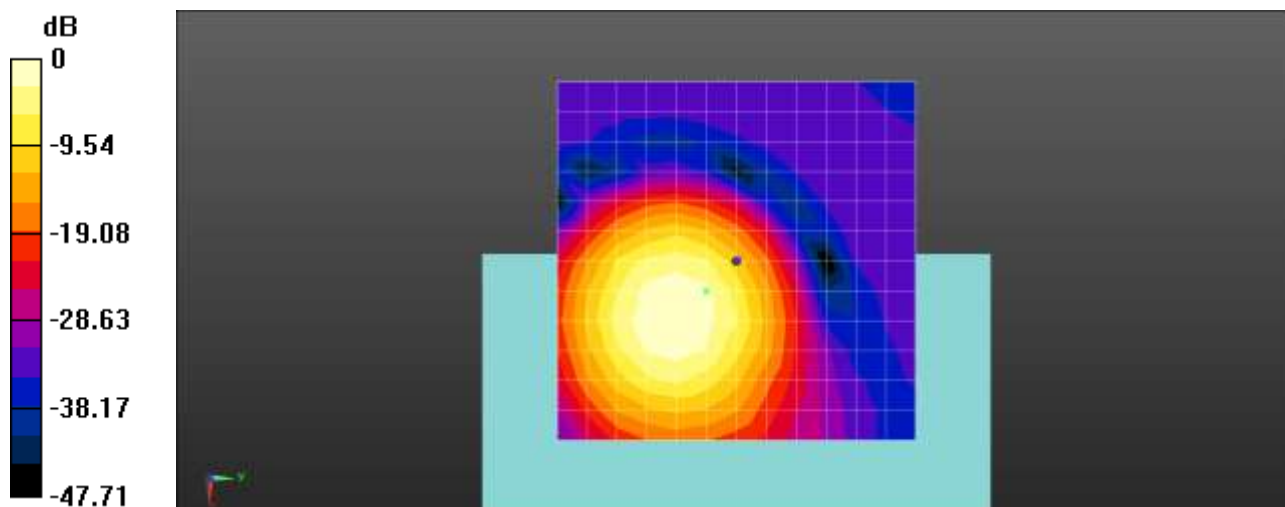

0 dB = 1.000 A/m = 0.00 dBA/m

Plot No.122

LTE 40 QPSK 10MHz 1RB 49offset 38750ch bitrate 75 kbits Freq.Response

Communication System: UID 0, LTE Band40 (0); Frequency: 2310 MHz;Duty Cycle: 1:2.30728
 Medium parameters used: $\sigma = 0$ S/m, $\epsilon_r = 1$; $\rho = 0$ kg/m³
 Phantom section: TCoil Section

T-Coil scan (scan for ANSI C63.19-2007 & 2011 compliance)/General Scans/z (axial) wideband at best

S/N/ABM Freq Resp(x,y,z,f) (1x1x1): Measurement grid: dx=10mm, dy=10mm

Signal Type: Audio File (.wav) 48k_Normal_51s new.wav

Output Gain: 58.25

Measure Window Start: 300ms

Measure Window Length: 51000ms

BWC applied: 9.13 dB

Device Reference Point: 0, 0, -6.3 mm

Category	Telephone parameters WD signal quality [(signal+noise)-to-noise ratio in decibels]
Category T1	0 dB to 10 dB
Category T2	10 dB to 20 dB
Category T3	20 dB to 30 dB
Category T4	> 30 dB

Cursor:

Diff = 2.00 dB

BWC Factor = 9.13 dB

Location: 4.3, -5, 3.7 mm

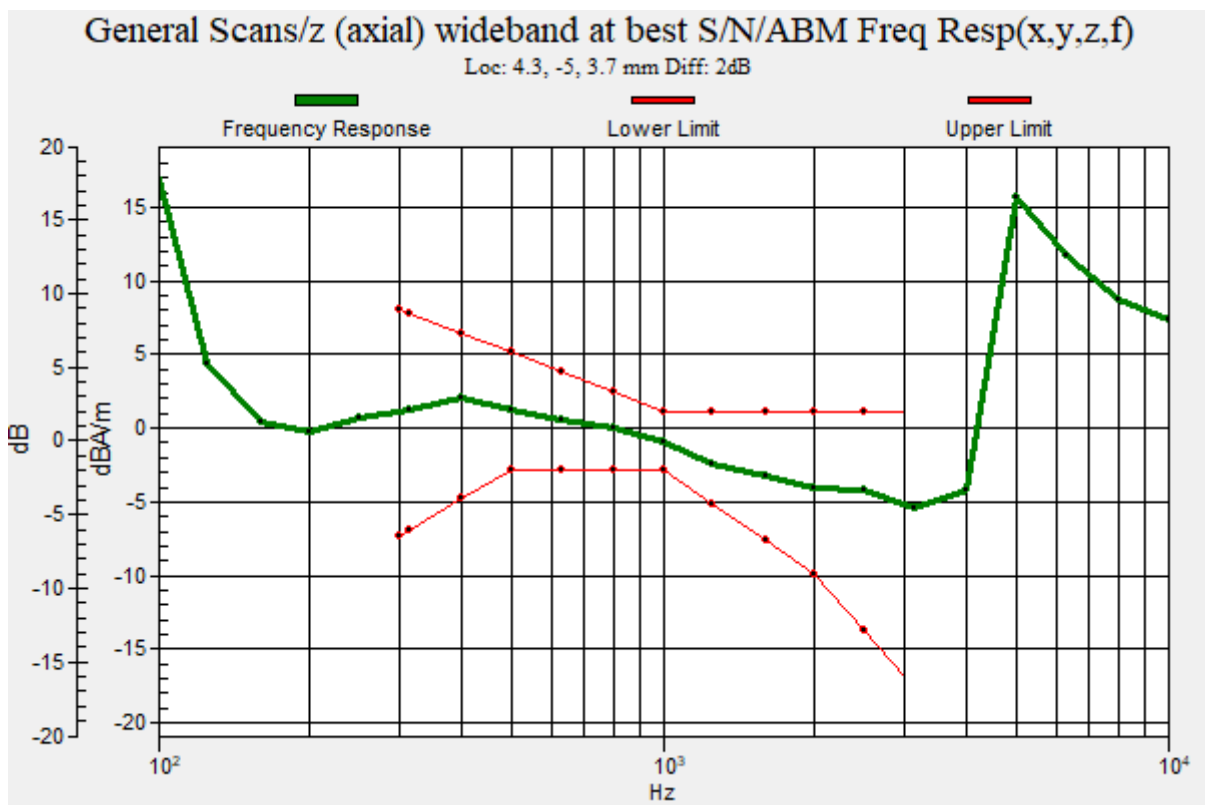

Plot No.123
LTE 40 QPSK 10MHz 1RB 49offset 38750ch bitrate 75 kbits y(transversal)

Communication System: UID 0, LTE Band40 (0); Frequency: 2310 MHz;Duty Cycle: 1:2.30728
Medium parameters used: $\sigma = 0$ S/m, $\epsilon_r = 1$; $\rho = 0$ kg/m³
Phantom section: TCoil Section

DASY5 Configuration:

- Probe: AM1DV3 - 3049; ; Calibrated: 2021-06-01
- Sensor-Surface: 0mm (Fix Surface)
- Electronics: DAE4 Sn652; Calibrated: 2022-01-24
- Phantom: HAC Test Arch with AMCC TCOIL
- Measurement SW: DASY52, Version 52.10 (4)

T-Coil scan (scan for ANSI C63.19-2007 & 2011 compliance)/General Scans/y (transversal) 4.2mm 50

x 50/ABM Signal(x,y,z) (13x13x1): Measurement grid: dx=10mm, dy=10mm

Signal Type: Audio File (.wav) 48k_voice_1kHz_1s.wav

Output Gain: 19.15

Measure Window Start: 300ms

Measure Window Length: 1000ms

BWC applied: -0.19 dB

Device Reference Point: 0, 0, -6.3 mm

Cursor:

ABM1 comp = -7.84 dBA/m

BWC Factor = -0.19 dB

Location: 4.2, 0, 3.7 mm

Cursor:

ABM2 = -41.39 dBA/m

Location: 4.2, 0, 3.7 mm

Cursor:

ABM1/ABM2 = 33.55 dB

ABM1 comp = -7.84 dBA/m

BWC Factor = -0.19 dB

Location: 4.2, 0, 3.7 mm

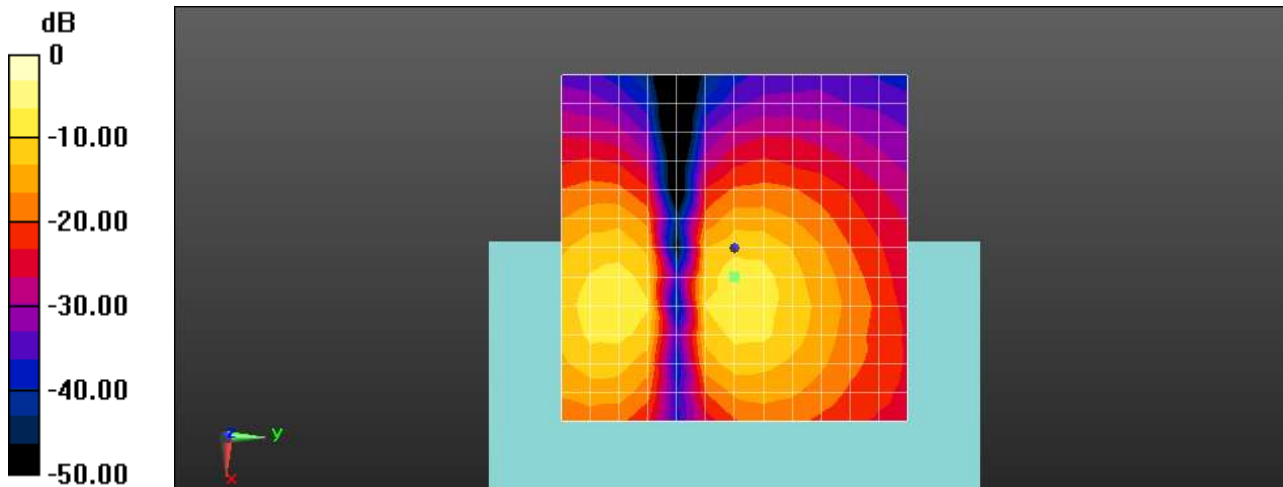

0 dB = 1.000 A/m = 0.00 dBA/m

Plot No.124

LTE 40 QPSK 10MHz 1RB 49offset 39200ch bitrate 75 kbits z(axial)

Communication System: UID 0, LTE Band40 (0); Frequency: 2355 MHz;Duty Cycle: 1:2.30728
 Medium parameters used: $\sigma = 0$ S/m, $\epsilon_r = 1$; $\rho = 0$ kg/m³
 Phantom section: TCoil Section

DASY5 Configuration:

- Probe: AM1DV3 - 3049; ; Calibrated: 2021-06-01
- Sensor-Surface: 0mm (Fix Surface)
- Electronics: DAE4 Sn652; Calibrated: 2022-01-24
- Phantom: HAC Test Arch with AMCC TCOIL
- Measurement SW: DASY52, Version 52.10 (4)

T-Coil scan (scan for ANSI C63.19-2007 & 2011 compliance)/General Scans/z (axial) 4.2mm 50 x 50/ABM Signal(x,y,z) (13x13x1): Measurement grid: dx=10mm, dy=10mm

Signal Type: Audio File (.wav) 48k_voice_1kHz_1s.wav
 Output Gain: 19.15
 Measure Window Start: 300ms
 Measure Window Length: 1000ms
 BWC applied: -0.19 dB
 Device Reference Point: 0, 0, -6.3 mm

Cursor:

ABM1 comp = -0.14 dBA/m
 BWC Factor = -0.19 dB
 Location: 4.2, -8.3, 3.7 mm

Cursor:

ABM2 = -34.51 dBA/m
 Location: 4.2, -8.3, 3.7 mm

Cursor:

ABM1/ABM2 = 34.37 dB
 ABM1 comp = -0.14 dBA/m
 BWC Factor = -0.19 dB
 Location: 4.2, -8.3, 3.7 mm

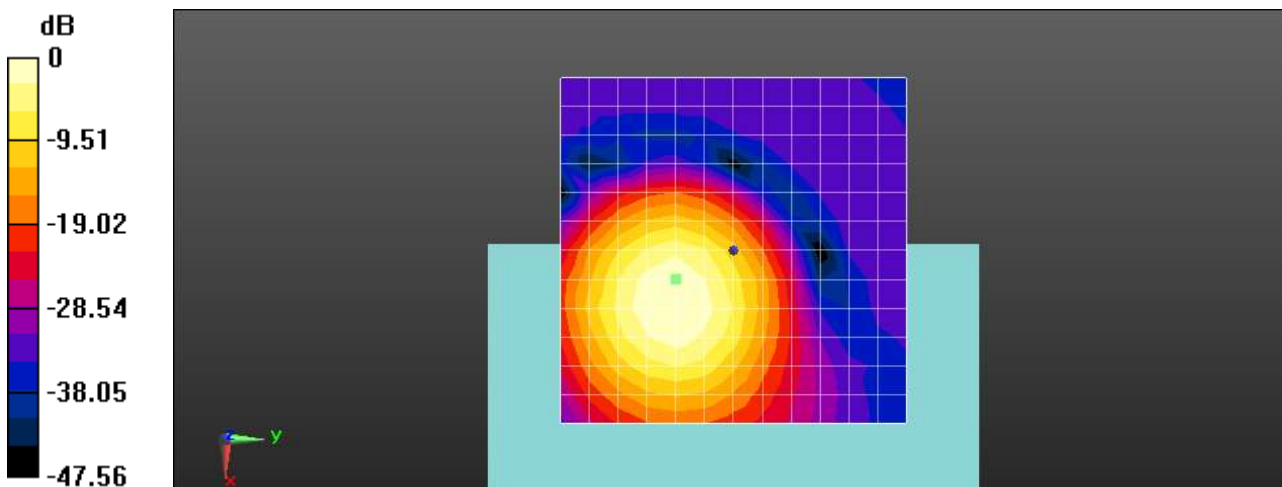

0 dB = 1.000 A/m = 0.00 dBA/m

Plot No.125
LTE 40 QPSK 10MHz 1RB 49offset 39200ch bitrate 75 kbits Freq.Response

Communication System: UID 0, LTE Band40 (0); Frequency: 2355 MHz;Duty Cycle: 1:2.30728
 Medium parameters used: $\sigma = 0$ S/m, $\epsilon_r = 1$; $\rho = 0$ kg/m³
 Phantom section: TCoil Section

T-Coil scan (scan for ANSI C63.19-2007 & 2011 compliance)/General Scans/z (axial) wideband at best S/N/ABM Freq Resp(x,y,z,f) (1x1x1): Measurement grid: dx=10mm, dy=10mm
 Signal Type: Audio File (.wav) 48k_Normal_51s new.wav
 Output Gain: 58.25
 Measure Window Start: 300ms
 Measure Window Length: 51000ms
 BWC applied: 9.13 dB
 Device Reference Point: 0, 0, -6.3 mm

Category	Telephone parameters WD signal quality [(signal+noise)-to-noise ratio in decibels]
Category T1	0 dB to 10 dB
Category T2	10 dB to 20 dB
Category T3	20 dB to 30 dB
Category T4	> 30 dB

Cursor:
 Diff = 2.00 dB
 BWC Factor = 9.13 dB
 Location: 5.7, -9.3, 3.7 mm

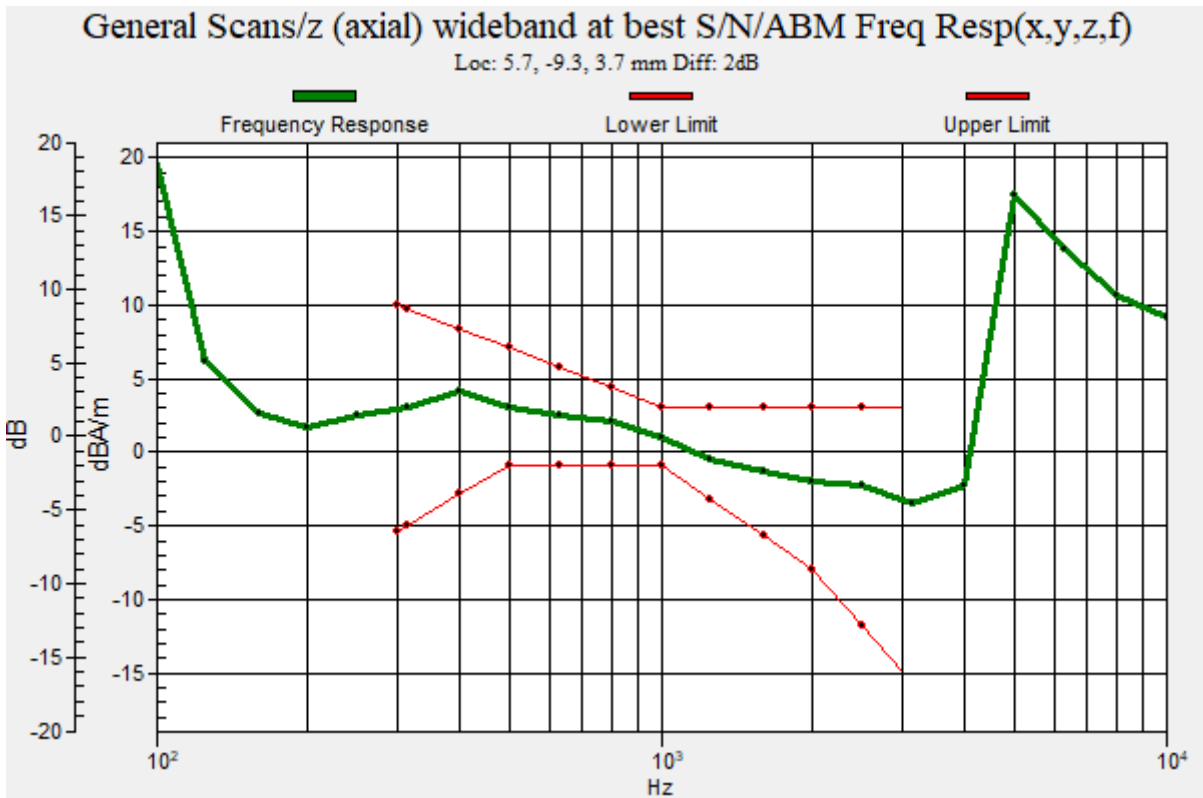

Plot No.126

LTE 40 QPSK 10MHz 1RB 49offset 39200ch bitrate 75 kbits y(transversal)

Communication System: UID 0, LTE Band40 (0); Frequency: 2355 MHz;Duty Cycle: 1:2.30728
Medium parameters used: $\sigma = 0$ S/m, $\epsilon_r = 1$; $\rho = 0$ kg/m³
Phantom section: TCoil Section

DASY5 Configuration:

- Probe: AM1DV3 - 3049; ; Calibrated: 2021-06-01
- Sensor-Surface: 0mm (Fix Surface)
- Electronics: DAE4 Sn652; Calibrated: 2022-01-24
- Phantom: HAC Test Arch with AMCC TCOIL
- Measurement SW: DASY52, Version 52.10 (4)

T-Coil scan (scan for ANSI C63.19-2007 & 2011 compliance)/General Scans/y (transversal) 4.2mm 50

x 50/ABM Signal(x,y,z) (13x13x1): Measurement grid: dx=10mm, dy=10mm

Signal Type: Audio File (.wav) 48k_voice_1kHz_1s.wav

Output Gain: 19.15

Measure Window Start: 300ms

Measure Window Length: 1000ms

BWC applied: -0.19 dB

Device Reference Point: 0, 0, -6.3 mm

Cursor:

ABM1 comp = -8.11 dBA/m

BWC Factor = -0.19 dB

Location: 4.2, 0, 3.7 mm

Cursor:

ABM2 = -41.53 dBA/m

Location: 4.2, 0, 3.7 mm

Cursor:

ABM1/ABM2 = 33.42 dB

ABM1 comp = -8.11 dBA/m

BWC Factor = -0.19 dB

Location: 4.2, 0, 3.7 mm

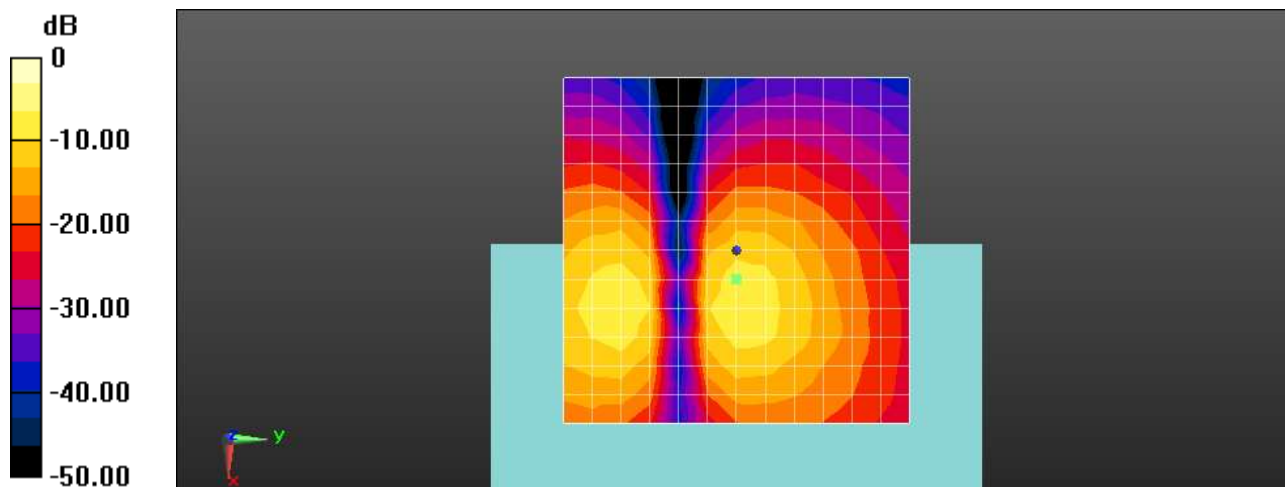

0 dB = 1.000 A/m = 0.00 dBA/m

Plot No.127

LTE 41 QPSK 20MHz 1RB 99offset 40620ch bitrate 75 kbits z(axial)

Communication System: UID 0, LTE Band 41 (0); Frequency: 2593 MHz;Duty Cycle: 1:2.30728
Medium parameters used: $\sigma = 0$ S/m, $\epsilon_r = 1$; $\rho = 0$ kg/m³
Phantom section: TCoil Section

DASY5 Configuration:

- Probe: AM1DV3 - 3049; ; Calibrated: 2021-06-01
- Sensor-Surface: 0mm (Fix Surface)
- Electronics: DAE4 Sn652; Calibrated: 2022-01-24
- Phantom: HAC Test Arch with AMCC TCOIL
- Measurement SW: DASY52, Version 52.10 (4)

T-Coil scan (scan for ANSI C63.19-2007 & 2011 compliance)/General Scans/z (axial) 4.2mm 50 x

50/ABM Signal(x,y,z) (13x13x1): Measurement grid: dx=10mm, dy=10mm

Signal Type: Audio File (.wav) 48k_voice_1kHz_1s.wav

Output Gain: 19.15

Measure Window Start: 300ms

Measure Window Length: 1000ms

BWC applied: -0.18 dB

Device Reference Point: 0, 0, -6.3 mm

Cursor:

ABM1 comp = -0.88 dBA/m

BWC Factor = -0.18 dB

Location: 4.2, -8.3, 3.7 mm

Cursor:

ABM2 = -34.02 dBA/m

Location: 4.2, -8.3, 3.7 mm

Cursor:

ABM1/ABM2 = 33.14 dB

ABM1 comp = -0.88 dBA/m

BWC Factor = -0.18 dB

Location: 4.2, -8.3, 3.7 mm

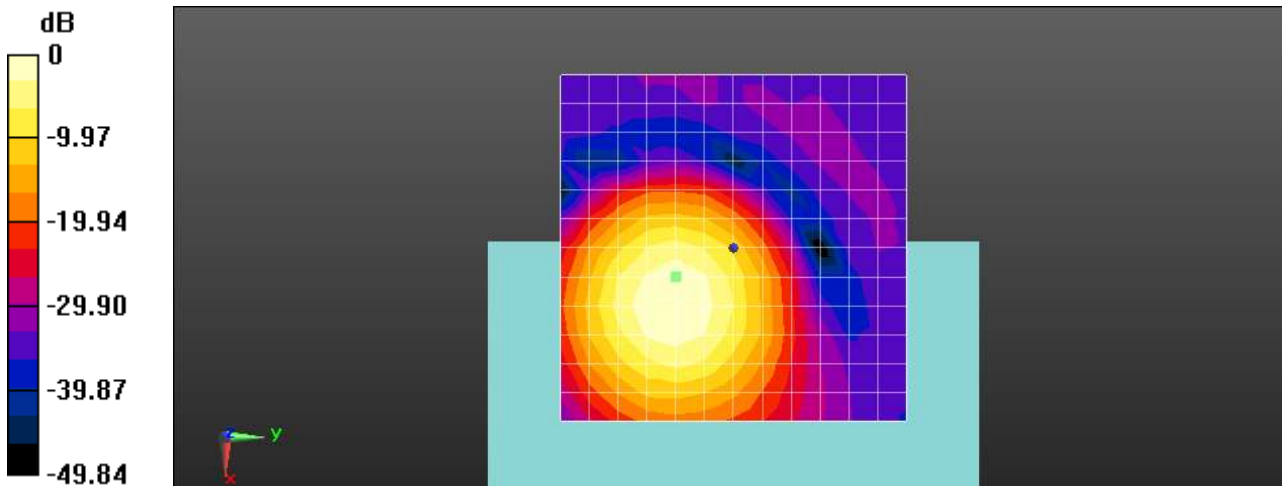

0 dB = 1.000 A/m = 0.00 dBA/m

Plot No.128
LTE 41 QPSK 20MHz 1RB 99offset 40620ch bitrate 75 kbits Freq.Response

Communication System: UID 0, LTE Band 41 (0); Frequency: 2593 MHz;Duty Cycle: 1:2.30728
 Medium parameters used: $\sigma = 0$ S/m, $\epsilon_r = 1$; $\rho = 0$ kg/m³
 Phantom section: TCoil Section

T-Coil scan (scan for ANSI C63.19-2007 & 2011 compliance)/General Scans/z (axial) wideband at best S/N/ABM Freq Resp(x,y,z,f) (1x1x1): Measurement grid: dx=10mm, dy=10mm
 Signal Type: Audio File (.wav) 48k_Normal_51s new.wav
 Output Gain: 58.25
 Measure Window Start: 300ms
 Measure Window Length: 51000ms
 BWC applied: 9.14 dB
 Device Reference Point: 0, 0, -6.3 mm

Category	Telephone parameters WD signal quality [(signal+noise)-to-noise ratio in decibels]
Category T1	0 dB to 10 dB
Category T2	10 dB to 20 dB
Category T3	20 dB to 30 dB
Category T4	> 30 dB

Cursor:
 Diff = 2.00 dB
 BWC Factor = 9.14 dB
 Location: 6.3, -9.2, 3.7 mm

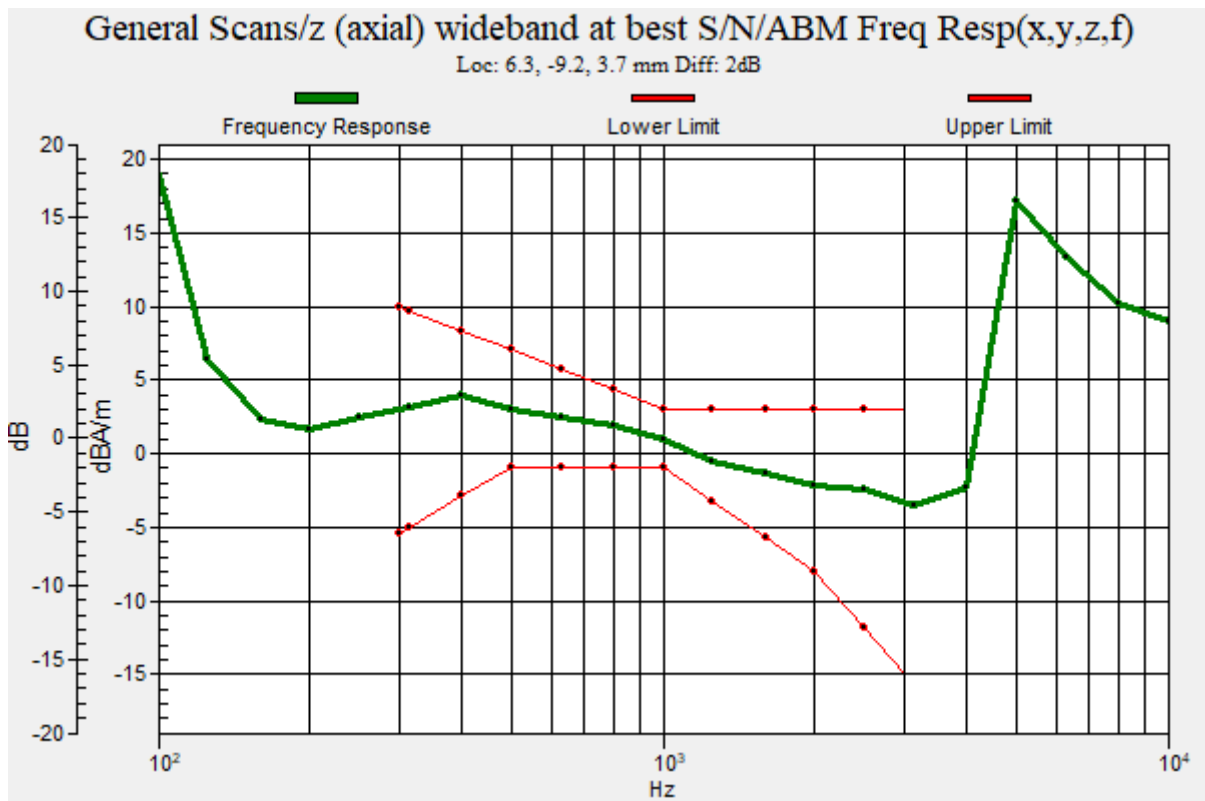

Plot No.129

LTE 41 QPSK 20MHz 1RB 99offset 40620ch bitrate 75 kbits y(transversal)

Communication System: UID 0, LTE Band 41 (0); Frequency: 2593 MHz;Duty Cycle: 1:2.30728
Medium parameters used: $\sigma = 0$ S/m, $\epsilon_r = 1$; $\rho = 0$ kg/m³
Phantom section: TCoil Section

DASY5 Configuration:

- Probe: AM1DV3 - 3049; ; Calibrated: 2021-06-01
- Sensor-Surface: 0mm (Fix Surface)
- Electronics: DAE4 Sn652; Calibrated: 2022-01-24
- Phantom: HAC Test Arch with AMCC TCOIL
- Measurement SW: DASY52, Version 52.10 (4)

T-Coil scan (scan for ANSI C63.19-2007 & 2011 compliance)/General Scans/y (transversal) 4.2mm 50 x 50/ABM Signal(x,y,z) (13x13x1): Measurement grid: dx=10mm, dy=10mm

Signal Type: Audio File (.wav) 48k_voice_1kHz_1s.wav
Output Gain: 19.15
Measure Window Start: 300ms
Measure Window Length: 1000ms
BWC applied: -0.18 dB
Device Reference Point: 0, 0, -6.3 mm

Cursor:

ABM1 comp = -14.53 dBA/m
BWC Factor = -0.18 dB
Location: -4.2, 4.2, 3.7 mm

Cursor:

ABM2 = -46.92 dBA/m
Location: -4.2, 4.2, 3.7 mm

Cursor:

ABM1/ABM2 = 32.40 dB
ABM1 comp = -14.53 dBA/m
BWC Factor = -0.18 dB
Location: -4.2, 4.2, 3.7 mm

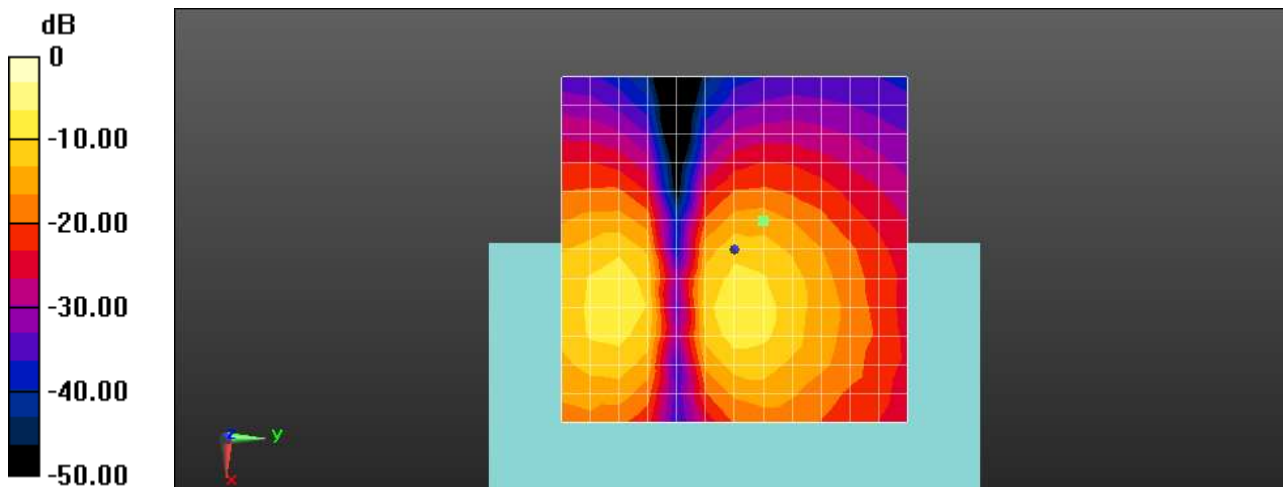

0 dB = 1.000 A/m = 0.00 dBA/m

Plot No.130

LTE 48 QPSK 20MHz 1RB 99offset 55990ch bitrate 75 kbits z(axial)

Communication System: UID 0, LTE 48 (0); Frequency: 3625 MHz;Duty Cycle: 1:2.30728
Medium parameters used: $\sigma = 0$ S/m, $\epsilon_r = 1$; $\rho = 0$ kg/m³
Phantom section: TCoil Section

DASY5 Configuration:

- Probe: AM1DV3 - 3049; ; Calibrated: 2021-06-01
- Sensor-Surface: 0mm (Fix Surface)
- Electronics: DAE4 Sn652; Calibrated: 2022-01-24
- Phantom: HAC Test Arch with AMCC TCOIL
- Measurement SW: DASY52, Version 52.10 (4)

T-Coil scan (scan for ANSI C63.19-2007 & 2011 compliance)/General Scans/z (axial) 4.2mm 50 x

50/ABM Signal(x,y,z) (13x13x1): Measurement grid: dx=10mm, dy=10mm

Signal Type: Audio File (.wav) 48k_voice_1kHz_1s.wav

Output Gain: 19.15

Measure Window Start: 300ms

Measure Window Length: 1000ms

BWC applied: -0.19 dB

Device Reference Point: 0, 0, -6.3 mm

Cursor:

ABM1 comp = 0.85 dBA/m

BWC Factor = -0.19 dB

Location: 8.3, -8.3, 3.7 mm

Cursor:

ABM2 = -33.75 dBA/m

Location: 8.3, -8.3, 3.7 mm

Cursor:

ABM1/ABM2 = 34.60 dB

ABM1 comp = 0.85 dBA/m

BWC Factor = -0.19 dB

Location: 8.3, -8.3, 3.7 mm

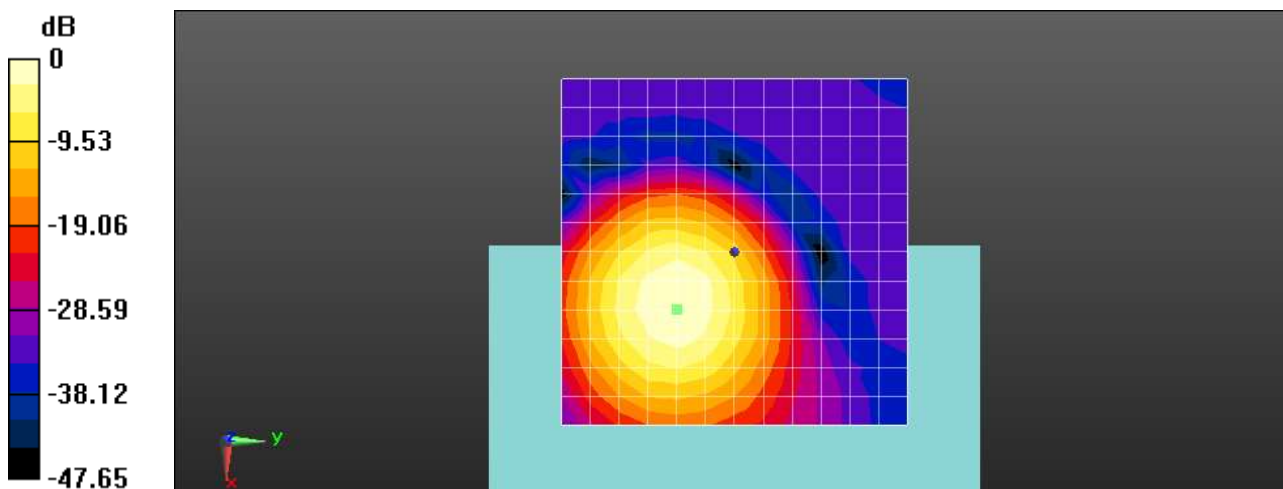

0 dB = 1.000 A/m = 0.00 dBA/m

Plot No.131
LTE 48 QPSK 20MHz 1RB 99offset 55990ch bitrate 75 kbits Freq.Response

Communication System: UID 0, LTE 48 (0); Frequency: 3625 MHz;Duty Cycle: 1:2.30728
 Medium parameters used: $\sigma = 0$ S/m, $\epsilon_r = 1$; $\rho = 0$ kg/m³
 Phantom section: TCoil Section

T-Coil scan (scan for ANSI C63.19-2007 & 2011 compliance)/General Scans/z (axial) wideband at best S/N/ABM Freq Resp(x,y,z,f) (1x1x1): Measurement grid: dx=10mm, dy=10mm
 Signal Type: Audio File (.wav) 48k_Normal_51s new.wav
 Output Gain: 58.25
 Measure Window Start: 300ms
 Measure Window Length: 51000ms
 BWC applied: 9.13 dB
 Device Reference Point: 0, 0, -6.3 mm

Category	Telephone parameters WD signal quality [(signal+noise)-to-noise ratio in decibels]
Category T1	0 dB to 10 dB
Category T2	10 dB to 20 dB
Category T3	20 dB to 30 dB
Category T4	> 30 dB

Cursor:
 Diff = 2.00 dB
 BWC Factor = 9.13 dB
 Location: 7.8, -8.5, 3.7 mm

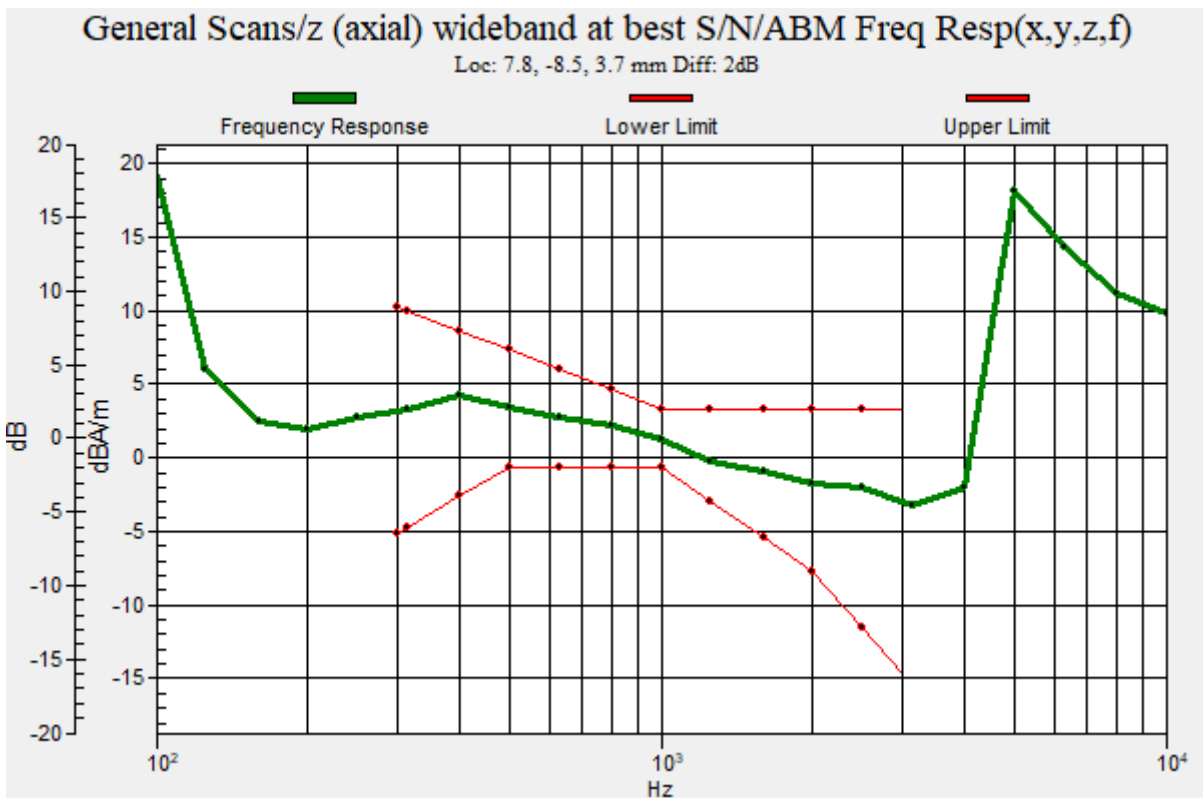

Plot No.132

LTE 48 QPSK 20MHz 1RB 99offset 55990ch bitrate 75 kbits y(transversal)

Communication System: UID 0, LTE 48 (0); Frequency: 3625 MHz;Duty Cycle: 1:2.30728
Medium parameters used: $\sigma = 0$ S/m, $\epsilon_r = 1$; $\rho = 0$ kg/m³
Phantom section: TCoil Section

DASY5 Configuration:

- Probe: AM1DV3 - 3049; ; Calibrated: 2021-06-01
- Sensor-Surface: 0mm (Fix Surface)
- Electronics: DAE4 Sn652; Calibrated: 2022-01-24
- Phantom: HAC Test Arch with AMCC TCOIL
- Measurement SW: DASY52, Version 52.10 (4)

T-Coil scan (scan for ANSI C63.19-2007 & 2011 compliance)/General Scans/y (transversal) 4.2mm 50 x 50/ABM Signal(x,y,z) (13x13x1): Measurement grid: dx=10mm, dy=10mm

Signal Type: Audio File (.wav) 48k_voice_1kHz_1s.wav
Output Gain: 19.15
Measure Window Start: 300ms
Measure Window Length: 1000ms
BWC applied: -0.19 dB
Device Reference Point: 0, 0, -6.3 mm

Cursor:

ABM1 comp = -13.25 dBA/m
BWC Factor = -0.19 dB
Location: 0, -12.5, 3.7 mm

Cursor:

ABM2 = -46.19 dBA/m
Location: 0, -12.5, 3.7 mm

Cursor:

ABM1/ABM2 = 32.94 dB
ABM1 comp = -13.25 dBA/m
BWC Factor = -0.19 dB
Location: 0, -12.5, 3.7 mm

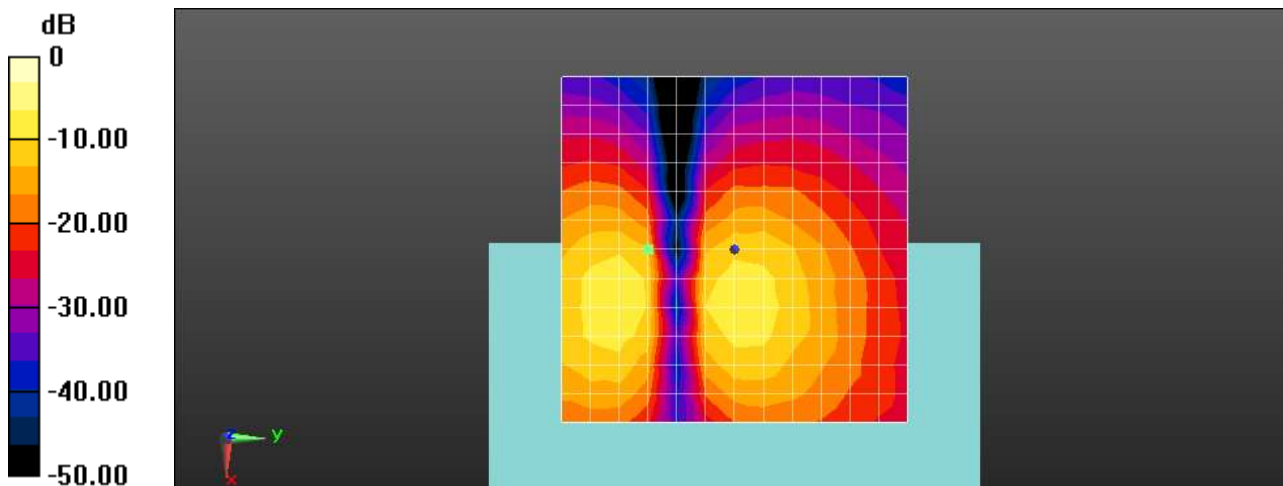

0 dB = 1.000 A/m = 0.00 dBA/m

Plot No.133
802_11b 1Mbps 6ch bitrate 40 z(axial)

Communication System: UID 0, 2450MHz FCC (0); Frequency: 2437 MHz;Duty Cycle: 1:1
Medium parameters used: $\sigma = 0$ S/m, $\epsilon_r = 1$; $\rho = 0$ kg/m³
Phantom section: TCoil Section

DASY5 Configuration:

- Probe: AM1DV3 - 3049; ; Calibrated: 2021-06-01
- Sensor-Surface: 0mm (Fix Surface)
- Electronics: DAE4 Sn652; Calibrated: 2022-01-24
- Phantom: HAC Test Arch with AMCC TCOIL
- Measurement SW: DASY52, Version 52.10 (4)

T-Coil scan (scan for ANSI C63.19-2007 & 2011 compliance)/General Scans/z (axial) 4.2mm 50 x 50/ABM Signal(x,y,z) (13x13x1): Measurement grid: dx=10mm, dy=10mm

Signal Type: Audio File (.wav) 48k_voice_1kHz_1s.wav
Output Gain: 19.15
Measure Window Start: 300ms
Measure Window Length: 1000ms
BWC applied: -0.19 dB
Device Reference Point: 0, 0, -6.3 mm

Cursor:

ABM1 comp = 0.01 dBA/m
BWC Factor = -0.19 dB
Location: 4.2, -8.3, 3.7 mm

Cursor:

ABM2 = -29.30 dBA/m
Location: 4.2, -8.3, 3.7 mm

Cursor:

ABM1/ABM2 = 29.31 dB
ABM1 comp = 0.01 dBA/m
BWC Factor = -0.19 dB
Location: 4.2, -8.3, 3.7 mm

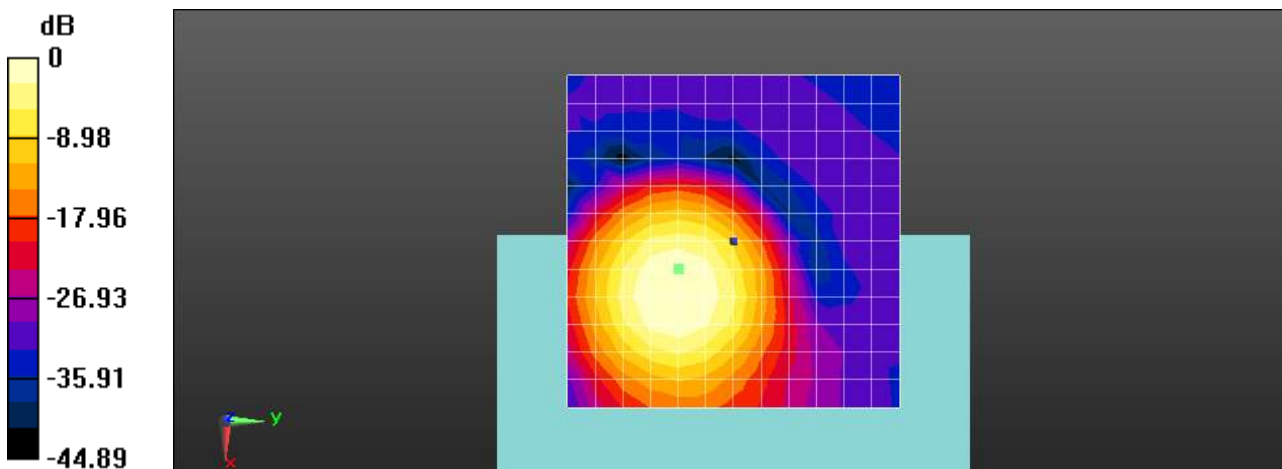

0 dB = 1.000 A/m = 0.00 dBA/m

Plot No.134
802_11b 1Mbps 6ch bitrate 40 Freq.Response

Communication System: UID 0, 2450MHz FCC (0); Frequency: 2437 MHz;Duty Cycle: 1:1
Medium parameters used: $\sigma = 0$ S/m, $\epsilon_r = 1$; $\rho = 0$ kg/m³
Phantom section: TCoil Section

T-Coil scan (scan for ANSI C63.19-2007 & 2011 compliance)/General Scans/z (axial) wideband at best S/N/ABM Freq Resp(x,y,z,f) (1x1x1): Measurement grid: dx=10mm, dy=10mm
Signal Type: Audio File (.wav) 48k_Normal_51s new.wav
Output Gain: 58.25
Measure Window Start: 300ms
Measure Window Length: 51000ms
BWC applied: 9.12 dB
Device Reference Point: 0, 0, -6.3 mm

Cursor:
Diff = 2.00 dB
BWC Factor = 9.12 dB
Location: 4.6, -9.2, 3.7 mm

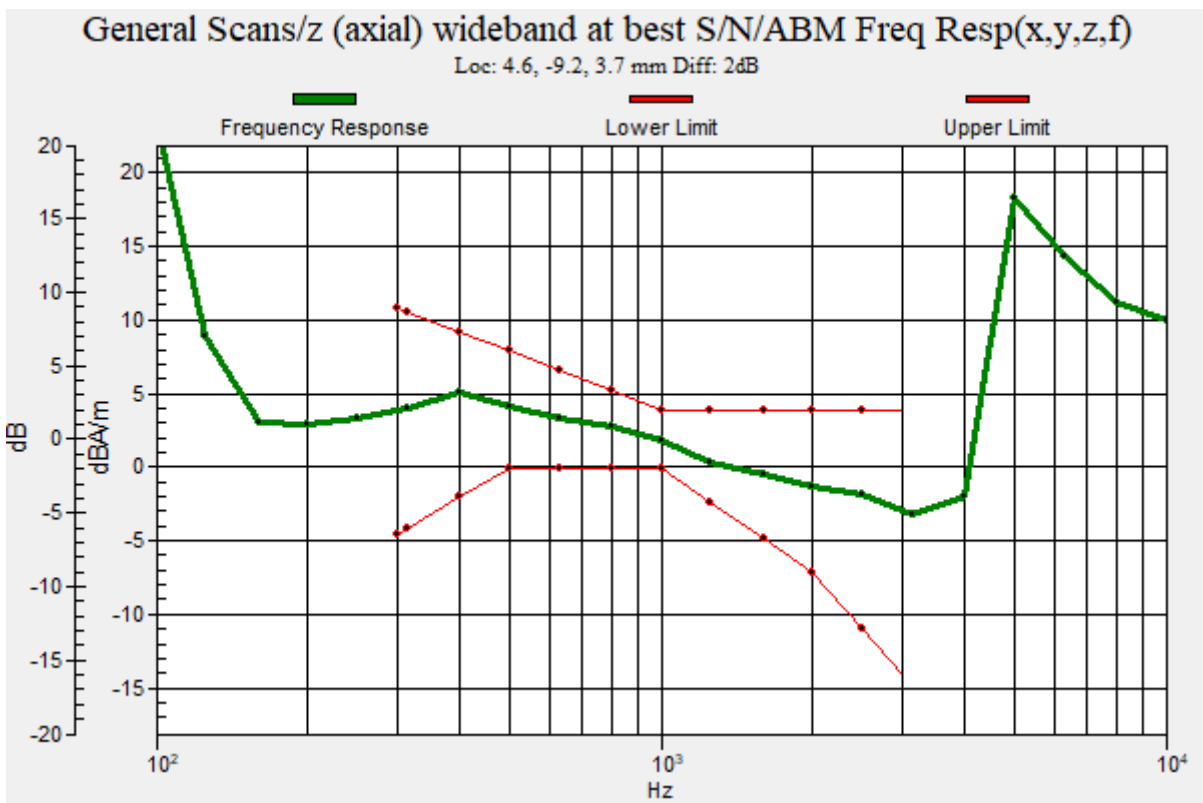

Plot No.135
802_11b 1Mbps 6ch bitrate 40 y(transversal)

Communication System: UID 0, 2450MHz FCC (0); Frequency: 2437 MHz;Duty Cycle: 1:1
Medium parameters used: $\sigma = 0$ S/m, $\epsilon_r = 1$; $\rho = 0$ kg/m³
Phantom section: TCoil Section

DASY5 Configuration:

- Probe: AM1DV3 - 3049; ; Calibrated: 2021-06-01
- Sensor-Surface: 0mm (Fix Surface)
- Electronics: DAE4 Sn652; Calibrated: 2022-01-24
- Phantom: HAC Test Arch with AMCC TCOIL
- Measurement SW: DASY52, Version 52.10 (4)

T-Coil scan (scan for ANSI C63.19-2007 & 2011 compliance)/General Scans/y (transversal) 4.2mm 50

x 50/ABM Signal(x,y,z) (13x13x1): Measurement grid: dx=10mm, dy=10mm

Signal Type: Audio File (.wav) 48k_voice_1kHz_1s.wav

Output Gain: 19.15

Measure Window Start: 300ms

Measure Window Length: 1000ms

BWC applied: -0.19 dB

Device Reference Point: 0, 0, -6.3 mm

Cursor:

ABM1 comp = -10.00 dBA/m

BWC Factor = -0.19 dB

Location: 0, -16.7, 3.7 mm

Cursor:

ABM2 = -42.67 dBA/m

Location: 0, -16.7, 3.7 mm

Cursor:

ABM1/ABM2 = 32.66 dB

ABM1 comp = -10.00 dBA/m

BWC Factor = -0.19 dB

Location: 0, -16.7, 3.7 mm

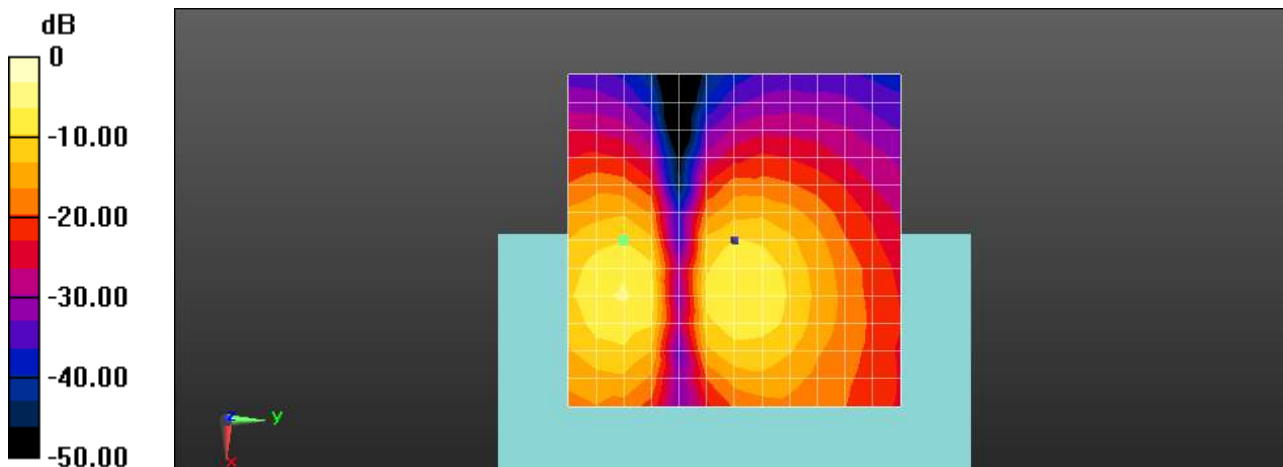

0 dB = 1.000 A/m = 0.00 dBA/m

Plot No.136
802_11a 54Mbps 40ch bitrate 75 z(axial)

Communication System: UID 0, WIFI 5GHz (0); Frequency: 5200 MHz;Duty Cycle: 1:1
Medium parameters used: $\sigma = 0$ S/m, $\epsilon_r = 1$; $\rho = 0$ kg/m³
Phantom section: TCoil Section

DASY5 Configuration:

- Probe: AM1DV3 - 3049; ; Calibrated: 2021-06-01
- Sensor-Surface: 0mm (Fix Surface)
- Electronics: DAE4 Sn652; Calibrated: 2022-01-24
- Phantom: HAC Test Arch with AMCC TCOIL
- Measurement SW: DASY52, Version 52.10 (4)

T-Coil scan (scan for ANSI C63.19-2007 & 2011 compliance)/General Scans/z (axial) 4.2mm 50 x 50/ABM Signal(x,y,z) (13x13x1): Measurement grid: dx=10mm, dy=10mm

Signal Type: Audio File (.wav) 48k_voice_1kHz_1s.wav
Output Gain: 19.15
Measure Window Start: 300ms
Measure Window Length: 1000ms
BWC applied: -0.19 dB
Device Reference Point: 0, 0, -6.3 mm

Cursor:

ABM1 comp = -1.00 dBA/m
BWC Factor = -0.19 dB
Location: 4.2, -12.5, 3.7 mm

Cursor:

ABM2 = -34.30 dBA/m
Location: 4.2, -12.5, 3.7 mm

Cursor:

ABM1/ABM2 = 33.30 dB
ABM1 comp = -1.00 dBA/m
BWC Factor = -0.19 dB
Location: 4.2, -12.5, 3.7 mm

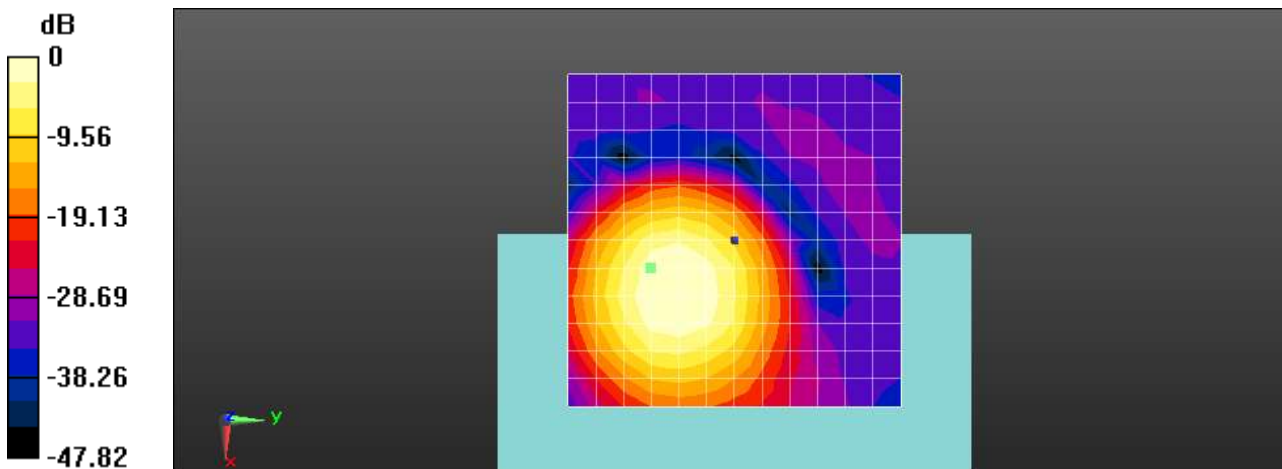

0 dB = 1.000 A/m = 0.00 dBA/m

Plot No.137

802_11a 54Mbps 40ch bitrate 75 Freq.Response

Communication System: UID 0, WIFI 5GHz (0); Frequency: 5200 MHz;Duty Cycle: 1:1
 Medium parameters used: $\sigma = 0$ S/m, $\epsilon_r = 1$; $\rho = 0$ kg/m³
 Phantom section: TCoil Section

T-Coil scan (scan for ANSI C63.19-2007 & 2011 compliance)/General Scans/z (axial) wideband at best

S/N/ABM Freq Resp(x,y,z,f) (1x1x1): Measurement grid: dx=10mm, dy=10mm

Signal Type: Audio File (.wav) 48k_Normal_51s new.wav

Output Gain: 58.25

Measure Window Start: 300ms

Measure Window Length: 51000ms

BWC applied: 9.13 dB

Device Reference Point: 0, 0, -6.3 mm

Category	Telephone parameters WD signal quality [(signal+noise)-to-noise ratio in decibels]
Category T1	0 dB to 10 dB
Category T2	10 dB to 20 dB
Category T3	20 dB to 30 dB
Category T4	> 30 dB

Cursor:

Diff = 2.00 dB

BWC Factor = 9.13 dB

Location: 2.8, -11.2, 3.7 mm

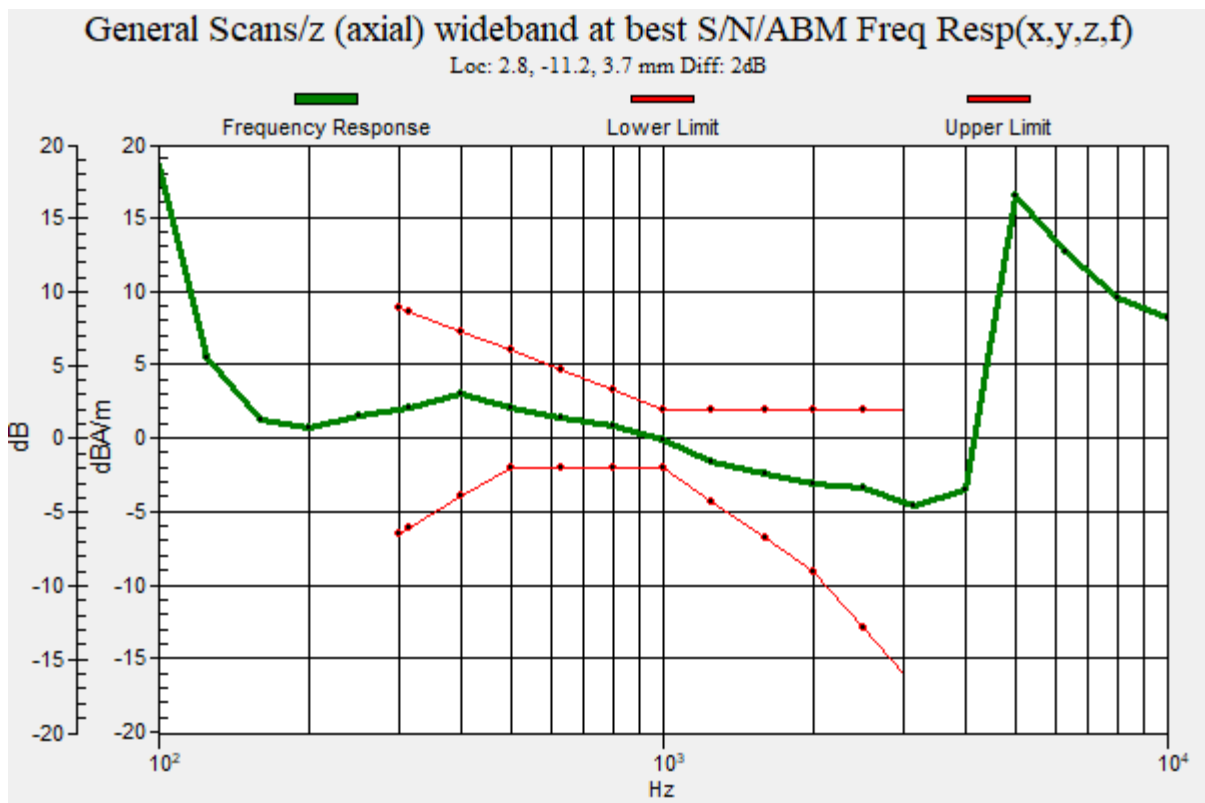

Plot No.138

802_11a 54Mbps 40ch bitrate 75 y(transversal)

Communication System: UID 0, WIFI 5GHz (0); Frequency: 5200 MHz;Duty Cycle: 1:1
Medium parameters used: $\sigma = 0$ S/m, $\epsilon_r = 1$; $\rho = 0$ kg/m³
Phantom section: TCoil Section

DASY5 Configuration:

- Probe: AM1DV3 - 3049; ; Calibrated: 2021-06-01
- Sensor-Surface: 0mm (Fix Surface)
- Electronics: DAE4 Sn652; Calibrated: 2022-01-24
- Phantom: HAC Test Arch with AMCC TCOIL
- Measurement SW: DASY52, Version 52.10 (4)

T-Coil scan (scan for ANSI C63.19-2007 & 2011 compliance)/General Scans/y (transversal) 4.2mm 50

x 50/ABM Signal(x,y,z) (13x13x1): Measurement grid: dx=10mm, dy=10mm

Signal Type: Audio File (.wav) 48k_voice_1kHz_1s.wav

Output Gain: 19.15

Measure Window Start: 300ms

Measure Window Length: 1000ms

BWC applied: -0.19 dB

Device Reference Point: 0, 0, -6.3 mm

Cursor:

ABM1 comp = -13.84 dBA/m

BWC Factor = -0.19 dB

Location: -4.2, -16.7, 3.7 mm

Cursor:

ABM2 = -47.50 dBA/m

Location: -4.2, -16.7, 3.7 mm

Cursor:

ABM1/ABM2 = 33.66 dB

ABM1 comp = -13.84 dBA/m

BWC Factor = -0.19 dB

Location: -4.2, -16.7, 3.7 mm

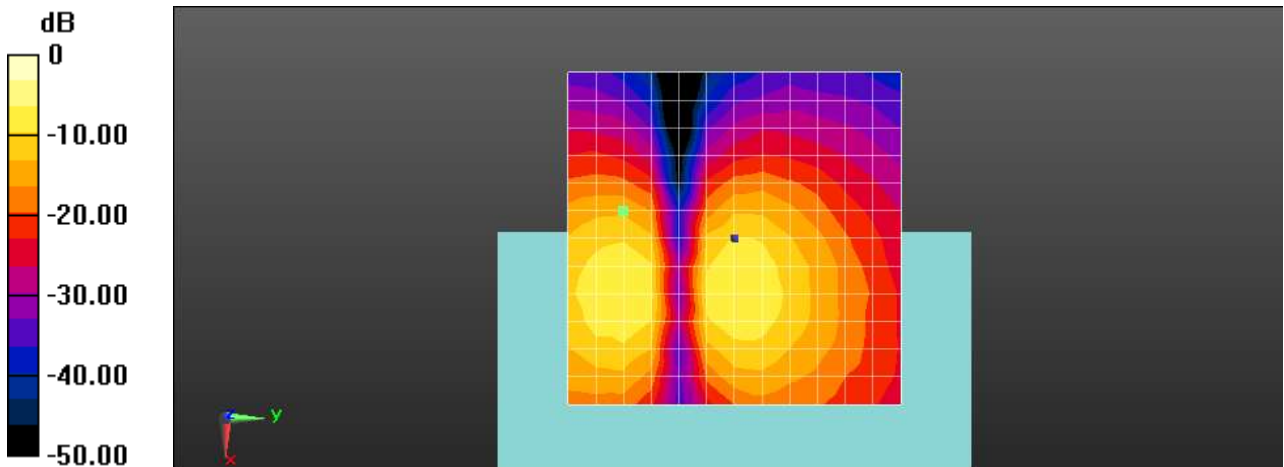

0 dB = 1.000 A/m = 0.00 dBA/m

Plot No.139

802_11a 54Mbps 60ch bitrate 75 z(axial)

Communication System: UID 0, WIFI 5GHz (0); Frequency: 5300 MHz;Duty Cycle: 1:1
Medium parameters used: $\sigma = 0$ S/m, $\epsilon_r = 1$; $\rho = 0$ kg/m³
Phantom section: TCoil Section

DASY5 Configuration:

- Probe: AM1DV3 - 3049; ; Calibrated: 2021-06-01
- Sensor-Surface: 0mm (Fix Surface)
- Electronics: DAE4 Sn652; Calibrated: 2022-01-24
- Phantom: HAC Test Arch with AMCC TCOIL
- Measurement SW: DASY52, Version 52.10 (4)

T-Coil scan (scan for ANSI C63.19-2007 & 2011 compliance)/General Scans/z (axial) 4.2mm 50 x 50/ABM Signal(x,y,z) (13x13x1): Measurement grid: dx=10mm, dy=10mm

Signal Type: Audio File (.wav) 48k_voice_1kHz_1s.wav
Output Gain: 19.15
Measure Window Start: 300ms
Measure Window Length: 1000ms
BWC applied: -0.19 dB
Device Reference Point: 0, 0, -6.3 mm

Cursor:

ABM1 comp = 0.39 dBA/m
BWC Factor = -0.19 dB
Location: 4.2, -8.3, 3.7 mm

Cursor:

ABM2 = -33.14 dBA/m
Location: 4.2, -8.3, 3.7 mm

Cursor:

ABM1/ABM2 = 33.54 dB
ABM1 comp = 0.39 dBA/m
BWC Factor = -0.19 dB
Location: 4.2, -8.3, 3.7 mm

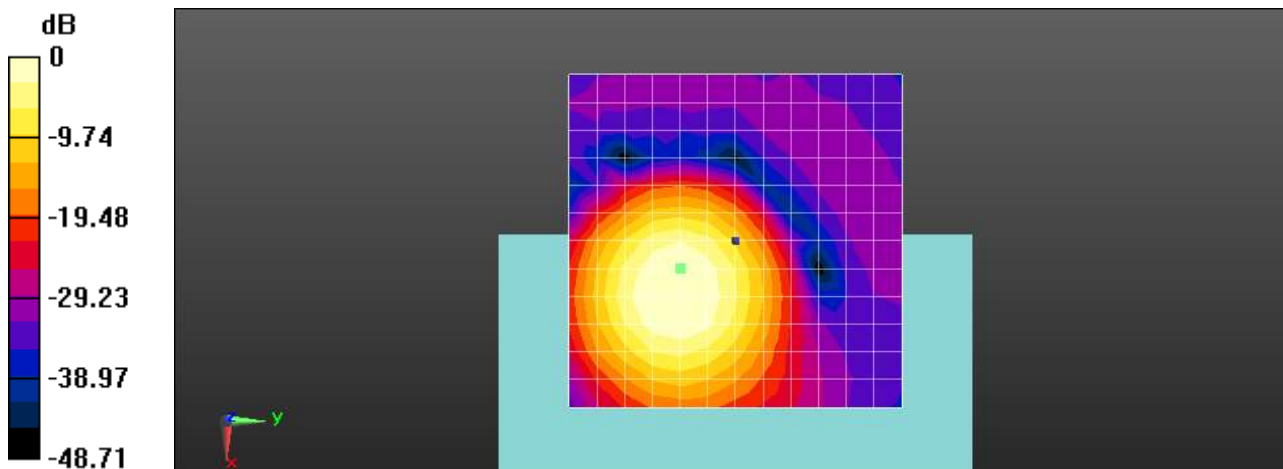

0 dB = 1.000 A/m = 0.00 dBA/m

Plot No.140
802_11a 54Mbps 60ch bitrate 75 Freq.Response

Communication System: UID 0, WIFI 5GHz (0); Frequency: 5300 MHz;Duty Cycle: 1:1
 Medium parameters used: $\sigma = 0$ S/m, $\epsilon_r = 1$; $\rho = 0$ kg/m³
 Phantom section: TCoil Section

T-Coil scan (scan for ANSI C63.19-2007 & 2011 compliance)/General Scans/z (axial) wideband at best S/N/ABM Freq Resp(x,y,z,f) (1x1x1): Measurement grid: dx=10mm, dy=10mm
 Signal Type: Audio File (.wav) 48k_Normal_51s new.wav
 Output Gain: 58.25
 Measure Window Start: 300ms
 Measure Window Length: 51000ms
 BWC applied: 9.13 dB
 Device Reference Point: 0, 0, -6.3 mm

Category	Telephone parameters WD signal quality [(signal+noise)-to-noise ratio in decibels]
Category T1	0 dB to 10 dB
Category T2	10 dB to 20 dB
Category T3	20 dB to 30 dB
Category T4	> 30 dB

Cursor:
 Diff = 2.00 dB
 BWC Factor = 9.13 dB
 Location: 4, -8.9, 3.7 mm

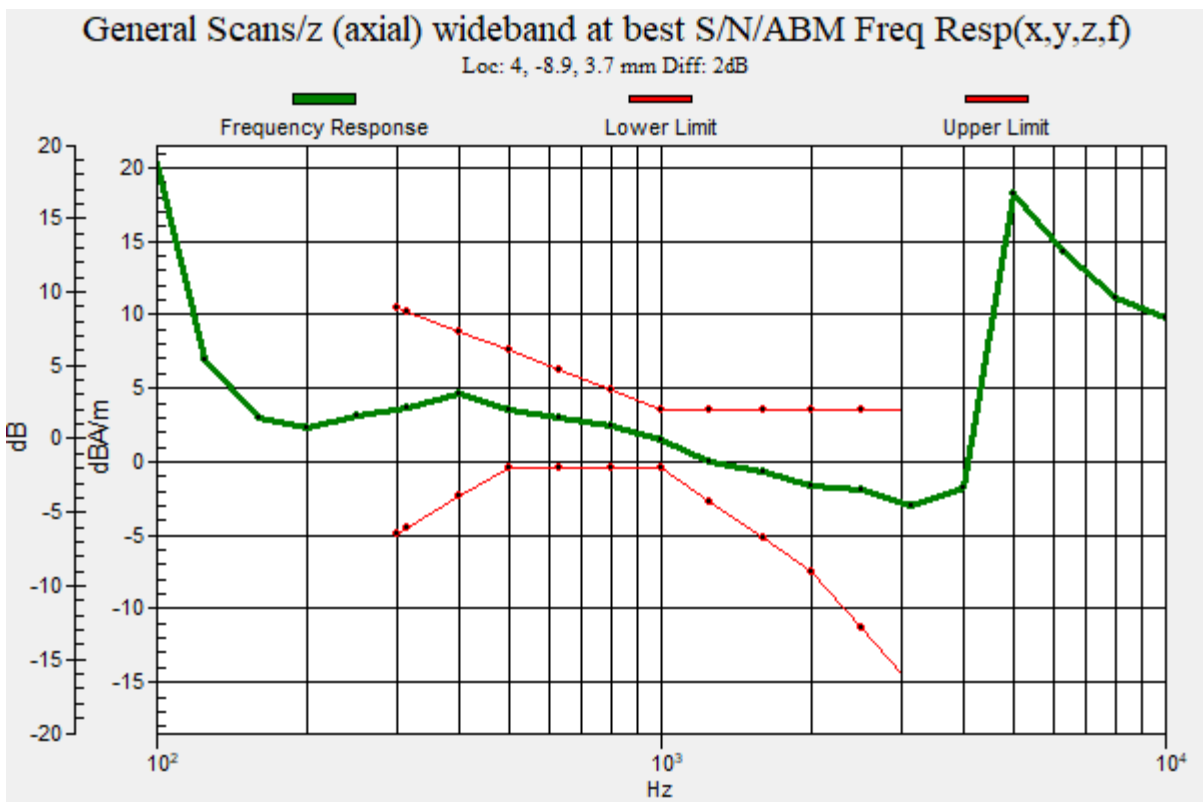

Plot No.141

802_11a 54Mbps 60ch bitrate 75 y(transversal)

Communication System: UID 0, WIFI 5GHz (0); Frequency: 5300 MHz;Duty Cycle: 1:1
Medium parameters used: $\sigma = 0$ S/m, $\epsilon_r = 1$; $\rho = 0$ kg/m³
Phantom section: TCoil Section

DASY5 Configuration:

- Probe: AM1DV3 - 3049; ; Calibrated: 2021-06-01
- Sensor-Surface: 0mm (Fix Surface)
- Electronics: DAE4 Sn652; Calibrated: 2022-01-24
- Phantom: HAC Test Arch with AMCC TCOIL
- Measurement SW: DASY52, Version 52.10 (4)

T-Coil scan (scan for ANSI C63.19-2007 & 2011 compliance)/General Scans/y (transversal) 4.2mm 50 x 50/ABM Signal(x,y,z) (13x13x1): Measurement grid: dx=10mm, dy=10mm

Signal Type: Audio File (.wav) 48k_voice_1kHz_1s.wav
Output Gain: 19.15
Measure Window Start: 300ms
Measure Window Length: 1000ms
BWC applied: -0.19 dB
Device Reference Point: 0, 0, -6.3 mm

Cursor:

ABM1 comp = -6.92 dBA/m
BWC Factor = -0.19 dB
Location: 4.2, -16.7, 3.7 mm

Cursor:

ABM2 = -40.98 dBA/m
Location: 4.2, -16.7, 3.7 mm

Cursor:

ABM1/ABM2 = 34.06 dB
ABM1 comp = -6.92 dBA/m
BWC Factor = -0.19 dB
Location: 4.2, -16.7, 3.7 mm

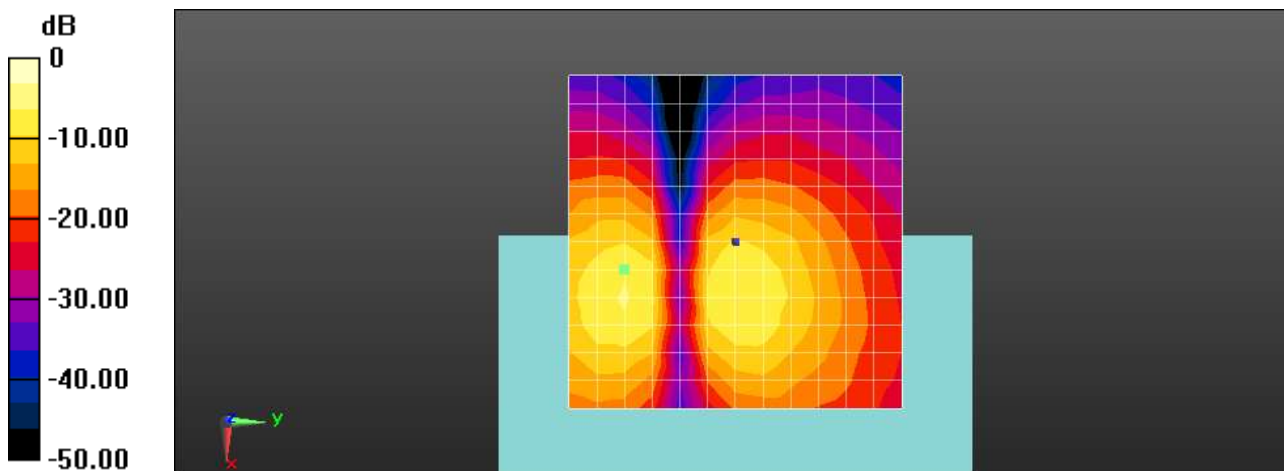

0 dB = 1.000 A/m = 0.00 dBA/m

Plot No.142
802_11a 54Mbps 120ch bitrate 75 z(axial)

Communication System: UID 0, WIFI 5GHz (0); Frequency: 5600 MHz;Duty Cycle: 1:1
Medium parameters used: $\sigma = 0$ S/m, $\epsilon_r = 1$; $\rho = 0$ kg/m³
Phantom section: TCoil Section

DASY5 Configuration:

- Probe: AM1DV3 - 3049; ; Calibrated: 2021-06-01
- Sensor-Surface: 0mm (Fix Surface)
- Electronics: DAE4 Sn652; Calibrated: 2022-01-24
- Phantom: HAC Test Arch with AMCC TCOIL
- Measurement SW: DASY52, Version 52.10 (4)

T-Coil scan (scan for ANSI C63.19-2007 & 2011 compliance)/General Scans/z (axial) 4.2mm 50 x 50/ABM Signal(x,y,z) (13x13x1): Measurement grid: dx=10mm, dy=10mm

Signal Type: Audio File (.wav) 48k_voice_1kHz_1s.wav
Output Gain: 19.15
Measure Window Start: 300ms
Measure Window Length: 1000ms
BWC applied: -0.18 dB
Device Reference Point: 0, 0, -6.3 mm

Cursor:

ABM1 comp = -1.24 dBA/m
BWC Factor = -0.18 dB
Location: 4.2, -8.3, 3.7 mm

Cursor:

ABM2 = -34.32 dBA/m
Location: 4.2, -8.3, 3.7 mm

Cursor:

ABM1/ABM2 = 33.07 dB
ABM1 comp = -1.24 dBA/m
BWC Factor = -0.18 dB
Location: 4.2, -8.3, 3.7 mm

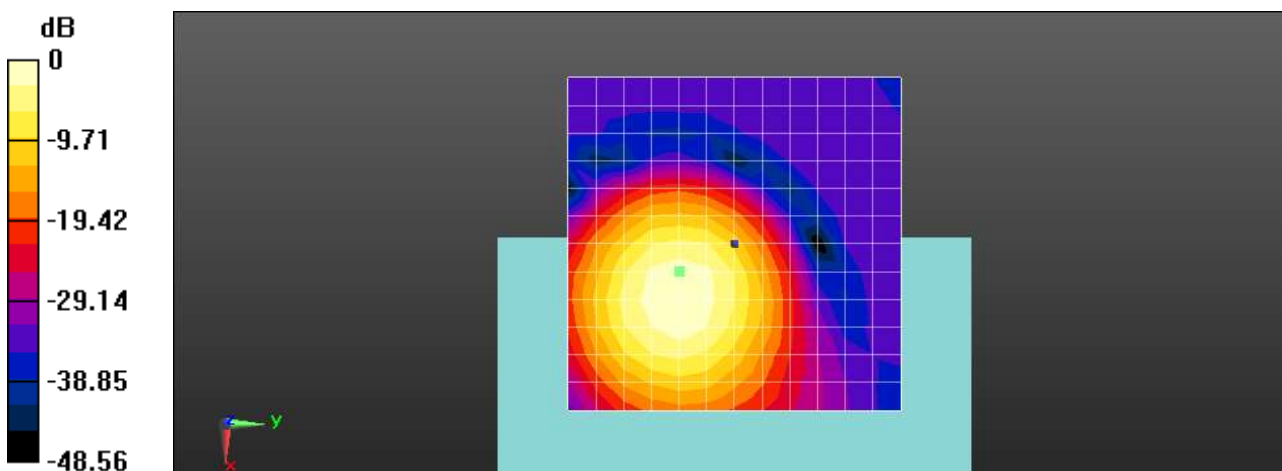

0 dB = 1.000 A/m = 0.00 dBA/m

Plot No.143

802_11a 54Mbps 120ch bitrate 75 Freq.Response

Communication System: UID 0, WIFI 5GHz (0); Frequency: 5600 MHz;Duty Cycle: 1:1
 Medium parameters used: $\sigma = 0$ S/m, $\epsilon_r = 1$; $\rho = 0$ kg/m³
 Phantom section: TCoil Section

T-Coil scan (scan for ANSI C63.19-2007 & 2011 compliance)/General Scans/z (axial) wideband at best

S/N/ABM Freq Resp(x,y,z,f) (1x1x1): Measurement grid: dx=10mm, dy=10mm

Signal Type: Audio File (.wav) 48k_Normal_51s new.wav

Output Gain: 58.25

Measure Window Start: 300ms

Measure Window Length: 51000ms

BWC applied: 9.14 dB

Device Reference Point: 0, 0, -6.3 mm

Category	Telephone parameters WD signal quality [(signal+noise)-to-noise ratio in decibels]
Category T1	0 dB to 10 dB
Category T2	10 dB to 20 dB
Category T3	20 dB to 30 dB
Category T4	> 30 dB

Cursor:

Diff = 2.00 dB

BWC Factor = 9.14 dB

Location: 4.8, -9.8, 3.7 mm

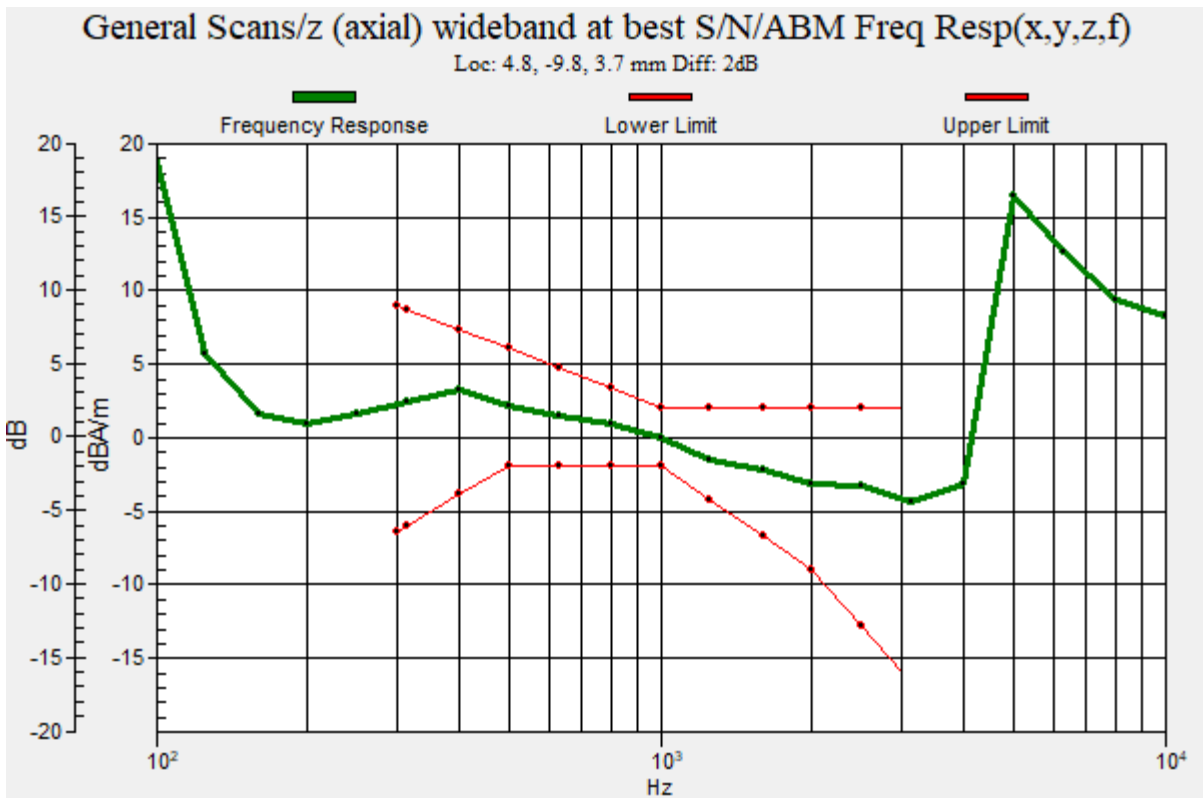

Plot No.144

802_11a 54Mbps 120ch bitrate 75 y(transversal)

Communication System: UID 0, WIFI 5GHz (0); Frequency: 5600 MHz;Duty Cycle: 1:1
Medium parameters used: $\sigma = 0$ S/m, $\epsilon_r = 1$; $\rho = 0$ kg/m³
Phantom section: TCoil Section

DASY5 Configuration:

- Probe: AM1DV3 - 3049; ; Calibrated: 2021-06-01
- Sensor-Surface: 0mm (Fix Surface)
- Electronics: DAE4 Sn652; Calibrated: 2022-01-24
- Phantom: HAC Test Arch with AMCC TCOIL
- Measurement SW: DASY52, Version 52.10 (4)

T-Coil scan (scan for ANSI C63.19-2007 & 2011 compliance)/General Scans/y (transversal) 4.2mm 50 x 50/ABM Signal(x,y,z) (13x13x1): Measurement grid: dx=10mm, dy=10mm

Signal Type: Audio File (.wav) 48k_voice_1kHz_1s.wav
Output Gain: 19.15
Measure Window Start: 300ms
Measure Window Length: 1000ms
BWC applied: -0.18 dB
Device Reference Point: 0, 0, -6.3 mm

Cursor:

ABM1 comp = -8.50 dBA/m
BWC Factor = -0.18 dB
Location: 4.2, -16.7, 3.7 mm

Cursor:

ABM2 = -42.00 dBA/m
Location: 4.2, -16.7, 3.7 mm

Cursor:

ABM1/ABM2 = 33.50 dB
ABM1 comp = -8.50 dBA/m
BWC Factor = -0.18 dB
Location: 4.2, -16.7, 3.7 mm

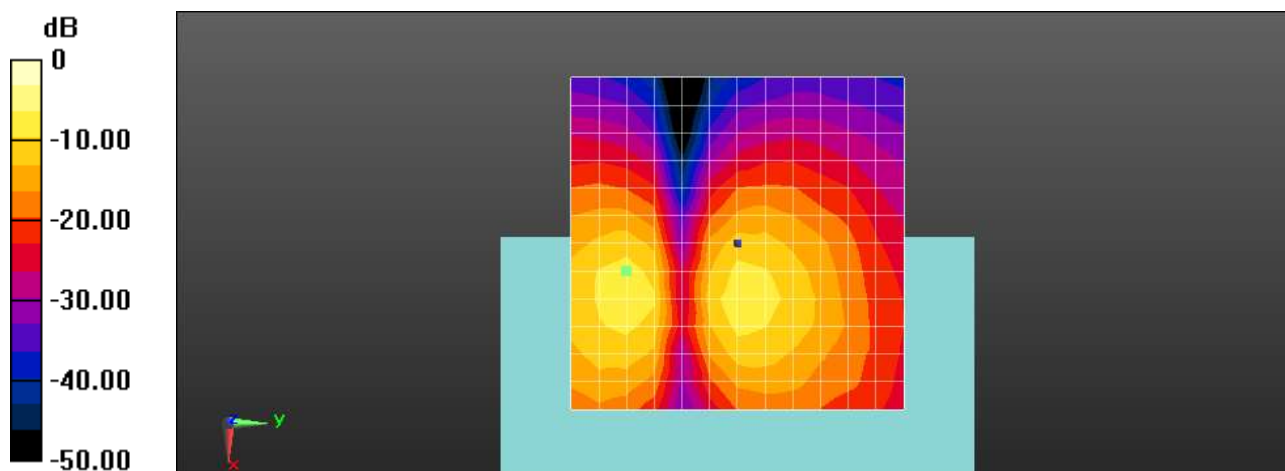

0 dB = 1.000 A/m = 0.00 dBA/m

Plot No.145

802_11a 54Mbps 157ch bitrate 75 z(axial)

Communication System: UID 0, WIFI 5GHz (0); Frequency: 5785 MHz;Duty Cycle: 1:1
Medium parameters used: $\sigma = 0$ S/m, $\epsilon_r = 1$; $\rho = 0$ kg/m³
Phantom section: TCoil Section

DASY5 Configuration:

- Probe: AM1DV3 - 3049; ; Calibrated: 2021-06-01
- Sensor-Surface: 0mm (Fix Surface)
- Electronics: DAE4 Sn652; Calibrated: 2022-01-24
- Phantom: HAC Test Arch with AMCC TCOIL
- Measurement SW: DASY52, Version 52.10 (4)

T-Coil scan (scan for ANSI C63.19-2007 & 2011 compliance)/General Scans/z (axial) 4.2mm 50 x 50/ABM Signal(x,y,z) (13x13x1): Measurement grid: dx=10mm, dy=10mm

Signal Type: Audio File (.wav) 48k_voice_1kHz_1s.wav
Output Gain: 19.15
Measure Window Start: 300ms
Measure Window Length: 1000ms
BWC applied: -0.18 dB
Device Reference Point: 0, 0, -6.3 mm

Cursor:

ABM1 comp = -1.36 dBA/m
BWC Factor = -0.18 dB
Location: 4.2, -8.3, 3.7 mm

Cursor:

ABM2 = -34.37 dBA/m
Location: 4.2, -8.3, 3.7 mm

Cursor:

ABM1/ABM2 = 33.02 dB
ABM1 comp = -1.36 dBA/m
BWC Factor = -0.18 dB
Location: 4.2, -8.3, 3.7 mm

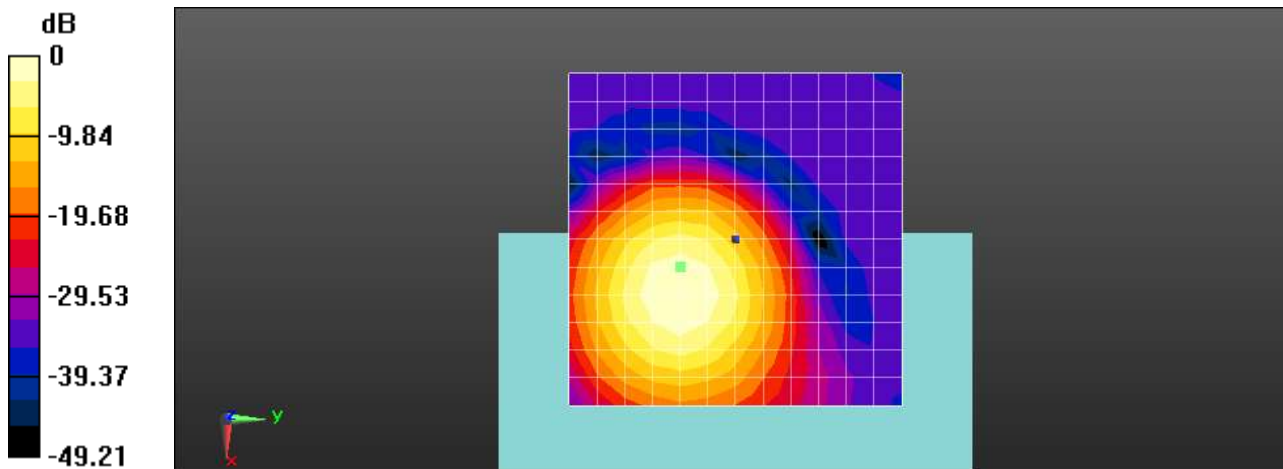

0 dB = 1.000 A/m = 0.00 dBA/m

Plot No.146

802_11a 54Mbps 157ch bitrate 75 Freq.Response

Communication System: UID 0, WIFI 5GHz (0); Frequency: 5785 MHz;Duty Cycle: 1:1
 Medium parameters used: $\sigma = 0$ S/m, $\epsilon_r = 1$; $\rho = 0$ kg/m³
 Phantom section: TCoil Section

T-Coil scan (scan for ANSI C63.19-2007 & 2011 compliance)/General Scans/z (axial) wideband at best

S/N/ABM Freq Resp(x,y,z,f) (1x1x1): Measurement grid: dx=10mm, dy=10mm

Signal Type: Audio File (.wav) 48k_Normal_51s new.wav

Output Gain: 58.25

Measure Window Start: 300ms

Measure Window Length: 51000ms

BWC applied: 9.14 dB

Device Reference Point: 0, 0, -6.3 mm

Category	Telephone parameters WD signal quality [(signal+noise)-to-noise ratio in decibels]
Category T1	0 dB to 10 dB
Category T2	10 dB to 20 dB
Category T3	20 dB to 30 dB
Category T4	> 30 dB

Cursor:

Diff = 2.00 dB

BWC Factor = 9.14 dB

Location: 5.5, -11, 3.7 mm

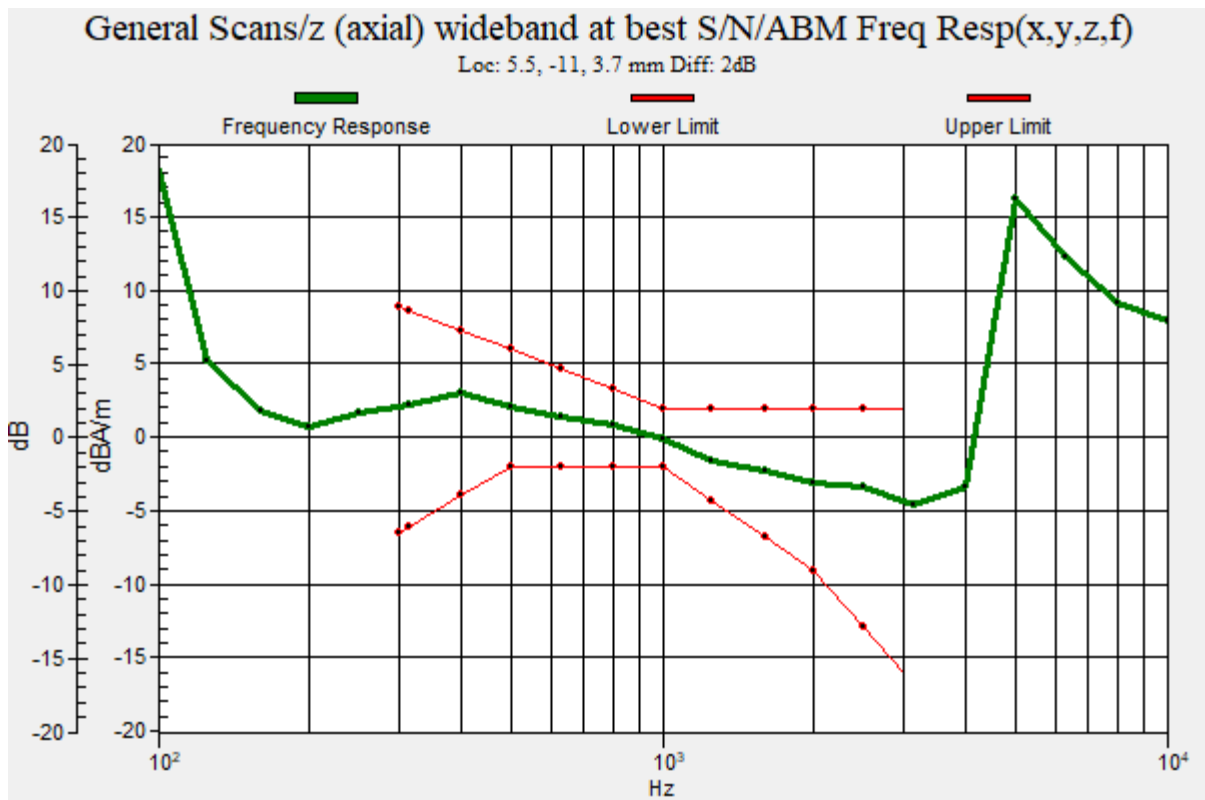

Plot No.147
802_11a 54Mbps 157ch bitrate 75 y(transversal)

Communication System: UID 0, WIFI 5GHz (0); Frequency: 5785 MHz;Duty Cycle: 1:1
Medium parameters used: $\sigma = 0$ S/m, $\epsilon_r = 1$; $\rho = 0$ kg/m³
Phantom section: TCoil Section

DASY5 Configuration:

- Probe: AM1DV3 - 3049; ; Calibrated: 2021-06-01
- Sensor-Surface: 0mm (Fix Surface)
- Electronics: DAE4 Sn652; Calibrated: 2022-01-24
- Phantom: HAC Test Arch with AMCC TCOIL
- Measurement SW: DASY52, Version 52.10 (4)

T-Coil scan (scan for ANSI C63.19-2007 & 2011 compliance)/General Scans/y (transversal) 4.2mm 50

x 50/ABM Signal(x,y,z) (13x13x1): Measurement grid: dx=10mm, dy=10mm

Signal Type: Audio File (.wav) 48k_voice_1kHz_1s.wav

Output Gain: 19.15

Measure Window Start: 300ms

Measure Window Length: 1000ms

BWC applied: -0.18 dB

Device Reference Point: 0, 0, -6.3 mm

Cursor:

ABM1 comp = -11.80 dBA/m

BWC Factor = -0.18 dB

Location: 0, -16.7, 3.7 mm

Cursor:

ABM2 = -44.61 dBA/m

Location: 0, -16.7, 3.7 mm

Cursor:

ABM1/ABM2 = 32.81 dB

ABM1 comp = -11.80 dBA/m

BWC Factor = -0.18 dB

Location: 0, -16.7, 3.7 mm

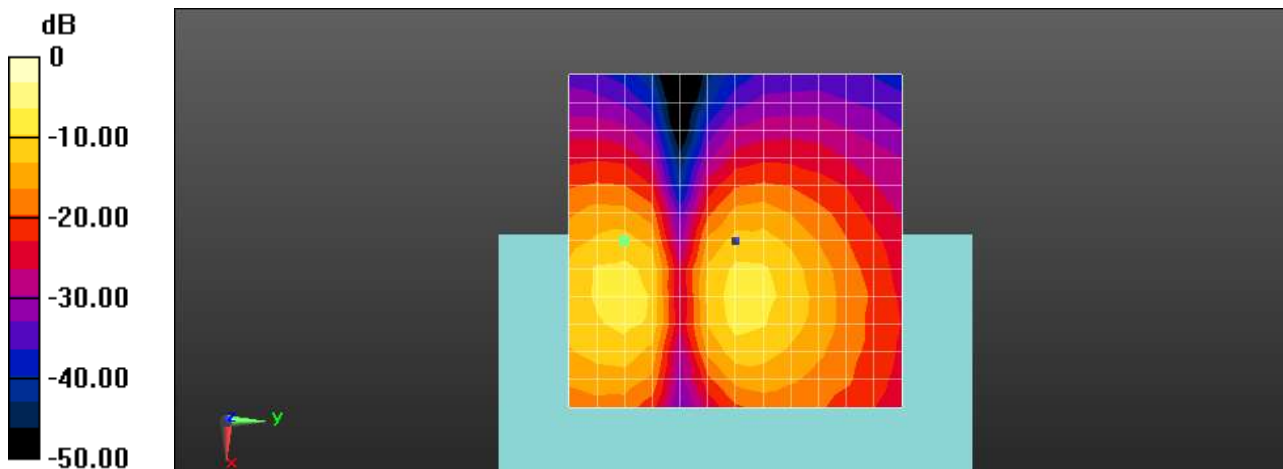

0 dB = 1.000 A/m = 0.00 dBA/m

Plot No.148

NR Band 5 DFTs-OFDM 20MHz 1RB 1offset 167300ch bitrate 40kbits z(axial)

Communication System: UID 0, NR Band 5 (0); Frequency: 836.5 MHz;Duty Cycle: 1:1
Medium parameters used: $\sigma = 0$ S/m, $\epsilon_r = 1$; $\rho = 0$ kg/m³
Phantom section: TCoil Section

DASY5 Configuration:

- Probe: AM1DV3 - 3049; ; Calibrated: 2021-06-01
- Sensor-Surface: 0mm (Fix Surface)
- Electronics: DAE4 Sn652; Calibrated: 2022-01-24
- Phantom: HAC Test Arch with AMCC TCOIL
- Measurement SW: DASY52, Version 52.10 (4)

T-Coil scan (scan for ANSI C63.19-2007 & 2011 compliance)/General Scans/z (axial) 4.2mm 50 x 50/ABM Signal(x,y,z) (13x13x1): Measurement grid: dx=10mm, dy=10mm

Signal Type: Audio File (.wav) 48k_voice_1kHz_1s.wav
Output Gain: 19.15
Measure Window Start: 300ms
Measure Window Length: 1000ms
BWC applied: -0.19 dB
Device Reference Point: 0, 0, -6.3 mm

Cursor:

ABM1 comp = -0.04 dBA/m
BWC Factor = -0.19 dB
Location: 8.3, -12.5, 3.7 mm

Cursor:

ABM2 = -36.41 dBA/m
Location: 8.3, -12.5, 3.7 mm

Cursor:

ABM1/ABM2 = 36.36 dB
ABM1 comp = -0.04 dBA/m
BWC Factor = -0.19 dB
Location: 8.3, -12.5, 3.7 mm

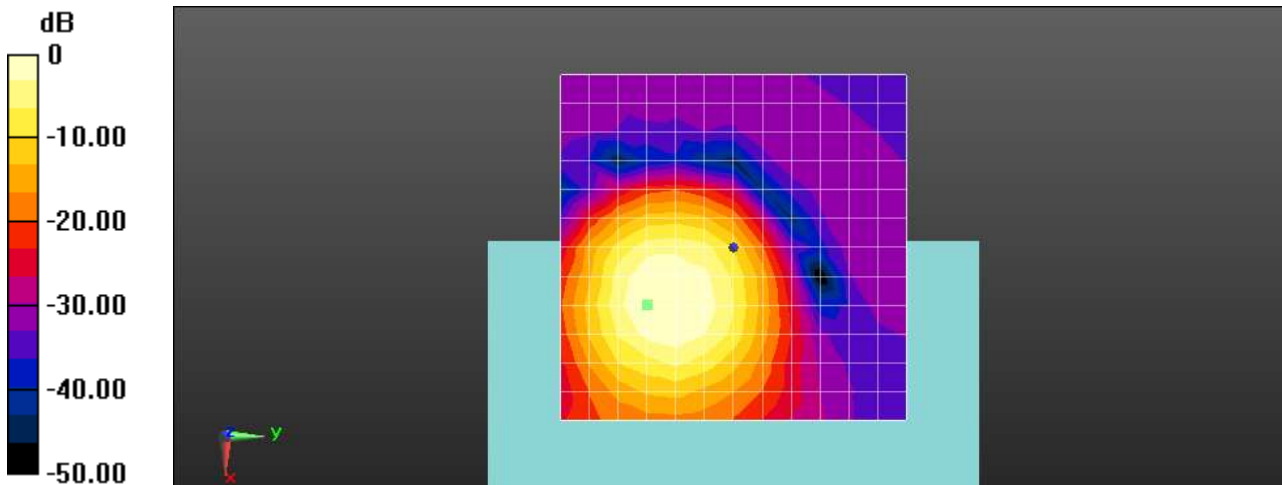

0 dB = 1.000 A/m = 0.00 dBA/m

Plot No.149

NR Band 5 DFTs-OFDM 20MHz 1RB 1offset 167300ch bitrate 40kbits Freq.Response

Communication System: UID 0, NR Band 5 (0); Frequency: 836.5 MHz;Duty Cycle: 1:1
 Medium parameters used: $\sigma = 0$ S/m, $\epsilon_r = 1$; $\rho = 0$ kg/m³
 Phantom section: TCoil Section

T-Coil scan (scan for ANSI C63.19-2007 & 2011 compliance)/General Scans/z (axial) wideband at best

S/N/ABM Freq Resp(x,y,z,f) (1x1x1): Measurement grid: dx=10mm, dy=10mm

Signal Type: Audio File (.wav) 48k_Normal_51s new.wav

Output Gain: 58.25

Measure Window Start: 300ms

Measure Window Length: 51000ms

BWC applied: 9.13 dB

Device Reference Point: 0, 0, -6.3 mm

Category	Telephone parameters WD signal quality [(signal+noise)-to-noise ratio in decibels]
Category T1	0 dB to 10 dB
Category T2	10 dB to 20 dB
Category T3	20 dB to 30 dB
Category T4	> 30 dB

Cursor:

Diff = 2.00 dB

BWC Factor = 9.13 dB

Location: 7.7, -11.7, 3.7 mm

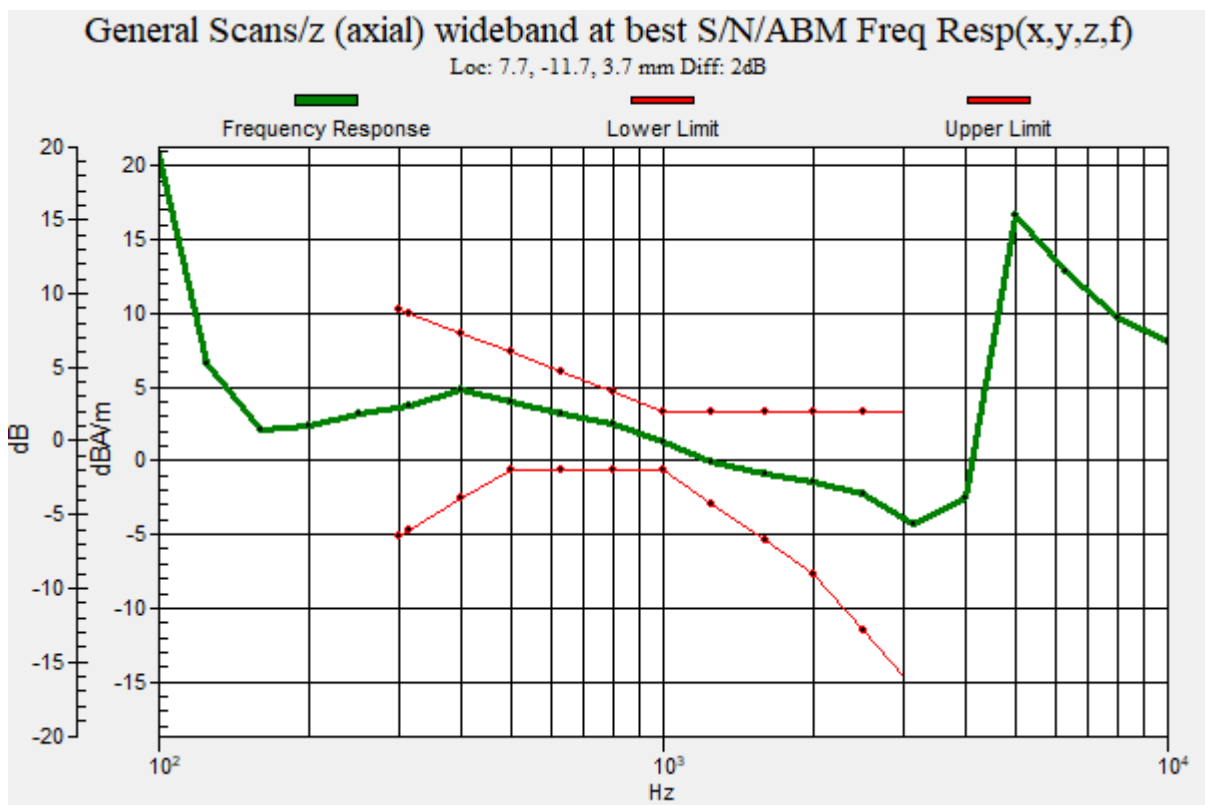

Plot No.150

NR Band 5 DFTs-OFDM 20MHz 1RB 1offset 167300ch bitrate 40kbits y(transversal)

Communication System: UID 0, NR Band 5 (0); Frequency: 836.5 MHz;Duty Cycle: 1:1
Medium parameters used: $\sigma = 0$ S/m, $\epsilon_r = 1$; $\rho = 0$ kg/m³
Phantom section: TCoil Section

DASY5 Configuration:

- Probe: AM1DV3 - 3049; ; Calibrated: 2021-06-01
- Sensor-Surface: 0mm (Fix Surface)
- Electronics: DAE4 Sn652; Calibrated: 2022-01-24
- Phantom: HAC Test Arch with AMCC TCOIL
- Measurement SW: DASY52, Version 52.10 (4)

T-Coil scan (scan for ANSI C63.19-2007 & 2011 compliance)/General Scans/y (transversal) 4.2mm 50

x 50/ABM Signal(x,y,z) (13x13x1): Measurement grid: dx=10mm, dy=10mm

Signal Type: Audio File (.wav) 48k_voice_1kHz_1s.wav

Output Gain: 19.15

Measure Window Start: 300ms

Measure Window Length: 1000ms

BWC applied: -0.19 dB

Device Reference Point: 0, 0, -6.3 mm

Cursor:

ABM1 comp = -10.46 dBA/m

BWC Factor = -0.19 dB

Location: 0, 0, 3.7 mm

Cursor:

ABM2 = -51.91 dBA/m

Location: 0, 0, 3.7 mm

Cursor:

ABM1/ABM2 = 41.46 dB

ABM1 comp = -10.46 dBA/m

BWC Factor = -0.19 dB

Location: 0, 0, 3.7 mm

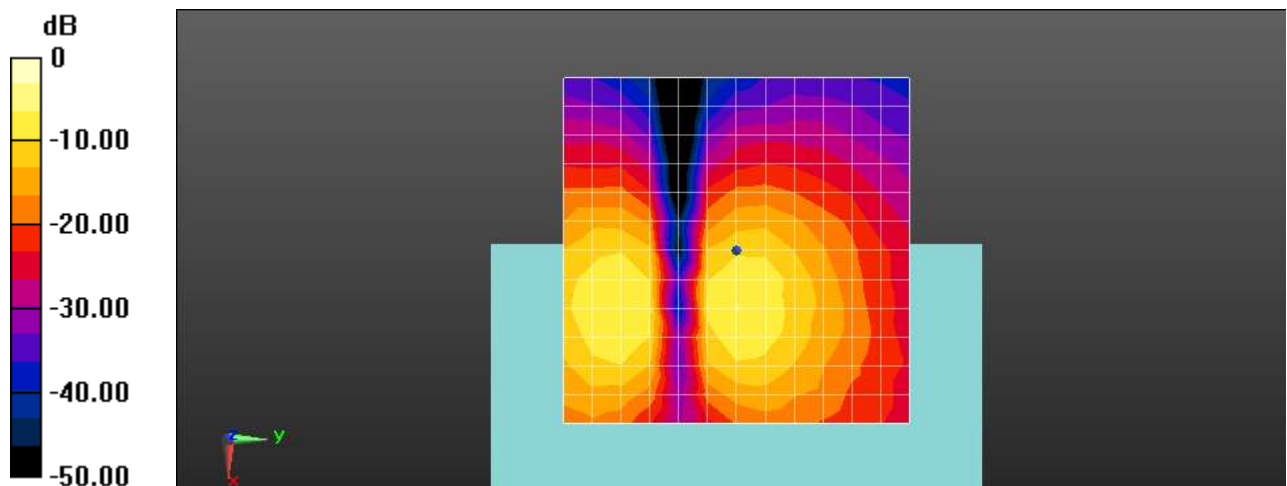

0 dB = 1.000 A/m = 0.00 dBA/m

Plot No.151

NR Band 12 DFTs-OFDM 15MHz 1RB 1offset 141500ch bitrate 40kbits z(axial)

Communication System: UID 0, NR Band 12 (0); Frequency: 707.5 MHz;Duty Cycle: 1:1
Medium parameters used: $\sigma = 0$ S/m, $\epsilon_r = 1$; $\rho = 0$ kg/m³
Phantom section: TCoil Section

DASY5 Configuration:

- Probe: AM1DV3 - 3049; ; Calibrated: 2021-06-01
- Sensor-Surface: 0mm (Fix Surface)
- Electronics: DAE4 Sn652; Calibrated: 2022-01-24
- Phantom: HAC Test Arch with AMCC TCOIL
- Measurement SW: DASY52, Version 52.10 (4)

T-Coil scan (scan for ANSI C63.19-2007 & 2011 compliance)/General Scans/z (axial) 4.2mm 50 x

50/ABM Signal(x,y,z) (13x13x1): Measurement grid: dx=10mm, dy=10mm

Signal Type: Audio File (.wav) 48k_voice_1kHz_1s.wav

Output Gain: 19.15

Measure Window Start: 300ms

Measure Window Length: 1000ms

BWC applied: -0.19 dB

Device Reference Point: 0, 0, -6.3 mm

Cursor:

ABM1 comp = -0.23 dBA/m

BWC Factor = -0.19 dB

Location: 8.3, -12.5, 3.7 mm

Cursor:

ABM2 = -36.15 dBA/m

Location: 8.3, -12.5, 3.7 mm

Cursor:

ABM1/ABM2 = 35.92 dB

ABM1 comp = -0.23 dBA/m

BWC Factor = -0.19 dB

Location: 8.3, -12.5, 3.7 mm

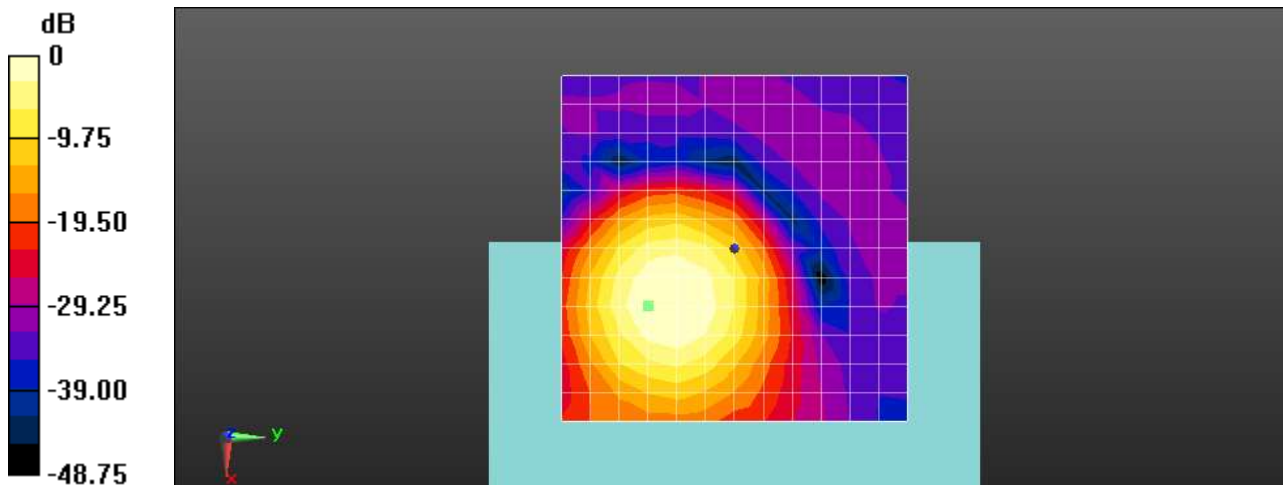

0 dB = 1.000 A/m = 0.00 dBA/m

Plot No.152

NR Band 12 DFTs-OFDM 15MHz 1RB 1offset 141500ch bitrate 40kbits Freq.Response

Communication System: UID 0, NR Band 12 (0); Frequency: 707.5 MHz;Duty Cycle: 1:1
 Medium parameters used: $\sigma = 0$ S/m, $\epsilon_r = 1$; $\rho = 0$ kg/m³
 Phantom section: TCoil Section

T-Coil scan (scan for ANSI C63.19-2007 & 2011 compliance)/General Scans/z (axial) wideband at best

S/N/ABM Freq Resp(x,y,z,f) (1x1x1): Measurement grid: dx=10mm, dy=10mm

Signal Type: Audio File (.wav) 48k_Normal_51s new.wav

Output Gain: 58.25

Measure Window Start: 300ms

Measure Window Length: 51000ms

BWC applied: 9.12 dB

Device Reference Point: 0, 0, -6.3 mm

Category	Telephone parameters WD signal quality [(signal+noise)-to-noise ratio in decibels]
Category T1	0 dB to 10 dB
Category T2	10 dB to 20 dB
Category T3	20 dB to 30 dB
Category T4	> 30 dB

Cursor:

Diff = 2.00 dB

BWC Factor = 9.12 dB

Location: 8, -11.1, 3.7 mm

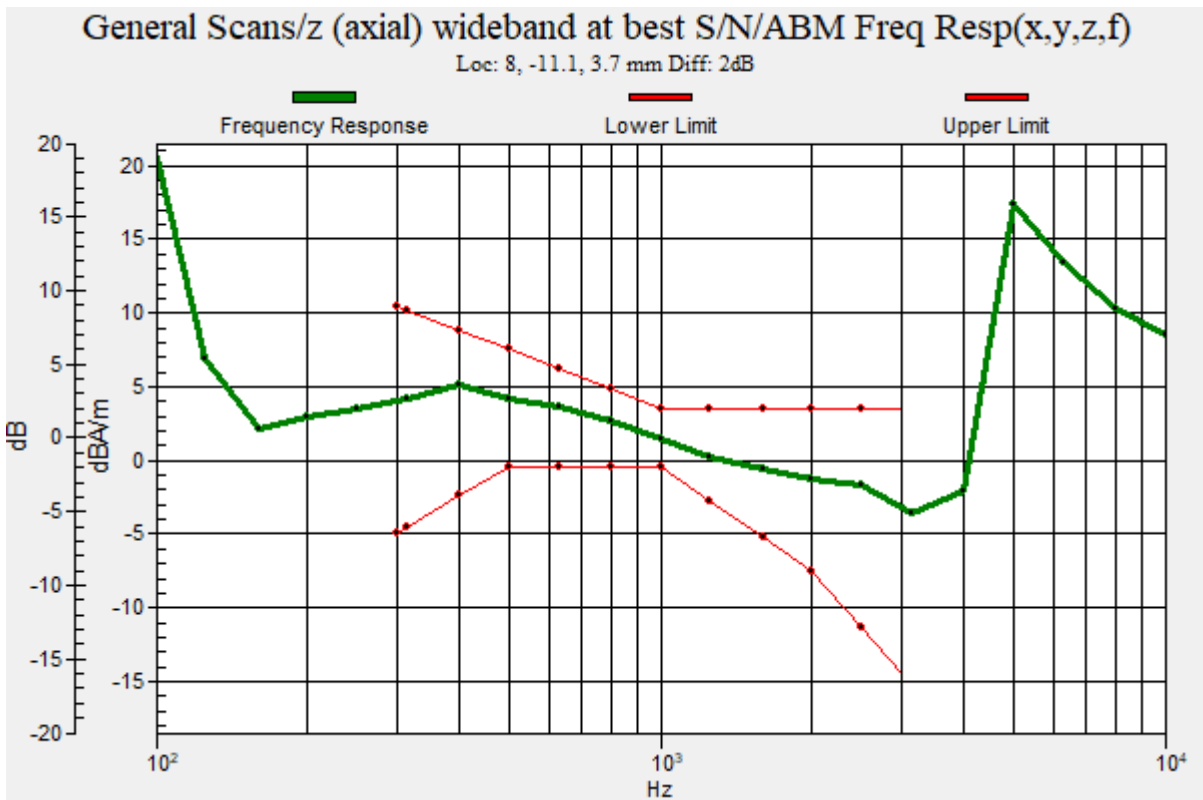

Plot No.153

NR Band 12 DFTs-OFDM 15MHz 1RB 1offset 141500ch bitrate 40kbits y(trnavsersal)

Communication System: UID 0, NR Band 12 (0); Frequency: 707.5 MHz;Duty Cycle: 1:1
Medium parameters used: $\sigma = 0$ S/m, $\epsilon_r = 1$; $\rho = 0$ kg/m³
Phantom section: TCoil Section

DASY5 Configuration:

- Probe: AM1DV3 - 3049; ; Calibrated: 2021-06-01
- Sensor-Surface: 0mm (Fix Surface)
- Electronics: DAE4 Sn652; Calibrated: 2022-01-24
- Phantom: HAC Test Arch with AMCC TCOIL
- Measurement SW: DASY52, Version 52.10 (4)

T-Coil scan (scan for ANSI C63.19-2007 & 2011 compliance)/General Scans/y (transversal) 4.2mm 50 x 50/ABM Signal(x,y,z) (13x13x1): Measurement grid: dx=10mm, dy=10mm

Signal Type: Audio File (.wav) 48k_voice_1kHz_1s.wav
Output Gain: 19.15
Measure Window Start: 300ms
Measure Window Length: 1000ms
BWC applied: -0.19 dB
Device Reference Point: 0, 0, -6.3 mm

Cursor:

ABM1 comp = -7.42 dBA/m
BWC Factor = -0.19 dB
Location: 4.2, -16.7, 3.7 mm

Cursor:

ABM2 = -40.91 dBA/m
Location: 4.2, -16.7, 3.7 mm

Cursor:

ABM1/ABM2 = 33.50 dB
ABM1 comp = -7.42 dBA/m
BWC Factor = -0.19 dB
Location: 4.2, -16.7, 3.7 mm

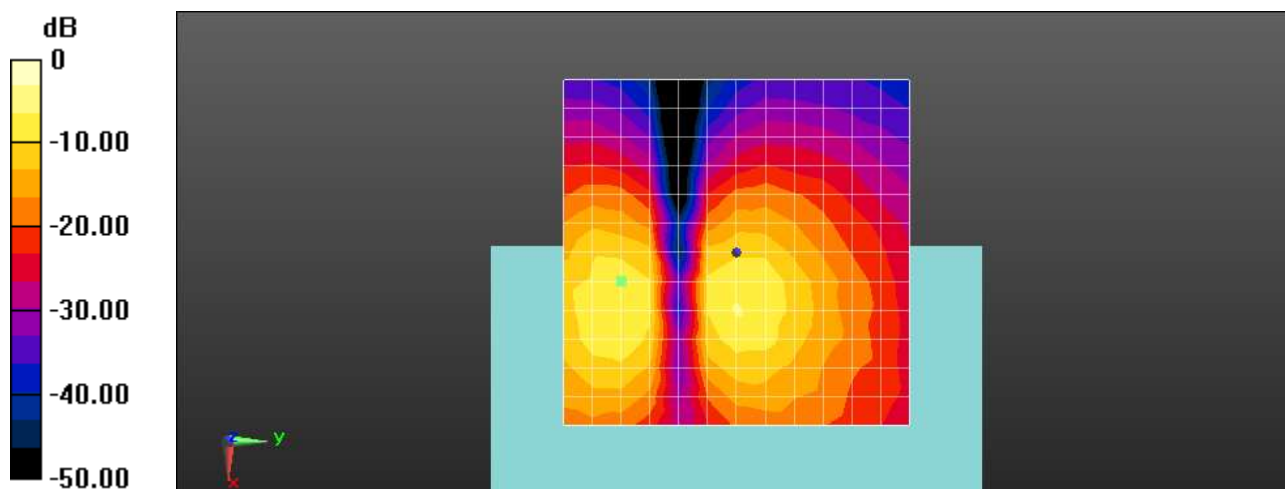

0 dB = 1.000 A/m = 0.00 dBA/m

Plot No.154

NR Band 25 DFTs-OFDM 40MHz 1RB 1offset 376500ch bitrate 40kbits z(axial)

Communication System: UID 0, NR n25 (0); Frequency: 1882.5 MHz;Duty Cycle: 1:1
Medium parameters used: $\sigma = 0$ S/m, $\epsilon_r = 1$; $\rho = 0$ kg/m³
Phantom section: TCoil Section

DASY5 Configuration:

- Probe: AM1DV3 - 3049; ; Calibrated: 2021-06-01
- Sensor-Surface: 0mm (Fix Surface)
- Electronics: DAE4 Sn652; Calibrated: 2022-01-24
- Phantom: HAC Test Arch with AMCC TCOIL
- Measurement SW: DASY52, Version 52.10 (4)

T-Coil scan (scan for ANSI C63.19-2007 & 2011 compliance)/General Scans/z (axial) 4.2mm 50 x

50/ABM Signal(x,y,z) (13x13x1): Measurement grid: dx=10mm, dy=10mm

Signal Type: Audio File (.wav) 48k_voice_1kHz_1s.wav

Output Gain: 19.15

Measure Window Start: 300ms

Measure Window Length: 1000ms

BWC applied: -0.20 dB

Device Reference Point: 0, 0, -6.3 mm

Cursor:

ABM1 comp = 1.54 dBA/m

BWC Factor = -0.20 dB

Location: 8.3, -8.3, 3.7 mm

Cursor:

ABM2 = -35.16 dBA/m

Location: 8.3, -8.3, 3.7 mm

Cursor:

ABM1/ABM2 = 36.71 dB

ABM1 comp = 1.54 dBA/m

BWC Factor = -0.20 dB

Location: 8.3, -8.3, 3.7 mm

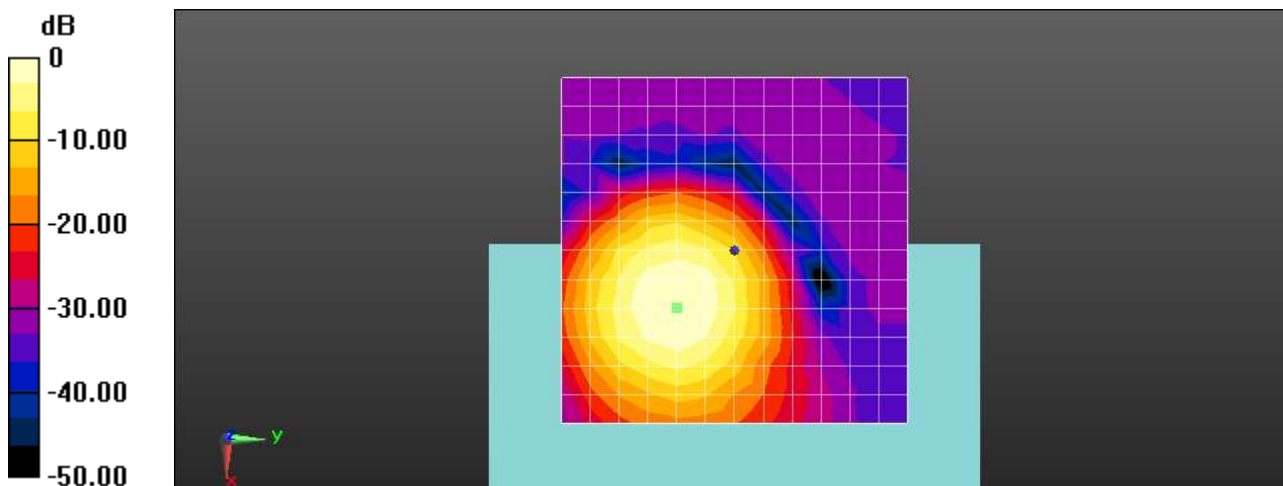

0 dB = 1.000 A/m = 0.00 dBA/m

Plot No.155

NR Band 25 DFTs-OFDM 40MHz 1RB 1offset 376500ch bitrate 40kbits Freq.Response

Communication System: UID 0, NR n25 (0); Frequency: 1882.5 MHz;Duty Cycle: 1:1
 Medium parameters used: $\sigma = 0$ S/m, $\epsilon_r = 1$; $\rho = 0$ kg/m³
 Phantom section: TCoil Section

T-Coil scan (scan for ANSI C63.19-2007 & 2011 compliance)/General Scans/z (axial) wideband at best

S/N/ABM Freq Resp(x,y,z,f) (1x1x1): Measurement grid: dx=10mm, dy=10mm

Signal Type: Audio File (.wav) 48k_Normal_51s new.wav

Output Gain: 58.25

Measure Window Start: 300ms

Measure Window Length: 51000ms

BWC applied: 9.12 dB

Device Reference Point: 0, 0, -6.3 mm

Category	Telephone parameters WD signal quality [(signal+noise)-to-noise ratio in decibels]
Category T1	0 dB to 10 dB
Category T2	10 dB to 20 dB
Category T3	20 dB to 30 dB
Category T4	> 30 dB

Cursor:

Diff = 2.00 dB

BWC Factor = 9.12 dB

Location: 7.5, -9.4, 3.7 mm

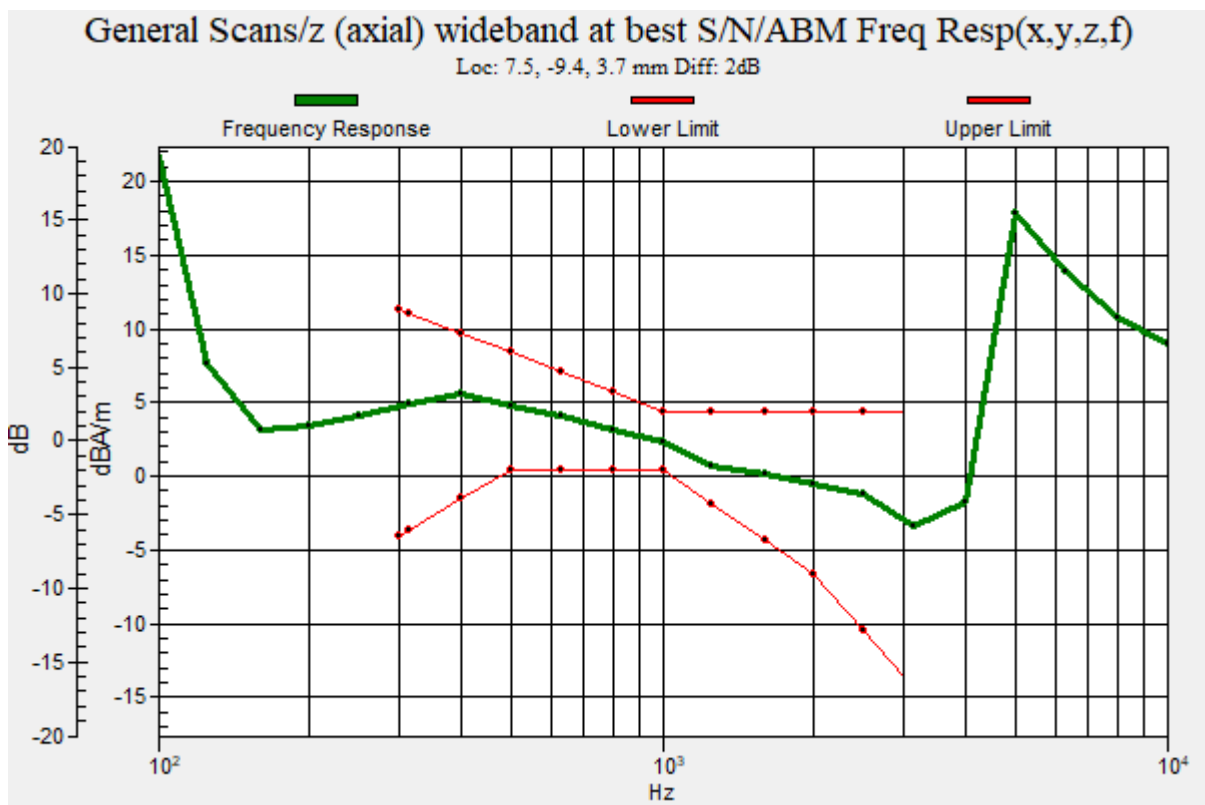

Plot No.156

NR Band 25 DFTs-OFDM 40MHz 1RB 1offset 376500ch bitrate 40kbits y(transversal)

Communication System: UID 0, NR n25 (0); Frequency: 1882.5 MHz;Duty Cycle: 1:1

Medium parameters used: $\sigma = 0$ S/m, $\epsilon_r = 1$; $\rho = 0$ kg/m³

Phantom section: TCoil Section

DASY5 Configuration:

- Probe: AM1DV3 - 3049; ; Calibrated: 2021-06-01
- Sensor-Surface: 0mm (Fix Surface)
- Electronics: DAE4 Sn652; Calibrated: 2022-01-24
- Phantom: HAC Test Arch with AMCC TCOIL
- Measurement SW: DASY52, Version 52.10 (4)

T-Coil scan (scan for ANSI C63.19-2007 & 2011 compliance)/General Scans/y (transversal) 4.2mm 50

x 50/ABM Signal(x,y,z) (13x13x1): Measurement grid: dx=10mm, dy=10mm

Signal Type: Audio File (.wav) 48k_voice_1kHz_1s.wav

Output Gain: 19.15

Measure Window Start: 300ms

Measure Window Length: 1000ms

BWC applied: -0.20 dB

Device Reference Point: 0, 0, -6.3 mm

Cursor:

ABM1 comp = -6.88 dBA/m

BWC Factor = -0.20 dB

Location: 4.2, 0, 3.7 mm

Cursor:

ABM2 = -42.93 dBA/m

Location: 4.2, 0, 3.7 mm

Cursor:

ABM1/ABM2 = 36.05 dB

ABM1 comp = -6.88 dBA/m

BWC Factor = -0.20 dB

Location: 4.2, 0, 3.7 mm

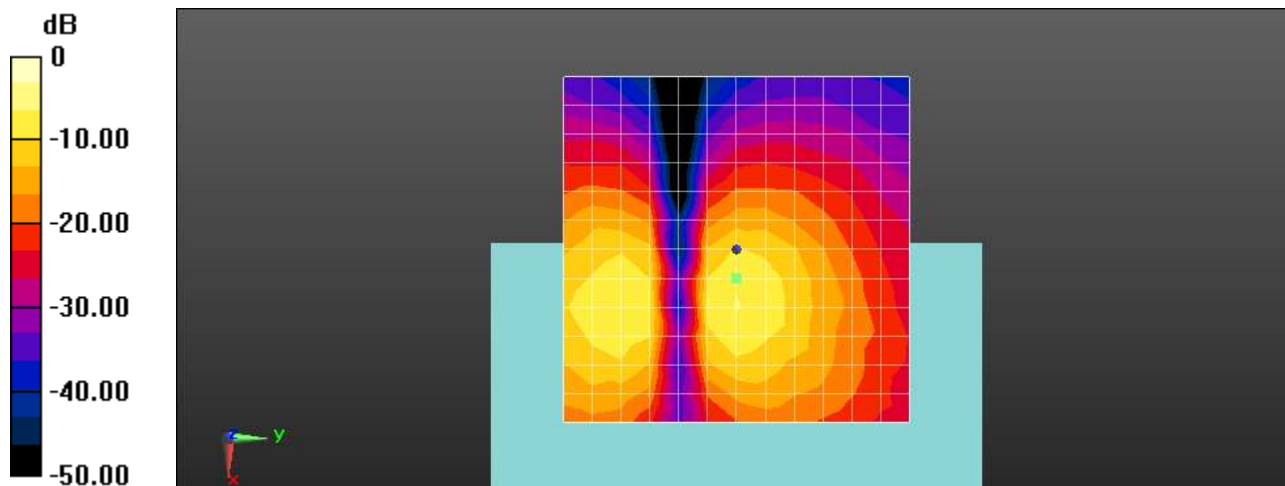

0 dB = 1.000 A/m = 0.00 dBA/m

Plot No.157

NR Band 30 DFTs-OFDM 10MHz 1RB 1offset 462000ch bitrate 40kbits z(axial)

Communication System: UID 0, NR n30 (0); Frequency: 2310 MHz;Duty Cycle: 1:1
Medium parameters used: $\sigma = 0$ S/m, $\epsilon_r = 1$; $\rho = 0$ kg/m³
Phantom section: TCoil Section

DASY5 Configuration:

- Probe: AM1DV3 - 3049; ; Calibrated: 2021-06-01
- Sensor-Surface: 0mm (Fix Surface)
- Electronics: DAE4 Sn652; Calibrated: 2022-01-24
- Phantom: HAC Test Arch with AMCC TCOIL
- Measurement SW: DASY52, Version 52.10 (4)

T-Coil scan (scan for ANSI C63.19-2007 & 2011 compliance)/General Scans/z (axial) 4.2mm 50 x

50/ABM Signal(x,y,z) (13x13x1): Measurement grid: dx=10mm, dy=10mm

Signal Type: Audio File (.wav) 48k_voice_1kHz_1s.wav

Output Gain: 19.15

Measure Window Start: 300ms

Measure Window Length: 1000ms

BWC applied: -0.20 dB

Device Reference Point: 0, 0, -6.3 mm

Cursor:

ABM1 comp = 1.40 dBA/m

BWC Factor = -0.20 dB

Location: 8.3, -8.3, 3.7 mm

Cursor:

ABM2 = -35.26 dBA/m

Location: 8.3, -8.3, 3.7 mm

Cursor:

ABM1/ABM2 = 36.65 dB

ABM1 comp = 1.40 dBA/m

BWC Factor = -0.20 dB

Location: 8.3, -8.3, 3.7 mm

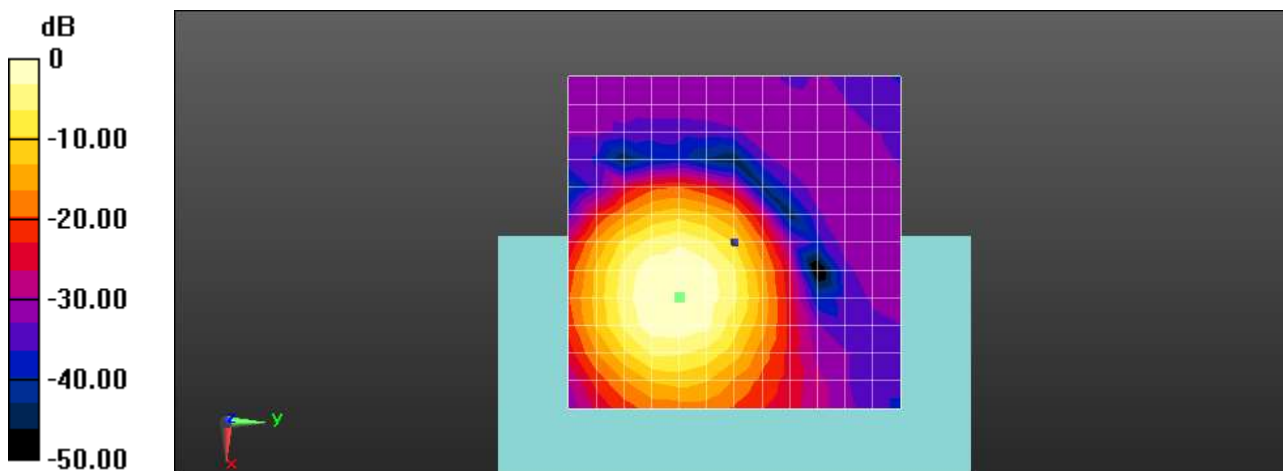

0 dB = 1.000 A/m = 0.00 dBA/m

Plot No.158

NR Band 30 DFTs-OFDM 10MHz 1RB 1offset 462000ch bitrate 40kbits Freq.Response

Communication System: UID 0, NR n30 (0); Frequency: 2310 MHz;Duty Cycle: 1:1
 Medium parameters used: $\sigma = 0$ S/m, $\epsilon_r = 1$; $\rho = 0$ kg/m³
 Phantom section: TCoil Section

T-Coil scan (scan for ANSI C63.19-2007 & 2011 compliance)/General Scans/z (axial) wideband at best

S/N/ABM Freq Resp(x,y,z,f) (1x1x1): Measurement grid: dx=10mm, dy=10mm

Signal Type: Audio File (.wav) 48k_Normal_51s new.wav

Output Gain: 58.25

Measure Window Start: 300ms

Measure Window Length: 51000ms

BWC applied: 9.12 dB

Device Reference Point: 0, 0, -6.3 mm

Category	Telephone parameters WD signal quality [(signal+noise)-to-noise ratio in decibels]
Category T1	0 dB to 10 dB
Category T2	10 dB to 20 dB
Category T3	20 dB to 30 dB
Category T4	> 30 dB

Cursor:

Diff = 2.00 dB

BWC Factor = 9.12 dB

Location: 7.6, -10.7, 3.7 mm

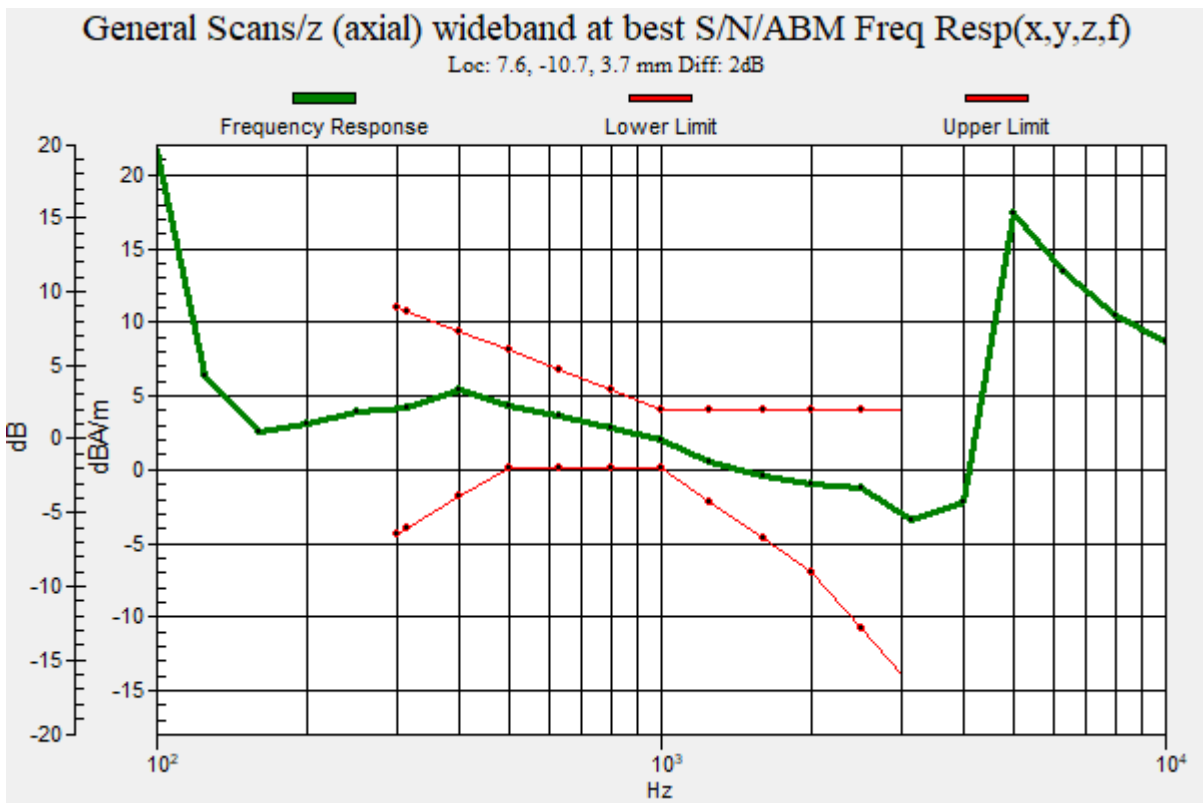

Plot No.159

NR Band 30 DFTs-OFDM 10MHz 1RB 1offset 462000ch bitrate 40kbits y(transversal)

Communication System: UID 0, NR n30 (0); Frequency: 2310 MHz;Duty Cycle: 1:1
Medium parameters used: $\sigma = 0$ S/m, $\epsilon_r = 1$; $\rho = 0$ kg/m³
Phantom section: TCoil Section

DASY5 Configuration:

- Probe: AM1DV3 - 3049; ; Calibrated: 2021-06-01
- Sensor-Surface: 0mm (Fix Surface)
- Electronics: DAE4 Sn652; Calibrated: 2022-01-24
- Phantom: HAC Test Arch with AMCC TCOIL
- Measurement SW: DASY52, Version 52.10 (4)

T-Coil scan (scan for ANSI C63.19-2007 & 2011 compliance)/General Scans/y (transversal) 4.2mm 50

x 50/ABM Signal(x,y,z) (13x13x1): Measurement grid: dx=10mm, dy=10mm

Signal Type: Audio File (.wav) 48k_voice_1kHz_1s.wav

Output Gain: 19.15

Measure Window Start: 300ms

Measure Window Length: 1000ms

BWC applied: -0.20 dB

Device Reference Point: 0, 0, -6.3 mm

Cursor:

ABM1 comp = -10.04 dBA/m

BWC Factor = -0.20 dB

Location: 0, 4.2, 3.7 mm

Cursor:

ABM2 = -46.44 dBA/m

Location: 0, 4.2, 3.7 mm

ABM1/ABM2 = 36.40 dB

ABM1 comp = -10.04 dBA/m

BWC Factor = -0.20 dB

Location: 0, 4.2, 3.7 mm

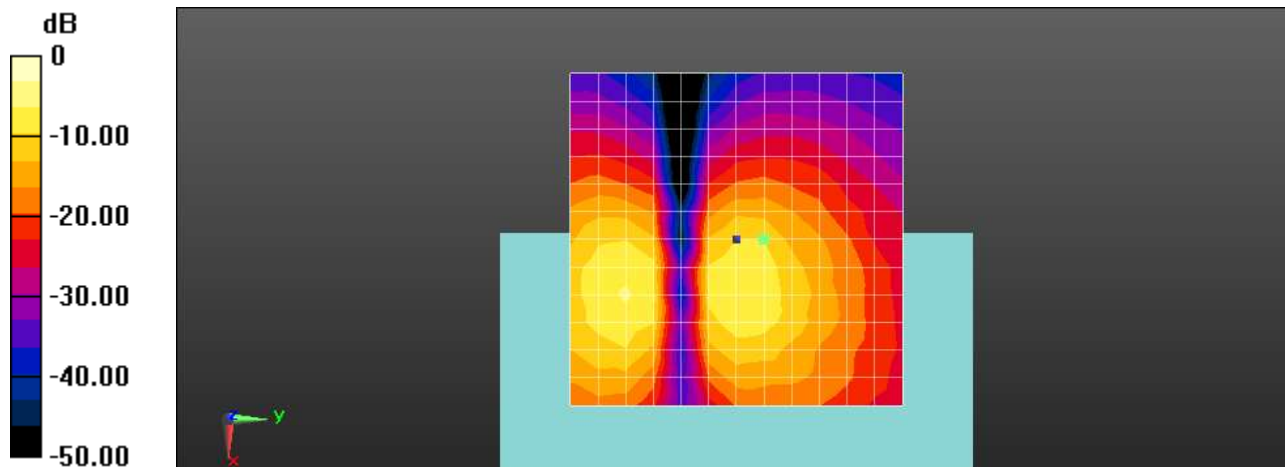

0 dB = 1.000 A/m = 0.00 dBA/m

Plot No.160

NR Band 66 DFTs-OFDM 40MHz 1RB 1offset 349000ch bitrate 40kbits z(axial)

Communication System: UID 0, NR Band 66 (0); Frequency: 1745 MHz;Duty Cycle: 1:1
Medium parameters used: $\sigma = 0$ S/m, $\epsilon_r = 1$; $\rho = 0$ kg/m³
Phantom section: TCoil Section

DASY5 Configuration:

- Probe: AM1DV3 - 3049; ; Calibrated: 2021-06-01
- Sensor-Surface: 0mm (Fix Surface)
- Electronics: DAE4 Sn652; Calibrated: 2022-01-24
- Phantom: HAC Test Arch with AMCC TCOIL
- Measurement SW: DASY52, Version 52.10 (4)

T-Coil scan (scan for ANSI C63.19-2007 & 2011 compliance)/General Scans/z (axial) 4.2mm 50 x

50/ABM Signal(x,y,z) (13x13x1): Measurement grid: dx=10mm, dy=10mm

Signal Type: Audio File (.wav) 48k_voice_1kHz_1s.wav

Output Gain: 19.15

Measure Window Start: 300ms

Measure Window Length: 1000ms

BWC applied: -0.19 dB

Device Reference Point: 0, 0, -6.3 mm

Cursor:

ABM1 comp = 0.88 dBA/m

BWC Factor = -0.19 dB

Location: 4.2, -8.3, 3.7 mm

Cursor:

ABM2 = -33.57 dBA/m

Location: 4.2, -8.3, 3.7 mm

Cursor:

ABM1/ABM2 = 34.45 dB

ABM1 comp = 0.88 dBA/m

BWC Factor = -0.19 dB

Location: 4.2, -8.3, 3.7 mm

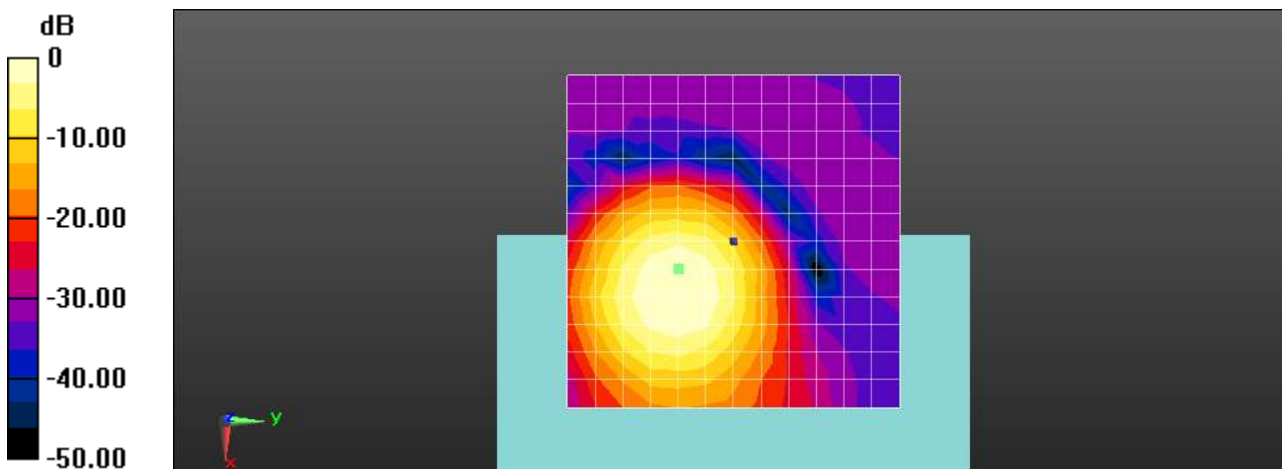

0 dB = 1.000 A/m = 0.00 dBA/m

Plot No.161

NR Band 66 DFTs-OFDM 40MHz 1RB 1offset 349000ch bitrate 40kbits Freq.Response

Communication System: UID 0, NR Band 66 (0); Frequency: 1745 MHz;Duty Cycle: 1:1
 Medium parameters used: $\sigma = 0$ S/m, $\epsilon_r = 1$; $\rho = 0$ kg/m³
 Phantom section: TCoil Section

T-Coil scan (scan for ANSI C63.19-2007 & 2011 compliance)/General Scans/z (axial) wideband at best

S/N/ABM Freq Resp(x,y,z,f) (1x1x1): Measurement grid: dx=10mm, dy=10mm

Signal Type: Audio File (.wav) 48k_Normal_51s new.wav

Output Gain: 58.25

Measure Window Start: 300ms

Measure Window Length: 51000ms

BWC applied: 9.13 dB

Device Reference Point: 0, 0, -6.3 mm

Category	Telephone parameters WD signal quality [(signal+noise)-to-noise ratio in decibels]
Category T1	0 dB to 10 dB
Category T2	10 dB to 20 dB
Category T3	20 dB to 30 dB
Category T4	> 30 dB

Cursor:

Diff = 2.00 dB

BWC Factor = 9.13 dB

Location: 5, -8.5, 3.7 mm

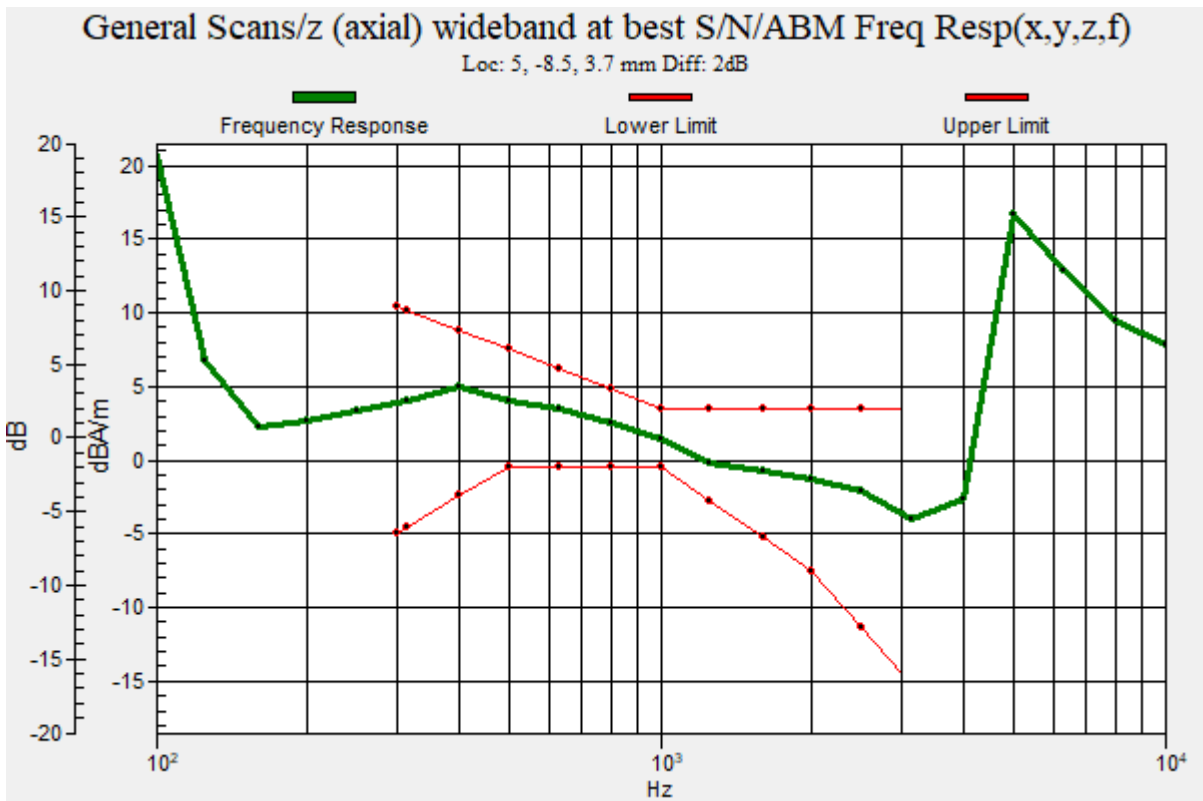

Plot No.162

NR Band 66 DFTs-OFDM 40MHz 1RB 1offset 349000ch bitrate 40kbits- y(transversal)

Communication System: UID 0, NR Band 66 (0); Frequency: 1745 MHz;Duty Cycle: 1:1
Medium parameters used: $\sigma = 0$ S/m, $\epsilon_r = 1$; $\rho = 0$ kg/m³
Phantom section: TCoil Section

DASY5 Configuration:

- Probe: AM1DV3 - 3049; ; Calibrated: 2021-06-01
- Sensor-Surface: 0mm (Fix Surface)
- Electronics: DAE4 Sn652; Calibrated: 2022-01-24
- Phantom: HAC Test Arch with AMCC TCOIL
- Measurement SW: DASY52, Version 52.10 (4)

T-Coil scan (scan for ANSI C63.19-2007 & 2011 compliance)/General Scans/y (transversal) 4.2mm 50 x 50/ABM Signal(x,y,z) (13x13x1): Measurement grid: dx=10mm, dy=10mm

Signal Type: Audio File (.wav) 48k_voice_1kHz_1s.wav
Output Gain: 19.15
Measure Window Start: 300ms
Measure Window Length: 1000ms
BWC applied: -0.19 dB
Device Reference Point: 0, 0, -6.3 mm

Cursor:

ABM1 comp = -10.89 dBA/m
BWC Factor = -0.19 dB
Location: 0, 4.2, 3.7 mm

Cursor:

ABM2 = -42.11 dBA/m
Location: 0, 4.2, 3.7 mm

Cursor:

ABM1/ABM2 = 31.22 dB
ABM1 comp = -10.89 dBA/m
BWC Factor = -0.19 dB
Location: 0, 4.2, 3.7 mm

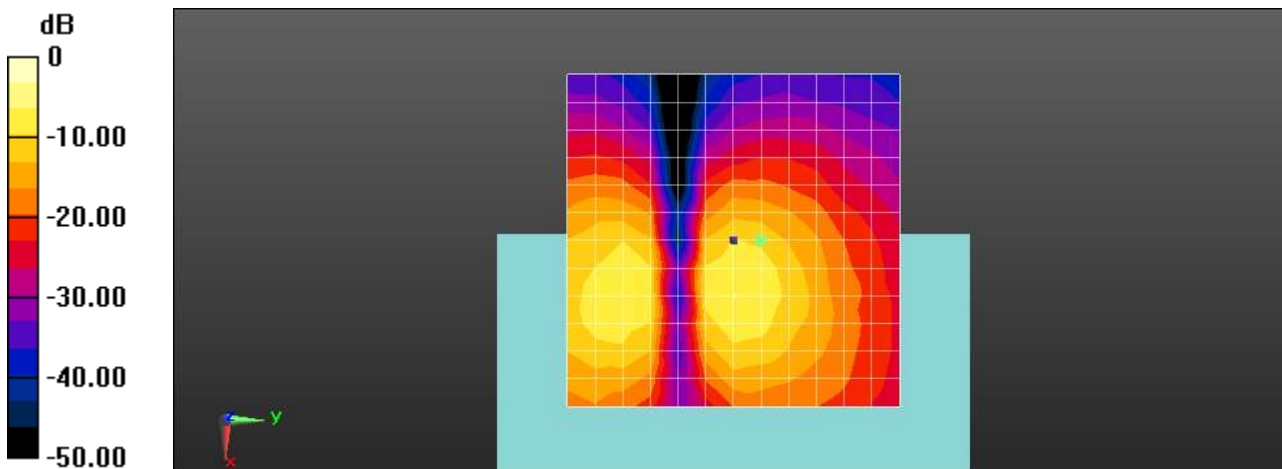

0 dB = 1.000 A/m = 0.00 dBA/m

Plot No.163

NR Band 71 DFTs-OFDM 20MHz 1RB 1offset 136100ch bitrate 40kbits z(axial)

Communication System: UID 0, NR Band 71 (0); Frequency: 680.5 MHz;Duty Cycle: 1:1
Medium parameters used: $\sigma = 0$ S/m, $\epsilon_r = 1$; $\rho = 0$ kg/m³
Phantom section: TCoil Section

DASY5 Configuration:

- Probe: AM1DV3 - 3049; ; Calibrated: 2021-06-01
- Sensor-Surface: 0mm (Fix Surface)
- Electronics: DAE4 Sn652; Calibrated: 2022-01-24
- Phantom: HAC Test Arch with AMCC TCOIL
- Measurement SW: DASY52, Version 52.10 (4)

T-Coil scan (scan for ANSI C63.19-2007 & 2011 compliance)/General Scans/z (axial) 4.2mm 50 x

50/ABM Signal(x,y,z) (13x13x1): Measurement grid: dx=10mm, dy=10mm

Signal Type: Audio File (.wav) 48k_voice_1kHz_1s.wav

Output Gain: 19.15

Measure Window Start: 300ms

Measure Window Length: 1000ms

BWC applied: -0.20 dB

Device Reference Point: 0, 0, -6.3 mm

Cursor:

ABM1 comp = -0.76 dBA/m

BWC Factor = -0.20 dB

Location: 8.3, -12.5, 3.7 mm

Cursor:

ABM2 = -36.35 dBA/m

Location: 8.3, -12.5, 3.7 mm

Cursor:

ABM1/ABM2 = 35.59 dB

ABM1 comp = -0.76 dBA/m

BWC Factor = -0.20 dB

Location: 8.3, -12.5, 3.7 mm

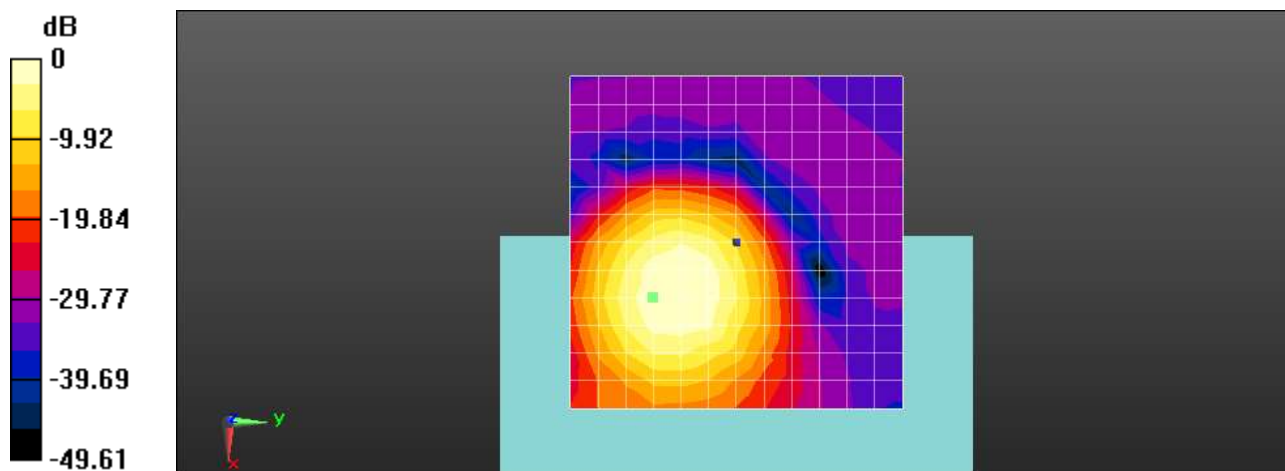

0 dB = 1.000 A/m = 0.00 dBA/m

Plot No.164
NR Band 71 DFTs-OFDM 20MHz 1RB 1offset 136100ch bitrate 40kbits Freq.Response

Communication System: UID 0, NR Band 71 (0); Frequency: 680.5 MHz;Duty Cycle: 1:1
 Medium parameters used: $\sigma = 0$ S/m, $\epsilon_r = 1$; $\rho = 0$ kg/m³

T-Coil scan (scan for ANSI C63.19-2007 & 2011 compliance)/General Scans/z (axial) wideband at best S/N/ABM Freq Resp(x,y,z,f) (1x1x1): Measurement grid: dx=10mm, dy=10mm
 Signal Type: Audio File (.wav) 48k_Normal_51s new.wav
 Output Gain: 58.25
 Measure Window Start: 300ms
 Measure Window Length: 51000ms
 BWC applied: 9.12 dB
 Device Reference Point: 0, 0, -6.3 mm

Category	Telephone parameters WD signal quality [(signal+noise)-to-noise ratio in decibels]
Category T1	0 dB to 10 dB
Category T2	10 dB to 20 dB
Category T3	20 dB to 30 dB
Category T4	> 30 dB

Cursor:
 Diff = 2.00 dB
 BWC Factor = 9.12 dB
 Location: 7.9, -11, 3.7 mm

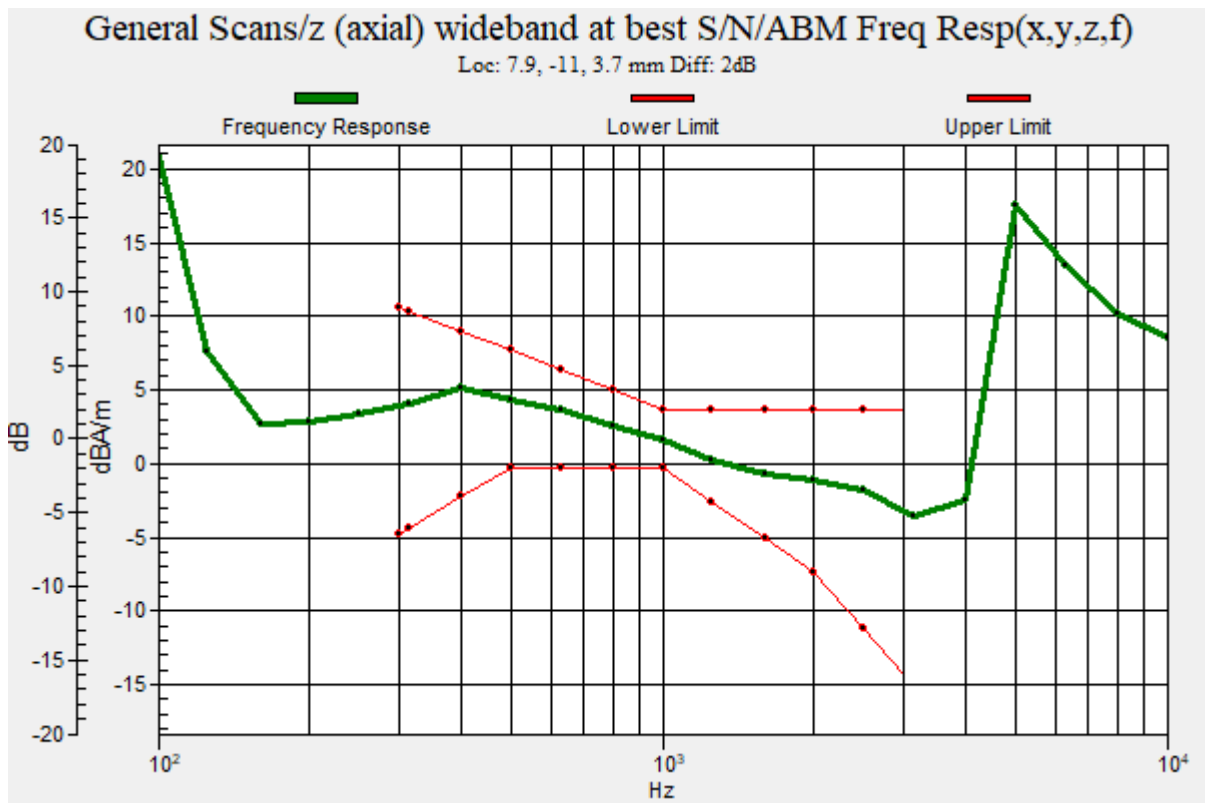

Plot No.165

NR Band 71 DFTs-OFDM 20MHz 1RB 1offset 136100ch bitrate 40kbits y(transversal)

Communication System: UID 0, NR Band 71 (0); Frequency: 680.5 MHz;Duty Cycle: 1:1
Medium parameters used: $\sigma = 0$ S/m, $\epsilon_r = 1$; $\rho = 0$ kg/m³
Phantom section: TCoil Section

DASY5 Configuration:

- Probe: AM1DV3 - 3049; ; Calibrated: 2021-06-01
- Sensor-Surface: 0mm (Fix Surface)
- Electronics: DAE4 Sn652; Calibrated: 2022-01-24
- Phantom: HAC Test Arch with AMCC TCOIL
- Measurement SW: DASY52, Version 52.10 (4)

T-Coil scan (scan for ANSI C63.19-2007 & 2011 compliance)/General Scans/y (transversal) 4.2mm 50

x 50/ABM Signal(x,y,z) (13x13x1): Measurement grid: dx=10mm, dy=10mm

Signal Type: Audio File (.wav) 48k_voice_1kHz_1s.wav

Output Gain: 19.15

Measure Window Start: 300ms

Measure Window Length: 1000ms

BWC applied: -0.20 dB

Device Reference Point: 0, 0, -6.3 mm

Cursor:

ABM1 comp = -9.90 dBA/m

BWC Factor = -0.20 dB

Location: 0, -16.7, 3.7 mm

Cursor:

ABM2 = -44.20 dBA/m

Location: 0, -16.7, 3.7 mm

Cursor:

ABM1/ABM2 = 34.30 dB

ABM1 comp = -9.90 dBA/m

BWC Factor = -0.20 dB

Location: 0, -16.7, 3.7 mm

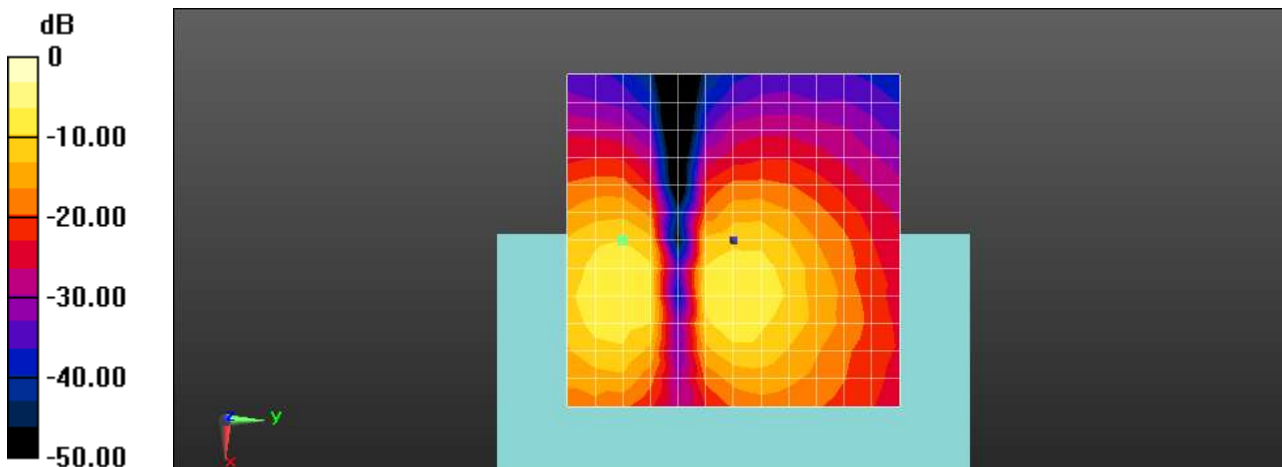

0 dB = 1.000 A/m = 0.00 dBA/m

Plot No.166

NR Band 41 DFTs-OFDM 100MHz 1RB 271offset 518598ch bitrate 6kbits z(axial)

Communication System: UID 0, n41 (0); Frequency: 2592.99 MHz; Duty Cycle: 1:4.00037

Medium parameters used: $\sigma = 0$ S/m, $\epsilon_r = 1$; $\rho = 0$ kg/m³

Phantom section: TCoil Section

DASY5 Configuration:

- Probe: AM1DV3 - 3049; ; Calibrated: 2021-06-01
- Sensor-Surface: 0mm (Fix Surface)
- Electronics: DAE4 Sn652; Calibrated: 2022-01-24
- Phantom: HAC Test Arch with AMCC TCOIL
- Measurement SW: DASY52, Version 52.10 (4)

T-Coil scan (scan for ANSI C63.19-2007 & 2011 compliance)/General Scans/z (axial) 4.2mm 50 x

50/ABM Signal(x,y,z) (13x13x1): Measurement grid: dx=10mm, dy=10mm

Signal Type: Audio File (.wav) 48k_voice_1kHz_1s.wav

Output Gain: 19.15

Measure Window Start: 300ms

Measure Window Length: 1000ms

BWC applied: -0.19 dB

Device Reference Point: 0, 0, -6.3 mm

Cursor:

ABM1 comp = 0.31 dBA/m

BWC Factor = -0.19 dB

Location: 4.2, -8.3, 3.7 mm

Cursor:

ABM2 = -35.89 dBA/m

Location: 4.2, -8.3, 3.7 mm

Cursor:

ABM1/ABM2 = 36.19 dB

ABM1 comp = 0.31 dBA/m

BWC Factor = -0.19 dB

Location: 4.2, -8.3, 3.7 mm

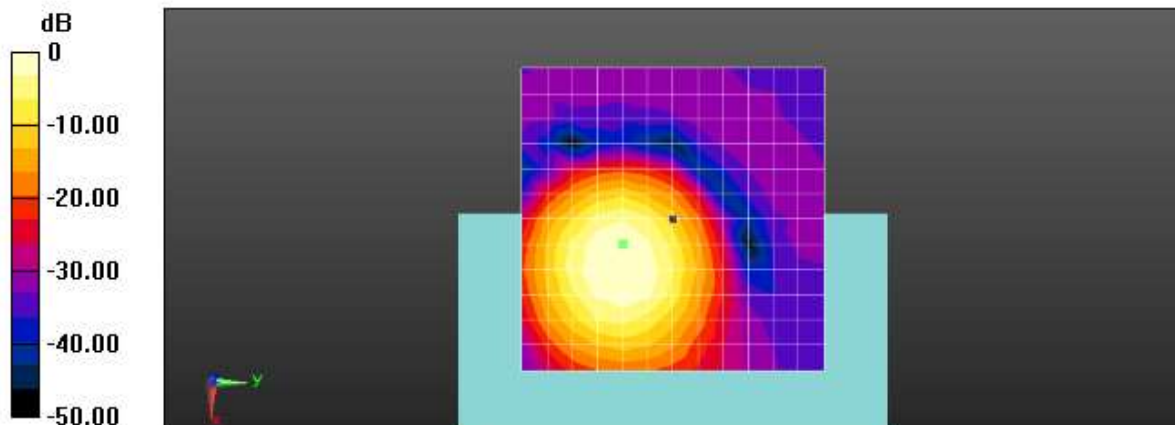

0 dB = 1.000 A/m = 0.00 dBA/m

Plot No.167

NR Band 41 DFTs-OFDM 100MHz 1RB 271offset 518598ch bitrate 6kbits Freq.Response

Communication System: UID 0, n41 (0); Frequency: 2592.99 MHz;Duty Cycle: 1:4.00037
 Medium parameters used: $\sigma = 0$ S/m, $\epsilon_r = 1$; $\rho = 0$ kg/m³
 Phantom section: TCoil Section

T-Coil scan (scan for ANSI C63.19-2007 & 2011 compliance)/General Scans/z (axial) wideband at best

S/N/ABM Freq Resp(x,y,z,f) (1x1x1): Measurement grid: dx=10mm, dy=10mm

Signal Type: Audio File (.wav) 48k_Normal_51s new.wav

Output Gain: 58.25

Measure Window Start: 300ms

Measure Window Length: 51000ms

BWC applied: 9.13 dB

Device Reference Point: 0, 0, -6.3 mm

Category	Telephone parameters WD signal quality [(signal+noise)-to-noise ratio in decibels]
Category T1	0 dB to 10 dB
Category T2	10 dB to 20 dB
Category T3	20 dB to 30 dB
Category T4	> 30 dB

Cursor:

Diff = 2.00 dB

BWC Factor = 9.13 dB

Location: 3.7, -9.9, 3.7 mm

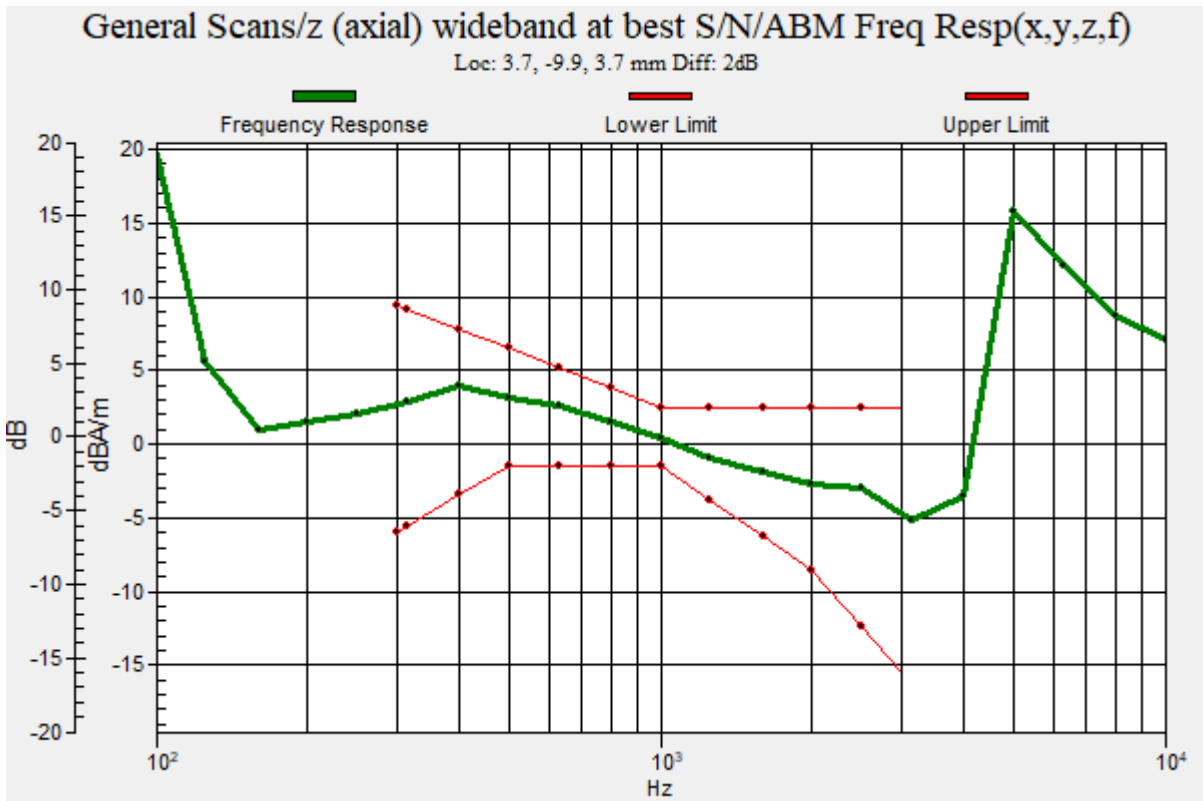

Plot No.168

NR Band 41 DFTs-OFDM 100MHz 1RB 271offset 518598ch bitrate 6kbits y(transversal)

Communication System: UID 0, n41 (0); Frequency: 2592.99 MHz;Duty Cycle: 1:4.00037
Medium parameters used: $\sigma = 0$ S/m, $\epsilon_r = 1$; $\rho = 0$ kg/m³
Phantom section: TCoil Section

DASY5 Configuration:

- Probe: AM1DV3 - 3049; ; Calibrated: 2021-06-01
- Sensor-Surface: 0mm (Fix Surface)
- Electronics: DAE4 Sn652; Calibrated: 2022-01-24
- Phantom: HAC Test Arch with AMCC TCOIL
- Measurement SW: DASY52, Version 52.10 (4)

T-Coil scan (scan for ANSI C63.19-2007 & 2011 compliance)/General Scans/y (transversal) 4.2mm 50 x 50/ABM Signal(x,y,z) (13x13x1): Measurement grid: dx=10mm, dy=10mm

Signal Type: Audio File (.wav) 48k_voice_1kHz_1s.wav
Output Gain: 19.15
Measure Window Start: 300ms
Measure Window Length: 1000ms
BWC applied: -0.19 dB
Device Reference Point: 0, 0, -6.3 mm

Cursor:

ABM1 comp = -11.02 dBA/m
BWC Factor = -0.19 dB
Location: 0, -20.8, 3.7 mm

Cursor:

ABM2 = -40.41 dBA/m
Location: 0, -20.8, 3.7 mm

Cursor:

ABM1/ABM2 = 29.39 dB
ABM1 comp = -11.02 dBA/m
BWC Factor = -0.19 dB
Location: 0, -20.8, 3.7 mm

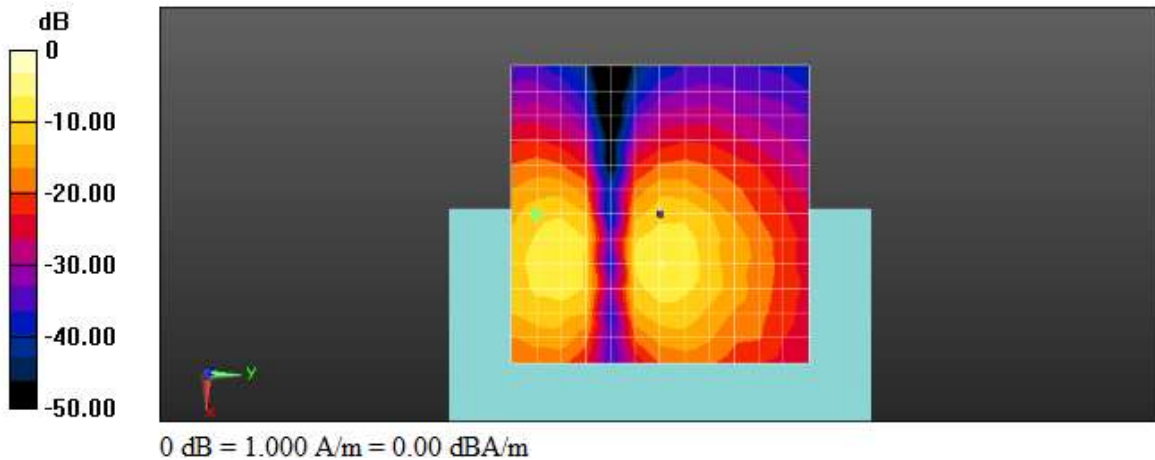

Plot No.169

NR Band 77 DFTs-OFDM 100MHz 1RB 271offset 656000ch bitrate 6kbits z(axial)

Communication System: UID 0, NR Band 77 (0); Frequency: 3840 MHz;Duty Cycle: 1:4.00037

Medium parameters used: $\sigma = 0$ S/m, $\epsilon_r = 1$; $\rho = 0$ kg/m³

Phantom section: TCoil Section

DASY5 Configuration:

- Probe: AM1DV3 - 3049; ; Calibrated: 2021-06-01
- Sensor-Surface: 0mm (Fix Surface)
- Electronics: DAE4 Sn652; Calibrated: 2022-01-24
- Phantom: HAC Test Arch with AMCC TCOIL
- Measurement SW: DASY52, Version 52.10 (4)

T-Coil scan (scan for ANSI C63.19-2007 & 2011 compliance)/General Scans/z (axial) 4.2mm 50 x

50/ABM Signal(x,y,z) (13x13x1): Measurement grid: dx=10mm, dy=10mm

Signal Type: Audio File (.wav) 48k_voice_1kHz_1s.wav

Output Gain: 19.15

Measure Window Start: 300ms

Measure Window Length: 1000ms

BWC applied: -0.19 dB

Device Reference Point: 0, 0, -6.3 mm

Cursor:

ABM1 comp = 0.13 dBA/m

BWC Factor = -0.19 dB

Location: 8.3, -8.3, 3.7 mm

Cursor:

ABM2 = -30.85 dBA/m

Location: 8.3, -8.3, 3.7 mm

Cursor:

ABM1/ABM2 = 30.98 dB

ABM1 comp = 0.13 dBA/m

BWC Factor = -0.19 dB

Location: 8.3, -8.3, 3.7 mm

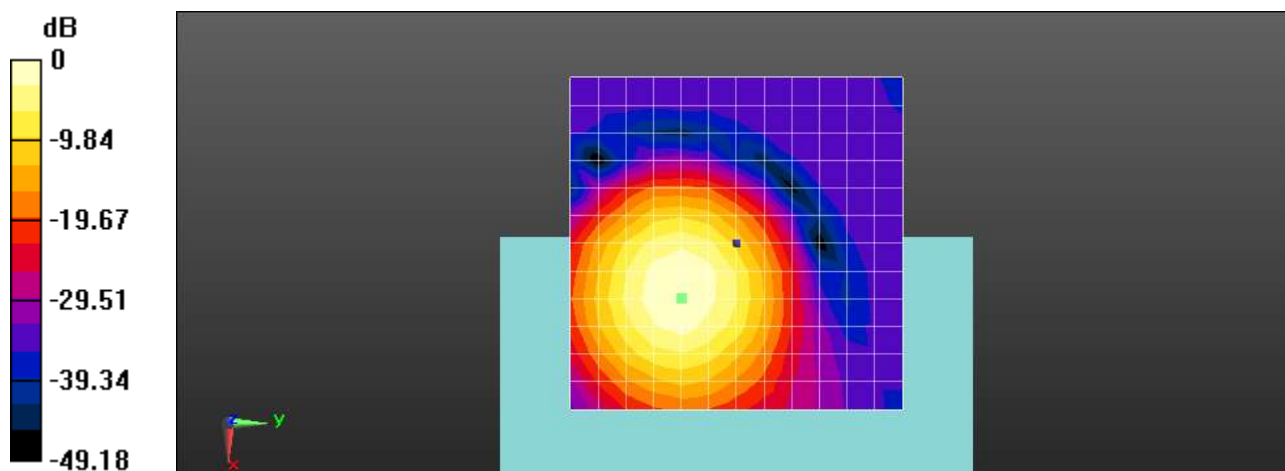

0 dB = 1.000 A/m = 0.00 dBA/m

Plot No.170

NR Band 77 DFTs-OFDM 100MHz 1RB 271offset 656000ch bitrate 6kbits Freq.Response

Communication System: UID 0, NR Band 77 (0); Frequency: 3840 MHz;Duty Cycle: 1:4.00037
 Medium parameters used: $\sigma = 0$ S/m, $\epsilon_r = 1$; $\rho = 0$ kg/m³
 Phantom section: TCoil Section

T-Coil scan (scan for ANSI C63.19-2007 & 2011 compliance)/General Scans/z (axial) wideband at best

S/N/ABM Freq Resp(x,y,z,f) (1x1x1): Measurement grid: dx=10mm, dy=10mm

Signal Type: Audio File (.wav) 48k_Normal_51s new.wav

Output Gain: 58.25

Measure Window Start: 300ms

Measure Window Length: 51000ms

BWC applied: 9.13 dB

Device Reference Point: 0, 0, -6.3 mm

Category	Telephone parameters WD signal quality [(signal+noise)-to-noise ratio in decibels]
Category T1	0 dB to 10 dB
Category T2	10 dB to 20 dB
Category T3	20 dB to 30 dB
Category T4	> 30 dB

Cursor:

Diff = 2.00 dB

BWC Factor = 9.13 dB

Location: 6.9, -10, 3.7 mm

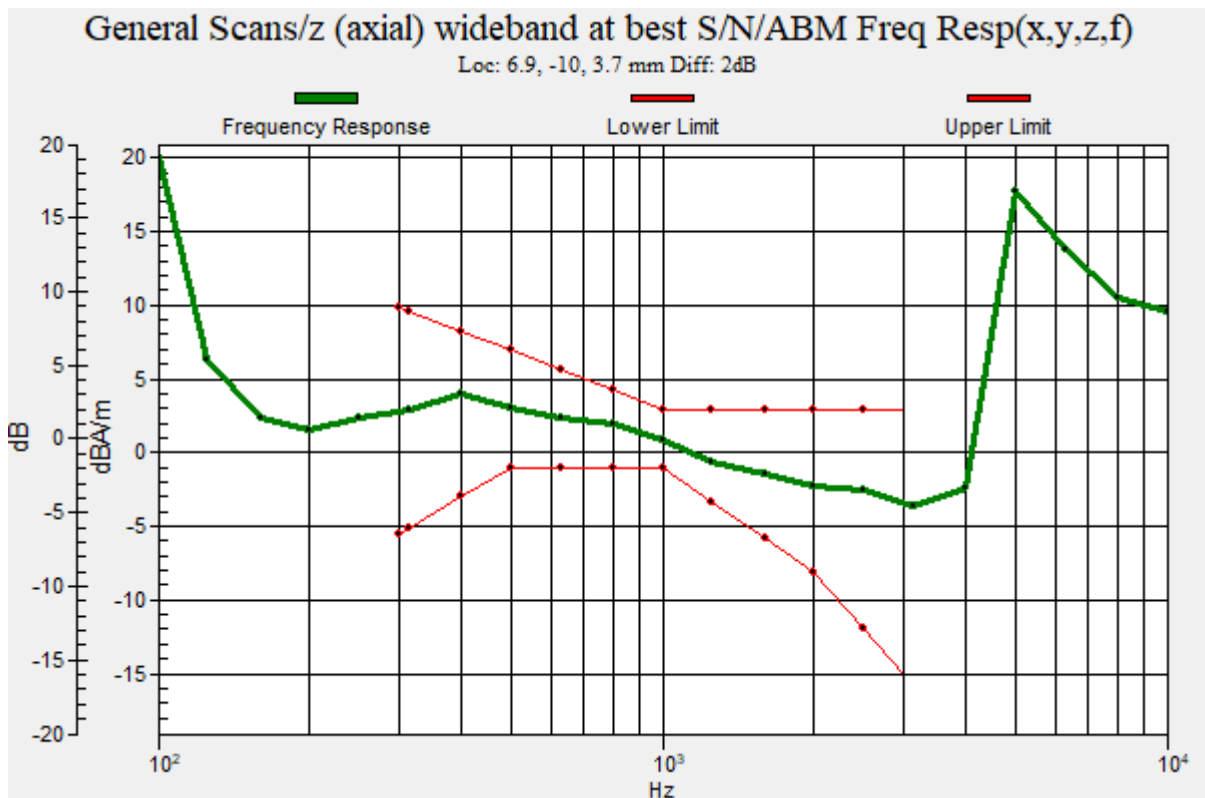

Plot No.171

NR Band 77 DFTs-OFDM 100MHz 1RB 271offset 656000ch bitrate 6kbps y(transversal)

Communication System: UID 0, NR Band 77 (0); Frequency: 3840 MHz;Duty Cycle: 1:4.00037
Medium parameters used: $\sigma = 0$ S/m, $\epsilon_r = 1$; $\rho = 0$ kg/m³
Phantom section: TCoil Section

DASY5 Configuration:

- Probe: AM1DV3 - 3049; ; Calibrated: 2021-06-01
- Sensor-Surface: 0mm (Fix Surface)
- Electronics: DAE4 Sn652; Calibrated: 2022-01-24
- Phantom: HAC Test Arch with AMCC TCOIL
- Measurement SW: DASY52, Version 52.10 (4)

T-Coil scan (scan for ANSI C63.19-2007 & 2011 compliance)/General Scans/y (transversal) 4.2mm 50

x 50/ABM Signal(x,y,z) (13x13x1): Measurement grid: dx=10mm, dy=10mm

Signal Type: Audio File (.wav) 48k_voice_1kHz_1s.wav

Output Gain: 19.15

Measure Window Start: 300ms

Measure Window Length: 1000ms

BWC applied: -0.19 dB

Device Reference Point: 0, 0, -6.3 mm

Cursor:

ABM1 comp = -14.47 dBA/m

BWC Factor = -0.19 dB

Location: -4.2, 4.2, 3.7 mm

Cursor:

ABM2 = -43.89 dBA/m

Location: -4.2, 4.2, 3.7 mm

Cursor:

ABM1/ABM2 = 29.43 dB

ABM1 comp = -14.47 dBA/m

BWC Factor = -0.19 dB

Location: -4.2, 4.2, 3.7 mm

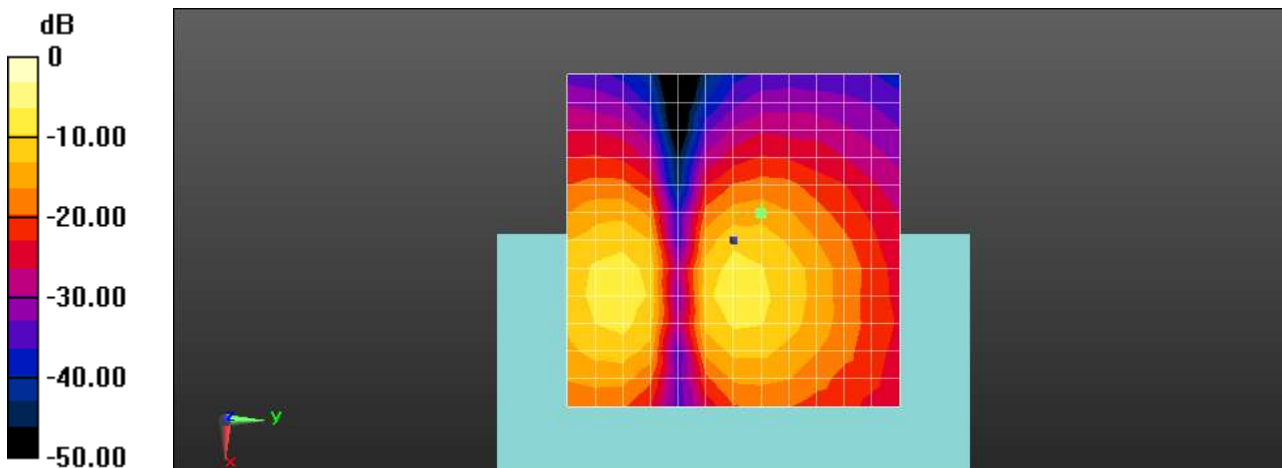

0 dB = 1.000 A/m = 0.00 dBA/m

Plot No.172

NR Band 77 DOD DFTs-OFDM 100MHz 1RB 271offset 633334ch bitrate 6kbits z(axial)

Communication System: UID 0, NR Band 77 (0); Frequency: 3500.01 MHz;Duty Cycle: 1:4.00037
Medium parameters used: $\sigma = 0$ S/m, $\epsilon_r = 1$; $\rho = 0$ kg/m³
Phantom section: TCoil Section

DASY5 Configuration:

- Probe: AM1DV3 - 3049; ; Calibrated: 2021-06-01
- Sensor-Surface: 0mm (Fix Surface)
- Electronics: DAE4 Sn652; Calibrated: 2022-01-24
- Phantom: HAC Test Arch with AMCC TCOIL
- Measurement SW: DASY52, Version 52.10 (4)

T-Coil scan (scan for ANSI C63.19-2007 & 2011 compliance)/General Scans/z (axial) 4.2mm 50 x 50/ABM Signal(x,y,z) (13x13x1): Measurement grid: dx=10mm, dy=10mm

Signal Type: Audio File (.wav) 48k_voice_1kHz_1s.wav
Output Gain: 19.15
Measure Window Start: 300ms
Measure Window Length: 1000ms
BWC applied: -0.19 dB
Device Reference Point: 0, 0, -6.3 mm

Cursor:

ABM1 comp = -1.07 dBA/m
BWC Factor = -0.19 dB
Location: 4.2, -8.3, 3.7 mm

Cursor:

ABM2 = -32.30 dBA/m
Location: 4.2, -8.3, 3.7 mm

Cursor:

ABM1/ABM2 = 31.23 dB
ABM1 comp = -1.07 dBA/m
BWC Factor = -0.19 dB
Location: 4.2, -8.3, 3.7 mm

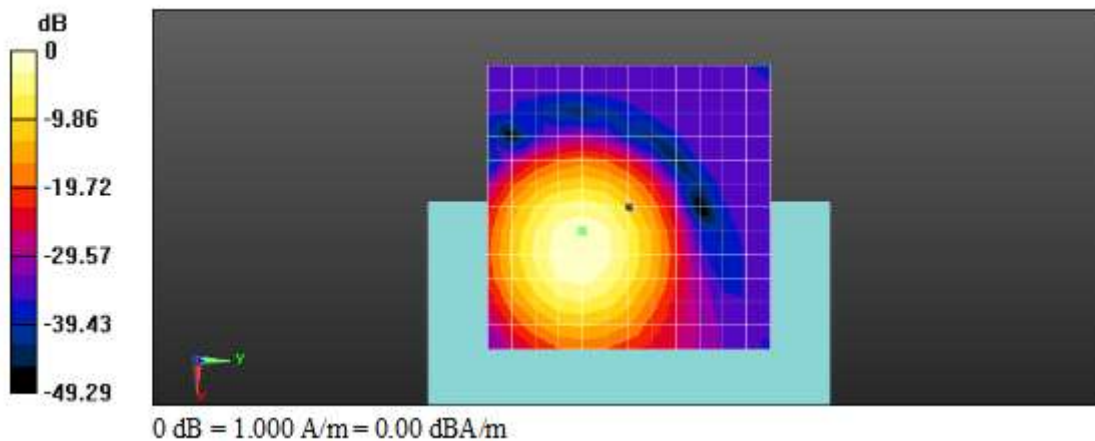

Plot No.173

NR Band 77 DOD DFTs-OFDM 100MHz 1RB 271offset 633334ch bitrate 6kbits Freq.Response

Communication System: UID 0, NR Band 77 (0); Frequency: 3500.01 MHz;Duty Cycle: 1:4.00037
 Medium parameters used: $\sigma = 0$ S/m, $\epsilon_r = 1$; $\rho = 0$ kg/m³
 Phantom section: TCoil Section

T-Coil scan (scan for ANSI C63.19-2007 & 2011 compliance)/General Scans/z (axial) wideband at best

S/N/ABM Freq Resp(x,y,z,f) (1x1x1): Measurement grid: dx=10mm, dy=10mm

Signal Type: Audio File (.wav) 48k_Normal_51s new.wav

Output Gain: 58.25

Measure Window Start: 300ms

Measure Window Length: 51000ms

BWC applied: 9.13 dB

Device Reference Point: 0, 0, -6.3 mm

Category	Telephone parameters WD signal quality [(signal+noise)-to-noise ratio in decibels]
Category T1	0 dB to 10 dB
Category T2	10 dB to 20 dB
Category T3	20 dB to 30 dB
Category T4	> 30 dB

Cursor:

Diff = 2.00 dB

BWC Factor = 9.13 dB

Location: 4, -8.9, 3.7 mm

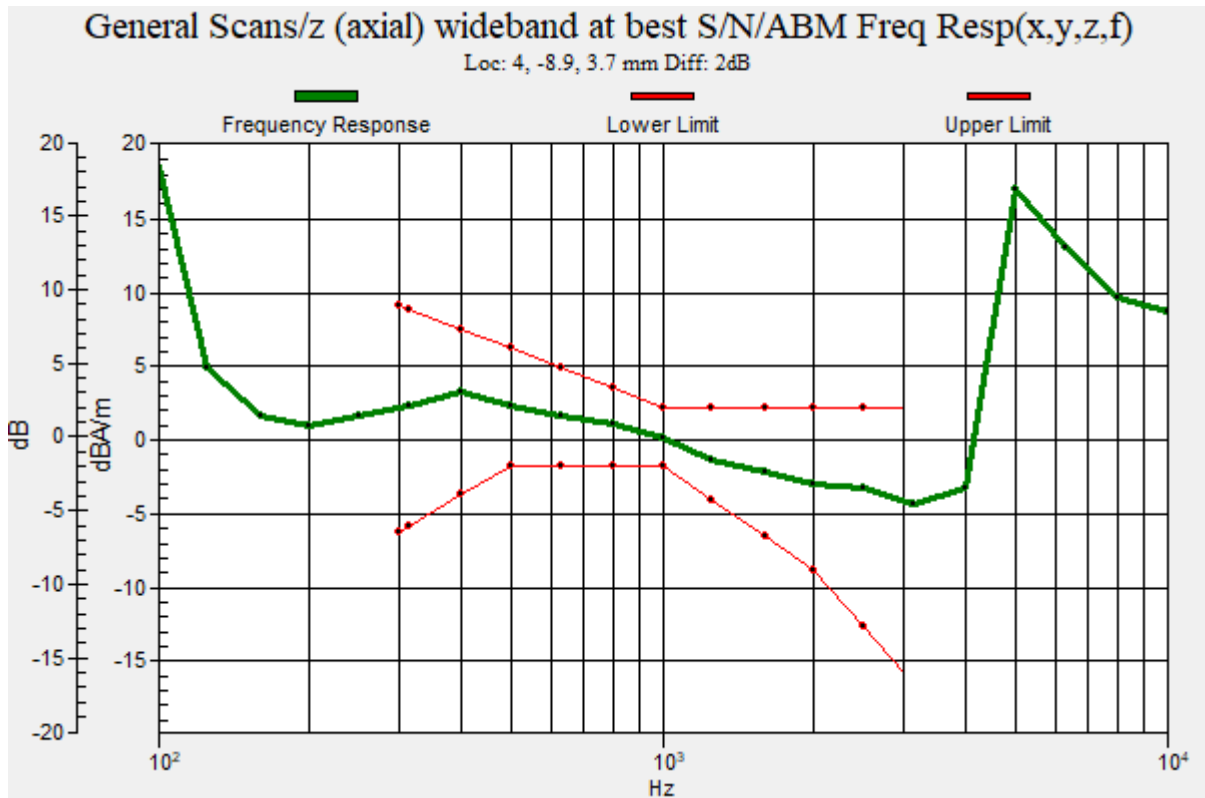

Plot No.174**NR Band 77 DOD DFTs-OFDM 100MHz 1RB 271offset 633334ch bitrate 6kbits y(transversal)**

Communication System: UID 0, NR Band 77 (0); Frequency: 3500.01 MHz;Duty Cycle: 1:4.00037
Medium parameters used: $\sigma = 0$ S/m, $\epsilon_r = 1$; $\rho = 0$ kg/m³
Phantom section: TCoil Section

DASY5 Configuration:

- Probe: AM1DV3 - 3049; ; Calibrated: 2021-06-01
- Sensor-Surface: 0mm (Fix Surface)
- Electronics: DAE4 Sn652; Calibrated: 2022-01-24
- Phantom: HAC Test Arch with AMCC TCOIL
- Measurement SW: DASY52, Version 52.10 (4)

T-Coil scan (scan for ANSI C63.19-2007 & 2011 compliance)/General Scans/y (transversal) 4.2mm 50

x 50/ABM Signal(x,y,z) (13x13x1): Measurement grid: dx=10mm, dy=10mm

Signal Type: Audio File (.wav) 48k_voice_1kHz_1s.wav

Output Gain: 19.15

Measure Window Start: 300ms

Measure Window Length: 1000ms

BWC applied: -0.19 dB

Device Reference Point: 0, 0, -6.3 mm

Cursor:

ABM1 comp = -11.19 dBA/m

BWC Factor = -0.19 dB

Location: 0, 4.2, 3.7 mm

Cursor:

ABM2 = -40.40 dBA/m

Location: 0, 4.2, 3.7 mm

Cursor:

ABM1/ABM2 = 29.21 dB

ABM1 comp = -11.19 dBA/m

BWC Factor = -0.19 dB

Location: 0, 4.2, 3.7 mm

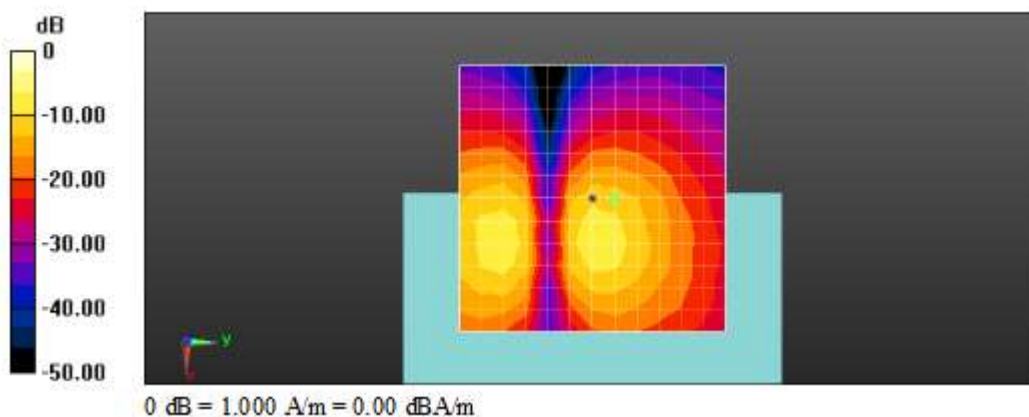

Attachment 2. HAC T-Coil Probe Certificates

**Calibration Laboratory of
Schmid & Partner
Engineering AG**
Zeughausstrasse 43, 8004 Zurich, Switzerland



S Schweizerischer Kalibrierdienst
S Service suisse d'étalonnage
C Servizio svizzero di taratura
S Swiss Calibration Service

Accredited by the Swiss Accreditation Service (SAS)
The Swiss Accreditation Service is one of the signatories to the EA
Multilateral Agreement for the recognition of calibration certificates

Accreditation No.: **SCS 0108**

Client **HCT (Dymstec)**

Certificate No: **AM1DV3-3050_Nov21**

CALIBRATION CERTIFICATE

Object	AM1DV3 - SN: 3050		
Calibration procedure(s)	QA CAL-24.v4 Calibration procedure for AM1D magnetic field probes and TMFS in the audio range		
Calibration date:	November 23, 2021		
<p>This calibration certificate documents the traceability to national standards, which realize the physical units of measurements (SI). The measurements and the uncertainties with confidence probability are given on the following pages and are part of the certificate.</p> <p>All calibrations have been conducted in the closed laboratory facility: environment temperature (22 ± 3)°C and humidity < 70%.</p> <p>Calibration Equipment used (M&TE critical for calibration)</p>			
Primary Standards	ID #	Cal Date (Certificate No.)	Scheduled Calibration
Keithley Multimeter Type 2001	SN: 0810278	31-Aug-21 (No. 31368)	Aug-22
Reference Probe AM1DV2	SN: 1006	15-Dec-20 (No. AM1DV2-1008_Dec20)	Dec-21
DAE4	SN: 781	23-Dec-20 (No. DAE4-781_Dec20)	Dec-21
Secondary Standards	ID #	Check Date (in house)	Scheduled Check
AMCC	SN: 1050	01-Oct-13 (in house check Oct-20)	Oct-23
AMMI Audio Measuring Instrument	SN: 1052	26-Sep-12 (in house check Oct-20)	Oct-23
Calibrated by:	Name Leif Klysner	Function Laboratory Technician	Signature
Approved by:	Name Niels Kuster	Function Quality Manager	Signature

Issued: November 24, 2021

This calibration certificate shall not be reproduced except in full without written approval of the laboratory.

결	담당자	확인자
재	DL 박성호 2021. 12. 09	CS 이영준 2021. 12. 09

References

- [1] ANSI-C63.19-2007
American National Standard for Methods of Measurement of Compatibility between Wireless Communications Devices and Hearing Aids.
- [2] ANSI-C63.19-2019 (ANSI-C63.19-2011)
American National Standard, Methods of Measurement of Compatibility between Wireless Communications Devices and Hearing Aids.
- [3] DASY5 manual, Chapter: Hearing Aid Compatibility (HAC) T-Coil Extension

Description of the AM1D probe

The AM1D Audio Magnetic Field Probe is a fully shielded magnetic field probe for the frequency range from 100 Hz to 20 kHz. The pickup coil is compliant with the dimensional requirements of [1+2]. The probe includes a symmetric low noise amplifier for the signal available at the shielded 3 pin connector at the side. Power is supplied via the same connector (phantom power supply) and monitored via the LED near the connector. The 7 pin connector at the end of the probe does not carry any signals, but determines the angle of the sensor when mounted on the DAE. The probe supports mechanical detection of the surface.

The single sensor in the probe is arranged in a tilt angle allowing measurement of 3 orthogonal field components when rotating the probe by 120° around its axis. It is aligned with the perpendicular component of the field, if the probe axis is tilted nominally 35.3° above the measurement plane, using the connector rotation and sensor angle stated below.

The probe is fully RF shielded when operated with the matching signal cable (shielded) and allows measurement of audio magnetic fields in the close vicinity of RF emitting wireless devices according to [1+2] without additional shielding.

Handling of the item

The probe is manufactured from stainless steel. In order to maintain the performance and calibration of the probe, it must not be opened. The probe is designed for operation in air and shall not be exposed to humidity or liquids. For proper operation of the surface detection and emergency stop functions in a DASY system, the probe must be operated with the special probe cup provided (larger diameter).

Methods Applied and Interpretation of Parameters

- *Coordinate System:* The AM1D probe is mounted in the DASY system for operation with a HAC Test Arch phantom with AMCC Helmholtz calibration coil according to [3], with the tip pointing to "southwest" orientation.
- *Functional Test:* The functional test preceding calibration includes test of Noise level RF immunity (1kHz AM modulated signal). The shield of the probe cable must be well connected. Frequency response verification from 100 Hz to 10 kHz.
- *Connector Rotation:* The connector at the end of the probe does not carry any signals and is used for fixation to the DAE only. The probe is operated in the center of the AMCC Helmholtz coil using a 1 kHz magnetic field signal. Its angle is determined from the two minima at nominally +120° and -120° rotation, so the sensor in the tip of the probe is aligned to the vertical plane in z-direction, corresponding to the field maximum in the AMCC Helmholtz calibration coil.
- *Sensor Angle:* The sensor tilting in the vertical plane from the ideal vertical direction is determined from the two minima at nominally +120° and -120°. DASY system uses this angle to align the sensor for radial measurements to the x and y axis in the horizontal plane.
- *Sensitivity:* With the probe sensor aligned to the z-field in the AMCC, the output of the probe is compared to the magnetic field in the AMCC at 1 kHz. The field in the AMCC Helmholtz coil is given by the geometry and the current through the coil, which is monitored on the precision shunt resistor of the coil.

AM1D probe identification and configuration data

Item	AM1DV3 Audio Magnetic 1D Field Probe
Type No	SP AM1 001 BA
Serial No	3050

Overall length	296 mm
Tip diameter	6.0 mm (at the tip)
Sensor offset	3.0 mm (centre of sensor from tip)
Internal Amplifier	20 dB

Manufacturer / Origin	Schmid & Partner Engineering AG, Zurich, Switzerland
-----------------------	--

Calibration data

Connector rotation angle	(in DASY system)	213.5 °	+/- 3.6 ° (k=2)
Sensor angle	(in DASY system)	0.17 °	+/- 0.5 ° (k=2)
Sensitivity at 1 kHz	(in DASY system)	0.00752 V/(A/m)	+/- 2.2 % (k=2)

The reported uncertainty of measurement is stated as the standard uncertainty of measurement multiplied by the coverage factor k=2, which for a normal distribution corresponds to a coverage probability of approximately 95%.

**Calibration Laboratory of
Schmid & Partner
Engineering AG**
Zeughausstrasse 43, 8004 Zurich, Switzerland



S Schweizerischer Kalibrierdienst
S Service suisse d'étalonnage
C Servizio svizzero di taratura
S Swiss Calibration Service

Accredited by the Swiss Accreditation Service (SAS)
The Swiss Accreditation Service is one of the signatories to the EA
Multilateral Agreement for the recognition of calibration certificates

Accreditation No.: **SCS 0108**

Client **HCT (Dymstec)**

Certificate No: **AM1DV3-3049_Jun21**

CALIBRATION CERTIFICATE		결 재	담당자	확인자																												
Object	AM1DV3 - SN: 3049		<i>JH</i>	<i>JH</i>																												
Calibration procedure(s)	QA CAL-24.v4 Calibration procedure for AM1D magnetic field probes and TMFS in the audio range		DL 박정호 2021.06.10	DL 박정호 2021.06.10																												
Calibration date:	June 1, 2021																															
<p>This calibration certificate documents the traceability to national standards, which realize the physical units of measurements (SI). The measurements and the uncertainties with confidence probability are given on the following pages and are part of the certificate.</p> <p>All calibrations have been conducted in the closed laboratory facility; environment temperature (22 ± 3)°C and humidity < 70%.</p> <p>Calibration Equipment used (M&TE critical for calibration)</p> <table border="1"> <thead> <tr> <th>Primary Standards</th> <th>ID #</th> <th>Cal Date (Certificate No.)</th> <th>Scheduled Calibration</th> </tr> </thead> <tbody> <tr> <td>Keithley Multimeter Type 2001</td> <td>SN: 0810278</td> <td>07-Sep-20 (No. 28647)</td> <td>Sep-21</td> </tr> <tr> <td>Reference Probe AM1DV2</td> <td>SN: 1008</td> <td>15-Dec-20 (No. AM1DV2-1008_Dec20)</td> <td>Dec-21</td> </tr> <tr> <td>DAE4</td> <td>SN: 781</td> <td>23-Dec-20 (No. DAE4-781_Dec20)</td> <td>Dec-21</td> </tr> </tbody> </table> <table border="1"> <thead> <tr> <th>Secondary Standards</th> <th>ID #</th> <th>Check Date (In house)</th> <th>Scheduled Check</th> </tr> </thead> <tbody> <tr> <td>AMCC</td> <td>SN: 1050</td> <td>01-Oct-13 (in house check Oct-20)</td> <td>Oct-23</td> </tr> <tr> <td>AMMI Audio Measuring Instrument</td> <td>SN: 1062</td> <td>28-Sep-12 (in house check Oct-20)</td> <td>Oct-23</td> </tr> </tbody> </table>					Primary Standards	ID #	Cal Date (Certificate No.)	Scheduled Calibration	Keithley Multimeter Type 2001	SN: 0810278	07-Sep-20 (No. 28647)	Sep-21	Reference Probe AM1DV2	SN: 1008	15-Dec-20 (No. AM1DV2-1008_Dec20)	Dec-21	DAE4	SN: 781	23-Dec-20 (No. DAE4-781_Dec20)	Dec-21	Secondary Standards	ID #	Check Date (In house)	Scheduled Check	AMCC	SN: 1050	01-Oct-13 (in house check Oct-20)	Oct-23	AMMI Audio Measuring Instrument	SN: 1062	28-Sep-12 (in house check Oct-20)	Oct-23
Primary Standards	ID #	Cal Date (Certificate No.)	Scheduled Calibration																													
Keithley Multimeter Type 2001	SN: 0810278	07-Sep-20 (No. 28647)	Sep-21																													
Reference Probe AM1DV2	SN: 1008	15-Dec-20 (No. AM1DV2-1008_Dec20)	Dec-21																													
DAE4	SN: 781	23-Dec-20 (No. DAE4-781_Dec20)	Dec-21																													
Secondary Standards	ID #	Check Date (In house)	Scheduled Check																													
AMCC	SN: 1050	01-Oct-13 (in house check Oct-20)	Oct-23																													
AMMI Audio Measuring Instrument	SN: 1062	28-Sep-12 (in house check Oct-20)	Oct-23																													
Calibrated by:	Name Leif Klynsner	Function Laboratory Technician	Signature <i>Leif Klynsner</i>																													
Approved by:	Name Kajla Pokovic	Function Technical Manager	Signature <i>Kajla Pokovic</i>																													
This calibration certificate shall not be reproduced except in full without written approval of the laboratory.				Issued: June 2, 2021																												

References

- [1] ANSI-C63.19-2007
American National Standard for Methods of Measurement of Compatibility between Wireless Communications Devices and Hearing Aids.
- [2] ANSI-C63.19-2011
American National Standard, Methods of Measurement of Compatibility between Wireless Communications Devices and Hearing Aids.
- [3] DASY5 manual, Chapter: Hearing Aid Compatibility (HAC) T-Coil Extension

Description of the AM1D probe

The AM1D Audio Magnetic Field Probe is a fully shielded magnetic field probe for the frequency range from 100 Hz to 20 kHz. The pickup coil is compliant with the dimensional requirements of [1+2]. The probe includes a symmetric low noise amplifier for the signal available at the shielded 3 pin connector at the side. Power is supplied via the same connector (phantom power supply) and monitored via the LED near the connector. The 7 pin connector at the end of the probe does not carry any signals, but determines the angle of the sensor when mounted on the DAE. The probe supports mechanical detection of the surface.

The single sensor in the probe is arranged in a tilt angle allowing measurement of 3 orthogonal field components when rotating the probe by 120° around its axis. It is aligned with the perpendicular component of the field, if the probe axis is tilted nominally 35.3° above the measurement plane, using the connector rotation and sensor angle stated below.

The probe is fully RF shielded when operated with the matching signal cable (shielded) and allows measurement of audio magnetic fields in the close vicinity of RF emitting wireless devices according to [1+2] without additional shielding.

Handling of the item

The probe is manufactured from stainless steel. In order to maintain the performance and calibration of the probe, it must not be opened. The probe is designed for operation in air and shall not be exposed to humidity or liquids. For proper operation of the surface detection and emergency stop functions in a DASY system, the probe must be operated with the special probe cup provided (larger diameter).

Methods Applied and Interpretation of Parameters

- *Coordinate System:* The AM1D probe is mounted in the DASY system for operation with a HAC Test Arch phantom with AMCC Helmholtz calibration coil according to [3], with the tip pointing to "southwest" orientation.
- *Functional Test:* The functional test preceding calibration includes test of Noise level RF immunity (1kHz AM modulated signal). The shield of the probe cable must be well connected. Frequency response verification from 100 Hz to 10 kHz.
- *Connector Rotation:* The connector at the end of the probe does not carry any signals and is used for fixation to the DAE only. The probe is operated in the center of the AMCC Helmholtz coil using a 1 kHz magnetic field signal. Its angle is determined from the two minima at nominally +120° and -120° rotation, so the sensor in the tip of the probe is aligned to the vertical plane in z-direction, corresponding to the field maximum in the AMCC Helmholtz calibration coil.
- *Sensor Angle:* The sensor tilting in the vertical plane from the ideal vertical direction is determined from the two minima at nominally +120° and -120°. DASY system uses this angle to align the sensor for radial measurements to the x and y axis in the horizontal plane.
- *Sensitivity:* With the probe sensor aligned to the z-field in the AMCC, the output of the probe is compared to the magnetic field in the AMCC at 1 kHz. The field in the AMCC Helmholtz coil is given by the geometry and the current through the coil, which is monitored on the precision shunt resistor of the coil.

AM1D probe identification and configuration data

Item	AM1DV3 Audio Magnetic 1D Field Probe
Type No	SP AM1 001 BA
Serial No	3049

Overall length	296 mm
Tip diameter	6.0 mm (at the tip)
Sensor offset	3.0 mm (centre of sensor from tip)
Internal Amplifier	20 dB

Manufacturer / Origin	Schmid & Partner Engineering AG, Zurich, Switzerland
-----------------------	--

Calibration data

Connector rotation angle	(in DASY system)	280.1 °	+/- 3.6 ° (k=2)
Sensor angle	(in DASY system)	-0.52 °	+/- 0.5 ° (k=2)
Sensitivity at 1 kHz	(in DASY system)	0.00746 V/(A/m)	+/- 2.2 % (k=2)

The reported uncertainty of measurement is stated as the standard uncertainty of measurement multiplied by the coverage factor $k=2$, which for a normal distribution corresponds to a coverage probability of approximately 95%.