

FCC LTE REPORT

Certification

Applicant Name:
SAMSUNG Electronics Co., Ltd.

Date of Issue:
May 16, 2022

Address:
129, Samsung-ro, Yeongtong-gu,
Suwon-si, Gyeonggi-do, 16677, Rep. of Korea

Location:
HCT CO., LTD.,
74, Seoicheon-ro 578beon-gil, Majang-myeon,
Icheon-si, Gyeonggi-do, 17383, Rep. of KOREA
Report No.: HCT-RF-2205-FC065

FCC ID: A3LSMG736U

APPLICANT: SAMSUNG Electronics Co., Ltd.

Model(s): SM-G736U
 Additional Model(s): SM-G736U1
 EUT Type: Mobile phone
 FCC Classification: Citizens Band End User Devices (CBE)
 FCC Rule Part(s): §96, §2

Mode (MHz)	Tx Frequency (MHz)	Emission Designator	Modulation	EIRP	
				Max. Power (W)	Max. Power (dBm/10 MHz)
LTE – Band 48 (5)	3552.5 – 3697.5	4M49G7D	QPSK	0.145	21.61
		4M49W7D	16QAM	0.117	20.69
		4M48W7D	64QAM	0.100	19.98
		4M48W7D	256QAM	0.051	17.06
LTE – Band 48 (10)	3555.0 – 3695.0	8M97G7D	QPSK	0.145	21.61
		8M94W7D	16QAM	0.117	20.69
		8M96W7D	64QAM	0.100	19.98
		8M92W7D	256QAM	0.051	17.06
LTE – Band 48 (15)	3557.5 – 3692.5	13M5G7D	QPSK	0.145	21.61
		13M4W7D	16QAM	0.117	20.69
		13M4W7D	64QAM	0.100	19.98
		13M5W7D	256QAM	0.051	17.06
LTE – Band 48 (20)	3560.0 – 3690.0	17M9G7D	QPSK	0.145	21.61
		17M9W7D	16QAM	0.117	20.69
		17M8W7D	64QAM	0.100	19.98
		17M8W7D	256QAM	0.051	17.06

The measurements shown in this report were made in accordance with the procedures specified in CFR47 section §2.947. I assume full responsibility for the accuracy and completeness of these measurements, and for the qualifications of all persons taking them.

HCT CO., LTD. Certifies that no party to this application has subject to a denial of Federal benefits that includes FCC benefits pursuant to section 5301 of the Anti-Drug Abuse Act of 1998,21 U.S. C.853(a)

Report No.: HCT-RF-2205-FC065

REVIEWED BY



Report prepared by : Jae Mun Do
Engineer of Telecommunication Testing Center

Report approved by : Jong Seok Lee
Manager of Telecommunication Testing Center

This test results were applied only to the test methods required by the standard.

This laboratory is not accredited for the test results marked *.

The above Test Report is the accredited test result by (KS Q) ISO/IEC 17025 and KOLAS(Korea Laboratory Accreditation Scheme), which signed the ILAC-MRA. (HCT Accreditation No.: KT197)

* The report shall not be reproduced except in full(only partly) without approval of the laboratory.

Version

TEST REPORT NO.	DATE	DESCRIPTION
HCT-RF-2205-FC065	May 16, 2022	- First Approval Report

The result shown in this test report refer only to the sample(s) tested unless otherwise stated.

Table of Contents

REVIEWED BY	2
1. GENERAL INFORMATION	5
2. INTRODUCTION	6
2.1. DESCRIPTION OF EUT	6
2.2. MEASURING INSTRUMENT CALIBRATION	6
2.3. TEST FACILITY	6
3. DESCRIPTION OF TESTS.....	7
3.1 TEST PROCEDURE	7
3.2 RADIATED POWER.....	8
3.3 RADIATED SPURIOUS EMISSIONS	9
3.4 PEAK- TO- AVERAGE RATIO.....	10
3.5 OCCUPIED BANDWIDTH.	12
3.6 SPURIOUS AND HARMONIC EMISSIONS AT ANTENNA TERMINAL	13
3.7 CHANNEL EDGE.....	15
3.8 Adjacent Channel Leakage Ratio.....	16
3.9 FREQUENCY STABILITY / VARIATION OF AMBIENT TEMPERATURE	17
3.10 End User Device Additional Requirement (CBSD Protocol).....	18
3.11 WORST CASE(RADIATED TEST)	19
3.12 WORST CASE(CONDUCTED TEST)	20
4. LIST OF TEST EQUIPMENT	21
5. MEASUREMENT UNCERTAINTY	22
6. SUMMARY OF TEST RESULTS	23
7. SAMPLE CALCULATION	25
8. TEST DATA	27
8.1 EQUIVALENT ISOTROPIC RADIATED POWER.....	27
8.2 RADIATED SPURIOUS EMISSIONS	29
8.3 PEAK-TO-AVERAGE RATIO.....	33
8.4 OCCUPIED BANDWIDTH	34
8.5 CONDUCTED SPURIOUS EMISSIONS	35
8.6 CHANNEL EDGE.....	36
8.7 Adjacent Channel Leakage Ratio(ACLR)	38
8.8 FREQUENCY STABILITY / VARIATION OF AMBIENT TEMPERATURE	39
8.9 End User Device Additional Requirements (CBSD Protocol).....	51
9. TEST PLOTS.....	55
10. ANNEX A_ TEST SETUP PHOTO.....	168

MEASUREMENT REPORT

1. GENERAL INFORMATION

Applicant Name:	SAMSUNG Electronics Co., Ltd.
Address:	129, Samsung-ro, Yeongtong-gu, Suwon-si, Gyeonggi-do, 16677, Rep. of Korea
FCC ID:	A3LSMG736U
Application Type:	Certification
FCC Classification:	Citizens Band End User Devices (CBE)
FCC Rule Part(s):	§96, §2
EUT Type:	Mobile Phone
Model(s):	SM-G736U
Additional Model(s):	SM-G736U1
Tx Frequency:	3552.5 – 3697.5 : 5 MHz 3555.0 – 3695.0 : 10 MHz 3557.5 – 3692.5 : 15 MHz 3560.0 – 3690.0 : 20 MHz
Date(s) of Tests:	April 01, 2022 ~ May 10, 2022
Serial number:	Radiated: R3CT307YGRJ Conducted: R3CT30RXHWD

2. INTRODUCTION

2.1. DESCRIPTION OF EUT

The EUT was a Mobile Phone with GSM/GPRS/EGPRS/UMTS and LTE, Sub6.

It also supports IEEE 802.11 a/b/g/n/ac/ax (20/40/80/160), Bluetooth, BT LE, NFC, WIFI 6E.

2.2. MEASURING INSTRUMENT CALIBRATION

The measuring equipment, which was utilized in performing the tests documented herein, has been calibrated in accordance with the manufacturer's recommendations for utilizing calibration equipment, which is traceable to recognized national standards.

2.3. TEST FACILITY

The Fully-anechoic chamber and conducted measurement facility used to collect the radiated data are located at the **74, Seoicheon-ro 578beon-gil, Majang-myeon, Icheon-si, Gyeonggi-do, 17383, Rep. of KOREA.**

3. DESCRIPTION OF TESTS

3.1 TEST PROCEDURE

Test Description	Test Procedure Used
Occupied Bandwidth	<ul style="list-style-type: none"> - KDB 971168 D01 v03r01 – Section 4.3 - ANSI C63.26-2015 – Section 5.4.4 - KDB 940660 D01 v01
Channel Edge/ ACLR	<ul style="list-style-type: none"> - KDB 971168 D01 v03r01 – Section 6.0 - ANSI C63.26-2015 – Section 5.7 - KDB 940660 D01 v01
Spurious and Harmonic Emissions at Antenna Terminal	<ul style="list-style-type: none"> - KDB 971168 D01 v03r01 – Section 6.0 - ANSI C63.26-2015 – Section 5.7 - KDB 940660 D01 v01
Conducted Output Power	<ul style="list-style-type: none"> - N/A (See SAR Report)
Peak- to- Average Ratio	<ul style="list-style-type: none"> - KDB 971168 D01 v03r01 – Section 5.7 - ANSI C63.26-2015 – Section 5.2.3.4 - KDB 940660 D01 v01
Frequency stability	<ul style="list-style-type: none"> - ANSI C63.26-2015 – Section 5.6 - KDB 940660 D01 v01
Effective Radiated Power/ Effective Isotropic Radiated Power	<ul style="list-style-type: none"> - KDB 971168 D01 v03r01 – Section 5.2 & 5.8 - ANSI/TIA-603-E-2016 – Section 2.2.17 - KDB 940660 D01 v01
Radiated Spurious and Harmonic Emissions	<ul style="list-style-type: none"> - KDB 971168 D01 v03r01 – Section 6.2 - ANSI/TIA-603-E-2016 – Section 2.2.12 - KDB 940660 D01 v01
End User Device Additional Requirement (CBSD Protocol)	<ul style="list-style-type: none"> - KDB 940660 D01 v01 - WINNF-TS-0122 V1.0.0

3.2 RADIATED POWER

Test Overview

Radiated tests are performed in the Fully-anechoic chamber.

The equipment under test is placed on a non-conductive table 3-meters away from the receive antenna in accordance with ANSI/TIA-603-E-2016 Clause 2.2.17.

Test Settings

1. Radiated power measurements are performed using the signal analyzer's "channel power" measurement capability for signals with continuous operation.
2. RBW = 1 – 5 % of the expected OBW, not to exceed 1 MHz
3. VBW \geq 3 x RBW
4. Span = 1.5 times the OBW
5. No. of sweep points $>$ 2 x span / RBW
6. Detector = RMS
7. Trigger is set to "free run" for signals with continuous operation with the sweep times set to "auto".
8. The integration bandwidth was roughly set equal to the measured OBW of the signal for signals with continuous operation.
9. Trace mode = trace averaging (RMS) over 100 sweeps
10. The trace was allowed to stabilize

Test Note

1. The turntable is rotated through 360 degrees, and the receiving antenna scans in order to determine the level of the maximized emission.
2. A half wave dipole is then substituted in place of the EUT. For emissions above 1 GHz, a horn antenna is substituted in place of the EUT. The substitute antenna is driven by a signal generator and the previously recorded signal was duplicated.

The power is calculated by the following formula;

$$P_d \text{ (dBm)} = P_g \text{ (dBm)} - \text{cable loss (dB)} + \text{antenna gain (dB)}$$

Where: P_d is the dipole equivalent power and P_g is the generator output power into the substitution antenna.

3. The maximum value is calculated by adding the forward power to the calibrated source plus its appropriate gain value. These steps are repeated with the receiving antenna in both vertical and horizontal polarization. the difference between the gain of the horn and an isotropic antenna are taken into consideration
4. The EUT was tested in three orthogonal planes(X, Y, Z) and in all possible test configurations and positioning.
5. All measurements are performed as RMS average measurements while the EUT is operating at its maximum duty cycle, at maximum power, and at the appropriate frequencies.

3.3 RADIATED SPURIOUS EMISSIONS

Test Overview

Radiated tests are performed in the Fully-anechoic chamber.

Radiated Spurious Emission Measurements at 3 meters by Substitution Method according to ANSI/TIA-603-E-2016.

Test Settings

1. RBW = 100 kHz for emissions below 1 GHz and 1 MHz for emissions above 1 GHz
2. VBW $\geq 3 \times$ RBW
3. Span = 1.5 times the OBW
4. No. of sweep points $> 2 \times$ span / RBW
5. Detector = Peak
6. Trace mode = Max Hold
7. The trace was allowed to stabilize
8. Test channel : Low/ Middle/ High
9. Frequency range : We are performed all frequency to 10th harmonics from 9 kHz.

Test Note

1. Measurements value show only up to 3 maximum emissions noted, or would be lesser if no specific emissions from the EUT are recorded (ie: margin > 20 dB from the applicable limit) and considered that's already beyond the background noise floor.
2. The EUT was tested in three orthogonal planes(X, Y, Z) and in all possible test configurations and positioning. The worst case emissions are reported with the EUT positioning, modulations, RB sizes and offsets, and channel bandwidth configurations shown in the test data
3. For spurious emissions above 1 GHz, a horn antenna is substituted in place of the EUT. The substitute antenna is driven by a signal generator and the previously recorded signal was duplicated.

The spurious emissions is calculated by the following formula;

$$\text{Result}_{(dBm)} = P_g_{(dBm)} - \text{cable loss}_{(dB)} + \text{antenna gain}_{(dBi)}$$

Where: P_g is the generator output power into the substitution antenna.

If the fundamental frequency is below 1 GHz, RF output power has been converted to EIRP.

$$\text{EIRP}_{(dBm)} = \text{ERP}_{(dBm)} + 2.15$$

3.4 PEAK- TO- AVERAGE RATIO

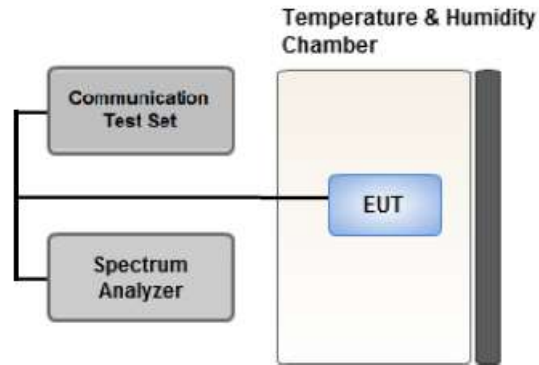

Test setup

① CCDF Procedure for PAPR

Test Settings

1. Set resolution/measurement bandwidth \geq signal's occupied bandwidth;
2. Set the number of counts to a value that stabilizes the measured CCDF curve;
3. Set the measurement interval as follows:
 - for continuous transmissions, set to 1 ms,
 - or burst transmissions, employ an external trigger that is synchronized with the EUT burst timing sequence, or use the internal burst trigger with a trigger level that allows the burst to stabilize and set the measurement interval to a time that is less than or equal to the burst duration.
4. Record the maximum PAPR level associated with a probability of 0.1 %.

② Alternate Procedure for PAPR

Use one of the procedures presented in 5.2(ANSI C63.26-2015) to measure the total peak power and record as P_{Pk} .
Use one of the applicable procedures presented 5.2(ANSI C63.26-2015) to measure the total average power and record as P_{Avg} . Determine the P.A.R. from:

$$P.A.R. (dB) = P_{Pk} (dBm) - P_{Avg} (dBm) \quad (P_{Avg} = \text{Average Power} + \text{Duty cycle Factor})$$

Test Settings(Peak Power)

The measurement instrument must have a RBW that is greater than or equal to the OBW of the signal to be measured and a VBW $\geq 3 \times$ RBW.

1. Set the RBW \geq OBW.
2. Set VBW $\geq 3 \times$ RBW.
3. Set span $\geq 2 \times$ OBW.
4. Sweep time $\geq 10 \times$ (number of points in sweep) \times (transmission symbol period).
5. Detector = peak.
6. Trace mode = max hold.
7. Allow trace to fully stabilize.
8. Use the peak marker function to determine the peak amplitude level.

Test Settings(Average Power)

1. Set span to $2 \times$ to $3 \times$ the OBW.
2. Set RBW \geq OBW.
3. Set VBW $\geq 3 \times$ RBW.
4. Set number of measurement points in sweep $\geq 2 \times$ span / RBW.
5. Sweep time:
Set $\geq [10 \times (\text{number of points in sweep}) \times (\text{transmission period})]$ for single sweep (automation-compatible) measurement. The transmission period is the (on + off) time.
6. Detector = power averaging (rms).
7. Set sweep trigger to "free run."
8. Trace average at least 100 traces in power averaging (rms) mode if sweep is set to auto-couple. (To accurately determine the average power over the on and off period of the transmitter, it can be necessary to increase the number of traces to be averaged above 100 or, if using a manually configured sweep time, increase the sweep time.)
9. Use the peak marker function to determine the maximum amplitude level.
10. Add $[10 \log (1/\text{duty cycle})]$ to the measured maximum power level to compute the average power during continuous transmission. For example, add $[10 \log (1/0.25)] = 6$ dB if the duty cycle is a constant 25 %.

3.5 OCCUPIED BANDWIDTH.

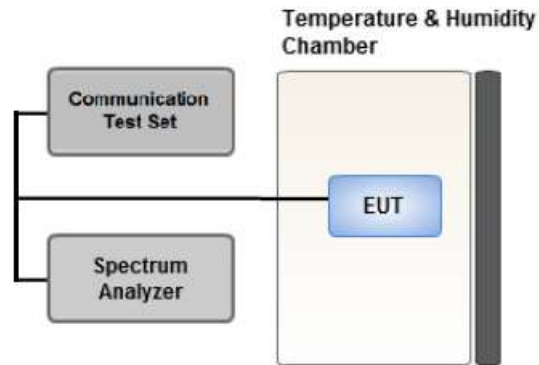

Test setup

The width of a frequency band such that, below the lower and above the upper frequency limits, the mean powers emitted are each equal to a specified percentage 0.5 % of the total mean power of a given emission.

The EUT makes a call to the communication simulator.

The conducted occupied bandwidth used the power splitter via EUT RF power connector between simulation base station and spectrum analyzer.

The communication simulator station system controlled a EUT to export maximum output power under transmission mode and specific channel frequency. Use OBW measurement function of Spectrum analyzer to measure 99 % occupied bandwidth

Test Settings

1. The signal analyzer's automatic bandwidth measurement capability was used to perform the 99 % occupied bandwidth and the 26 dB bandwidth. The bandwidth measurement was not influenced by any intermediate power nulls in the fundamental emission.
2. RBW = 1 – 5 % of the expected OBW
3. VBW $\geq 3 \times$ RBW
4. Detector = Peak
5. Trace mode = max hold
6. Sweep = auto couple
7. The trace was allowed to stabilize
8. If necessary, steps 2 – 7 were repeated after changing the RBW such that it would be within 1 – 5 % of the 99 % occupied bandwidth observed in Step 7

3.6 SPURIOUS AND HARMONIC EMISSIONS AT ANTENNA TERMINAL

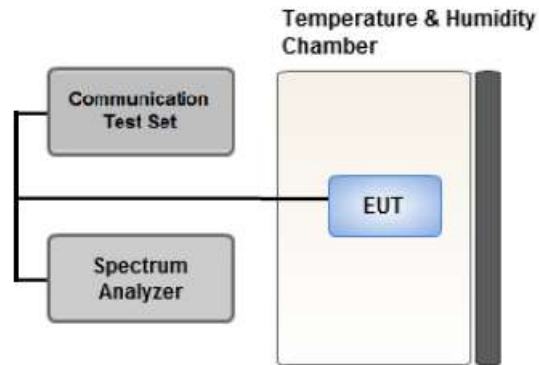

Test setup

Test Overview

The level of the carrier and the various conducted spurious and harmonic frequencies is measured by means of a calibrated spectrum analyzer. The spectrum is scanned from the lowest frequency generated in the equipment up to a frequency including its 10th harmonic. All out of band emissions are measured with a spectrum analyzer connected to the antenna terminal of the EUT while the EUT is operating at its maximum duty cycle, at maximum power, and at the appropriate frequencies. All data rates were investigated to determine the worst case configuration. All modes of operation were investigated and the worst case configuration results are reported in this section.

Test Settings

1. RBW = 1 MHz
2. VBW \geq 3 MHz
3. Detector = RMS
4. Trace Mode = Average
5. Sweep time = auto
6. Number of points in sweep \geq 2 x Span / RBW

Test Notes

1. Duty Cycle factor already applied on the factor.

- Duty Cycle factor(dB) = 3.979
- Factor(dB) = Duty Cycle factor + Cable Loss + Ext. Attenuator + Power Splitter
- Result(dBm) = Reading + Factor

2. Factor(dB)

Frequency Range (GHz)	Factor [dB]
0.03 – 1	29.249
1 – 5	31.955
5 – 10	32.570
10 – 15	33.095
15 – 20	33.468
Above 20	34.110

3.7 CHANNEL EDGE

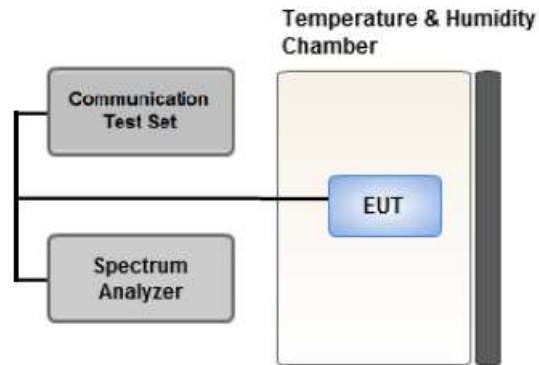

Test setup

Test Settings

1. Start and stop frequency were set such that the band edge would be placed in the center of the plot
2. Span was set large enough so as to capture all out of band emissions near the band edge
3. Within 1 MHz of the channel edge the RBW should be 2 % of EBW, then 1 MHz after that.
4. VBW > 3 x RBW
5. Detector = RMS
6. Number of sweep points $\geq 2 \times \text{Span/RBW}$
7. Trace mode = trace average
8. Sweep time = auto couple
9. The trace was allowed to stabilize

Test Notes

The conducted power of any emission outside the fundamental emission (whether in or outside of the authorized band) shall not exceed -13 dBm/MHz within 0-10 megahertz above the upper SAS-assigned channel edge and within 0-10 megahertz below the lower SAS-assigned channel edge. At all frequencies greater than 10 megahertz above the upper SAS assigned channel edge and less than 10 MHz below the lower SAS assigned channel edge, the conducted power of any emission shall not exceed -25 dBm/MHz.

The conducted power of any emissions below 3530 MHz or above 3720 MHz shall not exceed -40 dBm/MHz

3.8 Adjacent Channel Leakage Ratio

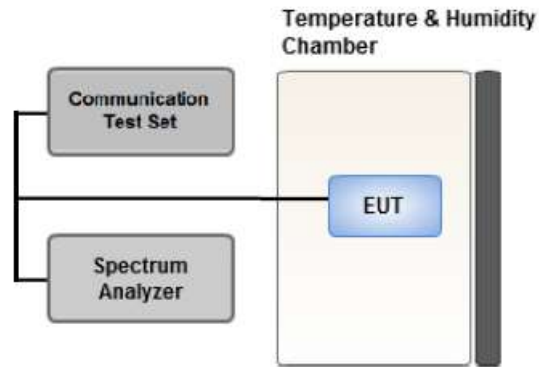

Test setup

Test Settings

1. Use ACP measurement function of Spectrum analyzer to measure adjacent channel leakage ratio
2. Integ BW = Assigned channel bandwidth
5. Detector = RMS
6. Number of sweep points $\geq 2 \times \text{Span}/\text{RBW}$
7. Trace mode = trace average
8. Sweep time = 1 s
9. The trace was allowed to stabilize

Test Notes

the Adjacent Channel Leakage Ratio for End User Devices shall be at least 30 dB.

3.9 FREQUENCY STABILITY / VARIATION OF AMBIENT TEMPERATURE

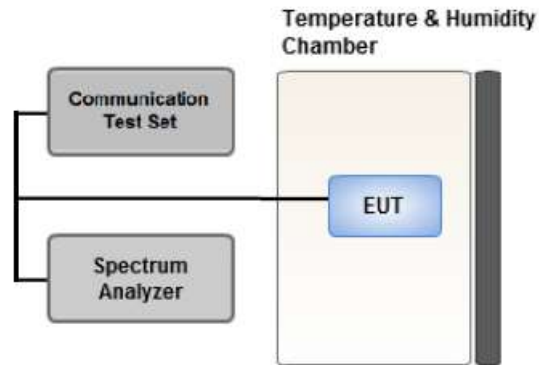

Test setup

Test Overview

Frequency stability testing is performed in accordance with the guidelines of ANSI C63.26-2015.

The frequency stability of the transmitter is measured by:

1. Temperature:

The temperature is varied from -30 °C to +50 °C in 10 °C increments using an environmental chamber.

2. Primary Supply Voltage:

- Unless otherwise specified, vary primary supply voltage from 85 % to 115 % of the nominal value for other than hand carried battery equipment.

- For hand carried, battery powered equipment, reduce the primary ac or dc supply voltage to the battery operating end point, which shall be specified by the manufacturer.

Test Settings

1. The carrier frequency of the transmitter is measured at room temperature

(20 °C to provide a reference).

2. The equipment is turned on in a "standby" condition for fifteen minutes before applying power to the transmitter. Measurement of the carrier frequency of the transmitter is made within one minute after applying power to the transmitter.

3. Frequency measurements are made at 10 °C intervals ranging from -30 °C to +50 °C. A period of at least one half-hour is provided to allow stabilization of the equipment at each temperature level.

3.10 End User Device Additional Requirement (CBSD Protocol)

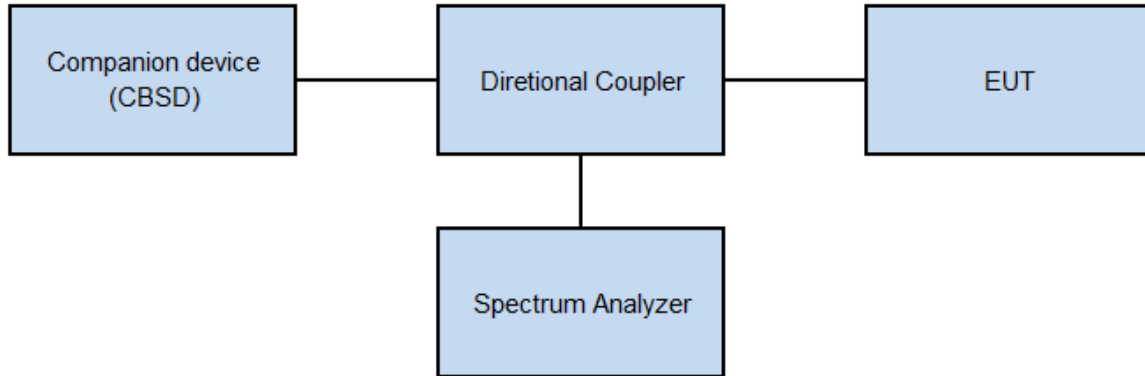

Test setup

Test Overview

End user device additional requirements (CBSD Protocol) are tested per the test procedures listed below. During testing, the EUT is connected to a certified CBSD (FCC ID: 2AS48SC-220) as a companion device to show compliance with Part 96.47.

End User Devices may operate only if they can positively receive and decode an authorization signal transmitted by a CBSD, including the frequencies and power limits for their operation.

Test Settings

- a. Setup companion device with 3570 MHz & 3610 MHz.
- b. Enable AP service from companion device.
- c. EUT is connected to a companion device.
- c. Check EUT Tx frequency and power.
- d. Disable AP service from companion device and check EUT stop transmission within 10 s.

3.11 WORST CASE(RADIATED TEST)

- The EUT was tested in three orthogonal planes(X, Y, Z) and in all possible test configurations and positioning.
- All modes of operation were investigated and the worst case configuration results are reported.
 Mode : Stand alone, Stand alone + External accessories (Earphone, AC adapter, etc)
 Worst case : Stand alone
- We were performed the RSE test in condition of co-location. There has no significant emission raised.
- WWAN + WLAN 5 GHz + BT (Worst case : Stand alone)
- The worst case is reported with the EUT positioning, modulations, RB sizes and offsets, and channel bandwidth configurations shown in the test data.
- Please refer to the table below.
- SM-G736U & additional models were tested and the worst case results are reported.
 (Worst case : SM-G736U)

[Worst case]

Test Description	Modulation	RB size	RB offset	Axis
Effective Isotropic Radiated Power	QPSK, 16QAM, 64QAM, 256QAM	1	0	X
Radiated Spurious and Harmonic Emissions	QPSK	1	0	Z

3.12 WORST CASE(CONDUCTED TEST)

- All modes of operation were investigated and the worst case configuration results are reported.
- SM-G736U & additional models were tested and the worst case results are reported.

(Worst case : SM-G736U)

[Worst case]

Test Description	Modulation	Bandwidth (MHz)	Frequency	RB size	RB offset		
Occupied Bandwidth	QPSK, 16QAM, 64QAM, 256QAM	5, 10, 15, 20	Mid	Full RB	0		
Peak-To-Average Ratio	QPSK, 16QAM, 64QAM, 256QAM	5, 10, 15, 20	Mid	Full RB	0		
Channel Edge	QPSK	5	Low	1	0		
			High	1	24		
		10	Low	1	0		
			High	1	49		
		15	Low	1	0		
			High	1	74		
		20	Low	1	0		
			High	1	99		
				5, 10, 15, 20	Low, Mid, High	Full RB	0
		Spurious and Harmonic Emissions at Antenna Terminal	QPSK	5, 10, 15, 20	Low, Mid, High	1	0

4. LIST OF TEST EQUIPMENT

Equipment	Model	Manufacturer	Serial No.	Due to Calibration	Calibration Interval
H.P.F	FBSR-02B(WHK1.2/15 G-10EF)	T&M SYSTEM	-	02/18/2023	Annual
H.P.F	FBSR-02B(WHK3.3/18 G-10EF)	T&M SYSTEM	-	02/18/2023	Annual
Power Splitter(DC ~ 26.5 GHz)	11667B	Hewlett Packard	11275	03/11/2023	Annual
DC Power Supply	E3632A	Agilent	MY40010147	06/28/2022	Annual
Dipole Antenna	UHAP	Schwarzbeck	557	04/05/2023	Biennial
Dipole Antenna	UHAP	Schwarzbeck	558	04/05/2023	Biennial
Chamber	SU-642	ESPEC	93008124	03/04/2023	Annual
Horn Antenna(1 ~ 18 GHz)	BBHA 9120D	Schwarzbeck	147	08/30/2022	Biennial
Horn Antenna(1 ~ 18 GHz)	BBHA 9120D	Schwarzbeck	9120D-1298	09/15/2023	Biennial
Horn Antenna(15 ~ 40 GHz)	BBHA 9170	Schwarzbeck	BBHA9170342	10/13/2022	Biennial
Horn Antenna(15 ~ 40 GHz)	BBHA 9170	Schwarzbeck	BBHA9170124	04/12/2023	Biennial
Signal Analyzer(10 Hz ~ 26.5 GHz)	N9020A	Agilent	MY52090906	05/18/2022	Annual
ATTENUATOR(20 dB)	8493C	Hewlett Packard	17280	06/01/2022	Annual
Spectrum Analyzer(10 Hz ~ 40 GHz)	FSV40	REOHDE & SCHWARZ	100931	09/29/2022	Annual
Base Station	8960 (E5515C)	Agilent	MY48360800	08/18/2022	Annual
Loop Antenna(9 kHz ~ 30 MHz)	FMZB1513	Schwarzbeck	1513-333	03/17/2024	Biennial
Bilog Antenna	VULB9160	Schwarzbeck	3150	03/03/2023	Biennial
Hybrid Antenna	VULB9168	Schwarzbeck	760	02/22/2023	Biennial
Wideband Radio Communication Tester	MT8821C	Anritsu Corp.	6262116770	07/12/2022	Annual
Wideband Radio Communication Tester	MT8820C	Anritsu Corp.	6200863156	12/29/2022	Annual
SIGNAL GENERATOR (100 kHz ~ 40 GHz)	SMB100A	REOHDE & SCHWARZ	177633	07/05/2022	Annual
Signal Analyzer(5 Hz ~ 40.0 GHz)	N9030B	KEYSIGHT	MY55480167	06/02/2022	Annual
FCC LTE Mobile Conducted RF Automation Test Software	-	HCT CO., LTD.,	-	-	-

Note:

1. Equipment listed above that has a calibration due date during the testing period, the testing is completed before equipment expiration date.
2. Especially, all antenna for measurement is calibrated in accordance with the requirements of C63.5 (Version : 2017).

5. MEASUREMENT UNCERTAINTY

The measurement uncertainties shown below were calculated in accordance with the requirements of ANSI C63.4:2014. All measurement uncertainty values are shown with a coverage factor of $k = 2$ to indicate a 95 % level of confidence. The measurement data shown herein meets or exceeds the U_{CISPR} measurement uncertainty values specified in CISPR 16-4-2 and, thus, can be compared directly to specified limits to determine compliance.

Parameter	Expanded Uncertainty (\pm dB)
Conducted Disturbance (150 kHz ~ 30 MHz)	2.00 (Confidence level about 95 %, $k=2$)
Radiated Disturbance (9 kHz ~ 30 MHz)	4.40 (Confidence level about 95 %, $k=2$)
Radiated Disturbance (30 MHz ~ 1 GHz)	5.74 (Confidence level about 95 %, $k=2$)
Radiated Disturbance (1 GHz ~ 18 GHz)	5.51 (Confidence level about 95 %, $k=2$)
Radiated Disturbance (18 GHz ~ 40 GHz)	5.92 (Confidence level about 95 %, $k=2$)
Radiated Disturbance (Above 40 GHz)	5.48 (Confidence level about 95 %, $k=2$)

6. SUMMARY OF TEST RESULTS

6.1 Test Condition : Conducted Test

Test Description	FCC Part Section(s)	Test Limit	Test Result
Occupied Bandwidth	§2.1049	N/A	PASS
Band Edge / Spurious and Harmonic Emissions at Antenna Terminal.	§2.1051, §96.41(e)	<ul style="list-style-type: none"> ■ -13 dBm/Mhz at frequencies within 0-10 MHz of channel edge ■ -25 dBm/MHz at frequencies greater than 10 MHz above and below channel edge ■ -40 dBm/MHz at frequencies below 3530 MHz and above 3720 MHz 	PASS
Adjacent Channel Leakage Ratio	§96.41(e)	At least 30 dB.	PASS
Conducted Output Power	§2.1046	N/A	<u>See Note1</u>
Frequency stability / variation of ambient temperature	§2.1055,	Emission must remain in band	PASS
End User Device Additional Requirements (CBSD Protocol)	§96.47	<p>End User Devices may operate only if they can positively receive and decode an authorization signal transmitted by a CBSD, including the frequencies and power limits for their operation.</p> <p>An End User Device must discontinue operations, change frequencies, or change its operational power level within 10 seconds of receiving instructions from its associated CBSD.</p>	PASS

Note:

1. See SAR Report
2. The EUT is an End User Device

6.2 Test Condition : Radiated Test

Test Description	FCC Part Section(s)	Test Limit	Test Result
Equivalent Isotropic Radiated Power	§96.41(b)	23 dBm/10 MHz	PASS
Radiated Spurious and Harmonic Emissions	§2.1053, §96.41(e)	-40 dBm/MHz	PASS

7. SAMPLE CALCULATION

7.1 ERP Sample Calculation

Ch./ Freq.		Measured Level(dBm)	Substitute Level(dBm)	Ant. Gain (dBd)	C.L	Pol.	ERP	
channel	Freq.(MHz)						W	dBm
128	824.20	-21.37	38.40	-10.61	0.95	H	0.483	26.84

ERP = Substitute LEVEL(dBm) + Ant. Gain – CL(Cable Loss)

- 1) The EUT mounted on a non-conductive turntable is 2.5 meter above test site ground level.
- 2) During the test , the turn table is rotated until the maximum signal is found.
- 3) Record the field strength meter’s level.
- 4) Replace the EUT with dipole/Horn antenna that is connected to a calibrated signal generator.
- 5) Increase the signal generator output till the field strength meter’s level is equal to the item (3).
- 6) The signal generator output level with Ant. Gain and cable loss are the rating of effective radiated power.

7.2 EIRP Sample Calculation

Ch./ Freq.		Measured Level(dBm)	Substitute Level(dBm)	Ant. Gain (dBi)	C.L	Pol.	EIRP	
channel	Freq.(MHz)						W	dBm
55990	2595.0	-15.75	18.45	9.90	1.76	H	0.456	26.59

EIRP = Substitute LEVEL(dBm) + Ant. Gain – CL(Cable Loss)

- 1) The EUT mounted on a non-conductive turntable is 2.5 meter above test site ground level.
- 2) During the test , the turn table is rotated until the maximum signal is found.
- 3) Record the field strength meter’s level.
- 4) Replace the EUT with dipole/Horn antenna that is connected to a calibrated signal generator.
- 5) Increase the signal generator output till the field strength meter’s level is equal to the item (3).
- 6) The signal generator output level with Ant. Gain and cable loss are the rating of equivalent isotropic radiated power.

7.3. Emission Designator

GSM Emission Designator

Emission Designator = 249KGXW

GSM BW = 249 kHz

G = Phase Modulation

X = Cases not otherwise covered

W = Combination (Audio/Data)

EDGE Emission Designator

Emission Designator = 249KG7W

GSM BW = 249 kHz

G = Phase Modulation

7 = Quantized/Digital Info

W = Combination (Audio/Data)

WCDMA Emission Designator

Emission Designator = 4M17F9W

WCDMA BW = 4.17 MHz

F = Frequency Modulation

9 = Composite Digital Info

W = Combination (Audio/Data)

QPSK Modulation

Emission Designator = 4M48G7D

LTE BW = 4.48 MHz

G = Phase Modulation

7 = Quantized/Digital Info

D = Data transmission; telemetry; telecommand

QAM Modulation

Emission Designator = 4M48W7D

LTE BW = 4.48 MHz

W = Amplitude/Angle Modulated

7 = Quantized/Digital Info

D = Data transmission; telemetry; telecommand

8. TEST DATA

8.1 EQUIVALENT ISOTROPIC RADIATED POWER

Freq (MHz)	Bandwidth	Modulation	Measured Level (dBm)	Substitute Level (dBm)	Ant. Gain(dBi)	C.L	Pol	EIRP	Limit
								dBm/10 MHz	
3552.5	LTE B48/ 5 MHz	QPSK	-26.30	12.23	12.40	3.02	H	21.61	23.0
		16-QAM	-27.22	11.31	12.40	3.02	H	20.69	
		64-QAM	-28.41	10.12	12.40	3.02	H	19.50	
		256-QAM	-31.02	7.51	12.40	3.02	H	16.89	
3625.0		QPSK	-26.51	12.11	12.25	3.05	H	21.32	
		16-QAM	-27.41	11.21	12.25	3.05	H	20.42	
		64-QAM	-28.46	10.16	12.25	3.05	H	19.37	
		256-QAM	-31.34	7.28	12.25	3.05	H	16.49	
3697.5		QPSK	-26.72	12.18	12.30	3.08	H	21.40	
		16-QAM	-31.10	7.80	12.30	3.08	H	17.02	
		64-QAM	-28.14	10.76	12.30	3.08	H	19.98	
		256-QAM	-31.06	7.84	12.30	3.08	H	17.06	

Freq (MHz)	Bandwidth	Modulation	Measured Level (dBm)	Substitute Level (dBm)	Ant. Gain(dBi)	C.L	Pol	EIRP	Limit
								dBm/10 MHz	
3555.0	LTE B48/ 10 MHz	QPSK	-26.50	12.04	12.39	3.02	H	21.41	23.0
		16-QAM	-27.30	11.24	12.39	3.02	H	20.61	
		64-QAM	-28.27	10.27	12.39	3.02	H	19.64	
		256-QAM	-31.60	6.94	12.39	3.02	H	16.31	
3625.0		QPSK	-26.47	12.16	12.25	3.05	H	21.36	
		16-QAM	-27.29	11.34	12.25	3.05	H	20.54	
		64-QAM	-28.34	10.29	12.25	3.05	H	19.49	
		256-QAM	-31.61	7.02	12.25	3.05	H	16.22	
3695.0		QPSK	-26.63	12.32	12.29	3.08	H	21.54	
		16-QAM	-27.56	11.39	12.29	3.08	H	20.61	
		64-QAM	-28.60	10.35	12.29	3.08	H	19.57	
		256-QAM	-31.77	7.18	12.29	3.08	H	16.40	

Freq (MHz)	Bandwidth	Modulation	Measured Level (dBm)	Substitute Level (dBm)	Ant. Gain(dBi)	C.L	Pol	EIRP	Limit
								dBm/10 MHz	
3557.5	LTE B48/ 15 MHz	QPSK	-26.44	12.10	12.38	3.01	H	21.47	23.0
		16-QAM	-27.24	11.30	12.38	3.01	H	20.67	
		64-QAM	-28.43	10.11	12.38	3.01	H	19.48	
		256-QAM	-31.53	7.01	12.38	3.01	H	16.38	
3625.0		QPSK	-26.62	12.01	12.25	3.05	H	21.21	
		16-QAM	-27.18	11.45	12.25	3.05	H	20.65	
		64-QAM	-28.54	10.09	12.25	3.05	H	19.29	
		256-QAM	-31.34	7.29	12.25	3.05	H	16.49	
3692.5		QPSK	-26.48	12.52	12.28	3.07	H	21.73	
		16-QAM	-27.36	11.64	12.28	3.07	H	20.85	
		64-QAM	-28.55	10.45	12.28	3.07	H	19.66	
		256-QAM	-31.55	7.45	12.28	3.07	H	16.66	

Freq (MHz)	Bandwidth	Modulation	Measured Level (dBm)	Substitute Level (dBm)	Ant. Gain(dBi)	C.L	Pol	EIRP	Limit
								dBm/10 MHz	
3560.0	LTE B48/ 20 MHz	QPSK	-26.56	11.98	12.38	3.01	H	21.35	23.0
		16-QAM	-27.52	11.02	12.38	3.01	H	20.39	
		64-QAM	-28.62	9.92	12.38	3.01	H	19.29	
		256-QAM	-31.75	6.79	12.38	3.01	H	16.16	
3625.0		QPSK	-26.48	12.15	12.25	3.05	H	21.35	
		16-QAM	-27.35	11.28	12.25	3.05	H	20.48	
		64-QAM	-28.41	10.22	12.25	3.05	H	19.42	
		256-QAM	-31.61	7.02	12.25	3.05	H	16.22	
3690.0		QPSK	-26.84	12.16	12.28	3.07	H	21.37	
		16-QAM	-27.39	11.61	12.28	3.07	H	20.82	
		64-QAM	-28.75	10.25	12.28	3.07	H	19.46	
		256-QAM	-31.67	7.33	12.28	3.07	H	16.54	

8.2 RADIATED SPURIOUS EMISSIONS

- ▣ MODE: LTE B48
- ▣ MODULATION SIGNAL: 5 MHz QPSK
- ▣ DISTANCE: 1 meters

Freq (MHz)	Measured Freq (MHz)	Measured Level (dBm)	Ant. Gain (dBi)	Substitute Level (dBm)	C.L	Pol	Result (dBm)	Limit (dBm)
55265 (3552.5)	7 105.00	-56.20	10.89	-56.33	4.35	H	-49.79	-40.00
	10 657.50	-57.97	12.22	-53.21	5.54	V	-46.53	-40.00
	14 210.00	-60.25	11.98	-49.34	6.54	H	-43.90	-40.00
55990 (3625.0)	7 250.00	-55.93	10.90	-57.52	4.35	V	-50.97	-40.00
	10 875.00	-57.89	10.95	-51.26	5.57	V	-45.88	-40.00
	14 500.00	-59.38	11.40	-48.03	6.54	V	-43.17	-40.00
56715 (3697.5)	7 395.00	-55.88	10.81	-57.12	4.43	H	-50.74	-40.00
	11 092.50	-57.83	11.08	-53.17	5.60	V	-47.69	-40.00
	14 790.00	-58.49	11.12	-47.71	6.62	V	-43.21	-40.00

MODE: LTE B48
 MODULATION SIGNAL: 10 MHz QPSK
 DISTANCE: 1 meters

Freq (MHz)	Measured Freq (MHz)	Measured Level (dBm)	Ant. Gain (dBi)	Substitute Level (dBm)	C.L	Pol	Result (dBm)	Limit (dBm)
55290 (3555.0)	7 110.00	-55.52	10.88	-55.97	4.34	H	-49.43	-40.00
	10 665.00	-58.21	11.23	-53.53	5.54	V	-47.84	-40.00
	14 220.00	-60.29	11.96	-49.28	6.51	V	-43.83	-40.00
55990 (3625.0)	7 250.00	-56.13	10.90	-57.72	4.35	H	-51.17	-40.00
	10 875.00	-58.76	10.95	-52.13	5.57	V	-46.75	-40.00
	14 500.00	-60.13	11.40	-48.78	6.54	H	-43.92	-40.00
56690 (3695.0)	7 390.00	-54.97	10.82	-55.91	4.42	V	-49.51	-40.00
	11 085.00	-57.54	11.07	-52.85	5.61	H	-47.39	-40.00
	14 780.00	-59.76	11.14	-48.87	6.61	H	-44.34	-40.00

MODE: LTE B48
 MODULATION SIGNAL: 15 MHz QPSK
 DISTANCE: 1 meters

Freq (MHz)	Measured Freq (MHz)	Measured Level (dBm)	Ant. Gain (dBi)	Substitute Level (dBm)	C.L	Pol	Result (dBm)	Limit (dBm)
55315 (3557.5)	7 115.00	-56.00	10.87	-56.97	4.34	V	-50.44	-40.00
	10 672.50	-57.30	11.24	-52.69	5.54	H	-46.99	-40.00
	14 230.00	-59.79	11.94	-48.58	6.50	V	-43.14	-40.00
55990 (3625.0)	7 250.00	-56.24	10.90	-57.83	4.35	H	-51.28	-40.00
	10 875.00	-58.66	10.95	-52.03	5.57	H	-46.65	-40.00
	14 500.00	-59.26	11.40	-47.91	6.54	V	-43.05	-40.00
56665 (3692.5)	7 385.00	-56.72	10.83	-57.37	4.41	H	-50.95	-40.00
	11 077.50	-57.30	11.06	-52.59	5.62	H	-47.15	-40.00
	14 770.00	-58.72	11.16	-47.67	6.58	V	-43.09	-40.00

MODE: LTE B48
 MODULATION SIGNAL: 20 MHz QPSK
 DISTANCE: 1 meters

Freq (MHz)	Measured Freq (MHz)	Measured Level (dBm)	Ant. Gain (dBi)	Substitute Level (dBm)	C.L	Pol	Result (dBm)	Limit (dBm)
55340 (3560.0)	7 120.00	-55.44	10.86	-56.93	4.34	V	-50.41	-40.00
	10 680.00	-56.60	11.26	-52.21	5.53	H	-46.48	-40.00
	14 240.00	-59.96	11.92	-48.54	6.45	V	-43.07	-40.00
55990 (3625.0)	7 250.00	-57.20	10.90	-58.79	4.35	V	-52.24	-40.00
	10 875.00	-58.50	10.95	-51.87	5.57	H	-46.49	-40.00
	14 500.00	-59.31	11.40	-47.96	6.54	H	-43.10	-40.00
56640 (3690.0)	7 380.00	-56.50	10.84	-56.87	4.40	H	-50.43	-40.00
	11 070.00	-56.75	11.04	-51.96	5.64	H	-46.56	-40.00
	14 760.00	-59.13	11.18	-47.96	6.58	V	-43.36	-40.00

8.3 PEAK-TO-AVERAGE RATIO

Band	Band Width	Frequency (MHz)	Modulation	Resource Block Size	Resource Block Offset	Data (dB)
48	5 MHz	3625.0	QPSK	25	0	5.24
			16-QAM			6.05
			64-QAM			7.09
			256-QAM			6.39
	10 MHz		QPSK	50		5.44
			16-QAM			6.12
			64-QAM			6.93
			256-QAM			6.46
	15 MHz		QPSK	75		5.23
			16-QAM			6.05
			64-QAM			7.08
			256-QAM			6.45
	20 MHz		QPSK	100		5.21
			16-QAM			5.96
			64-QAM			7.01
			256-QAM			6.46

Note:

1. Plots of the EUT's Peak- to- Average Ratio are shown Page 72 ~ 87.

8.4 OCCUPIED BANDWIDTH

Band	Band Width	Frequency (MHz)	Modulation	Resource Block Size	Resource Block Offset	Data (MHz)
48	5 MHz	3625.0	QPSK	25	0	4.4906
			16-QAM			4.4942
			64-QAM			4.4825
			256-QAM			4.4801
	10 MHz		QPSK	50		8.9710
			16-QAM			8.9401
			64-QAM			8.9612
			256-QAM			8.9219
	15 MHz		QPSK	75		13.494
			16-QAM			13.388
			64-QAM			13.388
			256-QAM			13.462
	20 MHz		QPSK	100		17.889
			16-QAM			17.876
			64-QAM			17.810
			256-QAM			17.837

Note:

1. Plots of the EUT's Occupied Bandwidth are shown Page 56 ~ 71.

8.5 CONDUCTED SPURIOUS EMISSIONS

Band	Band Width (MHz)	Frequency (MHz)	Frequency of Maximum Harmonic (GHz)	Factor (dB)	Measurement Maximum Data (dBm)	Result (dBm)	Limit (dBm)
48	5	3552.5	3.7807	31.955	-77.037	-45.082	-40.00
		3625.0	3.3924	31.955	-78.557	-46.602	
		3697.5	3.9258	31.955	-78.894	-46.939	
	10	3555.0	3.3201	31.955	-76.449	-44.494	
		3625.0	36.2490	34.110	-77.938	-43.828	
		3695.0	3.9213	31.955	-78.625	-46.670	
	15	3557.5	3.3201	31.955	-78.175	-46.220	
		3625.0	3.3879	31.955	-76.026	-44.071	
		3692.5	36.2510	34.110	-78.813	-44.703	
	20	3560.0	3.3206	31.955	-77.043	-45.088	
		3625.0	3.3859	31.955	-77.253	-45.298	
		3690.0	36.2210	34.110	-78.910	-44.800	

Note:

- Plots of the EUT's Conducted Spurious Emissions are shown Page 144 ~ 167.
- Duty Cycle factor already applied on the factor.
 - Duty Cycle factor(dB) = 3.979
 - Factor(dB) = Duty Cycle factor + Cable Loss + Ext. Attenuator + Power Splitter
 - Result(dBm) = Measurement Maximum Data (dBm) + Factor

Frequency Range (GHz)	Factor [dB]
0.03 – 1	29.249
1 – 5	31.955
5 – 10	32.570
10 – 15	33.095
15 – 20	33.468
Above 20	34.110

8.6 CHANNEL EDGE

BW (MHz)	RB (Size/Offset)	Freq. (MHz)	Outside of the authorized band (dBm)							
			Lower Side(MHz)				Upper Side(MHz)			
			Below 3530 MHz	-[B]MHz ~ 3530 MHz	-1 MHz ~ -[B]MHz	0 MHz ~ -1 MHz	0 MHz ~ +1 MHz	1 MHz ~ +[B]MHz	+ [B]MHz ~ 3720 MHz	Above 3720 MHz
5	25/0	3552.5	-50.87	-38.16	-29.24	-31.35	-31.56	-31.84	-40.39	-
		3625.0	-	-38.71	-28.93	-30.65	-31.90	-31.20	-40.24	-
		3697.5	-	-39.11	-29.52	-31.86	-32.57	-32.45	-40.85	-50.49
10	50/0	3555.0	-52.45	-45.40	-33.71	-35.80	-35.12	-34.74	-46.29	-
		3625.0	-	-44.40	-34.81	-35.53	-35.16	-34.45	-46.14	-
		3695.0	-	-45.92	-33.69	-36.04	-35.52	-33.58	-45.95	-51.20
15	75/0	3557.5	-49.90	-42.14	-36.32	-36.93	-36.95	-36.71	-49.22	-
		3625.0	-	-46.73	-36.02	-36.64	-36.72	-36.85	-48.83	-
		3692.5	-	-47.28	-31.39	-34.35	-33.94	-30.08	-37.16	-50.40
20	100/0	3560.0	-49.01	-42.77	-36.49	-38.06	-37.80	-37.61	-50.84	-
		3625.0	-	-47.94	-35.57	-37.63	-37.62	-37.58	-50.84	-
		3690.0	-	-48.30	-36.16	-38.25	-37.53	-38.22	-42.43	-49.98
Limit (dBm)			-40.00	-25.00	-13.00	-13.00	-13.00	-13.00	-25.00	-40.00

Note:

1. C.E = Channel Edge
2. Plots of the EUT's Channel Edge are shown Page 100 ~ 143.

BW (MHz)	RB (Size/ Offset)	Freq. (MHz)	Outside of the authorized band (dBm)							
			Lower Side(MHz)				Upper Side(MHz)			
			Below 3530 MHz	-[B]MHz ~ 3530 MHz	-1 MHz ~ -[B]MHz -1 MHz	0 MHz ~ -1 MHz	0 MHz ~ +1 MHz	1 MHz ~ +[B]MHz 3720 MHz	+[B]MHz ~ 3720 MHz	Above 3720 MHz
5	Lower Side: 1/0 Upper Side: 1/24	3552.5	-51.49	-39.78	-27.08	-22.54	-22.92	-26.99	-39.79	-
		3625.0	-	-38.99	-26.29	-23.13	-23.00	-25.88	-39.27	-
		3697.5	-	-40.38	-27.12	-23.11	-23.69	-27.35	-39.79	-50.52
10	Lower Side: 1/0 Upper Side: 1/49	3555.0	-50.35	-44.76	-28.30	-28.72	-28.64	-27.59	-45.00	-
		3625.0	-	-44.49	-28.09	-28.56	-28.42	-28.03	-44.38	-
		3695.0	-	-45.25	-28.52	-28.90	-29.21	-27.79	-44.93	-50.29
15	Lower Side: 1/0 Upper Side: 1/74	3557.5	-50.45	-44.78	-29.14	-28.47	-28.32	-28.52	-47.52	-
		3625.0	-	-47.63	-28.12	-28.40	-28.31	-28.61	-48.21	-
		3692.5	-	-47.96	-29.43	-29.19	-28.78	-29.71	-43.47	-49.91
20	Lower Side: 1/0 Upper Side: 1/99	3560.0	-49.51	-43.29	-29.25	-28.46	-28.42	-29.18	-49.38	-
		3625.0	-	-48.98	-28.49	-28.07	-28.40	-29.47	-50.13	-
		3690.0	-	-49.05	-29.79	-28.86	-28.99	-29.48	-42.95	-49.13
Limit (dBm)			-40.00	-25.00	-13.00	-13.00	-13.00	-13.00	-25.00	-40.00

Note:

1. C.E = Channel Edge
2. Plots of the EUT's Channel Edge are shown Page 100 ~ 143.

8.7 Adjacent Channel Leakage Ratio(ACLR)

Band Width	RB (Size/ Offset)	Frequency (MHz)	Adjacent Channel Leakage Ratio(dB)	
			Lower Side	Upper Side
5 MHz	25/0	3552.5	46.13	47.95
		3625.0	45.98	47.78
		3697.5	45.57	47.62
10 MHz	50/0	3555.0	50.28	50.16
		3625.0	49.91	50.13
		3695.0	48.90	49.52
15 MHz	75/0	3557.5	50.66	51.31
		3625.0	50.27	51.06
		3692.5	45.49	43.44
20 MHz	100/0	3560.0	50.22	52.33
		3625.0	50.16	52.02
		3690.0	49.76	50.88
Limit (dB)			ACLR > 30 dB	ACLR > 30 dB

Note:

1. Duty Cycle factor already applied on the factor.
 - Duty Cycle factor(dB) = 3.979
 - Factor(dB) = Duty Cycle factor + Cable Loss + Ext. Attenuator + Power Splitter
2. Plots of the EUT's Adjacent Channel Leakage Ratio(ACLR) are shown Page 88 ~ 99.

8.8 FREQUENCY STABILITY / VARIATION OF AMBIENT TEMPERATURE

- ▣ OPERATING FREQUENCY: 3,552,500,000 Hz
- ▣ BANDWIDTH: 5 MHz
- ▣ REFERENCE VOLTAGE: 3.860 VDC
- ▣ DEVIATION LIMIT: Emission must remain in band

Voltage (%)	Power (VDC)	Temp. (°C)	Frequency (Hz)	Frequency Error (Hz)	Deviation (%)	ppm
100 %	3.860	+20(Ref)	3552 500 004	0.0	0.000 000	0.000
100 %		-30	3552 500 009	4.9	0.000 000	0.001
100 %		-20	3552 500 009	5.0	0.000 000	0.001
100 %		-10	3552 500 010	5.9	0.000 000	0.002
100 %		0	3552 500 009	5.2	0.000 000	0.001
100 %		+10	3552 500 009	5.2	0.000 000	0.001
100 %		+30	3552 500 012	7.8	0.000 000	0.002
100 %		+40	3552 500 007	3.6	0.000 000	0.001
100 %		+50	3552 500 009	5.1	0.000 000	0.001
Batt. Endpoint	3.400	+20	3552 500 010	6.4	0.000 000	0.002

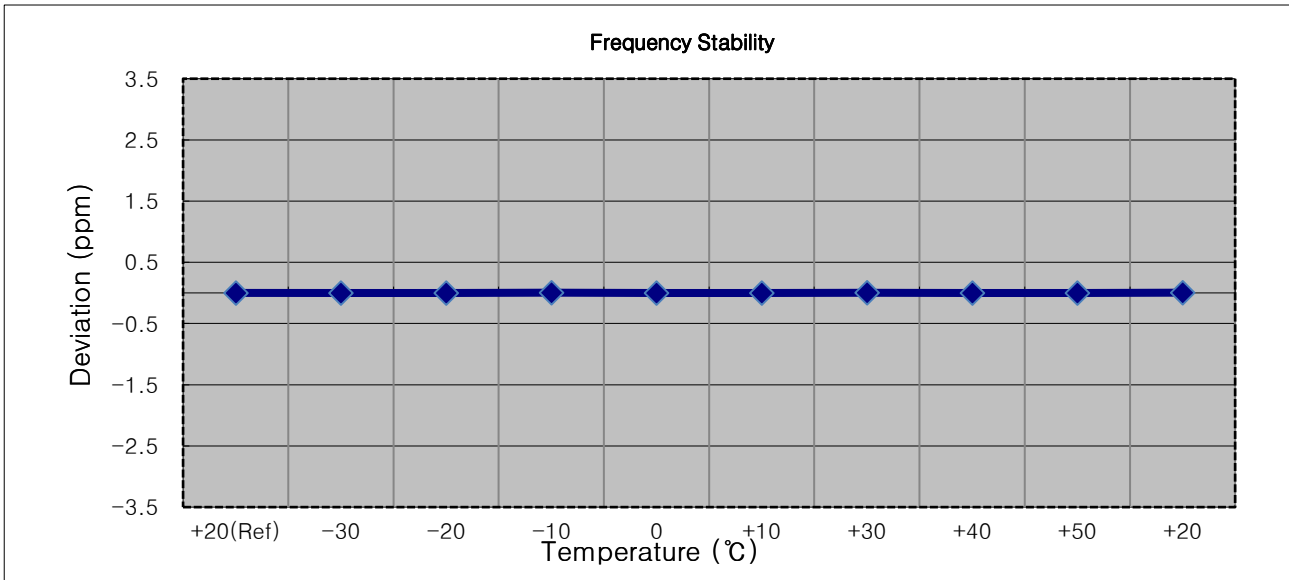

- OPERATING FREQUENCY: 3,555,000,000 Hz
- BANDWIDTH: 10 MHz
- REFERENCE VOLTAGE: 3.860 VDC
- DEVIATION LIMIT: Emission must remain in band

Voltage (%)	Power (VDC)	Temp. (°C)	Frequency (Hz)	Frequency Error (Hz)	Deviation (%)	ppm
100 %	3.860	+20(Ref)	3555 000 006	0.0	0.000 000	0.000
100 %		-30	3555 000 016	10.0	0.000 000	0.003
100 %		-20	3555 000 012	5.6	0.000 000	0.002
100 %		-10	3555 000 013	6.9	0.000 000	0.002
100 %		0	3555 000 012	5.7	0.000 000	0.002
100 %		+10	3555 000 017	11.1	0.000 000	0.003
100 %		+30	3555 000 010	4.4	0.000 000	0.001
100 %		+40	3555 000 012	5.8	0.000 000	0.002
100 %		+50	3555 000 014	8.3	0.000 000	0.002
Batt. Endpoint	3.400	+20	3555 000 015	8.8	0.000 000	0.002

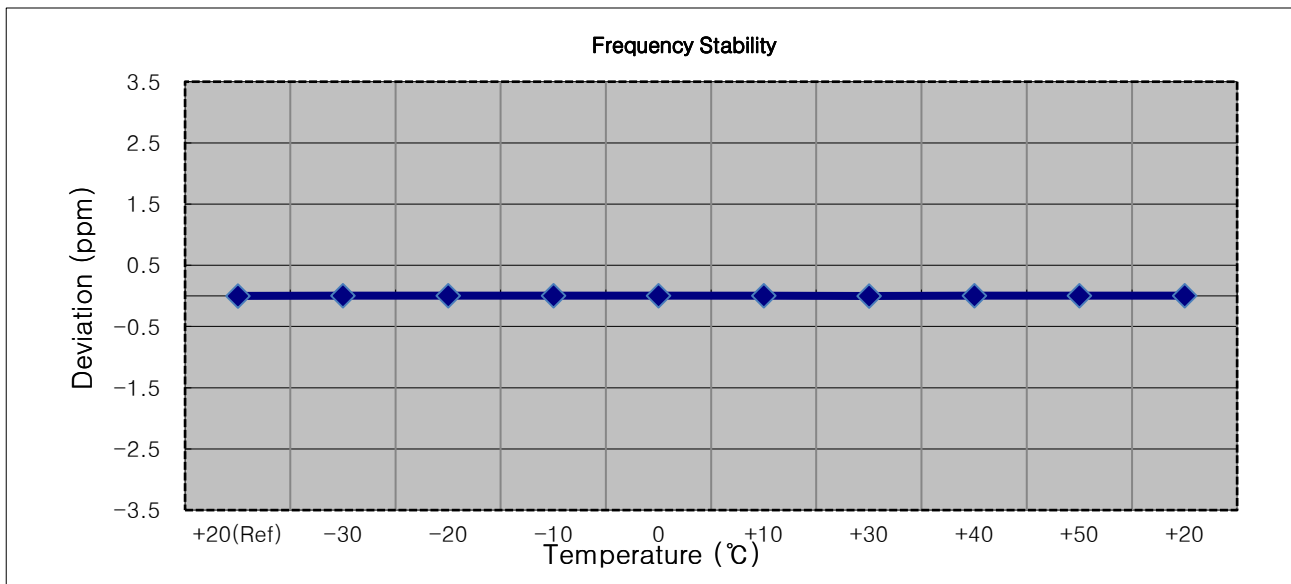

- OPERATING FREQUENCY: 3,557,500,000 Hz
- BANDWIDTH: 15 MHz
- REFERENCE VOLTAGE: 3.860 VDC
- DEVIATION LIMIT: Emission must remain in band

Voltage (%)	Power (VDC)	Temp. (°C)	Frequency (Hz)	Frequency Error (Hz)	Deviation (%)	ppm
100 %	3.860	+20(Ref)	3557 500 006	0.0	0.000 000	0.000
100 %		-30	3557 500 011	5.3	0.000 000	0.001
100 %		-20	3557 500 014	8.6	0.000 000	0.002
100 %		-10	3557 500 010	3.9	0.000 000	0.001
100 %		0	3557 500 013	7.7	0.000 000	0.002
100 %		+10	3557 500 013	7.7	0.000 000	0.002
100 %		+30	3557 500 013	7.3	0.000 000	0.002
100 %		+40	3557 500 012	6.5	0.000 000	0.002
100 %		+50	3557 500 012	6.1	0.000 000	0.002
Batt. Endpoint		3.400	+20	3557 500 013	7.0	0.000 000

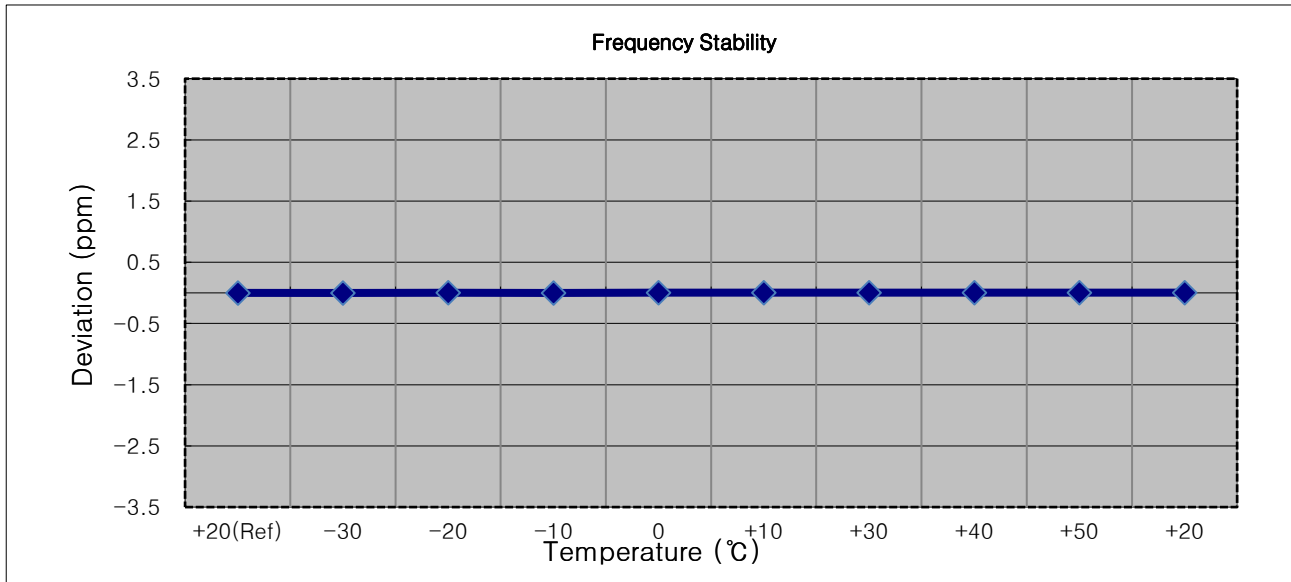

- ▣ OPERATING FREQUENCY: 3,560,000,000 Hz
- ▣ BANDWIDTH: 20 MHz
- ▣ REFERENCE VOLTAGE: 3.860 VDC
- ▣ DEVIATION LIMIT: Emission must remain in band

Voltage (%)	Power (VDC)	Temp. (°C)	Frequency (Hz)	Frequency Error (Hz)	Deviation (%)	ppm
100 %	3.860	+20(Ref)	3560 000 007	0.0	0.000 000	0.000
100 %		-30	3560 000 012	4.9	0.000 000	0.001
100 %		-20	3560 000 016	8.7	0.000 000	0.002
100 %		-10	3560 000 017	9.3	0.000 000	0.003
100 %		0	3560 000 015	7.9	0.000 000	0.002
100 %		+10	3560 000 017	9.2	0.000 000	0.003
100 %		+30	3560 000 015	7.5	0.000 000	0.002
100 %		+40	3560 000 016	8.6	0.000 000	0.002
100 %		+50	3560 000 013	6.0	0.000 000	0.002
Batt. Endpoint	3.400	+20	3560 000 017	9.8	0.000 000	0.003

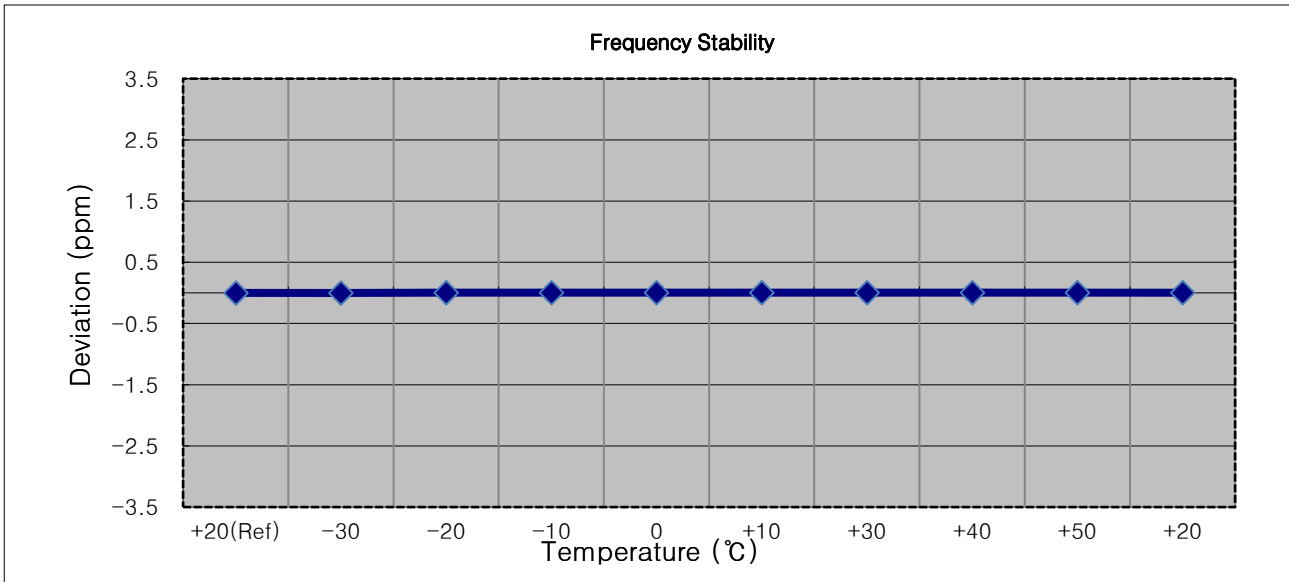

- ▣ OPERATING FREQUENCY: 3,625,000,000 Hz
- ▣ BANDWIDTH: 5 MHz
- ▣ REFERENCE VOLTAGE: 3.860 VDC
- ▣ DEVIATION LIMIT: Emission must remain in band

Voltage (%)	Power (VDC)	Temp. (°C)	Frequency (Hz)	Frequency Error (Hz)	Deviation (%)	ppm
100 %	3.860	+20(Ref)	3625 000 005	0.0	0.000 000	0.000
100 %		-30	3625 000 009	4.0	0.000 000	0.001
100 %		-20	3625 000 011	6.2	0.000 000	0.002
100 %		-10	3625 000 008	3.4	0.000 000	0.001
100 %		0	3625 000 011	6.6	0.000 000	0.002
100 %		+10	3625 000 009	4.3	0.000 000	0.001
100 %		+30	3625 000 009	4.1	0.000 000	0.001
100 %		+40	3625 000 010	5.2	0.000 000	0.001
100 %		+50	3625 000 012	6.9	0.000 000	0.002
Batt. Endpoint		3.400	+20	3625 000 011	5.9	0.000 000

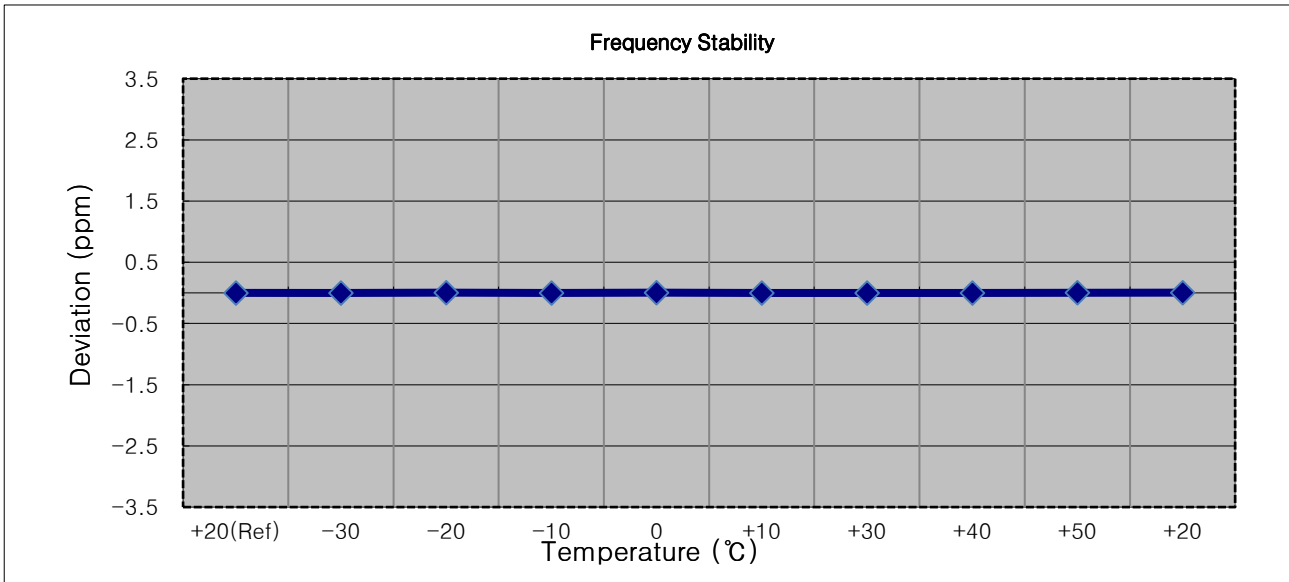

- ▣ OPERATING FREQUENCY: 3,625,000,000 Hz
- ▣ BANDWIDTH: 10 MHz
- ▣ REFERENCE VOLTAGE: 3.860 VDC
- ▣ DEVIATION LIMIT: Emission must remain in band

Voltage (%)	Power (VDC)	Temp. (°C)	Frequency (Hz)	Frequency Error (Hz)	Deviation (%)	ppm
100 %	3.860	+20(Ref)	3625 000 008	0.0	0.000 000	0.000
100 %		-30	3625 000 015	7.4	0.000 000	0.002
100 %		-20	3625 000 018	10.2	0.000 000	0.003
100 %		-10	3625 000 015	6.5	0.000 000	0.002
100 %		0	3625 000 017	9.4	0.000 000	0.003
100 %		+10	3625 000 011	2.9	0.000 000	0.001
100 %		+30	3625 000 014	6.3	0.000 000	0.002
100 %		+40	3625 000 015	7.4	0.000 000	0.002
100 %		+50	3625 000 017	8.7	0.000 000	0.002
Batt. Endpoint	3.400	+20	3625 000 016	8.2	0.000 000	0.002

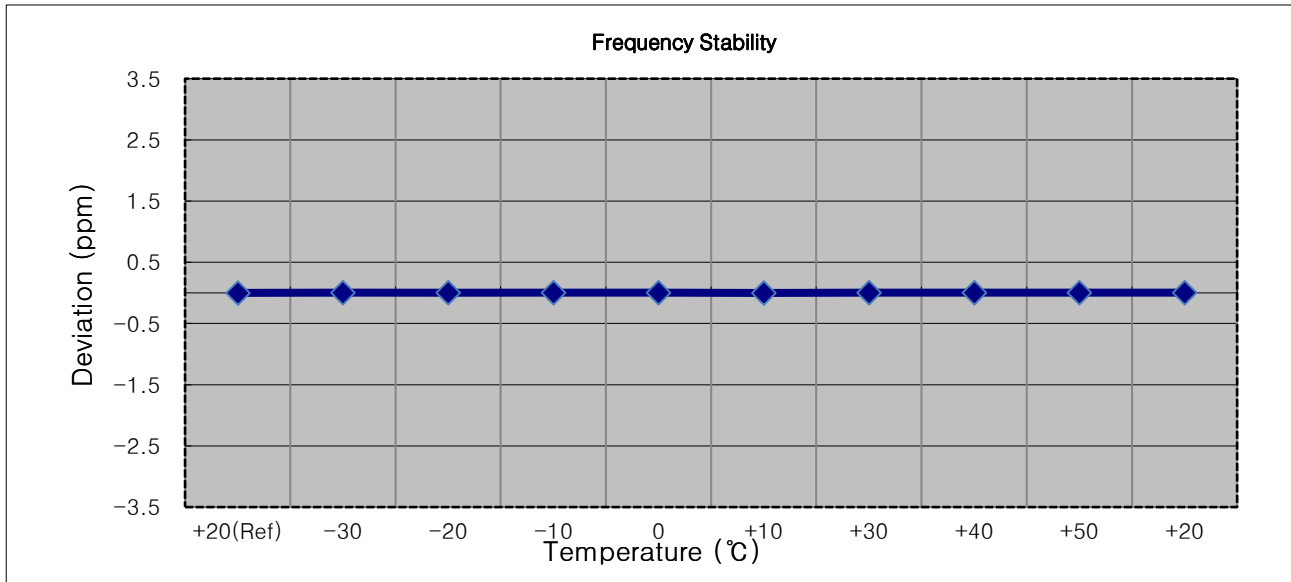

- OPERATING FREQUENCY: 3,625,000,000 Hz
- BANDWIDTH: 15 MHz
- REFERENCE VOLTAGE: 3.860 VDC
- DEVIATION LIMIT: Emission must remain in band

Voltage (%)	Power (VDC)	Temp. (°C)	Frequency (Hz)	Frequency Error (Hz)	Deviation (%)	ppm
100 %	3.860	+20(Ref)	3625 000 009	0.0	0.000 000	0.000
100 %		-30	3625 000 018	8.8	0.000 000	0.002
100 %		-20	3625 000 016	6.5	0.000 000	0.002
100 %		-10	3625 000 018	8.8	0.000 000	0.002
100 %		0	3625 000 018	9.1	0.000 000	0.003
100 %		+10	3625 000 015	6.1	0.000 000	0.002
100 %		+30	3625 000 018	8.3	0.000 000	0.002
100 %		+40	3625 000 016	6.3	0.000 000	0.002
100 %		+50	3625 000 015	5.3	0.000 000	0.001
Batt. Endpoint	3.400	+20	3625 000 018	8.6	0.000 000	0.002

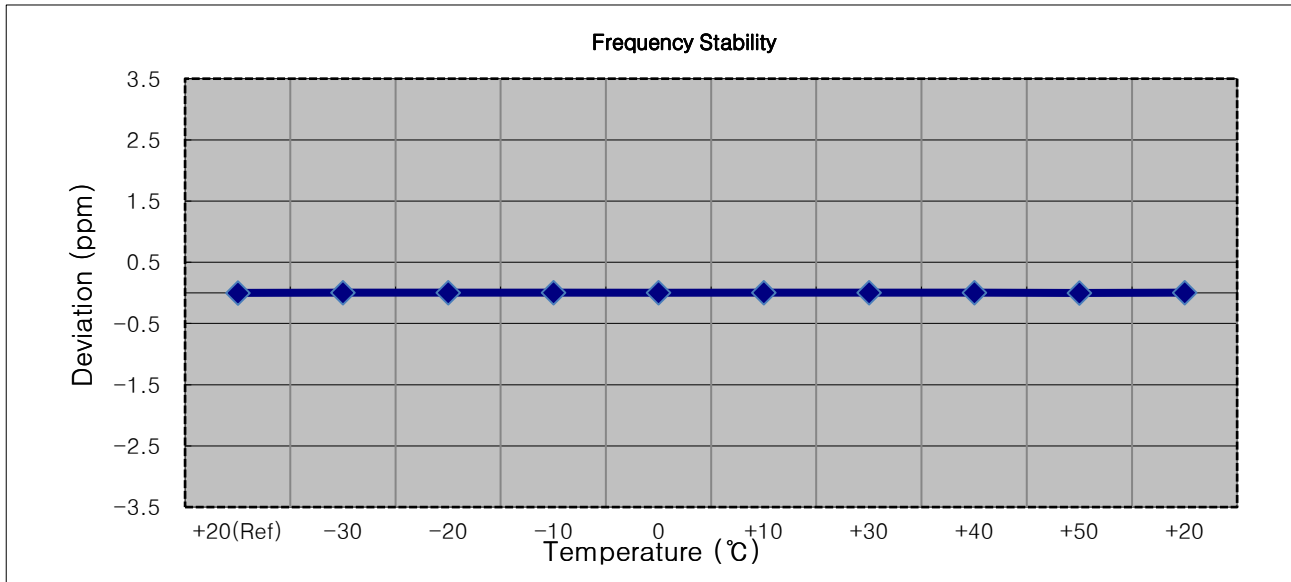

- OPERATING FREQUENCY: 3,625,000,000 Hz
- BANDWIDTH: 20 MHz
- REFERENCE VOLTAGE: 3.860 VDC
- DEVIATION LIMIT: Emission must remain in band

Voltage (%)	Power (VDC)	Temp. (°C)	Frequency (Hz)	Frequency Error (Hz)	Deviation (%)	ppm
100 %	3.860	+20(Ref)	3625 000 010	0.0	0.000 000	0.000
100 %		-30	3625 000 018	8.9	0.000 000	0.002
100 %		-20	3625 000 015	5.6	0.000 000	0.002
100 %		-10	3625 000 014	4.0	0.000 000	0.001
100 %		0	3625 000 018	8.8	0.000 000	0.002
100 %		+10	3625 000 017	7.2	0.000 000	0.002
100 %		+30	3625 000 019	9.8	0.000 000	0.003
100 %		+40	3625 000 019	9.8	0.000 000	0.003
100 %		+50	3625 000 016	6.6	0.000 000	0.002
Batt. Endpoint		3.400	+20	3625 000 014	4.4	0.000 000

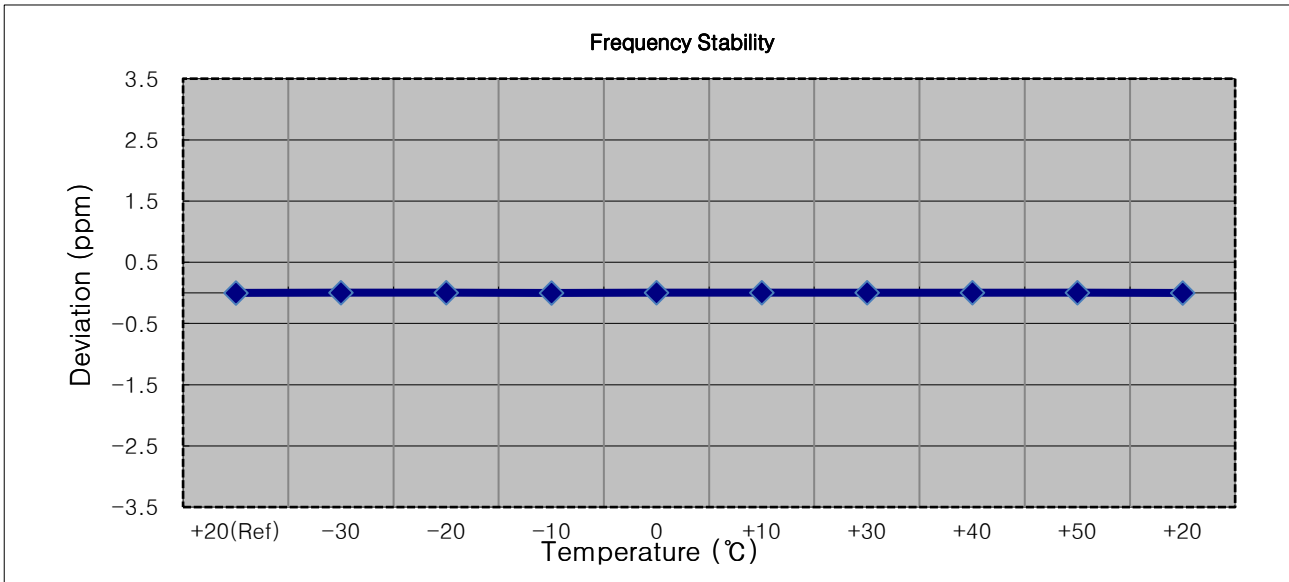

- ▣ OPERATING FREQUENCY: 3,697,500,000 Hz
- ▣ BANDWIDTH: 5 MHz
- ▣ REFERENCE VOLTAGE: 3.860 VDC
- ▣ DEVIATION LIMIT: Emission must remain in band

Voltage (%)	Power (VDC)	Temp. (°C)	Frequency (Hz)	Frequency Error (Hz)	Deviation (%)	ppm
100 %	3.860	+20(Ref)	3697 500 006	0.0	0.000 000	0.000
100 %		-30	3697 500 011	5.5	0.000 000	0.001
100 %		-20	3697 500 012	5.9	0.000 000	0.002
100 %		-10	3697 500 012	6.0	0.000 000	0.002
100 %		0	3697 500 012	6.0	0.000 000	0.002
100 %		+10	3697 500 012	6.4	0.000 000	0.002
100 %		+30	3697 500 011	5.4	0.000 000	0.001
100 %		+40	3697 500 012	5.8	0.000 000	0.002
100 %		+50	3697 500 011	4.9	0.000 000	0.001
Batt. Endpoint		3.400	+20	3697 500 011	5.5	0.000 000

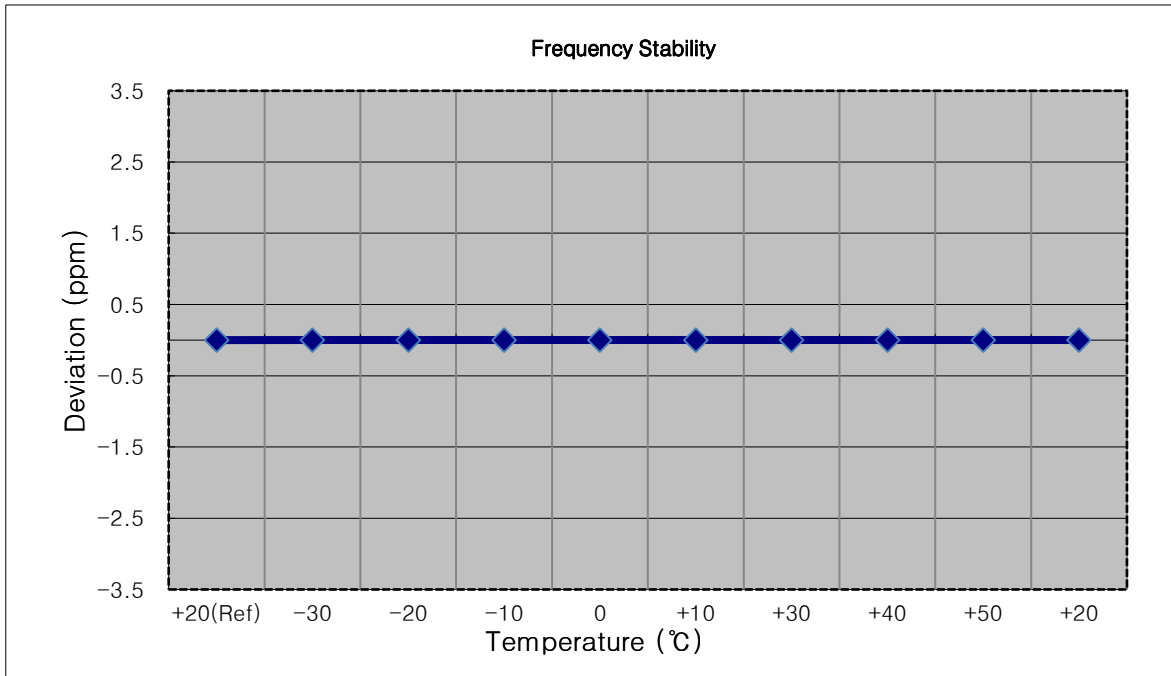

- ▣ OPERATING FREQUENCY: 3,695,000,000 Hz
- ▣ BANDWIDTH: 10 MHz
- ▣ REFERENCE VOLTAGE: 3.860 VDC
- ▣ DEVIATION LIMIT: Emission must remain in band

Voltage (%)	Power (VDC)	Temp. (°C)	Frequency (Hz)	Frequency Error (Hz)	Deviation (%)	ppm
100 %	3.860	+20(Ref)	3695 000 008	0.0	0.000 000	0.000
100 %		-30	3695 000 015	6.9	0.000 000	0.002
100 %		-20	3695 000 020	12.1	0.000 000	0.003
100 %		-10	3695 000 017	8.9	0.000 000	0.002
100 %		0	3695 000 019	10.3	0.000 000	0.003
100 %		+10	3695 000 015	7.2	0.000 000	0.002
100 %		+30	3695 000 014	6.1	0.000 000	0.002
100 %		+40	3695 000 017	8.4	0.000 000	0.002
100 %		+50	3695 000 016	7.8	0.000 000	0.002
Batt. Endpoint	3.400	+20	3695 000 018	10.1	0.000 000	0.003

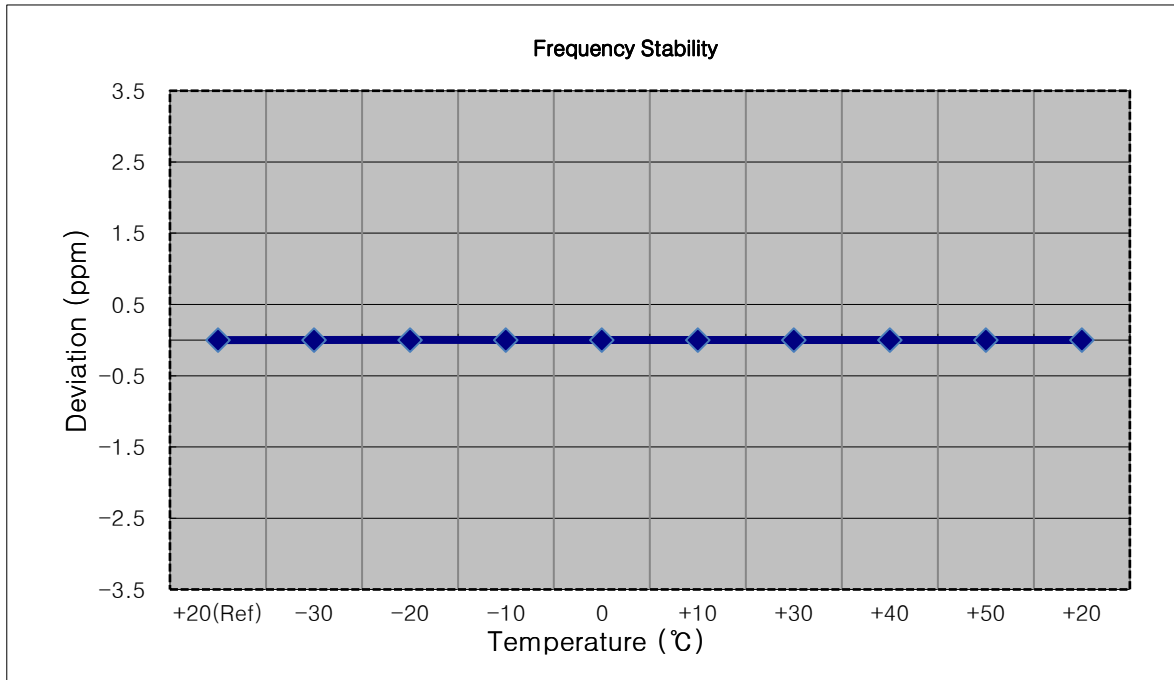

- ▣ OPERATING FREQUENCY: 3,692,500,000 Hz
- ▣ BANDWIDTH: 15 MHz
- ▣ REFERENCE VOLTAGE: 3.860 VDC
- ▣ DEVIATION LIMIT: Emission must remain in band

Voltage (%)	Power (VDC)	Temp. (°C)	Frequency (Hz)	Frequency Error (Hz)	Deviation (%)	ppm
100 %	3.860	+20(Ref)	3692 500 008	0.0	0.000 000	0.000
100 %		-30	3692 500 018	9.2	0.000 000	0.002
100 %		-20	3692 500 017	8.1	0.000 000	0.002
100 %		-10	3692 500 017	8.2	0.000 000	0.002
100 %		0	3692 500 017	8.3	0.000 000	0.002
100 %		+10	3692 500 016	7.3	0.000 000	0.002
100 %		+30	3692 500 015	6.6	0.000 000	0.002
100 %		+40	3692 500 018	9.7	0.000 000	0.003
100 %		+50	3692 500 018	9.2	0.000 000	0.002
Batt. Endpoint		3.400	+20	3692 500 018	9.8	0.000 000

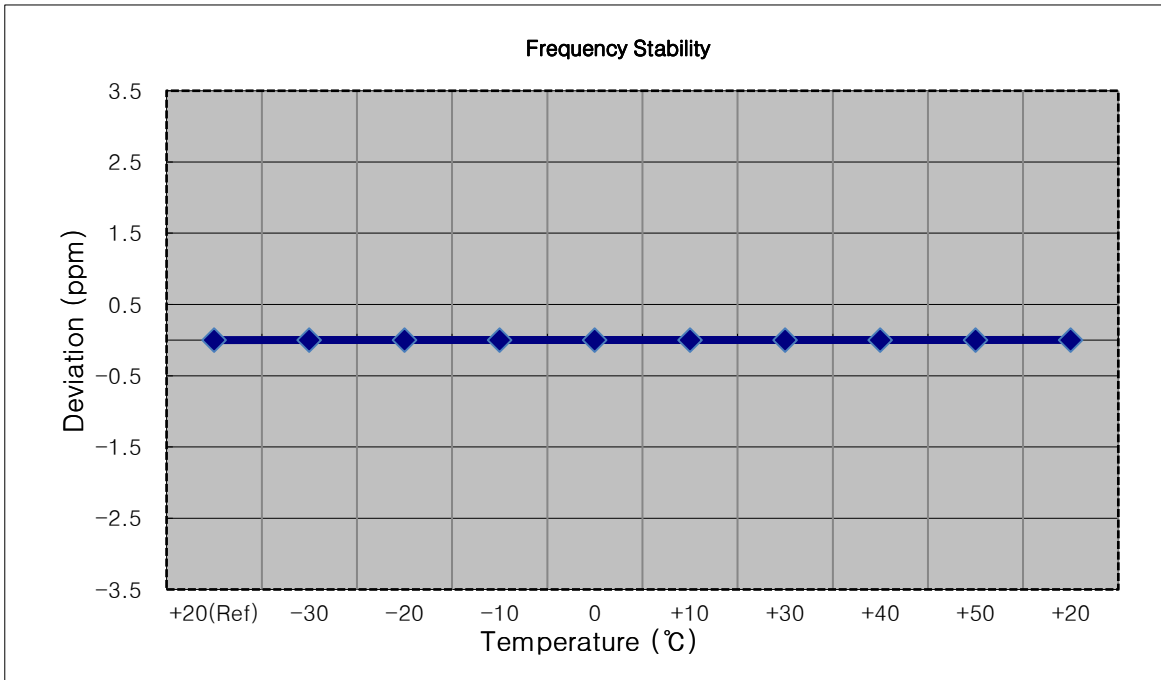

- ▣ OPERATING FREQUENCY: 3,690,000,000 Hz
- ▣ BANDWIDTH: 20 MHz
- ▣ REFERENCE VOLTAGE: 3.860 VDC
- ▣ DEVIATION LIMIT: Emission must remain in band

Voltage (%)	Power (VDC)	Temp. (°C)	Frequency (Hz)	Frequency Error (Hz)	Deviation (%)	ppm
100 %	3.860	+20(Ref)	3690 000 008	0.0	0.000 000	0.000
100 %		-30	3690 000 018	9.2	0.000 000	0.002
100 %		-20	3690 000 018	9.9	0.000 000	0.003
100 %		-10	3690 000 015	6.5	0.000 000	0.002
100 %		0	3690 000 016	7.6	0.000 000	0.002
100 %		+10	3690 000 019	10.2	0.000 000	0.003
100 %		+30	3690 000 018	9.2	0.000 000	0.002
100 %		+40	3690 000 020	11.6	0.000 000	0.003
100 %		+50	3690 000 016	7.2	0.000 000	0.002
Batt. Endpoint	3.400	+20	3690 000 014	5.3	0.000 000	0.001

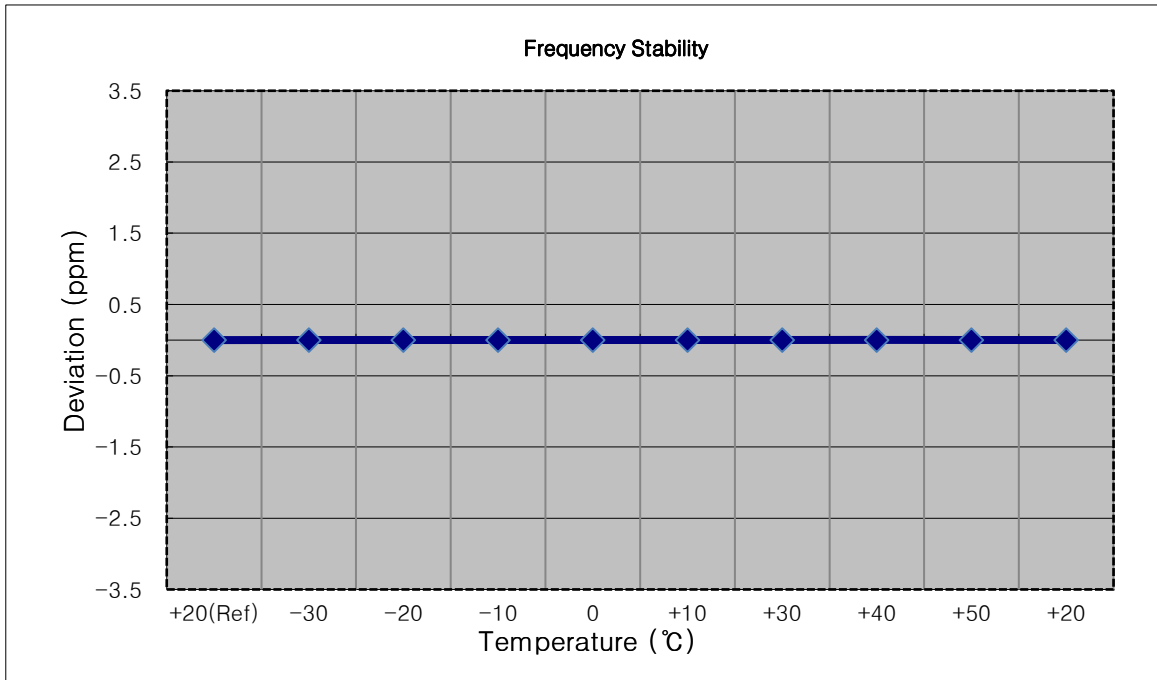

8.9 End User Device Additional Requirements (CBSD Protocol)

Test#1: 3570 MHz(BW: 20 MHz)

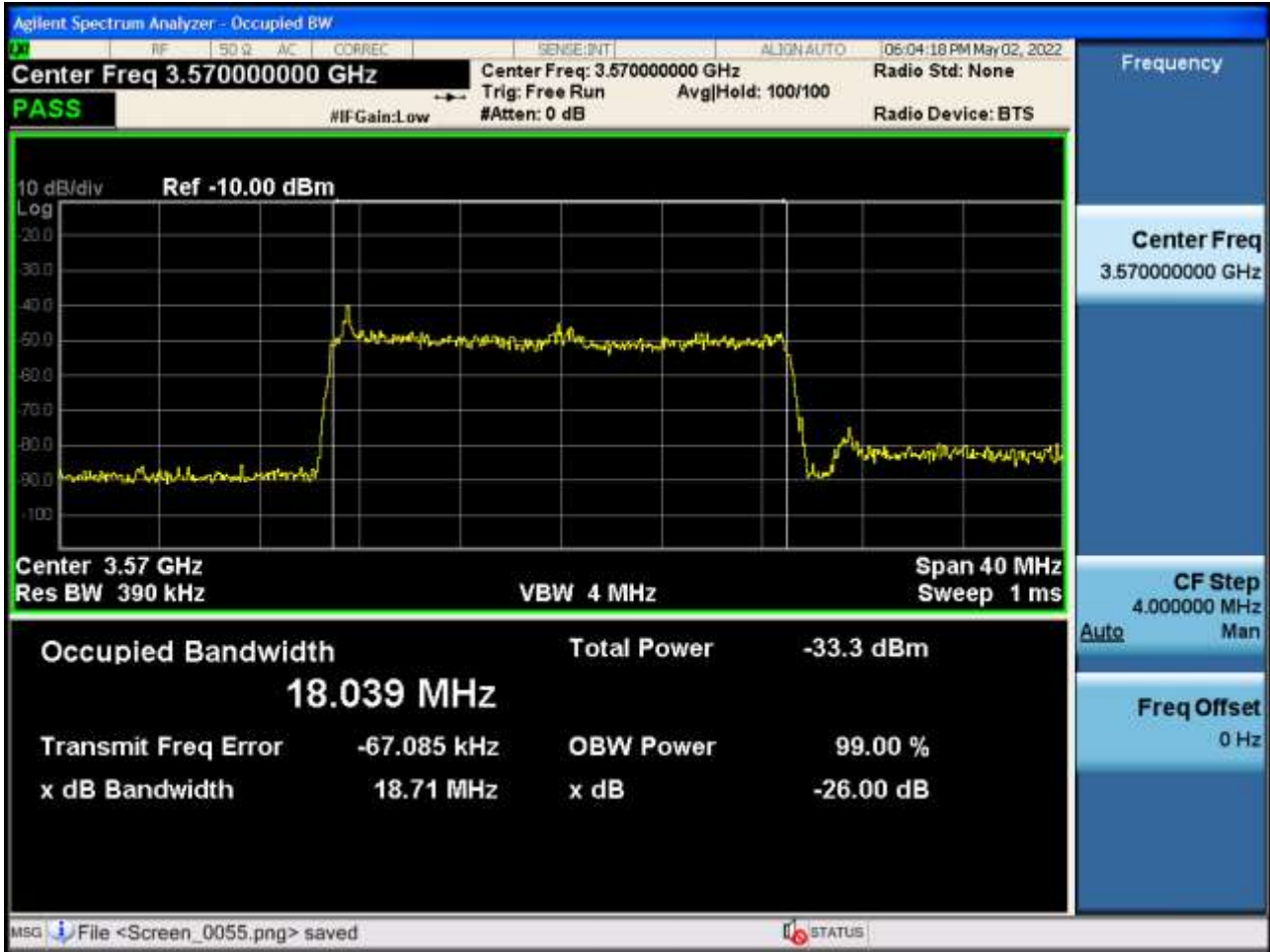

Operation Mode

Stop Operation Within 10 s

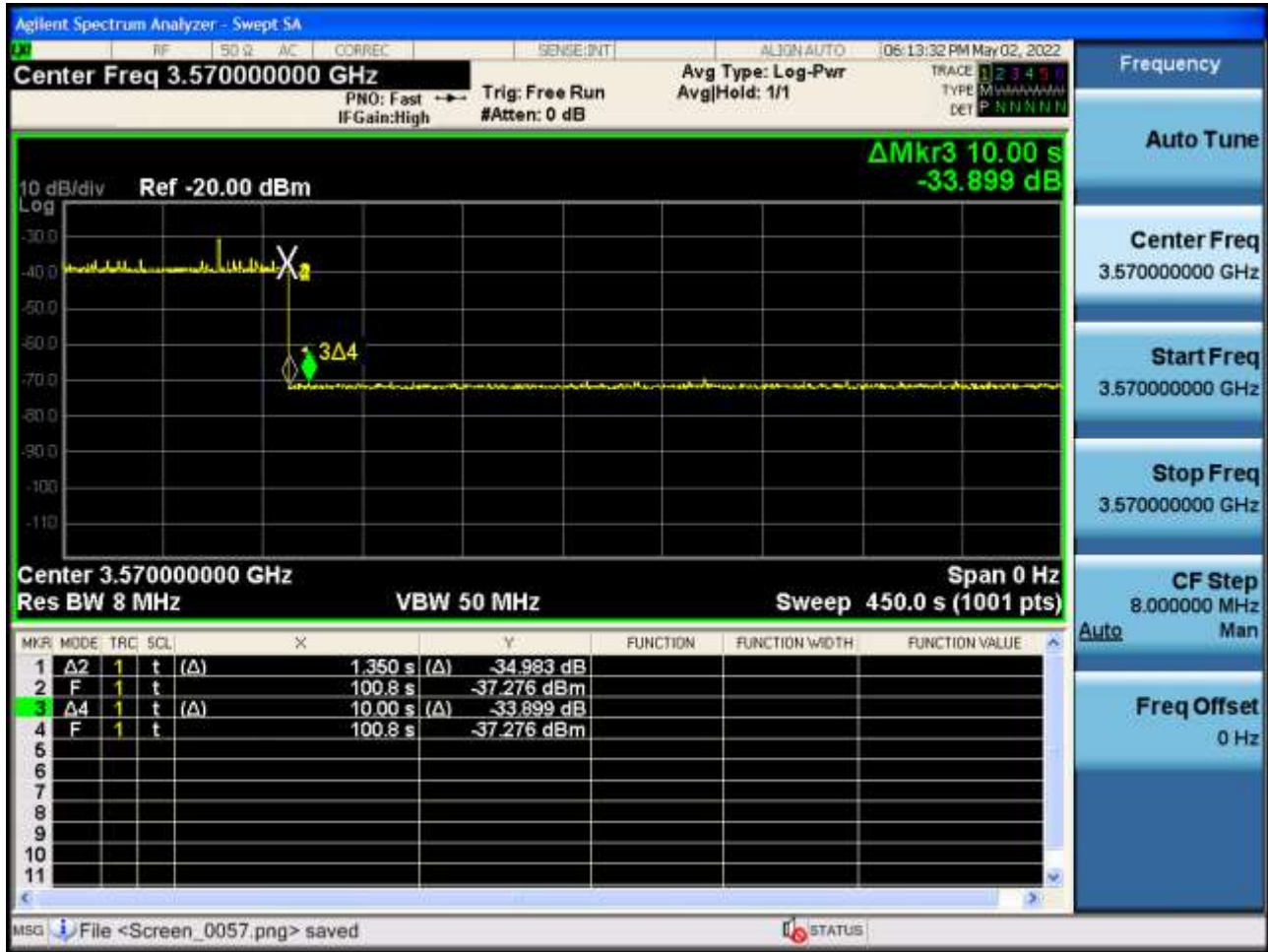

Note:

Marker 2: CBSD sends instructions to discontinue LTE operations.

Marker 1Δ2: EUT discontinues operation. (2.7 s)

Marker 3Δ4: 10 seconds elapsed time from CBSD sending instructions to EUT.(10.0 s)

Test#2: 3610 MHz(BW: 20 MHz)

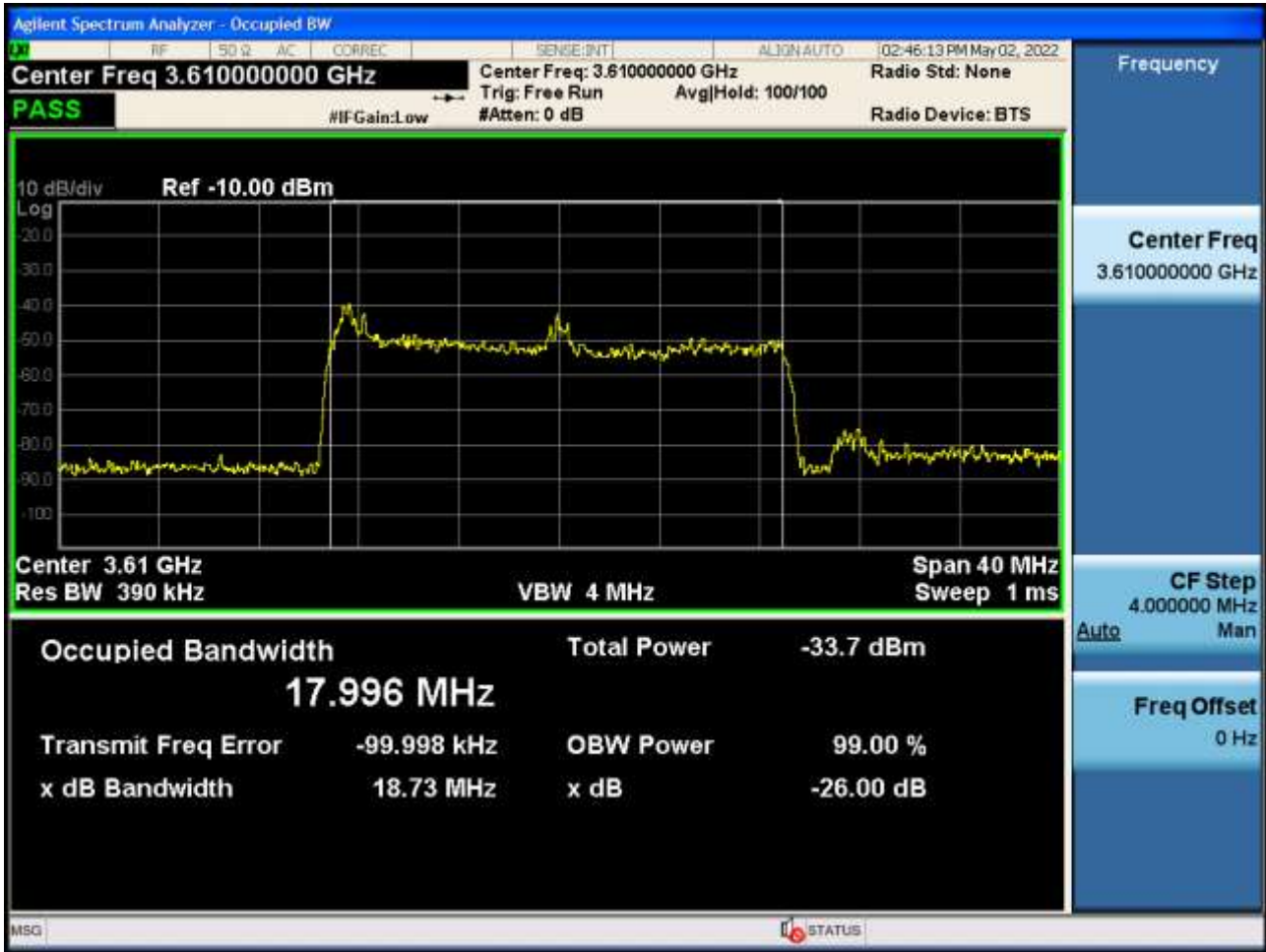

Operation Mode

Stop Operation Within 10 s



Note:

Marker 2: CBSD sends instructions to discontinue LTE operations.

Marker 1Δ2: EUT discontinues operation. (2.25 s)

Marker 3Δ4: 10 seconds elapsed time from CBSD sending instructions to EUT.(10.0 s)

9. TEST PLOTS

BAND 48. Occupied Bandwidth Plot (5 MHz Ch.5590 QPSK RB 25)

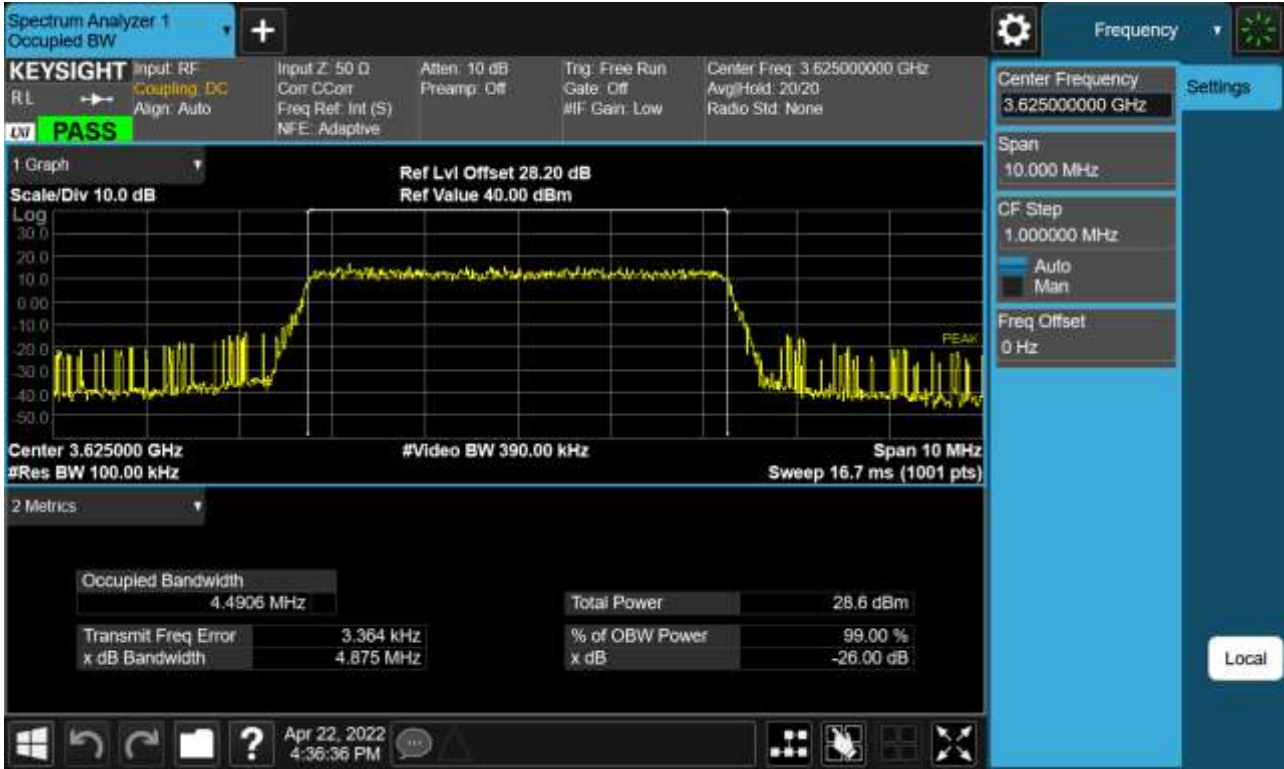

BAND 48. Occupied Bandwidth Plot (5 MHz Ch.55990 16-QAM RB 25)

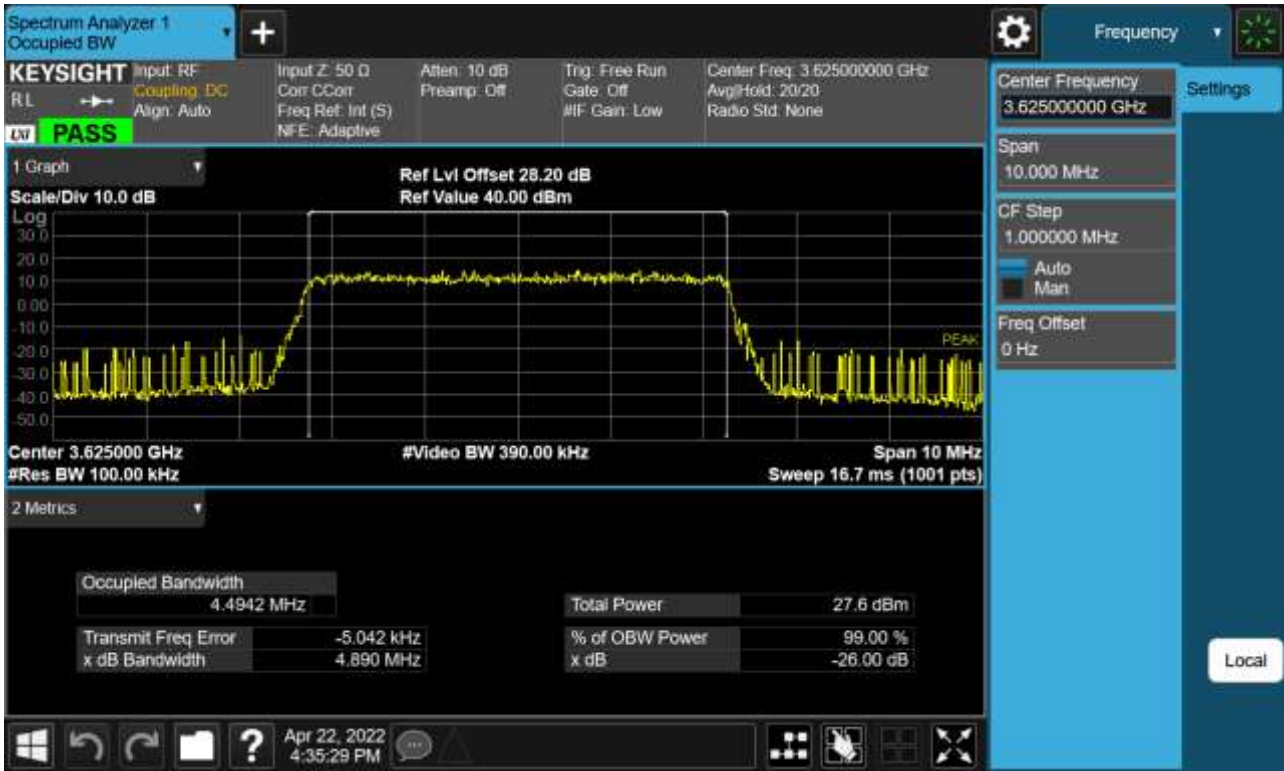

BAND 48. Occupied Bandwidth Plot (5 MHz Ch.55990 64-QAM RB 25)

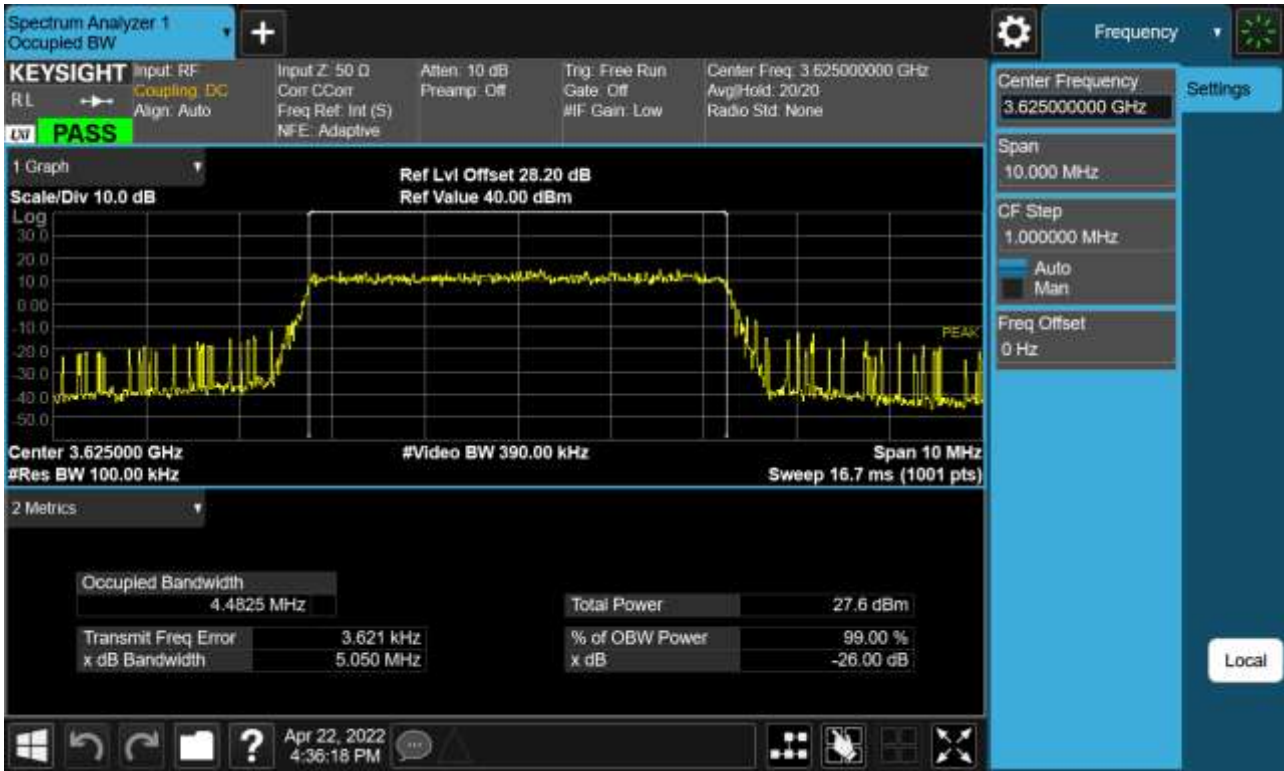

BAND 48. Occupied Bandwidth Plot (5 MHz Ch.55990 256-QAM RB 25)

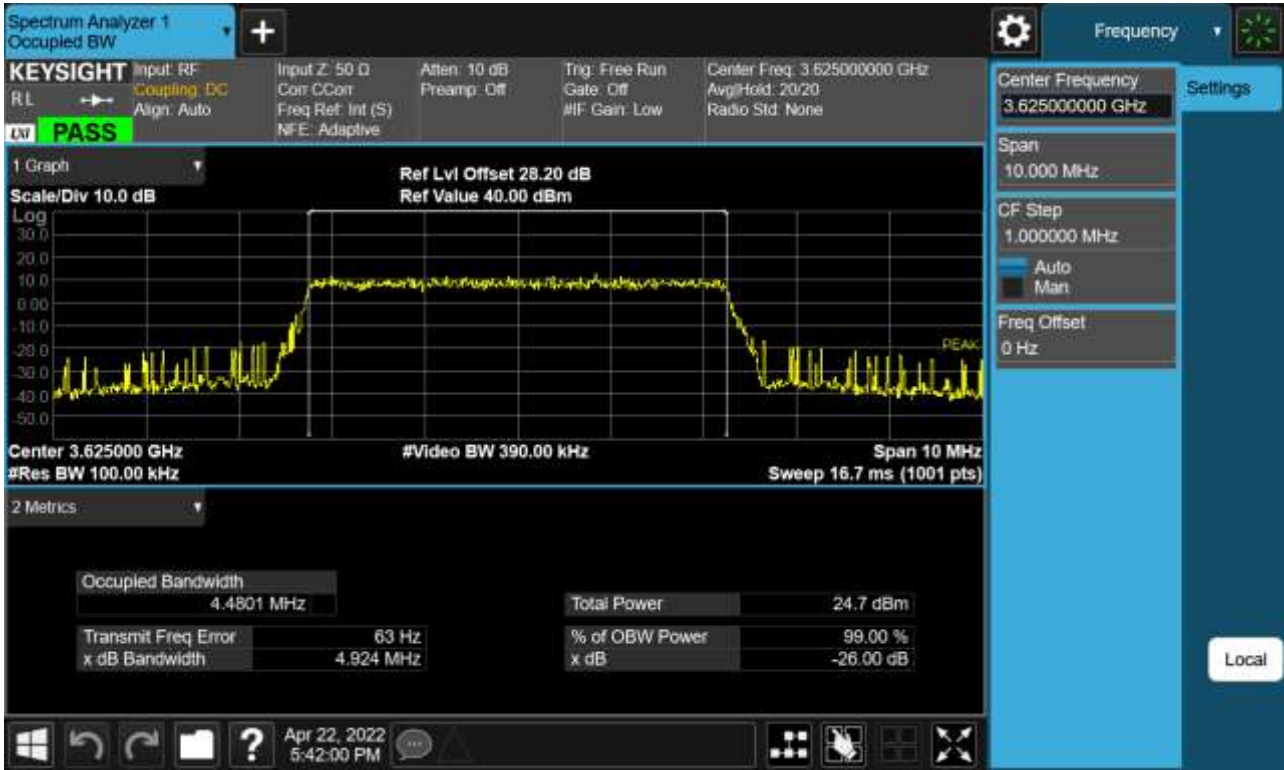

BAND 48. Occupied Bandwidth Plot (10 MHz Ch.55990 QPSK RB 50)

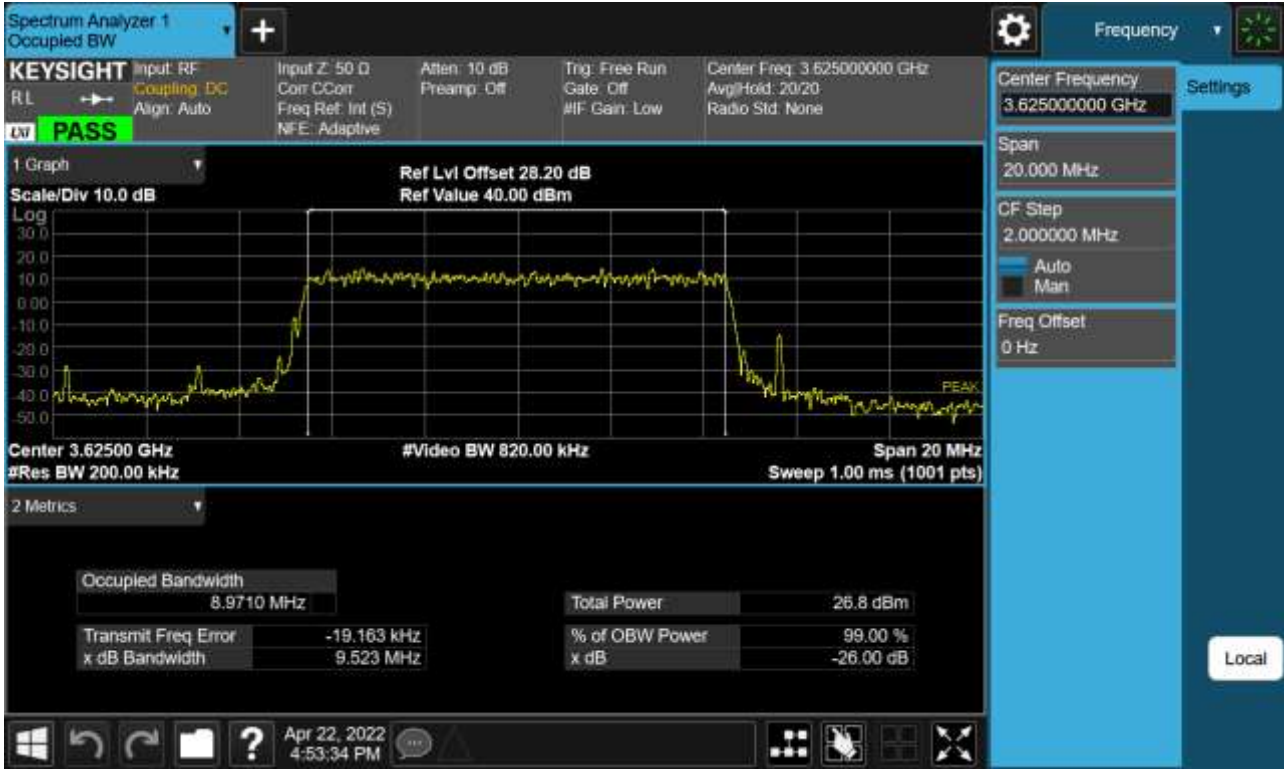

BAND 48. Occupied Bandwidth Plot (10 MHz Ch.55990 16-QAM RB 50)

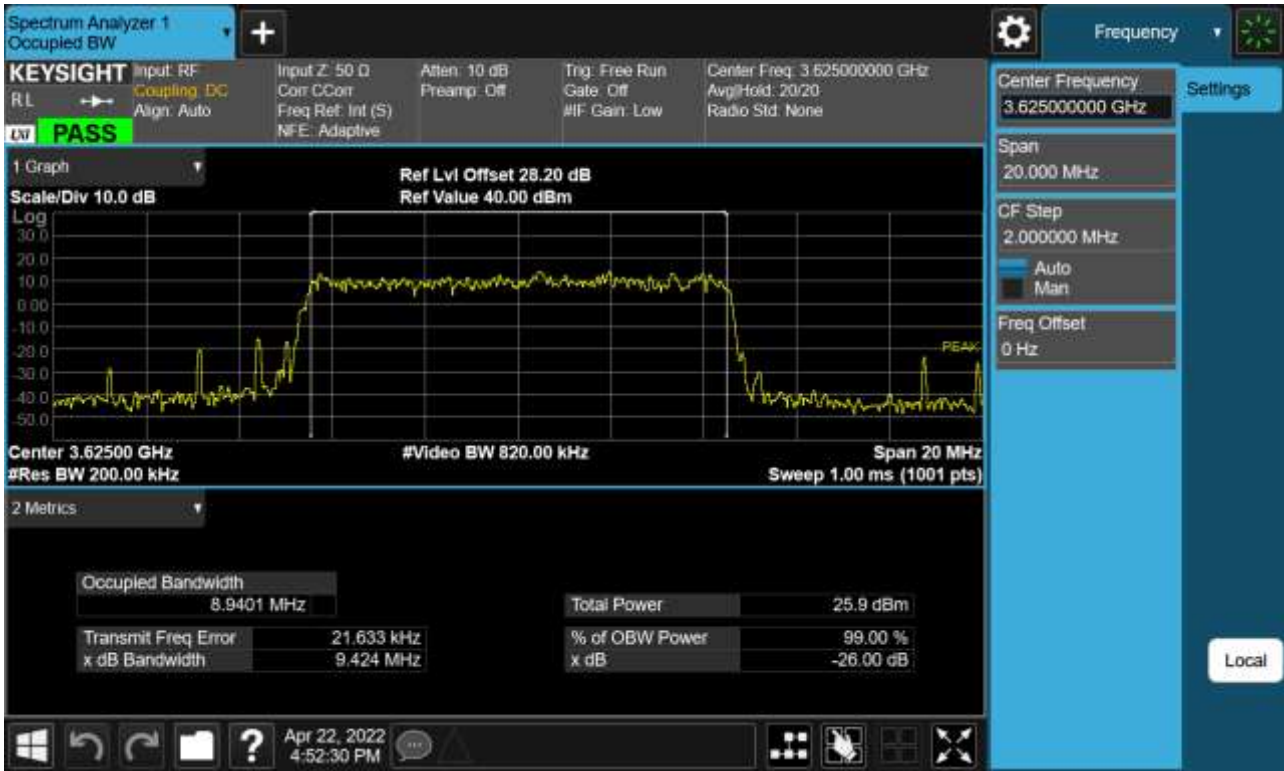

BAND 48. Occupied Bandwidth Plot (10 MHz Ch.55990 64-QAM RB 50)

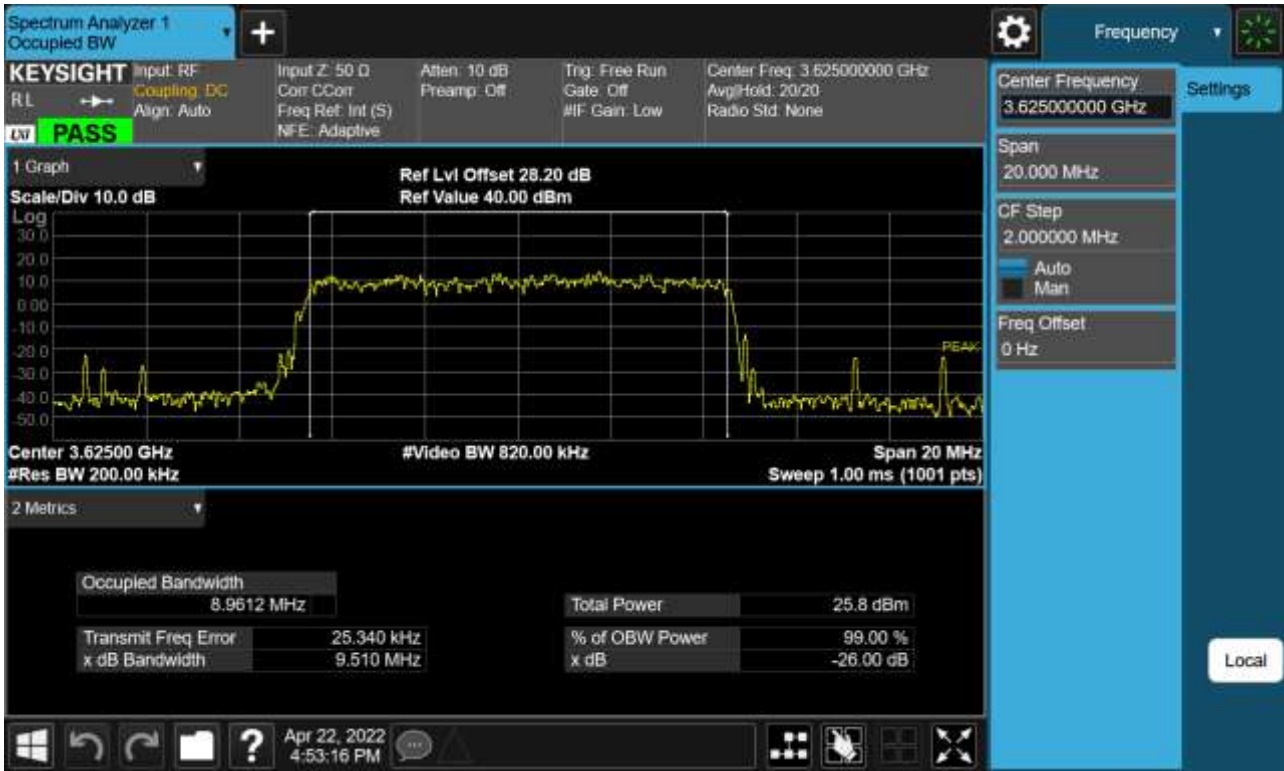

BAND 48. Occupied Bandwidth Plot (10 MHz Ch.55990 256-QAM RB 50)

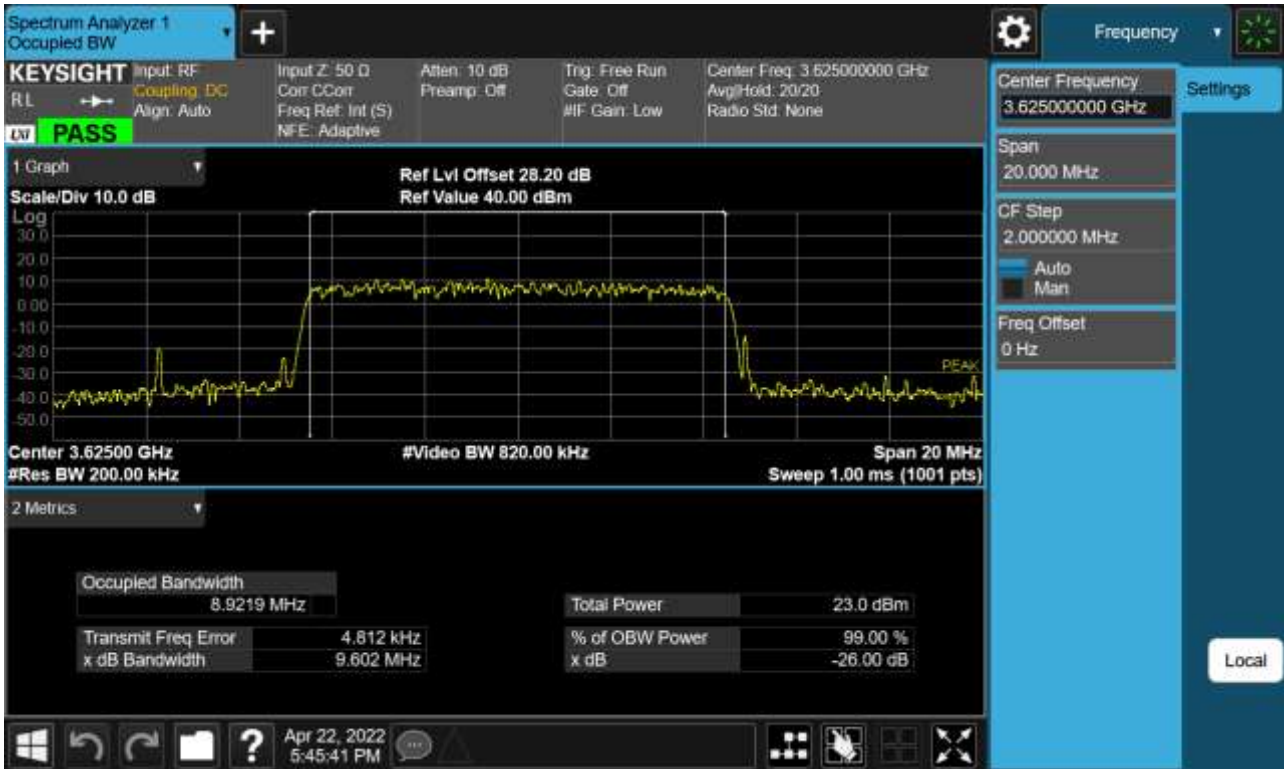

BAND 48. Occupied Bandwidth Plot (15 MHz Ch.55990 QPSK RB 75)

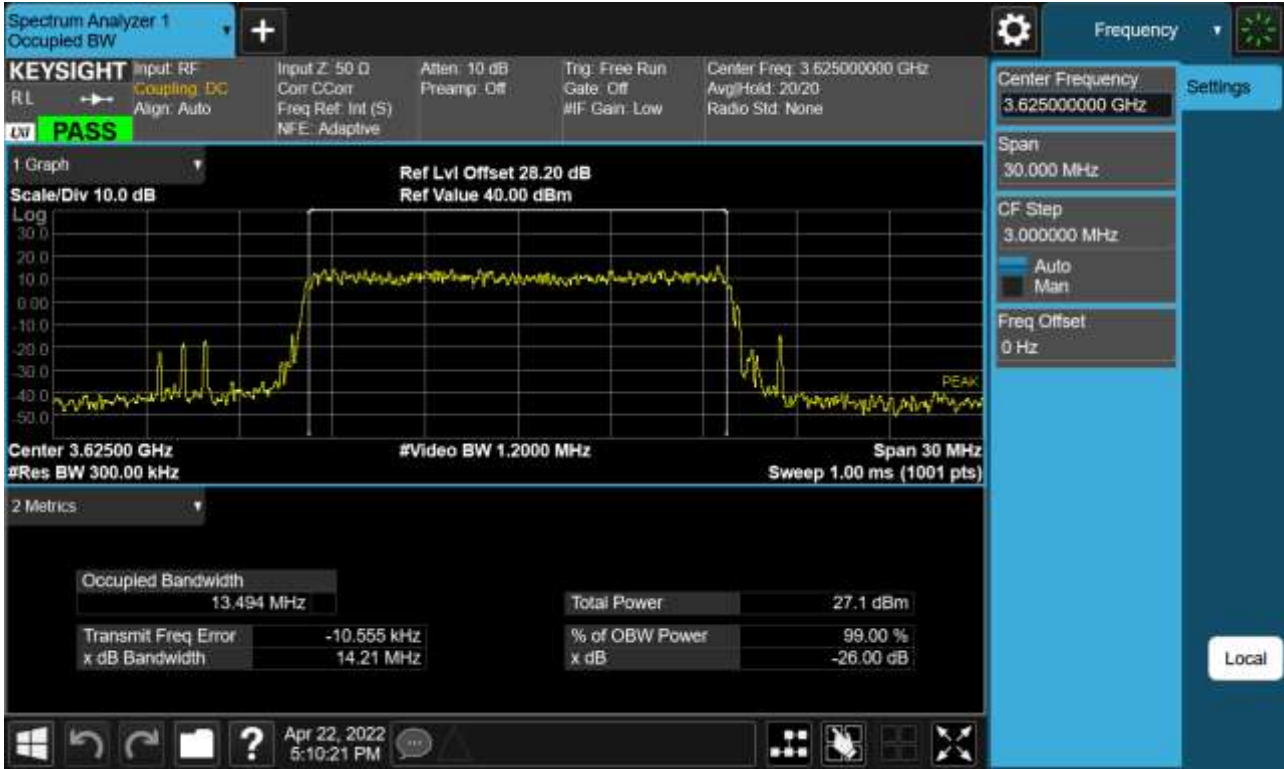

BAND 48. Occupied Bandwidth Plot (15 MHz Ch.55990 16-QAM RB 75)

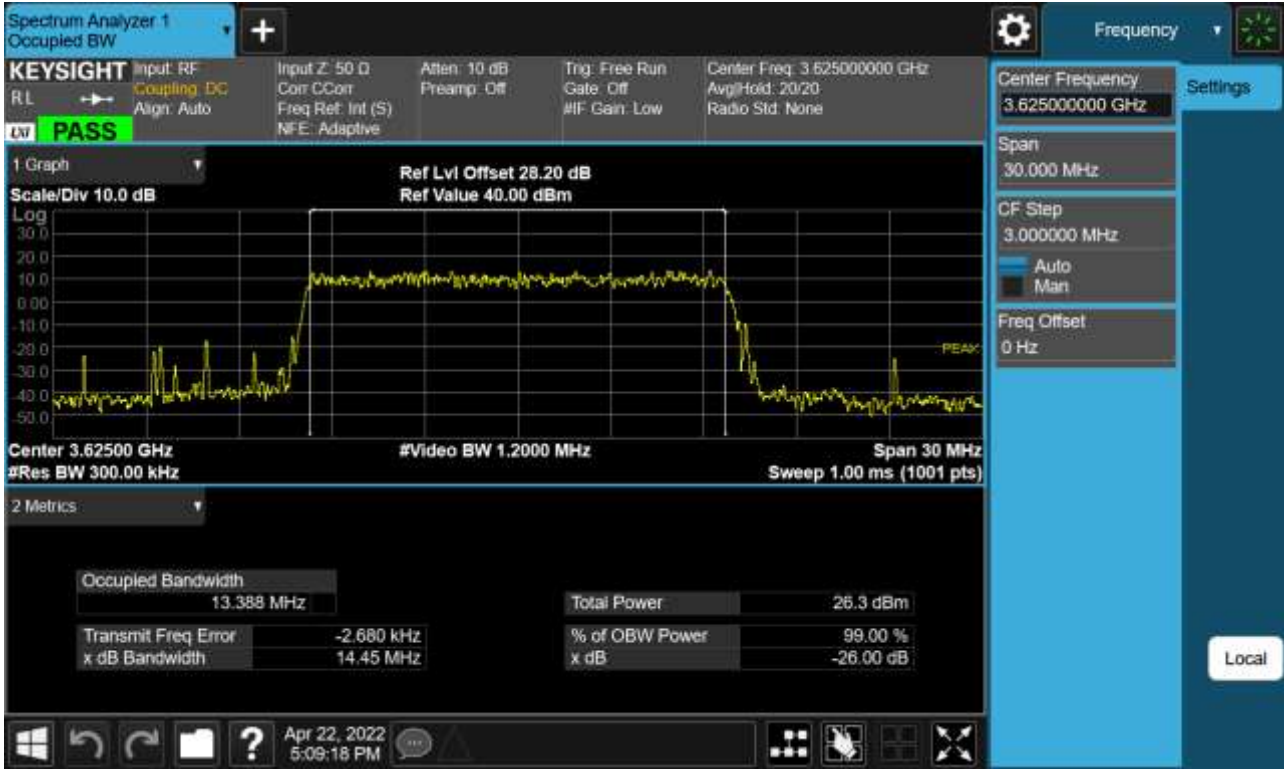

BAND 48. Occupied Bandwidth Plot (15 MHz Ch.55990 64-QAM RB 75)

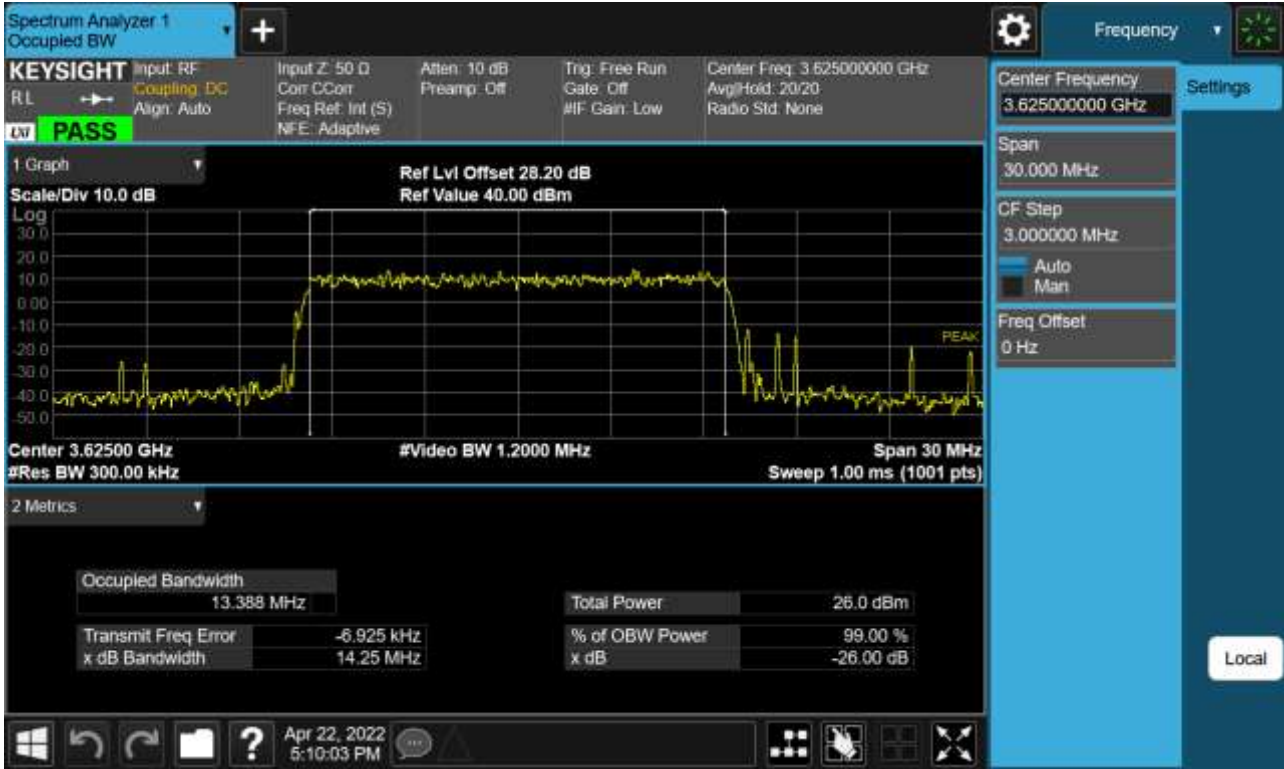

BAND 48. Occupied Bandwidth Plot (15 MHz Ch.55990 256-QAM RB 75)

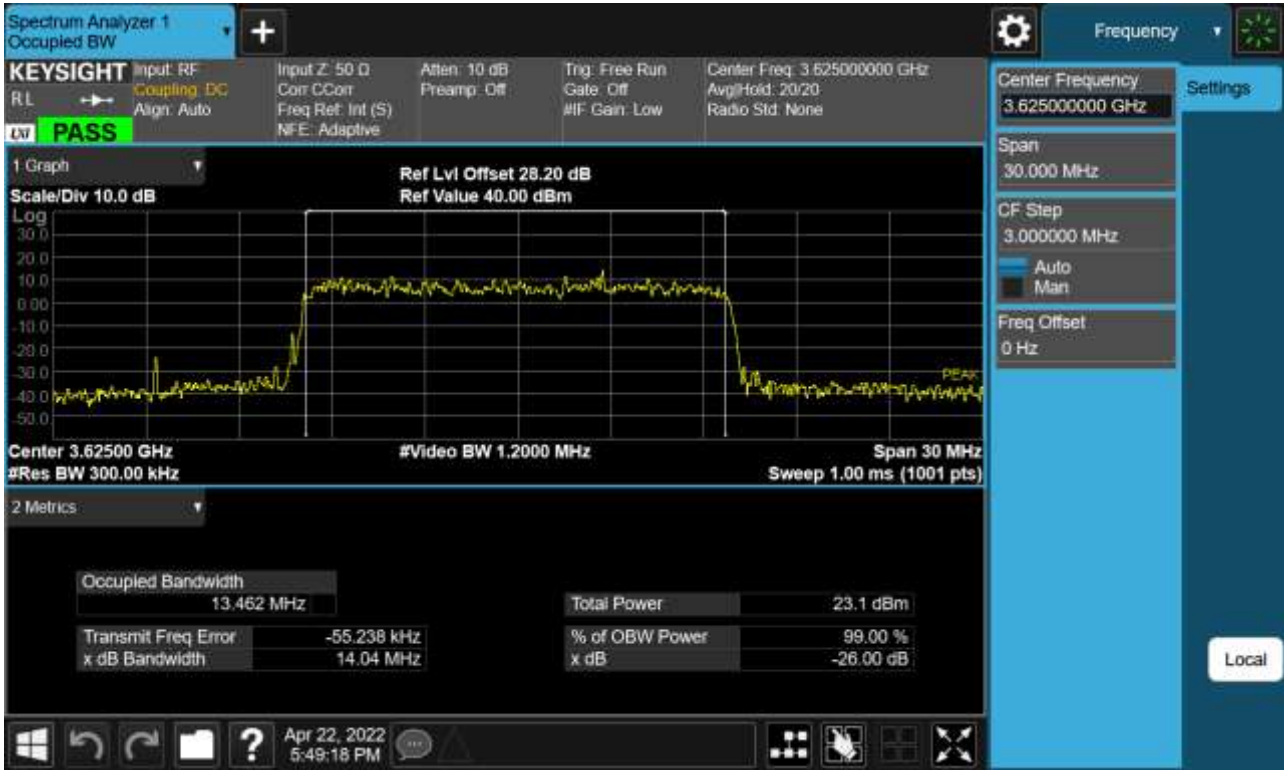

BAND 48. Occupied Bandwidth Plot (20 MHz Ch.55990 QPSK RB 100)

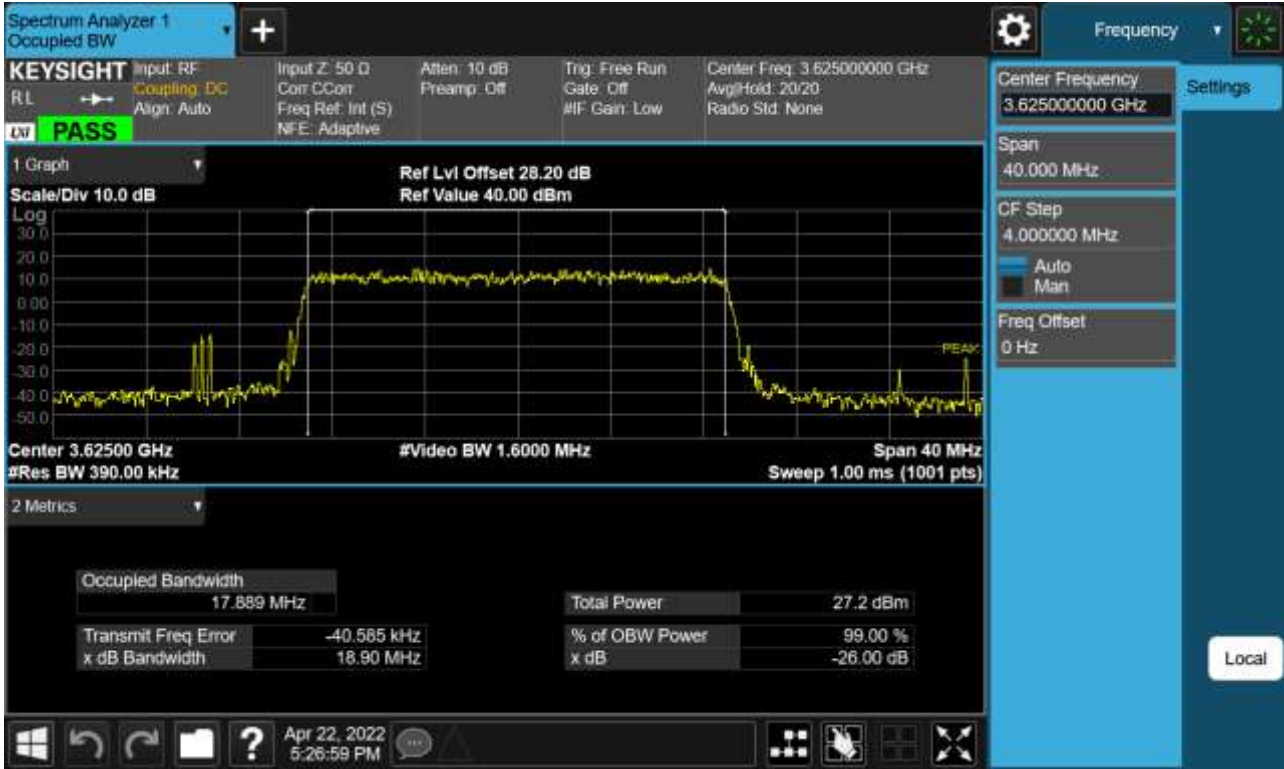

BAND 48. Occupied Bandwidth Plot (20 MHz Ch.55990 16-QAM RB 100)

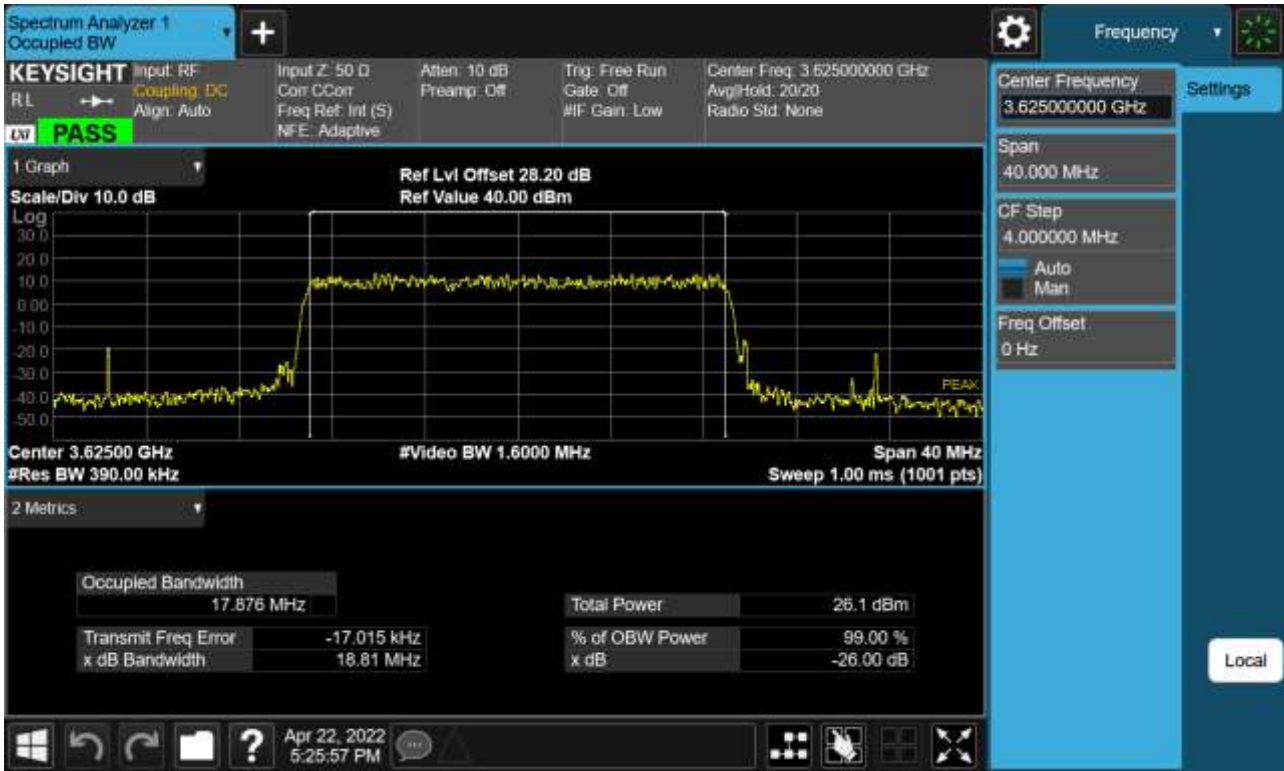

BAND 48. Occupied Bandwidth Plot (20 MHz Ch.55990 64-QAM RB 100)

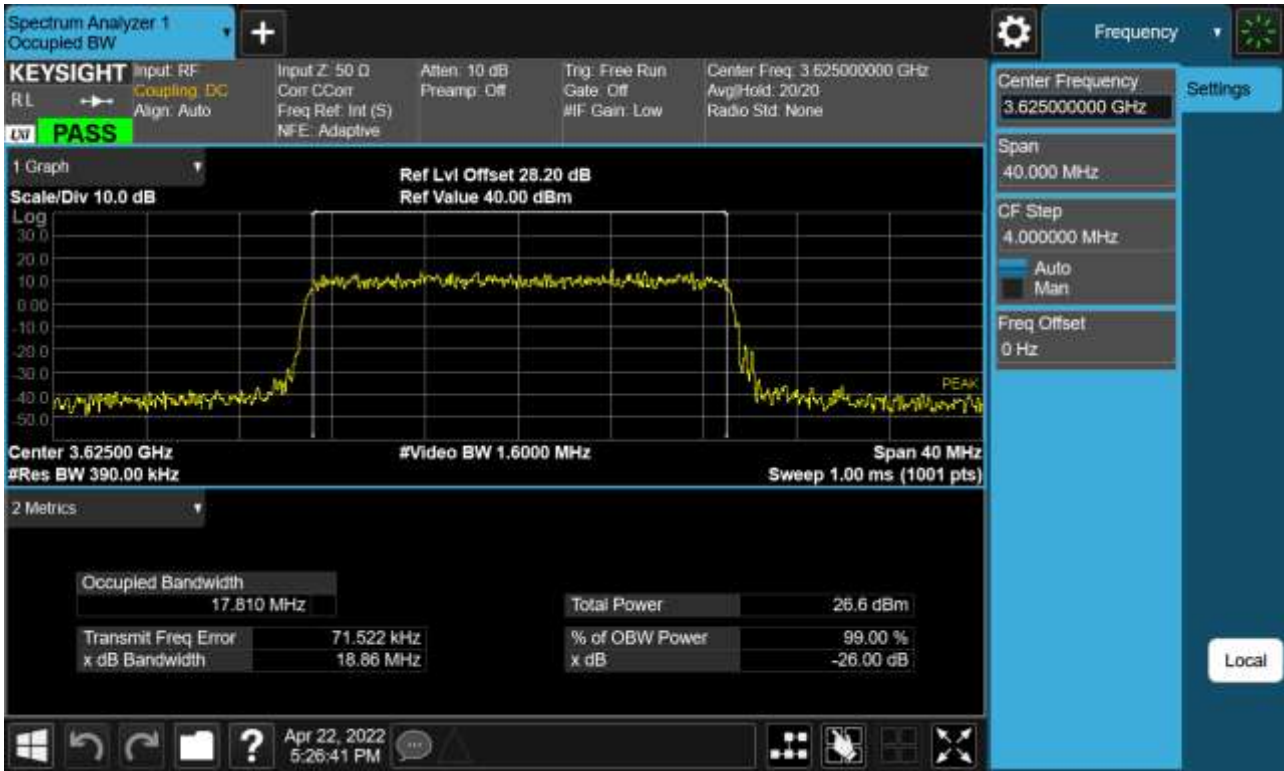

BAND 48. Occupied Bandwidth Plot (20 MHz Ch.55990 256-QAM RB 100)

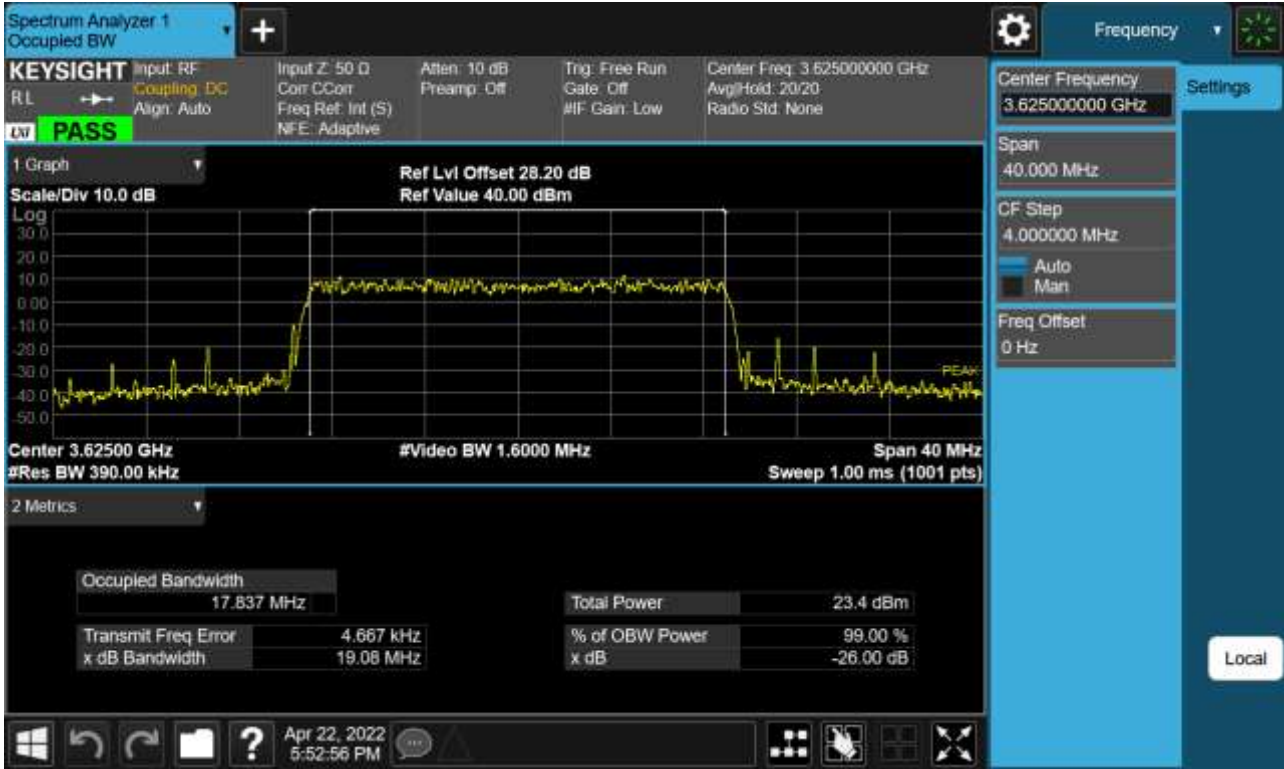

BAND 48. PAR Plot (5 M BW_Ch.55990_QPSK_RB25_0)

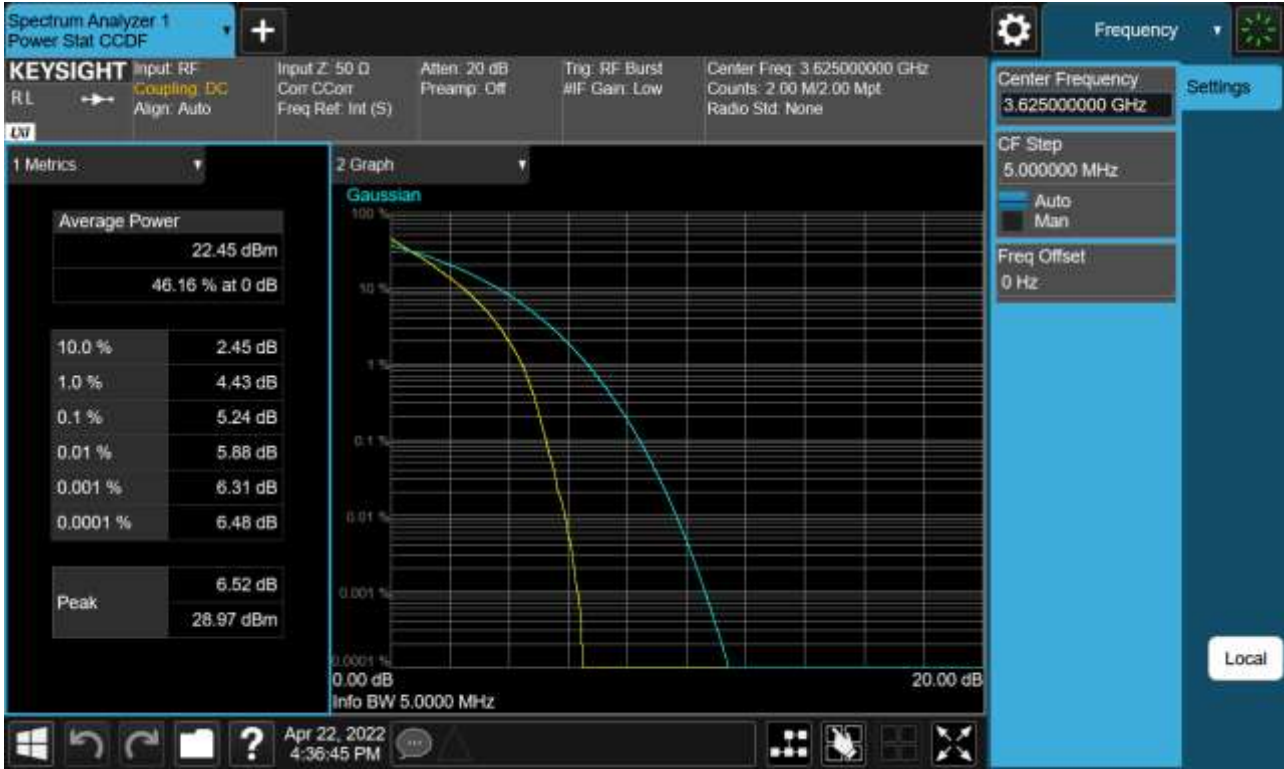

BAND 48. PAR Plot (5 M BW_Ch.55990_16QAM_RB25_0)

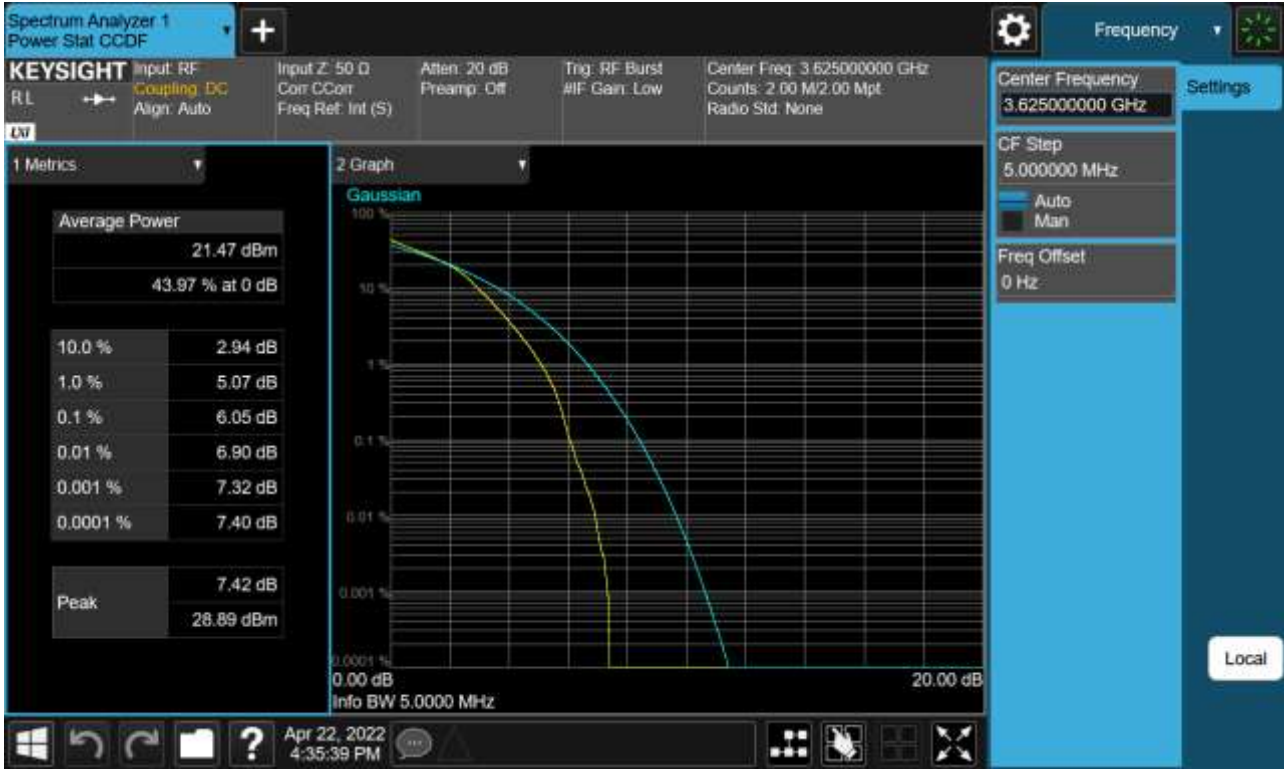

BAND 48. PAR Plot (5 M BW_Ch.55990_64QAM_RB25_0)



BAND 48. PAR Plot (5 M BW_Ch.55990_256QAM_RB25_0)

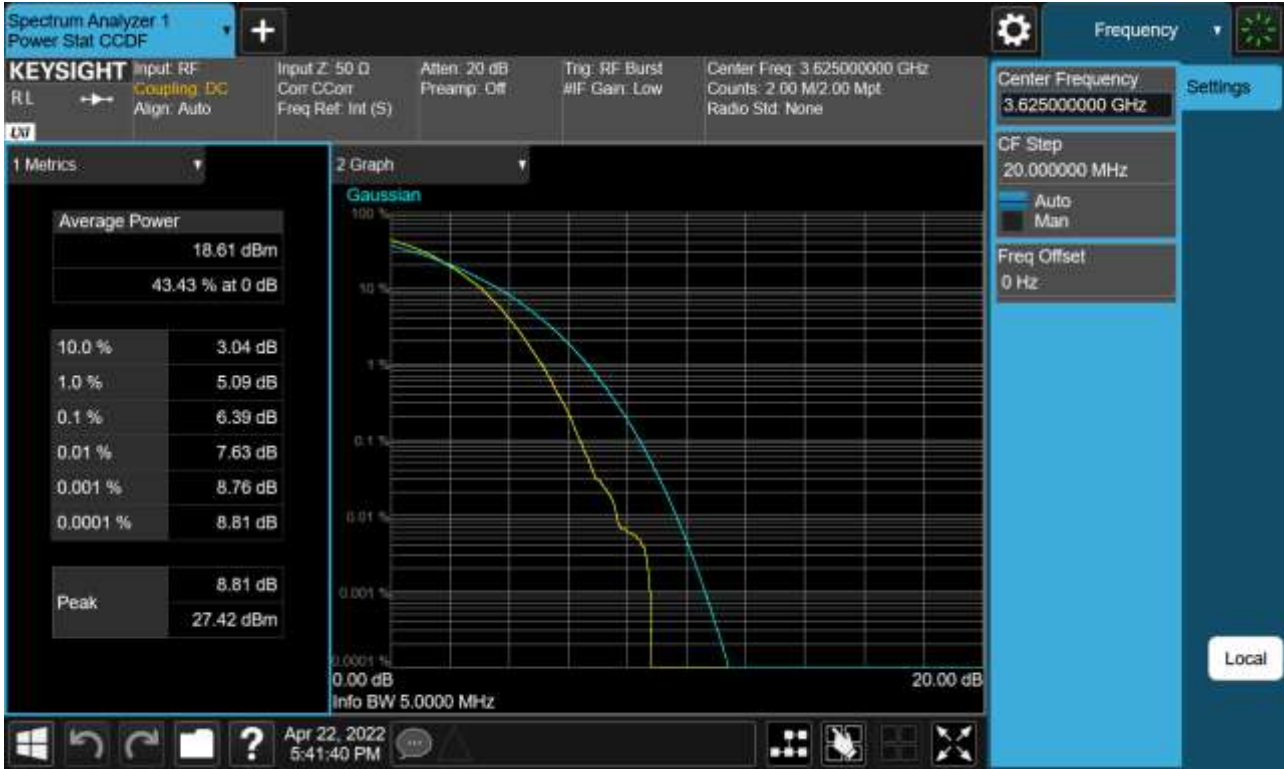

BAND 48. PAR Plot (10 M BW_Ch.55990_QPSK_RB50_0)



BAND 48. PAR Plot (10 M BW_Ch.55990_16QAM_RB50_0)



BAND 48. PAR Plot (10 M BW_Ch.55990_64QAM_RB50_0)

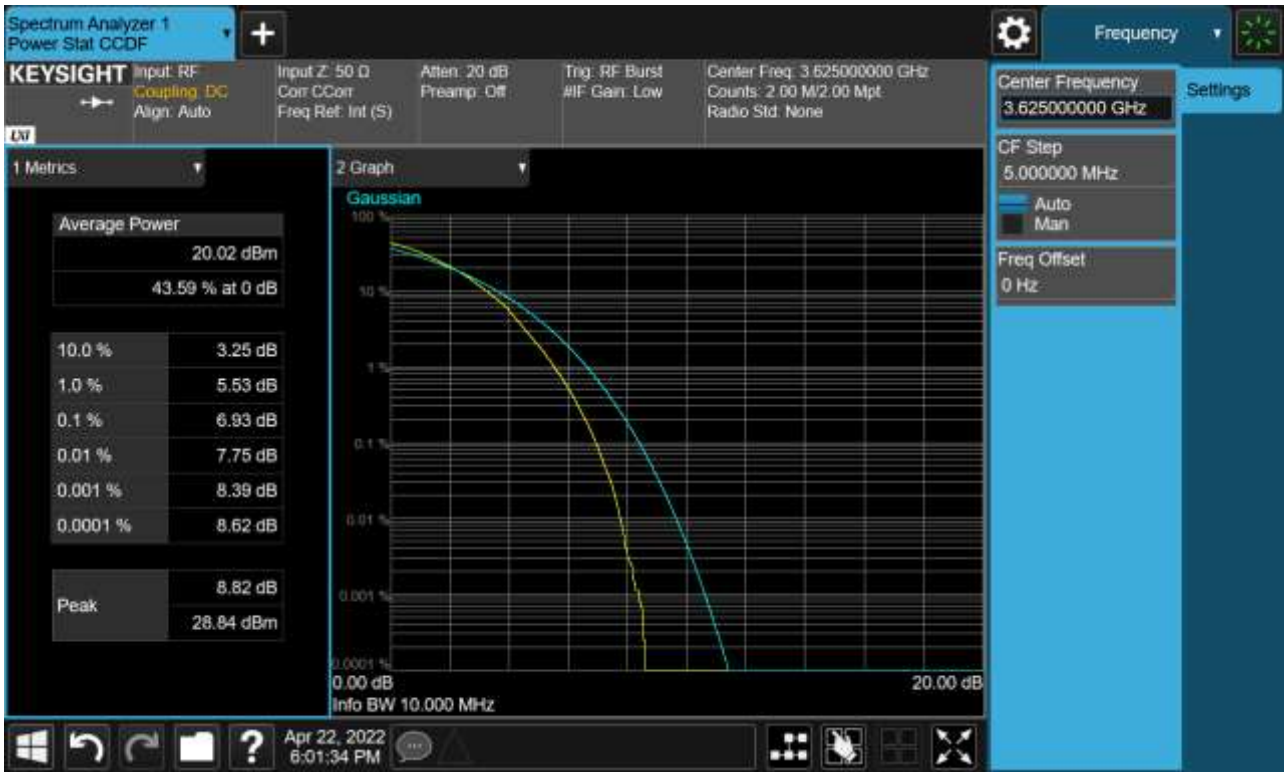

BAND 48. PAR Plot (10 M BW_Ch.55990_256QAM_RB50_0)



BAND 48. PAR Plot (15 M BW_Ch.55990_QPSK_RB75_0)

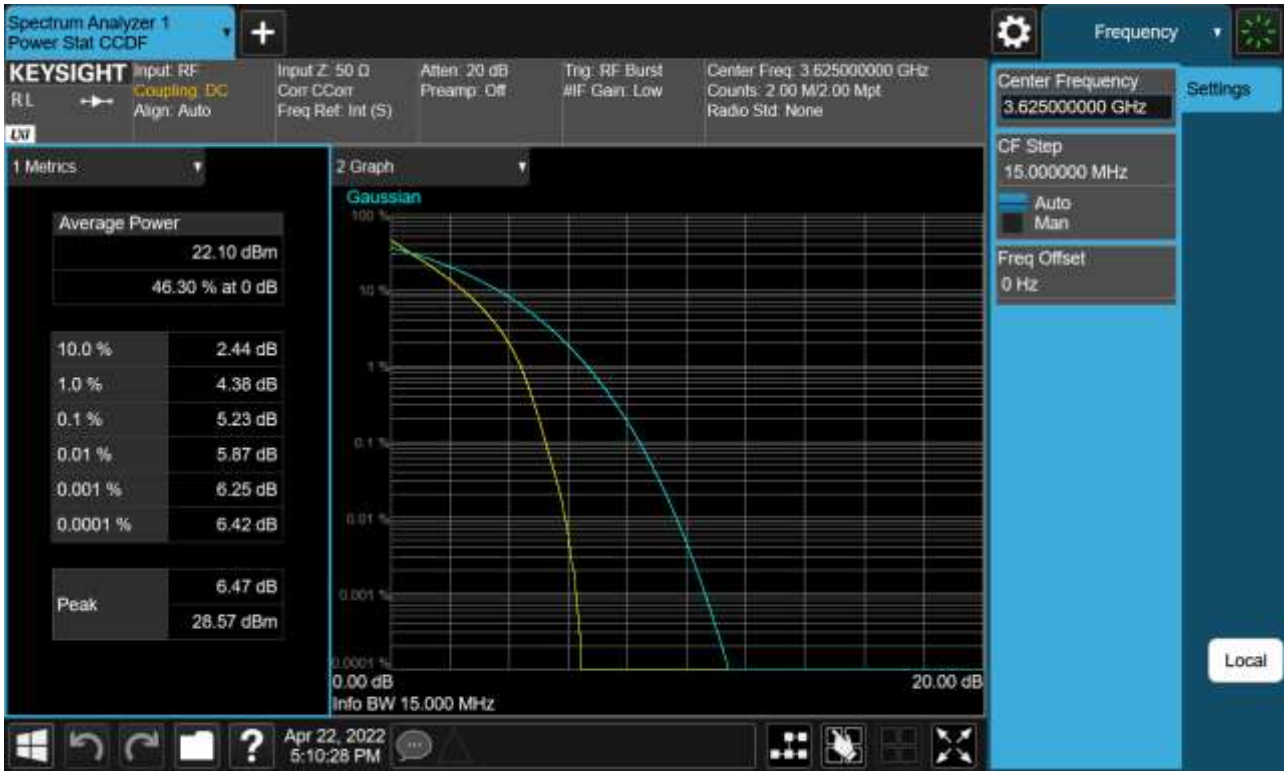

BAND 48. PAR Plot (15 M BW_Ch.55990_16QAM_RB75_0)

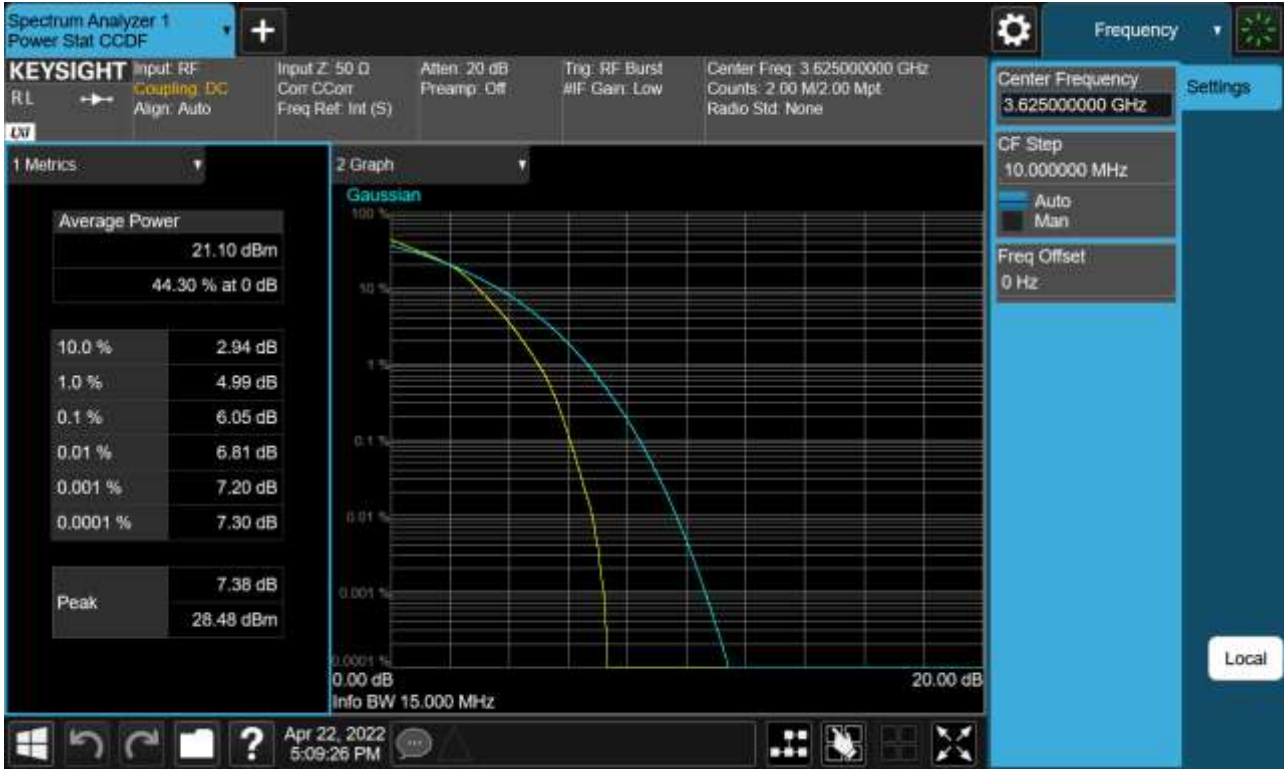

BAND 48. PAR Plot (15 M BW_Ch.55990_64QAM_RB75_0)



BAND 48. PAR Plot (15 M BW_Ch.55990_256QAM_RB75_0)

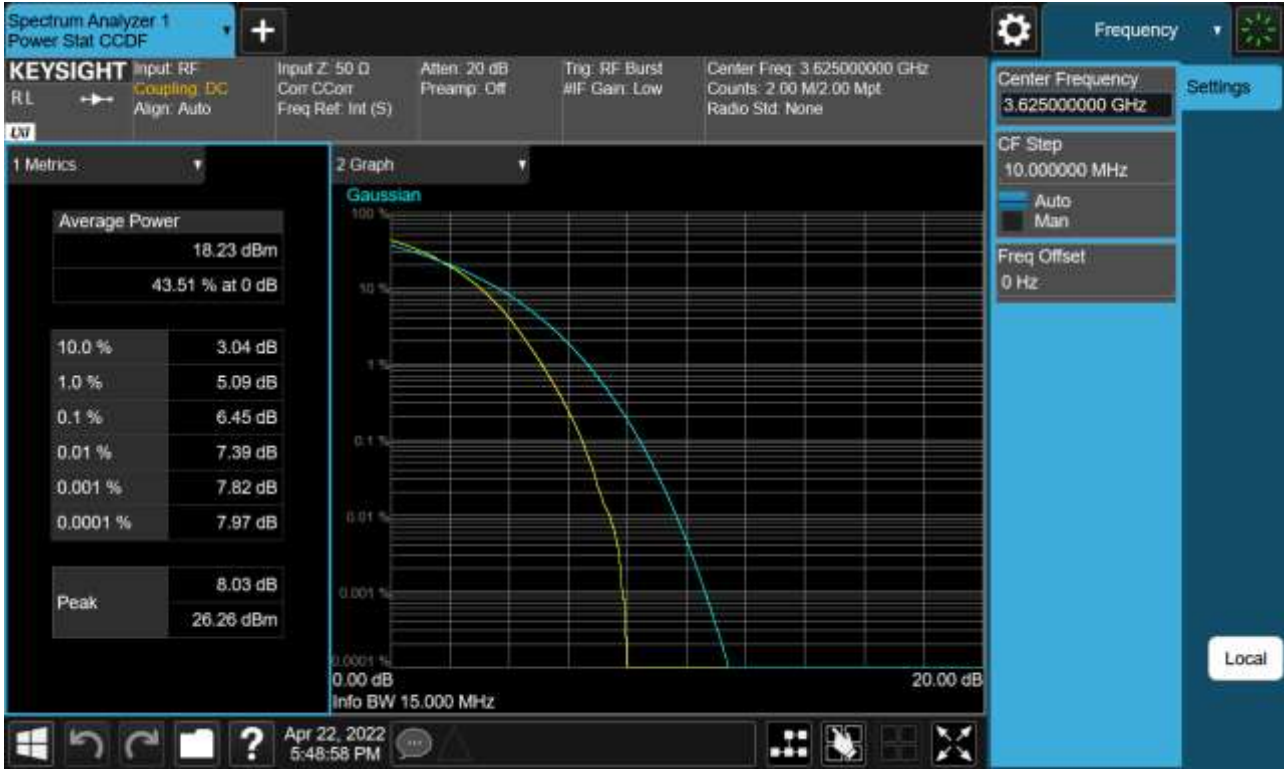

BAND 48. PAR Plot (20 M BW_Ch.55990_QPSK_RB100_0)

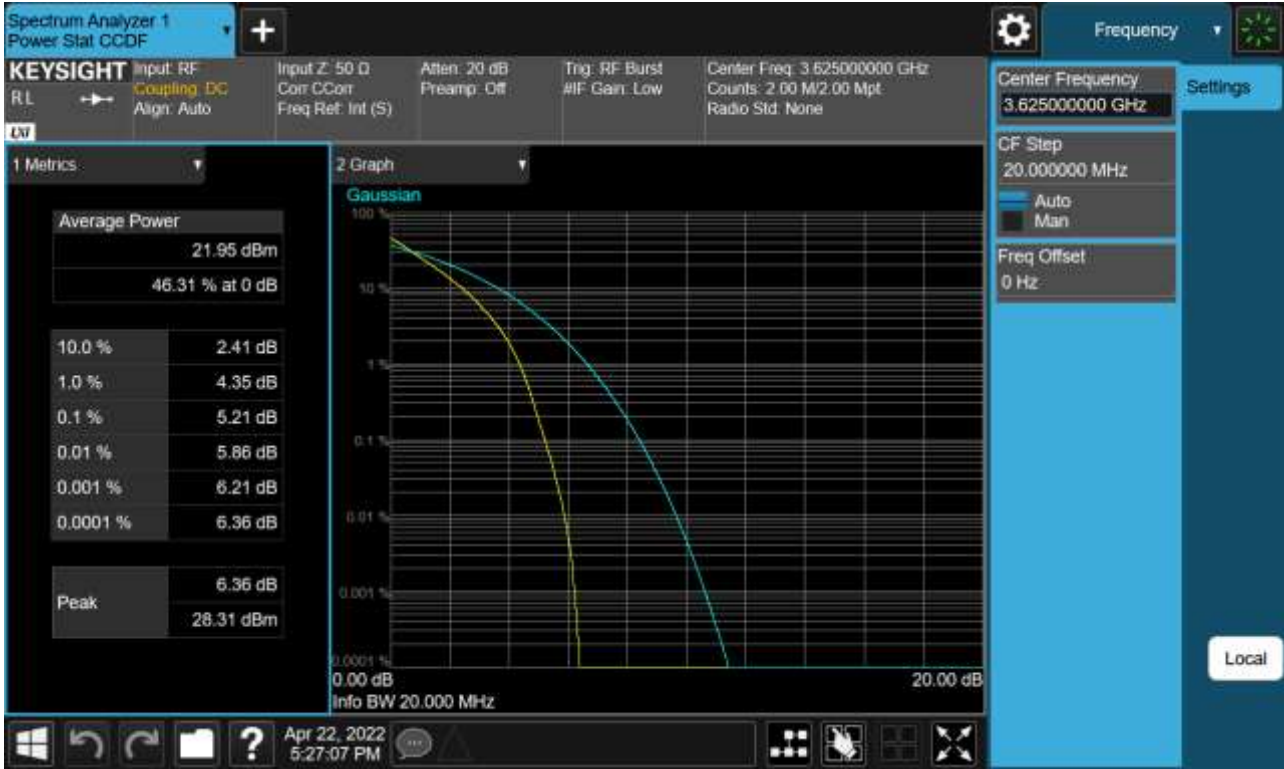

BAND 48. PAR Plot (20 M BW_Ch.55990_16QAM_RB100_0)



BAND 48. PAR Plot (20 M BW_Ch.55990_64QAM_RB100_0)



BAND 48. PAR Plot (20 M BW_Ch.55990_256QAM_RB100_0)



BAND 48. Adjacent Channel Leakage Ratio(ACLR) Plot (5 MHz Ch.55265 QPSK RB 25, Offset 0)

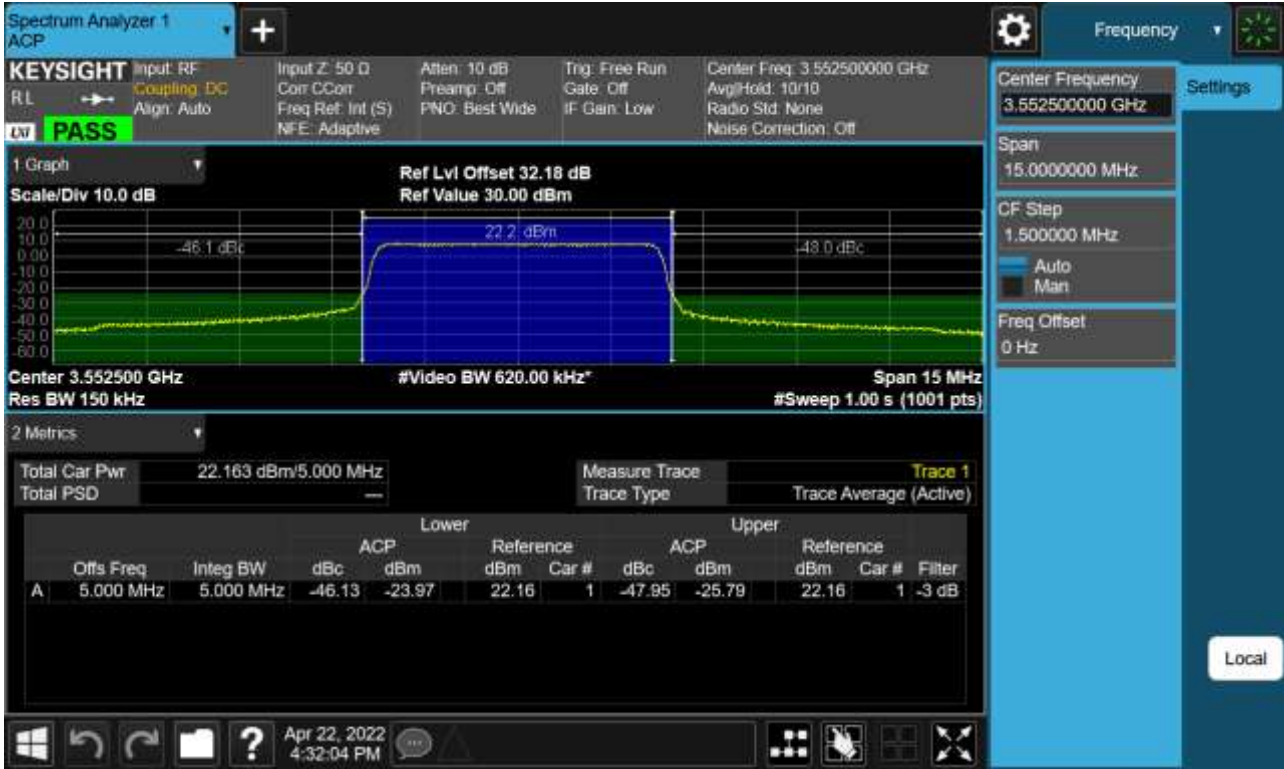

BAND 48. Adjacent Channel Leakage Ratio(ACLR) Plot (5 MHz Ch.55990 QPSK RB 25, Offset 0)

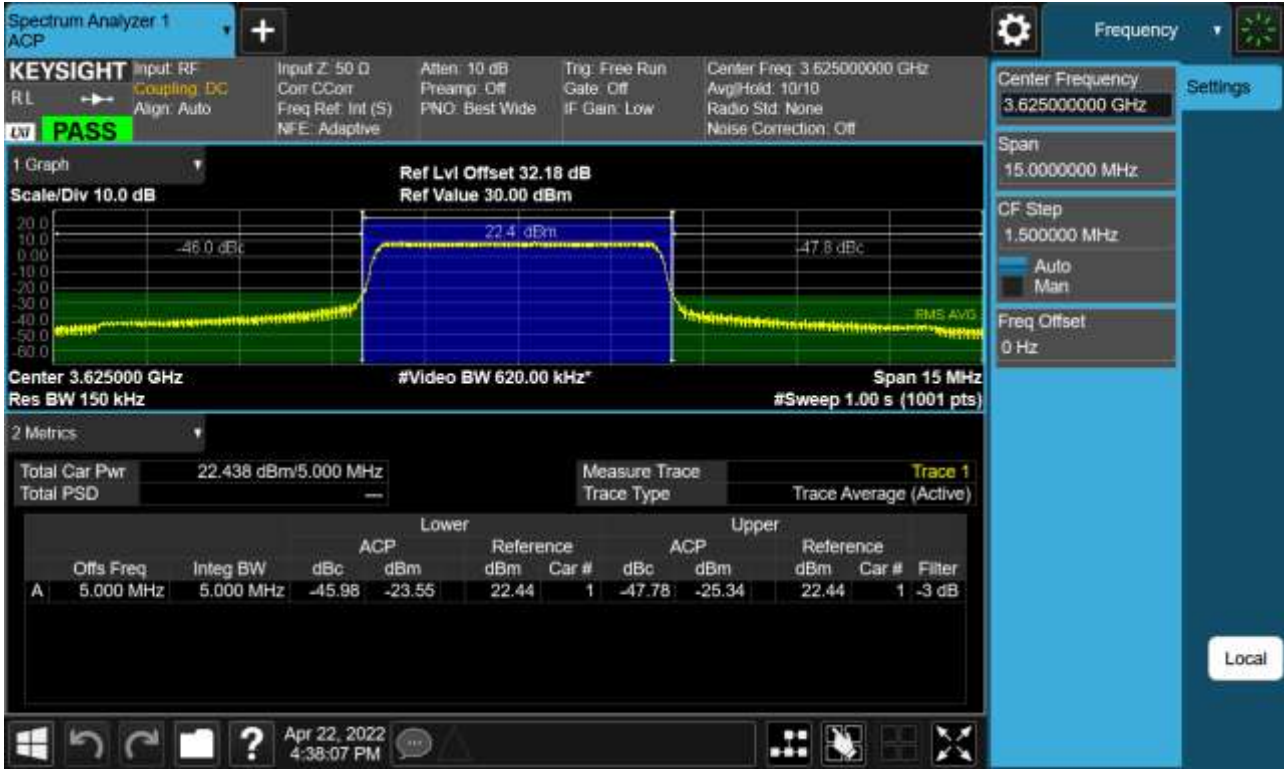

BAND 48. Adjacent Channel Leakage Ratio(ACLR) Plot (5 MHz Ch.56715 QPSK RB 25, Offset 0)

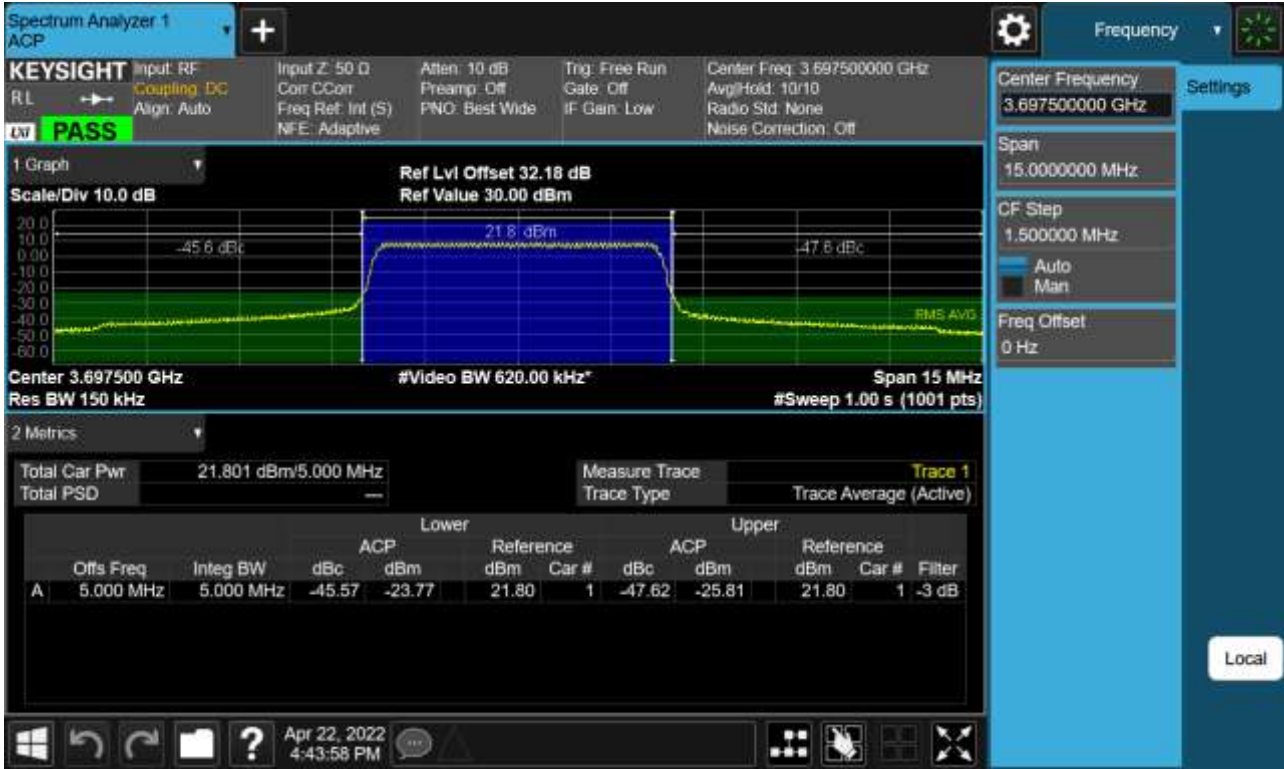

BAND 48. Adjacent Channel Leakage Ratio(ACLR) Plot (10 MHz Ch.55290 QPSK RB 50, Offset 0)

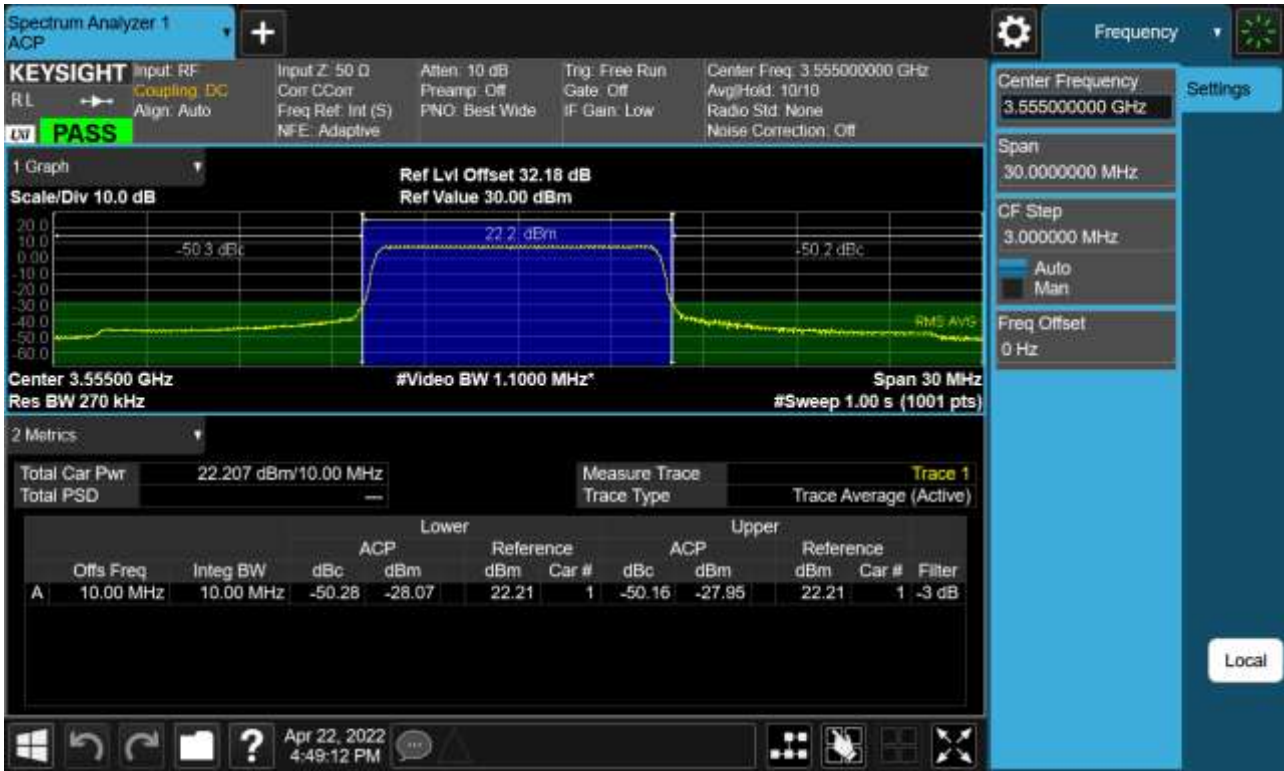

BAND 48. Adjacent Channel Leakage Ratio(ACLR) Plot (10 MHz Ch.55990 QPSK RB 50, Offset 0)

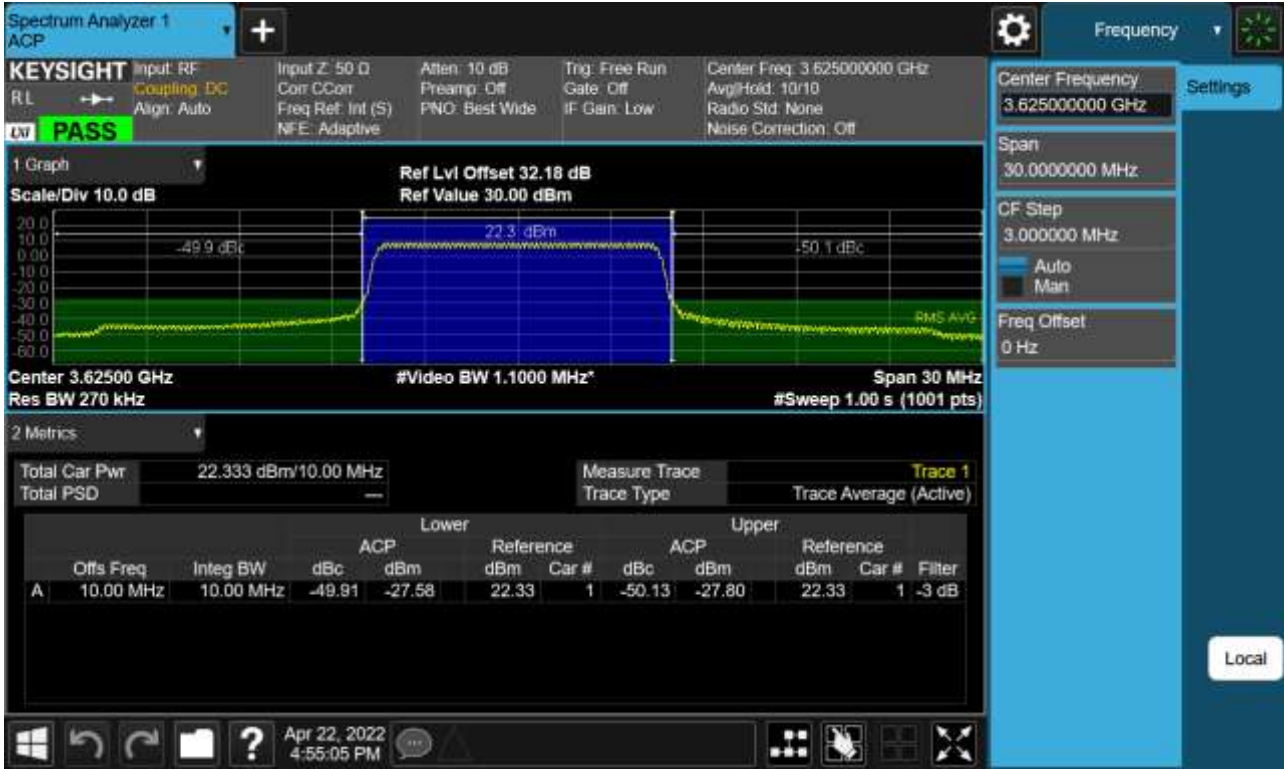

BAND 48. Adjacent Channel Leakage Ratio(ACLR) Plot (10 MHz Ch. 56690 QPSK RB 50, Offset 0)

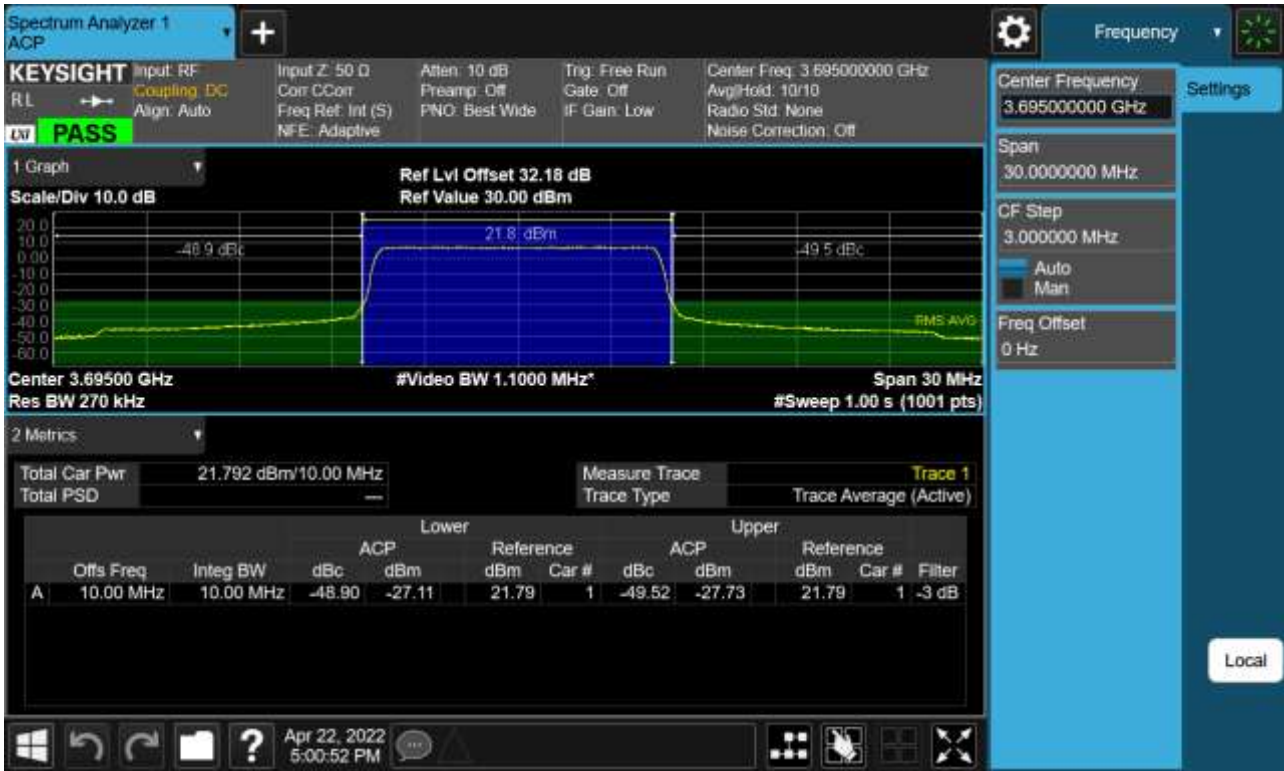

BAND 48. Adjacent Channel Leakage Ratio(ACLR) Plot (15 MHz Ch.55315 QPSK RB 75, Offset 0)

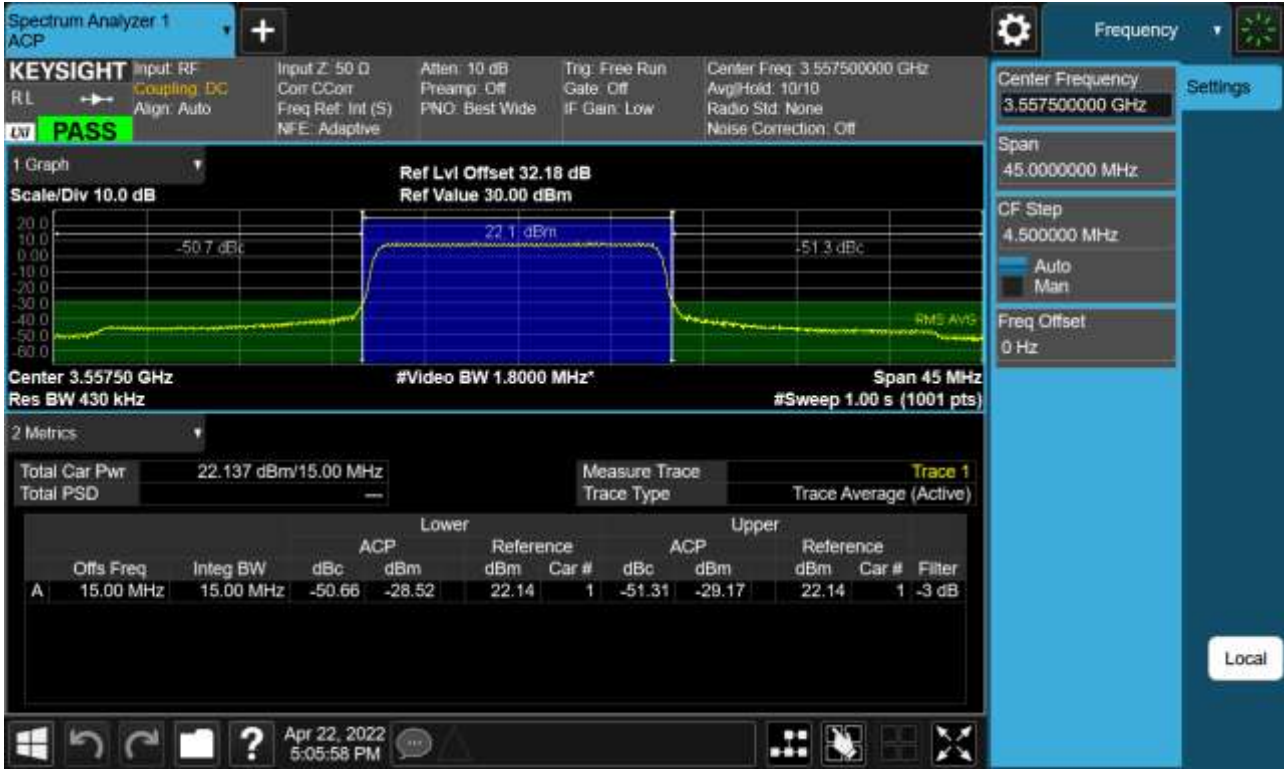

BAND 48. Adjacent Channel Leakage Ratio(ACLR) Plot (15 MHz Ch.55990 QPSK RB 75, Offset 0)

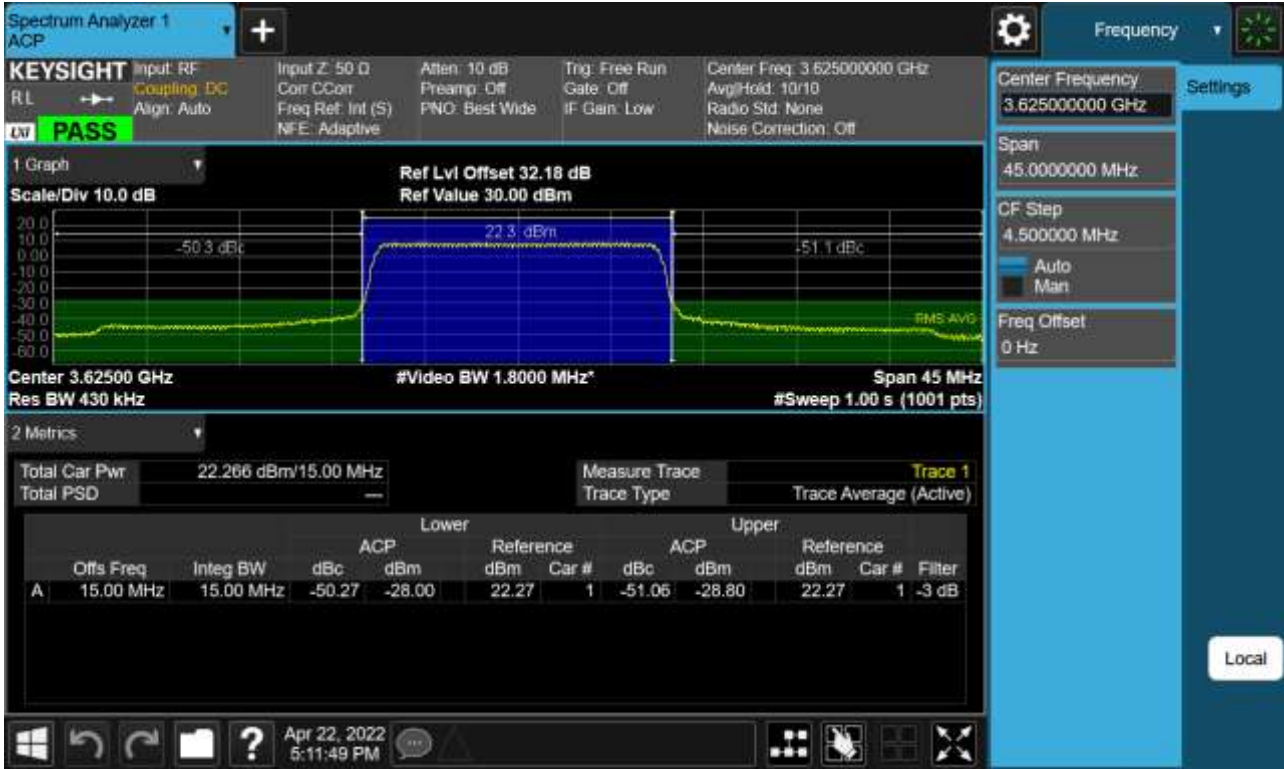

BAND 48. Adjacent Channel Leakage Ratio(ACLR) Plot (15 MHz Ch.56665 QPSK RB 75, Offset 0)

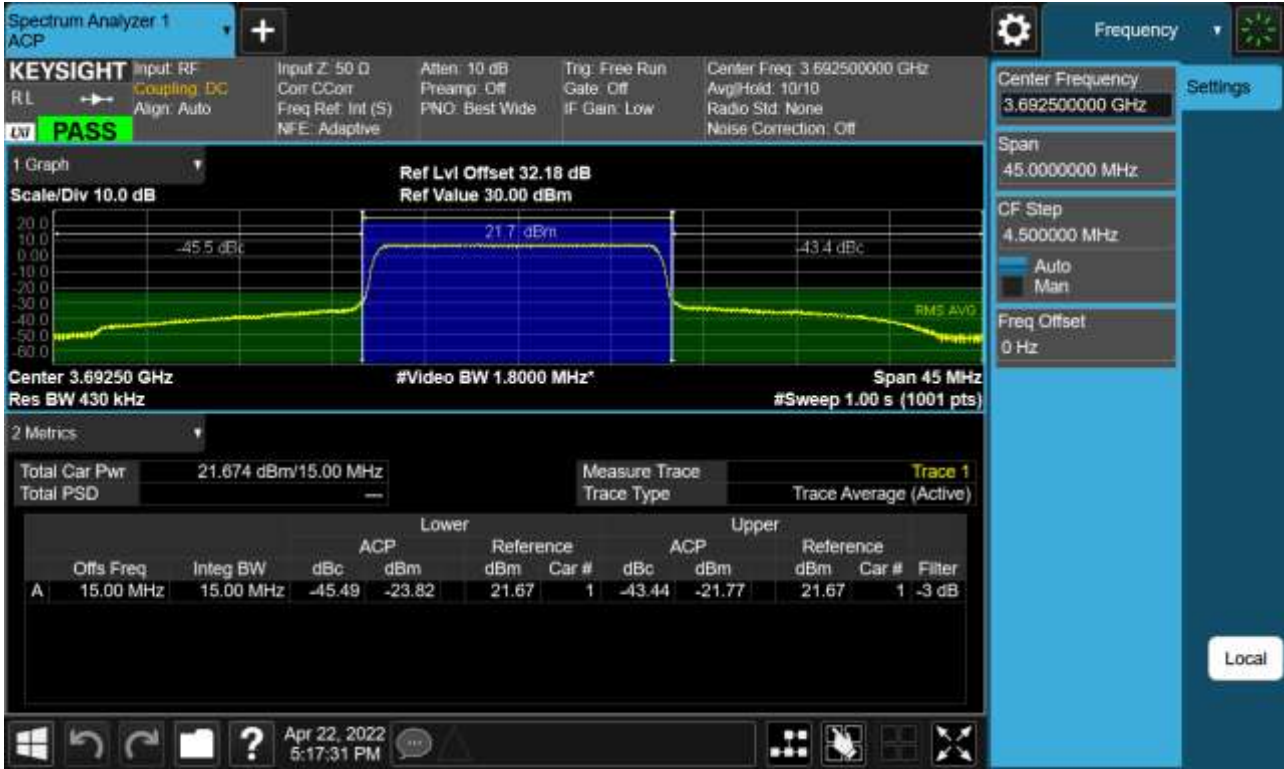

BAND 48. Adjacent Channel Leakage Ratio(ACLR) Plot (20 MHz Ch.55340 QPSK RB 100, Offset 0)

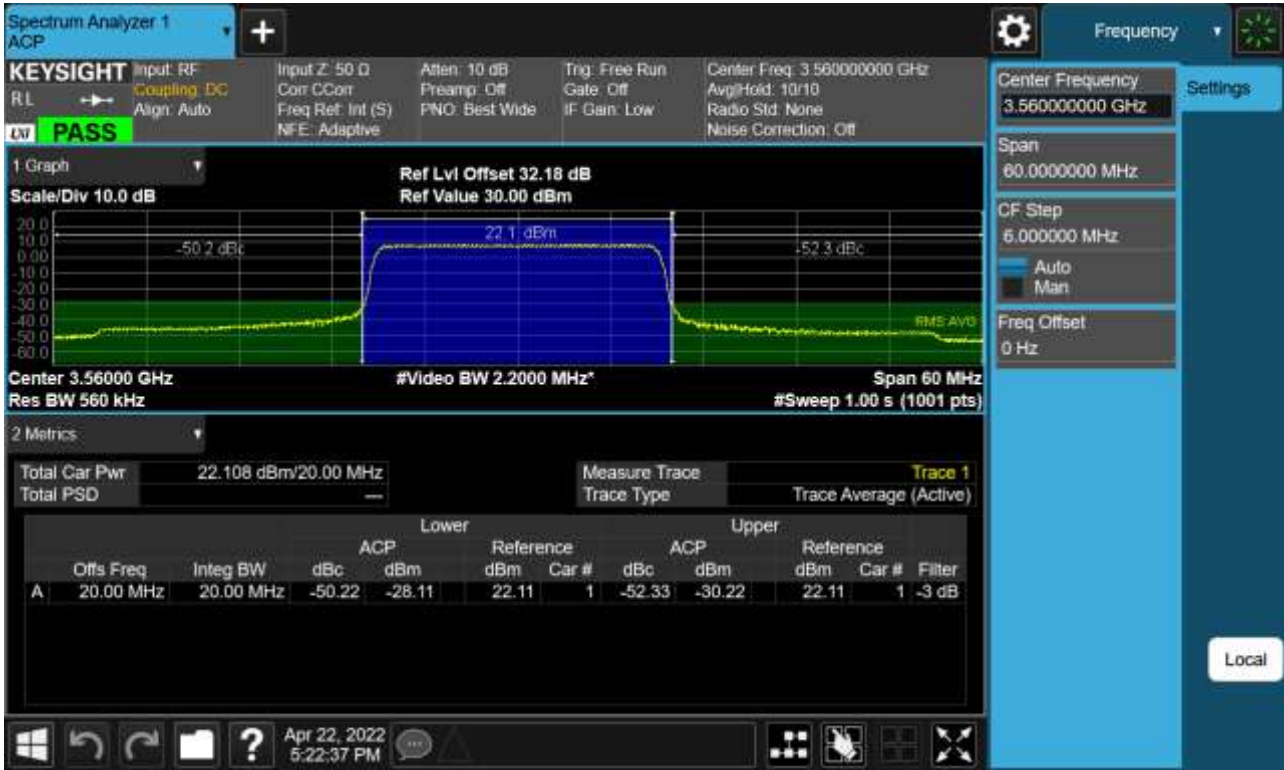

BAND 48. Adjacent Channel Leakage Ratio(ACLR) Plot (20 MHz Ch.55990 QPSK RB 100, Offset 0)

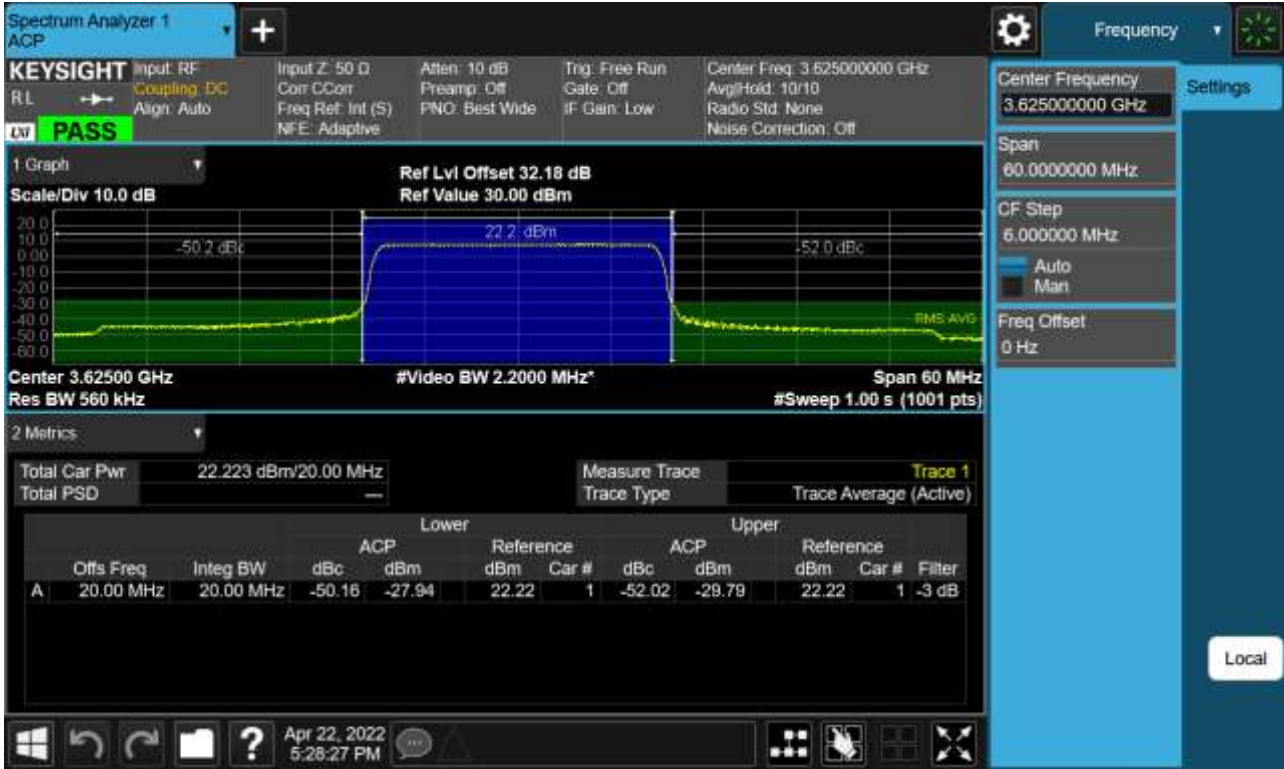

BAND 48. Adjacent Channel Leakage Ratio(ACLR) Plot (20 MHz Ch.56640 QPSK RB 100, Offset 0)

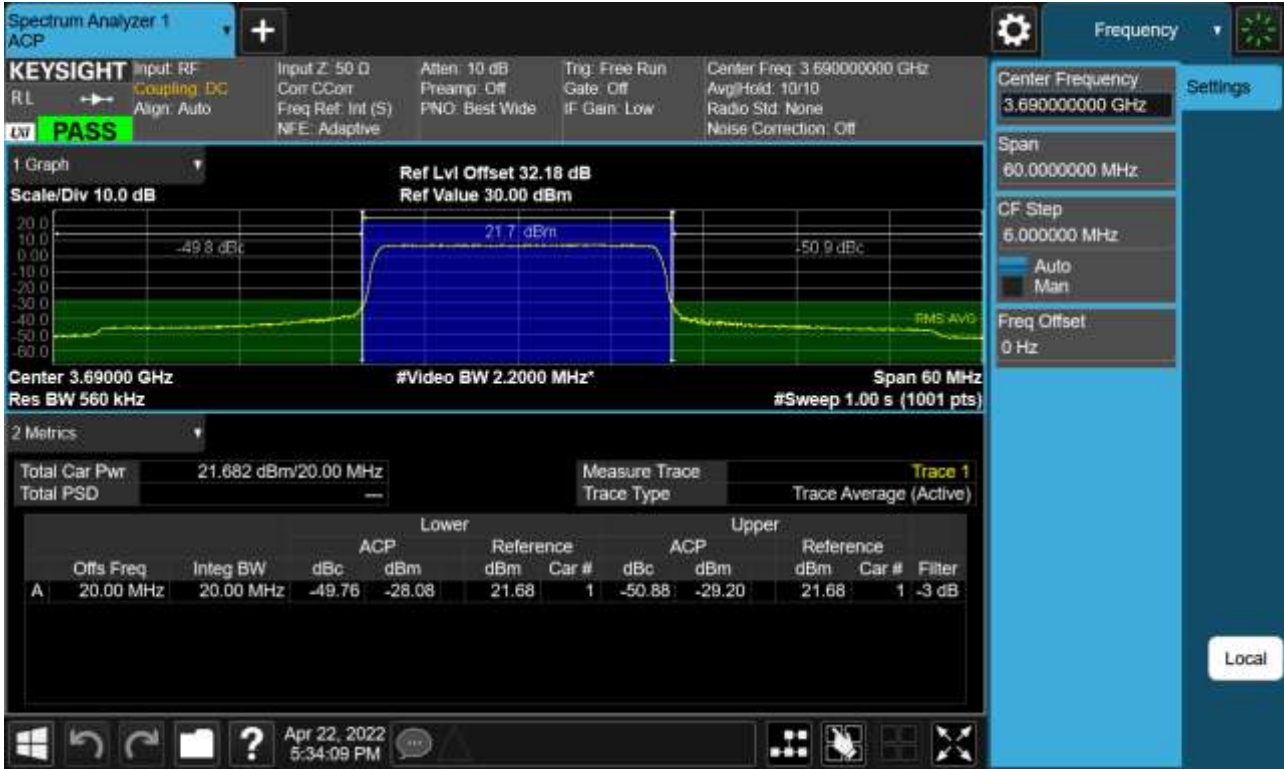

BAND 48. 5 M BandEdge(Lower)_Low_3552.5 MHz_QPSK_FullIRB

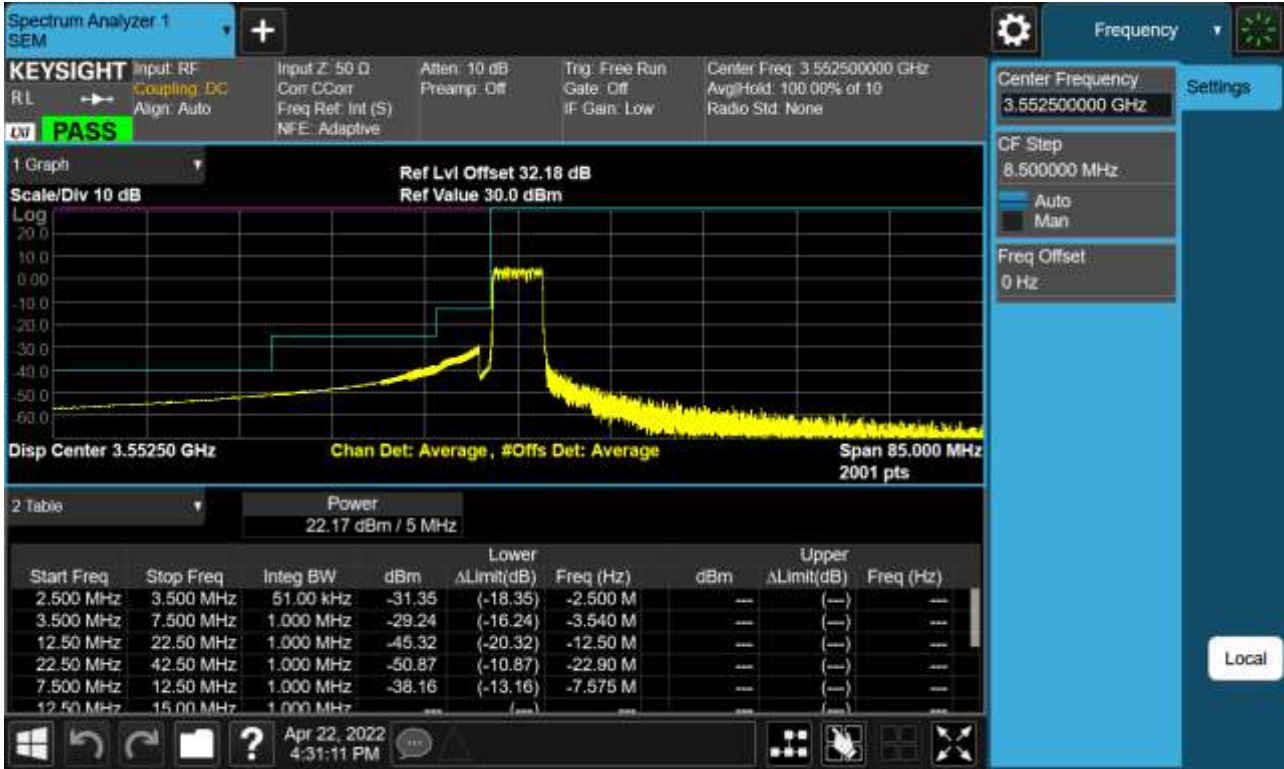

BAND 48. 5 M_BandEdge(Upper)_Low_3552.5 MHz_QPSK_FullRB

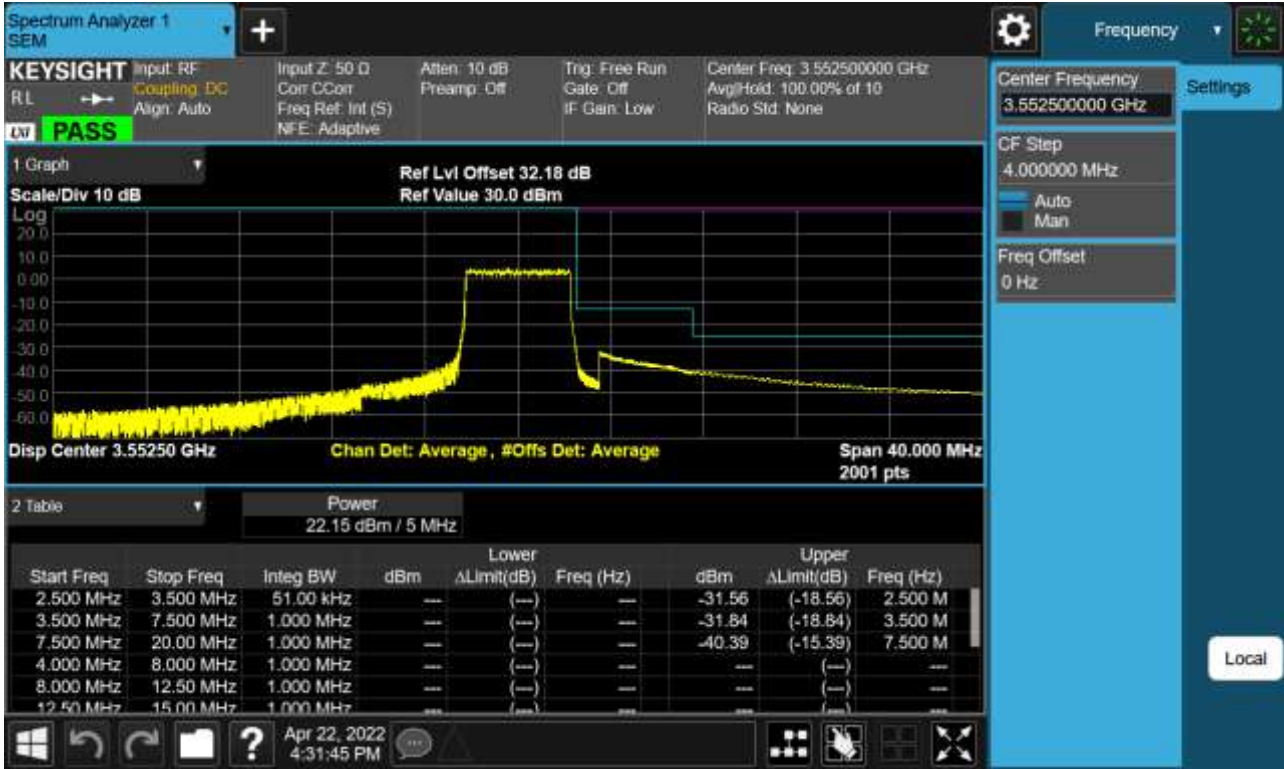

BAND 48. 5 M_BandEdge(Lower)_Low_3552.5 MHz_QPSK_1RB

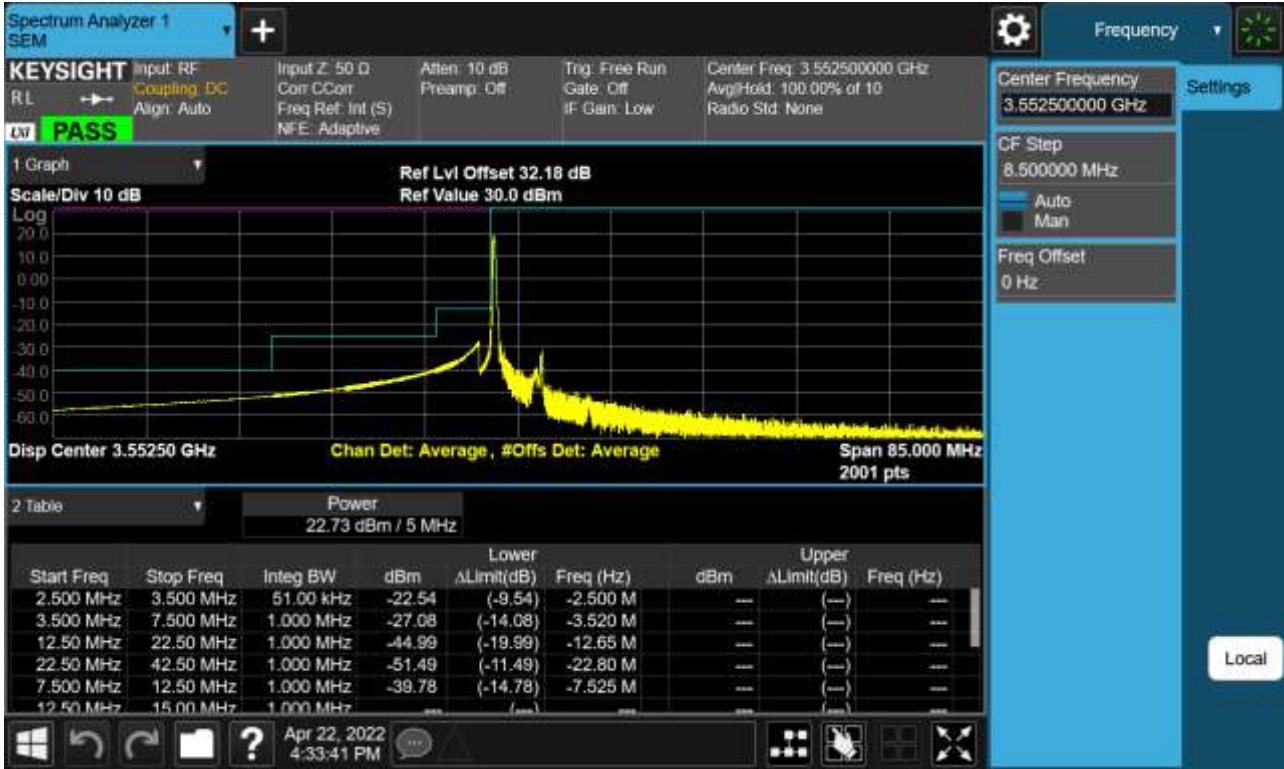

BAND 48. 5 M_BandEdge(Upper)_Low_3552.5 MHz_QPSK_1RB

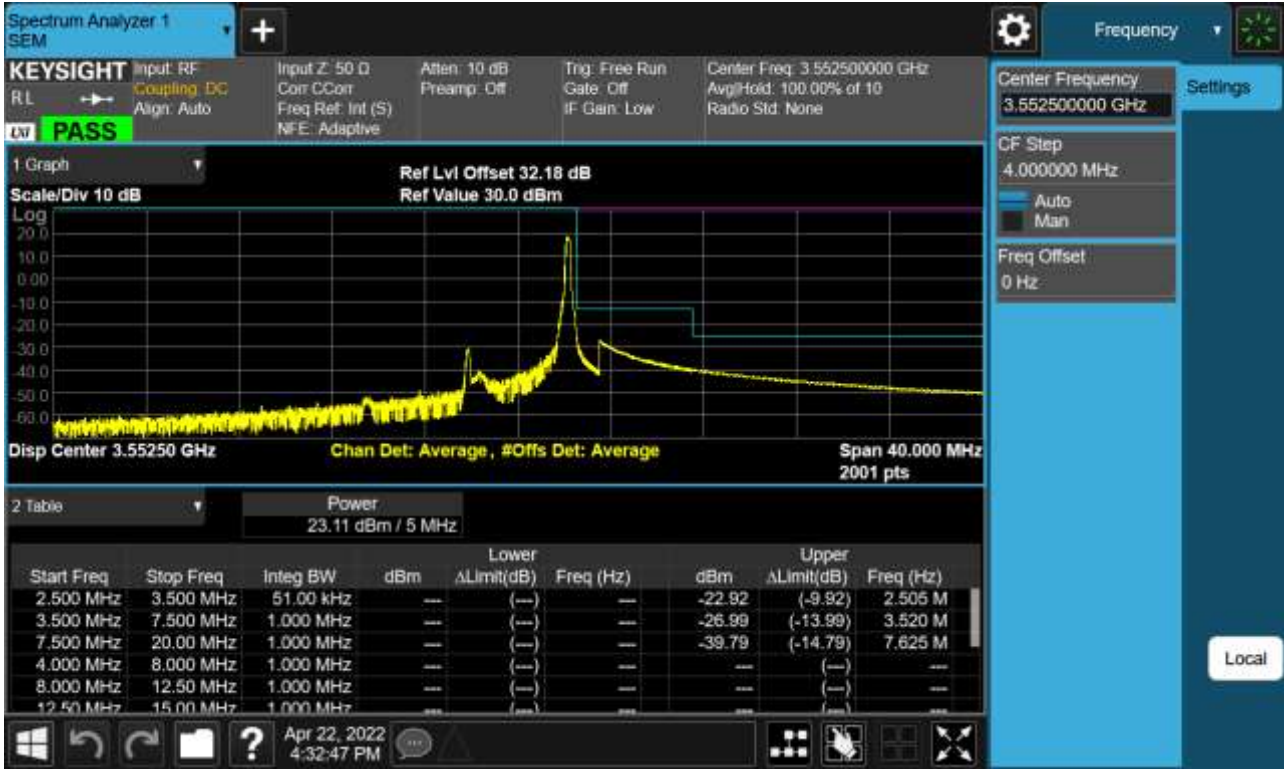

BAND 48. 5 M_BandEdge(Center)_Mid_3625 MHz_QPSK_FullIRB

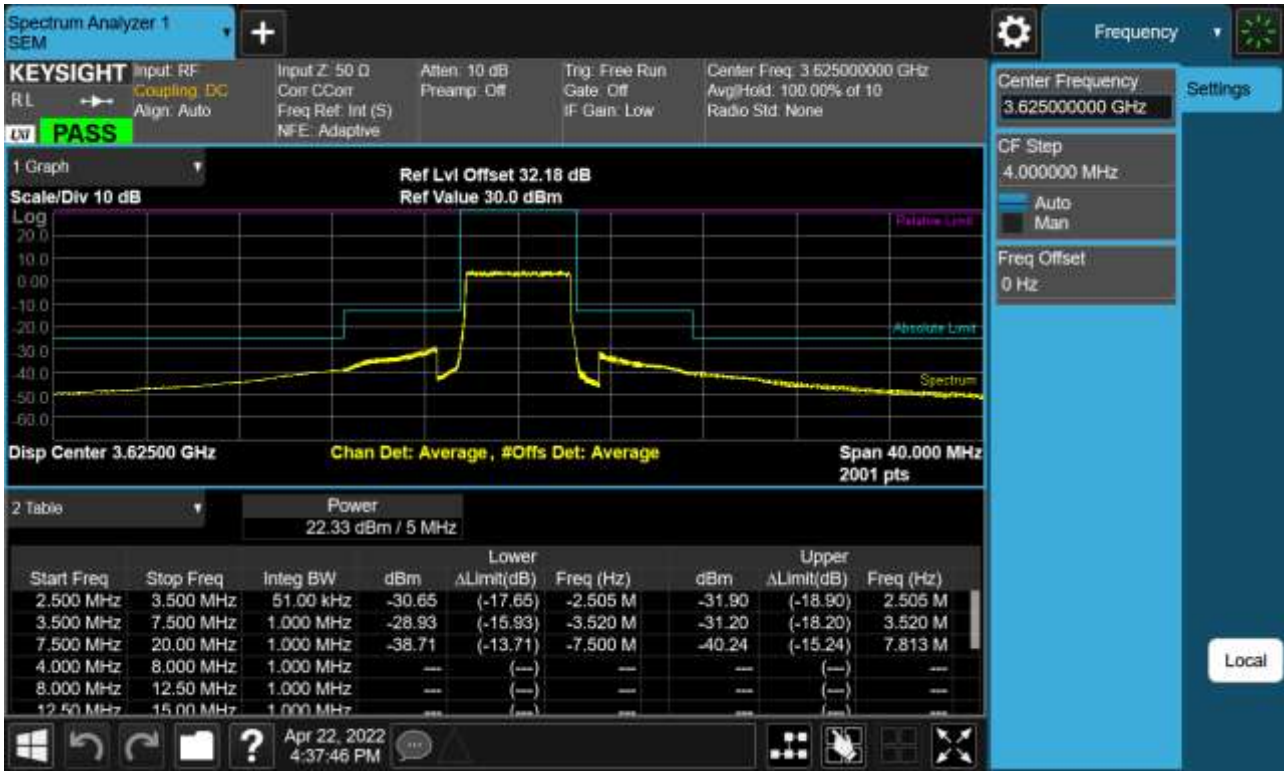

BAND 48. 5 M_BandEdge(Lower)_Mid_3625 MHz_QPSK_1RB

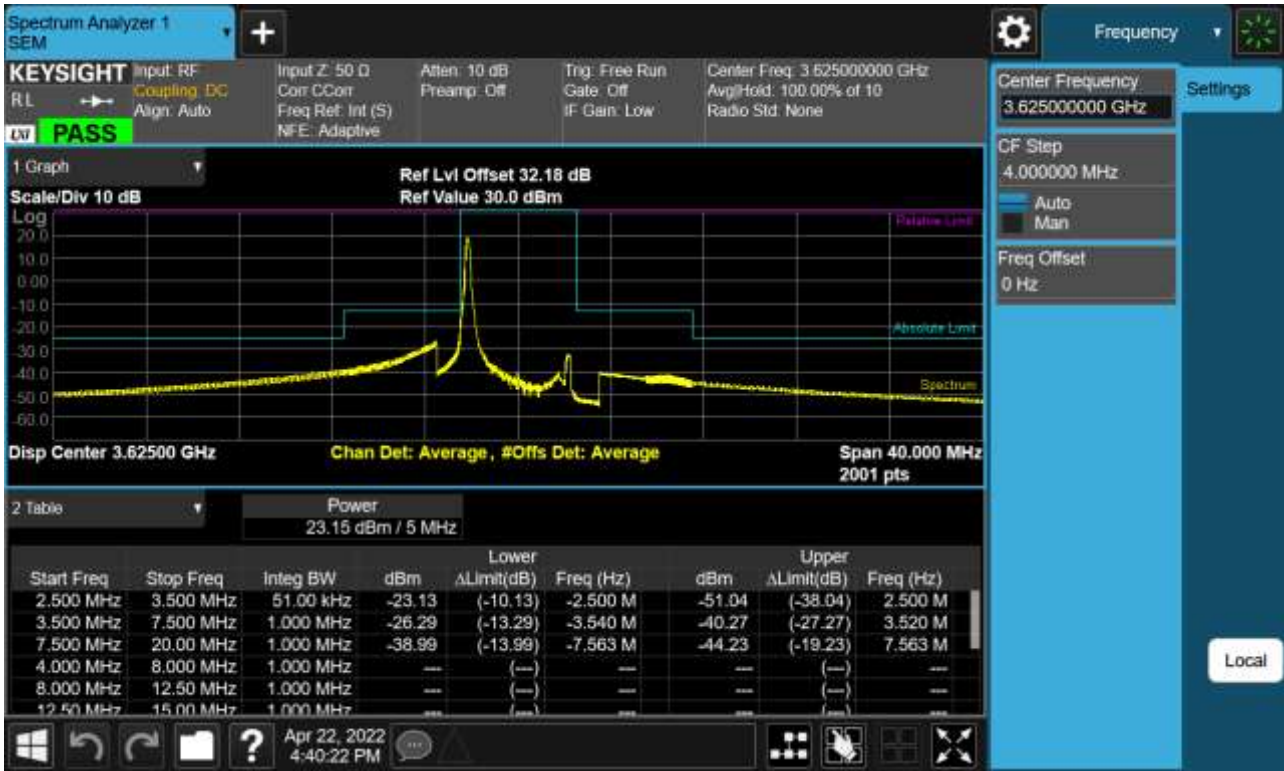

BAND 48. 5 M_BandEdge(Upper)_Mid_3625 MHz_QPSK_1RB

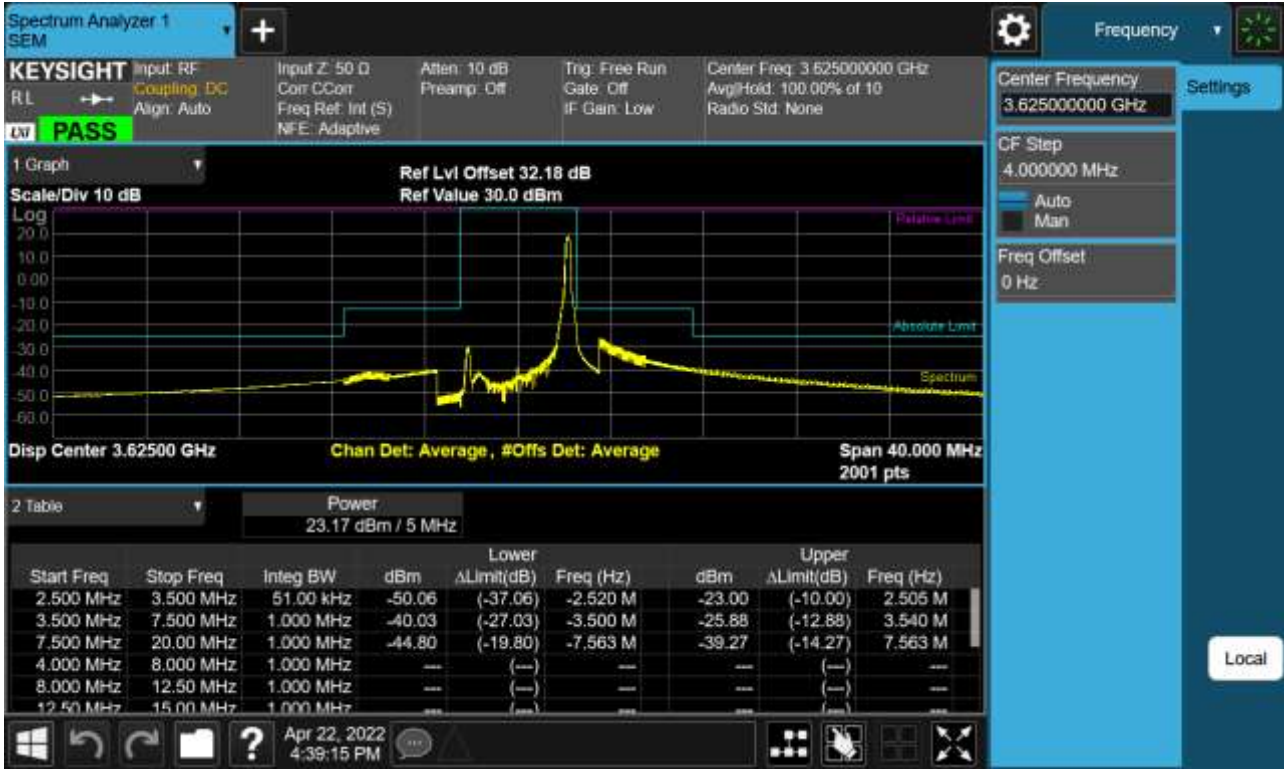

BAND 48. 5 M_BandEdge(Lower)_High_3697.5 MHz_QPSK_FullIRB

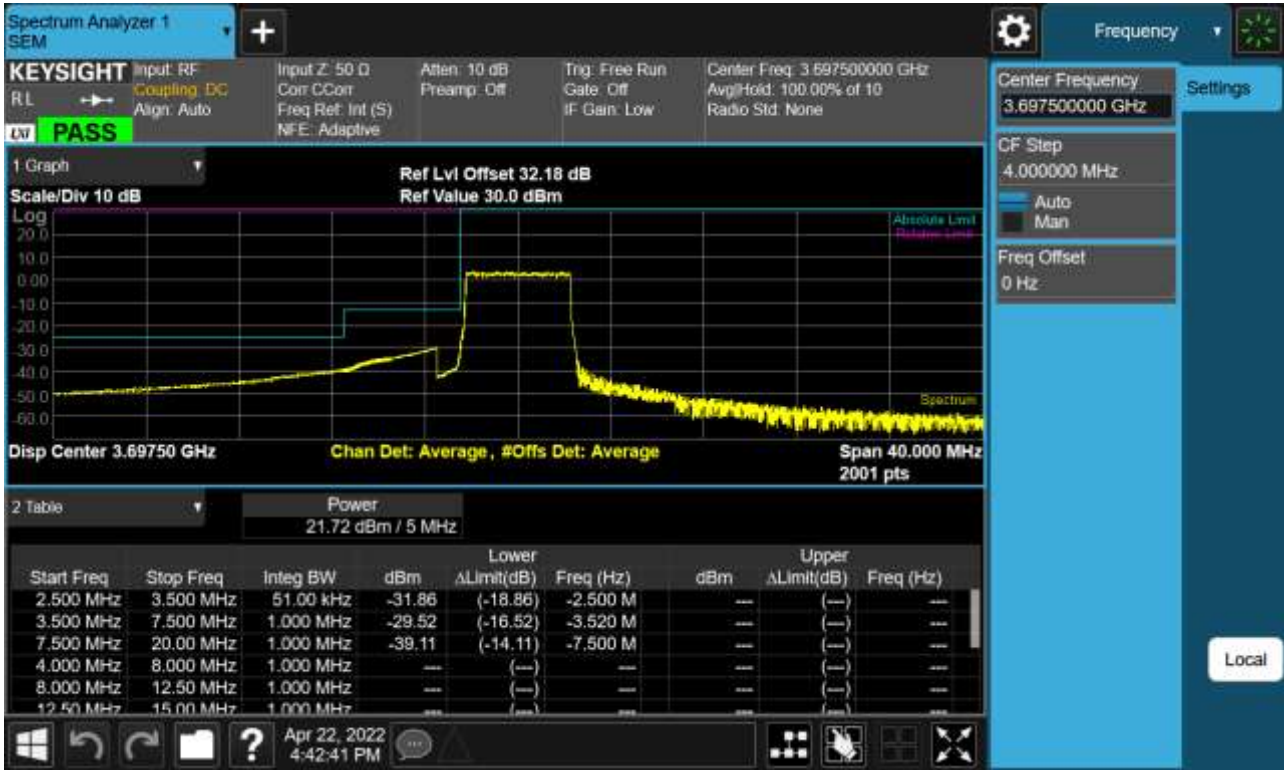

BAND 48. 5 M_BandEdge(Upper)_High_3697.5 MHz_QPSK_FullRB

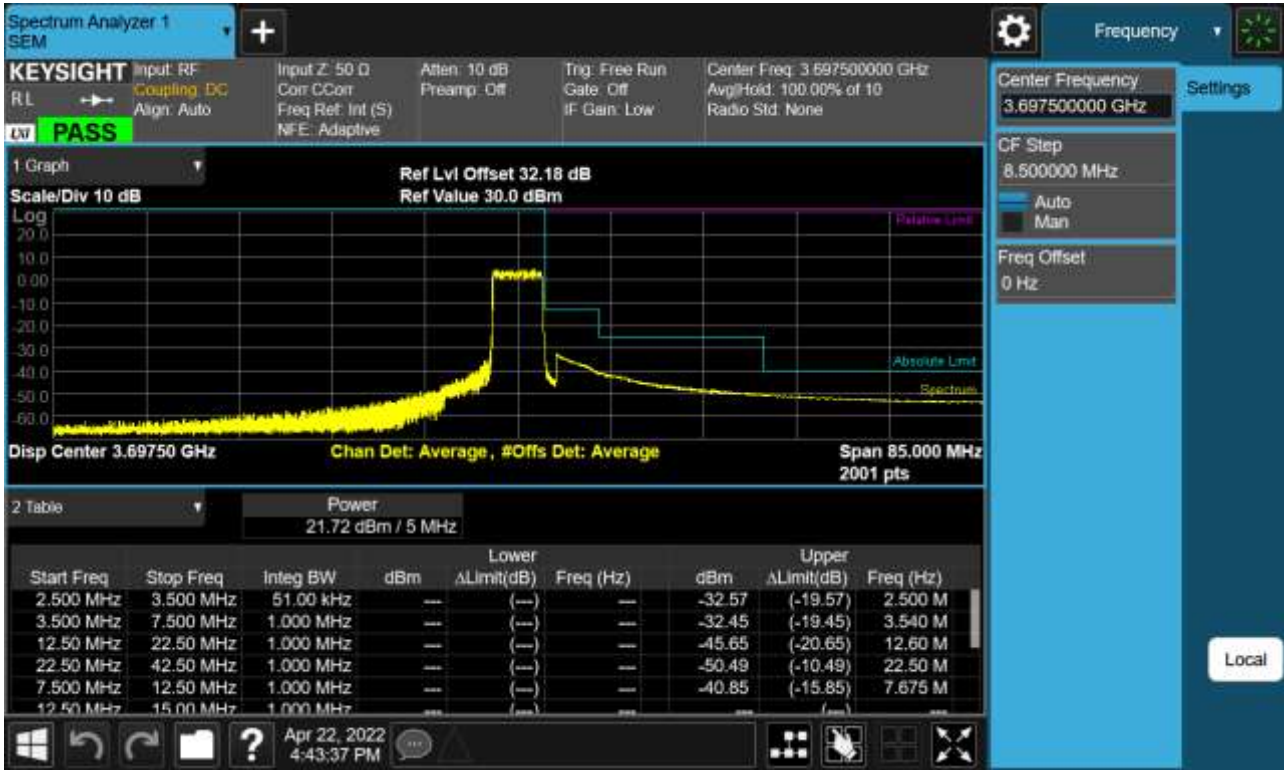

BAND 48. 5 M_BandEdge(Lower)_High_3697.5 MHz_QPSK_1RB

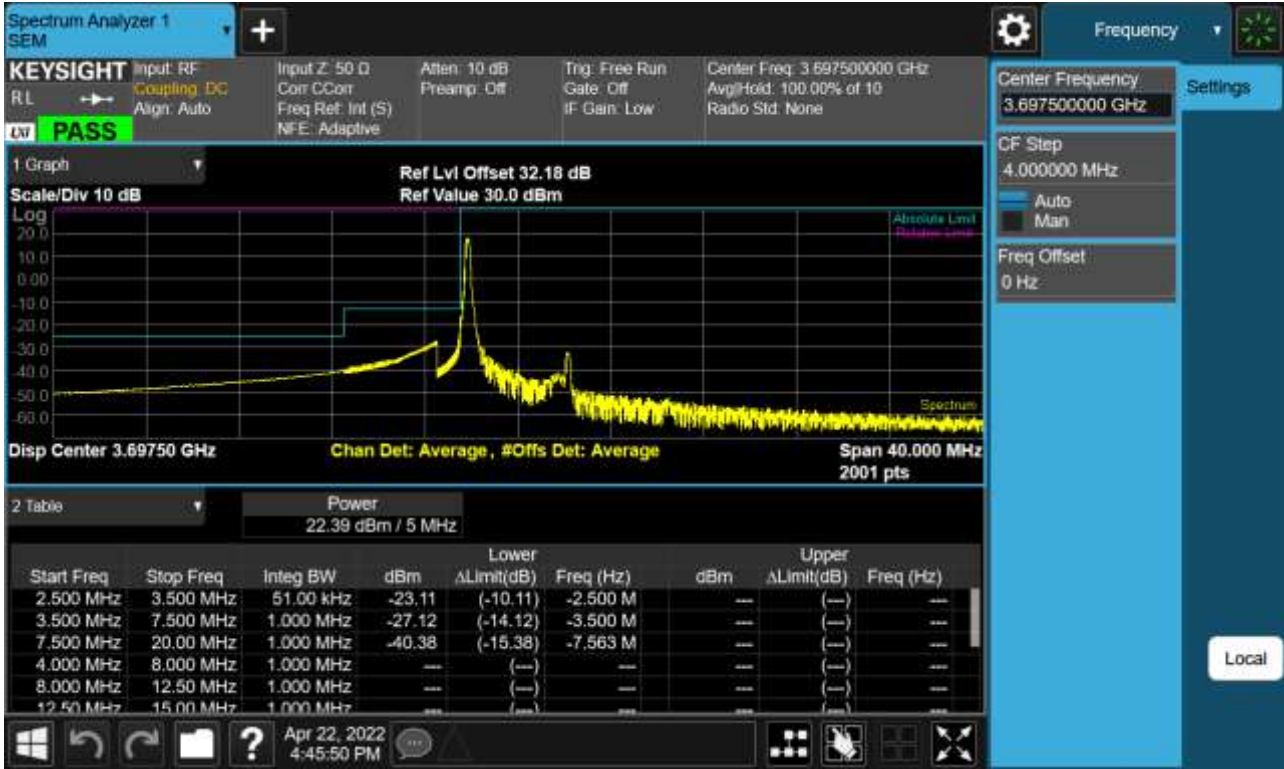

BAND 48. 5 M_BandEdge(Upper)_High_3697.5 MHz_QPSK_1RB

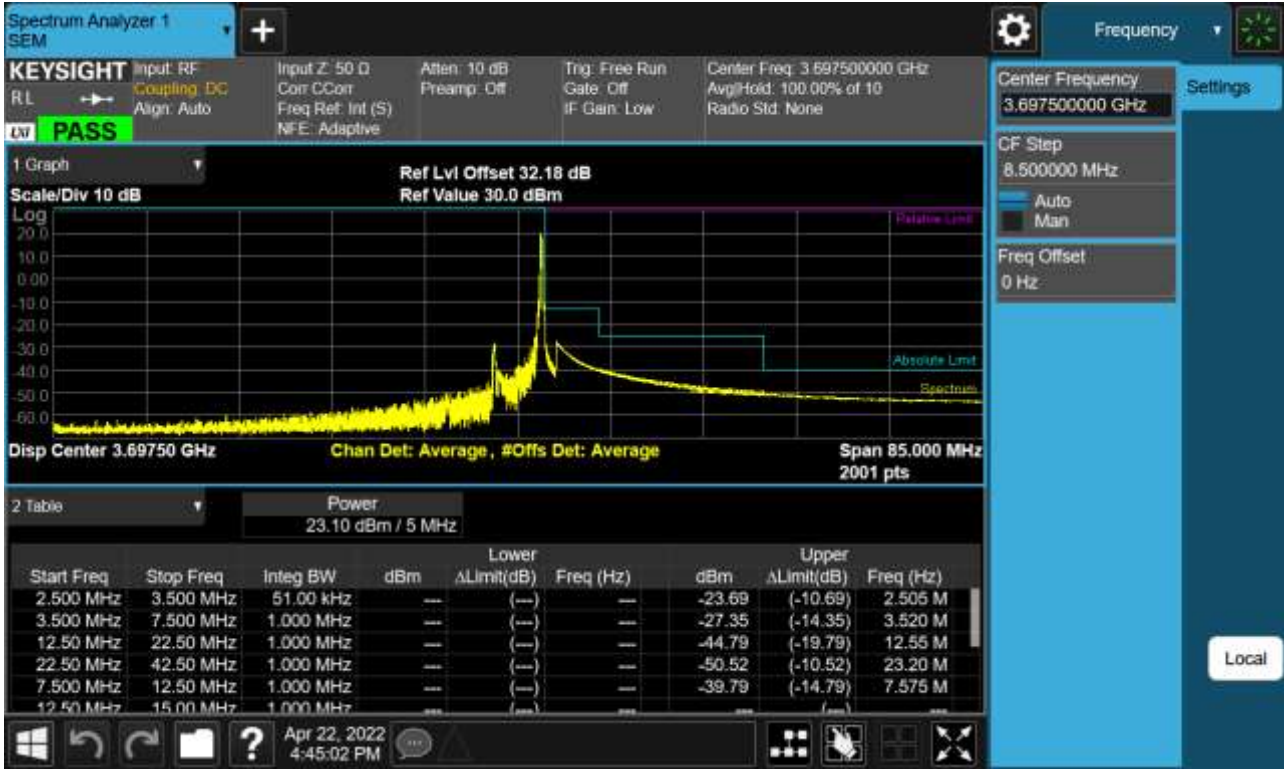

BAND 48. 10 M_BandEdge(Lower)_Low_3555 MHz_QPSK_FuIRB

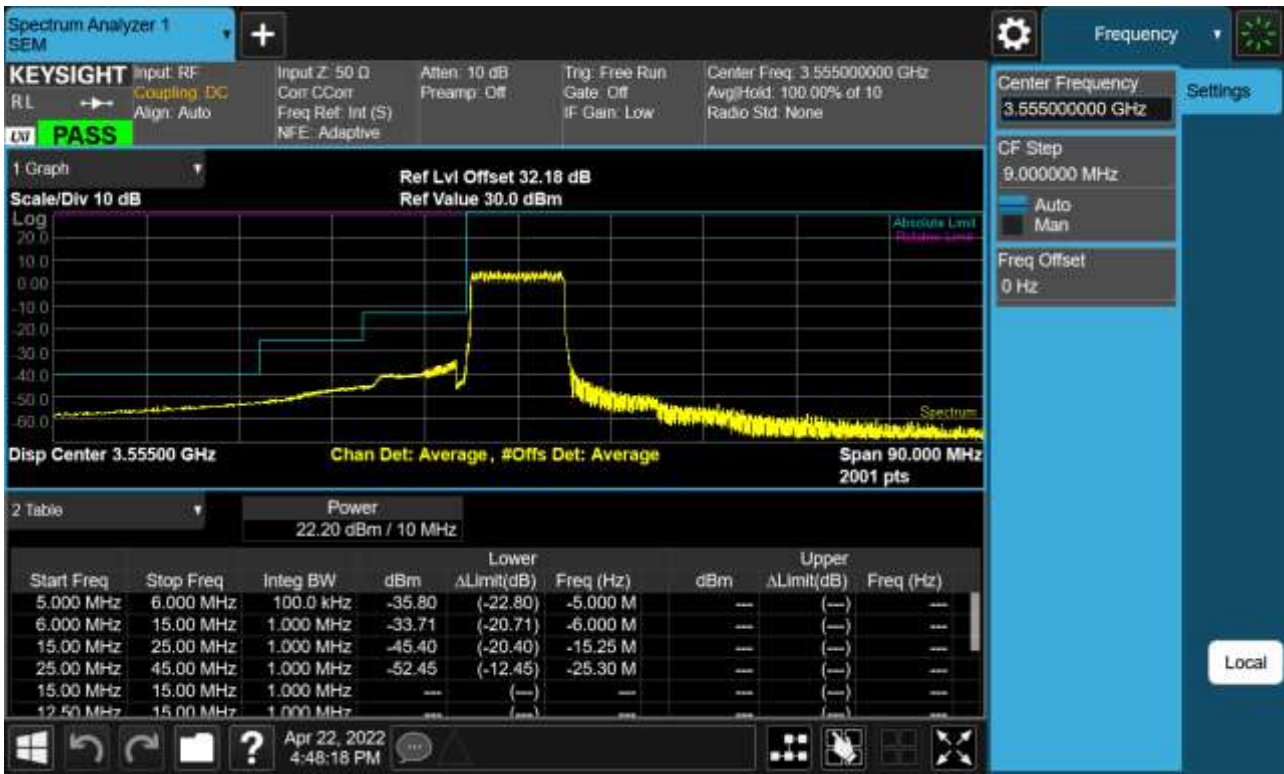

BAND 48. 10 M_BandEdge(Upper)_Low_3555 MHz_QPSK_FullRB

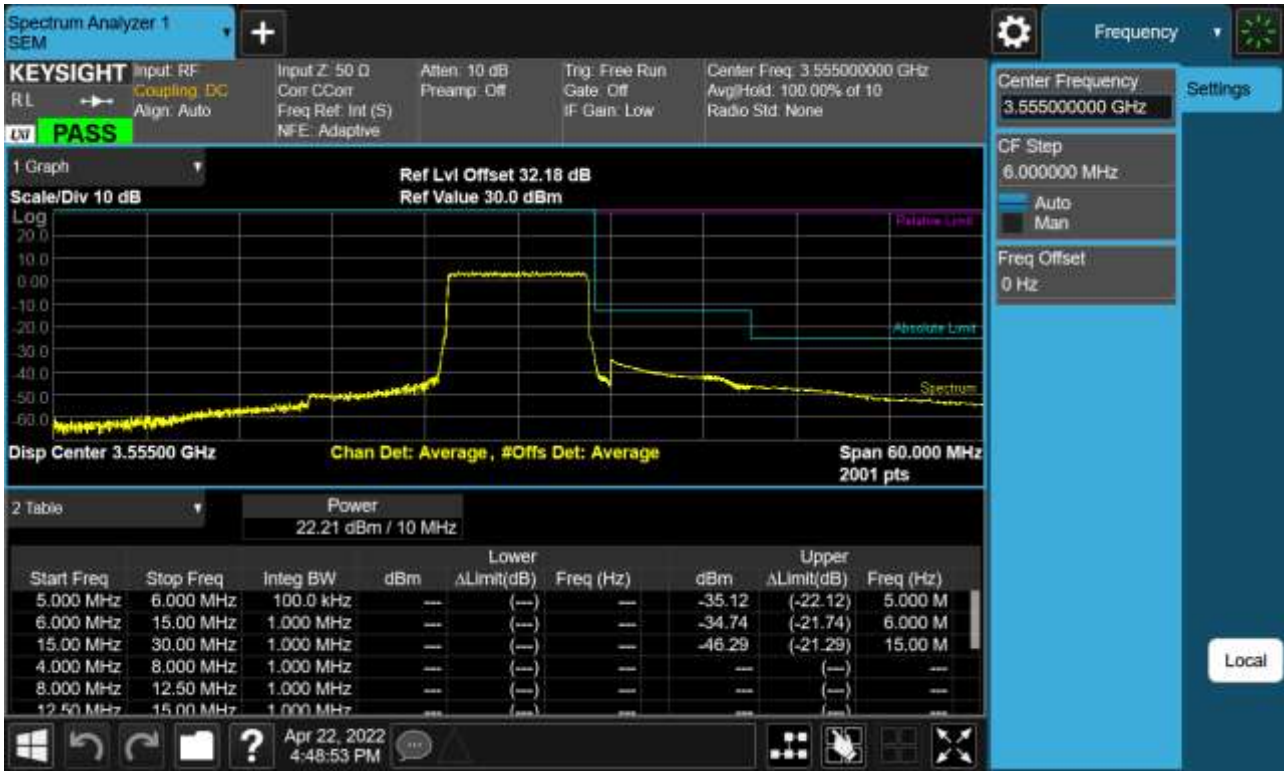

BAND 48. 10 M_BandEdge(Lower)_Low_3555 MHz_QPSK_1RB

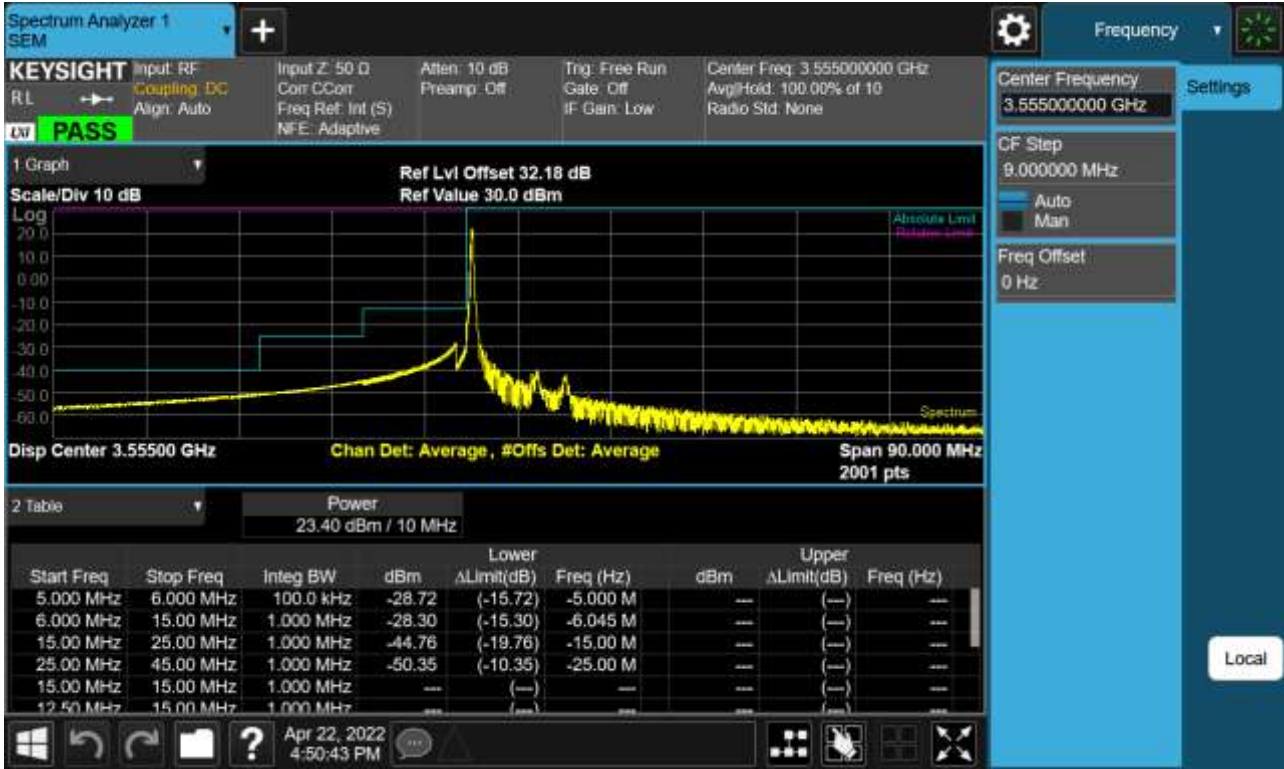

BAND 48. 10 M_BandEdge(Upper)_Low_3555 MHz_QPSK_1RB

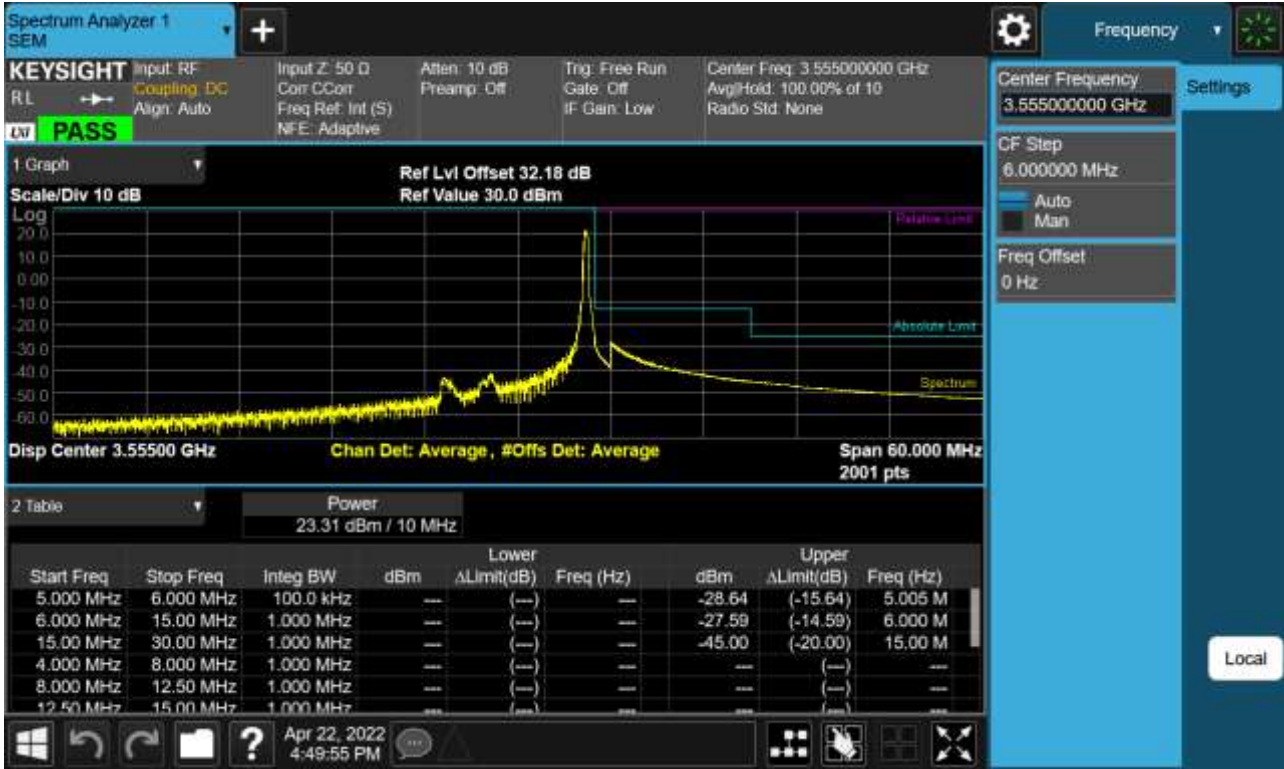

BAND 48. 10 M_BandEdge(Center)_Mid_3625 MHz_QPSK_FullRB



BAND 48. 10 M_BandEdge(Lower)_Mid_3625 MHz_QPSK_1RB

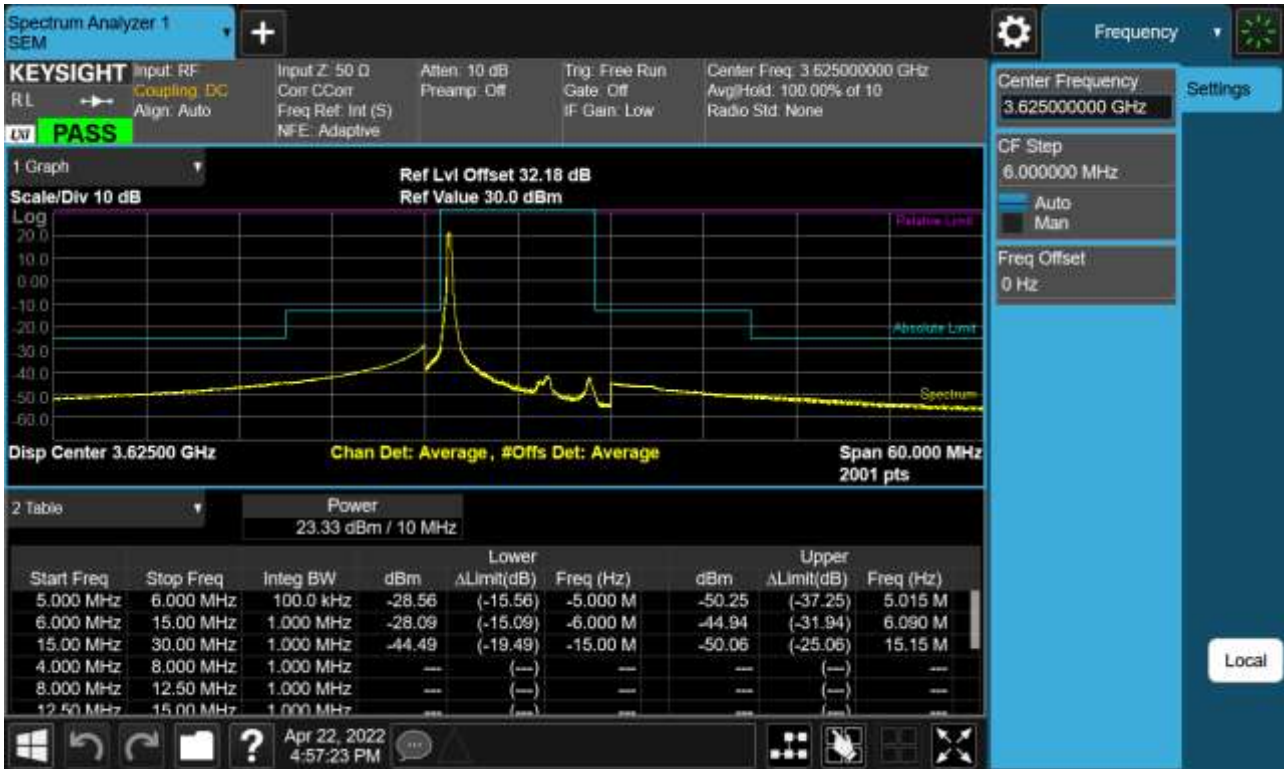

BAND 48. 10 M_BandEdge(Upper)_Mid_3625 MHz_QPSK_1RB

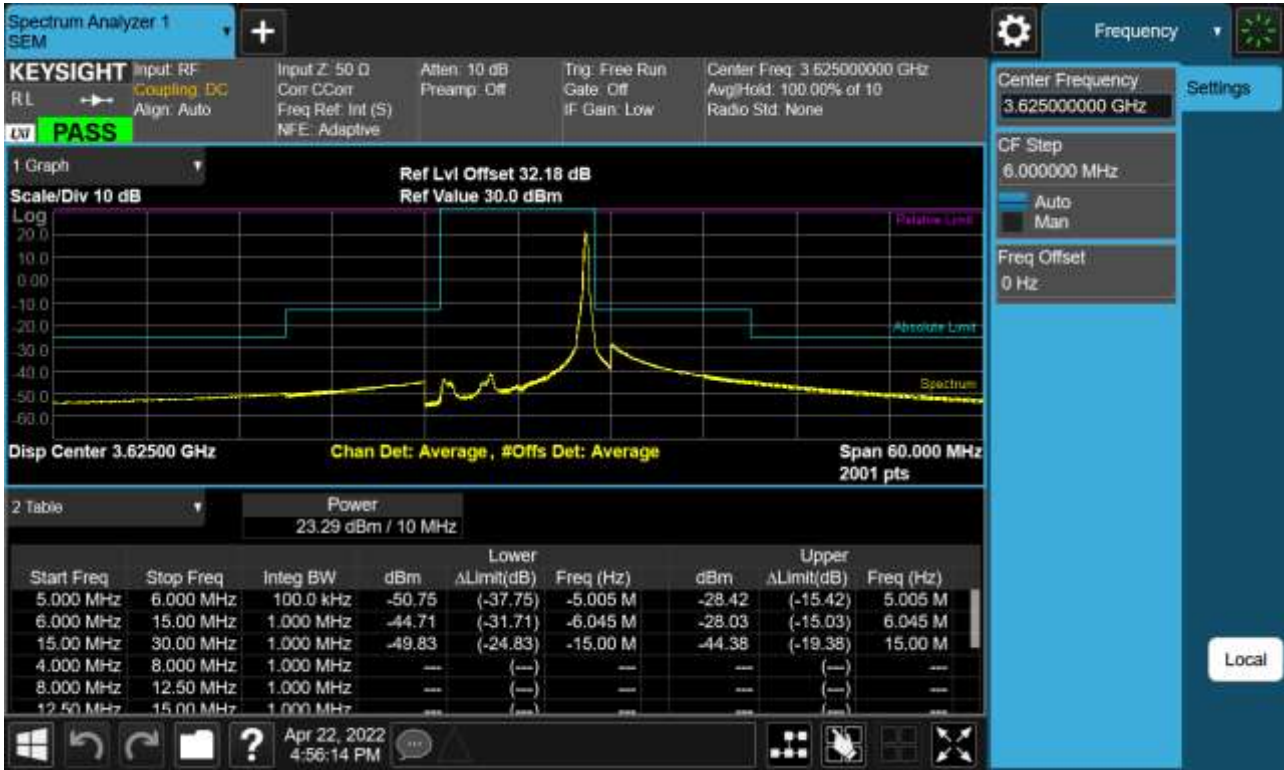

BAND 48. 10 M_BandEdge(Lower)_High_3695 MHz_QPSK_FullRB

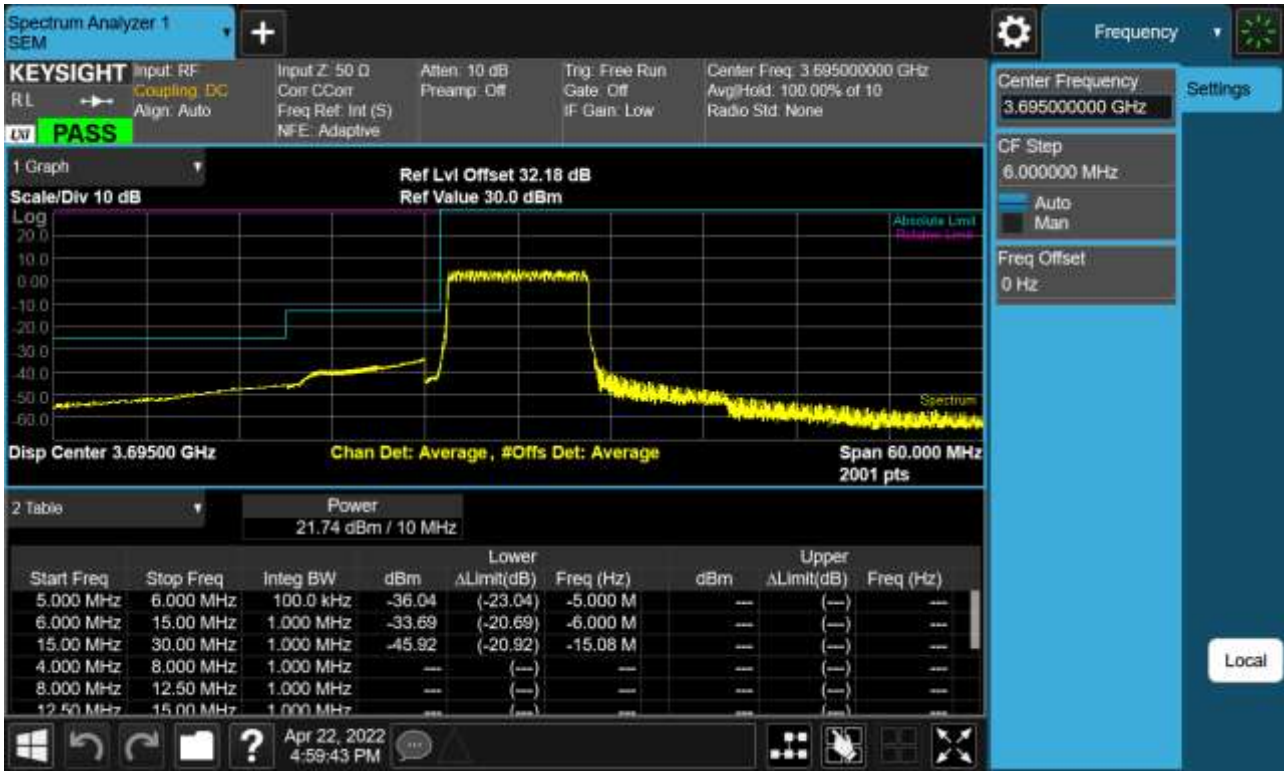

BAND 48. 10 M_BandEdge(Upper)_High_3695 MHz_QPSK_FullIRB

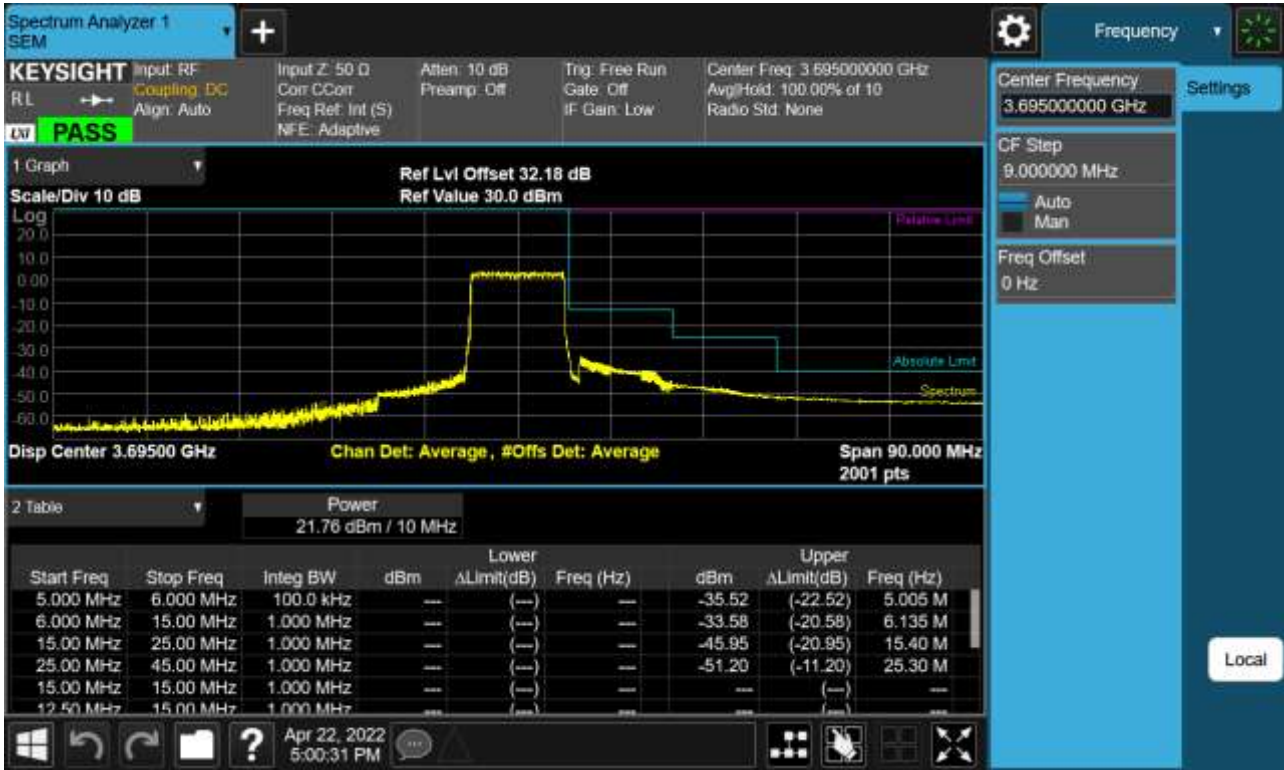

BAND 48. 10 M_BandEdge(Lower)_High_3695 MHz_QPSK_1RB

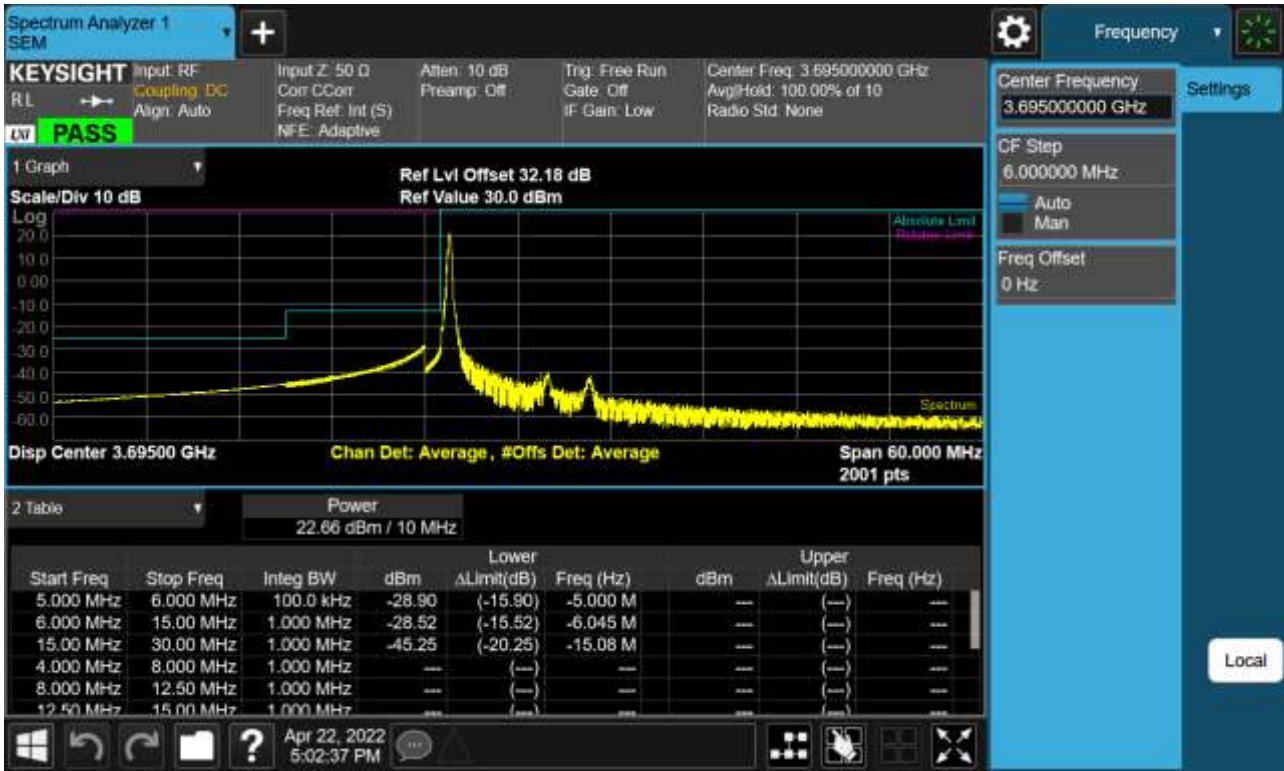

BAND 48. 10 M_BandEdge(Upper)_High_3695 MHz_QPSK_1RB

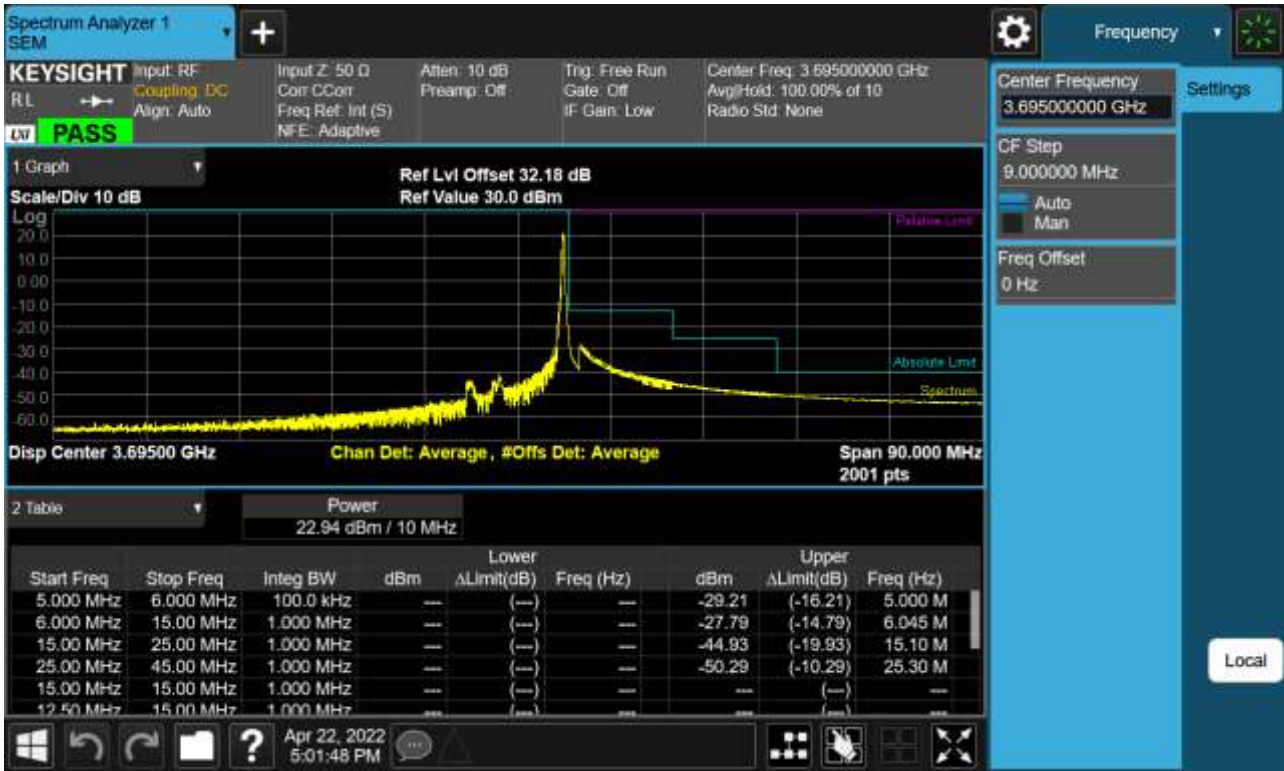

BAND 48. 15 M_BandEdge(Lower)_Low_3557.5 MHz_QPSK_FullIRB

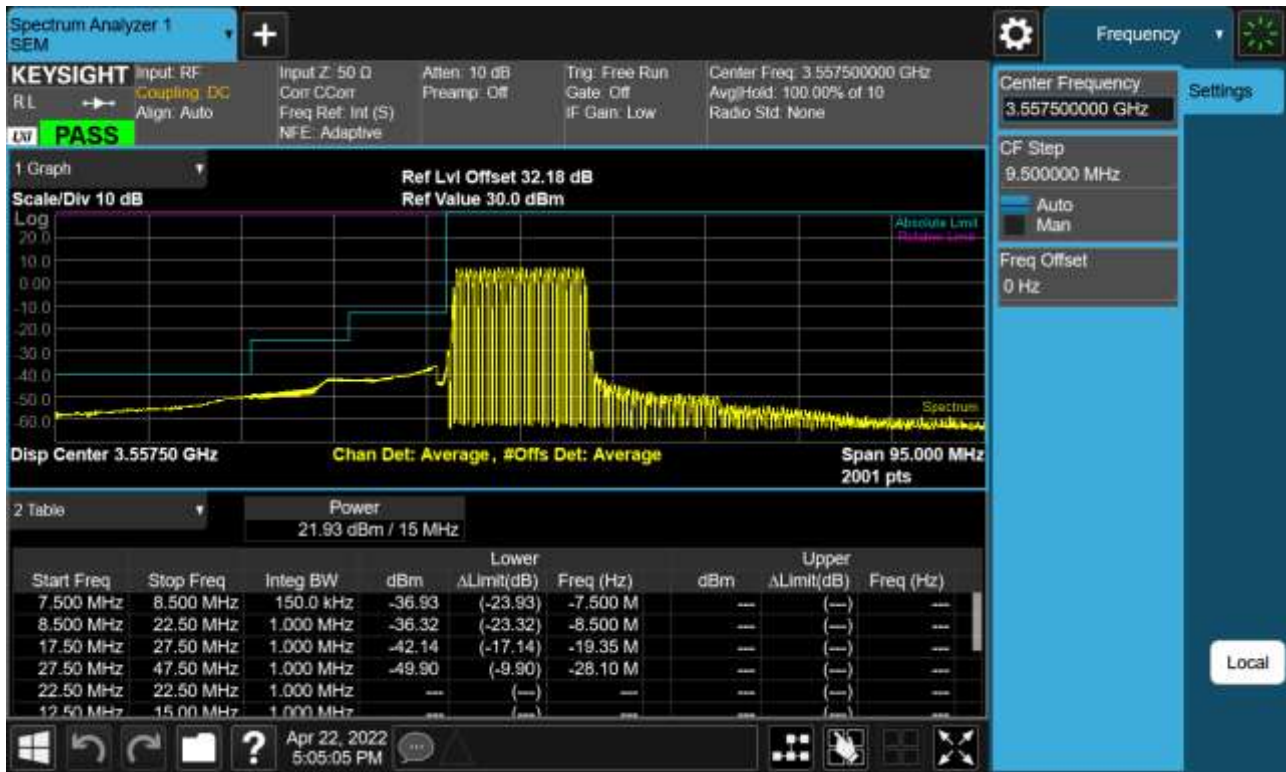

BAND 48. 15 M_BandEdge(Upper)_Low_3557.5 MHz_QPSK_FullIRB

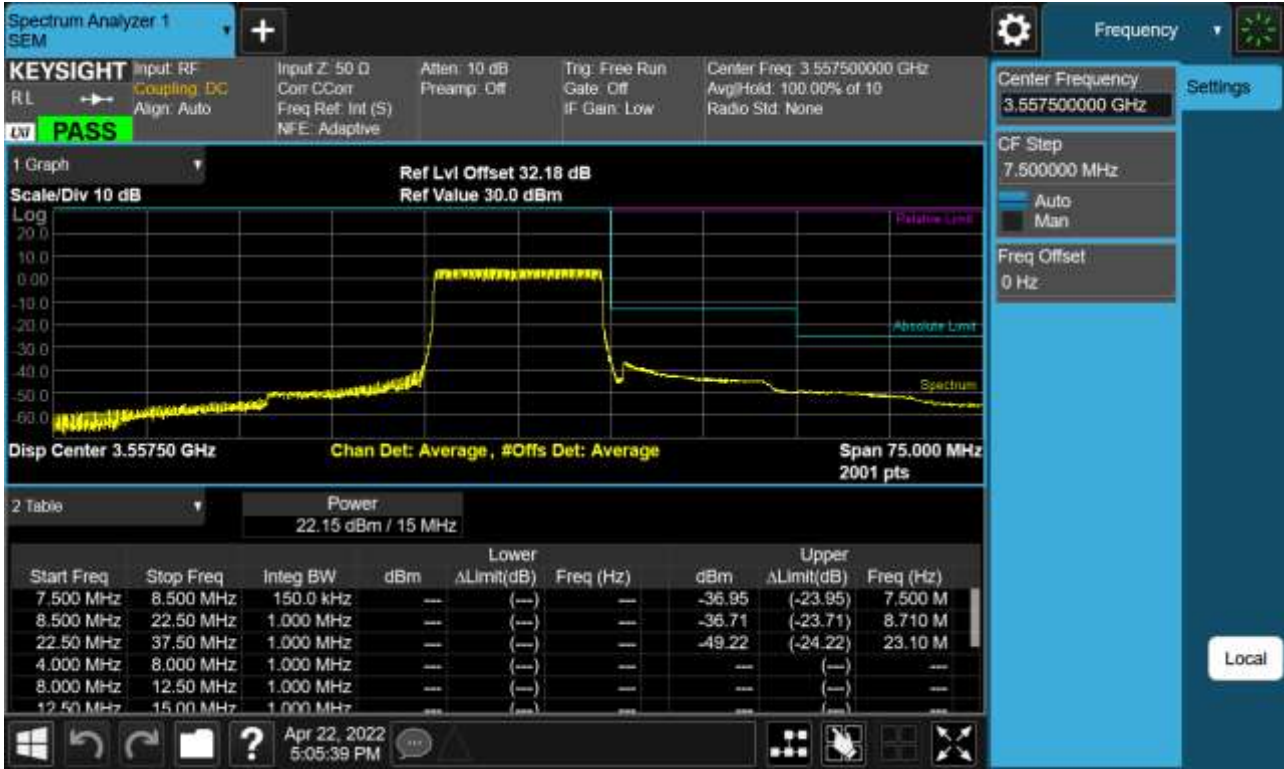

BAND 48. 15 M_BandEdge(Lower)_Low_3557.5 MHz_QPSK_1RB

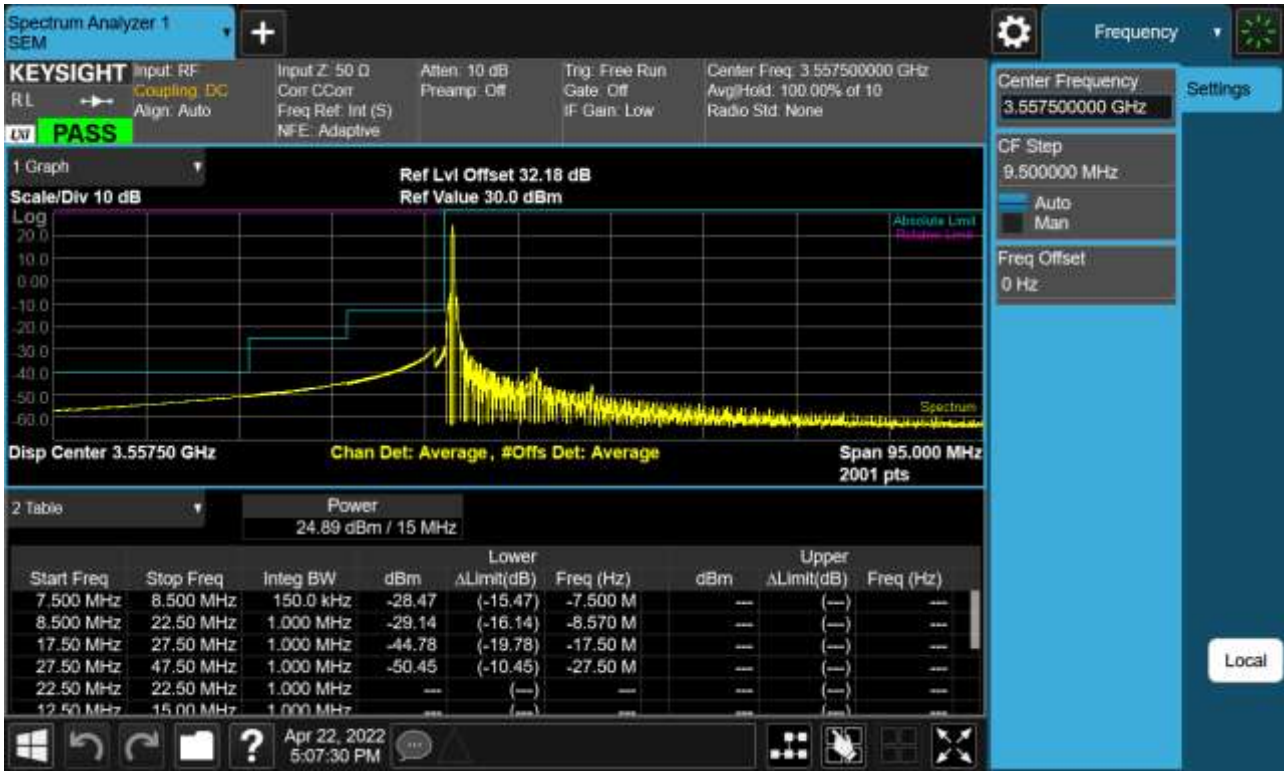

BAND 48. 15 M_BandEdge(Upper)_Low_3557.5 MHz_QPSK_1RB

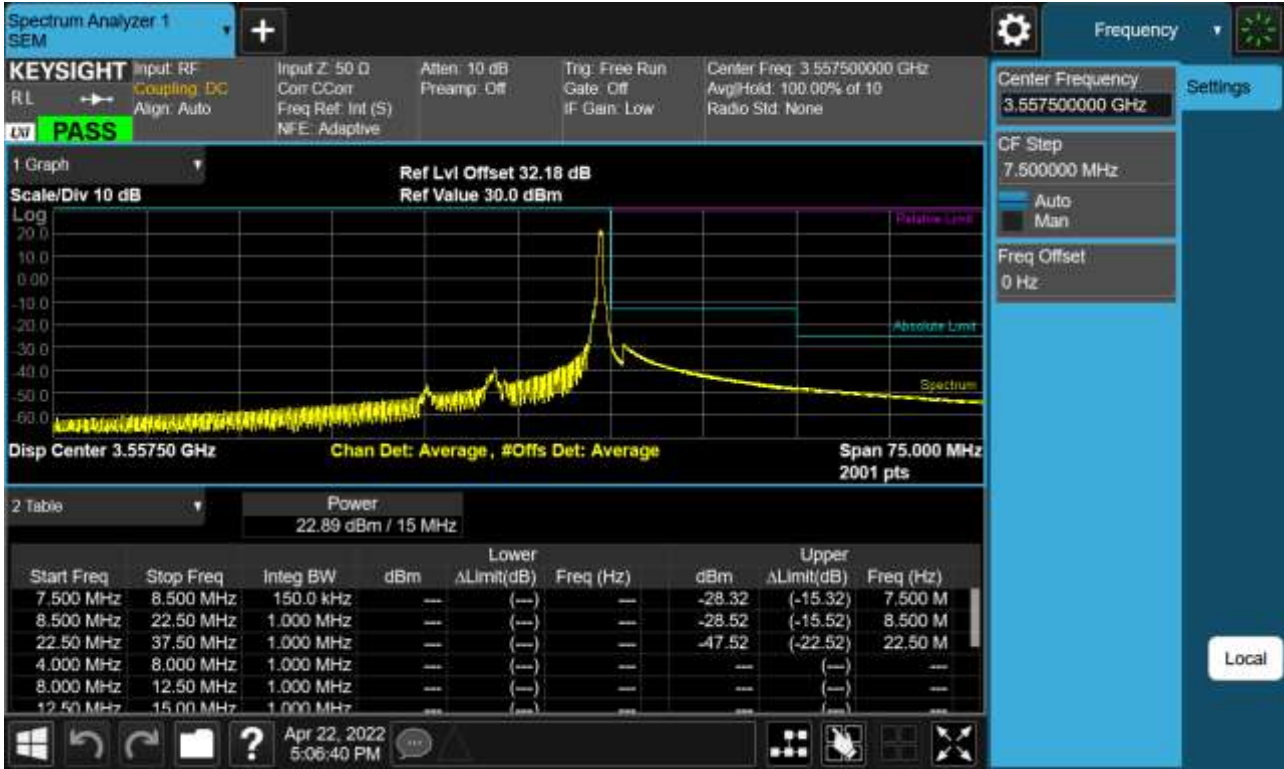

BAND 48. 15 M_BandEdge(Center)_Mid_3625 MHz_QPSK_FullRB

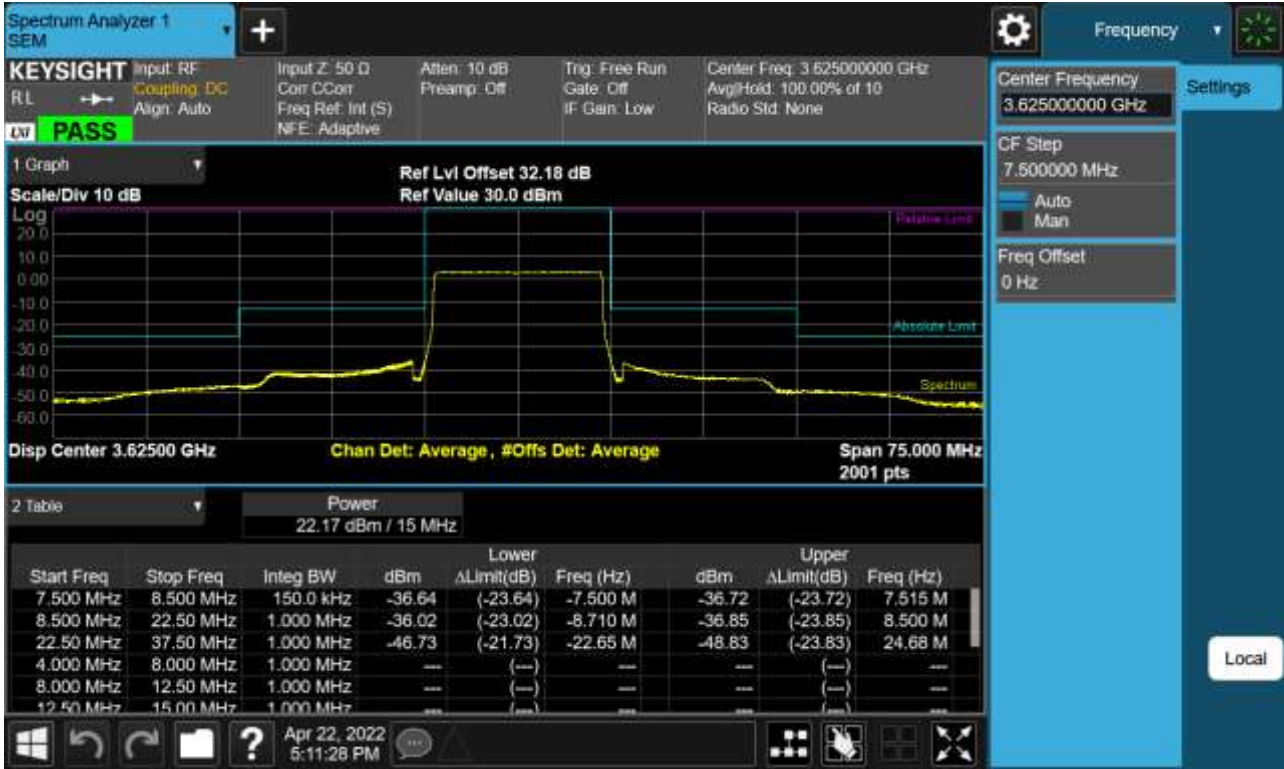

BAND 48. 15 M_BandEdge(Lower)_Mid_3625 MHz_QPSK_1RB

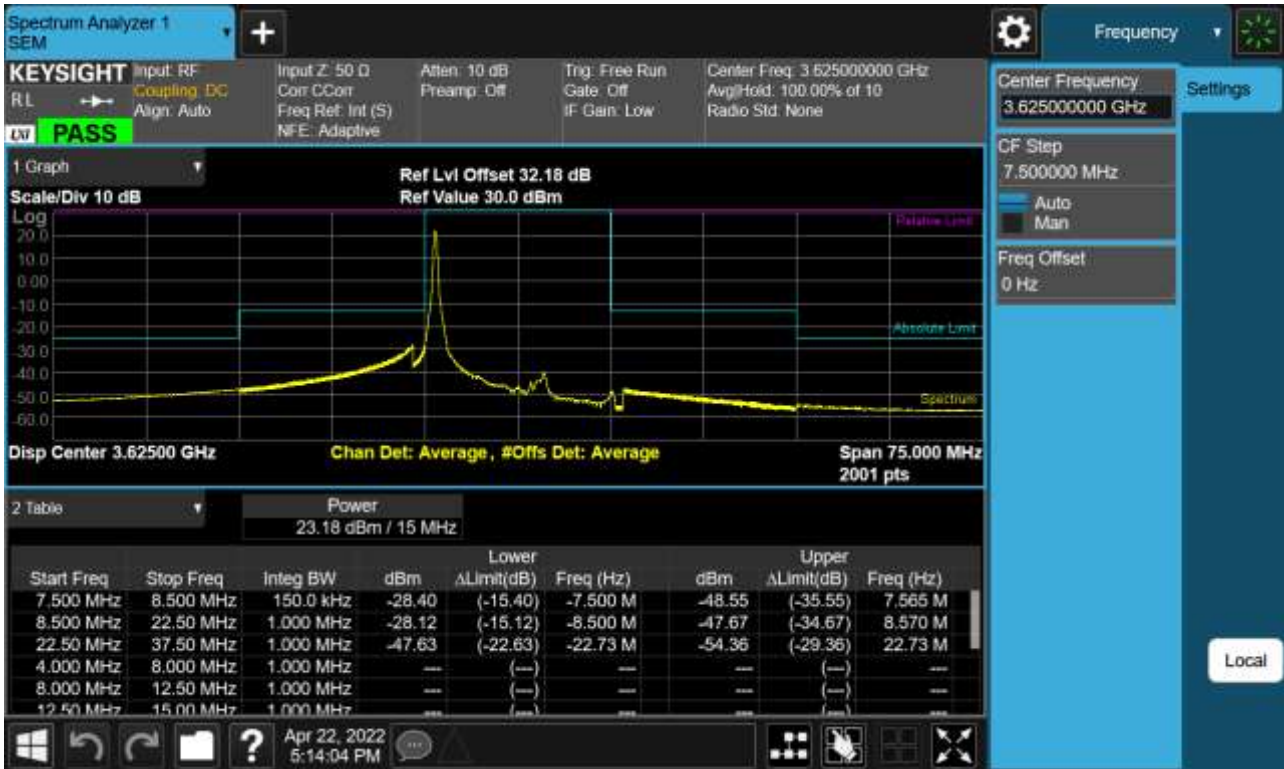

BAND 48. 15 M_BandEdge(Upper)_Mid_3625 MHz_QPSK_1RB

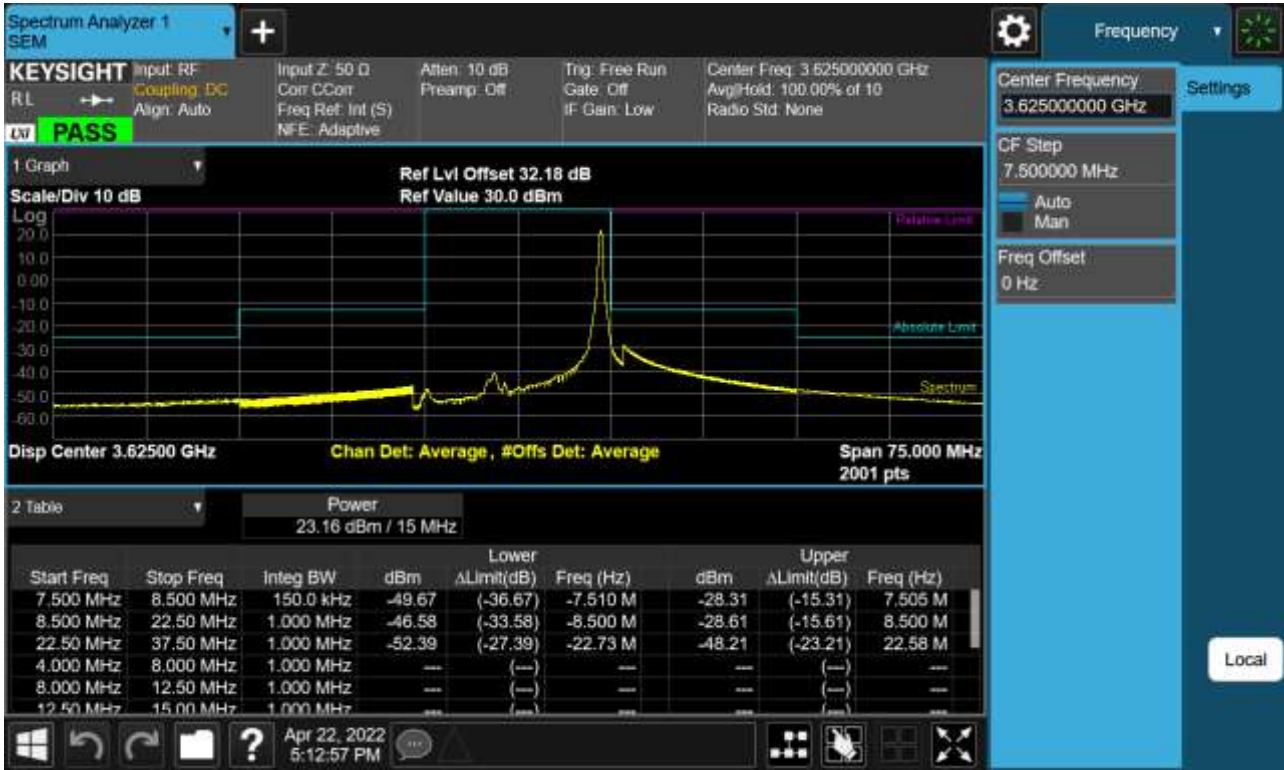

BAND 48. 15 M_BandEdge(Lower)_High_3692.5 MHz_QPSK_FullIRB

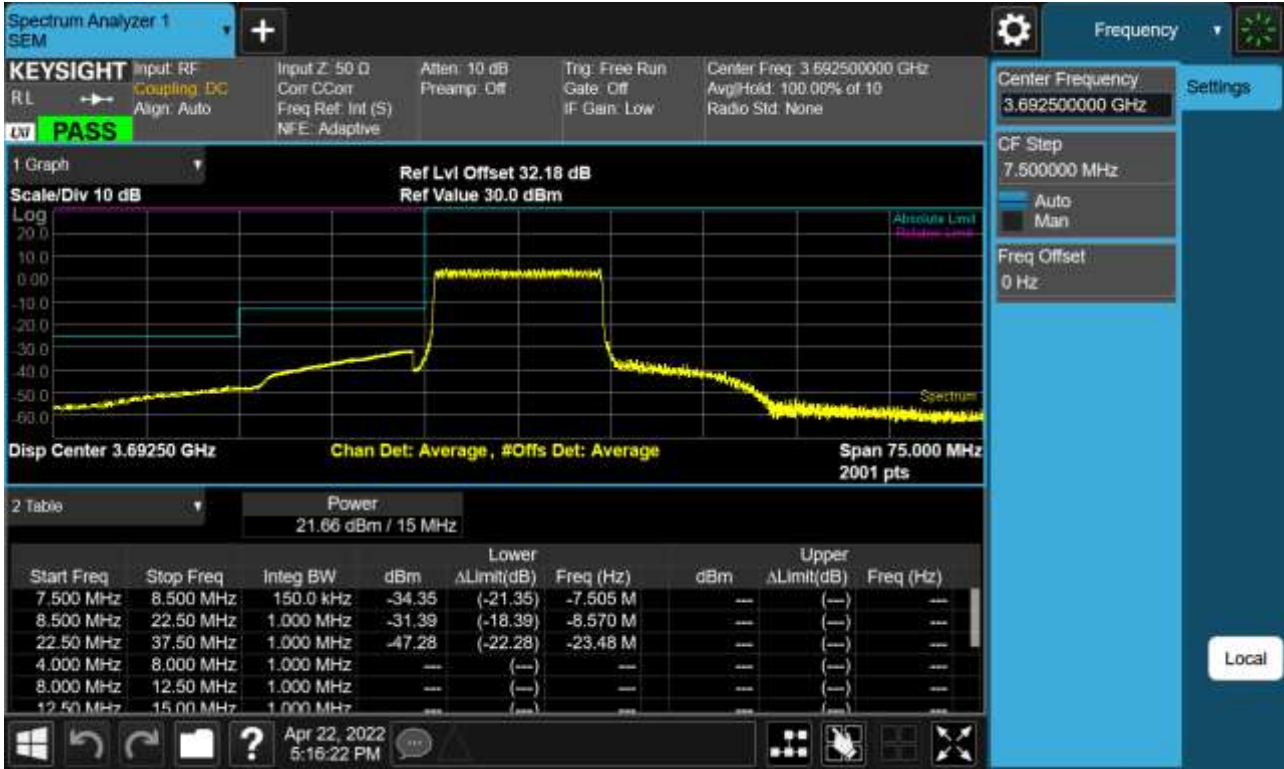

BAND 48. 15 M_BandEdge(Upper)_High_3692.5 MHz_QPSK_FullIRB



BAND 48. 15 M_BandEdge(Lower)_High_3692.5 MHz_QPSK_1RB

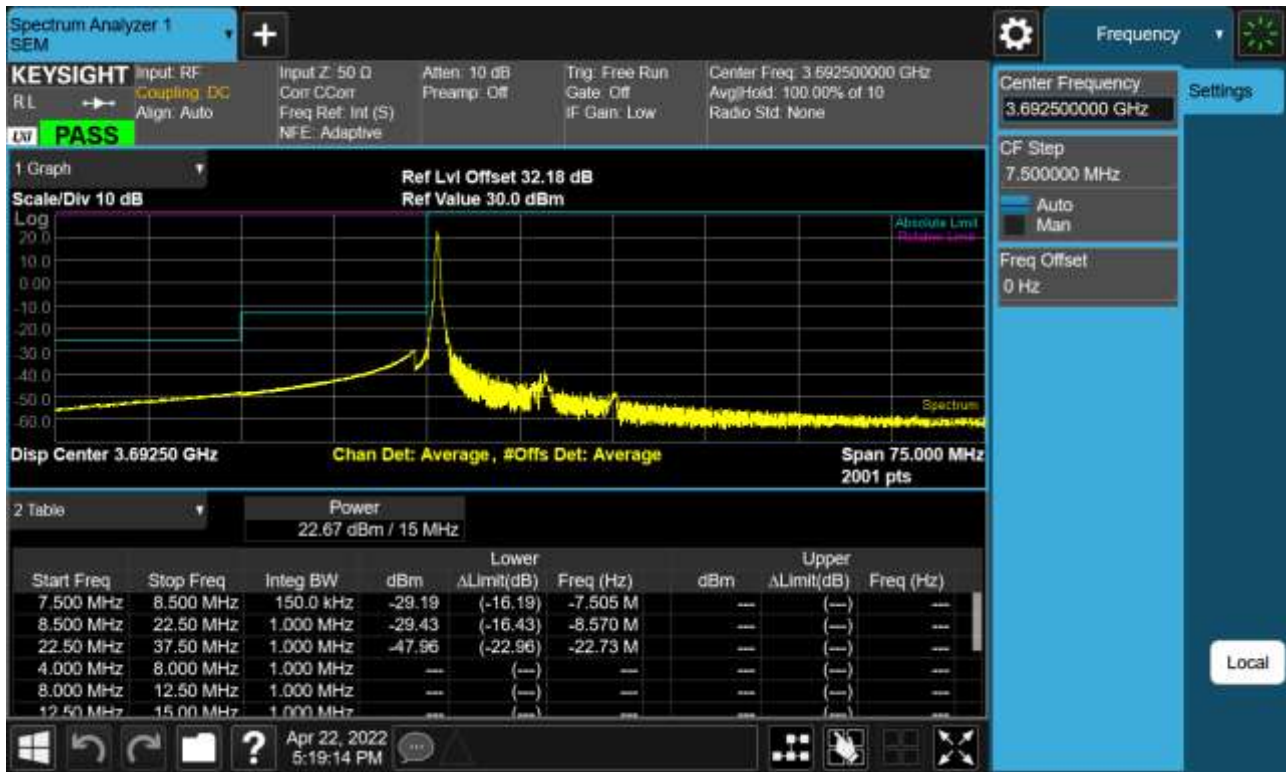

BAND 48. 15 M_BandEdge(Upper)_High_3692.5 MHz_QPSK_1RB

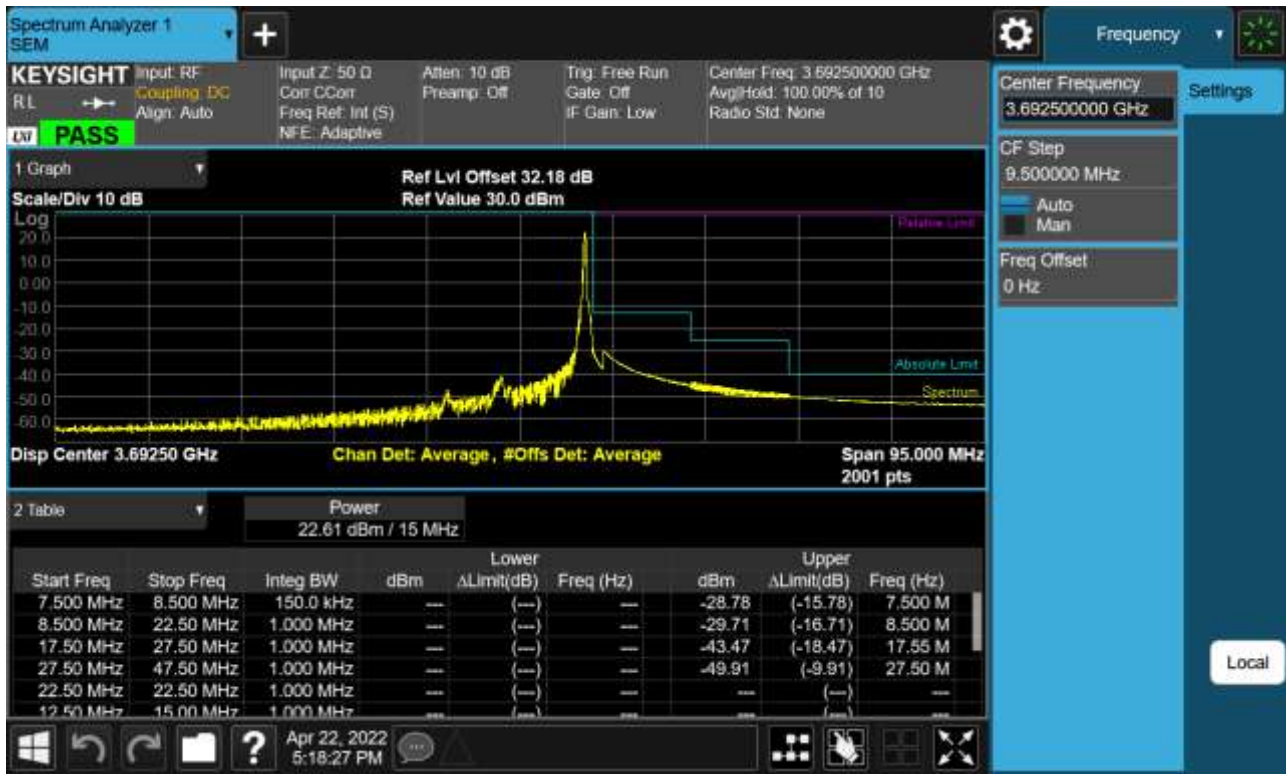

BAND 48. 20 M_BandEdge(Lower)_Low_3560 MHz_QPSK_FullRB



BAND 48. 20 M_BandEdge(Upper)_Low_3560 MHz_QPSK_FullRB

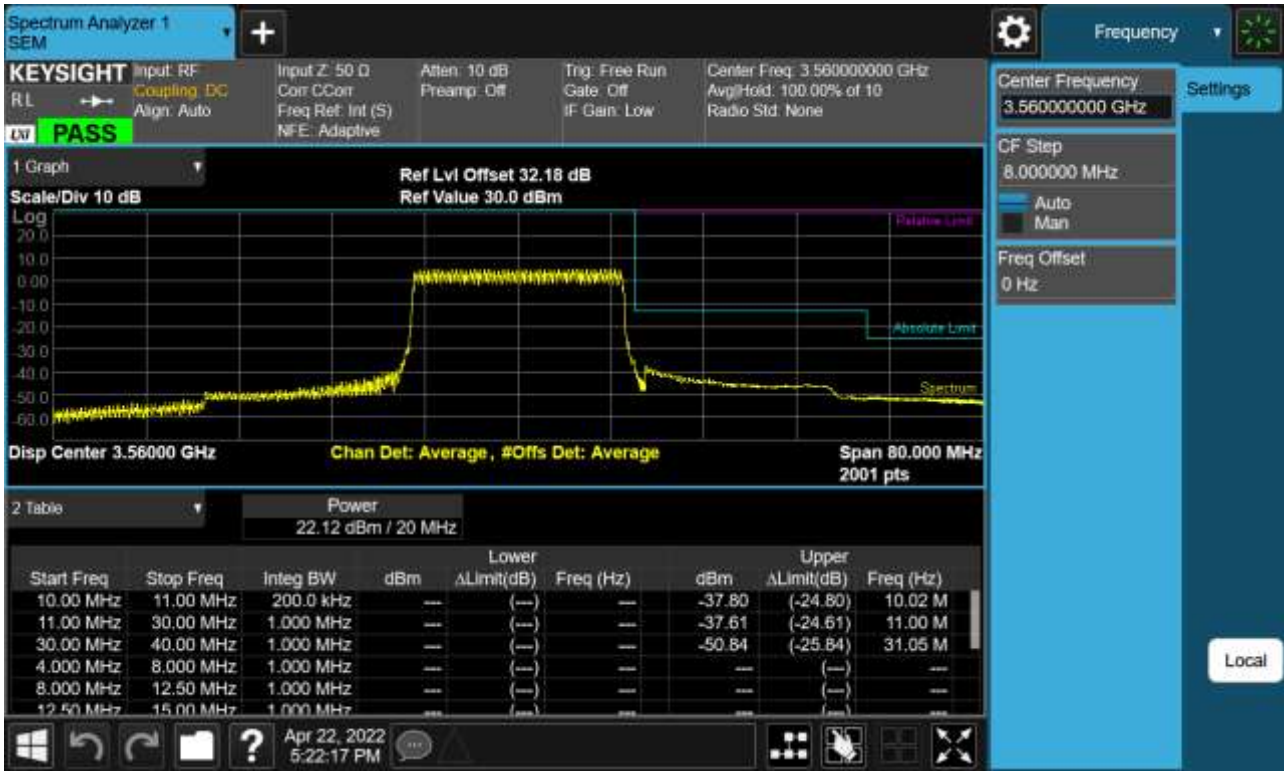

BAND 48. 20 M_BandEdge(Lower)_Low_3560 MHz_QPSK_1RB

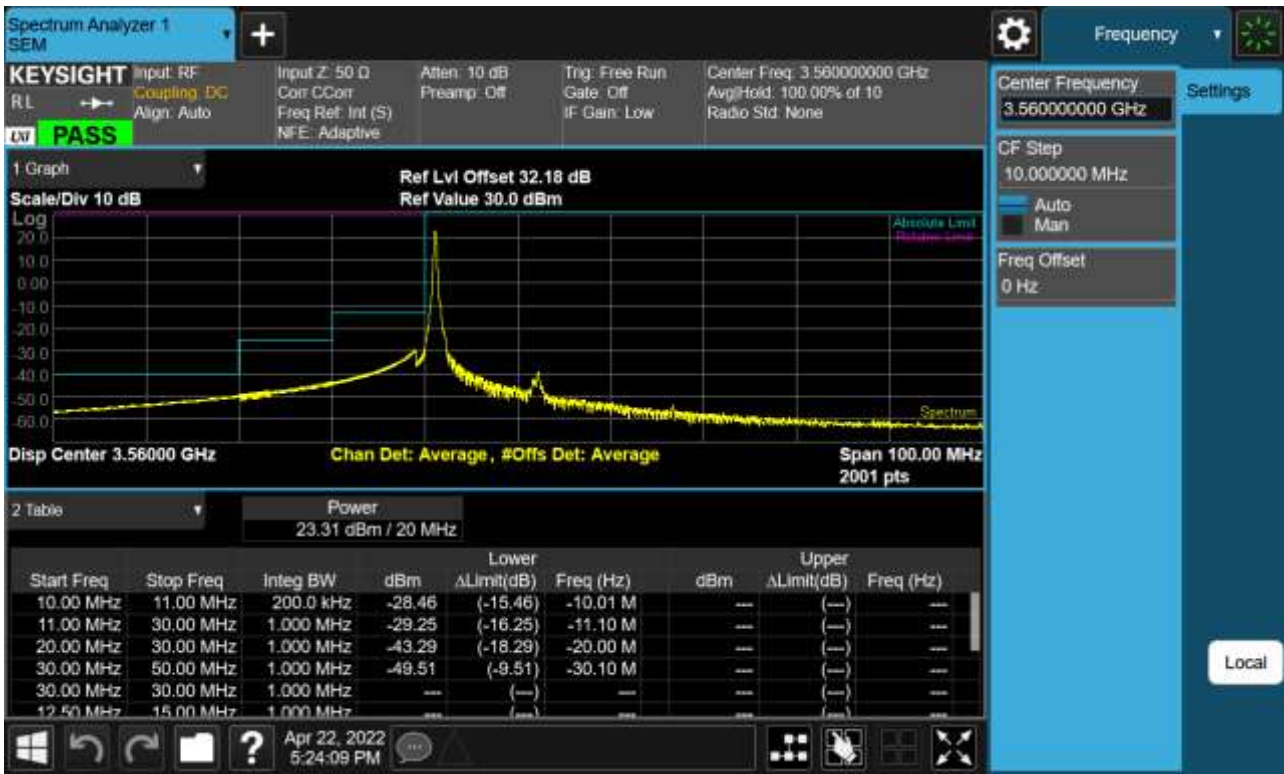

BAND 48. 20 M_BandEdge(Upper)_Low_3560 MHz_QPSK_1RB

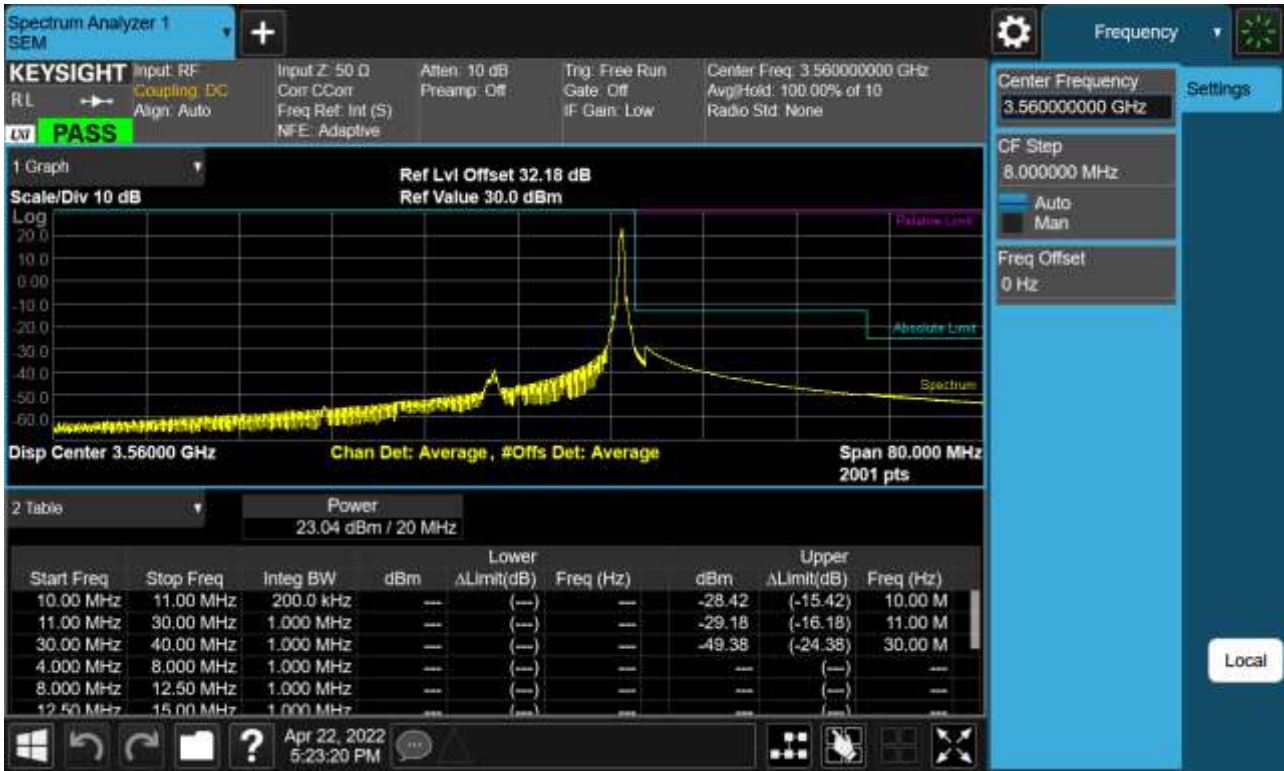

BAND 48. 20 M_BandEdge(Center)_Mid_3625 MHz_QPSK_FullRB



BAND 48. 20 M_BandEdge(Lower)_Mid_3625 MHz_QPSK_1RB

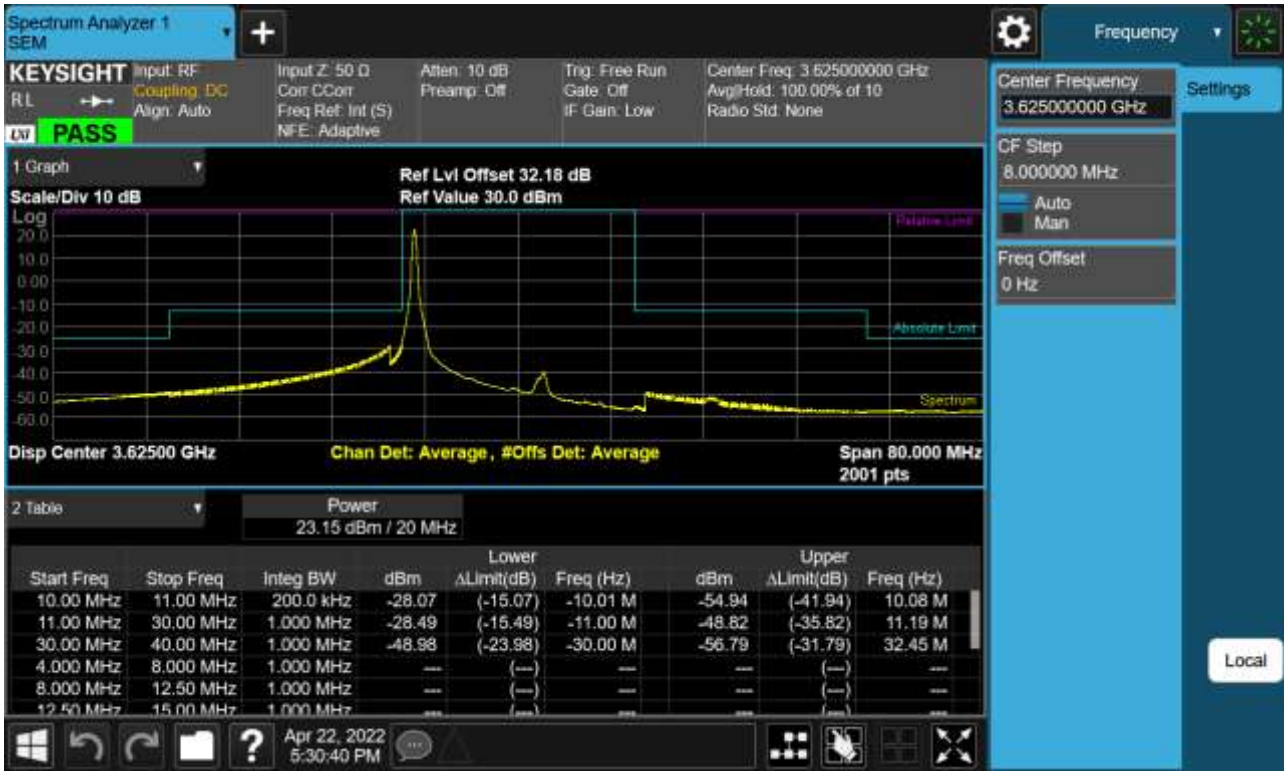

BAND 48. 20 M_BandEdge(Upper)_Mid_3625 MHz_QPSK_1RB

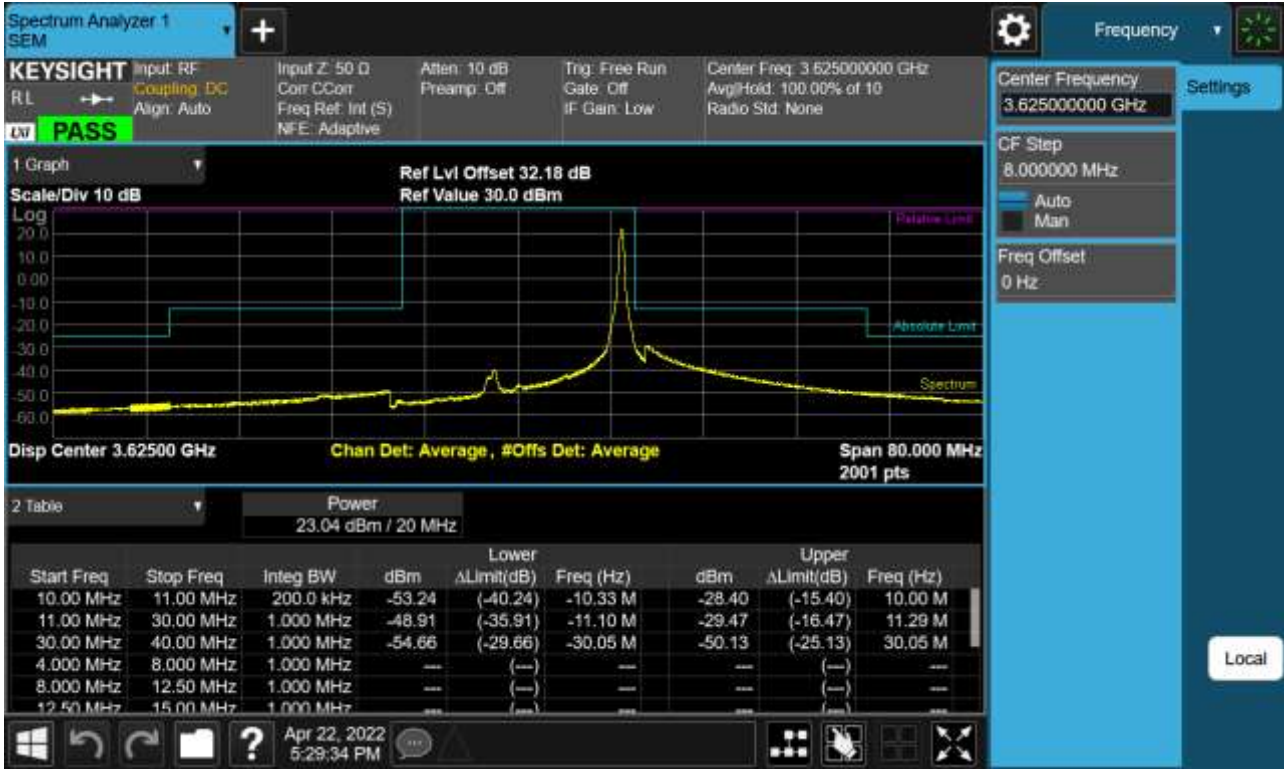

BAND 48. 20 M_BandEdge(Lower)_High_3690 MHz_QPSK_FullRB

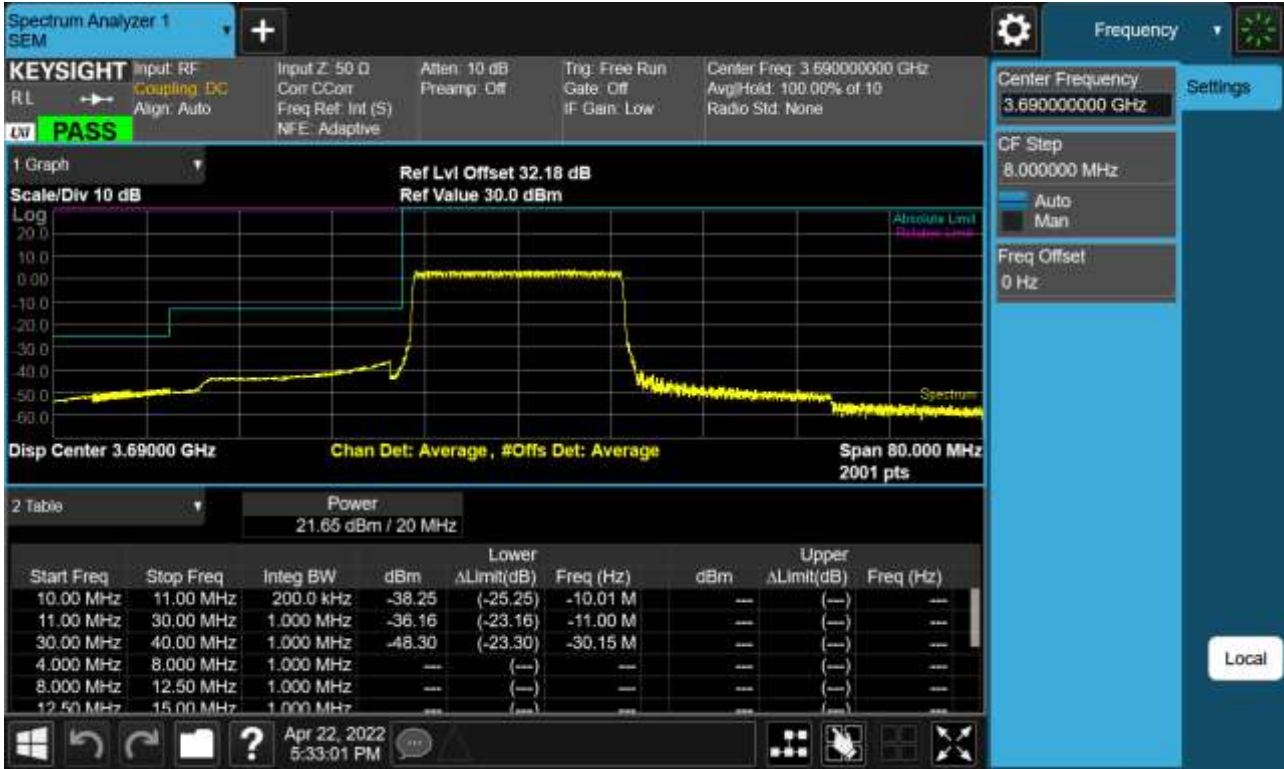

BAND 48. 20 M_BandEdge(Upper)_High_3690 MHz_QPSK_FullIRB

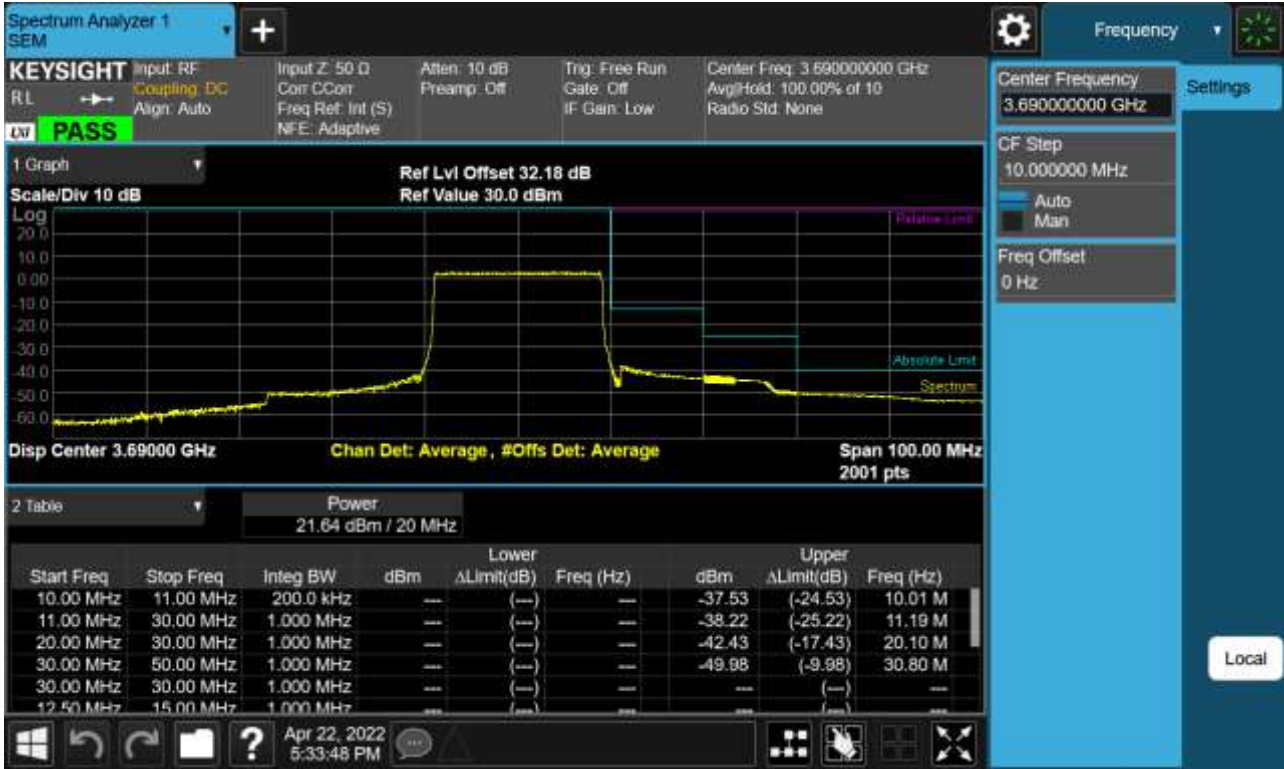

BAND 48. 20 M_BandEdge(Lower)_High_3690 MHz_QPSK_1RB

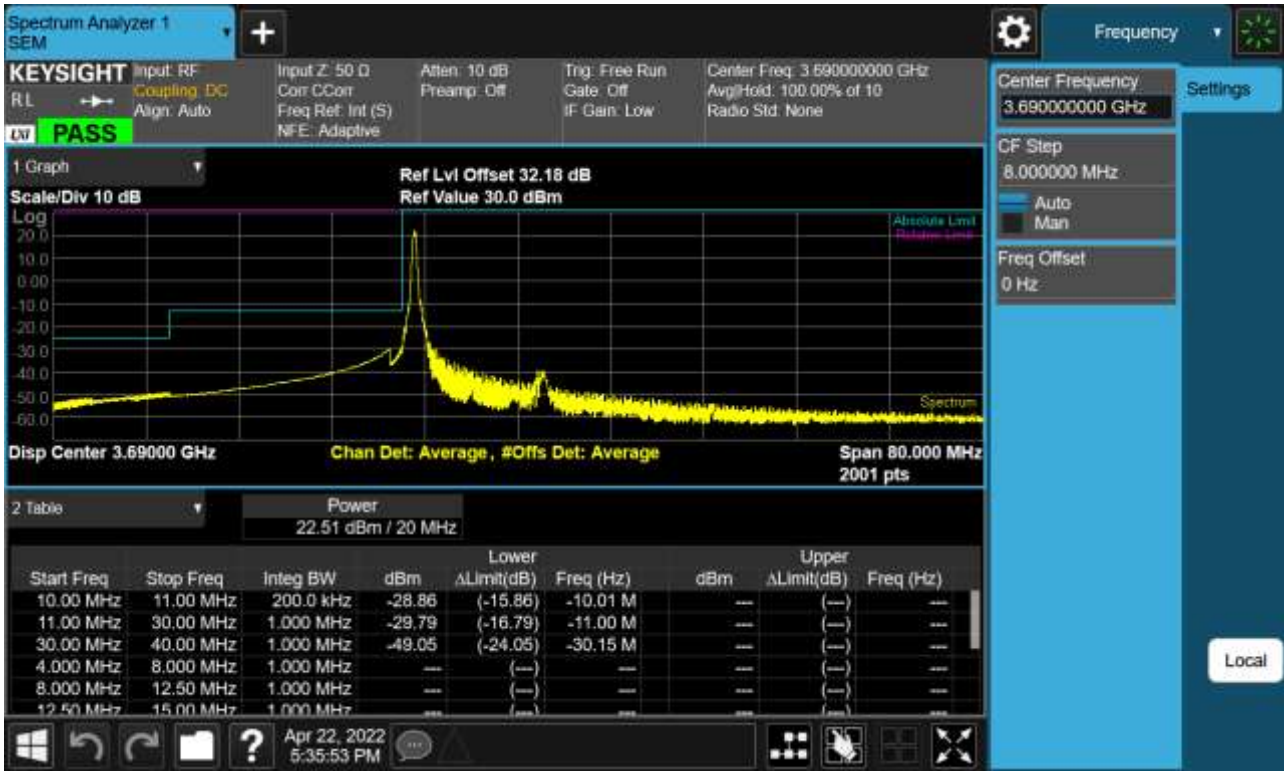

BAND 48. 20 M_BandEdge(Upper)_High_3690 MHz_QPSK_1RB

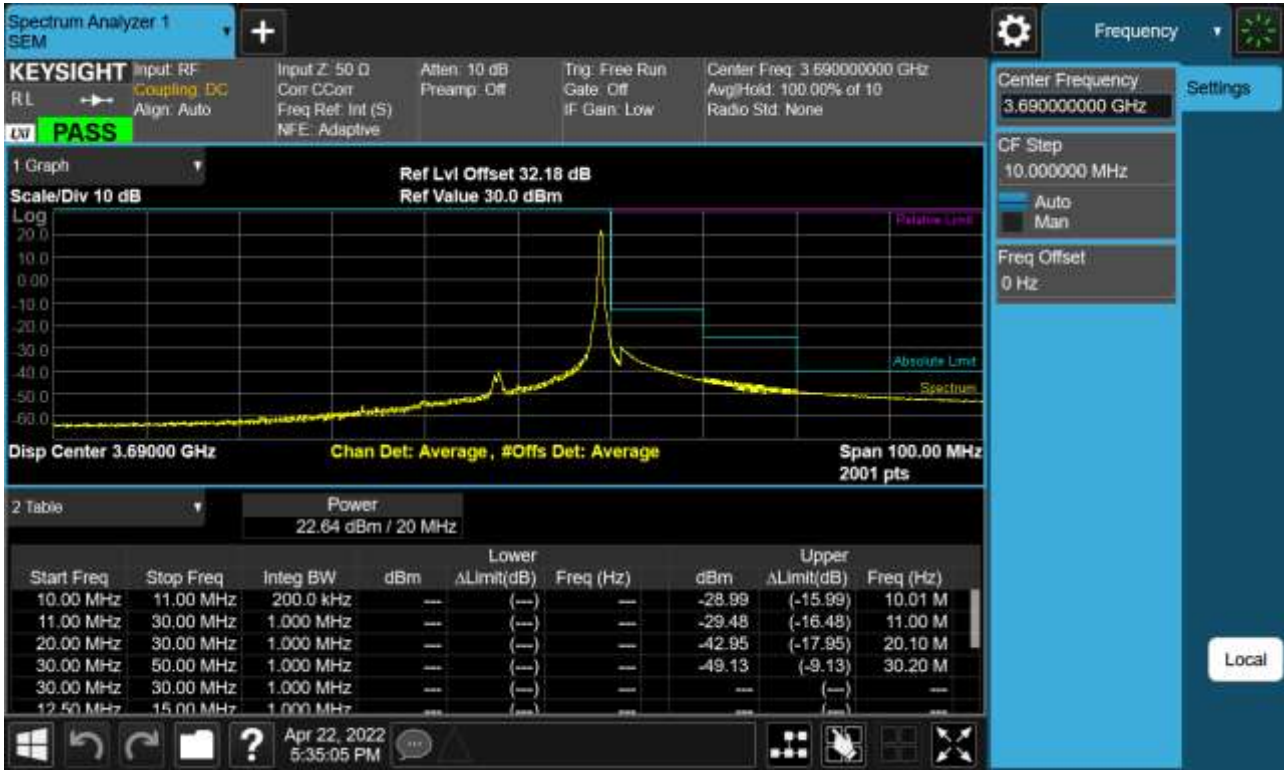

BAND 48. Conducted Spurious Plot 1 (5 MHz Ch.55265 QPSK RB 1, Offset 0)



BAND 48. Conducted Spurious Plot 2 (5 MHz Ch. 55265 QPSK RB 1, Offset 0)

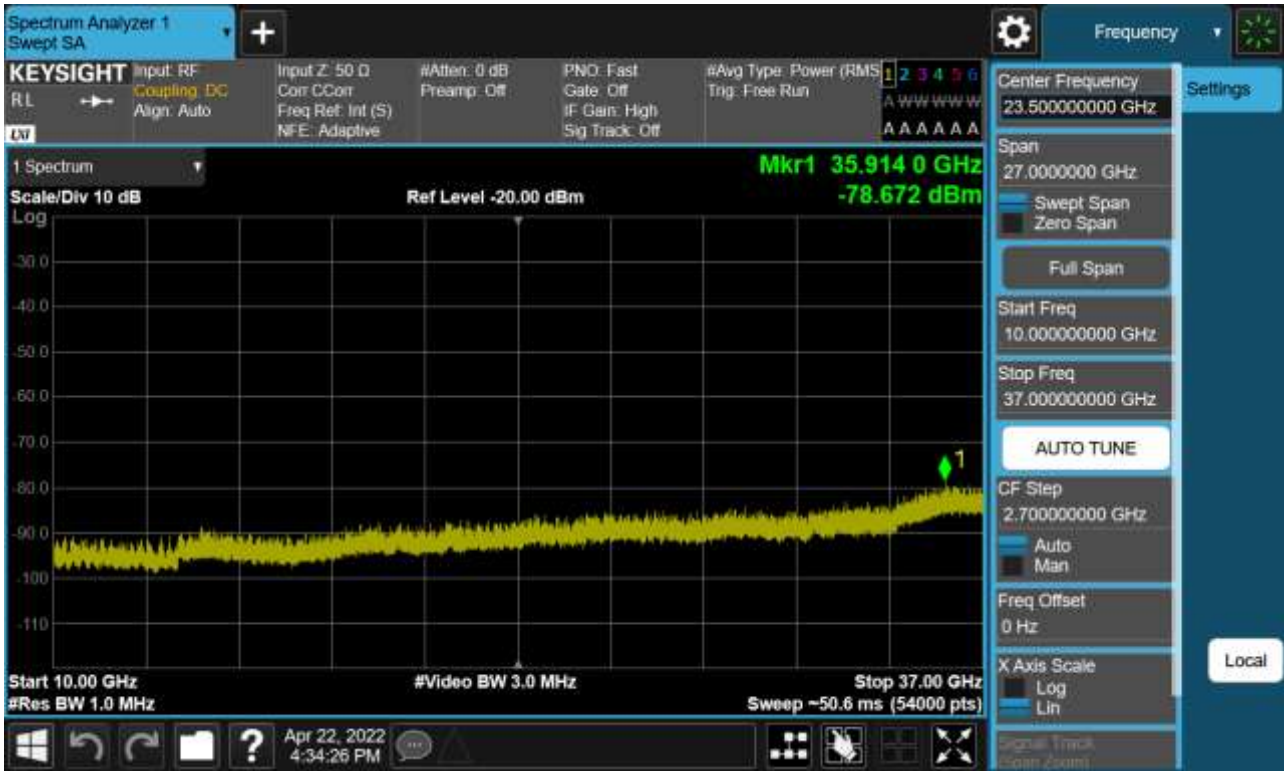

BAND 48. Conducted Spurious Plot 1 (5 MHz Ch.5590 QPSK RB 1, Offset 0)



BAND 48. Conducted Spurious Plot 2 (5 MHz Ch. 55990 QPSK RB 1, Offset 0)



BAND 48. Conducted Spurious Plot 1 (5 MHz Ch.56715 QPSK RB 1, Offset 0)



BAND 48. Conducted Spurious Plot 2 (5 MHz Ch. 56715 QPSK RB 1, Offset 0)

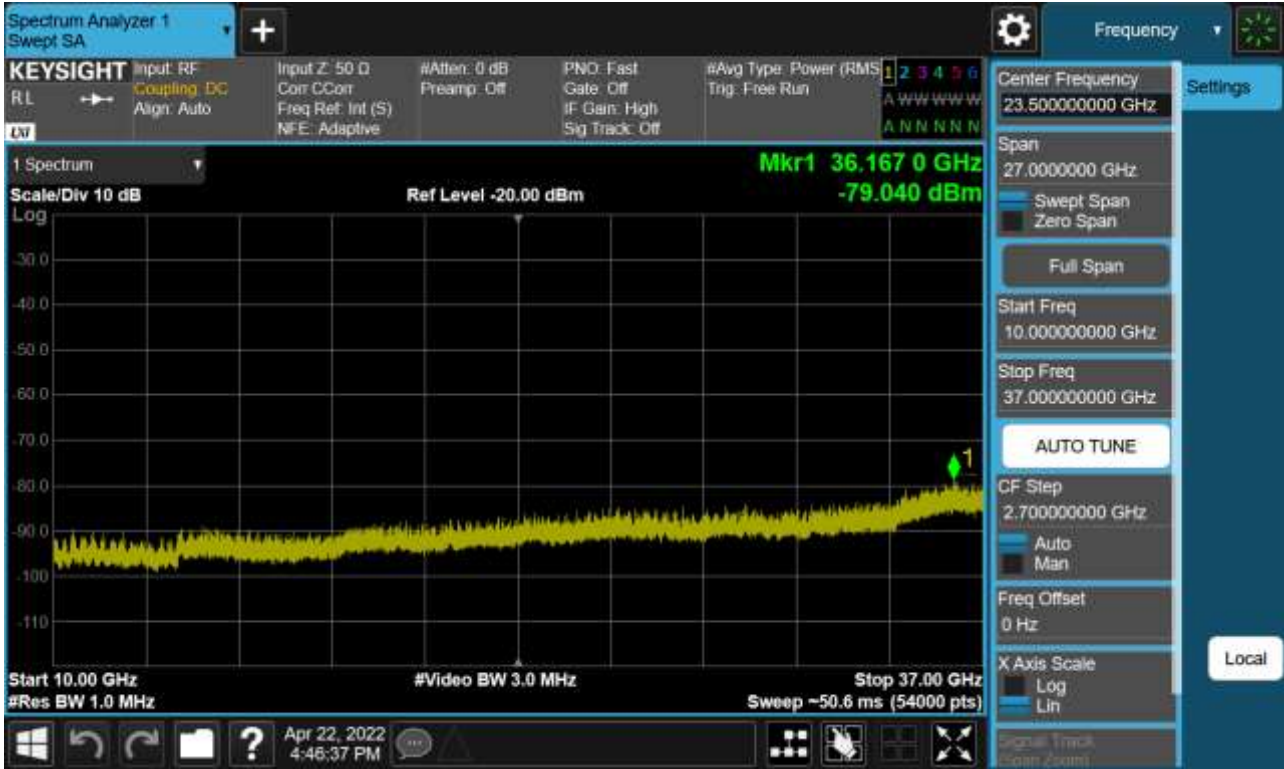

BAND 48. Conducted Spurious Plot 1 (10 MHz Ch.55290 QPSK RB 1, Offset 0)



BAND 48. Conducted Spurious Plot 2 (10 MHz Ch. 55290 QPSK RB 1, Offset 0)

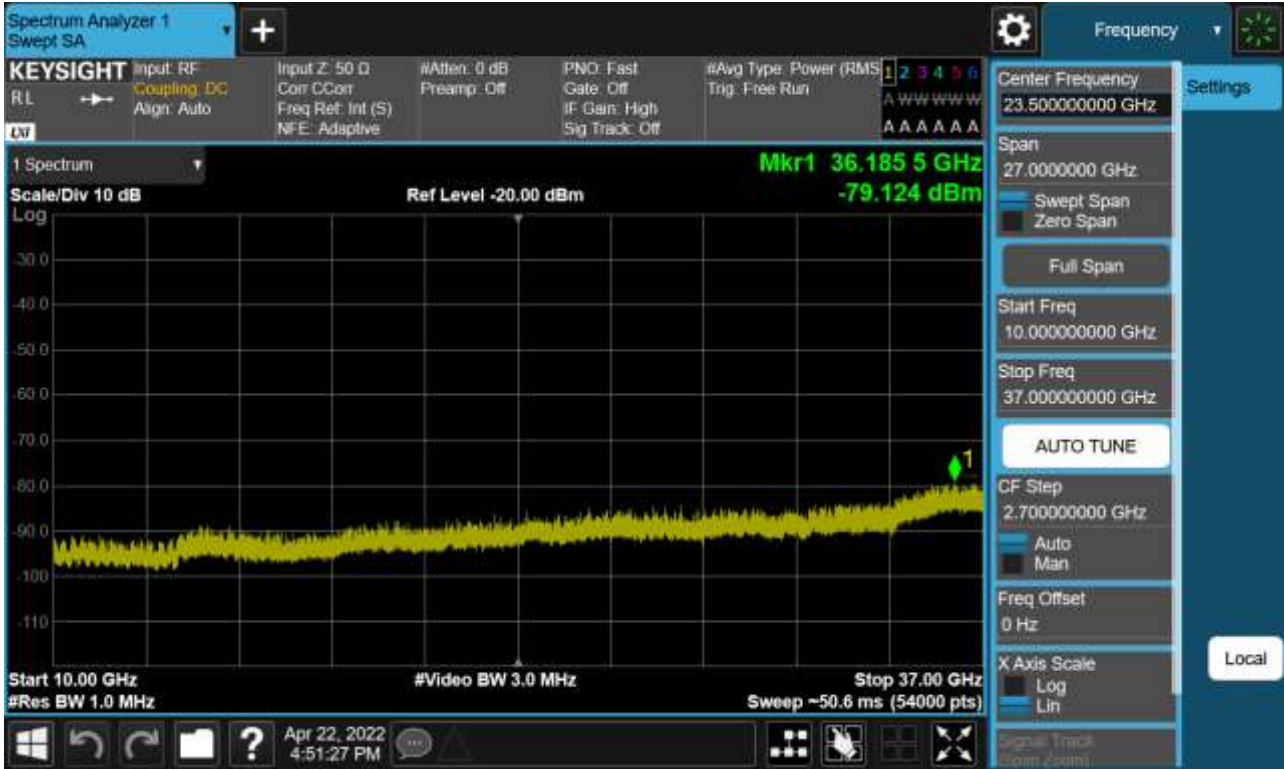

BAND 48. Conducted Spurious Plot 1 (10 MHz Ch.55990 QPSK RB 1, Offset 0)

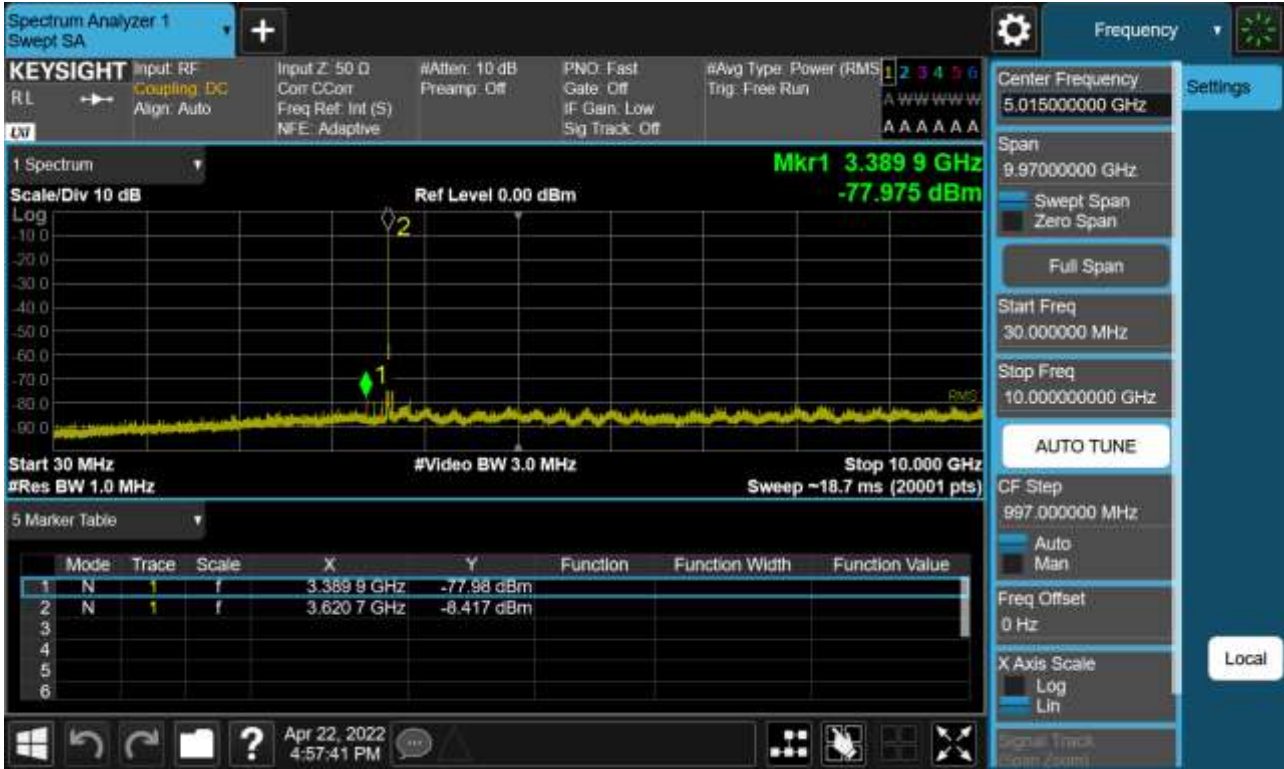

BAND 48. Conducted Spurious Plot 2 (10 MHz Ch. 55990 QPSK RB 1, Offset 0)

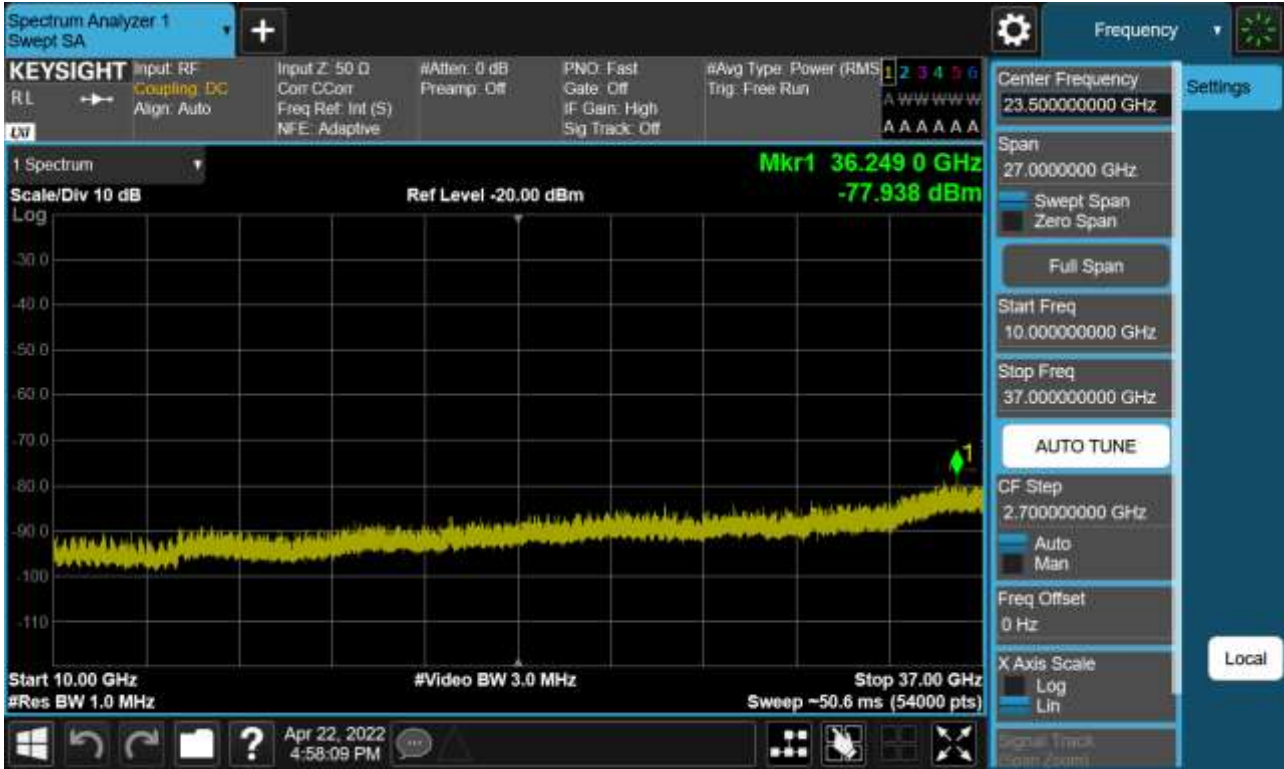

BAND 48. Conducted Spurious Plot 1 (10 MHz Ch. 56690 QPSK RB 1, Offset 0)



BAND 48. Conducted Spurious Plot 2 (10 MHz Ch. 56690 QPSK RB 1, Offset 0)

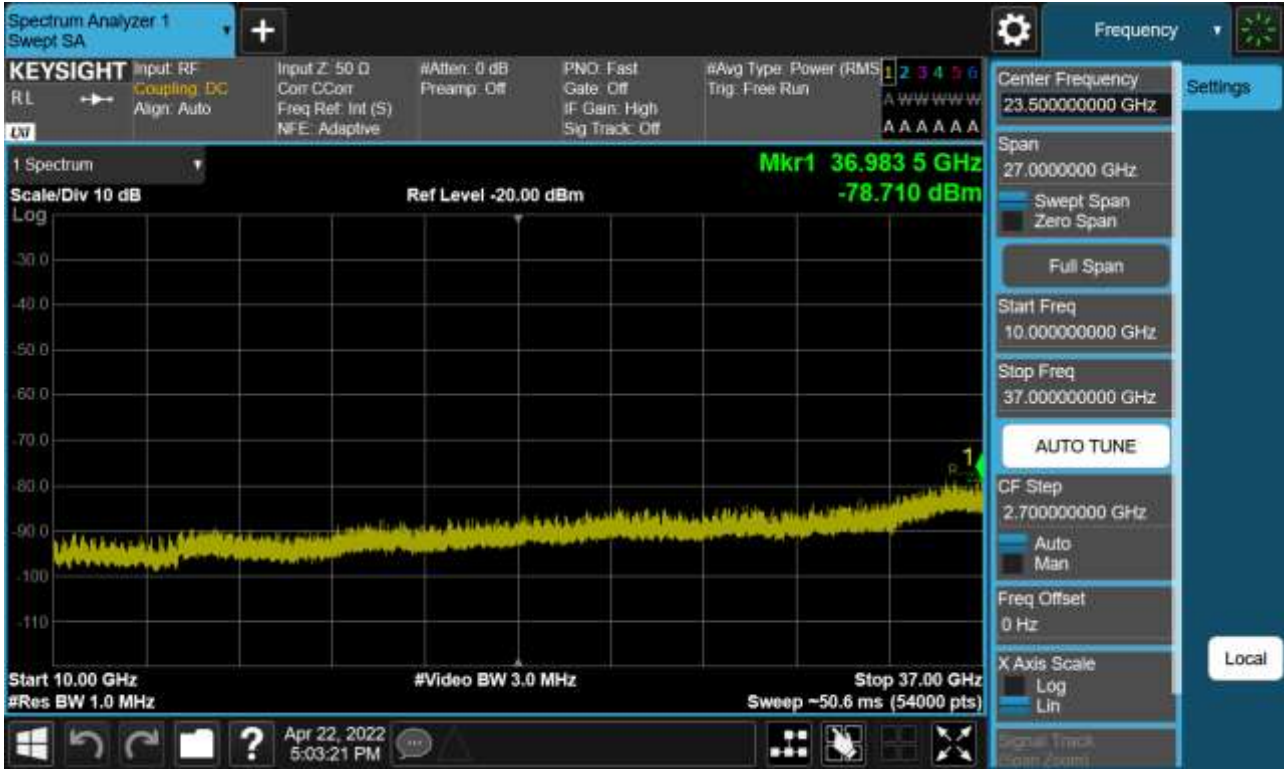

BAND 48. Conducted Spurious Plot 1 (15 MHz Ch.55315 QPSK RB 1, Offset 0)



BAND 48. Conducted Spurious Plot 2 (15 MHz Ch. 55315 QPSK RB 1, Offset 0)

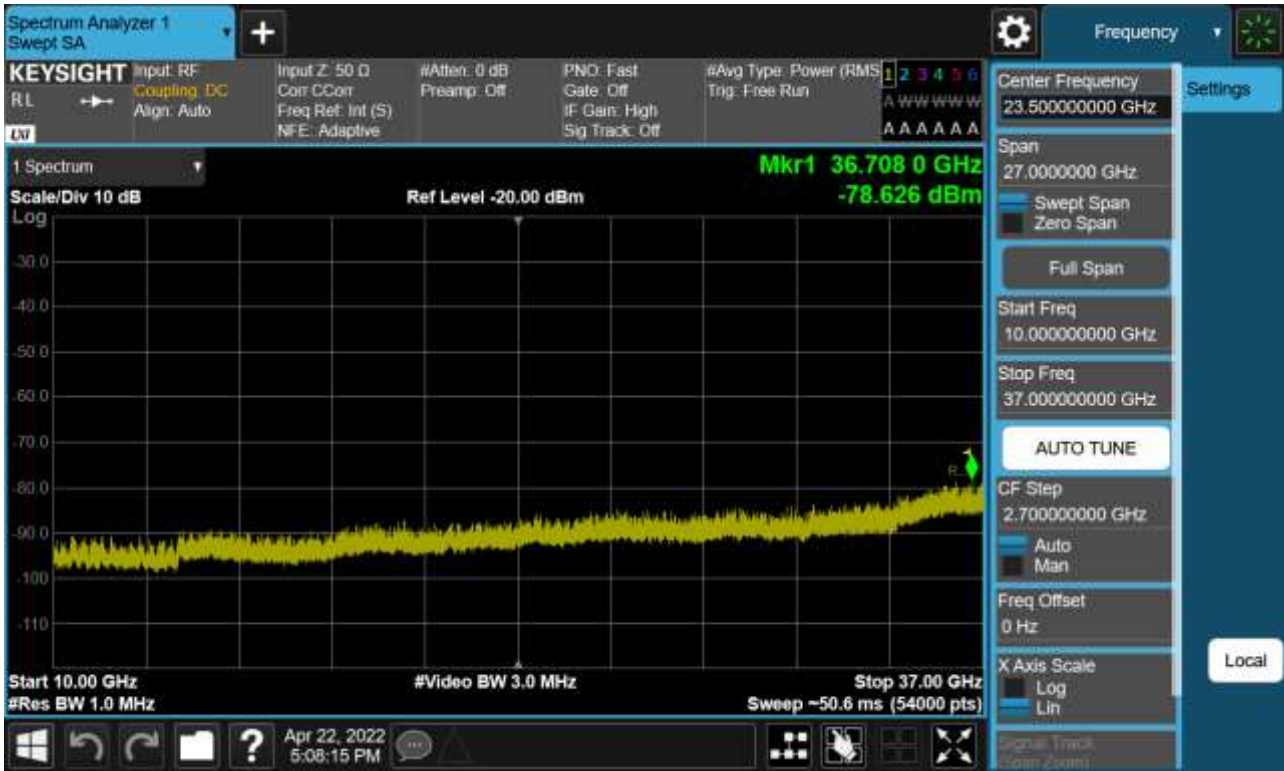

BAND 48. Conducted Spurious Plot 1 (15 MHz Ch.55990 QPSK RB 1, Offset 0)



BAND 48. Conducted Spurious Plot 2 (15 MHz Ch. 55990 QPSK RB 1, Offset 0)

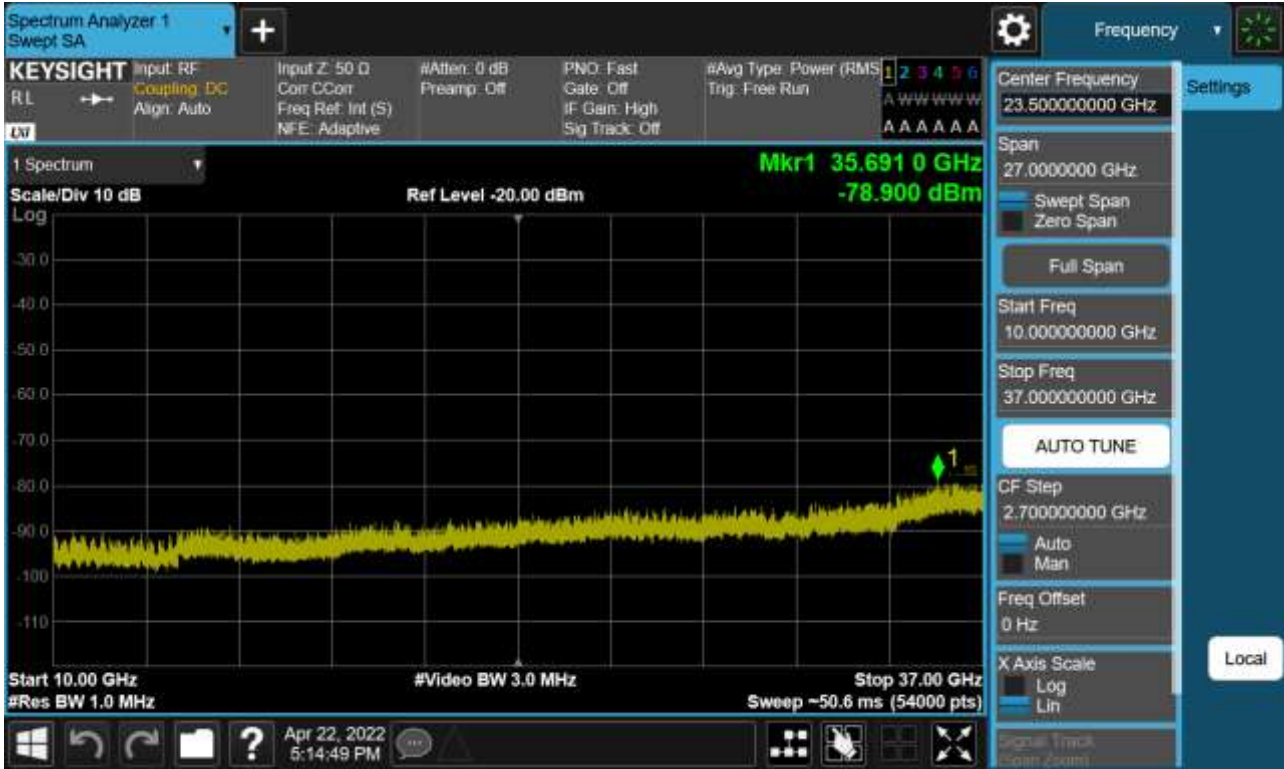

BAND 48. Conducted Spurious Plot 1 (15 MHz Ch.56665 QPSK RB 1, Offset 0)



BAND 48. Conducted Spurious Plot 2 (15 MHz Ch. 56665 QPSK RB 1, Offset 0)

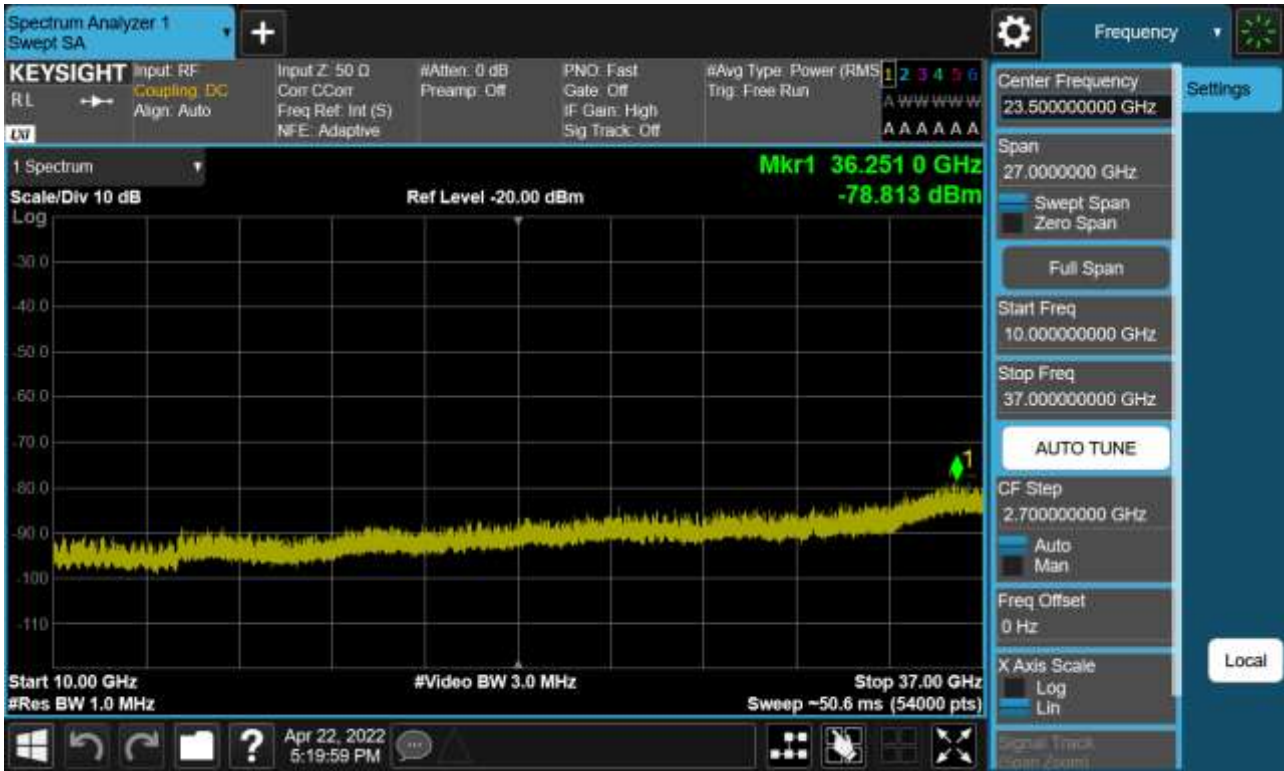

BAND 48. Conducted Spurious Plot 1 (20 MHz Ch.55340 QPSK RB 1, Offset 0)



BAND 48. Conducted Spurious Plot 2 (20 MHz Ch. 55340 QPSK RB 1, Offset 0)



BAND 48. Conducted Spurious Plot 1 (20 MHz Ch.55990 QPSK RB 1, Offset 0)

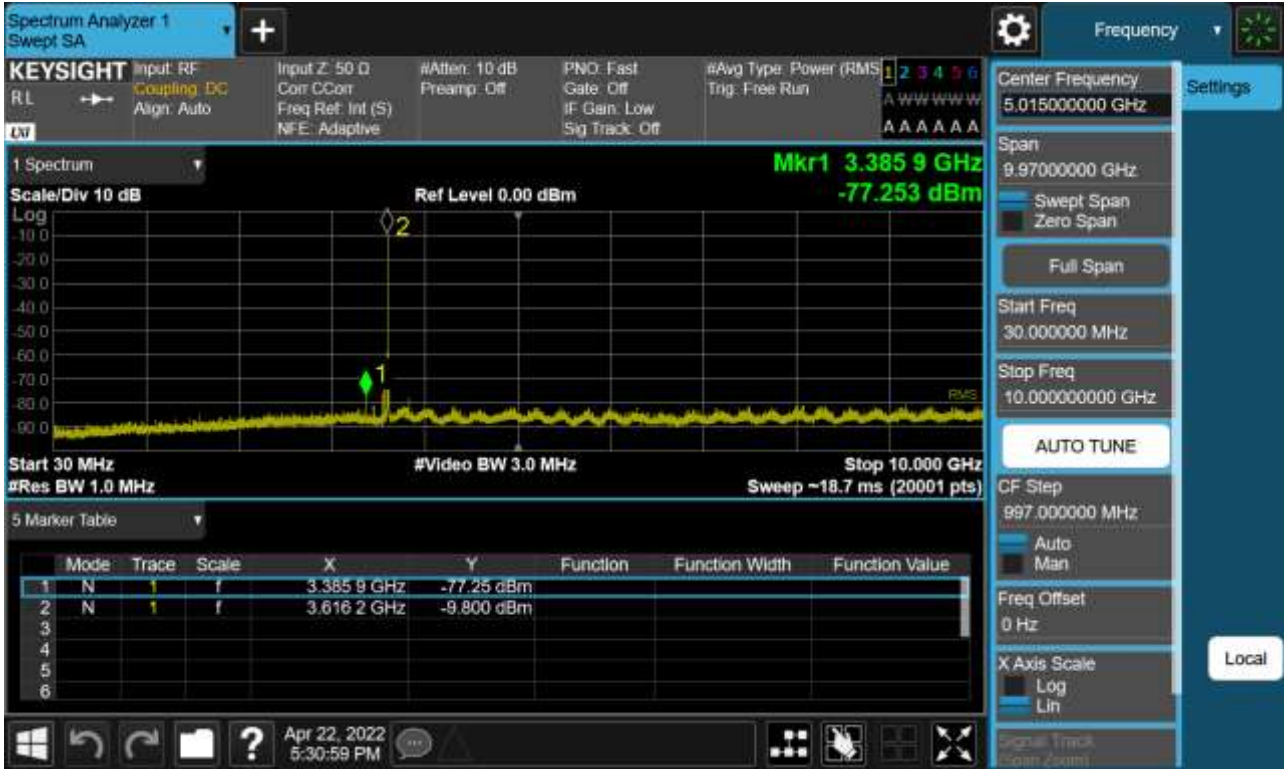

BAND 48. Conducted Spurious Plot 2 (20 MHz Ch. 55990 QPSK RB 1, Offset 0)

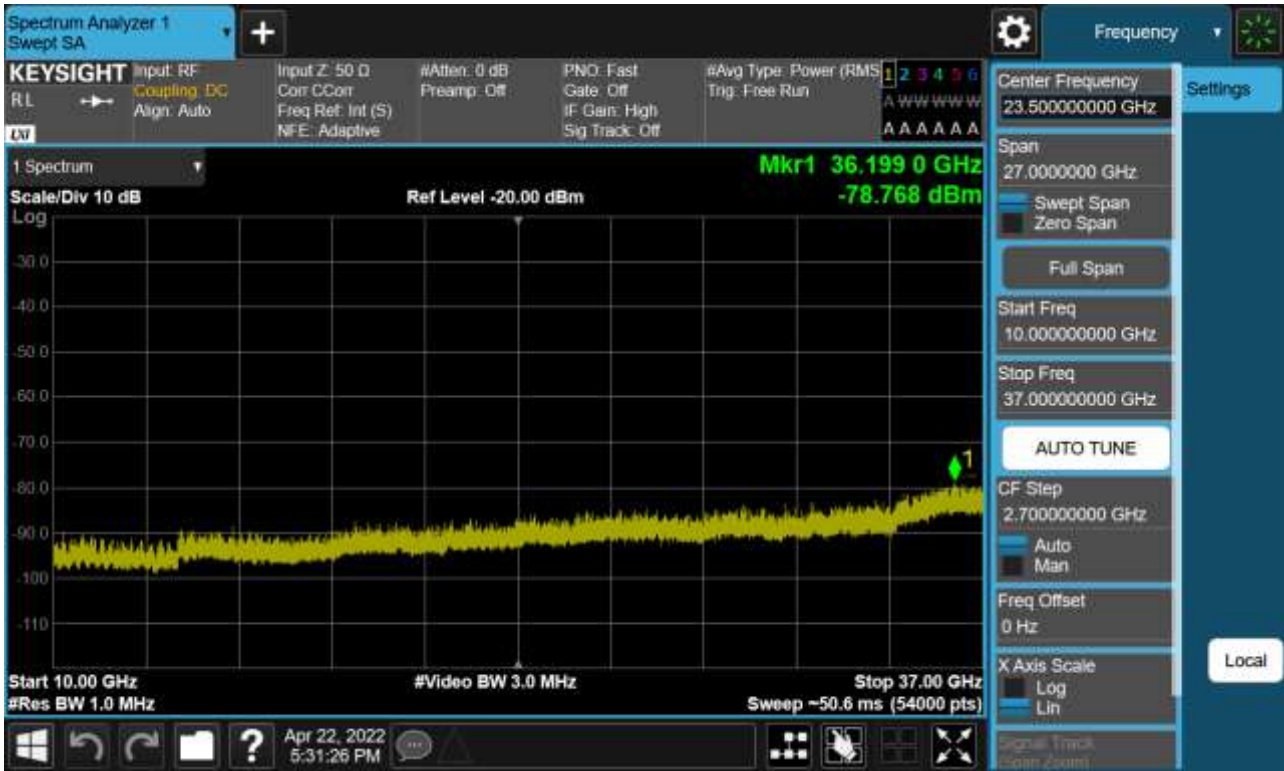

BAND 48. Conducted Spurious Plot 1 (20 MHz Ch.56640 QPSK RB 1, Offset 0)



BAND 48. Conducted Spurious Plot 2 (20 MHz Ch. 56640 QPSK RB 1, Offset 0)

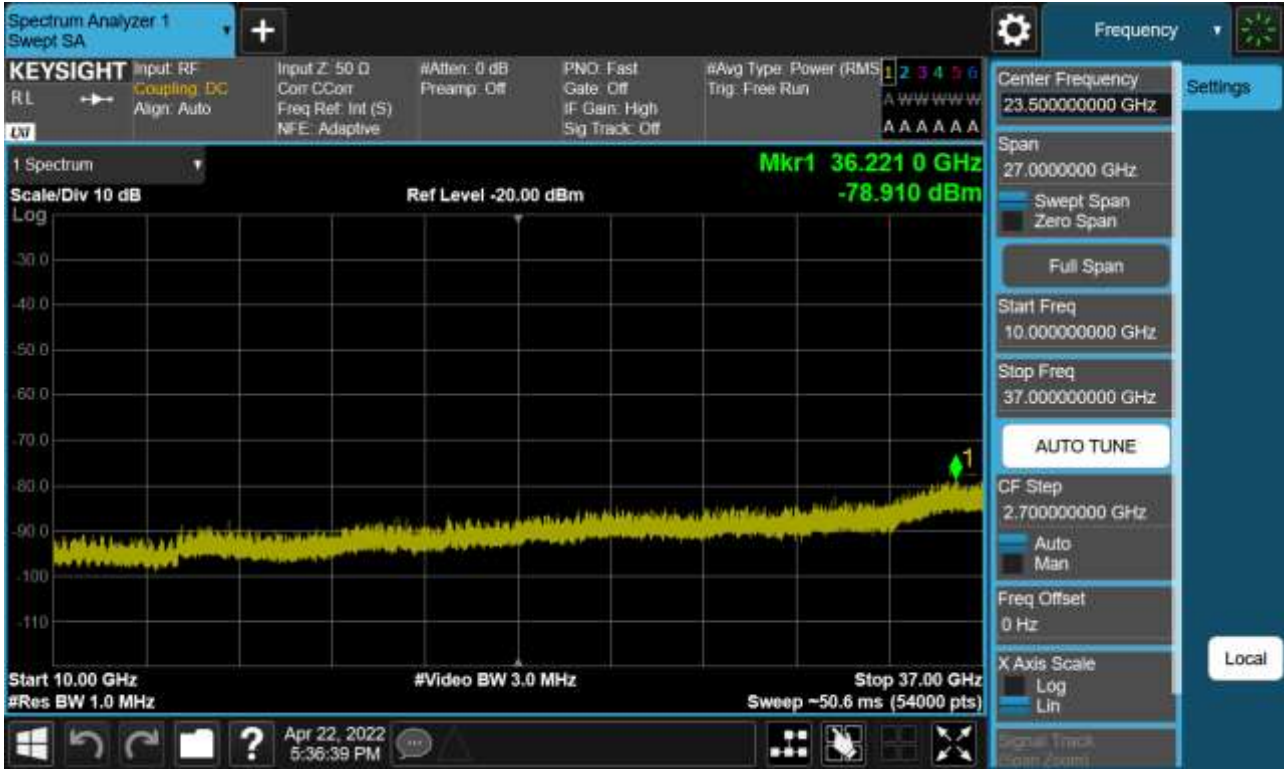

10. ANNEX A_ TEST SETUP PHOTO

Please refer to test setup photo file no. as follows;

No.	Description
1	HCT-RF-2205-FC065-P