



HCT Co., Ltd.
74, Seoicheon-ro 578beon-gil, Majang-myeon, Icheon-si, Gyeonggi-do, 17383 KOREA
Tel. +82 31 634 6300 Fax. +82 31 645 6401

PART 2 : RF Exposure Compliance Test Report

Applicant Name: SAMSUNG Electronics Co., Ltd. 129, Samsung-ro, Yeongtong-gu, Suwon-Si, Gyeonggi-do, 16677 Rep. of Korea	Date of Issue: May. 16, 2022 Test Report No.: HCT-SR-2205-FC010 Test Site: HCT CO., LTD.
--	---

FCC ID:

A3LSMG736U

Equipment Type:	Mobile Phone
Application Type:	Certification
FCC Rule Part(s):	CFR §2.1093
Model Name:	SM-G736U
Additional Model Name:	SM-G736U1
Date of Test:	May.09, 2022~ May.12, 2022
Results:	Pass

I attest to the accuracy of data. All measurements reported herein were performed by me or were made under my supervision and are correct to the best of my knowledge and belief. I assume full responsibility for the completeness of these measurements and vouch for the qualifications of all persons taking them.

Tested By

Jee-ILL, Lee
Test Engineer
SAR Team
Certification Division

Reviewed By

Yun-jeang, Heo
Technical Manager
SAR Team
Certification Division

This report only responds to the tested sample and may not be reproduced, except in full, without written approval of the HCT Co., Ltd.

REVISION HISTORY

The revision history for this test report is shown in table.

Revision No.	Date of Issue	Description
0	May. 16, 2022	Initial Release

This test results were applied only to the test methods required by the standard.

The above Test Report is not related to the accredited test result by (KS Q) ISO/IEC 17025 and KOLAS(Korea Laboratory Accreditation Scheme), which signed the ILAC-MRA.

Table of Contents

1. RF Exposure Limits	4
2. Test Location.....	6
3. Information of the DUT.....	7
4. Tx Varying Transmission Test Cases and Test Proposal	10
5. SAR Time Averaging Validation Test Procedures.....	13
6. Test Configurations	24
7. Time-varying Tx power measurement for below 6GHz frequency	27
8. Equipment List.....	53
9. Conclusion	54
Appendix A: Test Sequences	55
Appendix B:Test Procedures for sub6 NR + LTE Radio	57
Appendix C:Test setup Photo	

1. RF Exposure Limits

1.1 RF Exposure Limits for Frequencies < 6 GHz

HUMAN EXPOSURE	UNCONTROLLED ENVIRONMENT General Population (W/kg) or (mW/g)	CONTROLLED ENVIRONMENT Occupational (W/kg) or (mW/g)
SPATIAL PEAK SAR * (Partial Body)	1.6	8.0
SPATIAL AVERAGE SAR ** (Whole Body)	0.08	0.4
SPATIAL PEAK SAR *** (Hands / Feet / Ankle / Wrist)	4.0	20.0

NOTES:

- * The Spatial Peak value of the SAR averaged over any 1 g of tissue (defined as a tissue volume in the shape of a cube) and over the appropriate averaging time.
- ** The Spatial Average value of the SAR averaged over the whole-body.
- *** The Spatial Peak value of the SAR averaged over any 10 g of tissue (defined as a tissue volume in the shape of a cube) and over the appropriate averaging time.

Uncontrolled Environments are defined as locations where there is the exposure of individuals who have no knowledge or control of their exposure. The general population/uncontrolled exposure limits are applicable to situations in which the general public may be exposed or in which persons who are exposed as a consequence of their employment may not be mad fully aware of the potential for exposure or cannot exercise control over their exposure. Members of the general public would come under this category when exposure is not employment-related; for example, in the case of a wireless transmitter that exposes persons in its vicinity.

Controlled Environments are defined as locations where there is exposure that may be incurred by persons who are aware of the potential for exposure, (i.e.as a result of employment or occupation). In general, occupational/controlled exposure limits are applicable to situations in which persons are exposed as a consequence of their employment, who have been made fully aware of the potential for exposure and can exercise control over their exposure. This exposure category is also applicable when the exposure is of a transient nature due to incidental passage through a location where the exposure levels may be higher than the general population/uncontrolled limits, but the exposed person is fully aware of the potential for exposure and can exercise control over his or her exposure by leaving the area or by some other appropriate means.

1.2 RF Exposure Limits for Frequencies > 6 GHz

Per §1.1310 (d)(3), the MPE limits are applied for frequencies above 6 GHz. Power Density is expressed in units of W/m^2 or mW/cm^2 .

Peak Spatially Averaged Power Density was evaluated over a circular area of 4 cm^2 per interim FCC Guidance for near-field power density evaluations per October 2018 TCB Workshop notes

Frequency range (MHz)	Power density (mW/cm^2)	Averaging time (minutes)
(A) Limits for Occupational/Controlled Exposure		
1,500-100,000	5	6
(B) Limits for General Population/Uncontrolled Exposure		
1,500-100,000	1	30

Note: 1.0 mW/cm^2 is 10 W/m^2

1.3 Interim Guidance for Time Averaging

Per October 2018 TCB Workshop Notes, the below time-averaging windows can be used for assessing time-averaged exposures for devices that are capable of actively monitoring and adjusting power output over time to comply with exposure limits.

Interim Guidance	Frequency (GHz)	Maximum Averaging Time (sec)
SAR	< 3	100
	3 – 6	60
MPE	6 - 10	30
	10 - 16	14
	16 – 24	8
	24 – 42	4
	42 – 95	2

2. Test Location

2.1 Test Laboratory

Company Name	HCT Co., Ltd.
Address	74, Seoicheon-ro 578beon-gil, Majang-myeon, Icheon-si, Gyeonggi-do, 17383 KOREA
Telephone	031-645-6300
Fax.	031-645-6401

2.2 Test Facilities

Our laboratories are accredited and approved by the following approval agencies according to ISO/IEC 17025.

Korea	National Radio Research Agency (Designation No. KR0032)
	KOLAS (Testing No. KT197)

3. Information of the DUT

3.1 DUT Specification overview

Model Name	SM-G736U
Additional Model Name	SM-G736U1
Equipment Type	Mobile Phone
FCC ID	A3LSMG736U
Application Type	Certification
Applicant	SAMSUNG Electronics Co., Ltd.

Band & Mode	Operating Mode	Tx Frequency
GSM850	Voice / Data	824.2 MHz~ 848.8 MHz
GSM1900	Voice / Data	1 850.2 MHz~ 1 909.8 MHz
UMTS 850	Voice / Data	826.4 MHz~ 846.6 MHz
UMTS 1700	Voice / Data	1 712.4 MHz~ 1 752.6 MHz
UMTS 1900	Voice / Data	1 852.4 MHz~ 1 907.6 MHz
LTE Band 2 (PCS)	Voice / Data	1 850.7 MHz~ 1 909.3 MHz
LTE Band 4 (AWS)	Voice / Data	1 710.7 MHz~ 1 754.3 MHz
LTE Band 5 (Cell)	Voice / Data	824.7 MHz~ 848.3 MHz
LTE Band 7	Voice / Data	2 502.5 MHz~ 2 567.5 MHz
LTE Band 12	Voice / Data	699.7 MHz~ 715.3 MHz
LTE Band 13	Voice / Data	779.5 MHz~ 784.5 MHz
LTE Band 14	Voice / Data	790.5 MHz~ 795.5 MHz
LTE Band 25	Voice / Data	1 850.7 MHz~ 1 914.3 MHz
LTE Band 26	Voice / Data	814.7 MHz~ 848.3 MHz
LTE Band 30	Voice / Data	2 307.5 MHz ~ 2 312.5 MHz
LTE TDD Band 38	Voice / Data	2 572.5 MHz ~ 2 617.5 MHz
LTE TDD Band 40	Voice / Data	2 302.5 MHz ~ 2 397.5 MHz
LTE TDD Band 41	Voice / Data	2 498.5 MHz~ 2 687.5 MHz
LTE TDD Band 48	Voice / Data	3 552.5 MHz~ 3697.5 MHz
LTE Band 66 (AWS)	Voice / Data	1 710.7 MHz ~ 1 779.3 MHz
LTE Band 71	Voice / Data	665.5 MHz~ 695.5 MHz
NR Band n2 (PCS)	Voice / Data	1 852.5 MHz~ 1 907.5 MHz
NR Band n5 (Cell)	Voice / Data	826.5 MHz~ 846.5 MHz
NR Band n12	Voice / Data	701.5 MHz~ 713.5 MHz
NR Band n25	Voice / Data	1852.5 MHz ~ 1912.5 MHz
NR Band n25	Voice / Data	1852.5 MHz ~ 1912.5 MHz
NR Band n41	Voice / Data	2 506.02 MHz~ 2 679.99 MHz
NR Band n66	Voice / Data	1 712.5 MHz~ 1 777.5 MHz
NR Band n71	Voice / Data	665.5 MHz - 695.5 MHz
NR Band n77	Voice / Data	3 710 MHz~ 3 969.99 MHz
U-NII-1	Voice / Data	5 180 MHz ~ 5 240 MHz
U-NII-2A	Voice / Data	5 260 MHz ~ 5 320 MHz
U-NII-2C	Voice / Data	5 500 MHz ~ 5 720 MHz
U-NII-3	Voice / Data	5 745 MHz ~ 5 825 MHz
2.4 GHz WLAN	Voice / Data	2 412 MHz ~ 2 462 MHz
U-NII-5	Data	5 955 MHz – 6 425 MHz
U-NII-6	Data	6 425 MHz – 6 525 MHz
U-NII-7	Data	6 525 MHz – 6 875 MHz
U-NII-8	Data	6 875 MHz – 7 115 MHz
Bluetooth / LE 5.2	Data	2 402 MHz ~ 2 480 MHz
NFC	Data	13.56 MHz
Device Serial Numbers	Mode	Serial Number
	2G/3G/4G	VDB1706M
	5G Sub 6 NR	VDB1698M
The manufacturer has confirmed that the devices tested have the same physical, mechanical and thermal characteristics are within operational tolerances expected for production units.		

Measurement Plot SummaryTable

Test Case#	Test Scenario	Tech	Band	Antenna	DSI	Channel	Frequency	Conducted Plot No.	SAR Plot No.
1	Time-varying Tx. power transmission (Conducted Power, SAR)	LTE	B66	Main 2	2	132072	1720	1	
2			B48	Sub 3	1	55340	3560	2	
3		UMTS	B2	Main 2	2	9400	1880	3	
4		GPRS	1900	Main 2	2	661	1880	4	
5		Sub6 NR	n66	Main 2	2	349000	1745	5	
6		Sub6 NR	n25	Main 2	2	376500	1882.5	6	
7	Change in Call	LTE	B48	Sub 3	2	55340	3560	7	
8	Tech/Band Switch	LTE	B66	Main 2	2	132072	1720	8	
		UMTS	B2	Main 2	2	9400	1880		
9	DSI Switch	LTE	B48	Sub 3	0	55773	3603.3	9	
					1	55340	3560		
10	Time Window/Antenna Switch	LTE	B66	Main 2	2	132072	1720	10,11	
			B48	Sub 3	2	56207	3646.7		
11	SAR1 vs SAR2	LTE	B13	Main 1	2	23230	782	12	
		Sub6 NR	n66	Main 2	2	349000	1745		

3.2 Test Under Dynamic Transmission Condition for RF Exposure Compliance

This feature performs time averaging algorithm in real time to control and manage transmitting power and ensure the time-averaged RF exposure is in compliance with FCC requirements all the time.

The Smart Transmit algorithm maintains the time-averaged transmit power, in turn, time-averaged RF exposure of SAR_design_target for sub 6 radio or PD_design_target for 5G mmW NR, below the predefined time averaged power limit for each characterized technology and band.

Smart Transmit allows the device to transmit at higher power instantaneously, as high as Pmax, when needed, but enforces power limiting to maintain time-averaged transmit power to Plimit for frequencies < 6 GHz and input.power.limit for frequencies > 6 GHz.

Note that the device uncertainty for sub 6GHz WWAN is 1.0dB for this DUT and the reserve power margin is 3 dB.

This purpose of the Part 2 report is to demonstrate the DUT complies with FCC RF exposure requirement under Tx varying transmission scenarios, thereby validity of Qualcomm® Smart Transmit feature implementation in this device. It serves to compliment the Part 0 and Part 1 Test Reports to justify compliance per FCC

All Part 2 tests of this device were conducted according to the guidelines of the Qualcomm document 80-W2112-5 Rev. T

■ Test case reduction for multiple filings

Per the Guidance of the FCC and Qualcomm (Document No: 80-W2112-5 Rev. T, Sec.4.2,)

For multiple filings with same chipset, the test case reduction proposal for Part 2 testing is:

1. Full set of tests in the first filing, i.e., both power measurement and RF exposure measurement, are required.
2. For all subsequent filings with the same chipset, only power measurement (scenarios (a) – (h)) is required. In the case of scenario (a) time-varying Tx transmission test, only one band (instead of two bands) per technology is sufficient

■ **Regulatory body configuration:**

Based on regulatory requirement for each countries/regions, FCC time window/limits and/or ICNIRP 1998 time window/limits can be selected and/or combined. Additionally, Time-Averaged Exposure mode or Peak Exposure mode can be selected based on MCC for Smart Transmit to operate. In Time-Averaged Exposure mode, the wireless device can instantaneously transmit at high transmit powers and exceed the Plimit for a short duration before limiting the power to maintain the time-averaged transmit power under the Plimit; while in Peak Exposure mode, the maximum instantaneous transmit power is limited to Plimit. Depending on EFS version, regulatory body configuration is different.

■ **force peak for Tx transmitting frequency**

The Smart Transmit feature applies time-averaging windows when the device detects an MCC that matches Time-Averaged Exposure MCCs list. For each of the MCCs under Time-Averaged Exposure MCCs list, the Smart Transmit feature can limit either maximum peak power or maximum time-average power to Plimit per tech/band/antenna/DSI. If force peak is set to '1' for a given tech/band/antenna/DSI in the EFS, then the Smart Transmit feature limits the maximum Tx power to Plimit for the selected tech/band/antenna/DSI. In other words, with force peak set to '1', under static condition (i.e., fixed tech/band/antenna/DSI) and in single active Tx scenario, Smart Transmit can guarantee Tx power level of Plimit at all times.

The EFS Version of A3LSMG736U is EFS ver.16

This device was tested in part 2 of Tx Varying transmission(Time-Averaged Exposure mode) testing using US MCC (310).and MCC , '1' was used to test the peak exposure mode.

4. Tx Varying Transmission Test Cases and Test Proposal

To validate time averaging feature and demonstrate the compliance in Tx varying transmission conditions, the following transmission scenarios are covered in Part 2 test:

1. During a time-varying Tx power transmission: To prove that the Smart Transmit feature accounts for Tx power variations in time accurately.
2. During a call disconnect and re-establish scenario: To prove that the Smart Transmit feature accounts for history of past Tx power transmissions accurately.
3. During technology/band handover: To prove that the Smart Transmit feature functions correctly during transitions in technology/band.
4. During DSI (Device State Index) change: To prove that the Smart Transmit feature functions correctly during transition from one device state (DSI) to another.
5. During antenna (or beam) switch: To prove that the Smart Transmit feature functions correctly during transitions in antenna (such as AsDiv scenario) or beams (different antenna array configurations).
7. During time window switch: To prove that the Smart Transmit feature correctly handles the transition from one time window to another specified by FCC, and maintains the normalized time-averaged RF exposure to be less than normalized FCC limit of 1.0 at all times.
8. SAR exposure switching between two active radios (radio1 and radio2): To prove that the Smart Transmit feature functions correctly and ensures total RF exposure compliance when exposure varies among SAR_radio1 only, SAR_radio1 + SAR_radio2, and SAR_radio2 only scenarios.

As described in Part 0 report, the RF exposure is proportional to the Tx power for a SAR- and PD-characterized wireless device. Thus, feature validation in Part 2 can be effectively performed through conducted (for $f < 6\text{GHz}$) and radiated (for $f \geq 6\text{GHz}$) power measurement. Therefore, the compliance demonstration under dynamic transmission conditions and feature validation are done in conducted/radiated power measurement setup for transmission scenario 1 through 8.

■ Test case reduction for multiple filings

Per Qualcomm Document(80-W2112-5 Rev. T ,Sec 4.2 , For Multiple variants which uses the same chipset. -the same chipset and Smart Transmit algorithm are used in the new model- the number of test cases in Part 2 can be reduced in the case of multiple filings using same chipset (post full part 2 test on the first filing), i.e., the essential test cases in power measurement are required to ensure the Smart Transmit performs as expected in the new design, but the RF exposure measurement can be excluded.

Furthermore, as described in Section 5.2.1 of 80-W2112-5 Rev. T, for scenario (a), two bands per technology are selected for time-varying Tx transmission test to provide high confidence. In this case, one band per technology can be considered as well to reduce test cases further

The strategy for testing in Tx varying transmission condition is outlined as follows:

Demonstrate the total RF exposure averaged over FCC defined time windows does not exceed FCC's SAR and PD limits, through time-averaged power measurements

Measure conducted Tx power (for $f < 6\text{GHz}$) versus time, and radiated Tx power (EIR Pfor $f > 10\text{GHz}$) versus time.

Convert it into RF exposure and divide by respective FCC limits to get normalized exposure versus time.

Perform running time-averaging over FCC defined time windows.

Demonstrate that the total normalized time-averaged RF exposure is less than 1 for all transmission scenarios (i.e., transmission scenarios 1, 2, 3, 4, 5, 6, 7, and 8) at all times.

Mathematical expression:

– For sub-6 transmissions only:

$$1g_or_10gSAR(t) = \frac{conducted_Tx_power(t)}{conducted_Tx_power_Plimit} * 1g_or_10gSAR_Plimit \quad (1a)$$

$$\frac{\frac{1}{TSAR} \int_{t-TSAR}^t 1g_or_10gSAR(t) dt}{FCC\ SAR\ limit} \leq 1 \quad (1b)$$

where, $conducted_Tx_power(t)$, $conducted_Tx_power_Plimit$, and $1g_or_10gSAR_Plimit$ correspond to the measured instantaneous conducted Tx power, measured conducted Tx power at Plimit, and measured 1gSAR or 10gSAR values at Plimit corresponding to sub-6 transmission. Similarly, $radiated_Tx_power(t)$, $radiated_Tx_power_input_power_limit$, and $4cm^2PD_input_power_limit$ correspond to the measured instantaneous radiated Tx power, radiated Tx power at input.power.limit (i.e., radiated power limit), and 4cm2PD value at input.power.limit corresponding to mmW transmission. Both Plimit and input.power.limit are the parameters pre-defined in Part 0 and loaded via Embedded File System (EFS) onto the EUT. TSAR is the FCC defined time window for sub-6 radio; TPD is the FCC defined time window for mmW radio.

Demonstrate the total RF exposure averaged over FCC defined time windows does not exceed FCC's SAR and PD limits, through time-averaged SAR and PD measurements. Note as mentioned earlier, this measurement is performed for transmission scenario 1 only.

For sub-6 transmission only, measure instantaneous SAR versus time; for LTE+sub6 NR transmission, request low power (or all-down bits) on LTE so that measured SAR predominantly corresponds to sub6NR.

Convert it into RF exposure and divide by respective FCC limits to obtain normalized exposure versus time. Perform time averaging over FCC defined time window.

Demonstrate that the total normalized time-averaged RF exposure is less than 1 for transmission scenario 1 at all times.

Mathematical expression:

- For sub-6 transmission only:

$$1g_or_10gSAR(t) = \frac{pointSAR(t)}{pointSAR_Plimit} * 1g_or_10gSAR_Plimit \quad (3a)$$

$$\frac{\frac{1}{T_{SAR}} \int_{t-T_{SAR}}^t 1g_or_10gSAR(t) dt}{FCC\ SAR\ limit} \leq 1 \quad (3b)$$

- For LTE+mmW transmission:

$$1g_or_10gSAR(t) = \frac{conducted_Tx_power(t)}{conducted_Tx_power_Plimit} * 1g_or_10gSAR_Plimit \quad (4a)$$

$$4cm^2PD(t) = \frac{[pointE(t)]^2}{[pointE_input.power.limit]^2} * 4cm^2PD_input.power.limit \quad (4b)$$

$$\frac{\frac{1}{T_{SAR}} \int_{t-T_{SAR}}^t 1g_or_10gSAR(t) dt}{FCC\ SAR\ limit} + \frac{\frac{1}{T_{PD}} \int_{t-T_{PD}}^t 4cm^2PD(t) dt}{FCC\ 4cm^2PD\ limit} \leq 1 \quad (4c)$$

where, pointSAR(t), PointSAR_Plimit and 1g_or_10gSAR_Plimit correspond to the measured instantaneous point SAR, measured.

point SAR at Plimit, and measured 1gSAR or 10gSAR values at Plimit corresponding to sub-6 transmission.

Similarly, pointE(t), pointE_input.power.limit and 4cm²PD_input.power.limit correspond to the measured instantaneous E-field, E-field at input.power.limit, and 4cm²PD value at input.power.limit corresponding to mmW transmission.

Note: cDASY6 measurement system by Schmid & Partner Engineering AG (SPEAG) of Zurich, Switzerland measures relative E-field, and provides ratio of [pointE(t)]²/[pointE_input.power.limit]² versus time

5. SAR Time Averaging Validation Test Procedures

This chapter provides the test plan and test procedure for validating Qualcomm Smart Transmit feature for sub-6 transmission. The 100 seconds time window for operating $f < 3\text{GHz}$ is used as an example to detail the test procedures in this chapter. The same test plan and test procedures described in this chapter apply to 60 seconds time window for operating $f \geq 3\text{GHz}$.

5.1 Test sequence determination for validation

Following the FCC recommendation, two test sequences having time-variation in Tx power are predefined for sub-6 ($f < 6\text{GHz}$) validation:

Test sequence 1: request EUT's Tx power to be at maximum power, measured P_{max}^\dagger , for 80s, then requesting for half of the maximum power, i.e., measured $P_{max}/2$, for the rest of the time.

Test sequence 2: request EUT's Tx power to vary with time. This sequence is generated relative to measured P_{max} , measured P_{limit} and calculated $Preserve$ (= measured P_{limit} in dBm - $Reserve_power_margin$ in dB) of EUT based on measured P_{limit} .

The details for generating these two test sequences is described and listed in Appendix A.

NOTE: For test sequence generation, "measured P_{limit} " and "measured P_{max} " are used instead of the " P_{limit} " specified in EFS entry and " P_{max} " specified for the device, because Smart Transmit feature operates against the actual power level of the " P_{limit} " that was calibrated for the EUT. The "measured P_{limit} " accurately reflects what the feature is referencing to, therefore, it should be used during feature validation testing. The RF tune up and device- to-device variation are already considered in Part 0 report prior to determining P_{limit} .

5.2 Test configuration selection criteria for validating Smart Transmit feature

For validating Smart Transmit feature, this section provides a general guidance to select test cases. In practice, an adjustment can be made in test case selection. The justification/clarification may be provided.

5.2.1 Test configuration selection for time-varying Tx power transmission

The Smart Transmit time averaging feature operation is independent of bands, modes, and channels for a given technology. Hence, validation of Smart Transmit in one band/mode/channel per technology is sufficient. Two bands per technology are proposed and selected for this testing to provide high confidence in this validation.

The criteria for the selection are based on the P_{limit} values determined in Part 0 report. Select two bands* in each supported technology that correspond to least** and highest*** P_{limit} values that are less than P_{max} for validating Smart Transmit.

*If one P_{limit} level applies to all the bands within a technology, then only one band needs to be tested. In this case, within the bands having the same P_{limit} , the radio configuration (e.g., # of RBs, channel#) and device position that correspond to the highest measured 1gSAR at P_{limit} shown in Part 1 report is selected.

** In case of multiple bands having the same least P_{limit} within the technology, The "least P_{limit} " term also implies that the technology/band with the largest difference between P_{max} and P_{limit} ($P_{limit} < P_{max}$) should be considered in the selection.

*** The band having a higher P_{limit} needs to be properly selected so that the power limiting enforced by Smart Transmit can be validated using the pre-defined test sequences. If the highest P_{limit} in a technology is too high where the power limiting enforcement is not needed when testing with the pre-defined test sequences, then the next highest level is checked. This process is continued within the technology until the second band for validation testing is determined.

5.2.2 Test configuration selection for change in call

The criteria to select a test configuration for call-drop measurement is:

Select technology/band with least P_{limit} among all supported technologies/bands, and select the radio configuration (e.g., # of RBs, channel#) in this technology/band that corresponds to the highest *measured* 1gSAR at P_{limit} listed in Part 1 report.

In case of multiple bands having same least P_{limit} , then select the band having the highest *measured* 1gSAR at P_{limit} in Part 1 report.

This test is performed with the EUT's Tx power requested to be at maximum power, the above band selection will result in Tx power enforcement (i.e., EUT forced to have Tx power at $P_{reserve}$) for longest duration in one FCC defined time window. The call change (call drop/reestablish) is performed during the Tx power enforcement duration (i.e., during the time when EUT is forced to have Tx power at $P_{reserve}$). One test is sufficient as the feature operation is independent of technology and band.

5.2.3 Test configuration selection for change in technology/band

The selection criteria for this measurement is, for a given antenna, to have EUT switch from a technology/band with lowest P_{limit} within the technology group (in case of multiple bands having the same P_{limit} , then select the band with highest *measured* 1gSAR at P_{limit}) to a technology/band with highest P_{limit} within the technology group, in case of multiple bands having the same P_{limit} , then select the band with lowest *measured* 1gSAR at P_{limit} in Part 1 report, or vice versa.

This test is performed with the EUT's Tx power requested to be at maximum power, the technology/band switch is performed during Tx power enforcement duration (i.e., during the time when EUT is forced to have Tx power at $P_{reserve}$).

5.2.4 Test configuration selection for change in antenna

The criteria to select a test configuration for antenna switch measurement is:

Whenever possible and supported by the EUT, first select antenna switch configuration within the same technology/band (i.e., same technology and band combination).

Then, select any technology/band that supports multiple Tx antennas, and has the highest difference in P_{limit} among all supported antennas.

In case of multiple bands having same difference in P_{limit} among supported antennas, then select the band having the highest *measured* 1gSAR at P_{limit} in Part 1 report.

This test is performed with the EUT's Tx power requested to be at maximum power in selected technology/band, and antenna change is conducted during Tx power enforcement duration (i.e., during the time when EUT is forced to have Tx power at $P_{reserve}$).

5.2.5 Test configuration selection for change in DSI

The criteria to select a test configuration for DSI change test is

Select a technology/band having the $P_{limit} < P_{max}$ within any technology and DSI group, and for the same technology/band having a different P_{limit} in any other DSI group. Note that the selected DSI transition need to be supported by the device.

This test is performed with the EUT's Tx power requested to be at maximum power in selected technology/band, and DSI change is conducted during Tx power enforcement duration (i.e., during the time when EUT is forced to have Tx power at $P_{reserve}$).

5.2.6 Test configuration selection for change in time window

FCC specifies different time window for time averaging based on operation frequency. The criteria to select a test configuration for validating Smart Transmit feature and demonstrating the compliance during the change in time window is

Select any technology/band that has operation frequency classified in one time window defined by FCC (such as 100-seconds time window), and its corresponding P_{limit} is less than P_{max} if possible.

Select the 2nd technology/band that has operation frequency classified in a different time window defined by FCC (such as 60-seconds time window), and its corresponding P_{limit} is less than P_{max} if possible.

Note it is preferred both P_{limit} values of two selected technology/band less than corresponding P_{max} , but if not possible, at least one of technologies/bands has its P_{limit} less than P_{max} .

This test is performed with the EUT's Tx power requested to be at maximum power in selected technology/band. Test for one pair of time windows selected is sufficient as the feature operation is the same.

5.2.7 Test configuration selection for SAR exposure switching

If supported, the test configuration for SAR exposure switching should cover

1. SAR exposure switch when two active radios are in the same time window
2. SAR exposure switch when two active radios are in different time windows. One test with two active radios in any two different time windows is sufficient as Smart Transmit operation is the same for RF exposure switch in any combination of two different time windows. For device supporting LTE + mmW NR, this test is covered in Section 8.2.3 and 8.2.4.

The Smart Transmit time averaging operation is independent of the source of SAR exposure (for example, LTE vs. Sub6 NR) and ensures total time-averaged RF exposure compliance. Hence, validation of Smart Transmit in any one simultaneous SAR transmission scenario (i.e., one combination for LTE + Sub6 NR transmission) is sufficient, where the SAR exposure varies among SAR_{radio1} only, SAR_{radio1} + SAR_{radio2}, and SAR_{radio2} only scenarios.

The criteria to select a test configuration for validating Smart Transmit feature during SAR exposure switching scenarios is

-Select any two < 6GHz technologies/bands that the EUT supports simultaneous transmission (for example, LTE+Sub6NR).

- Among all supported simultaneous transmission configurations, the selection order is select one configuration where both P_{limit} of radio1 and radio2 is less than their corresponding P_{max} , preferably, with different P_{limits} . If this configuration is not available, then,select one configuration that has P_{limit} less than its P_{max} for at least one radio. If this can not be found, then,select one configuration that has P_{limit} of radio1 and radio2 greater than P_{max} but with least $(P_{limit} - P_{max})\delta$.

Test for one simultaneous transmission scenario is sufficient as the feature operation is the same.

5.3 Test procedures for conducted power measurements

This section provides general conducted power measurement procedures to perform compliance test under dynamic transmission scenarios described in Section 4. In practice, an adjustment can be made in these procedures. The justification/clarification may be provided.

5.3.1 Time-varying Tx power transmission scenario

This test is performed with the two pre-defined test sequences described in Section 5.1 for all the technologies and bands selected in Section 5.2.1. The purpose of the test is to demonstrate the effectiveness of power limiting enforcement and that the time-averaged SAR (corresponding time-averaged Tx power) does not exceed the FCC limit at all times (see Eq. (1a) and (1b)).

Test procedure

1. Measure P_{max} , measure P_{limit} and calculate $Reserve (= \text{measured } P_{limit} \text{ in dBm} - Reserve_power_margin \text{ in dB})$ and follow Section 5.1 to generate the test sequences for all the technologies and bands selected in Section 5.2.1. Both test sequence 1 and test sequence 2 are created based on measured P_{max} and measured P_{limit} of the EUT. Test condition to measure P_{max} and P_{limit} is:

- Measure P_{max} with Smart Transmit disabled and callbox set to request maximum power.
- Measure P_{limit} with Smart Transmit enabled and $Reserve_power_margin$ set to 0 dB, callbox set to request maximum power.

2. Set $Reserve_power_margin$ to actual (intended) value (3dB for this EUT based on Part 1 report) and reset power on EUT to enable Smart Transmit, establish radio link in desired radio configuration, with callbox requesting the EUT's Tx power to be at pre-defined test sequence 1, measure and record Tx power versus time, and then convert the conducted Tx power into 1gSAR or 10gSAR value (see Eq. (1a)) using measured P_{limit} from above Step 1. Perform running time average to determine time-averaged power and 1gSAR or 10gSAR versus time as illustrated in Figure 5-1 where using 100-seconds time window as an example.

NOTE: In Eq.(1a), instantaneous Tx power is converted into instantaneous 1gSAR or 10gSAR value by applying the measured worst-case 1gSAR or 10gSAR value at P_{limit} for the corresponding technology/band/antenna/DSI reported in Part 1 report.

NOTE: For an easier computation of the running time average, 0 dBm can be added at the beginning of the test sequences the length of the responding time window, for example, add 0dBm for 100-seconds so the running time average can be directly performed starting with the first 100-seconds data using excel spreadsheet. This technique applies to all tests performed in this Part 2 report for easier time-averaged computation using excel spreadsheet.

Figure 5-1 100s running average illustration

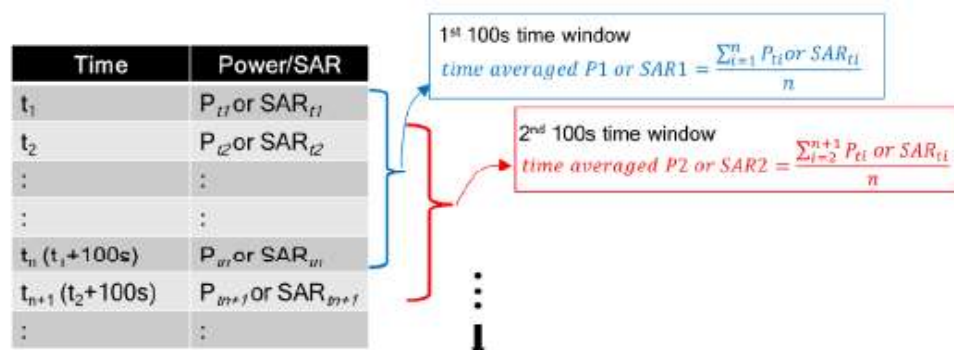

3. Make one plot containing:

- a. Instantaneous Tx power versus time measured in Step2,
- b. Requested Tx power used in Step 2 (test sequence1),
- c. Computed time-averaged power versus time determined in Step2,
- d. Time-averaged power limit (corresponding to FCC SAR limit of 1.6 W/kg for 1gSAR or 4.0W/kg for 10gSAR) givenby

$$Time\ averaged\ power\ limit = meas.P_{limit} + 10 \times \log\left(\frac{FCC\ SAR\ limit}{meas.SAR_P_{limit}}\right) \quad (5a)$$

where *meas. P_{limit}* and *meas. SAR_P_{limit}* correspond to measured power at *P_{limit}* and measured SAR at *P_{limit}*.

4. Make another plot containing:

- a. Computed time-averaged 1gSAR or 10gSAR versus time determined in Step2
- b. FCC 1gSAR/limit of 1.6W/kg or FCC 10gSAR/limit of 4.0W/kg.

5. Repeat Steps 2 ~ 4 for pre-defined test sequence 2 and replace the requested Tx power (test sequence 1) in Step 2 with test sequence2.

6. Repeat Steps 2 ~ 5 for all the selected technologies and bands.

The validation criteria are, at all times, the time-averaged power versus time shown in Step 3 plot shall not exceed the time-averaged power limit (defined in Eq. (5a)), in turn, the time-averaged 1gSAR or 10gSAR versus time shown in Step 4 plot shall not exceed the FCC limit of 1.6 W/kg for 1gSAR or 4.0 W/kg for 10gSAR (i.e., Eq. (1b)).

5.3.2 Change in call scenario

This test is to demonstrate that Smart Transmit feature accurately accounts for the past Tx powers during time-averaging when a new call is established.

The call disconnect and re-establishment needs to be performed during power limit enforcement, i.e., when the EUT's Tx power is at *Preserve* level, to demonstrate the continuity of RF exposure management and limiting in call change scenario. In other words, the RF exposure averaged over any FCC defined time window (including the time windows containing the call change) doesn't exceed FCC limit of 1.6 W/kg for 1gSAR or 4.0 W/kg for 10gSAR.

Test procedure

1. Measure *P_{limit}* for the technology/band selected in Section 5.2.2. Measure *P_{limit}* with Smart Transmit enabled and *Reserve_power_margin* set to 0 dB, callbox set to request maximum power.
2. Set *Reserve_power_margin* to actual (intended) value and reset power on EUT to enable Smart Transmit.
3. Establish radio link with callbox in the selected technology/band.
4. Request EUT's Tx power at 0 dBm for at least one time window specified for the selected technology/band, followed by requesting EUT's Tx power to be at maximum power for about ~60 seconds, and then drop the call for ~10 seconds. Afterwards, re-establish another call in the same radio configuration (i.e., same technology/band/channel) and continue callbox requesting EUT's Tx power to be at maximum power for the remaining time of at least another full duration of the specified time window. Measure and record Tx power versus time. Once the measurement is done, extract instantaneous Tx power versus time, convert the measured conducted Tx power into 1gSAR or 10gSAR value using Eq. (1a), and then perform the running time average to determine time-averaged power and 1gSAR or 10gSAR versus time.

NOTE: In Eq.(1a), instantaneous Tx power is converted into instantaneous 1gSAR or 10gSAR value by applying the measured worst-case 1gSAR or 10gSAR value at P_{limit} for the corresponding technology/band/antenna/DSI reported in Part 1 report.

5. Make one plot containing: (a) instantaneous Tx power versus time, (b) requested power, (c) computed time-averaged power, (d) time-averaged power limit calculated using Eq.(5a).
6. Make another plot containing: (a) computed time-averaged 1gSAR or 10gSAR versus time, and (b) FCC limit of 1.6 W/kg for 1gSAR or 4.0 W/kg for 10gSAR.

The validation criteria are, at all times, the time-averaged power versus time shall not exceed the time-averaged power limit (defined in Eq.(5a)), in turn, the time-averaged 1gSAR or 10gSAR versus time shall not exceed the FCC limit of 1.6 W/kg for 1gSAR or 4.0 W/kg for 10gSAR (i.e., Eq. (1b)).

5.3.3. Change in technology and band

This test is to demonstrate the correct power control by Smart Transmit during technology switches and/or band handovers.

Similar to the change in call test in Section 5.3.2, to validate the continuity of RF exposure limiting during the transition, the technology and band handover needs to be performed when EUT's Tx power is at $P_{reserve}$ level (i.e., during Tx power enforcement) to make sure that the EUT's Tx power from previous $P_{reserve}$ level to the new $P_{reserve}$ level (corresponding to new technology/band). Since the P_{limit} could vary with technology and band, Eq. (1a) can be written as follows to convert the instantaneous Tx power in 1gSAR or 10gSAR exposure for the two given radios, respectively:

$$1g_or_10gSAR_1(t) = \frac{conducted_Tx_power_1(t)}{conducted_Tx_power_P_{limit_1}} * 1g_or_10gSAR_P_{limit_1} \quad (6a)$$

$$1g_or_10gSAR_2(t) = \frac{conducted_Tx_power_2(t)}{conducted_Tx_power_P_{limit_2}} * 1g_or_10gSAR_P_{limit_2} \quad (6b)$$

$$\frac{1}{T_{SAR}} \left[\int_{t-T_{SAR}}^{t_1} \frac{1g_or_10gSAR_1(t)}{FCC\ SAR\ limit} dt + \int_{t-T_{SAR}}^t \frac{1g_or_10gSAR_2(t)}{FCC\ SAR\ limit} dt \right] \leq 1 \quad (6c)$$

where, $conducted_Tx_power_1(t)$, $conducted_Tx_power_P_{limit_1}$, and $1g_or_10gSAR_P_{limit_1}$ correspond to the measured instantaneous conducted Tx power, measured conducted Tx power at P_{limit} , and measured 1gSAR or 10gSAR value at P_{limit} of technology1/band1; $conducted_Tx_power_2(t)$, $conducted_Tx_power_P_{limit_2}(t)$, and $1g_or_10gSAR_P_{limit_2}$ correspond to the measured instantaneous conducted Tx power, measured conducted Tx power at P_{limit} , and measured 1gSAR or 10gSAR value at P_{limit} of technology2/band2. Transition from technology1/band1 to the technology2/band2 happens at time-instant 't1'.

Test procedure

1. Measure P_{limit} for both the technologies and bands selected in Section 5.2.3. Measure P_{limit} with Smart Transmit enabled and $Reserve_power_margin$ set to 0 dB, callbox set to request maximum power.
2. Set $Reserve_power_margin$ to actual (intended) value and reset power on EUT to enable Smart Transmit
3. Establish radio link with callbox in first technology/band selected.
4. Request EUT's Tx power at 0 dBm for at least one time window specified for the selected technology/band, followed by requesting EUT's Tx power to be at maximum power for about ~60 seconds, and then switch to second technology/band selected. Continue with callbox requesting EUT's Tx power to be at maximum power for the remaining time of at least another full duration of the specified time window. Measure and record Tx power versus time for the full duration of the test.
5. Once the measurement is done, extract instantaneous Tx power versus time, and convert the conducted Tx power into 1gSAR or 10gSAR value using Eq. (6a) and (6b) and corresponding measured P_{limit} values from Step 1 of this section. Perform the running time average to determine time-averaged power and 1gSAR or 10gSAR versus time.

NOTE: In Eq.(6a) & (6b), instantaneous Tx power is converted into instantaneous 1gSAR or 10gSAR value by applying the measured worst-case 1gSAR or 10gSAR value at P_{limit} for the corresponding technology/band/antenna/DSI reported in Part 1 report.

6. Make one plot containing: (a) instantaneous Tx power versus time, (b) requested power, (c) computed time-averaged power, (d) time-averaged power limit calculated using Eq.(5a).
7. Make another plot containing: (a) computed time-averaged 1gSAR or 10gSAR versus time, and (b) FCC limit of 1.6 W/kg for 1gSAR or 4.0 W/kg for 10gSAR.

The validation criteria are, at all times, the time-averaged 1gSAR or 10gSAR versus time shall not exceed the FCC limit of 1.6 W/kg for 1gSAR or 4.0 W/kg for 10gSAR (i.e., Eq. (6c)).

5.3.4 Change in antenna

This test is to demonstrate the correct power control by Smart Transmit during antenna switches from one antenna to another. The test procedure is identical to Section 5.3.3, by replacing technology/band switch operation with antenna switch. The validation criteria are, at all times, the time-averaged 1gSAR or 10gSAR versus time shall not exceed FCC limit of 1.6 W/kg for 1gSAR or 4.0 W/kg for 10gSAR.

5.3.5 Change in DSI

This test is to demonstrate the correct power control by Smart Transmit during DSI switches from one DSI to another. The test procedure is identical to Section 5.3.3, by replacing technology/band switch operation with DSI switch. The validation criteria are, at all times, the time-averaged 1gSAR or 10gSAR versus time shall not exceed FCC limit of 1.6 W/kg for 1gSAR or 4.0 W/kg for 10gSAR.

5.3.6 Change in time window

This test is to demonstrate the correct power control by Smart Transmit during the change in averaging time window when a specific band handover occurs. FCC specifies time-averaging windows of 100s for Tx frequency < 3GHz, and 60s for Tx frequency between 3GHz and 6GHz.

To validate the continuity of RF exposure limiting during the transition, the band handover test needs to be performed when EUT handovers from operation band less than 3GHz to greater than 3GHz and vice versa. The equations (3a) and (3b) in Section 4 can be written as follows for transmission scenario having change in time window,

$$1gSAR_1(t) = \frac{conducted_Tx_power_1(t)}{conducted_Tx_power_Plimit_1} * 1g_or_10g_SAR_Plimit_1 \quad (7a)$$

$$1gSAR_2(t) = \frac{conducted_Tx_power_2(t)}{conducted_Tx_power_Plimit_2} * 1g_or_10g_SAR_Plimit_2 \quad (7b)$$

$$\frac{1}{T1SAR} \left[\int_{t-T1SAR}^{t_1} \frac{1g_or_10g_SAR_1(t)}{FCC\ SAR\ limit} dt \right] + \frac{1}{T2SAR} \left[\int_{t-T2SAR}^t \frac{1g_or_10g_SAR_2(t)}{FCC\ SAR\ limit} dt \right] \leq 1 \quad (7c)$$

where, *conducted_Tx_power_1(t)*, *conducted_Tx_power_Plimit_1*, and *1g_or_10g_SAR_Plimit_1* correspond to the instantaneous Tx power, conducted Tx power at *Plimit*, and compliance *1g_or_10g_SAR* values at *Plimit_1* of band1 with time-averaging window 'T1SAR'; *conducted_Tx_power_2(t)*, *conducted_Tx_power_Plimit_2*, and *1g_or_10g_SAR_Plimit_2* correspond to the instantaneous Tx power, conducted Tx power at *Plimit*, and compliance *1g_or_10g_SAR* values at *Plimit_2* of band2 with time-averaging window 'T2SAR'. One of the two bands is less than 3GHz, another is greater than 3GHz. Transition from first band with time-averaging window 'T1SAR' to the second band with time-averaging window 'T2SAR' happens at time-instant 't1'.

Test procedure

1. Measure *P*_{limit} for both the technologies and bands selected in Section 5.2.6. Measure *P*_{limit} with Smart Transmit *enabled* and *Reserve_power_margin* set to 0 dB, callbox set to request maximum power.
2. Set *Reserve_power_margin* to actual (intended) value and enable SmartTransmit

Transition from 100s time window to 60s time window, and vice versa

3. Establish radio link with callbox in the technology/band having 100s time window selected in Section 5.2.6.
4. Request EUT's Tx power to be at 0 dBm for at least 100 seconds, followed by requesting EUT's Tx power to be at maximum power for about ~140 seconds, and then switch to second technology/band (having 60s time window) selected in Section 5.2.6. Continue with callbox requesting EUT's Tx power to be at maximum power for about ~60s in this second technology/band, and then switch back to the first technology/band. Continue with callbox requesting EUT's Tx power to be at maximum power for at least another 100s. Measure and record Tx power versus time for the entire duration of the test.
5. Once the measurement is done, extract instantaneous Tx power versus time, and convert the conducted Tx power into 1gSAR or 10gSAR value (see Eq. (7a) and (7b)) using corresponding technology/band Step 1 result, and then perform 100s running average to determine time-averaged 1gSAR or 10gSAR versus time. Note that in Eq.(7a) & (7b), instantaneous Tx power is converted into instantaneous 1gSAR or 10gSAR value by applying the worst-case 1gSAR or 10gSAR value tested in Part 1 for the selected technologies/bands at *P*_{limit}.
6. Make one plot containing: (a) instantaneous Tx power versus time measured in Step4.
7. Make another plot containing: (a) instantaneous 1gSAR versus time determined in Step 5, (b) computed time-averaged 1gSAR versus time determined in Step 5, and (c) corresponding regulatory *1gSAR*_{limit} of 1.6W/kg or *10gSAR*_{limit} of 4.0W/kg.

Transition from 60s time window to 100s time window, and vice versa

8. Establish radio link with callbox in the technology/band having 60s time window selected in Section 5.2.6.
9. Request EUT's Tx power to be at 0 dBm for at least 60 seconds, followed by requesting EUT's Tx power to be at maximum power for about ~80 seconds, and then switch to second technology/band (having 100s time window) selected in Section 5.2.6. Continue with callbox requesting EUT's Tx power to be at maximum power for about ~100s in this second technology/band, and then switch back to the first technology/band. Continue with callbox requesting EUT's Tx power to be at maximum power for the remaining time for a total test time of 500 seconds. Measure and record Tx power versus time for the entire duration of the test.
10. Repeat above Step 5~7 to generate the plots

The validation criteria is, at all times, the time-averaged 1gSAR or 10gSAR versus time shall not exceed the regulatory *1gSAR*_{limit} of 1.6W/kg or *10gSAR*_{limit} of 4.0W/kg.

5.3.7 SAR exposure switching

This test is to demonstrate that Smart Transmit feature accurately accounts for switching in exposures among SAR from radio1 only, SAR from both radio1 and radio2, and SAR from radio2 only scenarios, and ensures total time-averaged RF exposure complies with the FCC limit. The detailed test procedure for SAR exposure switching in the case of LTE+Sub6 NR non-standalone mode transmission scenario is provided in Appendix B.2.

Test procedure:

1. Measure conducted Tx power corresponding to P_{limit} for radio1 and radio2 in selected band. Test condition to measure conducted P_{limit} is:
 - Establish device in call with the callbox for radio1 technology/band. Measure conducted Tx power corresponding to radio1 P_{limit} with Smart Transmit enabled and Reserve_power_margin set to 0 dB, callbox set to request maximum power.
 - Repeat above step to measure conducted Tx power corresponding to radio2 P_{limit} . If radio2 is dependent on radio1 (for example, non-standalone mode of Sub6 NR requiring radio1 LTE as anchor), then establish radio1 + radio2 call with callbox, and request all down bits for radio1 LTE. In this scenario, with callbox requesting maximum power from radio2 Sub6 NR, measured conducted Tx power corresponds to radio2 P_{limit} (as radio1 LTE is at all-downbits)
2. Set Reserve_power_margin to actual (intended) value, with EUT setup for radio1 + radio2 call. In this description, it is assumed that radio2 has lower priority than radio1. Establish device in radio1+radio2 call, and request all-down bits or low power on radio1, with callbox requesting EUT's Tx power to be at maximum power in radio2 for at least one time window. After one time window, set callbox to request EUT's Tx power to be at maximum power on radio1, i.e., all-up bits. Continue radio1+radio2 call with both radios at maximum power for at least one time window, and drop (or request all-down bits on) radio2. Continue radio1 at maximum power for at least one time window. Record the conducted Tx power for both radio1 and radio2 for the entire duration of this test.
3. Once the measurement is done, extract instantaneous Tx power versus time for both radio1 and radio2 links. Convert the conducted Tx power for both these radios into 1gSAR or 10gSAR value (see Eq. (6a) and (6b)) using corresponding technology/band P_{limit} measured in Step 1, and then perform the running time average to determine time-averaged 1gSAR or 10gSAR versus time.
4. Make one plot containing: (a) instantaneous Tx power versus time measured in Step2.
5. Make another plot containing: (a) instantaneous 1gSAR versus time determined in Step 3, (b) computed time-averaged 1gSAR versus time determined in Step 3, and (c) corresponding regulatory $1gSAR_{limit}$ of 1.6W/kg or $10gSAR_{limit}$ of 4.0W/kg.

The validation criteria is, at all times, the time-averaged 1gSAR or 10gSAR versus time shall not exceed the regulatory $1gSAR_{limit}$ of 1.6W/kg or $10gSAR_{limit}$ of 4.0W/kg.

5.4 Test procedure for time-varying SAR measurements

This section provides general time-varying SAR measurement procedures to perform compliance test under dynamic transmission scenarios described in Section 4. In practice, an adjustment can be made in these procedures. The justification/clarification may be provided.

To perform the validation through SAR measurement for transmission scenario 1 described in Section 4, the “path loss” between callbox antenna and EUT needs to be calibrated to ensure that the EUT Tx power reacts to the requested power from callbox in a radiated call. It should be noted that when signaling in closed loop mode, protocol-level power control is in play, resulting in EUT not solely following callbox TPC (Tx power control) commands. In other words, EUT response has many dependencies (RSSI, quality of signal, path loss variation, fading, etc.) other than just TPC commands. These dependencies have less impact in conducted setup (as it is a controlled environment and the path loss can be very well calibrated) but have significant impact on radiated testing in an uncontrolled environment, such as SAR test setup. Therefore, the deviation in EUT Tx power from callbox requested power is expected, however the time- averaged SAR should not exceed FCC SAR requirement at all times as Smart Transmit controls Tx power at EUT.

The following steps are for time averaging feature validation through SAR measurement:

1. “Path Loss” calibration: Place the EUT against the phantom in the worst-case position determined based on Section 5.2.1. For each band selected, prior to SAR measurement, perform “path loss” calibration between callbox antenna and EUT. Since the SAR test environment is not controlled and well calibrated for OTA (Over the Air) test, extreme care needs to be taken to avoid the influence from reflections. The test setup is described in Section 7.1.

2. Time averaging feature validation:

i For a given radio configuration (technology/band) selected in Section 5.2.1, enable Smart Transmit and set *Reserve_power_margin* to 0 dB, with callbox to request maximum power, perform area scan, conduct point SAR measurement at peak location of the area scan. This point SAR value, *pointSAR_Plimit*, corresponds to point SAR at the measured *Plimit* (i.e., measured *Plimit* from the EUT in Step 1 of Section 5.3.1).

ii Set *Reserve_power_margin* to actual (intended) value and reset power on EUT to enable Smart Transmit. Note, if *Reserve_power_margin* cannot be set wirelessly, care must be taken to re-position the EUT in the exact same position relative to the SAM phantom as in above Step 2.i. Establish radio link in desired radio configuration, with callbox requesting the EUT’s Tx power at power levels described by test sequence 1 generated in Step 1 of Section 5.3.1, conduct point SAR measurement versus time at peak location of the area scan determined in Step 2.i of this section. Once the measurement is done, extract instantaneous point SAR vs time data, *point SAR(t)*, and convert it into instantaneous 1gSAR or 10gSAR vs. time using Eq. (3a), re-written below:

$$1g_or_10gSAR(t) = \frac{pointSAR(t)}{pointSAR_Plimit} * 1g_or_10gSAR_Plimit$$

where, *pointSAR_Plimit* is the value determined in Step 2.i, and *pointSAR(t)* is the instantaneous point SAR measured in Step 2.ii, *1g-or-10gSAR_Plimit* is the measured 1gSAR or 10gSAR value listed in Part 1 report.

iii. Perform 100s running average to determine time-averaged 1gSAR or 10gSAR versus time.

iv. Make one plot containing: (a) time-averaged 1gSAR or 10gSAR versus time determined in Step 2.iii of this section, (b) FCC limit of 1.6 W/kg for 1gSAR or 4.0 W/kg for 10gSAR.

v Repeat 2.ii ~ 2.iv for test sequence 2 generated in Step 1 of Section 5.3.1.

vi. Repeat 2.i ~ 2.v for all the technologies and bands selected in Section 5.2.1.

The time-averaging validation criteria for SAR measurement is that, at all times, the time- averaged 1gSAR or 10gSAR versus time shall not exceed FCC limit of 1.6 W/kg for 1gSAR or 4.0 W/kg for 10gSAR (i.e., Eq. (3b)).

6. Test Configurations

6.1 WWAN (sub-6)transmission

The *Plimit* values, corresponding to 1.0 W/kg (1gSAR) and 2.5 W/kg (10gSAR) of *SAR_design_target*, for technologies and bands supported by EUT are derived in Part 0 report and summarized in Table 6-1. Note all *Plimit* power levels entered in Table 6-1 correspond to average power levels after accounting for duty cycle in the case of TDD modulation schemes (for e.g., GSM, LTE TDD & Sub6 NR TDD).

Table 6-1: *Plimit* for supported technologies and bands (*Plimit* in EFS file)

Plimt corresponding to 1 W/kg (1g) 2.5W/kg(10g) SAR_Design_target							Pmax	Pmax	
SAR Exposure Position			Body worn/ Phablet	Phablet (Grip On)	Head (RCV ON)	Hotspot	EarJack	Maximum Tune-up Output Power (Burst Average Power) [dBm]	Maximum Tune-up Output Power (Frame Averaged Power) [dBm]
Averaging volume			1g/10g	10g	1g	1g	10g		
seperation Distance			15/0,19,13 mm	0 mm	0 mm	10 mm	0 mm		
Mode	Band	Antenna	DSI = 0	DSI = 4	DSI = 1	DSI = 2	DSI = 3		
GSM/GPRS/EDGE	850	Main 1	29.2	22.5	28.9	22.5	22.5	30.5	24.3
GSM/GPRS/EDGE	1900	Main 2	28.3	19.5	28.3	19.5	19.5	29.0	22.8
UMTS	5	Main 1	24.3	24.3	28.9	26.5	24.3	22.5	22.5
UMTS	4	Main 2	25.5	21.5	30.7	21.5	21.5	23.5	23.5
UMTS	2	Main 2	25.1	21.5	28.8	21.5	21.5	23.5	23.5
LTE FDD	12	Main 1	27.4	27.4	29.6	28.2	27.4	24.5	24.5
LTE FDD	13	Main 1	29.3	29.3	31.4	27.9	29.3	24.0	24.0
LTE FDD	14	Main 1	30.5	30.5	33.0	29.1	30.5	24.5	24.5
LTE FDD	26	Main 1	27.6	27.6	28.8	26.9	27.6	24.5	24.5
LTE FDD	5	Main 1	27.6	27.6	28.8	26.9	27.6	24.5	24.5
LTE FDD	66	Main 2	25.1	21.0	29.3	21.0	21.0	24.0	24.0
LTE FDD	66	Sub 1	26.5	24.9	19.0	26.2	24.9	22.0	22.0
LTE FDD	4	Main 2	25.1	21.0	29.3	21.0	21.0	24.0	24.0
LTE FDD	4	Sub 1	26.5	24.9	19.0	26.2	24.9	22.0	22.0
LTE FDD	2	Main 2	25.2	21.0	26.7	21.0	21.0	24.0	24.0
LTE FDD	2	Sub 1	26.4	25.0	19.0	26.4	25.0	22.0	22.0
LTE FDD	25	Main 2	25.2	21.0	26.7	21.0	21.0	24.0	24.0
LTE FDD	25	Sub 1	26.4	25.0	19.0	26.4	25.0	22.0	22.0
LTE FDD	71	Main 1	29.5	29.5	30.4	28.3	29.5	24.5	24.5
LTE FDD	7	Main 2	24.3	21.0	27.8	21.0	21.0	24.0	24.0
LTE FDD	30	Main 2	24.4	21.0	28.4	21.0	21.0	23.0	23.0
LTE TDD	40	Main 2	22.1	25.8	32.5	25.4	25.8	13.0	11.0
LTE TDD	48	Sub 3	22.1	24.2	18.0	21.4	24.2	22.5	20.5
LTE TDD PC3	41	Main 2	26.0	25.2	31.6	25.2	25.2	24.0	22.0
LTE TDD PC2	41	Main 2	28.3	27.1	31.7	24.9	27.1	26.5	22.9
LTE TDD	38	Main 2	26.0	25.2	31.6	25.2	25.2	24.0	22.0
NR FDD	5	Main1	27.9	27.9	28.5	26.1	27.9	24.0	24.0
NR FDD	12	Main 1	29.5	28.2	30.7	28.8	28.2	24.0	24.0
NR FDD	71	Main 1	30.4	29.6	30.3	28.6	29.6	24.0	24.0
NR FDD	30	Main 2	24.2	21.0	28.4	21.0	21.0	23.5	23.5
NR FDD	66	Main 2	25.3	21.0	29.0	21.0	21.0	24.0	24.0
NR FDD	2	Main 2	24.8	21.0	27.9	21.0	21.0	23.5	23.5
NR FDD	25	Main 2	24.8	21.0	27.9	21.0	21.0	23.5	23.5
NR TDD PC3	41	Main 2	21.0	21.0	21.0	21.0	21.0	24.5	24.5
NR TDD PC2	41	Main 2	21.0	21.0	21.0	21.0	21.0	26.0	26.0
NR TDD SRS0(PC2)	n77 DoD	Sub 3	17.5	17.5	17.5	17.5	17.5	27.0	27.0
NR TDD SRS0(PC3)	n77 DoD	Sub 3	17.5	17.5	17.5	17.5	17.5	24.5	24.5
NR TDD SRS1(PC2)	n77 DoD	Sub 5	15.0	15.0	15.0	15.0	15.0	22.6	22.6
NR TDD SRS1(PC3)	n77 DoD	Sub 5	15.0	15.0	15.0	15.0	15.0	22.6	22.6
NR TDD SRS2(PC2)	n77 DoD	Main 2	16.0	16.0	16.0	16.0	16.0	25.0	25.0
NR TDD SRS2(PC3)	n77 DoD	Main 2	16.0	16.0	16.0	16.0	16.0	23.5	23.5
NR TDD SRS3(PC2)	n77 DoD	Main 3	17.5	17.5	17.5	17.5	17.5	23.0	23.0
NR TDD SRS3(PC3)	n77 DoD	Main 3	17.5	17.5	17.5	17.5	17.5	23.0	23.0
NR TDD SRS0(PC2)	n77	Sub 3	17.5	17.5	17.5	17.5	17.5	27.0	27.0
NR TDD SRS0(PC3)	n77	Sub 3	17.5	17.5	17.5	17.5	17.5	24.5	24.5
NR TDD SRS1(PC2)	n77	Sub 5	15.0	15.0	15.0	15.0	15.0	22.6	22.6
NR TDD SR15(PC3)	n77	Sub 5	15.0	15.0	15.0	15.0	15.0	22.6	22.6
NR TDD SRS2(PC2)	n77	Main 2	16.0	16.0	16.0	16.0	16.0	25.0	25.0
NR TDD SRS2(PC3)	n77	Main 2	16.0	16.0	16.0	16.0	16.0	23.5	23.5
NR TDD SRS3(PC2)	n77	Main 3	17.5	17.5	17.5	17.5	17.5	23.0	23.0
NR TDD SRS3(PC3)	n77	Main 3	17.5	17.5	17.5	17.5	17.5	23.0	23.0

* Maximum tune up target power, P_{max} , is configured in NV settings in EUT to limit maximum transmitting power. This power is converted into peak power in NV settings for TDD schemes. The EUT maximum allowed output power is equal to $P_{max} + 1$ dB device uncertainty.

Based on selection criteria described in Section 5.2.1, the selected technologies/bands for testing time-varying test sequences are highlighted in yellow in Table 6-1. As per Part 1 report, the *Reserve_power_margin*(dB) for Samsung Mobile Phone (FCC ID: A3LSMG736U) is set to 3dB in EFS, and is used in Part 2 test.

The radio configurations used in Part 2 test for selected technologies, bands, DSIs and antennas are listed in Table 6-2. The corresponding worst-case radio configuration 1gSAR or 10gSAR values for selected technology/band/DSI are extracted from Part 1 report and are listed in the last column of Table 6-2.

Based on equations (1a), (2a), (3a) and (4a), it is clear that Part 2 testing outcome is normalized quantity, which implies that it can be applied to any radio configuration within a selected technology/band/DSI. Thus, as long as applying the worst-case SAR obtained from the worst radio configuration in Part 1 testing to calculate time-varying SAR exposure in equations (1a), (2a), (3a) and (4a), the accuracy in compliance demonstration remains the same.

Table 6-2: Radio configurations selected for Part 2 test

Test Case #	Test Scenario	Tech	Band	Antenna	DSI	Channel	Frequency [MHz]	RB/RB Offset/Bandwidth (MHz)	Mode	SAR Exposure Scenario	Part 1 Worst Case Measured SAR at Plimit (W/kg)
1	Time-varying Tx power transmission	LTE	B66	Main 2	2	132072	1720	1/49/20 MHz BW	QPSK	Hotspot, Rear, 10mm	0.453
2			B48	Sub 3	1	55340	3560	100/0/20 MHz BW	QPSK	RCV, Right Touch, 0mm	0.804
3		UMTS	B2	Main 2	2	9400	1880	-	RMC	Hotspot, Bottom, 10mm	0.762
4		GPRS	1900	Main 2	2	661	1880	-	GRPS, 2 Tx	Hotspot, Rear, 10mm	0.616
5		Sub6 NR	n66	Main 2	2	349000	1745	1/108/40 MHz BW	QPSK	Hotspot, Bottom, 10mm	0.442
6		Sub6 NR	n25	Main 2	2	376500	1882.5	108/54/40 MHz BW	QPSK	Hotspot, Bottom, 10mm	0.443
7	Change in Call	LTE	B48	Sub 3	1	55340	3560	100/0/20 MHz BW	QPSK	RCV, Right Touch, 0mm	0.804
8	Tech/Band Switch	LTE	B66	Main 2	2	132072	1720	1/49/20 MHz BW	QPSK	Hotspot, Rear, 10mm	0.453
		UMTS	B2	Main 2	2	9400	1880	-	RMC	Hotspot, Bottom, 10mm	0.762
9	DSI Switch	LTE	B48	Sub 3	0	55773	3603.3	1/99/20 MHz BW	QPSK	Bodyworn, Rear, 15mm	0.283
			B48	Sub 3	1	55340	3560	100/0/20 MHz BW	QPSK	RCV, Right Touch, 0mm	0.804
10	Time Window/Antenna Switch	LTE	B66	Main 2	2	132072	1720	1/49/20 MHz BW	QPSK	Hotspot, Rear, 10mm	0.453
			B48	Sub 3	2	56207	3646.7	1/99/20 MHz BW	QPSK	Hotspot, Left, 10mm	0.82
11	SAR1 vs SAR2	LTE	B13	Main 1	2	23230	782	1/24/10 MHz BW	QPSK	Hotspot, Bottom, 10mm	0.410
		Sub6 NR	n66	Main 2	2	349000	1745	1/108/40 MHz BW	QPSK	Hotspot, Bottom, 10mm	0.442

Note : that the EUT has a proximity sensor to manage extremity exposure, which is represented using DSI = 4; the head exposure can be distinguished through audio receiver mode, represented as DSI = 1; similarly, the hotspot exposure is distinguished via hotspot mode, represented as DSI = 2; the exposure for headset jack active scenario is represented using DSI = 3 and is managed as the same exposure condition as extremity exposure at 0 mm; DSI = 0 represents all other exposures which cannot be distinguished, thus, in this case, the maximum 1g SAR and/or 10gSAR among all remaining exposure scenarios or the minimum Plimit among all remaining exposure scenarios (i.e., body worn 1gSAR evaluation at 15mm spacing, phablet 10gSAR extremity evaluation at 6~11mm spacing, phablet 10gSAR extremity evaluation at 0mm spacing for left and right surfaces) is used in Smart Transmit feature for time averaging operation.

Based on the selection criteria described in Section 6.2, the radio configurations for the Tx varying transmission test cases listed in Section 6 are:

1. Technologies and bands for time-varying Tx power transmission: The test case 1~6 listed in Table 6-2 are selected to test with the test sequences defined in Section 7.1 in both time-varying conducted power measurement and time-varying SAR measurement. Note that only one GSM band were selected as the second band for these technologies has P_{limit} greater than P_{max} , requiring no Tx power limitation.

2. Technology and band for change in call test: LTE B48 band (test case 7 in Table 6-2) is selected for performing the call drop test in conducted power setup.

3. Technologies and bands for change in technology/band test: Following the guidelines in Section 5.2.3 and 5.2.4, test case 8 in Table 6-2 is selected for handover test from a technology/band/antenna with lowest P_{limit} within one technology group (LTE B66, DSI=2Hotspot mode), to a technology/band in the same DSI with highest P_{limit} within another technology group (WCDMA B2, DSI=2) in conducted power setup.

4. Technologies and bands for change in DSI: Based on selection criteria in Section 5.2.5, for a given technology and band, test case 9 in Table 6-2 is selected for DSI switch test by establishing a call in LTE B48 in Free space condition (i.e., DSI=0), and then handing over to DSI = 1 with RCV condition scenario in conducted power setup.

5. Technologies and bands for change in time-window/antenna: Based on selection criteria in Section 5.3.6, for a given DSI=2, test case 10 in Table 6-2 is selected for time window switch between 60s window (LTE 48, Antenna Sub 3) and 100s window (LTE B66, Antenna Main 2) in conducted power setup.

6. Technologies and bands for switch in SAR exposure: Based on selection criteria in Section

5.2.7 Scenario 1, test case 11 in Table 6-2 is selected for SAR exposure switching test in one of the supported simultaneous WWAN transmission scenario, i.e., LTE + Sub6 NR active in the same 100s time window, in conducted power setup. Since this device supports LTE+mmW NR, test for Section 5.2.7 Scenario 2 for RF exposure switch is covered in Sections 8.2.3 and 8.2.4 between LTE (100s window) and mmW NR (4s window).

7. Time-varying Tx power measurement for below 6GHz frequency

7.1 Conducted Measurement Test setup

Legacy Test Setup

The Rohde & Schwarz CMW500 callbox is used in this test. The test setup picture and schematic are shown in Figures 8-1a for measurements with a single antenna of EUT (see Appendix C–The test Setup Photo 1). and in Figures 8-1b for measurements involving antenna switch (see Appendix C The test Setup Photo 2).

For single antenna measurement, one port (RF1 COM) of the callbox is connected to the RF port of the EUT using a directional coupler. For antenna & technology switch measurement, two ports (RF1 COM and RF3 COM) of the callbox used for signaling two different technologies are connected to a combiner, which is in turn connected to a directional coupler. The other end of the directional coupler is connected to a splitter to connect to two RF ports of the EUT corresponding to the two antennas of interest. In both the setups, power meter is used to tap the directional coupler for measuring the conducted output power of the EUT. For time averaging validation test (Section 5.3.1), call drop test (Section 5.3.2), and DSI switch test (Section 5.3.4), only RF1 COM port of the callbox is used to communicate with the EUT. For technology/band switch measurement (Section. 5.3.3), both RF1 COM and RF3 COM port of callbox are used to switch from one technology communicating on RF1 COM port to another technology communicating on RF3 COM port. All the path losses from RF port of EUT to the callbox RF COM port and to the power meter are calibrated and automatically entered as offsets in the callbox and the power meter via test scripts on the PC used to control callbox and power meter.

LTE+Sub6 NR test setup:

If LTE conducted port and Sub6 NR conducted port are same on this EUT (i.e., they share the same antenna), then low-/high-pass filter is used to separate LTE and Sub6 NR signals for power meter measurement via directional couplers, as shown in below Figures 8-(c) (see Appendix C- Test setup photo-3)

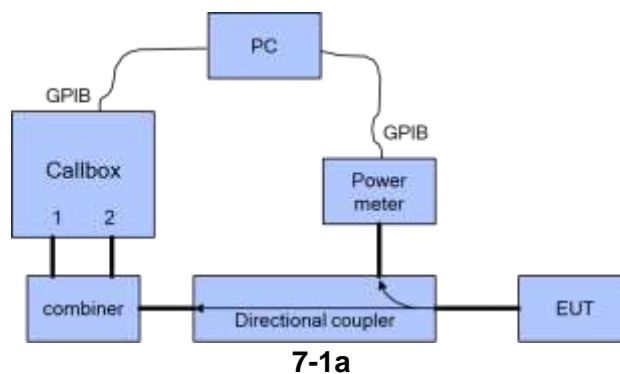

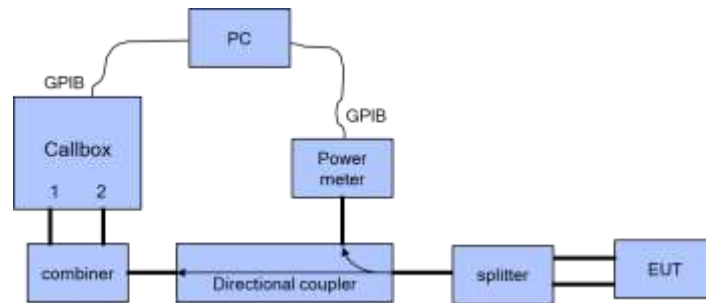

7-1b

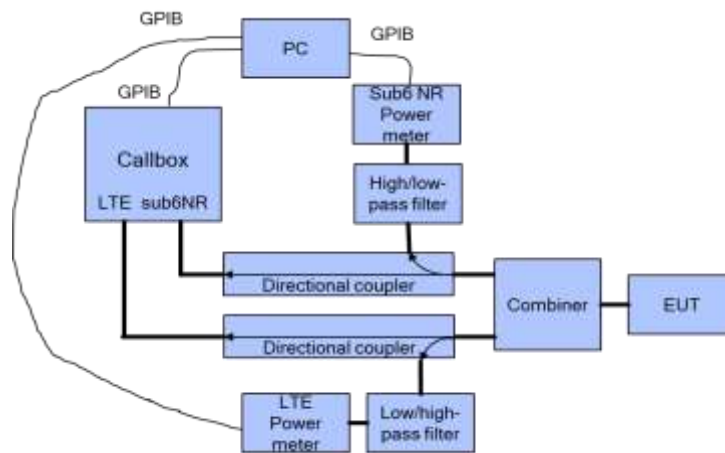

7-1c

Figure 7-1 Conducted power measurement setup

Both the callbox and power meter are connected to the PC using GPIB cables. Two test scripts are custom made for automation, and the test duration set in the test scripts is 600 seconds. For time-varying Tx power measurement, the PC runs the 1st test script to send GPIB commands to control the callbox’s requested power versus time, while at the same time to record the conducted power measured at EUT RF port using the power meter. The commands sent to the callbox to request power are:

- 0dBm for 100 seconds
- test sequence 1 or test sequence 2 (defined in Section 5.1 and generated in Section 5.5.1), for 360 seconds
- stay at the last power level of test sequence 1 or test sequence 2 for the remaining time.

Power meter readings are periodically recorded every 100ms. A running average of this measured Tx power over 100 seconds is performed in the post-data processing to determine the 100s-time averaged power. For call drop, technology/band/antenna switch, and DSI switch tests, after the call is established, the callbox is set to request the EUT’s Tx power at 0dBm for 100 seconds while simultaneously starting the 2nd test script runs at the same time to start recording the Tx power measured at EUT RF port using the power meter. After the initial 100 seconds since starting the Tx power recording, the callbox is set to request maximum power from the EUT for the rest of the test.

Note that the call drop/re-establish, or technology/band/antenna switch or DSI switch is manually performed when the Tx power of EUT is at *P_{reserve}* level. See Section 5.3 for detailed test procedure of call drop test, technology/band/antenna switch test and DSI switch test.

7.2 Plimit and Pmax measurement Results

The measured *P_{limit}* for all the selected radio configurations given in Table 6-2 are listed in below Table 7-1. *P_{max}* was also measured for radio configurations selected for testing time-varying Tx power transmission scenarios in order to generate test sequences following the test procedures in Section 5.1.

Table 7-1: Measured Plimit and Pmax of selected radio configuration

Test Case #	Test Scenario	Tech	Band	Antenna	DSI	Channel	Frequency [MHz]	RB/RB Offset/Bandwidth (MHz)	Mode	SAR Exposure Scenario	Plimit EFS Setting[dBm]	Tune Up Target Power Pmax[dBm]	Measured Plimit [dBm]	Measured Pmax [dBm]	Part 1 Worst Case Measured SAR at Plimit (W/kg)
1	Time-varying Tx power transmission	LTE	B66	Main 2	2	132072	1720	1/49/20 MHz BW	QPSK	Hotspot, Rear, 10mm	21	24	21.61	24.60	0.453
2			B48	Sub 3	1	55340	3560	100/0/20 MHz BW	QPSK	RCV, Right Touch, 0mm	18	19.5	18.17	19.07	0.804
3		UMTS	B2	Main 2	2	9400	1880	-	RMC	Hotspot, Bottom, 10mm	21.5	23.5	22.05	23.61	0.762
4		GPRS	1900	Main 2	2	661	1880	-	GRPS, 2 Tx	Hotspot, Rear, 10mm	19.5	23	19.68	22.17	0.616
5		Sub6 NR	n66	Main 2	2	349000	1745	1/108/40 MHz BW	QPSK	Hotspot, Bottom, 10mm	21.0	24.0	21.90	24.44	0.442
6		Sub6 NR	n25	Main 2	2	376500	1882.5	108/54/40 MHz BW	QPSK	Hotspot, Bottom, 10mm	21.0	23.5	21.75	24.30	0.443
7	Change in Call	LTE	B48	Sub 3	1	55340	3560	100/0/20 MHz BW	QPSK	RCV, Right Touch, 0mm	18	19.5	18.17	19.07	0.804
8	Tech/Band Switch	LTE	B66	Main 2	2	132072	1720	1/49/20 MHz BW	QPSK	Hotspot, Rear, 10mm	21	24	21.61	24.60	0.453
		UMTS	B2	Main 2	2	9400	1880	-	RMC	Hotspot, Bottom, 10mm	21.5	23.5	22.05	23.61	0.762
9	DSI Switch	LTE	B48	Sub 3	0	55773	3603.3	1/99/20 MHz BW	QPSK	Bodyworn, Rear, 15mm	20.5	20.5	20.40	20.40	0.283
			B48	Sub 3	1	55340	3560	100/0/20 MHz BW	QPSK	RCV, Right Touch, 0mm	18	19.5	18.17	19.07	0.804
10	Time Window/ Antenna Switch	LTE	B66	Main 2	2	132072	1720	1/49/20 MHz BW	QPSK	Hotspot, Rear, 10mm	21	24	21.61	24.60	0.453
			B48	Sub 3	2	56207	3646.7	1/99/20 MHz BW	QPSK	Hotspot, Left, 10mm	20.5	20.5	20.40	20.40	0.82
11	SAR1 vs SAR2	LTE	B13	Main 1	2	23230	782	1/24/10 MHz BW	QPSK	Hotspot, Bottom, 10mm	24.0	24.0	24.00	24.00	0.410
		Sub6 NR	n66	Main 2	2	349000	1745	1/108/40 MHz BW	QPSK	Hotspot, Bottom, 10mm	21.0	24.0	21.9	24.44	0.442

Note:

1. The device uncertainty of *P_{max}* is +1dB/-1.5dB as provided by manufacturer.
2. The above *P_{max}* / *P_{limit}* value for GPRS1900 is Frame Averaged Power for 2Tx Slots
3. The above *P_{max}* / *P_{limit}* value for TDD band LTE48 is time average power values

7.3 Time-varying Tx power measurement results

The measurement setup is shown in Figures 8-1(a), 8-1(b) and 8-1(c). The purpose of the time-varying Tx power measurement is to demonstrate the effectiveness of power limiting enforcement and that the time-averaged Tx power when represented in time-averaged 1gSAR or 10gSAR values does not exceed FCC limit as shown in Eq. (1a) and (1b), rewritten below:

$$1g_or_10gSAR(t) = \frac{conducted_Tx_power(t)}{conducted_Tx_power_P_{limit}} * 1g_or_10gSAR_P_{limit} \quad (1a)$$

$$\frac{\frac{1}{T_{SAR}} \int_{t-T_{SAR}}^t 1g_or_10gSAR(t) dt}{FCC\ SAR\ limit} \leq 1 \quad (1b)$$

where, $conducted_Tx_Power(t)$, $conducted_Tx_P_{limit}$, and $1g_or_10g\ SAR_P_{limit}$ correspond to the measured instantaneous conducted Tx power, measured conducted Tx power at P_{limit} , and measured 1gSAR and 10gSAR values at P_{limit} reported in Part 1 test (listed in Table 7-2 of this report as well). Following the test procedure in Section 5.3, the conducted Tx power measurement for all selected configurations are reported in this section. In all the conducted Tx power plots, the dotted line represents the requested power by callbox (test sequence 1 or test sequence 2), the blue curve represents the instantaneous conducted Tx power measured using power meter, the green curve represents time-averaged power and red line represents the conducted power limit that corresponds to FCC limit of 1.6 W/kg for 1gSAR or 4.0 W/kg for 10gSAR.

Similarly, in all the 1g or 10gSAR plots (when converted using Eq. (1a)), the green curve represents the 100s time averaged 1gSAR or 10gSAR value calculated based on instantaneous 1gSAR or 10gSAR; and the red line limit represents the FCC limit of 1.6 W/kg for 1gSAR or 4.0 W/kg for 10gSAR.

Time-varying Tx power measurements were conducted on test cases #1 ~ #5 in Table 7-2, by generating test sequence 1 and test sequence 2 given in Appendix A using measured P_{limit} and measured P_{max} for each of these test cases. Measurement results for test cases #1 ~ #5 are given in Sections 8.3.1 - 8.3.5.

7.3.1 LTE Band 66 (test case 1 in Table 6-2)

Conducted Plot No. 1

Test result for test sequence 1:

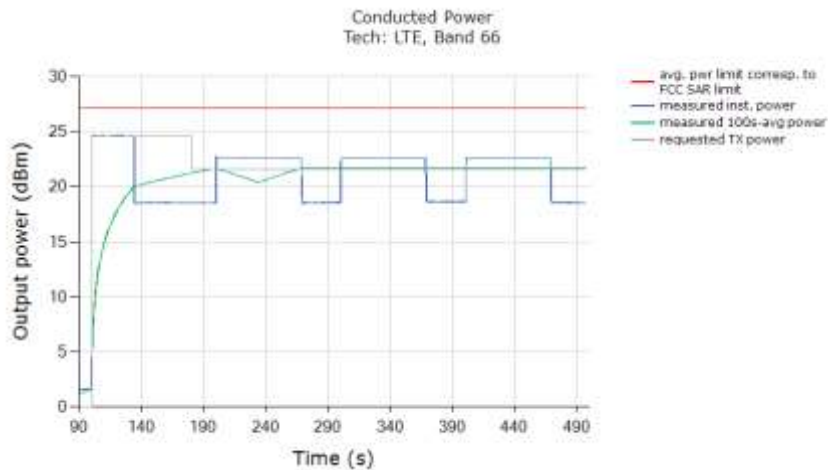

Above time-averaged conducted Tx power is converted/calculated into time-averaged 1gSAR using Equation (1a) and plotted below to demonstrate that the time-averaged 1gSAR versus time does not exceed the FCC limit of 1.6 W/kg for 1gSAR

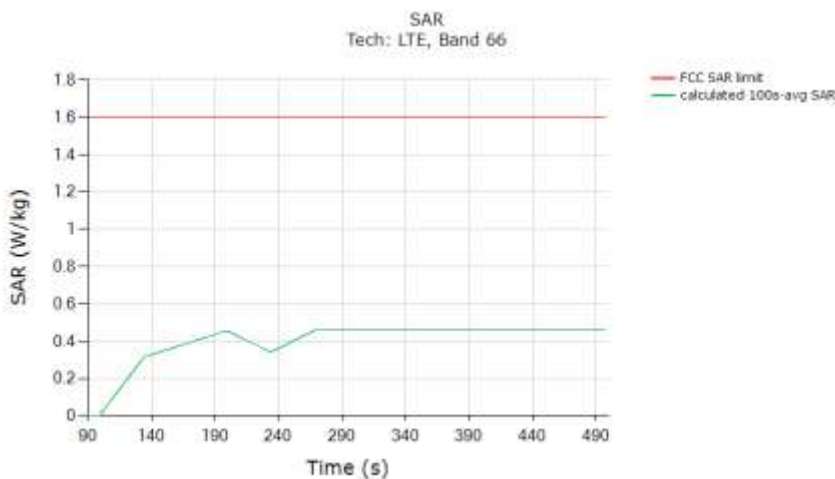

FCC 1g SAR Limit [W/kg]	1.6 W/kg
Max 100s-time averaged 1gSAR (green curve)	0.459 W/kg
Validated: Max time averaged SAR (green curve) is within 1dB device uncertainty of measured SAR at P_{limit} (last column in Table 7-2).	

Test result for test sequence 2:

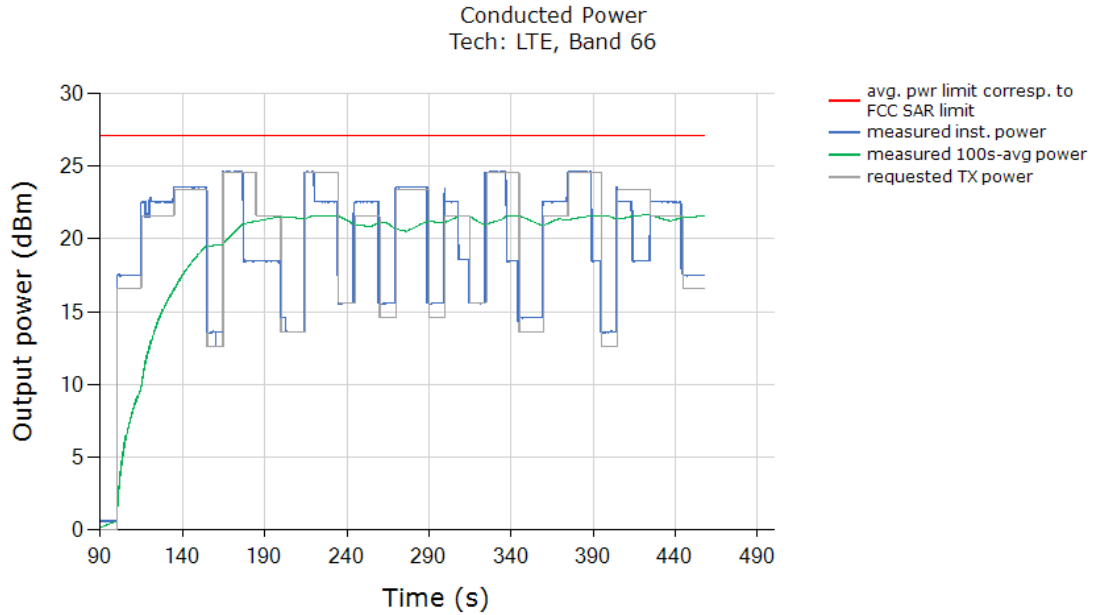

Above time-averaged conducted Tx power is converted/calculated into time-averaged 1gSAR using Equation (1a) and plotted below to demonstrate that the time-averaged 1gSAR versus time does not exceed the FCC limit of 1.6 W/kg for 1gSAR:

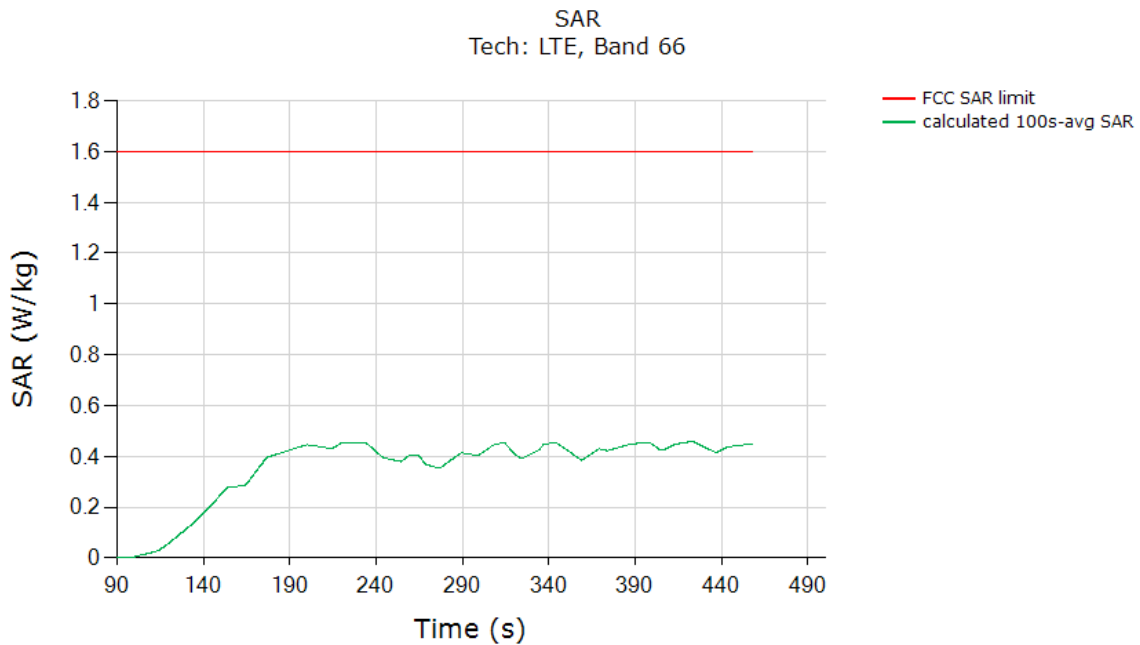

FCC 1g SAR Limit [W/kg]	1.6 W/kg
Max 100s-time averaged 1gSAR (green curve)	0.459 W/kg
Validated: Max time averaged SAR (green curve) is within 1dB device uncertainty of measured SAR at P_{limit} (last column in Table 7-2).	

7.3.2 LTE Band 48 (test case 2 in Table 6-2)

Conducted Plot No. 2

Test result for test sequence 1:

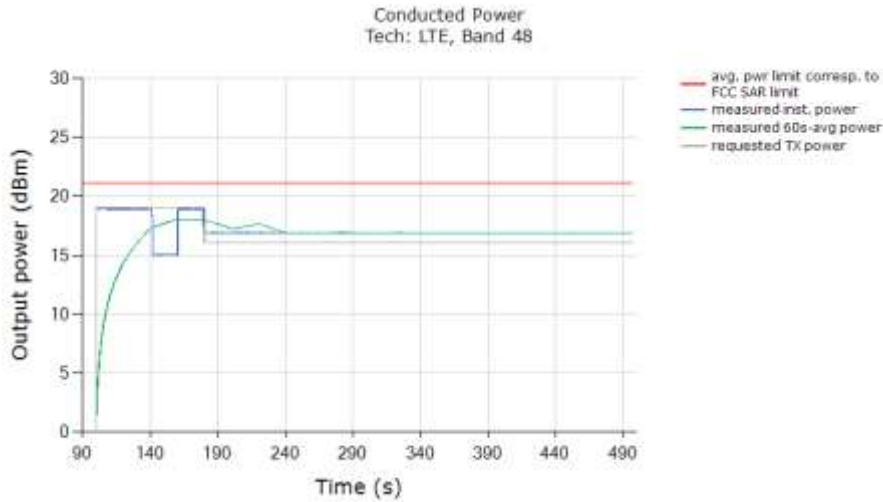

Above time-averaged conducted Tx power is converted/calculated into time-averaged 1gSAR using Equation (1a) and plotted below to demonstrate that the time-averaged 1gSAR versus time does not exceed the FCC limit of 1.6 W/kg for 1gSAR:

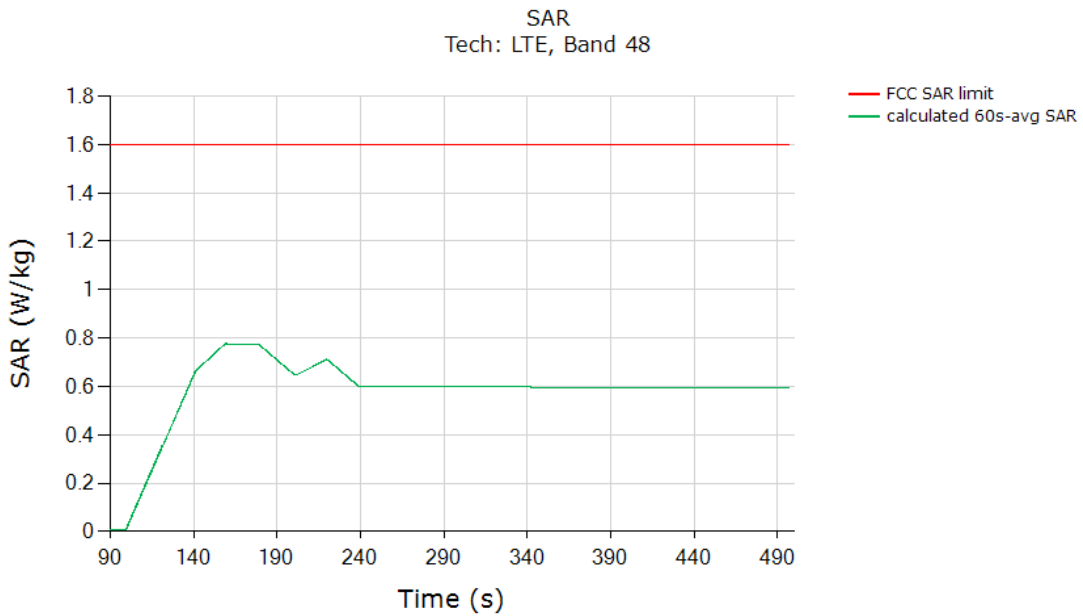

FCC 1g SAR Limit [W/kg]	1.6 W/kg
Max 60s-time averaged 10gSAR (green curve)	0.779 W/kg
Validated: Max time averaged SAR (green curve) is within 1dB device uncertainty of measured SAR at P_{limit} (last column in Table 7-2).	

Test result for test sequence 2:

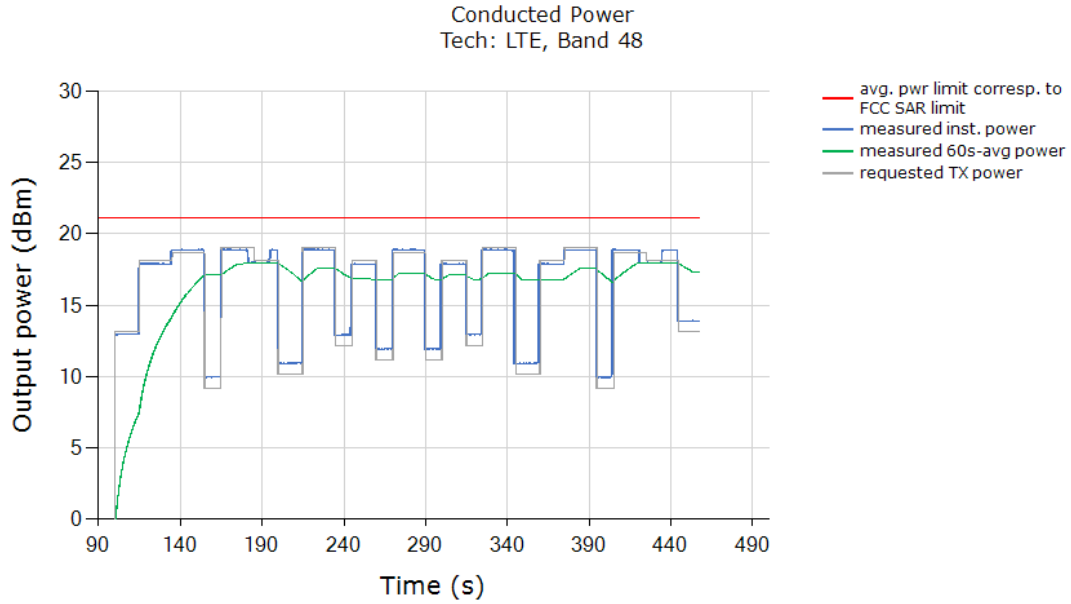

Above time-averaged conducted Tx power is converted/calculated into time-averaged 1gSAR using Equation (1a) and plotted below to demonstrate that the time-averaged 1gSAR versus time does not exceed the FCC limit of 1.6 W/kg for 1gSAR:

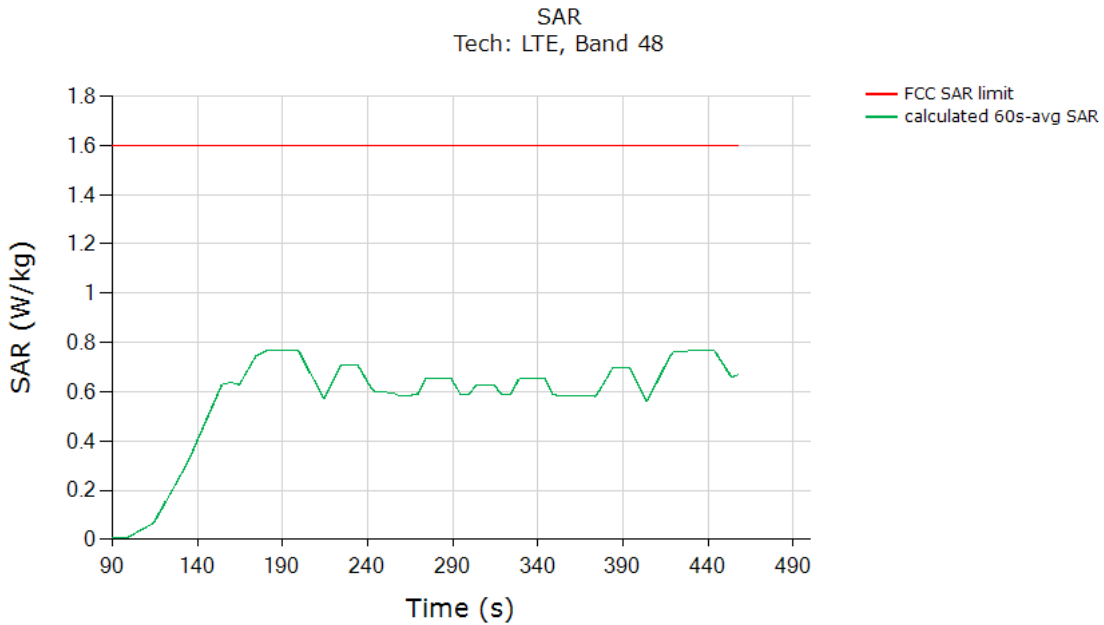

FCC 1g SAR Limit [W/kg]	1.6 W/kg
Max 60s-time averaged 10gSAR (green curve)	0.770W/kg
Validated: Max time averaged SAR (green curve) is within 1dB device uncertainty of measured SAR at P_{limit} (last column in Table 7-2).	

7.3.3 WCDMA Band 2 (test case 3 in Table 6-2)

Conducted Plot No. 3

Test result for test sequence 1

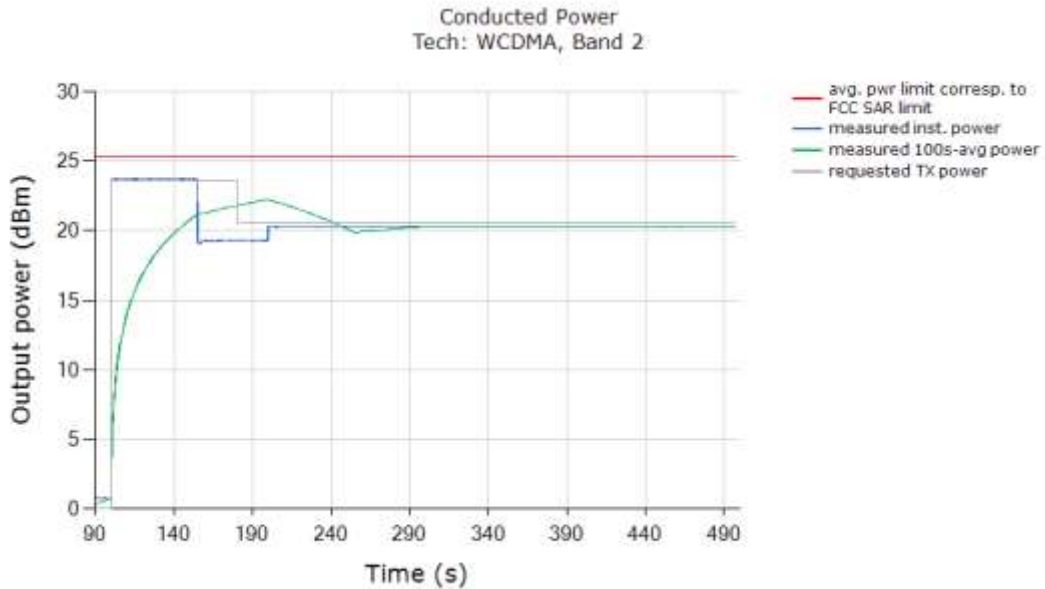

Above time-averaged conducted Tx power is converted/calculated into time-averaged 1gSAR using Equation (1a) and plotted below to demonstrate that the time-averaged 1gSAR versus time does not exceed the FCC limit of 1.6 W/kg for 1gSAR:

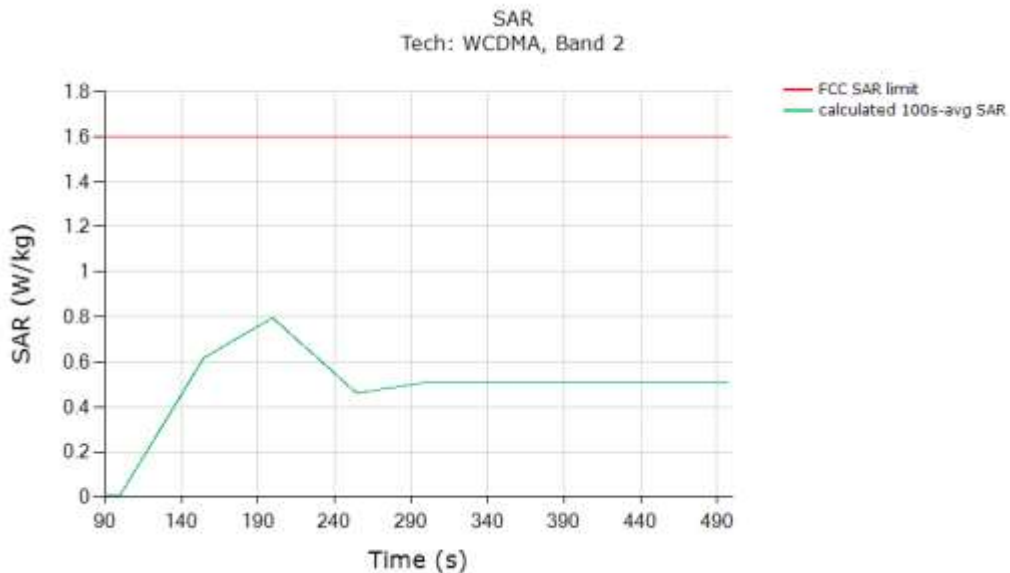

FCC 1g SAR Limit [W/kg]	1.6 W/kg
Max 100s-time averaged 1gSAR (green curve)	0.796W/kg
Validated: Max time averaged SAR (green curve) is within 1dB device uncertainty of measured SAR at P_{limit} (last column in Table 6-2).	

Test result for test sequence 2:

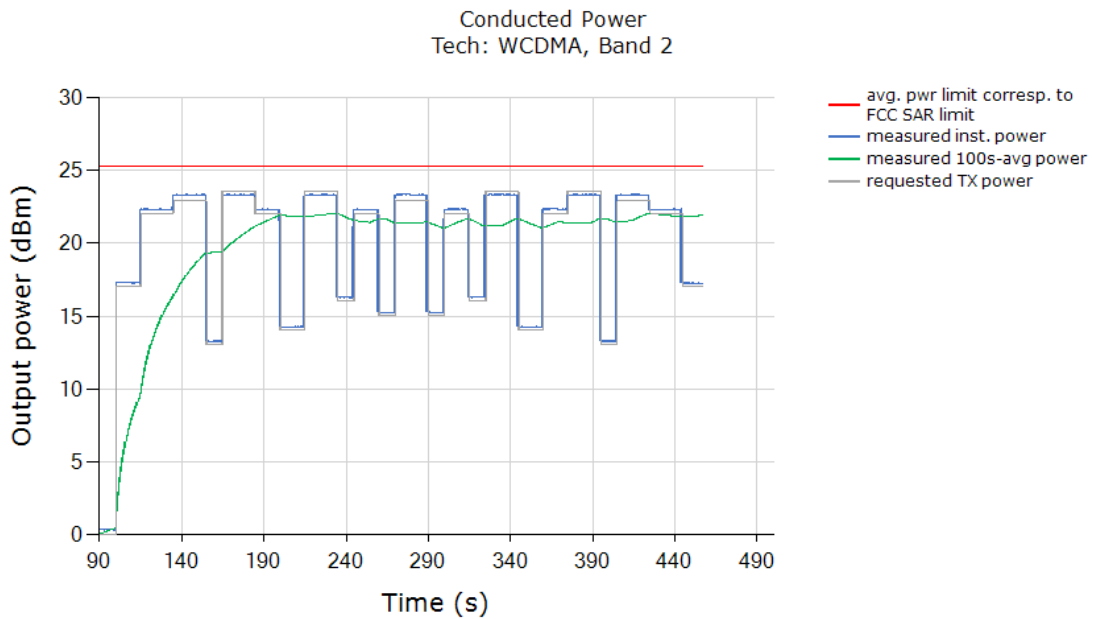

Above time-averaged conducted Tx power is converted/calculated into time-averaged 1gSAR using Equation (1a) and plotted below to demonstrate that the time-averaged 1gSAR versus time does not exceed the FCC limit of 1.6 W/kg for 1gSAR:

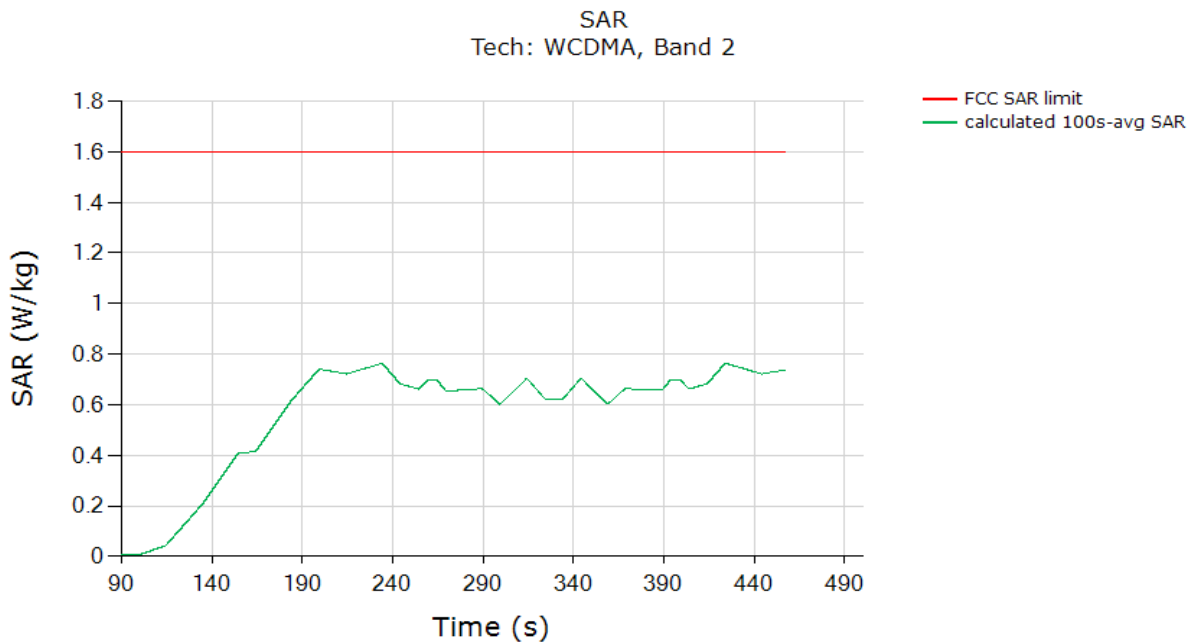

FCC 1g SAR Limit [W/kg]	1.6 W/kg
Max 100s-time averaged 1gSAR (green curve)	0.764 W/kg
Validated: Max time averaged SAR (green curve) is within 1dB device uncertainty of measured SAR at <i>Plimit</i> (last column in Table 6-2).	

7.3.4 GSM/GPRS/EDGE/1900 (test case 4 in Table 6-2)

Conducted Plot No. 4

Test result for test sequence 1

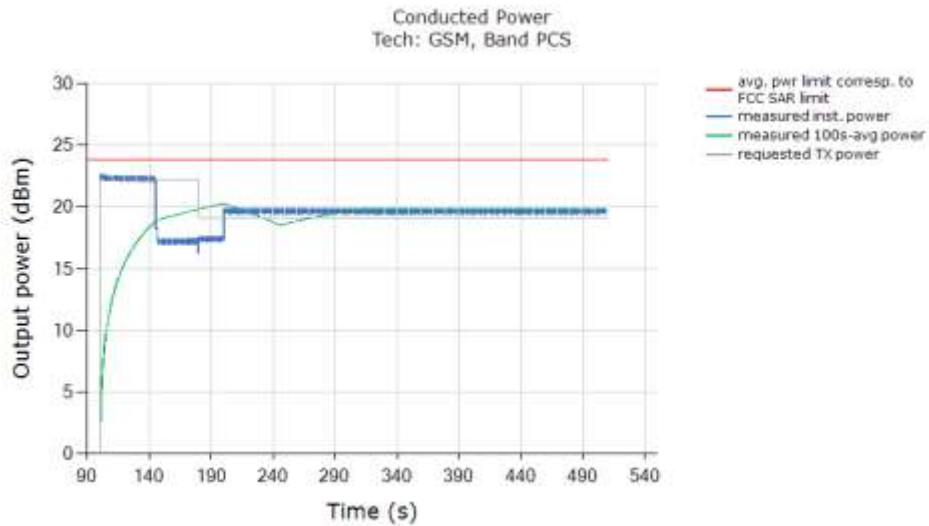

Above time-averaged conducted Tx power is converted/calculated into time-averaged 1gSAR using Equation (1a) and plotted below to demonstrate that the time-averaged 1gSAR versus time does not exceed the FCC limit of 1.6 W/kg for 1gSAR:

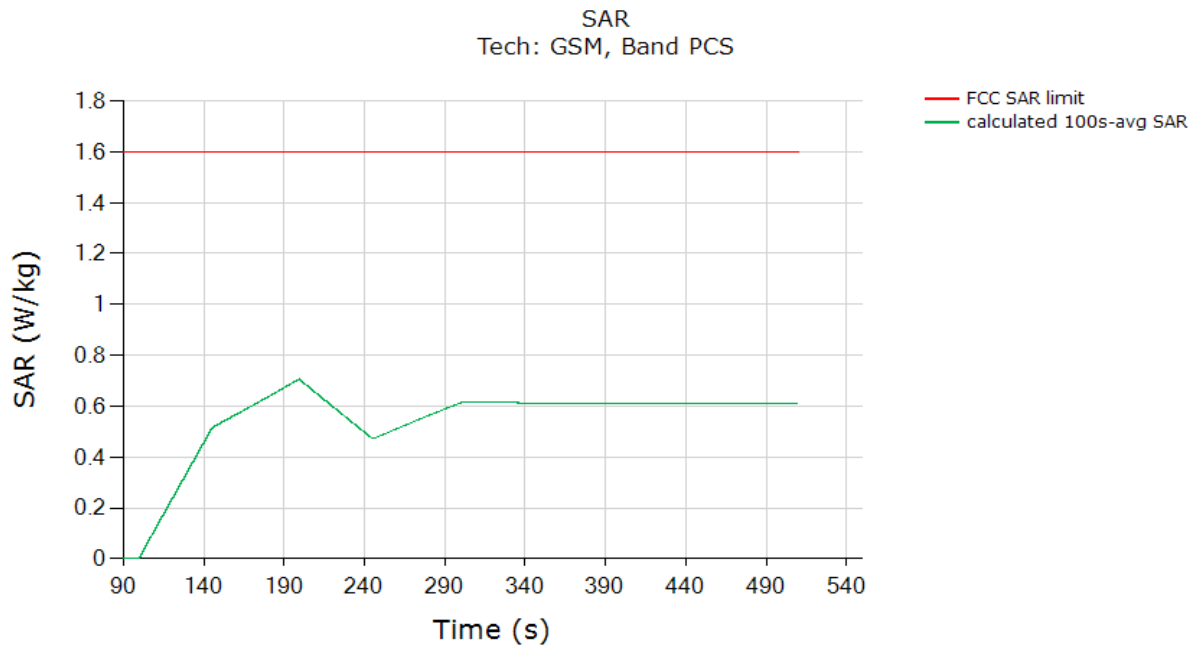

FCC 1g SAR Limit [W/kg]	1.6 W/kg
Max 100s-time averaged 1gSAR (green curve)	0.707W/kg
Validated: Max time averaged SAR (green curve) is within 1dB device uncertainty of measured SAR at P_{limit} (last column in Table 6-2).	

Test result for test sequence 2:

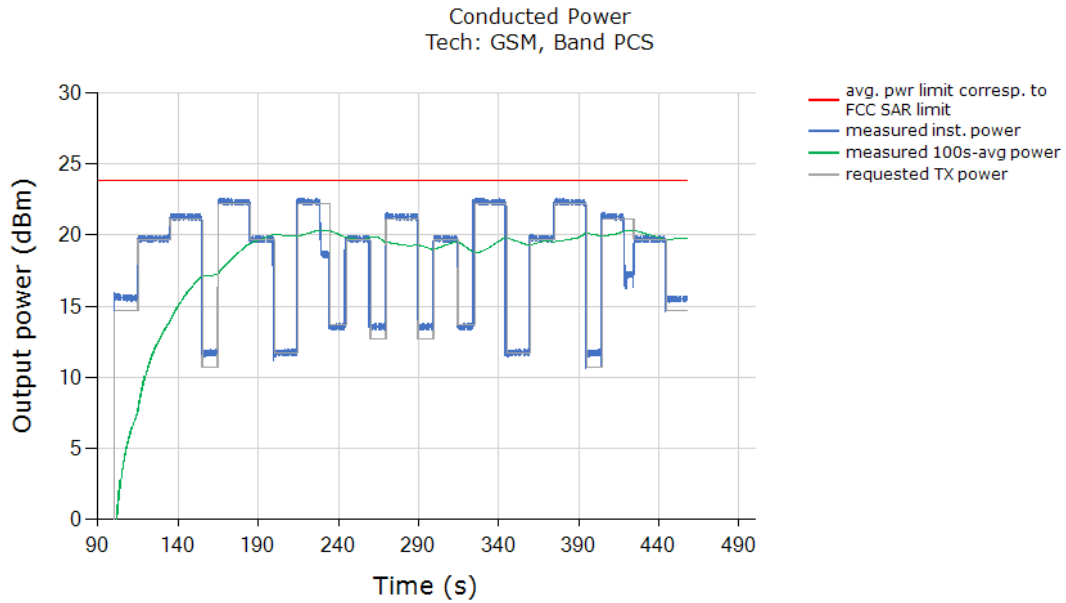

Above time-averaged conducted Tx power is converted/calculated into time-averaged 1gSAR using Equation (1a) and plotted below to demonstrate that the time-averaged 1gSAR versus time does not exceed the FCC limit of 1.6 W/kg for 1gSAR:

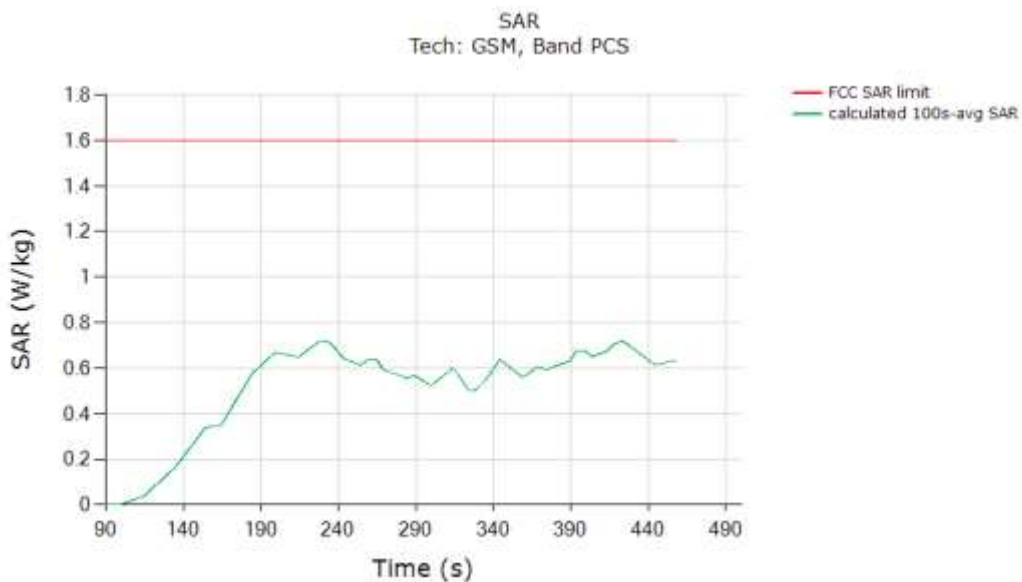

FCC 1g SAR Limit [W/kg]	1.6 W/kg
Max 100s-time averaged 1gSAR (green curve)	0.720W/kg
Validated: Max time averaged SAR (green curve) is within 1dB device uncertainty of measured SAR at <i>P</i> _{limit} (last column in Table 6-2).	

7.3.6Sub6 NR n66 (test case 5 in Table 6-2)

Conducted Plot No. 5

Test result for test sequence 1

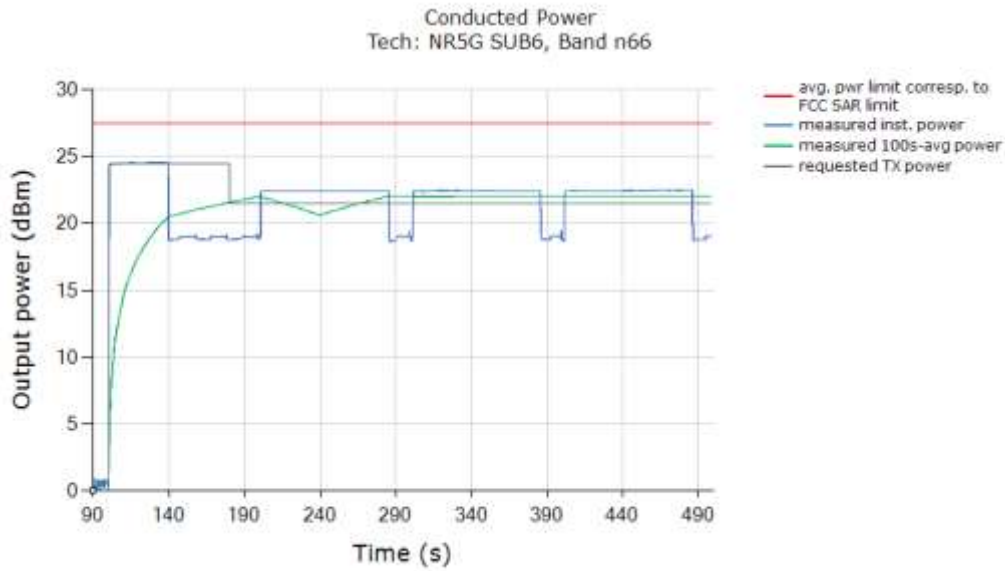

Above time-averaged conducted Tx power is converted/calculated into time-averaged 1gSAR using Equation (1a) and plotted below to demonstrate that the time-averaged 1gSAR versus time does not exceed the FCC limit of 1.6 W/kg for 1gSAR:

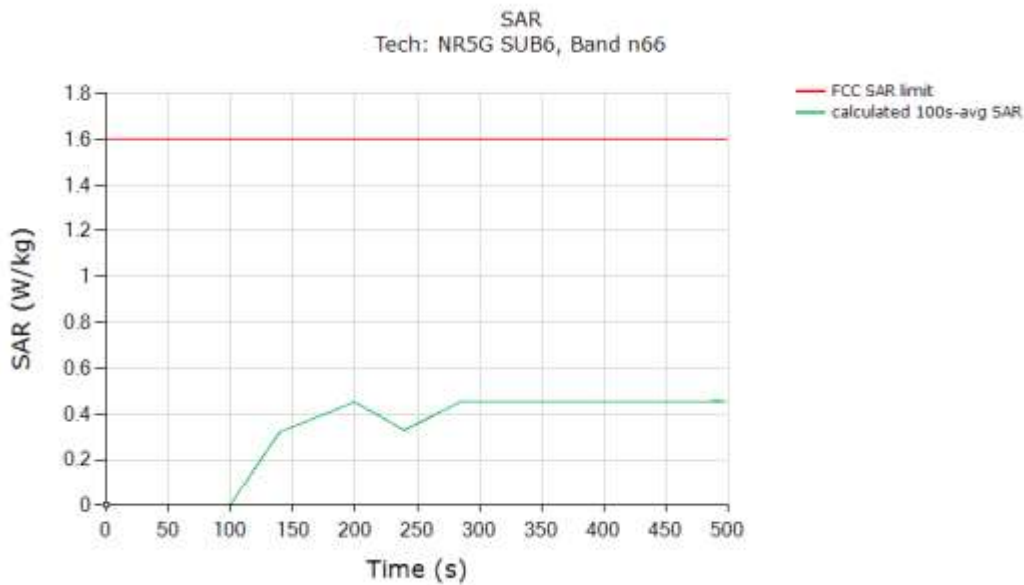

FCC 1g SAR Limit [W/kg]	1.6 W/kg
Max 100s-time averaged 1g SAR (green curve)	0.843W/kg
Validated: Max time averaged SAR (green curve) is within 1dB device uncertainty of measured SAR at <i>P</i> _{limit} (last column in Table 6-2).	

Test result for test sequence 2:

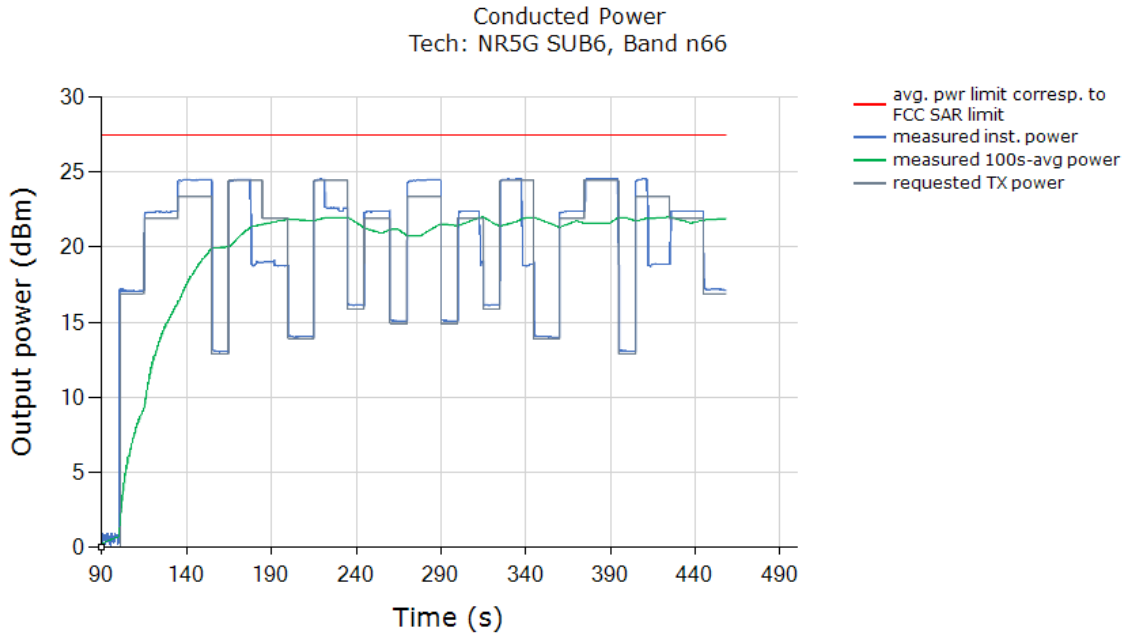

Above time-averaged conducted Tx power is converted/calculated into time-averaged 1gSAR using Equation (1a) and plotted below to demonstrate that the time-averaged 1gSAR versus time does not exceed the FCC limit of 1.6 W/kg for 1gSAR:

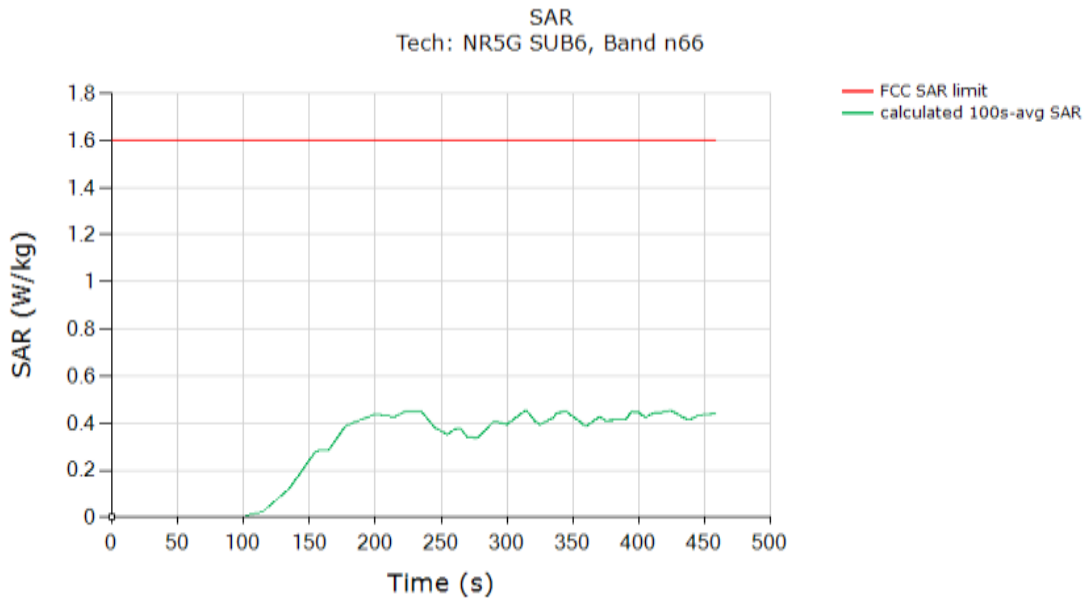

FCC 1g SAR Limit [W/kg]	1.6 W/kg
Max 100s-time averaged 1gSAR (green curve)	0.856W/kg
Validated: Max time averaged SAR (green curve) is within 1dB device uncertainty of measured SAR at <i>P</i> _{limit} (last column in Table 6-2).	

7.3.7 Sub6 NR n25 (test case 6 in Table 6-2)

Conducted Plot No. 6

Test result for test sequence 1

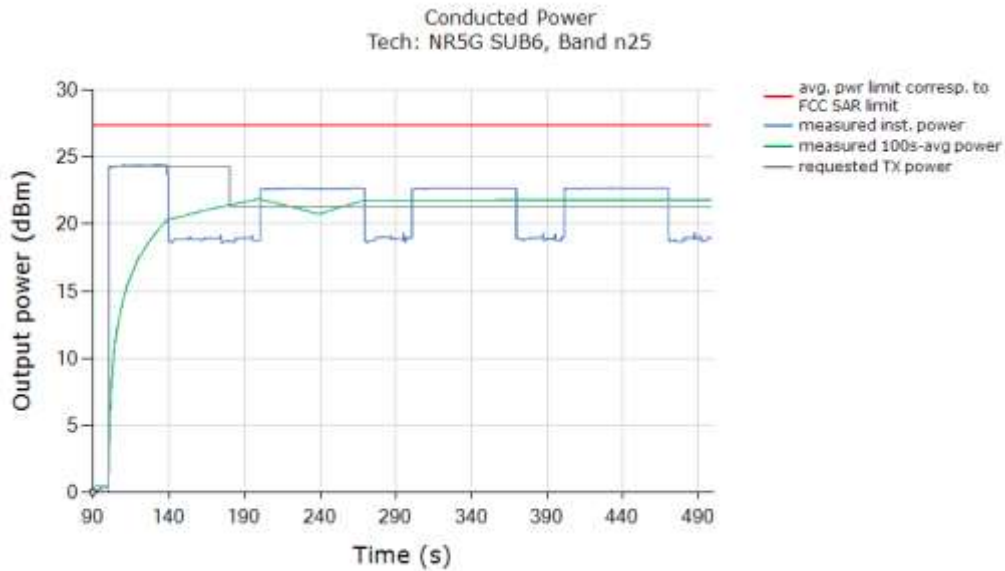

Above time-averaged conducted Tx power is converted/calculated into time-averaged 1gSAR using Equation (1a) and plotted below to demonstrate that the time-averaged 1gSAR versus time does not exceed the FCC limit of 1.6 W/kg for 1gSAR:

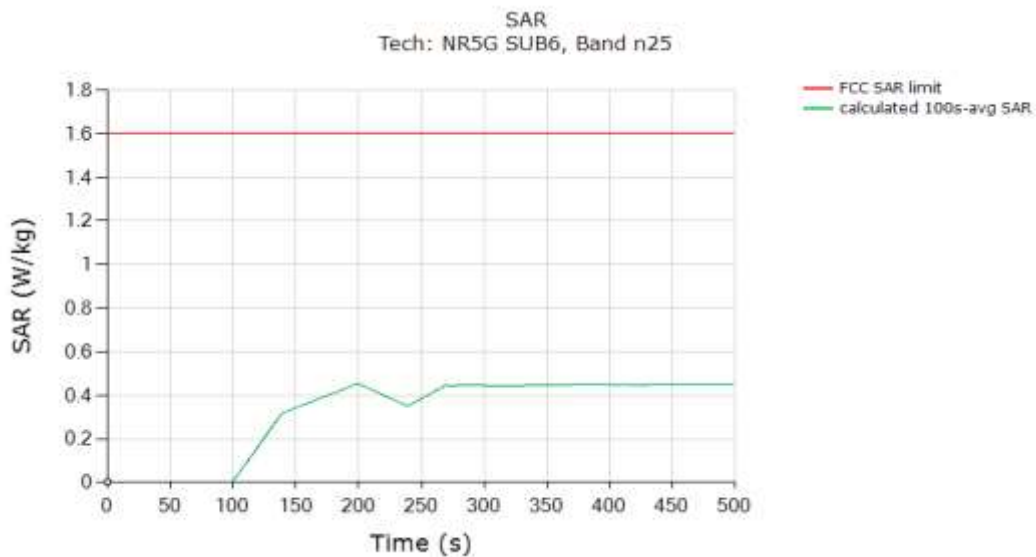

FCC 1g SAR Limit [W/kg]	1.6 W/kg
Max 100s-time averaged 1g SAR (green curve)	0.453 W/kg
Validated: Max time averaged SAR (green curve) is within 1dB device uncertainty of measured SAR at <i>P</i> _{limit} (last column in Table 6-2).	

Test result for test sequence 2:

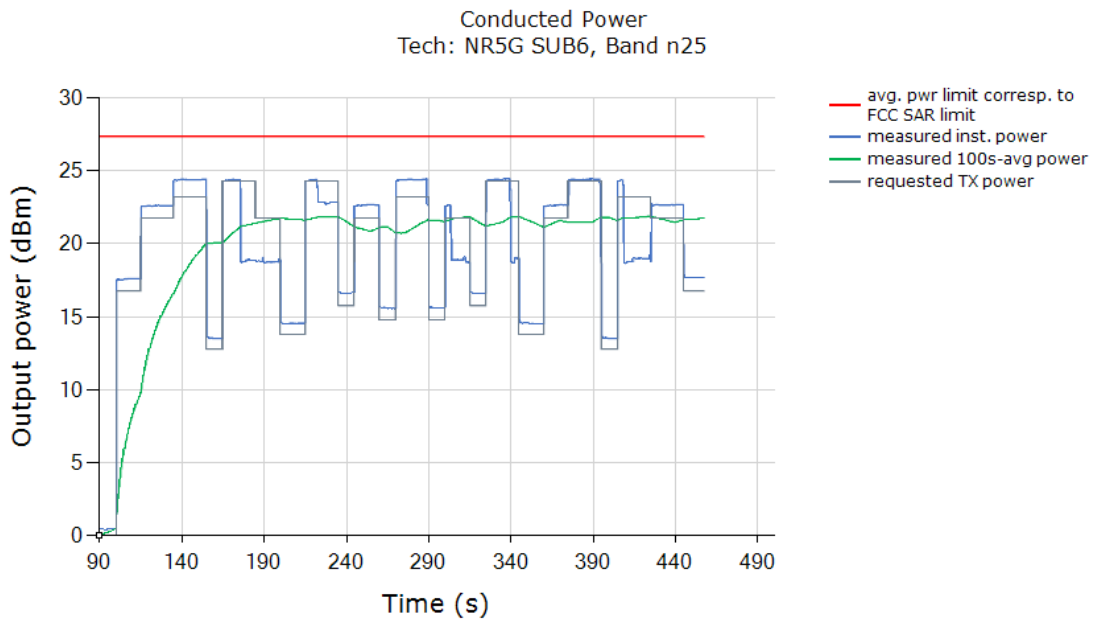

Above time-averaged conducted Tx power is converted/calculated into time-averaged 1gSAR using Equation (1a) and plotted below to demonstrate that the time-averaged 1gSAR versus time does not exceed the FCC limit of 1.6 W/kg for 1gSAR:

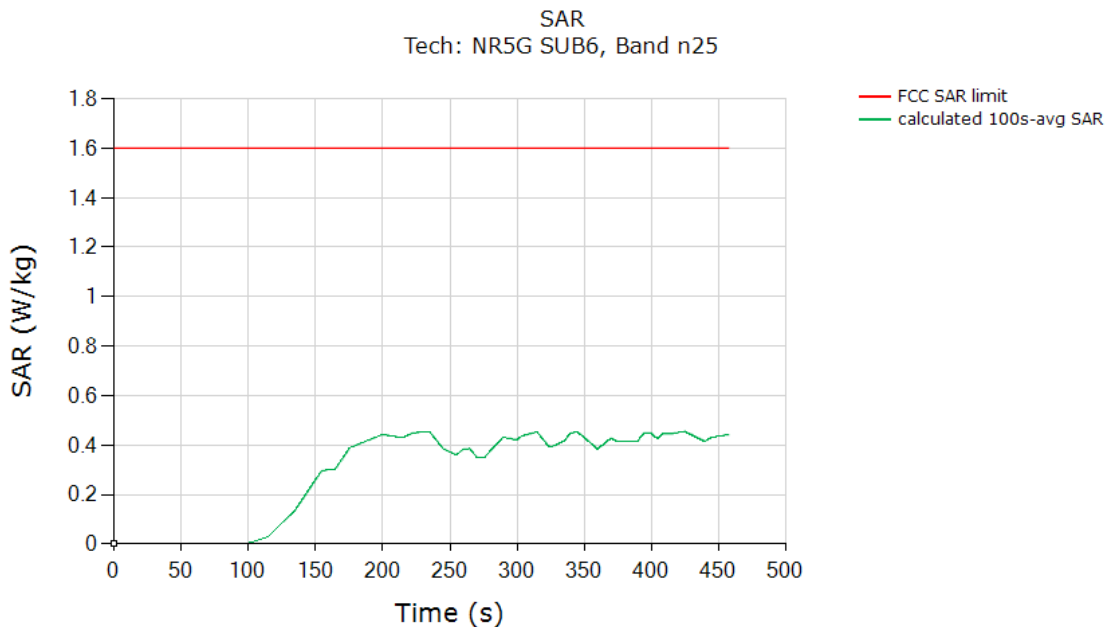

FCC 1g SAR Limit [W/kg]	1.6 W/kg
Max 100s-time averaged 1gSAR (green curve)	0.455W/kg
Validated: Max time averaged SAR (green curve) is within 1dB device uncertainty of measured SAR at P_{limit} (last column in Table 6-2).	

7.4 Change in Call Test results (test case 7 in Table 6-2)

This test was measured with LTE B48, DSI=1, and with callbox requesting maximum power. The call drop was manually performed when the EUT is transmitting at $P_{reserve}$ level as shown in the plot below (dotted black region). The measurement setup is shown in Figure 7-1(a) and (c). The detailed test procedure is described in Section 5.3.2.

Conducted Plot No. 7

Call drop test result:

Plot 1: Measured Tx power (dBm) versus time shows that the transmitting power kept the same $P_{reserve}$ level of LTE B48 after the call was re-established:

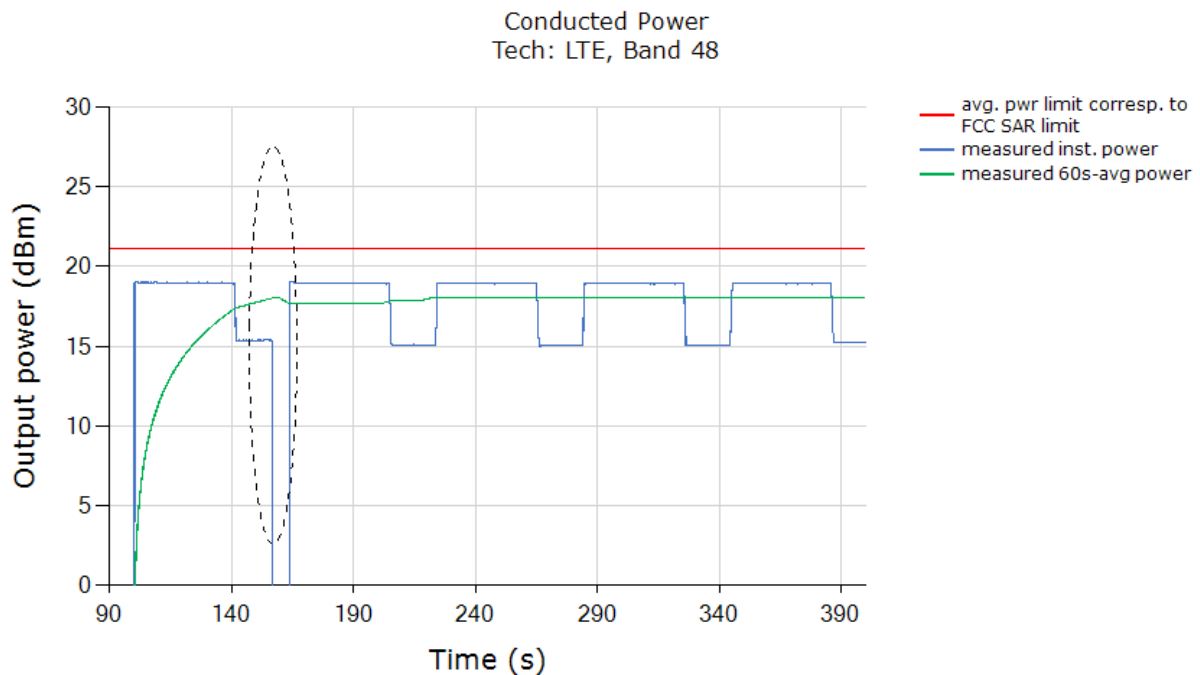

Note: The power level after the change in call kept the same $P_{reserve}$ level of LTE B48. The conducted power plot shows expected Tx transition.

Plot 2: Above time-averaged conducted Tx power is converted/calculated into time-averaged 1gSAR using Equation (1a) and plotted below to demonstrate that the time-averaged 1gSAR versus time does not exceed the FCC limit of 1.6 W/kg for 1gSAR:

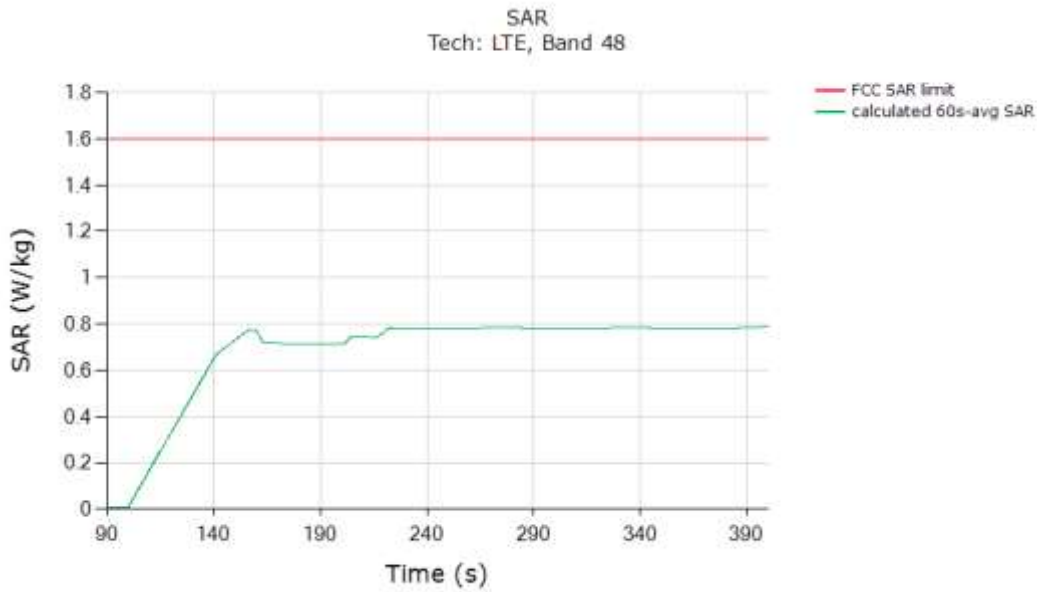

FCC 1g SAR Limit [W/kg]	1.6 W/kg
Max 60s-time averaged 1gSAR (green curve)	0.788 W/kg
Validated: Max time averaged SAR (green curve) is within 1dB device uncertainty of measured SAR at <i>P</i> _{limit} (last column in Table 7-2).	

The test result validated the continuity of power limiting in call change scenario.

7.5 Change in technology/band test results (test case 8 in Table 6-2)

This test was conducted with callbox requesting maximum power, and with technology switch from LTE B66, DSI = 2 (Hotspot) to WCDMA B2, DSI =2 (Hotspot). Following procedure detailed in Section 5.3.3, and using the measurement setup shown in Figure 7-1(a) the technology/band switch was performed when the EUT is transmitting at $P_{reserve}$ level as shown in the plot below (dotted black region).

Conducted Plot No. 8

Test result for change in technology/band:

Plot 1: Measured Tx power (dBm) versus time shows that the transmitting power changed from LTE B66, DSI =2 $P_{reserve}$ level to WCDMA B2, DSI = 2 $P_{reserve}$ level (within 1dB device uncertainty):

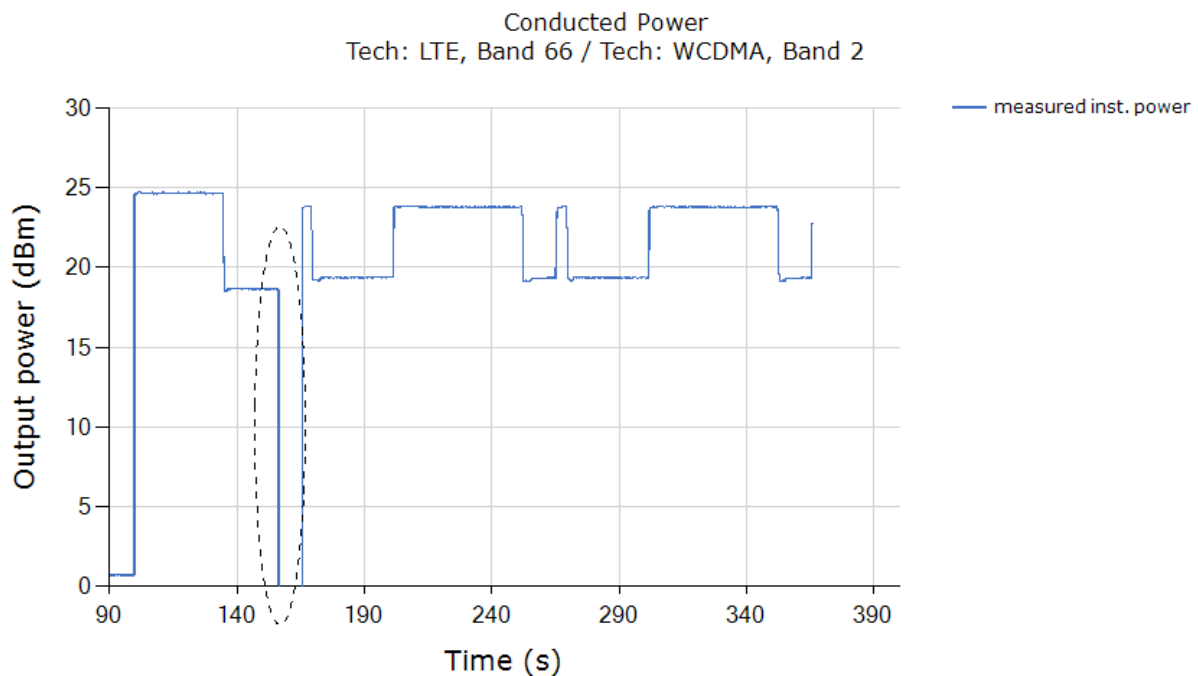

Note: As per Part 1 report, $Reserve_power_margin= 3dB$. Based on Table 7-1, EFS $P_{limit} = 21.0dBm$ for LTE B66 (DSI=3), and EFS $P_{limit} = 21.5dBm$ for WCDMA B2 (DSI=3), it can be seen from above plot that the difference in $P_{reserve} (= P_{limit} - 3dB Reserve_power_margin)$ power level corresponds to the expected difference in P_{limit} levels of 1dB (within 1dB of sub6 radio design related uncertainty). Therefore, the conducted power plot shows expected transition in Tx power.

Plot 2: All the time-averaged conducted Tx power measurement results were converted into time-averaged normalized SAR values using Equation (6a), (6b) and (6c), and plotted below to demonstrate that the time-averaged normalized SAR versus time does not exceed the normalized FCC limit of 1.0:

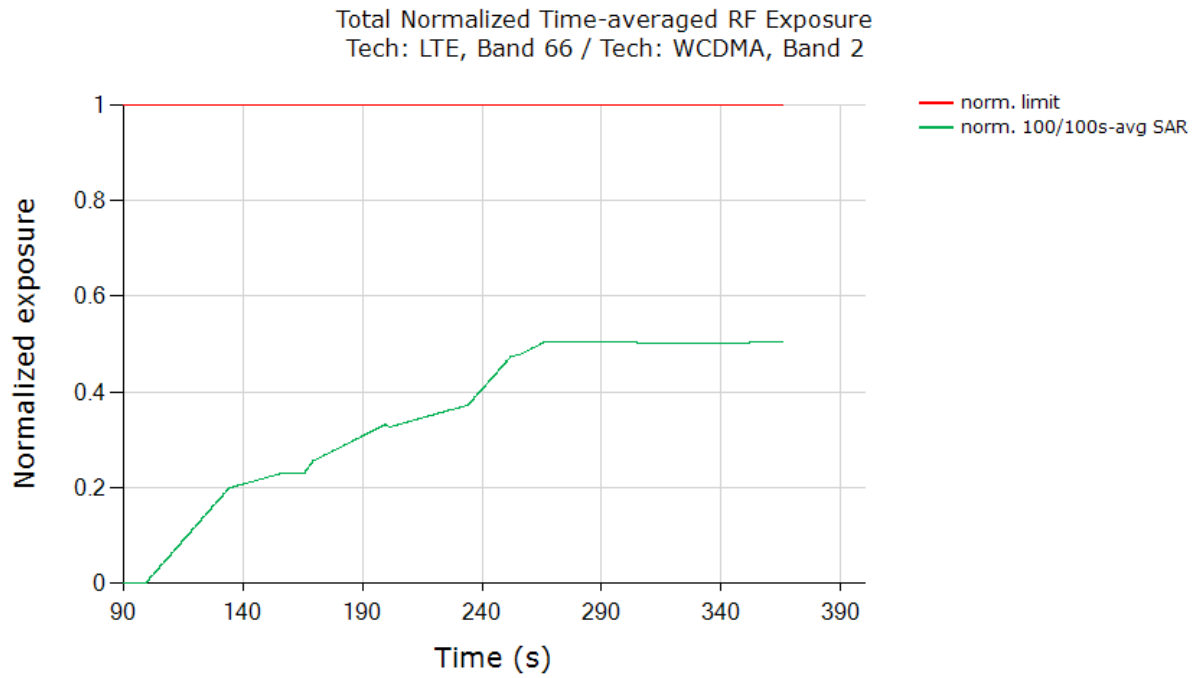

FCC normalized SAR limit	1.0
Max 100s-time averaged normalized SAR(green curve)	0.506
Validated:	

The test result validated the continuity of power limiting in technology/band switch scenario.

7.6 Change in DSI test results (test case 9 in Table 6-2)

This test was conducted with callbox requesting maximum power, and with DSI switch from LTE B48 DSI = 0 (Free space, Body worn) to DSI = 1(Head). Following procedure detailed in Section 5.3.5 using the measurement setup shown in Figure 8-1(a) and (c), the DSI switch was performed when the EUT is transmitting at $P_{reserve}$ level as shown in the plot below (dotted black circle).

Conducted Plot No.9

Test result for change in DSI:

Plot 1: Measured Tx power (dBm) versus time shows that the transmitting power changed when DSI = 0 switches to DSI = 1:

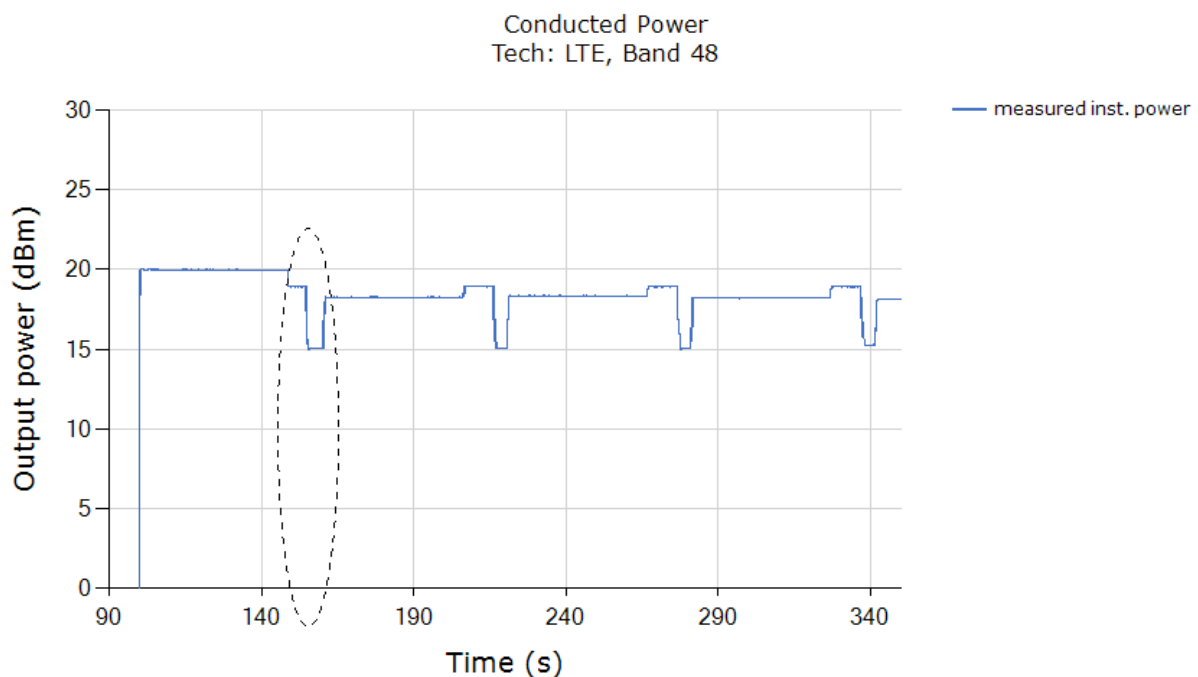

Note: As per the manufacturer, $Reserve_power_margin = 3dB$. Based on Table 8-1, $EFS\ P_{limit} = 20.5\ dBm$ for LTE B48, RCV DSI = 0, and $EFS\ P_{limit} = 18.0\ dBm$ for RCV DSI = 1. The difference in $P_{reserve} (= P_{limit} - 3dB\ Reserve_power_margin)$ level corresponds to the expected different in P_{limit} levels of 3.0 dB (within 1dB of sub6 radio design related uncertainty). Therefore, the conducted power plot shows expected transition in Tx power.

Plot 2: All the time-averaged conducted Tx power measurement results were converted into time-averaged normalized SAR values using Equation (6a), (6b) and (6c), and plotted below to demonstrate that the time-averaged normalized SAR versus time does not exceed the FCC limit of 1 unit.

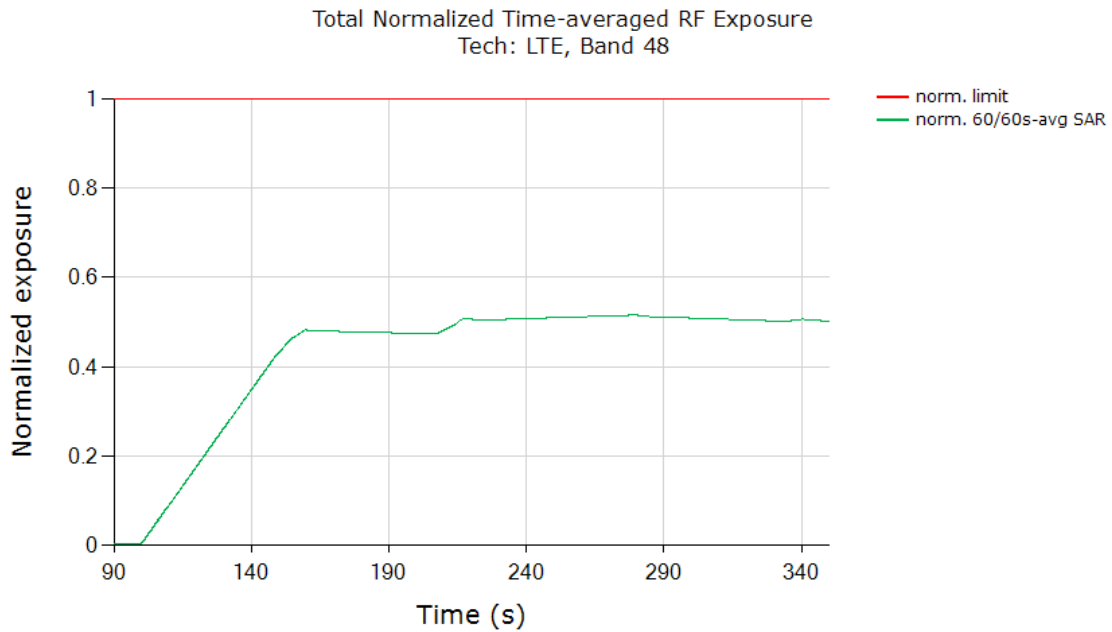

FCC normalized SAR limit	1.0
Max 60s-timeaveraged normalized SAR (green curve)	0.516
Validated:	

The test result validated the continuity of power limiting in DSI switch scenario.

7.7 Change in Time window/antenna switch test results (test case 10 in Table 6-2)

This test was conducted with callbox requesting maximum power, and with antenna switch between LTE B48, Antenna Sub 3(60s), DSI = 2 and LTE B66, Antenna Main 2 (100s), DSI = 2. Following procedure detailed in Section 5.3.6, and using the measurement setup shown in Figure 7-1(b) the tech/band/antenna switch was performed when the EUT is transmitting at *Preserve* level.

7.7.1 Test case 1 : transition from LTE B48 to LTE B66 (i.e 60s to 100s) then back to LTE B48 Conducted Plot No.10

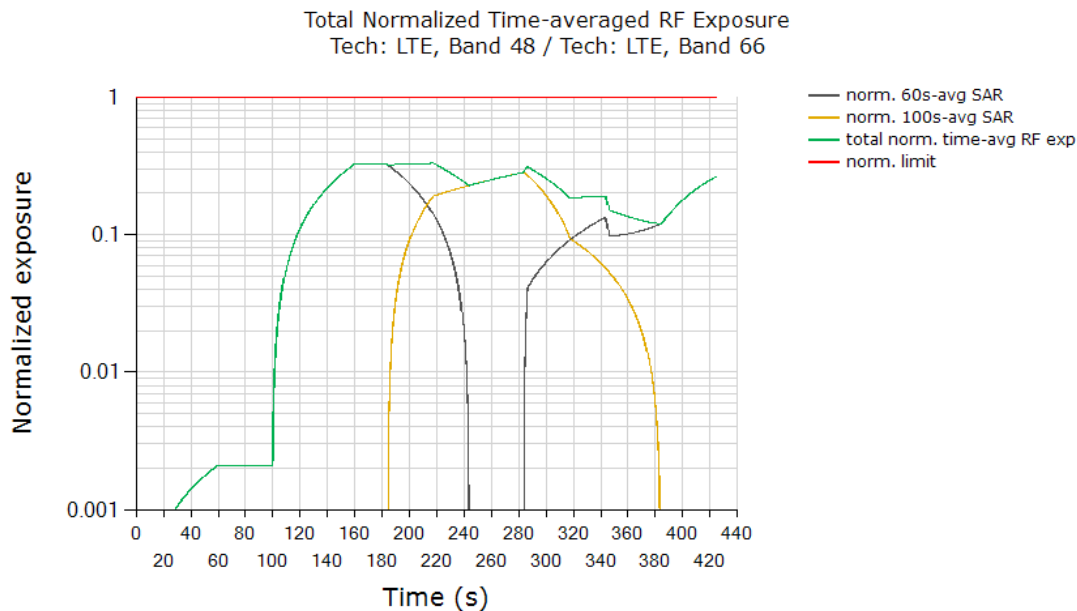
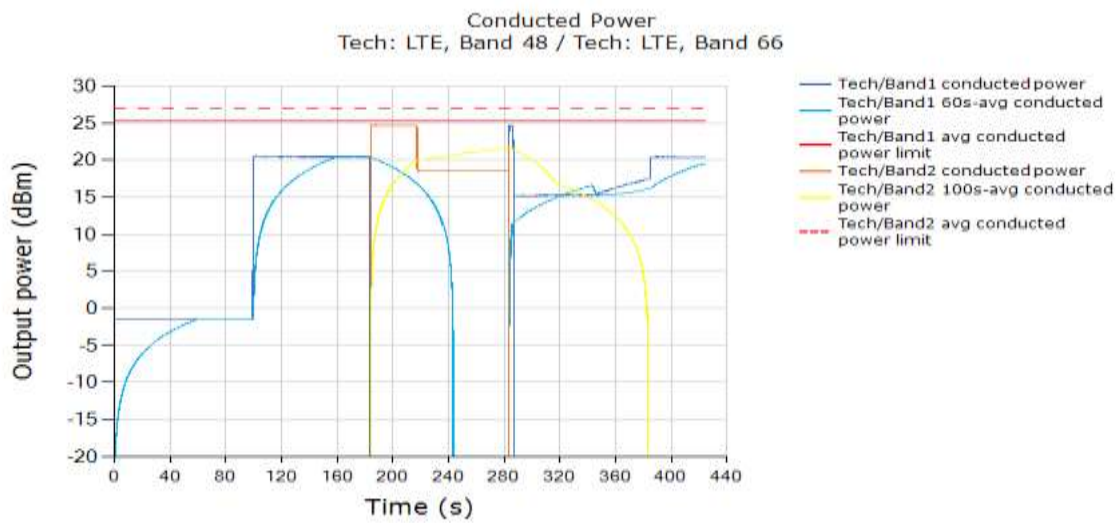

FCC normalized total exposure limit	1.0
Max Norm. Total time-avg. SAR (green curve) (green curve)	0.331
Validated:	

7.7.2 Test case 2 : transition from LTE B66 to LTE B48 (i.e 100s to 60s) then back to LTE B66
Conducted Plot No.11

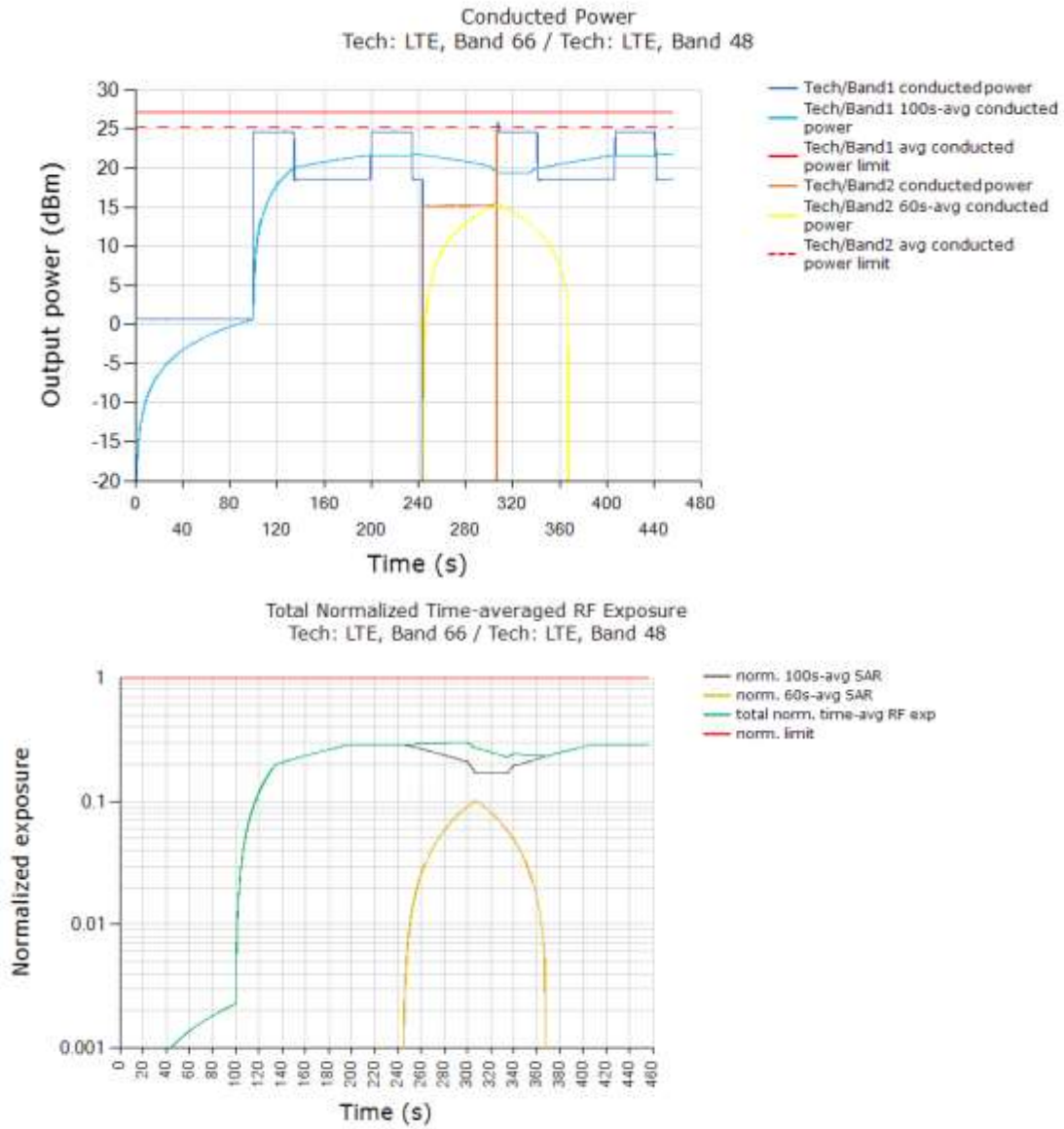

FCC normalized total exposure limit	1.0
Max Norm. Total time-avg. SAR (green curve) (green curve)	0.299
Validated:	

7.8 Switch in SAR exposure test results (test case 11 in Table 7-2)

This test was conducted with callbox requesting maximum power, and with the EUT in LTE B13 + Sub6 NR Band n66 call. Here, LTE B13, DSI = 2 (100s window, EFS P_{limit} = 24.0 dBm, P_{max} = 24.0 dBm, measured P_{limit} = 24.0 dBm), and Sub6 NR Band n66, DSI = 2 (100s window, P_{limit} = 21.0 dBm in EFS setting, EUT's average P_{max} = 24.0 dBm, measured P_{limit} = 21.9 dBm). Following procedure detailed in Section 5.3.7 and Appendix B.2, and using the measurement setup shown in Figure 6-1(c) since LTE and Sub6 NR are sharing the same antenna port. The SAR exposure switch measurement is performed with the EUT in various SAR exposure scenarios, i.e., in SARsub6NR only scenario (t =10s ~125s), SARsu6NR + SARLTE scenario (t =125s ~ 245s) and SARLTE only scenario (t >245s).

Conducted Plot No.12

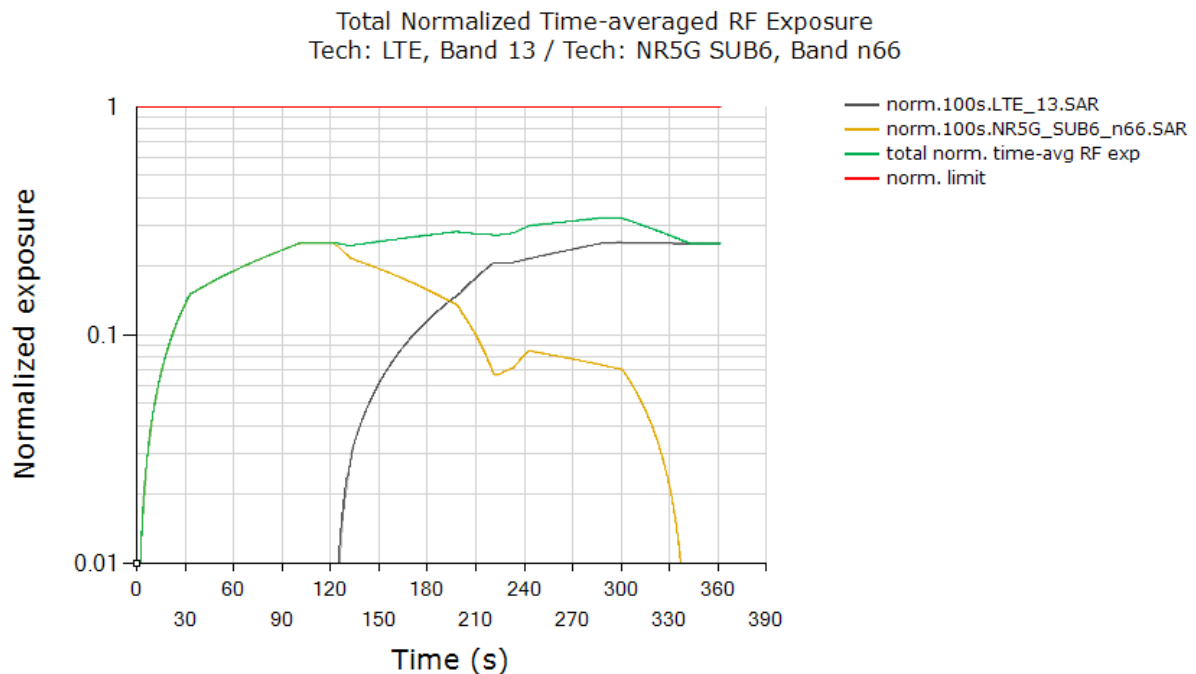

Plot 2: All the conducted Tx power measurement results were converted into time-averaged normalized SAR values using Equation (7a), (7b) and (7c), and plotted below to demonstrate that the time-averaged normalized SAR versus time does not exceed the FCC limit of 1 unit. Equation (7a) is used to convert the LTE Tx power of device to obtain 100s-averaged normalized SAR in LTE B13 as shown in black curve. Similarly, equation (7b) is used to obtain 100s-averaged normalized SAR in Sub6 NR n66 as shown in orange curve. Equation (7c) is used to obtain total time-averaged normalized SAR as shown in green curve (i.e., sum of black and orange curves).

LTE and Sub6NR Instantaneous and Time-averaged TX Power
 Tech: LTE, Band 13 / Tech: NR5G SUB6, Band n66

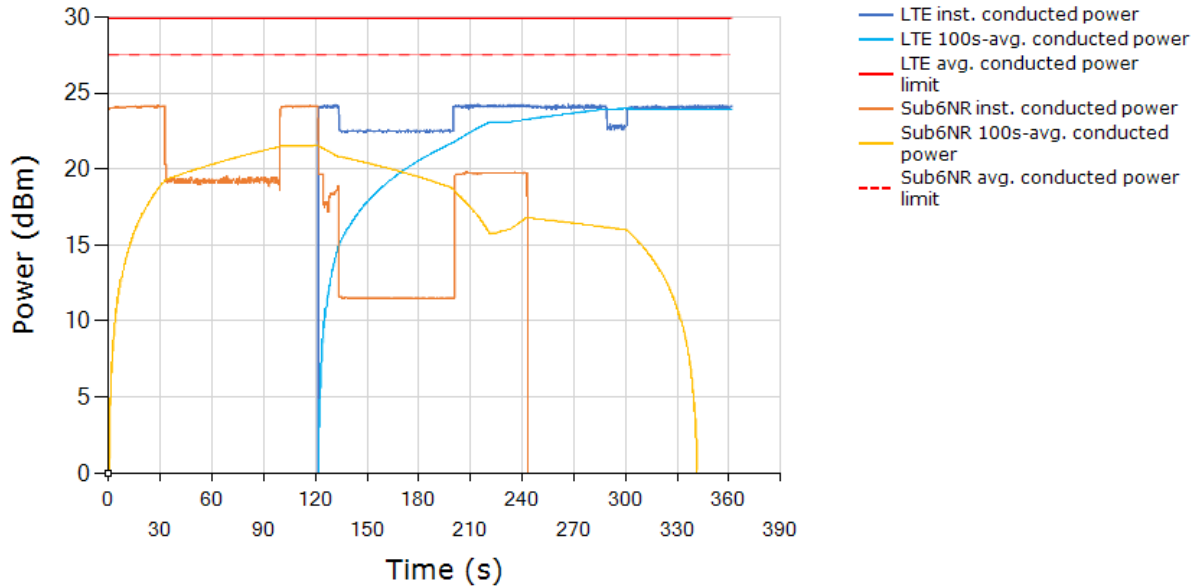

FCC normalized total exposure limit	1.0
Max Norm. Total time-avg. SAR (green curve) (green curve)	0.326
Validated:	

Plot Notes:

Device starts predominantly in Sub6 NR SAR exposure scenario between 5s and 125s, and in LTE SAR + Sub6 NR SAR exposure scenario between 125s and 245s, and in predominantly in LTE SAR exposure scenario after t=245s. Here, Smart Transmit allocates a maximum of 100% of exposure margin (based on 3dB reserve margin setting) for Sub6 NR. This corresponds to a normalized 1gSAR exposure value = $100\% * 0.442 \text{ W/kg measured SAR at Sub6 NR } P_{limit} / 1.6\text{W/kg limit} = 0.253 \pm 1\text{dB device related uncertainty}$ (see orange curve between 5s~125s). For predominantly LTE SAR exposure scenario, maximum normalized 1gSAR exposure should correspond to 100% exposure margin = $0.410 \text{ W/kg measured SAR at LTE } P_{limit} / 1.6\text{W/kg limit} = 0.254 \pm 1\text{dB device related uncertainty}$ (see black curve after t =245s).

Additionally, in SAR exposure switch test, at all times the total time-averaged normalized RF exposure (green curve) should not exceed normalized SAR_design_target + 1dB device uncertainty. In this test, with a maximum normalized SAR of 0.326 being $\leq 0.794 (= 1/1.6 + 1\text{dB device uncertainty})$, the above test result validated the continuity of power limiting in SAR exposure switch scenario.

8. Equipment List

Manufacturer	Type / Model	S/N	Calib. Date	Calib.Interval	Calib.Due
Anritsu	MT8821C	6201502997	07/08/2021	Annual	07/08/2022
Anritsu	MT8000A	6262036812	12/20/2021	Annual	12/20/2022
R&S	Power Sensor	1419.0006K02-109996-wi	12/16/2021	Annual	12/16/2022
R&S	Power Sensor	1419.0087K02101351-zV	12/16/2021	Annual	12/16/2022
Narda	Directional Coupler	03096	03/11/2022	Annual	03/11/2023
Narda	Directional Coupler	03089	03/29/2022	Annual	03/29/2023
Mini-circuits	Power Splitter	UU95102009	04/05/2022	Annual	04/05/2023
MICRO LAB	LA-15N	-	10/06/2021	Annual	10/06/2022
UIY	High Pass Filter	JH00026302	09/06/2021	Annual	09/06/2022
R&S	Wireless Communication Test Set CMW500	167918	04/15/2022	Annual	04/15/2023

9. Conclusion

Qualcomm Smart Transmit feature employed in Samsung mobile phone (FCC A3LSMG736U) has been validated through the conducted/radiated power measurement (as demonstrated in Chapters 8 and 9)

As demonstrated in this report, the power limiting enforcement is effective and the total normalized time-averaged RF exposure does not exceed 1.0 for all the transmission scenarios described in Section 4.

Therefore, the EUT complies with FCC RF exposure requirement.

Appendix A: Test Sequences

1. Test sequence is generated based on below parameters of the EUT:

- a. Measured maximum power (P_{max})
- b. Measured Tx_power_at_SAR_design_target (P_{limit})
- c. Reserve_power_margin (dB)

$P_{reserve}$ (dBm) = measured P_{limit} (dBm) – Reserve_power_margin (dB)
- d. SAR_time_window (100s for FCC)

2. Test Sequence 1 Waveform:

Based on the parameters above, the Test Sequence 1 is generated with one transition between high and low Tx powers. Here, high power = P_{max} ; low power = $P_{max}/2$, and the transition occurs after 80 seconds at high power P_{max} . As long as the power enforcement is taking into effective during one 100s/60s time window, the validation test with this defined test sequence 1 is valid, otherwise, select other radio configuration (band/DSI within the same technology group) having lower P_{limit} for this test. The Test sequence 1 waveform is shown below:

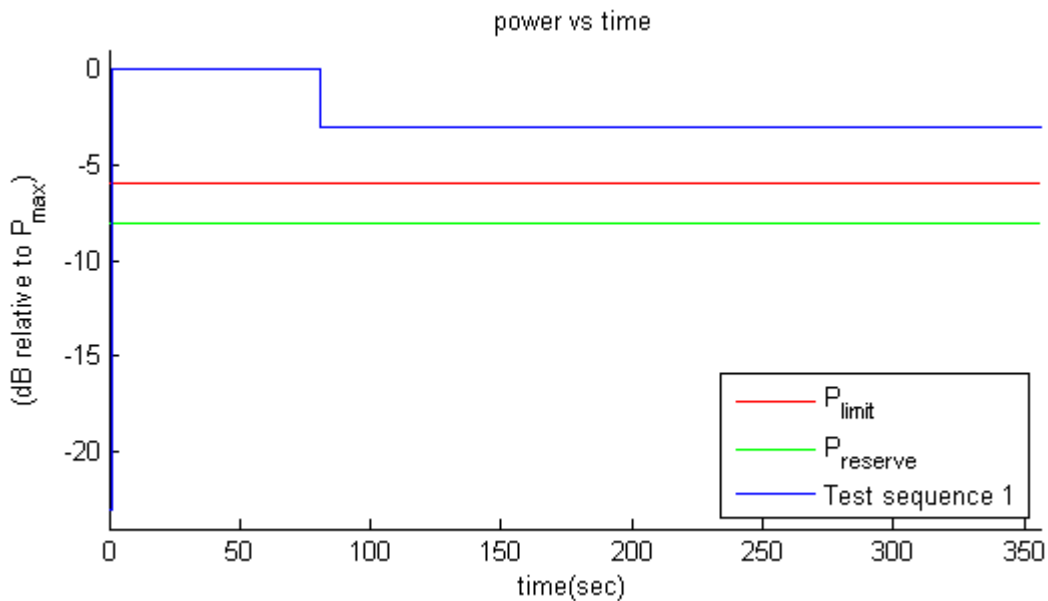

Figure 1 Test sequence 1 waveform

3. Test Sequence 2 Waveform:

Based on the parameters in A-1, the Test Sequence 2 is generated as described in Table A-1, which contains two 170 second-long sequences (yellow and green highlighted rows) that are mirrored around the center row of 20s, resulting in a total duration of 360 seconds:

Table -1 Test Sequence 2

Time duration (seconds)	dB relative to P_{limit} or $P_{reserve}$
15	$P_{reserve} - 2$
20	P_{limit}
20	$(P_{limit} + P_{max})/2$ averaged in mW and rounded to nearest 0.1 dB step
10	$P_{reserve} - 6$
20	P_{max}
15	P_{limit}
15	$P_{reserve} - 5$
20	P_{max}
10	$P_{reserve} - 3$
15	P_{limit}
10	$P_{reserve} - 4$
20	$(P_{limit} + P_{max})/2$ averaged in mW and rounded to nearest 0.1 dB step
10	$P_{reserve} - 4$
15	P_{limit}
10	$P_{reserve} - 3$
20	P_{max}
15	$P_{reserve} - 5$
15	P_{limit}
20	P_{max}
10	$P_{reserve} - 6$
20	$(P_{limit} + P_{max})/2$ averaged in mW and rounded to nearest 0.1 dB step
20	P_{limit}
15	$P_{reserve} - 2$

The Test Sequence 2 waveform is shown in Figure A-2

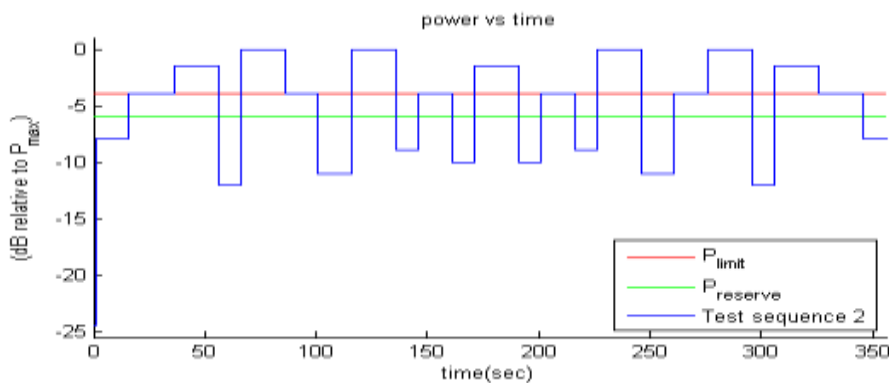

Appendix B: Test Procedures for sub6 NR + LTE Radio

Appendix B provides the test procedures for validating Qualcomm Smart Transmit feature for LTE + Sub6 NR non-standalone (NSA) mode transmission scenario, where sub-6GHz LTE link acts as an anchor.

B.1 Time-varying Tx power test for sub6 NR in NSA mode

Follows Section 5.2.1 to select test configurations for time-varying test. This test is performed with two pre-defined test sequences (described in Section 5.1) applied to Sub6 NR (with LTE on all-down bits or low power for the entire test after establishing the LTE+Sub6 NR call with the callbox). Follow the test procedures described in Section 5.3.1 to demonstrate the effectiveness of power limiting enforcement and that the time averaged Tx power of Sub6 NR when converted into 1gSAR values does not exceed the regulatory limit at all times (see Eq. (1a) and (1b)). Sub6 NR response to test sequence1 and test sequence2 will be similar to other technologies (say, LTE), and are shown in Sections 8.3.7 and 8.3.8.

B.2 Switch in SAR exposure between LTE vs. Sub6 NR during transmission

This test is to demonstrate that Smart Transmit feature accurately accounts for switching in exposures among SAR for LTE radio only, SAR from both LTE radio and sub6 NR, and SAR from sub6 NR only scenarios, and ensures total time-averaged RF exposure compliance with FCC limit.

Test procedure:

1. Measure conducted Tx power corresponding to P_{limit} for LTE and sub6 NR in selected band. Test condition to measure conducted P_{limit} is:

- Establish device in call with the callbox for LTE in desired band. Measure conducted Tx power corresponding to LTE P_{limit} with Smart Transmit enabled and *Reserve_power_margin* set to 0 dB, callbox set to request maximum power.
- Repeat above step to measure conducted Tx power corresponding to Sub6 NR P_{limit} . If testing LTE+Sub6 NR in non-standalone mode, then establish LTE+Sub6 NR call with callbox and request all down bits for radio1 LTE. In this scenario, with callbox requesting maximum power from Sub6 NR, measured conducted Tx power corresponds to radio2 P_{limit} (as radio1 LTE is at all-down bits)

2. Set *Reserve_power_margin* to actual (intended) value with EUT setup for LTE + Sub6 NR call. First, establish LTE connection in all-up bits with the callbox, and then Sub6 NR connection is added with callbox requesting UE to transmit at maximum power in Sub6 NR. As soon as the Sub6 NR connection is established, request all-down bits on LTE link (otherwise, Sub6 NR will not have sufficient RF exposure margin to sustain the call with LTE in all-up bits). Continue LTE (all-down bits)+Sub6 NR transmission for more than one time-window duration to test predominantly Sub6 NR SAR exposure scenario (as SAR exposure is negligible from all-down bits in LTE). After at least one time-window, request LTE to go all-up bits to test LTE SAR and Sub6 NR SAR exposure scenario. After at least one more time-window, drop (or request all-down bits) Sub6 NR transmission to test predominantly LTE SAR exposure scenario. Continue the test for at least one more time-window. Record the conducted Tx powers for both LTE and Sub6 NR for the entire duration of this test.

3. Once the measurement is done, extract instantaneous Tx power versus time for both LTE and Sub6 NR links. Similar to technology/band switch test in Section 5.3.3, convert the conducted Tx power for both these radios into 1gSAR value (see Eq. (6a) and (6b)) using corresponding technology/band P_{limit} measured in Step 1, and then perform 100s running average to determine time-averaged 1gSAR versus time as illustrated in Figure 3-1. Note that here it is assumed both radios have Tx frequencies < 3GHz, otherwise, 60s running average should be performed for radios having Tx frequency between 3GHz and 6GHz.

4. Make one plot containing: (a) instantaneous Tx power versus time measured in Step 2.

5. Make another plot containing: (a) instantaneous 1gSAR versus time determined in Step 3, (b) computed time-averaged 1gSAR versus time determined in Step 3, and (c) corresponding regulatory $1gSAR_{limit}$ of 1.6W/kg.

The validation criteria is, at all times, the time-averaged 1gSAR versus time shall not exceed the regulatory $1gSAR_{limit}$ of 1.6W/kg.