

REPORT

FCC Certification

Applicant Name:
SAMSUNG Electronics Co., Ltd.

Address:
129, Samsung-ro, Yeongtong-gu Suwon-si, Gyeonggi-do,
443-742 Rep. of Korea

Date of Issue:
December 09, 2014

Test Site/Location:
HCT CO., LTD., 74, Seoicheon-ro 578beon-gil,
Majang-myeon, Icheon-si, Gyeonggi-do, Korea

Report No.: HCT-R-1412-F002

HCT FRN: 0005866421

FCC ID: A3LSMG720N0

APPLICANT: SAMSUNG Electronics Co., Ltd.

FCC Model(s): SM-G720N0

EUT Type: Mobile Phone

FCC Classification: Licensed Portable Transmitter Held to Ear (PCE)

FCC Rule Part(s): §2 , §27

Tx Frequency: 706.5 MHz – 713.5 MHz (LTE – Band 17)

Max. RF Output Power:

Band 17 (5 MHz) :	0.048 W (QPSK) (16.83 dBm)
	0.052 W (16-QAM) (17.20 dBm)
Band 17 (10 MHz) :	0.054 W (QPSK) (17.32 dBm)
	0.045 W (16-QAM) (16.55 dBm)

Emission Designator(s):

Band 17 (5 MHz) :	4M47G7D (QPSK) / 4M46W7D (16-QAM)
Band 17 (10 MHz) :	8M92G7D (QPSK) / 8M90W7D (16-QAM)

The measurements shown in this report were made in accordance with the procedures specified in §2.947. I assume full responsibility for the accuracy and completeness of these measurements, and for the qualifications of all persons taking them.

HCT CO., LTD. Certifies that no party to this application has subject to a denial of Federal benefits that includes FCC benefits pursuant to section 5301 of the Anti-Drug Abuse Act of 1998,21 U.S. C.853(a)



Report prepared by
: Kyoung Houn Seo
Test engineer of RF Team



Approved by
: Chang Seok Choi
Manager of RF Team

This report only responds to the tested sample and may not be reproduced, except in full, without written approval of the HCT Co., Ltd.

Version

TEST REPORT NO.	DATE	DESCRIPTION
HCT-R-1412-F002	December 09, 2014	- First Approval Report

Table of Contents

1. GENERAL INFORMATION	4
2. INTRODUCTION	5
2.1. EUT DESCRIPTION.....	5
2.2. MEASURING INSTRUMENT CALIBRATION.....	5
2.3. TEST FACILITY	5
3. DESCRIPTION OF TESTS	6
3.1 ERP RADIATED POWER AND RADIATED SPURIOUS EMISSIONS	6
3.2 OCCUPIED BANDWIDTH.	8
3.3 BLOCK B FREQUENCY RANGE (704 – 710 and 734 – 740 MHz, 777 – 792 MHz)	9
3.4 SPURIOUS AND HARMONIC EMISSIONS AT ANTENNA TERMINAL.....	9
3.5 FREQUENCY STABILITY / VARIATION OF AMBIENT TEMPERATURE	10
4. LIST OF TEST EQUIPMENT	11
5. SUMMARY OF TEST RESULTS	12
6. SAMPLE CALCULATION	13
7. TEST DATA	14
7.1 EFFECTIVE RADIATED POWER OUTPUT	14
7.2 RADIATED SPURIOUS EMISSIONS.....	16
7.2.1 RADIATED SPURIOUS EMISSIONS (Band 17).....	16
7.3 OCCUPIED BANDWIDTH	18
7.4 CONDUCTED SPURIOUS EMISSIONS	18
7.4.1 BAND EDGE.....	18
7.5 FREQUENCY STABILITY / VARIATION OF AMBIENT TEMPERATURE	19
7.5.1 FREQUENCY STABILITY (LTE Band 17)	19
8. TEST PLOTS.....	21

MEASUREMENT REPORT

1. GENERAL INFORMATION

Applicant Name: SAMSUNG Electronics Co., Ltd.

Address: 129, Samsung-ro, Yeongtong-gu Suwon-si, Gyeonggi-do, 443-742 Rep. of Korea

FCC ID: A3LSMG720N0

Application Type: Certification

FCC Classification: Licensed Portable Transmitter Held to Ear (PCE)

FCC Rule Part(s): §2 , §27

EUT Type: Mobile Phone

FCC Model(s): SM-G720N0

Tx Frequency: 706.5 MHz – 713.5 MHz (LTE – Band 17)

Max. RF Output Power:

Band 17 (5 MHz) :	0.048 W (QPSK) (16.83 dBm)
	0.052 W (16-QAM) (17.20 dBm)
Band 17 (10 MHz) :	0.054 W (QPSK) (17.32 dBm)
	0.045 W (16-QAM) (16.55 dBm)

Emission Designator(s):

Band 17 (5 MHz) :	4M47G7D (QPSK) / 4M46W7D (16-QAM)
Band 17 (10 MHz) :	8M92G7D (QPSK) / 8M90W7D (16-QAM)

Date(s) of Tests: November 19, 2014 ~ December 08, 2014

Antenna Specification

Manufacturer: SAMSUNG ELECTRO-MECHANICS

Antenna type: PIFA Antenna

Peak Gain: Band 17: -11.8 dBi

2. INTRODUCTION

2.1. EUT DESCRIPTION

The SAMSUNG Electronics Co., Ltd. SM-G720N0 Mobile Phone consists of LTE 17.

2.2. MEASURING INSTRUMENT CALIBRATION

The measuring equipment, which was utilized in performing the tests documented herein, has been calibrated in accordance with the manufacturer's recommendations for utilizing calibration equipment, which is traceable to recognized national standards.

2.3. TEST FACILITY

The Fully-anechoic chamber and conducted measurement facility used to collect the radiated data are located at the **74, Seoicheon-ro 578beon-gil, Majang-myeon, Icheon-si, Gyeonggi-do, Korea.**

3. DESCRIPTION OF TESTS

3.1 ERP RADIATED POWER AND RADIATED SPURIOUS EMISSIONS

Note: ERP(Effective Radiated Power)

Test Procedure

Radiated emission measurements are performed in the Fully-anechoic chamber. The equipment under test is placed on a non-conductive table 3-meters away from the receive antenna in accordance with ANSI/TIA-603-C-2004 Clause 2.2.17. The turntable is rotated through 360 degrees, and the receiving antenna scans in order to determine the level of the maximized emission. The level and position of the maximized emission is recorded with the spectrum analyzer using a positive peak detector.

A half wave dipole is then substituted in place of the EUT. For emissions above 1GHz, a horn antenna is substituted in place of the EUT. The substitute antenna is driven by a signal generator and the previously recorded signal was duplicated.

The power is calculated by the following formula;

$$P_{d(dBm)} = P_{g(dBm)} - \text{cable loss}_{(dB)} + \text{antenna gain}_{(dB)}$$

Where: P_d is the dipole equivalent power and P_g is the generator output power into the substitution antenna.

Radiated spurious emissions

: Frequency Range : 30 MHz ~ 10th Harmonics of highest channel fundamental frequency.

5.1.1 Peak power measurements with a spectrum/signal analyzer or EMI receiver

The following procedure can be used to determine the total peak output power.

- a) Set the RBW \geq OBW.
- b) Set VBW \geq 3 \times RBW.
- c) Set span \geq 2 \times RBW
- d) Sweep time = auto couple.
- e) Detector = peak.
- f) Ensure that the number of measurement points \geq span/RBW.
- g) Trace mode = max hold.
- h) Allow trace to fully stabilize.
- i) Use the peak marker function to determine the peak amplitude level.

5.2.2 Procedures for use with a spectrum/signal analyzer when EUT cannot be configured to transmit continuously and sweep triggering/signal gating cannot be properly implemented

If the EUT cannot be configured to transmit continuously (burst duty cycle < 98%), then one of the following procedures can be used. The selection of the applicable procedure will depend on the characteristics of the measured burst duty cycle.

Measure the burst duty cycle with a spectrum/signal analyzer or EMC receiver can be used in zero-span mode if the response time and spacing between bins on the sweep are sufficient to permit accurate measurement of the burst on/off time of the transmitted signal.

5.2.2.2 Constant burst duty cycle

If the measured burst duty cycle is constant (i.e., duty cycle variations are less than ± 2 percent), then:

- a) Set span to at least 1.5 times the OBW.
- b) Set RBW = 1-5% of the OBW, not to exceed 1 MHz.
- c) Set VBW $\geq 3 \times$ RBW.
- d) Number of points in sweep $\geq 2 \times$ span / RBW. (This gives bin-to-bin spacing \leq RBW/2, so that narrowband signals are not lost between frequency bins.)
- e) Sweep time = auto.
- f) Detector = RMS (power averaging).
- g) Set sweep trigger to "free run".
- h) Trace average at least 100 traces in power averaging (i.e., RMS) mode.
- i) Compute power by integrating the spectrum across the OBW of the signal using the instrument's band power measurement function with band limits set equal to the OBW band edges. If the instrument does not have a band power function, sum the spectrum levels (in power units) at intervals equal to the RBW extending across the entire OBW of the spectrum.
- j) Add $10 \log (1/x)$, where x is the duty cycle, to the measured power in order to compute the average power during the actual transmission times (because the measurement represents an average over both the on and off times of the transmission).

For example, add $10 \log (1/0.25) = 6$ dB if the duty cycle is a constant 25%.

3.2 OCCUPIED BANDWIDTH.

Test set-up

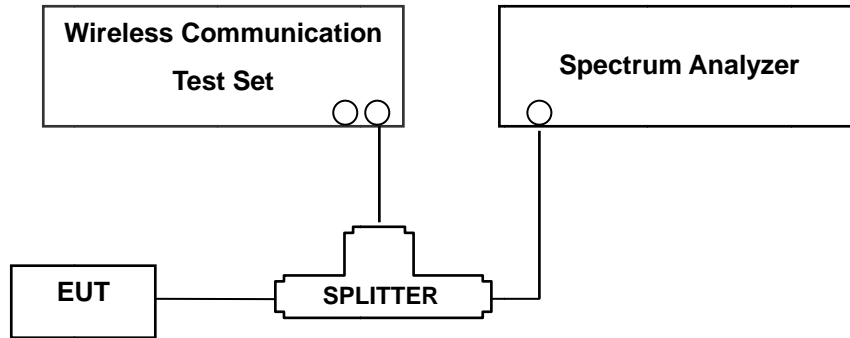

(Configuration of conducted Emission measurement)

Test Procedure

OBW is tested in accordance with KDB971168 D01 Power Meas License Digital Systems v02r02, October 17, 2014, Section 4.2..

The EUT was setup to maximum output power at its lowest channel. The occupied bandwidth was measured using a spectrum analyzer. The measurements are repeated for the highest and a middle channel. The EUT's occupied bandwidth is measured as the width of the signal between two points, one below the carrier center frequency and one above the carrier frequency, outside of which all emissions are attenuated at least 26 dB below the transmitter power. Plots of the EUT's occupied bandwidth are shown herein.

3.3 BLOCK B FREQUENCY RANGE (704 – 710 and 734 – 740 MHz, 777 – 792 MHz)

§27.5(c)

698-746 MHz Band. The following frequencies are available for licensing pursuant to this part in the 698–746 MHz band: (1) Three paired channel blocks of 12 MHz each are available for assignment as follows :

Block A : 698 – 704 MHz and 728 – 734 MHz ;

Block B : 704 – 710 MHz and 734 – 740 MHz ; and

Block C : 710 – 716 MHz and 740 – 746 MHz.

The EUT is only being authorized for operation in Blocks B and C.

3.4 SPURIOUS AND HARMONIC EMISSIONS AT ANTENNA TERMINAL.

Test Procedure

Spurious and harmonic emissions at antenna terminal is tested in accordance with KDB971168 D01 Power Meas License Digital Systems v02r02, October 17, 2014, Section 6.0.

The level of the carrier and the various conducted spurious and harmonic frequencies is measured by means of a calibrated spectrum analyzer.

The spectrum is scanned from the lowest frequency generated in the equipment up to a frequency including its 10th harmonic. On any frequency outside a licensee's frequency block, the power of any emission shall be attenuated below the transmitter power (P) by at least $43 + 10 \log(P)$ dB. Compliance with these provisions is based on the use of measurement instrumentation employing a resolution bandwidth of 1 MHz or greater. However, in the 100 kHz bands immediately outside and adjacent to the frequency block a resolution bandwidth of at least 30kHz bandwidth may be employed. The emission bandwidth is defined as the width of the signal between two points, one below the carrier center frequency and one above the carrier center frequency

NOTES: The analyzer plot offsets were determined by below conditions.

- For LTE Band 17, total offset 26.5 dB = 20 dB attenuator + 6 dB Divider + 0.5 dB RF cables.

3.5 FREQUENCY STABILITY / VARIATION OF AMBIENT TEMPERATURE

Test Set-up

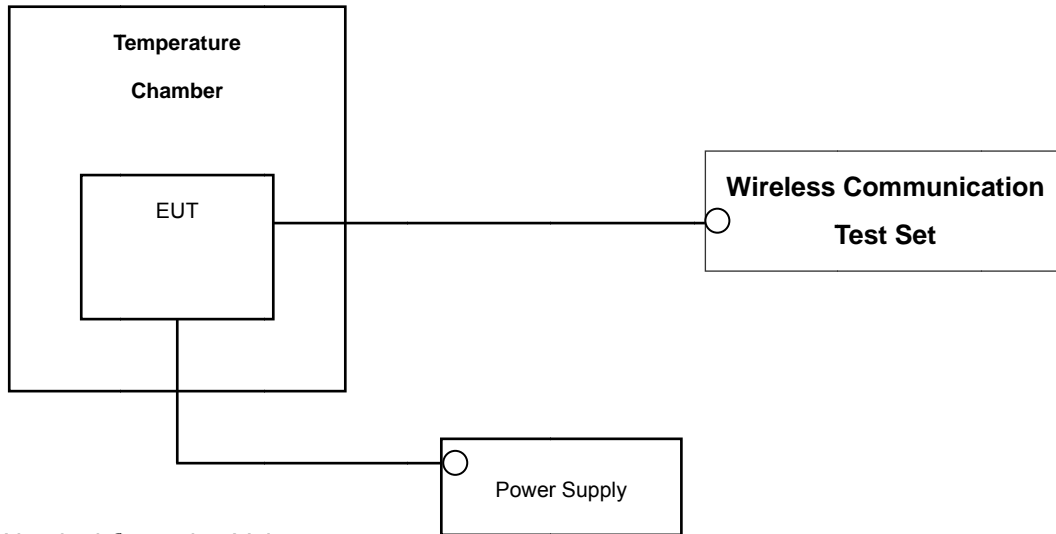

* Nominal Operating Voltage

Test Procedure

Frequency stability is tested in accordance with ANSI/TIA-603-C-2004 section 2.2.2

The frequency stability of the transmitter is measured by:

- a.) **Temperature:** The temperature is varied from - 30 °C to + 50 °C using an environmental chamber.
- b.) **Primary Supply Voltage:** The primary supply voltage is varied from the end point to 115 % of the voltage normally at the input to the device or at the power supply terminals if cables are not normally supplied.

Specification — the frequency stability of the transmitter shall be maintained within $\pm 0.00025\%$ (± 2.5 ppm) of the center frequency.

Time Period and Procedure:

The carrier frequency of the transmitter is measured at room temperature (20°C to provide a reference).

1. The equipment is turned on in a “standby” condition for one minute before applying power to the transmitter. Measurement of the carrier frequency of the transmitter is made within one minute after applying power to the transmitter.
2. Frequency measurements are made at 10°C intervals ranging from -30°C to +50°C. A period of at least one half-hour is provided to allow stabilization of the equipment at each temperature level.

4. LIST OF TEST EQUIPMENT

Manufacture	Model/ Equipment	Serial Number	Calibration Interval	Calibration Due
Agilent	N1921A/ Power Sensor	MY45241059	Annual	07/09/2015
Agilent	N1911A/ Power Meter	MY45100523	Annual	01/24/2015
MITEQ	AMF-6D-001180-35-20P/AMP	1081666	Annual	09/04/2015
Wainwright	WHK1.2/15G-10EF/H.P.F	4	Annual	06/17/2015
Wainwright	WRCJV2400/2483.5-2370/2520-60/12SS / B.R.F.	1	Annual	06/17/2015
Wainwright	WHK3.3/18G-10EF/H.P.F	2	Annual	06/17/2015
Hewlett Packard	11667B / Power Splitter	10545	Annual	02/22/2015
Hewlett Packard	11667B / Power Splitter	11275	Annual	05/19/2015
Digital	EP-3010/ Power Supply	3110117	Annual	10/29/2015
Schwarzbeck	UHAP/ Dipole Antenna	557	Biennial	03/05/2015
Schwarzbeck	UHAP/ Dipole Antenna	558	Biennial	05/03/2015
Korea Engineering	KR-1005L / Chamber	KRAC05063-3CH	Annual	10/29/2015
Schwarzbeck	BBHA 9120D/ Horn Antenna	147	Biennial	09/01/2016
Schwarzbeck	BBHA 9120D/ Horn Antenna	1151	Biennial	10/05/2015
Schwarzbeck	BBHA 9170/ Horn Antenna(15~40GHz)	BBHA9170541	Biennial	07/05/2015
Agilent	E4440A/Spectrum Analyzer	US45303008	Annual	04/09/2015
WEINSCHTEL	ATTENUATOR	BR0592	Annual	10/22/2015
REOHDE&SCHWARZ	FSV40/Spectrum Analyzer	1307.9002K40-100931-NK	Annual	06/09/2015
Agilent	8960 (E5515C)/ Base Station	MY48360222	Annual	08/26/2015
Anritsu Corp.	MT8820C/Wideband Radio Communication Tester	6200863156	Annual	04/01/2015

5. SUMMARY OF TEST RESULTS

FCC Part Section(s)	Test Description	Test Limit	Test Condition	Test Result
2.1049, 27.53	Occupied Bandwidth	N/A	CONDUCTED	PASS
2.1051, 27.53(c)	Band Edge / Spurious and Harmonic Emissions at Antenna Terminal.	$< 43 + 10 \log_{10}(P[\text{Watts}])$ at Band Edge and for all-of-band emissions		PASS
*2.1046	Conducted Output Power	N/A		PASS
2.1055, 27.54	Frequency stability / variation of ambient temperature	$< 2.5 \text{ ppm}$		PASS
27.50(c)(10)	Effective Radiated Power (Band 17)	$< 3 \text{ Watts max. ERP}$	RADIATED	PASS
2.1053, 27.53(c)	Undesirable Out-of-Band Emissions	$< 43 + 10 \log_{10}(P[\text{Watts}])$ for all out-of-band emissions		PASS

*: See SAR Report

6. SAMPLE CALCULATION

A. ERP Sample Calculation

Mode	Ch./ Freq.		Measured Level(dBm)	Substitute LEVEL(dBm)	Ant. Gain (dBd)	C.L	Pol.	ERP	
	channel	Freq.(MHz)						W	dBm
LTE	23755	706.5	-28.75	29.60	-10.21	0.76	V	0.073	18.63

ERP = SubstituteLEVEL(dBm) + Ant. Gain – CL(Cable Loss)

- 1) The EUT mounted on a wooden tripod is 0.8 meter above test site ground level.
- 2) During the test , the turn table is rotated and the antenna height is found.
- 3) Record the field strength meter’s level.
- 4) Replace the EUT with dipole/Horn antenna that is connected to a calibrated signal generator.
- 5) Increase the signal generator output till the field strength meter’s level is equal to the item (3).
- 6) The signal generator output level with Ant. Gain and cable loss are the rating of effective radiated power (ERP).

B. Emission Designator

QPSK Modulation

Emission Designator = 4M48G7D

LTE BW = 4.48 MHz

G = Phase Modulation

7 = Quantized/Digital Info

D = Data transmission; telemetry; telecommand

16QAM Modulation

Emission Designator = 4M48W7D

LTE BW = 4.48 MHz

W = main carrier modulated in a combination of two

or more of the following modes;

amplitude, angle, pulse

7 = Quantized/Digital Info

D = Data transmission; telemetry; telecommand

7. TEST DATA

7.1 EFFECTIVE RADIATED POWER OUTPUT

Freq (MHz)	Bandwidth	Modulation	Measured Level (dBm)	Substitute Level (dBm)	Ant. Gain(dBd)	C.L	Pol	ERP	
								W	dBm
706.5	5 MHz	QPSK	-32.99	28.04	-10.21	1.08	V	0.047	16.75
		16-QAM	-33.36	27.67	-10.21	1.08	V	0.043	16.38
710.0		QPSK	-32.53	28.14	-10.22	1.09	V	0.048	16.83
		16-QAM	-32.31	28.36	-10.22	1.09	V	0.051	17.05
713.5		QPSK	-32.71	28.14	-10.24	1.08	V	0.048	16.82
		16-QAM	-32.33	28.52	-10.24	1.08	V	0.052	17.20

Effective Radiated Power Data (Band 17 – 5 MHz)

Note: Worst case is 1 resource block

Freq (MHz)	Bandwidth	Modulation	Measured Level (dBm)	Substitute Level (dBm)	Ant. Gain(dBd)	C.L	Pol	ERP	
								W	dBm
709.0	10 MHz	QPSK	-32.76	28.16	-10.22	1.09	V	0.048	16.85
		16-QAM	-33.06	27.86	-10.22	1.09	V	0.045	16.55
710.0		QPSK	-32.52	28.15	-10.22	1.09	V	0.048	16.84
		16-QAM	-33.02	27.65	-10.22	1.09	V	0.043	16.34
711.0		QPSK	-31.96	28.63	-10.23	1.08	V	0.054	17.32
		16-QAM	-32.71	27.88	-10.23	1.08	V	0.045	16.57

Effective Radiated Power Data (Band 17 – 10 MHz)

Note: Worst case is 1 resource block.

NOTES:Effective Radiated Power Output Measurements by Substitution Methodaccording to ANSI/TIA/EIA-603-C-2004, Aug. 17, 2004:

The EUT was placed on a non-conductive styrofoam resin table 3-meters from the receive antenna. The receive antenna height and turntable rotation was adjusted for the highest reading on the receive spectrum analyzer.

A half-wave dipole was substituted in place of the EUT. This dipole antenna was driven by a signal generator and the level of the signal generator was adjusted to obtain the same receive spectrum analyzer reading. The conducted power at the terminals of the dipole is measured. The ERP is recorded.

Also, we have done x, y, z planes in EUT and horizontal and vertical polarization in detecting antenna. The worst case of the EUT is y plane in LTE mode. Also worst case of detecting Antenna is vertical polarization in LTE mode.

7.2 RADIATED SPURIOUS EMISSIONS

7.2.1 RADIATED SPURIOUS EMISSIONS (Band 17)

▣ OPERATING FREQUENCY :	<u>713.5 MHz</u>
▣ MEASURED OUTPUT POWER:	<u>17.20 dBm = 0.052 W</u>
▣ MODULATION SIGNAL:	<u>5 MHz 16-QAM</u>
▣ DISTANCE:	<u>3 meters</u>
▣ LIMIT: $43 + 10 \log_{10}(W) =$	<u>30.20 dBc</u>

Ch	Freq (MHz)	Measured Level (dBm)	Ant. Gain (dBd)	Substitute Level (dBm)	C.L	Pol	ERP (dBm)	dBc
23755 (706.50)	1,413.0	-43.69	7.80	-47.38	1.58	H	-41.16	58.36
	2,119.5	-54.48	9.55	-57.90	1.99	V	-50.34	67.54
	2,826.0	-57.70	10.84	-60.32	2.31	V	-51.79	68.99
23790 (710.00)	1,420.0	-42.03	7.86	-46.36	1.59	H	-40.09	57.29
	2,130.0	-57.11	9.49	-60.27	1.99	V	-52.77	69.97
	2,840.0	-56.95	10.90	-59.46	2.30	H	-50.86	68.06
23825 (713.50)	1,427.0	-46.24	7.90	-49.79	1.60	H	-43.49	60.69
	2,140.5	-56.43	9.42	-59.37	1.98	V	-51.93	69.13
	2,854.0	-56.19	10.94	-58.90	2.31	V	-50.27	67.47

NOTES: 1. Radiated Spurious Emission Measurements at 3 meters by Substitution Method

according to ANSI/TIA/EIA-603-C-2004, Aug. 17, 2004:

2. We are performed all frequency to 10th harmonics from 30 MHz. Measurements above show only up to 3 maximum emissions noted, or would be lesser if no specific emissions from the EUT are recorded (ie: margin > 20 dB from the applicable limit) and considered that's already beyond the background noise floor.
3. we have done x, y, z planes in EUT and horizontal and vertical polarization in detecting antenna.
4. Worst case is 1 resource block.

- ▣ OPERATING FREQUENCY : 711.0 MHz
- ▣ MEASURED OUTPUT POWER: 17.32 dBm = 0.054 W
- ▣ MODULATION SIGNAL: 10 MHz QPSK
- ▣ DISTANCE: 3 meters
- ▣ LIMIT: $43 + 10 \log_{10}(W) =$ 30.32 dBc

Ch	Freq (MHz)	Measured Level (dBm)	Ant. Gain (dBd)	Substitute Level (dBm)	C.L	Pol	ERP (dBm)	dBc
23780 (709.00)	1,418.0	-43.96	7.84	-47.69	1.58	V	-41.43	58.75
	2,127.0	-57.10	9.55	-60.32	1.99	H	-52.76	70.08
	2,836.0	-57.79	10.88	-60.28	2.30	V	-51.70	69.02
23790 (710.00)	1,420.0	-42.37	7.86	-46.70	1.59	V	-40.43	57.75
	2,130.0	-52.68	9.49	-55.84	1.99	H	-48.34	65.66
	2,840.0	-56.70	10.90	-59.21	2.30	V	-50.61	67.93
23800 (711.00)	1,422.0	-43.22	7.86	-47.55	1.59	V	-41.28	58.60
	2,133.0	-54.35	9.49	-57.51	1.99	H	-50.01	67.33
	2,844.0	-55.40	10.90	-57.91	2.30	H	-49.31	66.63

- NOTES:**
1. Radiated Spurious Emission Measurements at 3 meters by Substitution Method according to ANSI/TIA/EIA-603-C-2004, Aug. 17, 2004:
 2. We are performed all frequency to 10th harmonics from 30 MHz. Measurements above show only up to 3 maximum emissions noted, or would be lesser if no specific emissions from the EUT are recorded (ie: margin > 20 dB from the applicable limit) and considered that's already beyond the background noise floor.
 3. we have done x, y, z planes in EUT and horizontal and vertical polarization in detecting antenna.
 4. Worst case is 1 resource block.

7.3 OCCUPIED BANDWIDTH

Band	Band Width (MHz)	Frequency (MHz)	Modulation	Resource Block Size	Resource Block Offset	Data (MHz)
Band 17	5	710.0	QPSK	25	0	4.4661
			16-QAM	25	0	4.4647
	10	710.0	QPSK	50	0	8.9231
			16-QAM	50	0	8.8980

- Plots of the EUT's Occupied Bandwidth are shown Page 22 ~ 23.

7.4 CONDUCTED SPURIOUS EMISSIONS

Band	Band Width (MHz)	Frequency (MHz)	Modulation	Resource Block Size	Resource Block Offset	Frequency of Maximum Harmonic (GHz)	Maximum Data [dBm]
Band 17	5	706.5	QPSK	1	0	6.970750	-26.46
		710.0		1	0	6.991750	-27.07
		713.5		1	0	6.438750	-26.42
	10	709.0		1	0	5.632250	-26.47
		710.0		1	0	6.985250	-27.15
		711.0		1	0	6.961250	-25.98
				1	0		

- Plots of the EUT's Conducted Spurious Emissions are shown Page 30~ 35.

7.4.1 BAND EDGE

- Plots of the EUT's Band Edge are shown Page 24 ~ 29

7.5 FREQUENCY STABILITY / VARIATION OF AMBIENT TEMPERATURE

7.5.1 FREQUENCY STABILITY (LTE Band 17)

- ▣ OPERATING FREQUENCY: 710,000,000 Hz
- ▣ CHANNEL: 23790 (5 MHz)
- ▣ REFERENCE VOLTAGE: 3.85 VDC
- ▣ DEVIATION LIMIT: ± 0.000 25 % or 2.5 ppm

Voltage (%)	Power (VDC)	Temp. (°C)	Frequency (Hz)	Frequency Error (Hz)	Deviation (%)	ppm
100%	3.85	+20(Ref)	710 000 005	0	0.000 000	0.000
100%		-30	710 000 009	-0.10	0.000 001	0.006
100%		-20	710 000 009	2.20	0.000 001	0.006
100%		-10	710 000 002	-0.10	0.000 000	-0.004
100%		0	710 000 009	1.50	0.000 001	0.005
100%		+10	710 000 001	2.00	-0.000 001	-0.006
100%		+30	710 000 009	-8.00	0.000 001	0.005
100%		+40	710 000 002	1.70	0.000 000	-0.004
100%		+50	710 000 002	0.50	0.000 000	-0.005
115%		4.43	+20	710 000 000	2.70	-0.000 001
Batt. Endpoint	3.27	+20	710 000 008	-2.20	0.000 000	0.004

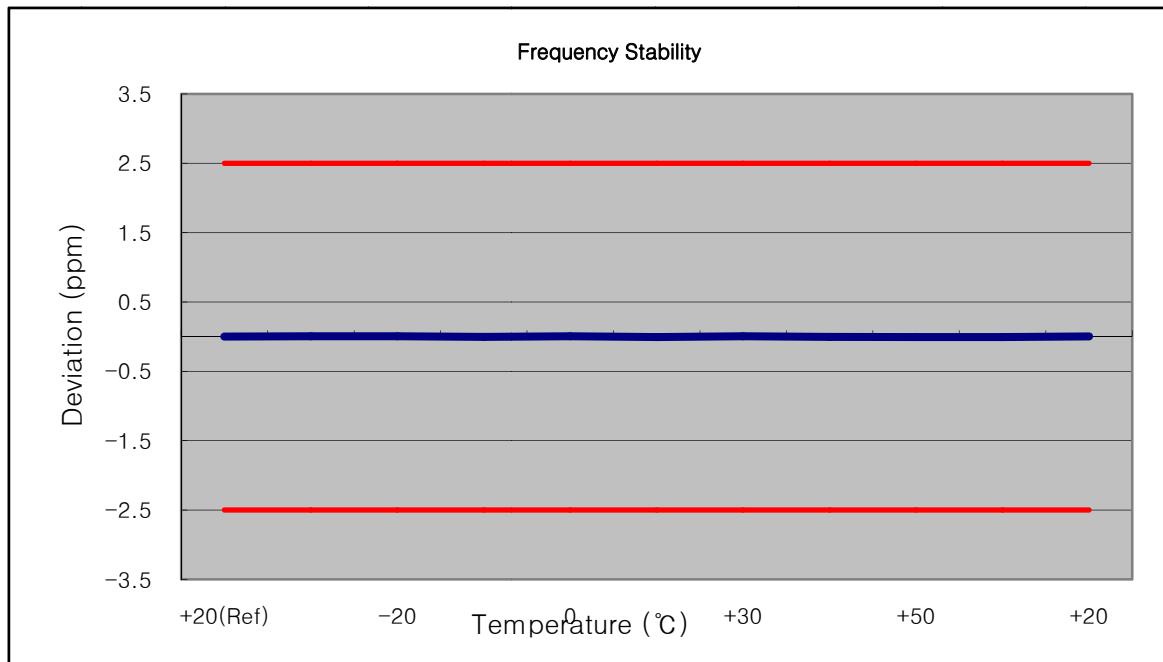

- ▣ OPERATING FREQUENCY: 710,000,000 Hz
- ▣ CHANNEL: 23790 (10 MHz)
- ▣ REFERENCE VOLTAGE: 3.85 VDC
- ▣ DEVIATION LIMIT: ± 0.000 25 % or 2.5 ppm

Voltage (%)	Power (VDC)	Temp. (°C)	Frequency (Hz)	Frequency Error (Hz)	Deviation (%)	ppm
100%	3.85	+20(Ref)	710 000 005	0	0.000 000	0.000
100%		-30	710 000 001	2.10	-0.000 001	-0.006
100%		-20	710 000 000	2.80	-0.000 001	-0.008
100%		-10	710 000 003	0.50	0.000 000	-0.003
100%		0	710 000 009	4.00	0.000 001	0.005
100%		+10	710 000 002	-1.50	0.000 000	-0.004
100%		+30	710 000 008	-0.10	0.000 000	0.004
100%		+40	709 999 999	-0.50	-0.000 001	-0.008
100%		+50	710 000 010	-3.10	0.000 001	0.006
115%		4.43	+20	710 000 007	1.80	0.000 000
Batt. Endpoint	3.27	+20	710 000 008	1.10	0.000 000	0.004

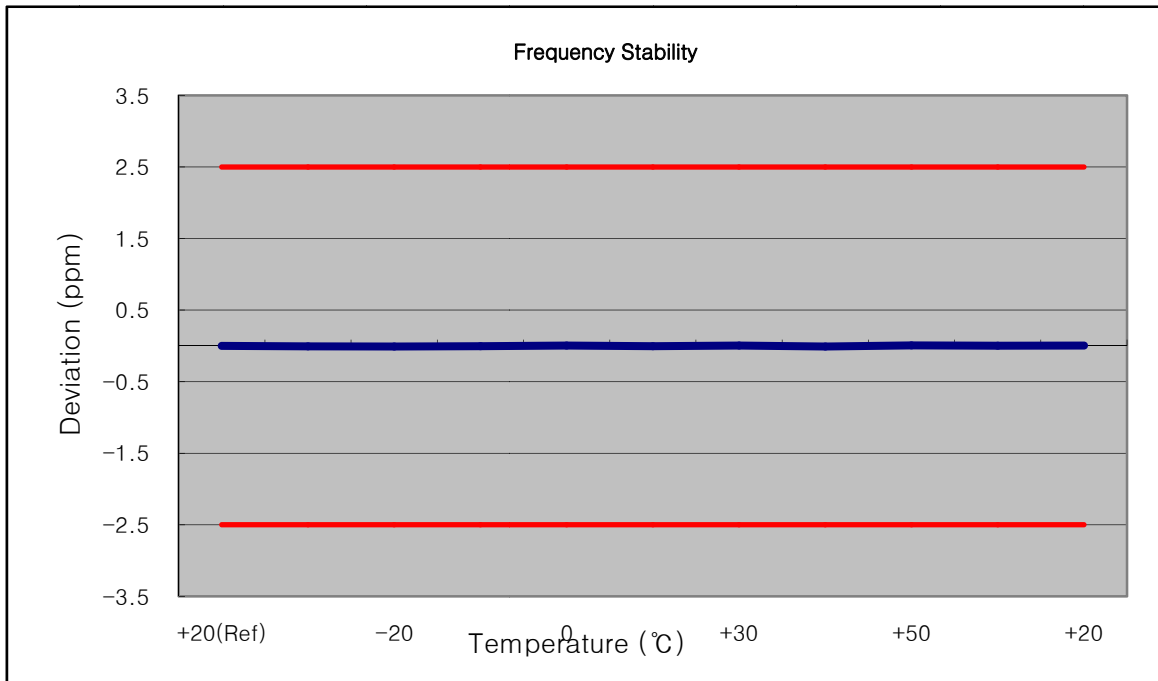

8. TEST PLOTS

BAND 17. Occupied Bandwidth Plot (5M BW Ch.23790 QPSK_RB25 0)

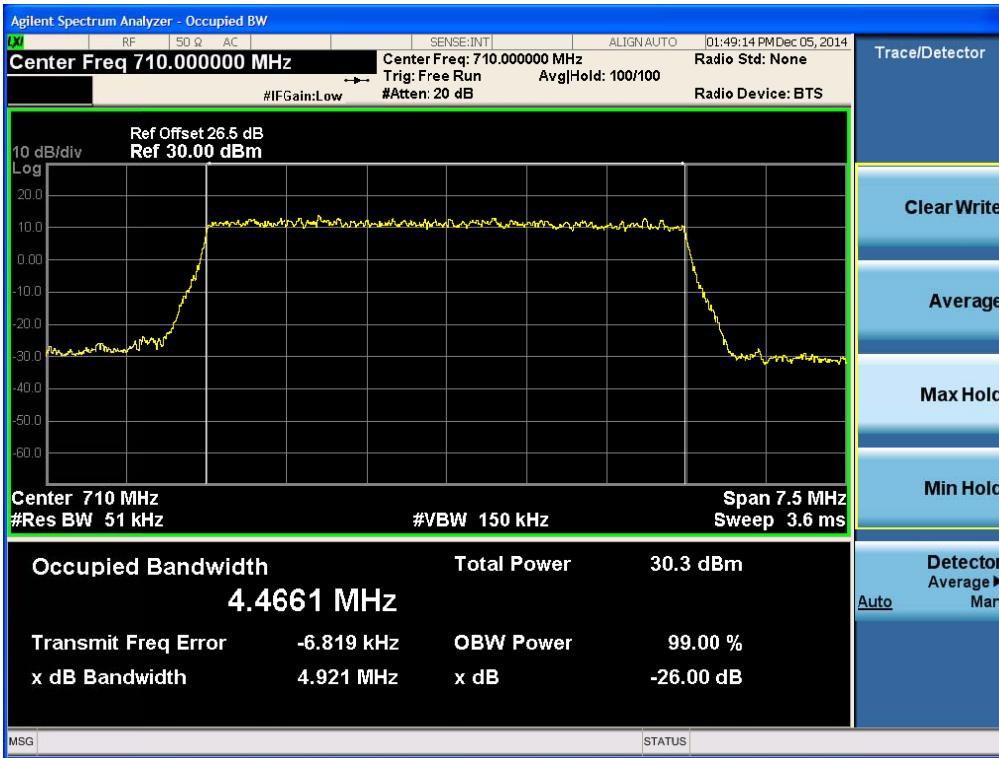

BAND 17. Occupied Bandwidth Plot (5M BW Ch.23790 16QAM_RB25 0)

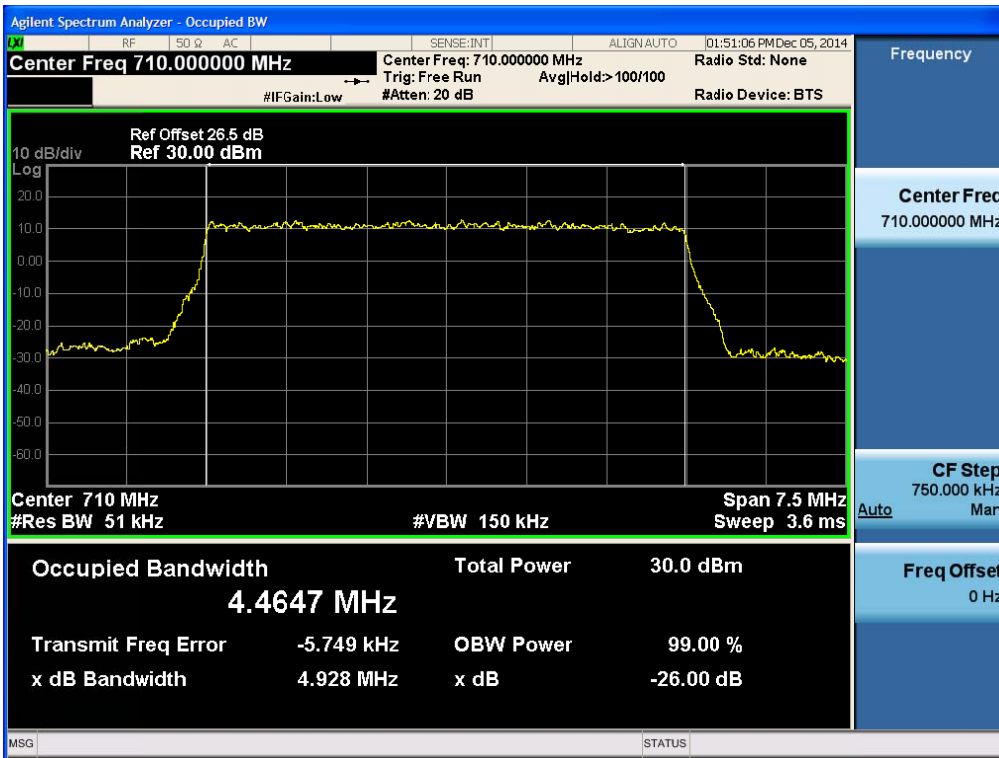

BAND 17. Occupied Bandwidth Plot (10M BW Ch.23790 QPSK_RB50 0)

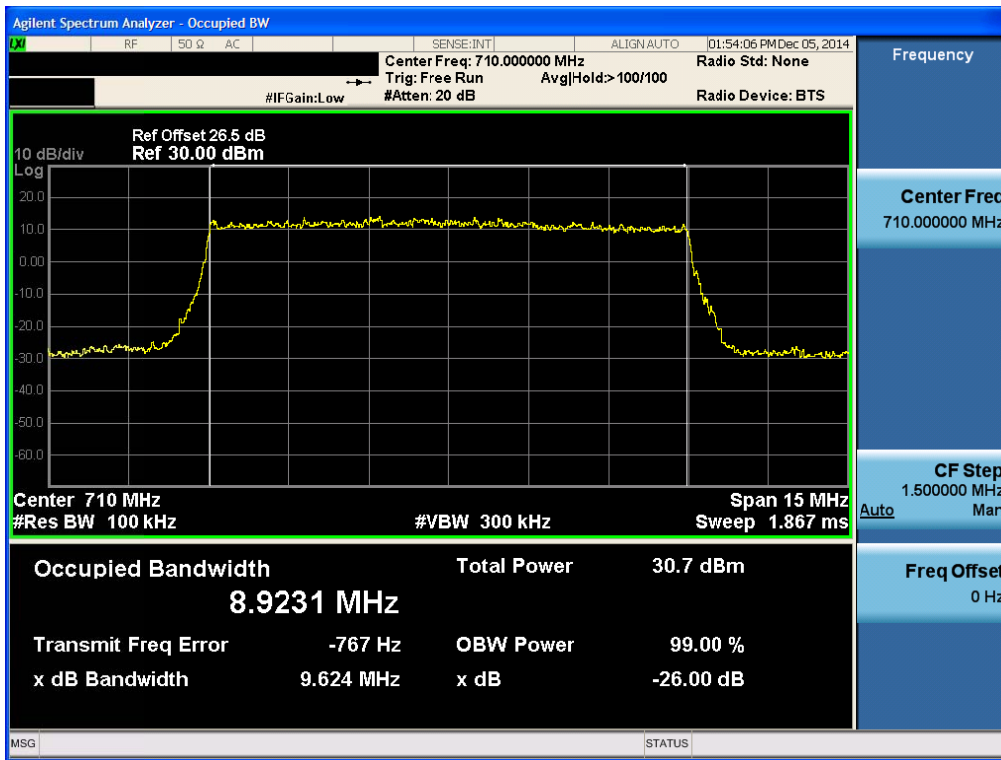

BAND 17. Occupied Bandwidth Plot (10M BW Ch.23790 16QAM_RB50 0)

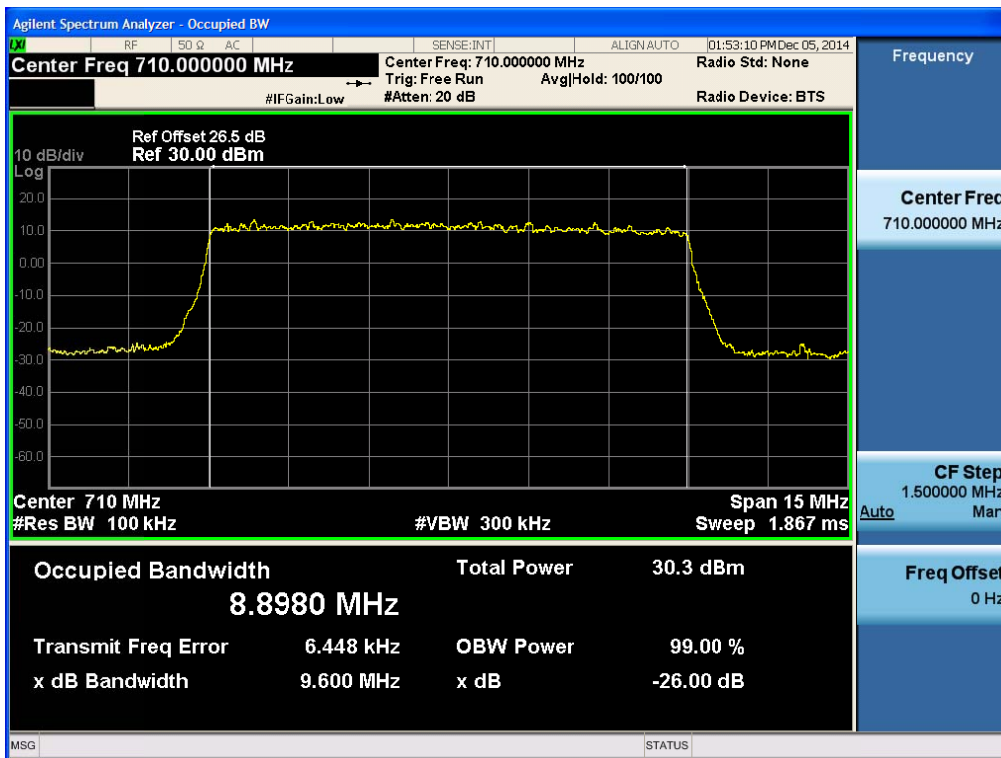

Band 17 Lower Band Edge Plot (5M BW Ch.23755 QPSK_RB1_Offset_0)

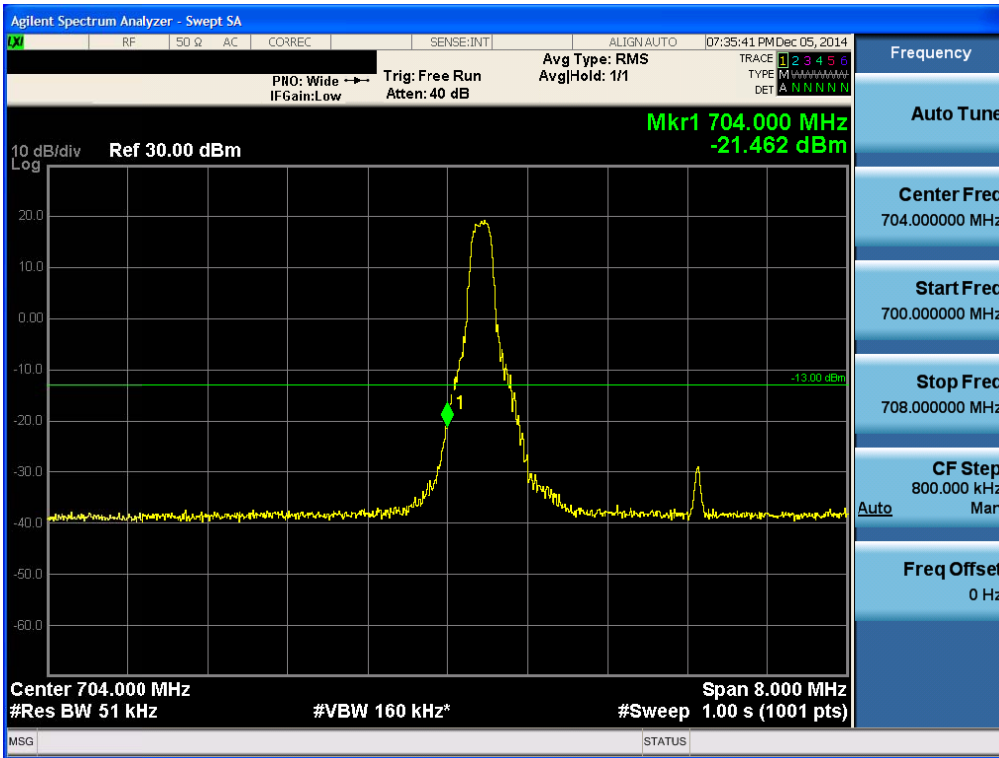

Band 17 Lower Band Edge Plot (5M BW Ch.23755 QPSK_RB25_Offset_0)

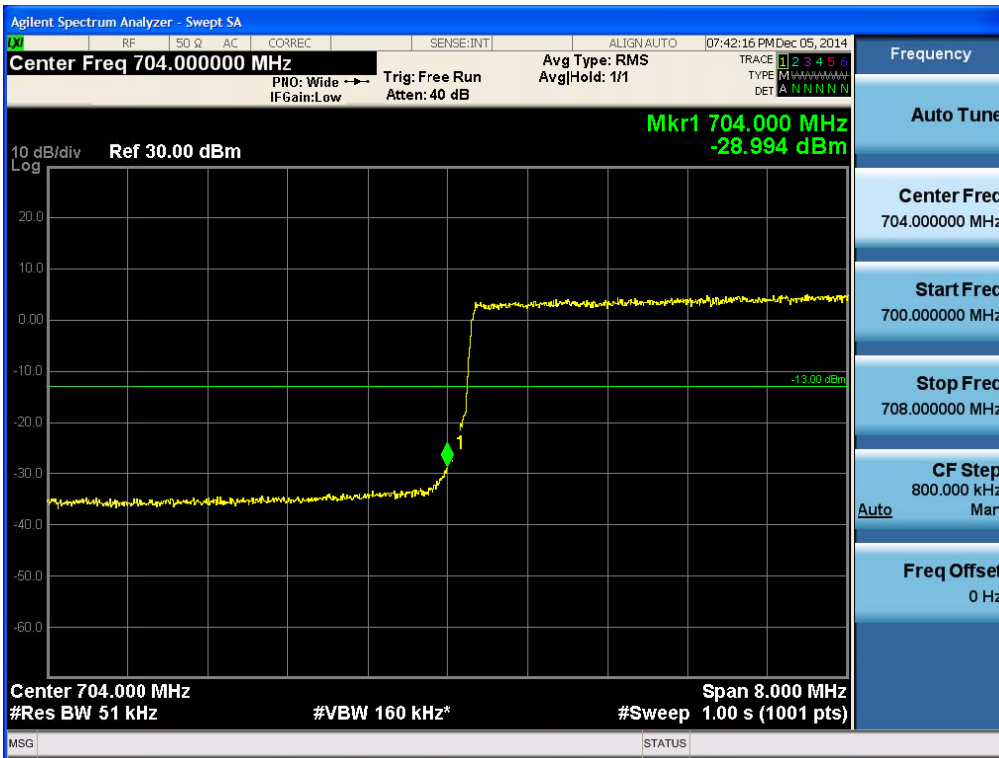

Band 17 L Lower Extended Band Edge Plot (5M BW Ch.23755 QPSK_RB25_0)

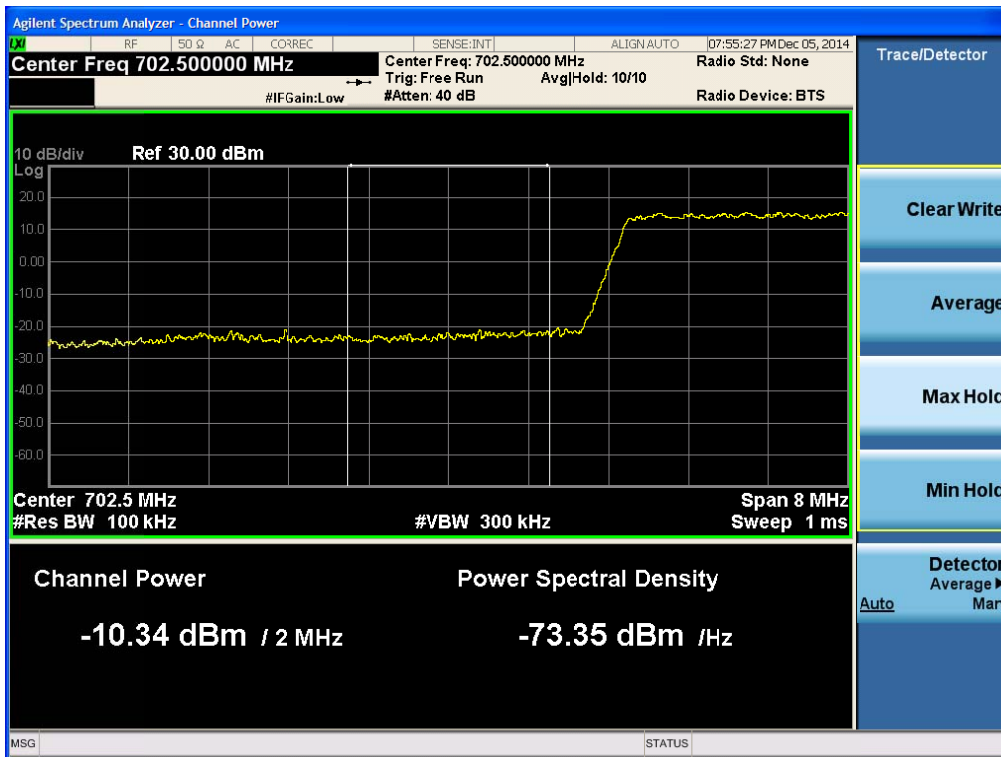

Band 17 Lower Band Edge Plot (10M BW Ch.23780 QPSK_RB1_Offset_0)

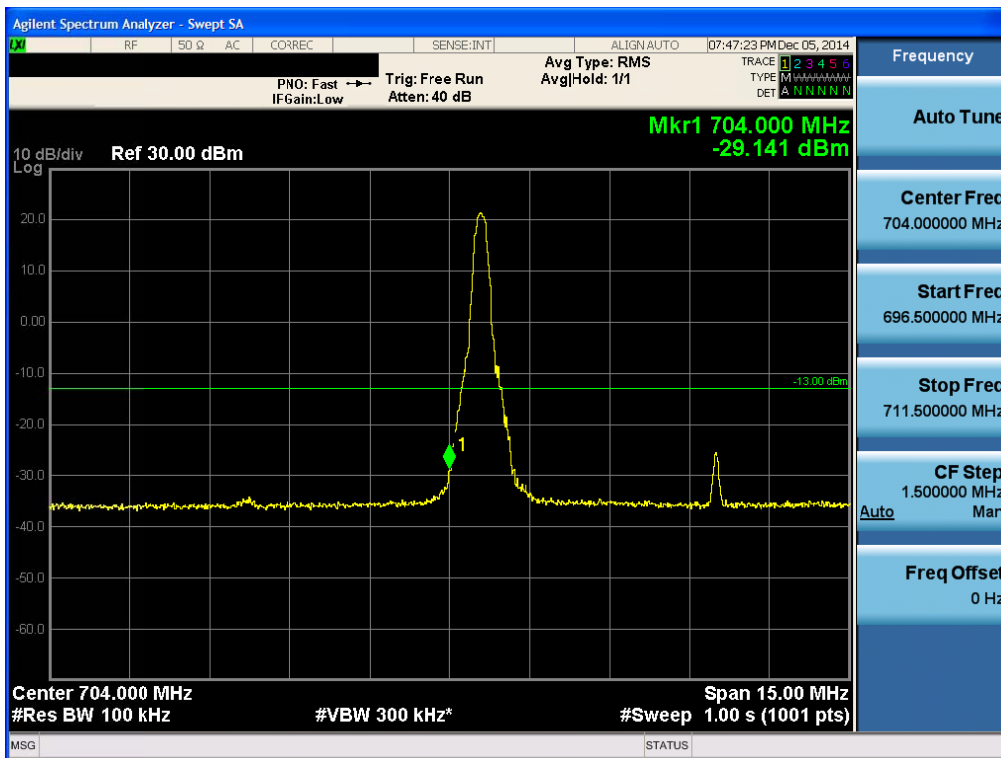

Band 17 Lower Band Edge Plot (10M BW Ch.23780 QPSK_RB50_Offset_0)

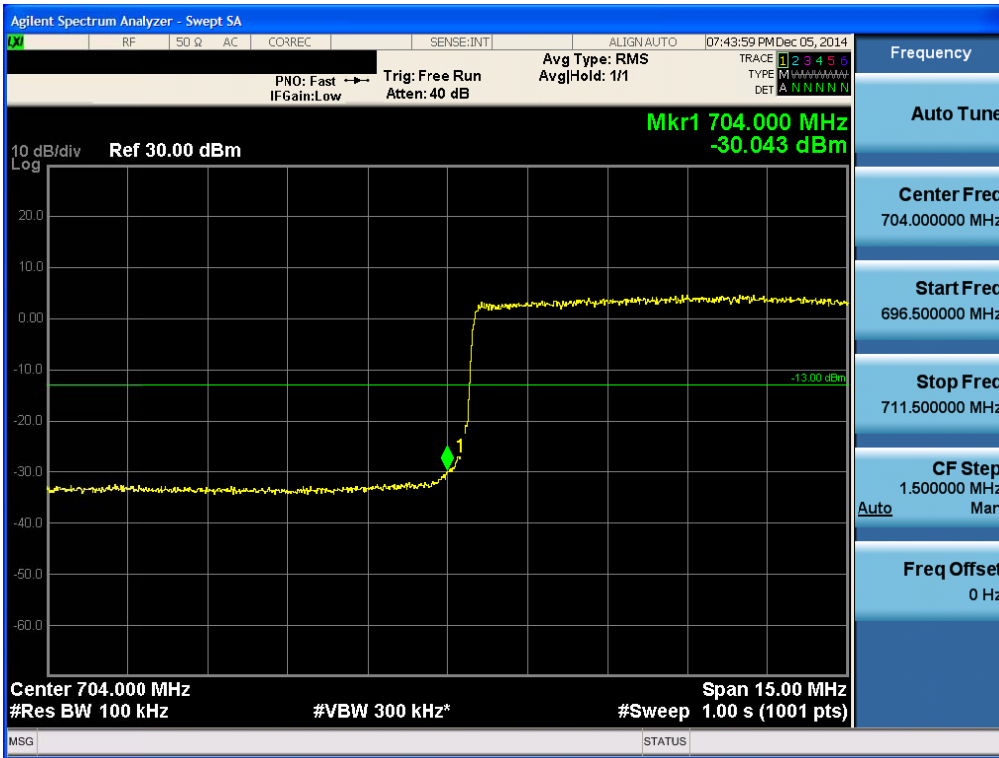

Band 17 Lower Extended Band Edge Plot (10M BW Ch.23780 QPSK_RB50_0)

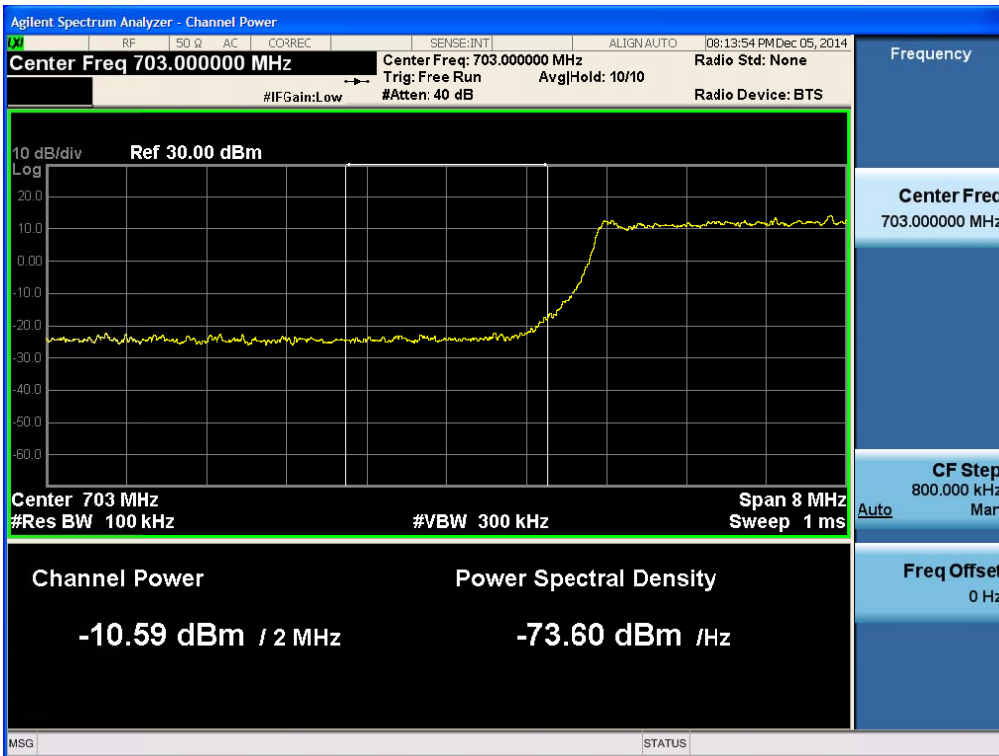

Band 17 Upper Band Edge Plot (5M BW Ch.23825 QPSK_RB1_Offset_24)

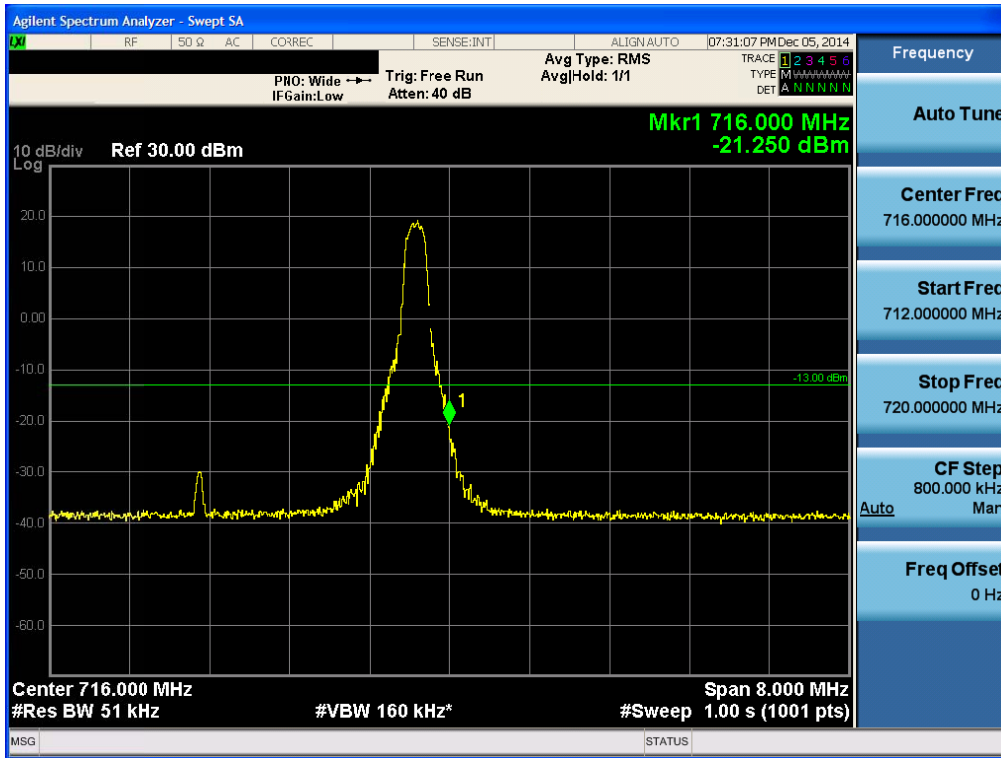

Band 17 Upper Band Edge Plot (5M BW Ch.23825 QPSK_RB25_Offset_0)

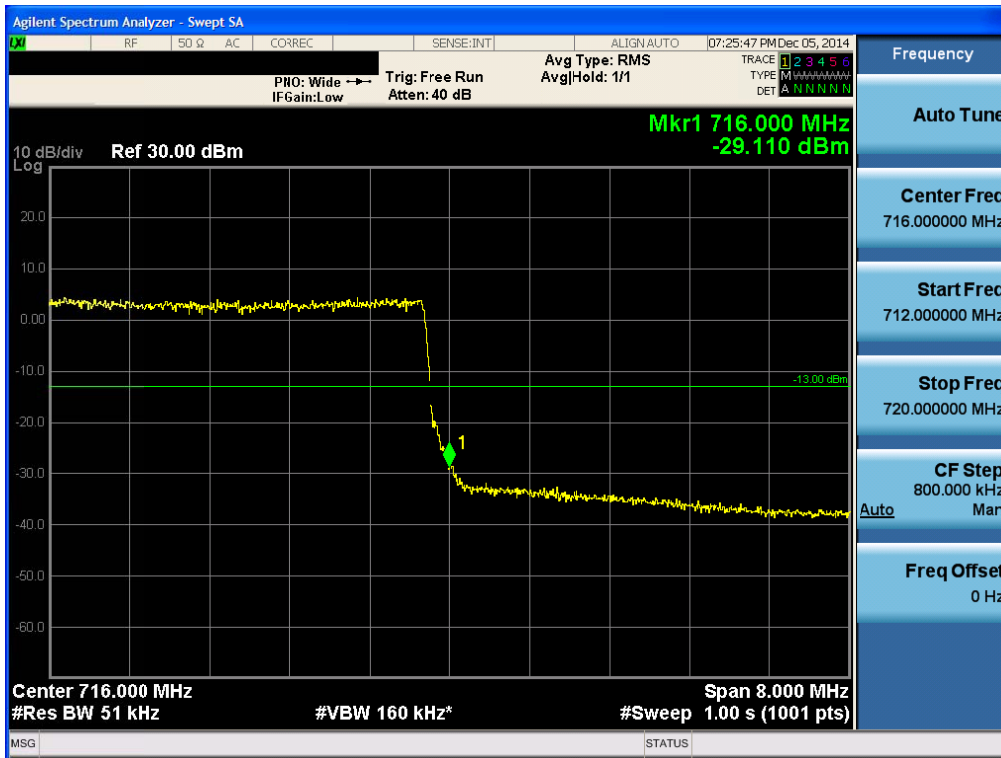

Band 17 Upper Extended Band Edge Plot (5M BW Ch.23825 QPSK_RB525_0)

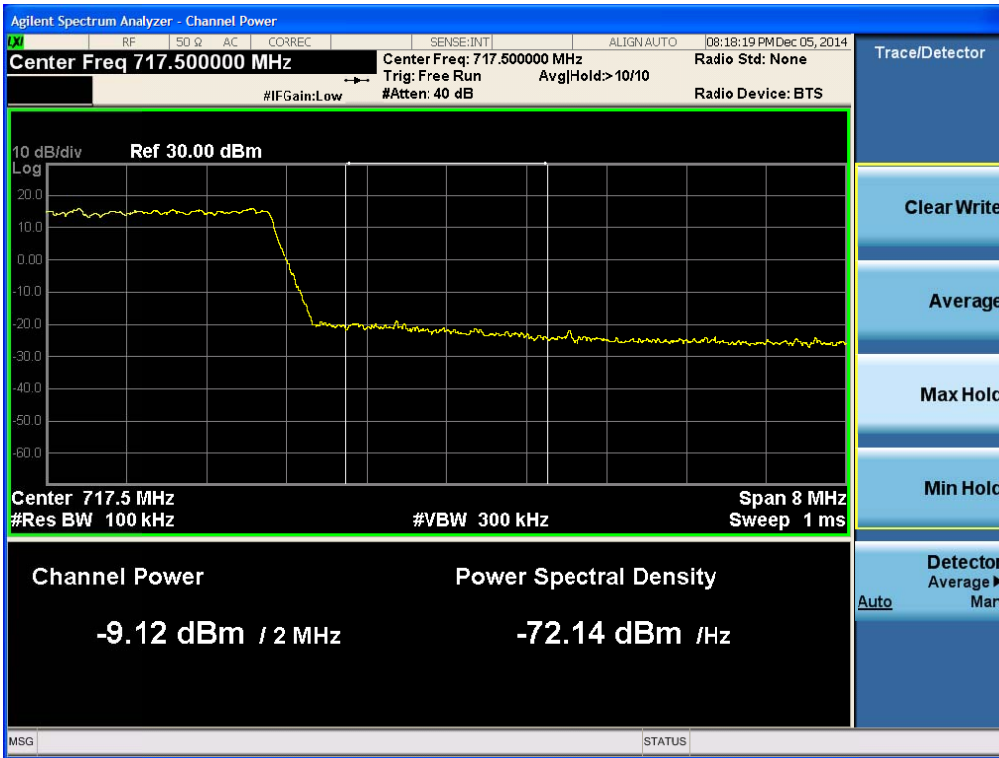

Band 17 Upper Band Edge Plot (10M BW Ch.23800 QPSK_RB1_Offset_49)

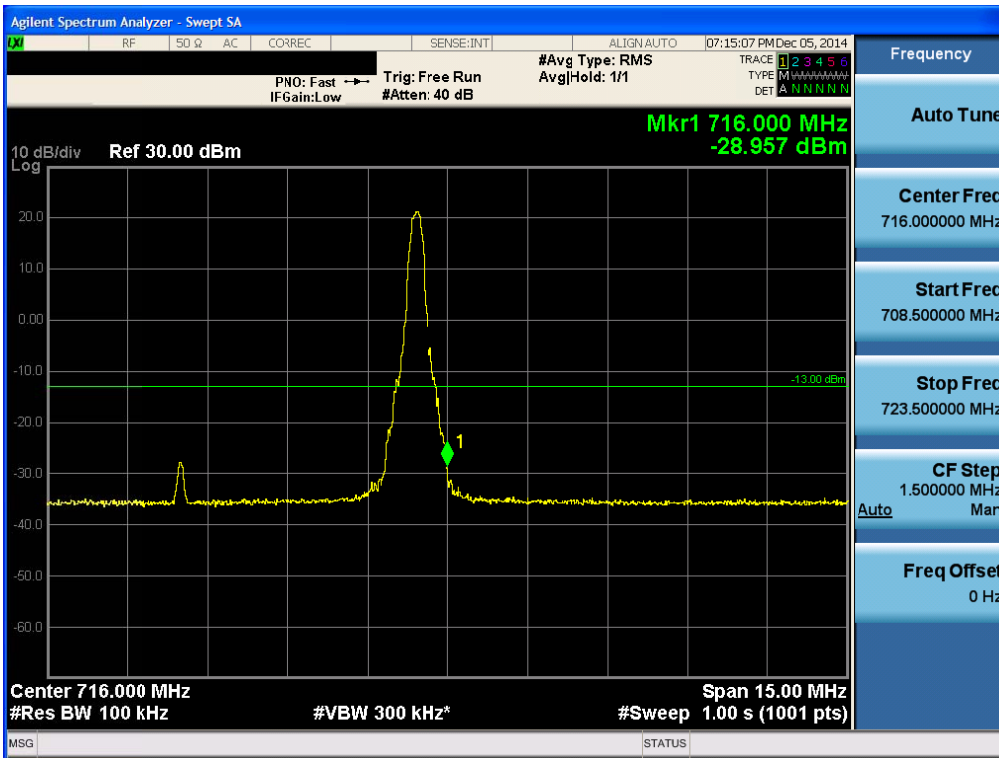

Band 17 Upper Band Edge Plot (10M BW Ch.23800 QPSK_RB50_Offset_0)

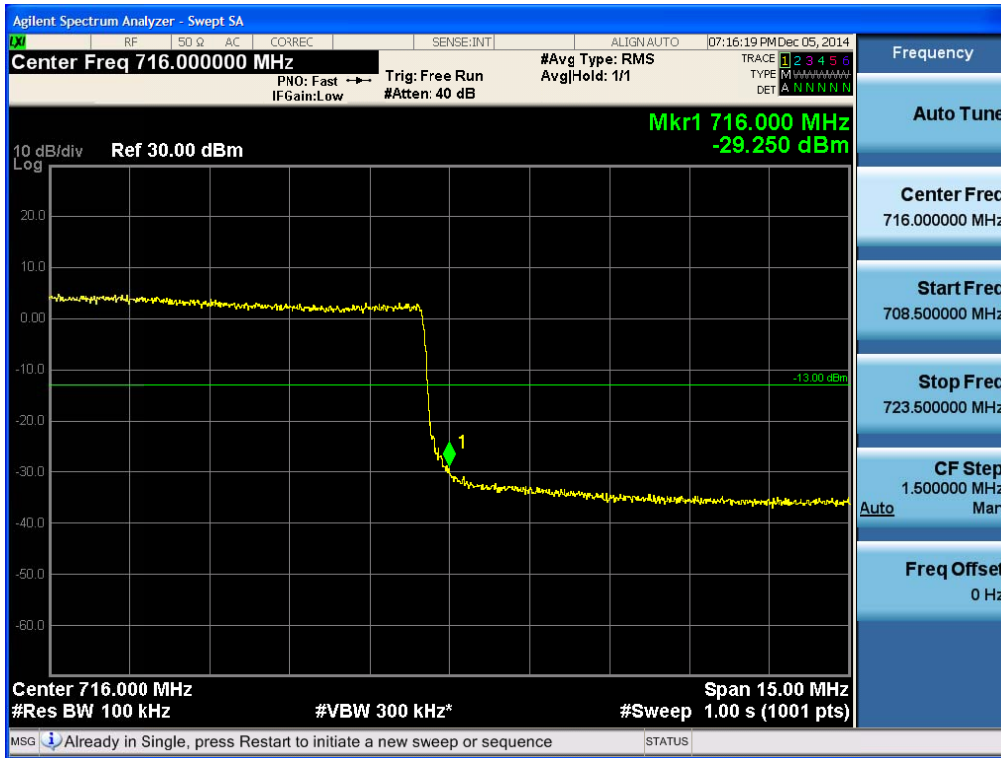

Band 17 Upper Extended Band Edge Plot (10M BW Ch.23800 QPSK_RB50_0)

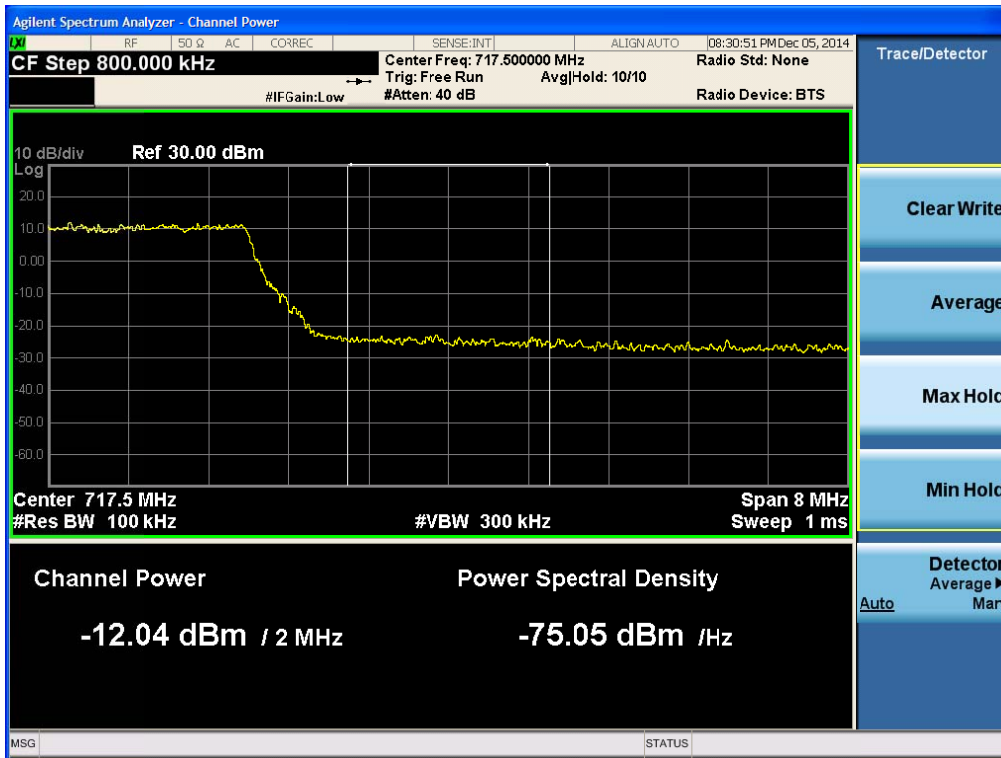

BAND 17. Conducted Spurious Plot_1 (23755ch_5MHz_QPSK_RB 1_0)

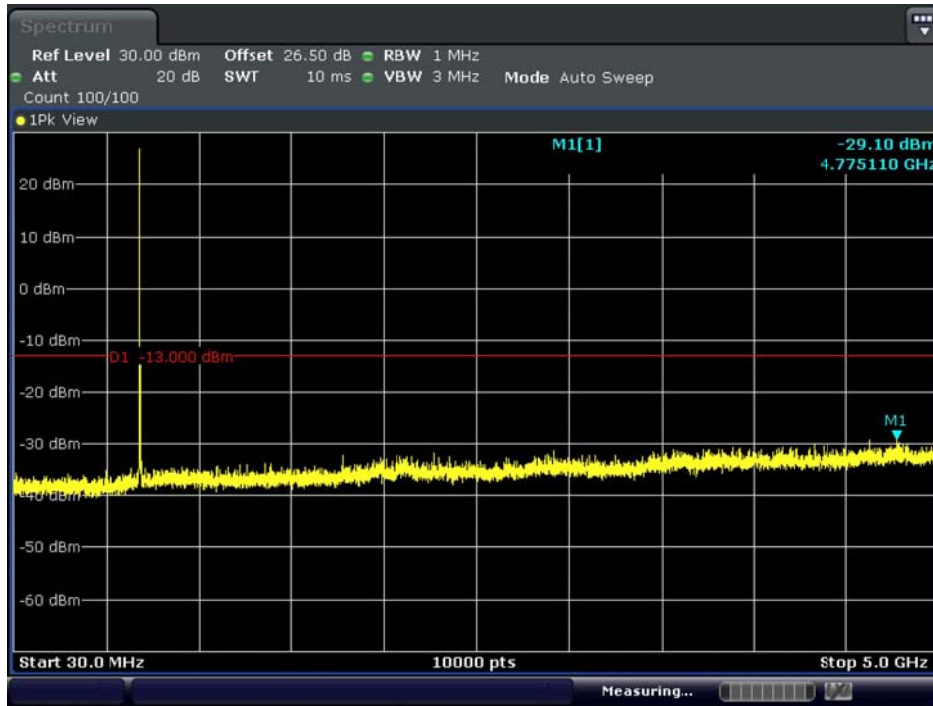

Date: 7.DEC.2014 21:36:43

BAND 17. Conducted Spurious Plot_2 (23755ch_5MHz_QPSK_RB 1_0)

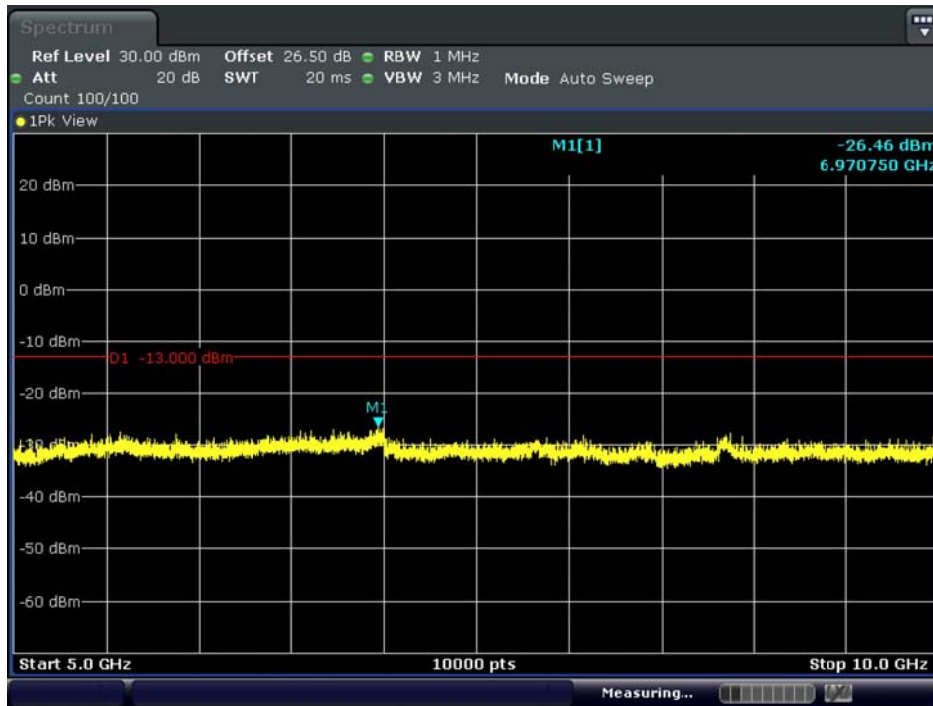

Date: 7.DEC.2014 21:36:59

BAND 17. Conducted Spurious Plot_1 (23790ch_5MHz_QPSK_RB 1_0)

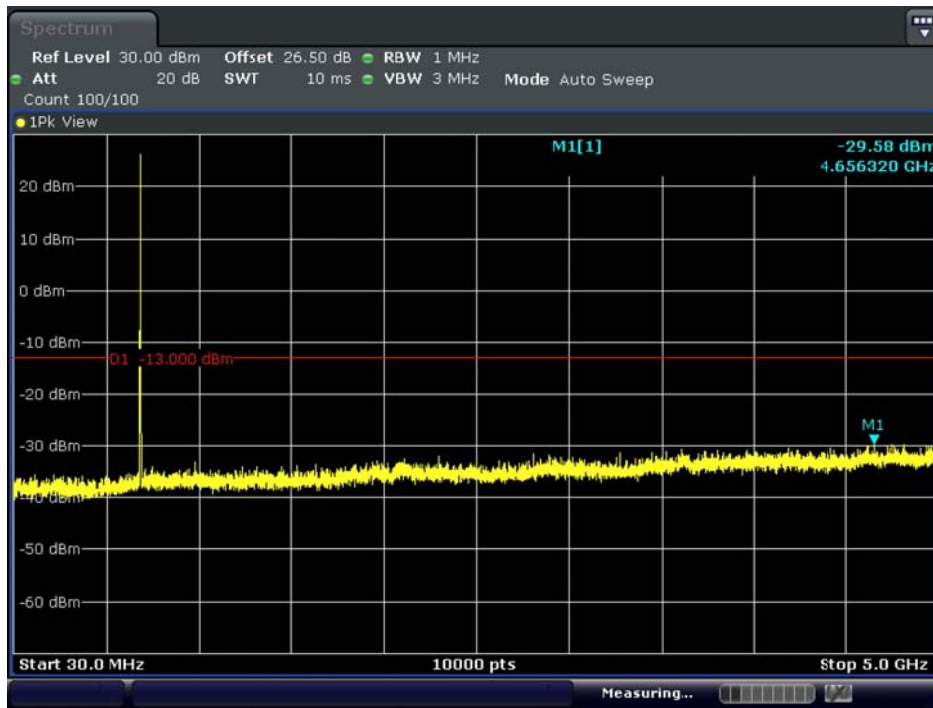

Date: 7.DEC.2014 21:37:13

BAND 17. Conducted Spurious Plot_2 (23790ch_5MHz_QPSK_RB 1_0)

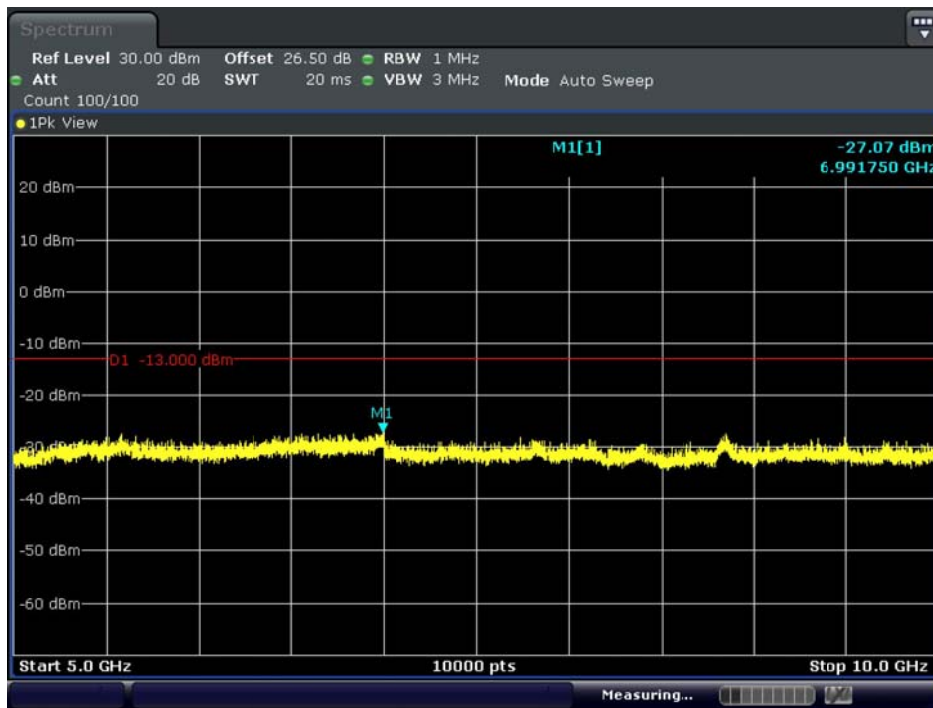

Date: 7.DEC.2014 21:37:29

BAND 17. Conducted Spurious Plot_1 (23825ch_5MHz_QPSK_RB 1_0)

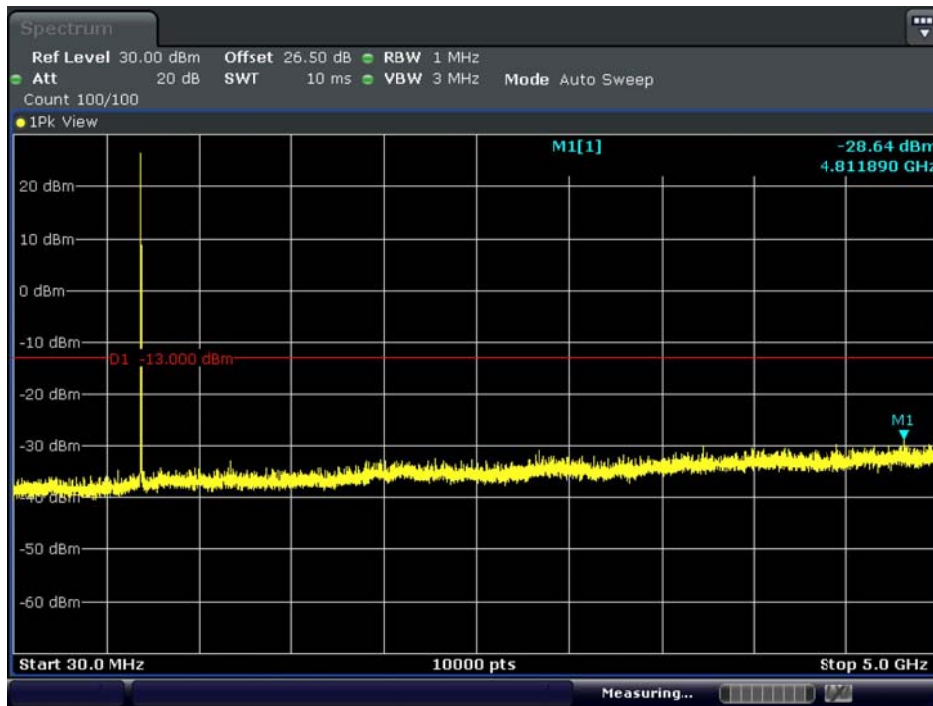

Date: 7.DEC.2014 21:37:42

BAND 17. Conducted Spurious Plot_2 (23825ch_5MHz_QPSK_RB 1_0)

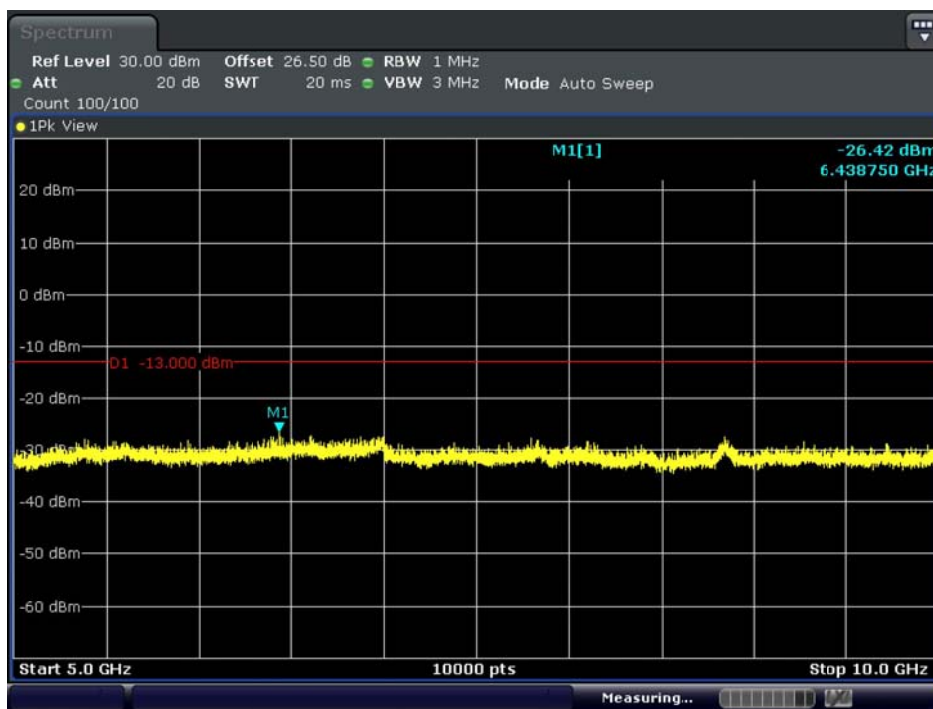

Date: 7.DEC.2014 21:37:58

BAND 17. Conducted Spurious Plot_1 (23780ch_10MHz_QPSK_RB 1_0)

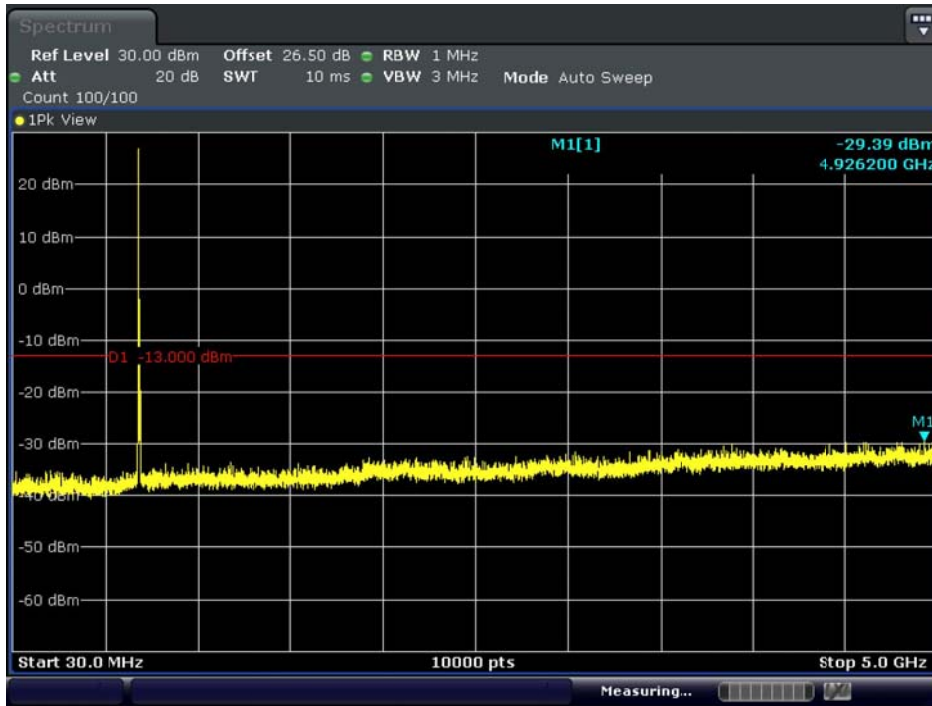

Date: 7.DEC.2014 21:42:29

BAND 17. Conducted Spurious Plot_2 (23780ch_10MHz_QPSK_RB 1_0)

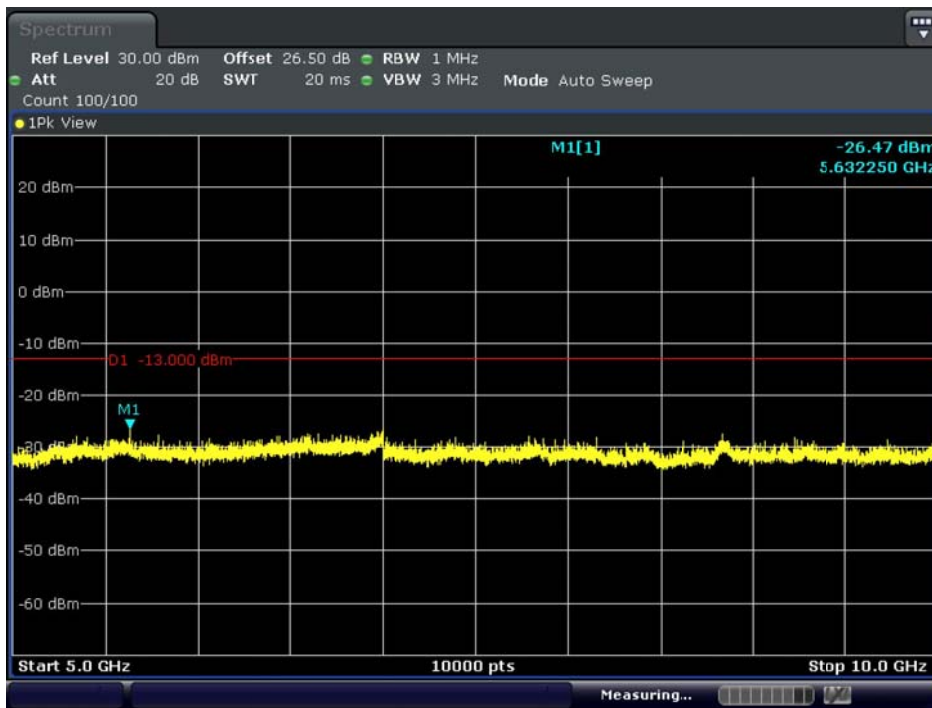

Date: 7.DEC.2014 21:42:46

BAND 17. Conducted Spurious Plot_1 (23790ch_10MHz_QPSK_RB 1_0)

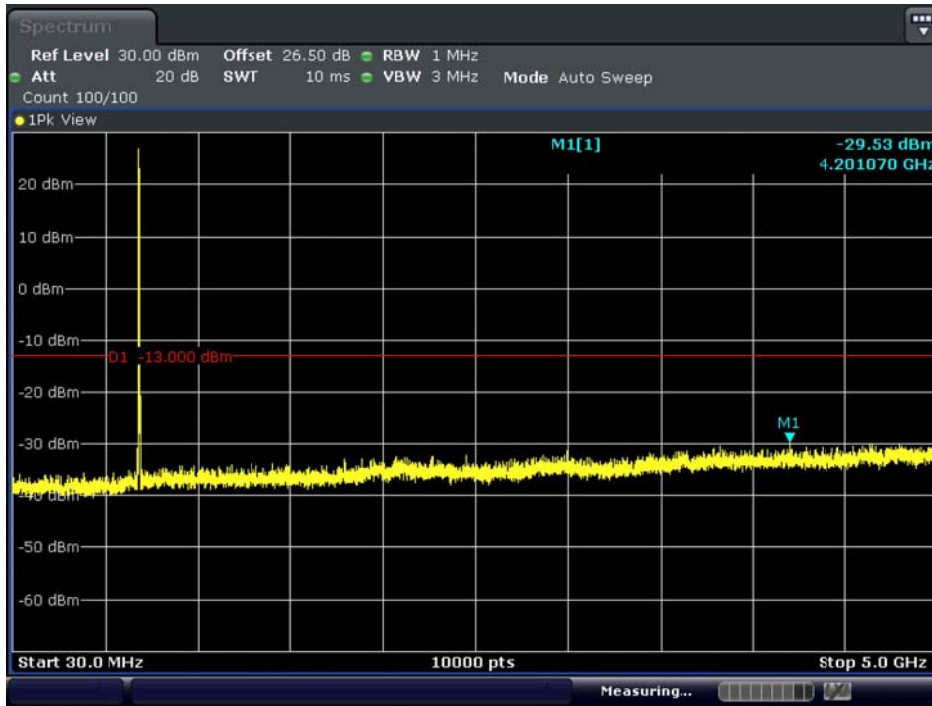

Date: 7.DEC.2014 21:43:03

BAND 17. Conducted Spurious Plot_2 (23790ch_10MHz_QPSK_RB 1_0)

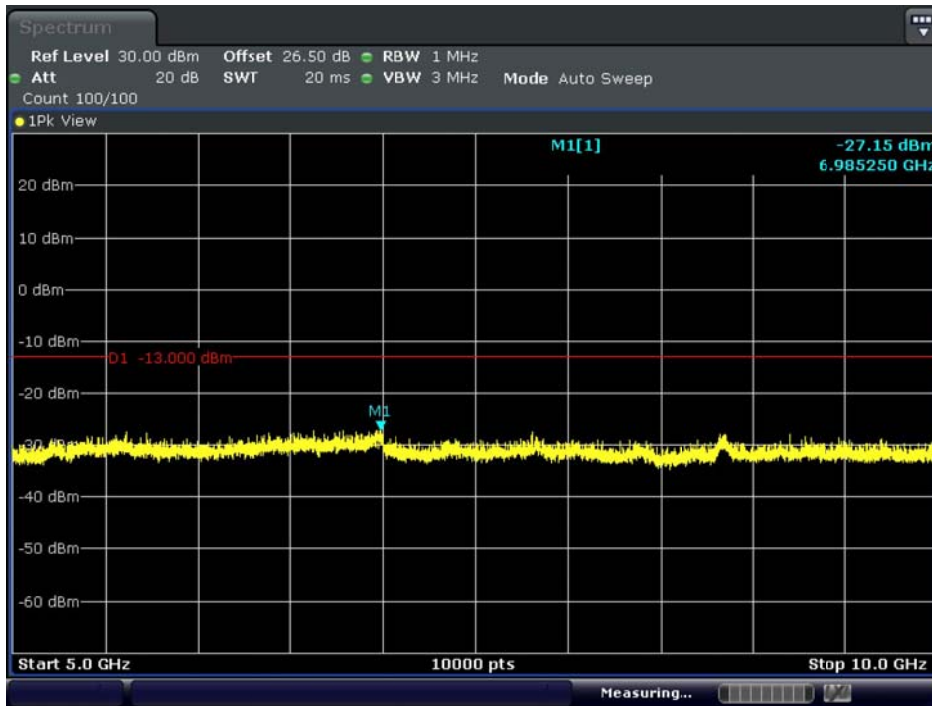

Date: 7.DEC.2014 21:43:19

BAND 17. Conducted Spurious Plot_1 (23800ch_10MHz_QPSK_RB 1_0)

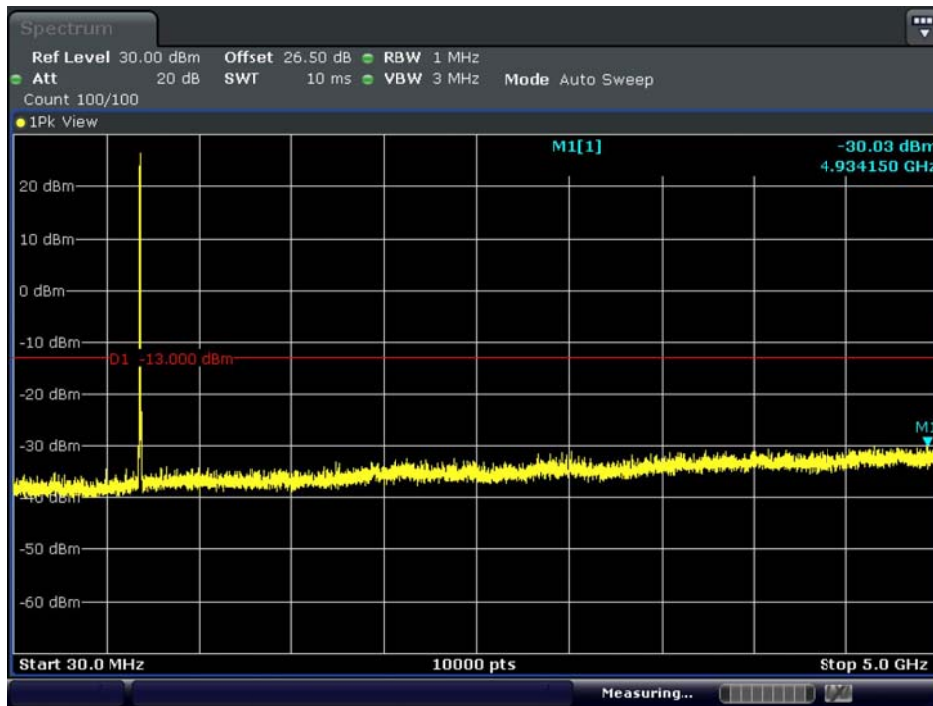

Date: 7.DEC.2014 21:43:36

BAND 17. Conducted Spurious Plot_2 (23800ch_10MHz_QPSK_RB 1_0)

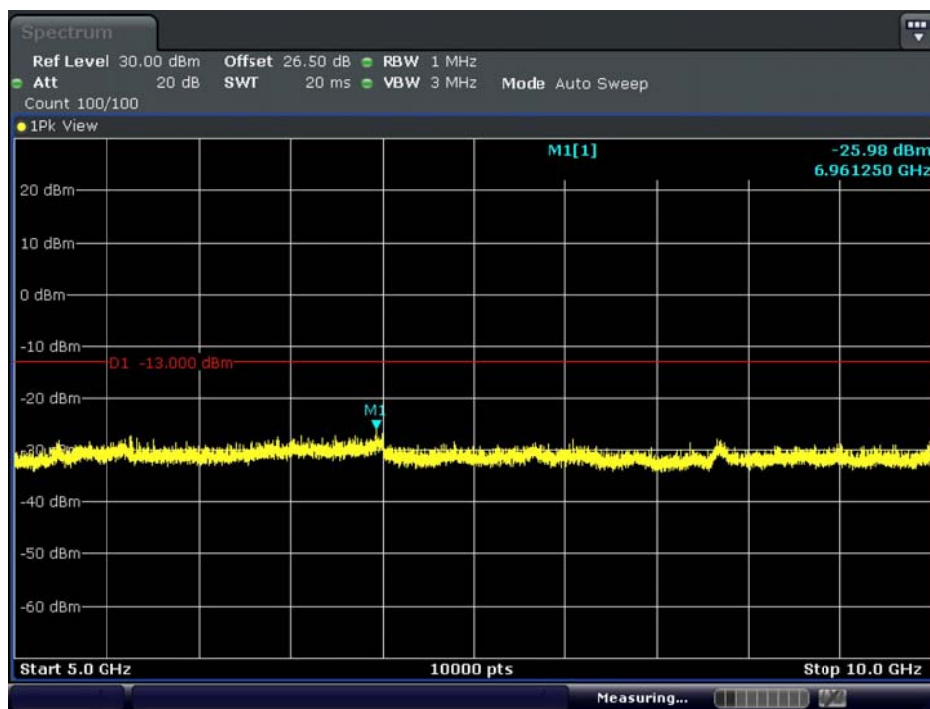

Date: 7.DEC.2014 21:43:52