

FCC LTE REPORT

Certification

Applicant Name:

SAMSUNG Electronics Co., Ltd.

Date of Issue:

July 16, 2021

Location:

HCT CO., LTD.,

Address:

 129, Samsung-ro, Yeongtong-gu,
 Suwon-si, Gyeonggi-do, 16677, Rep. of Korea

 74, Seoicheon-ro 578beon-gil, Majang-myeon,
 Icheon-si, Gyeonggi-do, 17383, Rep. of KOREA

Report No.: HCT-RF-2107-FC042

FCC ID:
A3LSMG715U1
APPLICANT:
SAMSUNG Electronics Co., Ltd.

Model(s): SM-G715U1
 EUT Type: Mobile Phone
 FCC Classification: Citizens Band End User Devices (CBE)
 FCC Rule Part(s): §96, §2

Mode (MHz)	Tx Frequency (MHz)	Emission Designator	Modulation	EIRP	
				Max. Power (W)	Max. Power (dBm/10MHz)
LTE – Band 48 (5)	3552.5 – 3697.5	4M48G7D	QPSK	0.133	21.23
		4M48W7D	16QAM	0.096	19.83
		4M48W7D	64QAM	0.073	18.62
LTE – Band 48 (10)	3555.0 – 3695.0	9M03G7D	QPSK	0.147	21.67
		8M90W7D	16QAM	0.106	20.27
		8M88W7D	64QAM	0.076	18.80
LTE – Band 48 (15)	3557.5 – 3692.5	13M4G7D	QPSK	0.155	21.90
		13M5W7D	16QAM	0.107	20.30
		13M3W7D	64QAM	0.088	19.42
LTE – Band 48 (20)	3560.0 – 3690.0	17M8G7D	QPSK	0.154	21.87
		17M8W7D	16QAM	0.116	20.63
		17M8W7D	64QAM	0.089	19.49

The measurements shown in this report were made in accordance with the procedures specified in CFR47 section §2.947. I assume full responsibility for the accuracy and completeness of these measurements, and for the qualifications of all persons taking them.

HCT CO., LTD. Certifies that no party to this application has subject to a denial of Federal benefits that includes FCC benefits pursuant to section 5301 of the Anti-Drug Abuse Act of 1998, 21 U.S. C.853(a)

Report No.: HCT-RF-2107-FC042

REVIEWED BY



Report prepared by : Jae Mun Do
Engineer of Telecommunication Testing Center

Report approved by : Jong Seok Lee
Manager of Telecommunication Testing Center

This test results were applied only to the test methods required by the standard.

This laboratory is not accredited for the test results marked *.

The above Test Report is the accredited test result by (KS Q) ISO/IEC 17025 and KOLAS(Korea Laboratory Accreditation Scheme), which signed the ILAC-MRA. (HCT Accreditation No.: KT197)

* The report shall not be reproduced except in full(only partly) without approval of the laboratory.

Version

TEST REPORT NO.	DATE	DESCRIPTION
HCT-RF-2107-FC042	July 16, 2021	- First Approval Report

The result shown in this test report refer only to the sample(s) tested unless otherwise stated.

Table of Contents

REVIEWED BY	2
1. GENERAL INFORMATION	5
2. INTRODUCTION	6
2.1. DESCRIPTION OF EUT	6
2.2. MEASURING INSTRUMENT CALIBRATION	6
2.3. TEST FACILITY	6
3. DESCRIPTION OF TESTS.....	7
3.1 TEST PROCEDURE	7
3.2 RADIATED POWER.....	8
3.3 RADIATED SPURIOUS EMISSIONS	9
3.4 PEAK- TO- AVERAGE RATIO.....	10
3.5 OCCUPIED BANDWIDTH.	12
3.6 SPURIOUS AND HARMONIC EMISSIONS AT ANTENNA TERMINAL	13
3.7 CHANNEL EDGE	14
3.8 Adjacent Channel Leakage Ratio.....	15
3.9 FREQUENCY STABILITY / VARIATION OF AMBIENT TEMPERATURE	16
3.10 End User Device Additional Requirement (CBSD Protocol)	17
3.11 WORST CASE(RADIATED TEST)	18
3.12 WORST CASE(CONDUCTED TEST)	19
4. LIST OF TEST EQUIPMENT	20
5. MEASUREMENT UNCERTAINTY	21
6. SUMMARY OF TEST RESULTS	22
7. SAMPLE CALCULATION	24
8. TEST DATA	26
8.1 EQUIVALENT ISOTROPIC RADIATED POWER.....	26
8.2 RADIATED SPURIOUS EMISSIONS	28
8.3 PEAK-TO-AVERAGE RATIO.....	32
8.4 OCCUPIED BANDWIDTH	33
8.5 CONDUCTED SPURIOUS EMISSIONS	34
8.6 CHANNEL EDGE	35
8.7 Adjacent Channel Leakage Ratio(ACLR)	37
8.8 FREQUENCY STABILITY / VARIATION OF AMBIENT TEMPERATURE	38
8.9 End User Device Additional Requirements (CBSD Protocol).....	50
9. TEST PLOTS.....	54
10. ANNEX A_ TEST SETUP PHOTO.....	163

MEASUREMENT REPORT

1. GENERAL INFORMATION

Applicant Name:	SAMSUNG Electronics Co., Ltd.
Address:	129, Samsung-ro, Yeongtong-gu, Suwon-si, Gyeonggi-do, 16677, Rep. of Korea
FCC ID:	A3LSMG715U1
Application Type:	Certification
FCC Classification:	Citizens Band End User Devices (CBE)
FCC Rule Part(s):	§96, §2
EUT Type:	Mobile Phone
Model(s):	SM-G715U1
Tx Frequency:	3552.5 – 3697.5 : 5 MHz 3555.0 – 3695.0 : 10 MHz 3557.5 – 3692.5 : 15 MHz 3560.0 – 3690.0 : 20 MHz
Date(s) of Tests:	June 28, 2021 ~ July 08, 2021
Serial number:	Radiated: UEH1488S Conducted: UEH1480S

2. INTRODUCTION

2.1. DESCRIPTION OF EUT

The EUT was a Mobile Phone with GSM/GPRS/EGPRS/UMTS and LTE.

It also supports IEEE 802.11 a/b/g/n/ac (HT20/40/80), Bluetooth, NFC, ANT+.

2.2. MEASURING INSTRUMENT CALIBRATION

The measuring equipment, which was utilized in performing the tests documented herein, has been calibrated in accordance with the manufacturer's recommendations for utilizing calibration equipment, which is traceable to recognized national standards.

2.3. TEST FACILITY

The Fully-anechoic chamber and conducted measurement facility used to collect the radiated data are located at the **74, Seoicheon-ro 578beon-gil, Majang-myeon, Icheon-si, Gyeonggi-do, 17383, Rep. of KOREA.**

3. DESCRIPTION OF TESTS

3.1 TEST PROCEDURE

Test Description	Test Procedure Used
Occupied Bandwidth	- KDB 971168 D01 v03r01 – Section 4.3 - ANSI C63.26-2015 – Section 5.4.4 - KDB 940660 D01 v01
Channel Edge/ ACLR	- KDB 971168 D01 v03r01 – Section 6.0 - ANSI C63.26-2015 – Section 5.7 - KDB 940660 D01 v01
Spurious and Harmonic Emissions at Antenna Terminal	- KDB 971168 D01 v03r01 – Section 6.0 - ANSI C63.26-2015 – Section 5.7 - KDB 940660 D01 v01
Conducted Output Power	- N/A (See SAR Report)
Peak- to- Average Ratio	- KDB 971168 D01 v03r01 – Section 5.7 - ANSI C63.26-2015 – Section 5.2.3.4 - KDB 940660 D01 v01
Frequency stability	- ANSI C63.26-2015 – Section 5.6 - KDB 940660 D01 v01
Effective Radiated Power/ Effective Isotropic Radiated Power	- KDB 971168 D01 v03r01 – Section 5.2 & 5.8 - ANSI/TIA-603-E-2016 – Section 2.2.17 - KDB 940660 D01 v01
Radiated Spurious and Harmonic Emissions	- KDB 971168 D01 v03r01 – Section 6.2 - ANSI/TIA-603-E-2016 – Section 2.2.12 - KDB 940660 D01 v01
End User Device Additional Requirement (CBSD Protocol)	- KDB 940660 D01 v01 - WINNF-TS-0122 V1.0.0

3.2 RADIATED POWER

Test Overview

Radiated tests are performed in the Fully-anechoic chamber.

The equipment under test is placed on a non-conductive table 3-meters away from the receive antenna in accordance with ANSI/TIA-603-E-2016 Clause 2.2.17.

Test Settings

1. Radiated power measurements are performed using the signal analyzer's "channel power" measurement capability for signals with continuous operation.
2. RBW = 1 – 5% of the expected OBW, not to exceed 1MHz
3. VBW ≥ 3 x RBW
4. Span = 1.5 times the OBW
5. No. of sweep points > 2 x span / RBW
6. Detector = RMS
7. Trigger is set to "free run" for signals with continuous operation with the sweep times set to "auto".
8. The integration bandwidth was set equal to 10MHz.
9. Trace mode = trace averaging (RMS) over 100 sweeps
10. The trace was allowed to stabilize

Test Note

1. The turntable is rotated through 360 degrees, and the receiving antenna scans in order to determine the level of the maximized emission.
2. A half wave dipole is then substituted in place of the EUT. For emissions above 1GHz, a horn antenna is substituted in place of the EUT. The substitute antenna is driven by a signal generator and the previously recorded signal was duplicated.

The power is calculated by the following formula;

$$P_{d(\text{dBm})} = P_{g(\text{dBm})} - \text{cable loss (dB)} + \text{antenna gain (dB)}$$

Where: P_d is the dipole equivalent power and P_g is the generator output power into the substitution antenna.

3. The maximum value is calculated by adding the forward power to the calibrated source plus its appropriate gain value. These steps are repeated with the receiving antenna in both vertical and horizontal polarization. the difference between the gain of the horn and an isotropic antenna are taken into consideration
4. The EUT was tested in three orthogonal planes(X, Y, Z) and in all possible test configurations and positioning.
5. All measurements are performed as RMS average measurements while the EUT is operating at its maximum duty cycle, at maximum power, and at the appropriate frequencies.

3.3 RADIATED SPURIOUS EMISSIONS

Test Overview

Radiated tests are performed in the Fully-anechoic chamber.

Radiated Spurious Emission Measurements at 3 meters by Substitution Method according to ANSI/TIA-603-E-2016.

Test Settings

1. RBW = 100kHz for emissions below 1GHz and NormalHz for emissions above 1GHz
2. VBW $\geq 3 \times$ RBW
3. Span = 1.5 times the OBW
4. No. of sweep points $> 2 \times$ span / RBW
5. Detector = RMS
6. Trace mode = Average
7. The trace was allowed to stabilize
8. Test channel : Low/ Middle/ High
9. Frequency range : We are performed all frequency to 10th harmonics from 9 kHz.

Test Note

1. Measurements value show only up to 3 maximum emissions noted, or would be lesser if no specific emissions from the EUT are recorded (ie: margin > 20 dB from the applicable limit) and considered that's already beyond the background noise floor.
2. The EUT was tested in three orthogonal planes(X, Y, Z) and in all possible test configurations and positioning. The worst case emissions are reported with the EUT positioning, modulations, RB sizes and offsets, and channel bandwidth configurations shown in the test data
3. For spurious emissions above 1GHz, a horn antenna is substituted in place of the EUT. The substitute antenna is driven by a signal generator and the previously recorded signal was duplicated.

The spurious emissions is calculated by the following formula;

$$\text{Result}_{(\text{dBm})} = P_{g(\text{dBm})} - \text{cable loss}_{(\text{dB})} + \text{antenna gain}_{(\text{dBi})}$$

Where: P_g is the generator output power into the substitution antenna.

If the fundamental frequency is below 1GHz, RF output power has been converted to EIRP.

$$\text{EIRP}_{(\text{dBm})} = \text{ERP}_{(\text{dBm})} + 2.15$$

3.4 PEAK- TO- AVERAGE RATIO

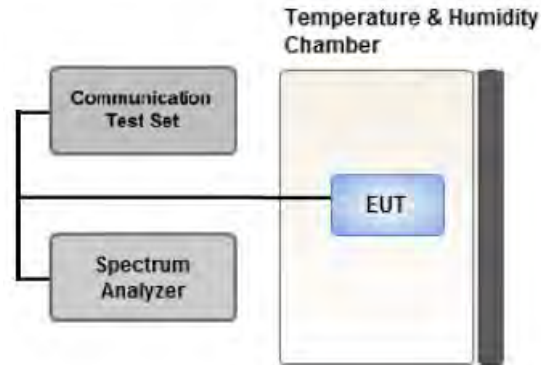

Test setup

① CCDF Procedure for PAPR

Test Settings

1. Set resolution/measurement bandwidth \geq signal's occupied bandwidth;
2. Set the number of counts to a value that stabilizes the measured CCDF curve;
3. Set the measurement interval as follows:
 - for continuous transmissions, set to 1 ms,
 - or burst transmissions, employ an external trigger that is synchronized with the EUT burst timing sequence, or use the internal burst trigger with a trigger level that allows the burst to stabilize and set the measurement interval to a time that is less than or equal to the burst duration.
4. Record the maximum PAPR level associated with a probability of 0.1%.

② Alternate Procedure for PAPR

Use one of the procedures presented in 5.2(ANSI C63.26-2015) to measure the total peak power and record as P_{PK} .

Use one of the applicable procedures presented 5.2(ANSI C63.26-2015) to measure the total average power and record as P_{Avg} . Determine the P.A.R. from:

$$P.A.R_{(dB)} = P_{PK} (dBm) - P_{Avg} (dBm) \quad (P_{Avg} = \text{Average Power} + \text{Duty cycle Factor})$$

Test Settings(Peak Power)

The measurement instrument must have a RBW that is greater than or equal to the OBW of the signal to be measured and a VBW $\geq 3 \times$ RBW.

1. Set the RBW \geq OBW.
2. Set VBW $\geq 3 \times$ RBW.
3. Set span $\geq 2 \times$ OBW.
4. Sweep time $\geq 10 \times$ (number of points in sweep) \times (transmission symbol period).
5. Detector = peak.
6. Trace mode = max hold.
7. Allow trace to fully stabilize.
8. Use the peak marker function to determine the peak amplitude level.

Test Settings(Average Power)

1. Set span to $2 \times$ to $3 \times$ the OBW.
2. Set RBW \geq OBW.
3. Set VBW $\geq 3 \times$ RBW.
4. Set number of measurement points in sweep $\geq 2 \times$ span / RBW.
5. Sweep time:

Set $\geq [10 \times$ (number of points in sweep) \times (transmission period)] for single sweep
(automation-compatible) measurement. The transmission period is the (on + off) time.
6. Detector = power averaging (rms).
7. Set sweep trigger to "free run."
8. Trace average at least 100 traces in power averaging (rms) mode if sweep is set to auto-couple. (To accurately determine the average power over the on and off period of the transmitter, it can be necessary to increase the number of traces to be averaged above 100 or, if using a manually configured sweep time, increase the sweep time.)
9. Use the peak marker function to determine the maximum amplitude level.
10. Add $[10 \log (1/\text{duty cycle})]$ to the measured maximum power level to compute the average power during continuous transmission. For example, add $[10 \log (1/0.25)] = 6$ dB if the duty cycle is a constant 25%.

3.5 OCCUPIED BANDWIDTH.



Test setup

The width of a frequency band such that, below the lower and above the upper frequency limits, the mean powers emitted are each equal to a specified percentage 0.5 % of the total mean power of a given emission.

The EUT makes a call to the communication simulator.

The conducted occupied bandwidth used the power splitter via EUT RF power connector between simulation base station and spectrum analyzer.

The communication simulator station system controlled a EUT to export maximum output power under transmission mode and specific channel frequency. Use OBW measurement function of Spectrum analyzer to measure 99 % occupied bandwidth

Test Settings

1. The signal analyzer's automatic bandwidth measurement capability was used to perform the 99% occupied bandwidth and the 26dB bandwidth. The bandwidth measurement was not influenced by any intermediate power nulls in the fundamental emission.
2. RBW = 1 – 5% of the expected OBW
3. VBW $\geq 3 \times$ RBW
4. Detector = Peak
5. Trace mode = max hold
6. Sweep = auto couple
7. The trace was allowed to stabilize
8. If necessary, steps 2 – 7 were repeated after changing the RBW such that it would be within 1 – 5% of the 99% occupied bandwidth observed in Step 7

3.6 SPURIOUS AND HARMONIC EMISSIONS AT ANTENNA TERMINAL



Test setup

Test Overview

The level of the carrier and the various conducted spurious and harmonic frequencies is measured by means of a calibrated spectrum analyzer. The spectrum is scanned from the lowest frequency generated in the equipment up to a frequency including its 10th harmonic. All out of band emissions are measured with a spectrum analyzer connected to the antenna terminal of the EUT while the EUT is operating at its maximum duty cycle, at maximum power, and at the appropriate frequencies. All data rates were investigated to determine the worst case configuration. All modes of operation were investigated and the worst case configuration results are reported in this section.

Test Settings

1. RBW = 1 MHz
2. VBW \geq 3 MHz
3. Detector = RMS
4. Trace Mode = Average
5. Sweep time = auto
6. Number of points in sweep \geq 2 x Span / RBW

Test Notes

1. Duty Cycle factor already applied on the factor.
 - Duty Cycle factor(dB) = 3.98
 - Factor(dB) = Duty Cycle factor + Cable Loss + Ext. Attenuator + Power Splitter
 - Result(dBm) = Reading + Factor

3.7 CHANNEL EDGE

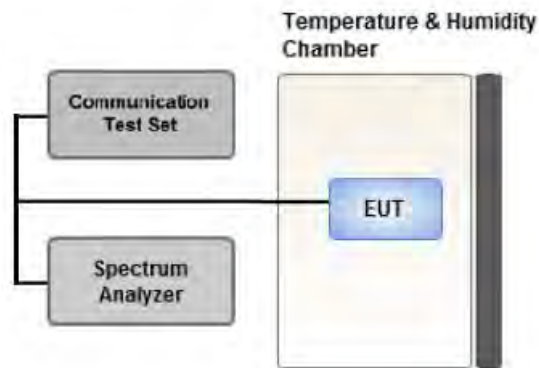

Test setup

Test Settings

1. Start and stop frequency were set such that the band edge would be placed in the center of the plot
2. Span was set large enough so as to capture all out of band emissions near the band edge
3. Within 1MHz of the channel edge the RBW should be 2% of EBW, then 1 MHz after that.
4. VBW > 3 x RBW
5. Detector = RMS
6. Number of sweep points $\geq 2 \times \text{Span}/\text{RBW}$
7. Trace mode = trace average
8. Sweep time = auto couple
9. The trace was allowed to stabilize

Test Notes

The conducted power of any End User Device emission outside the fundamental emission (whether in or outside of the authorized band) shall not exceed -13 dBm/MHz within 0 to B megahertz (where B is the bandwidth in megahertz of the assigned channel or multiple contiguous channels of the End User Device) above the upper CBSD-assigned channel edge and within 0 to B megahertz below the lower CBSD-assigned channel edge.

At all frequencies greater than B megahertz above the upper CBSD assigned channel edge and less than B megahertz below the lower CBSD-assigned channel edge, the conducted power of any End User Device emission shall not exceed -25 dBm/MHz . Notwithstanding the emission limits in this paragraph.

3.8 Adjacent Channel Leakage Ratio

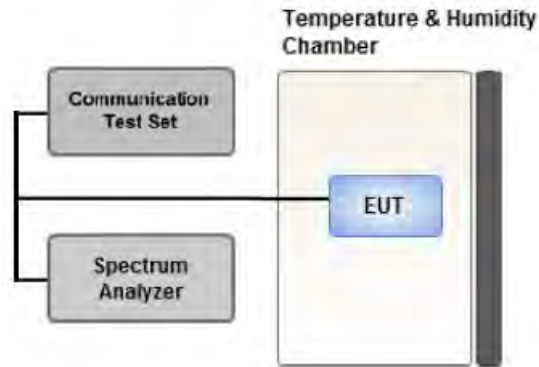

Test setup

Test Settings

1. Use ACP measurement function of Spectrum analyzer to measure adjacent channel leakage ratio
2. Integ BW = Assigned channel bandwidth
5. Detector = RMS
6. Number of sweep points $\geq 2 \times \text{Span/RBW}$
7. Trace mode = trace average
8. Sweep time = 1s
9. The trace was allowed to stabilize

Test Notes

the Adjacent Channel Leakage Ratio for End User Devices shall be at least 30 dB.

3.9 FREQUENCY STABILITY / VARIATION OF AMBIENT TEMPERATURE

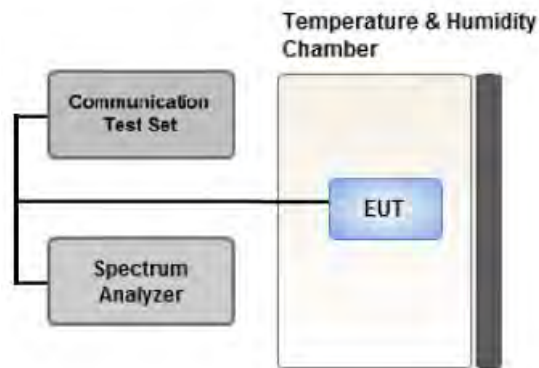

Test setup

Test Overview

Frequency stability testing is performed in accordance with the guidelines of ANSI C63.26-2015.

The frequency stability of the transmitter is measured by:

1. Temperature:

The temperature is varied from -30°C to +50°C in 10°C increments using an environmental chamber.

2. Primary Supply Voltage:

- Unless otherwise specified, vary primary supply voltage from 85% to 115% of the nominal value for other than hand carried battery equipment.
- For hand carried, battery powered equipment, reduce the primary ac or dc supply voltage to the battery operating end point, which shall be specified by the manufacturer.

Test Settings

1. The carrier frequency of the transmitter is measured at room temperature (20°C to provide a reference).
2. The equipment is turned on in a "standby" condition for fifteen minutes before applying power to the transmitter. Measurement of the carrier frequency of the transmitter is made within one minute after applying power to the transmitter.
3. Frequency measurements are made at 10°C intervals ranging from -30°C to +50°C. A period of at least one half-hour is provided to allow stabilization of the equipment at each temperature level.

3.10 End User Device Additional Requirement (CBSD Protocol)

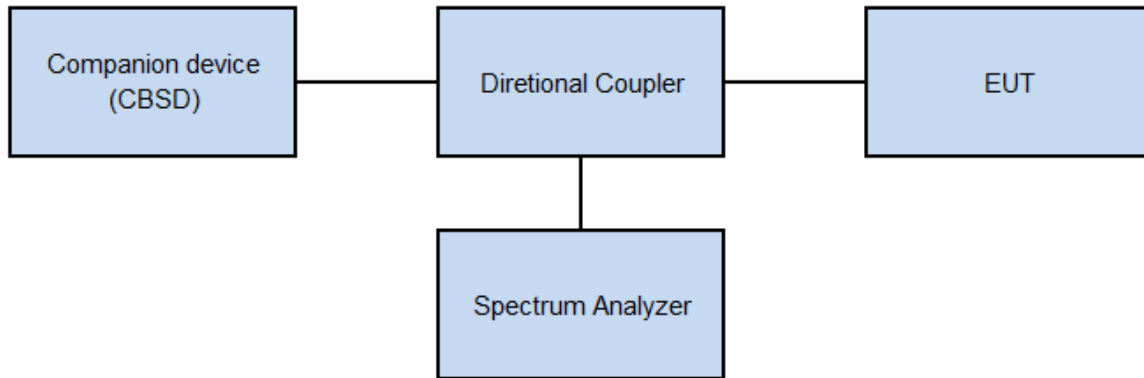

Test setup

Test Overview

End user device additional requirements (CBSD Protocol) are tested per the test procedures listed below. During testing, the EUT is connected to a certified CBSD (FCC ID: 2AS48SC-220) as a companion device to show compliance with Part 96.47.

End User Devices may operate only if they can positively receive and decode an authorization signal transmitted by a CBSD, including the frequencies and power limits for their operation.

Test Settings

- a. Setup companion device with 3570MHz & 3610MHz.
- b. Enable AP service from companion device.
- c. EUT is connected to a companion device.
- c. Check EUT Tx frequency and power.
- d. Disable AP service from companion device and check EUT stop transmission within 10s.

3.11 WORST CASE(RADIATED TEST)

- The EUT was tested in three orthogonal planes(X, Y, Z) and in all possible test configurations and positioning.
- All modes of operation were investigated and the worst case configuration results are reported.
- The worst case is reported with the EUT positioning, modulations, RB sizes and offsets, and channel bandwidth configurations shown in the test data.
- Please refer to the table below.

[Worst case]

Test Description	Modulation	RB size	RB offset	Axis
Effective Isotropic Radiated Power	QPSK, 16QAM, 64QAM	1	0	X
Radiated Spurious and Harmonic Emissions	QPSK	1	0	Z

3.12 WORST CASE(CONDUCTED TEST)

- All modes of operation were investigated and the worst case configuration results are reported.

[Worst case]

Test Description	Modulation	Bandwidth (MHz)	Frequency	RB size	RB offset
Occupied Bandwidth	QPSK, 16QAM, 64QAM	5, 10, 15, 20	Mid	Full RB	0
Peak-To-Average Ratio	QPSK, 16QAM, 64QAM	5, 10, 15, 20	Mid	Full RB	0
Channel Edge	QPSK	5	Low	1	0
			High	1	24
		10	Low	1	0
			High	1	49
		15	Low	1	0
			High	1	74
		20	Low	1	0
			High	1	99
		5, 10, 15, 20	Low, Mid, High	Full RB	0
		Spurious and Harmonic Emissions at Antenna Terminal	QPSK	5, 10, 15, 20	Low, Mid, High

4. LIST OF TEST EQUIPMENT

Manufacture	Model/ Equipment	Serial Number	Calibration Date	Calibrati on Interval	Calibration Due
T&M SYSTEM	FBSR-02B(WHK1.2/15G-10EF)/H.P.F	-	03/02/2021	Annual	03/02/2022
T&M SYSTEM	FBSR-02B(WHK3.3/18G-10EF)/H.P.F	-	03/02/2021	Annual	03/02/2022
Hewlett Packard	11667B / Power Splitter(DC~26.5 GHz)	11275	04/07/2021	Annual	04/07/2022
Hewlett Packard	E3632A/DC Power Supply	MY40004427	09/16/2020	Annual	09/16/2021
Schwarzbeck	UHAP/ Dipole Antenna	557	04/05/2021	Biennial	04/05/2023
Schwarzbeck	UHAP/ Dipole Antenna	558	04/05/2021	Biennial	04/05/2023
ESPEC	SU-642 / Chamber	93008124	03/15/2021	Annual	03/15/2022
Schwarzbeck	BBHA 9120D/ Horn Antenna(1~18GHz)	147	08/29/2019	Biennial	08/29/2021
Schwarzbeck	BBHA 9120D/ Horn Antenna(1~18GHz)	9120D-1298	09/25/2019	Biennial	09/25/2021
Schwarzbeck	BBHA 9170/ Horn Antenna(15~40GHz)	BBHA9170342	10/13/2020	Biennial	10/13/2022
Schwarzbeck	BBHA 9170/ Horn Antenna(15~40GHz)	BBHA9170124	02/11/2020	Biennial	02/11/2022
Agilent	N9020A/Signal Analyzer(10Hz~26.5GHz)	MY50200093	11/17/2020	Annual	11/17/2021
Hewlett Packard	8493C/ATTENUATOR(20dB)	17280	06/01/2021	Annual	06/01/2022
REOHDE & SCHWARZ	FSV40/Spectrum Analyzer(10Hz~40GHz)	100931	10/14/2020	Annual	10/14/2021
Agilent	8960 (E5515C)/ Base Station	MY48360800	08/26/2020	Annual	08/26/2021
Schwarzbeck	FMZB1513/ Loop Antenna(9kHz~30MHz)	1513-333	03/19/2020	Biennial	03/19/2022
Schwarzbeck	VULB9160/ Bilog Antenna	3150	03/03/2021	Biennial	03/03/2023
Schwarzbeck	VULB9168/ Hybrid Antenna	760	02/22/2021	Biennial	02/22/2023
Anritsu Corp.	MT8821C/Wideband Radio Communication Tester	6262116770	07/22/2020	Annual	07/22/2021
Anritsu Corp.	MT8820C/Wideband Radio Communication Tester	6201026545	01/07/2021	Annual	01/07/2022
REOHDE & SCHWARZ	SMB100A/ SIGNAL GENERATOR (100kHz~40GHz)	177633	07/05/2021	Annual	07/05/2022
KEYSIGHT	N9030B / Signal Analyzer(5Hz~40.0GHz)	MY55480167	06/02/2021	Annual	06/02/2022
HCT CO., LTD.,	FCC LTE Mobile Conducted RF Automation Test Software	-	-	-	-

Note:

- Equipment listed above that has a calibration due date during the testing period, the testing is completed before equipment expiration date.
- Especially, all antenna for measurement is calibrated in accordance with the requirements of C63.5 (Version : 2017).

5. MEASUREMENT UNCERTAINTY

The measurement uncertainties shown below were calculated in accordance with the requirements of ANSI C63.4:2014. All measurement uncertainty values are shown with a coverage factor of $k = 2$ to indicate a 95 % level of confidence. The measurement data shown herein meets or exceeds the U_{CISPR} measurement uncertainty values specified in CISPR 16-4-2 and, thus, can be compared directly to specified limits to determine compliance.

Parameter	Expanded Uncertainty (\pm dB)
Conducted Disturbance (150 kHz ~ 30 MHz)	1.82
Radiated Disturbance (9 kHz ~ 30 MHz)	3.40
Radiated Disturbance (30 MHz ~ 1 GHz)	4.80
Radiated Disturbance (1 GHz ~ 18 GHz)	5.70
Radiated Disturbance (18 GHz ~ 40 GHz)	5.05

6. SUMMARY OF TEST RESULTS

6.1 Test Condition : Conducted Test

Test Description	FCC Part Section(s)	Test Limit	Test Result
Occupied Bandwidth	§2.1049	N/A	PASS
Band Edge / Spurious and Harmonic Emissions at Antenna Terminal.	§2.1051, §96.41(e)	<ul style="list-style-type: none"> ■ within 0 MHz to B MHz above and below the assigned channel ≤ -13 dBm/MHz ■ greater than B MHz above and below the assigned channel ≤ -25 dBm/MHz ■ any emission below 3540 MHz and above 3710 MHz ≤ -25 dBm/MHz ■ any emission below 3530 MHz and above 3720 MHz ≤ -40 dBm/MHz 	PASS
Adjacent Channel Leakage Ratio	§96.41(e)	At least 30 dB.	PASS
Conducted Output Power	§2.1046	N/A	<u>See Note1</u>
Frequency stability / variation of ambient temperature	§2.1055,	Emission must remain in band	PASS
End User Device Additional Requirements (CBSD Protocol)	§96.47	<p>End User Devices may operate only if they can positively receive and decode an authorization signal transmitted by a CBSD, including the frequencies and power limits for their operation.</p> <p>An End User Device must discontinue operations, change frequencies, or change its operational power level within 10 seconds of receiving instructions from its associated CBSD.</p>	PASS

Note:

1. See SAR Report
2. The EUT is an End User Device

6.2 Test Condition : Radiated Test

Test Description	FCC Part Section(s)	Test Limit	Test Result
Equivalent Isotropic Radiated Power	§96.41(b)	23 dBm/10MHz	PASS
Radiated Spurious and Harmonic Emissions	§2.1053, §96.41(e)	-40 dBm/MHz	PASS

7. SAMPLE CALCULATION

7.1 ERP Sample Calculation

Ch./ Freq.		Measured Level(dBm)	Substitute Level(dBm)	Ant. Gain (dBd)	C.L	Pol.	ERP	
channel	Freq.(MHz)						W	dBm
128	824.20	-21.37	38.40	-10.61	0.95	H	0.483	26.84

$$\text{ERP} = \text{Substitute LEVEL(dBm)} + \text{Ant. Gain} - \text{CL(Cable Loss)}$$

- 1) The EUT mounted on a non-conductive turntable is 2.5 meter above test site ground level.
- 2) During the test , the turn table is rotated until the maximum signal is found.
- 3) Record the field strength meter's level.
- 4) Replace the EUT with dipole/Horn antenna that is connected to a calibrated signal generator.
- 5) Increase the signal generator output till the field strength meter's level is equal to the item (3).
- 6) The signal generator output level with Ant. Gain and cable loss are the rating of effective radiated power.

7.2 EIRP Sample Calculation

Ch./ Freq.		Measured Level(dBm)	Substitute Level(dBm)	Ant. Gain (dBi)	C.L	Pol.	EIRP	
channel	Freq.(MHz)						W	dBm
55990	2595.0	-15.75	18.45	9.90	1.76	H	0.456	26.59

$$\text{EIRP} = \text{Substitute LEVEL(dBm)} + \text{Ant. Gain} - \text{CL(Cable Loss)}$$

- 1) The EUT mounted on a non-conductive turntable is 2.5 meter above test site ground level.
- 2) During the test , the turn table is rotated until the maximum signal is found.
- 3) Record the field strength meter's level.
- 4) Replace the EUT with dipole/Horn antenna that is connected to a calibrated signal generator.
- 5) Increase the signal generator output till the field strength meter's level is equal to the item (3).
- 6) The signal generator output level with Ant. Gain and cable loss are the rating of equivalent isotropic radiated power.

7.3. Emission Designator

GSM Emission Designator

Emission Designator = 249KGXW

GSM BW = 249 kHz

G = Phase Modulation

X = Cases not otherwise covered

W = Combination (Audio/Data)

EDGE Emission Designator

Emission Designator = 249KG7W

GSM BW = 249 kHz

G = Phase Modulation

7 = Quantized/Digital Info

W = Combination (Audio/Data)

WCDMA Emission Designator

Emission Designator = 4M17F9W

WCDMA BW = 4.17 MHz

F = Frequency Modulation

9 = Composite Digital Info

W = Combination (Audio/Data)

QPSK Modulation

Emission Designator = 4M48G7D

LTE BW = 4.48 MHz

G = Phase Modulation

7 = Quantized/Digital Info

D = Data transmission; telemetry; telecommand

QAM Modulation

Emission Designator = 4M48W7D

LTE BW = 4.48 MHz

W = Amplitude/Angle Modulated

7 = Quantized/Digital Info

D = Data transmission; telemetry; telecommand

8. TEST DATA

8.1 EQUIVALENT ISOTROPIC RADIATED POWER

Freq (MHz)	Bandwidth	Modulation	Measured Level (dBm)	Substitute Level (dBm)	Ant. Gain(dBi)	C.L	Pol	EIRP	Limit
								dBm/10MHz	
3552.5	LTE B48/ 5 MHz	QPSK	-28.51	10.41	12.10	3.02	H	19.49	23.0
		16-QAM	-29.71	9.21	12.10	3.02	H	18.29	
		64-QAM	-31.21	7.71	12.10	3.02	H	16.79	
3625.0		QPSK	-27.02	12.03	12.25	3.05	H	21.23	
		16-QAM	-28.49	10.56	12.25	3.05	H	19.76	
		64-QAM	-29.83	9.22	12.25	3.05	H	18.42	
3697.5		QPSK	-27.44	11.86	12.40	3.08	H	21.18	
		16-QAM	-28.79	10.51	12.40	3.08	H	19.83	
		64-QAM	-30.00	9.30	12.40	3.08	H	18.62	

Freq (MHz)	Bandwidth	Modulation	Measured Level (dBm)	Substitute Level (dBm)	Ant. Gain(dBi)	C.L	Pol	EIRP	Limit
								dBm/10MHz	
3555.0	LTE B48/ 10 MHz	QPSK	-27.68	11.23	12.12	3.02	H	20.32	23.0
		16-QAM	-29.06	9.85	12.12	3.02	H	18.94	
		64-QAM	-30.30	8.61	12.12	3.02	H	17.70	
3625.0		QPSK	-26.58	12.47	12.25	3.05	H	21.67	
		16-QAM	-28.25	10.80	12.25	3.05	H	20.00	
		64-QAM	-29.45	9.60	12.25	3.05	H	18.80	
3695.0		QPSK	-27.01	12.25	12.39	3.08	H	21.56	
		16-QAM	-28.30	10.96	12.39	3.08	H	20.27	
		64-QAM	-29.79	9.47	12.39	3.08	H	18.78	

Freq (MHz)	Bandwidth	Modulation	Measured Level (dBm)	Substitute Level (dBm)	Ant. Gain(dBi)	C.L	Pol	EIRP	Limit
								dBm/10MHz	
3557.5	LTE B48/ 15 MHz	QPSK	-28.04	10.79	12.13	3.01	H	19.91	23.0
		16-QAM	-29.72	9.11	12.13	3.01	H	18.23	
		64-QAM	-30.50	8.33	12.13	3.01	H	17.45	
3625.0		QPSK	-26.65	12.40	12.25	3.05	H	21.60	
		16-QAM	-28.06	10.99	12.25	3.05	H	20.19	
		64-QAM	-28.83	10.22	12.25	3.05	H	19.42	
3692.5		QPSK	-26.61	12.59	12.38	3.07	H	21.90	
		16-QAM	-28.21	10.99	12.38	3.07	H	20.30	
		64-QAM	-29.35	9.85	12.38	3.07	H	19.16	

Freq (MHz)	Bandwidth	Modulation	Measured Level (dBm)	Substitute Level (dBm)	Ant. Gain(dBi)	C.L	Pol	EIRP	Limit
								dBm/10MHz	
3560.0	LTE B48/ 20 MHz	QPSK	-27.96	10.87	12.13	3.01	H	19.99	23.0
		16-QAM	-29.61	9.22	12.13	3.01	H	18.34	
		64-QAM	-30.35	8.48	12.13	3.01	H	17.60	
3625.0		QPSK	-26.79	12.26	12.25	3.05	H	21.46	
		16-QAM	-27.95	11.10	12.25	3.05	H	20.30	
		64-QAM	-29.02	10.03	12.25	3.05	H	19.23	
3690.0		QPSK	-26.64	12.56	12.38	3.07	H	21.87	
		16-QAM	-27.88	11.32	12.38	3.07	H	20.63	
		64-QAM	-29.02	10.18	12.38	3.07	H	19.49	

8.2 RADIATED SPURIOUS EMISSIONS

- ▣ MODE: LTE B48
- ▣ MODULATION SIGNAL: 5 MHz QPSK
- ▣ DISTANCE: 1 meters

Freq (MHz)	Measured Freq (MHz)	Measured Level (dBm)	Ant. Gain (dBi)	Substitute Level (dBm)	C.L	Pol	Result (dBm)	Limit (dBm)
55265 (3552.5)	7 105.00	-53.88	11.29	-54.67	4.35	H	-47.73	-40.00
	10 657.50	-57.97	10.90	-54.32	5.54	V	-48.96	-40.00
	14 210.00	-60.55	11.78	-48.47	6.54	H	-43.23	-40.00
55990 (3625.0)	7 250.00	-51.18	11.10	-53.75	4.35	H	-47.00	-40.00
	10 875.00	-58.74	10.65	-52.63	5.57	V	-47.55	-40.00
	14 500.00	-64.24	11.90	-52.93	6.54	V	-47.57	-40.00
56715 (3697.5)	7 395.00	-51.05	11.12	-51.67	4.43	H	-44.98	-40.00
	11 092.50	-56.25	11.15	-51.94	5.60	H	-46.39	-40.00
	14 790.00	-61.77	12.08	-51.12	6.62	H	-45.66	-40.00

MODE: LTE B48
 MODULATION SIGNAL: 10 MHz QPSK
 DISTANCE: 1 meters

Freq (MHz)	Measured Freq (MHz)	Measured Level (dBm)	Ant. Gain (dBi)	Substitute Level (dBm)	C.L	Pol	Result (dBm)	Limit (dBm)
55290 (3555.0)	7 110.00	-52.98	11.28	-53.62	4.31	H	-46.65	-40.00
	10 665.00	-57.88	10.90	-54.22	5.54	H	-48.86	-40.00
	14 220.00	-65.50	11.75	-53.15	6.51	V	-47.91	-40.00
55990 (3625.0)	7 250.00	-52.35	11.10	-54.92	4.35	V	-48.17	-40.00
	10 875.00	-59.41	10.65	-53.30	5.57	V	-48.22	-40.00
	14 500.00	-65.83	11.90	-54.52	6.54	V	-49.16	-40.00
56690 (3695.0)	7 390.00	-50.53	11.13	-51.07	4.42	H	-44.36	-40.00
	11 085.00	-57.53	11.13	-53.15	5.61	V	-47.64	-40.00
	14 780.00	-60.42	12.05	-49.76	6.61	H	-44.32	-40.00

MODE: LTE B48
 MODULATION SIGNAL: 15 MHz QPSK
 DISTANCE: 1 meters

Freq (MHz)	Measured Freq (MHz)	Measured Level (dBm)	Ant. Gain (dBi)	Substitute Level (dBm)	C.L	Pol	Result (dBm)	Limit (dBm)
55315 (3557.5)	7 115.00	-53.45	11.27	-54.12	4.34	H	-47.20	-40.00
	10 672.50	-57.63	10.90	-53.95	5.54	V	-48.59	-40.00
	14 230.00	-65.29	11.75	-52.80	6.50	V	-47.55	-40.00
55990 (3625.0)	7 250.00	-53.20	11.10	-55.77	4.35	H	-49.02	-40.00
	10 875.00	-58.74	10.65	-52.63	5.57	H	-47.55	-40.00
	14 500.00	-60.00	11.90	-48.68	6.54	V	-43.32	-40.00
56665 (3692.5)	7 385.00	-51.09	11.14	-51.66	4.41	H	-44.93	-40.00
	11 077.50	-57.95	11.10	-53.51	5.62	V	-48.03	-40.00
	14 770.00	-61.45	12.05	-50.80	6.58	H	-45.33	-40.00

MODE: LTE B48
 MODULATION SIGNAL: 20 MHz QPSK
 DISTANCE: 1 meters

Freq (MHz)	Measured Freq (MHz)	Measured Level (dBm)	Ant. Gain (dBi)	Substitute Level (dBm)	C.L	Pol	Result (dBm)	Limit (dBm)
55340 (3560.0)	7 120.00	-51.02	11.25	-51.75	4.34	H	-44.84	-40.00
	10 680.00	-56.81	10.90	-53.04	5.53	H	-47.67	-40.00
	14 240.00	-65.29	11.73	-53.13	6.45	V	-47.85	-40.00
55990 (3625.0)	7 250.00	-49.61	11.10	-52.18	4.35	V	-45.43	-40.00
	10 875.00	-58.70	10.65	-52.59	5.57	H	-47.51	-40.00
	14 500.00	-65.16	11.90	-53.85	6.54	V	-48.49	-40.00
56640 (3690.0)	7 380.00	-50.00	11.15	-50.61	4.40	H	-43.86	-40.00
	11 070.00	-56.38	11.10	-51.56	5.64	H	-46.10	-40.00
	14 760.00	-61.23	12.03	-50.59	6.58	H	-45.14	-40.00

8.3 PEAK-TO-AVERAGE RATIO

Band	Band Width	Frequency (MHz)	Modulation	Resource Block Size	Resource Block Offset	Data (dB)
48	5 MHz	3625.0	QPSK	25	0	5.46
			16-QAM			6.44
			64-QAM			6.63
	10 MHz		QPSK	50		5.50
			16-QAM			5.96
			64-QAM			6.71
	15 MHz		QPSK	75		5.30
			16-QAM			6.00
			64-QAM			6.87
	20 MHz		QPSK	100		5.22
			16-QAM			5.95
			64-QAM			6.51

Note:

1. Plots of the EUT's Peak- to- Average Ratio are shown Page 67 ~ 78.

8.4 OCCUPIED BANDWIDTH

Band	Band Width	Frequency (MHz)	Modulation	Resource Block Size	Resource Block Offset	Data (MHz)
48	5 MHz	3625.0	QPSK	25	0	4.4772
			16-QAM			4.4773
			64-QAM			4.4746
	10 MHz		QPSK	50		9.0291
			16-QAM			8.9014
			64-QAM			8.8824
	15 MHz		QPSK	75		13.358
			16-QAM			13.472
			64-QAM			13.304
	20 MHz		QPSK	100		17.789
			16-QAM			17.825
			64-QAM			17.823

Note:

1. Plots of the EUT's Occupied Bandwidth are shown Page 55 ~ 66

8.5 CONDUCTED SPURIOUS EMISSIONS

Band	Band Width (MHz)	Frequency (MHz)	Frequency of Maximum Harmonic (GHz)	Factor (dB)	Measurement Maximum Data (dBm)	Result (dBm)	Limit (dBm)
48	5	3552.5	3.8271	31.955	-75.395	-43.440	-40.00
		3625.0	3.7787	31.955	-75.112	-43.157	
		3697.5	3.7732	31.955	-76.095	-44.140	
	10	3555.0	3.8041	31.955	-75.180	-43.225	
		3625.0	3.8440	31.955	-75.245	-43.290	
		3695.0	3.7688	31.955	-75.145	-43.190	
	15	3557.5	3.8510	31.955	-75.441	-43.486	
		3625.0	3.8410	31.955	-75.327	-43.372	
		3692.5	3.8146	31.955	-75.349	-43.394	
	20	3560.0	3.8620	31.955	-75.474	-43.519	
		3625.0	3.7732	31.955	-78.212	-46.257	
		3690.0	3.7598	31.955	-75.103	-43.148	

Note:

1. Plots of the EUT's Conducted Spurious Emissions are shown Page 135 ~ 162.
2. Duty Cycle factor already applied on the factor.
 - Duty Cycle factor(dB) = 3.979
 - Factor(dB) = Duty Cycle factor + Cable Loss + Ext. Attenuator + Power Splitter
 - Result(dBm) = Measurement Maximum Data (dBm) + Factor

Frequency Range (GHz)	Factor [dB]
0.03 – 1	29.249
1 – 5	31.955
5 – 10	32.570
10 – 15	33.095
15 – 20	33.468
Above 20(26.5)	34.110

8.6 CHANNEL EDGE

BW (MHz)	RB (Size/Offset)	Freq. (MHz)	Outside of the authorized band (dBm)							
			Lower Side(MHz)				Upper Side(MHz)			
			Below 3530 MHz	-[B]MHz ~ 3530 MHz	-1 MHz ~ -[B]MHz	0 MHz ~ -1 MHz	0 MHz ~ +1 MHz	1 MHz ~ +[B]MHz	+ [B]MHz ~ 3720 MHz	Above 3720 MHz
5	25/0	3552.5	-47.68	-39.34	-22.26	-23.89	-24.46	-22.21	-38.12	-
		3625.0	-	-39.82	-25.15	-25.40	-25.28	-23.52	-38.88	-
		3697.5	-	-38.62	-23.39	-24.32	-24.75	-22.17	-37.83	-45.35
10	50/0	3555.0	-47.13	-39.72	-24.59	-28.94	-26.91	-23.08	-40.37	-
		3625.0	-	-41.83	-25.94	-28.69	-28.25	-24.04	-41.10	-
		3695.0	-	-39.24	-23.45	-27.26	-27.11	-21.60	-38.76	-44.99
15	75/0	3557.5	-45.77	-33.90	-26.26	-30.34	-28.88	-24.16	-41.88	-
		3625.0	-	-42.59	-28.06	-29.22	-30.07	-27.02	-42.70	-
		3692.5	-	-40.89	-26.31	-29.19	-29.19	-24.81	-32.82	-44.09
20	100/0	3560.0	-43.88	-31.34	-26.37	-31.77	-30.81	-24.84	-43.05	-
		3625.0	-	-43.22	-28.98	-33.14	-32.08	-27.43	-43.05	-
		3690.0	-	-42.57	-27.27	-32.85	-30.49	-24.71	-30.03	-41.79
Limit (dBm)			-40.00	-25.00	-13.00	-13.00	-13.00	-13.00	-25.00	-40.00

Note:

1. C.E = Channel Edge
2. Plots of the EUT's Channel Edge are shown Page 91 ~ 134

BW (MHz)	RB (Size/ Offset)	Freq. (MHz)	Outside of the authorized band (dBm)							
			Lower Side(MHz)				Upper Side(MHz)			
			Below 3530 MHz	-[B]MHz ~ 3530 MHz	-1 MHz ~ -[B]MHz	0 MHz ~ -1 MHz	0 MHz ~ +1 MHz	1 MHz ~ +[B]MHz	+[B]MHz ~ 3720 MHz	Above 3720 MHz
5	Lower Side: 1/0 Upper Side: 1/24	3552.5	-47.53	-38.42	-24.39	-18.99	-18.77	-24.83	-38.45	-
		3625.0	-	-39.13	-21.77	-20.21	-20.83	-22.68	-38.87	-
		3697.5	-	-38.55	-22.32	-19.53	-19.91	-21.58	-38.40	-44.94
10	Lower Side: 1/0 Upper Side: 1/49	3555.0	-47.29	-45.99	-26.20	-24.31	-24.36	-25.48	-46.38	-
		3625.0	-	-45.64	-27.27	-24.07	-24.85	-26.53	-45.53	-
		3695.0	-	-44.77	-25.44	-23.90	-23.43	-25.94	-44.65	-44.98
15	Lower Side: 1/0 Upper Side: 1/74	3557.5	-47.11	-44.72	-26.52	-22.26	-21.96	-26.06	-46.00	-
		3625.0	-	-46.09	-28.88	-23.06	-23.88	-27.87	-45.56	-
		3692.5	-	-45.73	-28.29	-22.37	-22.69	-27.70	-43.44	-44.33
20	Lower Side: 1/0 Upper Side: 1/99	3560.0	-47.19	-45.30	-29.78	-29.63	-29.07	-29.28	-46.41	-
		3625.0	-	-47.25	-30.47	-30.16	-29.93	-30.11	-45.57	-
		3690.0	-	-45.98	-30.41	-28.45	-28.88	-28.88	-42.66	-44.63
Limit (dBm)			-40.00	-25.00	-13.00	-13.00	-13.00	-13.00	-25.00	-40.00

Note:

1. C.E = Channel Edge
2. Plots of the EUT's Channel Edge are shown Page 91 ~ 134

8.7 Adjacent Channel Leakage Ratio(ACLR)

Band Width	RB (Size/ Offset)	Frequency (MHz)	Adjacent Channel Leakage Ratio(dB)	
			Lower Side	Upper Side
5 MHz	25/0	3552.5	38.19	37.81
		3625.0	37.43	37.91
		3697.5	37.32	38.00
10 MHz	50/0	3555.0	38.78	38.17
		3625.0	38.33	38.25
		3695.0	38.45	38.64
15 MHz	75/0	3557.5	38.20	38.15
		3625.0	37.66	38.19
		3692.5	37.96	38.40
20 MHz	100/0	3560.0	37.62	38.21
		3625.0	37.37	38.19
		3690.0	37.64	38.25
Limit (dB)			ACLR > 30dB	ACLR > 30dB

Note:

1. Plots of the EUT's Adjacent Channel Leakage Ratio(ACLR) are shown Page 79 ~ 90.

8.8 FREQUENCY STABILITY / VARIATION OF AMBIENT TEMPERATURE

- ▣ OPERATING FREQUENCY: 3,552,500,000
- ▣ BANDWIDTH: 5 MHz
- ▣ REFERENCE VOLTAGE: 3.850 VDC
- ▣ DEVIATION LIMIT: Emission must remain in band

Voltage (%)	Power (VDC)	Temp. (°C)	Frequency (Hz)	Frequency Error (Hz)	Deviation (%)	ppm
100%	3.850	+20(Ref)	3552 499 995	0.0	0.000 000	0.000
100%		-30	3552 499 992	-3.0	0.000 000	-0.001
100%		-20	3552 499 988	-7.2	0.000 000	-0.002
100%		-10	3552 499 989	-6.6	0.000 000	-0.002
100%		0	3552 500 001	5.7	0.000 000	0.002
100%		+10	3552 499 988	-6.9	0.000 000	-0.002
100%		+30	3552 499 991	-4.6	0.000 000	-0.001
100%		+40	3552 499 988	-7.4	0.000 000	-0.002
100%		+50	3552 499 989	-6.6	0.000 000	-0.002
Batt. Endpoint	3.600	+20	3552 499 990	-5.6	0.000 000	-0.002

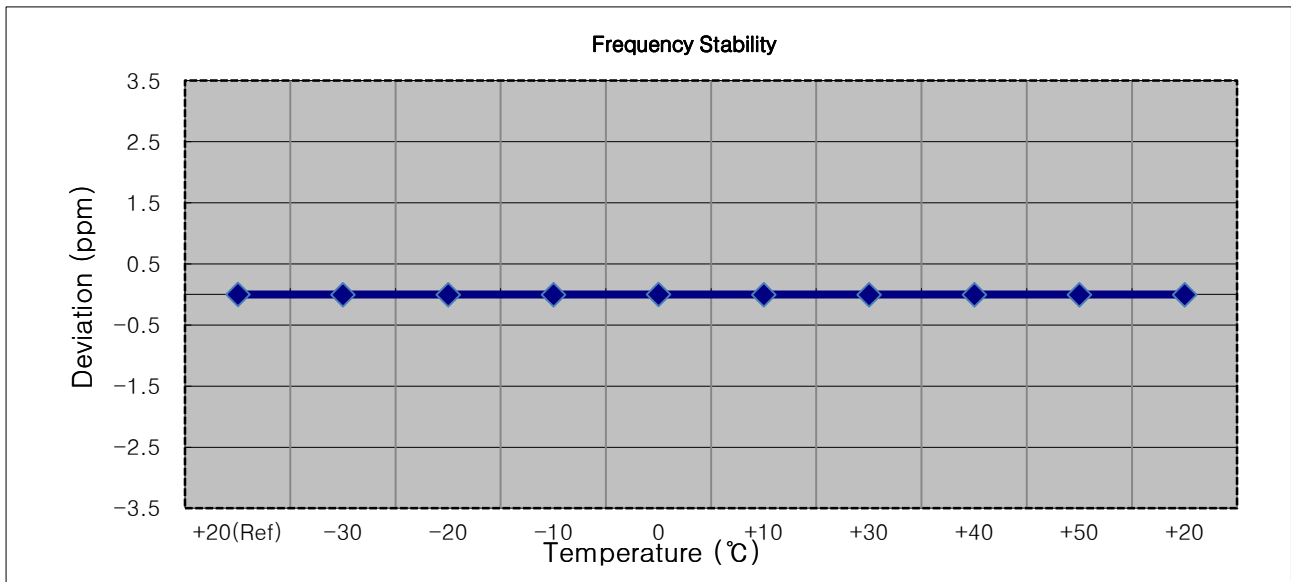

- OPERATING FREQUENCY: 3,555,000,000
- BANDWIDTH: 10 MHz
- REFERENCE VOLTAGE: 3.850 VDC
- DEVIATION LIMIT: Emission must remain in band

Voltage (%)	Power (VDC)	Temp. (°C)	Frequency (Hz)	Frequency Error (Hz)	Deviation (%)	ppm
100%	3.850	+20(Ref)	3554 999 995	0.0	0.000 000	0.000
100%		-30	3554 999 986	-8.6	0.000 000	-0.002
100%		-20	3554 999 987	-7.8	0.000 000	-0.002
100%		-10	3554 999 987	-7.8	0.000 000	-0.002
100%		0	3554 999 986	-8.6	0.000 000	-0.002
100%		+10	3554 999 986	-9.3	0.000 000	-0.003
100%		+30	3554 999 989	-5.9	0.000 000	-0.002
100%		+40	3554 999 989	-6.0	0.000 000	-0.002
100%		+50	3554 999 987	-7.5	0.000 000	-0.002
Batt. Endpoint	3.600	+20	3554 999 991	-4.2	0.000 000	-0.001

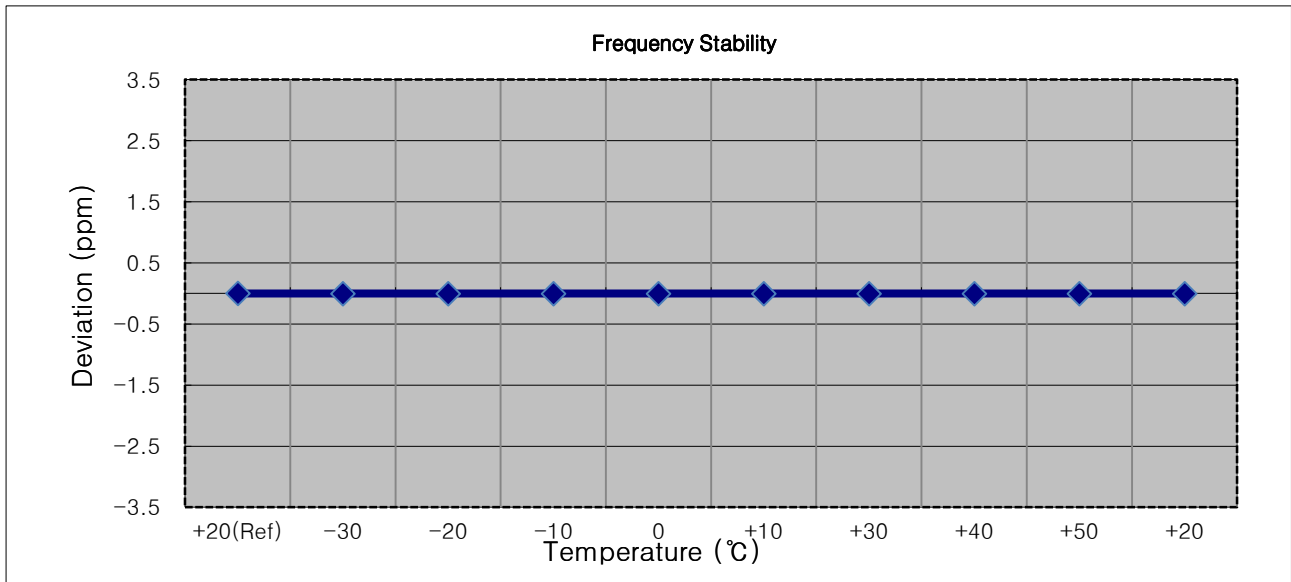

- ▣ OPERATING FREQUENCY: 3,557,500,000
- ▣ BANDWIDTH: 15 MHz
- ▣ REFERENCE VOLTAGE: 3.850 VDC
- ▣ DEVIATION LIMIT: Emission must remain in band

Voltage (%)	Power (VDC)	Temp. (°C)	Frequency (Hz)	Frequency Error (Hz)	Deviation (%)	ppm
100%	3.850	+20(Ref)	3557 499 992	0.0	0.000 000	0.000
100%		-30	3557 499 988	-3.1	0.000 000	-0.001
100%		-20	3557 499 988	-3.6	0.000 000	-0.001
100%		-10	3557 499 986	-5.3	0.000 000	-0.001
100%		0	3557 499 983	-8.1	0.000 000	-0.002
100%		+10	3557 499 985	-6.4	0.000 000	-0.002
100%		+30	3557 499 986	-5.5	0.000 000	-0.002
100%		+40	3557 499 987	-4.9	0.000 000	-0.001
100%		+50	3557 499 983	-8.3	0.000 000	-0.002
Batt. Endpoint		3.600	+20	3557 499 984	-7.3	0.000 000

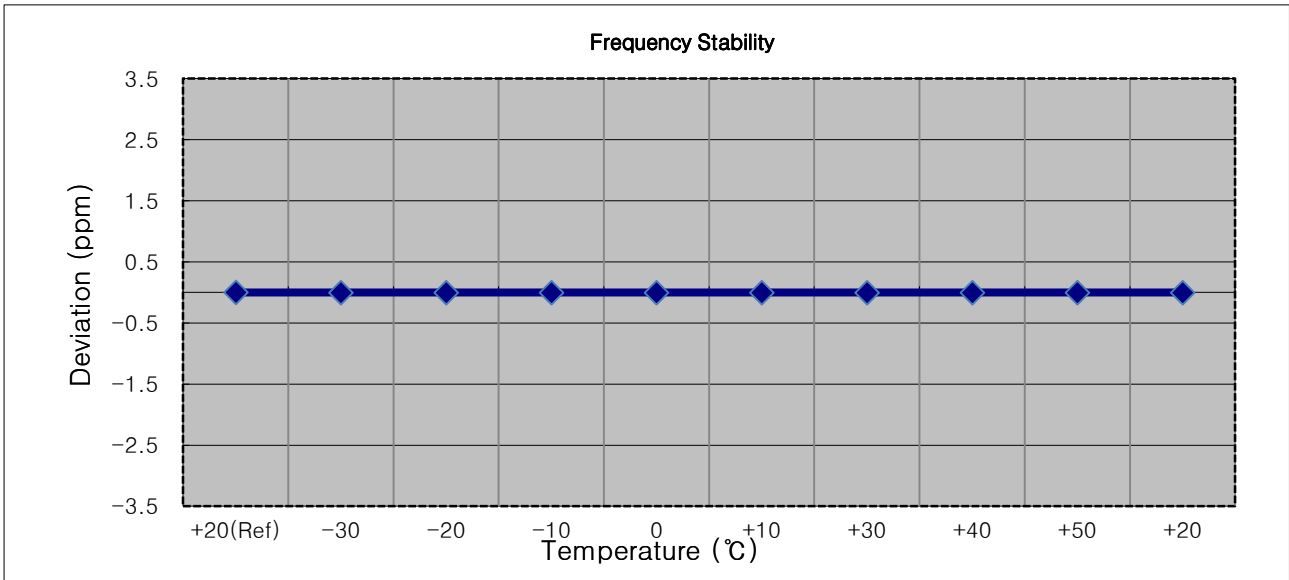

- OPERATING FREQUENCY: 3,560,000,000
- BANDWIDTH: 20 MHz
- REFERENCE VOLTAGE: 3.850 VDC
- DEVIATION LIMIT: Emission must remain in band

Voltage (%)	Power (VDC)	Temp. (°C)	Frequency (Hz)	Frequency Error (Hz)	Deviation (%)	ppm
100%	3.850	+20(Ref)	3559 999 992	0.0	0.000 000	0.000
100%		-30	3559 999 987	-5.0	0.000 000	-0.001
100%		-20	3559 999 986	-6.4	0.000 000	-0.002
100%		-10	3559 999 985	-7.2	0.000 000	-0.002
100%		0	3559 999 987	-5.5	0.000 000	-0.002
100%		+10	3559 999 987	-5.3	0.000 000	-0.001
100%		+30	3559 999 988	-4.5	0.000 000	-0.001
100%		+40	3559 999 986	-6.0	0.000 000	-0.002
100%		+50	3559 999 986	-6.1	0.000 000	-0.002
Batt. Endpoint		3.600	+20	3559 999 987	-5.4	0.000 000

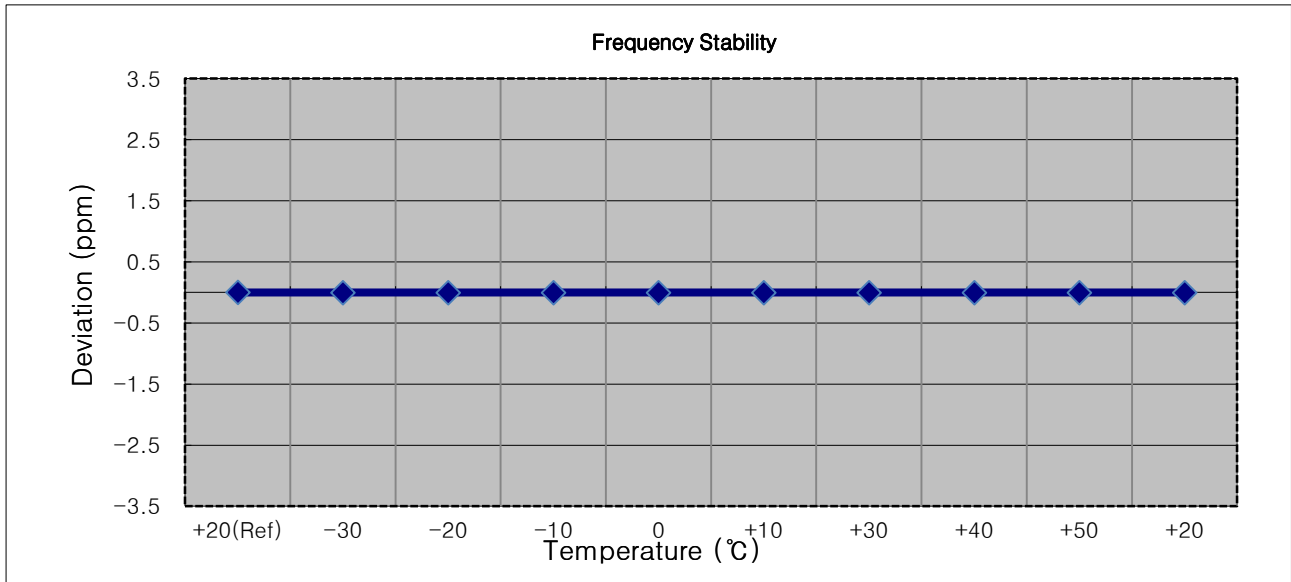

- ▣ OPERATING FREQUENCY: 3,625,000,000
- ▣ BANDWIDTH: 5 MHz
- ▣ REFERENCE VOLTAGE: 3.850 VDC
- ▣ DEVIATION LIMIT: Emission must remain in band

Voltage (%)	Power (VDC)	Temp. (°C)	Frequency (Hz)	Frequency Error (Hz)	Deviation (%)	ppm
100%	3.850	+20(Ref)	3624 999 993	0.0	0.000 000	0.000
100%		-30	3624 999 988	-4.7	0.000 000	-0.001
100%		-20	3624 999 987	-6.3	0.000 000	-0.002
100%		-10	3624 999 985	-7.8	0.000 000	-0.002
100%		0	3624 999 984	-9.0	0.000 000	-0.002
100%		+10	3624 999 987	-5.4	0.000 000	-0.001
100%		+30	3624 999 986	-7.0	0.000 000	-0.002
100%		+40	3624 999 987	-6.0	0.000 000	-0.002
100%		+50	3624 999 984	-8.4	0.000 000	-0.002
Batt. Endpoint		3.600	+20	3624 999 983	-9.7	0.000 000

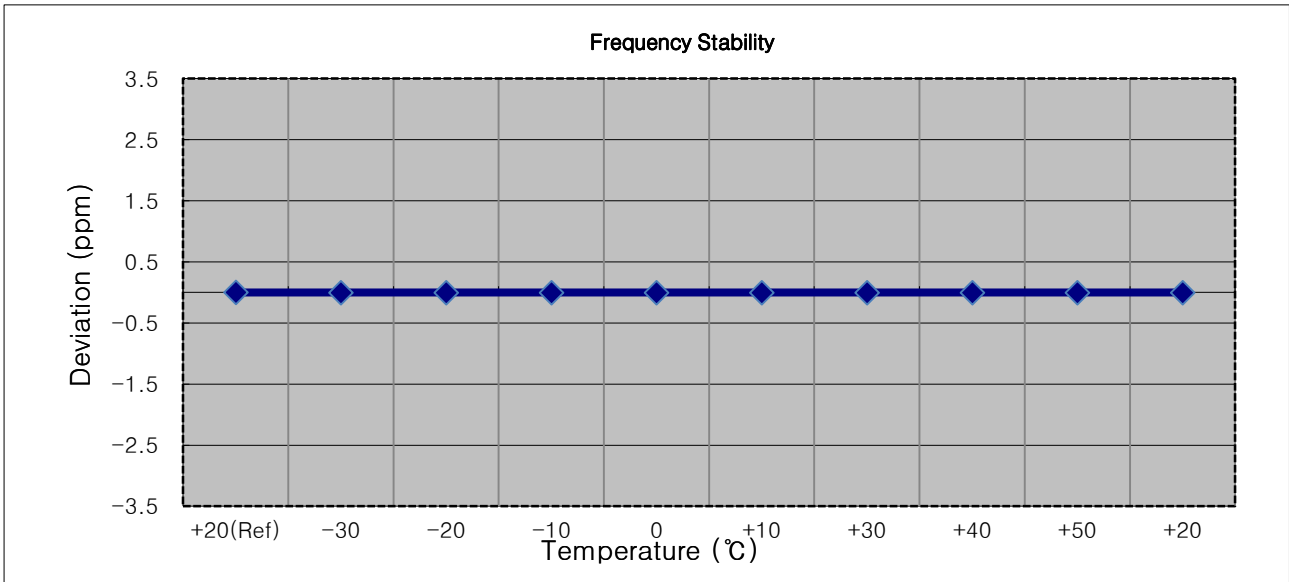

- OPERATING FREQUENCY: 3,625,000,000
- BANDWIDTH: 10 MHz
- REFERENCE VOLTAGE: 3.850 VDC
- DEVIATION LIMIT: Emission must remain in band

Voltage (%)	Power (VDC)	Temp. (°C)	Frequency (Hz)	Frequency Error (Hz)	Deviation (%)	ppm
100%	3.850	+20(Ref)	3624 999 992	0.0	0.000 000	0.000
100%		-30	3624 999 986	-6.0	0.000 000	-0.002
100%		-20	3624 999 988	-3.9	0.000 000	-0.001
100%		-10	3624 999 985	-7.2	0.000 000	-0.002
100%		0	3624 999 985	-6.6	0.000 000	-0.002
100%		+10	3624 999 984	-7.6	0.000 000	-0.002
100%		+30	3624 999 984	-8.2	0.000 000	-0.002
100%		+40	3624 999 987	-5.5	0.000 000	-0.002
100%		+50	3624 999 985	-7.2	0.000 000	-0.002
Batt. Endpoint	3.600	+20	3624 999 983	-9.4	0.000 000	-0.003

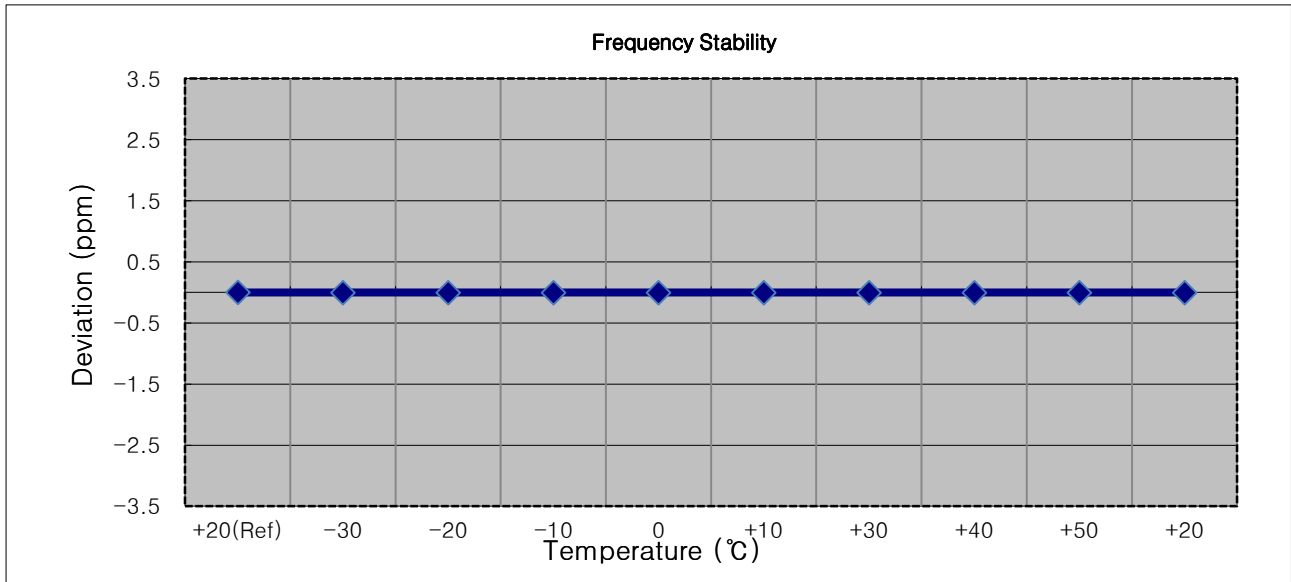

- ▣ OPERATING FREQUENCY: 3,625,000,000
- ▣ BANDWIDTH: 15 MHz
- ▣ REFERENCE VOLTAGE: 3.850 VDC
- ▣ DEVIATION LIMIT: Emission must remain in band

Voltage (%)	Power (VDC)	Temp. (°C)	Frequency (Hz)	Frequency Error (Hz)	Deviation (%)	ppm
100%	3.850	+20(Ref)	3624 999 994	0.0	0.000 000	0.000
100%		-30	3625 000 001	6.8	0.000 000	0.002
100%		-20	3624 999 987	-7.0	0.000 000	-0.002
100%		-10	3624 999 991	-2.9	0.000 000	-0.001
100%		0	3624 999 987	-7.7	0.000 000	-0.002
100%		+10	3624 999 989	-4.9	0.000 000	-0.001
100%		+30	3624 999 987	-7.6	0.000 000	-0.002
100%		+40	3624 999 989	-5.3	0.000 000	-0.001
100%		+50	3624 999 989	-5.2	0.000 000	-0.001
Batt. Endpoint		3.600	+20	3624 999 988	-6.3	0.000 000

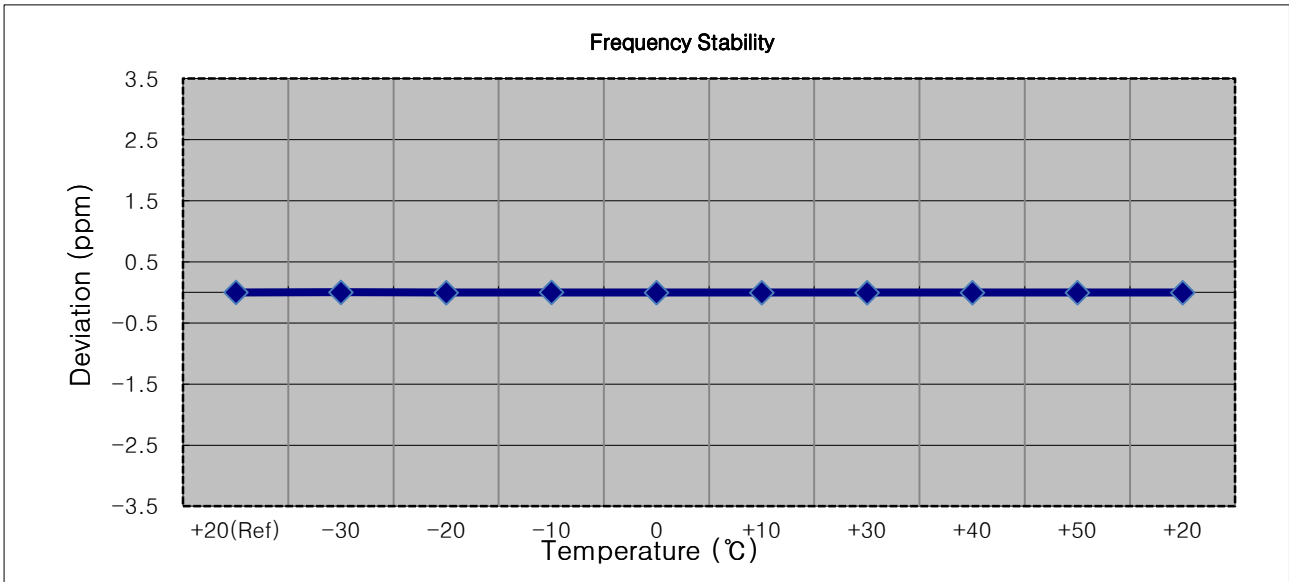

- OPERATING FREQUENCY: 3,625,000,000
- BANDWIDTH: 20 MHz
- REFERENCE VOLTAGE: 3.850 VDC
- DEVIATION LIMIT: Emission must remain in band

Voltage (%)	Power (VDC)	Temp. (°C)	Frequency (Hz)	Frequency Error (Hz)	Deviation (%)	ppm
100%	3.850	+20(Ref)	3624 999 996	0.0	0.000 000	0.000
100%		-30	3624 999 989	-6.7	0.000 000	-0.002
100%		-20	3624 999 990	-5.7	0.000 000	-0.002
100%		-10	3624 999 989	-6.4	0.000 000	-0.002
100%		0	3624 999 989	-6.1	0.000 000	-0.002
100%		+10	3624 999 989	-6.8	0.000 000	-0.002
100%		+30	3624 999 989	-6.5	0.000 000	-0.002
100%		+40	3624 999 987	-8.5	0.000 000	-0.002
100%		+50	3624 999 991	-4.5	0.000 000	-0.001
Batt. Endpoint	3.600	+20	3624 999 990	-6.0	0.000 000	-0.002

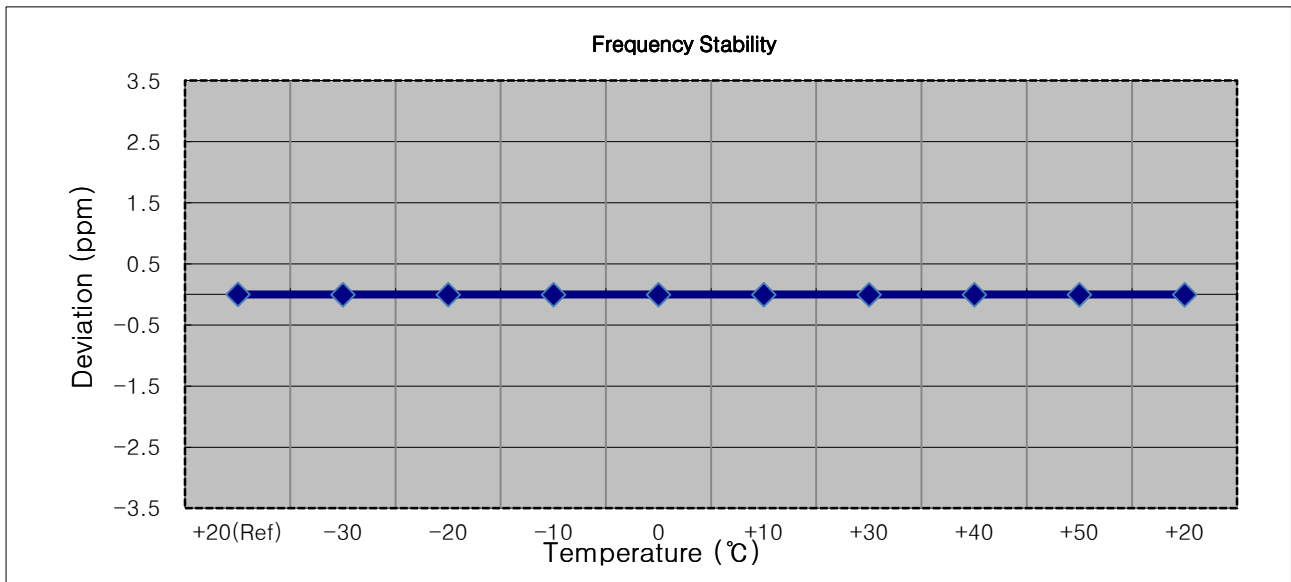

- ▣ OPERATING FREQUENCY: 3,697,500,000
- ▣ BANDWIDTH: 5 MHz
- ▣ REFERENCE VOLTAGE: 3.850 VDC
- ▣ DEVIATION LIMIT: Emission must remain in band

Voltage (%)	Power (VDC)	Temp. (°C)	Frequency (Hz)	Frequency Error (Hz)	Deviation (%)	ppm
100%	3.850	+20(Ref)	3697 499 994	0.0	0.000 000	0.000
100%		-30	3697 499 985	-9.1	0.000 000	-0.002
100%		-20	3697 499 988	-5.2	0.000 000	-0.001
100%		-10	3697 499 986	-7.8	0.000 000	-0.002
100%		0	3697 499 987	-6.2	0.000 000	-0.002
100%		+10	3697 499 984	-9.7	0.000 000	-0.003
100%		+30	3697 499 987	-6.8	0.000 000	-0.002
100%		+40	3697 499 987	-6.3	0.000 000	-0.002
100%		+50	3697 499 985	-8.2	0.000 000	-0.002
Batt. Endpoint		3.600	+20	3697 499 987	-6.4	0.000 000

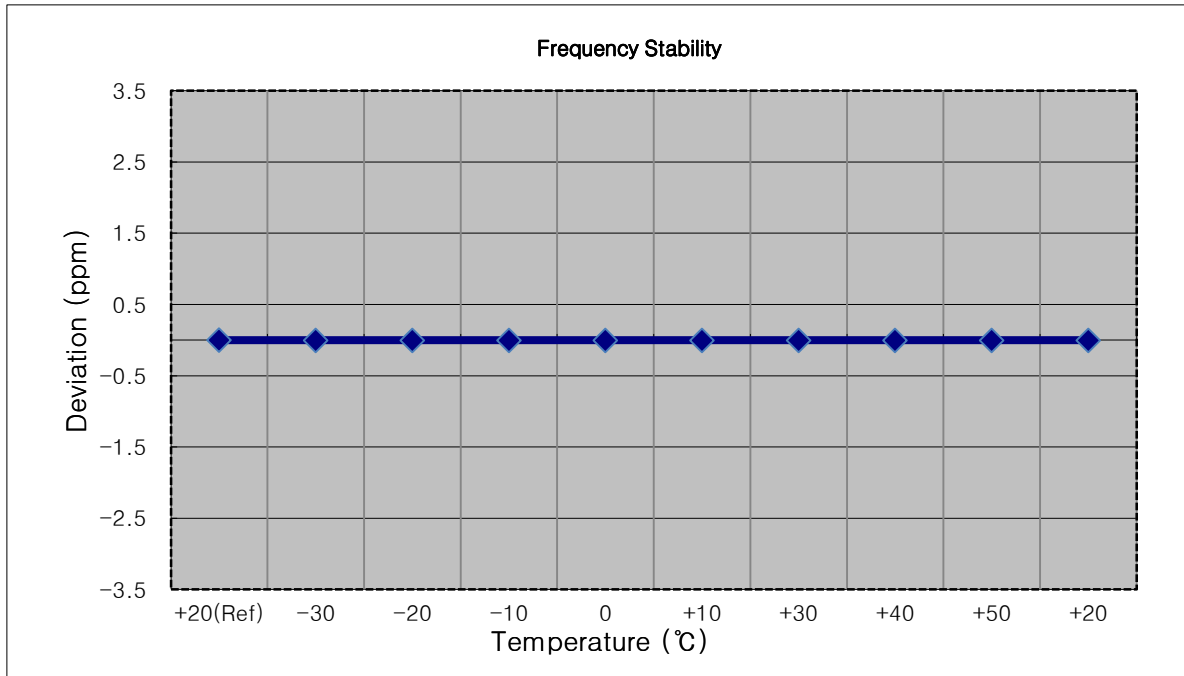

- ▣ OPERATING FREQUENCY: 3,695,000,000
- ▣ BANDWIDTH: 10 MHz
- ▣ REFERENCE VOLTAGE: 3.850 VDC
- ▣ DEVIATION LIMIT: Emission must remain in band

Voltage (%)	Power (VDC)	Temp. (°C)	Frequency (Hz)	Frequency Error (Hz)	Deviation (%)	ppm
100%	3.850	+20(Ref)	3694 999 995	0.0	0.000 000	0.000
100%		-30	3694 999 988	-7.6	0.000 000	-0.002
100%		-20	3694 999 990	-5.7	0.000 000	-0.002
100%		-10	3694 999 986	-9.3	0.000 000	-0.003
100%		0	3694 999 988	-7.5	0.000 000	-0.002
100%		+10	3694 999 986	-8.8	0.000 000	-0.002
100%		+30	3694 999 987	-8.3	0.000 000	-0.002
100%		+40	3694 999 987	-8.2	0.000 000	-0.002
100%		+50	3694 999 987	-8.7	0.000 000	-0.002
Batt. Endpoint	3.600	+20	3694 999 988	-7.0	0.000 000	-0.002

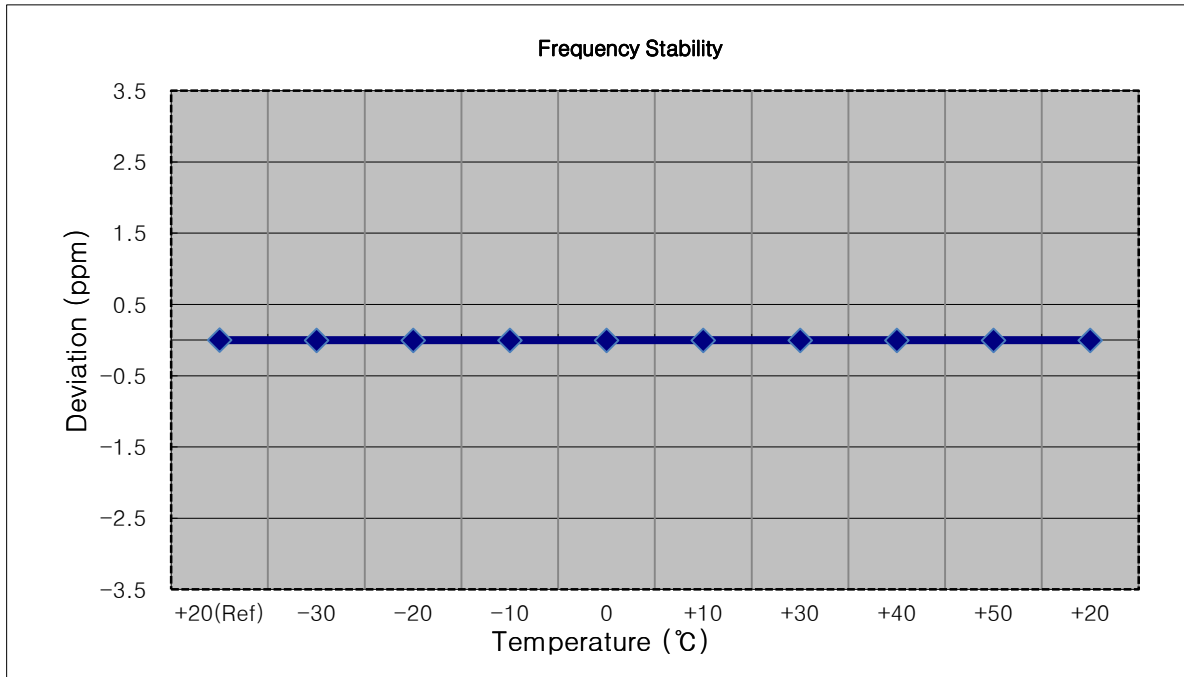

- ▣ OPERATING FREQUENCY: 3,692,500,000
- ▣ BANDWIDTH: 15 MHz
- ▣ REFERENCE VOLTAGE: 3.850 VDC
- ▣ DEVIATION LIMIT: Emission must remain in band

Voltage (%)	Power (VDC)	Temp. (°C)	Frequency (Hz)	Frequency Error (Hz)	Deviation (%)	ppm
100%	3.850	+20(Ref)	3692 499 993	0.0	0.000 000	0.000
100%		-30	3692 499 986	-7.0	0.000 000	-0.002
100%		-20	3692 499 987	-6.8	0.000 000	-0.002
100%		-10	3692 499 990	-3.8	0.000 000	-0.001
100%		0	3692 499 990	-3.2	0.000 000	-0.001
100%		+10	3692 499 986	-7.5	0.000 000	-0.002
100%		+30	3692 499 987	-6.1	0.000 000	-0.002
100%		+40	3692 499 988	-5.1	0.000 000	-0.001
100%		+50	3692 499 987	-6.5	0.000 000	-0.002
Batt. Endpoint		3.600	+20	3692 499 987	-6.6	0.000 000

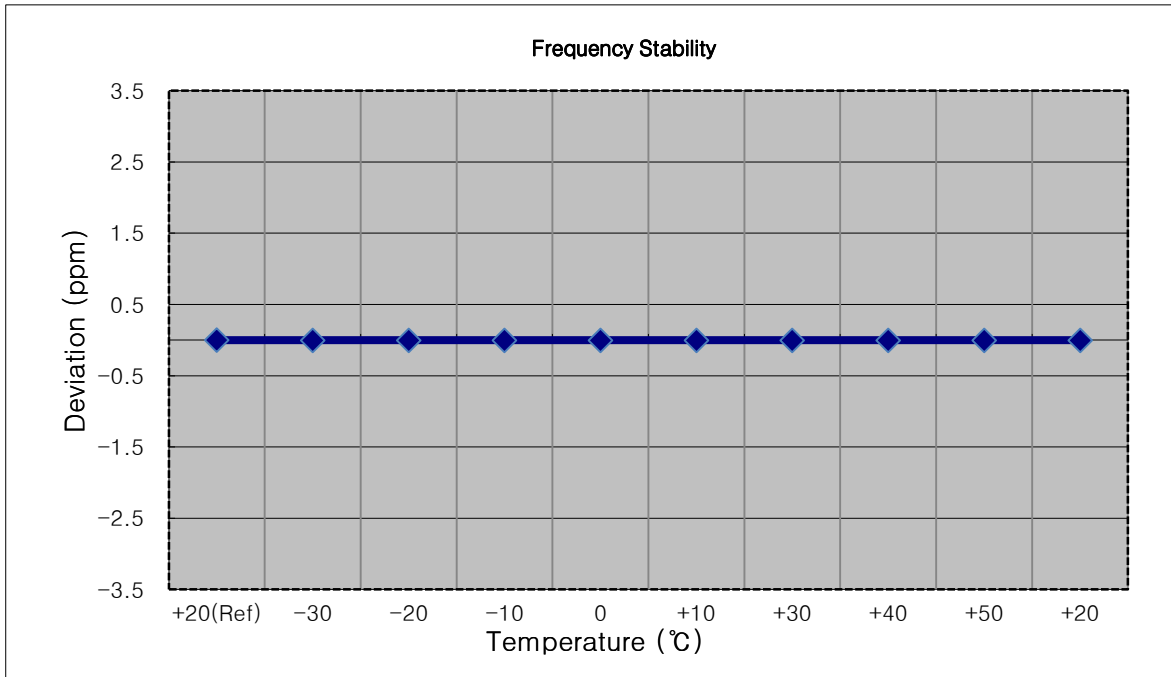

- ▣ OPERATING FREQUENCY: 3,690,000,000
- ▣ BANDWIDTH: 20 MHz
- ▣ REFERENCE VOLTAGE: 3.850 VDC
- ▣ DEVIATION LIMIT: Emission must remain in band

Voltage (%)	Power (VDC)	Temp. (°C)	Frequency (Hz)	Frequency Error (Hz)	Deviation (%)	ppm
100%	3.850	+20(Ref)	3689 999 994	0.0	0.000 000	0.000
100%		-30	3689 999 986	-7.3	0.000 000	-0.002
100%		-20	3689 999 987	-6.2	0.000 000	-0.002
100%		-10	3689 999 984	-9.1	0.000 000	-0.002
100%		0	3689 999 986	-8.0	0.000 000	-0.002
100%		+10	3689 999 988	-5.5	0.000 000	-0.001
100%		+30	3689 999 987	-6.8	0.000 000	-0.002
100%		+40	3689 999 987	-6.1	0.000 000	-0.002
100%		+50	3689 999 989	-4.3	0.000 000	-0.001
Batt. Endpoint		3.600	+20	3689 999 984	-9.8	0.000 000

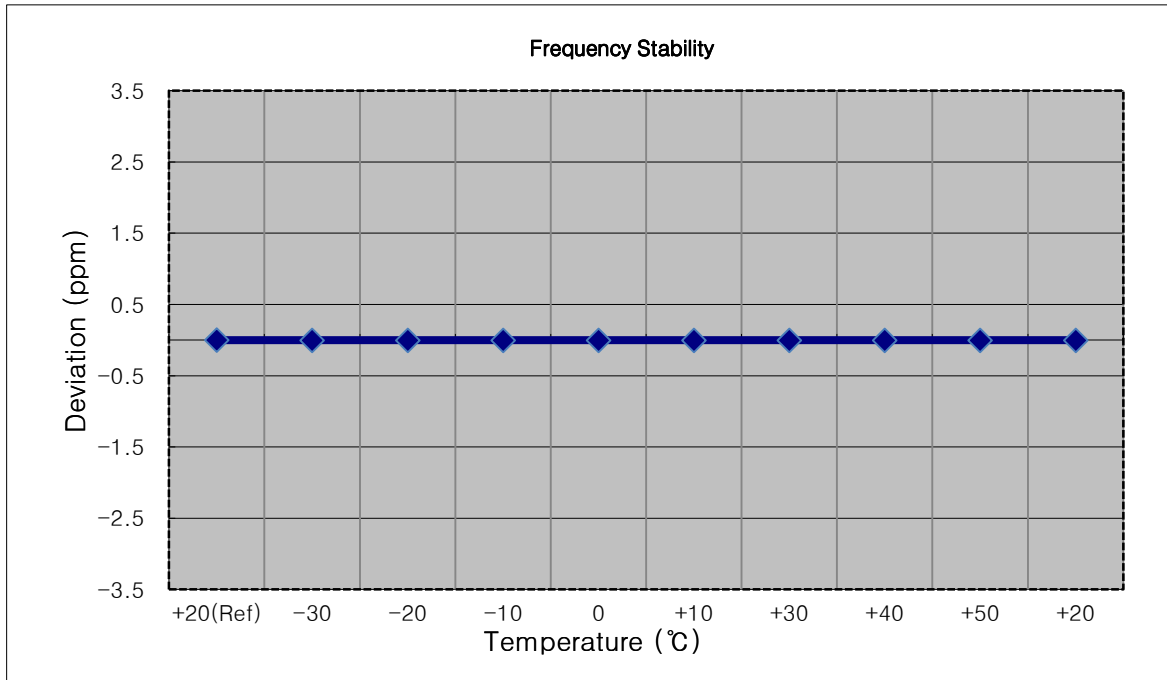

8.9 End User Device Additional Requirements (CBSD Protocol)

Test#1: 3570MHz(BW: 20MHz)

Operation Mode

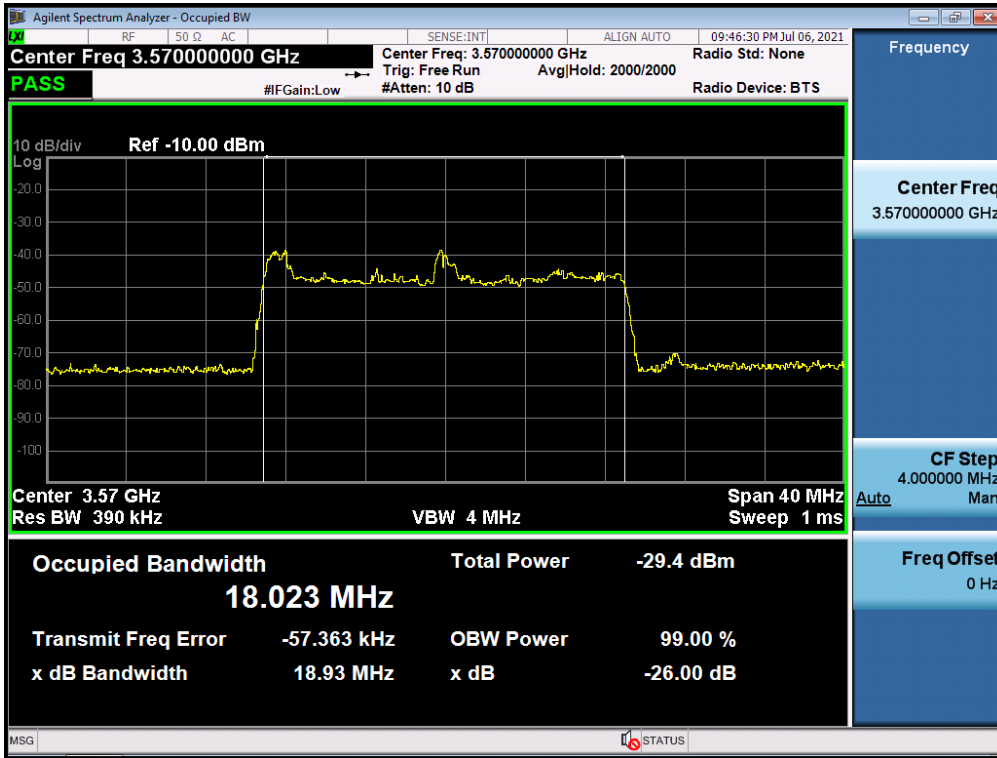

Stop Operation Within 10s

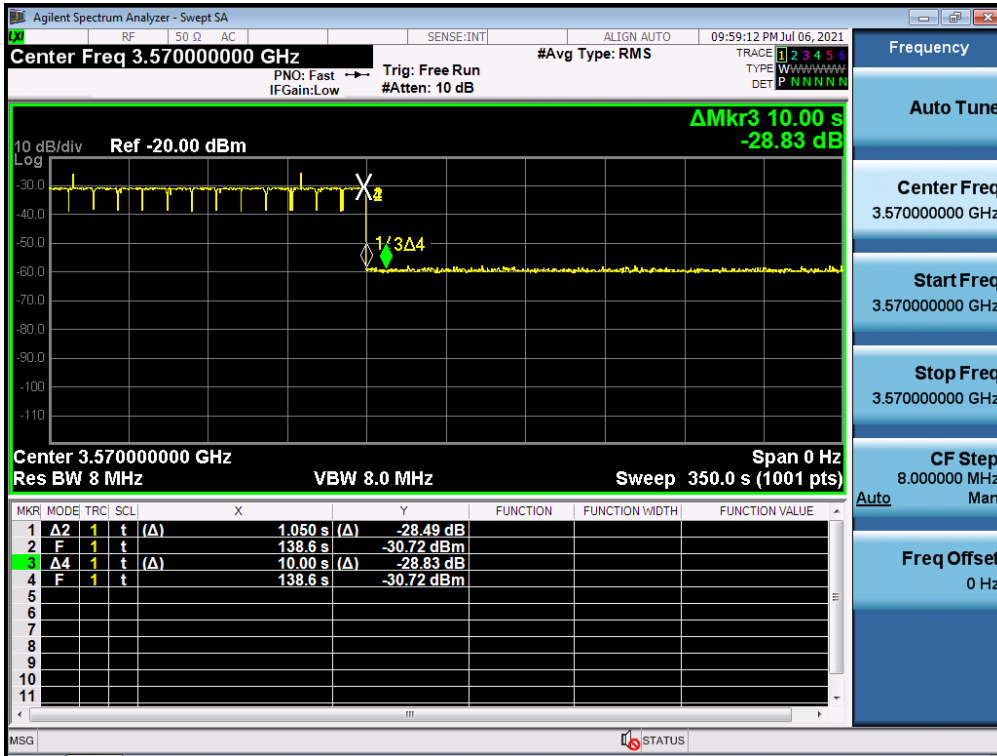

Note:

Marker 2: CBSD sends instructions to discontinue LTE operations.

Marker 1Δ2: EUT discontinues operation. (1.05s)

Marker 3Δ4: 10 seconds elapsed time from CBSD sending instructions to EUT.(10.0s)

Test#2: 3610MHz(BW: 20MHz)

Operation Mode

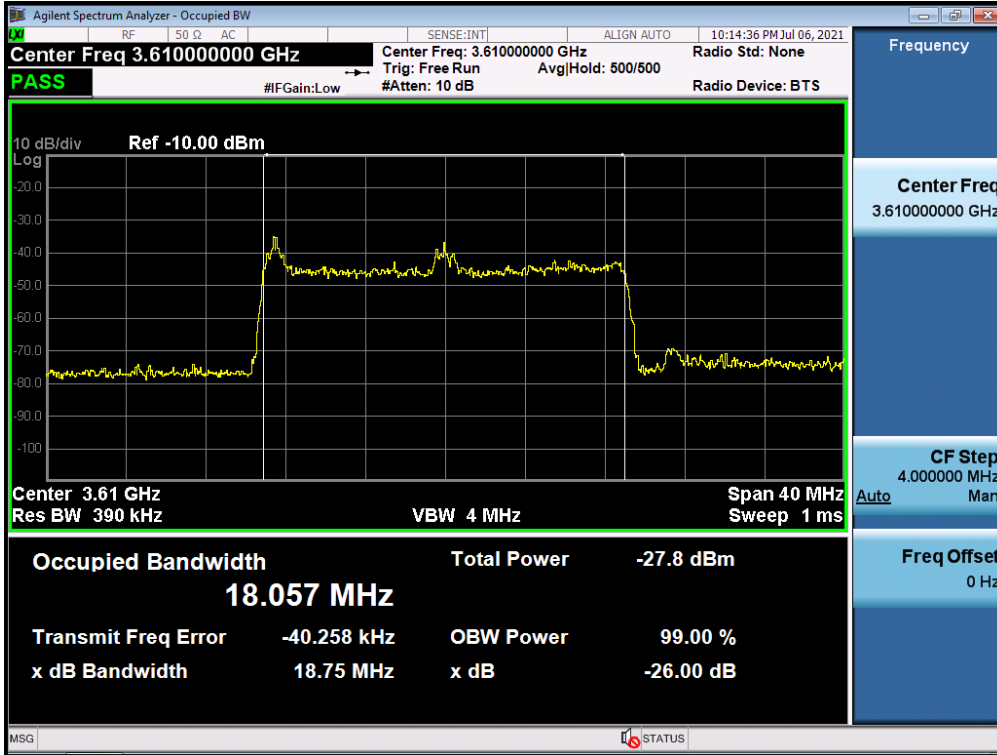

Stop Operation Within 10s

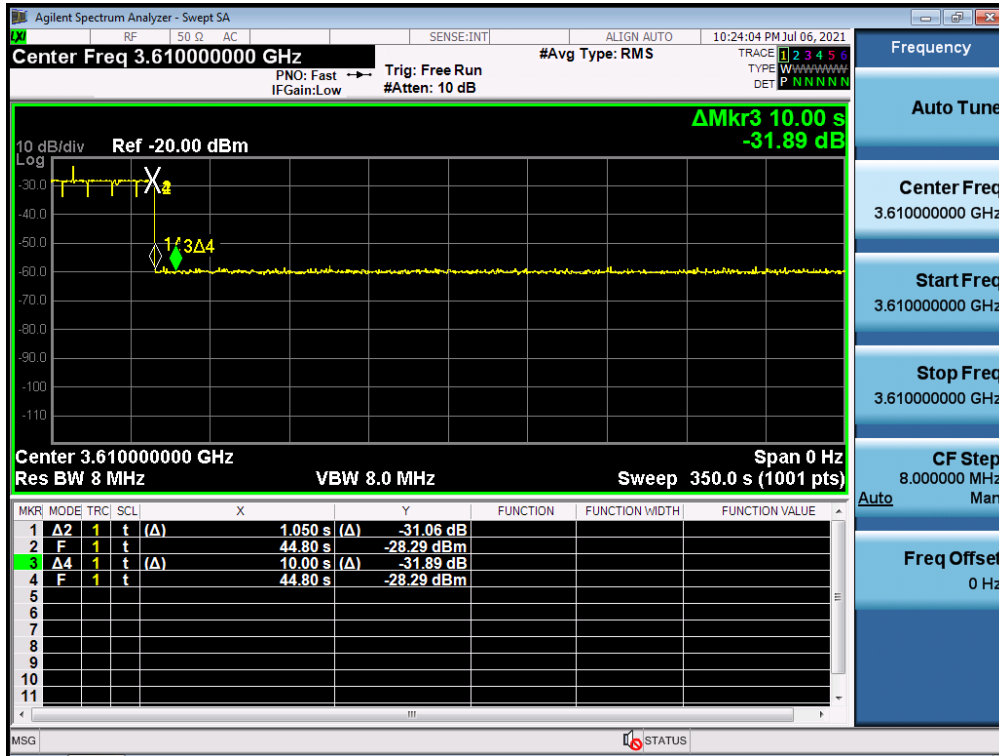

Note:

Marker 2: CBSD sends instructions to discontinue LTE operations.

Marker 1Δ2: EUT discontinues operation. (1.05s)

Marker 3Δ4: 10 seconds elapsed time from CBSD sending instructions to EUT.(10.0s)

9. TEST PLOTS

BAND 48. Occupied Bandwidth Plot (5 MHz Ch.55990 QPSK RB 25)

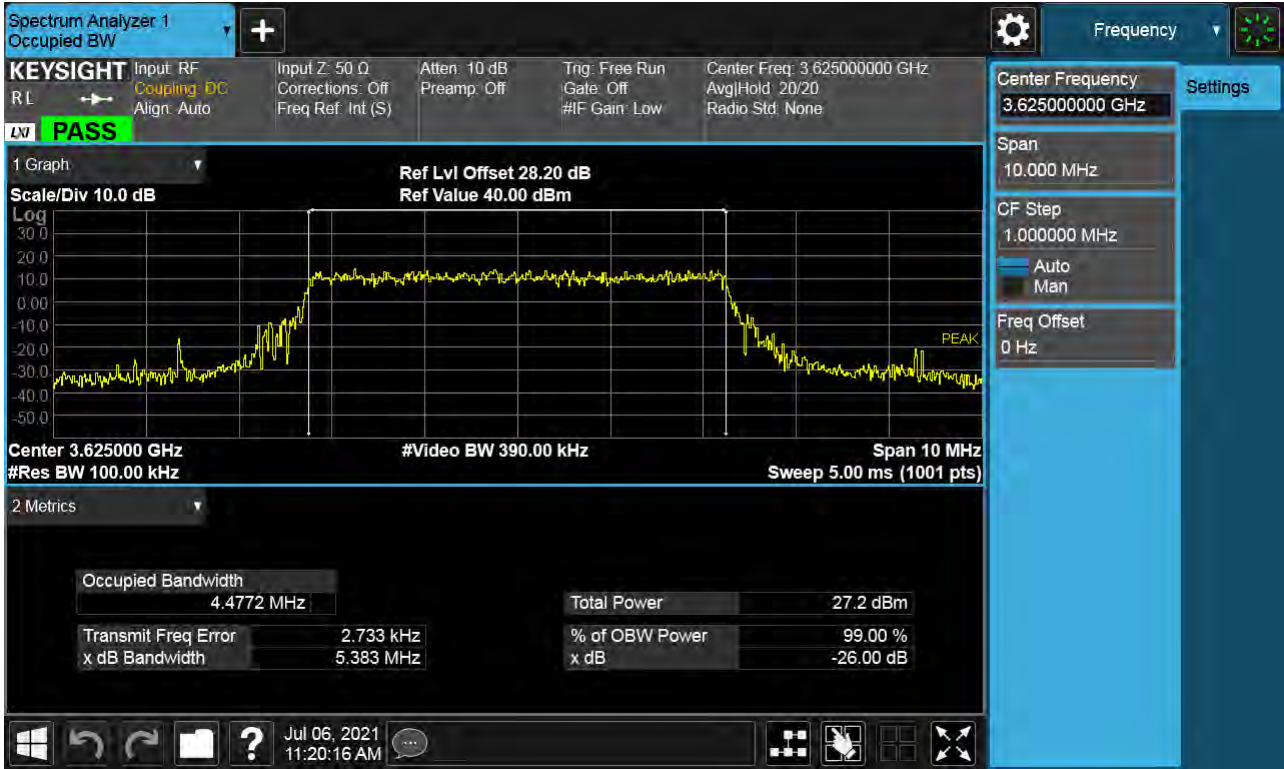

BAND 48. Occupied Bandwidth Plot (5 MHz Ch.55990 16-QAM RB 25)

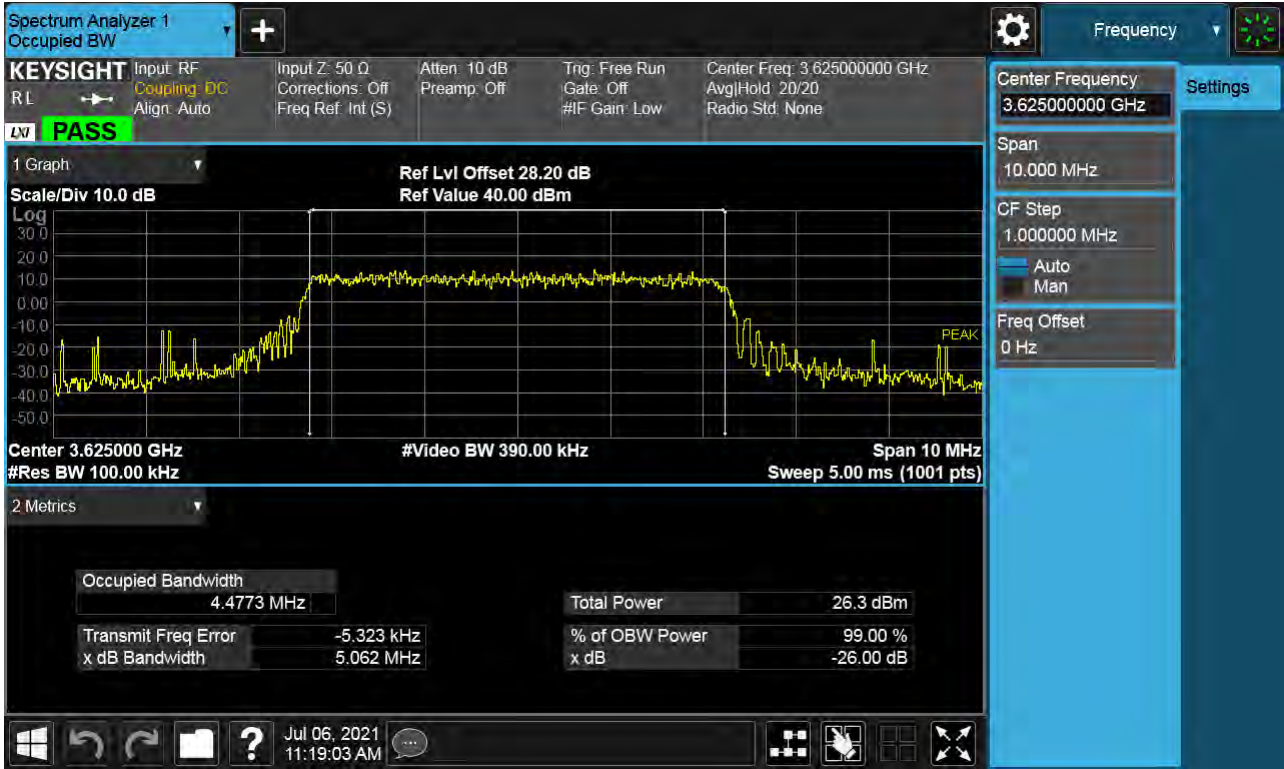

BAND 48. Occupied Bandwidth Plot (5 MHz Ch.55990 64-QAM RB 25)

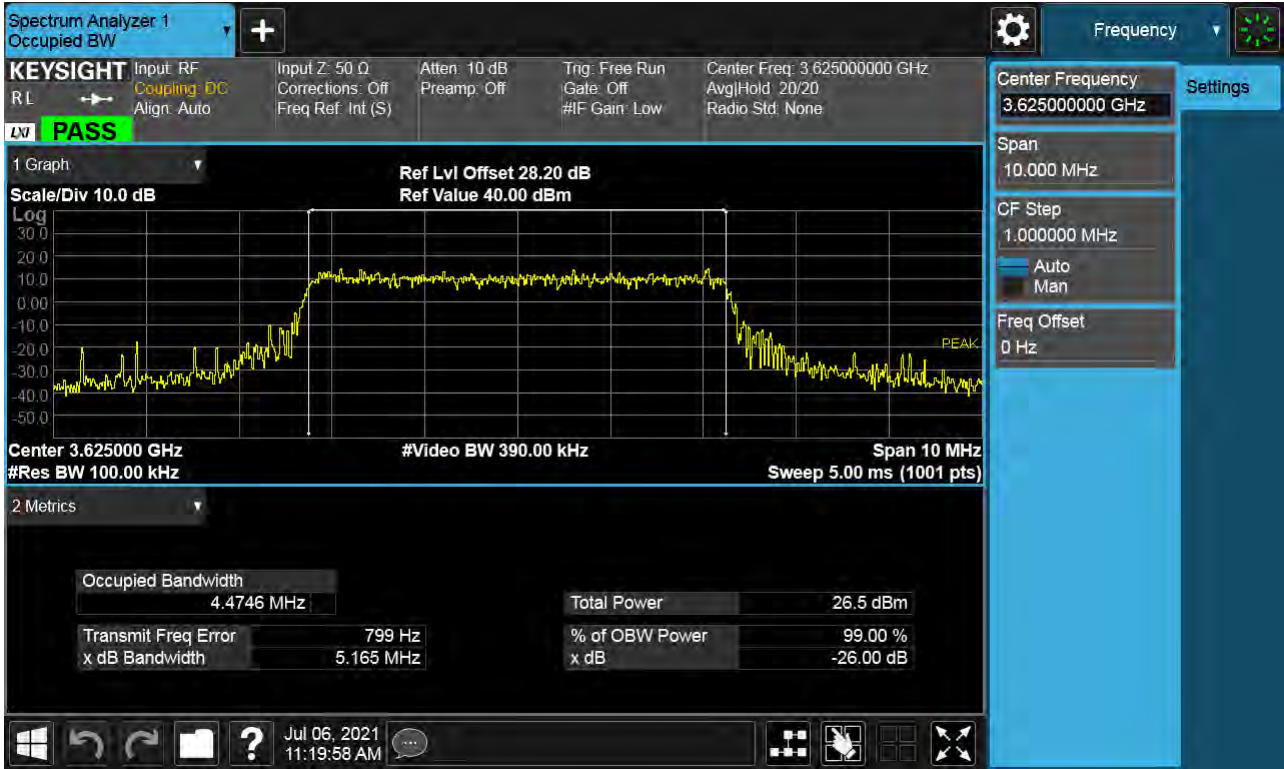

BAND 48. Occupied Bandwidth Plot (10 MHz Ch.55990 QPSK RB 50)

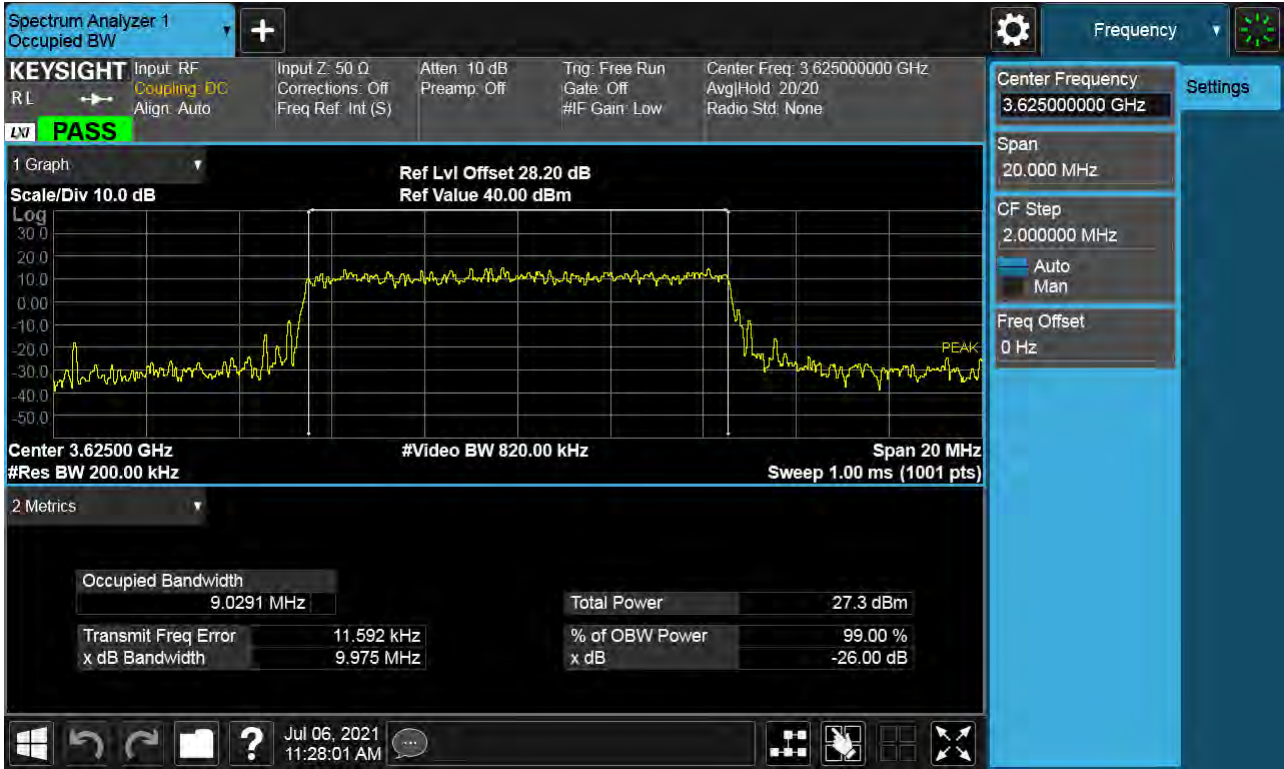

BAND 48. Occupied Bandwidth Plot (10 MHz Ch.55990 16-QAM RB 50)

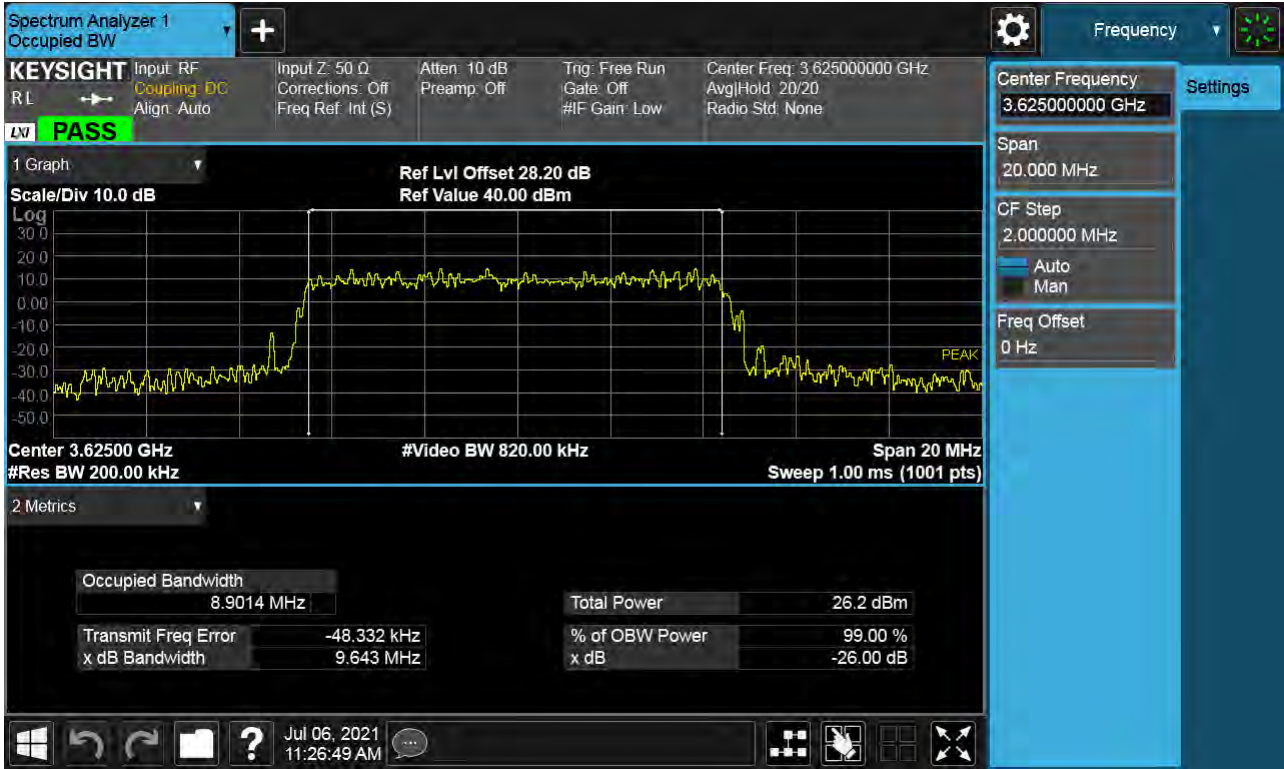

BAND 48. Occupied Bandwidth Plot (10 MHz Ch.55990 64-QAM RB 50)

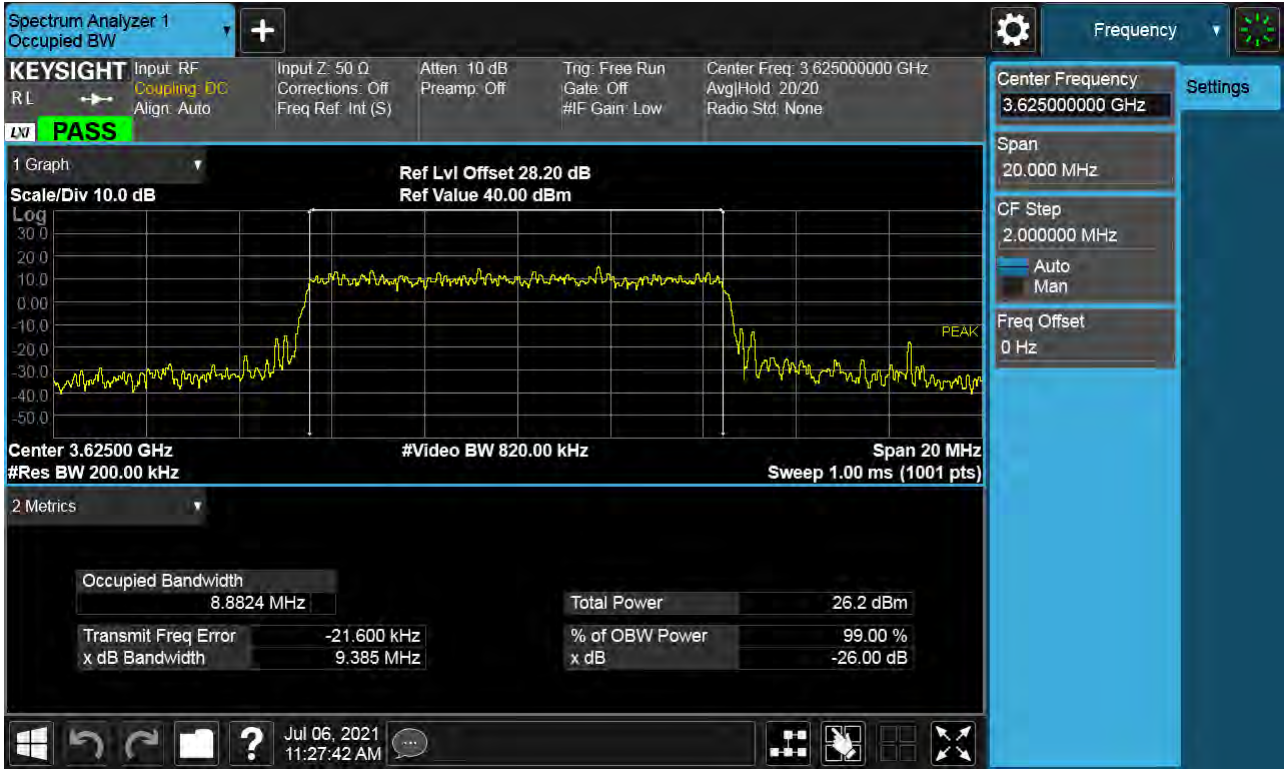

BAND 48. Occupied Bandwidth Plot (15 MHz Ch.55990 QPSK RB 75)

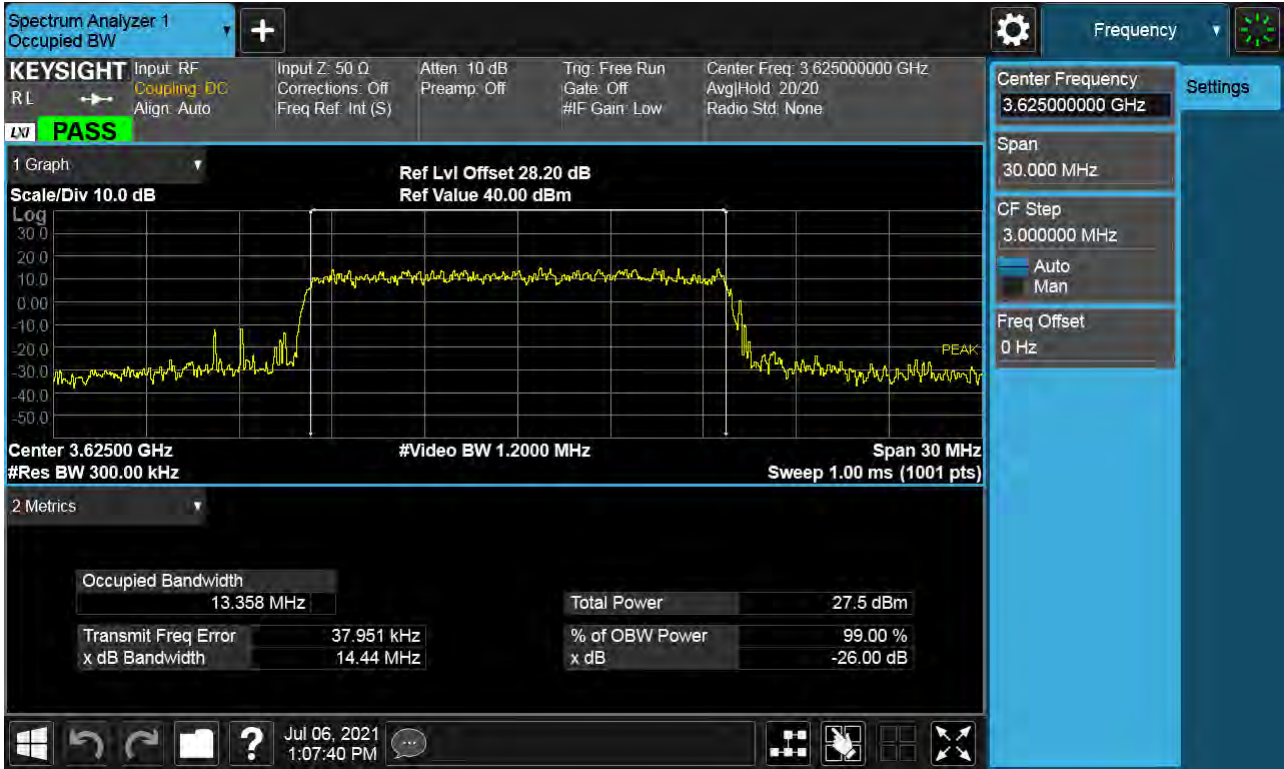

BAND 48. Occupied Bandwidth Plot (15 MHz Ch.55990 16-QAM RB 75)

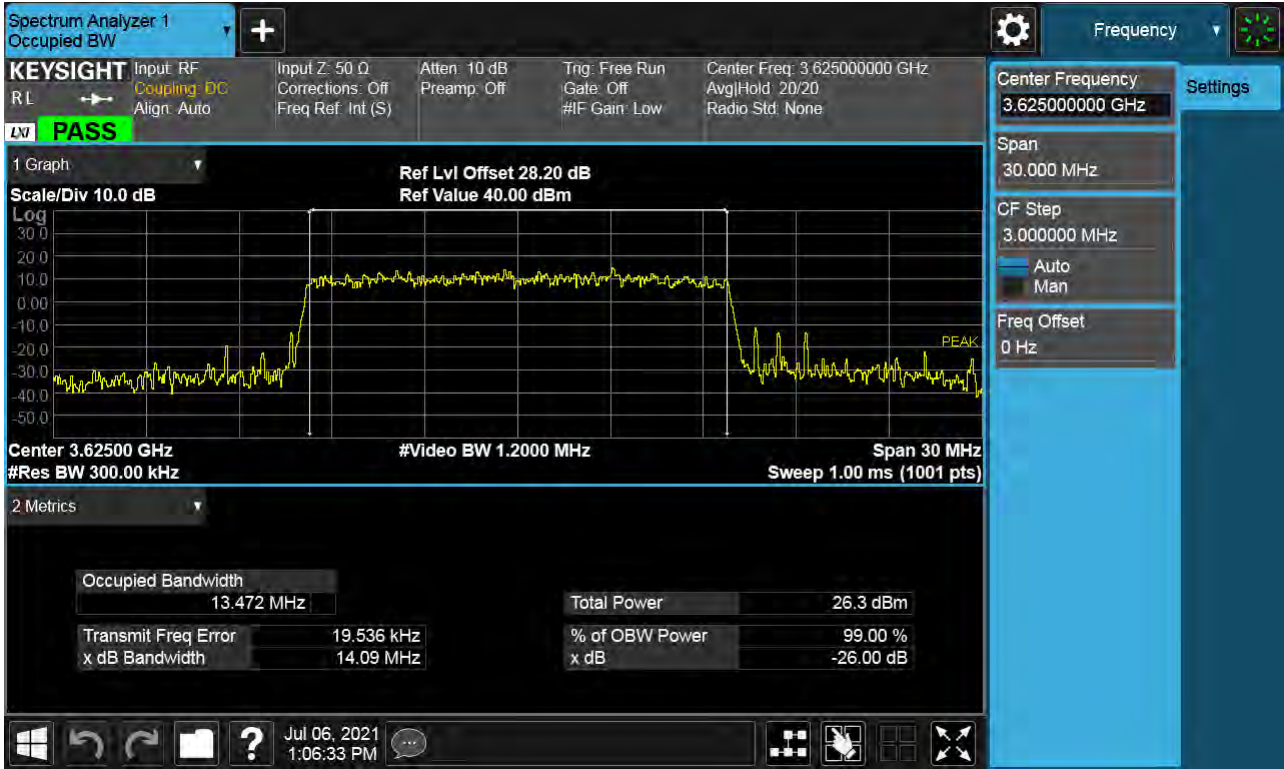

BAND 48. Occupied Bandwidth Plot (15 MHz Ch.55990 64-QAM RB 75)

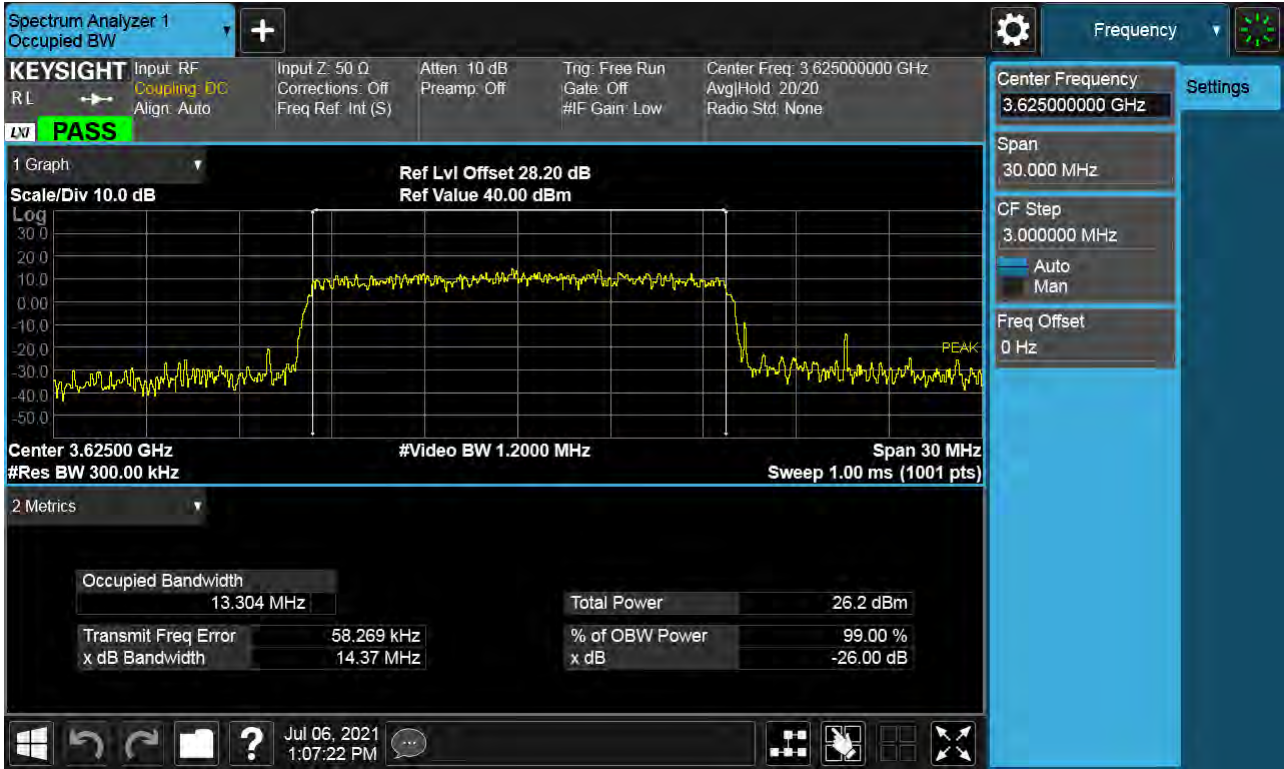

BAND 48. Occupied Bandwidth Plot (20 MHz Ch.5590 QPSK RB 100)

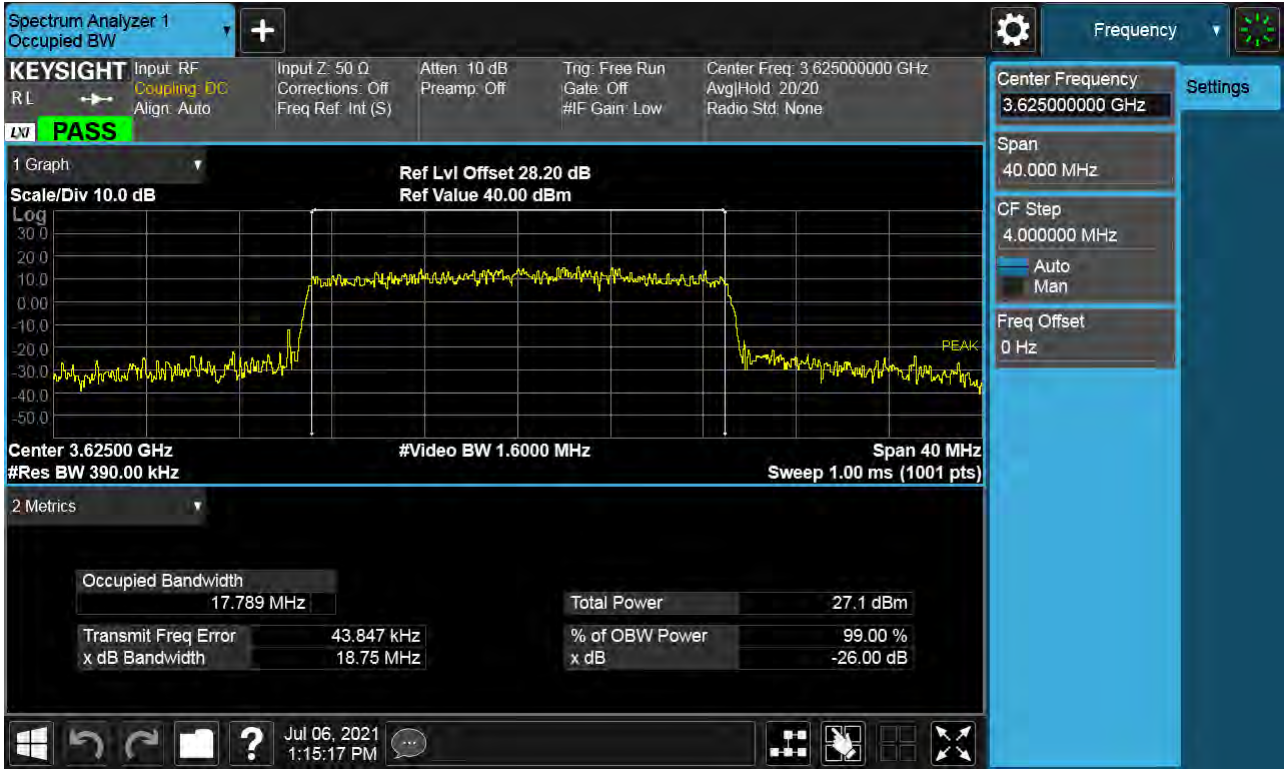

BAND 48. Occupied Bandwidth Plot (20 MHz Ch.55990 16-QAM RB 100)

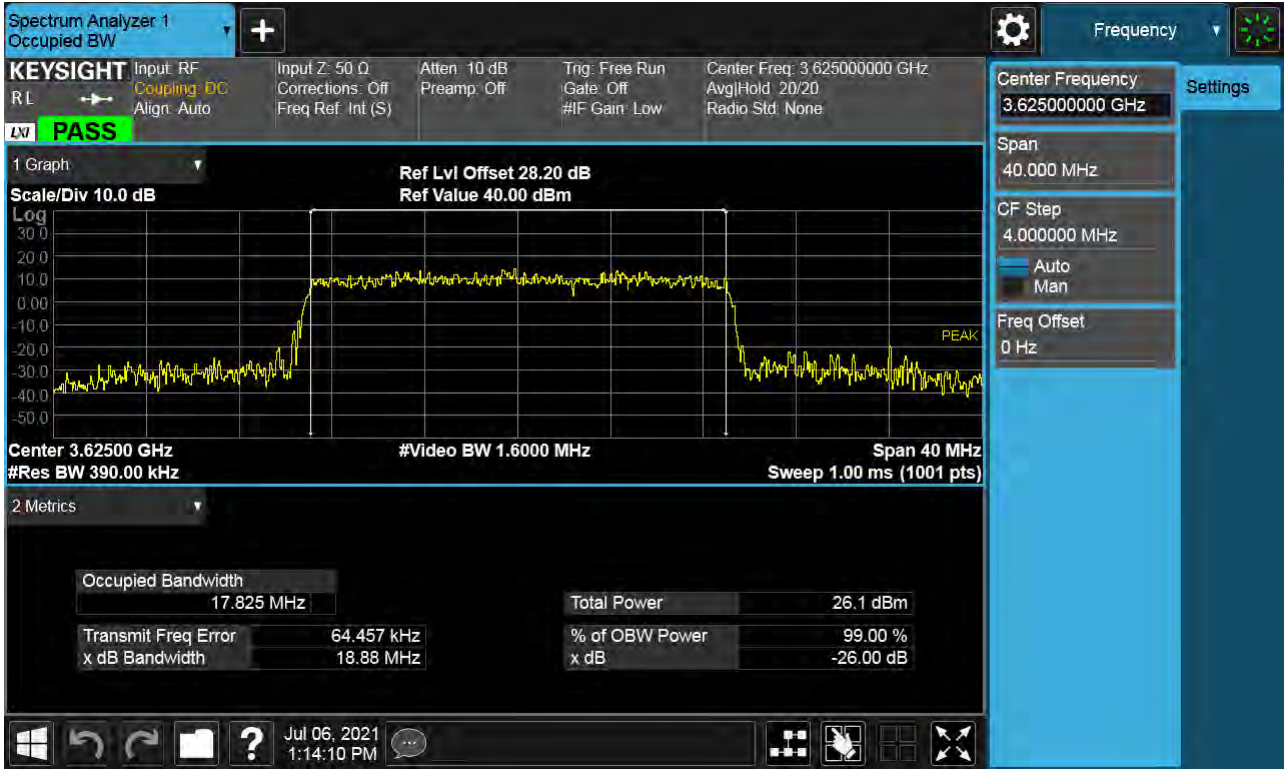

BAND 48. Occupied Bandwidth Plot (20 MHz Ch.55990 64-QAM RB 100)

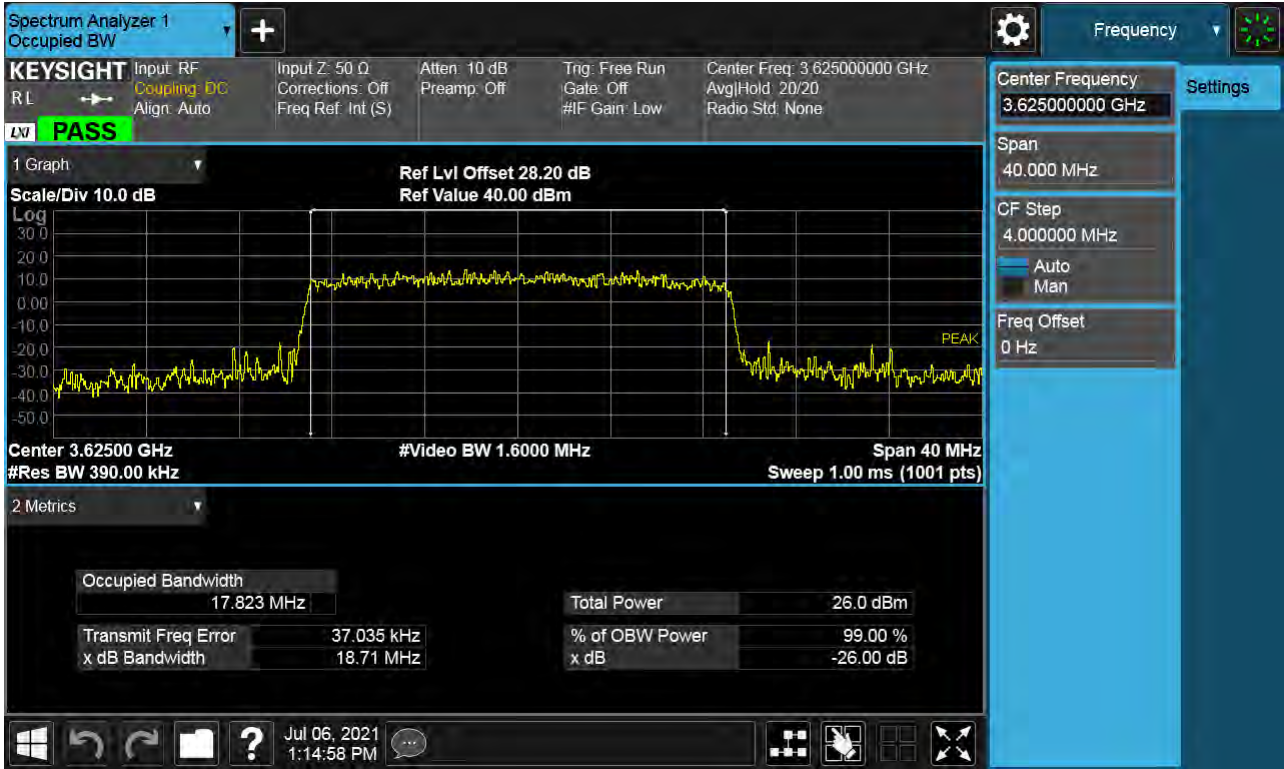

BAND 48. PAR Plot (5M BW_Ch.55990_QPSK_RB25_0)

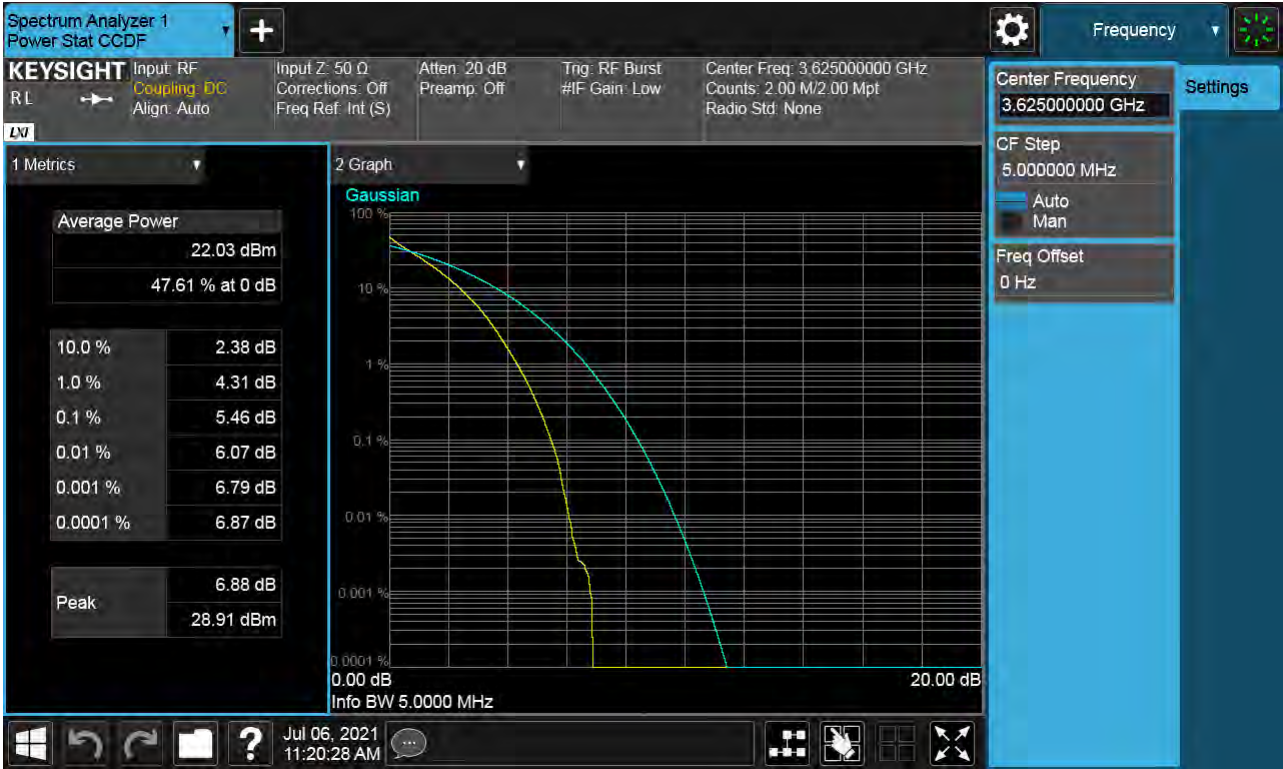

BAND 48. PAR Plot (5M BW_Ch.55990_16QAM_RB25_0)



BAND 48. PAR Plot (5M BW_Ch.55990_64QAM_RB25_0)



BAND 48. PAR Plot (10M BW_Ch.55990_QPSK_RB50_0)

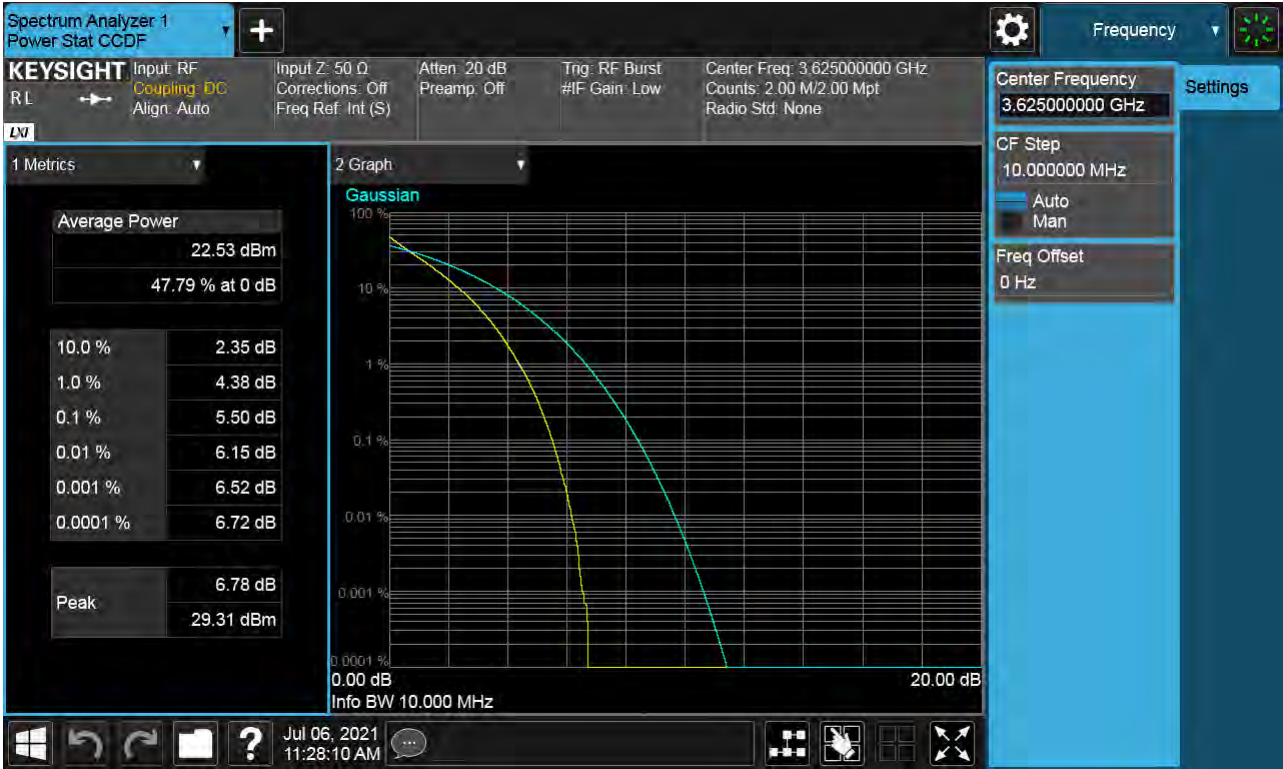

BAND 48. PAR Plot (10M BW_Ch.55990_16QAM_RB50_0)



BAND 48. PAR Plot (10M BW_Ch.55990_64QAM_RB50_0)



BAND 48. PAR Plot (15M BW_Ch.55990_QPSK_RB75_0)

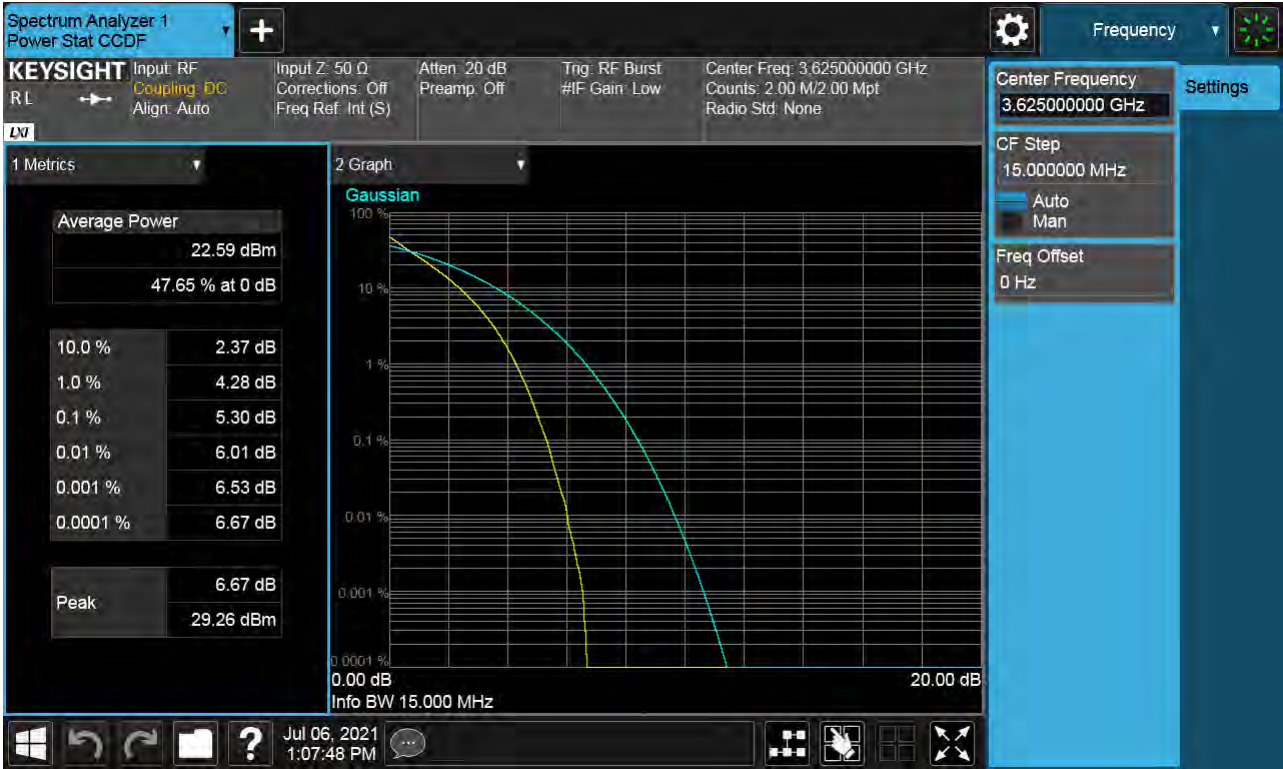

BAND 48. PAR Plot (15M BW_Ch.55990_16QAM_RB75_0)

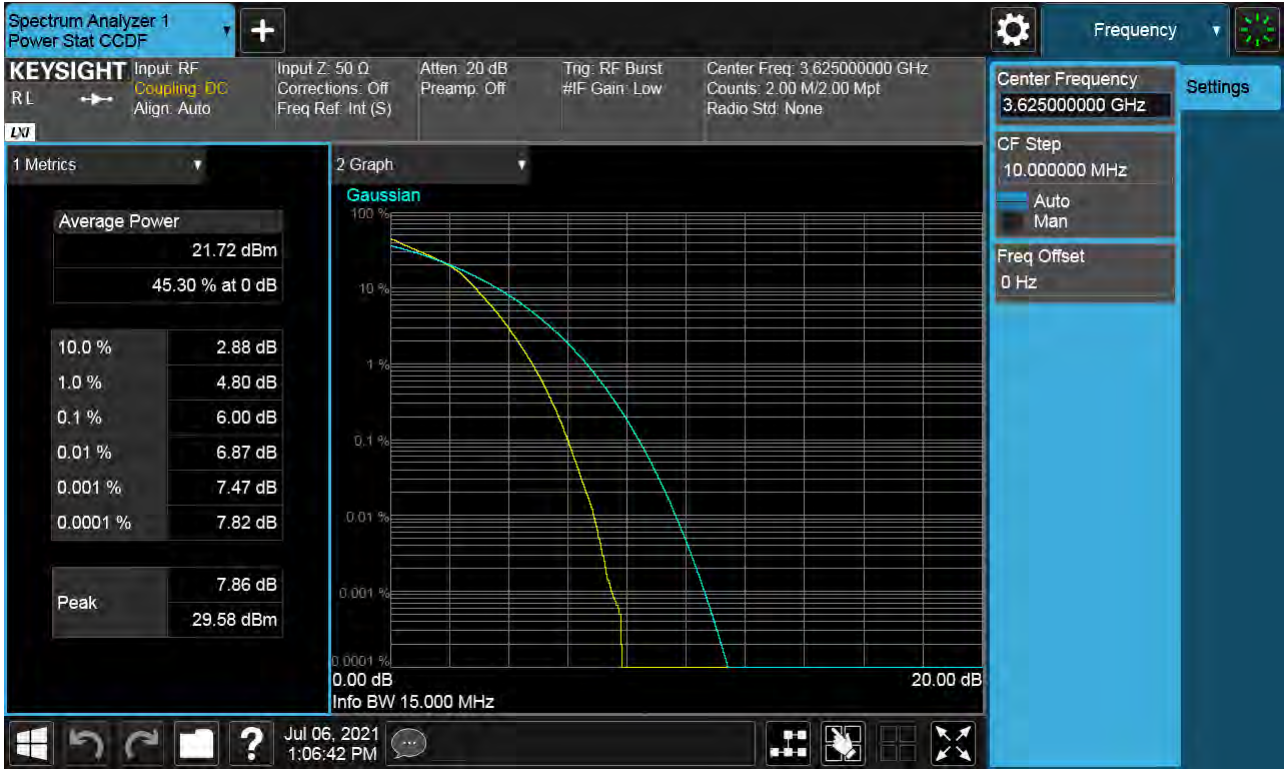

BAND 48. PAR Plot (15M BW_Ch.55990_64QAM_RB75_0)



BAND 48. PAR Plot (20M BW_Ch.55990_QPSK_RB100_0)

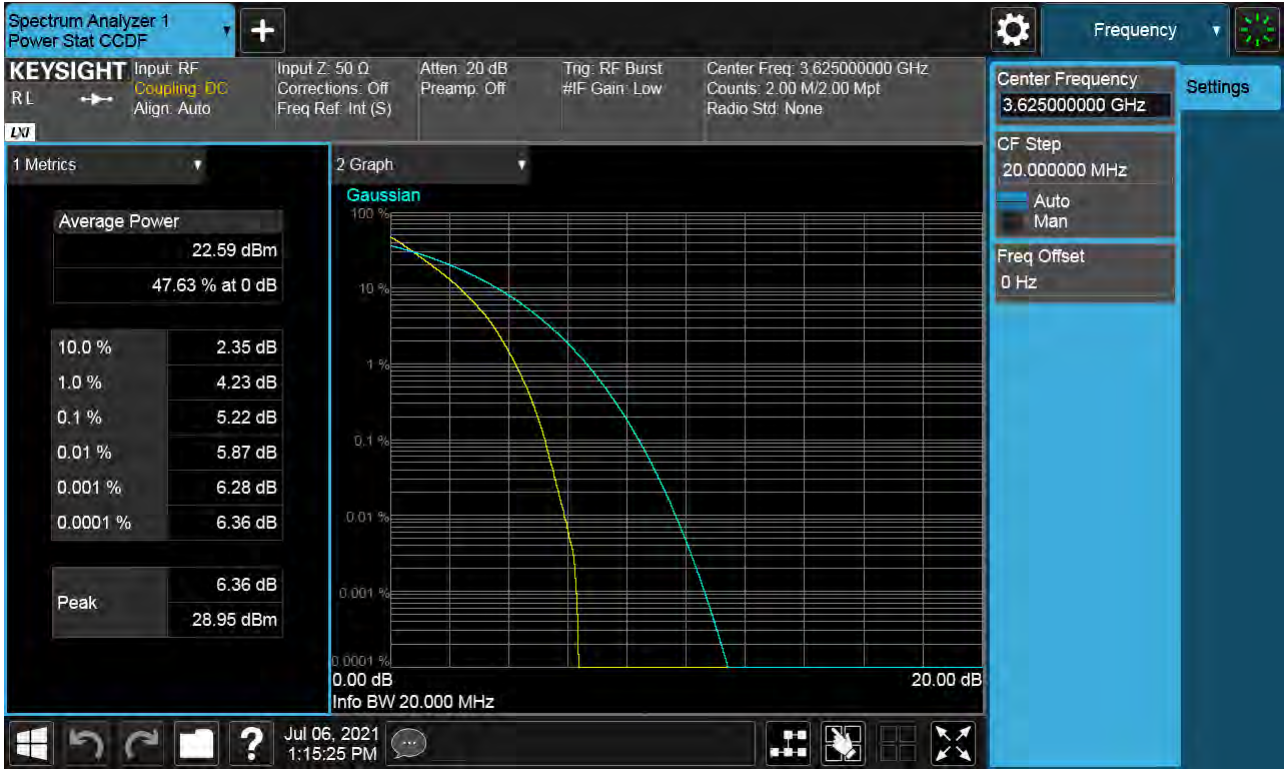

BAND 48. PAR Plot (20M BW_Ch.55990_16QAM_RB100_0)



BAND 48. PAR Plot (20M BW_Ch.55990_64QAM_RB100_0)



BAND 48. Adjacent Channel Leakage Ratio(ACLR) Plot (5 MHz Ch.55265 QPSK RB 25, Offset 0)



BAND 48. Adjacent Channel Leakage Ratio(ACLR) Plot (5 MHz Ch.55990 QPSK RB 25, Offset 0)

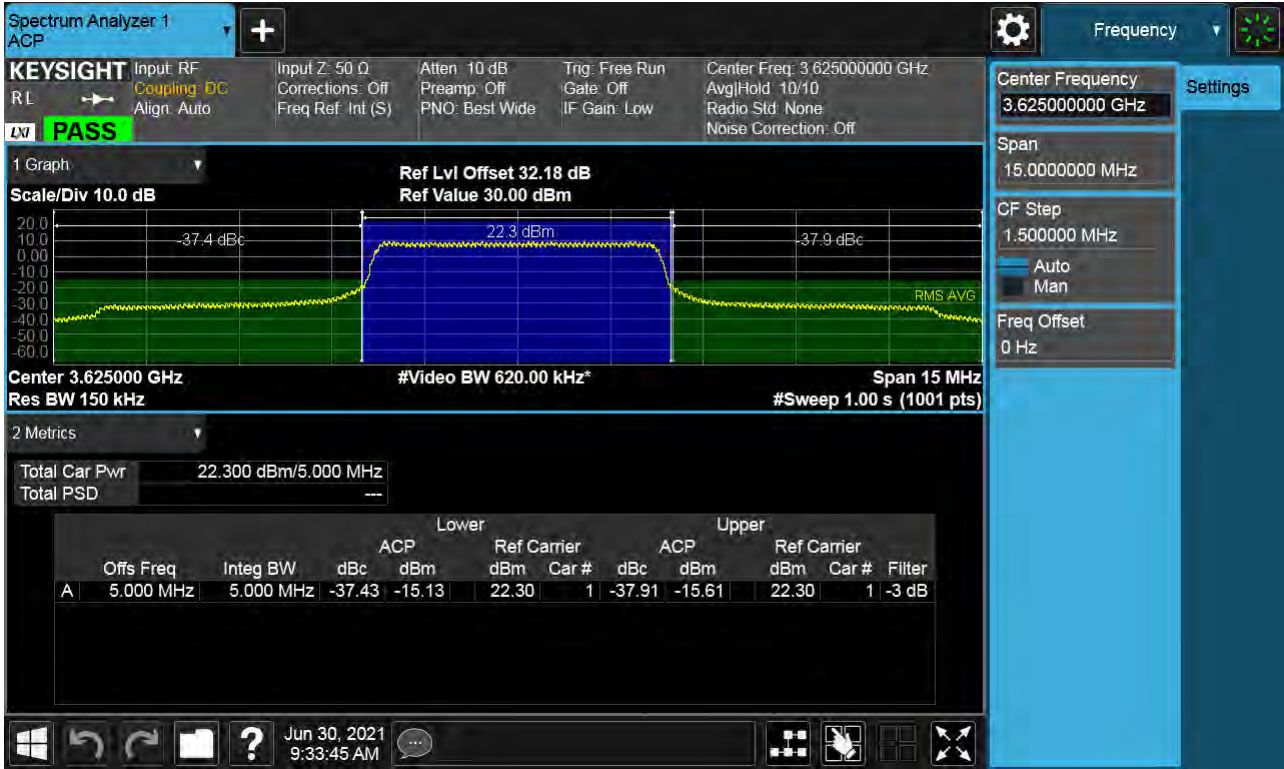

BAND 48. Adjacent Channel Leakage Ratio(ACLR) Plot (5 MHz Ch.56715 QPSK RB 25, Offset 0)

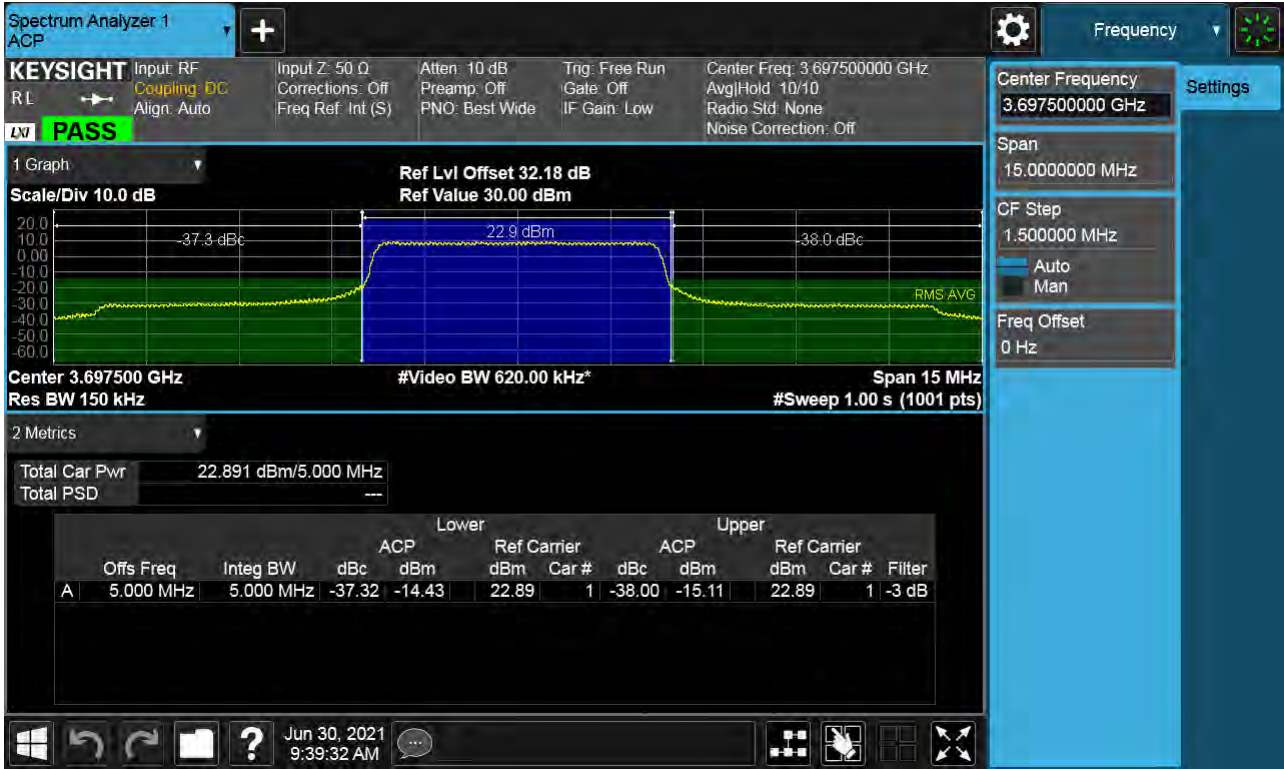

BAND 48. Adjacent Channel Leakage Ratio(ACLR) Plot (10 MHz Ch.55290 QPSK RB 50, Offset 0)

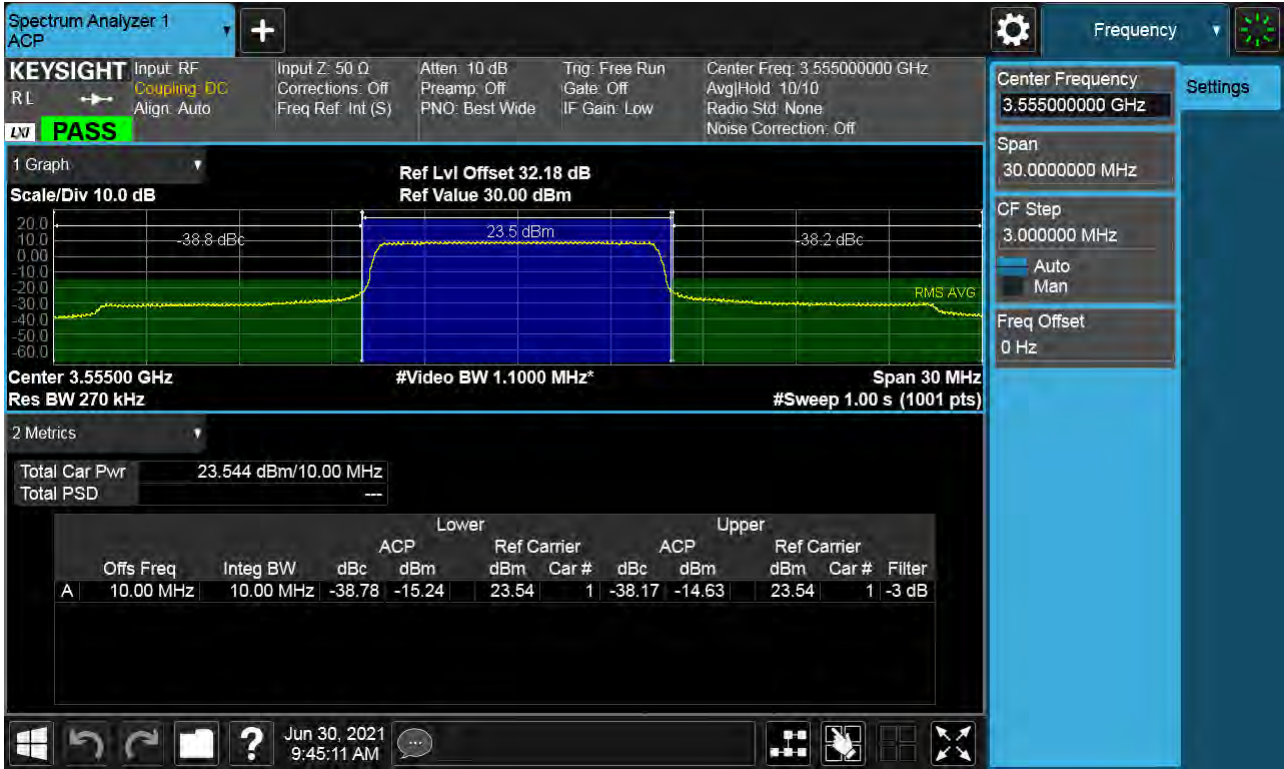

BAND 48. Adjacent Channel Leakage Ratio(ACLR) Plot (10 MHz Ch.5590 QPSK RB 50, Offset 0)

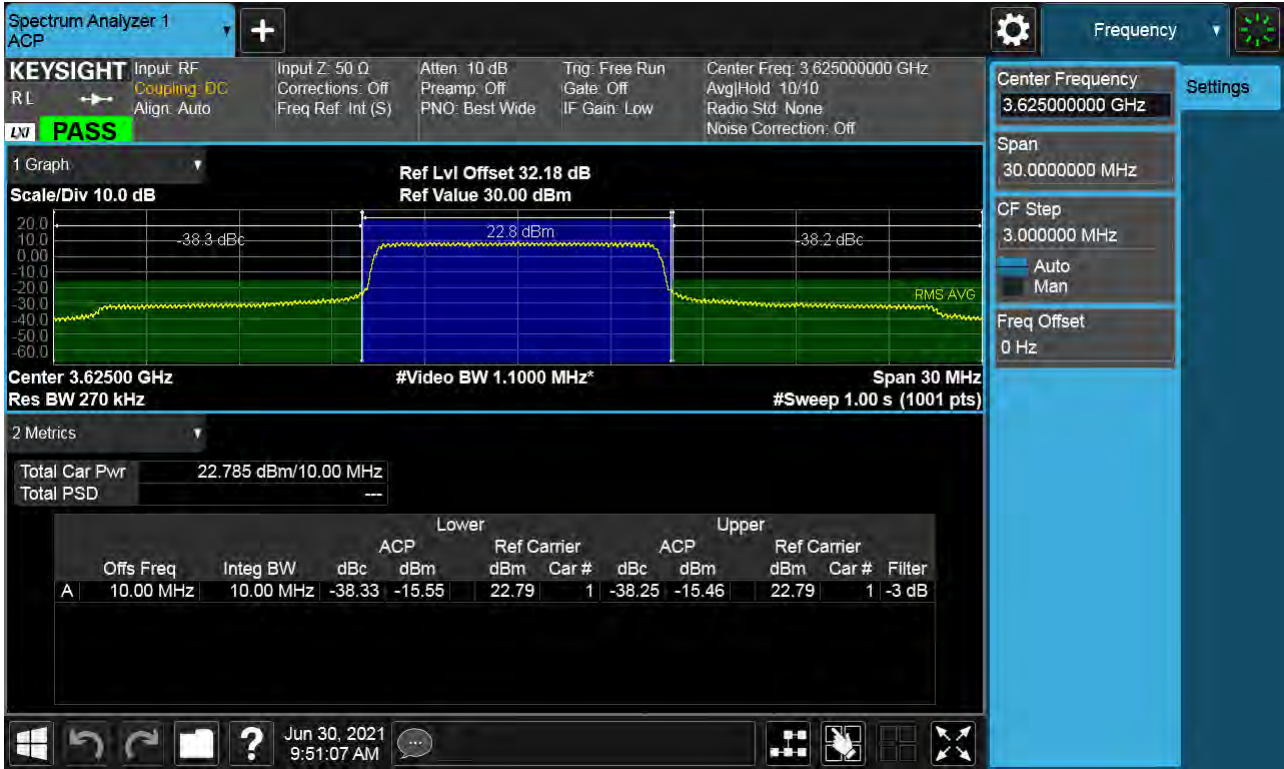

BAND 48. Adjacent Channel Leakage Ratio(ACLR) Plot (10 MHz Ch. 56690 QPSK RB 50, Offset 0)

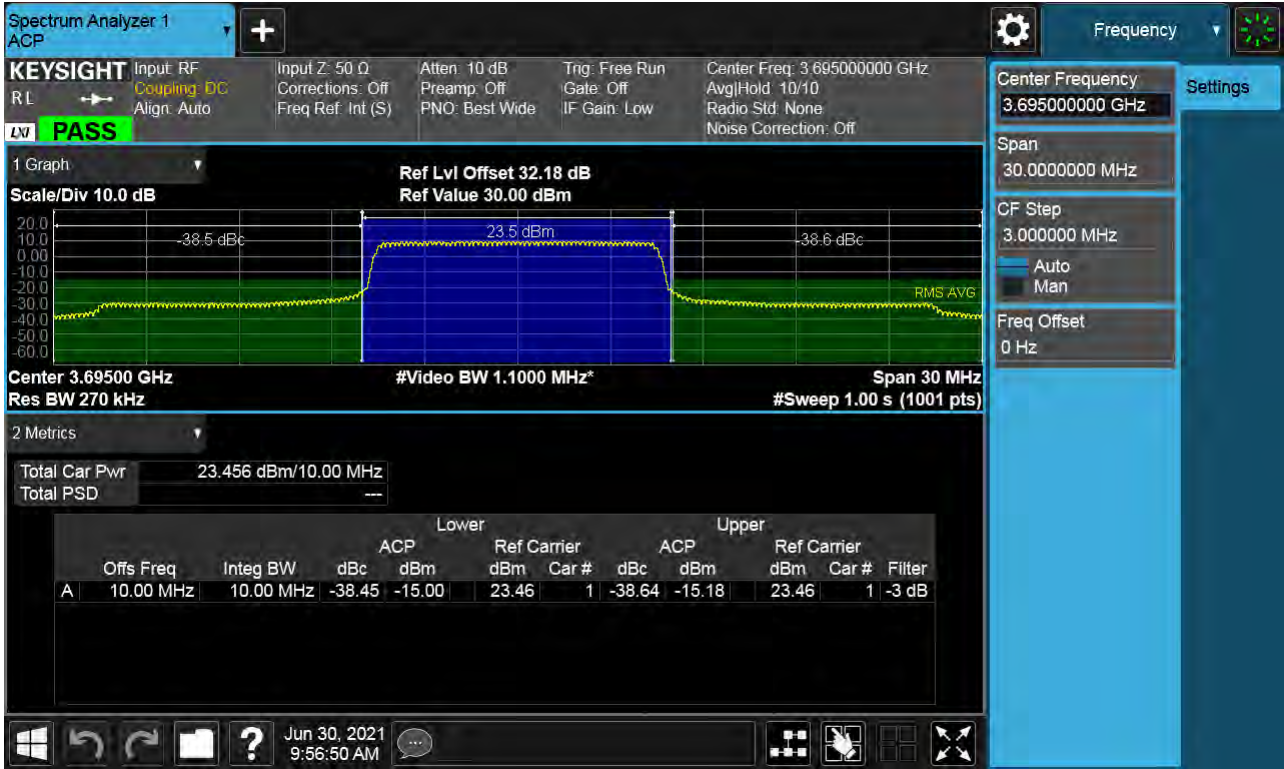

BAND 48. Adjacent Channel Leakage Ratio(ACLR) Plot (15 MHz Ch.55315 QPSK RB 75, Offset 0)

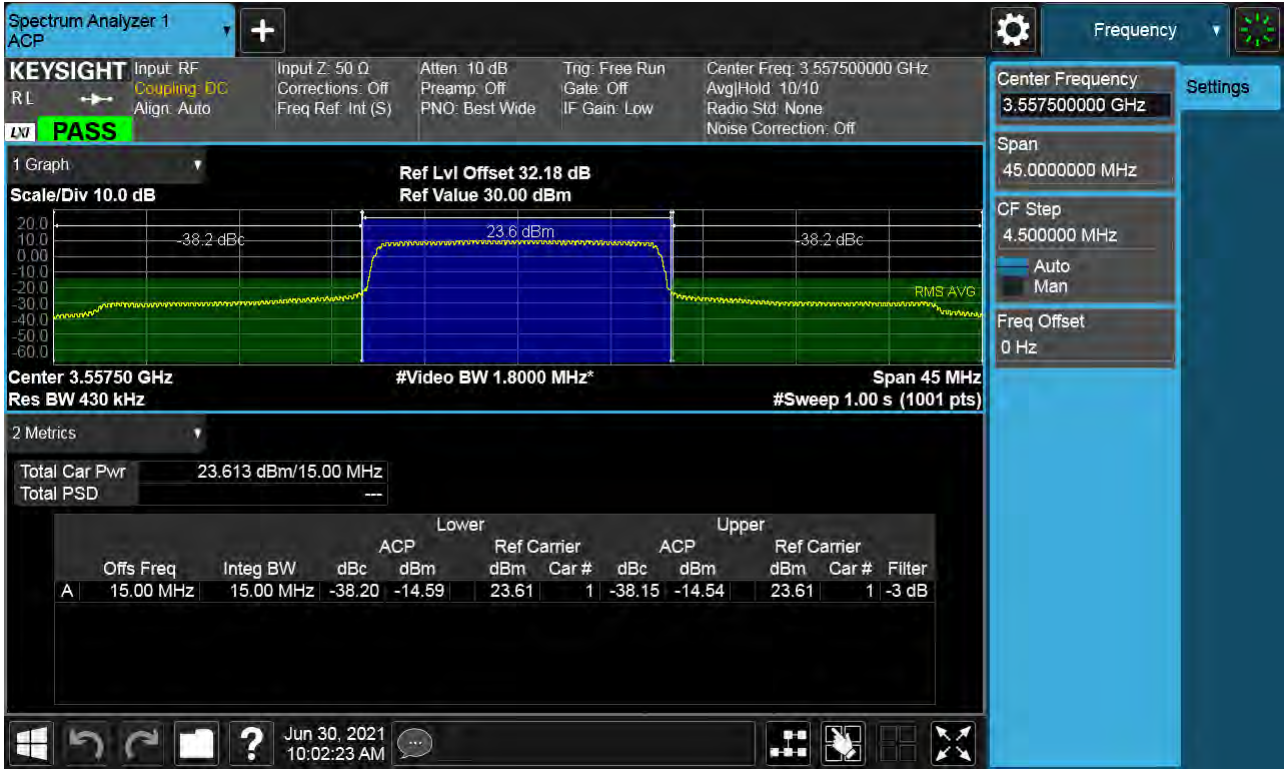

BAND 48. Adjacent Channel Leakage Ratio(ACLR) Plot (15 MHz Ch.55990 QPSK RB 75, Offset 0)

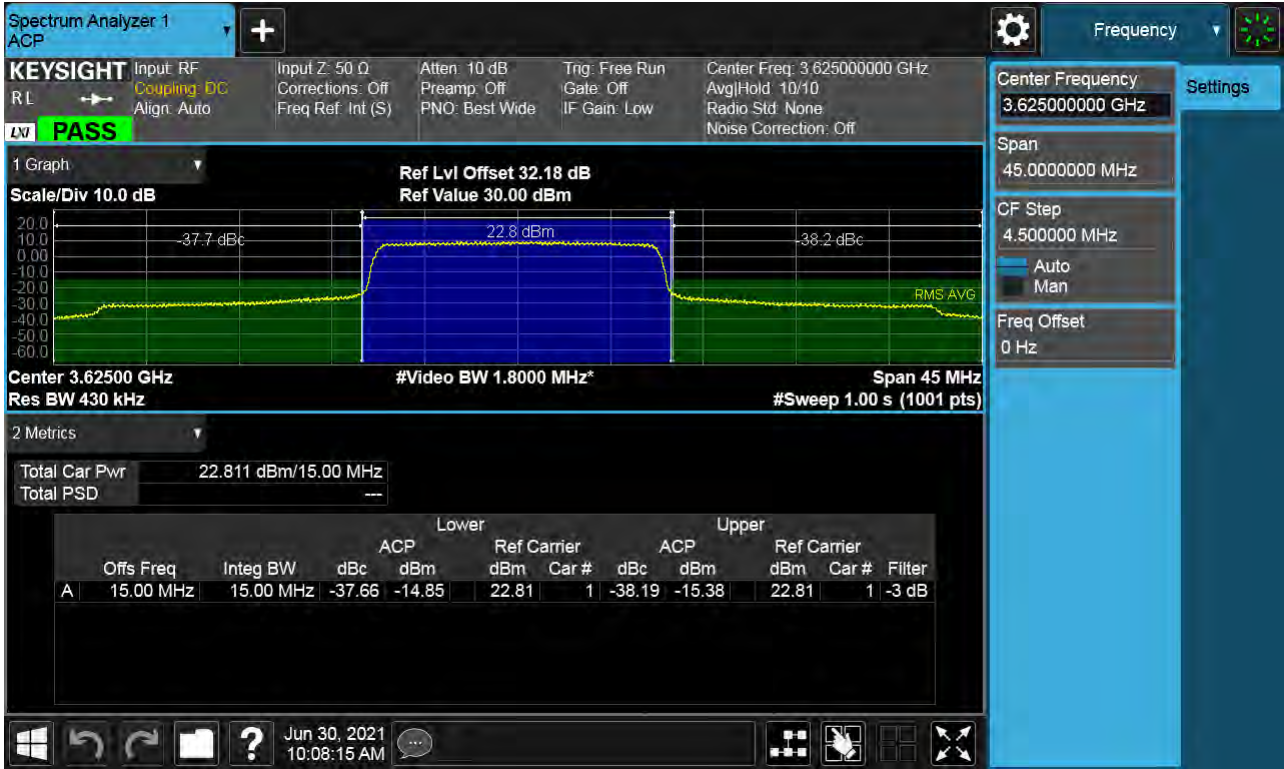

BAND 48. Adjacent Channel Leakage Ratio(ACLR) Plot (15 MHz Ch.56665 QPSK RB 75, Offset 0)

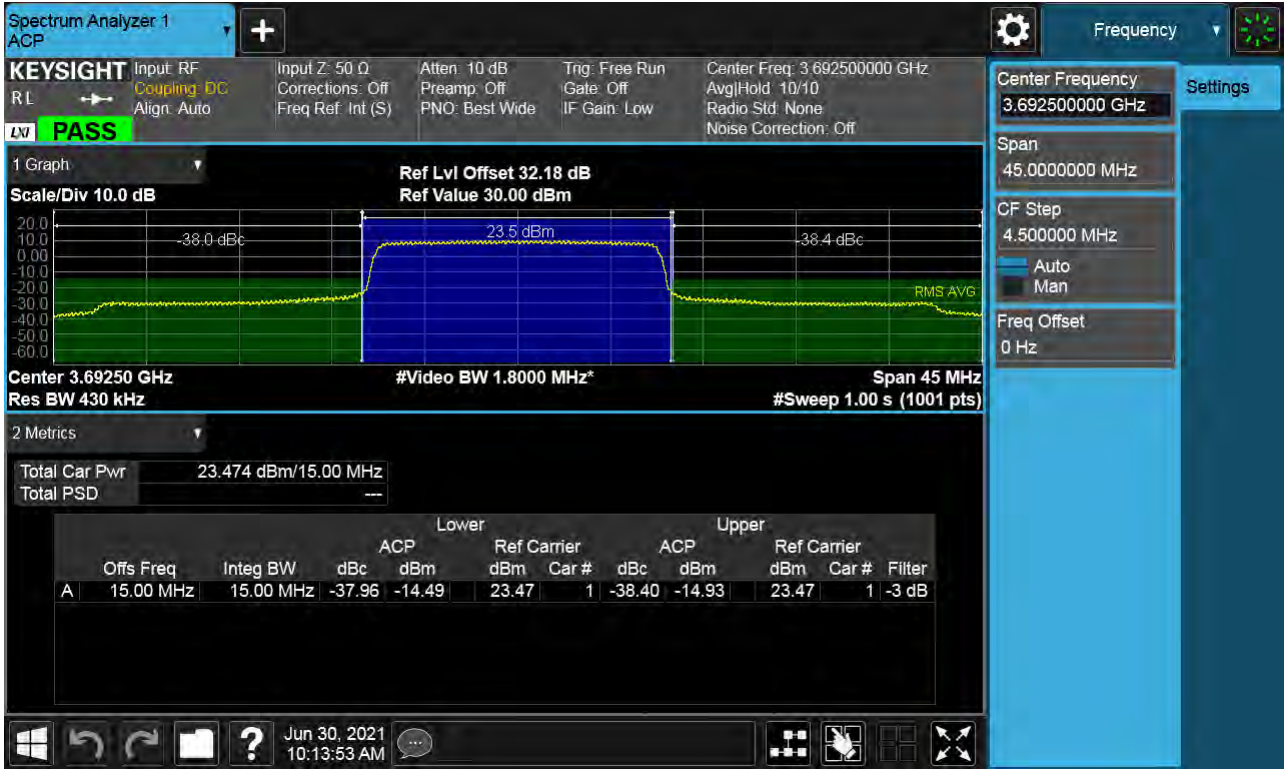

BAND 48. Adjacent Channel Leakage Ratio(ACLR) Plot (20 MHz Ch.55340 QPSK RB 100, Offset 0)

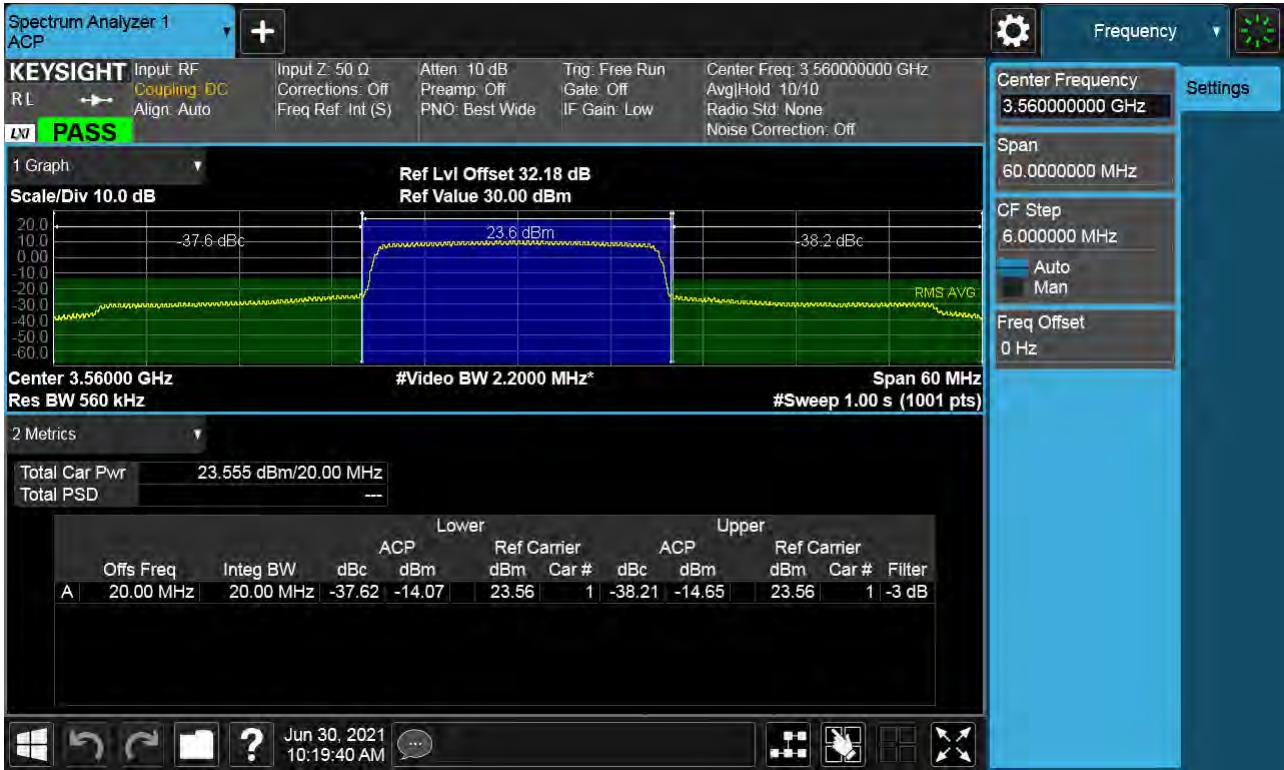

BAND 48. Adjacent Channel Leakage Ratio(ACLR) Plot (20 MHz Ch.55990 QPSK RB 100, Offset 0)

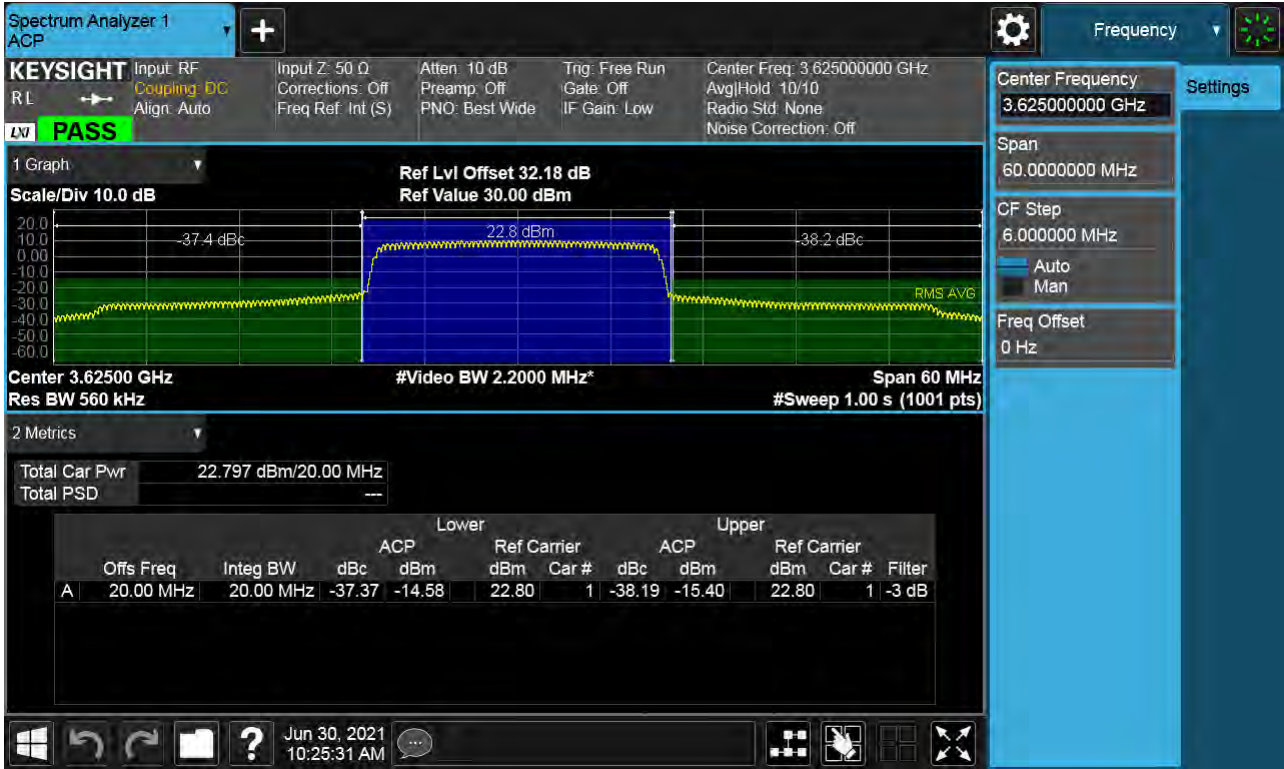

BAND 48. Adjacent Channel Leakage Ratio(ACLR) Plot (20 MHz Ch.56640 QPSK RB 100, Offset 0)

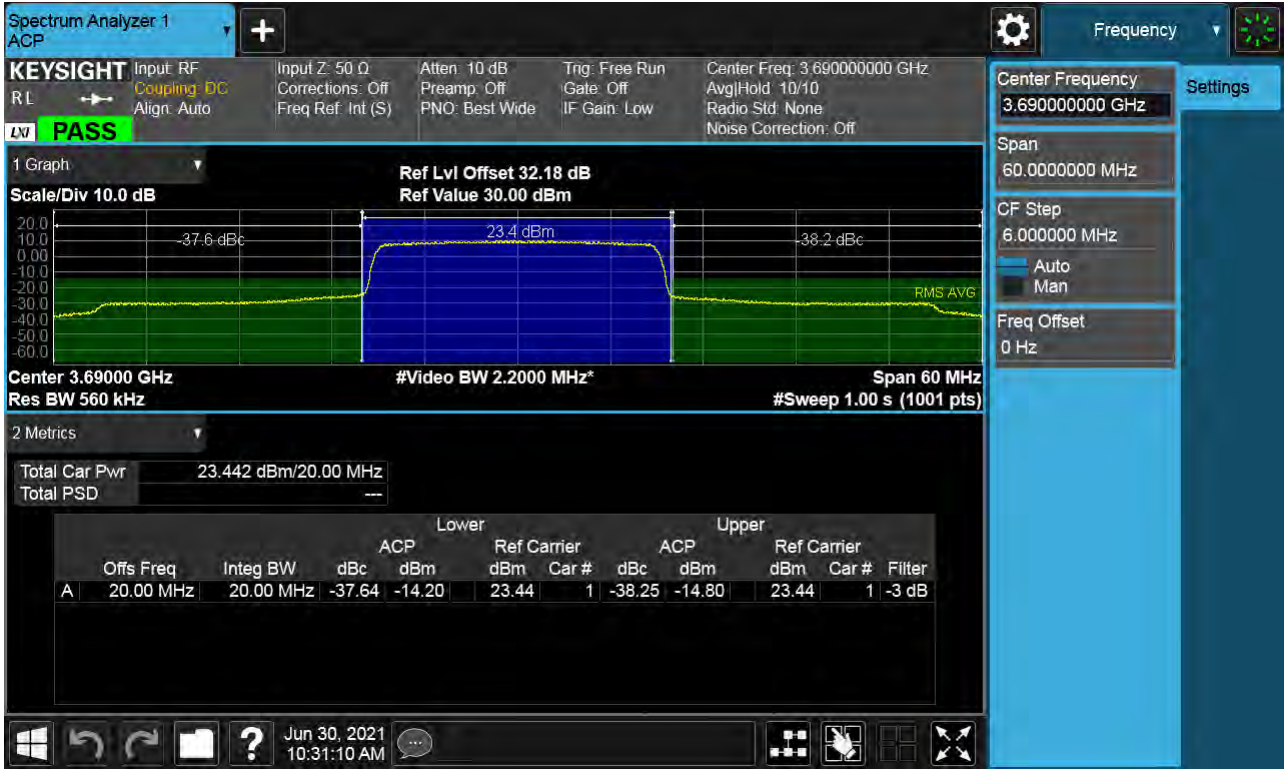

BAND 48. 5M BandEdge(Lower)_Low_3552.5MHz_QPSK_FullIRB

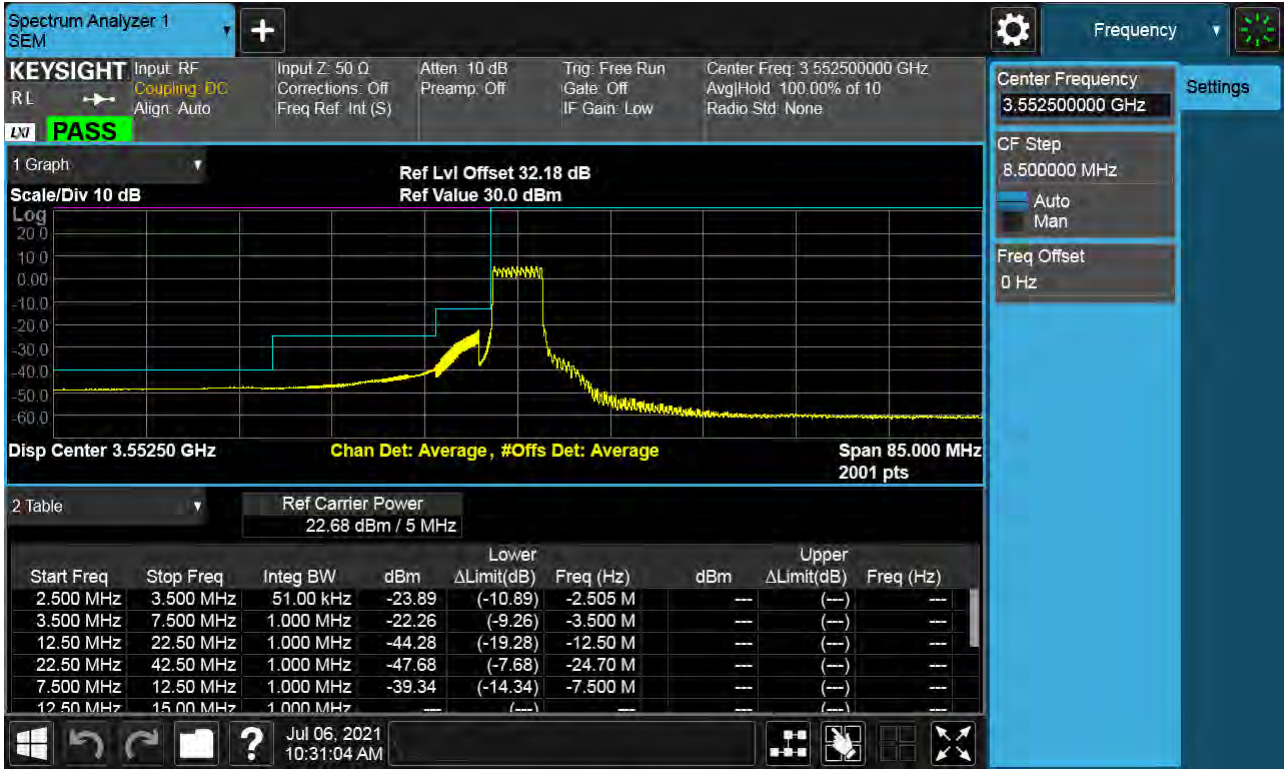

BAND 48. 5M_BandEdge(Upper)_Low_3552.5MHz_QPSK_FullIRB



BAND 48. 5M_BandEdge(Lower)_Low_3552.5MHz_QPSK_1RB

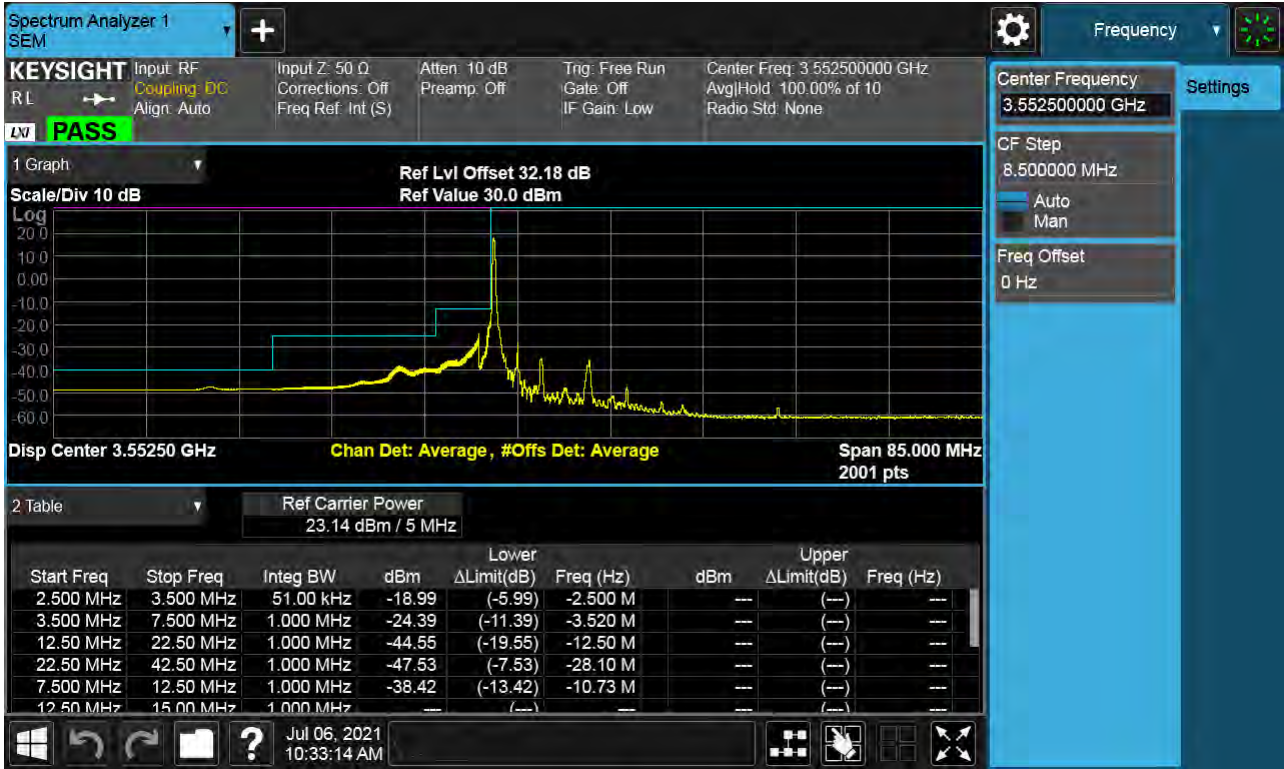

BAND 48. 5M_BandEdge(Upper)_Low_3552.5MHz_QPSK_1RB

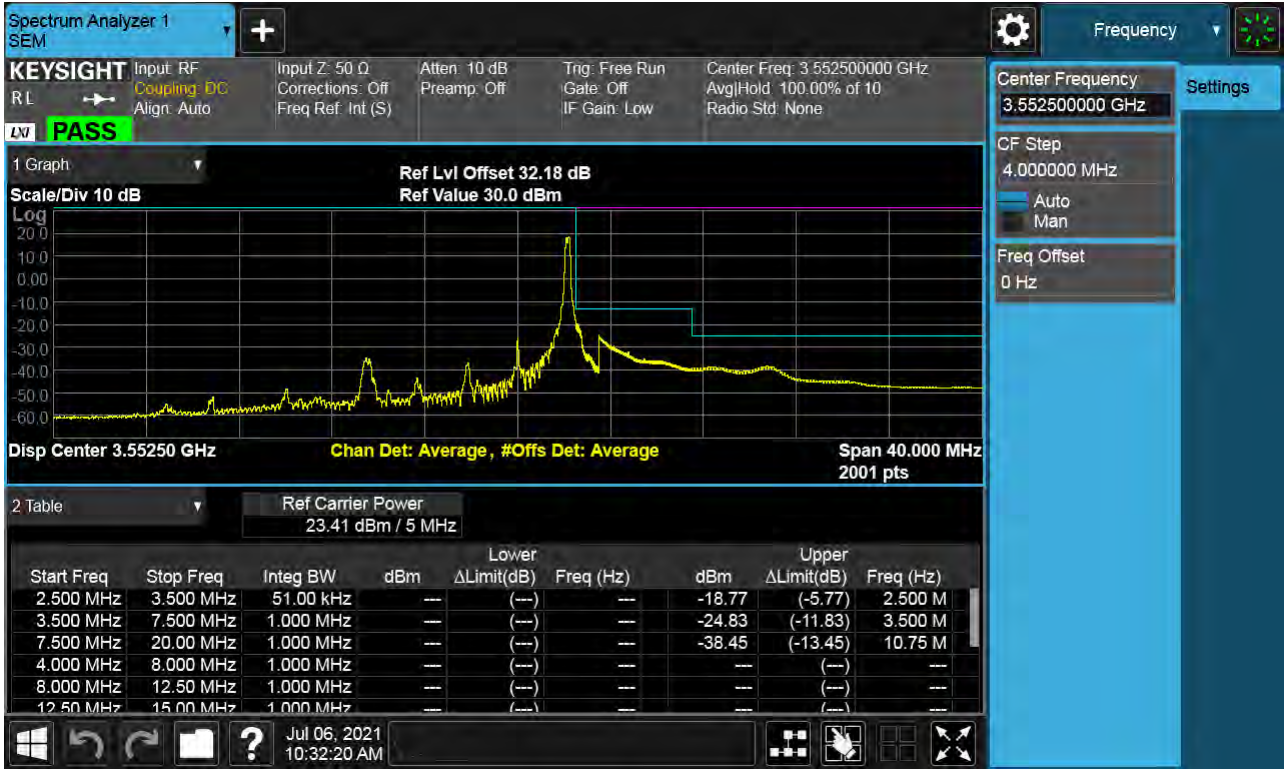

BAND 48. 5M_BandEdge(Center)_Mid_3625MHz_QPSK_FullIRB



BAND 48. 5M_BandEdge(Lower)_Mid_3625MHz_QPSK_1RB

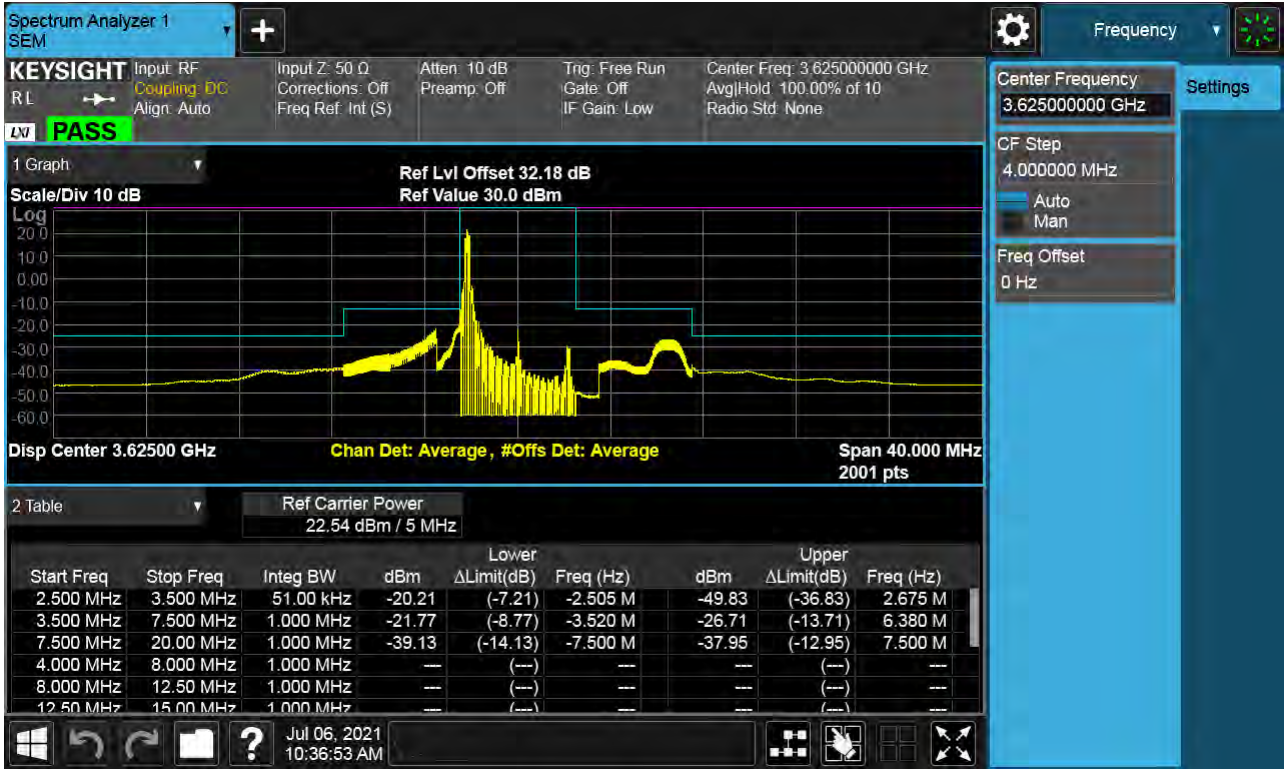

BAND 48. 5M_BandEdge(Upper)_Mid_3625MHz_QPSK_1RB

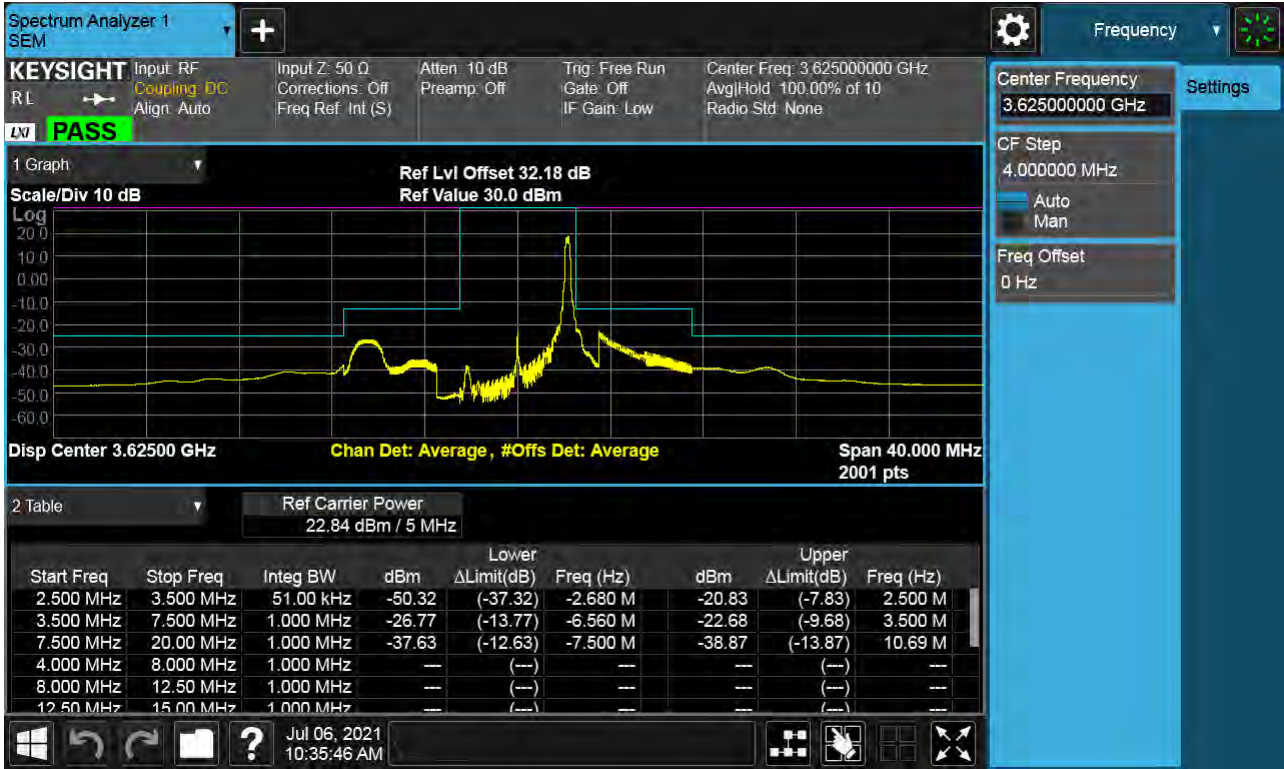

BAND 48. 5M_BandEdge(Lower)_High_3697.5MHz_QPSK_FullRB

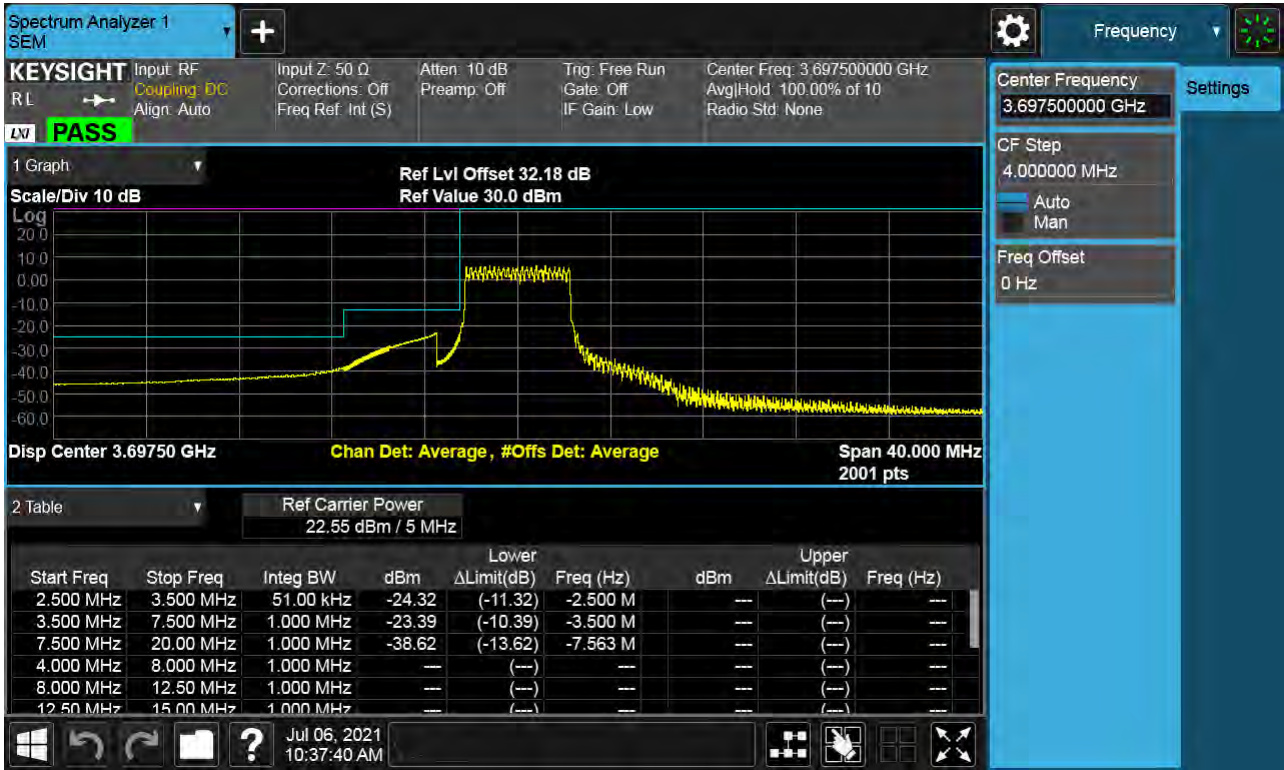

BAND 48. 5M_BandEdge(Upper)_High_3697.5MHz_QPSK_FullIRB

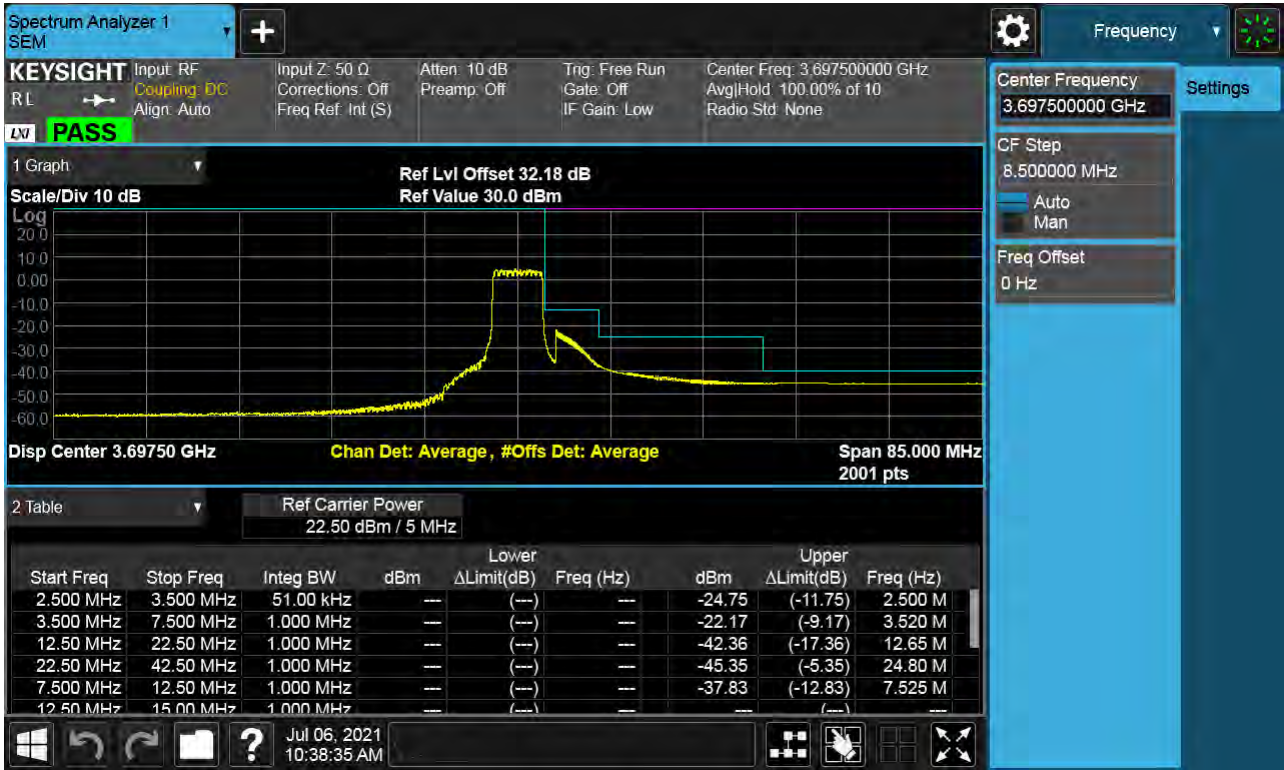

BAND 48. 5M_BandEdge(Lower)_High_3697.5MHz_QPSK_1RB

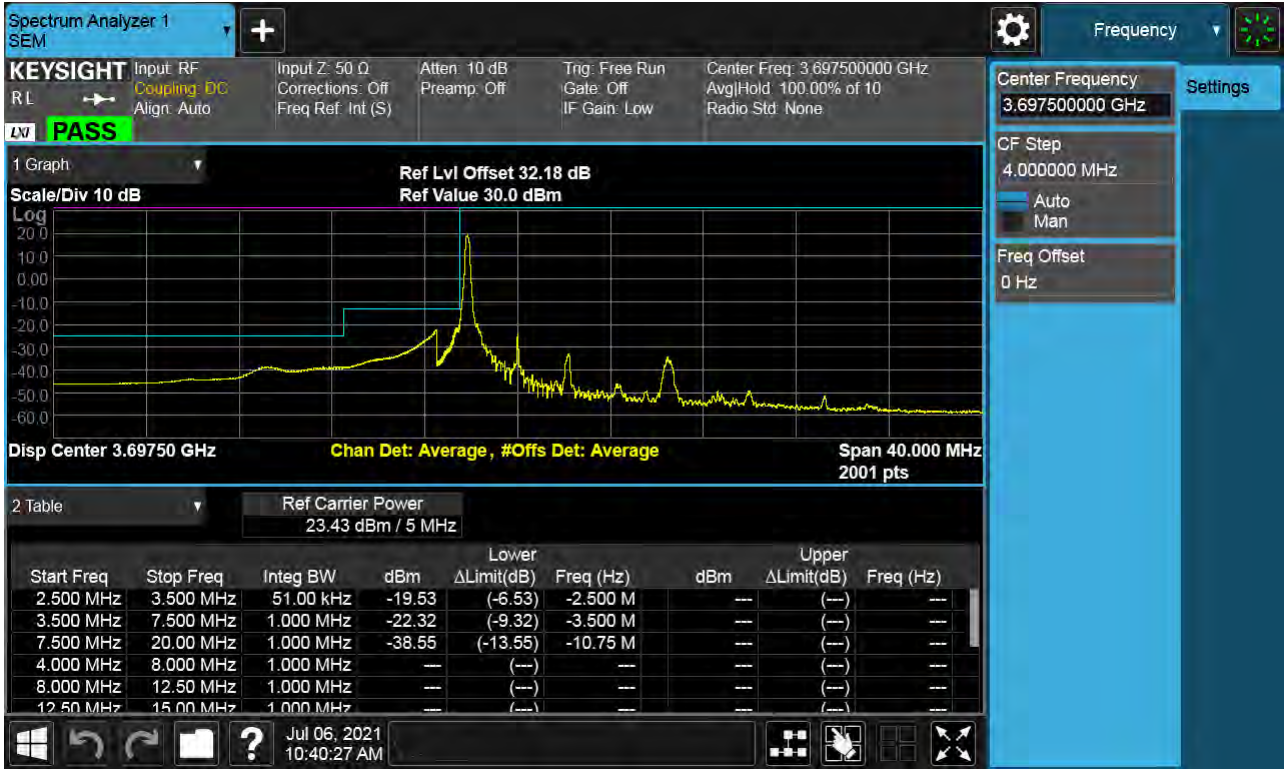

BAND 48. 5M_BandEdge(Upper)_High_3697.5MHz_QPSK_1RB

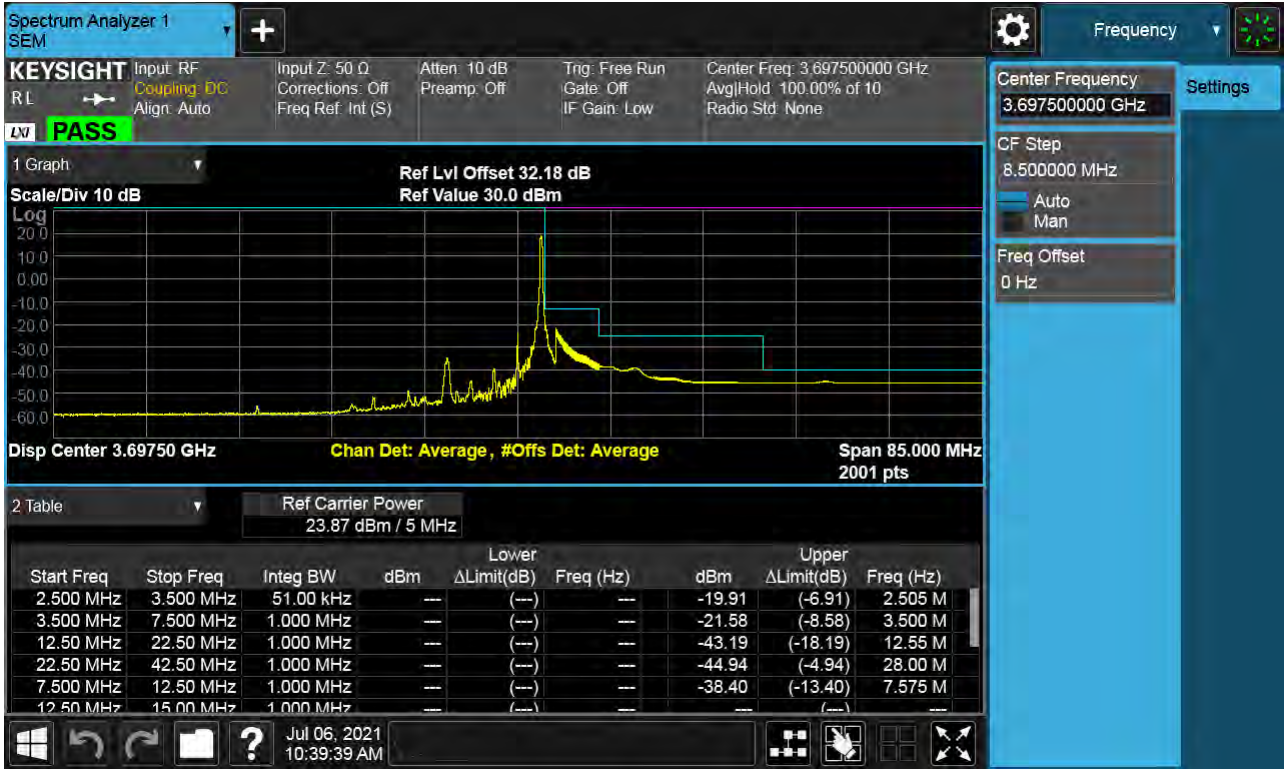

BAND 48. 10M_BandEdge(Lower)_Low_3555MHz_QPSK_FullIRB



BAND 48. 10M_BandEdge(Upper)_Low_3555MHz_QPSK_FullIRB

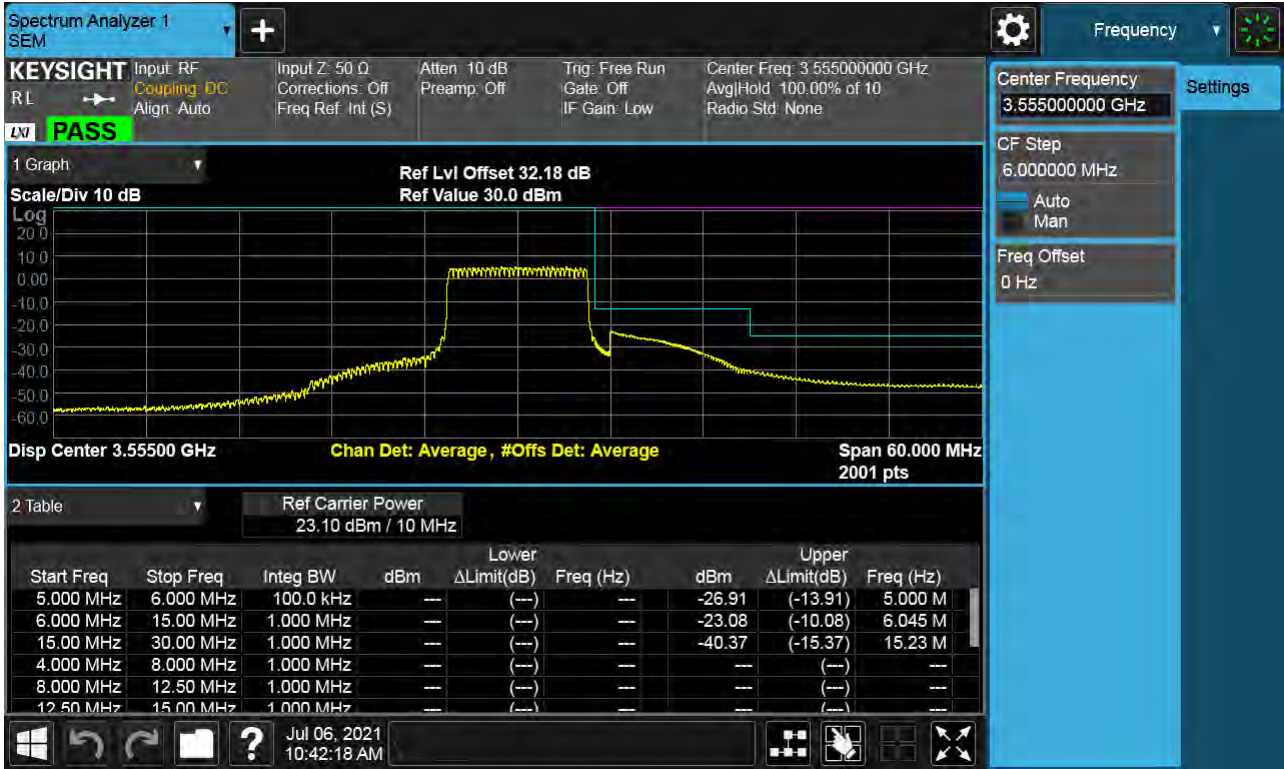

BAND 48. 10M_BandEdge(Lower)_Low_3555MHz_QPSK_1RB

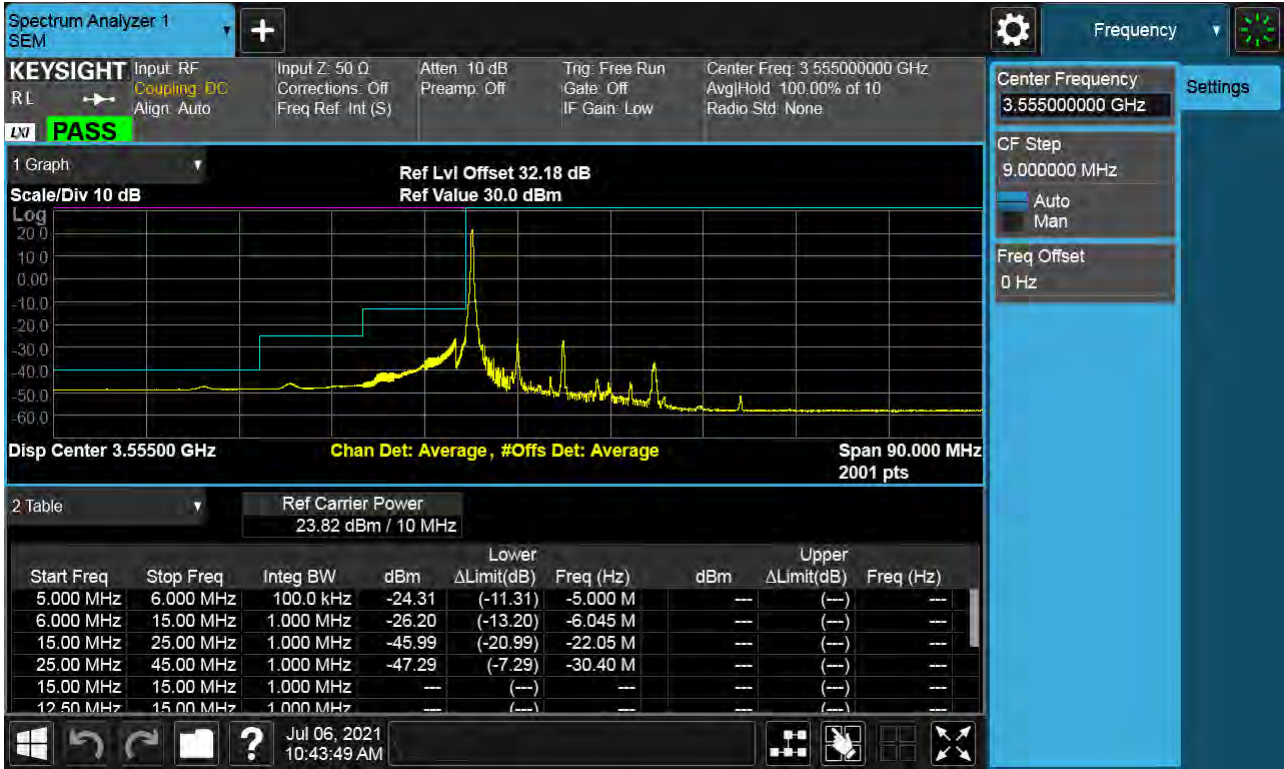

BAND 48. 10M_BandEdge(Upper)_Low_3555MHz_QPSK_1RB

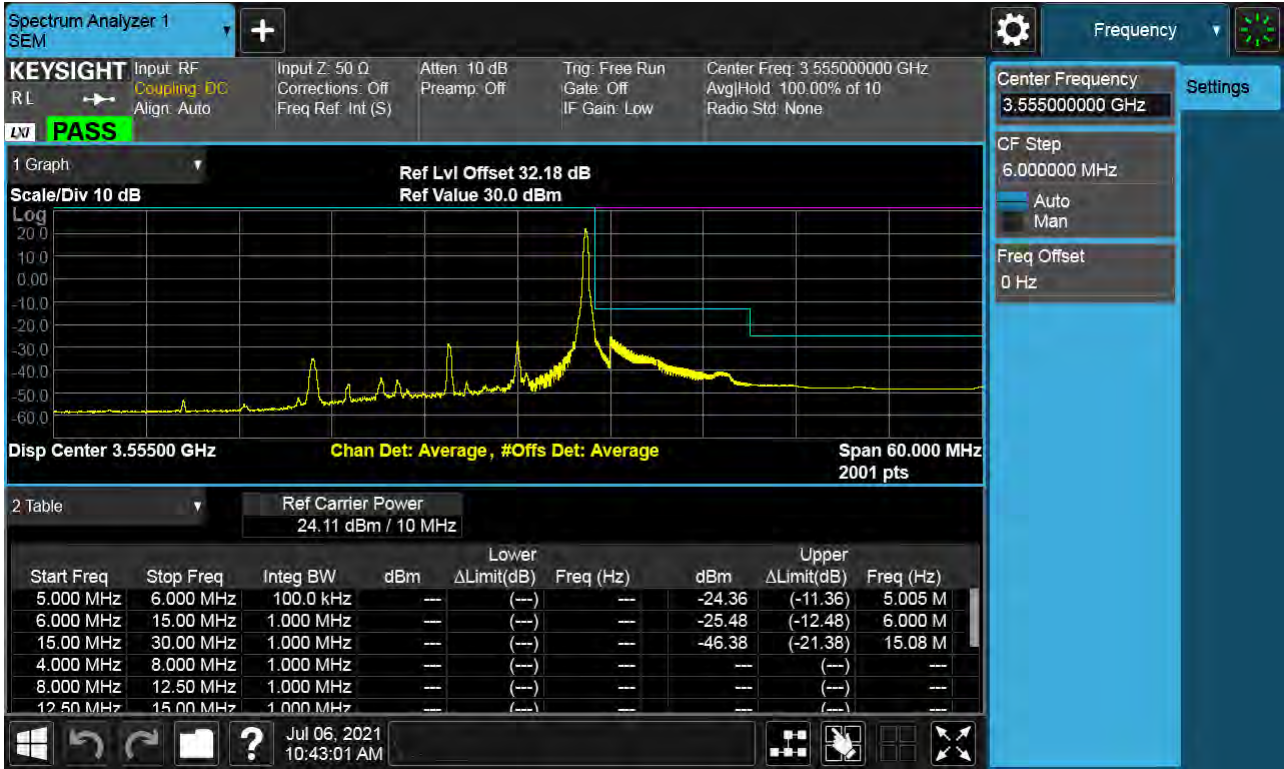

BAND 48. 10M_BandEdge(Center)_Mid_3625MHz_QPSK_FullIRB

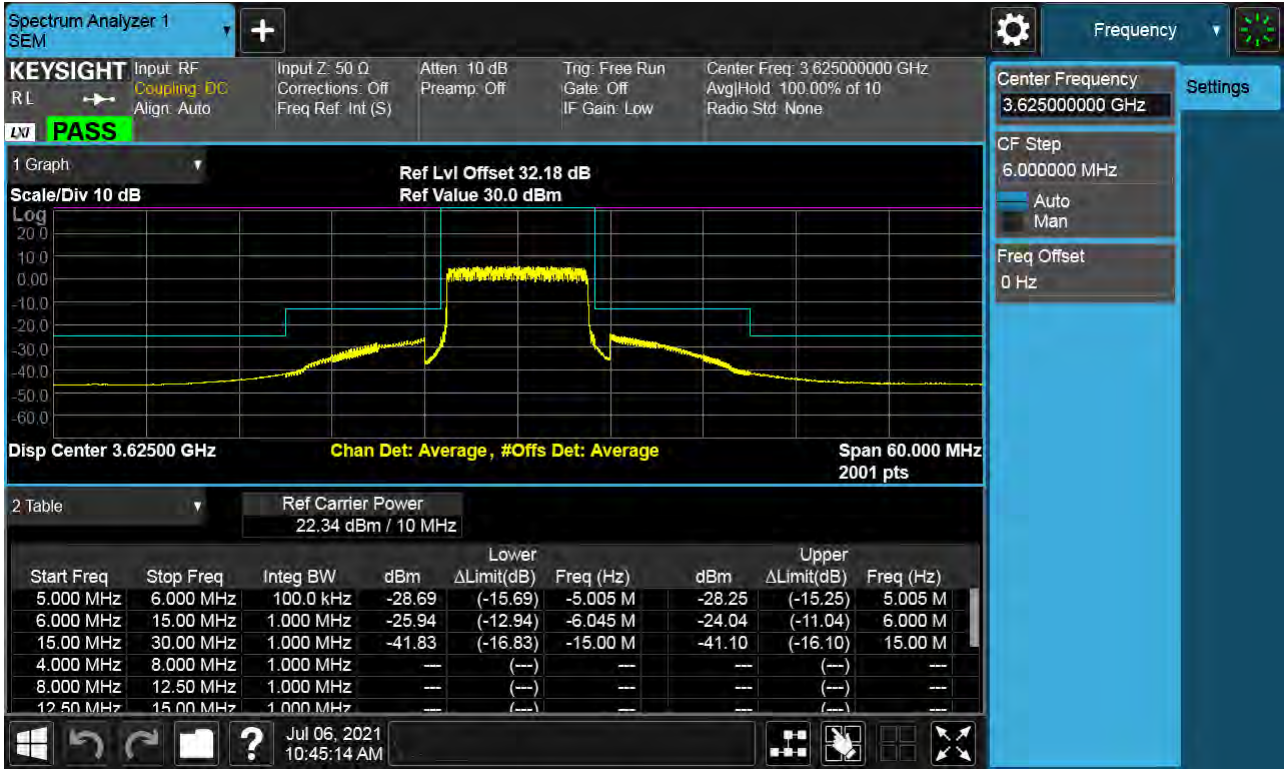

BAND 48. 10M_BandEdge(Lower)_Mid_3625MHz_QPSK_1RB

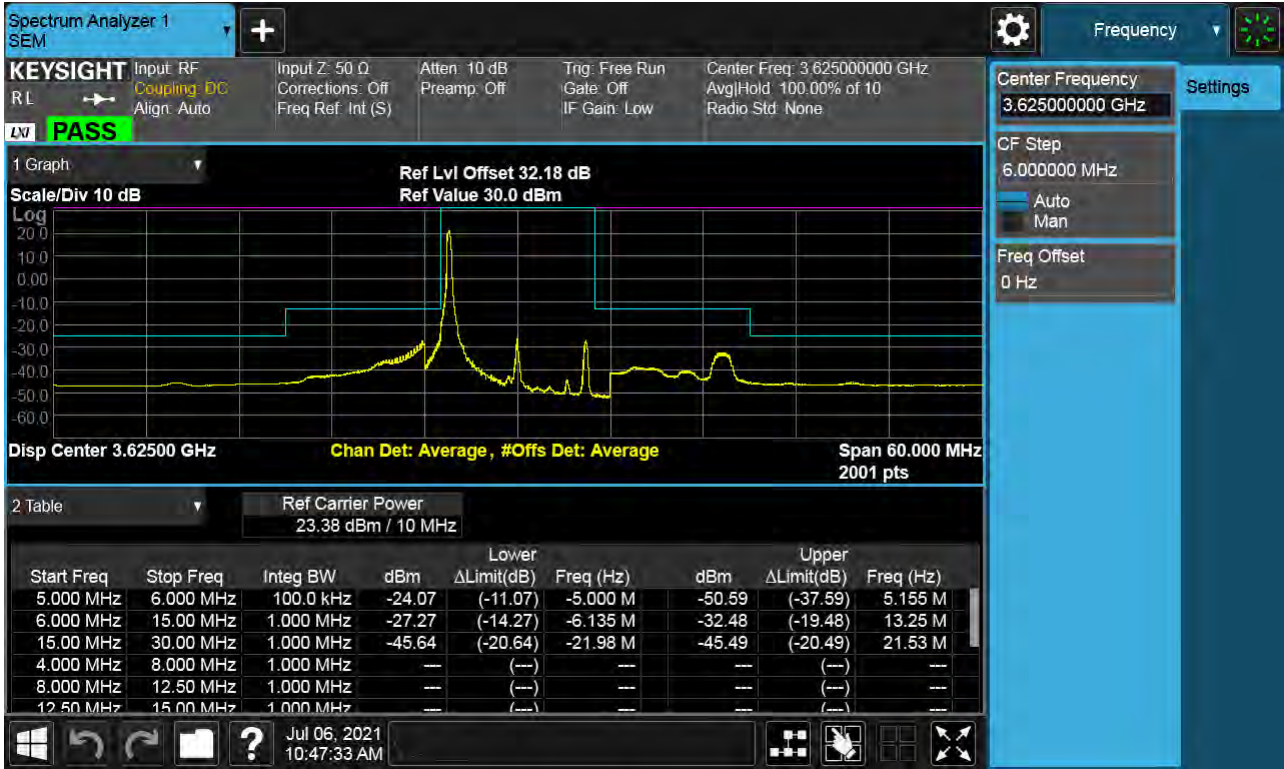

BAND 48. 10M_BandEdge(Upper)_Mid_3625MHz_QPSK_1RB

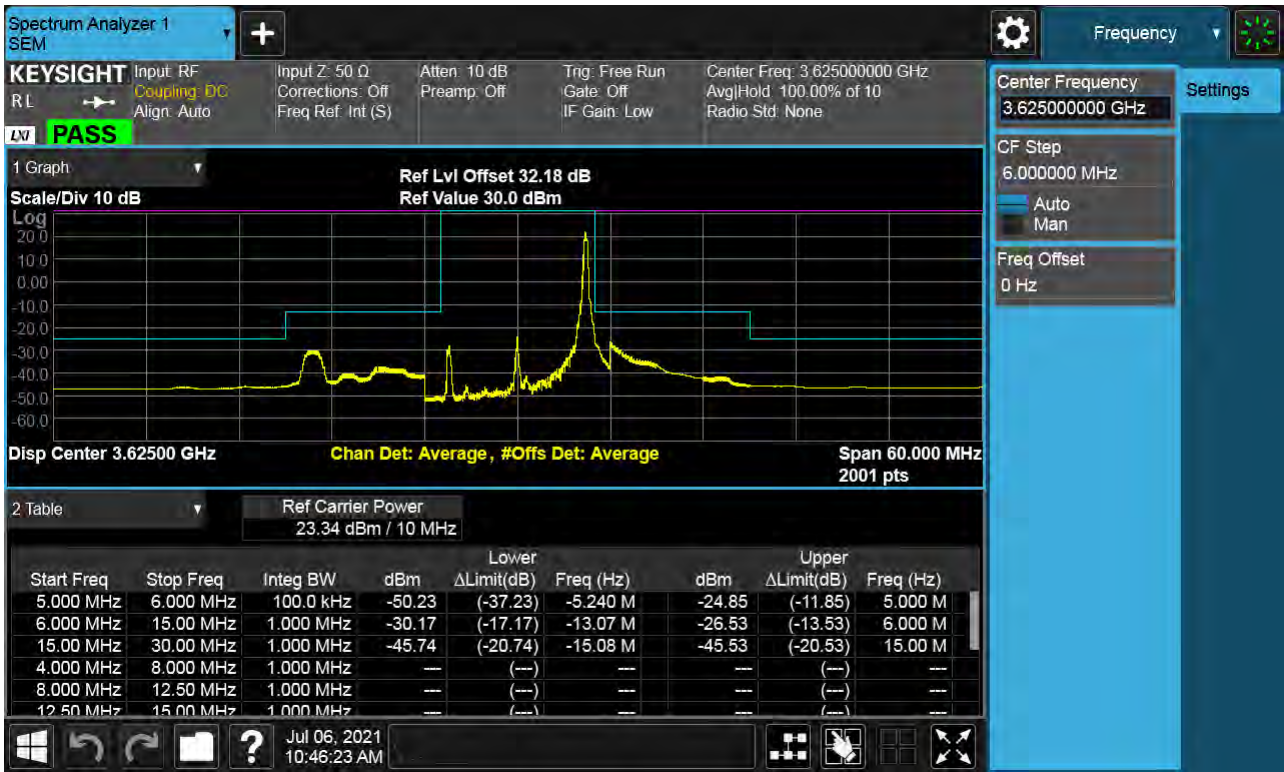

BAND 48. 10M_BandEdge(Lower)_High_3695MHz_QPSK_FullIRB



BAND 48. 10M_BandEdge(Upper)_High_3695MHz_QPSK_FullIRB

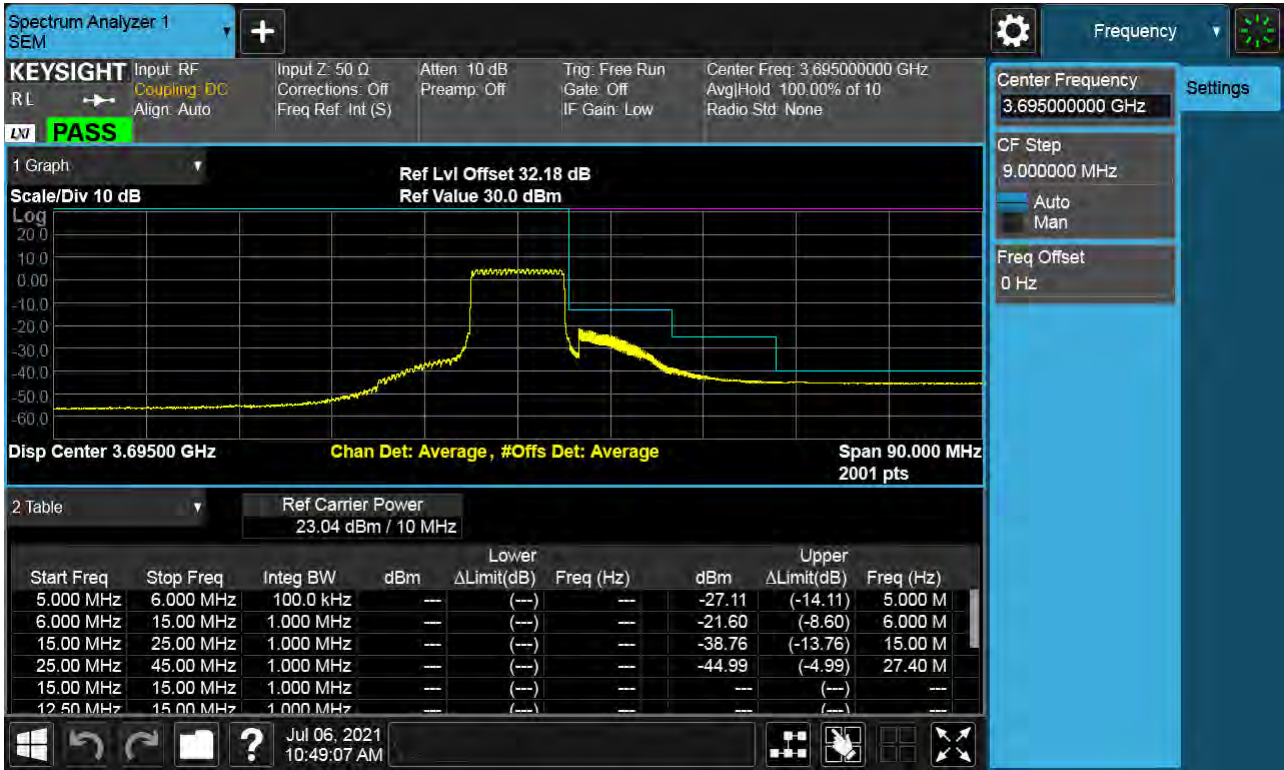

BAND 48. 10M_BandEdge(Lower)_High_3695MHz_QPSK_1RB

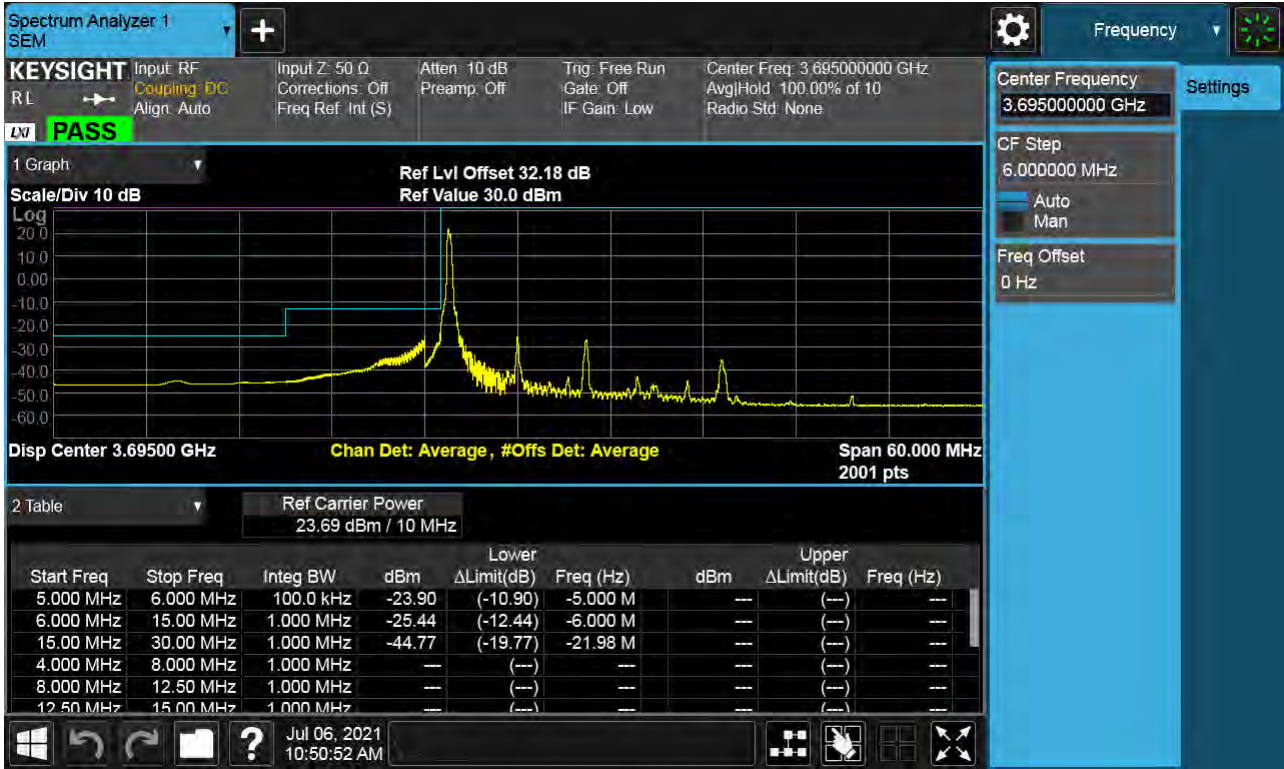

BAND 48. 10M_BandEdge(Upper)_High_3695MHz_QPSK_1RB

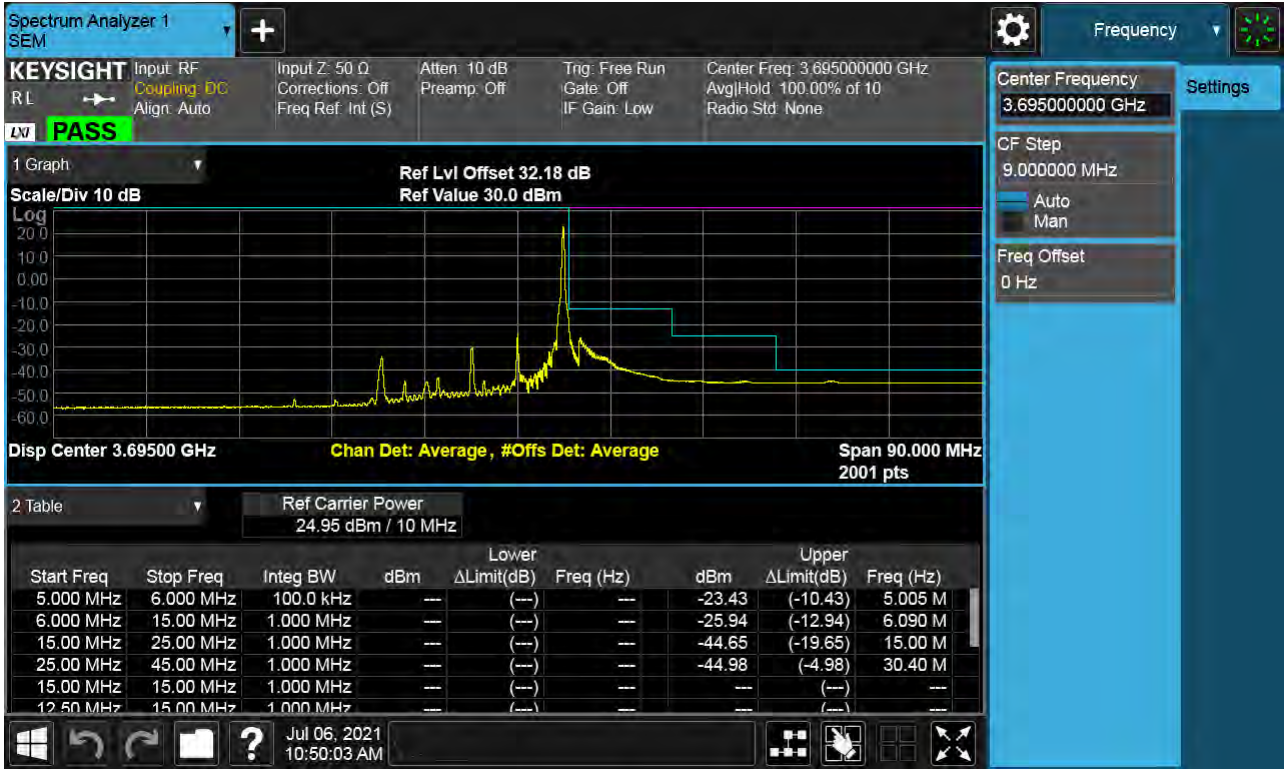

BAND 48. 15M_BandEdge(Lower)_Low_3557.5MHz_QPSK_FuIIRB

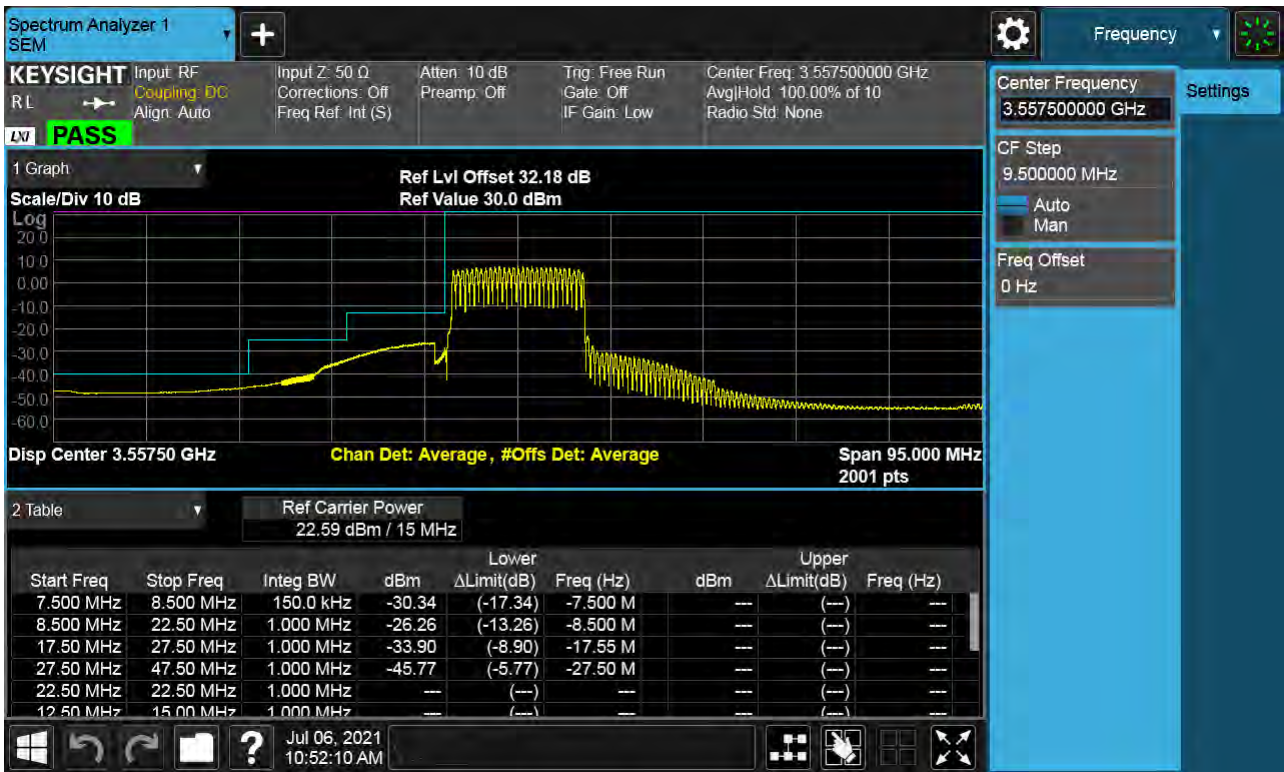

BAND 48. 15M_BandEdge(Upper)_Low_3557.5MHz_QPSK_FullRB

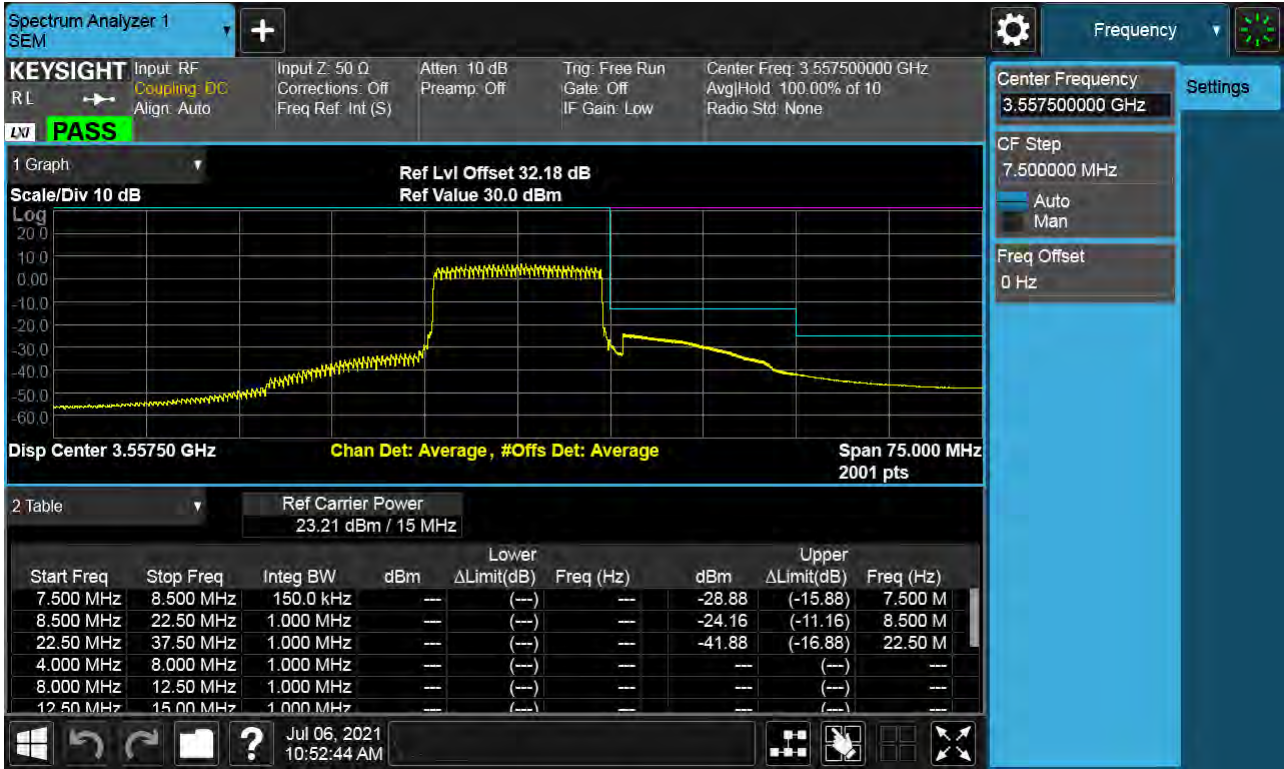

BAND 48. 15M_BandEdge(Lower)_Low_3557.5MHz_QPSK_1RB

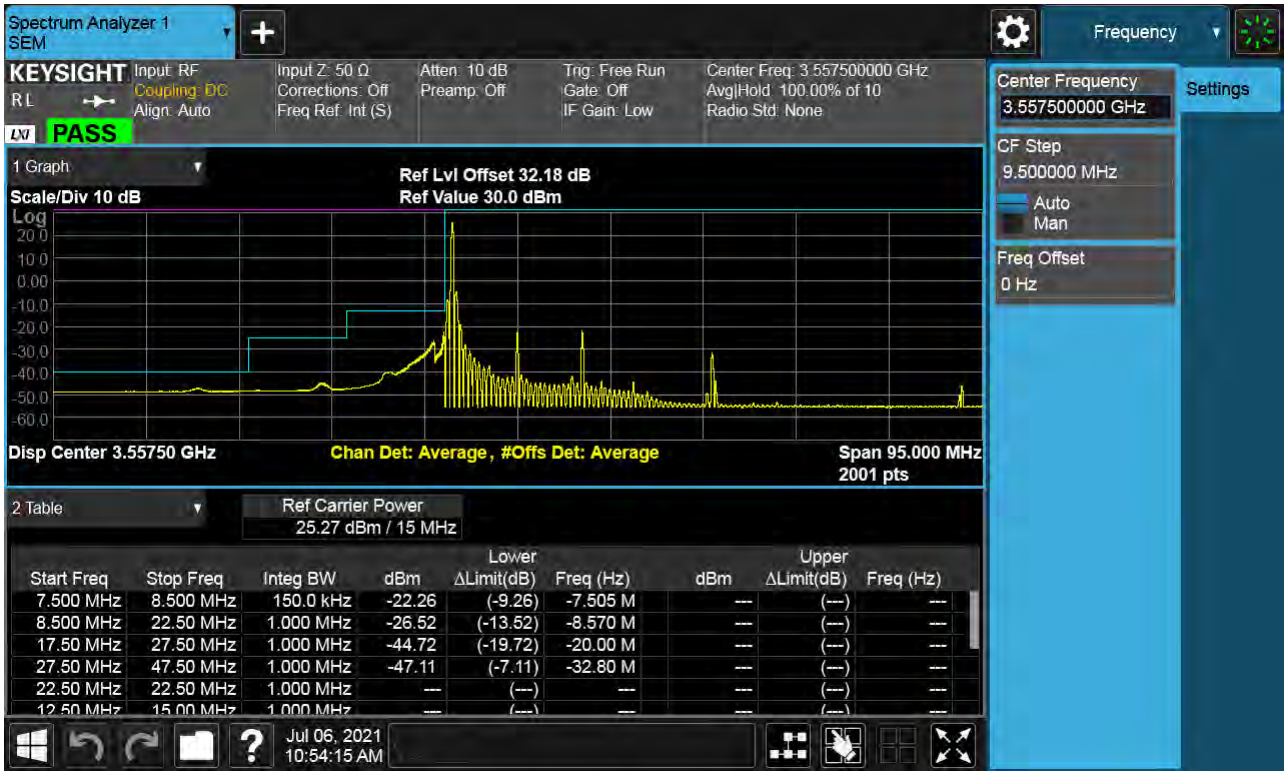

BAND 48. 15M_BandEdge(Upper)_Low_3557.5MHz_QPSK_1RB

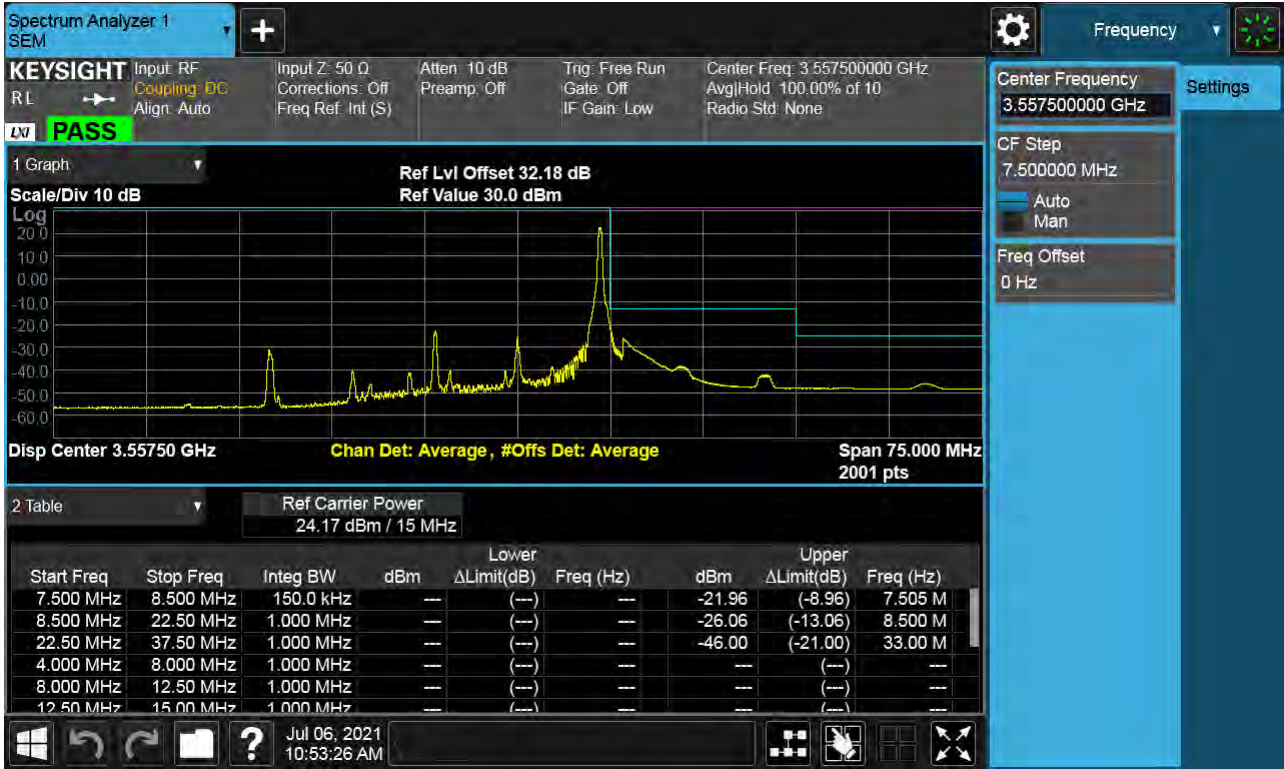

BAND 48. 15M_BandEdge(Center)_Mid_3625MHz_QPSK_FullIRB



BAND 48. 15M_BandEdge(Lower)_Mid_3625MHz_QPSK_1RB

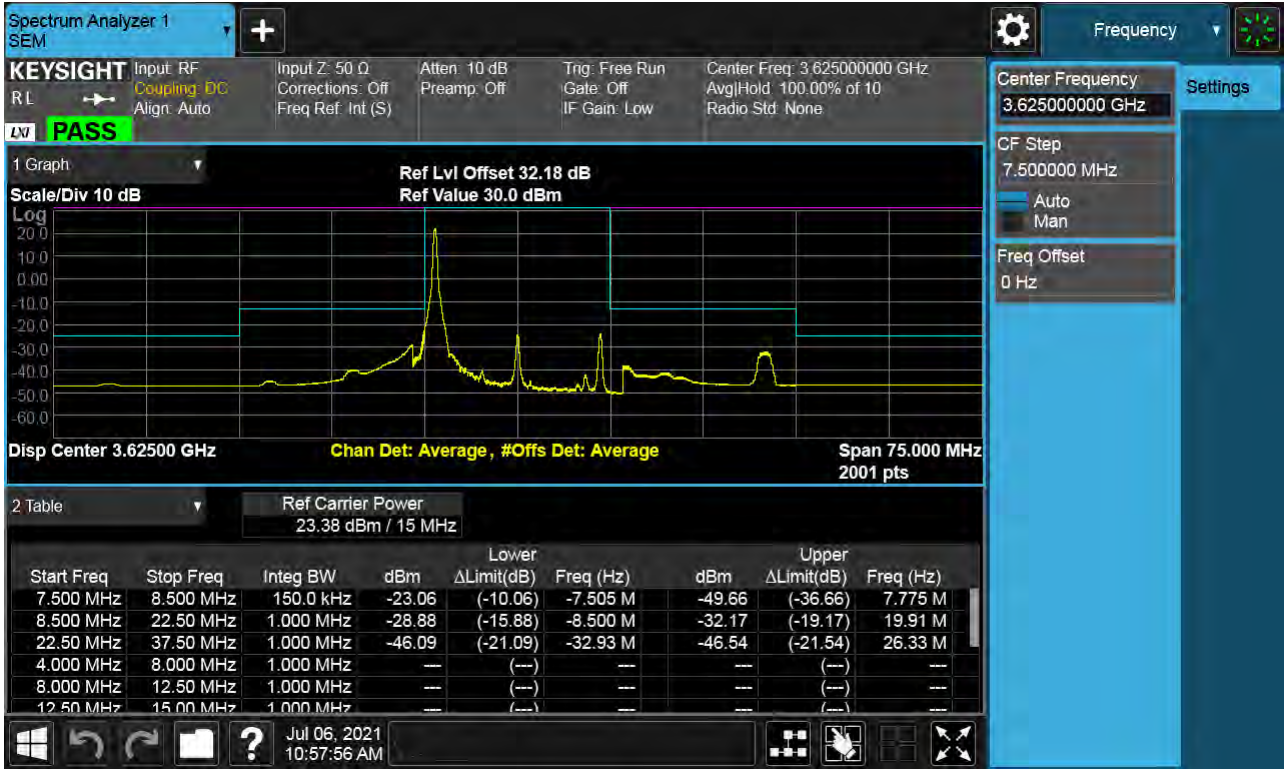

BAND 48. 15M_BandEdge(Upper)_Mid_3625MHz_QPSK_1RB

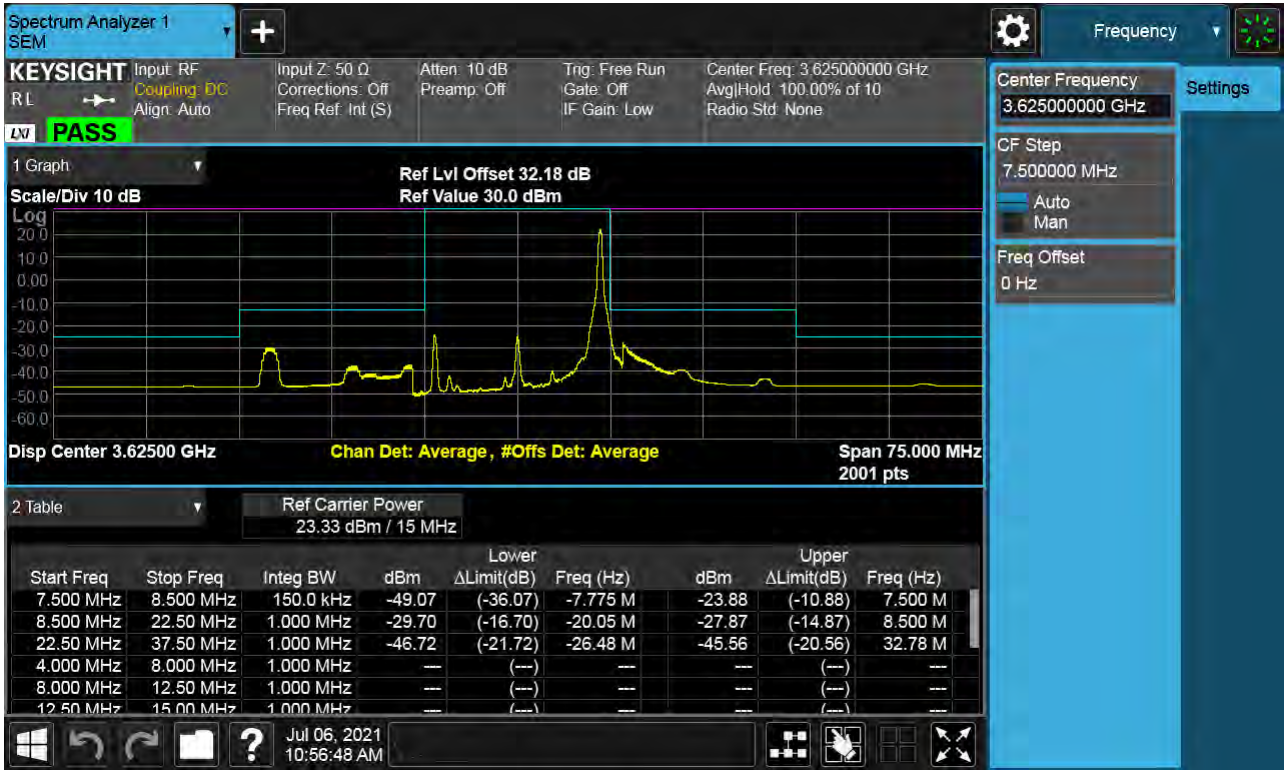

BAND 48. 15M_BandEdge(Lower)_High_3692.5MHz_QPSK_FullIRB

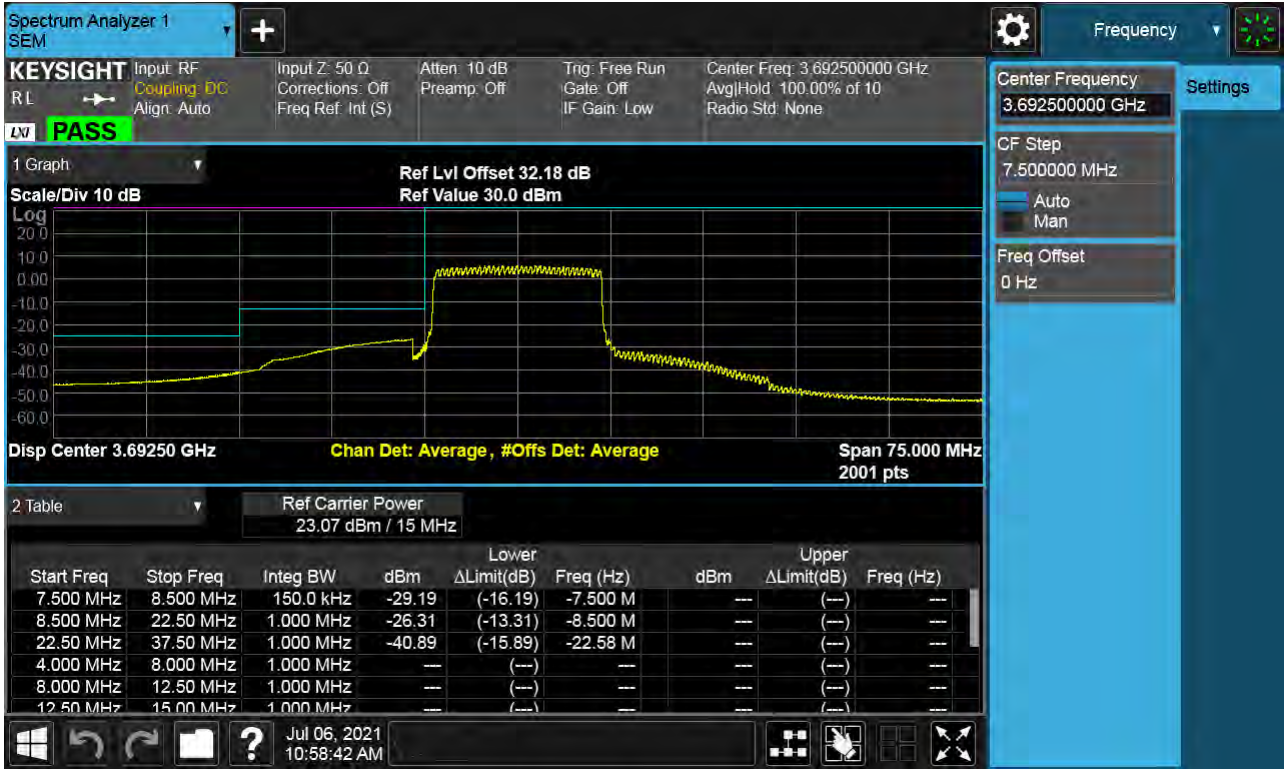

BAND 48. 15M_BandEdge(Upper)_High_3692.5MHz_QPSK_FullIRB

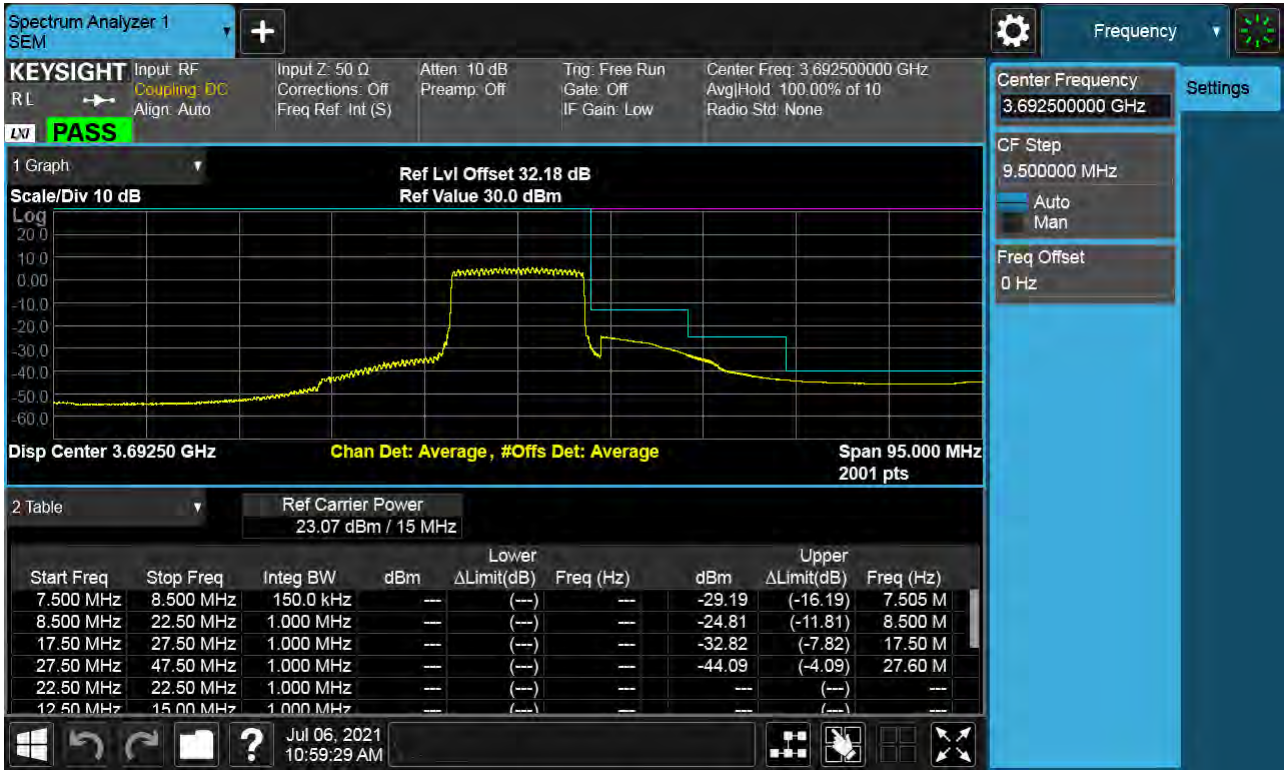

BAND 48. 15M_BandEdge(Lower)_High_3692.5MHz_QPSK_1RB

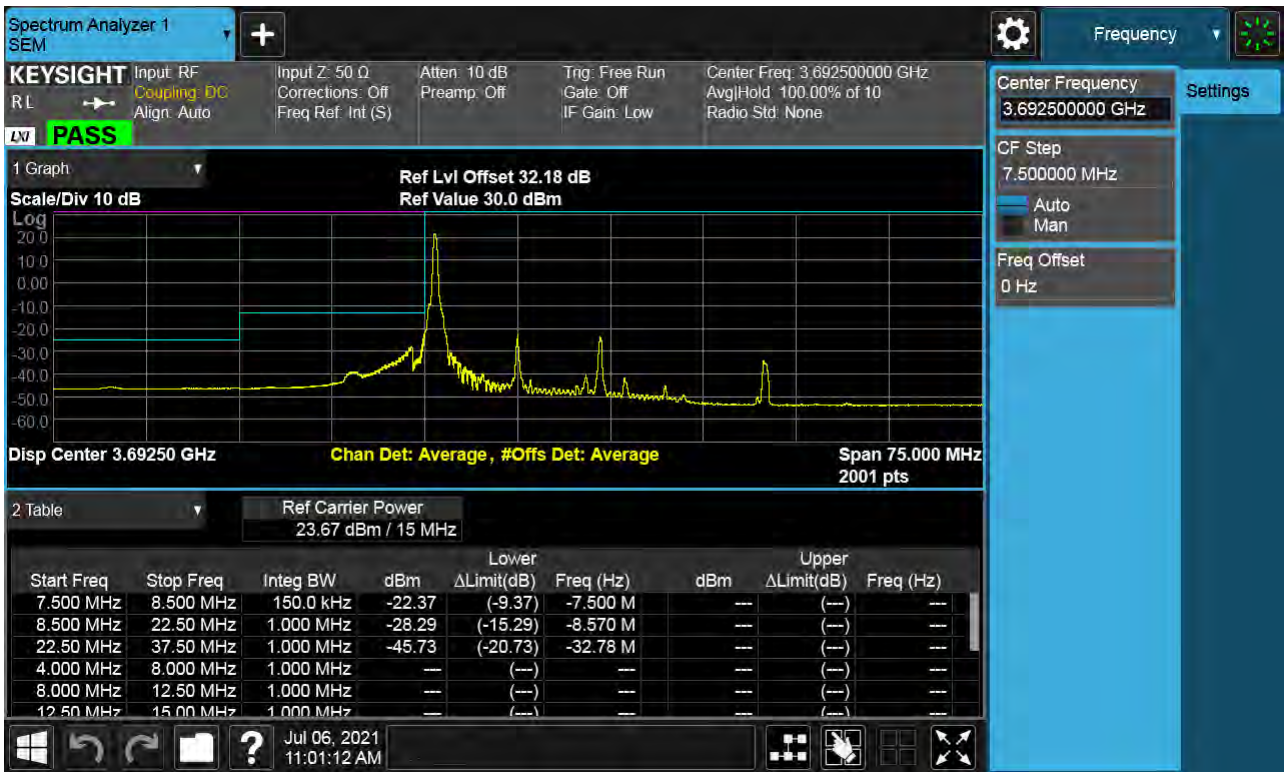

BAND 48. 15M_BandEdge(Upper)_High_3692.5MHz_QPSK_1RB

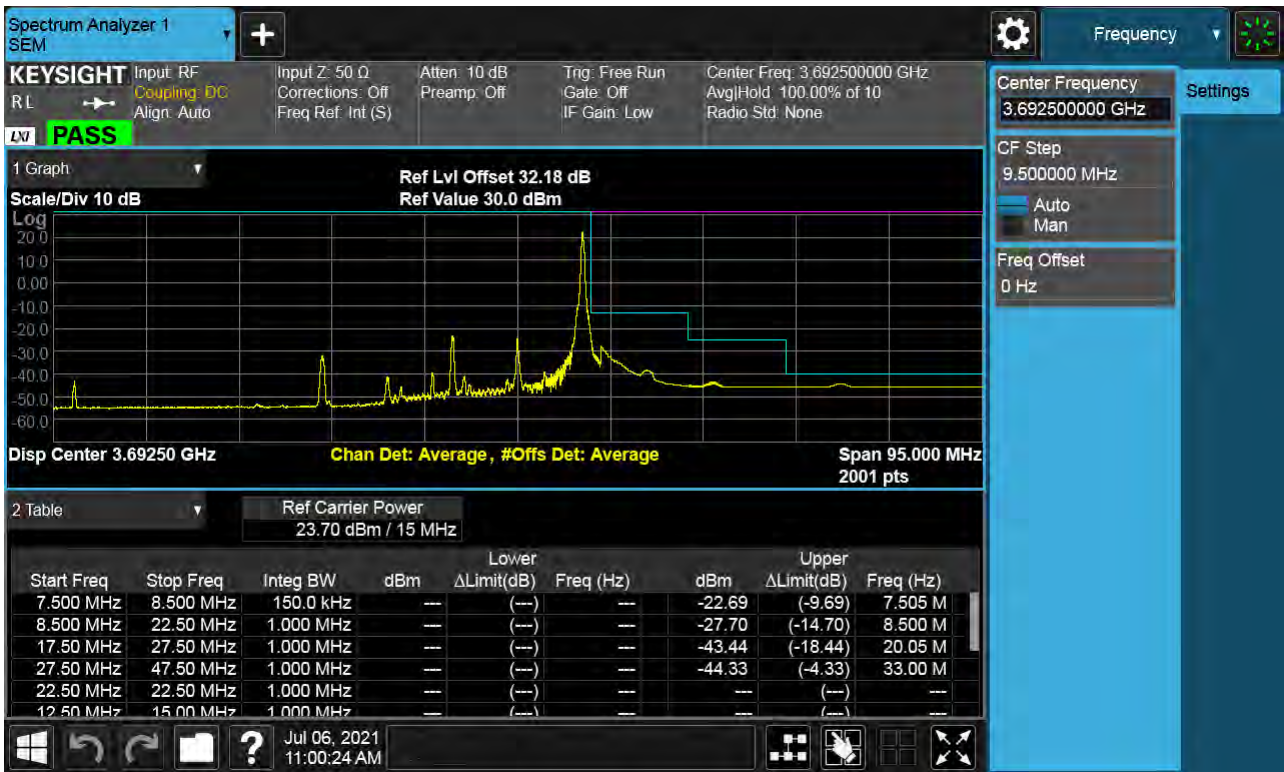

BAND 48. 20M_BandEdge(Lower)_Low_3560MHz_QPSK_FullIRB



BAND 48. 20M_BandEdge(Upper)_Low_3560MHz_QPSK_FullIRB

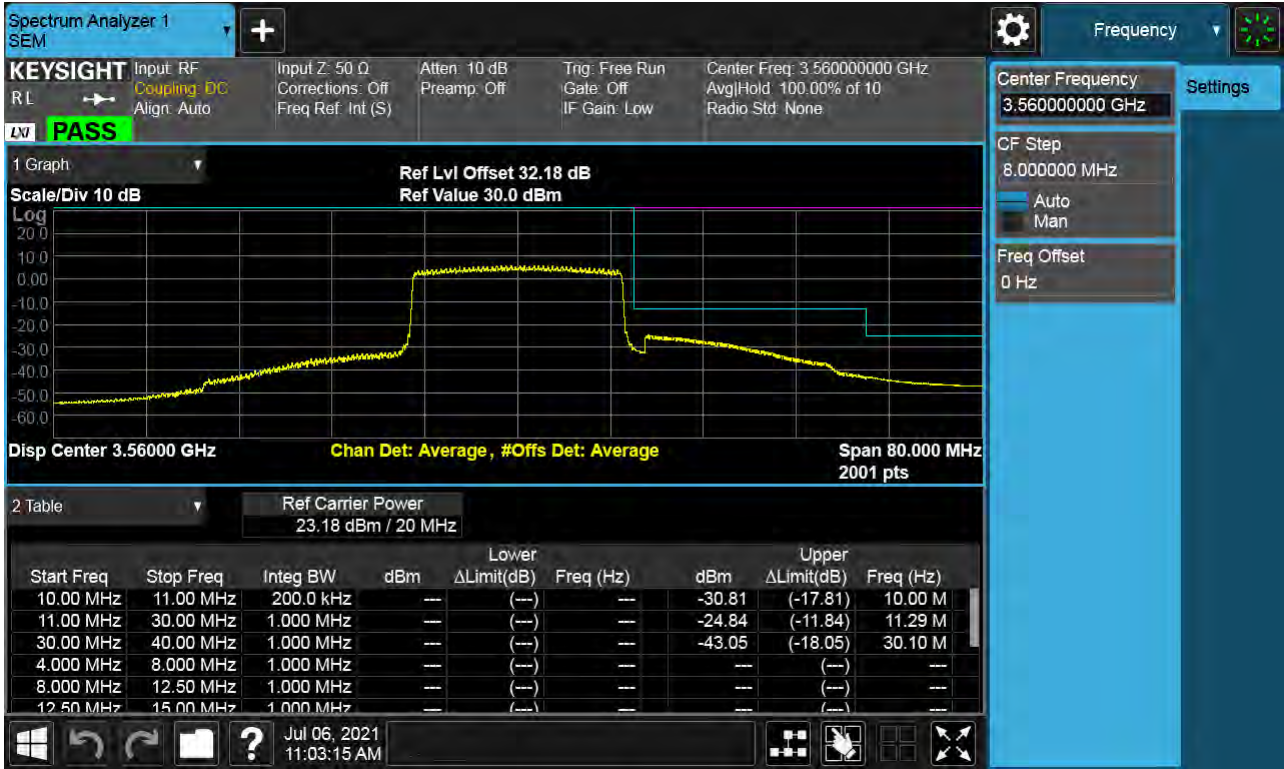

BAND 48. 20M_BandEdge(Lower)_Low_3560MHz_QPSK_1RB

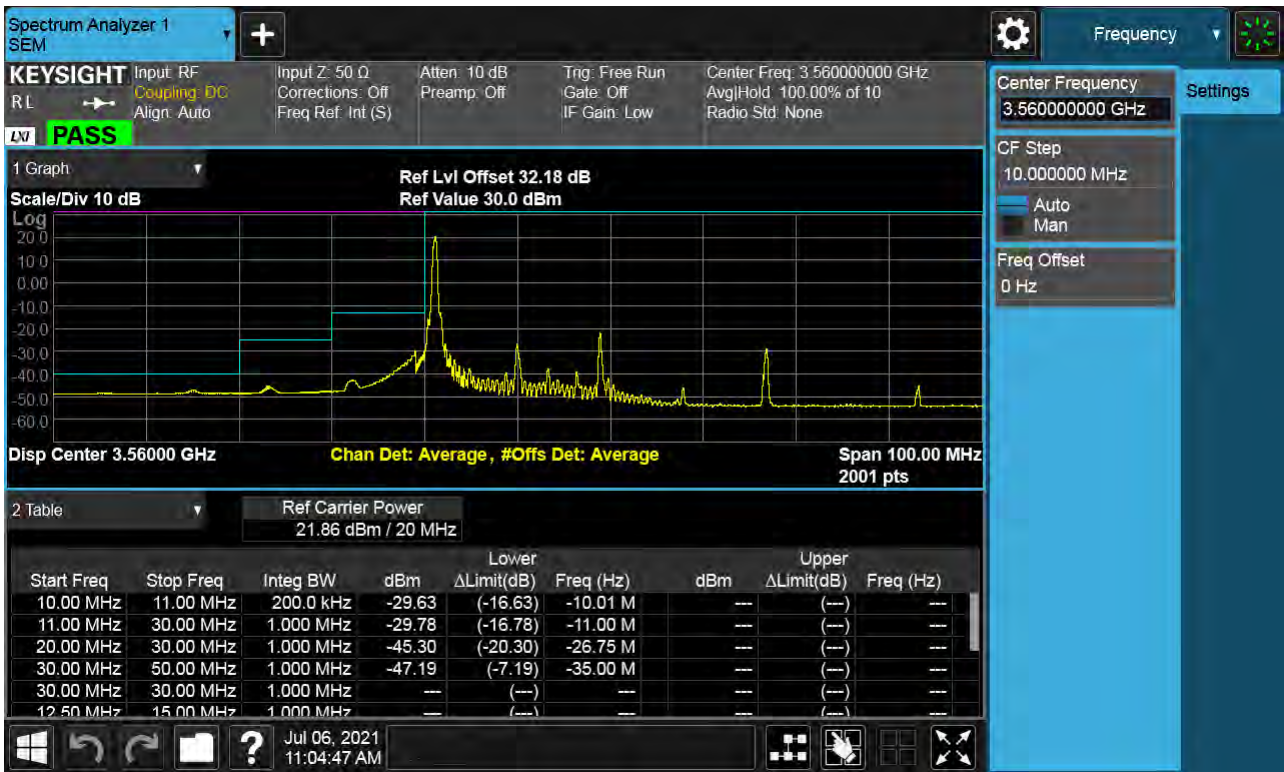

BAND 48. 20M_BandEdge(Upper)_Low_3560MHz_QPSK_1RB

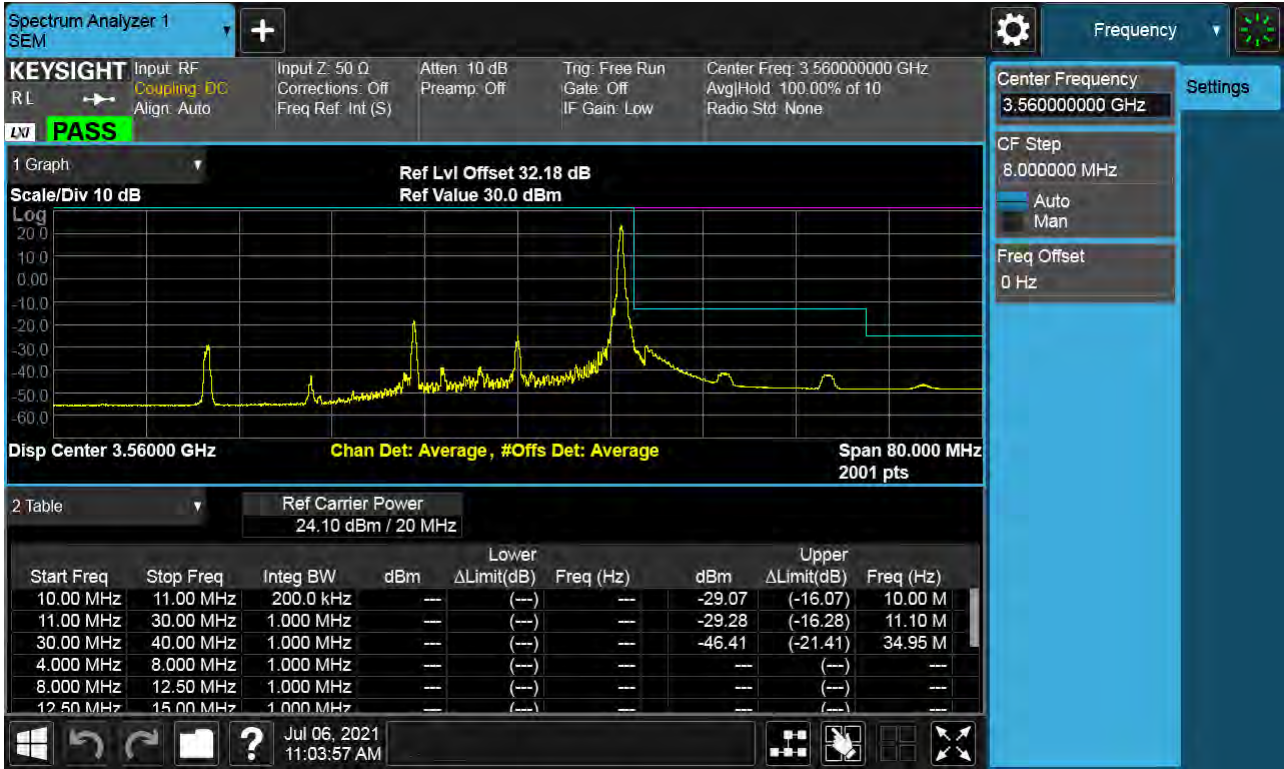

BAND 48. 20M_BandEdge(Center)_Mid_3625MHz_QPSK_FullIRB

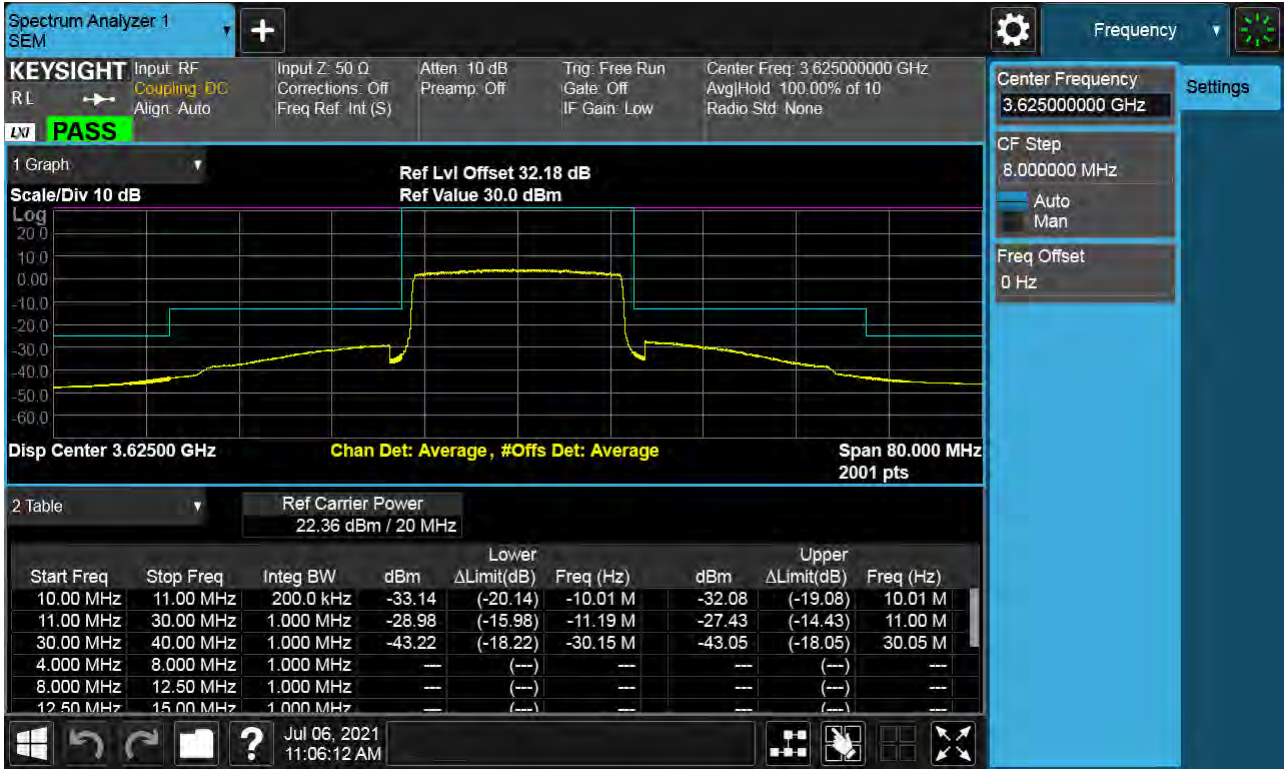

BAND 48. 20M_BandEdge(Lower)_Mid_3625MHz_QPSK_1RB

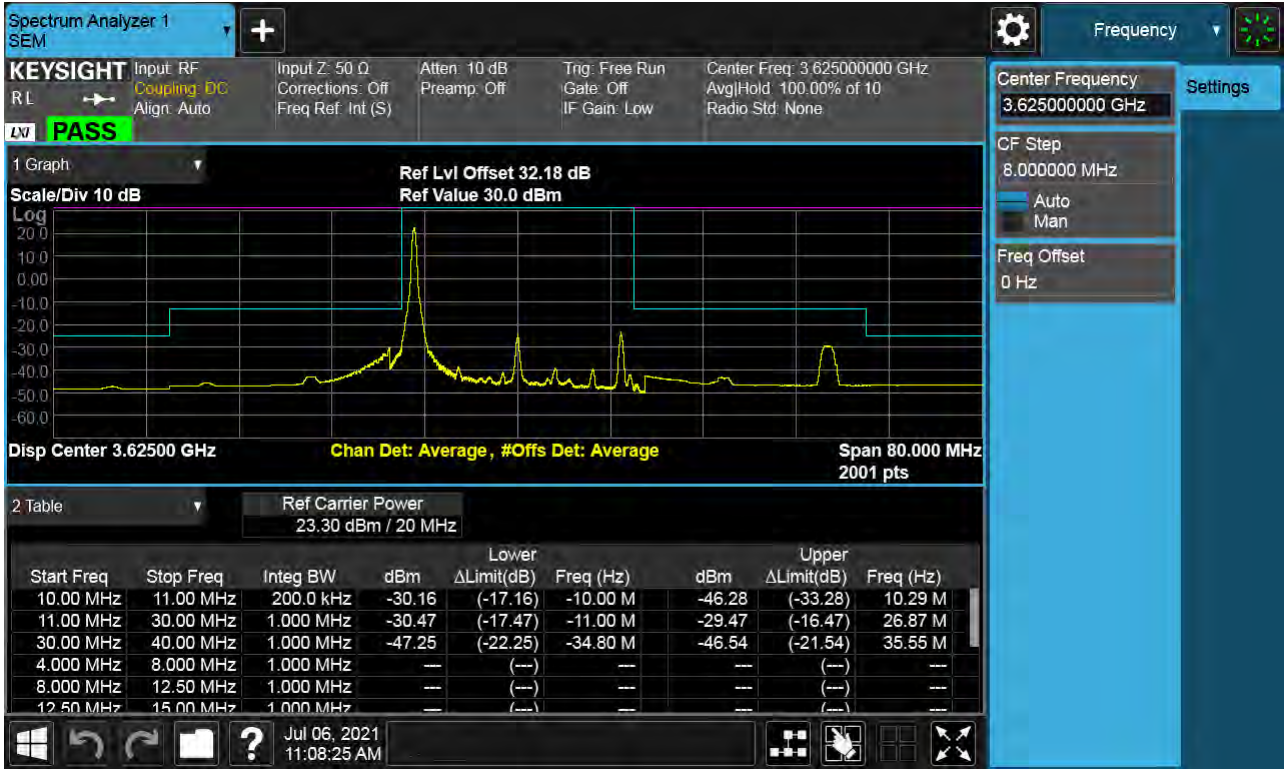

BAND 48. 20M_BandEdge(Upper)_Mid_3625MHz_QPSK_1RB

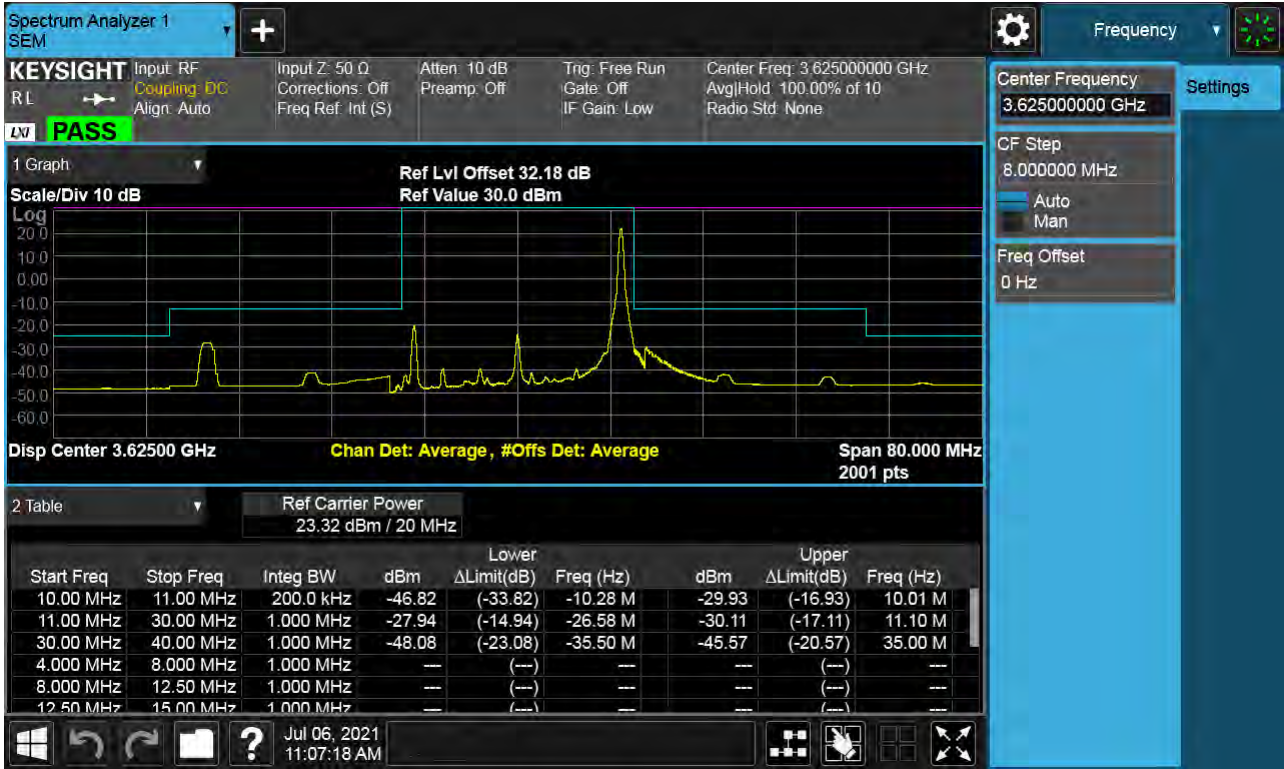

BAND 48. 20M_BandEdge(Lower)_High_3690MHz_QPSK_FullIRB

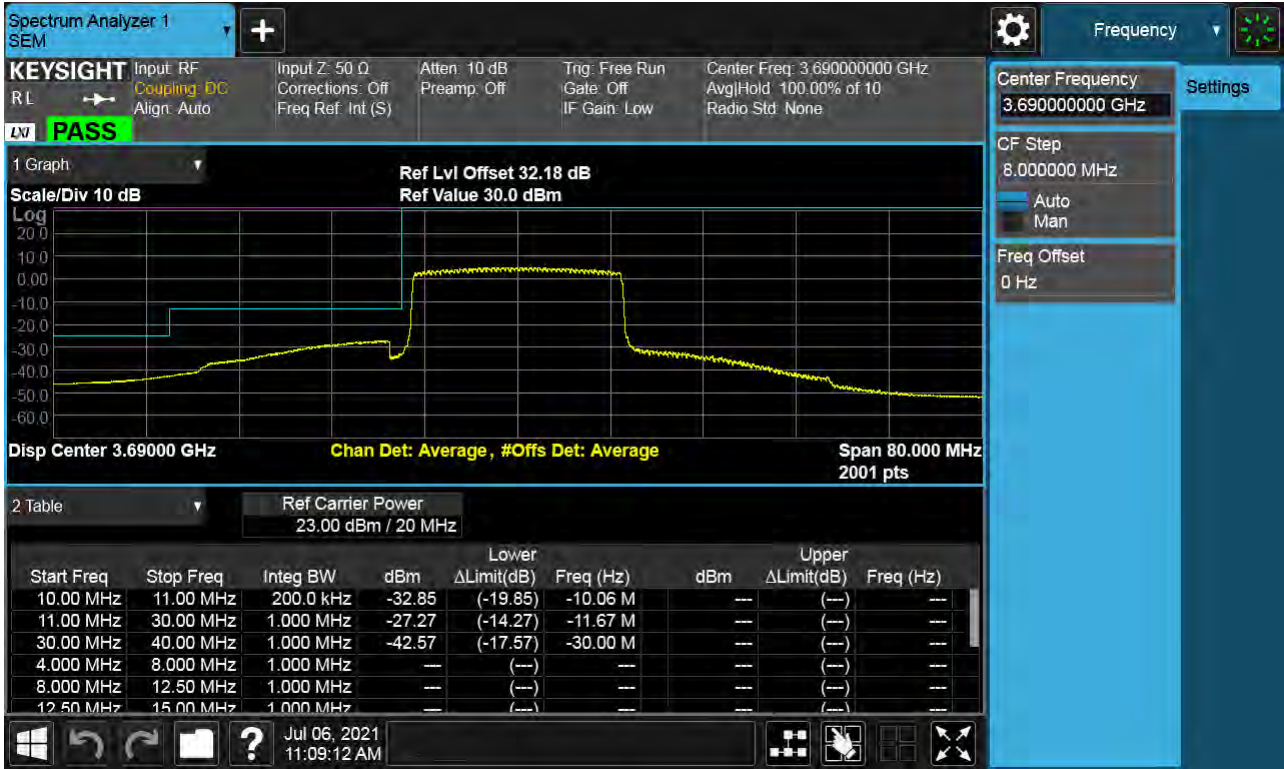

BAND 48. 20M_BandEdge(Upper)_High_3690MHz_QPSK_FullIRB



BAND 48. 20M_BandEdge(Lower)_High_3690MHz_QPSK_1RB

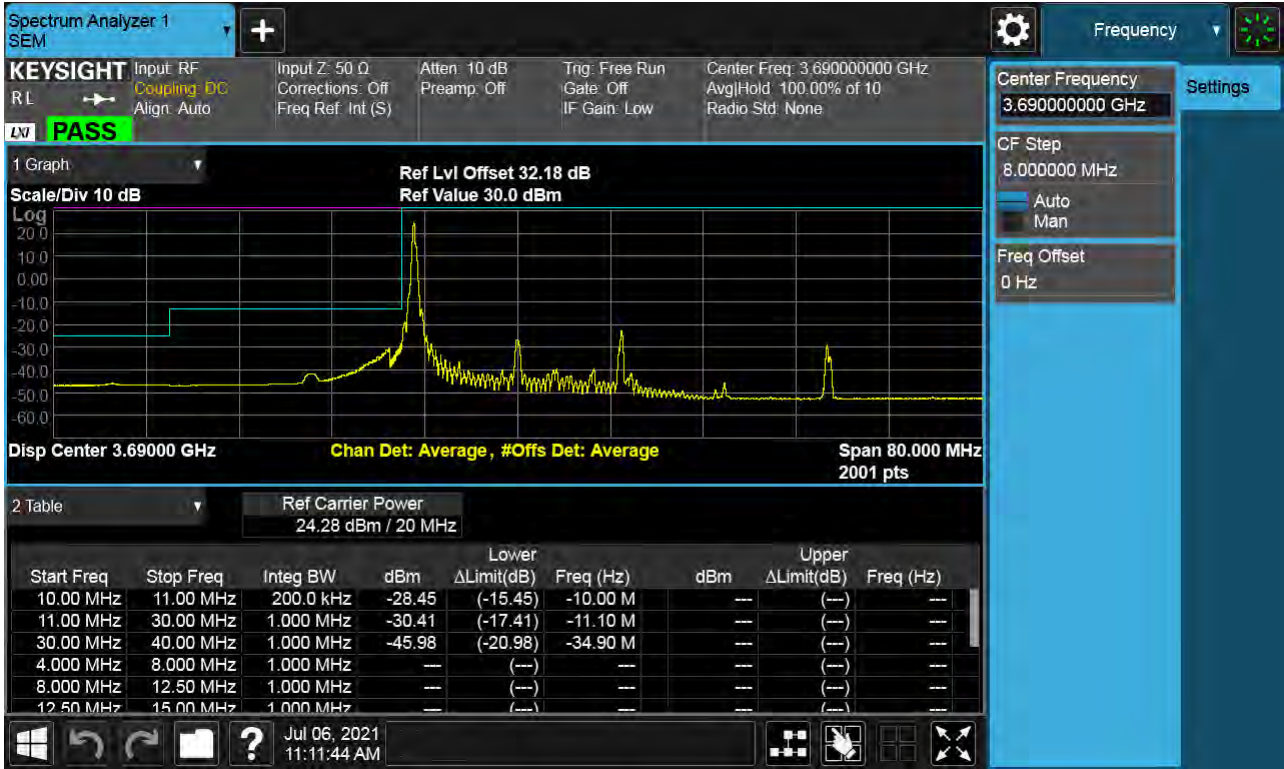

BAND 48. 20M_BandEdge(Upper)_High_3690MHz_QPSK_1RB

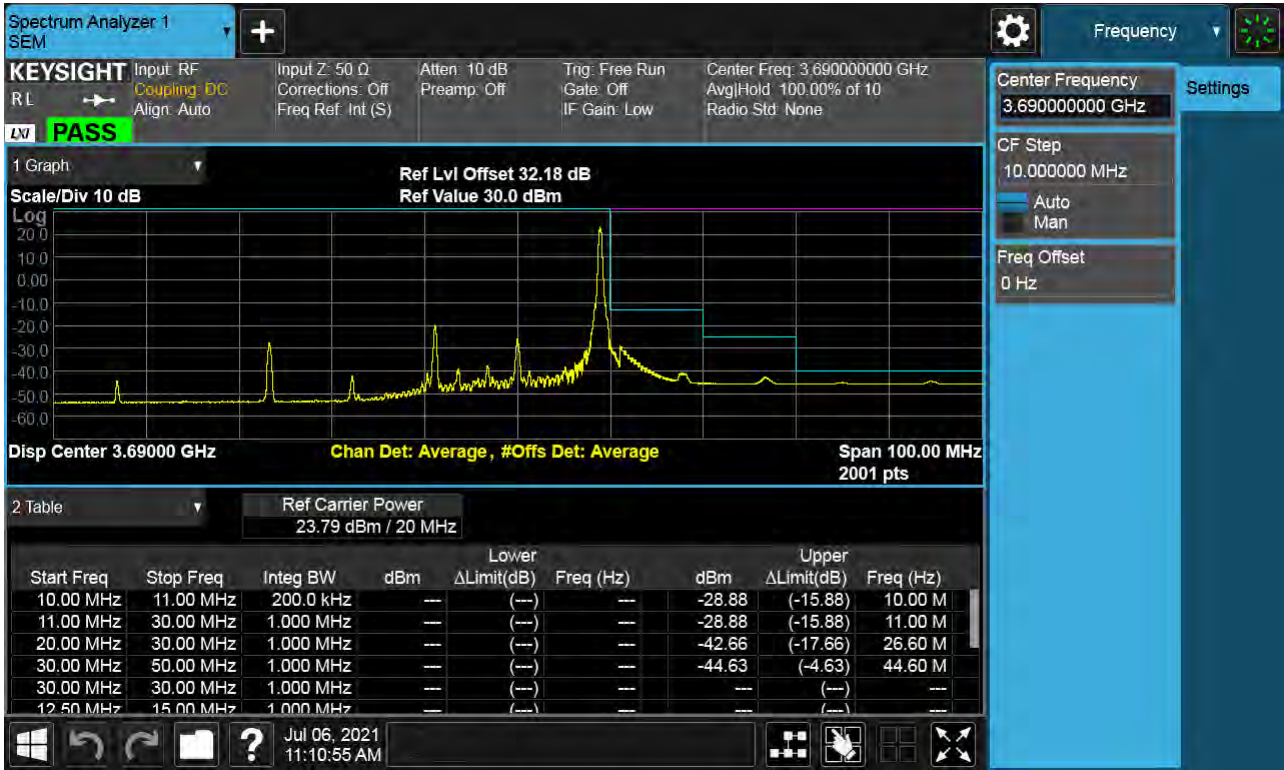

BAND 48. Conducted Spurious Plot 1 (5 MHz Ch.55265 QPSK RB 1, Offset 0)

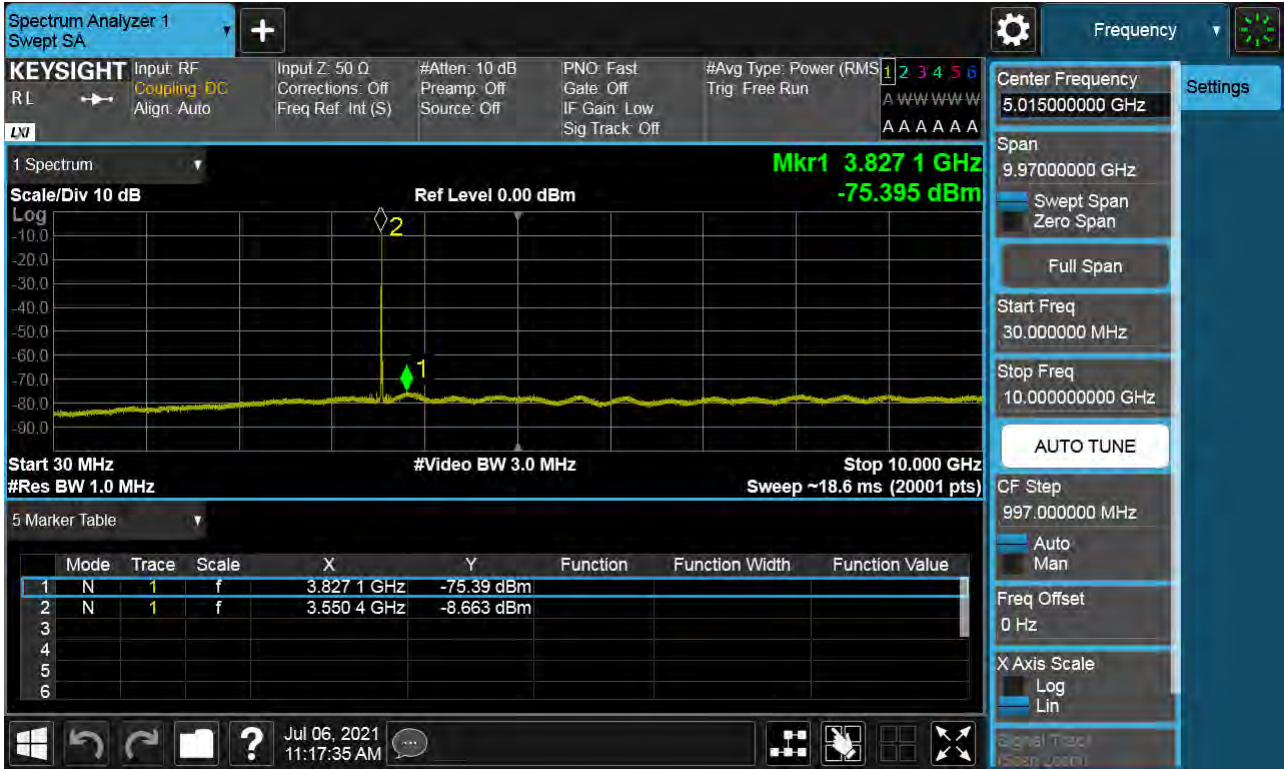

BAND 48. Conducted Spurious Plot 2 (5 MHz Ch. 55265 QPSK RB 1, Offset 0)



BAND 48. Conducted Spurious Plot 1 (5 MHz Ch.5590 QPSK RB 1, Offset 0)



BAND 48. Conducted Spurious Plot 2 (5 MHz Ch. 55990 QPSK RB 1, Offset 0)



BAND 48. Conducted Spurious Plot 1 (5 MHz Ch.56715 QPSK RB 1, Offset 0)



BAND 48. Conducted Spurious Plot 2 (5 MHz Ch.56715 QPSK RB 1, Offset 0)



BAND 48. Conducted Spurious Plot 3 (5 MHz Ch. 56715 QPSK RB 1, Offset 0)

