



Issue Date:

129 Samsung-ro,
Yeongtong-gu, Suwon-Si,
Gyeonggi-Do, 16677
Korea
Tel: 82-31-8062-4341
Fax: 82-31-279-9985

FCC TEST REPORT

Manufacturer: SAMSUNG Electronics Co., Ltd.

Model: SM-G610F/DD, SM-G610F/DS

FCC ID: A3LSMG610F

Application Type: Certification

EUT Type: Portable Handset

All measurements reported here are in accordance with FCC Rules,
47CFR Part2, Part22 and Part24.

Prepared By Date
HJ Jeon
Test Engineer

Checked By Date
CH Kim
Deputy Technical Manager

Authorized By Date
YG Choi
Technical Manager



Revision History

Rev. #	Issue Date	Revisions	Revised By
1		▪ Initial issue	HJ Jeon

– End of this page –



Table of Contents

§2.1033 General Information	4
1. INTRODUCTION	5
1.1. General.....	5
2. PRODUCT INFORMATION	5
2.1. Equipment Description	5
2.2. Device Capabilities	5
3. DESCRIPTION OF TESTS	6
3.1. Evaluation Procedure	6
3.2. Radiated Measurements	6
3.3. EMI Suppression Device(s)/Modifications	6
4. TEST EQUIPMENT LIST	7
5. SAMPLE CALCULATIONS	7
6. TEST RESULTS	9
6.1. Summary	9
6.2. Occupied Bandwidth.....	10
6.3. Spurious and Harmonic Emissions at Antenna Terminal	14
6.4. Band Edge Emissions at Antenna Terminal	40
6.5. Peak-Average Ratio	50
6.6. Frequency Stability / Temperature Variation	53
6.7. Radiated Power (ERP/EIRP).....	57
6.8. Radiated Spurious Emissions Measurements	60
7. CONCLUSION	68

**§2.1033 General Information**

APPLICANT: Samsung Electronics Co., Ltd.

APPLICANT ADDRESS: 129 Samsung-ro,
Yeongtong-gu, Suwon-si, Gyeonggi-do, 16677, Korea

TEST SITE: SAMSUNG Electronics QA Laboratory

TEST SITE ADDRESS: 129 Samsung-ro,
Yeongtong-gu, Suwon-si, Gyeonggi-do, 16677, Korea

FCC RULE PART(S): §2, §22, §24

TEST PROCEDURE(S): ANSI/TIA-603-D-2010, KDB971168 v02r02

BASE MODEL: SM-G610F/DD

VARIANT MODEL: SM-G610F/DS

FCC ID: A3LSMG610F

FCC CLASSIFICATION: PCS Licensed Transmitter Held to Ear (PCE)

MODE: GSM / GRPS / EDGE / WCDMA

EMISSION DESIGNATOR: 240KGXW (GSM850), 240KG7W (EDGE850)
237KGXW (GSM1900), 241KG7W (EDGE1900)
4M12F9W (WCDMA850)
4M19F9W (WCDMA1900)

TX FREQUENCY RANGE 824.2 – 848.8MHz (GSM850, EDGE850)
1850.2 – 1909.8MHz (GSM1900, EDGE1900)
826.4 – 846.6MHz (WCDMA850)
1852.4 – 1907.6MHz (WCDMA1900)

RX FREQUENCY RANGE 869.2 – 893.8MHz (GSM850, EDGE850)
1930.2 – 1989.8MHz (GSM1900, EDGE1900)
871.4 – 891.6MHz (WCDMA850)
1932.4 – 1987.6MHz (WCDMA1900)

MAX POWER RATING: 0.515 W ERP GSM850 (27.12dBm)
0.194 W ERP EDGE850 (22.88 dBm)
0.642 W EIRP GSM1900 (28.08 dBm)
0.400 W EIRP EDGE1900 (26.02 dBm)
0.064 W ERP WCDMA850 (18.04 dBm)
0.142 W EIRP WCDMA1900 (21.51 dBm)

TEST DEVICE SERIAL NO.: FCN-010-A,B,C,D

DATE(S) OF TEST: July 18 – July 29 , 2016



1. INTRODUCTION

1.1. General

These measurement tests were conducted at SAMSUNG Electronics QA Laboratory. The site address is 129 Samsung-ro, Yeongtong-gu, Suwon-si, Gyeonggi-do, 16677, Korea.

2. PRODUCT INFORMATION

2.1. Equipment Description

The Equipment Under Test (EUT) is the Samsung Portable Handset FCC ID: A3LSMG610F. The test data contained in this report pertains only to the emissions due to the EUT's 2G/3G licensed transmitters.

2.2. Device Capabilities

This device contains the following capabilities:

850/1900 GSM/GPRS/EDGE, 850/1900 WCDMA/HSPA, Multi-band LTE, 802.11 b/g/n WLAN, Bluetooth (1x, EDR, LE), ANT+



3. DESCRIPTION OF TESTS

3.1. Evaluation Procedure

The measurement procedures described in the "Land Mobile FM or PM -Communications Equipment-Measurements and Performance Standards" (ANSI/TIA-603-D-2010) and "Measurement Guidance for Certification of Licensed Digital Transmitters" (KDB 971168 v02r02) were used in the measurement of the Samsung Portable Handset FCC ID: A3LSMG610F.

3.2. Radiated Measurements

The radiated and spurious measurements were made at the full anechoic chamber. The equipment under test was placed on the Turn Device at the same height and a distance of 3-meters from the measuring antenna.

The turn device is designed for mobile device measurements. Different sized devices can be mounted on the mounting bracket made of Rohacell.

The turn device is mounted onto a turntable to have both 360° vertical and horizontal rotation. The measurement was made for each horizontal/vertical position in combination with horizontally and vertically polarized measuring antenna at Fully-anechoic chamber, it is equivalent to test in 3-orthogonal planes.

The substitution antenna will replace the EUT antenna at the same position. The frequency of the signal generator shall be set to the frequencies that were measured on the EUT. The output level of the signal generator shall be adjusted until an equal or a known related level that was measured from the EUT. This level was recorded. For emissions above 1 GHz, the above procedure is repeated by using horn antennas and dBi gain is taken into consideration.

The power of the emission is calculated using the following formula:

$$P_{d[\text{dBm}]} = P_{g[\text{dBm}]} - \text{cable loss}_{[\text{dB}]} + \text{antenna gain}_{[\text{dBd,dBi}]}$$

Where P_d is the dipole equivalent power, P_g is the generator output into the substitution antenna, and the antenna gain is the gain of the substitute antenna used relative to either a half-wave dipole(dBd) or an isotropic source(dBi). The cable connects the generator to the substitute antenna and the substitute level is equal to $P_{g[\text{dBm}]} - \text{cable loss}_{[\text{dB}]}$.

Radiated power levels and radiated spurious emissions levels are investigated per ANSI/TIA-603-D-2010.

3.3. EMI Suppression Device(s)/Modifications

No EMI suppression device(s) were added and no modifications were made during testing.



4. TEST EQUIPMENT LIST

The measuring equipment, which was utilized in performing the tests documented herein, has been calibrated in accordance with the manufacturer's recommendations for utilizing calibration equipment, which is traceable to recognized national standards.

Description	Model	Serial No.	Manufacturer	Cal. Date	Cal. Due
Wireless Communications Test Set	E5515C	GB42230535	Agilent	2016-01-08	2017-01-08
Wireless Communications Test Set	E5515C	GB42360886	Agilent	2015-08-21	2016-08-21
PSA Series Spectrum Analyzer	E4440A	MY46187454	Agilent	2016-03-08	2017-03-08
PXA Signal Analyzer	N9030A	MY52350977	Agilent	2015-10-20	2016-10-20
PSG Analog Signal Generator	E8257D	MY51501209	Agilent	2015-11-04	2016-11-04
EPM Series Power Meter	E4419B	GB41293846	Agilent	2015-09-22	2016-09-22
POWER SENSOR	E9300H	MY41495838	Agilent	2015-09-18	2016-09-18
DC Power Supply	E3640A	MY40003595	Agilent	2016-05-09	2017-05-09
Temperature Humidity Chamber	SH-241	92009549	Espec	2015-11-18	2016-11-18
Loop Antenna	HFH2-Z2	100275	R&S	2015-06-04	2017-06-04
DIPOLE ANTENNA	UHA 9105	9105-2412	Schwarzbeck	2015-09-08	2017-09-08
LOG PERIODIC DIPOLE ANTENNA	HL040	353255/020	R&S	2014-10-15	2016-10-15
HORN Antenna	3115	156245	ETS LINDGREN	2015-05-07	2017-05-07
HORN Antenna & Pre-amplifier assembly	HAP18-26N	216249	Flann	2015-12-02	2017-12-02
HORN Antenna & Pre-amplifier assembly	HAP26-40N	216252	Flann	2015-04-30	2017-04-30
PRE-AMPLIFIER	8449B	3008A00691	Agilent	2015-11-25	2016-11-25
RF Power Amplifier	5S1G4	304866	AR	2016-02-12	2017-02-12
Hygrothermograph Data Logger	SK-L200TH2a	5110	SATO	2015-10-26	2016-10-26
Hygrothermograph Data Logger	SK-L200TH2a	5077	SATO	2015-11-06	2016-11-06
Hygrothermograph Data Logger	SK-L200TH2a	5078	SATO	2015-11-06	2016-11-06
Power Divider	11636B	58456	Agilent	2016-04-21	2017-04-21
Highpass filter	WHK3.0/18G-10SS	206	Wainwright	2016-01-06	2017-01-06
Highpass filter	WHV1.0/15G-10SS	39	Wainwright	2016-01-06	2017-01-06
Attenuator 10dB	8491B	MY39264180	Agilent	2016-06-28	2017-06-28
Attenuator 20dB	8493C	74158	Agilent	2015-08-20	2016-08-20
Network Analyzer	8753E	JP38160590	HP	2016-06-24	2017-06-24

Table 4-1 Test Equipment



5. SAMPLE CALCULATIONS

5.1. GSM Emission Designator

Emission Designator = 250KGXW

GSM BW = 250kHz

G = Phase Modulation

X = Cases not otherwise covered

W = Combination (Audio/Data)

5.2. EDGE Emission Designator

Emission Designator = 250KG7W

EDGE BW = 250kHz

G = Phase Modulation

7 = Quantized/Digital Info

W = Combination (Audio/Data)

5.3. WCDMA Emission Designator

Emission Designator = 4M16F9W

WCDMA BW = 4.16MHz

F = Frequency Modulation

9 = Composite Digital Info

W = Combination (Audio/Data) (Measured at the 99.75% power bandwidth)

5.4. Spurious Radiated Emission

Example: Spurious emission at 3700.40MHz

The receive spectrum analyzer reading at 3 meters with the EUT on the turn device was -81.0dBm. The gain of the substituted antenna is 8.1dBi. The signal generator connected to the substituted antenna terminals is adjusted to produce a reading of -81.0dBm on the spectrum analyzer. The loss of the cable between the signal generator and the terminals of the substituted antenna is 2.0dB at 3700.40MHz. So 6.1dB is added to the signal generator reading of -30.9dBm yielding -24.80dBm. The fundamental EIRP was 25.50dBm so this harmonic was 25.50dBm - (-24.80) = 50.3dBc.



6. TEST RESULTS

6.1. Summary

FCC Part Section(s)	Test Description	Test Limit	Test Condition	Test Result	Reference
TRANSMITTER MODE (TX)					
2.1049	Occupied Bandwidth	N/A	CONDUCTED	PASS	Section 6.2
2.1051 22.917(a) 24.238(a)	Conducted Band Edge / Spurious Emissions	$> 43 + 10 \log_{10} (P[\text{Watts}])$ at Band Edge and for all out-of-band emissions		PASS	Sections 6.3, 6.4
24.232(d)	Peak-Average Ratio	$< 13 \text{ dB}$		PASS	Section 6.5
2.1046	Transmitter Conducted Output Power	N/A		PASS	See FCC SAR Report
2.1055 22.355 24.235	Frequency Stability	$< 2.5 \text{ ppm}$ (part 22) Emission must remain in band (Part 24)		PASS	Section 6.6
22.913(a.2)	Effective Radiated Power	$< 7 \text{ Watts max. ERP}$	RADIATED	PASS	Section 6.7
24.232(c)	Equivalent Isotropic Radiated Power	$< 2 \text{ Watts max. EIRP}$		PASS	Section 6.7
2.1053 22.917(a) 24.238(a)	Radiated Spurious Emissions	$> 43 + 10 \log_{10} (P[\text{Watts}])$ for all out-of-band emissions		PASS	Section 6.8

Table 6-1. Summary of Test Results

Notes:

1. All modes of operation and data rates were investigated. The test results shown in the following sections represent the worst case emissions.
2. The analyzer plots shown in this section were all taken with a correction value loaded into the analyzer. The correction value was used to account for the losses of the cables and attenuators used as part of the system to connect the EUT to the analyzer at all frequencies of interest.
3. All antenna port conducted emissions testing was performed on a test bench with the antenna port of the EUT connected to the spectrum analyzer through calibrated cables and attenuators.
4. For conducted spurious emissions, automated test software was used to measure emissions and capture the corresponding plots necessary to show compliance. The measurement software utilized is SAMSUNG Electronics "Measurement Automation System", Version 4.1.11.

6.2. Occupied Bandwidth §2.1049

Test Overview

The Occupied bandwidth, that is the frequency bandwidth such that, below its lower and above its upper frequency limits, the mean powers radiated are each equal to 0.5 percent of the total mean power radiated by a given emission shall be measured. All modes of operation were investigated and the worst case configuration results are reported in this section.

Test Procedure Used

KDB 971168 v02r02 – Section 4.2

Test Settings

1. The signal analyzer's automatic bandwidth measurement capability was used to perform the 99% Occupied bandwidth and the 26dB bandwidth. The bandwidth measurement was not influenced by any intermediate power nulls in the fundamental emission.
2. RBW = 1~5% of the expected OBW
3. VBW $\geq 3 \times$ RBW
4. Detector = Peak
5. Trace mode = max hold
6. Sweep = auto couple
7. The trace was allowed to stabilize
8. If necessary, steps 2~7 were repeated after changing the RBW such that it would be within 1~5% of the 99% occupied bandwidth observed in Step 7

Test Setup

The EUT and measurement equipment were set up as shown in the diagram below.

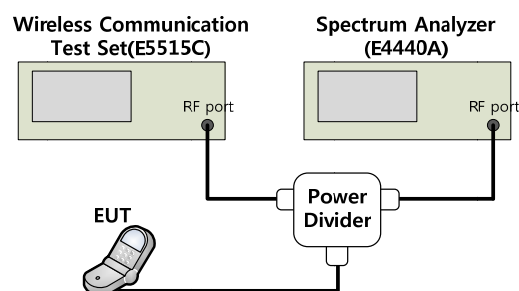
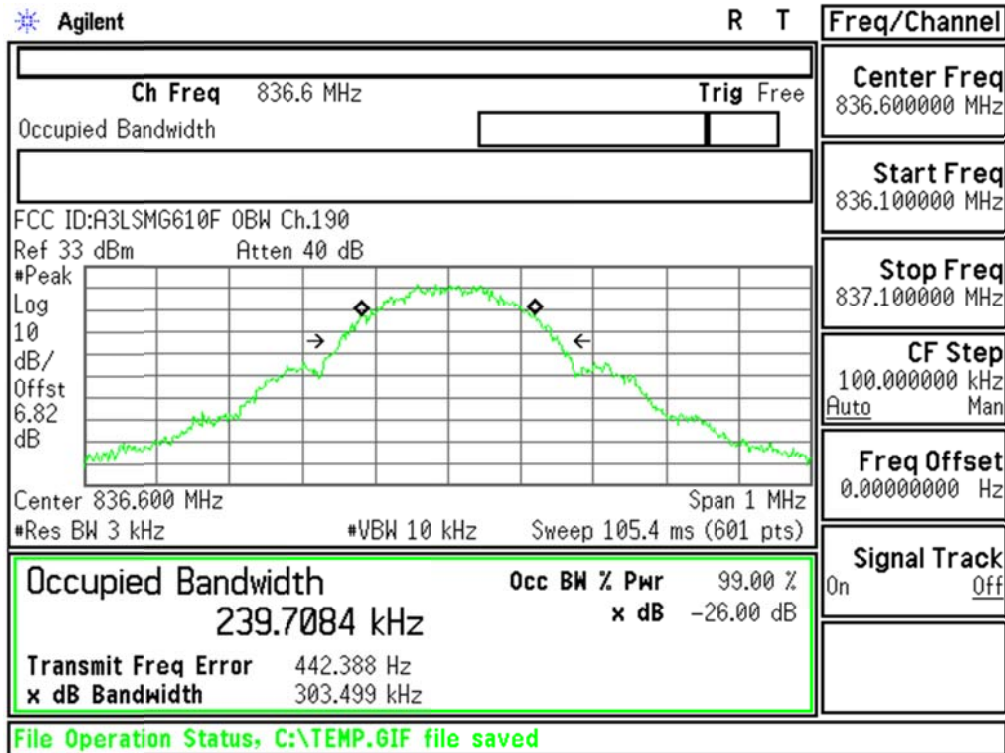

Figure 6-1. Test Instruments & Measurement Setup



Issue Date:

Test Plots



Plot 6-1. Occupied Bandwidth Plot (Cellular GSM Mode - Ch.190)

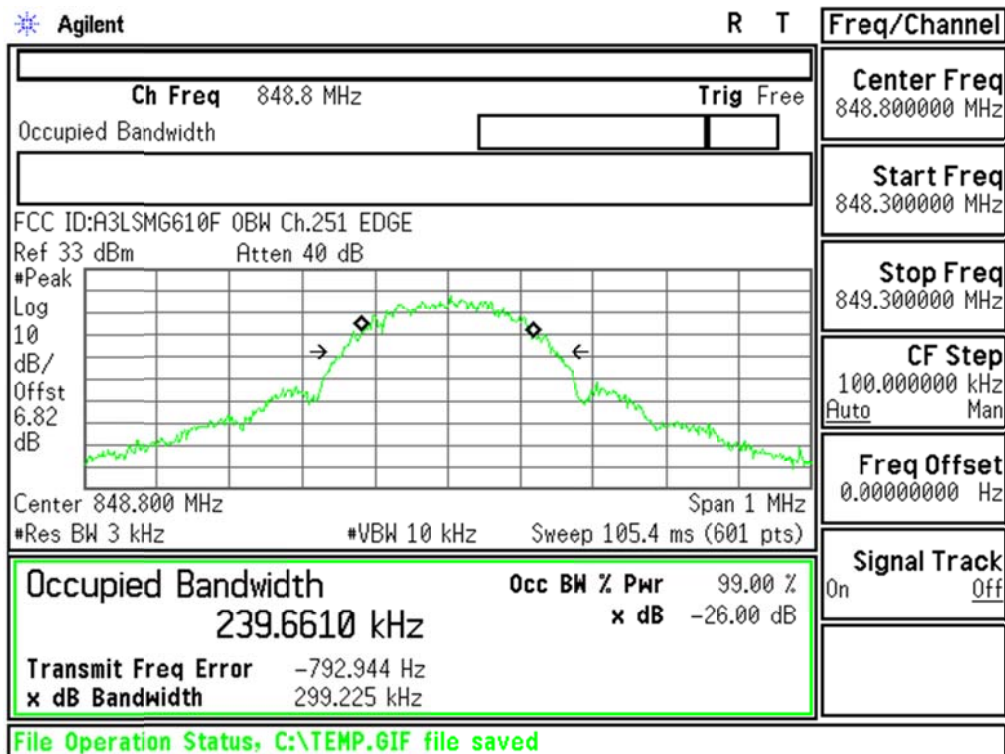

Plot 6-2. Occupied Bandwidth Plot (EDGE850 Mode - Ch.251)



Issue Date:

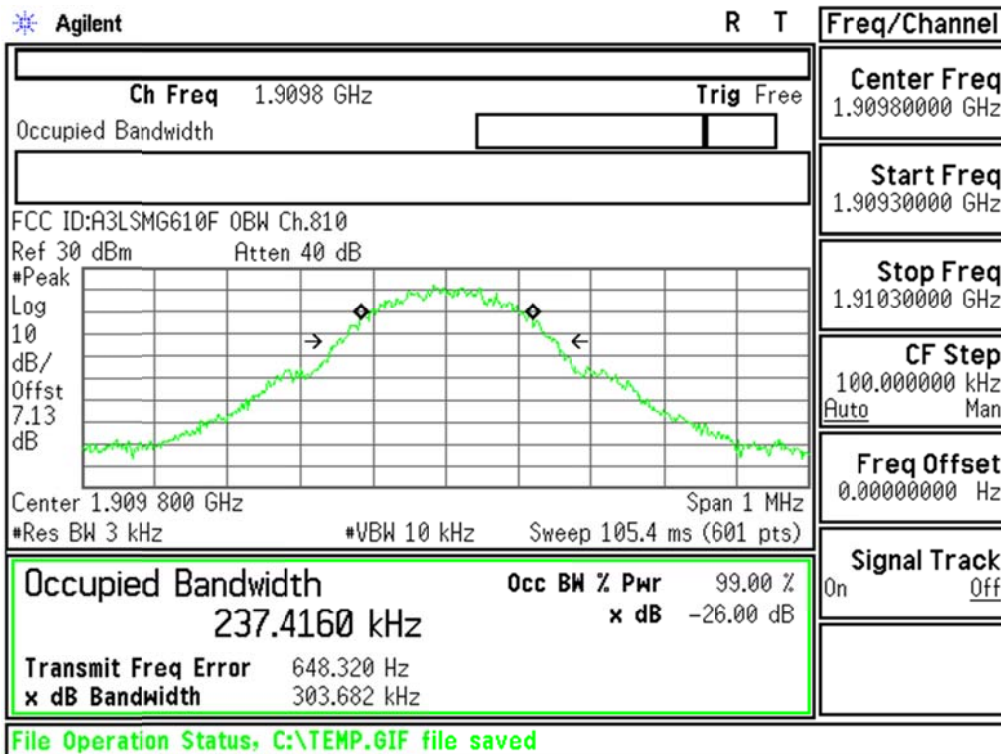

Plot 6-3. Occupied Bandwidth Plot (PCS GSM Mode - Ch.810)

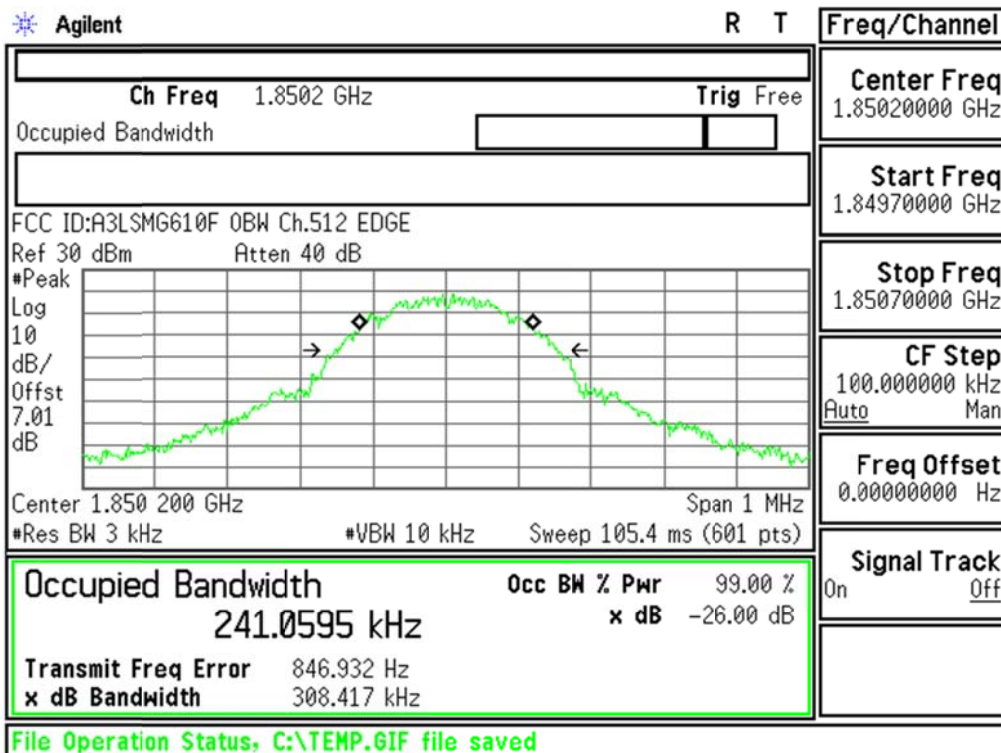

Plot 6-4. Occupied Bandwidth Plot (EDGE1900 Mode - Ch.512)



Issue Date:

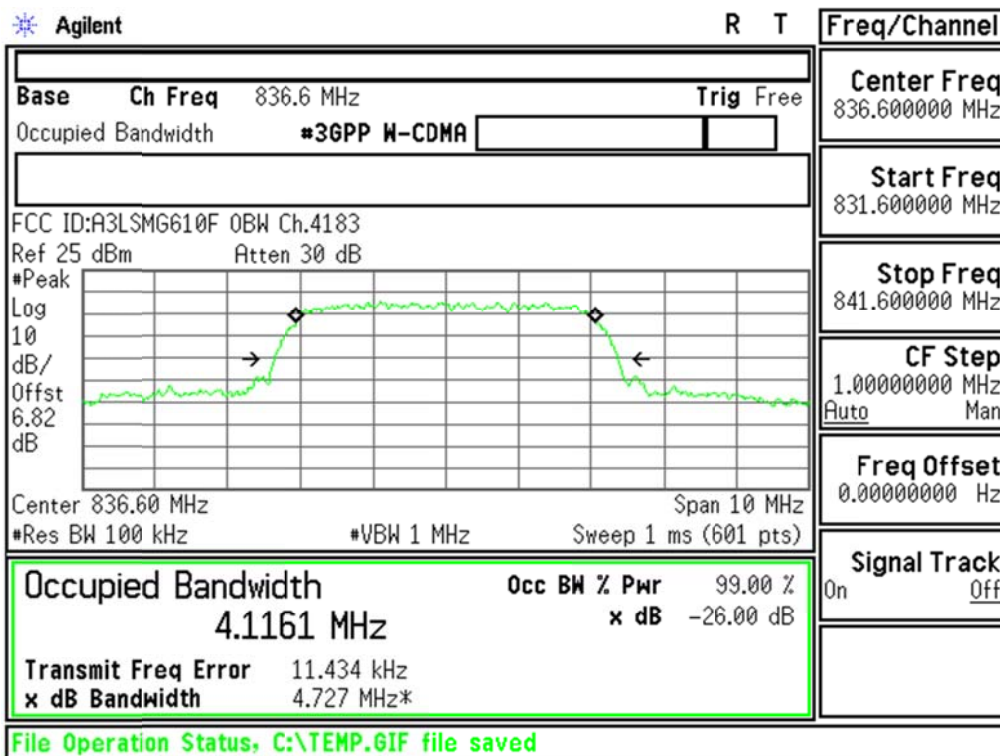

Plot 6-5. Occupied Bandwidth Plot (Cellular WCDMA Mode - Ch.4183(DL4408))

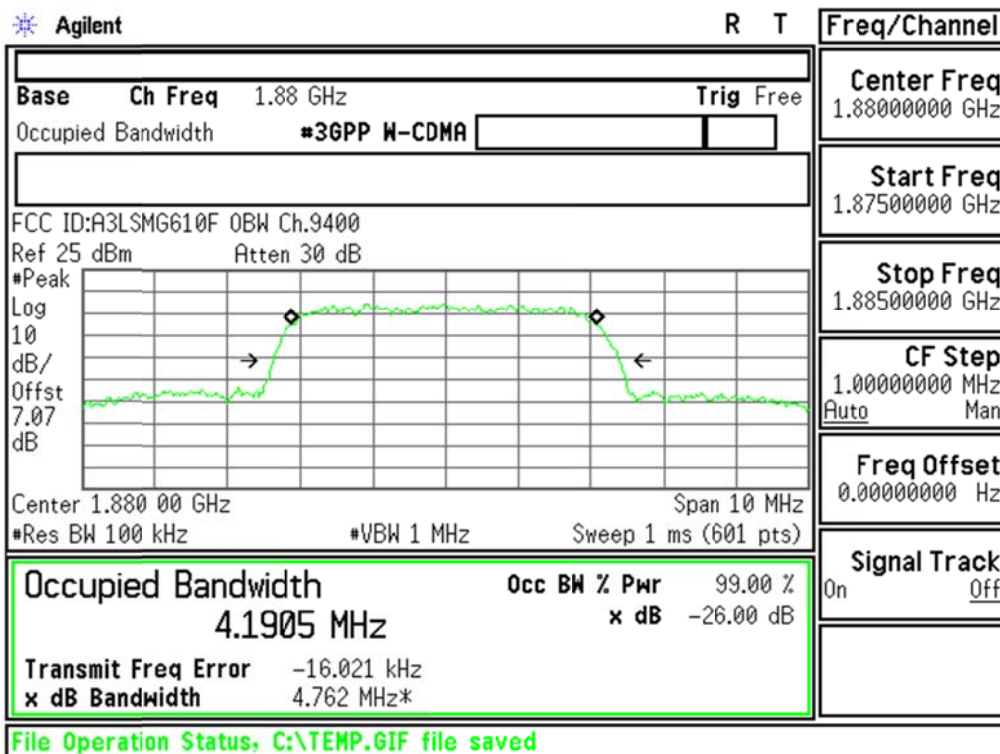

Plot 6-6. Occupied Bandwidth Plot (PCS WCDMA Mode - Ch.9400(DL9800))



6.3. Spurious and Harmonic Emissions at Antenna Terminal
§2.1051 §22.917(a) §24.238(a)

Test Overview

The level of the carrier and the various conducted spurious and harmonic frequencies is measured by means of a calibrated spectrum analyzer. The spectrum is scanned from the lowest frequency generated in the equipment up to a frequency including its 10th harmonic. All out of band emissions are measured with a spectrum analyzer connected to the antenna terminal of the EUT while the EUT is operating at maximum power, and at the appropriate frequencies. All data rates were investigated to determine the worst case configuration. All modes of operation were investigated and the worst case configuration results are reported in this section.

The minimum permissible attenuation level of any spurious emission is $43 + 10 \log_{10}(P_{[Watts]})$, where P is the transmitter power in Watts. Limit equivalent to -13dBm, calculation shown below.

$$\begin{aligned}43 + 10 \log_{10}(1.567W) &= 44.95 \text{ dB} \\1.567W &= 31.95 \text{ dBm} \\31.95 \text{ dBm} - 44.95 \text{ dB} &= -13 \text{ dBm}\end{aligned}$$

Test Procedure Used

KDB 971168 v02r02 – Section 6.0

Test Settings

1. Start frequency was set to 30MHz and stop frequency was set to 12GHz for Cell, 20GHz for PCS (separated into at least two plots per channel)
2. RBW = 1MHz
3. VBW = 3MHz
4. Detector = Max Peak
5. Trace mode = max hold
6. Sweep time = auto couple
7. The trace was allowed to stabilize

Test Setup

The EUT and measurement equipment were set up as shown in the diagram below.

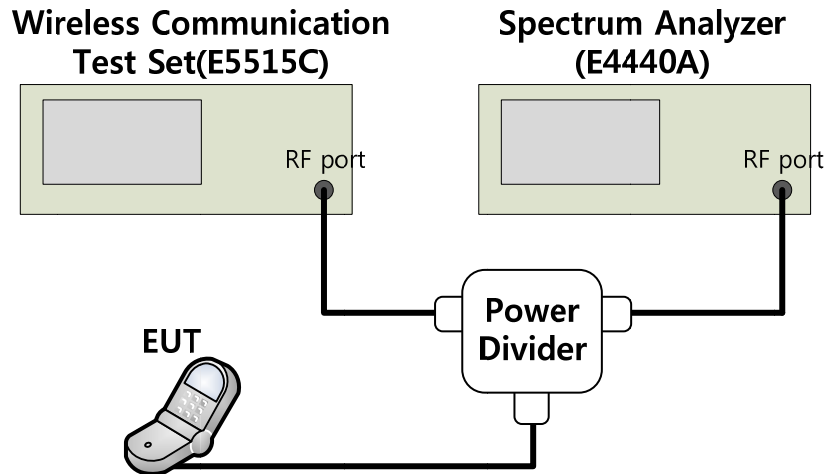

Figure 6-2. Test Instruments & Measurement Setup

Test Notes

1. Compliance with the applicable limits is based on the use of measurement instrumentation employing a resolution bandwidth of 100 kHz or greater for Part 22 and 1 MHz or greater for Part 24. However, in the 1 MHz bands immediately outside and adjacent to the frequency block a resolution bandwidth of at least one percent of the emission bandwidth of the fundamental emission of the transmitter may be employed. The emission bandwidth is defined as the width of the signal between two points, one below the carrier center frequency and one above the carrier center frequency, outside of which all emissions are attenuated at least 26dB below the transmitter power.
2. The offset which applied to above 4GHz frequencies is the worst-case value of the RF path-loss¹ in the frequency range 4GHz to 20GHz.

¹ RF path-loss = EUT output – Spectrum Analyzer input



Issue Date:

Test Plots

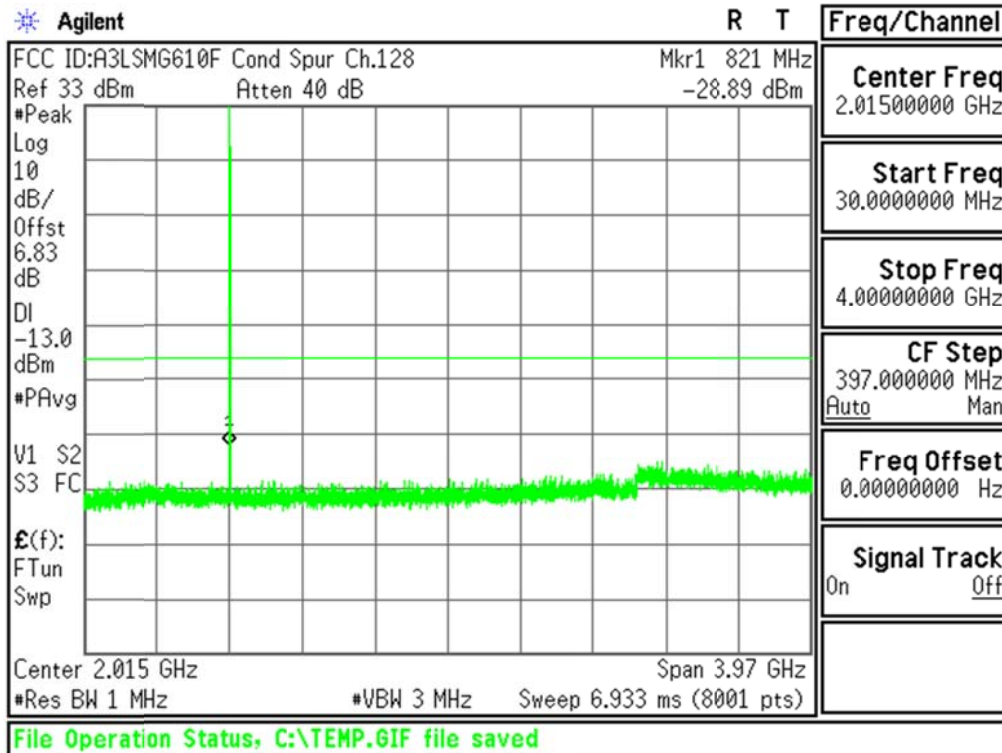

Plot 6-7. Conducted Spurious Plot (Cellular GSM Mode - Ch.128)

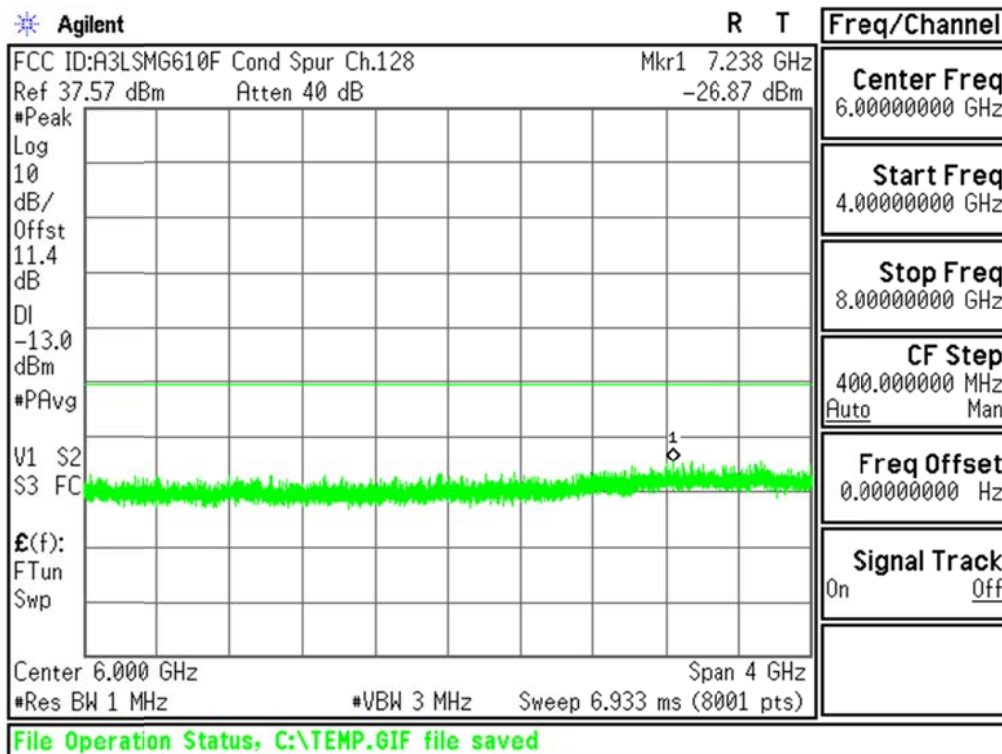

Plot 6-8. Conducted Spurious Plot (Cellular GSM Mode - Ch.128)



Issue Date:

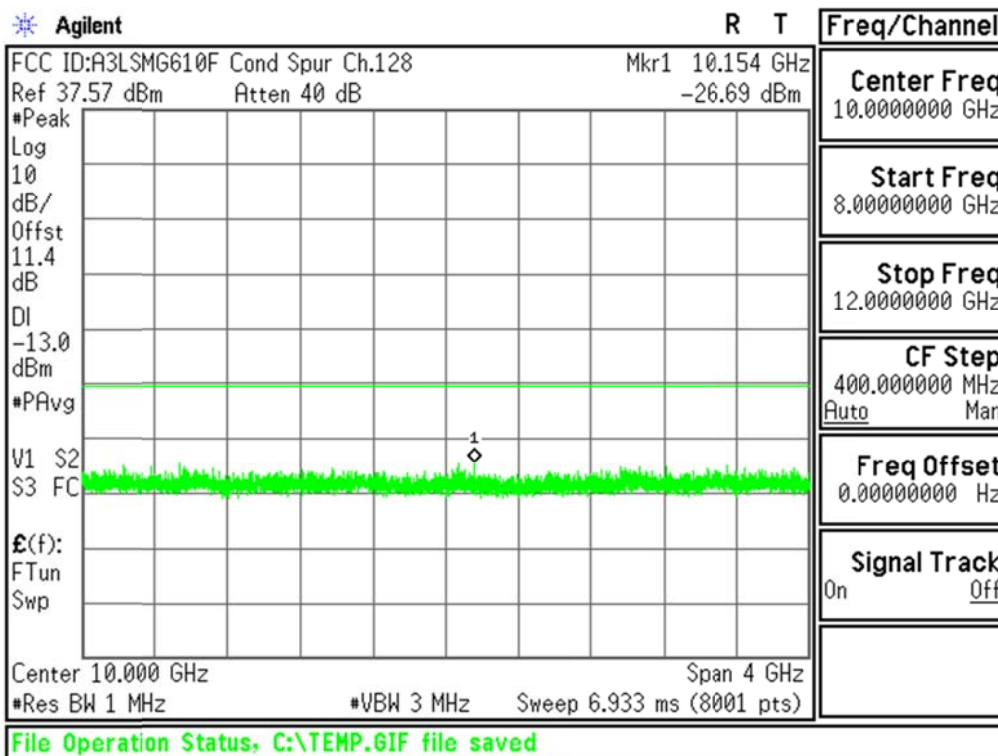

Plot 6-9. Conducted Spurious Plot (Cellular GSM Mode - Ch.128)

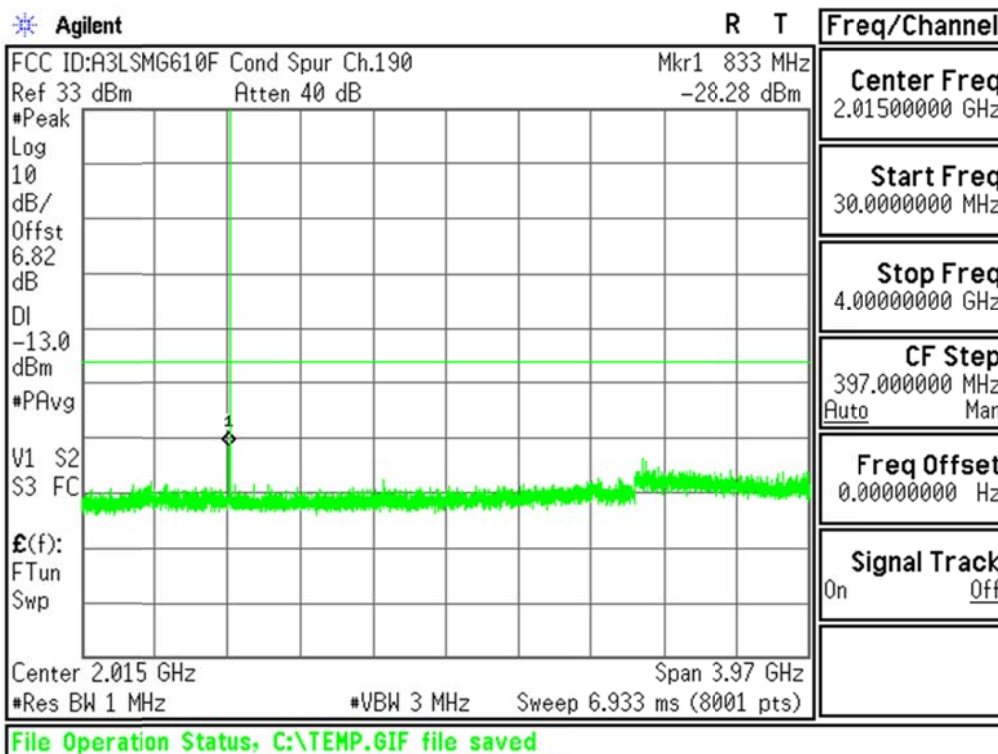

Plot 6-10. Conducted Spurious Plot (Cellular GSM Mode - Ch.190)



Issue Date:

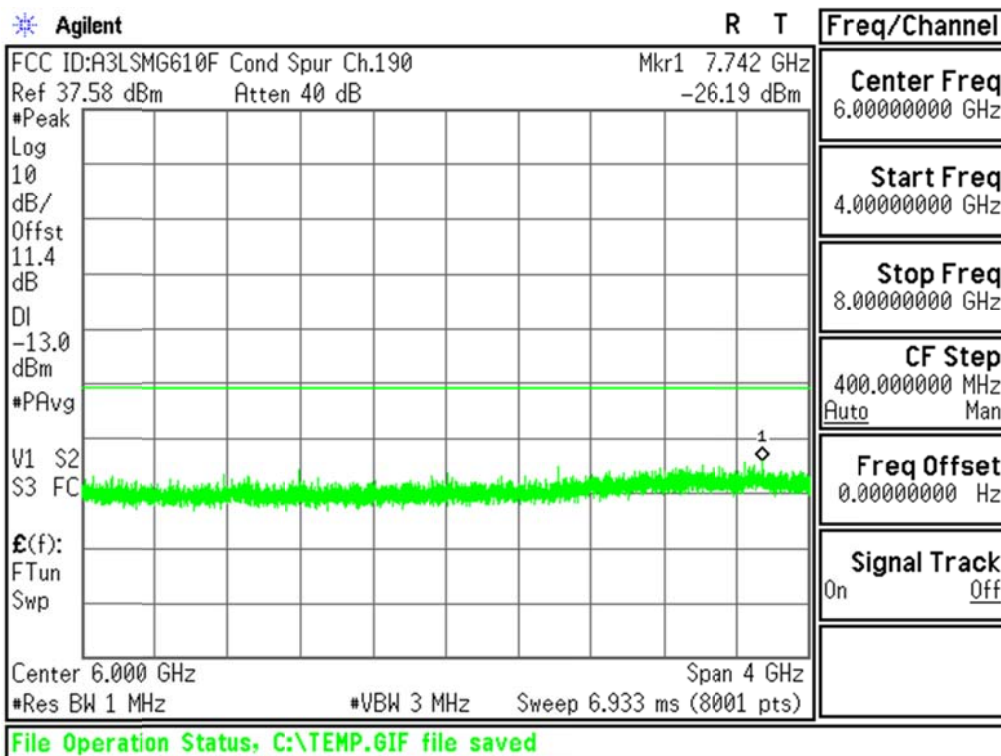

Plot 6-11. Conducted Spurious Plot (Cellular GSM Mode - Ch.190)

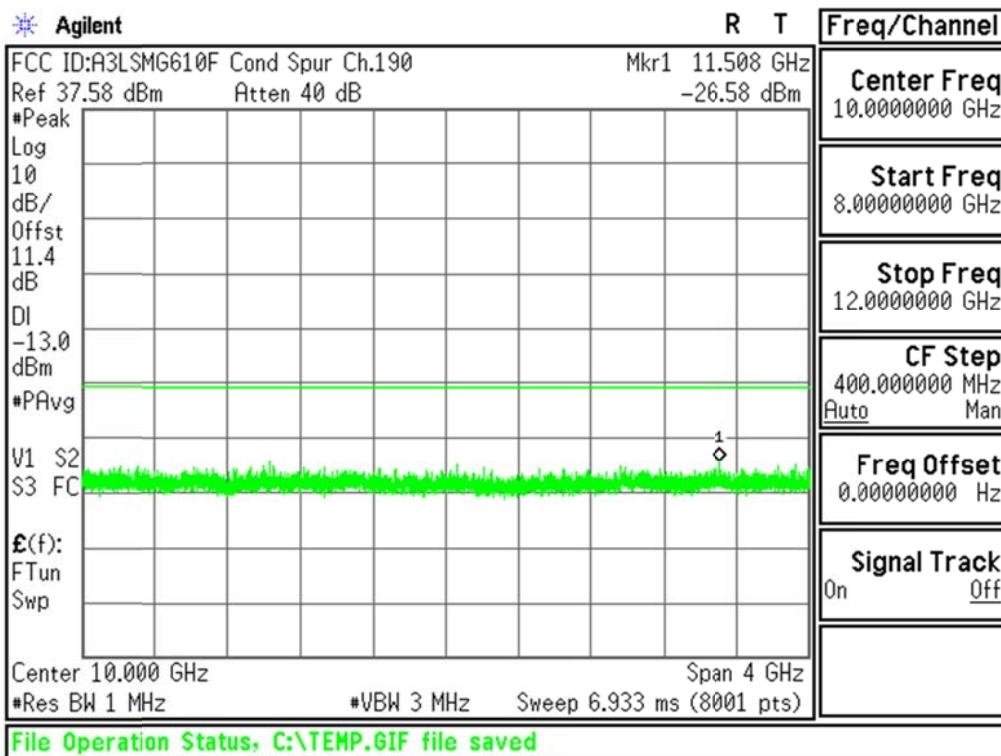

Plot 6-12. Conducted Spurious Plot (Cellular GSM Mode - Ch.190)



Issue Date:

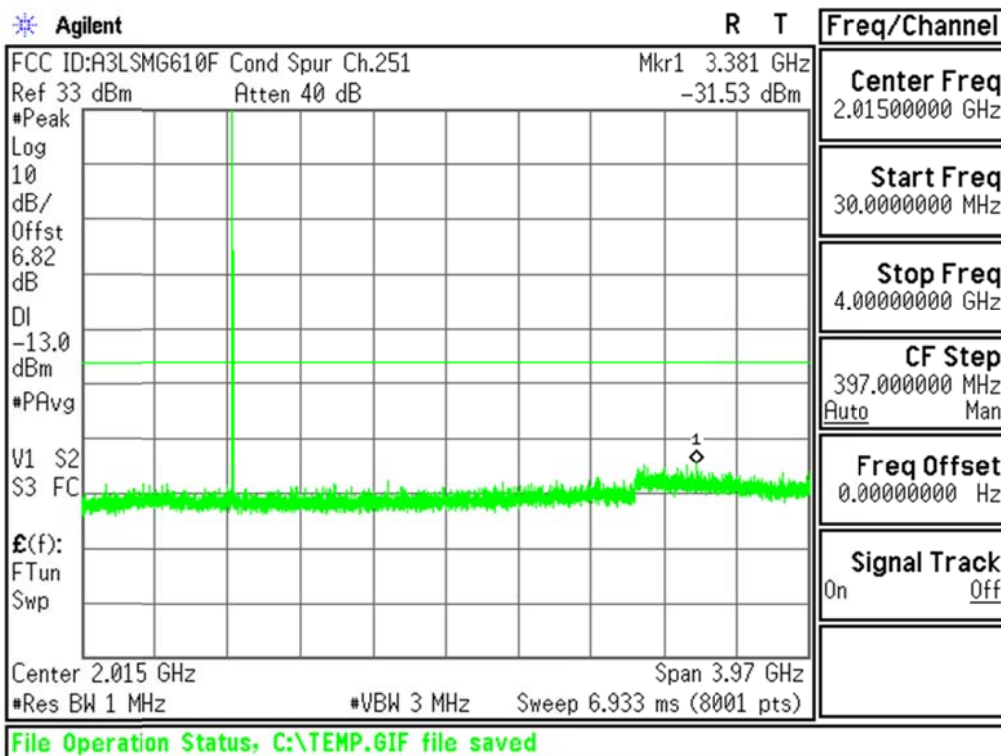

Plot 6-13. Conducted Spurious Plot (Cellular GSM Mode - Ch.251)

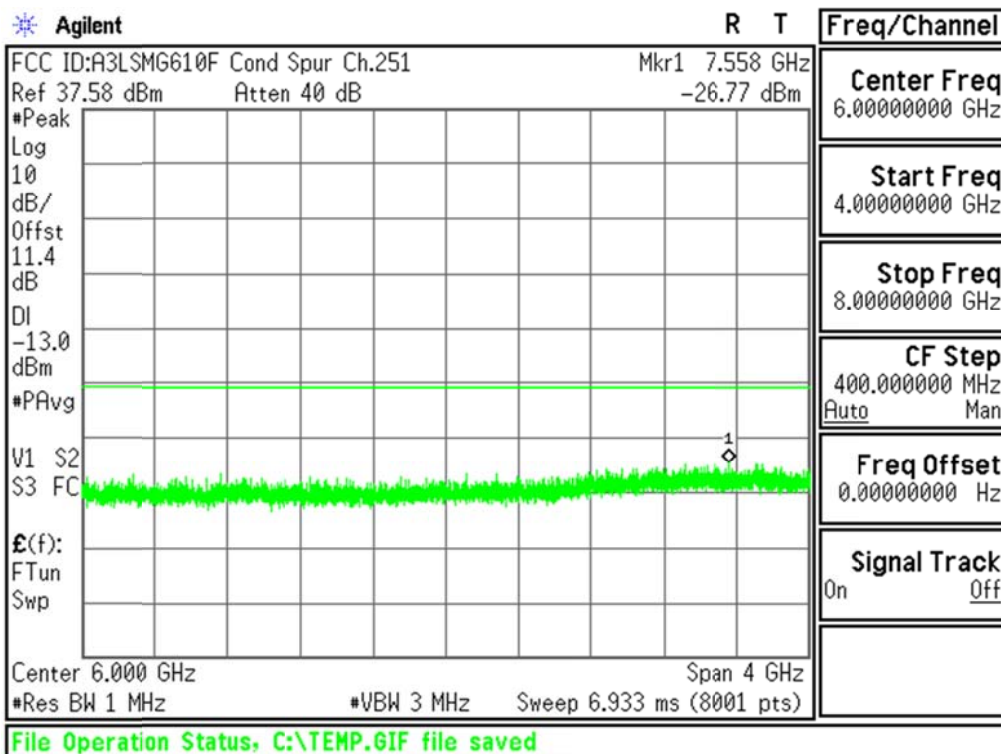

Plot 6-14. Conducted Spurious Plot (Cellular GSM Mode - Ch.251)



Issue Date:

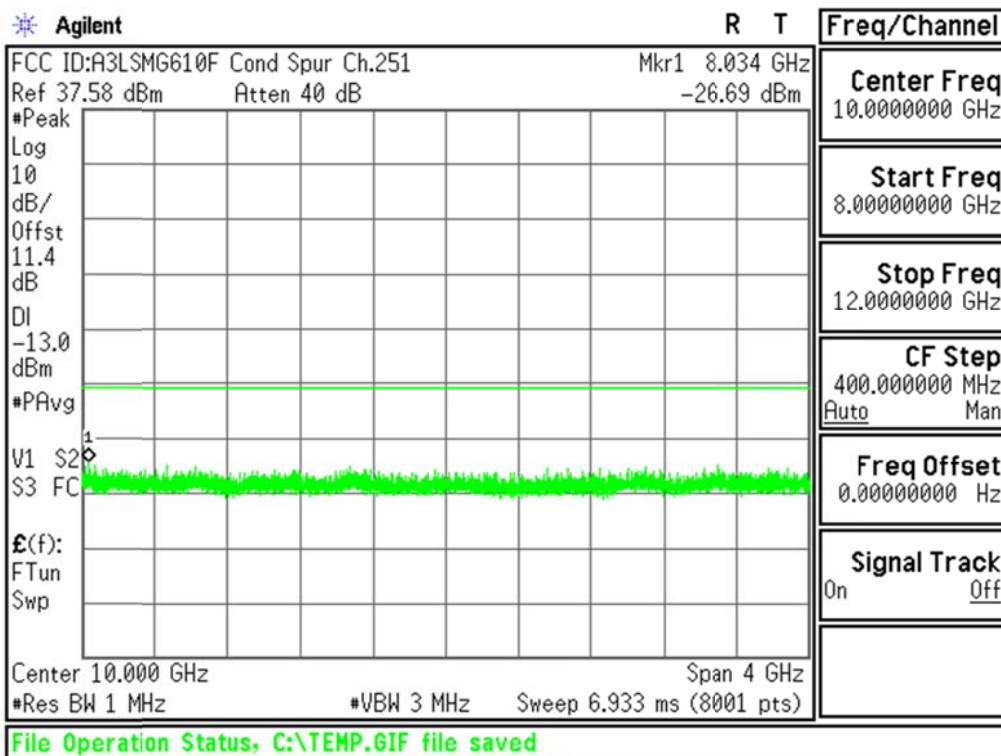

Plot 6-15. Conducted Spurious Plot (Cellular GSM Mode - Ch.251)

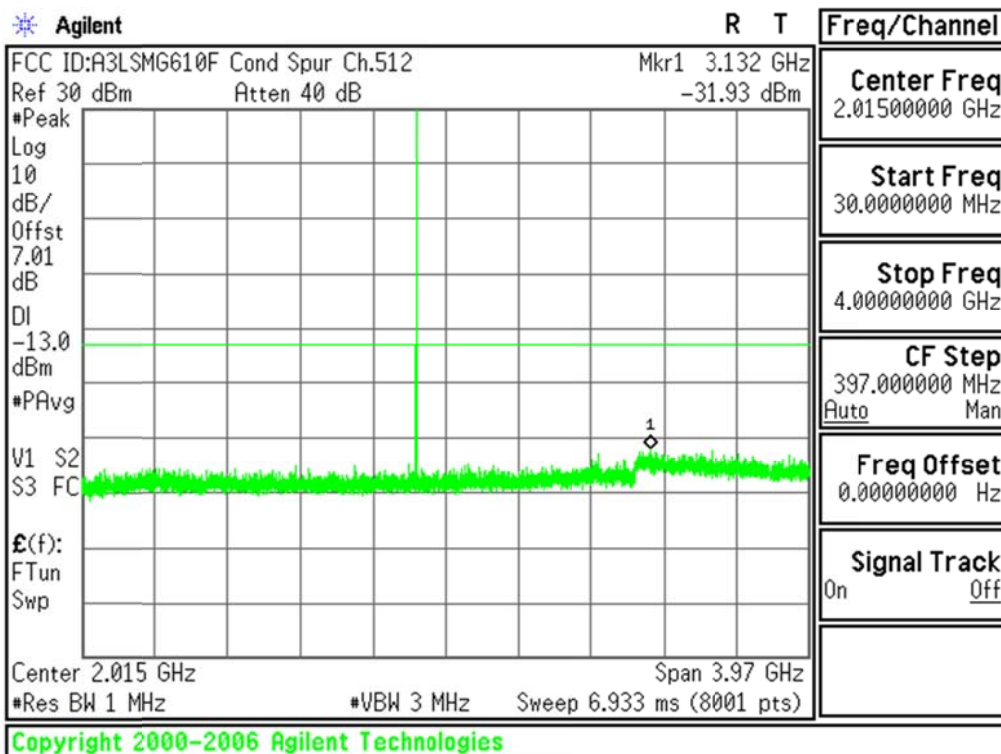

Plot 6-16. Conducted Spurious Plot (PCS GSM Mode - Ch.512)



Issue Date:

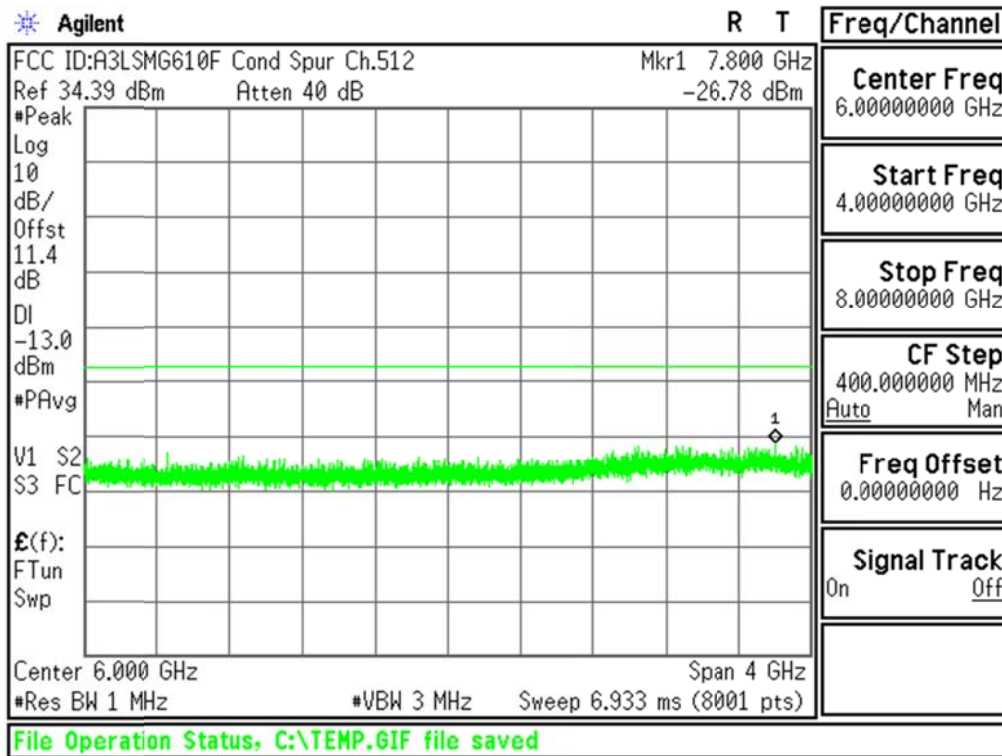

Plot 6-17. Conducted Spurious Plot (PCS GSM Mode - Ch.512)

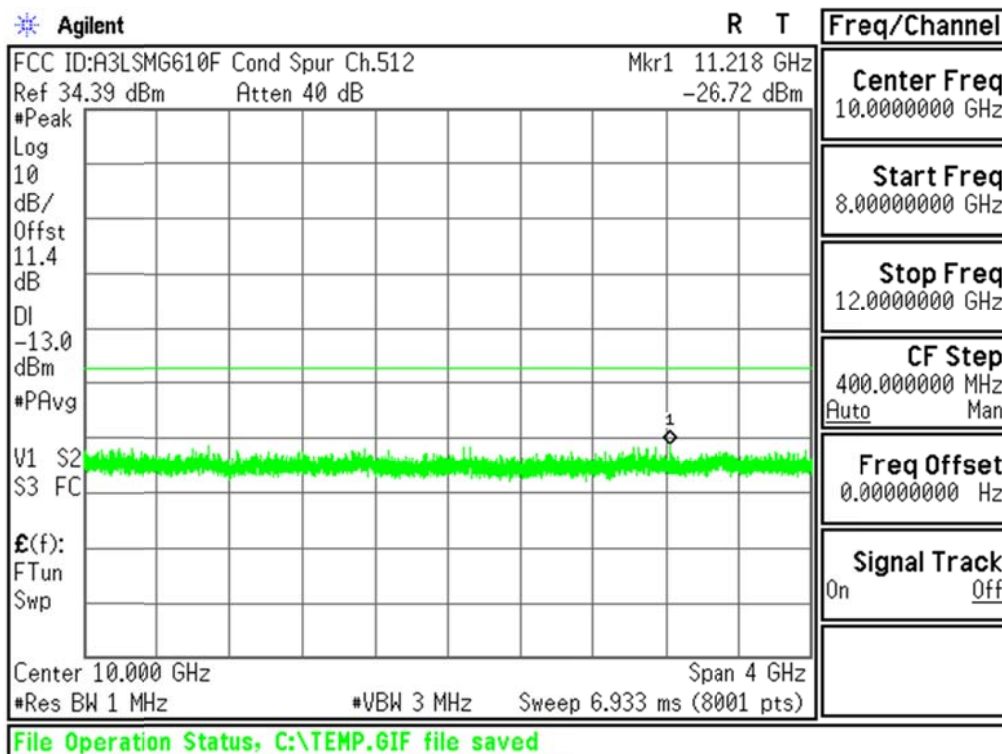

Plot 6-18. Conducted Spurious Plot (PCS GSM Mode - Ch.512)



Issue Date:

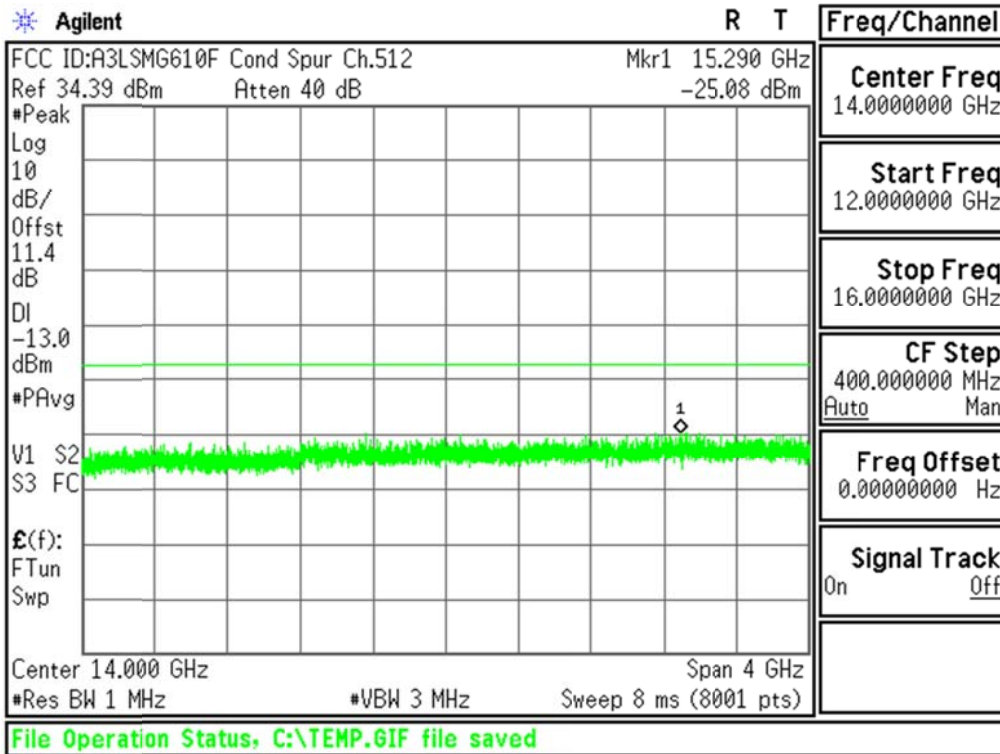

Plot 6-19. Conducted Spurious Plot (PCS GSM Mode - Ch.512)

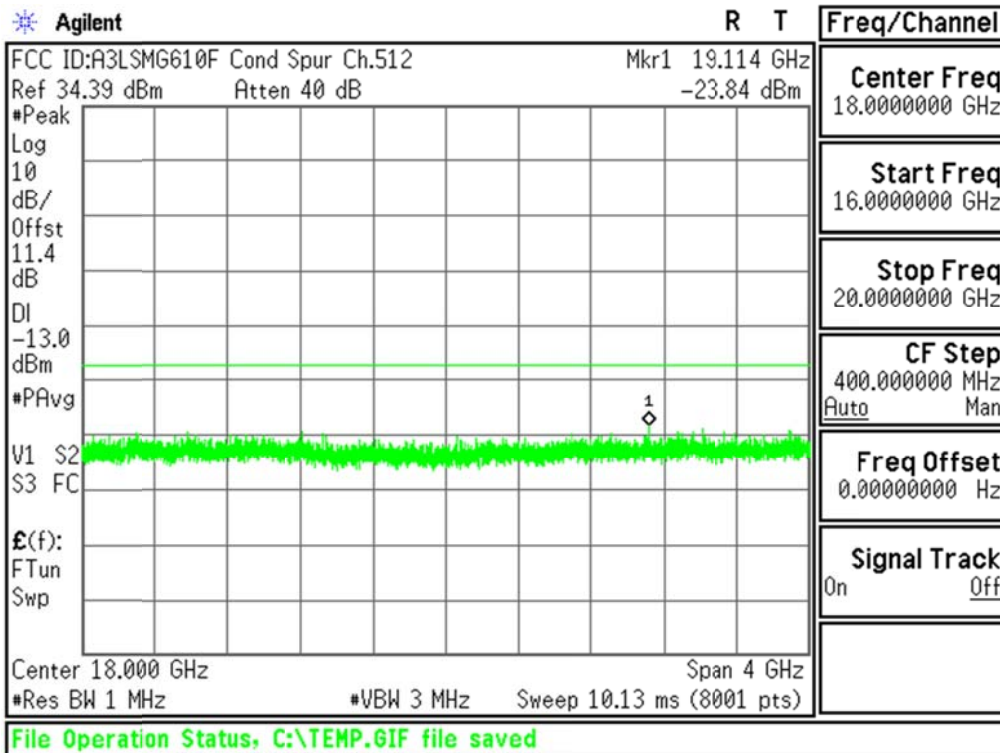

Plot 6-20. Conducted Spurious Plot (PCS GSM Mode - Ch.512)



Issue Date:

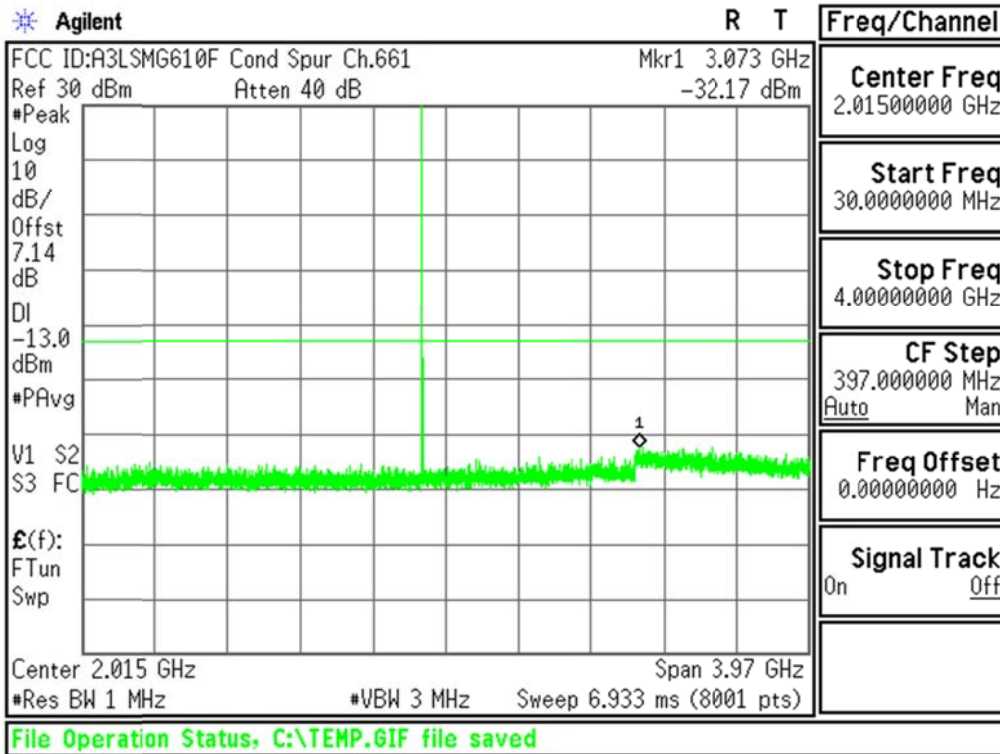

Plot 6-21. Conducted Spurious Plot (PCS GSM Mode - Ch.661)

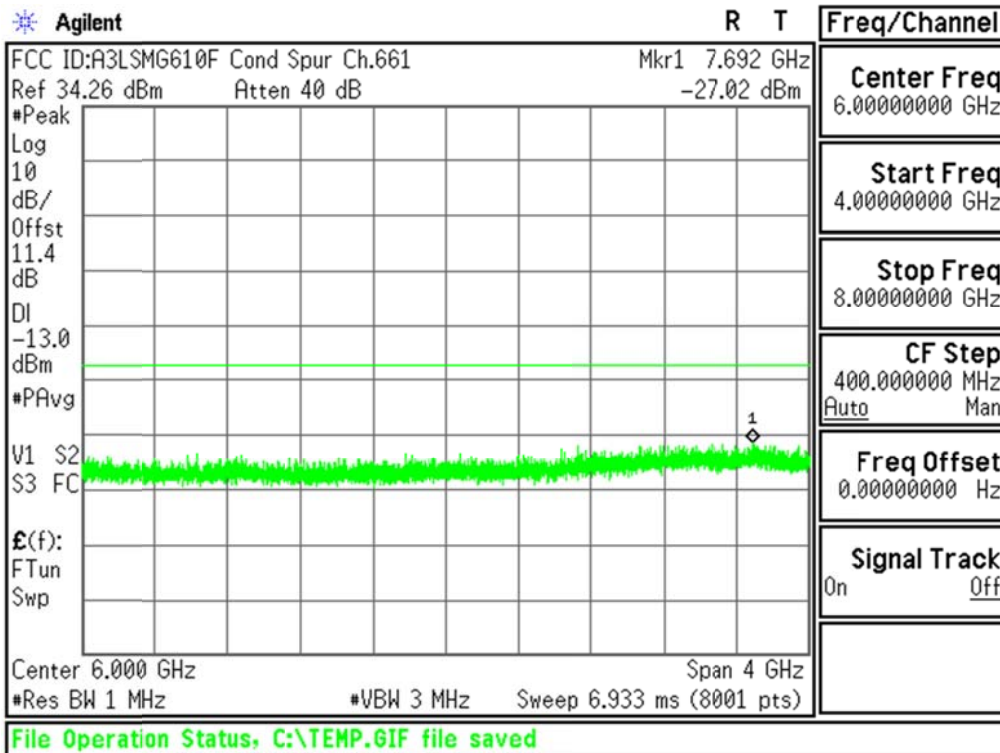

Plot 6-22. Conducted Spurious Plot (PCS GSM Mode - Ch.661)



Issue Date:

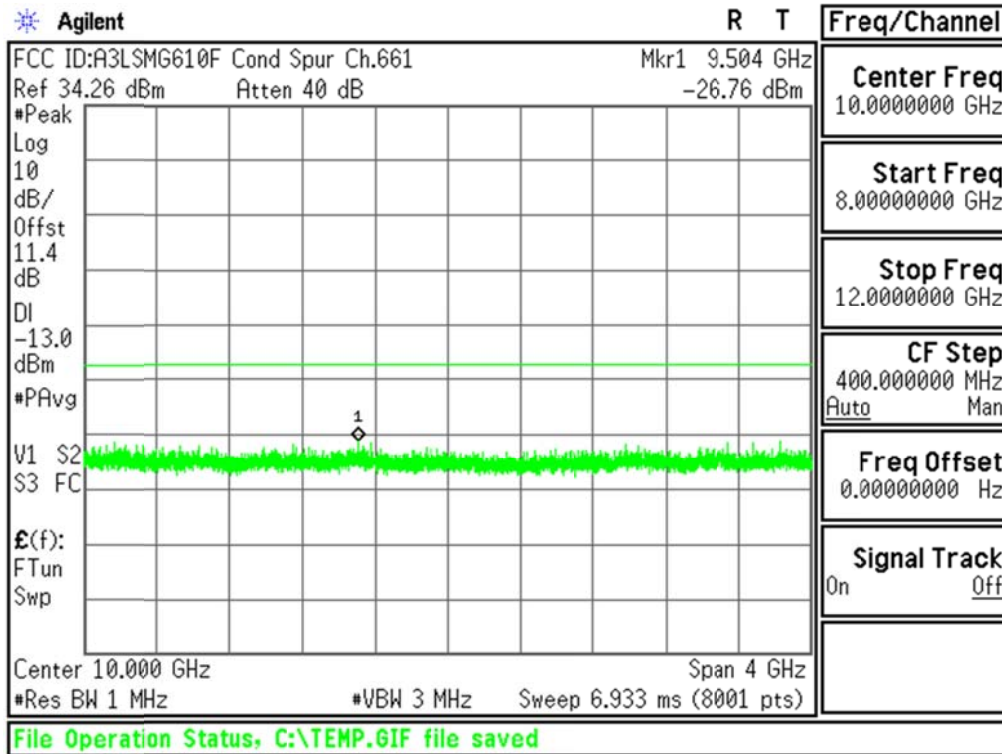

Plot 6-23. Conducted Spurious Plot (PCS GSM Mode - Ch.661)

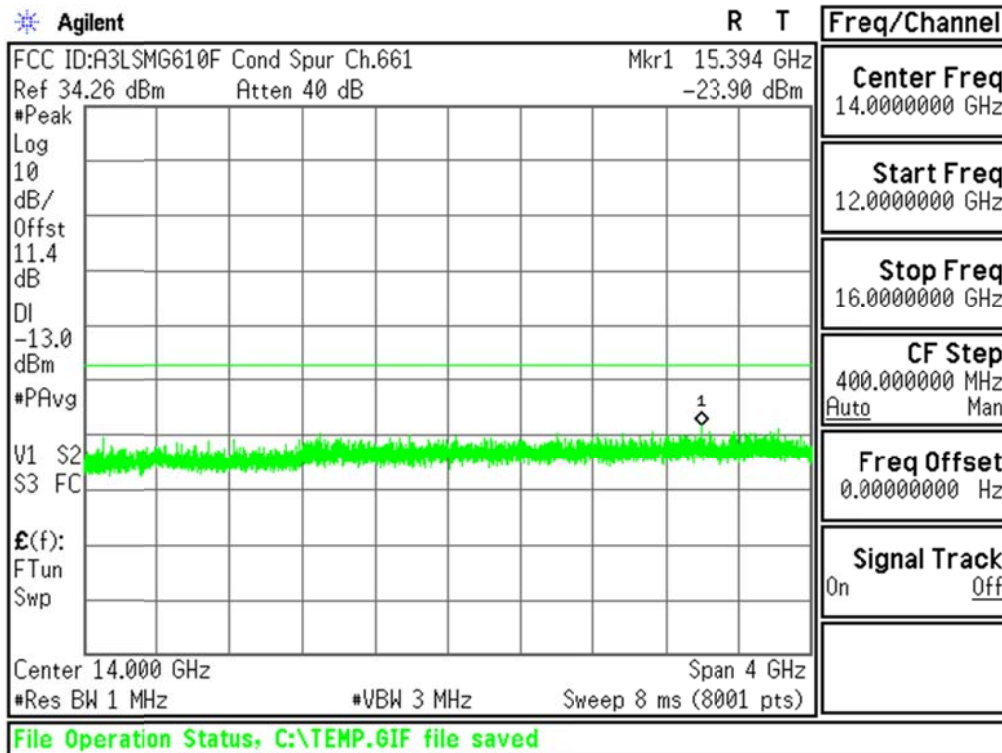

Plot 6-24. Conducted Spurious Plot (PCS GSM Mode - Ch.661)



Issue Date:

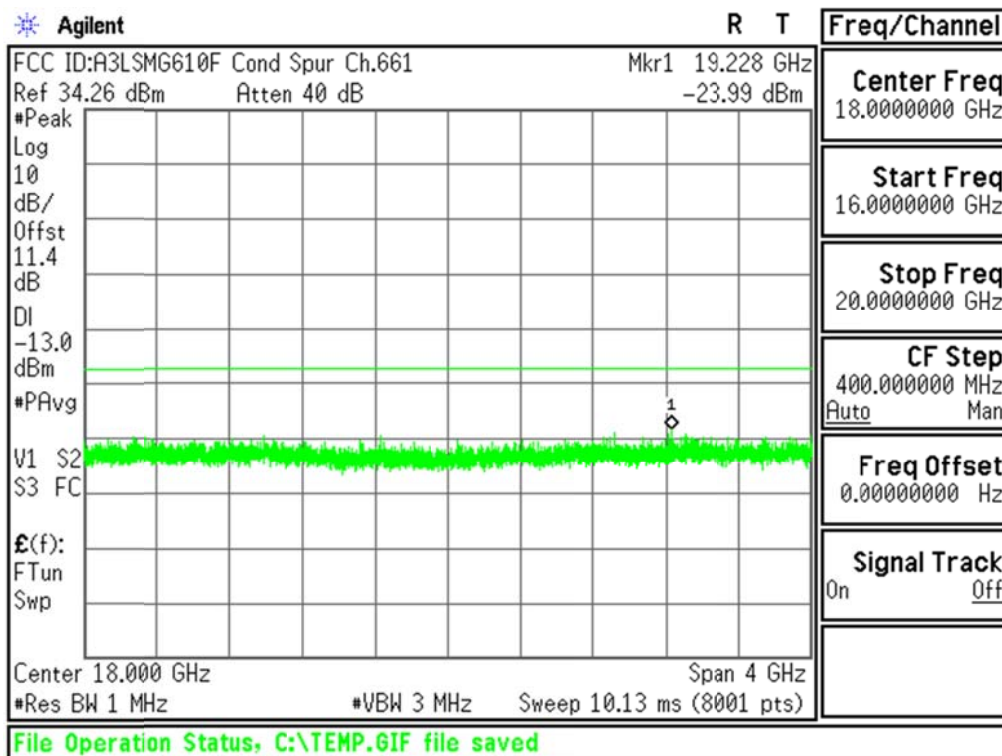

Plot 6-25. Conducted Spurious Plot (PCS GSM Mode - Ch.661)

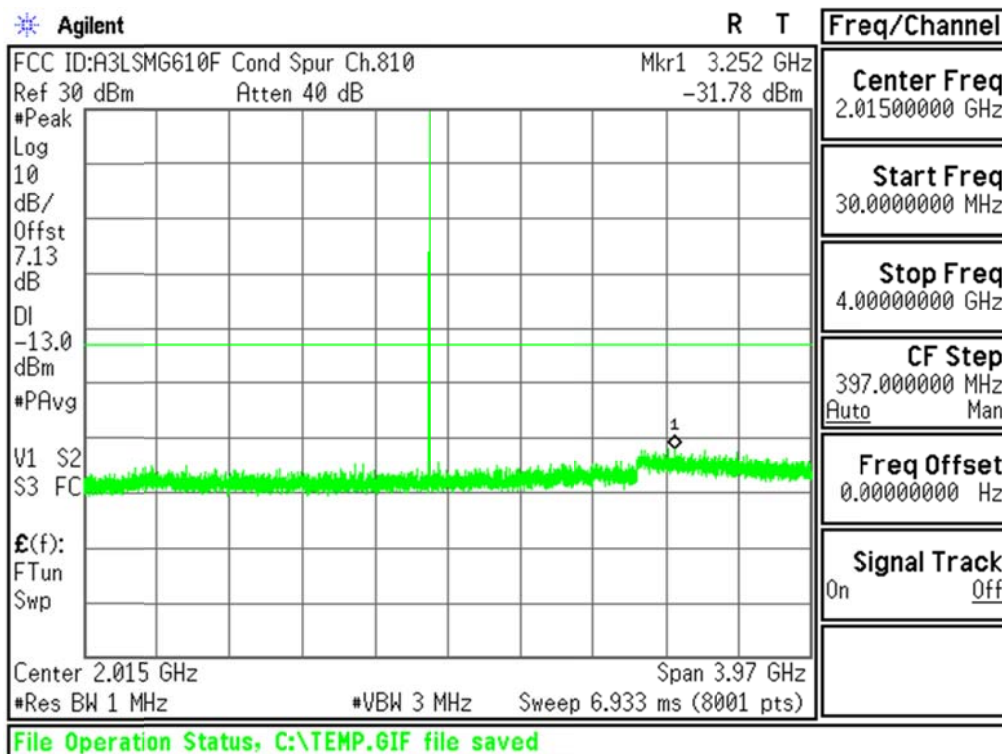

Plot 6-26. Conducted Spurious Plot (PCS GSM Mode - Ch.810)



Issue Date:

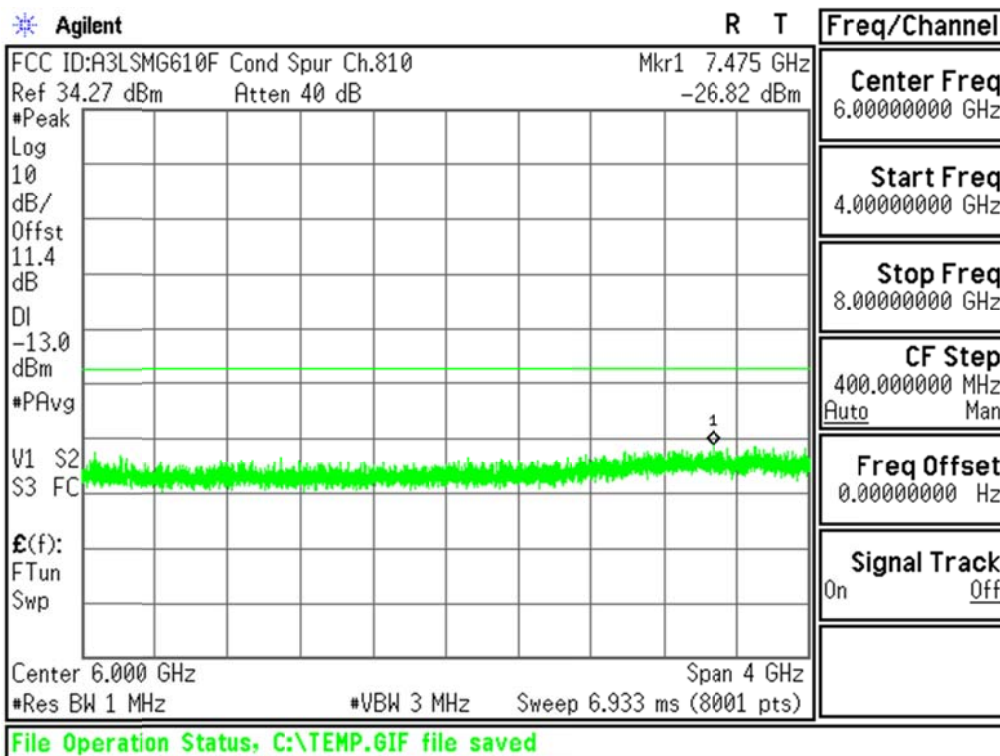

Plot 6-27. Conducted Spurious Plot (PCS GSM Mode - Ch.810)

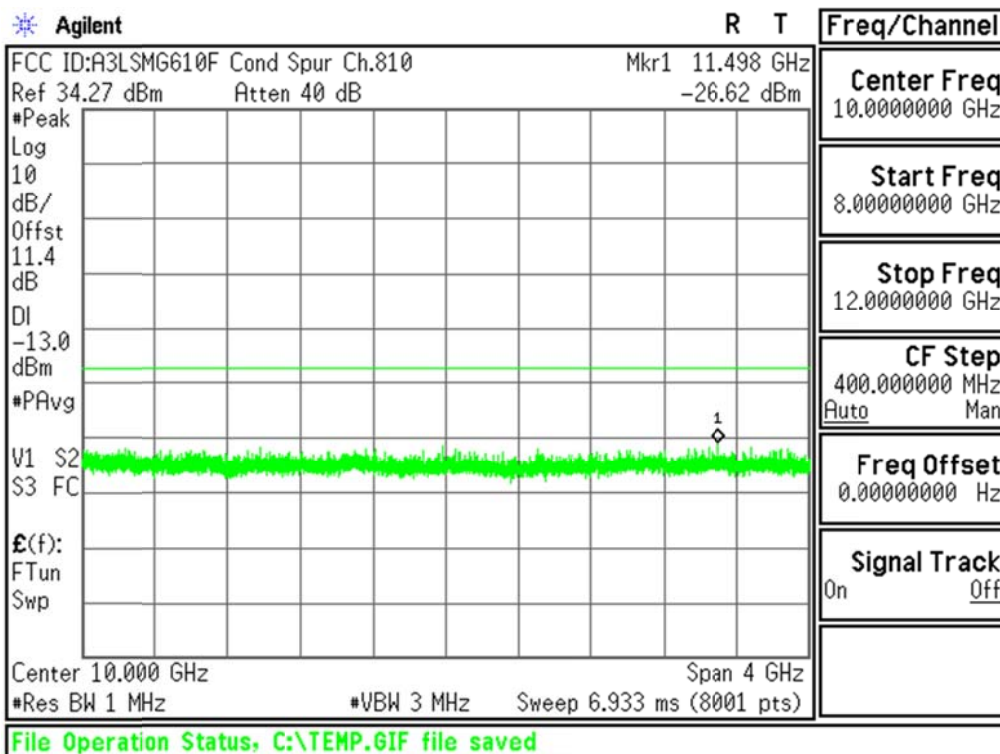

Plot 6-28. Conducted Spurious Plot (PCS GSM Mode - Ch.810)



Issue Date:

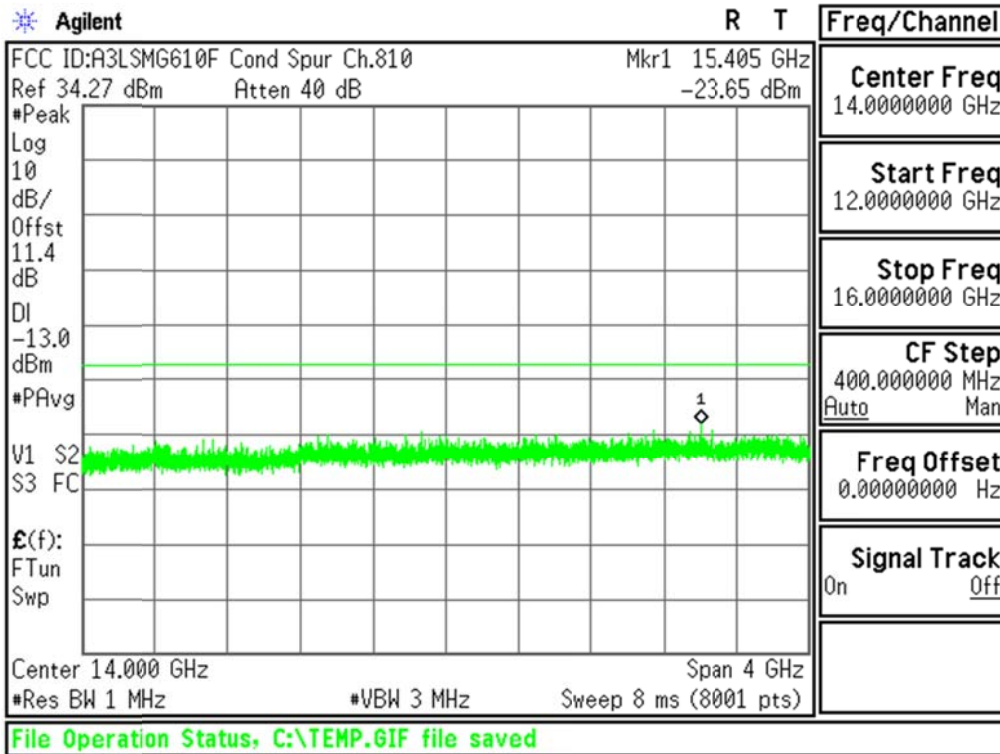

Plot 6-29. Conducted Spurious Plot (PCS GSM Mode - Ch.810)

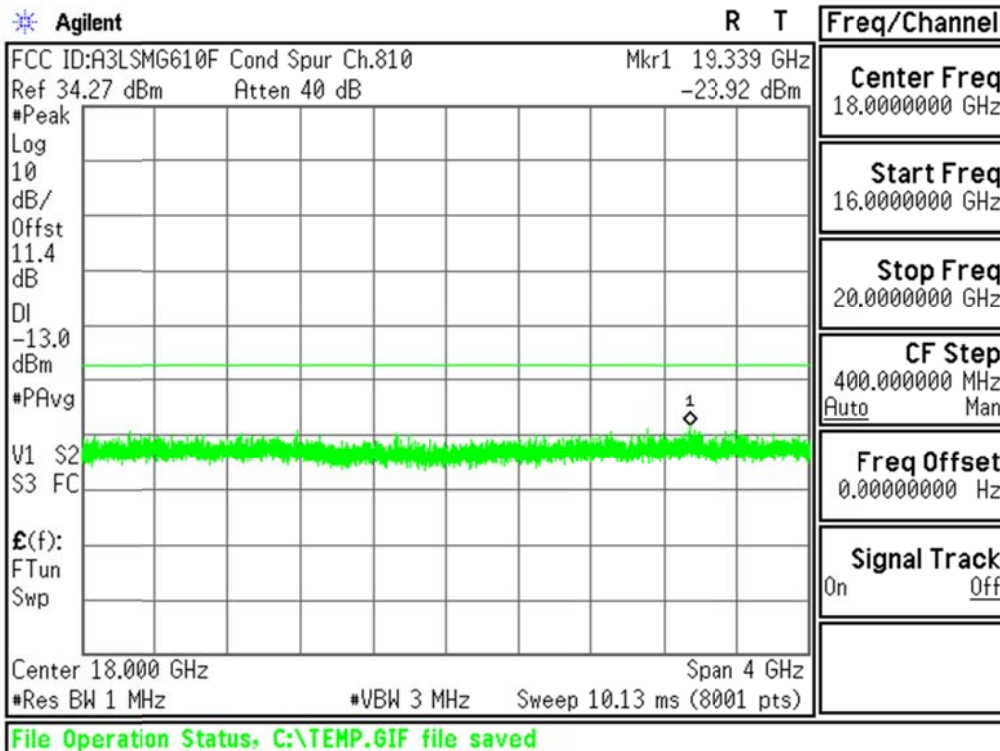

Plot 6-30. Conducted Spurious Plot (PCS GSM Mode - Ch.810)



Issue Date:

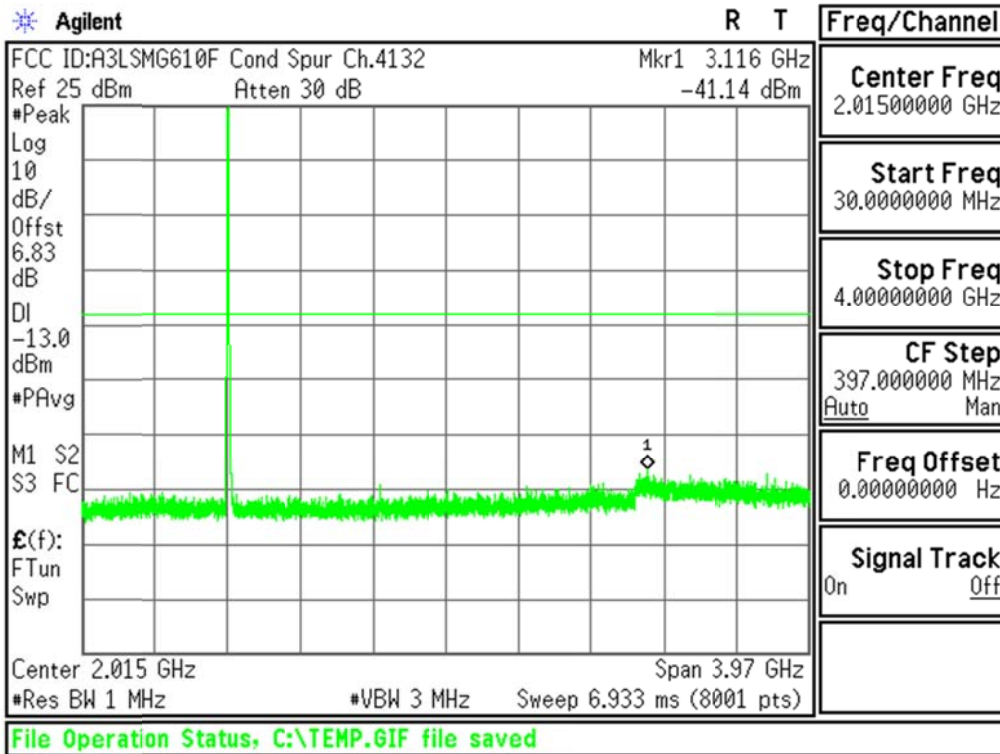

Plot 6-31. Conducted Spurious Plot (Cellular WCDMA Mode - Ch.4132(DL4357))

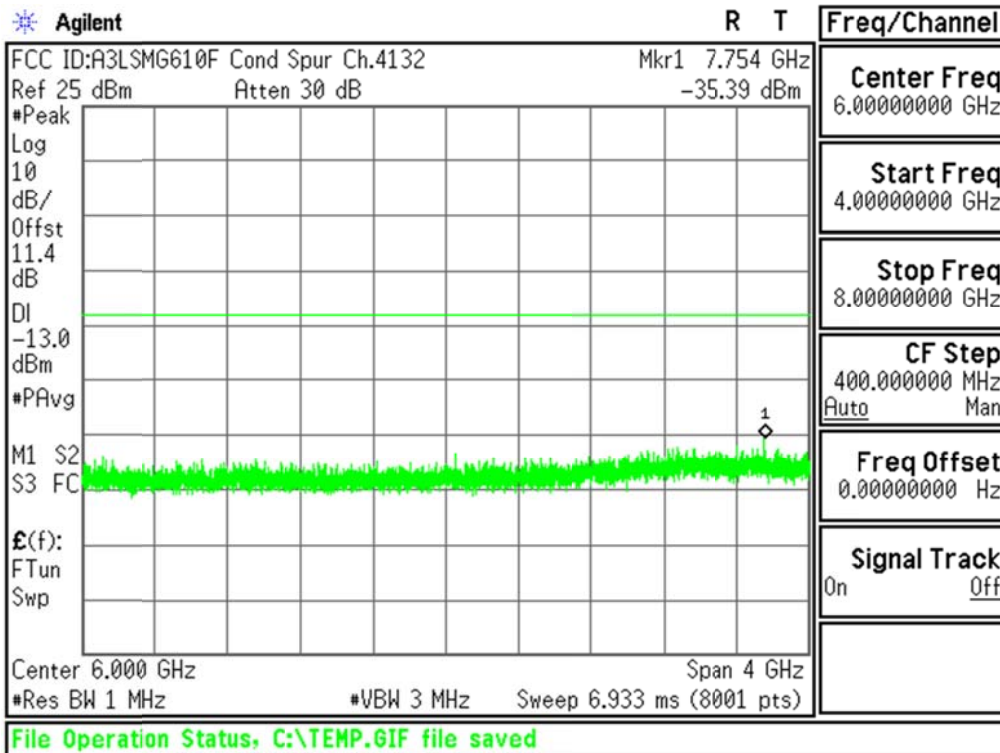

Plot 6-32. Conducted Spurious Plot (Cellular WCDMA Mode - Ch.4132(DL4357))



Issue Date:

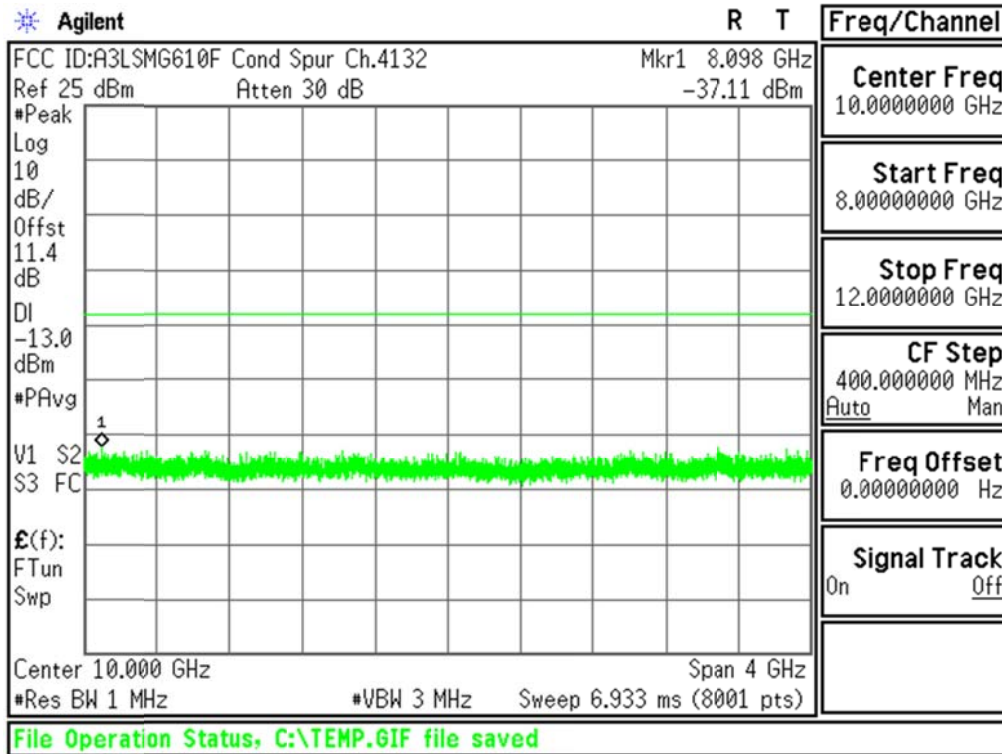

Plot 6-33. Conducted Spurious Plot (Cellular WCDMA Mode - Ch.4132(DL4357))

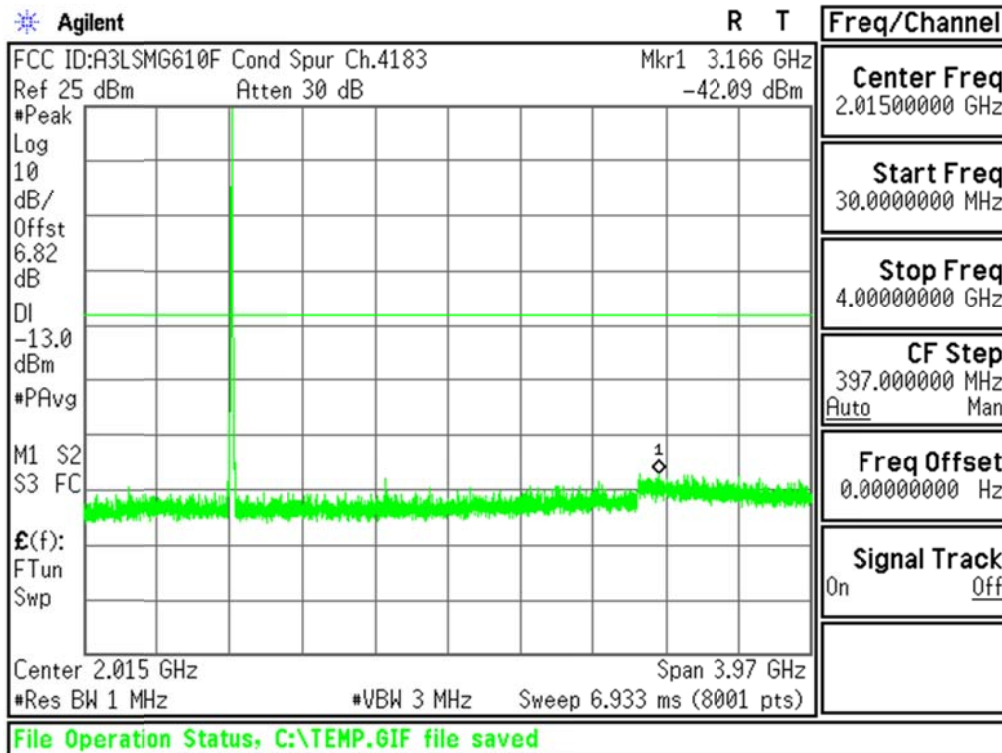

Plot 6-34. Conducted Spurious Plot (Cellular WCDMA Mode - Ch.4183(DL4408))



Issue Date:

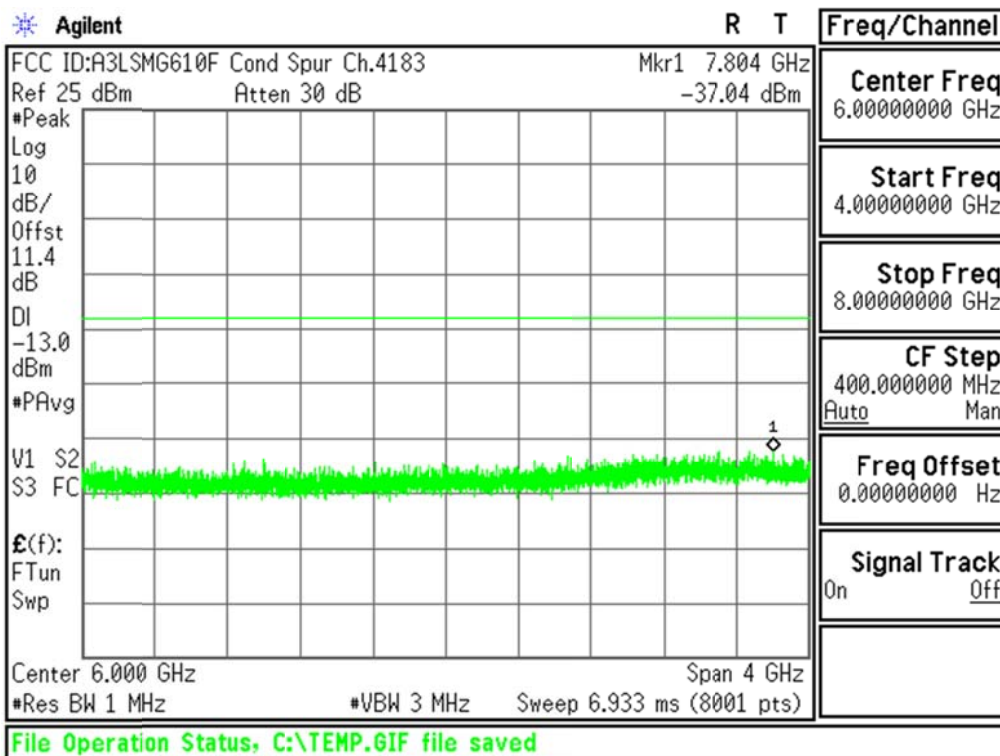

Plot 6-35. Conducted Spurious Plot (Cellular WCDMA Mode - Ch.4183(DL4408))

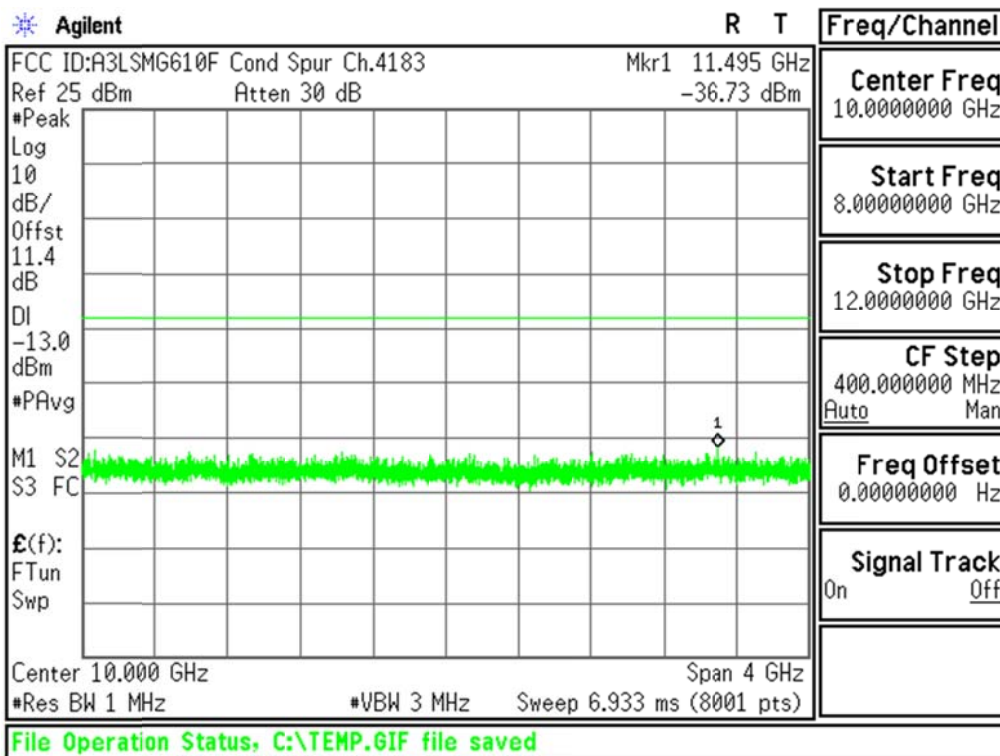

Plot 6-36. Conducted Spurious Plot (Cellular WCDMA Mode - Ch.4183(DL4408))



Issue Date:

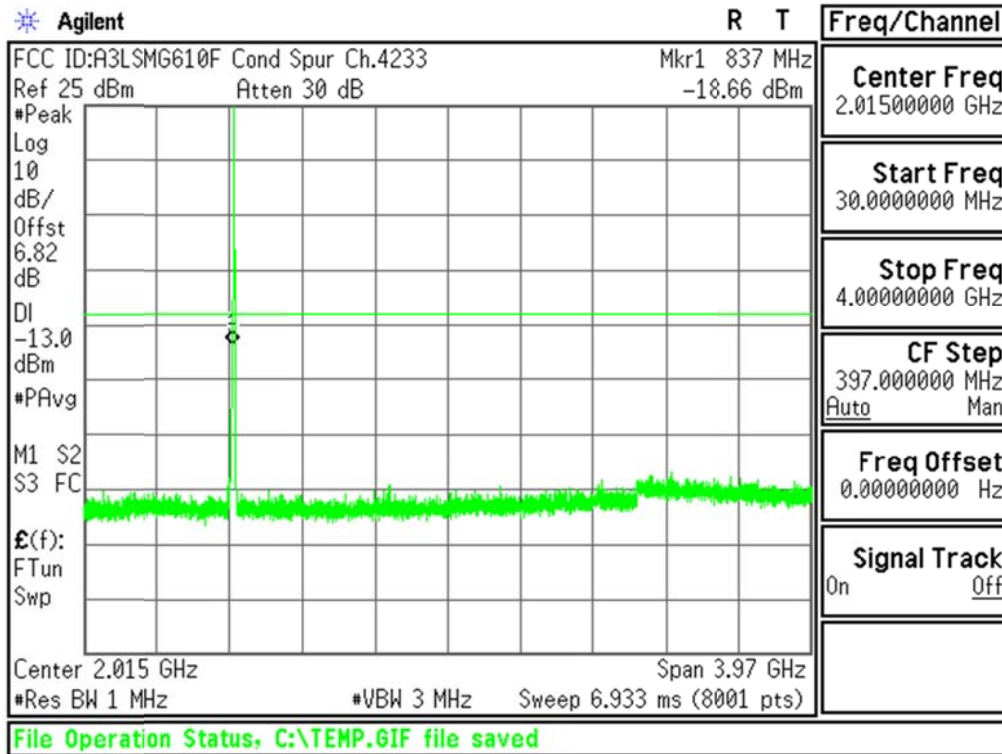

Plot 6-37. Conducted Spurious Plot (Cellular WCDMA Mode - Ch.4233(DL4458))

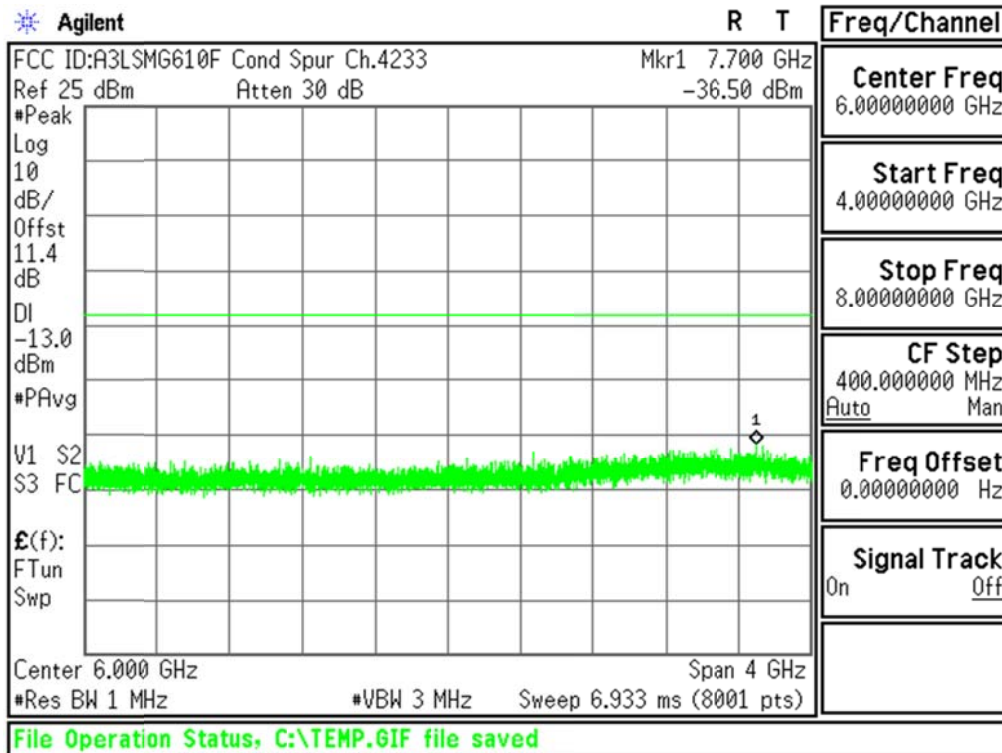

Plot 6-38. Conducted Spurious Plot (Cellular WCDMA Mode - Ch.4233(DL4458))



Issue Date:

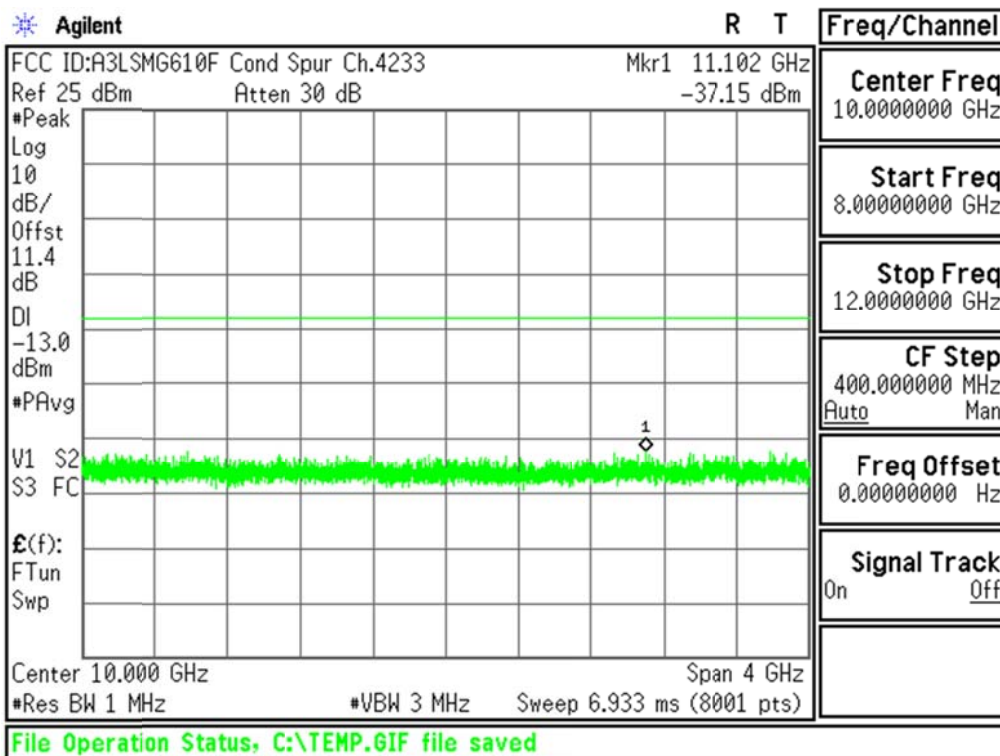

Plot 6-39. Conducted Spurious Plot (Cellular WCDMA Mode - Ch.4233(DL4458))

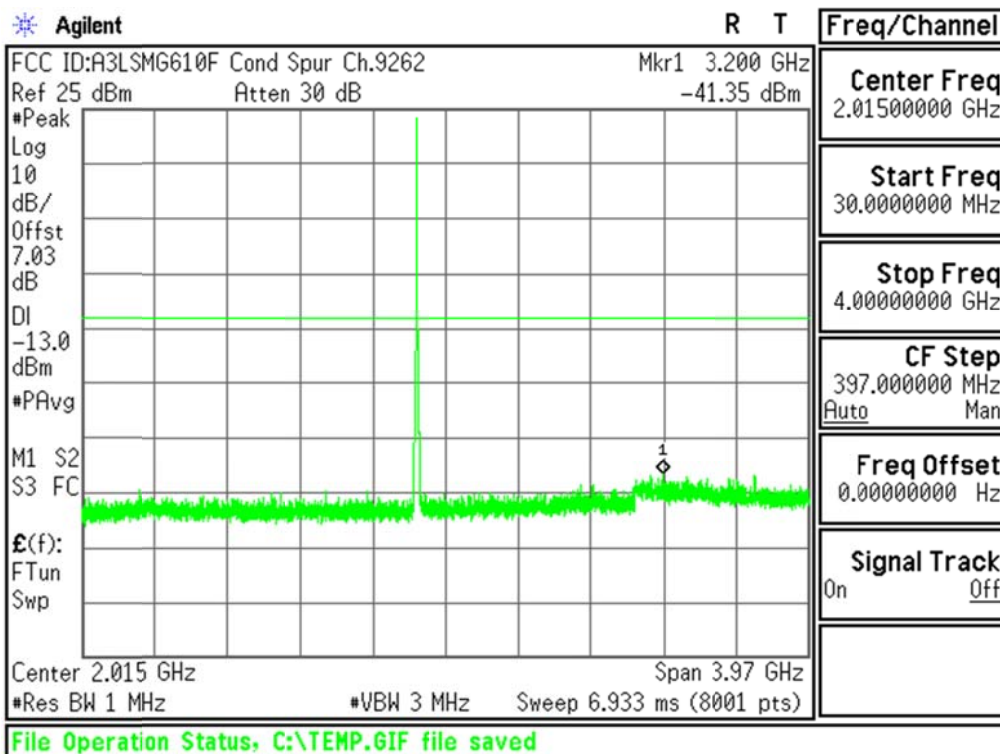

Plot 6-40. Conducted Spurious Plot (PCS WCDMA Mode - Ch.9262(DL9662))



Issue Date:

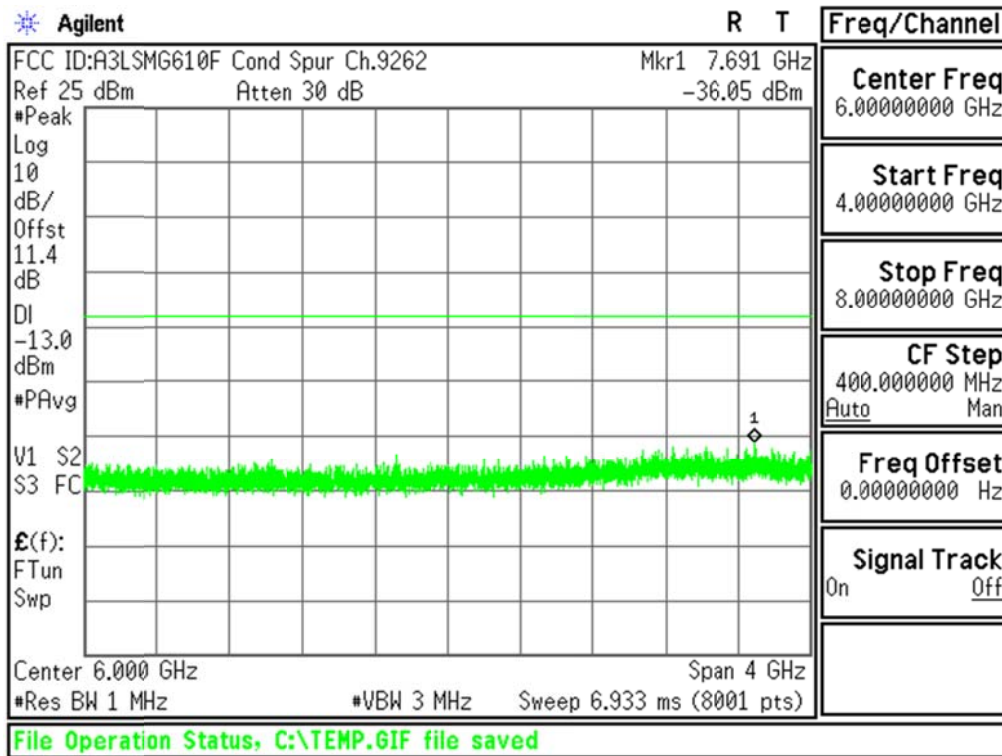

Plot 6-41. Conducted Spurious Plot (PCS WCDMA Mode - Ch.9262(DL9662))

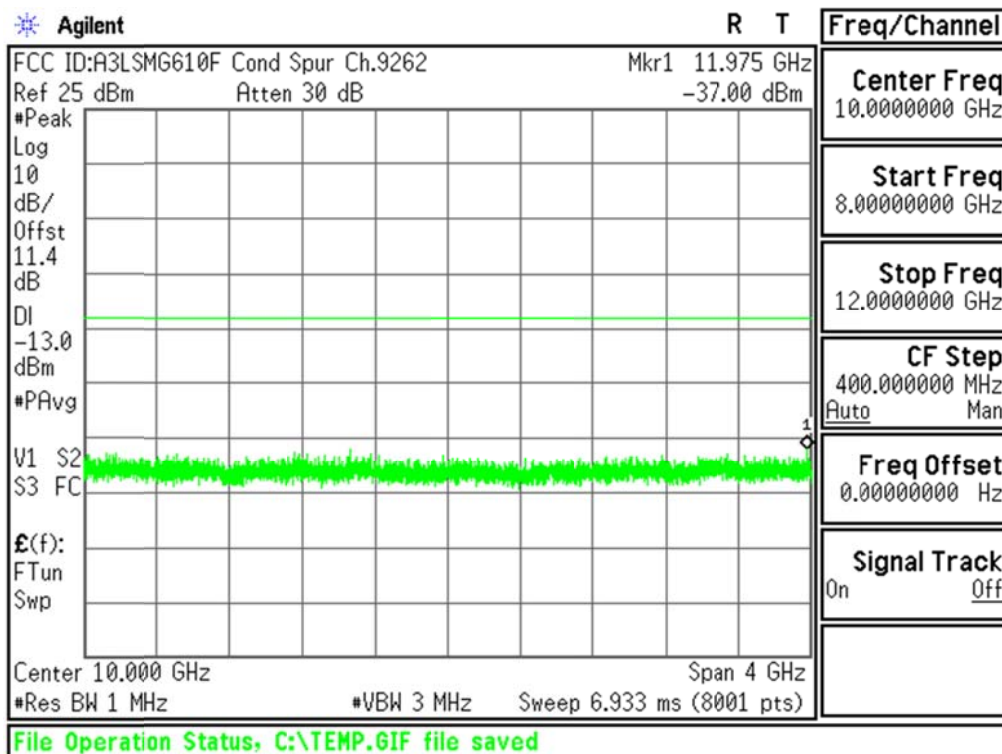

Plot 6-42. Conducted Spurious Plot (PCS WCDMA Mode - Ch.9262(DL9662))



Issue Date:

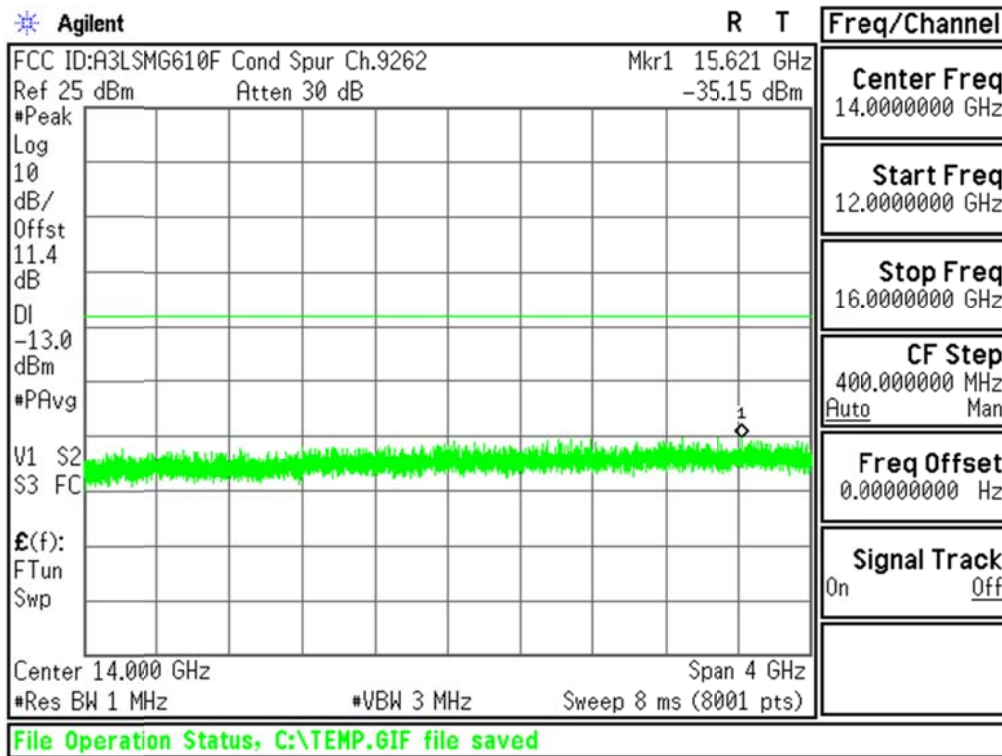

Plot 6-43. Conducted Spurious Plot (PCS WCDMA Mode - Ch.9262(DL9662))

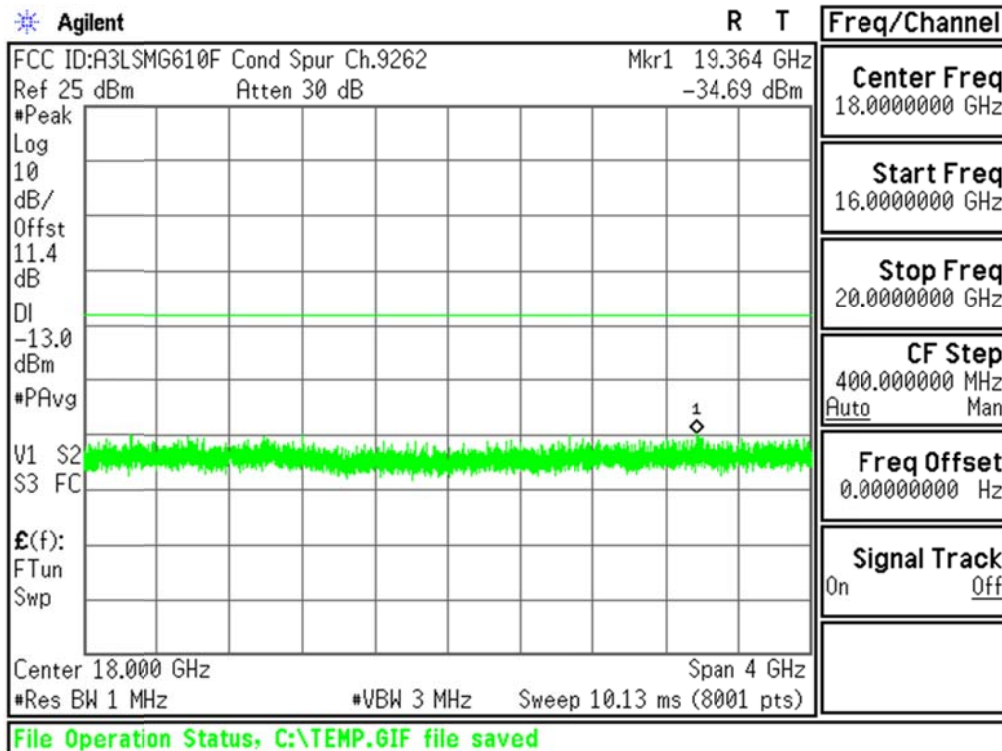

Plot 6-44. Conducted Spurious Plot (PCS WCDMA Mode - Ch.9262(DL9662))



Issue Date:

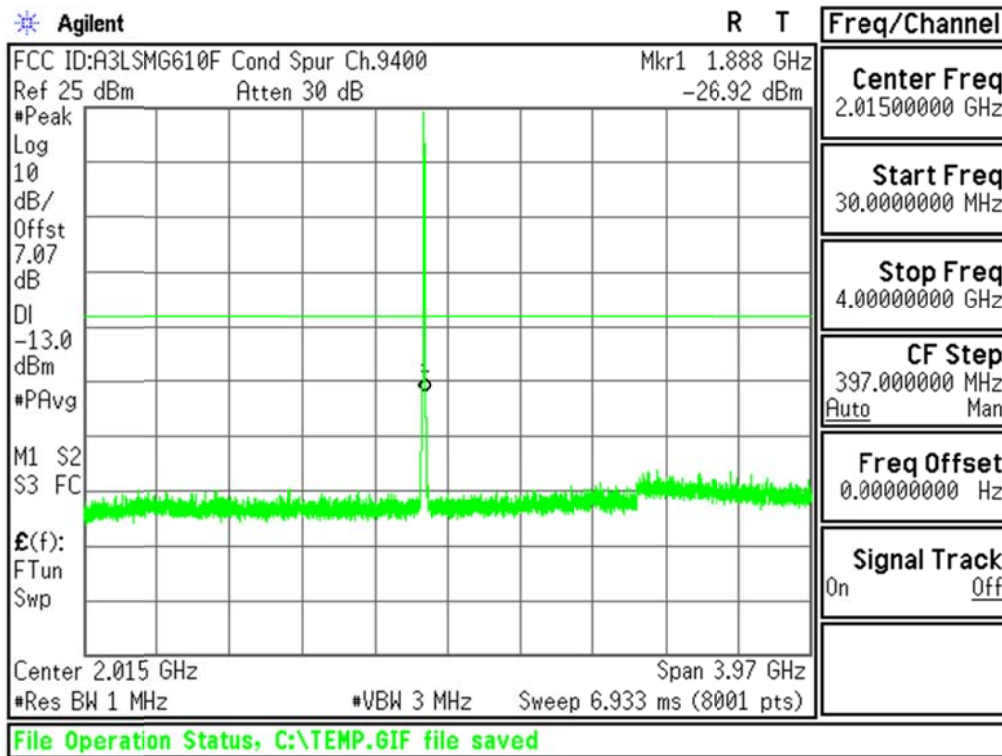

Plot 6-45. Conducted Spurious Plot (PCS WCDMA Mode - Ch.9400(DL9800))

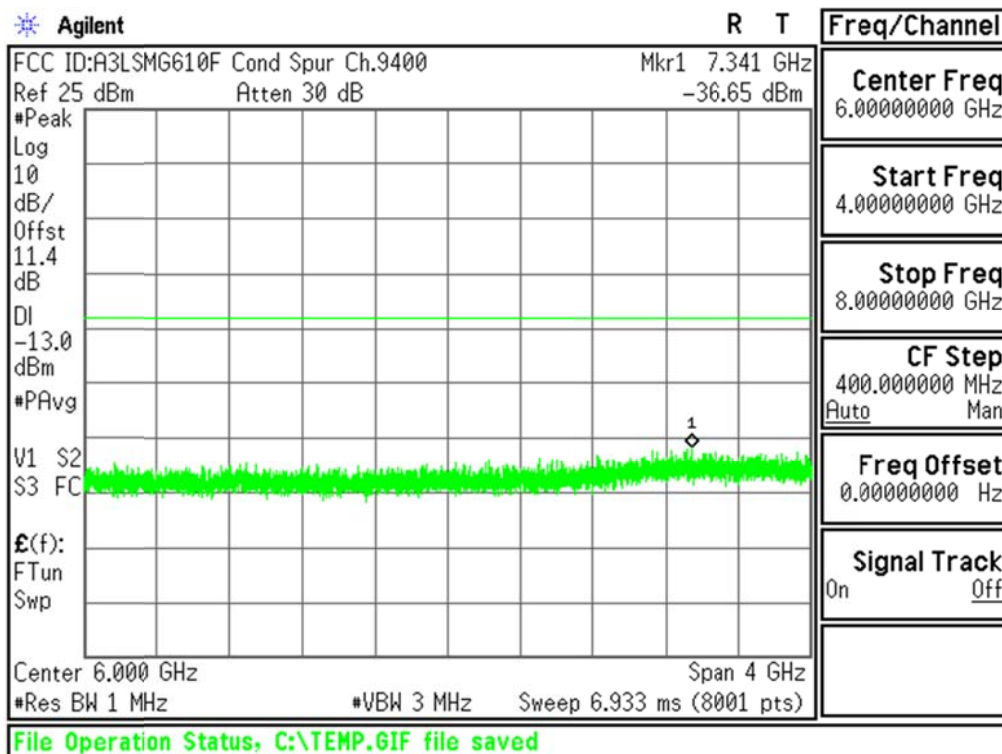

Plot 6-46. Conducted Spurious Plot (PCS WCDMA Mode - Ch.9400(DL9800))



Issue Date:

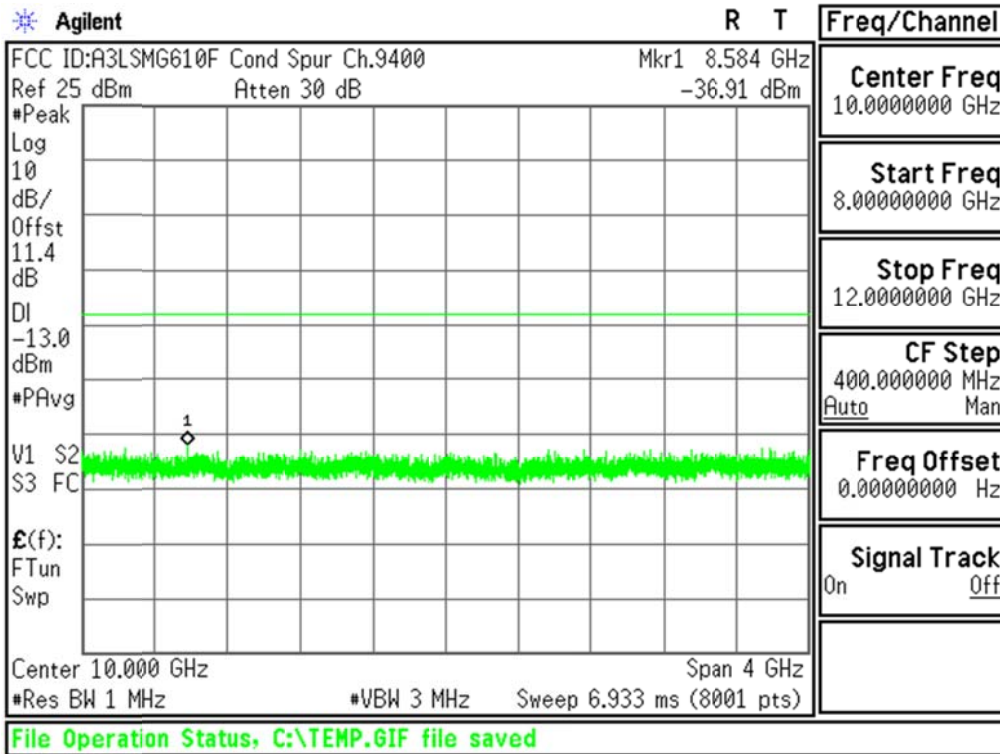

Plot 6-47. Conducted Spurious Plot (PCS WCDMA Mode - Ch.9400(DL9800))

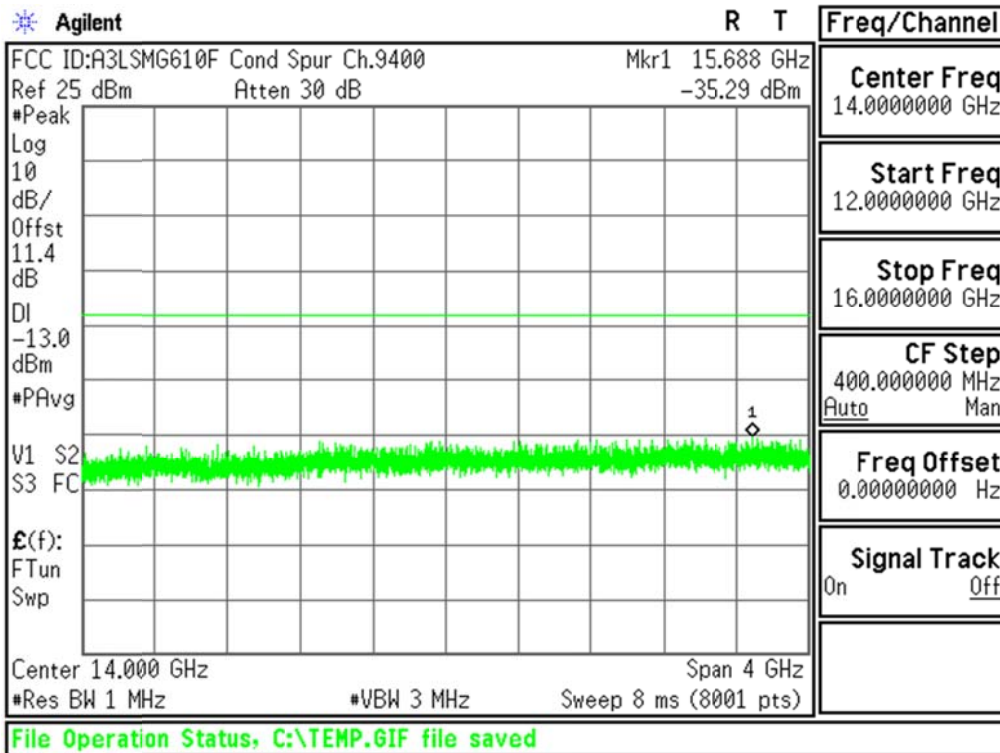

Plot 6-48. Conducted Spurious Plot (PCS WCDMA Mode - Ch.9400(DL9800))



Issue Date:

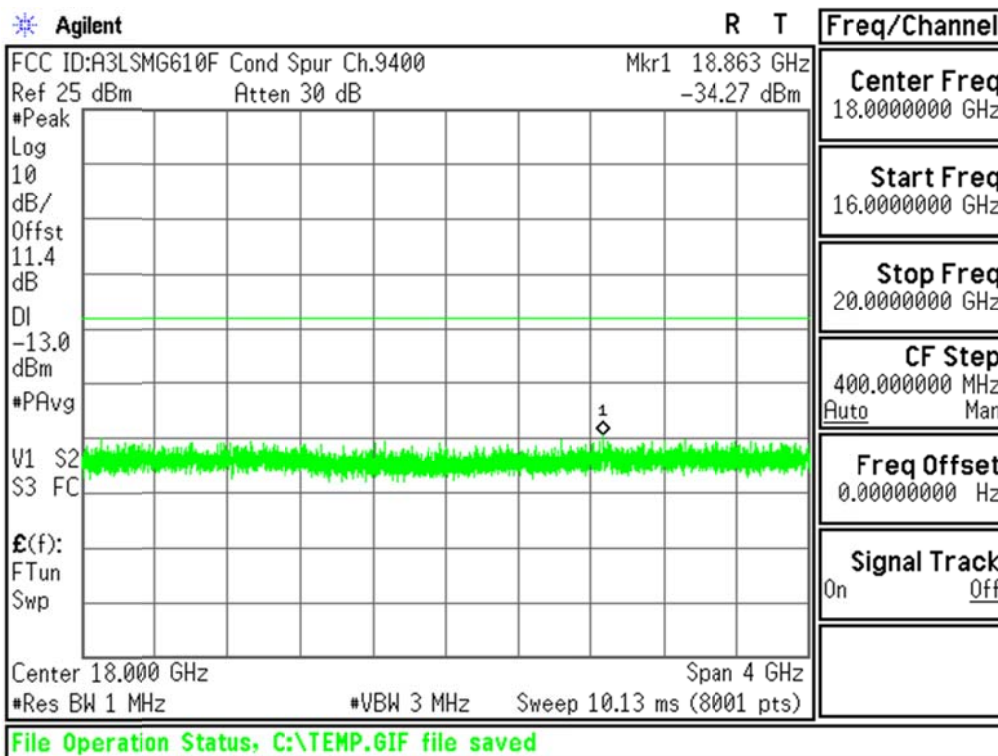

Plot 6-49. Conducted Spurious Plot (PCS WCDMA Mode - Ch.9400(DL9800))

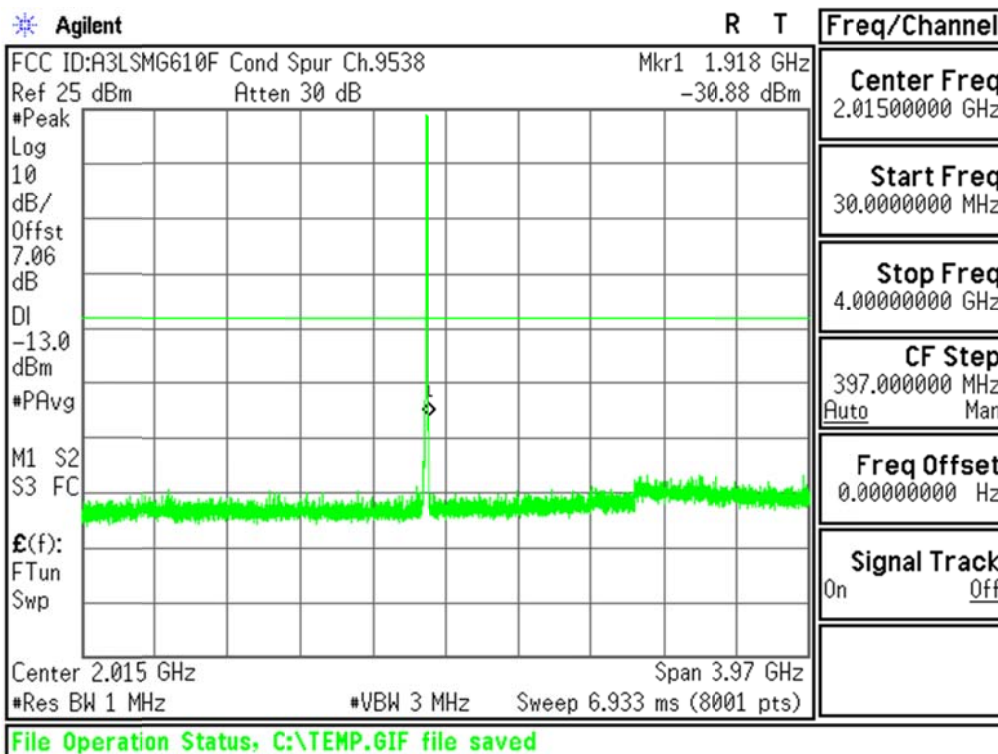

Plot 6-50. Conducted Spurious Plot (PCS WCDMA Mode - Ch.9538(DL9938))



Issue Date:

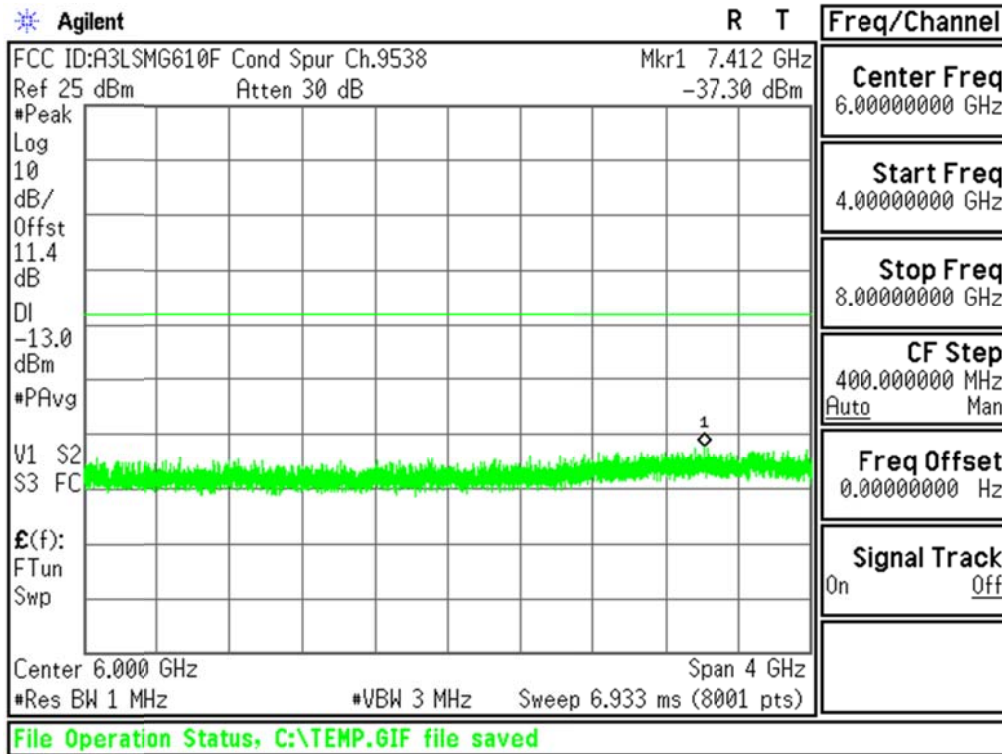

Plot 6-51. Conducted Spurious Plot (PCS WCDMA Mode - Ch.9538(DL9938))

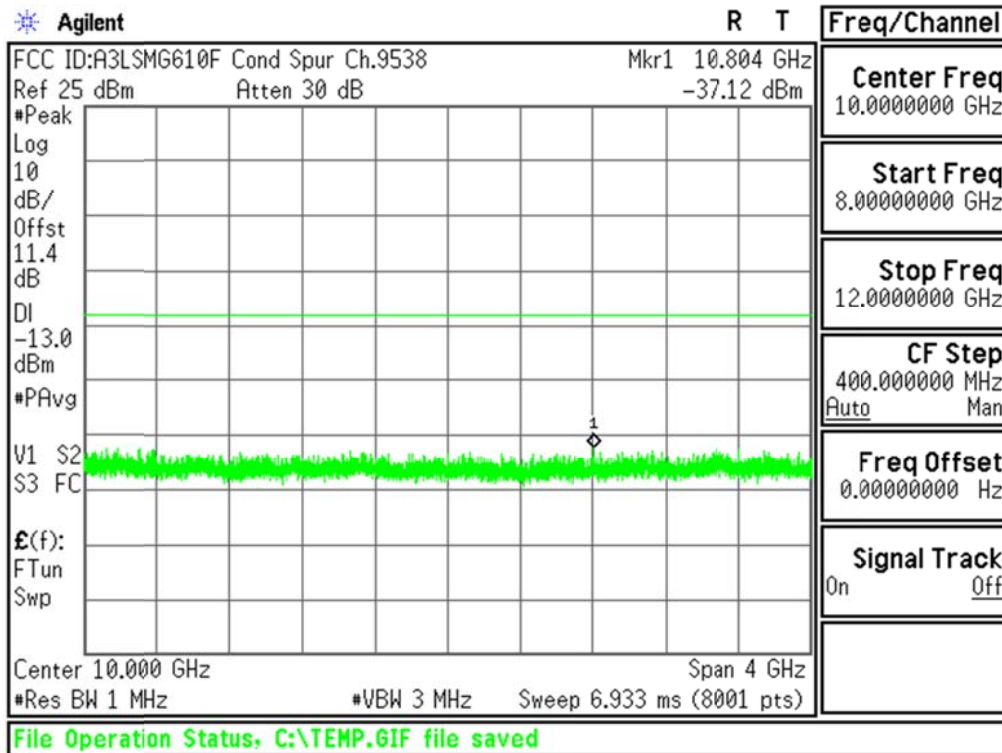

Plot 6-52. Conducted Spurious Plot (PCS WCDMA Mode - Ch.9538(DL9938))



Issue Date:

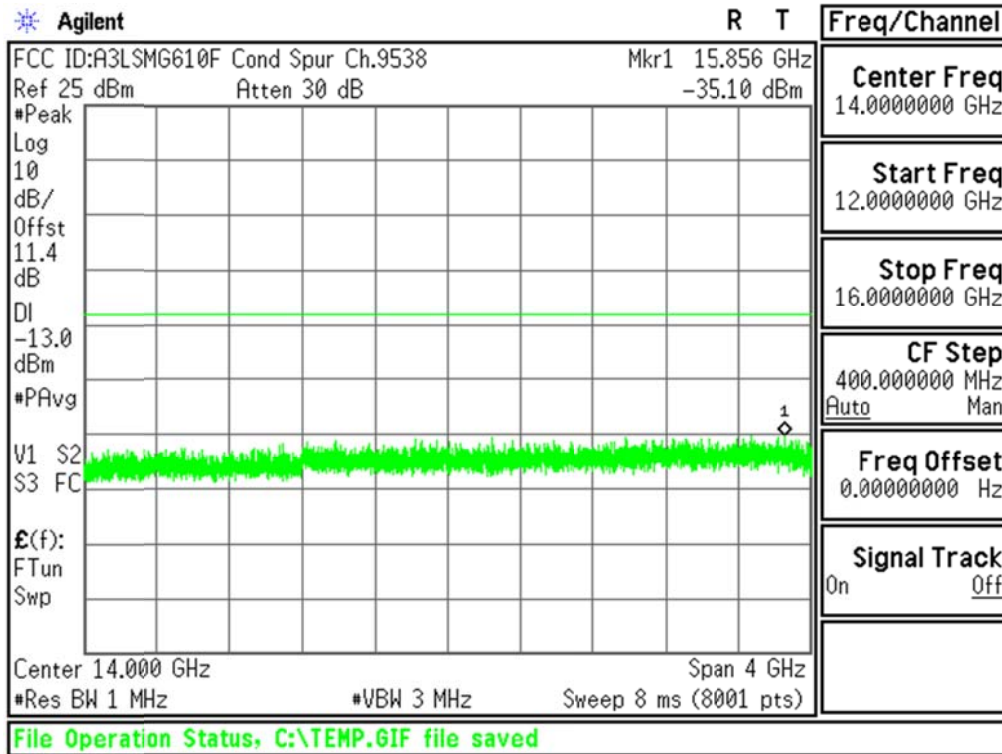

Plot 6-53. Conducted Spurious Plot (PCS WCDMA Mode - Ch.9538(DL9938))

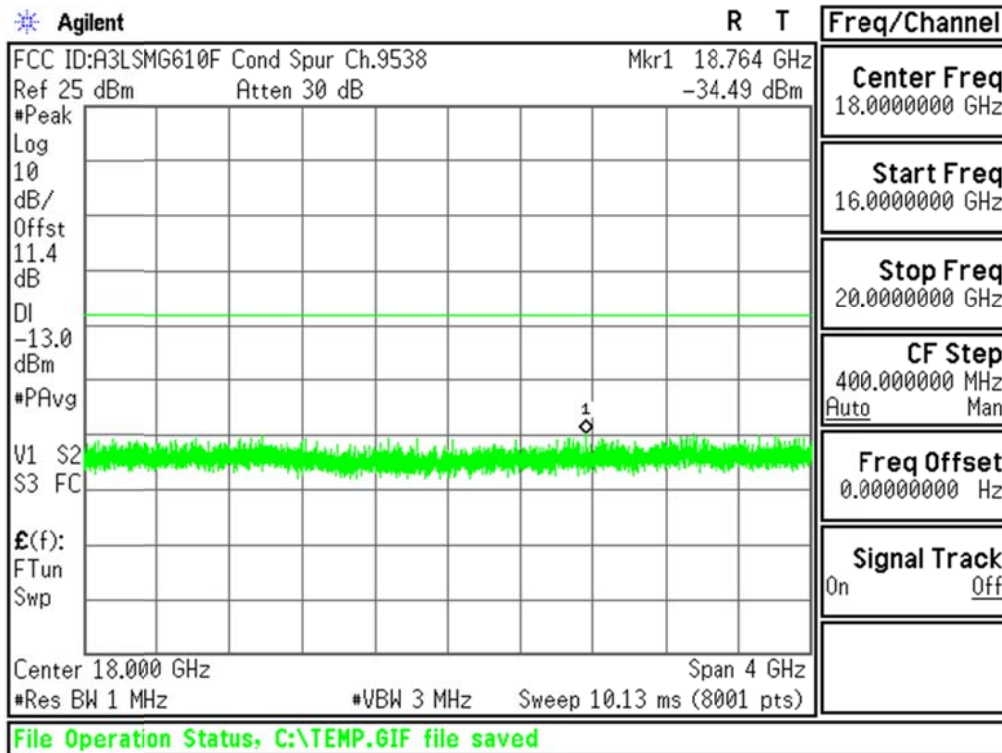

Plot 6-54. Conducted Spurious Plot (PCS WCDMA Mode - Ch.9538(DL9938))



6.4. Band Edge Emissions at Antenna Terminal §2.1051 § 22.917(a) §24.238(a)

Test Overview

All out of band emissions are measured with a spectrum analyzer connected to the antenna terminal of the EUT while the EUT is operating at its maximum duty cycle, at maximum power, and at the appropriate frequencies. All data rates were investigated to determine the worst case configuration. All modes of operation were investigated and the worst case configuration results are reported in this section.

The minimum permissible attenuation level of any spurious emission is $43 + 10\log_{10}(P_{\text{Watts}})$, where P is the transmitter power in Watts. Limit equivalent to -13dBm, calculation shown below.

$$43 + 10\log_{10}(1.567W) = 44.95 \text{ dB}$$

$$1.567W = 31.95 \text{ dBm}$$

$$31.95 \text{ dBm} - 44.95 \text{ dB} = -13 \text{ dBm}$$

Test Procedure Used

KDB 971168 v02r02 – Section 6.0

Test Settings

1. Start and stop frequency were set such that the band edge would be placed at the edge of the plot for GSM, in the center of the plot for WCDMA.
2. Span was set large enough so as to capture all out of band emissions near the band edge
3. RBW > 1% of the emission bandwidth
4. VBW $\geq 3 \times$ RBW
5. Detector = RMS
6. Number of sweep points $\geq 2 \times$ Span/RBW
7. Trace mode = max hold
8. Sweep time = auto couple
9. The trace was allowed to stabilize

Test Setup

The EUT and measurement equipment were set up as shown in the diagram below.

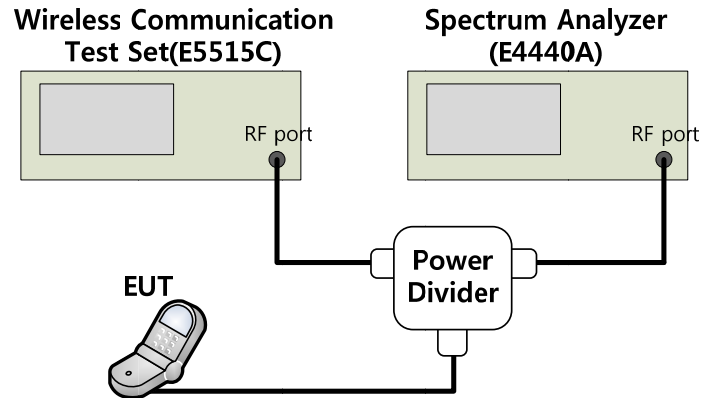

Figure 6-3. Test Instruments & Measurement Setup

Test Notes

1. Per 22.917(b) and 24.238(b), in the 1 MHz bands immediately outside and adjacent to the frequency block a resolution bandwidth of at least one percent of the emission bandwidth of the fundamental emission of the transmitter may be employed to demonstrate compliance with the out-of-band emissions limit.

Example:

In Case of GSM, $0.01 \times 273 \text{ KHz} = 2.73 \text{ KHz}$

A resolution BW of 3 KHz was used for measurement at the band edges.



Issue Date:

Test Plots

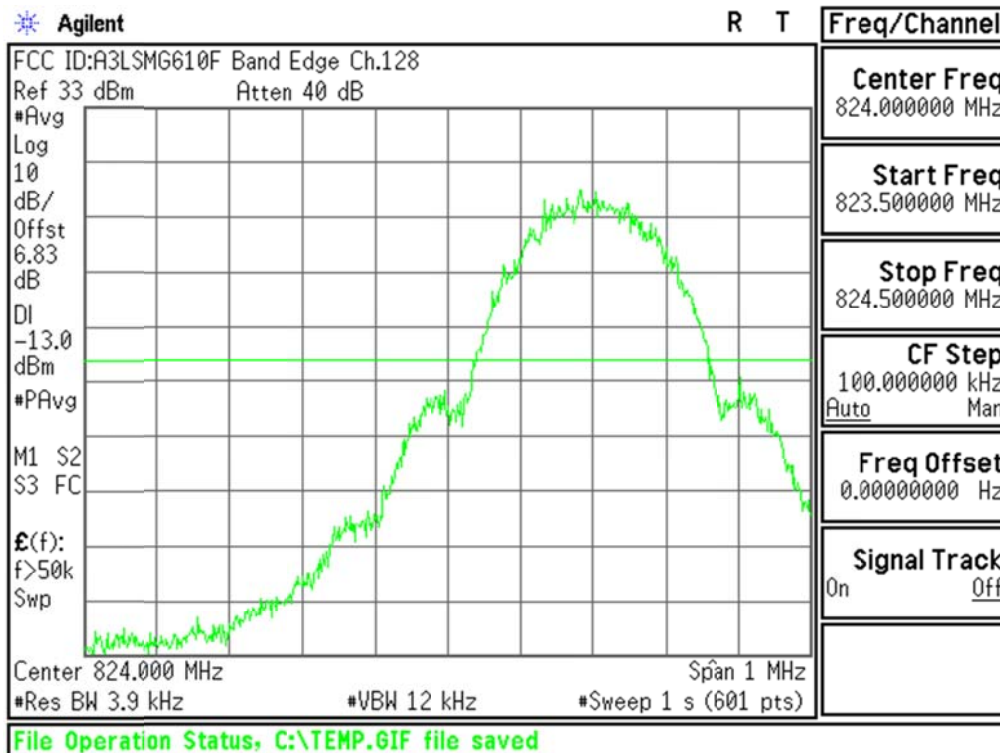

Plot 6-55. Lower Band Edge Plot (Cellular GSM Mode – Ch.128)

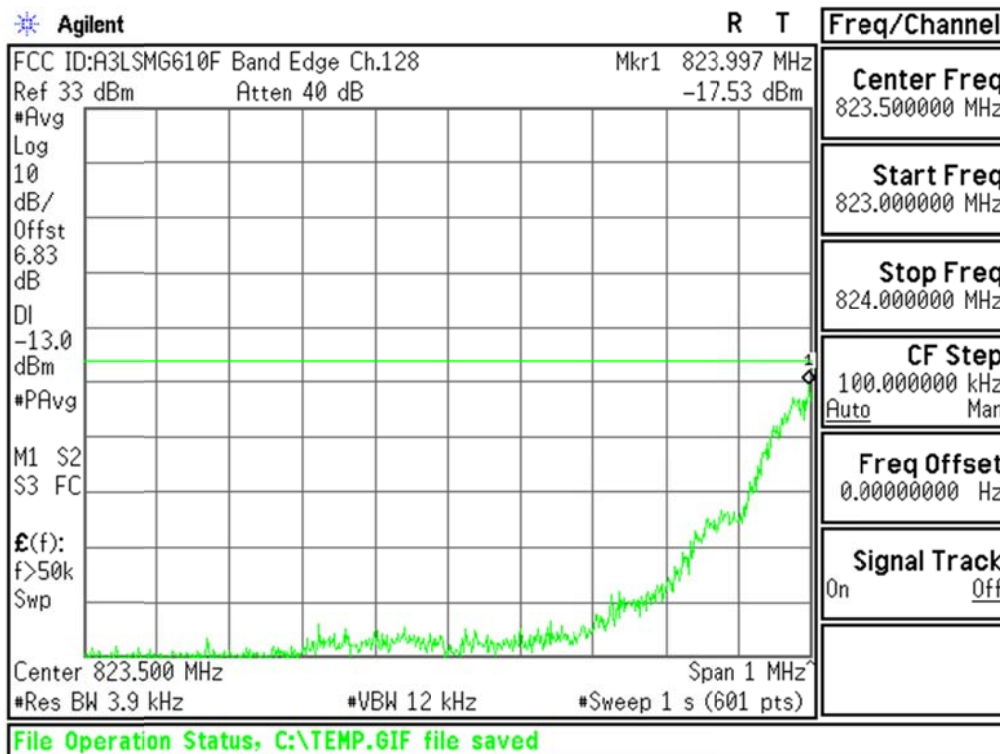

Plot 6-56. Lower Band Edge Plot (Cellular GSM Mode – Ch.128)



Issue Date:

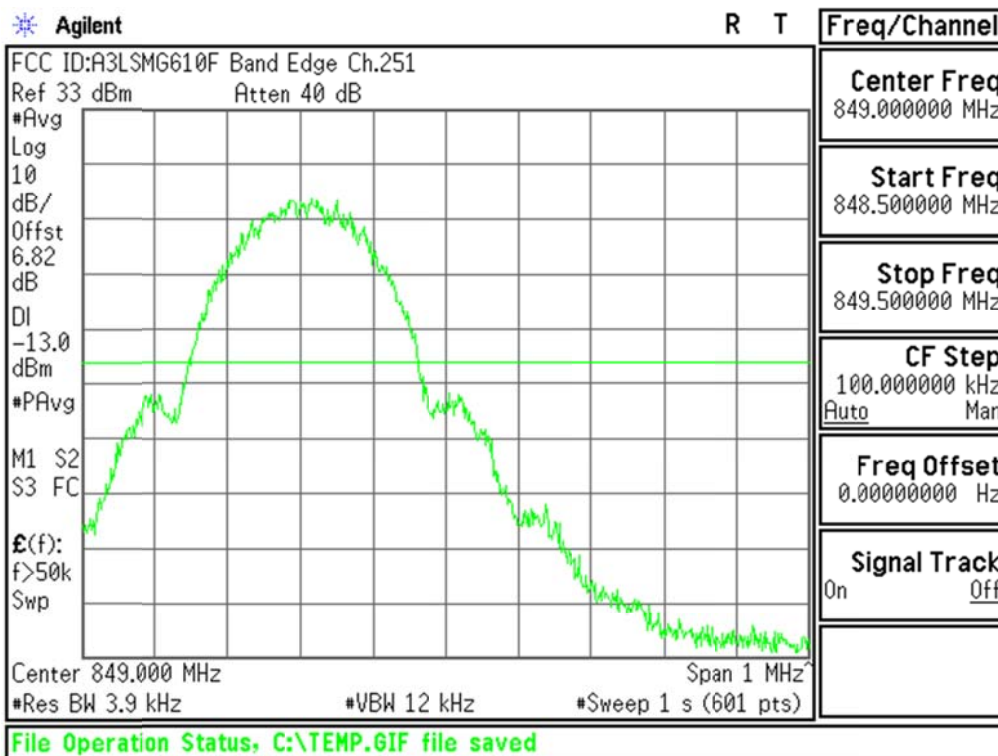

Plot 6-57. Upper Band Edge Plot (Cellular GSM Mode – Ch.251)

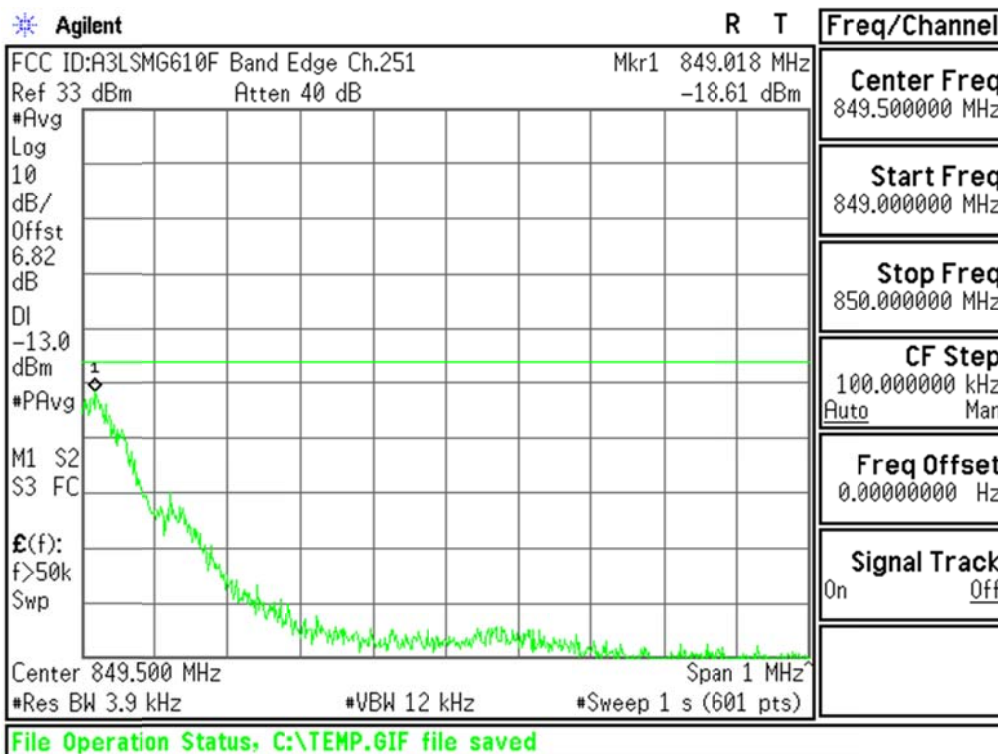

Plot 6-58. Upper Band Edge Plot (Cellular GSM Mode – Ch.251)



Issue Date:

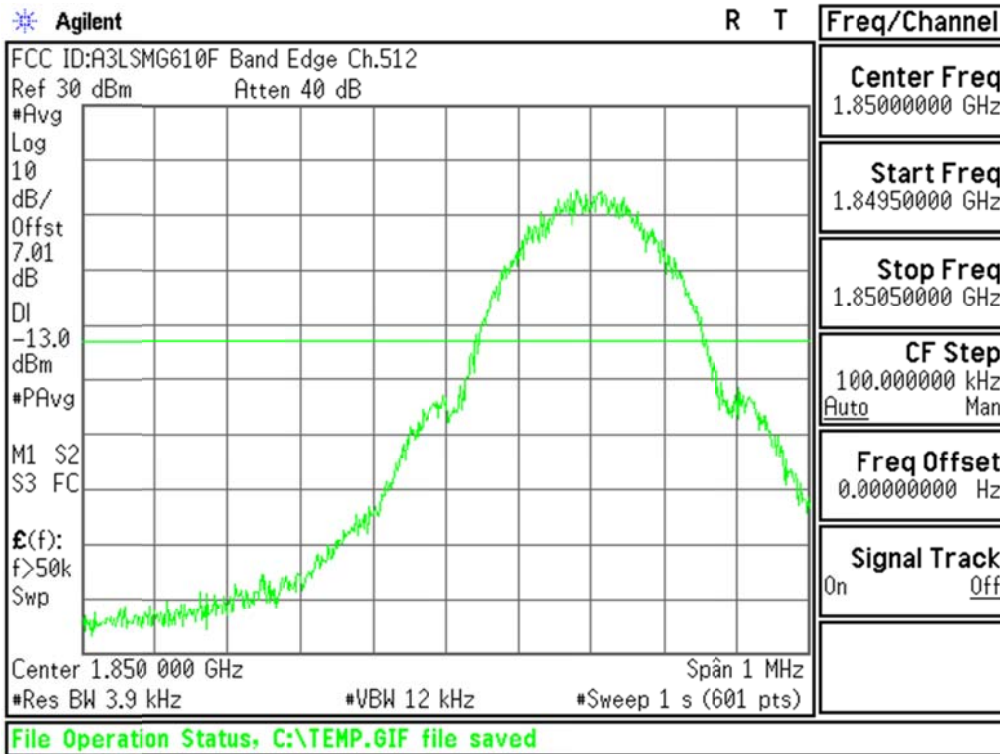

Plot 6-59. Lower Band Edge Plot (PCS GSM Mode – Ch.512)

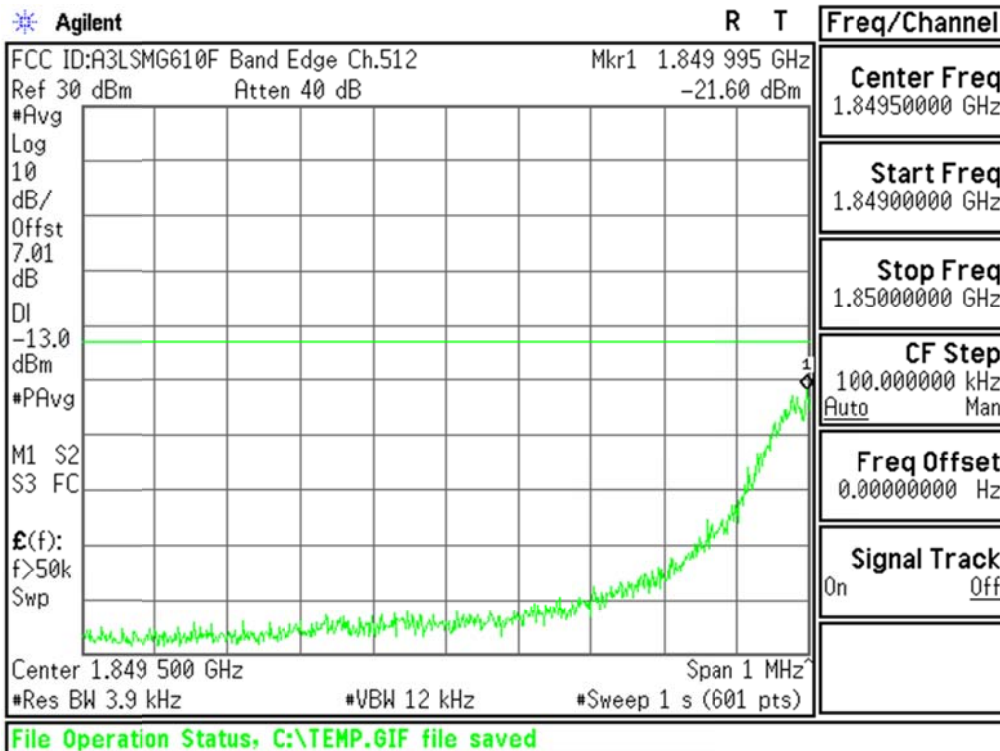

Plot 6-60. Lower Band Edge Plot (PCS GSM Mode – Ch.512)



Issue Date:

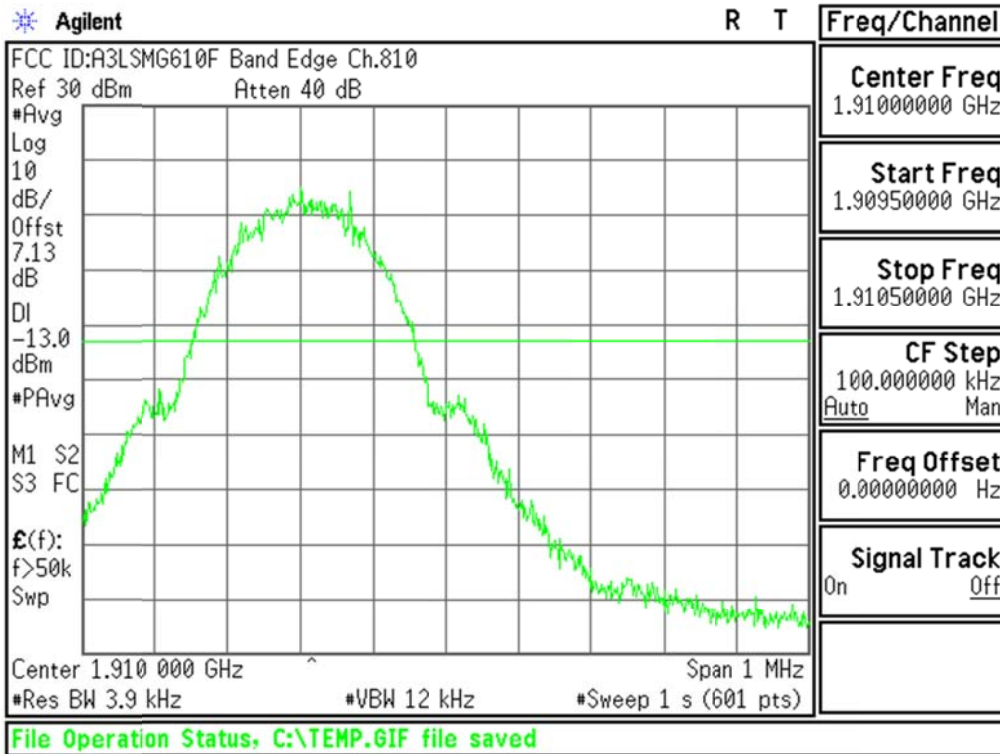

Plot 6-61. Upper Band Edge Plot (PCS GSM Mode – Ch.810)

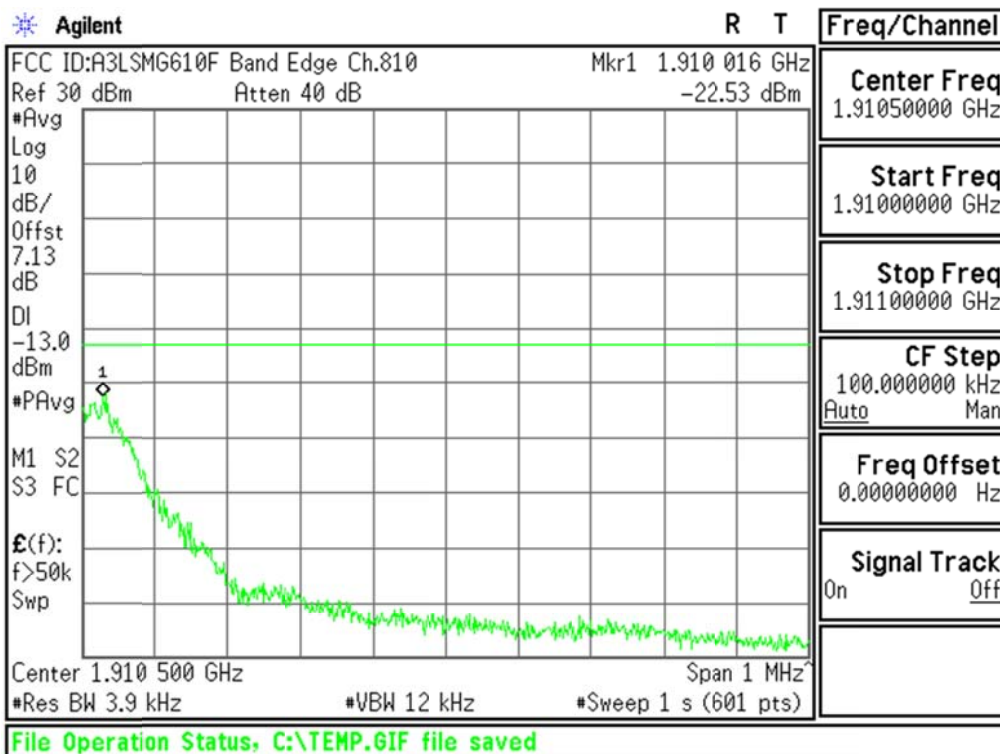

Plot 6-62. Upper Band Edge Plot (PCS GSM Mode – Ch.810)



Issue Date:

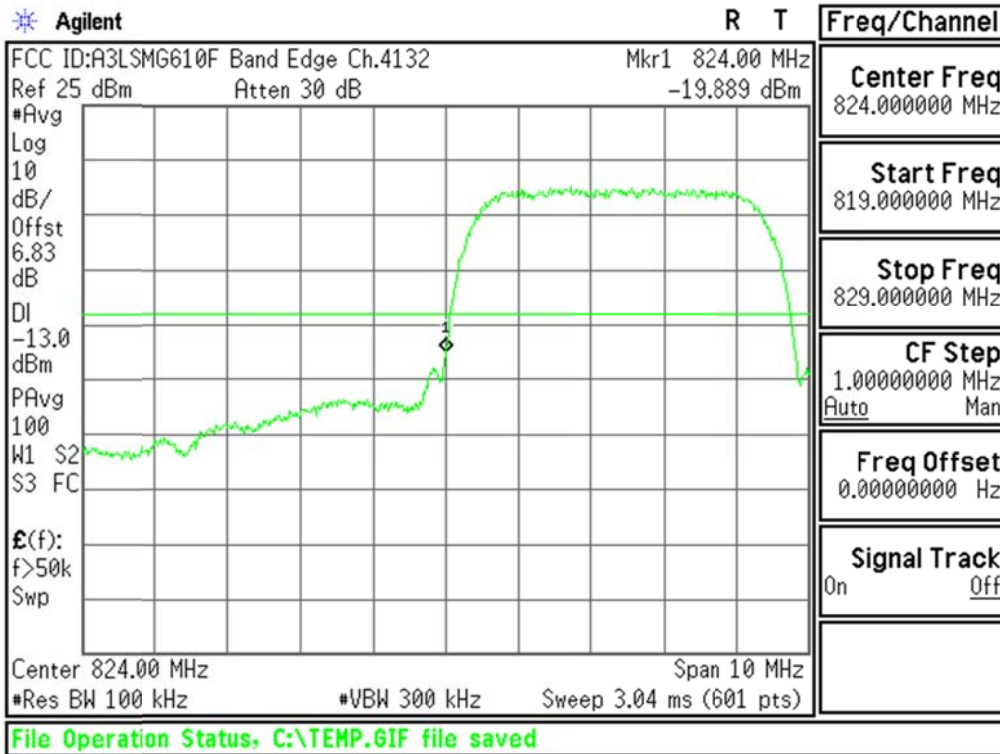

Plot 6-63. Lower Band Edge Plot (Cellular WCDMA Mode - Ch.4132(DL4357))

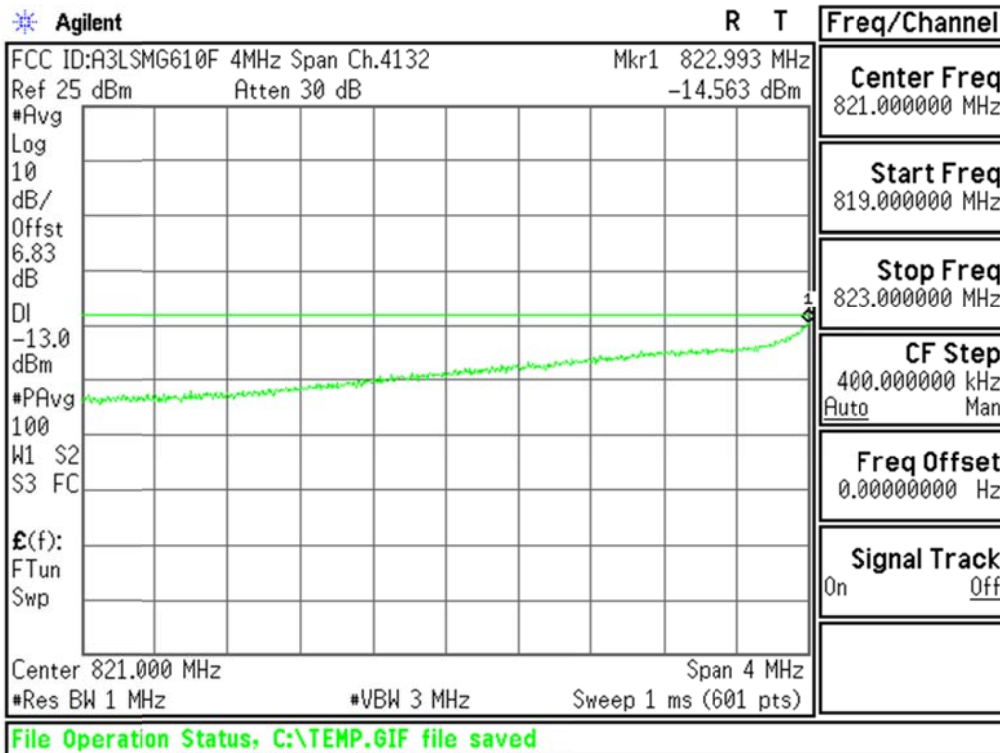

Plot 6-64. Extended Lower Band Edge Plot (Cellular WCDMA Mode - Ch.4132(DL4357))



Issue Date:

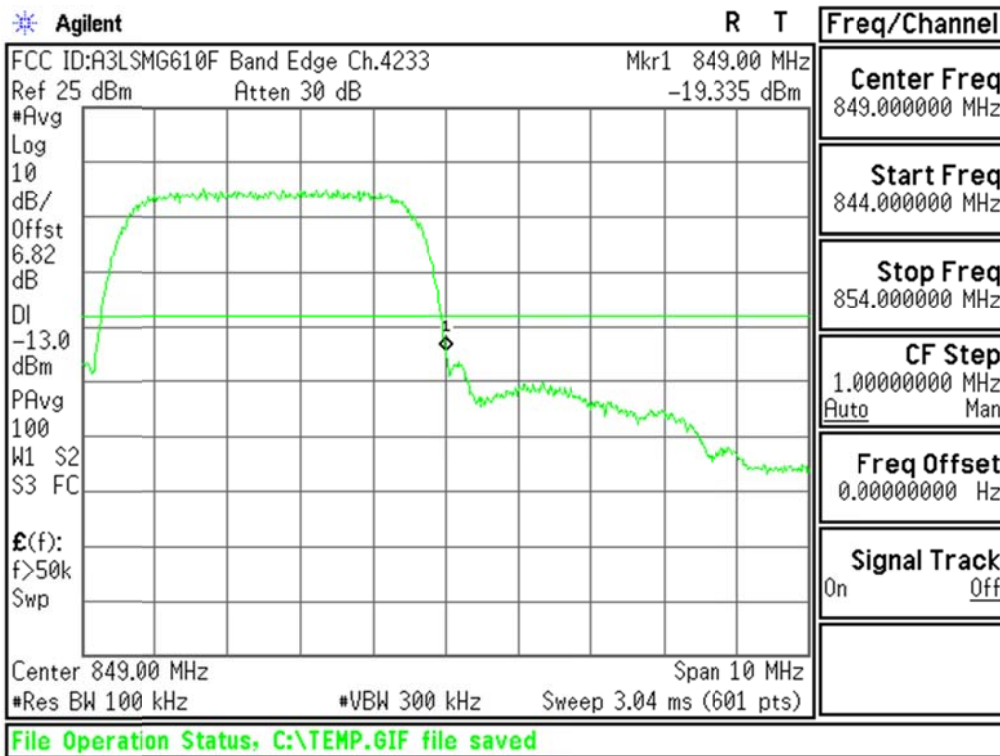

Plot 6-65. Upper Band Edge Plot (Cellular WCDMA Mode - Ch.4233(DL4458))

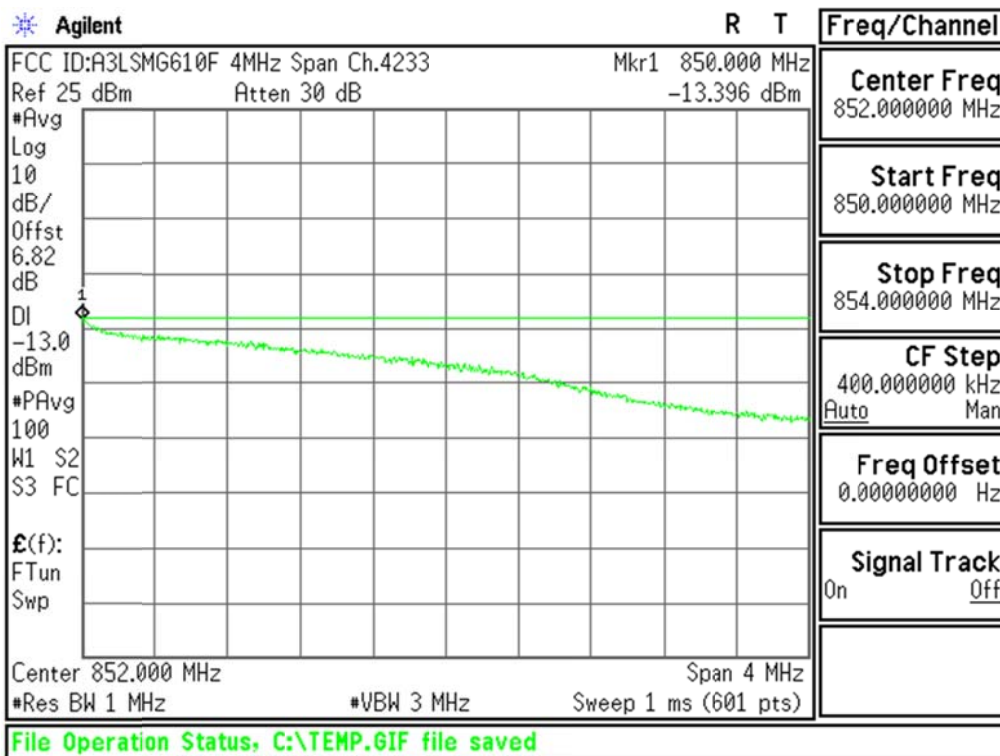

Plot 6-66. Extended Upper Band Edge Plot (Cellular WCDMA Mode - Ch.4233(DL4458))



Issue Date:

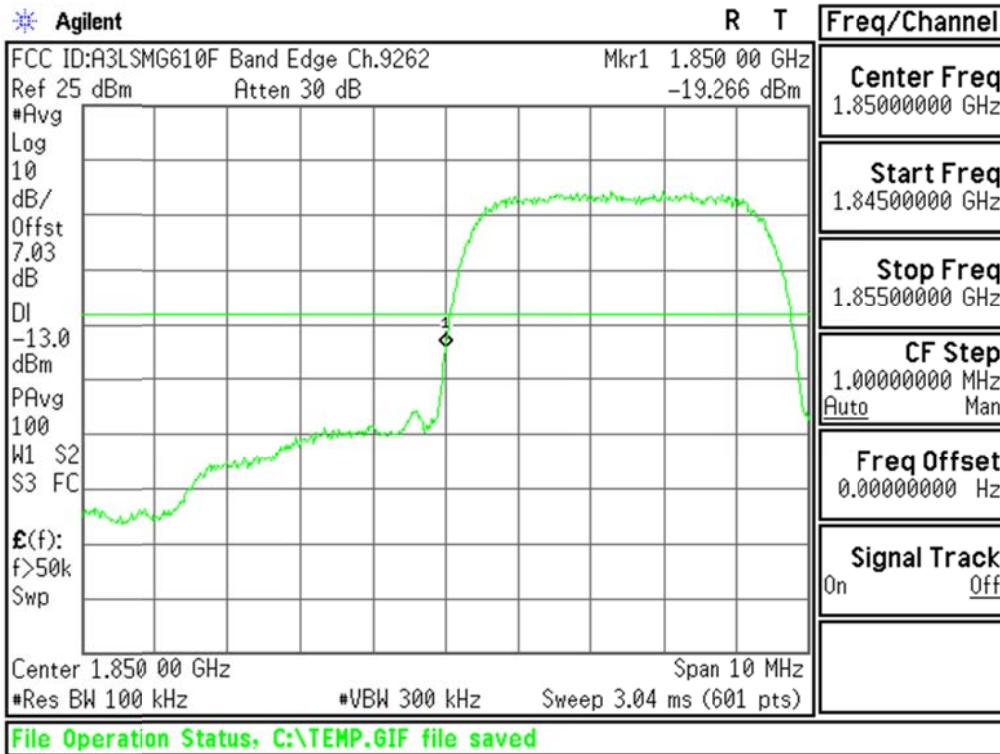

Plot 6-67. Lower Band Edge Plot (PCS WCDMA Mode - Ch.9262(DL9662))

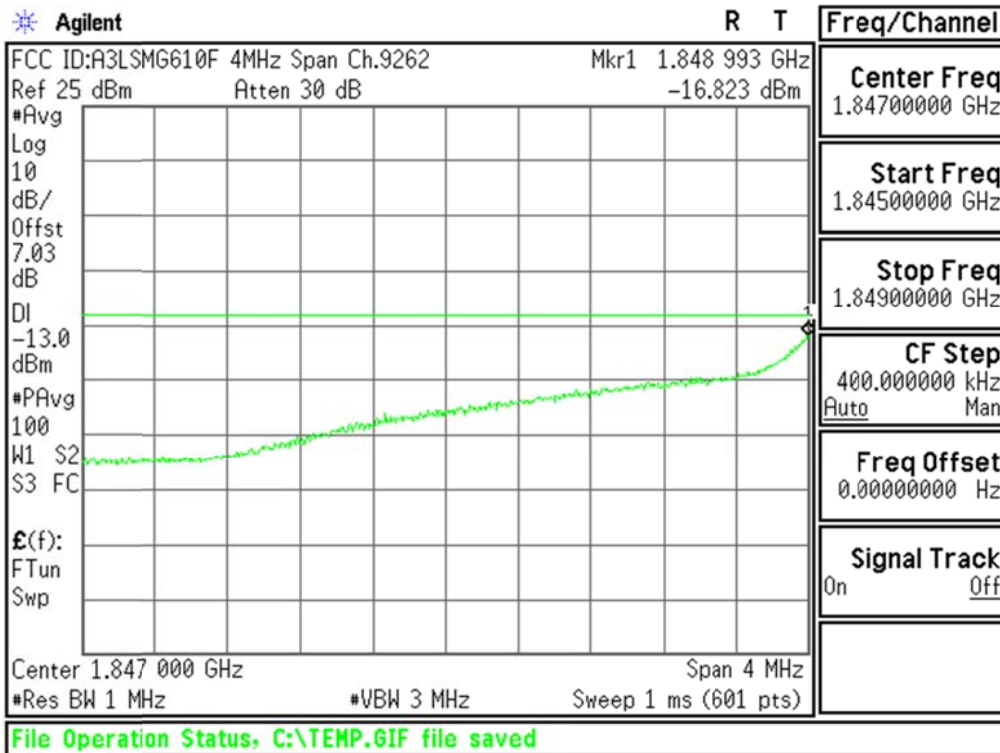

Plot 6-68. Extended Lower Band Edge Plot (PCS WCDMA Mode - Ch.9262(DL9662))



Issue Date:

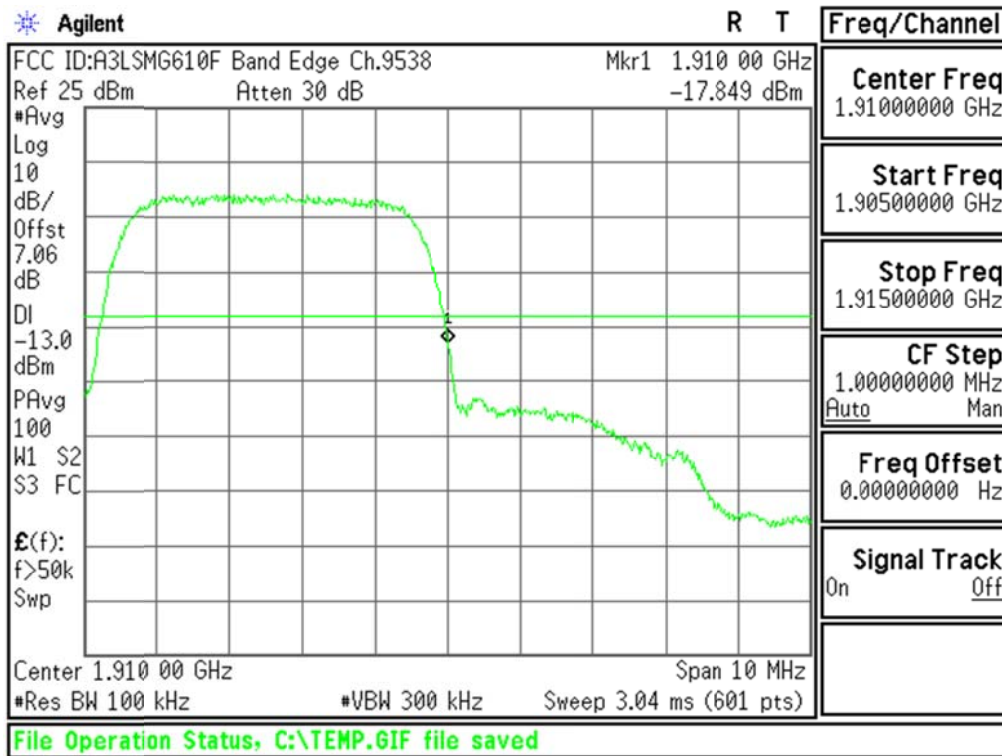

Plot 6-69. Upper Band Edge Plot (PCS WCDMA Mode - Ch.9538(DL9938))

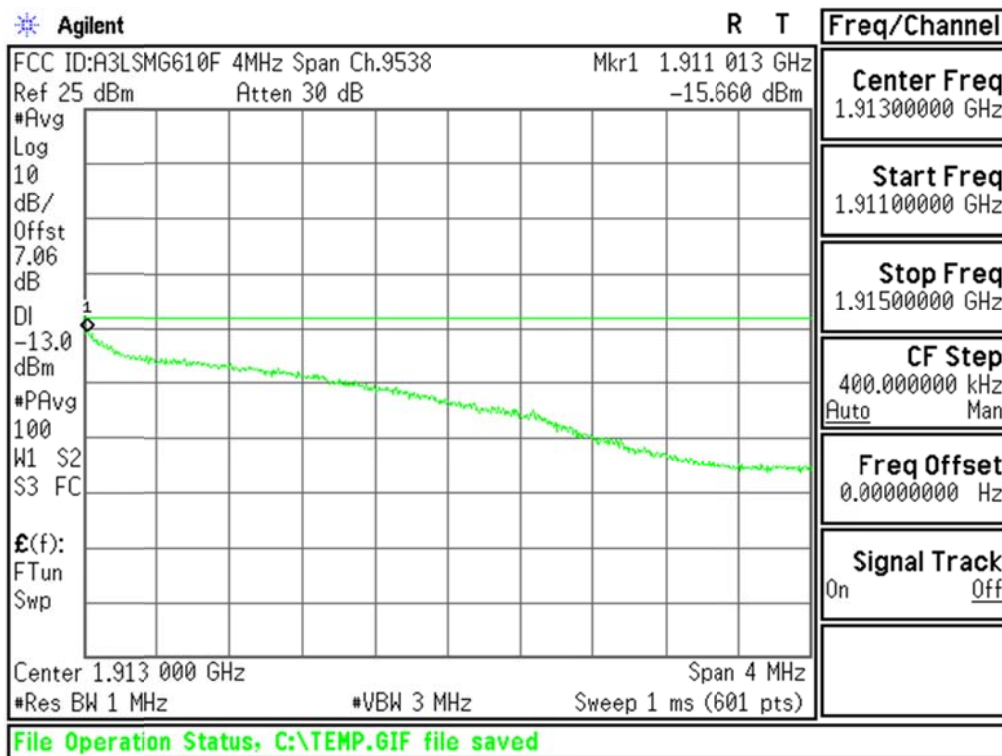

Plot 6-70. Extended Upper Band Edge Plot (PCS WCDMA Mode - Ch.9538(DL9938))

6.5. Peak-Average Ratio §24.232(d)

Test Overview

A peak to average ratio measurement is performed at the conducted port of the EUT. The spectrum analyzer's Complementary Cumulative Distribution Function (CCDF) measurement profile is used to determine the largest deviation between the average and the peak power of the EUT in a given bandwidth. The CCDF curve shows how much time the peak waveform spends at or above a given average power level. The percent of time the signal spends at or above the level defines the probability for that particular power level.

Test Procedure Used

KDB 971168 v02r02 – Section 5.7.1

Test Settings

1. The signal analyzer's CCDF measurement profile is enabled
2. Frequency = carrier center frequency
3. Measurement BW > Emission bandwidth of signal
4. The signal analyzer was set to collect 1 million samples to generate the CCDF curve
5. The measurement interval was set depending on the type of signal analyzed. For continuous signals (>98% duty cycle), the measurement interval was set to 1ms. For burst transmissions, the spectrum analyzer was set to use an interval "RF Burst" trigger that is synced with an incoming pulse and the measurement interval is set to less than the duration of the "on time" of one burst to ensure that energy is only captured during a time in which the transmitter is operating at maximum power

Test Setup

The EUT and measurement equipment were set up as shown in the diagram below.

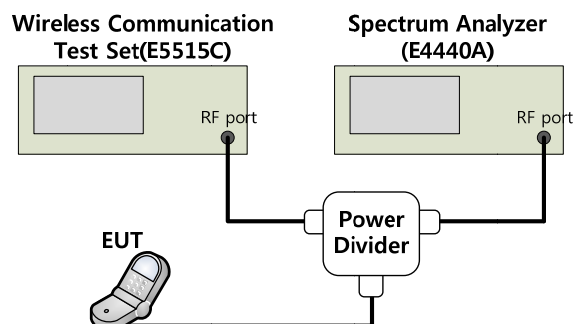
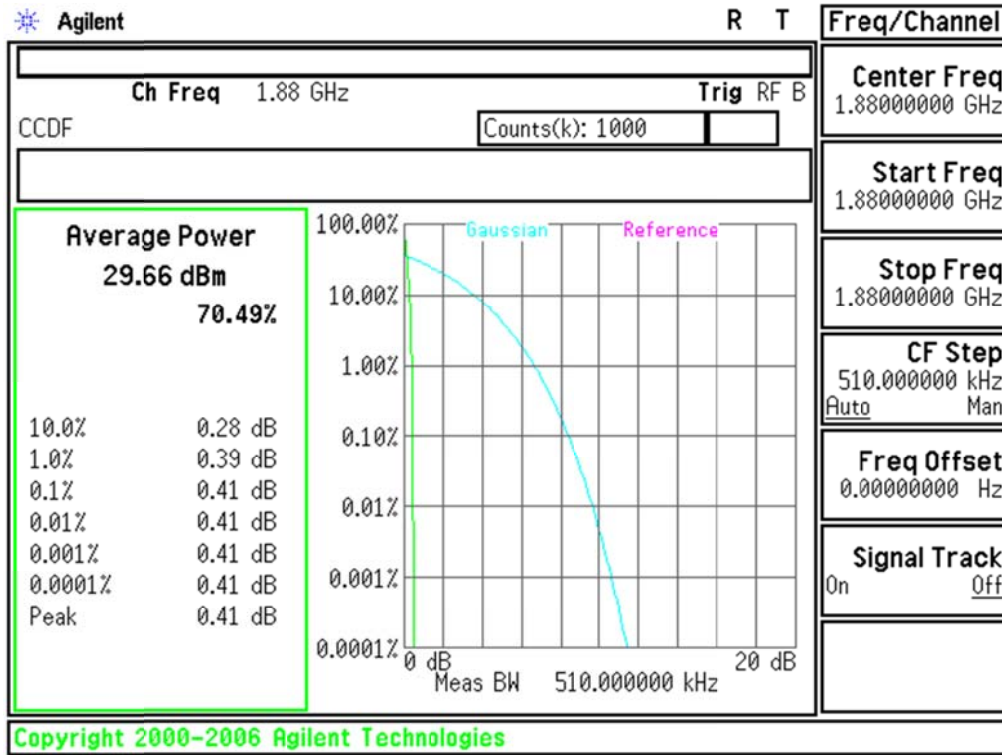

Figure 6-4. Test Instruments & Measurement Setup



Test Plots



Plot 6-71. Peak-Average Ratio Plot (PCS GSM Mode - Ch.661)

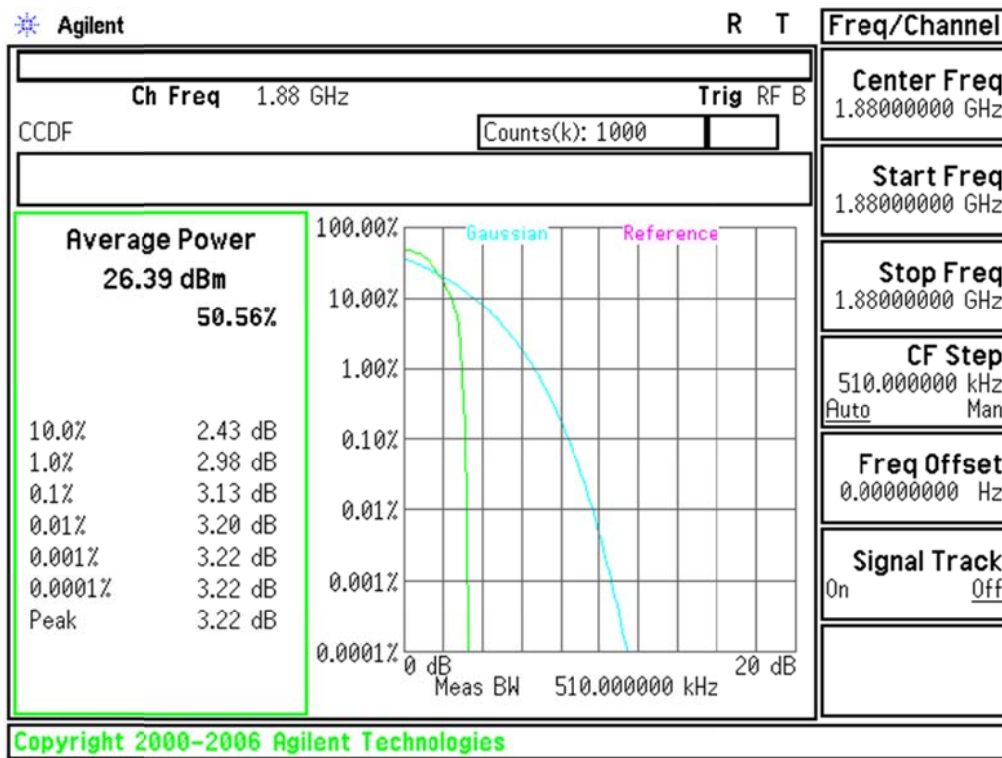

Plot 6-72. Peak-Average Ratio Plot (EDGE1900 Mode - Ch.661)



Issue Date:

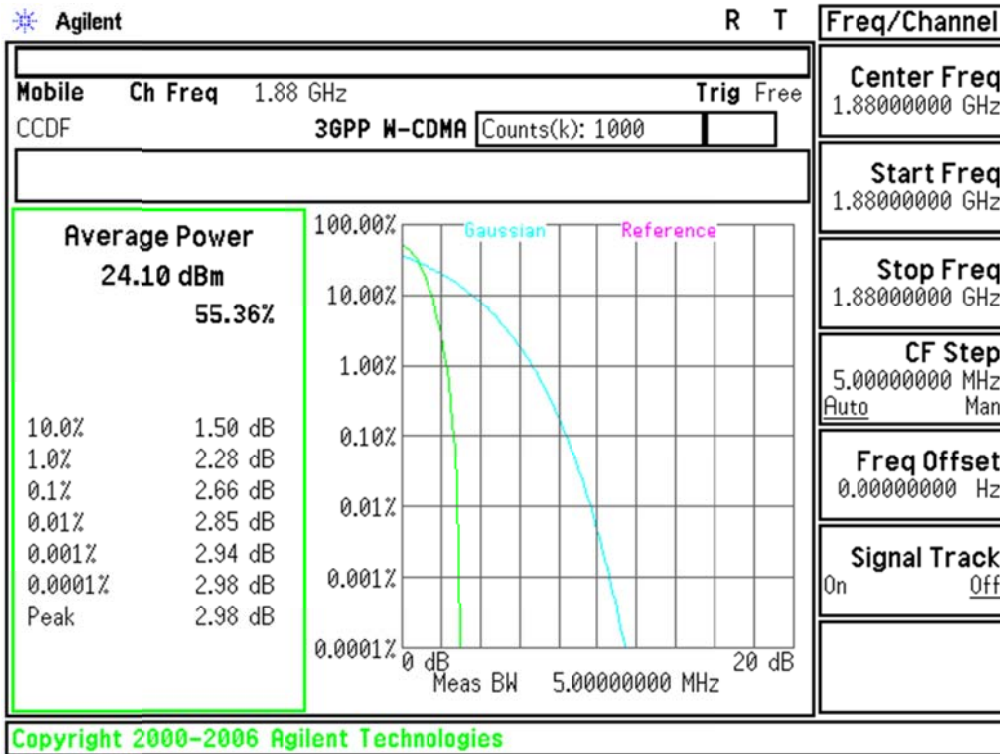

Plot 6-73. Peak-Average Ratio Plot (PCS WCDMA Mode - Ch.9400(DL9800))



6.6. Frequency Stability / Temperature Variation
§2.1055 §22.355 §24.229 §24.235

Test Overview and Limit

Frequency stability testing is performed in accordance with the guidelines of ANSI/TIA-603-D-2010. The frequency stability of the transmitter is measured by:

1. Temperature: The temperature is varied from -30°C to +50°C in 10°C increments using an environmental chamber.
2. Primary Supply Voltage: The primary supply voltage is varied from 85% to 115% of the nominal value for other than hand carried battery equipment. For hand-carried, battery-powered equipment, primary supply voltage is reduced to the battery operating end point(=Bat..End) which shall be specified by the manufacturer.

For part 22, the frequency stability of the transmitter shall be maintained within $\pm 0.00025\%$ (± 2.5 ppm) of the center frequency. For part 24, the frequency stability shall be sufficient to ensure that the fundamental emission stays within the authorized frequency block.

Test Procedure Used

ANSI/TIA-603-D-2010

Test Settings

1. The equipment is turned on in a "standby" condition for fifteen minutes before applying power to the transmitter. Measurement of the carrier frequency of the transmitter is made within one minute after applying power to the transmitter.
2. Frequency measurements are made at 10°C intervals ranging from -30°C to +50°C. A period of time sufficient to stabilize EUT at each temperature level shall be allowed prior to frequency measurement.

Test Setup

The EUT and measurement equipment were set up as shown in the diagram below.

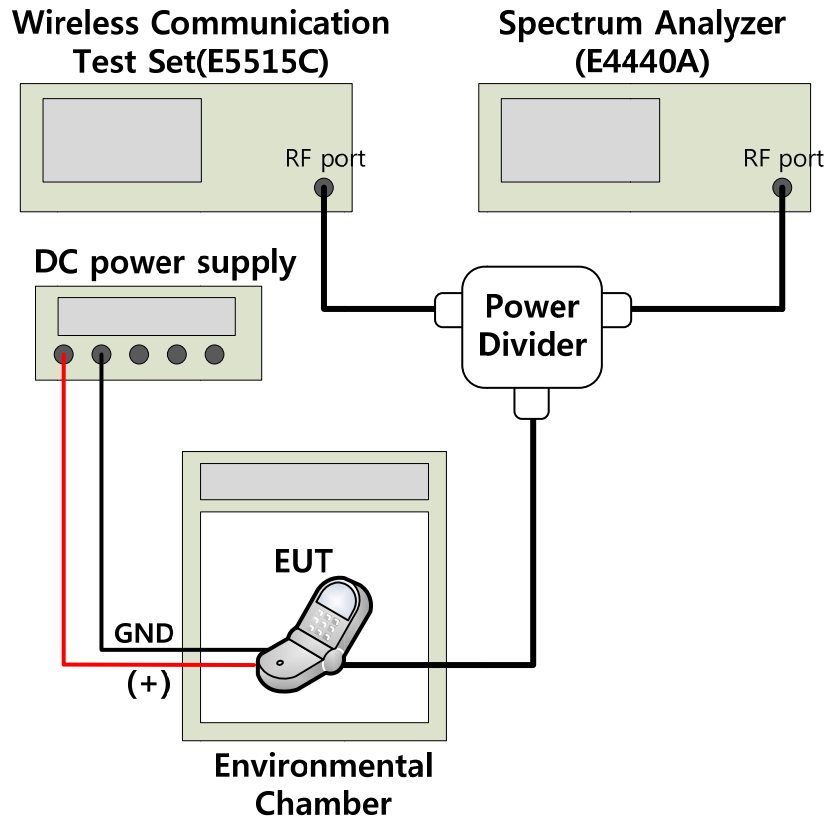

Figure 6-5. Test Instruments & Measurement Setup

Test Notes

1. MCF is the Measured Carrier Frequency
ACF is the Assigned Carrier Frequency
2. Calculate the ppm frequency error by the following:

$$\text{ppm error} = \left(\frac{\text{MCF}_{[\text{MHz}]} - \text{ACF}_{[\text{MHz}]}}{\text{ACF}_{[\text{MHz}]}} \right) \times 10^6$$

3. For part 24, the fundamental emission should stay within the authorized frequency block. But, based on the results of the frequency stability test at the center channel, the frequency deviation results measured are very small. As such it is determined that the channels at the band edge would remain in-band when the maximum measured frequency deviation noted during the frequency stability tests is applied. Therefore the device is determined to remain operating in band over the temperature and voltage range as tested.



Issue Date:

Mode : Cellular GSM
 Channel : 190
 Operating Frequency : 836.6 MHz
 Reference Voltage : 3.85 VDC

Voltage [%]	Power [VDC]	Temp [°C]	ACF [MHz]	MCF [MHz]	Freq. Dev. [Hz]	ppm error	Limit [ppm]
100 %	3.85	-30	836.6	836.600024	23.72	0.028	±2.5
		-20	836.6	836.599977	-22.60	-0.027	
		-10	836.6	836.600013	12.86	0.015	
		0	836.6	836.600017	17.49	0.021	
		+10	836.6	836.600021	20.95	0.025	
		+20	836.6	836.599982	-18.32	-0.022	
		+30	836.6	836.599989	-10.52	-0.013	
		+40	836.6	836.599980	-20.04	-0.024	
Bat. End	3.40	+20	836.6	836.599981	-19.49	-0.023	

Table 6-2. Frequency Stability Data (Cellular GSM Mode - Ch.190)

Mode : PCS GSM
 Channel : 661
 Operating Frequency : 1880 MHz
 Reference Voltage : 3.85 VDC

Voltage [%]	Power [VDC]	Temp [°C]	ACF [MHz]	MCF [MHz]	Freq. Dev. [Hz]	ppm error
100 %	3.85	-30	1880	1,880.000013	12.96	0.007
		-20	1880	1,879.999981	-19.35	-0.010
		-10	1880	1,879.999986	-13.71	-0.007
		0	1880	1,879.999984	-15.91	-0.008
		+10	1880	1,879.999986	-13.63	-0.007
		+20	1880	1,879.999987	-12.98	-0.007
		+30	1880	1,879.999979	-20.93	-0.011
		+40	1880	1,879.999980	-20.02	-0.011
Bat. End	3.40	+20	1880	1,879.999993	-7.13	-0.004

Table 6-3. Frequency Stability Data (PCS GSM Mode - Ch.661)



Issue Date:

Mode : Cellular WCDMA
 Channel : 4183
 Operating Frequency : 836.6 MHz
 Reference Voltage : 3.85 VDC

Voltage [%]	Power [VDC]	Temp [°C]	ACF [MHz]	MCF [MHz]	Freq. Dev. [Hz]	ppm error	Limit [ppm]
100 %	3.85	-30	836.6	836.600005	5.42	0.006	±2.5
		-20	836.6	836.600005	4.80	0.006	
		-10	836.6	836.600004	3.61	0.004	
		0	836.6	836.600004	3.95	0.005	
		+10	836.6	836.600003	3.39	0.004	
		+20	836.6	836.600003	3.04	0.004	
		+30	836.6	836.600003	3.11	0.004	
		+40	836.6	836.600003	3.26	0.004	
Bat. End	3.40	+20	836.6	836.600003	2.85	0.003	

Table 6-4. Frequency Stability Data (Cellular WCDMA Mode - Ch.4183)

Mode : PCS WCDMA
 Channel : 9400
 Operating Frequency : 1880 MHz
 Reference Voltage : 3.85 VDC

Voltage [%]	Power [VDC]	Temp [°C]	ACF [MHz]	MCF [MHz]	Freq. Dev. [Hz]	ppm error
100 %	3.85	-30	1880	1,880.000009	9.48	0.005
		-20	1880	1,880.000008	8.19	0.004
		-10	1880	1,880.000008	7.96	0.004
		0	1880	1,880.000008	8.17	0.004
		+10	1880	1,880.000006	6.34	0.003
		+20	1880	1,880.000007	7.13	0.004
		+30	1880	1,880.000006	6.29	0.003
		+40	1880	1,880.000006	6.48	0.003
Bat. End	3.40	+20	1880	1,880.000006	6.36	0.003

Table 6-5. Frequency Stability Data (PCS WCDMA Mode - Ch.9400)



6.7. Radiated Power (ERP/EIRP)
§22.913(a)(2) §24.232(c)

Test Overview

Effective Radiated Power (ERP) and Equivalent Isotropic Radiated Power (EIRP) measurements are performed using the substitution method described in ANSI/TIA-603-D-2010 with the EUT transmitting into an integral antenna. Measurements on signals operating below 1GHz are performed using dipole antennas. Measurements on signals operating above 1GHz are performed using broadband horn antennas. All measurements are performed as RMS average measurements while the EUT is operating at its maximum duty cycle, at maximum power, and at the appropriate frequencies.

Test Procedure Used

KDB 971168 v02r02 – Section 5.2.1

ANSI/TIA-603-D-2010 – Section 2.2.17

Test Settings

1. Radiated power measurements are performed using the signal analyzer's "channel power" measurement capability for signals with continuous operation. For signals with burst transmission, the signal analyzer's "time domain power" measurement capability is used
2. RBW = 1 – 5% of the expected OBW, not to exceed 1MHz
3. VBW $\geq 3 \times$ RBW
4. Span = 1.5 times the OBW
5. No. of sweep points $\geq 2 \times$ span / RBW
6. Detector = RMS
7. Trigger is set to "free run" for signals with continuous operation with the sweep times set to "auto". Trigger is set to enable triggering only on full power bursts with the sweep time set less than or equal to the transmission burst duration
8. The integration bandwidth was roughly set equal to the measured OBW of the signal for signals with continuous operation. For signals with burst transmission, the "gating" function was enabled to ensure that measurements are performed during times in which the transmitter is operating at its maximum power
9. Trace mode = trace averaging (RMS) over 100 sweeps
10. The trace was allowed to stabilize

Test Setup

The EUT and measurement equipment were set up as shown in the diagram below.

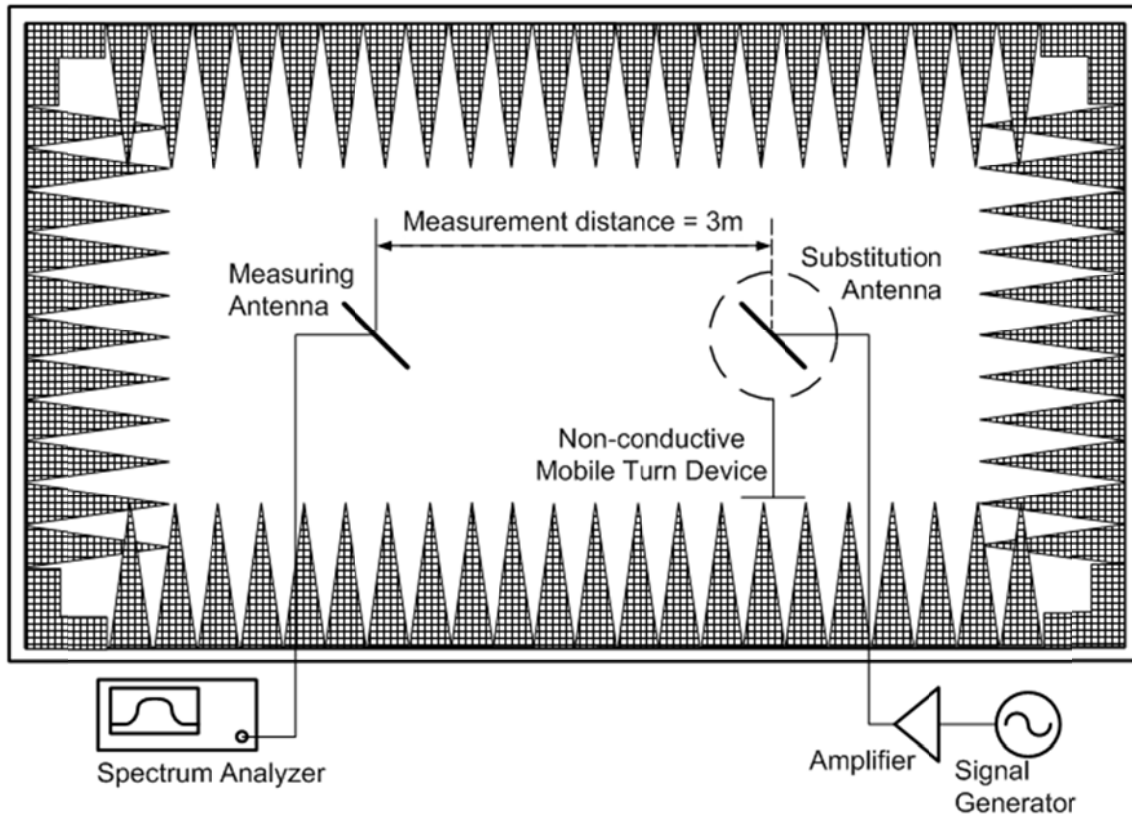

Figure 6-6. Test Instruments & Measurement Setup

Test Notes

1. This device employs GSM, GPRS and EDGE capabilities. The EUT was tested under all configurations and the highest power is reported in GSM mode using a Power Control Level of "0" in the PCS Band and "5" in the Cellular Band.
2. This device employs UMTS technology with WCDMA (AMR/RMC), HSDPA and HSUPA capabilities. For WCDMA and HSUPA transmission, all configurations were investigated and the worst case UMTS emissions were found in RMC WCDMA mode at 12.2kbps with HSDPA inactive and TPC bits all set to "1".
3. The EUT was tested with its standard battery.
4. The EUT was tested with Turn Device and the worst case test setup is reported in the tables below.



Test Results

Mode	Freq. [MHz]	Ant Pol (H/V)	EUT Pol [degree]		EUT Lev. [dBm]	S/G Lev. [dBm]	Tx C/L [dB]	Gain [dBd]	ERP [dBm]	Limit [dBm]	Margin [dB]
			Azimuth	Elevation							
GSM850	824.2	H	316	182	-8.95	21.62	2.30	5.32	24.64	38.45	13.81
GSM850	836.6	H	94	360	-8.36	24.00	2.30	5.25	26.95	38.45	11.50
GSM850	848.8	H	88	360	-8.12	24.23	2.32	5.21	27.12	38.45	11.33
EDGE850	848.8	H	81	360	-12.36	19.99	2.32	5.21	22.88	38.45	15.57

Table 6-6. ERP (Cellular GSM)

Mode	Freq. [MHz]	Ant Pol (H/V)	EUT Pol [degree]		EUT Lev. [dBm]	S/G Lev. [dBm]	Tx C/L [dB]	Gain [dBi]	EIRP [dBm]	Limit [dBm]	Margin [dB]
			Azimuth	Elevation							
GSM1900	1850.2	H	15	178	-16.73	22.39	3.48	9.17	28.08	33.01	4.93
GSM1900	1880.0	V	261	277	-17.71	21.99	3.53	8.95	27.41	33.01	6.06
GSM1900	1909.8	V	216	277	-19.00	21.09	3.64	8.63	26.08	33.01	8.72
EDGE1900	1880.0	H	15	184	-19.26	20.60	3.53	8.95	26.02	33.01	6.99

Table 6-7. EIRP (PCS GSM)

Mode	Freq. [MHz]	Ant Pol (H/V)	EUT Pol [degree]		EUT Lev. [dBm]	S/G Lev. [dBm]	Tx C/L [dB]	Gain [dBd]	ERP [dBm]	Limit [dBm]	Margin [dB]
			Azimuth	Elevation							
WCDMA850	826.4	H	315	177	-17.81	13.10	2.29	5.29	16.10	38.45	22.35
WCDMA850	836.6	H	88	350	-17.27	15.09	2.30	5.25	18.04	38.45	20.41
WCDMA850	846.6	H	88	350	-17.75	14.60	2.32	5.21	17.49	38.45	20.96

Table 6-8. ERP (Cellular WCDMA)

Mode	Freq. [MHz]	Ant Pol (H/V)	EUT Pol [degree]		EUT Lev. [dBm]	S/G Lev. [dBm]	Tx C/L [dB]	Gain [dBi]	EIRP [dBm]	Limit [dBm]	Margin [dB]
			Azimuth	Elevation							
WCDMA1900	1852.4	H	11	176	-23.30	15.82	3.48	9.17	21.51	33.01	11.50
WCDMA1900	1880.0	H	21	176	-24.21	15.65	3.53	8.95	21.07	33.01	11.94
WCDMA1900	1907.6	V	153	96	-24.83	15.26	3.64	8.63	20.25	33.01	14.83

Table 6-9. EIRP (PCS WCDMA)



6.8. Radiated Spurious Emissions Measurements
§2.1053 §22.917(a) §24.238(a)

Test Overview

Radiated spurious emissions measurements are performed using the substitution method described in ANSI/TIA-603-D-2010 with the EUT transmitting into an integral antenna. Measurements on signals operating below 1GHz are performed using dipole antennas. Measurements on signals operating above 1GHz are performed using broadband horn antennas. All measurements are performed as peak measurements while the EUT is operating at its maximum duty cycle, at maximum power, and at the appropriate frequencies.

Test Procedure Used

KDB 971168 v02r02 – Section 5.8

ANSI/TIA-603-D-2010 – Section 2.2.12

Test Settings

1. RBW = 100kHz for emissions below 1GHz and 1MHz for emissions above 1GHz
2. VBW $\geq 3 \times$ RBW
3. Span = 1.5 times the OBW
4. No. of sweep points $\geq 2 \times$ span / RBW
5. Detector = Max Peak
6. Trace mode = max hold
7. The trace was allowed to stabilize

– End of this page –

Test Setup

The EUT and measurement equipment were set up as shown in the diagram below.

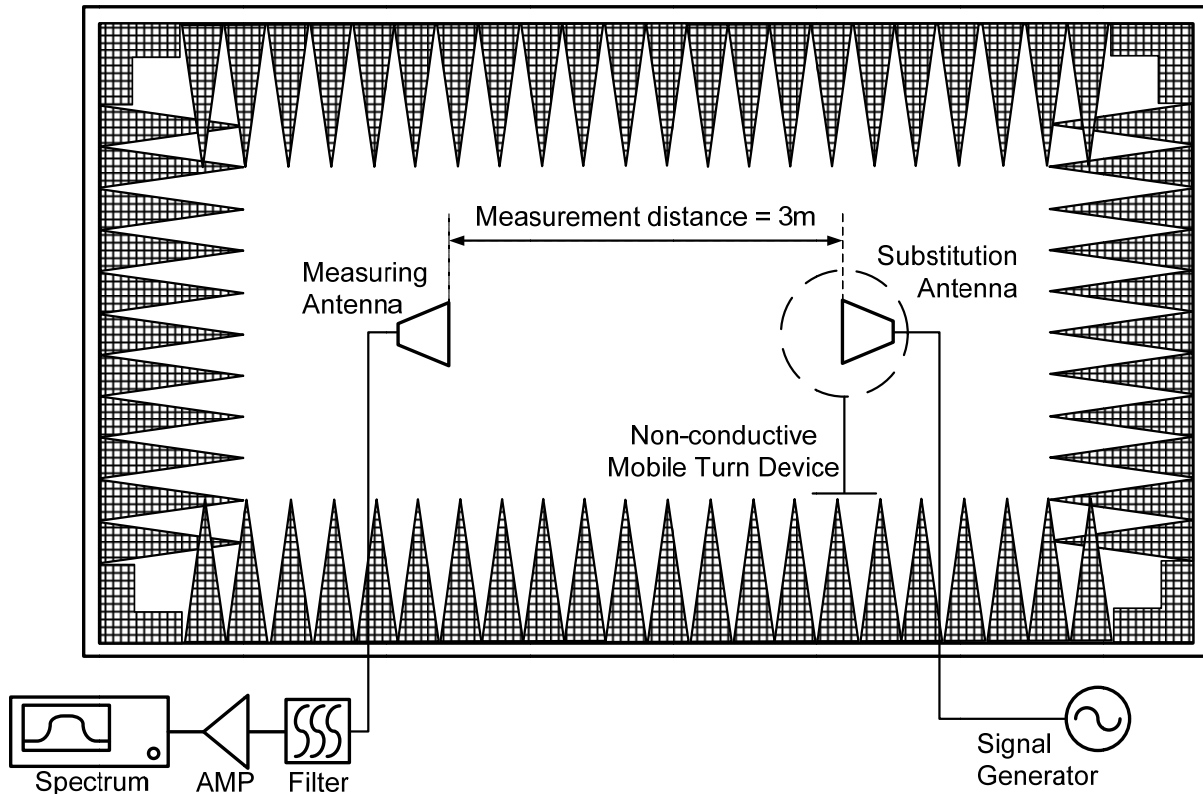

Figure 6-7. Test Instruments & Measurement Setup

Test Notes

1. This device employs GSM, GPRS and EDGE capabilities. The EUT was tested under all configurations and the highest power is reported in GSM mode using a Power Control Level of "0" in the PCS Band and "5" in the Cellular Band.
2. This device employs UMTS technology with WCDMA (AMR/RMC), HSDPA and HSUPA capabilities. For WCDMA and HSUPA transmission, all configurations were investigated and the worst case UMTS emissions were found in RMC WCDMA mode at 12.2kbps with HSDPA inactive and TPC bits all set to "1".
3. The EUT was tested with its standard battery.
4. The EUT was tested with Turn Device and the worst case test setup is reported in the tables below.
5. The spectrum is measured from 9kHz to the 10th harmonic of the fundamental frequency of the transmitter. The worst-case emissions are reported however emissions whose levels were not within 20dB of the respective limits were not reported.



Issue Date:

Test Results

Operating Frequency : 824.2 MHz
 Channel : 128
 Measured Output Power : 24.64 dBm = 0.291 Watt
 Modulation Signal : GSM(GMSK)
 Distance : 3 meters
 Limit : $43 + 10 \log_{10}(W)$ = 37.64 dBc
 RSE Limit : -13 dBm

Freq. [MHz]	Ant Pol (H/V)	EUT Pol [degree]		EUT Level [dBm]	S/G Lev. [dBm]	Tx C/L [dBm]	Ant. Gain [dBd]	RSE Level [dBm]
		Azimuth	Elevation					
1648.4	V	95	263	-47.57	-49.53	3.25	8.86	-43.92
2472.6	H	94	360	-46.76	-45.49	4.04	9.91	-39.62
3296.8	H	23	360	-54.44	-47.66	4.76	9.61	-42.81
4121.0	V	172	263	-58.37	-48.72	5.28	9.75	-44.25

Table 6-10. Radiated Spurious Data (Cellular GSM Mode - Ch.128)

Operating Frequency : 836.6 MHz
 Channel : 190
 Measured Output Power : 26.95 dBm = 0.495 Watt
 Modulation Signal : GSM(GMSK)
 Distance : 3 meters
 Limit : $43 + 10 \log_{10}(W)$ = 39.95 dBc
 RSE Limit : -13 dBm

Freq. [MHz]	Ant Pol (H/V)	EUT Pol [degree]		EUT Level [dBm]	S/G Lev. [dBm]	Tx C/L [dBm]	Ant. Gain [dBd]	RSE Level [dBm]
		Azimuth	Elevation					
1673.2	H	102	360	-47.12	-49.33	3.37	9.24	-43.46
2509.8	V	230	122	-48.89	-47.74	4.04	9.91	-41.87
3346.4	V	296	104	-56.68	-50.15	4.78	9.60	-45.33
4183.0	H	15	360	-57.14	-47.71	5.37	10.02	-43.06

Table 6-11. Radiated Spurious Data (Cellular GSM Mode - Ch.190)

- End of this page -



Issue Date:

Operating Frequency : 848.8 MHz
 Channel : 251
 Measured Output Power : 27.12 dBm = 0.515 Watt
 Modulation Signal : GSM(GMSK)
 Distance : 3 meters
 Limit : $43 + 10 \log_{10}(W)$ = 40.12 dBc
 RSE Limit : -13 dBm

Freq. [MHz]	Ant Pol (H/V)	EUT Pol [degree]		EUT Level [dBm]	S/G Lev. [dBm]	Tx C/L [dBm]	Ant. Gain [dBd]	RSE Level [dBm]
		Azimuth	Elevation					
1697.6	H	102	343	-47.96	-50.48	3.37	9.24	-44.61
1697.6	V	315	293	-43.19	-41.25	4.19	9.70	-35.74
2546.4	H	168	360	-59.86	-53.48	4.81	9.59	-48.70
2546.4	H	174	360	-57.56	-48.23	5.46	10.26	-43.43

Table 6-12. Radiated Spurious Data (Cellular GSM Mode - Ch.251)

Operating Frequency : 1850.2 MHz
 Channel : 512
 Measured Output Power : 28.08 dBm = 0.642 Watt
 Modulation Signal : GSM(GMSK)
 Distance : 3 meters
 Limit : $43 + 10 \log_{10}(W)$ = 41.08 dBc
 RSE Limit : -13 dBm

Freq. [MHz]	Ant Pol (H/V)	EUT Pol [degree]		EUT Level [dBm]	S/G Lev. [dBm]	Tx C/L [dBm]	Ant. Gain [dBi]	RSE Level [dBm]
		Azimuth	Elevation					
3700.4	H	295	88	-59.19	-51.66	5.03	9.91	-46.78
5550.6	H	169	360	-60.19	-47.05	6.18	11.21	-42.02
7400.8	H	Noise floor		-63.56	-42.30	7.25	9.34	-40.21
9251.0	H			-65.25	-42.44	8.30	11.61	-39.13

Table 6-13. Radiated Spurious Data (PCS GSM Mode - Ch.512)



Issue Date:

Operating Frequency : 1880.0 MHz
 Channel : 661
 Measured Output Power : 27.41 dBm = 0.550 Watt
 Modulation Signal : GSM(GMSK)
 Distance : 3 meters
 Limit : $43 + 10 \log_{10}(W)$ = 40.41 dBc
 RSE Limit : -13 dBm

Freq. [MHz]	Ant Pol (H/V)	EUT Pol [degree]		EUT Level [dBm]	S/G Lev. [dBm]	Tx C/L [dBm]	Ant. Gain [dBi]	RSE Level [dBm]
		Azimuth	Elevation					
3760.0	V	20	71	-61.53	-53.33	5.10	9.79	-48.64
5640.0	H	183	360	-62.28	-48.35	6.38	11.01	-43.72
7520.0	V	Noise floor		-63.68	-42.88	7.27	9.73	-40.42
9400	V			-63.68	-40.72	8.21	11.64	-37.29

Table 6-14. Radiated Spurious Data (PCS GSM Mode - Ch.661)

Operating Frequency : 1909.8 MHz
 Channel : 810
 Measured Output Power : 26.08 dBm = 0.406 Watt
 Modulation Signal : GSM(GMSK)
 Distance : 3 meters
 Limit : $43 + 10 \log_{10}(W)$ = 39.08 dBc
 RSE Limit : -13 dBm

Freq. [MHz]	Ant Pol (H/V)	EUT Pol [degree]		EUT Level [dBm]	S/G Lev. [dBm]	Tx C/L [dBm]	Ant. Gain [dBi]	RSE Level [dBm]
		Azimuth	Elevation					
3819.6	H	308	360	-59.70	-51.31	5.10	9.67	-46.74
5729.4	H	135	360	-62.67	-47.93	6.47	10.95	-43.45
7639.2	H	Noise floor		-64.05	-42.82	7.52	9.71	-40.63
9549.0	V			-66.35	-42.42	8.36	11.87	-38.91

Table 6-15. Radiated Spurious Data (PCS GSM Mode - Ch.810)

- End of this page -



Issue Date:

Operating Frequency : 826.4 MHz
 Channel : 4357
 Measured Output Power : 16.10 dBm = 0.040 Watt
 Modulation Signal : WCDMA
 Distance : 3 meters
 Limit : $43 + 10 \log_{10}(W)$ = 29.10 dBc
 RSE Limit : -13 dBm

Freq. [MHz]	Ant Pol (H/V)	EUT Pol [degree]		EUT Level [dBm]	S/G Lev. [dBm]	Tx C/L [dBm]	Ant. Gain [dBd]	RSE Level [dBm]
		Azimuth	Elevation					
1652.8	V	360	98	-60.78	-62.75	3.25	8.86	-57.14
2479.2	H	343	5	-59.34	-57.68	4.04	9.91	-51.81
3305.6	V	Noise floor		-62.65	-56.02	4.76	9.61	-51.17
4132.0	H			-63.55	-53.27	5.28	9.75	-48.80

Table 6-16. Radiated Spurious Data (Cellular WCDMA Mode - Ch.4132)

Operating Frequency : 836.6 MHz
 Channel : 4408
 Measured Output Power : 18.04 dBm = 0.064 Watt
 Modulation Signal : WCDMA
 Distance : 3 meters
 Limit : $43 + 10 \log_{10}(W)$ = 31.04 dBc
 RSE Limit : -13 dBm

Freq. [MHz]	Ant Pol (H/V)	EUT Pol [degree]		EUT Level [dBm]	S/G Tx Level [dBm]	Tx C/L [dBm]	Ant. Gain [dBd]	RSE Level [dBm]
		Azimuth	Elevation					
1673.2	H	108	360	-59.01	-61.23	3.37	9.24	-55.36
2509.8	V	Noise floor		-61.47	-59.88	4.04	9.91	-54.01
3346.4	H			-62.31	-55.79	4.78	9.60	-50.97

Table 6-17. Radiated Spurious Data (Cellular WCDMA Mode - Ch.4183)



Issue Date:

Operating Frequency : 846.6 MHz
 Channel : 4458
 Measured Output Power : 17.49 dBm = 0.056 Watt
 Modulation Signal : WCDMA
 Distance : 3 meters
 Limit : $43 + 10 \log_{10}(W)$ = 30.49 dBc
 RSE Limit : -13 dBm

Freq. [MHz]	Ant Pol (H/V)	EUT Pol [degree]		EUT Level [dBm]	S/G Lev. [dBm]	Tx C/L [dBm]	Ant. Gain [dBd]	RSE Level [dBm]
		Azimuth	Elevation					
1693.2	H	100	360	-56.37	-58.89	3.37	9.24	-53.02
2539.8	V	Noise floor		-60.92	-58.98	4.19	9.70	-53.48
3386.4	V	Noise floor		-61.85	-55.43	4.81	9.59	-50.65

Table 6-18. Radiated Spurious Data (Cellular WCDMA Mode - Ch.4233)

Operating Frequency : 1852.4 MHz
 Channel : 9662
 Measured Output Power : 21.51 dBm = 0.142 Watt
 Modulation Signal : WCDMA
 Distance : 3 meters
 Limit : $43 + 10 \log_{10}(W)$ = 34.51 dBc
 RSE Limit : -13 dBm

Freq. [MHz]	Ant Pol (H/V)	EUT Pol [degree]		EUT Level [dBm]	S/G Lev. [dBm]	Tx C/L [dBm]	Ant. Gain [dBi]	RSE Level [dBm]
		Azimuth	Elevation					
3704.8	H	171	2	-57.53	-50.00	5.03	9.91	-45.12
5557.2	H	Noise floor		-63.05	-49.91	6.18	11.21	-44.88
7409.6	V	Noise floor		-63.05	-41.94	7.25	9.34	-39.85

Table 6-19. Radiated Spurious Data (PCS WCDMA Mode - Ch.9262)

- End of this page -



Issue Date:

Operating Frequency : 1880.0 MHz
 Channel : 9800
 Measured Output Power : 21.07 dBm = 0.128 Watt
 Modulation Signal : WCDMA
 Distance : 3 meters
 Limit : $43 + 10 \log_{10}(W)$ = 34.07 dBc
 RSE Limit : -13 dBm

Freq. [MHz]	Ant Pol (H/V)	EUT Pol [degree]		EUT Level [dBm]	S/G Lev. [dBm]	Tx C/L [dBm]	Ant. Gain [dBi]	RSE Level [dBm]
		Azimuth	Elevation					
3760.0	V	286	257	-59.02	-50.82	5.10	9.79	-46.13
5640.0	H	Noise floor		-64.03	-50.10	6.38	11.01	-45.47
7520.0	H			-64.41	-43.89	7.27	9.73	-41.43

Table 6-20. Radiated Spurious Data (PCS WCDMA Mode - Ch.9400)

Operating Frequency : 1907.6 MHz
 Channel : 9938
 Measured Output Power : 20.25 dBm = 0.106 Watt
 Modulation Signal : WCDMA
 Distance : 3 meters
 Limit : $43 + 10 \log_{10}(W)$ = 33.25 dBc
 RSE Limit : -13 dBm

Freq. [MHz]	Ant Pol (H/V)	EUT Pol [degree]		EUT Level [dBm]	S/G Tx Level [dBm]	Tx C/L [dBm]	Ant. Gain [dBi]	RSE Level [dBm]
		Azimuth	Elevation					
3815.2	H	289	360	-61.17	-52.78	5.10	9.67	-48.21
5722.8	H	Noise floor		-64.27	-50.01	6.40	10.99	-45.42
7630.4	H			-64.11	-42.88	7.52	9.71	-40.69

Table 6-21. Radiated Spurious Data (PCS WCDMA Mode - Ch.9538)

- End of this page -



7. CONCLUSION

The data collected relate only the item(s) tested and show that the Samsung Portable Handset FCC ID: A3LSMG610F compliance with all the requirements of Parts 2, 22 and 24 of the FCC rules.

– End of this report –