

FCC Approval

Antenna location & Distance

★주의사항★

반드시 해당 모델의 외곽 line만을 이용하여 작성 바랍니다.
(PCB외곽 아닙니다.).

(FCC document중 2, 3 label & location문서 동일)

FCC ID: A3LSMG360H

Model: SM-G360H/DS

Date: 14.09.24

* Placement of each antenna

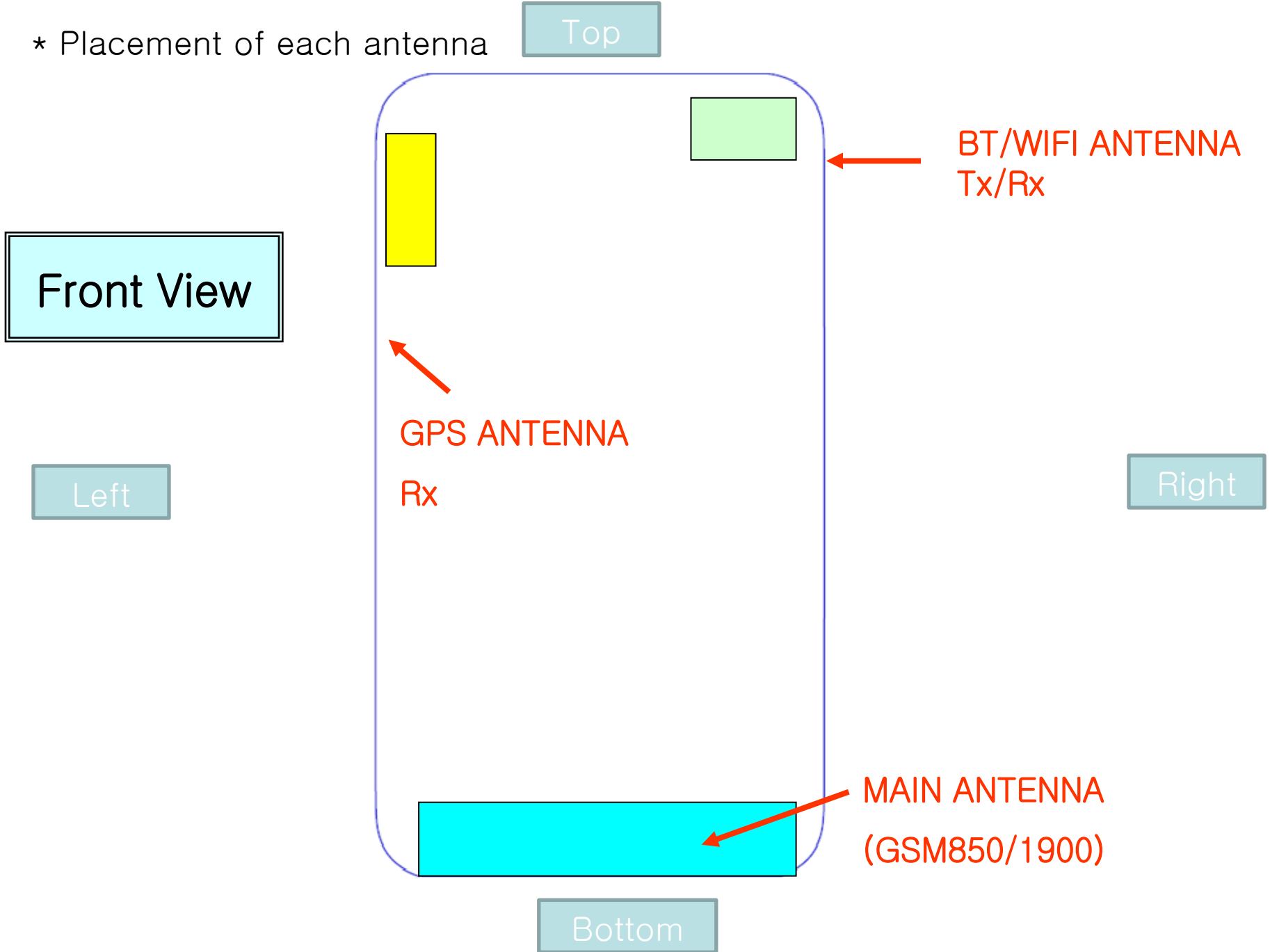

* Antenna pattern (FCC Band만 표기)

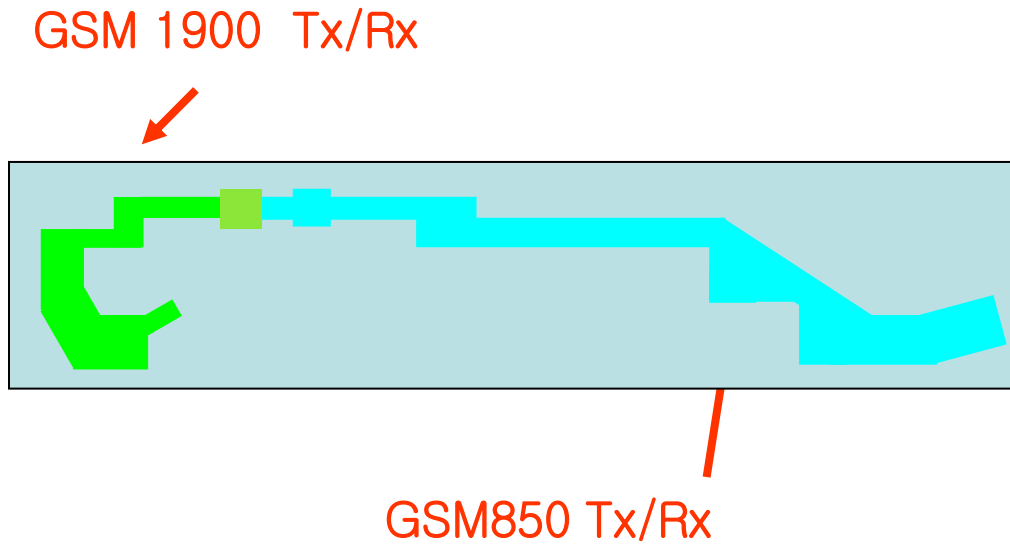

* Distance between BT/WLAN antenna and Main antenna

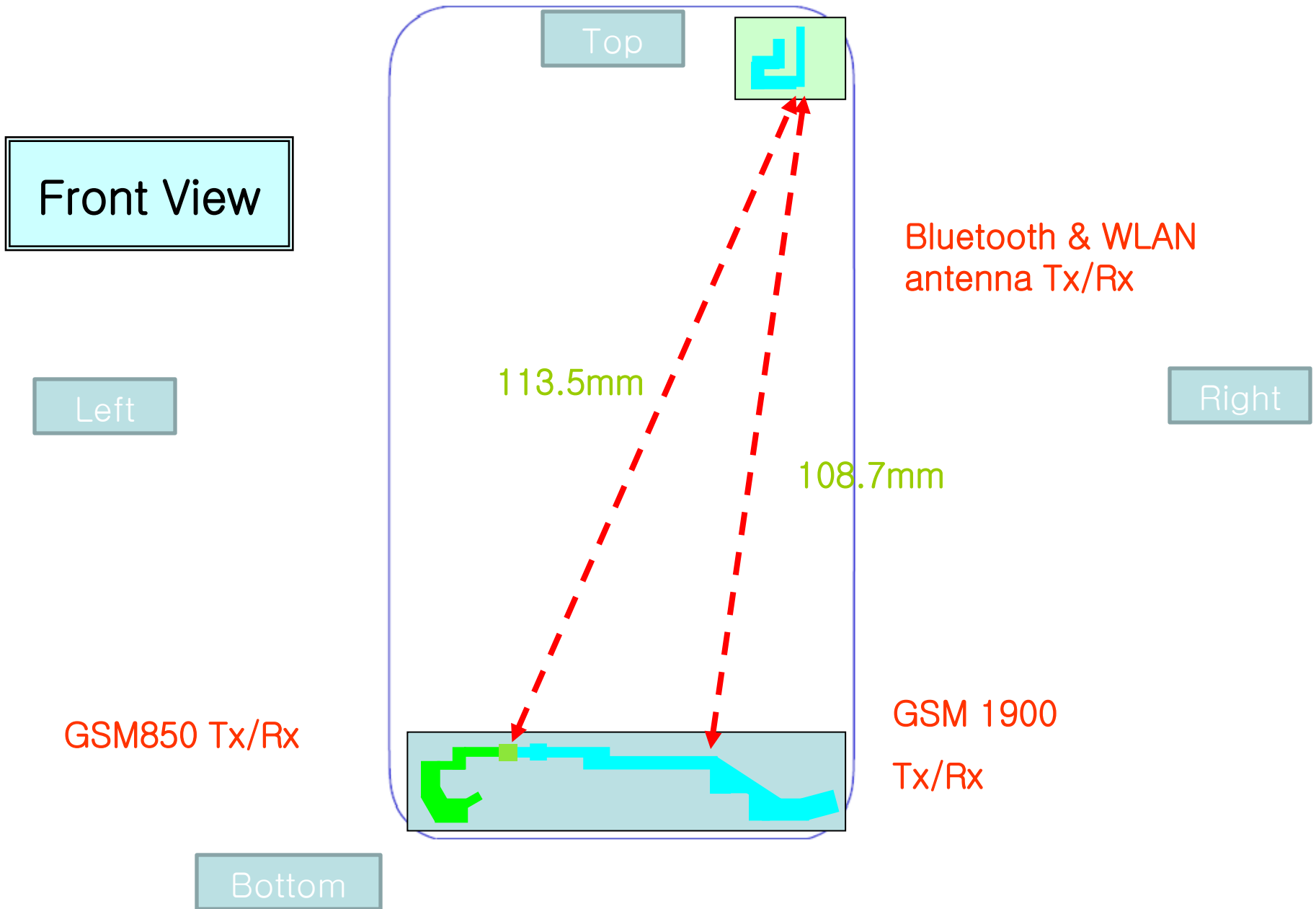

* Distance between Main antenna and edge

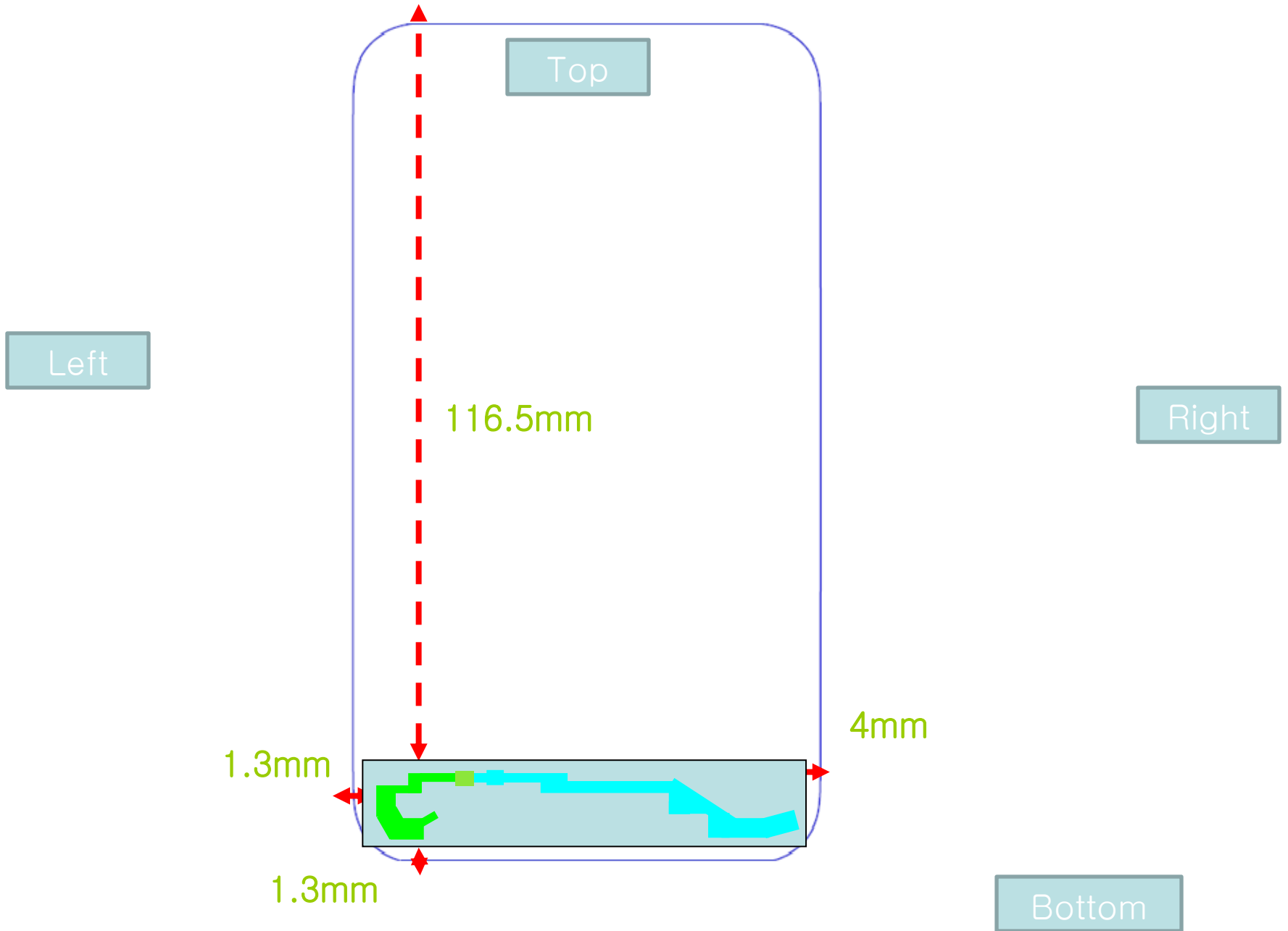

* Distance between Bluetooth antenna and edge

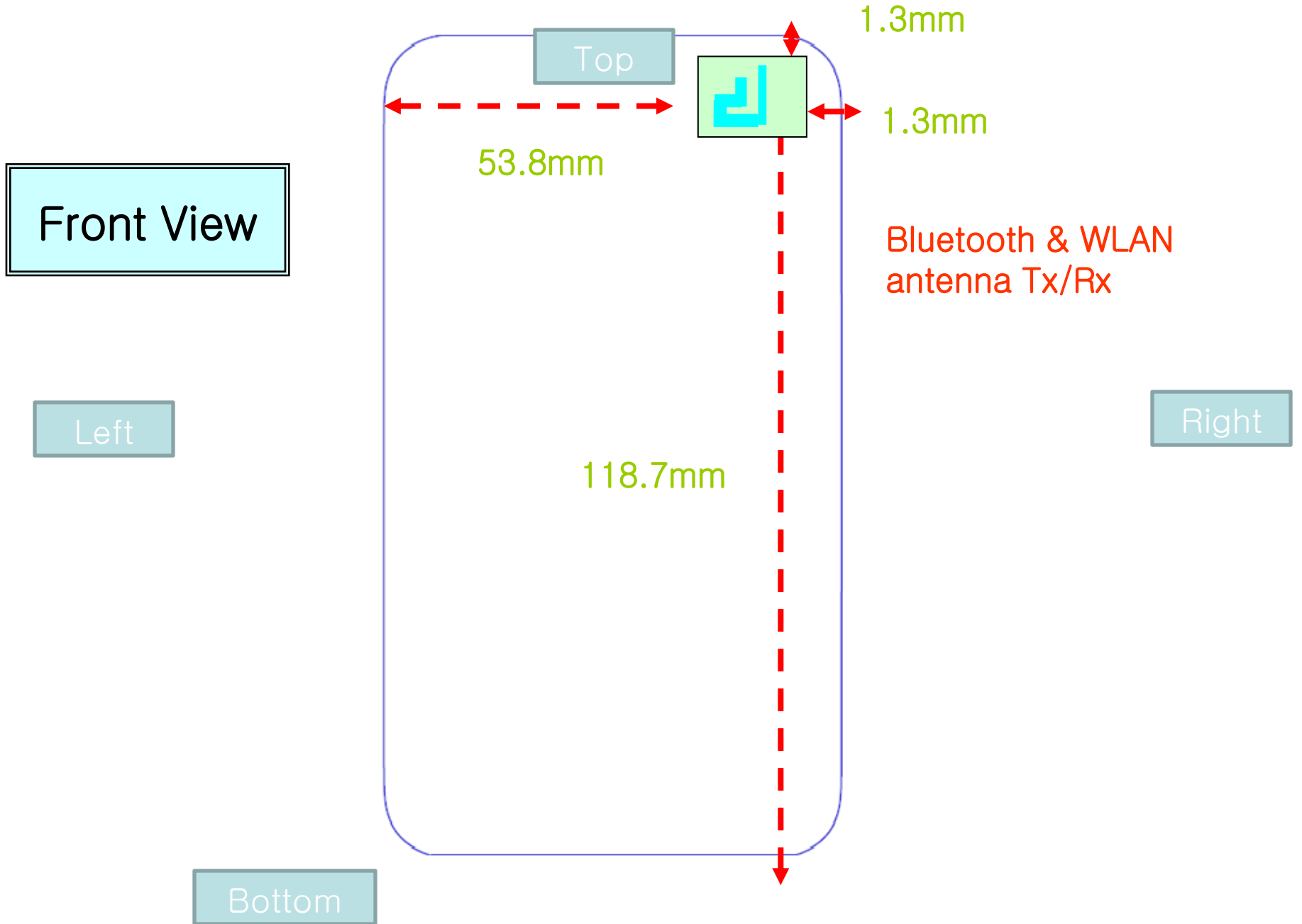

* Diagonal dimension of LCD and device

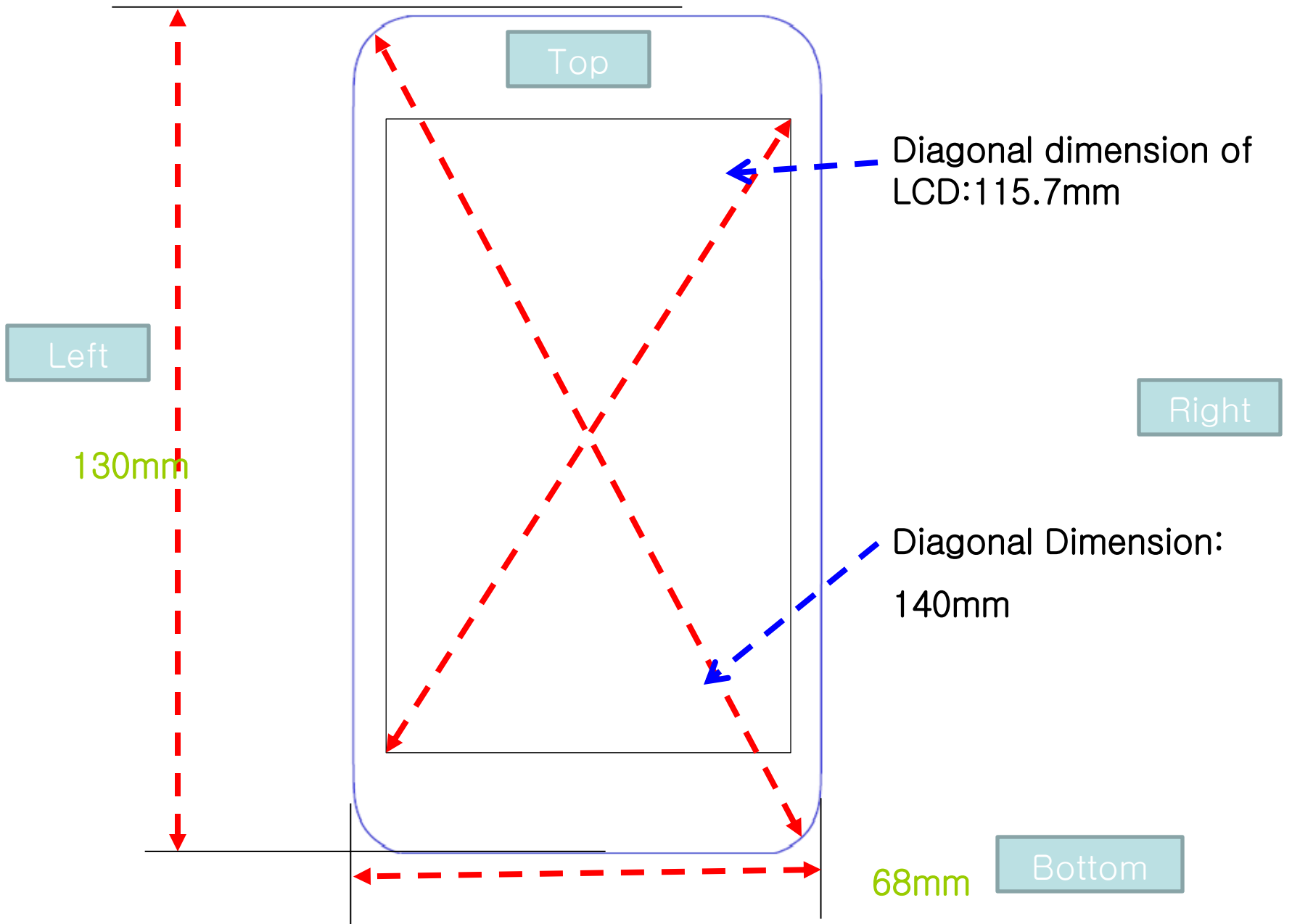

NFC Antenna

Inside of Battery
Cover

Front View

Left

Bottom

Top

Top

Battery

Non-support

Right

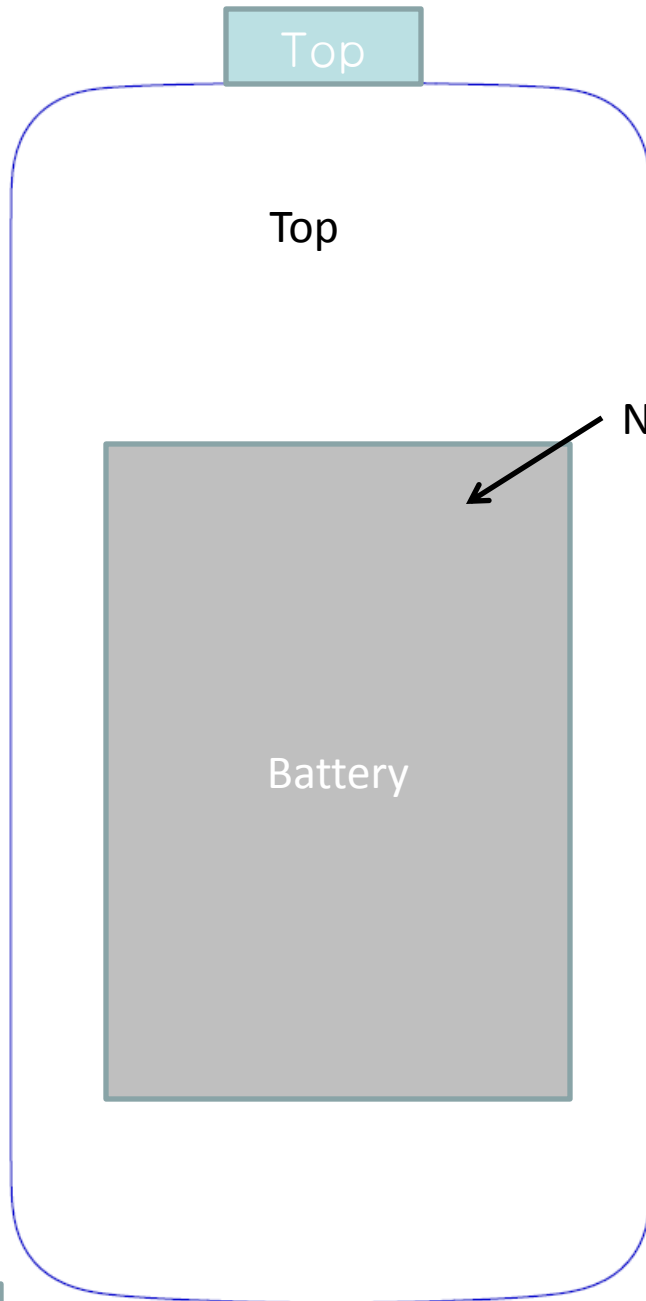

* Distance between Main antenna and edge

Top View

Rear

Left

1.3mm

1mm

4mm

Right

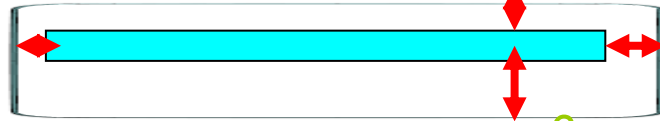

6mm

Main antenna

Front

* Distance between Bluetooth antenna and edge

Top View

Left

Rear

Bluetooth & WLAN antenna

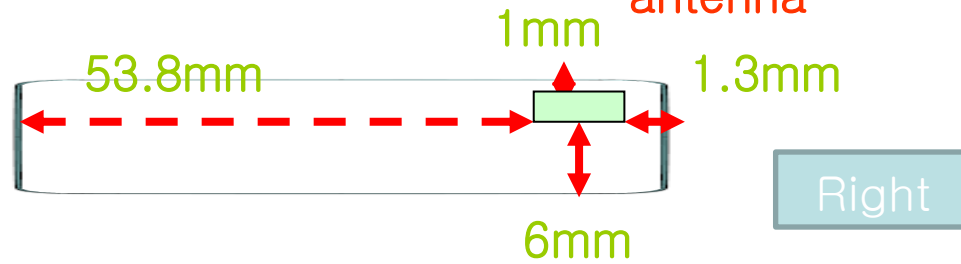

Right

Front