

FCC SAR Test Report

APPLICANT : Samsung Electronics Co., Ltd.
EQUIPMENT : MOBILE PHONE
BRAND NAME : SAMSUNG
MODEL NAME : SM-G3502I
FCC ID : A3LSMG3502I
STANDARD : FCC 47 CFR Part 2 (2.1093)
ANSI/IEEE C95.1-1992
IEEE 1528-2003

The product testing was completed on Nov. 18, 2013. We, SPORTON INTERNATIONAL (SHENZHEN) INC., would like to declare that the tested sample has been evaluated in accordance with the procedures and shown the compliance with the applicable technical standards.

The test results in this report apply exclusively to the tested model / sample. Without written approval of SPORTON INTERNATIONAL (SHENZHEN) INC., the test report shall not be reproduced except in full.

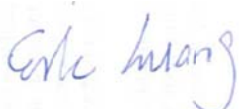

Reviewed by: Eric Huang / Deputy Manager



Approved by: Jones Tsai / Manager



SPORTON INTERNATIONAL (SHENZHEN) INC.

No. 101, Complex Building C, Guanlong Village, Xili Town, Nanshan District, Shenzhen, Guangdong, P.R.C.



Table of Contents

1. Statement of Compliance4
2. Administration Data5
2.1 Testing Laboratory.....5
2.2 Applicant5
2.3 Manufacturer.....5
2.4 Application Details.....5
3. General Information6
3.1 Description of Equipment Under Test (EUT)6
3.2 Maximum RF output power among production units.....7
3.3 Applied Standard.....8
3.4 Device Category and SAR Limits8
3.5 Test Conditions.....8
4. Specific Absorption Rate (SAR).....9
4.1 Introduction9
4.2 SAR Definition.....9
5. SAR Measurement System.....10
5.1 E-Field Probe11
5.2 Data Acquisition Electronics (DAE)11
5.3 Robot12
5.4 Measurement Server.....12
5.5 Phantom.....13
5.6 Device Holder13
5.7 Data Storage and Evaluation14
5.8 Test Equipment List.....16
6. Tissue Simulating Liquids.....17
7. System Verification Procedures18
7.1 Purpose of System Performance check18
7.2 System Setup.....18
7.3 SAR System Verification Results19
8. EUT Testing Position20
8.1 Define two imaginary lines on the handset.....20
8.2 Cheek Position21
8.3 Tilted Position.....21
8.4 Body Worn Position.....22
9. Measurement Procedures23
9.1 Spatial Peak SAR Evaluation.....23
9.2 Power Reference Measurement.....24
9.3 Area & Zoom Scan Procedures.....24
9.4 Volume Scan Procedures.....25
9.5 SAR Averaged Methods.....25
9.6 Power Drift Monitoring.....25
10. Conducted RF Output Power (Unit: dBm).....26
11. Antenna Location29
12. SAR Test Results31
12.1 Head SAR31
12.2 Hotspot SAR32
12.3 Body Worn SAR.....33
12.4 Repeated SAR Measurement34
12.5 Highest SAR Plot35
13. Simultaneous Transmission Analysis.....39
13.1 Head Exposure Conditions40
13.2 Hotspot Exposure Conditions.....41
13.3 Body-Worn Exposure Conditions42
14. Uncertainty Assessment43
15. References.....45
Appendix A. Plots of System Performance Check
Appendix B. Plots of SAR Measurement
Appendix C. DASYS Calibration Certificate
Appendix D. SAR System Validation
Appendix E. Test Setup Photos

1. Statement of Compliance

The maximum results of Specific Absorption Rate (SAR) found during testing for **Samsung Electronics Co., Ltd. SM-G3502I** are as follows.

<Highest SAR Summary>

Exposure Position	Frequency Band	Reported 1g-SAR (W/kg)	Equipment Class	Highest Reported 1g-SAR (W/kg)
Head	GSM850	0.27	PCE	0.34
	GSM1900	0.34	PCE	
	WLAN 2.4GHz Band	0.22	DTS	
	Bluetooth	0.06	DSS	
Hotspot (Separation 1cm)	GSM850	0.60	PCE	1.09
	GSM1900	1.09	PCE	
	WLAN 2.4GHz Band	0.14	DTS	
	Bluetooth	0.09	DSS	
Body-worn (Separation 1cm)	GSM850	0.60	PCE	1.09
	GSM1900	1.09	PCE	
	WLAN 2.4GHz Band	0.14	DTS	
	Bluetooth	0.09	DSS	

<Highest Simultaneous Transmission SAR>

Exposure Position	Frequency Band	Equipment Class	Highest Reported Simultaneous Transmission 1g-SAR (W/kg)
Body (Separation 1cm)	GSM1900	PCE	1.23
	WLAN 2.4GHz Band	DTS	
Body (Separation 1cm)	GSM1900	PCE	1.18
	Bluetooth	DSS	

This device is in compliance with Specific Absorption Rate (SAR) for general population/uncontrolled exposure limits (1.6 W/kg) specified in FCC 47 CFR part 2 (2.1093) and ANSI/IEEE C95.1-1992, and had been tested in accordance with the measurement methods and procedures specified in IEEE 1528-2003.



2. Administration Data

2.1 Testing Laboratory

Test Site	SPORTON INTERNATIONAL (SHENZHEN) INC.
Test Site Location	No. 101, Complex Building C, Guanlong Village, Xili Town, Nanshan District, Shenzhen, Guangdong, P.R.C. TEL: +86-755-8637-9589 FAX: +86-755-8637-9595

2.2 Applicant

Company Name	Samsung Electronics Co., Ltd.
Address	No.9 WeiWu Rd., Micro Electronic Industrial Park ,Jingang Highway, Xiqing District, Tianjin, China

2.3 Manufacturer

Company Name	Samsung Electronics Co., Ltd.
Address	No.9 WeiWu Rd., Micro Electronic Industrial Park ,Jingang Highway, Xiqing District, Tianjin, China

2.4 Application Details

Date of Start during the Test	Nov. 06, 2013
Date of End during the Test	Nov. 18, 2013



3. General Information

3.1 Description of Equipment Under Test (EUT)

Product Feature & Specification	
Equipment	MOBILE PHONE
Brand Name	SAMSUNG
Model Name	SM-G3502I
FCC ID	A3LSMG3502I
IMEI Number	SIM1: 359357050000828 SIM2: 359358050000826
Wireless Technology and Frequency Range	GSM850: 824.2 MHz ~ 848.8 MHz GSM1900: 1850.2 MHz ~ 1909.8 MHz WLAN 2.4GHz Band: 2412 MHz ~ 2462 MHz Bluetooth: 2402 MHz ~ 2480 MHz
Mode	<ul style="list-style-type: none">• GSM• GPRS/EGPRS Class 33• WLAN 2.4GHz 802.11b/g/n HT20• Bluetooth v2.0 + EDR/Bluetooth 4.0
Antenna Type	WWAN: Internal Antenna WLAN: FPCB Antenna Bluetooth: FPCB Antenna
HW Version	REV1.0
SW Version	G3502I.01
EUT Stage	Identical Prototype
Remark: <ol style="list-style-type: none">1. The above EUT's information was declared by manufacturer. Please refer to the specifications or user's manual for more detailed description.2. This device supports GPRS/EGPRS operation up to class 33.3. 802.11n- HT40 is not supported in 2.4GHz frequency band.4. This device does not support DTM operation.5. This device supports dual-SIM but single-active, 2 SIM cards insertion will enable transmission of either one network connection at a time; SAR testing was performed with one SIM card inserted.	



3.2 Maximum RF output power among production units

Burst Average Power (dBm)		
Mode / Band	GSM850	GSM1900
Voice (GMSK, 1 Tx slot)	32.7	30
(GMSK, 1 Tx slot)	32.7	30
(GMSK, 2 Tx slots)	30.5	27.7
(GMSK, 3 Tx slots)	29	26
(GMSK, 4 Tx slots)	27.5	24
(8PSK, 1 Tx slot)	27	25.5
(8PSK, 2 Tx slots)	26.7	25.3
(8PSK, 3 Tx slots)	24.5	22.5
(8PSK, 4 Tx slots)	24.5	22.5

Average Power (dBm)			
Mode / Band	IEEE 802.11		
	11b	11g	11n-HT20
WLAN 2.4GHz Band	17.5	14.5	13.5

Bluetooth Average Power (dBm)	
V2.0 + EDR	12



3.3 Applied Standard

The Specific Absorption Rate (SAR) testing specification, method, and procedure for this device is in accordance with the following standards:

- FCC 47 CFR Part 2 (2.1093)
- ANSI/IEEE C95.1-1992
- IEEE 1528-2003
- FCC KDB 865664 D01 SAR Measurement Requirements for 100 MHz to 6 GHz v01r01
- FCC KDB 447498 D01 General RF Exposure Guidance v05r01
- FCC KDB 648474 D04 SAR Evaluation Considerations for Wireless Handsets v01r01
- FCC KDB 248227 D01 SAR Measurement Procedures for 802.11 a/b/g Transmitters v01r02
- FCC KDB 941225 D03 Recommended SAR Test Reduction Procedures for GSM / GPRS / EDGE v01
- FCC KDB 941225 D06 SAR Evaluation Procedures for Portable Devices with Wireless Router Capabilities v01r01

3.4 Device Category and SAR Limits

This device belongs to portable device category because its radiating structure is allowed to be used within 20 centimeters of the body of the user. Limit for General Population/Uncontrolled exposure should be applied for this device, it is 1.6 W/kg as averaged over any 1 gram of tissue.

3.5 Test Conditions

3.5.1 Ambient Condition

Ambient Temperature	20 to 24 °C
Humidity	< 60 %

3.5.2 Test Configuration

For WWAN SAR testing, the device was controlled by using a base station emulator. Communication between the device and the emulator was established by air link. The distance between the EUT and the antenna of the emulator is larger than 50 cm and the output power radiated from the emulator antenna is at least 30 dB smaller than the output power of EUT.

For WLAN SAR testing, WLAN engineering testing software installed on the EUT can provide continuous transmitting RF signal.

4. Specific Absorption Rate (SAR)

4.1 Introduction

SAR is related to the rate at which energy is absorbed per unit mass in an object exposed to a radio field. The SAR distribution in a biological body is complicated and is usually carried out by experimental techniques or numerical modeling. The standard recommends limits for two tiers of groups, occupational/controlled and general population/uncontrolled, based on a person's awareness and ability to exercise control over his or her exposure. In general, occupational/controlled exposure limits are higher than the limits for general population/uncontrolled.

4.2 SAR Definition

The SAR definition is the time derivative (rate) of the incremental energy (dW) absorbed by (dissipated in) an incremental mass (dm) contained in a volume element (dv) of a given density (ρ). The equation description is as below:

$$\text{SAR} = \frac{d}{dt} \left(\frac{dW}{dm} \right) = \frac{d}{dt} \left(\frac{dW}{\rho dv} \right)$$

SAR is expressed in units of Watts per kilogram (W/kg)

SAR measurement can be either related to the temperature elevation in tissue by

$$\text{SAR} = c \left(\frac{\delta T}{\delta t} \right)$$

Where: C is the specific heat capacity, δT is the temperature rise and δt is the exposure duration, or related to the electrical field in the tissue by

$$\text{SAR} = \frac{\sigma |E|^2}{\rho}$$

Where: σ is the conductivity of the tissue, ρ is the mass density of the tissue and E is the RMS electrical field strength.

However for evaluating SAR of low power transmitter, electrical field measurement is typically applied.

5. SAR Measurement System

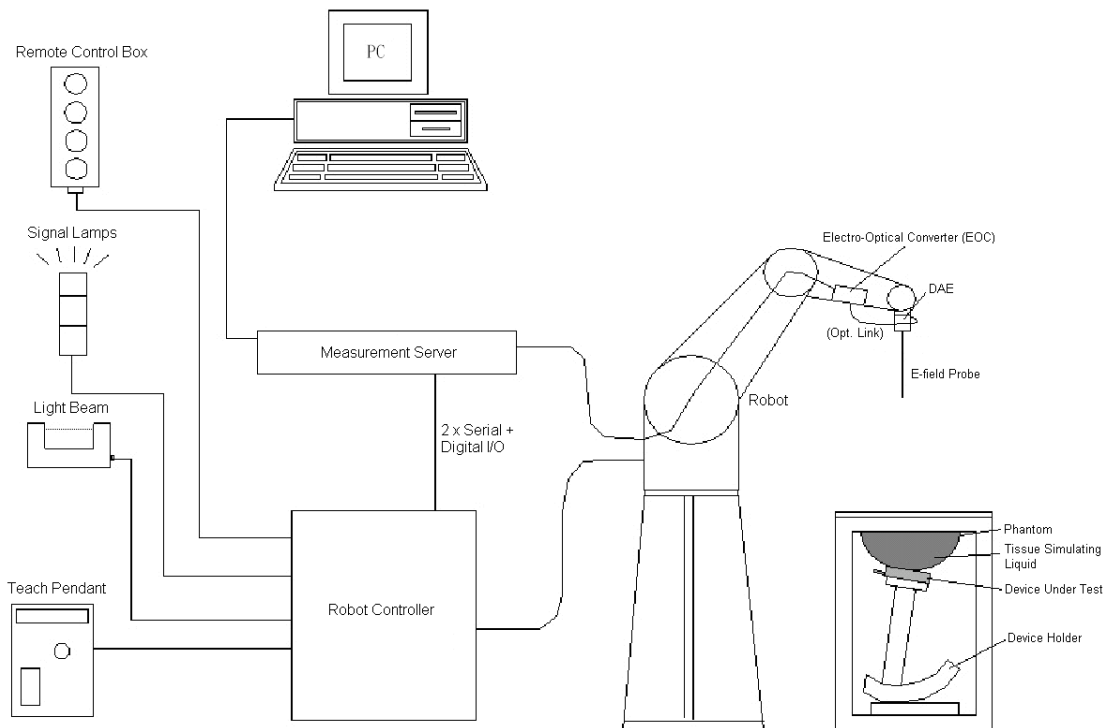

Fig 5.1 SPEAG DASY System Configurations

The DASY system for performance compliance tests is illustrated above graphically. This system consists of the following items:

- A standard high precision 6-axis robot with controller, a teach pendant and software
- A data acquisition electronic (DAE) attached to the robot arm extension
- A dosimetric probe equipped with an optical surface detector system
- The electro-optical converter (EOC) performs the conversion between optical and electrical signals
- A measurement server performs the time critical tasks such as signal filtering, control of the robot operation and fast movement interrupts.
- A probe alignment unit which improves the accuracy of the probe positioning
- A computer operating Windows XP
- DASY software
- Remote control with teach pendant and additional circuitry for robot safety such as warning lamps, etc.
- The SAM twin phantom
- A device holder
- Tissue simulating liquid
- Dipole for evaluating the proper functioning of the system

Component details are described in in the following sub-sections.

5.1 E-Field Probe

The SAR measurement is conducted with the dosimetric probe (manufactured by SPEAG). The probe is specially designed and calibrated for use in liquid with high permittivity. The dosimetric probe has special calibration in liquid at different frequency. This probe has a built in optical surface detection system to prevent from collision with phantom.

5.1.1 E-Field Probe Specification

<EX3DV4 Probe>

Construction	Symmetrical design with triangular core Built-in shielding against static charges PEEK enclosure material (resistant to organic solvents, e.g., DGBE)	
Frequency	10 MHz to 6 GHz; Linearity: ± 0.2 dB	
Directivity	± 0.3 dB in HSL (rotation around probe axis) ± 0.5 dB in tissue material (rotation normal to probe axis)	
Dynamic Range	10 μ W/g to 100 mW/g; Linearity: ± 0.2 dB (noise: typically $< 1 \mu$ W/g)	
Dimensions	Overall length: 330 mm (Tip: 20 mm) Tip diameter: 2.5 mm (Body: 12 mm) Typical distance from probe tip to dipole centers: 1 mm	

Fig 5.2 Photo of EX3DV4

5.1.2 E-Field Probe Calibration

Each probe needs to be calibrated according to a dosimetric assessment procedure with accuracy better than $\pm 10\%$. The spherical isotropy shall be evaluated and within ± 0.25 dB. The sensitivity parameters (NormX, NormY, and NormZ), the diode compression parameter (DCP) and the conversion factor (ConvF) of the probe are tested. The calibration data can be referred to appendix C of this report.

5.2 Data Acquisition Electronics (DAE)

The data acquisition electronics (DAE) consists of a highly sensitive electrometer-grade preamplifier with auto-zeroing, a channel and gain-switching multiplexer, a fast 16 bit AD-converter and a command decoder and control logic unit. Transmission to the measurement server is accomplished through an optical downlink for data and status information as well as an optical uplink for commands and the clock. The input impedance of the DAE is 200 MOhm; the inputs are symmetrical and floating. Common mode rejection is above 80 dB.



Fig 5.3 Photo of DAE

5.3 Robot

The SPEAG DASY system uses the high precision robots (DASY5: TX90XL) type from Stäubli SA (France). For the 6-axis controller system, the robot controller version (DASY5: CS8c) from Stäubli is used. The Stäubli robot series have many features that are important for our application:

- High precision (repeatability ± 0.035 mm)
- High reliability (industrial design)
- Jerk-free straight movements
- Low ELF interference (the closed metallic construction shields against motor control fields)



Fig 5.4 Photo of DASY5

5.4 Measurement Server

The measurement server is based on a PC/104 CPU board with CPU (DASY5: 400 MHz, Intel Celeron), chipdisk (DASY5: 128 MB), RAM (DASY5: 128 MB). The necessary circuits for communication with the DAE electronic box, as well as the 16 bit AD converter system for optical detection and digital I/O interface are contained on the DASY I/O board, which is directly connected to the PC/104 bus of the CPU board.

The measurement server performs all the real-time data evaluation for field measurements and surface detection, controls robot movements and handles safety operations.



Fig 5.5 Photo of Server for DASY5

5.5 Phantom

<SAM Twin Phantom>

Shell Thickness	2 ± 0.2 mm; Center ear point: 6 ± 0.2 mm
Filling Volume	Approx. 25 liters
Dimensions	Length: 1000 mm; Width: 500 mm; Height: adjustable feet
Measurement Areas	Left Hand, Right Hand, Flat Phantom



Fig 5.6 Photo of SAM Phantom

The bottom plate contains three pair of bolts for locking the device holder. The device holder positions are adjusted to the standard measurement positions in the three sections. A white cover is provided to tap the phantom during off-periods to prevent water evaporation and changes in the liquid parameters. On the phantom top, three reference markers are provided to identify the phantom position with respect to the robot.

5.6 Device Holder

<Device Holder for SAM Twin Phantom>

The SAR in the phantom is approximately inversely proportional to the square of the distance between the source and the liquid surface. For a source at 5 mm distance, a positioning uncertainty of ± 0.5 mm would produce a SAR uncertainty of ± 20 %. Accurate device positioning is therefore crucial for accurate and repeatable measurements. The positions in which the devices must be measured are defined by the standards.

The DASY device holder is designed to cope with different positions given in the standard. It has two scales for the device rotation (with respect to the body axis) and the device inclination (with respect to the line between the ear reference points). The rotation center for both scales is the ear reference point (ERP). Thus the device needs no repositioning when changing the angles.

The DASY device holder is constructed of low-loss POM material having the following dielectric parameters: relative permittivity $\epsilon = 3$ and loss tangent $\delta = 0.02$. The amount of dielectric material has been reduced in the closest vicinity of the device, since measurements have suggested that the influence of the clamp on the test results could thus be lowered.



Fig 5.7 Device Holder

5.7 Data Storage and Evaluation

5.7.1 Data Storage

The DASY software stores the assessed data from the data acquisition electronics as raw data (in microvolt readings from the probe sensors), together with all the necessary software parameters for the data evaluation (probe calibration data, liquid parameters and device frequency and modulation data) in measurement files. The post-processing software evaluates the desired unit and format for output each time the data is visualized or exported. This allows verification of the complete software setup even after the measurement and allows correction of erroneous parameter settings. For example, if a measurement has been performed with an incorrect crest factor parameter in the device setup, the parameter can be corrected afterwards and the data can be reevaluated.

The measured data can be visualized or exported in different units or formats, depending on the selected probe type (e.g., [V/m], [A/m], [mW/g]). Some of these units are not available in certain situations or give meaningless results, e.g., a SAR-output in a non-lose media, will always be zero. Raw data can also be exported to perform the evaluation with other software packages.

5.7.2 Data Evaluation

The DASY post-processing software (SEMCAD) automatically executes the following procedures to calculate the field units from the microvolt readings at the probe connector. The parameters used in the evaluation are stored in the configuration modules of the software :

Probe parameters :	- Sensitivity	Norm _i , a _{i0} , a _{i1} , a _{i2}
	- Conversion factor	ConvF _i
	- Diode compression point	dcp _i
Device parameters :	- Frequency	f
	- Crest factor	cf
	Media parameters :	- Conductivity
	- Density	ρ

These parameters must be set correctly in the software. They can be found in the component documents or they can be imported into the software from the configuration files issued for the DASY components. In the direct measuring mode of the multi-meter option, the parameters of the actual system setup are used. In the scan visualization and export modes, the parameters stored in the corresponding document files are used.

The first step of the evaluation is a linearization of the filtered input signal to account for the compression characteristics of the detector diode. The compensation depends on the input signal, the diode type and the DC-transmission factor from the diode to the evaluation electronics. If the exciting field is pulsed, the crest factor of the signal must be known to correctly compensate for peak power.

The formula for each channel can be given as :

$$V_i = U_i + U_i^2 \cdot \frac{cf}{dcp_i}$$

with V_i = compensated signal of channel i , ($i = x, y, z$)
 U_i = input signal of channel i , ($i = x, y, z$)
 cf = crest factor of exciting field (DASY parameter)
 dcp_i = diode compression point (DASY parameter)

From the compensated input signals, the primary field data for each channel can be evaluated :

$$\text{E-field Probes : } E_i = \sqrt{\frac{V_i}{\text{Norm}_i \cdot \text{ConvF}}}$$

$$\text{H-field Probes : } H_i = \sqrt{V_i \cdot \frac{a_{i0} + a_{i1}f + a_{i2}f^2}{f}}$$

with V_i = compensated signal of channel i , ($i = x, y, z$)
 Norm_i = sensor sensitivity of channel i , ($i = x, y, z$), $\mu\text{V}/(\text{V/m})^2$ for E-field Probes
 ConvF = sensitivity enhancement in solution
 a_{ij} = sensor sensitivity factors for H-field probes
 f = carrier frequency [GHz]
 E_i = electric field strength of channel i in V/m
 H_i = magnetic field strength of channel i in A/m

The RSS value of the field components gives the total field strength (Hermitian magnitude) :

$$E_{\text{tot}} = \sqrt{E_x^2 + E_y^2 + E_z^2}$$

The primary field data are used to calculate the derived field units.

$$\text{SAR} = E_{\text{tot}}^2 \cdot \frac{\sigma}{\rho \cdot 1000}$$

with SAR = local specific absorption rate in mW/g
 E_{tot} = total field strength in V/m
 σ = conductivity in [mho/m] or [Siemens/m]
 ρ = equivalent tissue density in g/cm^3

Note that the density is set to 1, to account for actual head tissue density rather than the density of the tissue simulating liquid.



5.8 Test Equipment List

Table with 6 columns: Manufacturer, Name of Equipment, Type/Model, Serial Number, Last Cal., Due Date. Rows include various test equipment like System Validation Kits, Phantom, Dielectric Assessment Kit, etc.

Table 5.1 Test Equipment List

Note:

- 1. The calibration certificate of DASY can be referred to appendix C of this report.
2. Referring to KDB 865664 D01v01r01, the dipole calibration interval can be extended to 3 years with justification.
3. The justification data of dipole D835V2, SN: 4d091, D1900V2, SN: 5d118, can be found in appendix C.
4. The Insertion Loss calibration of Dual Directional Coupler and Attenuator were characterized via the network analyzer and compensated during system check.
5. In system check we need to monitor the level on the power meter, and adjust the power amplifier level to have precise power level to the dipole;
6. Attenuator 1 insertion loss is calibrated by the network Analyzer, which the calibration is valid, before system check.

6. Tissue Simulating Liquids

For the measurement of the field distribution inside the SAM phantom with DASY, the phantom must be filled with around 25 liters of homogeneous body tissue simulating liquid. For head SAR testing, the liquid height from the ear reference point (ERP) of the phantom to the liquid top surface is larger than 15 cm, which is shown in Fig. 6.1. For body SAR testing, the liquid height from the center of the flat phantom to the liquid top surface is larger than 15 cm, which is shown in Fig. 6.2.



Fig 6.1 Photo of Liquid Height for Head SAR



Fig 6.2 Photo of Liquid Height for Body SAR

The following table gives the recipes for tissue simulating liquid.

Frequency (MHz)	Water (%)	Sugar (%)	Cellulose (%)	Salt (%)	Preventol (%)	DGBE (%)	Conductivity (σ)	Permittivity (ϵ_r)
For Head								
835	40.3	57.9	0.2	1.4	0.2	0	0.90	41.5
1800, 1900, 2000	55.2	0	0	0.3	0	44.5	1.40	40.0
2450	55.0	0	0	0	0	45.0	1.80	39.2
For Body								
835	50.8	48.2	0	0.9	0.1	0	0.97	55.2
1800, 1900, 2000	70.2	0	0	0.4	0	29.4	1.52	53.3
2450	68.6	0	0	0	0	31.4	1.95	52.7

Table 6.1 Recipes of Tissue Simulating Liquid

The dielectric parameters of the liquids were verified prior to the SAR evaluation using a SPEAG DAK-3.5 Dielectric Probe Kit and a R&S Network Analyzer.

The following table shows the measuring results for simulating liquid.

Frequency (MHz)	Liquid Type	Liquid Temp. ($^{\circ}\text{C}$)	Conductivity (σ)	Permittivity (ϵ_r)	Conductivity Target (σ)	Permittivity Target (ϵ_r)	Delta (σ) (%)	Delta (ϵ_r) (%)	Limit (%)	Date
835	Head	22.7	0.91	42.91	0.9	41.5	1.11	3.40	± 5	Nov. 07, 2013
1900	Head	22.6	1.417	40.994	1.4	40	1.21	2.49	± 5	Nov. 07, 2013
2450	Head	22.7	1.878	40.464	1.8	39.2	4.33	3.22	± 5	Nov. 18, 2013
835	Body	22.7	0.975	54.314	0.97	55.2	0.52	-1.61	± 5	Nov. 06, 2013
1900	Body	22.6	1.533	54.611	1.52	53.3	2.46	-3.17	± 5	Nov. 07, 2013
2450	Body	22.7	1.949	51.667	1.95	52.7	-0.05	-1.96	± 5	Nov. 18, 2013

Table 6.2 Measuring Results for Simulating Liquid

7. System Verification Procedures

Each DASY system is equipped with one or more system validation kits. These units, together with the predefined measurement procedures within the DASY software, enable the user to conduct the system performance check and system validation. System validation kit includes a dipole, tripod holder to fix it underneath the flat phantom and a corresponding distance holder.

7.1 Purpose of System Performance check

The system performance check verifies that the system operates within its specifications. System and operator errors can be detected and corrected. It is recommended that the system performance check be performed prior to any usage of the system in order to guarantee reproducible results. The system performance check uses normal SAR measurements in a simplified setup with a well characterized source. This setup was selected to give a high sensitivity to all parameters that might fail or vary over time. The system check does not intend to replace the calibration of the components, but indicates situations where the system uncertainty is exceeded due to drift or failure.

7.2 System Setup

In the simplified setup for system evaluation, the EUT is replaced by a calibrated dipole and the power source is replaced by a continuous wave that comes from a signal generator. The calibrated dipole must be placed beneath the flat phantom section of the SAM twin phantom with the correct distance holder. The distance holder should touch the phantom surface with a light pressure at the reference marking and be oriented parallel to the long side of the phantom. The equipment setup is shown below:

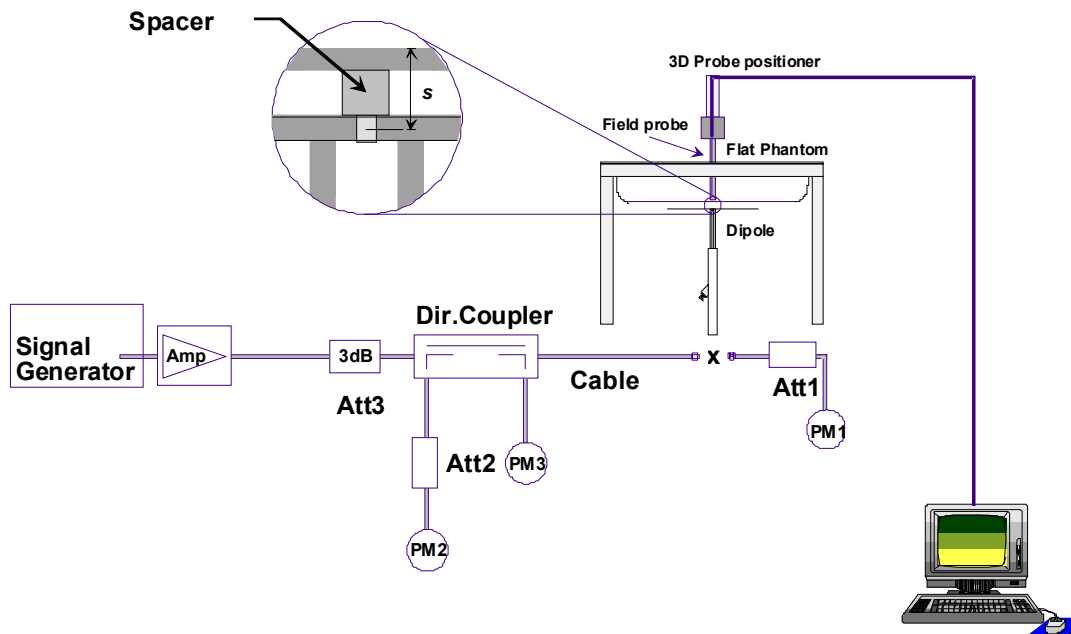

Fig 7.1 System Setup for System Evaluation

1. Signal Generator
2. Amplifier
3. Directional Coupler
4. Power Meter
5. Calibrated Dipole



Fig 7.2 Photo of Dipole Setup

7.3 SAR System Verification Results

Comparing to the original SAR value provided by SPEAG, the verification data should be within its specification of 10 %. Table 7.1 shows the target SAR and measured SAR after normalized to 1W input power. The table below indicates the system performance check can meet the variation criterion and the plots can be referred to Appendix A of this report.

Date	Frequency (MHz)	Liquid Type	Input Power (mW)	Dipole S/N	Probe S/N	Target 1g SAR (W/kg)	Measured 1g SAR (W/kg)	Normalized 1g SAR (W/kg)	Deviation (%)
Nov. 07, 2013	835	Head	250	4d091	3819	9.4	2.53	10.12	7.66
Nov. 07, 2013	1900	Head	250	5d118	3819	40.3	10.3	41.2	2.23
Nov. 18, 2013	2450	Head	250	840	3819	53.6	12.8	51.2	-4.48
Nov. 06, 2013	835	Body	250	4d091	3819	9.42	2.22	8.88	-5.73
Nov. 07, 2013	1900	Body	250	5d118	3819	41.8	10.2	40.8	-2.39
Nov. 18, 2013	2450	Body	250	840	3819	50.4	12.1	48.4	-3.97

Table 7.1 Target and Measurement SAR after Normalized

8. EUT Testing Position

8.1 Define two imaginary lines on the handset

- The vertical centerline passes through two points on the front side of the handset - the midpoint of the width w_t of the handset at the level of the acoustic output, and the midpoint of the width w_b of the bottom of the handset.
- The horizontal line is perpendicular to the vertical centerline and passes through the center of the acoustic output. The horizontal line is also tangential to the face of the handset at point A.
- The two lines intersect at point A. Note that for many handsets, point A coincides with the center of the acoustic output; however, the acoustic output may be located elsewhere on the horizontal line. Also note that the vertical centerline is not necessarily parallel to the front face of the handset, especially for clamshell handsets, handsets with flip covers, and other irregularly shaped handsets.

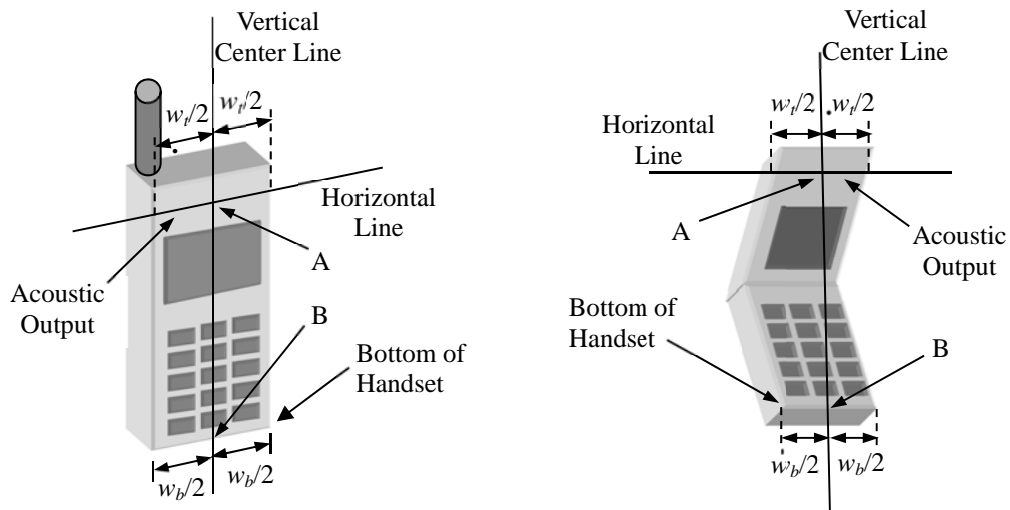

Fig 8.1 Illustration for Handset Vertical and Horizontal Reference Lines

8.2 Cheek Position

- (a) To position the device with the vertical center line of the body of the device and the horizontal line crossing the center piece in a plane parallel to the sagittal plane of the phantom. While maintaining the device in this plane, align the vertical center line with the reference plane containing the three ear and mouth reference point (M: Mouth, RE: Right Ear, and LE: Left Ear) and align the center of the ear piece with the line RE-LE.
- (b) To move the device towards the phantom with the ear piece aligned with the line LE-RE until the phone touched the ear. While maintaining the device in the reference plane and maintaining the phone contact with the ear, move the bottom of the phone until any point on the front side is in contact with the cheek of the phantom or until contact with the ear is lost (see Fig. 8.2).

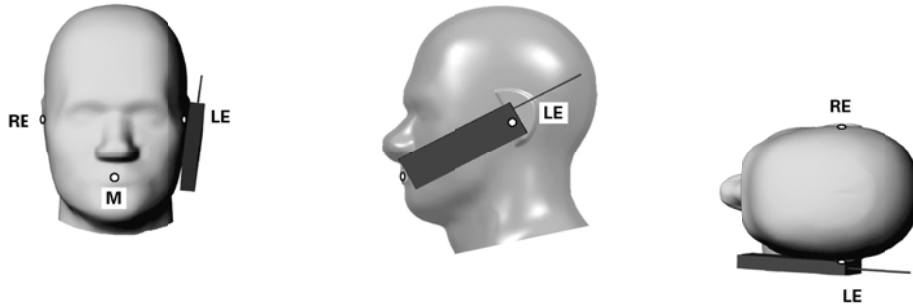

Fig 8.2 Illustration for Cheek Position

8.3 Tilted Position

- (a) To position the device in the “cheek” position described above.
- (b) While maintaining the device the reference plane described above and pivoting against the ear, moves it outward away from the mouth by an angle of 15 degrees or until contact with the ear is lost (see Fig. 8.3).

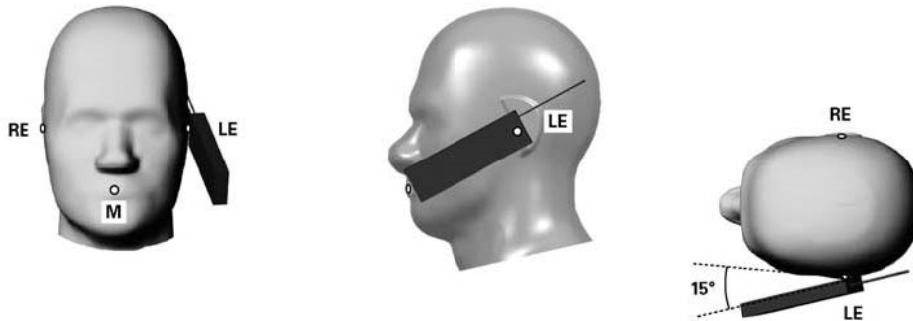

Fig 8.3 Illustration for Tilted Position

8.4 Body Worn Position

- (a) To position the device parallel to the phantom surface with either keypad up or down.
- (b) To adjust the device parallel to the flat phantom.
- (c) To adjust the distance between the device surface and the flat phantom to 1 cm.

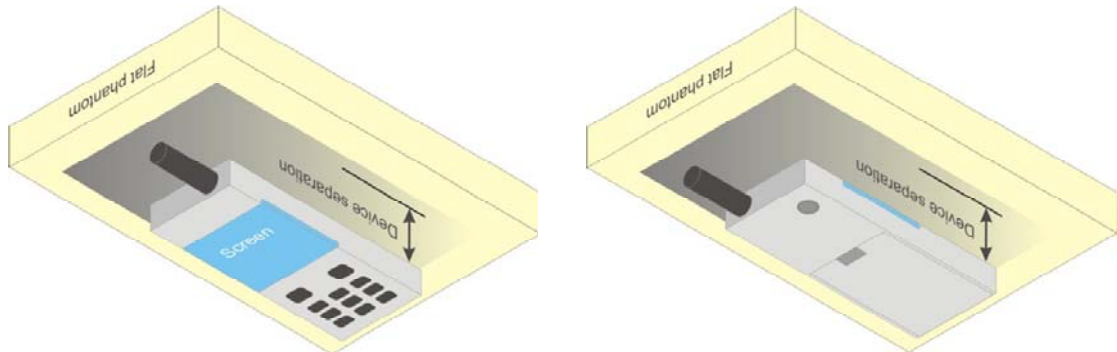

Fig 8.4 Illustration for Body Worn Position

8.5 Hotspot Position

- (a) To position the device parallel to the phantom surface with all sides and either keypad up or down.
- (b) To adjust the device parallel to the flat phantom.
- (c) To adjust the distance between the device and the flat phantom to 1 cm.

<EUT Setup Photos>

Please refer to Appendix E for the test setup photos.



9. Measurement Procedures

The measurement procedures are as follows:

<Conducted power measurement>

- (a) For WWAN power measurement, use base station simulator to configure EUT WWAN transmission in conducted connection with RF cable, at maximum power in each supported wireless interface and frequency band.
- (b) Read the WWAN RF power level from the base station simulator.
- (c) For WLAN/BT power measurement, use engineering software to configure EUT WLAN/BT continuously transmission, at maximum RF power in each supported wireless interface and frequency band
- (d) Connect EUT RF port through RF cable to the power meter, and measure WLAN/BT output power

<SAR measurement>

- (a) Use base station simulator to configure EUT WWAN transmission in radiated connection, and engineering software to configure EUT WLAN/BT continuously transmission, at maximum RF power, in the highest power channel.
- (b) Place the EUT in the positions as Appendix E demonstrates.
- (c) Set scan area, grid size and other setting on the DASY software.
- (d) Measure SAR results for the highest power channel on each testing position.
- (e) Find out the largest SAR result on these testing positions of each band
- (f) Measure SAR results for other channels in worst SAR testing position if the reported SAR of highest power channel is larger than 0.8 W/kg

According to the test standard, the recommended procedure for assessing the peak spatial-average SAR value consists of the following steps:

- (a) Power reference measurement
- (b) Area scan
- (c) Zoom scan
- (d) Power drift measurement

9.1 Spatial Peak SAR Evaluation

The procedure for spatial peak SAR evaluation has been implemented according to the test standard. It can be conducted for 1g and 10g, as well as for user-specific masses. The DASY software includes all numerical procedures necessary to evaluate the spatial peak SAR value.

The base for the evaluation is a "cube" measurement. The measured volume must include the 1g and 10g cubes with the highest averaged SAR values. For that purpose, the center of the measured volume is aligned to the interpolated peak SAR value of a previously performed area scan.

The entire evaluation of the spatial peak values is performed within the post-processing engine (SEMCAD). The system always gives the maximum values for the 1g and 10g cubes. The algorithm to find the cube with highest averaged SAR is divided into the following stages:

- (a) Extraction of the measured data (grid and values) from the Zoom Scan
- (b) Calculation of the SAR value at every measurement point based on all stored data (A/D values and measurement parameters)
- (c) Generation of a high-resolution mesh within the measured volume
- (d) Interpolation of all measured values from the measurement grid to the high-resolution grid
- (e) Extrapolation of the entire 3-D field distribution to the phantom surface over the distance from sensor to surface
- (f) Calculation of the averaged SAR within masses of 1g and 10g

9.2 Power Reference Measurement

The Power Reference Measurement and Power Drift Measurements are for monitoring the power drift of the device under test in the batch process. The minimum distance of probe sensors to surface determines the closest measurement point to phantom surface. This distance cannot be smaller than the distance of sensor calibration points to probe tip as defined in the probe properties.

9.3 Area & Zoom Scan Procedures

First Area Scan is used to locate the approximate location(s) of the local peak SAR value(s). The measurement grid within an Area Scan is defined by the grid extent, grid step size and grid offset. Next, in order to determine the EM field distribution in a three-dimensional spatial extension, Zoom Scan is required. The Zoom Scan is performed around the highest E-field value to determine the averaged SAR-distribution over 10 g. Area scan and zoom scan resolution setting follows KDB 865664 D01v01r01 quoted below.

When the 1-g SAR of the highest peak is within 2 dB of the SAR limit, additional zoom scans are required for other peaks within 2 dB of the highest peak that have not been included in any zoom scan to ensure there is no increase in SAR.

		≤ 3 GHz	> 3 GHz	
Maximum distance from closest measurement point (geometric center of probe sensors) to phantom surface		5 ± 1 mm	$\frac{1}{2} \cdot \delta \cdot \ln(2) \pm 0.5$ mm	
Maximum probe angle from probe axis to phantom surface normal at the measurement location		30° ± 1°	20° ± 1°	
Maximum area scan spatial resolution: $\Delta x_{Area}, \Delta y_{Area}$		≤ 2 GHz: ≤ 15 mm 2 – 3 GHz: ≤ 12 mm	3 – 4 GHz: ≤ 12 mm 4 – 6 GHz: ≤ 10 mm	
		When the x or y dimension of the test device, in the measurement plane orientation, is smaller than the above, the measurement resolution must be ≤ the corresponding x or y dimension of the test device with at least one measurement point on the test device.		
Maximum zoom scan spatial resolution: $\Delta x_{Zoom}, \Delta y_{Zoom}$		≤ 2 GHz: ≤ 8 mm 2 – 3 GHz: ≤ 5 mm*	3 – 4 GHz: ≤ 5 mm* 4 – 6 GHz: ≤ 4 mm*	
Maximum zoom scan spatial resolution, normal to phantom surface	uniform grid: $\Delta z_{Zoom}(n)$	≤ 5 mm	3 – 4 GHz: ≤ 4 mm 4 – 5 GHz: ≤ 3 mm 5 – 6 GHz: ≤ 2 mm	
	graded grid	$\Delta z_{Zoom}(1)$: between 1 st two points closest to phantom surface	≤ 4 mm	3 – 4 GHz: ≤ 3 mm 4 – 5 GHz: ≤ 2.5 mm 5 – 6 GHz: ≤ 2 mm
		$\Delta z_{Zoom}(n>1)$: between subsequent points	≤ 1.5 · $\Delta z_{Zoom}(n-1)$	
Minimum zoom scan volume	x, y, z	≥ 30 mm	3 – 4 GHz: ≥ 28 mm 4 – 5 GHz: ≥ 25 mm 5 – 6 GHz: ≥ 22 mm	
Note: δ is the penetration depth of a plane-wave at normal incidence to the tissue medium; see draft standard IEEE P1528-2011 for details. * When zoom scan is required and the <i>reported</i> SAR from the area scan based 1-g SAR estimation procedures of KDB 447498 is ≤ 1.4 W/kg, ≤ 8 mm, ≤ 7 mm and ≤ 5 mm zoom scan resolution may be applied, respectively, for 2 GHz to 3 GHz, 3 GHz to 4 GHz and 4 GHz to 6 GHz.				



9.4 Volume Scan Procedures

The volume scan is used to assess overlapping SAR distributions for antennas transmitting in different frequency bands. It is equivalent to an oversized zoom scan used in standalone measurements. The measurement volume will be used to enclose all the simultaneous transmitting antennas. For antennas transmitting simultaneously in different frequency bands, the volume scan is measured separately in each frequency band. In order to sum correctly to compute the 1g aggregate SAR, the EUT remains in the same test position for all measurements and all volume scans use the same spatial resolution and grid spacing. When all volume scans are completed, the software, SEMCAD postprocessor can combine and subsequently superpose these measurement data to calculate the multiband SAR.

9.5 SAR Averaged Methods

In DASy, the interpolation and extrapolation are both based on the modified Quadratic Shepard's method. The interpolation scheme combines a least-square fitted function method and a weighted average method which are the two basic types of computational interpolation and approximation.

Extrapolation routines are used to obtain SAR values between the lowest measurement points and the inner phantom surface. The extrapolation distance is determined by the surface detection distance and the probe sensor offset. The uncertainty increases with the extrapolation distance. To keep the uncertainty within 1% for the 1 g and 10 g cubes, the extrapolation distance should not be larger than 5 mm.

9.6 Power Drift Monitoring

All SAR testing is under the EUT with a full charged battery and transmit maximum output power. In DASy measurement software, the power reference measurement and power drift measurement procedures are used for monitoring the power drift of EUT during SAR test. Both these procedures measure the field at a specified reference position before and after the SAR testing. The software will calculate the field difference in dB. If the power drifts more than 5%, the SAR will be retested.



10. Conducted RF Output Power (Unit: dBm)

<GSM Conducted Power>

General Note:

- 1. Per KDB 447498 D01v05r01, the maximum output power channel is used for SAR testing and for further SAR test reduction.
2. For Head SAR testing, the EUT was set in GSM Voice for GSM850/1900.
3. For Body worn SAR testing, the EUT was set in GPRS 3 Tx slots and GSM Voice for GSM850/1900.
4. For hotspot SAR testing, the EUT was set in GPRS 3 Tx slots for GSM850/1900.

Table with 7 columns: Band: GSM850, Channel, Frequency (MHz), Burst Average Power (dBm) [128, 189, 251], Frame-Average Power (dBm) [128, 189, 251]. Rows include GSM (GMSK, 1 Tx slot) with value 32.01, and GPRS (GMSK, 3 Tx slots) with value 24.13.

Remark: The frame-averaged power is linearly scaled the maximum burst averaged power over 8 time slots.

The calculated method are shown as below:

- Frame-averaged power = Maximum burst averaged power (1 Tx Slot) - 9 dB
Frame-averaged power = Maximum burst averaged power (2 Tx Slots) - 6 dB
Frame-averaged power = Maximum burst averaged power (3 Tx Slots) - 4.26 dB
Frame-averaged power = Maximum burst averaged power (4 Tx Slots) - 3 dB

Table with 7 columns: Band: GSM1900, Channel, Frequency (MHz), Burst Average Power (dBm) [512, 661, 810], Frame-Average Power (dBm) [512, 661, 810]. Rows include GSM (GMSK, 1 Tx slot) with value 29.25, and GPRS (GMSK, 3 Tx slots) with value 21.19.

Remark: The frame-averaged power is linearly scaled the maximum burst averaged power over 8 time slots.

The calculated method are shown as below:

- Frame-averaged power = Maximum burst averaged power (1 Tx Slot) - 9 dB
Frame-averaged power = Maximum burst averaged power (2 Tx Slots) - 6 dB
Frame-averaged power = Maximum burst averaged power (3 Tx Slots) - 4.26 dB
Frame-averaged power = Maximum burst averaged power (4 Tx Slots) - 3 dB



<WLAN 2.4GHz Band Conducted Power>

General Note:

1. Per KDB 248227 D01 v01r02, choose the highest output power channel to test SAR and determine further SAR exclusion
2. For each frequency band, testing at higher data rates and higher order modulations is not required when the maximum average output power for each of these configurations is less than 1/4dB higher than those measured at the lowest data rate
3. Per KDB 248227 D01 v01r02, 11g and 11n-HT20 output power is less than 1/4dB higher than 11b mode, thus the SAR can be excluded.

802.11b Average Power (dBm)					
Channel	Frequency (MHz)	Data Rate (bps)			
		1M bps	2M bps	5.5M bps	11M bps
CH 01	2412	16.48	16.43	16.47	16.46
CH 06	2437	16.37	16.29	16.41	16.43
CH 11	2462	16.24	16.00	16.25	16.24

802.11g Average Power (dBm)									
Channel	Frequency (MHz)	Data Rate (bps)							
		6M bps	9M bps	12M bps	18M bps	24M bps	36M bps	48M bps	54M bps
CH 01	2412	13.71	13.61	13.66	13.62	13.59	13.67	13.69	13.68
CH 06	2437	13.57	13.48	13.55	13.44	13.46	13.49	13.54	13.49
CH 11	2462	13.27	13.19	13.25	13.15	13.14	13.19	13.24	13.25

802.11n-HT20 Average Power (dBm)									
Channel	Frequency (MHz)	MCS Index							
		MCS0	MCS1	MCS2	MCS3	MCS4	MCS5	MCS6	MCS7
CH 01	2412	12.73	12.66	12.71	12.68	12.65	12.71	12.71	12.68
CH 06	2437	12.43	12.36	12.39	12.35	12.35	12.40	12.43	12.50
CH 11	2462	12.37	12.33	12.33	12.28	12.23	12.34	12.31	12.48



<Bluetooth Conducted Power>

Bluetooth Burst Average Power (dBm)_DH5				
Channel	Frequency (MHz)	Data Rate		
		1Mbps	2Mbps	3Mbps
CH 00	2402	11.41	9.39	9.39
CH 39	2441	10.87	8.83	8.82
CH 78	2480	11.18	9.13	9.11

Bluetooth Source-base time-average Power (dBm)_DH5				
Channel	Frequency (MHz)	Data Rate		
		1Mbps	2Mbps	3Mbps
CH 00	2402	10.62	8.6	8.60
CH 39	2441	10.08	8.04	8.03
CH 78	2480	10.39	8.34	8.32

Note:

- 1. The data above is the average power level during the "ON" burst of Bluetooth transmitter.
- 2. Bluetooth SAR testing was performed at DH5 due to highest duty factor, theoretical maximum 83.3% duty factor of DH5 is used to determine source-base time-average power
- 3. For Bluetooth SAR testing, the EUT was set in 1Mbps due to its highest frame-average power.

11. Antenna Location

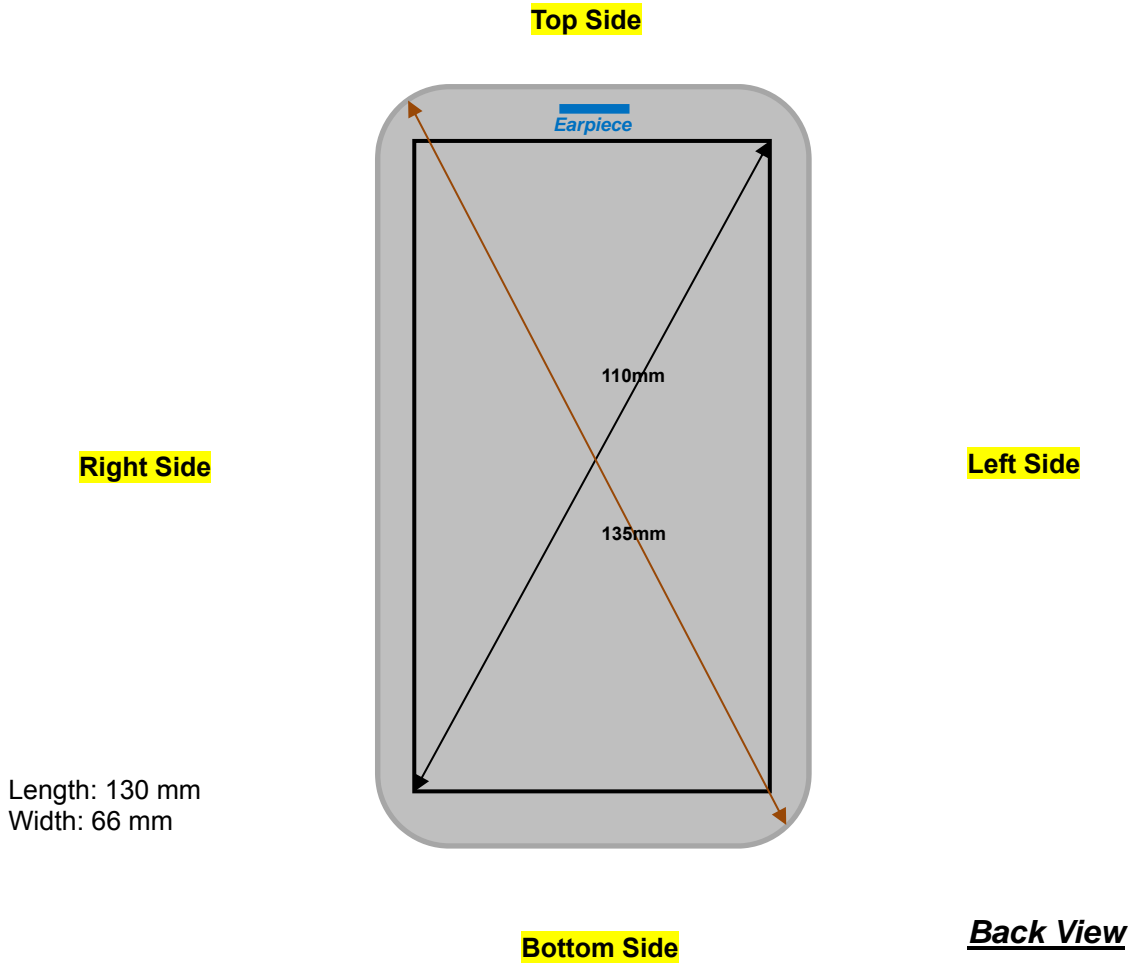

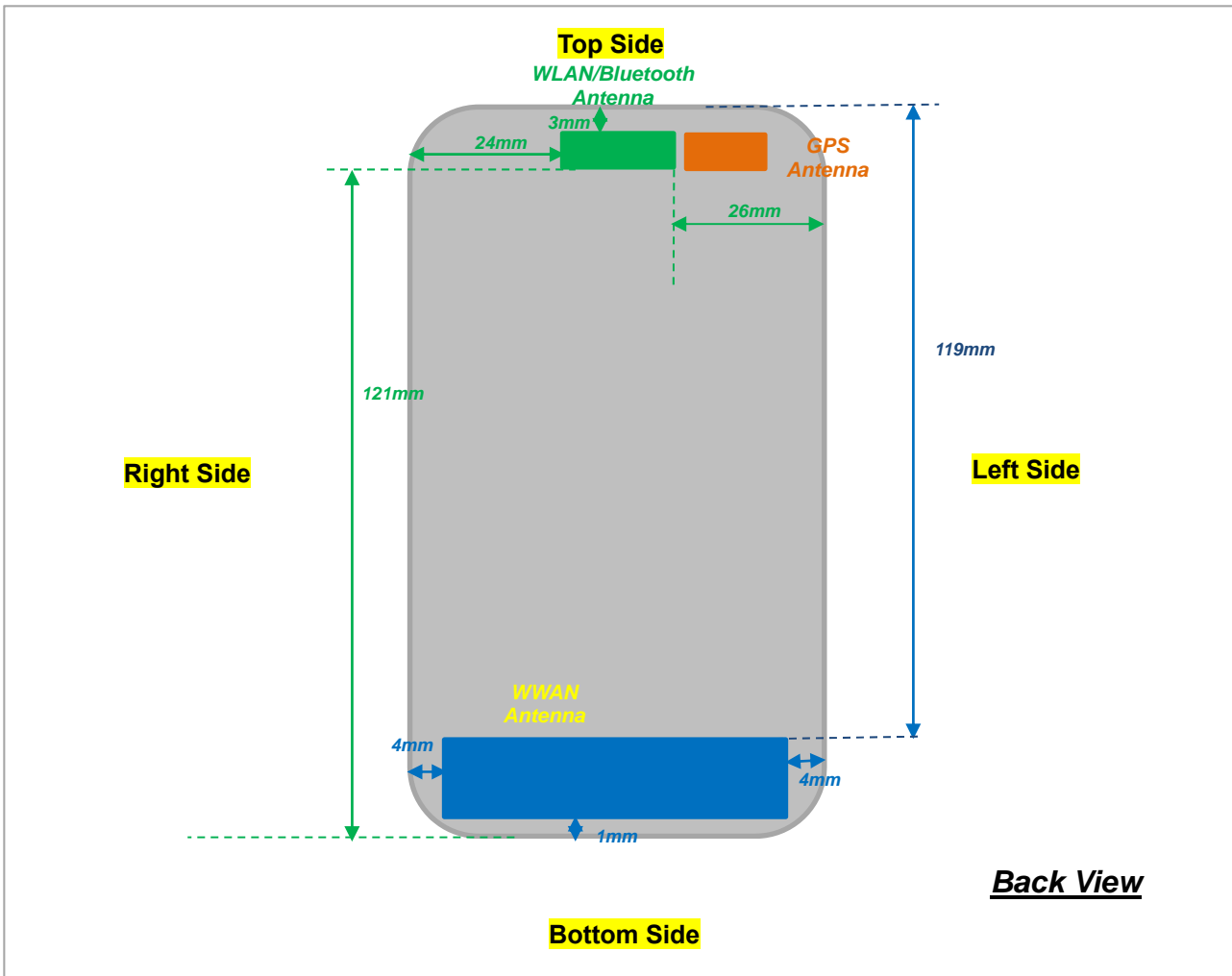

Distance of the Antenna to the EUT surface/edge						
Antennas	Back	Front	Top Side	Bottom Side	Right Side	Left Side
WWAN	≤ 25mm	≤ 25mm	119mm	≤ 25mm	≤ 25mm	≤ 25mm
Bluetooth & WLAN	≤ 25mm	≤ 25mm	≤ 25mm	121mm	≤ 25mm	26mm

Positions for SAR tests; Hotspot mode						
Antennas	Back	Front	Top Side	Bottom Side	Right Side	Left Side
WWAN	Yes	Yes	No	Yes	Yes	Yes
Bluetooth & WLAN	Yes	Yes	Yes	No	Yes	No

Note: Referring to KDB 941225 D06 v01r01, when the overall device length and width are $\geq 9\text{cm} \times 5\text{cm}$, the test distance is 10 mm. SAR must be measured for all sides and surfaces with a transmitting antenna located within 25mm from that surface or edge



12. SAR Test Results

General Note:

1. Per KDB 447498 D01v05r01, the reported SAR is the measured SAR value adjusted for maximum tune-up tolerance.
 - a. Tune-up scaling Factor = tune-up limit power (mW) / EUT RF power (mW), where tune-up limit is the maximum rated power among all production units.
 - b. Reported SAR(W/kg)= Measured SAR(W/kg)*Tune-up Scaling Factor
2. Per KDB 447498 D01v05r01, for each exposure position, if the highest output channel reported SAR ≤0.8W/kg, other channels SAR testing is not necessary.
3. Body-worn SAR testing was performed at 10mm separation, and this distance is determined by the handset manufacturer that there will be body-worn accessories that users may acquire at the time of equipment certification, to enable users to purchase aftermarket body-worn accessories with the required minimum separation.
4. Per KDB 648474 D04v01r01, when the *reported* SAR for a body-worn accessory measured without a headset connected to the handset is ≤ 1.2 W/kg, SAR testing with a headset connected to the handset is not required.

12.1 Head SAR

<GSM SAR>

Plot No.	Band	Mode	Test Position	Ch.	Freq. (MHz)	Average Power (dBm)	Tune-Up Limit (dBm)	Scaling Factor	Power Drift (dB)	Measured 1g SAR (W/kg)	Reported 1g SAR (W/kg)
41	GSM850	GSM Voice	Right Cheek	128	824.2	32.01	32.7	1.172	0.03	0.225	0.264
42	GSM850	GSM Voice	Right Tilted	128	824.2	32.01	32.7	1.172	0.01	0.151	0.177
43	GSM850	GSM Voice	Left Cheek	128	824.2	32.01	32.7	1.172	-0.03	0.227	0.266
44	GSM850	GSM Voice	Left Tilted	128	824.2	32.01	32.7	1.172	-0.03	0.142	0.166

Plot No.	Band	Mode	Test Position	Ch.	Freq. (MHz)	Average Power (dBm)	Tune-Up Limit (dBm)	Scaling Factor	Power Drift (dB)	Measured 1g SAR (W/kg)	Reported 1g SAR (W/kg)
31	GSM1900	GSM Voice	Right Cheek	661	1880	29.25	30	1.189	-0.1	0.285	0.339
32	GSM1900	GSM Voice	Right Tilted	661	1880	29.25	30	1.189	0.01	0.131	0.156
33	GSM1900	GSM Voice	Left Cheek	661	1880	29.25	30	1.189	-0.09	0.215	0.256
34	GSM1900	GSM Voice	Left Tilted	661	1880	29.25	30	1.189	0.01	0.122	0.145

<WLAN2.4GHz SAR>

Plot No.	Band	Mode	Test Position	Ch.	Freq. (MHz)	Average Power (dBm)	Tune-Up Limit (dBm)	Scaling Factor	Power Drift (dB)	Measured 1g SAR (W/kg)	Reported 1g SAR (W/kg)
51	WLAN 2.4GHz	802.11b 1Mbps	Right Cheek	1	2412	16.48	17.5	1.265	0.02	0.171	0.216
52	WLAN 2.4GHz	802.11b 1Mbps	Right Tilted	1	2412	16.48	17.5	1.265	0.11	0.109	0.138
53	WLAN 2.4GHz	802.11b 1Mbps	Left Cheek	1	2412	16.48	17.5	1.265	0.11	0.085	0.108
54	WLAN 2.4GHz	802.11b 1Mbps	Left Tilted	1	2412	16.48	17.5	1.265	0.04	0.093	0.118

<Bluetooth SAR>

Plot No.	Band	Mode	Test Position	Ch.	Freq. (MHz)	Average Power (dBm)	Tune-Up Limit (dBm)	Scaling Factor	Power Drift (dB)	Measured SAR _{1g} (W/kg)	Reported SAR _{1g} (W/kg)
61	Bluetooth	1Mbps	Right Cheek	0	2402	11.41	12	1.146	-0.01	0.055	0.063
62	Bluetooth	1Mbps	Right Tilted	0	2402	11.41	12	1.146	-0.07	0.033	0.038
63	Bluetooth	1Mbps	Left Cheek	0	2402	11.41	12	1.146	-0.08	0.029	0.033
64	Bluetooth	1Mbps	Left Tilted	0	2402	11.41	12	1.146	0.01	0.034	0.039



12.2 Hotspot SAR

Distance of the Antenna to the EUT surface/edge						
Antennas	Back	Front	Top Side	Bottom Side	Right Side	Left Side
WWAN	≤ 25mm	≤ 25mm	119mm	≤ 25mm	≤ 25mm	≤ 25mm
Bluetooth & WLAN	≤ 25mm	≤ 25mm	≤ 25mm	121mm	≤ 25mm	26mm

Positions for SAR tests; Hotspot mode						
Antennas	Back	Front	Top Side	Bottom Side	Right Side	Left Side
WWAN	Yes	Yes	No	Yes	Yes	Yes
Bluetooth & WLAN	Yes	Yes	Yes	No	Yes	No

Note: Per KDB 941225 D06 v01r01, when the overall device length and width are ≥ 9cm*5cm, the test distance is 10 mm. SAR must be measured for all sides and surfaces with a transmitting antenna located within 25mm from that surface or edge.

<GSM SAR>

Plot No.	Band	Mode	Test Position	Gap (cm)	Ch.	Freq. (MHz)	Average Power (dBm)	Tune-Up Limit (dBm)	Scaling Factor	Power Drift (dB)	Measured 1g SAR (W/kg)	Reported 1g SAR (W/kg)
1	GSM850	GPRS(3 Tx slots)	Front	1	128	824.2	28.39	29	1.151	-0.04	0.357	0.411
2	GSM850	GPRS(3 Tx slots)	Back	1	128	824.2	28.39	29	1.151	-0.04	0.517	0.595
3	GSM850	GPRS(3 Tx slots)	Left Side	1	128	824.2	28.39	29	1.151	-0.07	0.262	0.302
4	GSM850	GPRS(3 Tx slots)	Right Side	1	128	824.2	28.39	29	1.151	-0.01	0.235	0.270
5	GSM850	GPRS(3 Tx slots)	Bottom Side	1	128	824.2	28.39	29	1.151	0.01	0.055	0.063

Plot No.	Band	Mode	Test Position	Gap (cm)	Ch.	Freq. (MHz)	Average Power (dBm)	Tune-Up Limit (dBm)	Scaling Factor	Power Drift (dB)	Measured 1g SAR (W/kg)	Reported 1g SAR (W/kg)
11	GSM1900	GPRS(3 Tx slots)	Front	1	661	1880	25.45	26	1.135	-0.11	0.601	0.682
12	GSM1900	GPRS(3 Tx slots)	Back	1	661	1880	25.45	26	1.135	-0.06	0.953	1.082
13	GSM1900	GPRS(3 Tx slots)	Left Side	1	661	1880	25.45	26	1.135	0.06	0.133	0.151
14	GSM1900	GPRS(3 Tx slots)	Right Side	1	661	1880	25.45	26	1.135	-0.05	0.1	0.114
15	GSM1900	GPRS(3 Tx slots)	Bottom Side	1	661	1880	25.45	26	1.135	0.02	0.523	0.594
18	GSM1900	GPRS(3 Tx slots)	Back	1	512	1850.2	25.39	26	1.151	-0.04	0.813	0.936
19	GSM1900	GPRS(3 Tx slots)	Back	1	810	1909.8	25.44	26	1.138	-0.07	0.96	1.092

<WLAN 2.4GHz SAR>

Plot No.	Band	Mode	Test Position	Gap (cm)	Ch.	Freq. (MHz)	Average Power (dBm)	Tune-Up Limit (dBm)	Scaling Factor	Power Drift (dB)	Measured 1g SAR (W/kg)	Reported 1g SAR (W/kg)
71	WLAN 2.4GHz	802.11b 1Mbps	Front	1	1	2412	16.48	17.5	1.265	-0.05	0.021	0.027
72	WLAN 2.4GHz	802.11b 1Mbps	Back	1	1	2412	16.48	17.5	1.265	0.07	0.110	0.139
73	WLAN 2.4GHz	802.11b 1Mbps	Right Side	1	1	2412	16.48	17.5	1.265	-0.09	0.033	0.042
74	WLAN 2.4GHz	802.11b 1Mbps	Top Side	1	1	2412	16.48	17.5	1.265	-0.08	0.114	0.144

<Bluetooth SAR>

Plot No.	Band	Mode	Test Position	Gap (cm)	Ch.	Freq. (MHz)	Average Power (dBm)	Tune-Up Limit (dBm)	Scaling Factor	Power Drift (dB)	Measured SAR _{1g} (W/kg)	Reported SAR _{1g} (W/kg)
81	Bluetooth	1Mbps	Front	1	0	2402	11.41	12	1.146	0.03	0.00899	0.010
82	Bluetooth	1Mbps	Back	1	0	2402	11.41	12	1.146	-0.05	0.078	0.089
83	Bluetooth	1Mbps	Right Side	1	0	2402	11.41	12	1.146	-0.1	0.000918	0.001
84	Bluetooth	1Mbps	Top Side	1	0	2402	11.41	12	1.146	-0.05	0.027	0.031



12.3 Body Worn SAR

<GSM SAR>

Plot No.	Band	Mode	Test Position	Gap (cm)	Ch.	Freq. (MHz)	Average Power (dBm)	Tune-Up Limit (dBm)	Scaling Factor	Power Drift (dB)	Measured 1g SAR (W/kg)	Reported 1g SAR (W/kg)
1	GSM850	GPRS(3 Tx slots)	Front	1	128	824.2	28.39	29	1.151	-0.04	0.357	0.411
2	GSM850	GPRS(3 Tx slots)	Back	1	128	824.2	28.39	29	1.151	-0.04	0.517	0.595
6	GSM850	GSM Voice	Front	1	128	824.2	32.01	32.7	1.172	0.05	0.345	0.404
7	GSM850	GSM Voice	Back	1	128	824.2	32.01	32.7	1.172	0.01	0.499	0.585

Plot No.	Band	Mode	Test Position	Gap (cm)	Ch.	Freq. (MHz)	Average Power (dBm)	Tune-Up Limit (dBm)	Scaling Factor	Power Drift (dB)	Measured 1g SAR (W/kg)	Reported 1g SAR (W/kg)
11	GSM1900	GPRS(3 Tx slots)	Front	1	661	1880	25.45	26	1.135	-0.11	0.601	0.682
12	GSM1900	GPRS(3 Tx slots)	Back	1	661	1880	25.45	26	1.135	-0.06	0.953	1.082
18	GSM1900	GPRS(3 Tx slots)	Back	1	512	1850.2	25.39	26	1.151	-0.04	0.813	0.936
19	GSM1900	GPRS(3 Tx slots)	Back	1	810	1909.8	25.44	26	1.138	-0.07	0.96	1.092
16	GSM1900	GSM Voice	Front	1	661	1880	29.25	30	1.189	-0.08	0.482	0.573
17	GSM1900	GSM Voice	Back	1	661	1880	29.25	30	1.189	-0.07	0.749	0.890
21	GSM1900	GSM Voice	Back	1	512	1850.2	28.94	30	1.276	-0.03	0.643	0.821
22	GSM1900	GSM Voice	Back	1	810	1909.8	28.89	30	1.291	-0.05	0.784	1.012

<WLAN 2.4GHz SAR>

Plot No.	Band	Mode	Test Position	Gap (cm)	Ch.	Freq. (MHz)	Average Power (dBm)	Tune-Up Limit (dBm)	Scaling Factor	Power Drift (dB)	Measured 1g SAR (W/kg)	Reported 1g SAR (W/kg)
71	WLAN 2.4GHz	802.11b 1Mbps	Front	1	1	2412	16.48	17.5	1.265	-0.05	0.021	0.027
72	WLAN 2.4GHz	802.11b 1Mbps	Back	1	1	2412	16.48	17.5	1.265	0.07	0.110	0.139

<Bluetooth SAR>

Plot No.	Band	Mode	Test Position	Gap (cm)	Ch.	Freq. (MHz)	Average Power (dBm)	Tune-Up Limit (dBm)	Scaling Factor	Power Drift (dB)	Measured SAR _{1g} (W/kg)	Reported SAR _{1g} (W/kg)
81	Bluetooth	1Mbps	Front	1	0	2402	11.41	12	1.146	0.03	0.00899	0.010
82	Bluetooth	1Mbps	Back	1	0	2402	11.41	12	1.146	-0.05	0.078	0.089



12.4 Repeated SAR Measurement

Plot No.	Band	Mode	Test Position	Gap (cm)	Ch.	Freq. (MHz)	Average Power (dBm)	Tune-Up Limit (dBm)	Tune-up Scaling Factor	Power Drift (dB)	Measured 1g SAR (W/kg)	Ratio	Reported 1g SAR (W/kg)
19	GSM1900	GPRS(3 Tx slots)	Back	1	810	1909.8	25.44	26	1.138	-0.07	0.96	1	1.092
20	GSM1900	GPRS(3 Tx slots)	Back	1	810	1909.8	25.32	26	1.138	-0.09	0.95	1.011	1.081

Note:

1. Per KDB 865664 D01v01r01, for each frequency band, repeated SAR measurement is required only when the measured SAR is ≥ 0.8 W/kg
2. Per KDB 865664 D01v01r01, if the ratio among the repeated measurement is ≤ 1.2 and the measured SAR < 1.45 W/kg, only one repeated measurement is required.
3. The ratio is the largest SAR to the smallest SAR among original and repeated measurement.
4. All measurement SAR result is scaled-up to account for tune-up tolerance and is compliant.

12.5 Highest SAR Plot

Test Laboratory: Sporton International Inc. SAR/HAC Testing Lab

Date: 2013.11.06

02 GSM850_GPRS(3 Tx slots)_Back_1cm_Ch128

Communication System: GPRS/EDGE11; Frequency: 824.2 MHz; Duty Cycle: 1:2.77
 Medium: MSL_835_131106 Medium parameters used: $f = 824.2$ MHz; $\sigma = 0.965$ mho/m; $\epsilon_r = 54.393$; $\rho = 1000$ kg/m³
 Ambient Temperature : 23.4 °C; Liquid Temperature : 22.7 °C

DASY5 Configuration:

- Probe: EX3DV4 - SN3819; ConvF(9.5, 9.5, 9.5); Calibrated: 2012.11.26;
- Sensor-Surface: 2mm (Mechanical Surface Detection)
- Electronics: DAE4 Sn1303; Calibrated: 2012.11.22
- Phantom: SAM2; Type: QD000P40CD; Serial: TP:1671
- Measurement SW: DASY52, Version 52.8 (2); SEMCAD X Version 14.6.6 (6824)

Ch128/Area Scan (61x101x1): Interpolated grid: dx=15mm, dy=15mm
 Maximum value of SAR (interpolated) = 0.593 W/kg

Ch128/Zoom Scan (5x5x7)/Cube 0: Measurement grid: dx=8mm, dy=8mm, dz=5mm
 Reference Value = 25.474 V/m; Power Drift = -0.04 dB
 Peak SAR (extrapolated) = 0.649 mW/g
SAR(1 g) = 0.517 mW/g; SAR(10 g) = 0.389 mW/g
 Maximum value of SAR (measured) = 0.596 W/kg

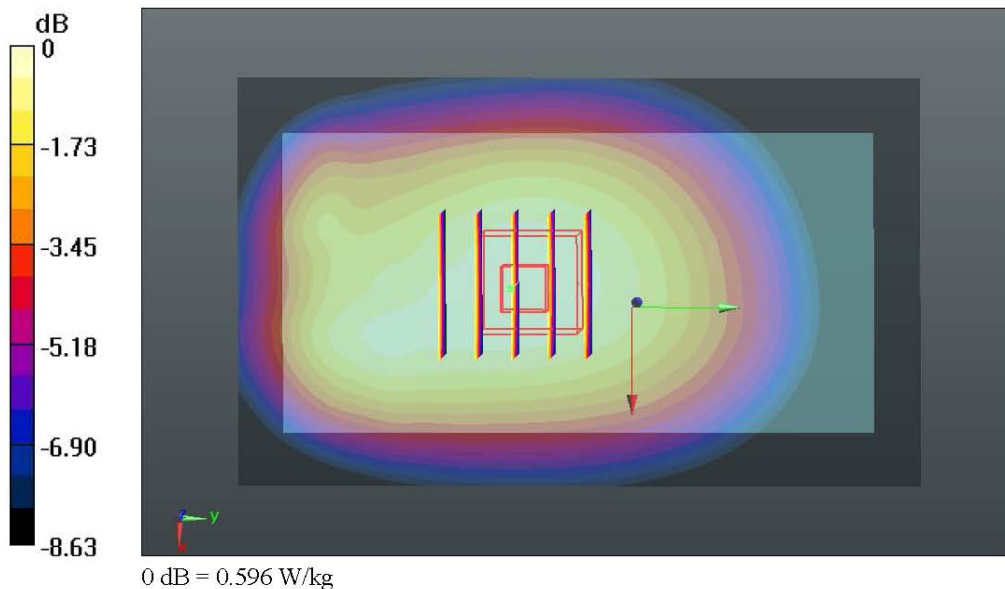

Test Laboratory: Sporton International Inc. SAR/HAC Testing Lab

Date: 2013.11.07

19 GSM1900_GPRS(3 Tx slots)_Back_1cm_Ch810

Communication System: GPRS/EDGE11; Frequency: 1909.8 MHz; Duty Cycle: 1:2.77
 Medium: MSL_1900_131107 Medium parameters used: $f = 1910$ MHz; $\sigma = 1.544$ mho/m; $\epsilon_r = 54.586$; $\rho = 1000$ kg/m³
 Ambient Temperature : 23.5 °C; Liquid Temperature : 22.6 °C

DASY5 Configuration:

- Probe: EX3DV4 - SN3819; ConvF(7.67, 7.67, 7.67); Calibrated: 2012.11.26;
- Sensor-Surface: 2mm (Mechanical Surface Detection)
- Electronics: DAE4 Sn1303; Calibrated: 2012.11.22
- Phantom: SAM1; Type: QD000P40CD; Serial: TP:1670
- Measurement SW: DASY52, Version 52.8 (2); SEMCAD X Version 14.6.6 (6824)

Ch810/Area Scan (61x101x1): Interpolated grid: dx=15mm, dy=15mm
 Maximum value of SAR (interpolated) = 1.22 W/kg

Ch810/Zoom Scan (5x5x7)/Cube 0: Measurement grid: dx=8mm, dy=8mm, dz=5mm
 Reference Value = 29.630 V/m; Power Drift = -0.07 dB
 Peak SAR (extrapolated) = 1.586 mW/g
SAR(1 g) = 0.960 mW/g; SAR(10 g) = 0.532 mW/g
 Maximum value of SAR (measured) = 1.31 W/kg

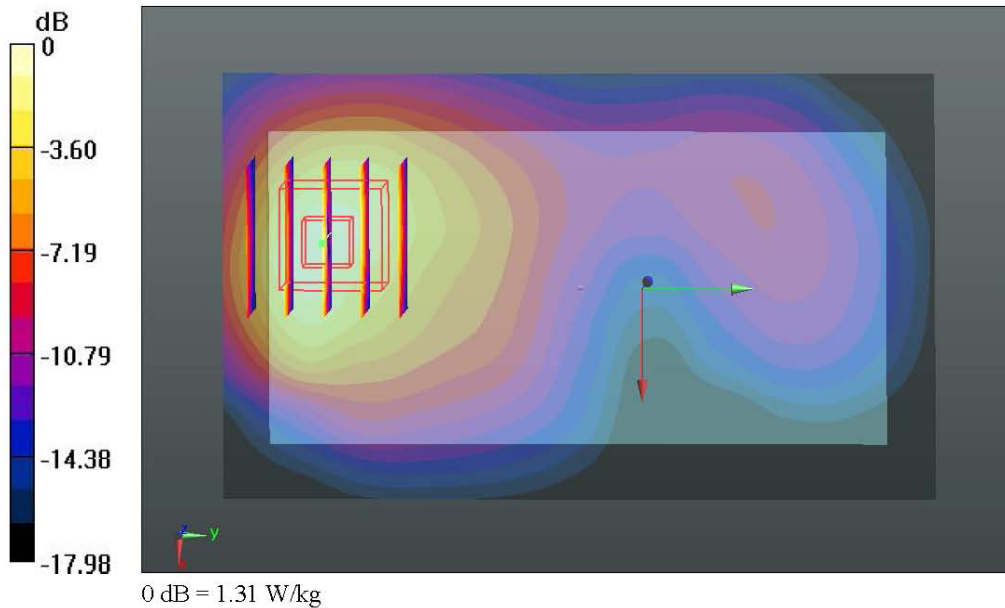

Test Laboratory: Sporton International Inc. SAR/HAC Testing Lab

Date: 2013.11.18

51 WLAN2.4GHz_802.11b_Right Cheek_Ch1

Communication System: UID 0, WIFI (0); Frequency: 2412 MHz; Duty Cycle: 1:1
 Medium: HSL_2450_131118 Medium parameters used: f = 2412 MHz; $\sigma = 1.834$ S/m; $\epsilon_r = 40.615$;
 $\rho = 1000$ kg/m³
 Ambient Temperature : 23.5 °C; Liquid Temperature : 22.7 °C

DASY5 Configuration:

- Probe: EX3DV4 - SN3819; ConvF(6.99, 6.99, 6.99); Calibrated: 2012.11.26;
- Sensor-Surface: 2mm (Mechanical Surface Detection)
- Electronics: DAE4 Sn1303; Calibrated: 2012.11.22
- Phantom: SAM2; Type: QD000P40CD; Serial: TP:1671
- Measurement SW: DASY52, Version 52.8 (7); SEMCAD X Version 14.6.10 (7164)

Ch1/Area Scan (71x121x1): Interpolated grid: dx=12mm, dy=12mm
 Maximum value of SAR (interpolated) = 0.247 W/kg

Ch1/Zoom Scan (7x7x7)/Cube 0: Measurement grid: dx=5mm, dy=5mm, dz=5mm
 Reference Value = 12.253 V/m; Power Drift = 0.02 dB
 Peak SAR (extrapolated) = 0.330 W/kg
SAR(1 g) = 0.171 W/kg; SAR(10 g) = 0.084 W/kg
 Maximum value of SAR (measured) = 0.249 W/kg

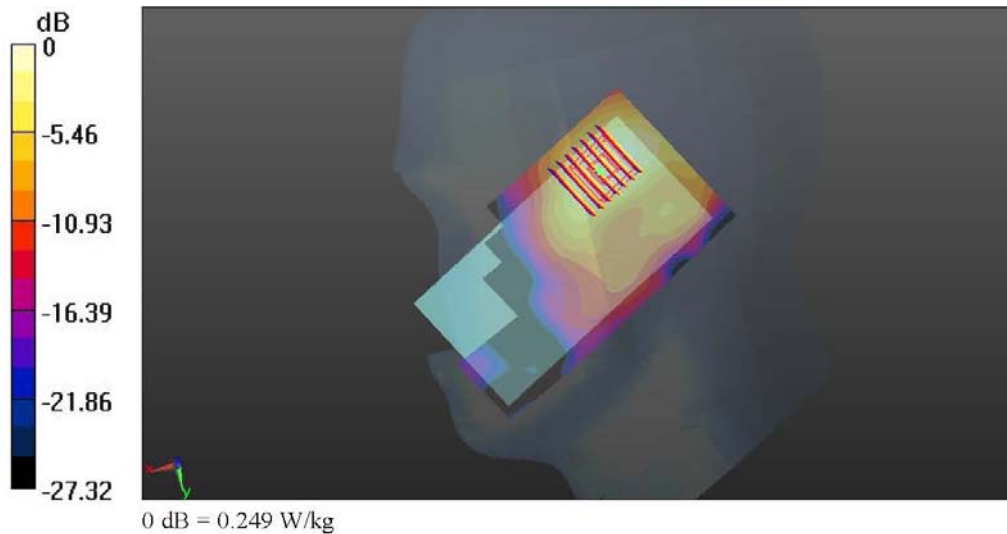

Test Laboratory: Sporton International Inc. SAR/HAC Testing Lab

Date: 2013.11.18

82 BT_DH5_Back_1cm_Ch0

Communication System: UID 0, Bluetooth (0); Frequency: 2402 MHz, Duty Cycle: 1:1.20
 Medium: MSL_2450_131118 Medium parameters used: $f = 2402$ MHz; $\sigma = 1.885$ S/m; $\epsilon_r = 51.834$;
 $\rho = 1000$ kg/m³
 Ambient Temperature : 23.6 °C; Liquid Temperature : 22.7 °C

DASY5 Configuration:

- Probe: EX3DV4 - SN3819; ConvF(7.21, 7.21, 7.21); Calibrated: 2012.11.26;
- Sensor-Surface: 2mm (Mechanical Surface Detection)
- Electronics: DAE4 Sn1303; Calibrated: 2012.11.22
- Phantom: SAM1; Type: QD000P40CD; Serial: TP:1670
- Measurement SW: DASY52, Version 52.8 (7); SEMCAD X Version 14.6.10 (7164)

Ch0/Area Scan (71x131x1): Interpolated grid: dx=12mm, dy=12mm
 Maximum value of SAR (interpolated) = 0.140 W/kg

Ch0/Zoom Scan (7x7x7)/Cube 0: Measurement grid: dx=5mm, dy=5mm, dz=5mm
 Reference Value = 8.191 V/m; Power Drift = -0.05 dB
 Peak SAR (extrapolated) = 0.180 W/kg
SAR(1 g) = 0.078 W/kg; SAR(10 g) = 0.035 W/kg
 Maximum value of SAR (measured) = 0.124 W/kg

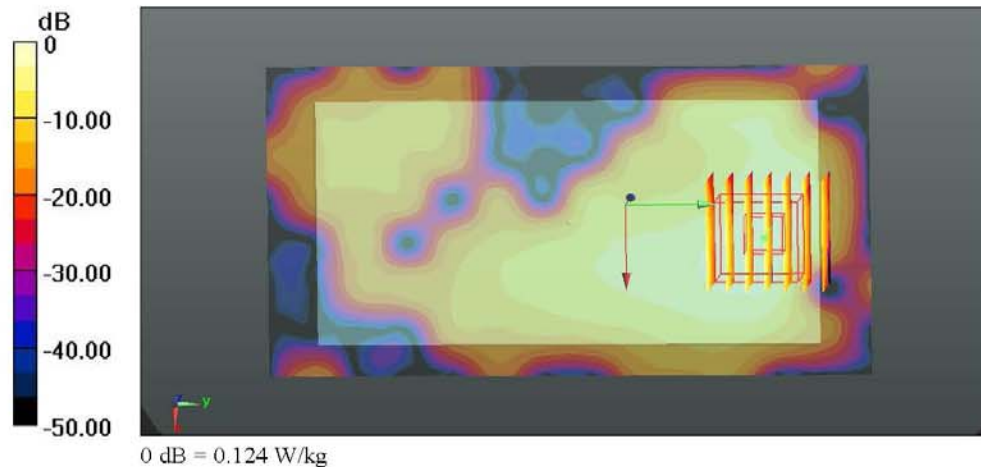

13. Simultaneous Transmission Analysis

NO.	Simultaneous Transmission Configurations	Portable Handset Exposure positions			Note
		Head	Body-worn	Hotspot	
1.	GSM(Voice) + WLAN 2.4GHz	Yes	Yes		-
2.	GSM(Voice) + Bluetooth	Yes	Yes		-
3.	GPRS/EDGE(Data) + WLAN 2.4GHz		Yes	Yes	2.4GHz Hotspot
4.	GPRS/EDGE(Data) + Bluetooth		Yes	Yes	Bluetooth Tethering

General Note:

1. WLAN 2.4GHz and Bluetooth share the same antenna, and cannot transmit simultaneously.
2. The device does not have limitation to operate VOIP in GPRS/EDGE wireless interface; considering the data rate of GPRS/EDGE to support VOIP quality and realistic operation, SAR testing was not performed evaluation VOIP operation in GPRS/EDGE mode.
3. The reported SAR summation is calculated based on the same configuration and test position.
4. Per KDB 447498 D01v05r01, simultaneous transmission SAR is compliant if,
 - i) Scalar SAR summation < 1.6W/kg.
 - ii) $SPLSR = (SAR_1 + SAR_2)^{1.5} / (min. \text{ separation distance, mm})$, and the peak separation distance is determined from the square root of $[(x_1-x_2)^2 + (y_1-y_2)^2 + (z_1-z_2)^2]$, where (x_1, y_1, z_1) and (x_2, y_2, z_2) are the coordinates of the extrapolated peak SAR locations in the zoom scan
If $SPLSR \leq 0.04$, simultaneously transmission SAR measurement is not necessary
 - iii) Simultaneously transmission SAR measurement, and the reported multi-band SAR < 1.6W/kg



13.1 Head Exposure Conditions

<WWAN + WLAN 2.4GHz>

Position	WWAN (PCE)			WLAN 2.4GHz (DTS)		Summed SAR (W/kg)	SPLSR ≤ 0.04	Case No
	Band	Plot No	SAR (W/kg)	Plot No	SAR (W/kg)			
Right Cheek	GSM850	41	0.264	51	0.216	0.48		
	GSM1900	31	0.339	51	0.216	0.56		
Right Tilted	GSM850	42	0.177	52	0.138	0.32		
	GSM1900	32	0.156	52	0.138	0.29		
Left Cheek	GSM850	43	0.266	53	0.108	0.37		
	GSM1900	33	0.256	53	0.108	0.36		
Left Tilted	GSM850	44	0.166	54	0.118	0.28		
	GSM1900	34	0.145	54	0.118	0.26		

<WWAN + Bluetooth>

Position	WWAN (PCE)			Bluetooth (DSS)		Summed SAR (W/kg)	SPLSR ≤ 0.04	Case No
	Band	Plot No	SAR (W/kg)	Plot No	SAR (W/kg)			
Right Cheek	GSM850	41	0.264	61	0.063	0.33		
	GSM1900	31	0.339	61	0.063	0.40		
Right Tilted	GSM850	42	0.177	62	0.038	0.22		
	GSM1900	32	0.156	62	0.038	0.19		
Left Cheek	GSM850	43	0.266	63	0.033	0.30		
	GSM1900	33	0.256	63	0.033	0.29		
Left Tilted	GSM850	44	0.166	64	0.039	0.21		
	GSM1900	34	0.145	64	0.039	0.18		



13.2 Hotspot Exposure Conditions

<WWAN + WLAN 2.4GHz>

Position	WWAN (PCE)			WLAN 2.4GHz (DTS)		Summed SAR (W/kg)	SPLSR ≤ 0.04	Case No
	Band	Plot No	SAR (W/kg)	Plot No	SAR (W/kg)			
Front	GSM850	1	0.411	71	0.027	0.44		
	GSM1900	11	0.682	71	0.027	0.71		
Back	GSM850	2	0.595	72	0.139	0.73		
	GSM1900	19	1.092	72	0.139	1.23		
Left Side	GSM850	3	0.302			0.30		
	GSM1900	13	0.151			0.15		
Right Side	GSM850	4	0.27	73	0.042	0.31		
	GSM1900	14	0.114	73	0.042	0.16		
Top Side	GSM850			74	0.144	0.14		
	GSM1900			74	0.144	0.14		
Bottom Side	GSM850	5	0.063			0.06		
	GSM1900	15	0.594			0.59		

<WWAN + Bluetooth>

Position	WWAN (PCE)			Bluetooth (DSS)		Summed SAR (W/kg)	SPLSR ≤ 0.04	Case No
	Band	Plot No	SAR (W/kg)	Plot No	SAR (W/kg)			
Front	GSM850	1	0.411	81	0.010	0.42		
	GSM1900	11	0.682	81	0.010	0.69		
Back	GSM850	2	0.595	82	0.089	0.68		
	GSM1900	19	1.092	82	0.089	1.18		
Left Side	GSM850	3	0.302			0.30		
	GSM1900	13	0.151			0.15		
Right Side	GSM850	4	0.27	83	0.001	0.27		
	GSM1900	14	0.114	83	0.001	0.12		
Top Side	GSM850			84	0.031	0.03		
	GSM1900			84	0.031	0.03		
Bottom Side	GSM850	5	0.063			0.06		
	GSM1900	15	0.594			0.59		



13.3 Body-Worn Exposure Conditions

<WWAN + WLAN 2.4GHz>

Position	WWAN (PCE)			WLAN 2.4GHz (DTS)		Summed SAR (W/kg)	SPLSR ≤ 0.04	Case No
	Band	Plot No	SAR (W/kg)	Plot No	SAR (W/kg)			
Front	GSM850	1	0.411	71	0.027	0.44		
	GSM1900	11	0.682	71	0.027	0.71		
Back	GSM850	2	0.595	72	0.139	0.73		
	GSM1900	19	1.092	72	0.139	1.23		

<WWAN + Bluetooth>

Position	WWAN (PCE)			Bluetooth (DSS)		Summed SAR (W/kg)	SPLSR ≤ 0.04	Case No
	Band	Plot No	SAR (W/kg)	Plot No	SAR (W/kg)			
Front	GSM850	1	0.411	81	0.010	0.42		
	GSM1900	11	0.682	81	0.010	0.69		
Back	GSM850	2	0.595	82	0.089	0.68		
	GSM1900	19	1.092	82	0.089	1.18		

Test Engineer : Luke Lu

14. Uncertainty Assessment

The component of uncertainty may generally be categorized according to the methods used to evaluate them. The evaluation of uncertainty by the statistical analysis of a series of observations is termed a Type A evaluation of uncertainty. The evaluation of uncertainty by means other than the statistical analysis of a series of observation is termed a Type B evaluation of uncertainty. Each component of uncertainty, however evaluated, is represented by an estimated standard deviation, termed standard uncertainty, which is determined by the positive square root of the estimated variance.

A Type A evaluation of standard uncertainty may be based on any valid statistical method for treating data. This includes calculating the standard deviation of the mean of a series of independent observations; using the method of least squares to fit a curve to the data in order to estimate the parameter of the curve and their standard deviations; or carrying out an analysis of variance in order to identify and quantify random effects in certain kinds of measurement.

A type B evaluation of standard uncertainty is typically based on scientific judgment using all of the relevant information available. These may include previous measurement data, experience, and knowledge of the behavior and properties of relevant materials and instruments, manufacture’s specification, data provided in calibration reports and uncertainties assigned to reference data taken from handbooks. Broadly speaking, the uncertainty is either obtained from an outdoor source or obtained from an assumed distribution, such as the normal distribution, rectangular or triangular distributions indicated in Table 14.1

Uncertainty Distributions	Normal	Rectangular	Triangular	U-Shape
Multi-plying Factor ^(a)	1/k ^(b)	1/√3	1/√6	1/√2

(a) standard uncertainty is determined as the product of the multiplying factor and the estimated range of variations in the measured quantity

(b) κ is the coverage factor

Table 14.1. Standard Uncertainty for Assumed Distribution

The combined standard uncertainty of the measurement result represents the estimated standard deviation of the result. It is obtained by combining the individual standard uncertainties of both Type A and Type B evaluation using the usual “root-sum-squares” (RSS) methods of combining standard deviations by taking the positive square root of the estimated variances.

Expanded uncertainty is a measure of uncertainty that defines an interval about the measurement result within which the measured value is confidently believed to lie. It is obtained by multiplying the combined standard uncertainty by a coverage factor. Typically, the coverage factor ranges from 2 to 3. Using a coverage factor allows the true value of a measured quantity to be specified with a defined probability within the specified uncertainty range. For purpose of this document, a coverage factor two is used, which corresponds to confidence interval of about 95 %. The DASY uncertainty Budget is shown in the following tables.

Error Description	Uncertainty Value (±%)	Probability Distribution	Divisor	Ci (1g)	Ci (10g)	Standard Uncertainty (1g)	Standard Uncertainty (10g)
Measurement System							
Probe Calibration	6.0	Normal	1	1	1	± 6.0 %	± 6.0 %
Axial Isotropy	4.7	Rectangular	√3	0.7	0.7	± 1.9 %	± 1.9 %
Hemispherical Isotropy	9.6	Rectangular	√3	0.7	0.7	± 3.9 %	± 3.9 %
Boundary Effects	1.0	Rectangular	√3	1	1	± 0.6 %	± 0.6 %
Linearity	4.7	Rectangular	√3	1	1	± 2.7 %	± 2.7 %
System Detection Limits	1.0	Rectangular	√3	1	1	± 0.6 %	± 0.6 %
Readout Electronics	0.3	Normal	1	1	1	± 0.3 %	± 0.3 %
Response Time	0.8	Rectangular	√3	1	1	± 0.5 %	± 0.5 %
Integration Time	2.6	Rectangular	√3	1	1	± 1.5 %	± 1.5 %
RF Ambient Noise	3.0	Rectangular	√3	1	1	± 1.7 %	± 1.7 %
RF Ambient Reflections	3.0	Rectangular	√3	1	1	± 1.7 %	± 1.7 %
Probe Positioner	0.4	Rectangular	√3	1	1	± 0.2 %	± 0.2 %
Probe Positioning	2.9	Rectangular	√3	1	1	± 1.7 %	± 1.7 %
Max. SAR Eval.	1.0	Rectangular	√3	1	1	± 0.6 %	± 0.6 %
Test Sample Related							
Device Positioning	2.9	Normal	1	1	1	± 2.9 %	± 2.9 %
Device Holder	3.6	Normal	1	1	1	± 3.6 %	± 3.6 %
Power Drift	5.0	Rectangular	√3	1	1	± 2.9 %	± 2.9 %
Phantom and Setup							
Phantom Uncertainty	4.0	Rectangular	√3	1	1	± 2.3 %	± 2.3 %
Liquid Conductivity (Target)	5.0	Rectangular	√3	0.64	0.43	± 1.8 %	± 1.2 %
Liquid Conductivity (Meas.)	2.5	Normal	1	0.64	0.43	± 1.6 %	± 1.1 %
Liquid Permittivity (Target)	5.0	Rectangular	√3	0.6	0.49	± 1.7 %	± 1.4 %
Liquid Permittivity (Meas.)	2.5	Normal	1	0.6	0.49	± 1.5 %	± 1.2 %
Combined Standard Uncertainty						± 11.0 %	± 10.8 %
Coverage Factor for 95 %						K=2	
Expanded Uncertainty						± 22.0 %	± 21.5 %

Table 14.2. Uncertainty Budget for frequency range 300 MHz to 3 GHz



15. References

- [1] FCC 47 CFR Part 2 "Frequency Allocations and Radio Treaty Matters; General Rules and Regulations"
- [2] ANSI/IEEE Std. C95.1-1992, "IEEE Standard for Safety Levels with Respect to Human Exposure to Radio Frequency Electromagnetic Fields, 3 kHz to 300 GHz", September 1992
- [3] IEEE Std. 1528-2003, "Recommended Practice for Determining the Peak Spatial-Average Specific Absorption Rate (SAR) in the Human Head from Wireless Communications Devices: Measurement Techniques", December 2003
- [4] SPEAG DASY System Handbook
- [5] FCC KDB 248227 D01 v01r02, "SAR Measurement Procedures for 802.11 a/b/g Transmitters", May 2007
- [6] FCC KDB 447498 D01 v05r01, "Mobile and Portable Device RF Exposure Procedures and Equipment Authorization Policies", May 2013
- [7] FCC KDB 648474 D04 v01r01, "SAR Evaluation Considerations for Wireless Handsets", May 2013
- [8] FCC KDB 941225 D03 v01, "Recommended SAR Test Reduction Procedures for GSM / GPRS / EDGE", December 2008
- [9] FCC KDB 941225 D06 v01r01, "SAR Evaluation Procedures for Portable Devices with Wireless Router Capabilities", May 2013
- [10] FCC KDB 865664 D01 v01r01, "SAR Measurement Requirements for 100 MHz to 6 GHz", May 2013



Appendix A. Plots of System Performance Check

The plots are shown as follows.



Appendix B. Plots of SAR Measurement

The plots are shown as follows.



Appendix C. DAS Y Calibration Certificate

The DAS Y calibration certificates are shown as follows.