



Accredited by the Swiss Accreditation Service (SAS)
The Swiss Accreditation Service is one of the signatories to the EA
Multilateral Agreement for the recognition of calibration certificates

Accreditation No.: **SCS 108**

Client **PC Test**

Certificate No: **ES3-3258_Feb14**

CALIBRATION CERTIFICATE

Object **ES3DV3 - SN:3258**

Calibration procedure(s) **QA CAL-01.v9, QA CAL-23.v5, QA CAL-25.v6
Calibration procedure for dosimetric E-field probes** *CCV
3/16/14*

Calibration date: **February 25, 2014**

This calibration certificate documents the traceability to national standards, which realize the physical units of measurements (SI).
The measurements and the uncertainties with confidence probability are given on the following pages and are part of the certificate.

All calibrations have been conducted in the closed laboratory facility: environment temperature (22 ± 3)°C and humidity < 70%.

Calibration Equipment used (M&TE critical for calibration)

Primary Standards	ID	Cal Date (Certificate No.)	Scheduled Calibration
Power meter E4419B	GB41293874	04-Apr-13 (No. 217-01733)	Apr-14
Power sensor E4412A	MY41498087	04-Apr-13 (No. 217-01733)	Apr-14
Reference 3 dB Attenuator	SN: S5054 (3c)	04-Apr-13 (No. 217-01737)	Apr-14
Reference 20 dB Attenuator	SN: S5277 (20x)	04-Apr-13 (No. 217-01735)	Apr-14
Reference 30 dB Attenuator	SN: S5129 (30b)	04-Apr-13 (No. 217-01738)	Apr-14
Reference Probe ES3DV2	SN: 3013	30-Dec-13 (No. ES3-3013_Dec13)	Dec-14
DAE4	SN: 660	13-Dec-13 (No. DAE4-660_Dec13)	Dec-14
Secondary Standards	ID	Check Date (in house)	Scheduled Check
RF generator HP 8648C	US3642U01700	4-Aug-99 (in house check Apr-13)	In house check: Apr-16
Network Analyzer HP 8753E	US37390585	18-Oct-01 (in house check Oct-13)	In house check: Oct-14

Calibrated by:	Name Israe El-Naouq	Function Laboratory Technician	Signature <i>Israe El-Naouq</i>
Approved by:	Katja Pokovic	Technical Manager	<i>Katja Pokovic</i>

Issued: February 27, 2014

This calibration certificate shall not be reproduced except in full without written approval of the laboratory.

PCT# 80615



Accredited by the Swiss Accreditation Service (SAS)

Accreditation No.: **SCS 108**

The Swiss Accreditation Service is one of the signatories to the EA
Multilateral Agreement for the recognition of calibration certificates

Glossary:

TSL	tissue simulating liquid
NORM _{x,y,z}	sensitivity in free space
ConvF	sensitivity in TSL / NORM _{x,y,z}
DCP	diode compression point
CF	crest factor (1/duty_cycle) of the RF signal
A, B, C, D	modulation dependent linearization parameters
Polarization φ	φ rotation around probe axis
Polarization ϑ	ϑ rotation around an axis that is in the plane normal to probe axis (at measurement center), i.e., $\vartheta = 0$ is normal to probe axis
Connector Angle	information used in DASY system to align probe sensor X to the robot coordinate system

Calibration is Performed According to the Following Standards:

- IEEE Std 1528-2013, "IEEE Recommended Practice for Determining the Peak Spatial-Averaged Specific Absorption Rate (SAR) in the Human Head from Wireless Communications Devices: Measurement Techniques", June 2013
- IEC 62209-1, "Procedure to measure the Specific Absorption Rate (SAR) for hand-held devices used in close proximity to the ear (frequency range of 300 MHz to 3 GHz)", February 2005

Methods Applied and Interpretation of Parameters:

- NORM_{x,y,z}:** Assessed for E-field polarization $\vartheta = 0$ ($f \leq 900$ MHz in TEM-cell; $f > 1800$ MHz: R22 waveguide). NORM_{x,y,z} are only intermediate values, i.e., the uncertainties of NORM_{x,y,z} does not affect the E²-field uncertainty inside TSL (see below ConvF).
- NORM(f)_{x,y,z} = NORM_{x,y,z} * frequency_response** (see Frequency Response Chart). This linearization is implemented in DASY4 software versions later than 4.2. The uncertainty of the frequency response is included in the stated uncertainty of ConvF.
- DCP_{x,y,z}:** DCP are numerical linearization parameters assessed based on the data of power sweep with CW signal (no uncertainty required). DCP does not depend on frequency nor media.
- PAR:** PAR is the Peak to Average Ratio that is not calibrated but determined based on the signal characteristics
- A_{x,y,z}; B_{x,y,z}; C_{x,y,z}; D_{x,y,z}; VR_{x,y,z}:** A, B, C, D are numerical linearization parameters assessed based on the data of power sweep for specific modulation signal. The parameters do not depend on frequency nor media. VR is the maximum calibration range expressed in RMS voltage across the diode.
- ConvF and Boundary Effect Parameters:** Assessed in flat phantom using E-field (or Temperature Transfer Standard for $f \leq 800$ MHz) and inside waveguide using analytical field distributions based on power measurements for $f > 800$ MHz. The same setups are used for assessment of the parameters applied for boundary compensation (alpha, depth) of which typical uncertainty values are given. These parameters are used in DASY4 software to improve probe accuracy close to the boundary. The sensitivity in TSL corresponds to NORM_{x,y,z} * ConvF whereby the uncertainty corresponds to that given for ConvF. A frequency dependent ConvF is used in DASY version 4.4 and higher which allows extending the validity from ± 50 MHz to ± 100 MHz.
- Spherical isotropy (3D deviation from isotropy):** in a field of low gradients realized using a flat phantom exposed by a patch antenna.
- Sensor Offset:** The sensor offset corresponds to the offset of virtual measurement center from the probe tip (on probe axis). No tolerance required.
- Connector Angle:** The angle is assessed using the information gained by determining the NORM_x (no uncertainty required).

Probe ES3DV3

SN:3258

Manufactured: January 25, 2010
Calibrated: February 25, 2014

Calibrated for DASY/EASY Systems
(Note: non-compatible with DASY2 system!)

DASY/EASY - Parameters of Probe: ES3DV3 - SN:3258

Basic Calibration Parameters

	Sensor X	Sensor Y	Sensor Z	Unc (k=2)
Norm ($\mu V/(V/m)^2$) ^A	1.29	1.19	1.23	$\pm 10.1\%$
DCP (mV) ^B	104.5	107.0	103.0	

Modulation Calibration Parameters

UID	Communication System Name		A dB	B dB $\sqrt{\mu V}$	C	D dB	VR mV	Unc ^E (k=2)
0	CW	X	0.0	0.0	1.0	0.00	222.4	$\pm 3.8\%$
		Y	0.0	0.0	1.0		202.2	
		Z	0.0	0.0	1.0		207.1	
10010- CAA	SAR Validation (Square, 100ms, 10ms)	X	5.09	65.6	14.1	10.00	44.8	$\pm 1.9\%$
		Y	1.68	57.4	9.3		40.7	
		Z	4.01	62.4	13.0		51.1	
10011- CAB	UMTS-FDD (WCDMA)	X	3.34	67.5	18.9	2.91	131.2	$\pm 0.5\%$
		Y	3.43	67.9	18.7		137.1	
		Z	3.42	67.8	19.0		146.0	
10012- CAA	IEEE 802.11b WiFi 2.4 GHz (DSSS, 1 Mbps)	X	3.40	70.9	19.8	1.87	134.2	$\pm 0.7\%$
		Y	3.19	70.2	19.2		137.9	
		Z	3.46	70.8	19.6		149.6	
10021- DAB	GSM-FDD (TDMA, GMSK)	X	30.24	99.7	28.7	9.39	131.2	$\pm 1.4\%$
		Y	12.91	88.5	23.9		147.5	
		Z	30.37	99.5	28.9		128.0	
10023- DAB	GPRS-FDD (TDMA, GMSK, TN 0)	X	29.88	100.0	29.0	9.57	123.0	$\pm 1.9\%$
		Y	16.02	92.5	25.4		140.7	
		Z	30.01	100.0	29.4		125.8	
10024- DAB	GPRS-FDD (TDMA, GMSK, TN 0-1)	X	44.57	99.7	25.9	6.56	119.6	$\pm 1.7\%$
		Y	28.97	95.3	23.2		127.6	
		Z	43.72	99.8	26.3		120.1	
10027- DAB	GPRS-FDD (TDMA, GMSK, TN 0-1-2)	X	53.52	99.7	24.4	4.80	129.4	$\pm 2.2\%$
		Y	54.55	99.9	22.9		143.3	
		Z	51.63	99.7	24.8		127.5	
10028- DAB	GPRS-FDD (TDMA, GMSK, TN 0-1-2-3)	X	58.93	99.8	23.4	3.55	133.4	$\pm 2.2\%$
		Y	77.54	99.7	21.3		125.3	
		Z	56.64	99.8	23.8		130.8	
10032- CAA	IEEE 802.15.1 Bluetooth (GFSK, DH5)	X	47.03	99.5	21.3	1.16	136.3	$\pm 1.7\%$
		Y	95.86	95.2	17.1		138.2	
		Z	39.68	100.0	22.2		132.3	
10039- CAB	CDMA2000 (1xRTT, RC1)	X	4.84	66.8	19.1	4.57	131.3	$\pm 0.9\%$
		Y	4.75	67.0	18.9		135.2	
		Z	4.86	66.7	19.0		127.2	

10081-CAB	CDMA2000 (1xRTT, RC3)	X	4.06	66.8	19.0	3.97	148.4	±0.7 %
		Y	3.96	66.6	18.6		134.7	
		Z	4.13	66.9	19.1		143.4	
10098-CAB	UMTS-FDD (HSUPA, Subtest 2)	X	4.63	66.8	18.7	3.98	137.3	±0.7 %
		Y	4.75	67.5	18.8		148.4	
		Z	4.65	66.7	18.7		133.2	
10100-CAB	LTE-FDD (SC-FDMA, 100% RB, 20 MHz, QPSK)	X	6.66	68.5	20.3	5.67	144.0	±1.2 %
		Y	6.27	67.1	19.3		130.6	
		Z	6.62	68.2	20.1		140.5	
10108-CAB	LTE-FDD (SC-FDMA, 100% RB, 10 MHz, QPSK)	X	6.53	68.0	20.2	5.80	142.6	±1.4 %
		Y	6.17	66.8	19.3		129.2	
		Z	6.52	67.8	20.1		139.0	
10110-CAB	LTE-FDD (SC-FDMA, 100% RB, 5 MHz, QPSK)	X	6.19	67.3	19.9	5.75	137.9	±1.4 %
		Y	6.12	67.3	19.6		149.5	
		Z	6.19	67.1	19.8		136.1	
10114-CAA	IEEE 802.11n (HT Greenfield, 13.5 Mbps, BPSK)	X	10.49	69.5	21.7	8.10	132.4	±2.5 %
		Y	10.23	69.1	21.3		144.3	
		Z	10.45	69.3	21.6		129.5	
10117-CAA	IEEE 802.11n (HT Mixed, 13.5 Mbps, BPSK)	X	10.46	69.5	21.7	8.07	133.9	±2.5 %
		Y	10.26	69.2	21.3		147.4	
		Z	10.47	69.4	21.7		130.5	
10151-CAB	LTE-TDD (SC-FDMA, 50% RB, 20 MHz, QPSK)	X	11.61	77.4	26.8	9.28	118.8	±3.0 %
		Y	9.89	75.2	25.7		144.9	
		Z	12.01	77.8	26.9		119.6	
10154-CAB	LTE-FDD (SC-FDMA, 50% RB, 10 MHz, QPSK)	X	6.20	67.3	19.9	5.75	139.2	±1.2 %
		Y	5.86	66.2	19.0		128.5	
		Z	6.22	67.3	19.9		136.3	
10160-CAB	LTE-FDD (SC-FDMA, 50% RB, 15 MHz, QPSK)	X	6.63	67.8	20.1	5.82	144.1	±1.4 %
		Y	6.31	66.8	19.3		133.1	
		Z	6.66	67.7	20.0		140.9	
10169-CAB	LTE-FDD (SC-FDMA, 1 RB, 20 MHz, QPSK)	X	5.25	67.5	20.2	5.73	143.6	±1.2 %
		Y	4.92	66.7	19.5		131.0	
		Z	5.29	67.4	20.2		140.7	
10172-CAB	LTE-TDD (SC-FDMA, 1 RB, 20 MHz, QPSK)	X	13.49	87.5	31.6	9.21	139.0	±2.7 %
		Y	7.83	75.5	26.0		124.9	
		Z	13.47	86.5	31.1		137.8	
10175-CAB	LTE-FDD (SC-FDMA, 1 RB, 10 MHz, QPSK)	X	5.22	67.4	20.1	5.72	144.3	±1.4 %
		Y	5.08	67.5	19.9		147.9	
		Z	5.26	67.2	20.0		139.6	
10181-CAB	LTE-FDD (SC-FDMA, 1 RB, 15 MHz, QPSK)	X	5.24	67.5	20.1	5.72	144.5	±1.2 %
		Y	5.06	67.4	19.8		147.0	
		Z	5.29	67.3	20.1		139.2	

10193-CAA	IEEE 802.11n (HT Greenfield, 6.5 Mbps, BPSK)	X	10.12	69.1	21.6	8.09	128.8	±2.2 %
		Y	9.76	68.4	21.0		132.8	
		Z	10.08	68.9	21.5		123.4	
10196-CAA	IEEE 802.11n (HT Mixed, 6.5 Mbps, BPSK)	X	10.15	69.2	21.7	8.10	130.2	±2.2 %
		Y	9.77	68.5	21.0		134.1	
		Z	10.10	69.0	21.5		124.0	
10219-CAA	IEEE 802.11n (HT Mixed, 7.2 Mbps, BPSK)	X	10.02	69.0	21.5	8.03	128.7	±2.2 %
		Y	9.67	68.5	21.0		133.3	
		Z	10.02	68.9	21.5		123.9	
10222-CAA	IEEE 802.11n (HT Mixed, 15 Mbps, BPSK)	X	10.46	69.6	21.7	8.06	134.0	±2.2 %
		Y	10.09	68.8	21.1		139.7	
		Z	10.40	69.3	21.6		128.7	
10225-CAB	UMTS-FDD (HSPA+)	X	7.09	67.1	19.6	5.97	131.2	±1.4 %
		Y	6.98	67.2	19.4		138.0	
		Z	7.06	66.8	19.4		127.2	
10237-CAB	LTE-TDD (SC-FDMA, 1 RB, 10 MHz, QPSK)	X	13.63	87.8	31.7	9.21	141.6	±3.0 %
		Y	7.85	75.5	26.0		126.5	
		Z	13.99	87.7	31.6		141.4	
10252-CAB	LTE-TDD (SC-FDMA, 50% RB, 10 MHz, QPSK)	X	12.86	81.4	28.9	9.24	142.1	±3.0 %
		Y	8.91	73.4	24.8		129.9	
		Z	13.15	81.4	28.8		142.0	
10267-CAB	LTE-TDD (SC-FDMA, 100% RB, 10 MHz, QPSK)	X	11.63	77.5	26.8	9.30	118.7	±3.0 %
		Y	9.62	74.3	25.2		138.4	
		Z	11.96	77.7	26.9		119.3	
10274-CAB	UMTS-FDD (HSUPA, Subtest 5, 3GPP Rel8.10)	X	6.14	67.4	19.3	4.87	149.9	±0.9 %
		Y	5.90	66.9	18.7		132.8	
		Z	6.20	67.5	19.3		146.6	
10275-CAB	UMTS-FDD (HSUPA, Subtest 5, 3GPP Rel8.4)	X	4.45	66.9	18.9	3.96	130.1	±0.7 %
		Y	4.50	67.2	18.8		137.9	
		Z	4.64	67.6	19.3		149.2	
10291-AAB	CDMA2000, RC3, SO55, Full Rate	X	3.79	67.5	19.2	3.46	145.3	±0.7 %
		Y	3.74	67.5	18.9		128.2	
		Z	3.78	67.3	19.1		139.1	
10292-AAB	CDMA2000, RC3, SO32, Full Rate	X	3.77	67.8	19.3	3.39	147.0	±0.5 %
		Y	3.69	67.7	18.9		130.1	
		Z	3.73	67.3	19.0		141.3	
10297-AAA	LTE-FDD (SC-FDMA, 50% RB, 20 MHz, QPSK)	X	6.52	67.9	20.1	5.81	141.4	±1.4 %
		Y	6.41	67.6	19.7		147.4	
		Z	6.51	67.7	20.1		135.4	
10311-AAA	LTE-FDD (SC-FDMA, 100% RB, 15 MHz, QPSK)	X	7.17	68.7	20.7	6.06	147.7	±1.4 %
		Y	6.69	67.2	19.6		128.6	
		Z	7.12	68.4	20.5		142.0	

10315-AAA	IEEE 802.11b WiFi 2.4 GHz (DSSS, 1 Mbps, 96pc duty cycle)	X	3.04	70.0	19.6	1.71	129.8	±0.5 %
		Y	3.25	71.3	19.7		136.9	
		Z	3.09	69.9	19.5		148.7	
10403-AAB	CDMA2000 (1xEV-DO, Rev. 0)	X	4.73	67.3	18.6	3.76	135.7	±0.5 %
		Y	4.93	69.1	19.0		141.5	
		Z	4.73	67.1	18.4		132.7	
10404-AAB	CDMA2000 (1xEV-DO, Rev. A)	X	4.67	67.5	18.6	3.77	134.0	±0.5 %
		Y	4.92	69.4	19.1		139.8	
		Z	4.65	67.1	18.5		130.7	

The reported uncertainty of measurement is stated as the standard uncertainty of measurement multiplied by the coverage factor $k=2$, which for a normal distribution corresponds to a coverage probability of approximately 95%.

^A The uncertainties of NormX,Y,Z do not affect the E^2 -field uncertainty inside TSL. (see Pages 8 and 9).

^B Numerical linearization parameter: uncertainty not required.

^E Uncertainty is determined using the max. deviation from linear response applying rectangular distribution and is expressed for the square of the field value.

DASY/EASY - Parameters of Probe: ES3DV3 - SN:3258

Calibration Parameter Determined in Head Tissue Simulating Media

f (MHz) ^C	Relative Permittivity ^F	Conductivity (S/m) ^F	ConvF X	ConvF Y	ConvF Z	Alpha ^G	Depth (mm) ^G	Unct. (k=2)
750	41.9	0.89	6.53	6.53	6.53	0.40	1.60	± 12.0 %
835	41.5	0.90	6.27	6.27	6.27	0.80	1.17	± 12.0 %
1750	40.1	1.37	5.19	5.19	5.19	0.80	1.10	± 12.0 %
1900	40.0	1.40	5.04	5.04	5.04	0.68	1.27	± 12.0 %
2450	39.2	1.80	4.52	4.52	4.52	0.78	1.23	± 12.0 %
2600	39.0	1.96	4.34	4.34	4.34	0.76	1.33	± 12.0 %

^C Frequency validity of ± 100 MHz only applies for DASY v4.4 and higher (see Page 2), else it is restricted to ± 50 MHz. The uncertainty is the RSS of the ConvF uncertainty at calibration frequency and the uncertainty for the indicated frequency band.

^F At frequencies below 3 GHz, the validity of tissue parameters (ϵ and σ) can be relaxed to ± 10% if liquid compensation formula is applied to measured SAR values. At frequencies above 3 GHz, the validity of tissue parameters (ϵ and σ) is restricted to ± 5%. The uncertainty is the RSS of the ConvF uncertainty for indicated target tissue parameters.

^G Alpha/Depth are determined during calibration. SPEAG warrants that the remaining deviation due to the boundary effect after compensation is always less than ± 1% for frequencies below 3 GHz and below ± 2% for frequencies between 3-6 GHz at any distance larger than half the probe tip diameter from the boundary.

DASY/EASY - Parameters of Probe: ES3DV3 - SN:3258

Calibration Parameter Determined in Body Tissue Simulating Media

f (MHz) ^C	Relative Permittivity ^F	Conductivity (S/m) ^F	ConvF X	ConvF Y	ConvF Z	Alpha ^G	Depth (mm) ^G	Unct. (k=2)
750	55.5	0.96	6.15	6.15	6.15	0.61	1.32	± 12.0 %
835	55.2	0.97	6.11	6.11	6.11	0.80	1.15	± 12.0 %
1750	53.4	1.49	4.83	4.83	4.83	0.47	1.74	± 12.0 %
1900	53.3	1.52	4.61	4.61	4.61	0.55	1.59	± 12.0 %
2450	52.7	1.95	4.14	4.14	4.14	0.80	1.11	± 12.0 %
2600	52.5	2.16	3.91	3.91	3.91	0.80	1.00	± 12.0 %

^C Frequency validity of ± 100 MHz only applies for DASY v4.4 and higher (see Page 2), else it is restricted to ± 50 MHz. The uncertainty is the RSS of the ConvF uncertainty at calibration frequency and the uncertainty for the indicated frequency band.

^F At frequencies below 3 GHz, the validity of tissue parameters (ϵ and σ) can be relaxed to ± 10% if liquid compensation formula is applied to measured SAR values. At frequencies above 3 GHz, the validity of tissue parameters (ϵ and σ) is restricted to ± 5%. The uncertainty is the RSS of the ConvF uncertainty for indicated target tissue parameters.

^G Alpha/Depth are determined during calibration. SPEAG warrants that the remaining deviation due to the boundary effect after compensation is always less than ± 1% for frequencies below 3 GHz and below ± 2% for frequencies between 3-6 GHz at any distance larger than half the probe tip diameter from the boundary.

Frequency Response of E-Field (TEM-Cell:ifi110 EXX, Waveguide: R22)

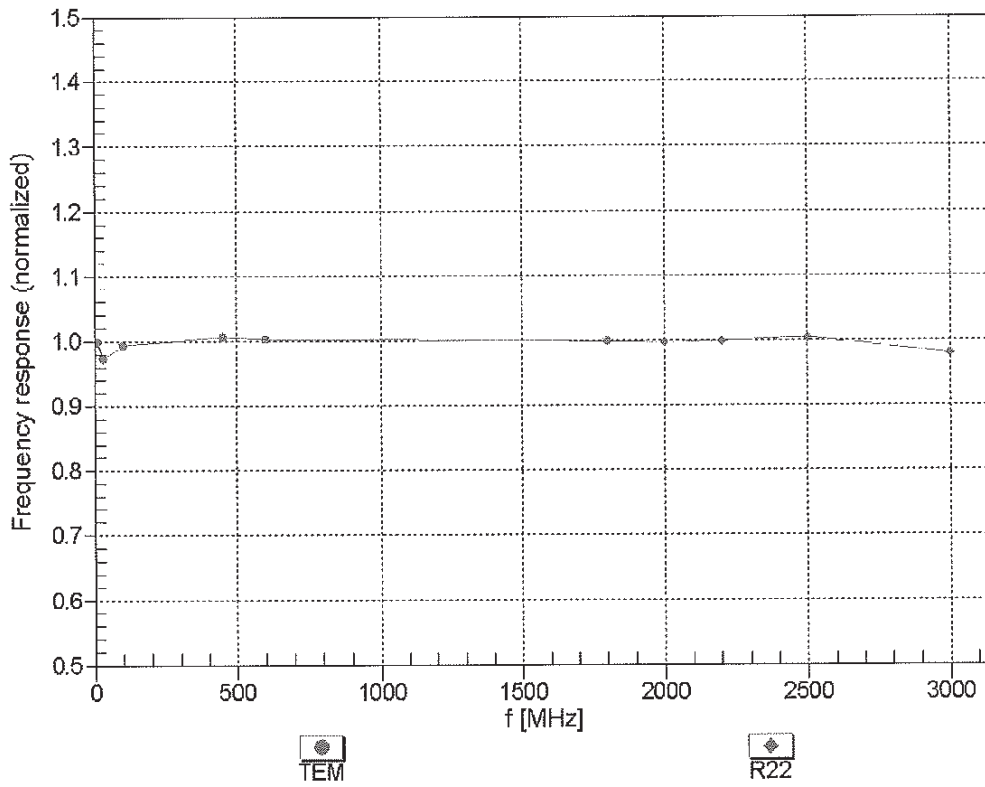

Uncertainty of Frequency Response of E-field: $\pm 6.3\%$ (k=2)

Receiving Pattern (ϕ), $\theta = 0^\circ$

f=600 MHz,TEM

f=1800 MHz,R22

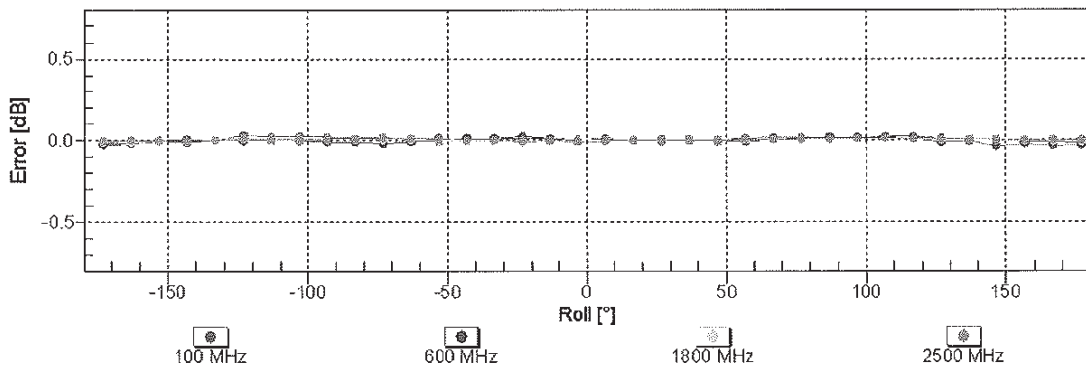
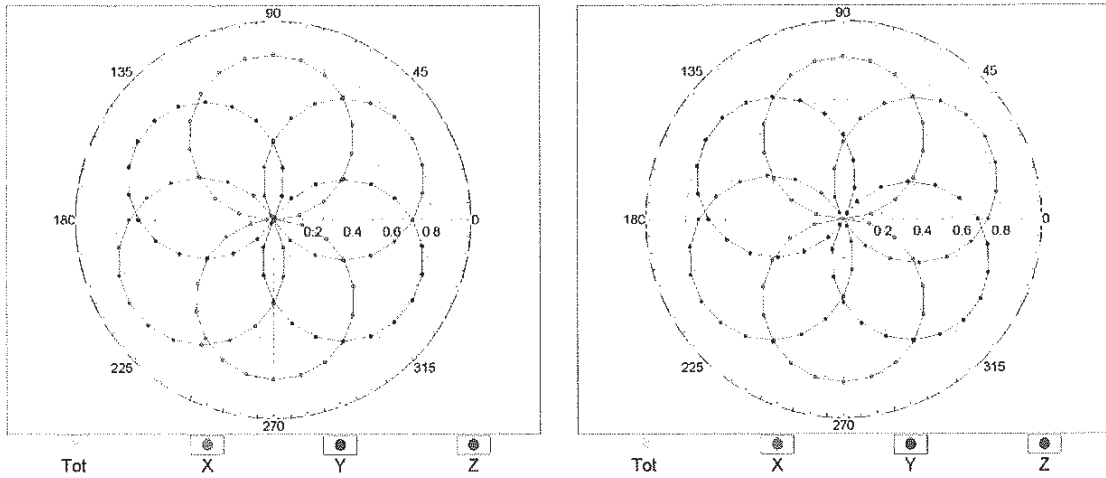

Uncertainty of Axial Isotropy Assessment: $\pm 0.5\%$ ($k=2$)

Dynamic Range f(SAR_{head}) (TEM cell , f_{eval}= 1900 MHz)

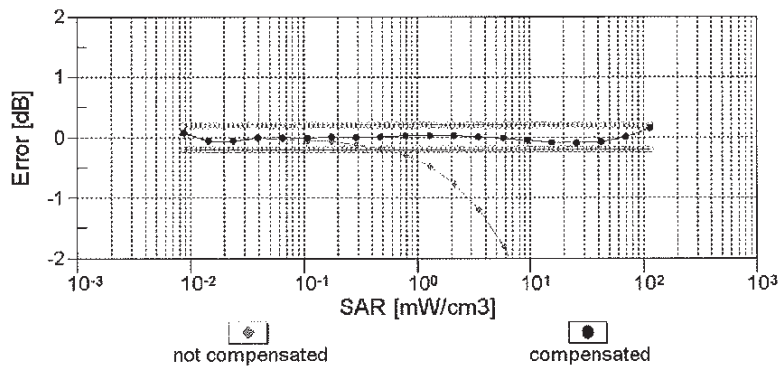
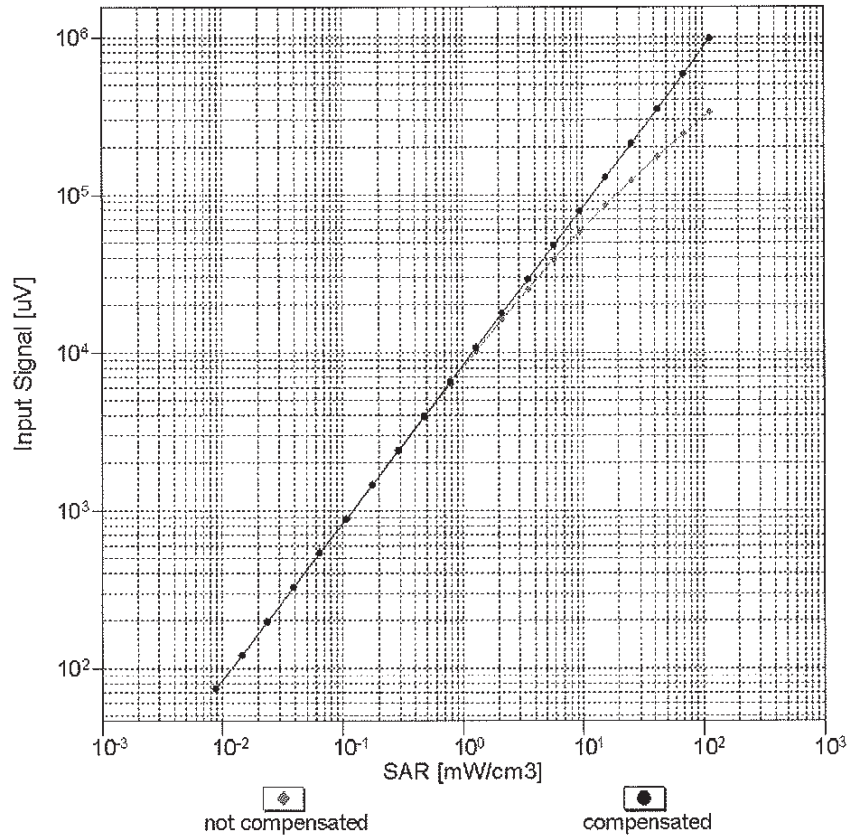

Uncertainty of Linearity Assessment: ± 0.6% (k=2)

Conversion Factor Assessment

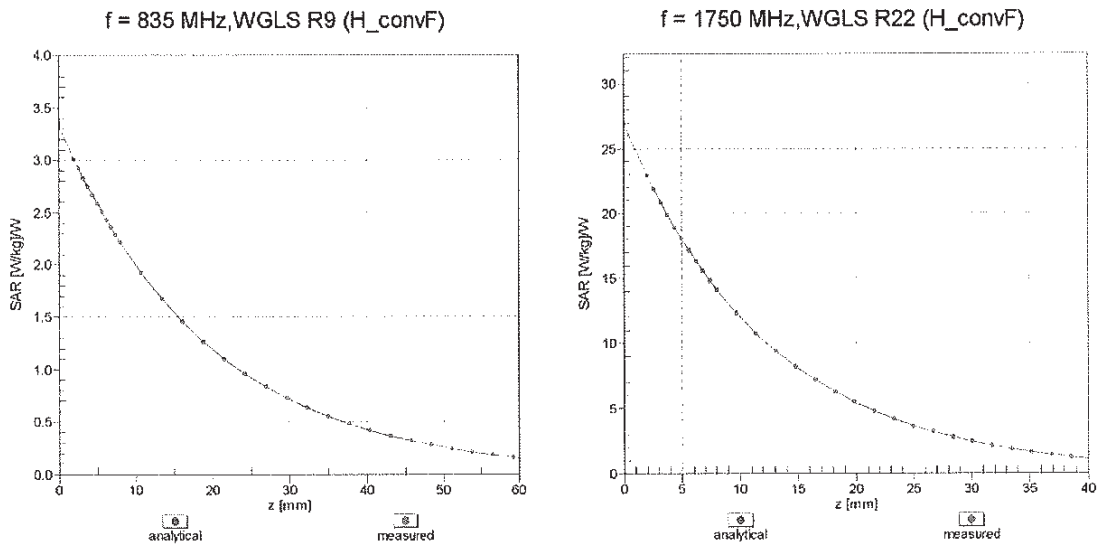

Deviation from Isotropy in Liquid Error (ϕ, θ), f = 900 MHz

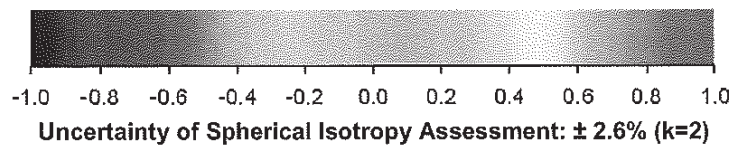
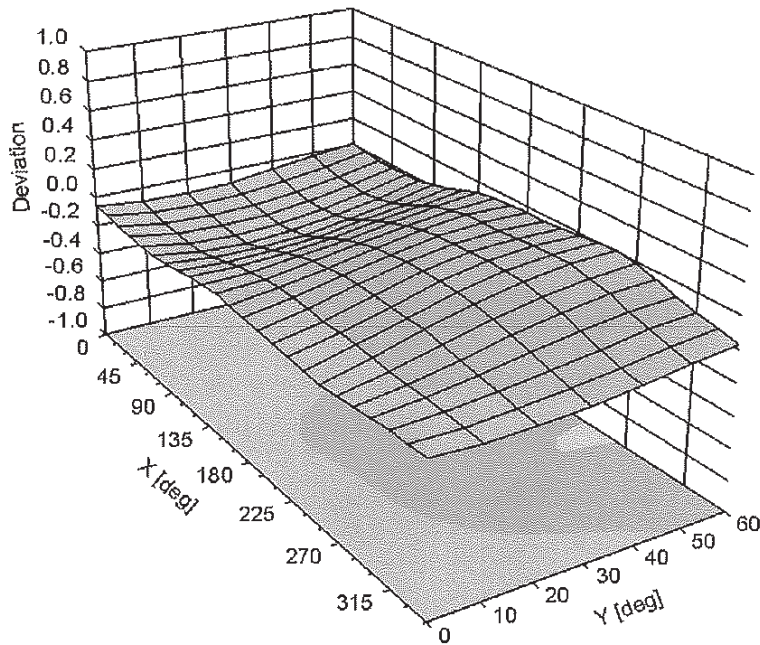

DASY/EASY - Parameters of Probe: ES3DV3 - SN:3258

Other Probe Parameters

Sensor Arrangement	Triangular
Connector Angle (°)	-123.1
Mechanical Surface Detection Mode	enabled
Optical Surface Detection Mode	disabled
Probe Overall Length	337 mm
Probe Body Diameter	10 mm
Tip Length	10 mm
Tip Diameter	4 mm
Probe Tip to Sensor X Calibration Point	2 mm
Probe Tip to Sensor Y Calibration Point	2 mm
Probe Tip to Sensor Z Calibration Point	2 mm
Recommended Measurement Distance from Surface	3 mm



Accredited by the Swiss Accreditation Service (SAS)
The Swiss Accreditation Service is one of the signatories to the EA
Multilateral Agreement for the recognition of calibration certificates

Accreditation No.: **SCS 108**

Client **PC Test**

Certificate No: **ES3-3263_May14**

CALIBRATION CERTIFICATE

Object **ES3DV3 - SN:3263**

Calibration procedure(s) **QA CAL-01.v9, QA CAL-23.v5, QA CAL-25.v6
Calibration procedure for dosimetric E-field probes**

ccv
7/17/14

Calibration date: **May 15, 2014**

This calibration certificate documents the traceability to national standards, which realize the physical units of measurements (SI).
The measurements and the uncertainties with confidence probability are given on the following pages and are part of the certificate.

All calibrations have been conducted in the closed laboratory facility: environment temperature (22 ± 3)°C and humidity < 70%.

Calibration Equipment used (M&TE critical for calibration)

Primary Standards	ID	Cal Date (Certificate No.)	Scheduled Calibration
Power meter E4419B	GB41293874	03-Apr-14 (No. 217-01911)	Apr-15
Power sensor E4412A	MY41498087	03-Apr-14 (No. 217-01911)	Apr-15
Reference 3 dB Attenuator	SN: S5054 (3c)	03-Apr-14 (No. 217-01915)	Apr-15
Reference 20 dB Attenuator	SN: S5277 (20x)	03-Apr-14 (No. 217-01919)	Apr-15
Reference 30 dB Attenuator	SN: S5129 (30b)	03-Apr-14 (No. 217-01920)	Apr-15
Reference Probe ES3DV2	SN: 3013	30-Dec-13 (No. ES3-3013_Dec13)	Dec-14
DAE4	SN: 660	13-Dec-13 (No. DAE4-660_Dec13)	Dec-14
Secondary Standards	ID	Check Date (in house)	Scheduled Check
RF generator HP 8648C	US3642U01700	4-Aug-99 (in house check Apr-13)	In house check: Apr-16
Network Analyzer HP 8753E	US37390585	18-Oct-01 (in house check Oct-13)	In house check: Oct-14

	Name	Function	Signature
Calibrated by:	Jeton Kastrati	Laboratory Technician	
Approved by:	Katja Pokovic	Technical Manager	
			Issued: May 15, 2014
This calibration certificate shall not be reproduced except in full without written approval of the laboratory.			



Accredited by the Swiss Accreditation Service (SAS)

Accreditation No.: **SCS 108**

The Swiss Accreditation Service is one of the signatories to the EA
Multilateral Agreement for the recognition of calibration certificates

Glossary:

TSL	tissue simulating liquid
NORM _{x,y,z}	sensitivity in free space
ConvF	sensitivity in TSL / NORM _{x,y,z}
DCP	diode compression point
CF	crest factor (1/duty_cycle) of the RF signal
A, B, C, D	modulation dependent linearization parameters
Polarization φ	φ rotation around probe axis
Polarization ϑ	ϑ rotation around an axis that is in the plane normal to probe axis (at measurement center), i.e., $\vartheta = 0$ is normal to probe axis
Connector Angle	information used in DASY system to align probe sensor X to the robot coordinate system

Calibration is Performed According to the Following Standards:

- IEEE Std 1528-2013, "IEEE Recommended Practice for Determining the Peak Spatial-Averaged Specific Absorption Rate (SAR) in the Human Head from Wireless Communications Devices: Measurement Techniques", June 2013
- IEC 62209-1, "Procedure to measure the Specific Absorption Rate (SAR) for hand-held devices used in close proximity to the ear (frequency range of 300 MHz to 3 GHz)", February 2005

Methods Applied and Interpretation of Parameters:

- NORM_{x,y,z}**: Assessed for E-field polarization $\vartheta = 0$ ($f \leq 900$ MHz in TEM-cell; $f > 1800$ MHz: R22 waveguide). NORM_{x,y,z} are only intermediate values, i.e., the uncertainties of NORM_{x,y,z} does not affect the E²-field uncertainty inside TSL (see below ConvF).
- NORM(f)_{x,y,z}** = NORM_{x,y,z} * frequency_response (see Frequency Response Chart). This linearization is implemented in DASY4 software versions later than 4.2. The uncertainty of the frequency response is included in the stated uncertainty of ConvF.
- DCP_{x,y,z}**: DCP are numerical linearization parameters assessed based on the data of power sweep with CW signal (no uncertainty required). DCP does not depend on frequency nor media.
- PAR**: PAR is the Peak to Average Ratio that is not calibrated but determined based on the signal characteristics
- A_{x,y,z}; B_{x,y,z}; C_{x,y,z}; D_{x,y,z}; VR_{x,y,z}; A, B, C, D** are numerical linearization parameters assessed based on the data of power sweep for specific modulation signal. The parameters do not depend on frequency nor media. VR is the maximum calibration range expressed in RMS voltage across the diode.
- ConvF and Boundary Effect Parameters**: Assessed in flat phantom using E-field (or Temperature Transfer Standard for $f \leq 800$ MHz) and inside waveguide using analytical field distributions based on power measurements for $f > 800$ MHz. The same setups are used for assessment of the parameters applied for boundary compensation (alpha, depth) of which typical uncertainty values are given. These parameters are used in DASY4 software to improve probe accuracy close to the boundary. The sensitivity in TSL corresponds to NORM_{x,y,z} * ConvF whereby the uncertainty corresponds to that given for ConvF. A frequency dependent ConvF is used in DASY version 4.4 and higher which allows extending the validity from ± 50 MHz to ± 100 MHz.
- Spherical isotropy (3D deviation from isotropy)**: in a field of low gradients realized using a flat phantom exposed by a patch antenna.
- Sensor Offset**: The sensor offset corresponds to the offset of virtual measurement center from the probe tip (on probe axis). No tolerance required.
- Connector Angle**: The angle is assessed using the information gained by determining the NORM_x (no uncertainty required).

Probe ES3DV3

SN:3263

Manufactured: January 25, 2010
Calibrated: May 15, 2014

Calibrated for DASY/EASY Systems
(Note: non-compatible with DASY2 system!)

DASY/EASY - Parameters of Probe: ES3DV3 - SN:3263

Basic Calibration Parameters

	Sensor X	Sensor Y	Sensor Z	Unc (k=2)
Norm ($\mu\text{V}/(\text{V}/\text{m})^2$) ^A	1.21	1.24	1.13	$\pm 10.1 \%$
DCP (mV) ^B	103.8	102.3	104.7	

Modulation Calibration Parameters

UID	Communication System Name		A dB	B dB $\sqrt{\mu\text{V}}$	C	D dB	VR mV	Unc ^E (k=2)
0	CW	X	0.0	0.0	1.0	0.00	156.3	$\pm 3.5 \%$
		Y	0.0	0.0	1.0		203.1	
		Z	0.0	0.0	1.0		197.2	
10010- CAA	SAR Validation (Square, 100ms, 10ms)	X	2.33	59.4	10.8	10.00	46.4	$\pm 1.4 \%$
		Y	4.39	63.4	13.6		50.8	
		Z	1.35	55.5	7.8		39.6	
10011- CAB	UMTS-FDD (WCDMA)	X	3.49	68.2	19.1	2.91	126.7	$\pm 0.7 \%$
		Y	3.28	66.9	18.5		120.7	
		Z	2.74	63.1	15.1		113.5	
10012- CAA	IEEE 802.11b WiFi 2.4 GHz (DSSS, 1 Mbps)	X	3.51	72.0	20.3	1.87	127.9	$\pm 0.7 \%$
		Y	3.21	69.4	18.8		124.1	
		Z	1.93	60.6	12.6		113.3	
10013- CAA	IEEE 802.11g WiFi 2.4 GHz (DSSS-OFDM, 6 Mbps)	X	11.30	70.8	23.3	9.46	125.2	$\pm 2.5 \%$
		Y	12.42	72.7	24.4		129.4	
		Z	10.03	67.8	21.1		105.5	
10021- DAB	GSM-FDD (TDMA, GMSK)	X	24.45	99.1	27.6	9.39	141.4	$\pm 1.4 \%$
		Y	29.93	99.5	29.0		124.5	
		Z	4.53	73.0	18.1		111.6	
10023- DAB	GPRS-FDD (TDMA, GMSK, TN 0)	X	25.10	99.7	27.9	9.57	134.2	$\pm 1.9 \%$
		Y	24.85	96.1	28.0		120.2	
		Z	5.99	76.5	19.1		142.5	
10024- DAB	GPRS-FDD (TDMA, GMSK, TN 0-1)	X	24.34	93.0	23.0	6.56	117.1	$\pm 1.4 \%$
		Y	26.49	92.6	24.2		148.7	
		Z	4.00	69.6	13.8		136.6	
10027- DAB	GPRS-FDD (TDMA, GMSK, TN 0-1-2)	X	51.24	99.9	23.5	4.80	131.1	$\pm 1.9 \%$
		Y	56.83	99.5	24.3		101.8	
		Z	1.70	61.4	9.1		107.7	
10028- DAB	GPRS-FDD (TDMA, GMSK, TN 0-1-2-3)	X	60.12	99.6	22.2	3.55	138.7	$\pm 1.9 \%$
		Y	64.73	99.9	23.4		105.5	
		Z	1.13	58.4	6.0		116.0	
10032- CAA	IEEE 802.15.1 Bluetooth (GFSK, DH5)	X	77.27	99.6	19.6	1.16	149.5	$\pm 2.5 \%$
		Y	60.44	99.7	21.0		109.4	
		Z	0.34	55.9	2.9		131.4	
10039- CAB	CDMA2000 (1xRTT, RC1)	X	4.79	66.8	19.0	4.57	124.5	$\pm 0.9 \%$
		Y	4.85	66.4	18.8		125.6	
		Z	4.06	63.4	16.1		108.1	

10081-CAB	CDMA2000 (1xRTT, RC3)	X	3.93	66.1	18.5	3.97	119.8	±0.7 %
		Y	3.90	65.5	18.2		120.1	
		Z	3.29	62.4	15.3		108.5	
10098-CAB	UMTS-FDD (HSUPA, Subtest 2)	X	4.68	66.9	18.7	3.98	131.2	±0.7 %
		Y	4.64	66.6	18.6		130.5	
		Z	4.15	64.5	16.5		118.8	
10100-CAB	LTE-FDD (SC-FDMA, 100% RB, 20 MHz, QPSK)	X	6.61	68.1	20.0	5.67	137.5	±1.7 %
		Y	6.70	68.4	20.2		137.7	
		Z	5.90	65.6	17.9		124.0	
10108-CAB	LTE-FDD (SC-FDMA, 100% RB, 10 MHz, QPSK)	X	6.44	67.5	19.8	5.80	135.1	±1.7 %
		Y	6.60	68.0	20.1		135.4	
		Z	5.75	64.9	17.6		121.8	
10110-CAB	LTE-FDD (SC-FDMA, 100% RB, 5 MHz, QPSK)	X	6.14	67.1	19.7	5.75	131.6	±1.2 %
		Y	6.28	67.4	19.9		132.7	
		Z	5.62	65.5	18.2		118.4	
10114-CAA	IEEE 802.11n (HT Greenfield, 13.5 Mbps, BPSK)	X	10.18	68.8	21.2	8.10	124.3	±1.9 %
		Y	10.60	69.7	21.8		126.2	
		Z	9.38	67.0	19.8		108.4	
10117-CAA	IEEE 802.11n (HT Mixed, 13.5 Mbps, BPSK)	X	10.23	68.9	21.3	8.07	125.0	±1.9 %
		Y	10.56	69.6	21.7		127.1	
		Z	9.37	67.1	19.8		109.1	
10151-CAB	LTE-TDD (SC-FDMA, 50% RB, 20 MHz, QPSK)	X	10.23	75.7	26.0	9.28	125.0	±2.7 %
		Y	14.60	83.3	29.5		147.3	
		Z	8.05	69.7	22.3		106.3	
10154-CAB	LTE-FDD (SC-FDMA, 50% RB, 10 MHz, QPSK)	X	6.12	67.0	19.6	5.75	131.6	±1.4 %
		Y	6.28	67.4	19.9		132.4	
		Z	5.49	64.7	17.4		117.9	
10160-CAB	LTE-FDD (SC-FDMA, 50% RB, 15 MHz, QPSK)	X	6.57	67.5	19.8	5.82	136.0	±1.4 %
		Y	6.71	67.9	20.1		137.1	
		Z	5.89	65.2	17.8		122.4	
10169-CAB	LTE-FDD (SC-FDMA, 1 RB, 20 MHz, QPSK)	X	4.82	66.0	19.3	5.73	113.5	±1.4 %
		Y	5.12	66.3	19.4		116.6	
		Z	4.75	65.9	18.3		142.7	
10172-CAB	LTE-TDD (SC-FDMA, 1 RB, 20 MHz, QPSK)	X	9.53	80.6	28.6	9.21	136.5	±2.2 %
		Y	11.32	81.6	28.8		109.2	
		Z	6.84	72.0	23.8		117.3	
10175-CAB	LTE-FDD (SC-FDMA, 1 RB, 10 MHz, QPSK)	X	4.86	66.2	19.4	5.72	112.9	±1.2 %
		Y	5.10	66.2	19.4		115.9	
		Z	4.55	64.9	17.8		137.7	
10181-CAB	LTE-FDD (SC-FDMA, 1 RB, 15 MHz, QPSK)	X	4.81	66.0	19.2	5.72	111.6	±1.2 %
		Y	5.13	66.4	19.5		116.1	
		Z	4.70	65.7	18.3		137.1	
10193-CAA	IEEE 802.11n (HT Greenfield, 6.5 Mbps, BPSK)	X	9.80	68.3	21.0	8.09	117.2	±2.2 %
		Y	10.23	69.1	21.6		121.5	
		Z	9.85	68.9	20.8		148.4	

10196-CAA	IEEE 802.11n (HT Mixed, 6.5 Mbps, BPSK)	X	9.81	68.4	21.1	8.10	117.7	±2.2 %
		Y	10.23	69.2	21.6		121.7	
		Z	9.87	69.0	20.9		149.9	
10219-CAA	IEEE 802.11n (HT Mixed, 7.2 Mbps, BPSK)	X	9.71	68.3	21.0	8.03	117.8	±2.2 %
		Y	10.12	69.1	21.6		121.0	
		Z	8.90	66.6	19.6		104.1	
10222-CAA	IEEE 802.11n (HT Mixed, 15 Mbps, BPSK)	X	10.14	68.7	21.2	8.06	122.3	±1.9 %
		Y	10.52	69.5	21.7		125.4	
		Z	9.28	66.8	19.6		108.5	
10225-CAB	UMTS-FDD (HSPA+)	X	7.25	67.8	19.9	5.97	146.3	±1.7 %
		Y	7.32	67.5	19.8		149.3	
		Z	6.52	65.7	18.0		130.7	
10237-CAB	LTE-TDD (SC-FDMA, 1 RB, 10 MHz, QPSK)	X	9.55	80.7	28.7	9.21	137.2	±2.5 %
		Y	11.34	81.7	28.9		109.9	
		Z	6.98	72.5	24.0		119.5	
10252-CAB	LTE-TDD (SC-FDMA, 50% RB, 10 MHz, QPSK)	X	9.26	74.1	25.3	9.24	115.6	±3.3 %
		Y	13.72	82.5	29.3		137.9	
		Z	8.83	73.3	24.4		144.1	
10267-CAB	LTE-TDD (SC-FDMA, 100% RB, 10 MHz, QPSK)	X	10.06	75.2	25.8	9.30	122.9	±2.7 %
		Y	14.69	83.4	29.6		147.6	
		Z	8.02	69.6	22.3		103.4	
10274-CAB	UMTS-FDD (HSUPA, Subtest 5, 3GPP Rel8.10)	X	6.08	67.2	19.0	4.87	140.2	±1.2 %
		Y	6.23	67.5	19.2		143.5	
		Z	5.52	65.4	17.4		125.1	
10275-CAB	UMTS-FDD (HSUPA, Subtest 5, 3GPP Rel8.4)	X	4.44	66.7	18.7	3.96	122.1	±0.7 %
		Y	4.39	66.3	18.5		124.4	
		Z	3.83	63.7	16.0		114.0	
10291-AAB	CDMA2000, RC3, SO55, Full Rate	X	3.64	66.7	18.6	3.46	115.7	±0.7 %
		Y	3.60	66.0	18.2		118.0	
		Z	3.17	64.2	16.3		108.4	
10292-AAB	CDMA2000, RC3, SO32, Full Rate	X	3.62	67.0	18.8	3.39	116.9	±0.9 %
		Y	3.54	66.1	18.2		119.1	
		Z	3.24	64.2	15.8		145.6	
10297-AAA	LTE-FDD (SC-FDMA, 50% RB, 20 MHz, QPSK)	X	6.43	67.5	19.8	5.81	132.0	±1.4 %
		Y	6.60	68.0	20.1		134.9	
		Z	5.81	65.4	18.0		115.0	
10311-AAA	LTE-FDD (SC-FDMA, 100% RB, 15 MHz, QPSK)	X	7.04	68.1	20.2	6.06	137.5	±1.4 %
		Y	7.19	68.6	20.5		140.3	
		Z	6.26	65.7	18.2		119.6	
10315-AAA	IEEE 802.11b WiFi 2.4 GHz (DSSS, 1 Mbps, 96pc duty cycle)	X	3.05	70.0	19.4	1.71	121.7	±0.7 %
		Y	2.91	68.7	18.7		123.4	
		Z	1.83	60.2	12.3		108.4	
10316-AAA	IEEE 802.11g WiFi 2.4 GHz (ERP-OFDM, 6 Mbps, 96pc duty cycle)	X	10.05	68.7	21.4	8.36	117.3	±1.9 %
		Y	10.57	69.7	22.0		122.8	
		Z	9.11	66.5	19.7		103.1	

10403-AAB	CDMA2000 (1xEV-DO, Rev. 0)	X	4.81	68.3	18.8	3.76	125.8	±0.7 %
		Y	4.65	66.5	18.1		130.8	
		Z	3.98	64.7	16.0		114.7	
10404-AAB	CDMA2000 (1xEV-DO, Rev. A)	X	4.91	69.1	19.2	3.77	123.3	±0.7 %
		Y	4.60	66.6	18.1		128.5	
		Z	3.73	64.0	15.4		112.0	
10415-AAA	IEEE 802.11b WiFi 2.4 GHz (DSSS, 1 Mbps, 99pc duty cycle)	X	2.78	69.0	19.0	1.54	121.9	±0.7 %
		Y	2.46	66.8	17.9		122.5	
		Z	1.83	60.9	13.0		112.4	
10416-AAA	IEEE 802.11g WiFi 2.4 GHz (ERP-OFDM, 6 Mbps, 99pc duty cycle)	X	9.88	68.4	21.2	8.23	116.6	±1.7 %
		Y	10.29	69.2	21.7		121.5	
		Z	9.25	67.3	20.2		103.4	

The reported uncertainty of measurement is stated as the standard uncertainty of measurement multiplied by the coverage factor $k=2$, which for a normal distribution corresponds to a coverage probability of approximately 95%.

^A The uncertainties of NormX,Y,Z do not affect the E^2 -field uncertainty inside TSL (see Pages 8 and 9).

^B Numerical linearization parameter: uncertainty not required.

^E Uncertainty is determined using the max. deviation from linear response applying rectangular distribution and is expressed for the square of the field value.

DASY/EASY - Parameters of Probe: ES3DV3 - SN:3263

Calibration Parameter Determined in Head Tissue Simulating Media

f (MHz) ^C	Relative Permittivity ^F	Conductivity (S/m) ^F	ConvF X	ConvF Y	ConvF Z	Alpha ^G	Depth ^G (mm)	Unct. (k=2)
750	41.9	0.89	6.42	6.42	6.42	0.72	1.18	± 12.0 %
835	41.5	0.90	6.23	6.23	6.23	0.27	2.02	± 12.0 %
1750	40.1	1.37	5.41	5.41	5.41	0.74	1.23	± 12.0 %
1900	40.0	1.40	5.08	5.08	5.08	0.80	1.16	± 12.0 %
2450	39.2	1.80	4.47	4.47	4.47	0.80	1.22	± 12.0 %
2600	39.0	1.96	4.33	4.33	4.33	0.66	1.41	± 12.0 %

^C Frequency validity of ± 100 MHz only applies for DASY v4.4 and higher (see Page 2), else it is restricted to ± 50 MHz. The uncertainty is the RSS of the ConvF uncertainty at calibration frequency and the uncertainty for the indicated frequency band.

^F At frequencies below 3 GHz, the validity of tissue parameters (ϵ and σ) can be relaxed to ± 10% if liquid compensation formula is applied to measured SAR values. At frequencies above 3 GHz, the validity of tissue parameters (ϵ and σ) is restricted to ± 5%. The uncertainty is the RSS of the ConvF uncertainty for indicated target tissue parameters.

^G Alpha/Depth are determined during calibration. SPEAG warrants that the remaining deviation due to the boundary effect after compensation is always less than ± 1% for frequencies below 3 GHz and below ± 2% for frequencies between 3-6 GHz at any distance larger than half the probe tip diameter from the boundary.

DASY/EASY - Parameters of Probe: ES3DV3 - SN:3263

Calibration Parameter Determined in Body Tissue Simulating Media

f (MHz) ^C	Relative Permittivity ^F	Conductivity (S/m) ^F	ConvF X	ConvF Y	ConvF Z	Alpha ^G	Depth (mm) ^G	Unct. (k=2)
750	55.5	0.96	6.19	6.19	6.19	0.52	1.41	± 12.0 %
835	55.2	0.97	6.16	6.16	6.16	0.68	1.28	± 12.0 %
1750	53.4	1.49	4.98	4.98	4.98	0.38	1.91	± 12.0 %
1900	53.3	1.52	4.78	4.78	4.78	0.66	1.35	± 12.0 %
2450	52.7	1.95	4.27	4.27	4.27	0.72	1.13	± 12.0 %
2600	52.5	2.16	4.11	4.11	4.11	0.74	1.07	± 12.0 %

^C Frequency validity of ± 100 MHz only applies for DASY v4.4 and higher (see Page 2), else it is restricted to ± 50 MHz. The uncertainty is the RSS of the ConvF uncertainty at calibration frequency and the uncertainty for the indicated frequency band.

^F At frequencies below 3 GHz, the validity of tissue parameters (ϵ and σ) can be relaxed to ± 10% if liquid compensation formula is applied to measured SAR values. At frequencies above 3 GHz, the validity of tissue parameters (ϵ and σ) is restricted to ± 5%. The uncertainty is the RSS of the ConvF uncertainty for indicated target tissue parameters.

^G Alpha/Depth are determined during calibration. SPEAG warrants that the remaining deviation due to the boundary effect after compensation is always less than ± 1% for frequencies below 3 GHz and below ± 2% for frequencies between 3-6 GHz at any distance larger than half the probe tip diameter from the boundary.

Frequency Response of E-Field

(TEM-Cell:ifi110 EXX, Waveguide: R22)

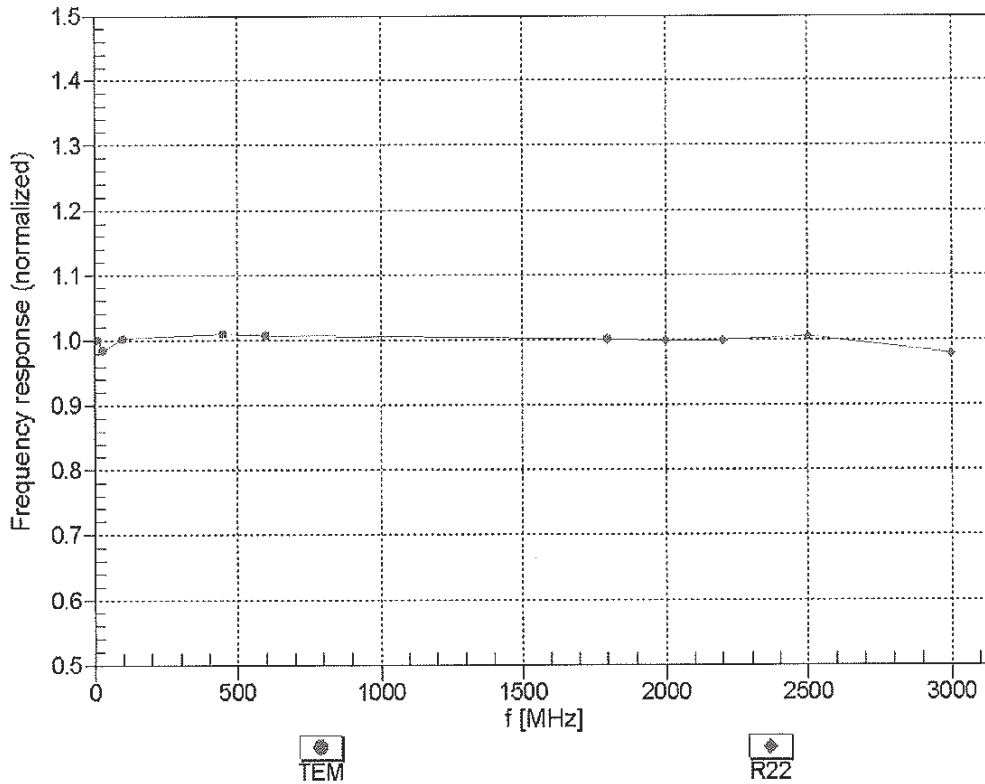

Uncertainty of Frequency Response of E-field: $\pm 6.3\%$ (k=2)

Receiving Pattern (ϕ), $\theta = 0^\circ$

f=600 MHz,TEM

f=1800 MHz,R22

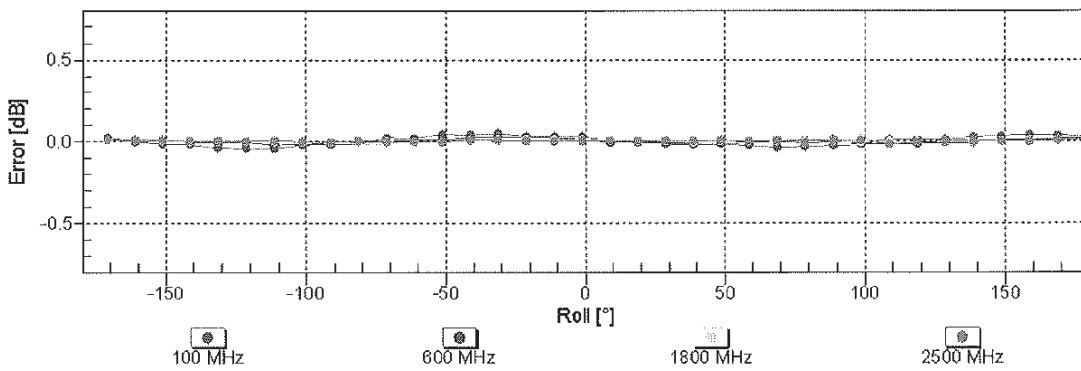
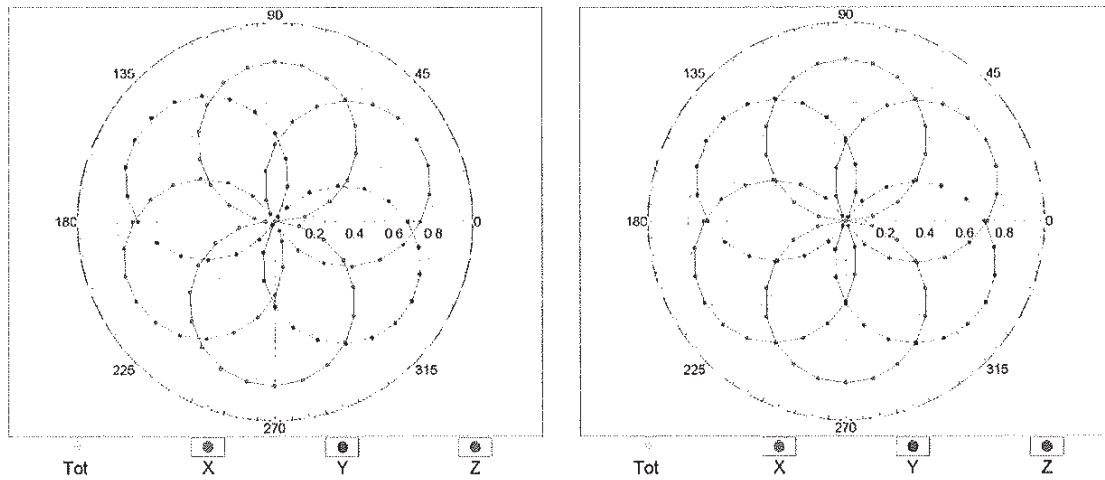

Uncertainty of Axial Isotropy Assessment: $\pm 0.5\%$ (k=2)

Dynamic Range $f(SAR_{head})$ (TEM cell , $f_{eval}= 1900$ MHz)

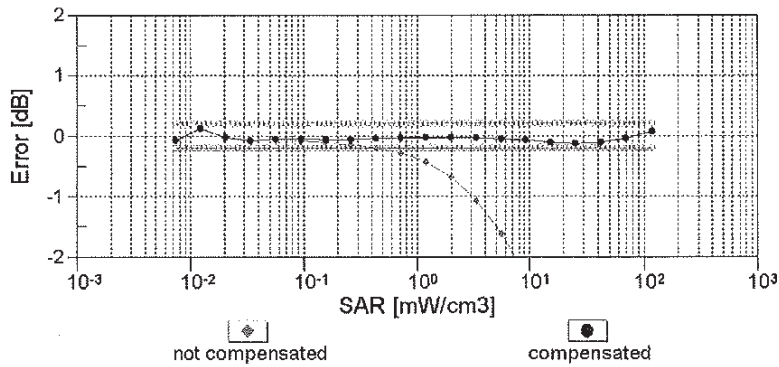
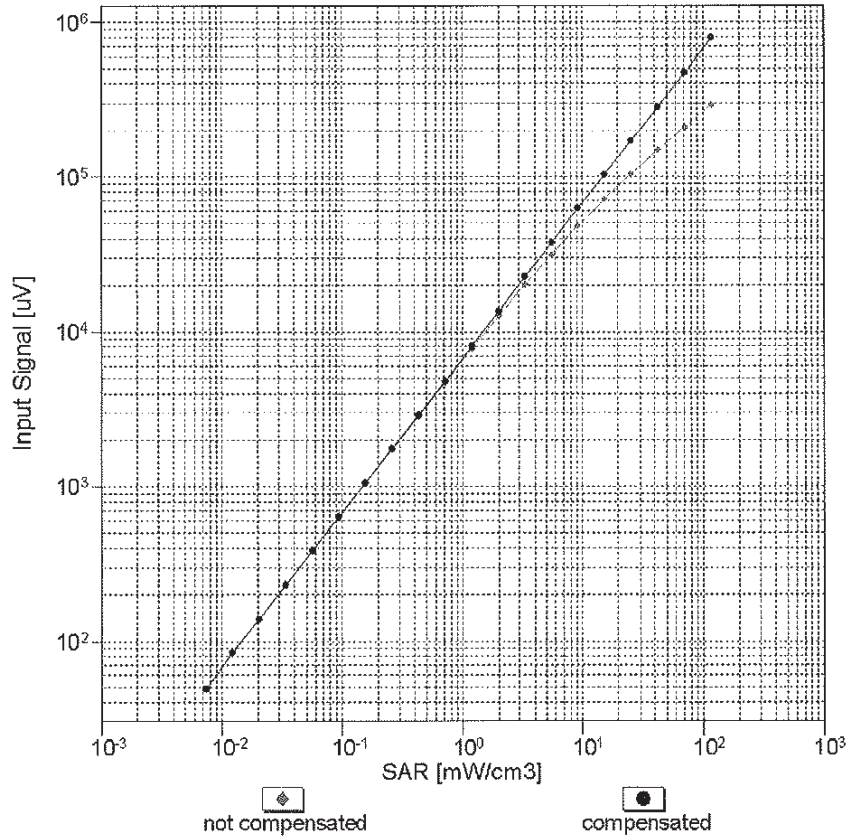

Uncertainty of Linearity Assessment: $\pm 0.6\%$ ($k=2$)

Conversion Factor Assessment

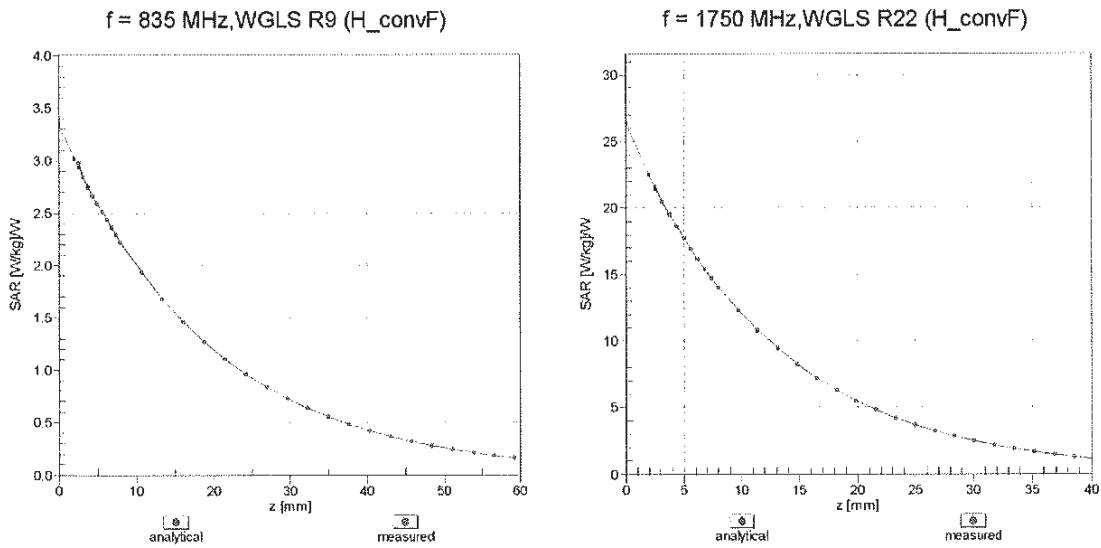

Deviation from Isotropy in Liquid Error (ϕ, θ), f = 900 MHz

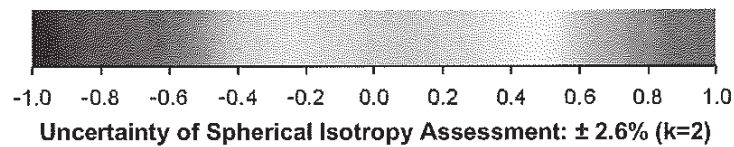
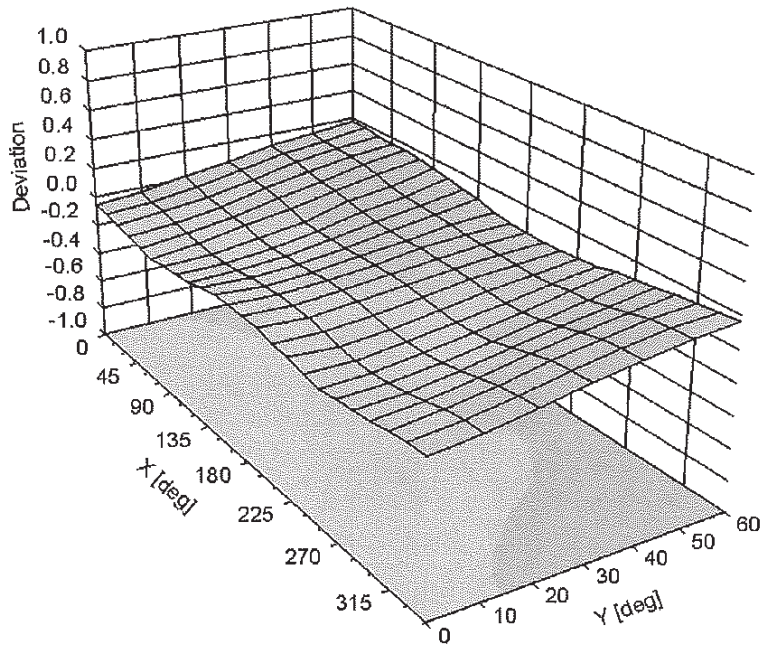

DASY/EASY - Parameters of Probe: ES3DV3 - SN:3263

Other Probe Parameters

Sensor Arrangement	Triangular
Connector Angle (°)	-111.2
Mechanical Surface Detection Mode	enabled
Optical Surface Detection Mode	disabled
Probe Overall Length	337 mm
Probe Body Diameter	10 mm
Tip Length	10 mm
Tip Diameter	4 mm
Probe Tip to Sensor X Calibration Point	2 mm
Probe Tip to Sensor Y Calibration Point	2 mm
Probe Tip to Sensor Z Calibration Point	2 mm
Recommended Measurement Distance from Surface	3 mm



Accredited by the Swiss Accreditation Service (SAS)
The Swiss Accreditation Service is one of the signatories to the EA
Multilateral Agreement for the recognition of calibration certificates

Accreditation No.: **SCS 108**

Client **PC Test**

Certificate No: **ES3-3319_Apr14**

CALIBRATION CERTIFICATE

Object **ES3DV3 - SN:3319**

Calibration procedure(s) **QA CAL-01.v9, QA CAL-23.v5, QA CAL-25.v6
Calibration procedure for dosimetric E-field probes**

Calibration date: **April 17, 2014**

*CCV
5/17/14*

This calibration certificate documents the traceability to national standards, which realize the physical units of measurements (SI).
The measurements and the uncertainties with confidence probability are given on the following pages and are part of the certificate.

All calibrations have been conducted in the closed laboratory facility: environment temperature (22 ± 3)°C and humidity < 70%.

Calibration Equipment used (M&TE critical for calibration)

Primary Standards	ID	Cal Date (Certificate No.)	Scheduled Calibration
Power meter E4419B	GB41293874	03-Apr-14 (No. 217-01911)	Apr-15
Power sensor E4412A	MY41498087	03-Apr-14 (No. 217-01911)	Apr-15
Reference 3 dB Attenuator	SN: S5054 (3c)	03-Apr-14 (No. 217-01915)	Apr-15
Reference 20 dB Attenuator	SN: S5277 (20x)	03-Apr-14 (No. 217-01919)	Apr-15
Reference 30 dB Attenuator	SN: S5129 (30b)	03-Apr-14 (No. 217-01920)	Apr-15
Reference Probe ES3DV2	SN: 3013	30-Dec-13 (No. ES3-3013_Dec13)	Dec-14
DAE4	SN: 660	13-Dec-13 (No. DAE4-660_Dec13)	Dec-14
Secondary Standards	ID	Check Date (in house)	Scheduled Check
RF generator HP 8648C	US3642U01700	4-Aug-99 (in house check Apr-13)	In house check: Apr-16
Network Analyzer HP 8753E	US37390585	18-Oct-01 (in house check Oct-13)	In house check: Oct-14

Calibrated by:	Name Claudio Leubler	Function Laboratory Technician	Signature
Approved by:	Name Katja Pokovic	Function Technical Manager	

Issued: April 21, 2014

This calibration certificate shall not be reproduced except in full without written approval of the laboratory.



Accredited by the Swiss Accreditation Service (SAS)
The Swiss Accreditation Service is one of the signatories to the EA
Multilateral Agreement for the recognition of calibration certificates

Accreditation No.: **SCS 108**

Glossary:

TSL	tissue simulating liquid
NORM _{x,y,z}	sensitivity in free space
ConvF	sensitivity in TSL / NORM _{x,y,z}
DCP	diode compression point
CF	crest factor (1/duty_cycle) of the RF signal
A, B, C, D	modulation dependent linearization parameters
Polarization φ	φ rotation around probe axis
Polarization ϑ	ϑ rotation around an axis that is in the plane normal to probe axis (at measurement center), i.e., $\vartheta = 0$ is normal to probe axis
Connector Angle	information used in DASY system to align probe sensor X to the robot coordinate system

Calibration is Performed According to the Following Standards:

- a) IEEE Std 1528-2013, "IEEE Recommended Practice for Determining the Peak Spatial-Averaged Specific Absorption Rate (SAR) in the Human Head from Wireless Communications Devices: Measurement Techniques", June 2013
- b) IEC 62209-1, "Procedure to measure the Specific Absorption Rate (SAR) for hand-held devices used in close proximity to the ear (frequency range of 300 MHz to 3 GHz)", February 2005

Methods Applied and Interpretation of Parameters:

- *NORM_{x,y,z}*: Assessed for E-field polarization $\vartheta = 0$ ($f \leq 900$ MHz in TEM-cell; $f > 1800$ MHz: R22 waveguide). *NORM_{x,y,z}* are only intermediate values, i.e., the uncertainties of *NORM_{x,y,z}* does not affect the E^2 -field uncertainty inside TSL (see below *ConvF*).
- *NORM(f)_{x,y,z} = NORM_{x,y,z} * frequency_response* (see Frequency Response Chart). This linearization is implemented in DASY4 software versions later than 4.2. The uncertainty of the frequency response is included in the stated uncertainty of *ConvF*.
- *DCP_{x,y,z}*: DCP are numerical linearization parameters assessed based on the data of power sweep with CW signal (no uncertainty required). DCP does not depend on frequency nor media.
- *PAR*: PAR is the Peak to Average Ratio that is not calibrated but determined based on the signal characteristics
- *A_{x,y,z}; B_{x,y,z}; C_{x,y,z}; D_{x,y,z}; VR_{x,y,z}*: *A, B, C, D* are numerical linearization parameters assessed based on the data of power sweep for specific modulation signal. The parameters do not depend on frequency nor media. *VR* is the maximum calibration range expressed in RMS voltage across the diode.
- *ConvF and Boundary Effect Parameters*: Assessed in flat phantom using E-field (or Temperature Transfer Standard for $f \leq 800$ MHz) and inside waveguide using analytical field distributions based on power measurements for $f > 800$ MHz. The same setups are used for assessment of the parameters applied for boundary compensation (alpha, depth) of which typical uncertainty values are given. These parameters are used in DASY4 software to improve probe accuracy close to the boundary. The sensitivity in TSL corresponds to *NORM_{x,y,z} * ConvF* whereby the uncertainty corresponds to that given for *ConvF*. A frequency dependent *ConvF* is used in DASY version 4.4 and higher which allows extending the validity from ± 50 MHz to ± 100 MHz.
- *Spherical isotropy (3D deviation from isotropy)*: in a field of low gradients realized using a flat phantom exposed by a patch antenna.
- *Sensor Offset*: The sensor offset corresponds to the offset of virtual measurement center from the probe tip (on probe axis). No tolerance required.
- *Connector Angle*: The angle is assessed using the information gained by determining the *NORM_x* (no uncertainty required).

Probe ES3DV3

SN:3319

Manufactured:	January 10, 2012
Repaired:	April 11, 2014
Calibrated:	April 17, 2014

Calibrated for DASY/EASY Systems
(Note: non-compatible with DASY2 system!)

DASY/EASY - Parameters of Probe: ES3DV3 - SN:3319

Basic Calibration Parameters

	Sensor X	Sensor Y	Sensor Z	Unc (k=2)
Norm ($\mu\text{V}/(\text{V}/\text{m})^2$) ^A	1.11	1.08	1.15	$\pm 10.1\%$
DCP (mV) ^B	102.6	104.2	103.7	

Modulation Calibration Parameters

UID	Communication System Name		A dB	B dB $\sqrt{\mu\text{V}}$	C	D dB	VR mV	Unc ^E (k=2)
0	CW	X	0.0	0.0	1.0	0.00	199.6	$\pm 3.5\%$
		Y	0.0	0.0	1.0		188.8	
		Z	0.0	0.0	1.0		178.5	
10010- CAA	SAR Validation (Square, 100ms, 10ms)	X	3.31	63.3	12.9	10.00	42.6	$\pm 2.2\%$
		Y	5.10	68.0	14.1		38.8	
		Z	2.84	61.7	12.1		44.3	
10011- CAB	UMTS-FDD (WCDMA)	X	3.30	66.9	18.4	2.91	136.7	$\pm 0.5\%$
		Y	3.32	67.1	18.4		127.0	
		Z	3.45	68.0	19.1		145.1	
10012- CAA	IEEE 802.11b WiFi 2.4 GHz (DSSS, 1 Mbps)	X	3.12	69.3	19.0	1.87	138.7	$\pm 0.7\%$
		Y	3.22	70.2	19.3		127.0	
		Z	3.40	71.3	19.9		146.4	
10021- DAB	GSM-FDD (TDMA, GMSK)	X	25.66	99.7	28.3	9.39	139.0	$\pm 1.4\%$
		Y	16.30	92.5	25.7		141.7	
		Z	25.20	99.5	28.1		144.9	
10023- DAB	GPRS-FDD (TDMA, GMSK, TN 0)	X	25.81	100.0	28.5	9.57	128.3	$\pm 2.2\%$
		Y	13.99	89.5	24.6		129.0	
		Z	25.39	99.7	28.3		141.2	
10024- DAB	GPRS-FDD (TDMA, GMSK, TN 0-1)	X	37.04	99.8	25.7	6.56	131.4	$\pm 2.2\%$
		Y	37.62	99.7	25.0		139.6	
		Z	38.36	99.8	25.3		145.5	
10027- DAB	GPRS-FDD (TDMA, GMSK, TN 0-1-2)	X	48.04	99.6	23.8	4.80	144.6	$\pm 1.9\%$
		Y	29.62	94.2	22.1		129.3	
		Z	43.87	99.7	24.0		129.9	
10028- DAB	GPRS-FDD (TDMA, GMSK, TN 0-1-2-3)	X	54.95	99.9	22.9	3.55	149.6	$\pm 1.7\%$
		Y	57.76	99.6	22.2		138.2	
		Z	54.27	99.8	22.7		137.3	
10032- CAA	IEEE 802.15.1 Bluetooth (GFSK, DH5)	X	44.58	99.9	21.1	1.16	134.6	$\pm 1.7\%$
		Y	96.74	98.9	18.8		149.0	
		Z	59.46	99.9	20.4		149.1	
10039- CAB	CDMA2000 (1xRTT, RC1)	X	4.70	66.3	18.7	4.57	130.9	$\pm 0.9\%$
		Y	4.85	67.1	19.0		147.5	
		Z	4.88	67.3	19.3		147.2	

10081-CAB	CDMA2000 (1xRTT, RC3)	X	3.90	65.8	18.4	3.97	130.0	±0.7 %
		Y	4.00	66.5	18.6		140.8	
		Z	3.99	66.5	18.7		142.5	
10098-CAB	UMTS-FDD (HSUPA, Subtest 2)	X	4.64	66.7	18.6	3.98	143.1	±0.9 %
		Y	4.58	66.5	18.4		132.8	
		Z	4.60	66.7	18.6		131.9	
10100-CAB	LTE-FDD (SC-FDMA, 100% RB, 20 MHz, QPSK)	X	6.32	67.1	19.5	5.67	125.8	±1.4 %
		Y	6.41	67.4	19.5		138.4	
		Z	6.51	67.9	19.9		143.6	
10108-CAB	LTE-FDD (SC-FDMA, 100% RB, 10 MHz, QPSK)	X	6.48	67.7	20.0	5.80	148.0	±1.4 %
		Y	6.28	66.9	19.4		135.8	
		Z	6.39	67.4	19.8		141.0	
10110-CAB	LTE-FDD (SC-FDMA, 100% RB, 5 MHz, QPSK)	X	6.17	67.2	19.8	5.75	141.0	±1.4 %
		Y	5.94	66.3	19.1		132.2	
		Z	6.08	67.0	19.6		137.9	
10114-CAA	IEEE 802.11n (HT Greenfield, 13.5 Mbps, BPSK)	X	10.35	69.2	21.5	8.10	133.6	±2.2 %
		Y	9.93	68.1	20.7		124.5	
		Z	10.29	69.2	21.5		131.9	
10117-CAA	IEEE 802.11n (HT Mixed, 13.5 Mbps, BPSK)	X	10.42	69.4	21.6	8.07	140.6	±2.2 %
		Y	9.93	68.1	20.7		125.5	
		Z	10.28	69.1	21.5		132.6	
10151-CAB	LTE-TDD (SC-FDMA, 50% RB, 20 MHz, QPSK)	X	11.18	78.2	27.5	9.28	143.6	±3.3 %
		Y	9.33	73.0	24.5		124.3	
		Z	10.45	76.4	26.6		132.7	
10154-CAB	LTE-FDD (SC-FDMA, 50% RB, 10 MHz, QPSK)	X	6.16	67.2	19.8	5.75	145.7	±1.4 %
		Y	5.96	66.4	19.1		133.0	
		Z	6.08	66.9	19.6		138.6	
10160-CAB	LTE-FDD (SC-FDMA, 50% RB, 15 MHz, QPSK)	X	6.32	66.6	19.4	5.82	126.2	±1.4 %
		Y	6.40	66.9	19.4		137.3	
		Z	6.51	67.4	19.8		143.8	
10169-CAB	LTE-FDD (SC-FDMA, 1 RB, 20 MHz, QPSK)	X	5.12	67.3	20.0	5.73	147.9	±1.2 %
		Y	4.90	66.4	19.4		134.4	
		Z	5.07	67.2	20.0		141.5	
10172-CAB	LTE-TDD (SC-FDMA, 1 RB, 20 MHz, QPSK)	X	9.44	80.0	28.6	9.21	128.7	±3.3 %
		Y	8.63	77.8	27.1		143.9	
		Z	10.62	83.7	30.3		148.2	
10175-CAB	LTE-FDD (SC-FDMA, 1 RB, 10 MHz, QPSK)	X	5.04	66.9	19.8	5.72	140.4	±1.4 %
		Y	4.92	66.6	19.5		133.7	
		Z	5.01	66.9	19.8		134.9	
10181-CAB	LTE-FDD (SC-FDMA, 1 RB, 15 MHz, QPSK)	X	5.05	67.0	19.9	5.72	140.6	±1.4 %
		Y	4.90	66.5	19.4		132.4	
		Z	4.97	66.7	19.7		134.1	

10193-CAA	IEEE 802.11n (HT Greenfield, 6.5 Mbps, BPSK)	X	9.98	68.8	21.4	8.09	131.1	±2.5 %
		Y	10.00	68.8	21.2		145.5	
		Z	10.14	69.4	21.7		144.7	
10196-CAA	IEEE 802.11n (HT Mixed, 6.5 Mbps, BPSK)	X	9.99	68.9	21.5	8.10	132.0	±2.7 %
		Y	10.05	69.0	21.3		148.1	
		Z	10.16	69.5	21.8		145.8	
10219-CAA	IEEE 802.11n (HT Mixed, 7.2 Mbps, BPSK)	X	9.88	68.8	21.4	8.03	131.3	±2.5 %
		Y	9.96	69.0	21.3		147.8	
		Z	10.03	69.3	21.6		144.7	
10222-CAA	IEEE 802.11n (HT Mixed, 15 Mbps, BPSK)	X	10.34	69.3	21.6	8.06	137.1	±2.2 %
		Y	9.93	68.2	20.8		127.8	
		Z	10.07	68.6	21.2		125.1	
10225-CAB	UMTS-FDD (HSPA+)	X	6.97	66.8	19.4	5.97	133.6	±1.4 %
		Y	6.90	66.7	19.2		129.7	
		Z	7.14	67.5	19.8		147.4	
10237-CAB	LTE-TDD (SC-FDMA, 1 RB, 10 MHz, QPSK)	X	9.18	79.3	28.2	9.21	128.1	±3.5 %
		Y	8.54	77.6	27.0		144.1	
		Z	9.99	81.9	29.4		141.7	
10252-CAB	LTE-TDD (SC-FDMA, 50% RB, 10 MHz, QPSK)	X	9.65	75.1	26.1	9.24	126.1	±3.5 %
		Y	9.34	74.2	25.3		141.3	
		Z	10.46	77.6	27.3		144.1	
10267-CAB	LTE-TDD (SC-FDMA, 100% RB, 10 MHz, QPSK)	X	10.46	76.2	26.5	9.30	133.6	±3.5 %
		Y	9.23	72.7	24.4		122.8	
		Z	9.90	74.8	25.7		123.8	
10274-CAB	UMTS-FDD (HSUPA, Subtest 5, 3GPP Rel8.10)	X	6.04	67.1	19.0	4.87	149.9	±1.2 %
		Y	6.02	67.1	18.9		142.8	
		Z	6.00	67.1	19.0		141.0	
10275-CAB	UMTS-FDD (HSUPA, Subtest 5, 3GPP Rel8.4)	X	4.22	65.6	18.1	3.96	131.0	±0.9 %
		Y	4.49	66.9	18.6		144.3	
		Z	4.55	67.3	19.1		147.0	
10291-AAB	CDMA2000, RC3, SO55, Full Rate	X	3.74	67.2	18.9	3.46	145.6	±0.5 %
		Y	3.66	66.8	18.5		136.7	
		Z	3.71	67.2	18.9		136.5	
10292-AAB	CDMA2000, RC3, SO32, Full Rate	X	3.65	67.0	18.7	3.39	147.2	±0.7 %
		Y	3.61	66.8	18.4		139.6	
		Z	3.64	67.1	18.8		139.6	
10297-AAA	LTE-FDD (SC-FDMA, 50% RB, 20 MHz, QPSK)	X	6.37	67.3	19.8	5.81	140.5	±1.4 %
		Y	6.24	66.8	19.3		134.0	
		Z	6.33	67.2	19.8		134.8	
10311-AAA	LTE-FDD (SC-FDMA, 100% RB, 15 MHz, QPSK)	X	7.00	68.0	20.2	6.06	146.8	±1.7 %
		Y	6.82	67.4	19.7		140.3	
		Z	6.90	67.8	20.1		141.4	

10315-AAA	IEEE 802.11b WiFi 2.4 GHz (DSSS, 1 Mbps, 96pc duty cycle)	X	2.85	68.5	18.8	1.71	129.5	±0.5 %
		Y	3.09	70.0	19.2		146.1	
		Z	3.15	70.6	19.8		146.8	
10403-AAB	CDMA2000 (1xEV-DO, Rev. 0)	X	4.73	67.9	18.7	3.76	137.5	±0.5 %
		Y	4.77	68.3	18.7		126.5	
		Z	4.77	68.1	18.8		128.1	
10404-AAB	CDMA2000 (1xEV-DO, Rev. A)	X	4.55	67.6	18.6	3.77	132.0	±0.7 %
		Y	4.89	69.1	19.1		148.8	
		Z	4.90	69.1	19.3		148.0	

The reported uncertainty of measurement is stated as the standard uncertainty of measurement multiplied by the coverage factor $k=2$, which for a normal distribution corresponds to a coverage probability of approximately 95%.

^A The uncertainties of NormX,Y,Z do not affect the E^2 -field uncertainty inside TSL (see Pages 8 and 9).

^B Numerical linearization parameter: uncertainty not required.

^E Uncertainty is determined using the max. deviation from linear response applying rectangular distribution and is expressed for the square of the field value.

DASY/EASY - Parameters of Probe: ES3DV3 - SN:3319

Calibration Parameter Determined in Head Tissue Simulating Media

f (MHz) ^C	Relative Permittivity ^F	Conductivity (S/m) ^F	ConvF X	ConvF Y	ConvF Z	Alpha ^G	Depth ^G (mm)	Unct. (k=2)
750	41.9	0.89	6.48	6.48	6.48	0.28	2.09	± 12.0 %
835	41.5	0.90	6.27	6.27	6.27	0.34	1.72	± 12.0 %
1750	40.1	1.37	5.24	5.24	5.24	0.80	1.14	± 12.0 %
1900	40.0	1.40	5.05	5.05	5.05	0.72	1.24	± 12.0 %
2450	39.2	1.80	4.45	4.45	4.45	0.77	1.23	± 12.0 %
2600	39.0	1.96	4.29	4.29	4.29	0.80	1.27	± 12.0 %

^C Frequency validity of ± 100 MHz only applies for DASY v4.4 and higher (see Page 2), else it is restricted to ± 50 MHz. The uncertainty is the RSS of the ConvF uncertainty at calibration frequency and the uncertainty for the indicated frequency band.

^F At frequencies below 3 GHz, the validity of tissue parameters (ϵ and σ) can be relaxed to ± 10% if liquid compensation formula is applied to measured SAR values. At frequencies above 3 GHz, the validity of tissue parameters (ϵ and σ) is restricted to ± 5%. The uncertainty is the RSS of the ConvF uncertainty for indicated target tissue parameters.

^G Alpha/Depth are determined during calibration. SPEAG warrants that the remaining deviation due to the boundary effect after compensation is always less than ± 1% for frequencies below 3 GHz and below ± 2% for frequencies between 3-6 GHz at any distance larger than half the probe tip diameter from the boundary.

DASY/EASY - Parameters of Probe: ES3DV3 - SN:3319

Calibration Parameter Determined in Body Tissue Simulating Media

f (MHz) ^C	Relative Permittivity ^F	Conductivity (S/m) ^F	ConvF X	ConvF Y	ConvF Z	Alpha ^G	Depth ^G (mm)	Unct. (k=2)
750	55.5	0.96	6.25	6.25	6.25	0.39	1.65	± 12.0 %
835	55.2	0.97	6.18	6.18	6.18	0.56	1.37	± 12.0 %
1750	53.4	1.49	4.85	4.85	4.85	0.57	1.46	± 12.0 %
1900	53.3	1.52	4.67	4.67	4.67	0.53	1.58	± 12.0 %
2450	52.7	1.95	4.24	4.24	4.24	0.74	1.10	± 12.0 %
2600	52.5	2.16	4.05	4.05	4.05	0.80	1.02	± 12.0 %

^C Frequency validity of ± 100 MHz only applies for DASY v4.4 and higher (see Page 2), else it is restricted to ± 50 MHz. The uncertainty is the RSS of the ConvF uncertainty at calibration frequency and the uncertainty for the indicated frequency band.

^F At frequencies below 3 GHz, the validity of tissue parameters (ϵ and σ) can be relaxed to ± 10% if liquid compensation formula is applied to measured SAR values. At frequencies above 3 GHz, the validity of tissue parameters (ϵ and σ) is restricted to ± 5%. The uncertainty is the RSS of the ConvF uncertainty for indicated target tissue parameters.

^G Alpha/Depth are determined during calibration. SPEAG warrants that the remaining deviation due to the boundary effect after compensation is always less than ± 1% for frequencies below 3 GHz and below ± 2% for frequencies between 3-6 GHz at any distance larger than half the probe tip diameter from the boundary.

Frequency Response of E-Field (TEM-Cell:ifi110 EXX, Waveguide: R22)

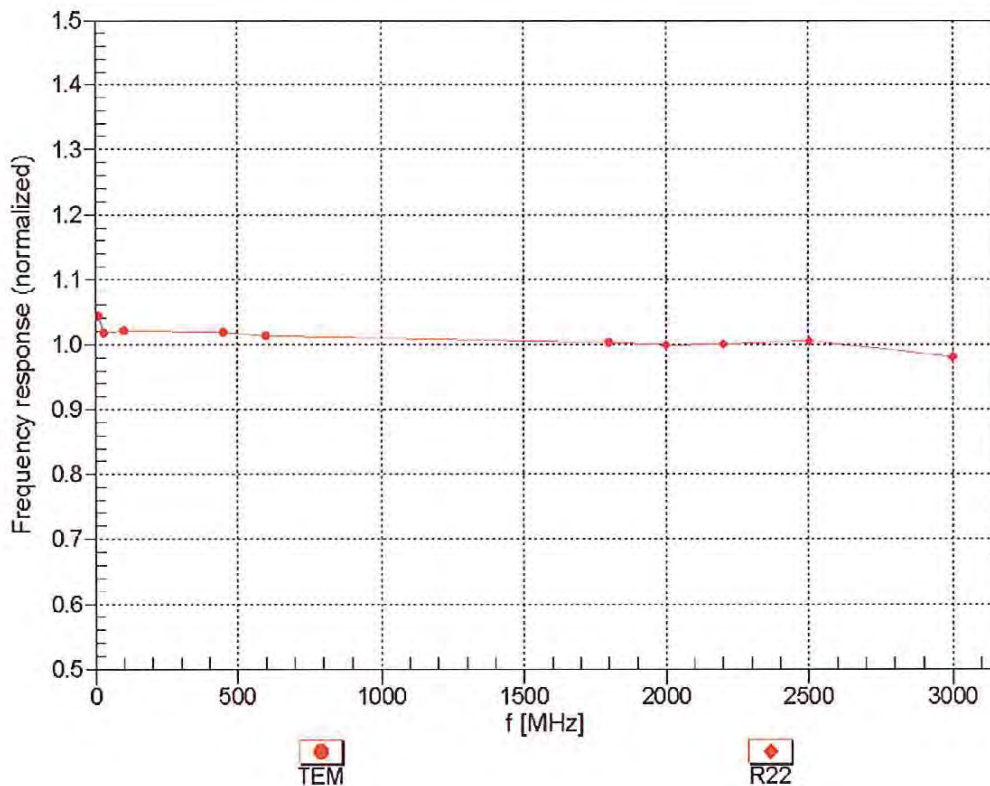

Uncertainty of Frequency Response of E-field: $\pm 6.3\%$ (k=2)

Receiving Pattern (ϕ), $\vartheta = 0^\circ$

f=600 MHz,TEM

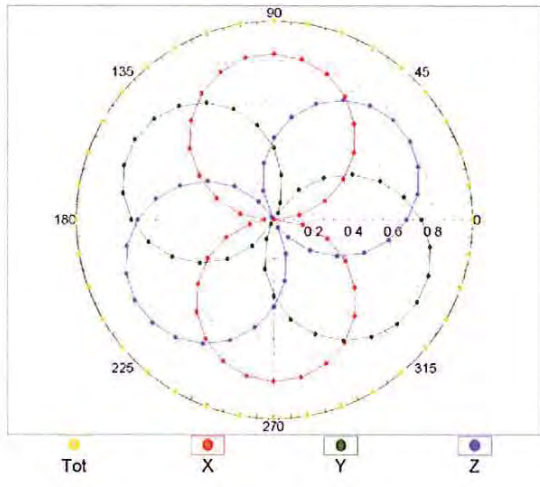

f=1800 MHz,R22

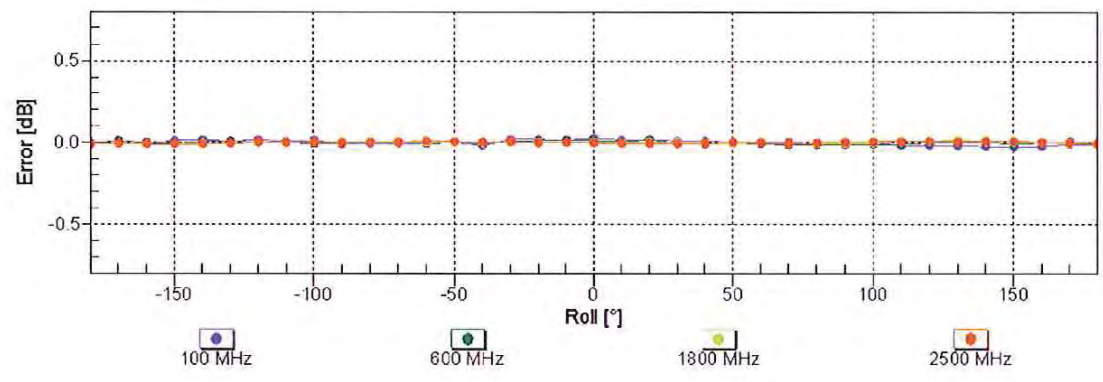
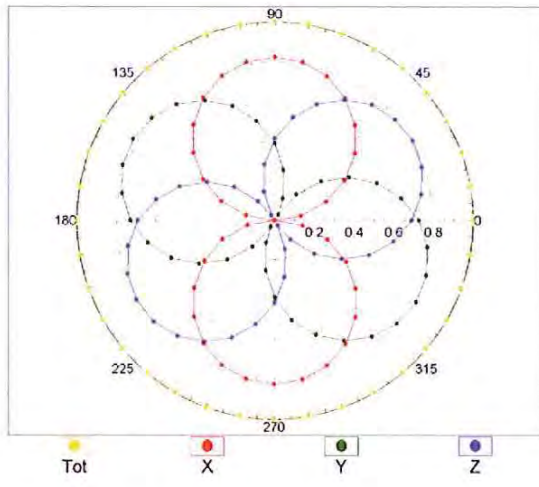

Uncertainty of Axial Isotropy Assessment: $\pm 0.5\%$ (k=2)

Dynamic Range $f(\text{SAR}_{\text{head}})$ (TEM cell, $f_{\text{eval}} = 1900 \text{ MHz}$)

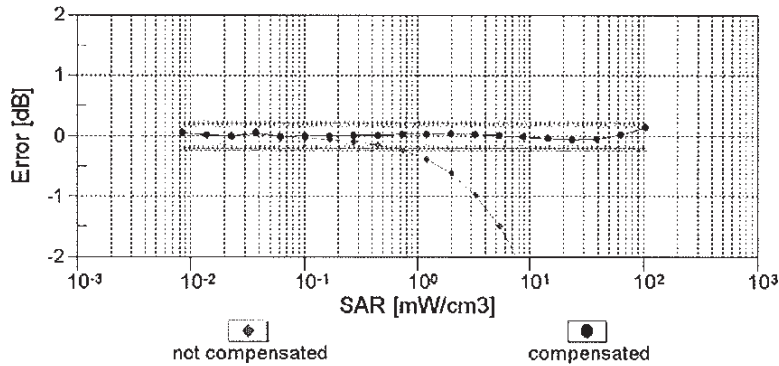
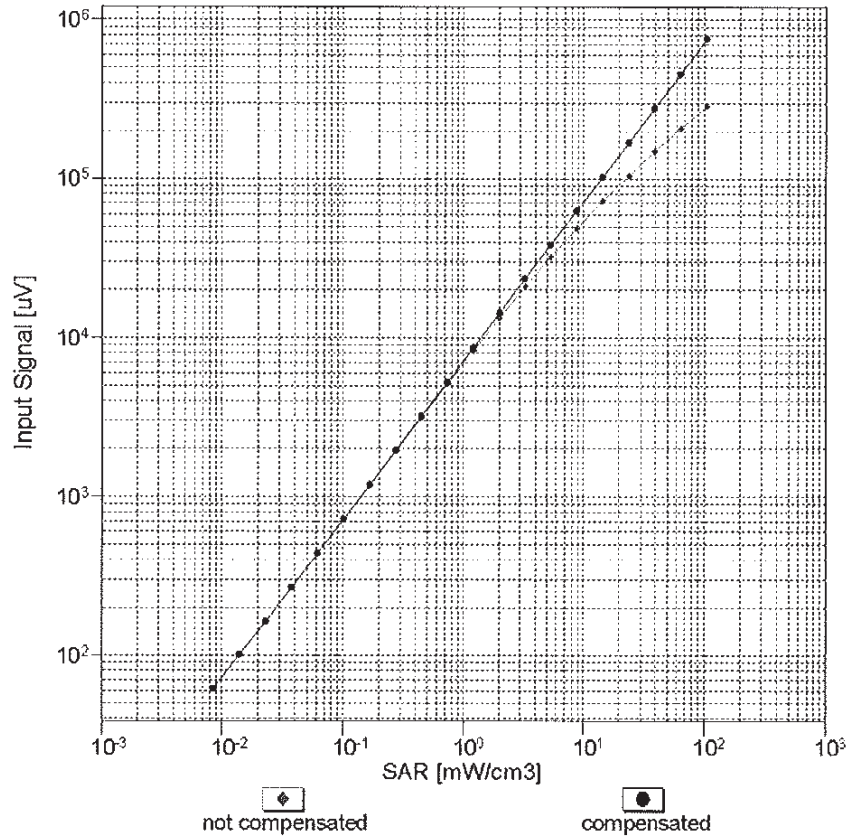

Uncertainty of Linearity Assessment: $\pm 0.6\%$ ($k=2$)

Conversion Factor Assessment

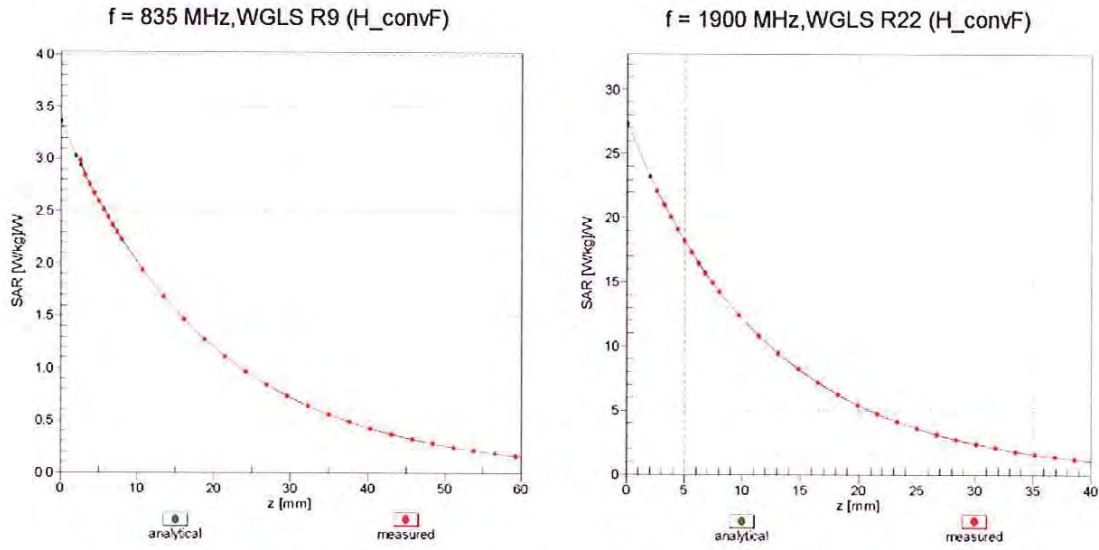

Deviation from Isotropy in Liquid Error (ϕ, θ), f = 900 MHz

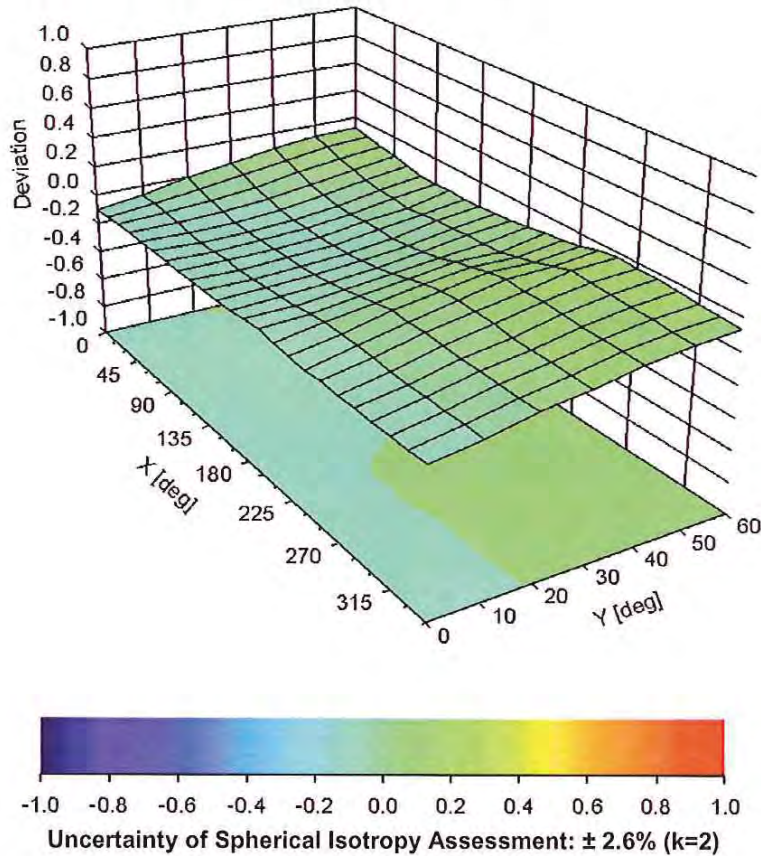

DASY/EASY - Parameters of Probe: ES3DV3 - SN:3319**Other Probe Parameters**

Sensor Arrangement	Triangular
Connector Angle (°)	-119.8
Mechanical Surface Detection Mode	enabled
Optical Surface Detection Mode	disabled
Probe Overall Length	337 mm
Probe Body Diameter	10 mm
Tip Length	10 mm
Tip Diameter	4 mm
Probe Tip to Sensor X Calibration Point	2 mm
Probe Tip to Sensor Y Calibration Point	2 mm
Probe Tip to Sensor Z Calibration Point	2 mm
Recommended Measurement Distance from Surface	3 mm



Accredited by the Swiss Accreditation Service (SAS)
The Swiss Accreditation Service is one of the signatories to the EA
Multilateral Agreement for the recognition of calibration certificates

Accreditation No.: **SCS 108**

Client **PC Test**

Certificate No: **D835V2-4d119_Apr14**

CALIBRATION CERTIFICATE

Object **D835V2 - SN: 4d119**

Calibration procedure(s) **QA CAL-05.v9
Calibration procedure for dipole validation kits above 700 MHz**

Calibration date: **April 07, 2014**

*CCV
4/25/14*

This calibration certificate documents the traceability to national standards, which realize the physical units of measurements (SI).
The measurements and the uncertainties with confidence probability are given on the following pages and are part of the certificate.

All calibrations have been conducted in the closed laboratory facility: environment temperature (22 ± 3)°C and humidity < 70%.

Calibration Equipment used (M&TE critical for calibration)

Primary Standards	ID #	Cal Date (Certificate No.)	Scheduled Calibration
Power meter EPM-442A	GB37480704	09-Oct-13 (No. 217-01827)	Oct-14
Power sensor HP 8481A	US37292783	09-Oct-13 (No. 217-01827)	Oct-14
Power sensor HP 8481A	MY41092317	09-Oct-13 (No. 217-01828)	Oct-14
Reference 20 dB Attenuator	SN: 5058 (20k)	03-Apr-14 (No. 217-01918)	Apr-15
Type-N mismatch combination	SN: 5047.2 / 06327	03-Apr-14 (No. 217-01921)	Apr-15
Reference Probe ES3DV3	SN: 3205	30-Dec-13 (No. ES3-3205_Dec13)	Dec-14
DAE4	SN: 601	25-Apr-13 (No. DAE4-601_Apr13)	Apr-14
Secondary Standards	ID #	Check Date (in house)	Scheduled Check
RF generator R&S SMT-06	100005	04-Aug-99 (in house check Oct-13)	In house check: Oct-16
Network Analyzer HP 8753E	US37390585 S4206	18-Oct-01 (in house check Oct-13)	In house check: Oct-14

Calibrated by:	Name Leif Klysner	Function Laboratory Technician	Signature
Approved by:	Name Katja Pokovic	Function Technical Manager	Signature

Issued: April 9, 2014

This calibration certificate shall not be reproduced except in full without written approval of the laboratory.



Accredited by the Swiss Accreditation Service (SAS)
The Swiss Accreditation Service is one of the signatories to the EA
Multilateral Agreement for the recognition of calibration certificates

Accreditation No.: **SCS 108**

Glossary:

TSL	tissue simulating liquid
ConvF	sensitivity in TSL / NORM x,y,z
N/A	not applicable or not measured

Calibration is Performed According to the Following Standards:

- a) IEEE Std 1528-2013, "IEEE Recommended Practice for Determining the Peak Spatial-Averaged Specific Absorption Rate (SAR) in the Human Head from Wireless Communications Devices: Measurement Techniques", June 2013
- b) IEC 62209-1, "Procedure to measure the Specific Absorption Rate (SAR) for hand-held devices used in close proximity to the ear (frequency range of 300 MHz to 3 GHz)", February 2005
- c) KDB 865664, "SAR Measurement Requirements for 100 MHz to 6 GHz"

Additional Documentation:

- d) DASY4/5 System Handbook

Methods Applied and Interpretation of Parameters:

- *Measurement Conditions:* Further details are available from the Validation Report at the end of the certificate. All figures stated in the certificate are valid at the frequency indicated.
- *Antenna Parameters with TSL:* The dipole is mounted with the spacer to position its feed point exactly below the center marking of the flat phantom section, with the arms oriented parallel to the body axis.
- *Feed Point Impedance and Return Loss:* These parameters are measured with the dipole positioned under the liquid filled phantom. The impedance stated is transformed from the measurement at the SMA connector to the feed point. The Return Loss ensures low reflected power. No uncertainty required.
- *Electrical Delay:* One-way delay between the SMA connector and the antenna feed point. No uncertainty required.
- *SAR measured:* SAR measured at the stated antenna input power.
- *SAR normalized:* SAR as measured, normalized to an input power of 1 W at the antenna connector.
- *SAR for nominal TSL parameters:* The measured TSL parameters are used to calculate the nominal SAR result.

The reported uncertainty of measurement is stated as the standard uncertainty of measurement multiplied by the coverage factor $k=2$, which for a normal distribution corresponds to a coverage probability of approximately 95%.

Measurement Conditions

DASY system configuration, as far as not given on page 1.

DASY Version	DASY5	V52.8.7
Extrapolation	Advanced Extrapolation	
Phantom	Modular Flat Phantom	
Distance Dipole Center - TSL	15 mm	with Spacer
Zoom Scan Resolution	dx, dy, dz = 5 mm	
Frequency	835 MHz ± 1 MHz	

Head TSL parameters

The following parameters and calculations were applied.

	Temperature	Permittivity	Conductivity
Nominal Head TSL parameters	22.0 °C	41.5	0.90 mho/m
Measured Head TSL parameters	(22.0 ± 0.2) °C	41.6 ± 6 %	0.94 mho/m ± 6 %
Head TSL temperature change during test	< 0.5 °C	----	----

SAR result with Head TSL

SAR averaged over 1 cm ³ (1 g) of Head TSL	Condition	
SAR measured	250 mW input power	2.38 W/kg
SAR for nominal Head TSL parameters	normalized to 1W	9.22 W/kg ± 17.0 % (k=2)

SAR averaged over 10 cm ³ (10 g) of Head TSL	condition	
SAR measured	250 mW input power	1.53 W/kg
SAR for nominal Head TSL parameters	normalized to 1W	5.97 W/kg ± 16.5 % (k=2)

Body TSL parameters

The following parameters and calculations were applied.

	Temperature	Permittivity	Conductivity
Nominal Body TSL parameters	22.0 °C	55.2	0.97 mho/m
Measured Body TSL parameters	(22.0 ± 0.2) °C	53.6 ± 6 %	1.02 mho/m ± 6 %
Body TSL temperature change during test	< 0.5 °C	----	----

SAR result with Body TSL

SAR averaged over 1 cm ³ (1 g) of Body TSL	Condition	
SAR measured	250 mW input power	2.44 W/kg
SAR for nominal Body TSL parameters	normalized to 1W	9.34 W/kg ± 17.0 % (k=2)

SAR averaged over 10 cm ³ (10 g) of Body TSL	condition	
SAR measured	250 mW input power	1.59 W/kg
SAR for nominal Body TSL parameters	normalized to 1W	6.15 W/kg ± 16.5 % (k=2)

Appendix

Antenna Parameters with Head TSL

Impedance, transformed to feed point	51.2 Ω - 1.6 j Ω
Return Loss	- 34.0 dB

Antenna Parameters with Body TSL

Impedance, transformed to feed point	46.3 Ω - 4.5 j Ω
Return Loss	- 24.4 dB

General Antenna Parameters and Design

Electrical Delay (one direction)	1.386 ns
----------------------------------	----------

After long term use with 100W radiated power, only a slight warming of the dipole near the feedpoint can be measured.

The dipole is made of standard semirigid coaxial cable. The center conductor of the feeding line is directly connected to the second arm of the dipole. The antenna is therefore short-circuited for DC-signals. On some of the dipoles, small end caps are added to the dipole arms in order to improve matching when loaded according to the position as explained in the "Measurement Conditions" paragraph. The SAR data are not affected by this change. The overall dipole length is still according to the Standard.

No excessive force must be applied to the dipole arms, because they might bend or the soldered connections near the feedpoint may be damaged.

Additional EUT Data

Manufactured by	SPEAG
Manufactured on	June 29, 2010

DASY5 Validation Report for Head TSL

Date: 07.04.2014

Test Laboratory: SPEAG, Zurich, Switzerland

DUT: Dipole 835 MHz; Type: D835V2; Serial: D835V2 - SN: 4d119

Communication System: UID 0 - CW; Frequency: 835 MHz

Medium parameters used: $f = 835$ MHz; $\sigma = 0.94$ S/m; $\epsilon_r = 41.6$; $\rho = 1000$ kg/m³

Phantom section: Flat Section

Measurement Standard: DASY5 (IEEE/IEC/ANSI C63.19-2007)

DASY52 Configuration:

- Probe: ES3DV3 - SN3205; ConvF(6.22, 6.22, 6.22); Calibrated: 30.12.2013;
- Sensor-Surface: 3mm (Mechanical Surface Detection)
- Electronics: DAE4 Sn601; Calibrated: 25.04.2013
- Phantom: Flat Phantom 4.9L; Type: QD000P49AA; Serial: 1001
- DASY52 52.8.7(1137); SEMCAD X 14.6.10(7164)

Dipole Calibration for Head Tissue/Pin=250 mW, d=15mm/Zoom Scan (7x7x7)/Cube 0:

Measurement grid: dx=5mm, dy=5mm, dz=5mm

Reference Value = 56.289 V/m; Power Drift = 0.01 dB

Peak SAR (extrapolated) = 3.59 W/kg

SAR(1 g) = 2.38 W/kg; SAR(10 g) = 1.53 W/kg

Maximum value of SAR (measured) = 2.80 W/kg

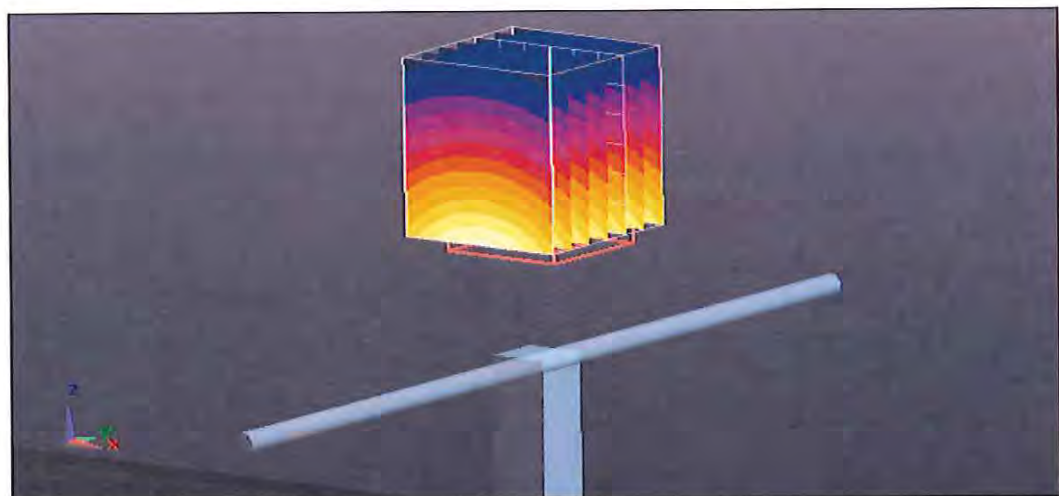
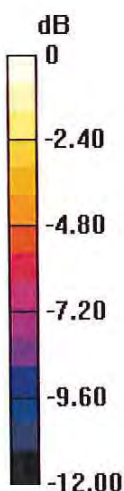

0 dB = 2.80 W/kg = 4.47 dBW/kg

Impedance Measurement Plot for Head TSL

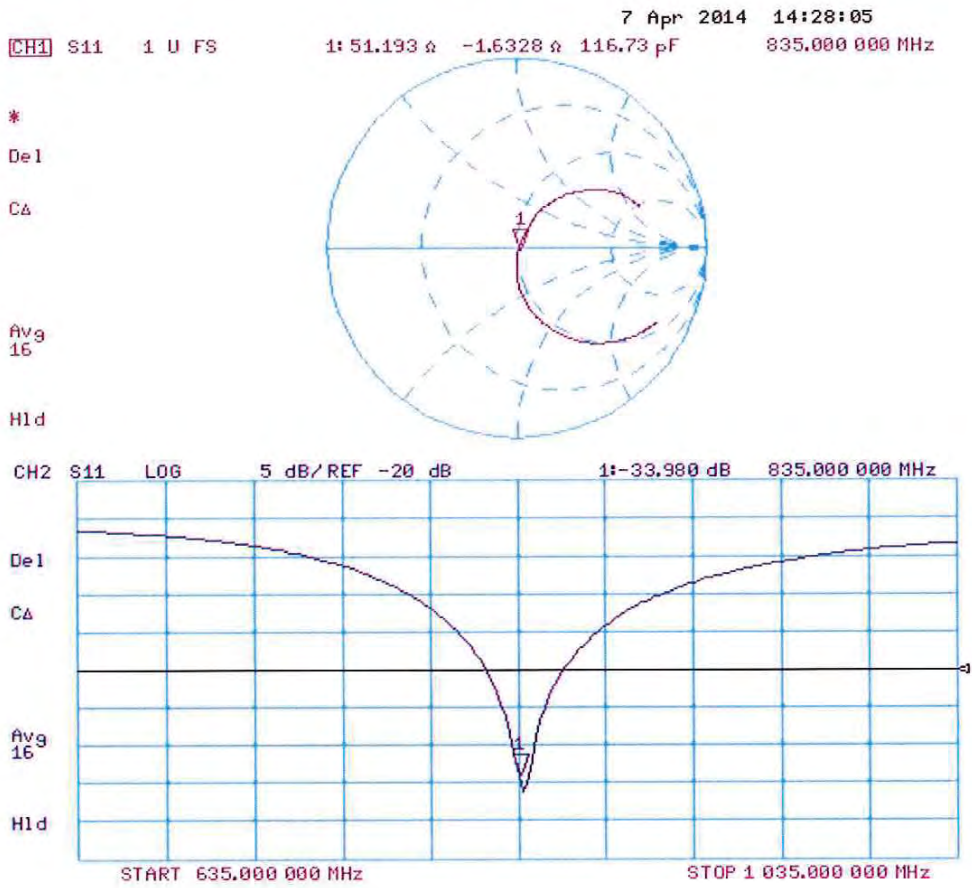

DASY5 Validation Report for Body TSL

Date: 07.04.2014

Test Laboratory: SPEAG, Zurich, Switzerland

DUT: Dipole 835 MHz; Type: D835V2; Serial: D835V2 - SN: 4d119

Communication System: UID 0 - CW; Frequency: 835 MHz

Medium parameters used: $f = 835 \text{ MHz}$; $\sigma = 1.02 \text{ S/m}$; $\epsilon_r = 53.6$; $\rho = 1000 \text{ kg/m}^3$

Phantom section: Flat Section

Measurement Standard: DASY5 (IEEE/IEC/ANSI C63.19-2007)

DASY52 Configuration:

- Probe: ES3DV3 - SN3205; ConvF(6.09, 6.09, 6.09); Calibrated: 30.12.2013;
- Sensor-Surface: 3mm (Mechanical Surface Detection)
- Electronics: DAE4 Sn601; Calibrated: 25.04.2013
- Phantom: Flat Phantom 4.9L; Type: QD000P49AA; Serial: 1001
- DASY52 52.8.7(1137); SEMCAD X 14.6.10(7164)

Dipole Calibration for Body Tissue/Pin=250 mW, d=15mm/Zoom Scan (7x7x7)/Cube 0:

Measurement grid: dx=5mm, dy=5mm, dz=5mm

Reference Value = 54.594 V/m; Power Drift = -0.01 dB

Peak SAR (extrapolated) = 3.61 W/kg

SAR(1 g) = 2.44 W/kg; SAR(10 g) = 1.59 W/kg

Maximum value of SAR (measured) = 2.85 W/kg

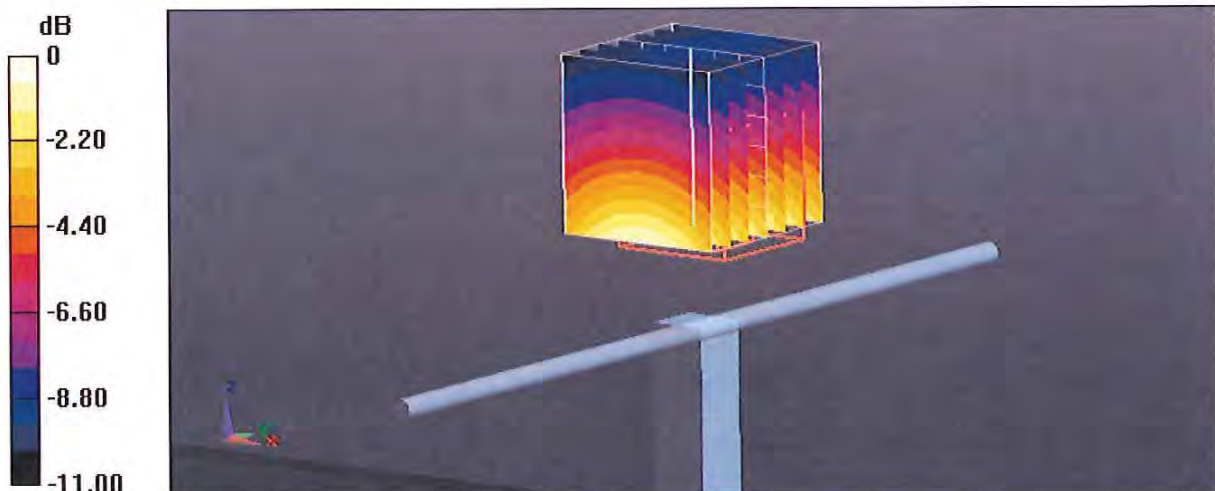

0 dB = 2.85 W/kg = 4.55 dBW/kg

Impedance Measurement Plot for Body TSL

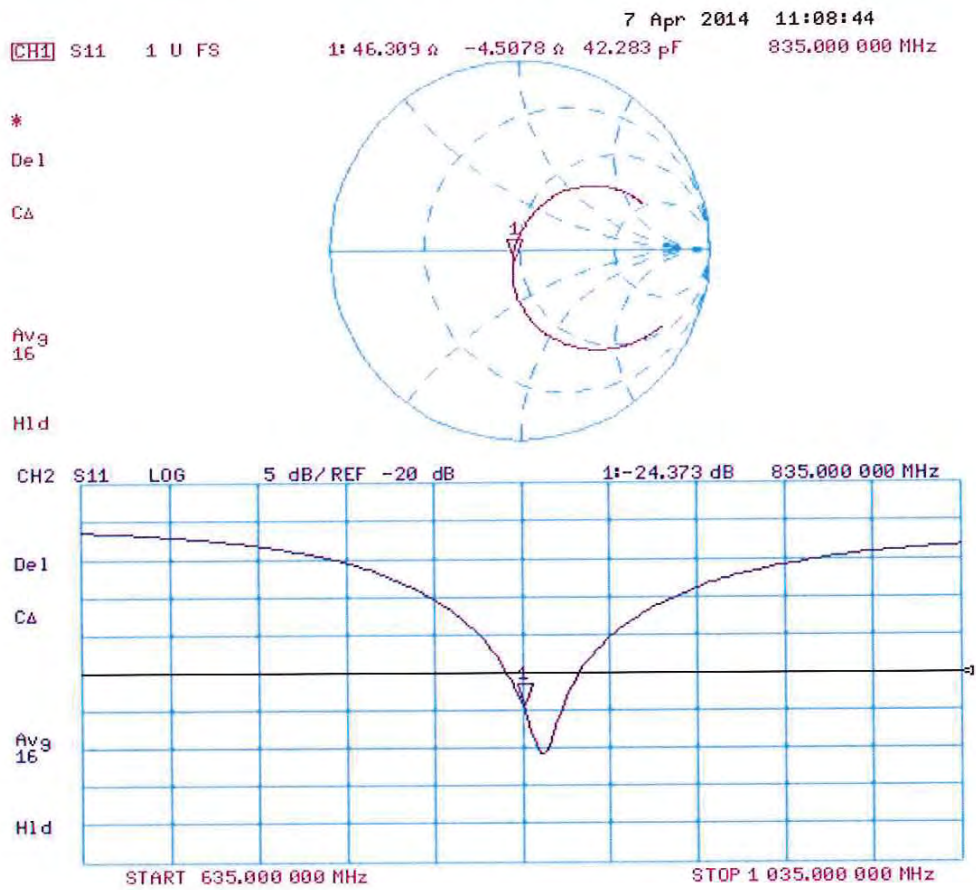



Accredited by the Swiss Accreditation Service (SAS)
The Swiss Accreditation Service is one of the signatories to the EA
Multilateral Agreement for the recognition of calibration certificates

Accreditation No.: **SCS 108**

Client **PC Test**

Certificate No: **D1900V2-5d141_Apr14**

CALIBRATION CERTIFICATE

Object **D1900V2 - SN: 5d141**

Calibration procedure(s) **QA CAL-05.v9
Calibration procedure for dipole validation kits above 700 MHz**

Calibration date: **April 09, 2014**

*✓ Kok
5/7/14*

This calibration certificate documents the traceability to national standards, which realize the physical units of measurements (SI).
The measurements and the uncertainties with confidence probability are given on the following pages and are part of the certificate.

All calibrations have been conducted in the closed laboratory facility: environment temperature (22 ± 3)°C and humidity < 70%.

Calibration Equipment used (M&TE critical for calibration)

Primary Standards	ID #	Cal Date (Certificate No.)	Scheduled Calibration
Power meter EPM-442A	GB37480704	09-Oct-13 (No. 217-01827)	Oct-14
Power sensor HP 8481A	US37292783	09-Oct-13 (No. 217-01827)	Oct-14
Power sensor HP 8481A	MY41092317	09-Oct-13 (No. 217-01828)	Oct-14
Reference 20 dB Attenuator	SN: 5058 (20k)	03-Apr-14 (No. 217-01918)	Apr-15
Type-N mismatch combination	SN: 5047.2 / 06327	03-Apr-14 (No. 217-01921)	Apr-15
Reference Probe ES3DV3	SN: 3205	30-Dec-13 (No. ES3-3205_Dec13)	Dec-14
DAE4	SN: 601	25-Apr-13 (No. DAE4-601_Apr13)	Apr-14

Secondary Standards	ID #	Check Date (in house)	Scheduled Check
RF generator R&S SMT-06	100005	04-Aug-99 (in house check Oct-13)	In house check: Oct-16
Network Analyzer HP 8753E	US37390585 S4206	18-Oct-01 (in house check Oct-13)	In house check: Oct-14

Calibrated by: **Claudio Leubler** Name: Claudio Leubler Function: Laboratory Technician

Approved by: **Katja Pokovic** Name: Katja Pokovic Function: Technical Manager

Signature

Issued: April 9, 2014

This calibration certificate shall not be reproduced except in full without written approval of the laboratory.



Accredited by the Swiss Accreditation Service (SAS)

Accreditation No.: **SCS 108**

The Swiss Accreditation Service is one of the signatories to the EA
Multilateral Agreement for the recognition of calibration certificates

Glossary:

TSL	tissue simulating liquid
ConvF	sensitivity in TSL / NORM x,y,z
N/A	not applicable or not measured

Calibration is Performed According to the Following Standards:

- IEEE Std 1528-2013, "IEEE Recommended Practice for Determining the Peak Spatial-Averaged Specific Absorption Rate (SAR) in the Human Head from Wireless Communications Devices: Measurement Techniques", June 2013
- IEC 62209-1, "Procedure to measure the Specific Absorption Rate (SAR) for hand-held devices used in close proximity to the ear (frequency range of 300 MHz to 3 GHz)", February 2005
- KDB 865664, "SAR Measurement Requirements for 100 MHz to 6 GHz"

Additional Documentation:

- DASY4/5 System Handbook

Methods Applied and Interpretation of Parameters:

- Measurement Conditions:** Further details are available from the Validation Report at the end of the certificate. All figures stated in the certificate are valid at the frequency indicated.
- Antenna Parameters with TSL:** The dipole is mounted with the spacer to position its feed point exactly below the center marking of the flat phantom section, with the arms oriented parallel to the body axis.
- Feed Point Impedance and Return Loss:** These parameters are measured with the dipole positioned under the liquid filled phantom. The impedance stated is transformed from the measurement at the SMA connector to the feed point. The Return Loss ensures low reflected power. No uncertainty required.
- Electrical Delay:** One-way delay between the SMA connector and the antenna feed point. No uncertainty required.
- SAR measured:** SAR measured at the stated antenna input power.
- SAR normalized:** SAR as measured, normalized to an input power of 1 W at the antenna connector.
- SAR for nominal TSL parameters:** The measured TSL parameters are used to calculate the nominal SAR result.

The reported uncertainty of measurement is stated as the standard uncertainty of measurement multiplied by the coverage factor $k=2$, which for a normal distribution corresponds to a coverage probability of approximately 95%.

Measurement Conditions

DASY system configuration, as far as not given on page 1.

DASY Version	DASY5	V52.8.7
Extrapolation	Advanced Extrapolation	
Phantom	Modular Flat Phantom	
Distance Dipole Center - TSL	10 mm	with Spacer
Zoom Scan Resolution	dx, dy, dz = 5 mm	
Frequency	1900 MHz \pm 1 MHz	

Head TSL parameters

The following parameters and calculations were applied.

	Temperature	Permittivity	Conductivity
Nominal Head TSL parameters	22.0 °C	40.0	1.40 mho/m
Measured Head TSL parameters	(22.0 \pm 0.2) °C	39.1 \pm 6 %	1.36 mho/m \pm 6 %
Head TSL temperature change during test	< 0.5 °C	----	----

SAR result with Head TSL

SAR averaged over 1 cm ³ (1 g) of Head TSL	Condition	
SAR measured	250 mW input power	9.91 W/kg
SAR for nominal Head TSL parameters	normalized to 1W	40.1 W/kg \pm 17.0 % (k=2)

SAR averaged over 10 cm ³ (10 g) of Head TSL	condition	
SAR measured	250 mW input power	5.17 W/kg
SAR for nominal Head TSL parameters	normalized to 1W	20.8 W/kg \pm 16.5 % (k=2)

Body TSL parameters

The following parameters and calculations were applied.

	Temperature	Permittivity	Conductivity
Nominal Body TSL parameters	22.0 °C	53.3	1.52 mho/m
Measured Body TSL parameters	(22.0 \pm 0.2) °C	52.4 \pm 6 %	1.52 mho/m \pm 6 %
Body TSL temperature change during test	< 0.5 °C	----	----

SAR result with Body TSL

SAR averaged over 1 cm ³ (1 g) of Body TSL	Condition	
SAR measured	250 mW input power	10.2 W/kg
SAR for nominal Body TSL parameters	normalized to 1W	40.6 W/kg \pm 17.0 % (k=2)

SAR averaged over 10 cm ³ (10 g) of Body TSL	condition	
SAR measured	250 mW input power	5.41 W/kg
SAR for nominal Body TSL parameters	normalized to 1W	21.6 W/kg \pm 16.5 % (k=2)

Appendix

Antenna Parameters with Head TSL

Impedance, transformed to feed point	52.8 Ω + 5.5 j Ω
Return Loss	- 24.5 dB

Antenna Parameters with Body TSL

Impedance, transformed to feed point	48.8 Ω + 6.3 j Ω
Return Loss	- 23.7 dB

General Antenna Parameters and Design

Electrical Delay (one direction)	1.199 ns
----------------------------------	----------

After long term use with 100W radiated power, only a slight warming of the dipole near the feedpoint can be measured.

The dipole is made of standard semirigid coaxial cable. The center conductor of the feeding line is directly connected to the second arm of the dipole. The antenna is therefore short-circuited for DC-signals. On some of the dipoles, small end caps are added to the dipole arms in order to improve matching when loaded according to the position as explained in the "Measurement Conditions" paragraph. The SAR data are not affected by this change. The overall dipole length is still according to the Standard.

No excessive force must be applied to the dipole arms, because they might bend or the soldered connections near the feedpoint may be damaged.

Additional EUT Data

Manufactured by	SPEAG
Manufactured on	March 11, 2011

DASY5 Validation Report for Head TSL

Date: 09.04.2014

Test Laboratory: SPEAG, Zurich, Switzerland

DUT: Dipole 1900 MHz; Type: D1900V2; Serial: D1900V2 - SN: 5d141

Communication System: UID 0 - CW; Frequency: 1900 MHz

Medium parameters used: $f = 1900$ MHz; $\sigma = 1.36$ S/m; $\epsilon_r = 39.1$; $\rho = 1000$ kg/m³

Phantom section: Flat Section

Measurement Standard: DASY5 (IEEE/IEC/ANSI C63.19-2007)

DASY52 Configuration:

- Probe: ES3DV3 - SN3205; ConvF(5.06, 5.06, 5.06); Calibrated: 30.12.2013;
- Sensor-Surface: 3mm (Mechanical Surface Detection)
- Electronics: DAE4 Sn601; Calibrated: 25.04.2013
- Phantom: Flat Phantom 5.0 (front); Type: QD000P50AA; Serial: 1001
- DASY52 52.8.7(1137); SEMCAD X 14.6.10(7164)

Dipole Calibration for Head Tissue/Pin=250 mW, d=10mm/Zoom Scan (7x7x7)/Cube 0:

Measurement grid: dx=5mm, dy=5mm, dz=5mm

Reference Value = 99.080 V/m; Power Drift = 0.01 dB

Peak SAR (extrapolated) = 18.2 W/kg

SAR(1 g) = 9.91 W/kg; SAR(10 g) = 5.17 W/kg

Maximum value of SAR (measured) = 12.5 W/kg

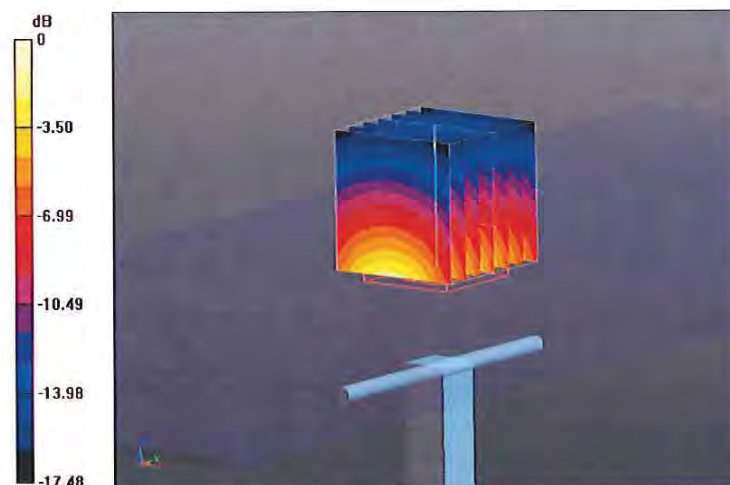

0 dB = 12.5 W/kg = 10.97 dBW/kg

Impedance Measurement Plot for Head TSL

9 Apr 2014 11:03:32
[CH1] S11 1 U FS 1: 52.760 Ω 5.4512 Ω 456.62 μ H 1 900.000 000 MHz

*
Del
CA
Avg
16
H1d

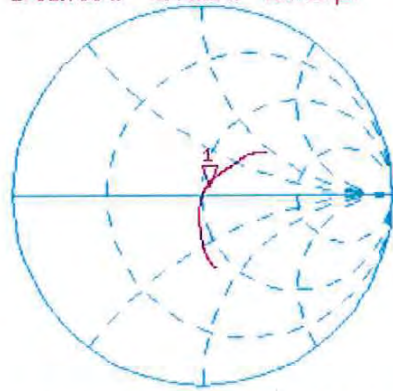

CH2 S11 LOG 5 dB/REF -20 dB 1:-24.525 dB 1 900.000 000 MHz

CA
Avg
16
H1d

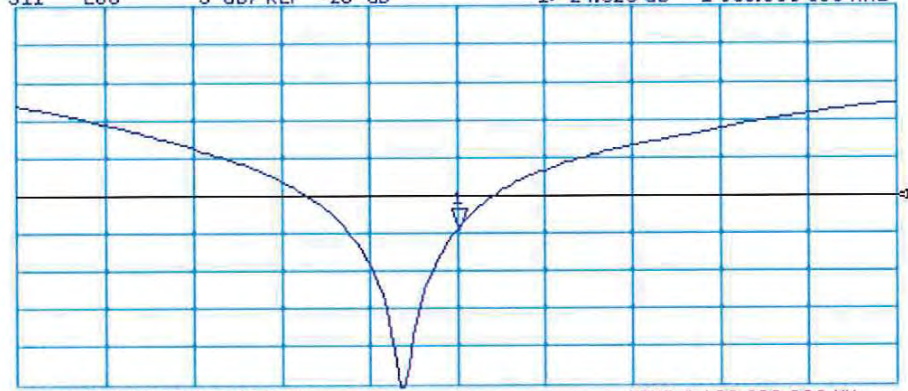

START 1 700.000 000 MHz STOP 2 100.000 000 MHz

DASY5 Validation Report for Body TSL

Date: 09.04.2014

Test Laboratory: SPEAG, Zurich, Switzerland

DUT: Dipole 1900 MHz; Type: D1900V2; Serial: D1900V2 - SN: 5d141

Communication System: UID 0 - CW; Frequency: 1900 MHz

Medium parameters used: $f = 1900$ MHz; $\sigma = 1.52$ S/m; $\epsilon_r = 52.4$; $\rho = 1000$ kg/m³

Phantom section: Flat Section

Measurement Standard: DASY5 (IEEE/IEC/ANSI C63.19-2007)

DASY52 Configuration:

- Probe: ES3DV3 - SN3205; ConvF(4.76, 4.76, 4.76); Calibrated: 30.12.2013;
- Sensor-Surface: 3mm (Mechanical Surface Detection)
- Electronics: DAE4 Sn601; Calibrated: 25.04.2013
- Phantom: Flat Phantom 5.0 (back); Type: QD000P50AA; Serial: 1002
- DASY52 52.8.7(1137); SEMCAD X 14.6.10(7164)

Dipole Calibration for Body Tissue/Pin=250 mW, d=10mm/Zoom Scan (7x7x7)/Cube 0:

Measurement grid: dx=5mm, dy=5mm, dz=5mm

Reference Value = 95.820 V/m; Power Drift = -0.01 dB

Peak SAR (extrapolated) = 17.9 W/kg

SAR(1 g) = 10.2 W/kg; SAR(10 g) = 5.41 W/kg

Maximum value of SAR (measured) = 12.9 W/kg

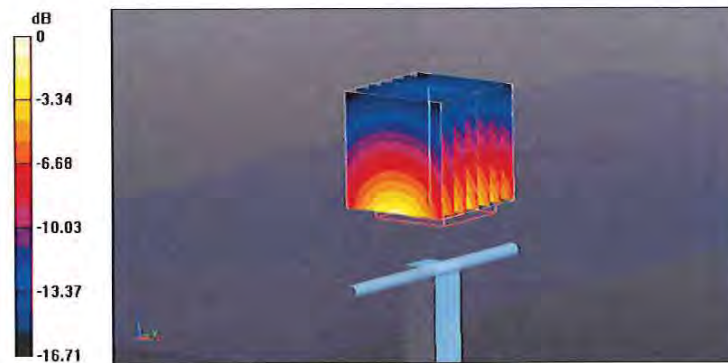

Impedance Measurement Plot for Body TSL

9 Apr 2014 11:02:32

[CH1] S11 1 U FS 1: 48.752 Ω 6.3320 Ω 530.41 pF 1 900.000 000 MHz

*
Del
CA

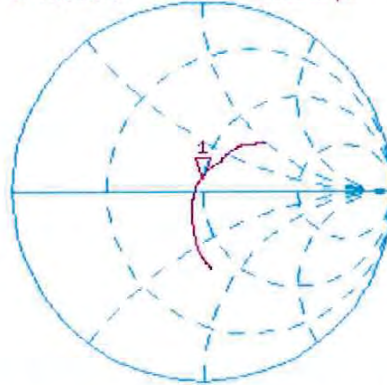

Avg
16
↑

CH2 S11 LOG 5 dB/REF -20 dB 1:-23.715 dB 1 900.000 000 MHz

CA
Avg
16
↑

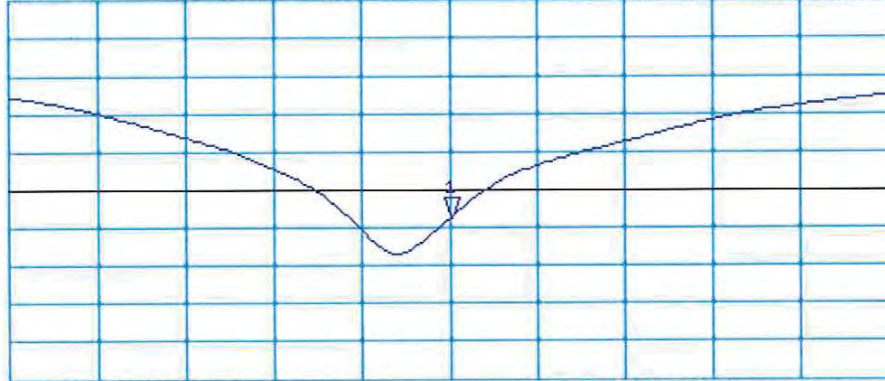

START 1 700.000 000 MHz

STOP 2 100.000 000 MHz



Accredited by the Swiss Accreditation Service (SAS)
The Swiss Accreditation Service is one of the signatories to the EA
Multilateral Agreement for the recognition of calibration certificates

Accreditation No.: **SCS 108**

Client **PC Test**

Certificate No: **D2450V2-797_Jan14**

CALIBRATION CERTIFICATE

Object **D2450V2 - SN: 797**

Calibration procedure(s) **QA CAL-05.v9
Calibration procedure for dipole validation kits above 700 MHz**

Calibration date: **January 21, 2014**

*CC ✓
2/5/14*

This calibration certificate documents the traceability to national standards, which realize the physical units of measurements (SI).
The measurements and the uncertainties with confidence probability are given on the following pages and are part of the certificate.

All calibrations have been conducted in the closed laboratory facility: environment temperature (22 ± 3)°C and humidity < 70%.

Calibration Equipment used (M&TE critical for calibration)

Primary Standards	ID #	Cal Date (Certificate No.)	Scheduled Calibration
Power meter EPM-442A	GB37480704	09-Oct-13 (No. 217-01827)	Oct-14
Power sensor HP 8481A	US37292783	09-Oct-13 (No. 217-01827)	Oct-14
Power sensor HP 8481A	MY41092317	09-Oct-13 (No. 217-01828)	Oct-14
Reference 20 dB Attenuator	SN: 5058 (20k)	04-Apr-13 (No. 217-01736)	Apr-14
Type-N mismatch combination	SN: 5047.3 / 06327	04-Apr-13 (No. 217-01739)	Apr-14
Reference Probe ES3DV3	SN: 3205	30-Dec-13 (No. ES3-3205_Dec13)	Dec-14
DAE4	SN: 601	25-Apr-13 (No. DAE4-601_Apr13)	Apr-14
Secondary Standards	ID #	Check Date (in house)	Scheduled Check
RF generator R&S SMT-06	100005	04-Aug-99 (in house check Oct-13)	In house check: Oct-16
Network Analyzer HP 8753E	US37390585 S4206	18-Oct-01 (in house check Oct-13)	In house check: Oct-14

Calibrated by: **Israe EI-Naouq** (Name) / **Laboratory Technician** (Function) / *Israe EI-Naouq* (Signature)

Approved by: **Katja Pokovic** (Name) / **Technical Manager** (Function) / *Katja Pokovic* (Signature)

Issued: January 21, 2014

This calibration certificate shall not be reproduced except in full without written approval of the laboratory.



Accredited by the Swiss Accreditation Service (SAS)

Accreditation No.: **SCS 108**

The Swiss Accreditation Service is one of the signatories to the EA
Multilateral Agreement for the recognition of calibration certificates

Glossary:

TSL	tissue simulating liquid
ConvF	sensitivity in TSL / NORM x,y,z
N/A	not applicable or not measured

Calibration is Performed According to the Following Standards:

- a) IEEE Std 1528-2013, "IEEE Recommended Practice for Determining the Peak Spatial-Averaged Specific Absorption Rate (SAR) in the Human Head from Wireless Communications Devices: Measurement Techniques", June 2013
- b) IEC 62209-1, "Procedure to measure the Specific Absorption Rate (SAR) for hand-held devices used in close proximity to the ear (frequency range of 300 MHz to 3 GHz)", February 2005
- c) KDB 865664, "SAR Measurement Requirements for 100 MHz to 6 GHz"

Additional Documentation:

- d) DASY4/5 System Handbook

Methods Applied and Interpretation of Parameters:

- *Measurement Conditions:* Further details are available from the Validation Report at the end of the certificate. All figures stated in the certificate are valid at the frequency indicated.
- *Antenna Parameters with TSL:* The dipole is mounted with the spacer to position its feed point exactly below the center marking of the flat phantom section, with the arms oriented parallel to the body axis.
- *Feed Point Impedance and Return Loss:* These parameters are measured with the dipole positioned under the liquid filled phantom. The impedance stated is transformed from the measurement at the SMA connector to the feed point. The Return Loss ensures low reflected power. No uncertainty required.
- *Electrical Delay:* One-way delay between the SMA connector and the antenna feed point. No uncertainty required.
- *SAR measured:* SAR measured at the stated antenna input power.
- *SAR normalized:* SAR as measured, normalized to an input power of 1 W at the antenna connector.
- *SAR for nominal TSL parameters:* The measured TSL parameters are used to calculate the nominal SAR result.

The reported uncertainty of measurement is stated as the standard uncertainty of measurement multiplied by the coverage factor $k=2$, which for a normal distribution corresponds to a coverage probability of approximately 95%.

Measurement Conditions

DASY system configuration, as far as not given on page 1.

DASY Version	DASY5	V52.8.7
Extrapolation	Advanced Extrapolation	
Phantom	Modular Flat Phantom	
Distance Dipole Center - TSL	10 mm	with Spacer
Zoom Scan Resolution	dx, dy, dz = 5 mm	
Frequency	2450 MHz ± 1 MHz	

Head TSL parameters

The following parameters and calculations were applied.

	Temperature	Permittivity	Conductivity
Nominal Head TSL parameters	22.0 °C	39.2	1.80 mho/m
Measured Head TSL parameters	(22.0 ± 0.2) °C	38.7 ± 6 %	1.86 mho/m ± 6 %
Head TSL temperature change during test	< 0.5 °C	----	----

SAR result with Head TSL

SAR averaged over 1 cm³ (1 g) of Head TSL	Condition	
SAR measured	250 mW input power	13.2 W/kg
SAR for nominal Head TSL parameters	normalized to 1W	51.8 W/kg ± 17.0 % (k=2)

SAR averaged over 10 cm³ (10 g) of Head TSL	condition	
SAR measured	250 mW input power	6.13 W/kg
SAR for nominal Head TSL parameters	normalized to 1W	24.3 W/kg ± 16.5 % (k=2)

Body TSL parameters

The following parameters and calculations were applied.

	Temperature	Permittivity	Conductivity
Nominal Body TSL parameters	22.0 °C	52.7	1.95 mho/m
Measured Body TSL parameters	(22.0 ± 0.2) °C	51.3 ± 6 %	2.04 mho/m ± 6 %
Body TSL temperature change during test	< 0.5 °C	----	----

SAR result with Body TSL

SAR averaged over 1 cm³ (1 g) of Body TSL	Condition	
SAR measured	250 mW input power	12.7 W/kg
SAR for nominal Body TSL parameters	normalized to 1W	49.4 W/kg ± 17.0 % (k=2)

SAR averaged over 10 cm³ (10 g) of Body TSL	condition	
SAR measured	250 mW input power	5.86 W/kg
SAR for nominal Body TSL parameters	normalized to 1W	23.1 W/kg ± 16.5 % (k=2)

Appendix

Antenna Parameters with Head TSL

Impedance, transformed to feed point	53.5 Ω + 3.2 j Ω
Return Loss	- 26.7 dB

Antenna Parameters with Body TSL

Impedance, transformed to feed point	50.0 Ω + 4.9 j Ω
Return Loss	- 26.2 dB

General Antenna Parameters and Design

Electrical Delay (one direction)	1.151 ns
----------------------------------	----------

After long term use with 100W radiated power, only a slight warming of the dipole near the feedpoint can be measured.

The dipole is made of standard semirigid coaxial cable. The center conductor of the feeding line is directly connected to the second arm of the dipole. The antenna is therefore short-circuited for DC-signals. On some of the dipoles, small end caps are added to the dipole arms in order to improve matching when loaded according to the position as explained in the "Measurement Conditions" paragraph. The SAR data are not affected by this change. The overall dipole length is still according to the Standard.

No excessive force must be applied to the dipole arms, because they might bend or the soldered connections near the feedpoint may be damaged.

Additional EUT Data

Manufactured by	SPEAG
Manufactured on	January 24, 2006

DASY5 Validation Report for Head TSL

Date: 21.01.2014

Test Laboratory: SPEAG, Zurich, Switzerland

DUT: Dipole 2450 MHz; Type: D2450V2; Serial: D2450V2 - SN: 797

Communication System: UID 0 - CW; Frequency: 2450 MHz

Medium parameters used: $f = 2450$ MHz; $\sigma = 1.86$ S/m; $\epsilon_r = 38.7$; $\rho = 1000$ kg/m³

Phantom section: Flat Section

Measurement Standard: DASY5 (IEEE/IEC/ANSI C63.19-2007)

DASY52 Configuration:

- Probe: ES3DV3 - SN3205; ConvF(4.53, 4.53, 4.53); Calibrated: 30.12.2013;
- Sensor-Surface: 3mm (Mechanical Surface Detection)
- Electronics: DAE4 Sn601; Calibrated: 25.04.2013
- Phantom: Flat Phantom 5.0 (front); Type: QD000P50AA; Serial: 1001
- DASY52 52.8.7(1137); SEMCAD X 14.6.10(7164)

Dipole Calibration for Head Tissue/Pin=250 mW, d=10mm/Zoom Scan (7x7x7)/Cube 0:

Measurement grid: dx=5mm, dy=5mm, dz=5mm

Reference Value = 99.151 V/m; Power Drift = 0.05 dB

Peak SAR (extrapolated) = 27.5 W/kg

SAR(1 g) = 13.2 W/kg; SAR(10 g) = 6.13 W/kg

Maximum value of SAR (measured) = 16.9 W/kg

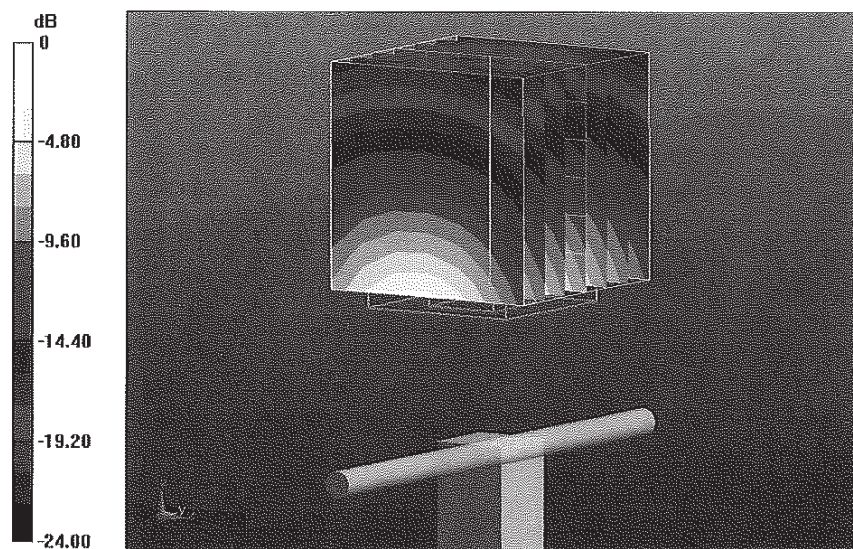

0 dB = 16.9 W/kg = 12.28 dBW/kg

Impedance Measurement Plot for Head TSL

21 Jan 2014 11:31:52

CH1 S11 1 U FS 2: 53.512 Ω 3.2285 Ω 209.73 pF 2 450.000 000 MHz

*
De1
CA

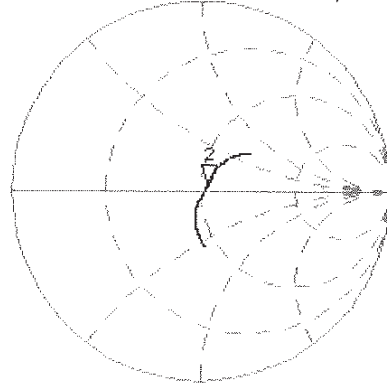

Avg
16

H1d

CH2 S11 LOG 5 dB/REF -20 dB 2:-25.730 dB 2 450.000 000 MHz

CA

Avg
16

H1d

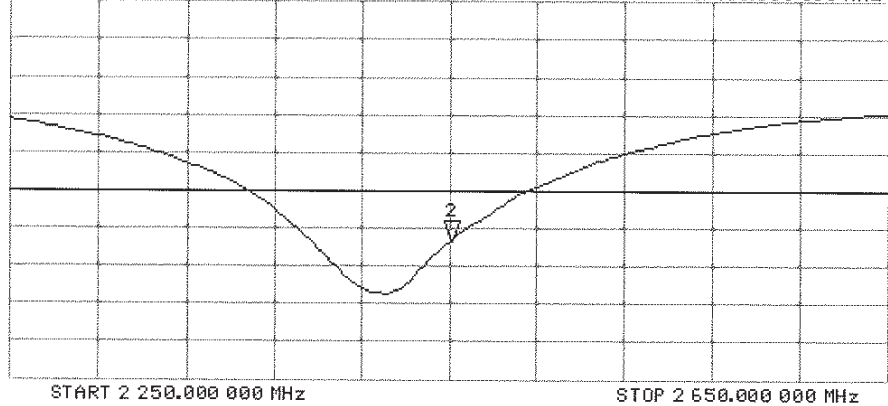

DASY5 Validation Report for Body TSL

Date: 21.01.2014

Test Laboratory: SPEAG, Zurich, Switzerland

DUT: Dipole 2450 MHz; Type: D2450V2; Serial: D2450V2 - SN: 797

Communication System: UID 0 - CW; Frequency: 2450 MHz

Medium parameters used: $f = 2450$ MHz; $\sigma = 2.04$ S/m; $\epsilon_r = 51.3$; $\rho = 1000$ kg/m³

Phantom section: Flat Section

Measurement Standard: DASY5 (IEEE/IEC/ANSI C63.19-2007)

DASY52 Configuration:

- Probe: ES3DV3 - SN3205; ConvF(4.35, 4.35, 4.35); Calibrated: 30.12.2013;
- Sensor-Surface: 3mm (Mechanical Surface Detection)
- Electronics: DAE4 Sn601; Calibrated: 25.04.2013
- Phantom: Flat Phantom 5.0 (back); Type: QD000P50AA; Serial: 1002
- DASY52 52.8.7(1137); SEMCAD X 14.6.10(7164)

Dipole Calibration for Body Tissue/Pin=250 mW, d=10mm/Zoom Scan (7x7x7)/Cube 0:

Measurement grid: dx=5mm, dy=5mm, dz=5mm

Reference Value = 93.709 V/m; Power Drift = 0.01 dB

Peak SAR (extrapolated) = 26.4 W/kg

SAR(1 g) = 12.7 W/kg; SAR(10 g) = 5.86 W/kg

Maximum value of SAR (measured) = 16.8 W/kg

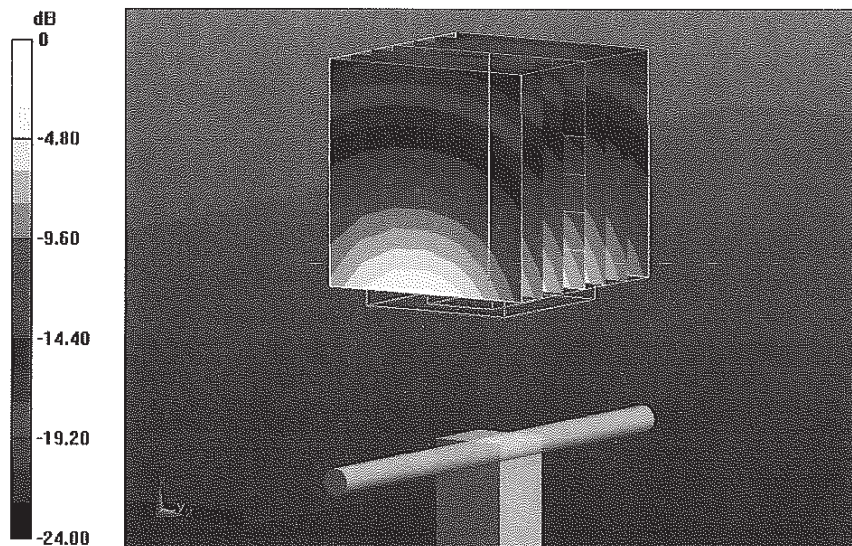

0 dB = 16.8 W/kg = 12.25 dBW/kg

Impedance Measurement Plot for Body TSL

21 Jan 2014 11:31:29

[CH1] S11 1 U FS 2: 49.994 Ω 4.9258 Ω 319.98 pH 2 450.000 000 MHz

*
De l
CA

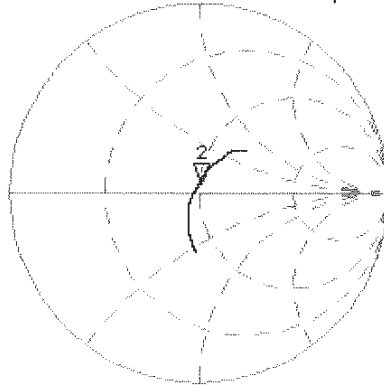

Avg
16

H1 d

CH2 S11 LOG 5 dB/REF -20 dB 2:-26.162 dB 2 450.000 000 MHz

CA

Avg
16

H1 d

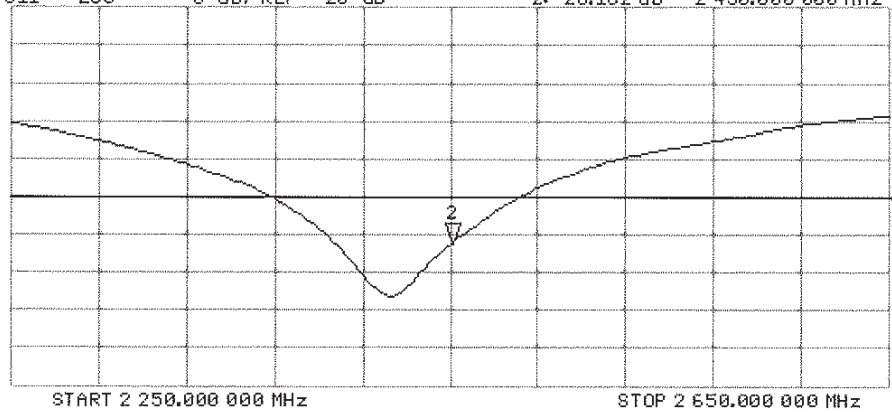

APPENDIX D: SAR TISSUE SPECIFICATIONS

Measurement Procedure for Tissue verification:



- 1) The network analyzer and probe system was configured and calibrated.
- 2) The probe was immersed in the tissue. The tissue was placed in a nonmetallic container. Trapped air bubbles beneath the flange were minimized by placing the probe at a slight angle.
- 3) The complex admittance with respect to the probe aperture was measured
- 4) The complex relative permittivity ϵ can be calculated from the below equation (Pournaropoulos and Misra):

$$Y = \frac{j2\omega\epsilon_r\epsilon_0}{[\ln(b/a)]^2} \int_a^b \int_a^b \int_0^\pi \cos\phi' \frac{\exp[-j\omega r(\mu_0\epsilon_r'\epsilon_0)^{1/2}]}{r} d\phi' d\rho' d\rho$$

where Y is the admittance of the probe in contact with the sample, the primed and unprimed coordinates refer to source and observation points, respectively, $r^2 = \rho^2 + \rho'^2 - 2\rho\rho' \cos\phi'$, ω is the angular frequency, and $j = \sqrt{-1}$.

**Table D-I
Composition of the Tissue Equivalent Matter**

Frequency (MHz)	835	835	1900	1900	2450	2450
Tissue	Head	Body	Head	Body	Head	Body
Ingredients (% by weight)						
Bactericide	0.1	0.1			See page 2	
DGBE			44.92	29.44		26.7
HEC	1	1				
NaCl	1.45	0.94	0.18	0.39		0.1
Sucrose	57	44.9				
Water	40.45	53.06	54.9	70.17		73.2

FCC ID: A3LSMG316ML		SAR EVALUATION REPORT		Reviewed by: Quality Manager
Test Dates: 12/09/14 - 12/12/14	DUT Type: Portable Handset			APPENDIX D: Page 1 of 2

2 Composition / Information on ingredients

The Item is composed of the following ingredients:

H2O	Water, 52 – 75%
C8H18O3	Diethylene glycol monobutyl ether (DGBE), 25 – 48% (CAS-No. 112-34-5, EC-No. 203-961-6, EC-index-No. 603-096-00-8) Relevant for safety; Refer to the respective Safety Data Sheet*.
NaCl	Sodium Chloride, <1.0%

**Figure D-1
Composition of 2.4 GHz Head Tissue Equivalent Matter**

Note: 2.4 GHz head liquid recipes are proprietary SPEAG. Since the composition is approximate to the actual liquids utilized, the manufacturer tissue-equivalent liquid data sheets are provided below.

Measurement Certificate / Material Test

Item Name	Head Tissue Simulating Liquid (HSL2450V2)
Product No.	SL AAH 245 BA (Charge: 130212-2)
Manufacturer	SPEAG

Measurement Method

TSL dielectric parameters measured using calibrated OCP probe.

Setup Validation

Validation results were within $\pm 2.5\%$ towards the target values of Methanol.

Target Parameters

Target parameters as defined in the IEEE 1528 and IEC 62209 compliance standards.

Test Condition

Ambient	Environment temperatur (22 ± 3)°C and humidity < 70%.
TSL Temperature	23°C
Test Date	13-Feb-13
Operator	DI



Additional Information

TSL Density	0.988 g/cm ³
TSL Heat-capacity	3.680 kJ/(kg*K)

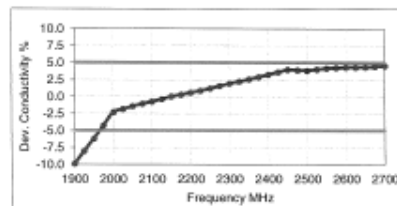
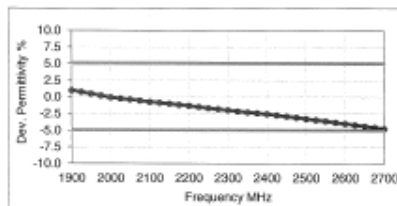
f (MHz)	Measured			Target			Diff. to Target [%]	
	HP-e'	HP-e''	sigma	eps	sigma	delta-eps	delta-sigma	
1900	40.4	11.94	1.26	40.0	1.40	1.0	-0.9	
1925	40.3	12.02	1.29	40.0	1.40	0.7	-8.0	
1950	40.2	12.11	1.31	40.0	1.40	0.5	-8.2	
1975	40.1	12.20	1.34	40.0	1.40	0.2	-4.2	
2000	40.0	12.29	1.37	40.0	1.40	-0.1	-2.3	
2025	39.9	12.39	1.40	40.0	1.42	-0.2	-1.9	
2050	39.8	12.49	1.42	39.9	1.44	-0.4	-1.4	
2075	39.6	12.57	1.45	39.9	1.47	-0.6	-1.1	
2100	39.5	12.65	1.48	39.8	1.49	-0.7	-0.7	
2125	39.4	12.74	1.51	39.8	1.51	-0.9	-0.4	
2150	39.3	12.82	1.53	39.7	1.53	-1.0	0.0	
2175	39.2	12.89	1.56	39.7	1.56	-1.2	0.3	
2200	39.1	12.97	1.59	39.6	1.58	-1.3	0.6	
2225	39.0	13.04	1.61	39.6	1.60	-1.5	0.9	
2250	38.9	13.11	1.64	39.6	1.62	-1.7	1.2	
2275	38.8	13.20	1.67	39.5	1.64	-1.8	1.6	
2300	38.7	13.28	1.70	39.5	1.67	-2.0	2.0	
2325	38.6	13.35	1.73	39.4	1.69	-2.1	2.3	
2350	38.5	13.42	1.75	39.4	1.71	-2.3	2.6	
2375	38.4	13.50	1.78	39.3	1.73	-2.4	2.9	
2400	38.3	13.58	1.81	39.3	1.76	-2.6	3.3	
2425	38.2	13.65	1.84	39.2	1.78	-2.7	3.6	
2450	38.1	13.73	1.87	39.2	1.80	-2.9	4.0	
2475	38.0	13.79	1.90	39.2	1.83	-3.1	3.9	
2500	37.9	13.85	1.93	39.1	1.85	-3.3	3.9	
2525	37.8	13.94	1.96	39.1	1.88	-3.4	4.0	
2550	37.7	14.02	1.99	39.1	1.91	-3.6	4.2	
2575	37.6	14.09	2.02	39.0	1.94	-3.8	4.3	
2600	37.5	14.17	2.05	39.0	1.96	-4.0	4.4	
2625	37.4	14.23	2.08	39.0	1.99	-4.2	4.4	
2650	37.3	14.29	2.11	38.9	2.02	-4.3	4.4	
2675	37.1	14.36	2.14	38.9	2.05	-4.5	4.5	
2700	37.0	14.43	2.17	38.9	2.07	-4.8	4.6	



**Figure D-2
2.4 GHz Head Tissue Equivalent Matter**

FCC ID: A3LSMG316ML		SAR EVALUATION REPORT		Reviewed by: Quality Manager
Test Dates: 12/09/14 - 12/12/14	DUT Type: Portable Handset			APPENDIX D: Page 2 of 2

APPENDIX E: SAR SYSTEM VALIDATION



Per FCC KDB 865664 D02v01, SAR system validation status should be documented to confirm measurement accuracy. The SAR systems (including SAR probes, system components and software versions) used for this device were validated against its performance specifications prior to the SAR measurements. Reference dipoles were used with the required tissue- equivalent media for system validation, according to the procedures outlined in FCC KDB 865664 D01 v01 and IEEE 1528-2013. Since SAR probe calibrations are frequency dependent, each probe calibration point was validated at a frequency within the valid frequency range of the probe calibration point, using the system that normally operates with the probe for routine SAR measurements and according to the required tissue-equivalent media.

A tabulated summary of the system validation status including the validation date(s), measurement frequencies, SAR probes and tissue dielectric parameters has been included.

SAR SYSTEM #	FREQ. [MHz]	DATE	PROBE SN	PROBE TYPE	PROBE CAL. POINT		COND.	PERM.	CW VALIDATION			MOD. VALIDATION		
							(σ)	(ϵ_r)	SENSI-TIVITY	PROBE LINEARITY	PROBE ISOTROPY	MOD. TYPE	DUTY FACTOR	PAR
G	835	6/30/2014	3258	ES3DV3	835	Head	0.907	40.95	PASS	PASS	PASS	GMSK	PASS	N/A
D	1900	9/30/2014	3263	ES3DV3	1900	Head	1.421	39.44	PASS	PASS	PASS	GMSK	PASS	N/A
G	2450	3/6/2014	3258	ES3DV3	2450	Head	1.736	38.36	PASS	PASS	PASS	OFDM/TDD	PASS	PASS
K	835	10/13/2014	3288	ES3DV3	835	Body	0.998	52.95	PASS	PASS	PASS	GMSK	PASS	N/A
H	1900	7/10/2014	3319	ES3DV3	1900	Body	1.562	53.41	PASS	PASS	PASS	GMSK	PASS	N/A
E	2450	11/3/2014	3332	ES3DV3	2450	Body	1.996	52.21	PASS	PASS	PASS	OFDM/TDD	PASS	PASS

Table E-I
SAR System Validation Summary

NOTE: While the probes have been calibrated for both CW and modulated signals, all measurements were performed using communication systems calibrated for CW signals only. Modulations in the table above represent test configurations for which the measurement system has been validated per FCC KDB Publication 865664 D01v01 for scenarios when CW probe calibrations are used with other signal types. SAR systems were validated for modulated signals with a periodic duty cycle, such as GMSK, or with a high peak to average ratio (>5 dB), such as OFDM according to KDB 865664.

FCC ID: A3LSMG316ML		SAR EVALUATION REPORT		Reviewed by: Quality Manager
Test Dates: 12/09/14 - 12/12/14	DUT Type: Portable Handset			APPENDIX E: Page 1 of 1