

HAC VOLUME CONTROL TEST REPORT

**FCC 47 CFR § 20.19
ANSI C63.19-2019
ANSI/TIA-5050 2018**

For

GSM/WCDMA/LTE 5G NR Phone + BT/BLE, DTS/UNII a/b/g/n/ac/ax, NFC and WPT

MODEL NUMBER : SM-F956U, SM-F956U1

FCC ID: A3LSMF956U

REPORT NUMBER: 4791196575-S8V3

ISSUE DATE: 5/16/2024

Prepared for

**SAMSUNG ELECTRONICS CO., LTD.
129 SAMSUNG-RO, YEONGTONG-GU, SUWON-SI,
GYEONGGI-DO, 16677, KOREA**

Prepared by

UL Korea, Ltd.

26th floor, 152, Teheran-ro, Gangnam-gu Seoul, 06236, Korea

**Suwon Test Site: UL Korea, Ltd. Suwon Laboratory
218 Maeyeong-ro, Yeongtong-gu,
Suwon-si, Gyeonggi-do, 16675, Korea
TEL: (031) 337-9902
FAX: (031) 213-5433**



Testing Laboratory

TL-637

Revision History

Rev.	Date	Revisions	Revised By
V1	4/27/2024	Initial Issue	-
V2	5/2/2024	Added note in Sec.9.4 for conversational gain only test result Updated worst case plots in Sec.9.5 Revised Appendix B – removed empty plots	Eunji Choi
V3	5/16/2024	Added note about transmit power in Sec.8.1.	Eunji Choi

Table of Contents

1. Attestation of Test Results.....	4
2. Test Methodology	5
3. Facilities and Accreditation	5
4. Calibration and Uncertainty	5
4.1. <i>Measuring Instrument Calibration.....</i>	<i>5</i>
4.2. <i>Measurement Uncertainty</i>	<i>6</i>
4.3. <i>Decision Rule.....</i>	<i>6</i>
5. Test Procedures for all Technologies	7
5.1. <i>General Procedures ANSI/TIA-5050 2018, Section 5.....</i>	<i>7</i>
5.2. <i>Receive Volume Control Performance</i>	<i>7</i>
5.3. <i>Receive Distortion and Noise Performance (PN-SDNR).....</i>	<i>8</i>
5.4. <i>Receive Acoustic Frequency Response Performance</i>	<i>8</i>
6. Base Station Simulator – software/firmware.....	9
6.1. <i>VoLTE.....</i>	<i>9</i>
6.2. <i>VoNR</i>	<i>9</i>
6.3. <i>VoWi-Fi.....</i>	<i>9</i>
7. Receive Volume Control Requirements	10
7.1. <i>Receive Volume Control.....</i>	<i>10</i>
7.2. <i>Receive Distortion and Noise</i>	<i>10</i>
7.3. <i>Receive Acoustic Frequency Response.....</i>	<i>10</i>
7.4. <i>HAC Compliance under Waiver DA 23-914.....</i>	<i>12</i>
8. Device Under Test.....	13
8.1. <i>Air Interfaces and Operating Mode.....</i>	<i>14</i>
9. HAC (Volume Control) Test Results	15
9.1. <i>CMRS Narrow-band/Wide-band Codec Investigation.....</i>	<i>15</i>
9.2. <i>Antenna and Air Interface Investigation for VoLTE/VoNR/VoWiFi</i>	<i>16</i>
9.3. <i>Other Voice Codecs Investigation for GSM/WCDMA/VoLTE/VoNR/VoWiFi.....</i>	<i>28</i>
9.4. <i>HAC (Volume Control) Test Results.....</i>	<i>32</i>
9.5. <i>Worst Case Volume Control Test Plot.....</i>	<i>35</i>
Appendix	37
4790976523-S7 <i>Appendix A_Setup Photo</i>	<i>37</i>
4790976523-S7 <i>Appendix B_Test Plots</i>	<i>37</i>

1. Attestation of Test Results

Applicant Name	SAMSUNG ELECTRONICS CO.,LTD.
FCC ID	A3LSMF956U
Model Name	SM-F956U, SM-F956U1
Applicable Standards	FCC 47 CFR § 20.19 ANSI C63.19-2019 ANSI/TIA-5050 2018
Conversational Gain	16.43 dB with hearing aid and 19.24 dB without hearing aid
Date Tested	4/5/2024 to 4/23/2024
Test Results	Pass

UL Korea, Ltd. tested the above equipment in accordance with the requirements set forth in the above standards. All indications of Pass/Fail in this report are opinions expressed by UL Korea, Ltd. based on interpretations and/or observations of test results. Measurement Uncertainties were not taken into account and are published for informational purposes only. The test results show that the equipment tested is capable of demonstrating compliance with the requirements as documented in this report.

Note: The results documented in this report apply only to the tested sample, under the conditions and modes of operation as described herein. This document may not be altered or revised in any way unless done so by UL Korea, Ltd. and all revisions are duly noted in the revisions section. Any alteration of this document not carried out by UL Korea, Ltd. will constitute fraud and shall nullify the document. This report must not be used by the client to claim product certification, approval, or endorsement by IAS, any agency of the Federal Government, or any agency of any government.

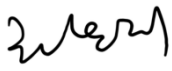
Approved & Released By: 	Prepared By: 
Justin Park Operations Leader UL Korea, Ltd. Suwon Laboratory	Eunji Choi Senior Laboratory Engineer UL Korea, Ltd. Suwon Laboratory

2. Test Methodology

The tests documented in this report were performed in accordance with FCC 47 CFR § 20.19, ANSI C63.19-2019 and ANSI/TIA-5050 2018 Communications Products – Receive Volume Control Requirements for Wireless (Mobile) Devices and FCC published KDB procedures.

KDB 285076 D01 HAC Guidance v06r04
 KDB 285076 D03 HAC FAQ v01r06
 KDB 285076 D04 Volume Control v02
 KDB 285076 D05 CG Interim Waiver DA 23-914 v01

TCB workshop updates

3. Facilities and Accreditation

The test sites and measurement facilities used to collect data are located at

Suwon
Volume Control Room

UL Korea, Ltd. is accredited by IAS, Laboratory Code TL-637.

The full scope of accreditation can be viewed at <https://www.iasonline.org/wp-content/uploads/2017/05/TL-637-cert-New.pdf>

4. Calibration and Uncertainty

4.1. Measuring Instrument Calibration

The measuring equipment used to perform the tests documented in this report has been calibrated in accordance with the manufacturers' recommendations and is traceable to recognized national standards.

Name of Equipment	Manufacturer	Type/Model	Serial No.	Cal. Due Date
Head and Torso Simulator incl Right Ear Simulator and Handset Positioner	Brue&Kjaer	-4128-D-001-	3287425	07-06-2024
Single Channel, Universal Microphone Conditioning Amplifier	Brue&Kjaer	-1708---	100426	06-15-2024
Sound Calibrator, Class 1 and LS, 94 and 114 dB, 1 kHz.	Brue&Kjaer	-4231---	3026386	06-12-2024
Production Test USB-DAQ 8/2-ch.	Brue&Kjaer	-3670-A-082-	3670-000120	06-13-2024
Sound Level Meter	Brue&Kjaer	-2250-L-S-	3130250	03-31-2024
Communications Tester	R & S	CMW500	150314	07-26-2024
Communications Tester	R & S	CMW500	169801	01-03-2025
Up/Down-Converter	R & S	CMW-Z800A	100145	N/A
Wireless Test Platform	Keysight	E7515B	MY57510596	07-27-2024
Audio Analyzer	Keysight	U8903B	MY61170007	07-27-2024

4.2. Measurement Uncertainty

Measurement Uncertainty for Volume Control Measurement

a	c	d	e f(d,k)	f	k	h = cxf/e
Uncertainty component	Tol.(±%)	Prob. Dist.	Div.	ci	vi	ui (± %)
Measurement System - Input channels of Audio Interface (Production Test USB DAQ Type 3670)						
Overall Frequency Response (re. 1 kHz)	0.02	Rectangular	1.732	1	∞	0.01
Measurement System - Output channels of Audio Interface (Production Test USB DAQ Type 3670)						
Measurement System - Pre-Amplifier (Signal Conditioner Type 1708)						
Gain Tolerance 10 Hz 100 kHz	0.01	Rectangular	1.732	1	∞	0.01
Measurement System - Ear-Simulator (Right Ear Simulator Type 4158-C)						
Typical Sensitivity	0.19	Rectangular	1.732	1	∞	0.11
Test Sample Related						
Repeatability Test(Conversational Gain)	5.76	Normal	1	1	40	5.76
Repeatability Test(Acoustic Frequency Response)	1.54	Normal	1	1	40	1.54
Repeatability Test(Distortion)	11.85	Normal	1	1	40	11.85
Combined Standard Uncertainty U_c(y) =			Expanded Uncertainty			
Conversational Gain	5.76	Conversational Gain				11.53
Acoustic Frequency Response	1.55	Acoustic Frequency Response				3.09
Distortion	11.85	Distortion				23.71
Notes for table						
1. Ci - is te sensitivity coefficient						
2. Expanded Std. Uncertainty on Pow er, Coverage Factor = 2, > 95% Confidence						

4.3. Decision Rule

Decision rule for statement(s) of conformity is based on Procedure 2, Clause 4.4.3 in IEC Guide 115:2021.

5. Test Procedures for all Technologies

5.1. General Procedures ANSI/TIA-5050 2018, Section 5

The following requirements shall be met for at least one volume control setting for the narrowband transmission mode (if supported) and the wideband transmission mode (if supported).

Quiet room is a room with background noise no greater than 40 dBA.

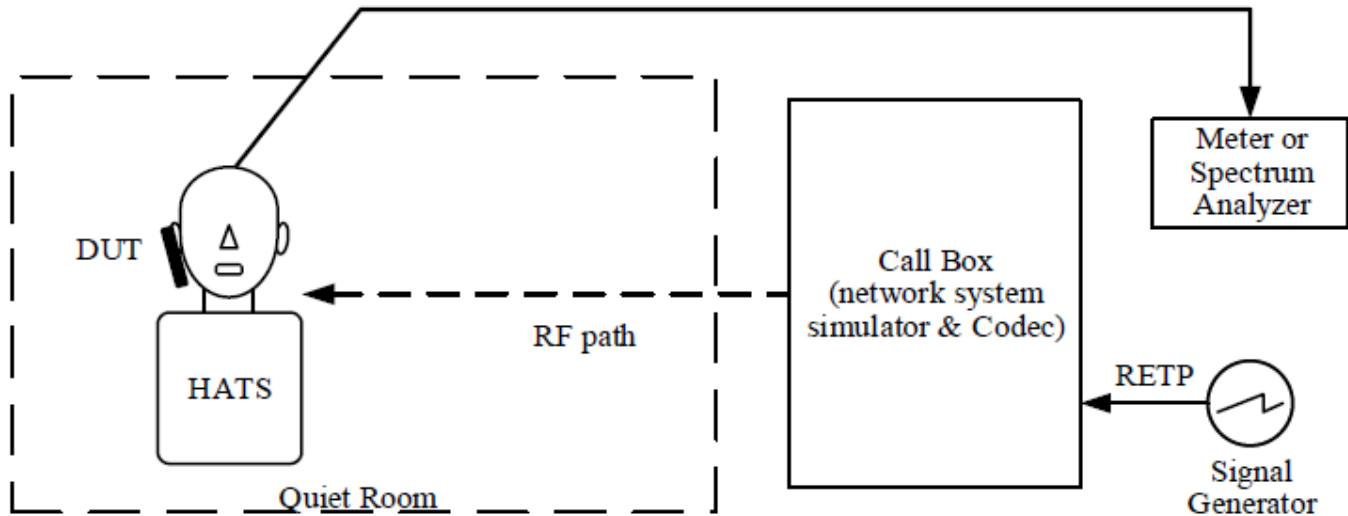

Figure 1. Test Arrangement

5.2. Receive Volume Control Performance

Method of Measurement

- 1) Configure the DUT with a mounting force of 8N and test equipment as shown in Figure 1 in an active call state with the applicable codec for the transmission mode under test.
- 2) Set the DUT volume control to the maximum setting.
- 3) If the DUT has an adjustable tone control feature, a tone control setting that meets the frequency response requirements in section 5.3.1 shall be used.
- 4) Apply the real speech test signal at a level of -20 dBm₀ at the RETP and measure the acoustic output at the Drum Reference Point (DRP) over one complete sequence of the test signal.
- 5) Translate the measurement made at the DRP to the Free Field (FF) using the translation data in Annex B.
- 6) Over the applicable frequency band, determine the ASL in dBSPL for the resulting sound pressure level in accordance with Method B of ITU-T Recommendation P.56:
 - a. Narrowband 100 Hz through 4000 Hz.
 - b. Wideband 100 Hz through 7720 Hz.
- 7) Calculate the Conversational Gain by subtracting 70 dB from the measured dBSPL.
[Conversational Gain = (Measured dBSPL Level – 70 dBSPL) dB]
- 8) Measure the output distortion per clause 5.2. If a distortion failure occurs at the maximum volume control setting, reduce the volume control setting and repeat the measurement to determine if a setting can be found for which the conversational gain requirement is met without a distortion failure.
- 9) Repeat steps 2-8 with a mounting force of 2N.

5.3. Receive Distortion and Noise Performance (PN-SDNR)

Receive distortion is specified in terms of Signal-to-Distortion-and-Noise Ratio (SDNR) using a Pulsed Noise (PN) test signal. PN-SDNR is the ratio of the signal power to the total A-weighted distortion and noise power of the signal output expressed in dB. It is measured using a pulsed 1/3 octave pink noise input signal as described in TIA-5050 2018 Annex A.

Method of Measurement

- 1) Configure the DUT with a mounting force of 8N and test equipment as shown in Figure 1 in an active call state with the applicable codec for the transmission mode under test with the volume control at the setting determined in 5.1.1.
- 2) Receive distortion and noise is measured using the PN-SDNR procedure as described in Annex A.
- 3) To ensure DUT activation, apply the real speech test signal at a level of -20 dBm0 followed immediately by the initial 1/3 octave center frequency PN test signal in Table A.1 based on the narrowband or wideband operating mode. Measure the acoustic output at the DRP over the complete sequence of the PN test signal.
- 4) Translate the measurement made at the DRP to the FF using the translation data in Annex B.
- 5) Calculate the acoustic output unweighted total signal power of the stimulus measurement band as described in A.2.
- 6) Calculate the notched A-weighting distortion and noise components as described in A.3.
- 7) Calculate the ratio of the signal power to the total A-weighted distortion and noise power using Eq A-1.
- 8) Repeat for each of the remaining 1/3 octave center frequencies in Table A.1 based on the narrowband or wideband operating mode.

Repeat steps 2-8 with a mounting force of 2N.

5.4. Receive Acoustic Frequency Response Performance

For the volume control settings determined in 5.1.1 with a mounting force of 8N and 2N, the receive frequency response shall be measured at the DRP in 1/12 octave bands. After translation to the FF or DF, it shall fall between the applicable upper and lower limits.

The exact limit values at any 1/12 octave band center frequency falling between two consecutive points specified in the table may be calculated using the formula given in equation below:

$$X_f = X_1 + (X_2 - X_1) * \left(\frac{\log_{10} f - \log_{10} f_1}{\log_{10} f_2 - \log_{10} f_1} \right)$$

Method of Measurement

- 1) Configure the DUT with a mounting force of 8N and test equipment as shown in Figure 1 in an active call state with the applicable codec for the transmission mode under test with the volume control at the setting determined in 5.1.1.
- 2) If the DUT has an adjustable tone control feature the initial measurement is to be performed with the default tone control setting.
- 3) Apply the real speech test signal with a level of -20 dBm0 at the RETP.
- 4) Capture the frequency spectrum at the DRP of the HATS using real-time analysis with 1/12 octave bands over the frequency range from 100 Hz to 4000 Hz for narrowband measurements, or over the frequency range from 100 Hz to 8000 Hz for wideband measurements, averaged over the entire duration of the test signal.
- 5) Transform the DRP frequency spectrum measurement to the FF or DF (see Annex B).
- 6) Divide the 1/12 octave measurement data by the 1/12 octave frequency spectrum of the test signal at the RETP and present the measurement in terms of dB(Pa/V).
- 7) Apply the applicable frequency response limits to determine compliance.
- 8) If the default tone control setting does not meet the requirement, repeat the above steps for other tone control settings to determine a tone control setting that meets the requirements.
- 9) Repeat with a mounting force of 2N.

6. Base Station Simulator – software/firmware

6.1. VoLTE

Refer to the below software/firmware License list for measurement VoLTE.

Firmware	License Keys	Software Name (CMW500)
V3.7.70 for LTE	KS500	LTE FDD R8 SIG BASIC
	KS550	LTE TDD R8 SIG BASIC
V3.7.20 for Audio	KA100	IP APPL ENABLING IPv4
	KA150	IP APPL ENABLING IPv4
	KAA20	IP APPL IMS BASIC
	KM050	DATA APPL MEAS
	KS104	EVS SPEECH CODEC

6.2. VoNR

Refer to the below software/firmware License list for measurement VoNR.

License Option	Software Name (Keysight E7515B)
C8700201A	IMS-SIP Emulation
C87350P1A	5G NR IP data

6.3. VoWi-Fi

Refer to the below software/firmware License list for measurement VoWi-Fi.

Firmware	License Keys	Software Name (CMW500)
V3.7.50 for WLAN	KS650	WLAN A/B/G SIG BASIC
	KS651	WLAN N SIG BASIC
	KS656	WLAN IEEE 802.11ac
	KS657	WLAN IEEE 802.11ax
V3.7.20 for Audio	KA100	IP APPL ENABLING IPv4
	KA150	IP APPL ENABLING IPv6
	KAA20	IP APPL IMS BASIC
	KM050	DATA APPL MEAS
	KS104	EVS SPEECH CODEC
Firmware	License Keys	Software Name (CMW500)
V4.0.190 for WLAN	KS650	WLAN A/B/G SIG BASIC
	KS651	WLAN N SIG BASIC
	KS656	WLAN IEEE 802.11ac
	KS657	WLAN IEEE 802.11ax
V4.0.190 for Audio	KA100	IP APPL ENABLING IPv4
	KA150	IP APPL ENABLING IPv6
	KAA20	IP APPL IMS BASIC
	KM050	DATA APPL MEAS
	KS104	EVS SPEECH CODEC

7. Receive Volume Control Requirements

7.1. Receive Volume Control

1. With a mounting force of 8N, the DUT shall have at least one volume control setting that will produce a conversational gain of ≥ 18 dB with the output distortion and the frequency response meeting the requirements in clause 5.2.1 & 5.3.1 respectively.

2. With a mounting force of 2N, the DUT shall have at least one volume control setting that will produce a conversational gain of ≥ 6 dB with the output distortion and the frequency response meeting the requirements in clause 5.2.1 & 5.3.1 respectively.

7.2. Receive Distortion and Noise

With a mounting force of 8N and 2N, the ratio of the stimulus signal power to the 100 Hz to 8000 Hz total A-weighted distortion and noise power shall be ≥ 20 dB when tested over the range of 1/3 octave band center frequencies.

7.3. Receive Acoustic Frequency Response

The results for each 1/12 octave band measurement are to be evaluated against the upper and lower limit values only at the center frequency point for that band (i.e., not the entire width of the band). For graphical purposes, the individual 1/12 octave band measurement results are plotted as points on a linear dB scale (y-axis) versus the band's center frequency on a logarithmic frequency scale (x-axis). The frequency response limits are floating or "best fit" (i.e., the maximum and minimum deviations from the upper and lower limits should be equidistant from those limits).

1. Narrowband: The 1/12 octave band frequency response after translation to the FF or DF shall fall between the upper and lower limits given in Table 1 and shown in Figure 2.

Table 1 – Narrowband Receive Frequency Response Limits

Lower Limit Frequency (Hz)	Lower Limit (dB)	Upper Limit Frequency (Hz)	Upper Limit (dB)
300	-6	100	+6
3400	-6	4000	+6

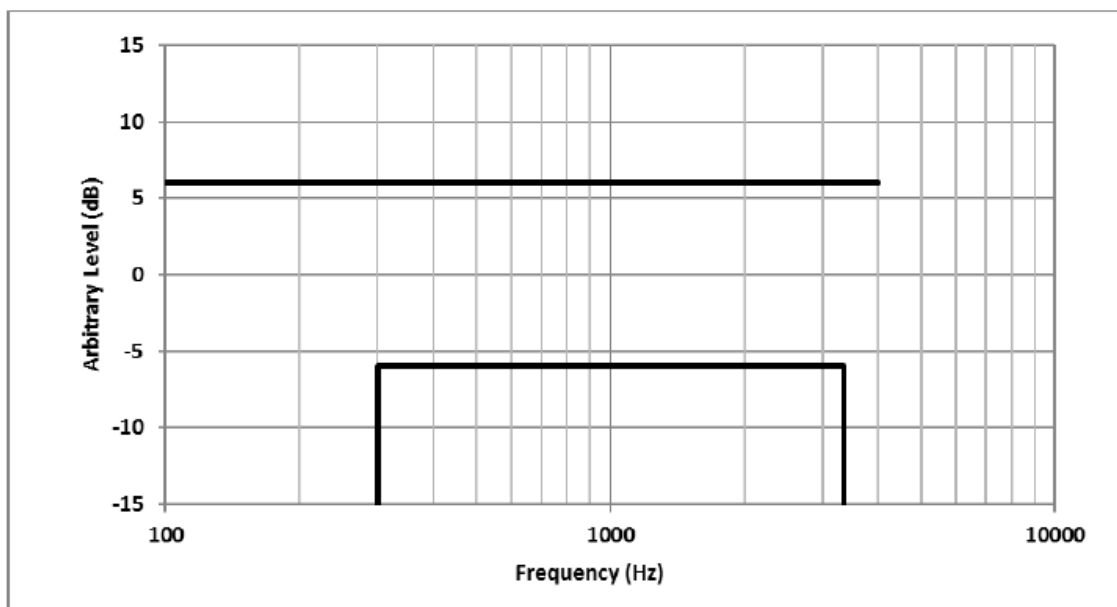

Figure 2 – Narrowband Receive Frequency Response Limits

- 2. Wideband: The 1/12 octave band frequency response after translation to the FF or DF shall fall between the upper and lower limits given in Table 2 and shown in Figure 3.

Table 2 – Wideband Receive Frequency Response Limits

Lower Limit Frequency (Hz)	Lower Limit (dB)	Upper Limit Frequency (Hz)	Upper Limit (dB)
200	-10	100	+6
300	-6	1000	+6
5000	-6	2000	+8
6300	-12	8000	+8

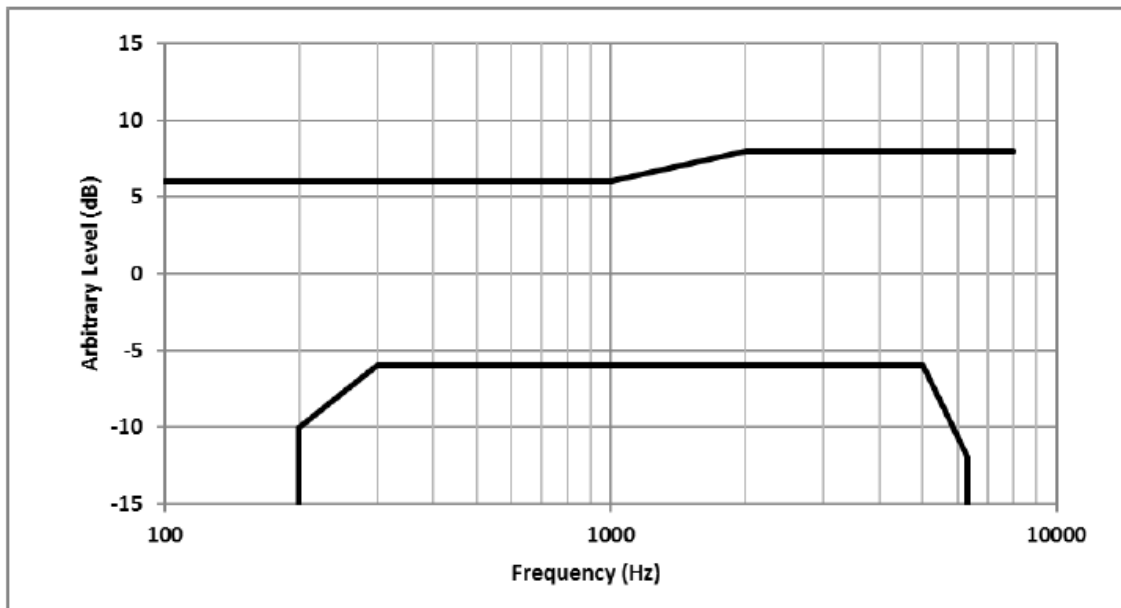

Figure 3 – Wideband Receive Frequency Response Limits

7.4. HAC Compliance under Waiver DA 23-914

The following technical testing requirements for the conversational gain, distortion, and frequency response tests that amends KDB 285076 D04 Volume Control under the conditions of the limited-term waiver DA 23-914.

- a. Under the waiver, only CMRS narrowband and CMRS wideband voice codecs are required to comply with the volume control requirements of the TIA 5050-2018 Volume Control Standard as amended as follows:
 1. For the 2N mounting force test, one narrowband and one wideband voice codec embedded with the handset must pass with at least one volume control setting with a conversational gain of ≥ 6 dB for all voice services, bands of operation and air interfaces over which it operates using one codec bit rate of the applicant's choosing.
 2. For the 8N mounting force test, one narrowband and one wideband voice codec embedded with the handset must pass with at least one volume control setting with a conversational gain of ≥ 6 dB for all voice services, bands of operation and air interfaces over which they operate but is not required to meet or exceed the full 18 dB of conversational gain specified in section 5.1.1 of the TIA 5050 Volume Control Standard using one codec bit rate of the applicant's choosing.
- b. For all other narrowband and wideband codecs not evaluated in **a.** above, TIA 5050-2018 Receive Distortion and Noise Performance and Receive Acoustic Frequency Response Performance evaluations are not required; however, these codecs shall be assessed for conversational gain and documented in the test report at the 2N and 8N levels with a gain of ≥ 6 dB for all voice services, bands of operation and air interfaces over which they operate. The handset volume setting used to comply with **a.** shall be used for these other CMRS codec evaluations.
- c. Any other codec for voice services embedded in the handset, not identified in **a.** and **b.** above, is not required to comply or demonstrate in the test reports for conversational gain.

8. Device Under Test

Normal operation	Held to head	
Back Cover	The Back Cover is not removable	
Test sample information	S/N	Notes
	R3CX309QRMZ	Volume Control Test
	R3CX309QRZF	Volume Control Test

8.1. Air Interfaces and Operating Mode

Air Interface	Bands (MHz)	Type	Volume Control Tested	Simultaneous Transmitter	OTT Testing Required? Name of Voice Service	Audio Codecs Evaluated
GSM	850	VO	Yes ⁴ FR V1, FR V2, HR V1	Wi-Fi and BT	CMRS	FR V1, FR V2, HR V1
	1900					
	GPRS/EDGE	VD	No ⁵	Wi-Fi and BT	No ⁵ Google Meet	OPUS
W-CDMA (UMTS)	850 (V)	VO	Yes ⁴ AMR-NB, AMR-WB	Wi-Fi and BT	CMRS	AMR-NB & AMR-WB
	1750 (IV)					
	1900 (II)					
	HSPA	VD	No ⁵	Wi-Fi and BT	No ⁵ Google Meet	OPUS
LTE - FDD	680 (B71)	VD	Yes ³ EVS-nb 24.4 kbps EVS-w b 24.4 kbps Yes ⁴ AMR-NB, AMR-WB, EVS-nb, EVS-w b No ⁵ EVS-sw b, OPUS	NR, Wi-Fi and BT	VoLTE No ⁵ Google Meet	AMR-NB, AMR-WB, EVS and OPUS
	700 (B12)					
	780 (B13)					
	790 (B14)					
	850 (B5/26)					
	1700 (B4/66)					
	1900 (B2/25)					
	2300 (B30)					
2600 (B7)						
LTE - TDD	2300 (B40)	VD		NR, Wi-Fi and BT	VoLTE No ⁵ Google Meet	AMR-NB, AMR-WB, EVS and OPUS
	2600 (B38/41)					
	3600 (B48)					
NR - FDD	680 (n71)	VD	Yes ³ EVS-nb 24.4 kbps EVS-w b 24.4 kbps Yes ⁴ AMR-NB, AMR-WB, EVS-nb, EVS-w b No ⁵ EVS-sw b, OPUS	LTE, Wi-Fi and BT	VoNR No ⁵ Google Meet	AMR-NB, AMR-WB, EVS and OPUS
	700 (n12)					
	850 (n5/26)					
	1700 (n66)					
	1700 (n70)					
	1900 (n2/25)					
	2300 (n30)					
2600 (n7)						
NR - TDD	2600 (n38/n41)	VD		LTE, Wi-Fi and BT	VoNR No ⁵ Google Meet	AMR-NB, AMR-WB, EVS and OPUS
	3600 (n48)					
	3500 (n77 DoD)					
	3700 (n77)					
Wi-Fi	2450	VD	Yes ³ EVS-nb 13.2 kbps EVS-w b 13.2 kbps Yes ⁴ AMR-NB, AMR-WB, EVS-nb, EVS-w b No ⁵ EVS-sw b, OPUS	WWAN, BT and U-NII	VoWiFi No ⁵ Google Meet	AMR-NB, AMR-WB, EVS and OPUS
	5200 (U-NII-1)			WWAN, BT and WiFi 2.4GHz		
	5300 (U-NII-2A)					
	5500 (U-NII-2C)					
	5800 (U-NII-3)	VD	Yes ^{1,2}		WWAN, BT and WiFi 2.4GHz	VoWiFi No ^{1,5} Google Meet
	5900 (U-NII-4)					
	6175 (U-NII-5)					
	6475 (U-NII-6)					
6700 (U-NII-7)	VD	N/A ¹		N/A	N/A	
7000 (U-NII-8)						
BT	2450	DT	N/A	WWAN and U-NII	N/A	N/A

Type
 VO: Legacy Cellular Voice Service
 DT: Digital Transport only (no voice)
 VD: IP Voice Service over Digital Transport
 CMRS: Commercial Mobile Radio Service
 BT: Bluetooth

Note:
 1. ANSI C63.19 only requires HAC evaluations for Frequencies under 6GHz.
 2. 5.925-6 GHz in U-NII-5 band is evaluated for VoWiFi.
 3. Tested Conversational Gain, Frequency Response, PN-SDNR.
 4. Tested only Conversational Gain. (Waiver DA 23-914)
 5. Not required to comply with Volume Control standard. (Waiver DA 23-914)

Note(s):

All tests were performed with the transmit power set to the maximum power for held-to-head conditions (RCV active). For air interfaces with a Time Averaged SAR (TAS) algorithm Pmax is considered the maximum power.

9. HAC (Volume Control) Test Results

CMRS NB/WB Codecs and bitrate; EVS-nb 24.4 kbps and EVS-wb 24.4 kbps were chosen by applicant. All Volume Control measurements were performed with volume max-1 level.

9.1. CMRS Narrow-band/Wide-band Codec Investigation

An investigation was performed to determine the worst-case CMRS NB/WB Codec per technology. All subsequent measurements were determined by this investigation.

2N Mounting Force

Codec (NB or WB)	Volume Control Level	Mode / Band	Antenna	Voice Codec / Codec bitrate (kbps)	Channel and Frequency	Bandwidth	Waveform / Modulation	RB (Allocation/Offset)	Volume Control Results				
									2N				
									Noise (LAF_MAX) (dBA)	Conversational Gain (dB)	Frequency Response Margin (dB)		FN-SDNR margin (dB)
FF	DF												
NB	Max - 1	LTE Band 66	Ant.B	EVS-NB 24.4 kbit/s	132322 1745 MHz	20 MHz	QPSK	1/0	23.9	16.77	2.11	1.81	12.06
WB	Max - 1	LTE Band 66	Ant.B	EVS-WB 24.4 kbit/s	132322 1745 MHz	20 MHz	QPSK	1/0	23.9	17.76	2.11	2.10	6.21
NB	Max - 1	LTE Band 41 PC2	Ant.B	EVS-NB 24.4 kbit/s	40620 2593 MHz	20 MHz	QPSK	1/0	24.4	16.73	2.18	1.87	8.18
WB	Max - 1	LTE Band 41 PC2	Ant.B	EVS-WB 24.4 kbit/s	40620 2593 MHz	20 MHz	QPSK	1/0	24.4	17.55	2.16	2.20	6.72
NB	Max - 1	NR Band n12	Ant.D	EVS-NB 24.4 kbit/s	141500 707.5 MHz	15 MHz	DFT-s-OFDM QPSK	1/1	22.4	17.46	2.10	1.88	8.81
WB	Max - 1	NR Band n12	Ant.D	EVS-WB 24.4 kbit/s	141500 707.5 MHz	15 MHz	DFT-s-OFDM QPSK	1/1	22.4	18.64	2.21	2.50	6.00
NB	Max - 1	NR Band n41 PC2	Ant.E	EVS-NB 24.4 kbit/s	518598 2592.99 MHz	100 MHz	DFT-s-OFDM QPSK	1/1	25.3	17.60	2.11	1.91	7.98
WB	Max - 1	NR Band n41 PC2	Ant.E	EVS-WB 24.4 kbit/s	518598 2592.99 MHz	100 MHz	DFT-s-OFDM QPSK	1/1	25.3	18.71	2.19	2.50	7.55
NB	Max - 1	WiFi 2.4GHz 802.11b	MIMO	EVS-NB 24.4 kbit/s	CH.6 2437 MHz	20 MHz	DSSS 1 Mbps	N/A	23.9	16.80	2.24	1.91	6.81
WB	Max - 1	WiFi 2.4GHz 802.11b	MIMO	EVS-WB 24.4 kbit/s	CH.6 2437 MHz	20 MHz	DSSS 1 Mbps	N/A	23.9	17.86	2.22	2.20	7.35
NB	Max - 1	WiFi 5GHz 802.11a	MIMO	EVS-NB 24.4 kbit/s	CH.40 5200 MHz	20 MHz	BPSK 6 Mbps	N/A	25.7	16.98	2.26	1.93	10.73
WB	Max - 1	WiFi 5GHz 802.11a	MIMO	EVS-WB 24.4 kbit/s	CH.40 5200 MHz	20 MHz	BPSK 6 Mbps	N/A	25.7	17.87	2.15	2.20	6.00

8N Mounting Force

Codec (NB or WB)	Volume Control Level	Mode / Band	Antenna	Voice Codec / Codec bitrate (kbps)	Channel and Frequency	Bandwidth	Waveform / Modulation	RB (Allocation/Offset)	Volume Control Results				
									8N				
									Noise (LAF_MAX) (dBA)	Conversational Gain (dB)	Frequency Response Margin (dB)		FN-SDNR margin (dB)
FF	DF												
NB	Max - 1	LTE Band 66	Ant.B	EVS-NB 24.4 kbit/s	132322 1745 MHz	20 MHz	QPSK	1/0	24.6	19.99	2.09	1.88	10.70
WB	Max - 1	LTE Band 66	Ant.B	EVS-WB 24.4 kbit/s	132322 1745 MHz	20 MHz	QPSK	1/0	24.6	20.83	2.20	2.00	8.00
NB	Max - 1	LTE Band 41 PC2	Ant.B	EVS-NB 24.4 kbit/s	40620 2593 MHz	20 MHz	QPSK	1/0	24.4	19.95	2.10	1.95	12.40
WB	Max - 1	LTE Band 41 PC2	Ant.B	EVS-WB 24.4 kbit/s	40620 2593 MHz	20 MHz	QPSK	1/0	24.4	20.74	2.18	2.20	6.60
NB	Max - 1	NR Band n12	Ant.D	EVS-NB 24.4 kbit/s	141500 707.5 MHz	15 MHz	DFT-s-OFDM QPSK	1/1	22.4	20.31	1.92	1.70	4.80
WB	Max - 1	NR Band n12	Ant.D	EVS-WB 24.4 kbit/s	141500 707.5 MHz	15 MHz	DFT-s-OFDM QPSK	1/1	22.4	21.45	2.18	2.50	5.00
NB	Max - 1	NR Band n41 PC2	Ant.E	EVS-NB 24.4 kbit/s	518598 2592.99 MHz	100 MHz	DFT-s-OFDM QPSK	1/1	22.4	20.34	2.06	1.85	7.50
WB	Max - 1	NR Band n41 PC2	Ant.E	EVS-WB 24.4 kbit/s	518598 2592.99 MHz	100 MHz	DFT-s-OFDM QPSK	1/1	22.4	21.44	2.21	2.60	6.10
NB	Max - 1	WiFi 2.4GHz 802.11b	MIMO	EVS-NB 24.4 kbit/s	CH.6 2437 MHz	20 MHz	DSSS 1 Mbps	N/A	26.1	20.25	2.12	1.89	9.80
WB	Max - 1	WiFi 2.4GHz 802.11b	MIMO	EVS-WB 24.4 kbit/s	CH.6 2437 MHz	20 MHz	DSSS 1 Mbps	N/A	26.1	21.17	2.26	2.30	6.90
NB	Max - 1	WiFi 5GHz 802.11a	MIMO	EVS-NB 24.4 kbit/s	CH.40 5200 MHz	20 MHz	BPSK 6 Mbps	N/A	26.1	20.17	2.09	1.95	12.40
WB	Max - 1	WiFi 5GHz 802.11a	MIMO	EVS-WB 24.4 kbit/s	CH.40 5200 MHz	20 MHz	BPSK 6 Mbps	N/A	26.1	21.03	2.45	2.40	7.00

Note(s):

- For all technologies, it is observed that EVS-NB 24.4 kbps is the worst-case.

9.2. Antenna and Air Interface Investigation for VoLTE/VoNR/VoWiFi

Using the worst-case codec found in sec.9.1, a limited set of RBs/modulations/bandwidths/channels/bands/data rates were tested to confirm that there is no effect to compliance when changing the air interface.

2N Mounting Force – VoLTE FDD

Codec (NB or WB)	Volume Control Level	Mode / Band	Antenna	Voice Codec / Codec bitrate (kbps)	Channel and Frequency	Bandwidth	Waveform / Modulation	RB (Allocation/ Offset)	Volume Control Results					
									2N				FN-SDNR margin (dB)	
									Noise (LAF_MAX) (dBA)	Conversational Gain (dB)	Frequency Response Margin (dB)			
FF	DF													
NB	Max - 1	LTE Band 66	Ant.B	EV-S-NB 24.4 kbit/s	132322 1745 MHz	20 MHz	QPSK	1/0	23.9	16.77	2.11	1.81	12.06	
NB	Max - 1		Ant.E	EV-S-NB 24.4 kbit/s	132322 1745 MHz	20 MHz	QPSK	1/0	23.9	16.80	2.16	1.87	11.47	
NB	Max - 1		Ant.B	EV-S-NB 24.4 kbit/s	132322 1745 MHz	20 MHz	QPSK	1/49	23.9	16.95	2.08	1.78	12.49	
NB	Max - 1		Ant.B	EV-S-NB 24.4 kbit/s	132322 1745 MHz	20 MHz	QPSK	1/99	23.9	16.96	2.08	1.78	9.19	
NB	Max - 1		Ant.B	EV-S-NB 24.4 kbit/s	132322 1745 MHz	20 MHz	QPSK	50/0	23.9	16.90	2.08	1.77	10.62	
NB	Max - 1		Ant.B	EV-S-NB 24.4 kbit/s	132322 1745 MHz	20 MHz	QPSK	50/24	23.9	16.88	2.11	1.80	10.51	
NB	Max - 1		Ant.B	EV-S-NB 24.4 kbit/s	132322 1745 MHz	20 MHz	QPSK	50/50	23.9	16.86	2.13	1.82	9.86	
NB	Max - 1		Ant.B	EV-S-NB 24.4 kbit/s	132322 1745 MHz	20 MHz	QPSK	100/0	23.9	16.88	2.14	1.85	11.44	
NB	Max - 1		Ant.B	EV-S-NB 24.4 kbit/s	132322 1745 MHz	20 MHz	16QAM	1/0	23.9	16.86	2.10	1.79	7.06	
NB	Max - 1		Ant.B	EV-S-NB 24.4 kbit/s	132322 1745 MHz	20 MHz	64QAM	1/0	23.9	16.85	2.20	1.90	11.10	
NB	Max - 1		Ant.B	EV-S-NB 24.4 kbit/s	132322 1745 MHz	20 MHz	256QAM	1/0	23.9	16.85	2.11	1.79	12.31	
NB	Max - 1		Ant.B	EV-S-NB 24.4 kbit/s	132322 1745 MHz	15 MHz	QPSK	1/0	23.9	16.84	2.18	1.85	11.67	
NB	Max - 1		Ant.B	EV-S-NB 24.4 kbit/s	132322 1745 MHz	10 MHz	QPSK	1/0	23.9	16.97	2.17	1.89	11.79	
NB	Max - 1		Ant.B	EV-S-NB 24.4 kbit/s	132322 1745 MHz	5 MHz	QPSK	1/0	23.9	17.00	2.12	1.81	12.83	
NB	Max - 1		Ant.B	EV-S-NB 24.4 kbit/s	132322 1745 MHz	3 MHz	QPSK	1/0	23.9	16.91	2.12	1.81	10.29	
NB	Max - 1		Ant.B	EV-S-NB 24.4 kbit/s	132322 1745 MHz	1.4 MHz	QPSK	1/0	23.9	16.97	2.15	1.84	8.93	
NB	Max - 1		Ant.B	EV-S-NB 24.4 kbit/s	132072 1720 MHz	20 MHz	QPSK	1/0	23.9	16.94	2.15	1.83	11.31	
NB	Max - 1		Ant.B	EV-S-NB 24.4 kbit/s	132572 1770 MHz	20 MHz	QPSK	1/0	23.9	16.91	2.12	1.82	11.19	
WB	Max - 1		LTE Band 7	Ant.B	EV-S-WB 24.4 kbit/s	21100 2535 MHz	20 MHz	QPSK	1/0	23.9	17.70	2.00	2.00	8.68
NB	Max - 1			Ant.B	EV-S-NB 24.4 kbit/s	21100 2535 MHz	20 MHz	QPSK	1/0	23.9	16.93	2.06	1.75	8.65
WB	Max - 1	LTE Band 12	Ant.A	EV-S-WB 24.4 kbit/s	23095 707.5 MHz	10 MHz	QPSK	1/0	23.9	17.90	2.27	2.30	7.23	
NB	Max - 1		Ant.A	EV-S-NB 24.4 kbit/s	23095 707.5 MHz	10 MHz	QPSK	1/0	23.9	16.78	2.06	1.76	11.54	
WB	Max - 1	LTE Band 13	Ant.A	EV-S-WB 24.4 kbit/s	23230 782 MHz	10 MHz	QPSK	1/0	23.9	17.82	2.12	2.10	5.88	
NB	Max - 1		Ant.A	EV-S-NB 24.4 kbit/s	23230 782 MHz	10 MHz	QPSK	1/0	23.9	16.91	2.19	1.89	7.50	
WB	Max - 1	LTE Band 14	Ant.A	EV-S-WB 24.4 kbit/s	23330 793 MHz	10 MHz	QPSK	1/0	23.9	17.62	2.07	2.00	5.01	
NB	Max - 1		Ant.A	EV-S-NB 24.4 kbit/s	23330 793 MHz	10 MHz	QPSK	1/0	23.9	16.86	2.09	1.79	11.53	
WB	Max - 1	LTE Band 25	Ant.B	EV-S-WB 24.4 kbit/s	26365 1882.5 MHz	20 MHz	QPSK	1/0	23.9	17.68	2.07	2.00	5.01	
NB	Max - 1		Ant.B	EV-S-NB 24.4 kbit/s	26365 1882.5 MHz	20 MHz	QPSK	1/0	23.9	16.82	2.08	1.77	11.39	
WB	Max - 1	LTE Band 26	Ant.A	EV-S-WB 24.4 kbit/s	26865 831.5 MHz	15 MHz	QPSK	1/0	23.9	17.64	2.05	2.10	6.09	
NB	Max - 1		Ant.A	EV-S-NB 24.4 kbit/s	26865 831.5 MHz	15 MHz	QPSK	1/0	23.9	16.82	2.10	1.79	11.69	
WB	Max - 1	LTE Band 30	Ant.B	EV-S-WB 24.4 kbit/s	27710 2310 MHz	10 MHz	QPSK	1/0	23.9	17.54	2.01	2.10	5.34	
NB	Max - 1		Ant.B	EV-S-NB 24.4 kbit/s	27710 2310 MHz	10 MHz	QPSK	1/0	23.9	16.86	2.02	1.71	9.19	
WB	Max - 1	LTE Band 71	Ant.A	EV-S-WB 24.4 kbit/s	133297 680.5 MHz	20 MHz	QPSK	1/0	23.9	17.73	2.06	2.00	5.88	
NB	Max - 1		Ant.A	EV-S-NB 24.4 kbit/s	133297 680.5 MHz	20 MHz	QPSK	1/0	23.9	16.99	2.15	1.82	8.17	

2N Mounting Force – VoLTE TDD

Codec (NB or WB)	Volume Control Level	Mode / Band	Antenna	Voice Codec / Codec bitrate (kbps)	Channel and Frequency	Bandwidth	Waveform / Modulation	RB (Allocation/ Offset)	Volume Control Results				
									2N				
									Noise (LAF_MAX) (dBA)	Conversational Gain (dB)	Frequency Response Margin (dB)		PN-SDNR margin (dB)
FF	DF												
NB	Max - 1	LTE Band 41 PC2	Ant.B	EV-S-NB 24.4 kbit/s	40620 2593 MHz	20 MHz	QPSK	1/0	24.4	16.73	2.18	1.87	8.18
NB	Max - 1		Ant.B	EV-S-NB 24.4 kbit/s	40620 2593 MHz	20 MHz	QPSK	1/49	24.4	17.13	2.11	1.80	10.80
NB	Max - 1		Ant.B	EV-S-NB 24.4 kbit/s	40620 2593 MHz	20 MHz	QPSK	1/99	24.4	17.07	2.16	1.86	12.49
NB	Max - 1		Ant.B	EV-S-NB 24.4 kbit/s	40620 2593 MHz	20 MHz	QPSK	50/0	24.4	17.03	2.08	1.77	11.46
NB	Max - 1		Ant.B	EV-S-NB 24.4 kbit/s	40620 2593 MHz	20 MHz	QPSK	50/24	24.4	17.04	2.17	1.84	11.85
NB	Max - 1		Ant.B	EV-S-NB 24.4 kbit/s	40620 2593 MHz	20 MHz	QPSK	50/50	24.4	17.01	2.11	1.80	11.30
NB	Max - 1		Ant.B	EV-S-NB 24.4 kbit/s	40620 2593 MHz	20 MHz	QPSK	100/0	24.4	17.02	2.10	1.79	12.47
NB	Max - 1		Ant.B	EV-S-NB 24.4 kbit/s	40620 2593 MHz	20 MHz	16QAM	1/0	24.4	17.00	2.09	1.78	11.53
NB	Max - 1		Ant.B	EV-S-NB 24.4 kbit/s	40620 2593 MHz	20 MHz	64QAM	1/0	24.4	16.98	2.07	1.76	11.99
NB	Max - 1		Ant.B	EV-S-NB 24.4 kbit/s	40620 2593 MHz	20 MHz	256QAM	1/0	24.4	16.96	2.09	1.78	11.93
NB	Max - 1		Ant.B	EV-S-NB 24.4 kbit/s	40620 2593 MHz	15 MHz	QPSK	1/0	24.4	16.94	2.20	1.90	11.50
NB	Max - 1		Ant.B	EV-S-NB 24.4 kbit/s	40620 2593 MHz	10 MHz	QPSK	1/0	24.4	16.92	2.11	1.81	7.19
NB	Max - 1		Ant.B	EV-S-NB 24.4 kbit/s	40620 2593 MHz	5 MHz	QPSK	1/0	24.4	16.90	2.11	1.81	12.68
NB	Max - 1		Ant.B	EV-S-NB 24.4 kbit/s	39750 2506 MHz	20 MHz	QPSK	1/0	24.4	16.89	2.14	1.84	8.40
NB	Max - 1		Ant.B	EV-S-NB 24.4 kbit/s	40185 2549.5 MHz	20 MHz	QPSK	1/0	24.4	16.88	2.11	1.79	7.88
NB	Max - 1		Ant.B	EV-S-NB 24.4 kbit/s	41055 2636.5 MHz	20 MHz	QPSK	1/0	24.4	16.83	2.20	1.89	12.77
NB	Max - 1		Ant.B	EV-S-NB 24.4 kbit/s	41490 2680 MHz	20 MHz	QPSK	1/0	24.4	16.81	2.21	1.90	11.48
WB	Max - 1		LTE Band 41 PC3	Ant.B	EV-S-WB 24.4 kbit/s	40620 2593 MHz	20 MHz	QPSK	1/0	24.4	17.55	2.06	2.10
NB	Max - 1	Ant.B		EV-S-NB 24.4 kbit/s	40620 2593 MHz	20 MHz	QPSK	1/0	24.4	16.73	2.11	1.80	11.51
WB	Max - 1	LTE Band 48	Ant.E	EV-S-WB 24.4 kbit/s	55773 3603.3 MHz	20 MHz	QPSK	1/0	24.4	17.52	2.06	2.10	7.14
NB	Max - 1		Ant.E	EV-S-NB 24.4 kbit/s	55773 3603.3 MHz	20 MHz	QPSK	1/0	24.4	16.75	2.20	1.89	8.96

2N Mounting Force – VoNR FDD

Codec (NB or WB)	Volume Control Level	Mode / Band	Antenna	Voice Codec / Codec bitrate (kbps)	Channel and Frequency	Bandwidth	Waveform / Modulation	RB (Allocation/ Offset)	Volume Control Results					
									2N					
									Noise (LAF_MAX) (dBA)	Conversational Gain (dB)	Frequency Response Margin (dB)		PN-SDNR margin (dB)	
FF	DF													
NB	Max - 1	NR Band n12	Ant.D	EV-S-NB 24.4 kbit/s	141500 707.5 MHz	15 MHz	DFT-s-OFDM QPSK	1/1	22.4	17.46	2.10	1.88	8.81	
NB	Max - 1		Ant.A+B	EV-S-NB 24.4 kbit/s	141500 707.5 MHz	15 MHz	DFT-s-OFDM QPSK	1/1	25.3	17.67	2.13	1.87	7.25	
NB	Max - 1		Ant.A	EV-S-NB 24.4 kbit/s	141500 707.5 MHz	15 MHz	DFT-s-OFDM QPSK	1/1	23.2	17.70	2.06	1.85	9.69	
NB	Max - 1		Ant.D	EV-S-NB 24.4 kbit/s	141500 707.5 MHz	15 MHz	DFT-s-OFDM QPSK	1/39	23.2	17.63	2.07	1.85	7.75	
NB	Max - 1		Ant.D	EV-S-NB 24.4 kbit/s	141500 707.5 MHz	15 MHz	DFT-s-OFDM QPSK	1/77	23.2	17.70	1.99	1.97	7.45	
NB	Max - 1		Ant.D	EV-S-NB 24.4 kbit/s	141500 707.5 MHz	15 MHz	DFT-s-OFDM QPSK	36/0	23.2	17.65	2.06	1.85	6.97	
NB	Max - 1		Ant.D	EV-S-NB 24.4 kbit/s	141500 707.5 MHz	15 MHz	DFT-s-OFDM QPSK	36/21	23.2	17.58	2.00	1.82	8.08	
NB	Max - 1		Ant.D	EV-S-NB 24.4 kbit/s	141500 707.5 MHz	15 MHz	DFT-s-OFDM QPSK	36/43	23.2	17.57	1.93	1.76	9.47	
NB	Max - 1		Ant.D	EV-S-NB 24.4 kbit/s	141500 707.5 MHz	15 MHz	DFT-s-OFDM QPSK	75/0	23.2	17.60	2.01	1.88	7.99	
NB	Max - 1		Ant.D	EV-S-NB 24.4 kbit/s	141500 707.5 MHz	15 MHz	DFT-s-OFDM pi/2 BPSK	1/1	23.2	17.67	2.06	1.86	6.24	
NB	Max - 1		Ant.D	EV-S-NB 24.4 kbit/s	141500 707.5 MHz	15 MHz	DFT-s-OFDM 16QAM	1/1	23.2	17.61	2.12	1.90	6.67	
NB	Max - 1		Ant.D	EV-S-NB 24.4 kbit/s	141500 707.5 MHz	15 MHz	DFT-s-OFDM 64QAM	1/1	23.2	17.57	2.10	1.77	5.33	
NB	Max - 1		Ant.D	EV-S-NB 24.4 kbit/s	141500 707.5 MHz	15 MHz	DFT-s-OFDM 256QAM	1/1	23.2	17.53	2.05	1.74	6.21	
NB	Max - 1		Ant.D	EV-S-NB 24.4 kbit/s	141500 707.5 MHz	15 MHz	CP-OFDM QPSK	1/1	23.2	17.55	2.01	1.81	5.61	
NB	Max - 1		Ant.D	EV-S-NB 24.4 kbit/s	141500 707.5 MHz	15 MHz	CP-OFDM QPSK	1/39	23.2	17.51	2.01	1.94	5.97	
NB	Max - 1		Ant.D	EV-S-NB 24.4 kbit/s	141500 707.5 MHz	15 MHz	CP-OFDM QPSK	1/77	23.2	17.49	2.08	1.94	6.37	
NB	Max - 1		Ant.D	EV-S-NB 24.4 kbit/s	141500 707.5 MHz	15 MHz	CP-OFDM QPSK	36/0	23.2	17.52	1.96	1.68	9.88	
NB	Max - 1		Ant.D	EV-S-NB 24.4 kbit/s	141500 707.5 MHz	15 MHz	CP-OFDM QPSK	36/21	23.2	17.54	2.03	1.81	7.25	
NB	Max - 1		Ant.D	EV-S-NB 24.4 kbit/s	141500 707.5 MHz	15 MHz	CP-OFDM QPSK	36/43	23.2	17.83	2.07	1.90	4.67	
NB	Max - 1		Ant.D	EV-S-NB 24.4 kbit/s	141500 707.5 MHz	15 MHz	CP-OFDM QPSK	75/0	23.2	17.73	2.03	1.86	6.71	
NB	Max - 1		Ant.D	EV-S-NB 24.4 kbit/s	141500 707.5 MHz	15 MHz	CP-OFDM 16QAM	1/1	23.2	17.68	2.01	1.80	5.18	
NB	Max - 1		Ant.D	EV-S-NB 24.4 kbit/s	141500 707.5 MHz	15 MHz	CP-OFDM 64QAM	1/1	23.2	17.60	2.07	1.93	6.34	
NB	Max - 1		Ant.D	EV-S-NB 24.4 kbit/s	141500 707.5 MHz	15 MHz	CP-OFDM 256QAM	1/1	23.2	17.63	1.98	1.85	6.35	
NB	Max - 1		Ant.D	EV-S-NB 24.4 kbit/s	141500 707.5 MHz	10 MHz	DFT-s-OFDM QPSK	1/1	23.2	17.66	2.07	1.80	6.21	
NB	Max - 1		Ant.D	EV-S-NB 24.4 kbit/s	141500 707.5 MHz	5 MHz	DFT-s-OFDM QPSK	1/1	23.2	17.59	2.03	1.88	5.48	
NB	Max - 1		Ant.D	EV-S-NB 24.4 kbit/s	141300 706.5 MHz	15 MHz	DFT-s-OFDM QPSK	1/1	23.2	17.59	2.08	1.92	4.31	
NB	Max - 1		Ant.D	EV-S-NB 24.4 kbit/s	141700 708.5 MHz	15 MHz	DFT-s-OFDM QPSK	1/1	23.2	17.64	1.98	1.81	5.21	
WB	Max - 1		NR Band n7	Ant.E	EV-S-WB 24.4 kbit/s	507000 2535 MHz	40 MHz	DFT-s-OFDM QPSK	1/1	23.2	18.65	2.12	2.40	5.59
NB	Max - 1			Ant.E	EV-S-NB 24.4 kbit/s	507000 2535 MHz	40 MHz	DFT-s-OFDM QPSK	1/1	23.2	17.52	2.00	1.77	8.12
WB	Max - 1		NR Band n25	Ant.E	EV-S-WB 24.4 kbit/s	376500 1882.5 MHz	40 MHz	DFT-s-OFDM QPSK	1/1	23.2	18.62	2.12	2.50	7.34
NB	Max - 1	Ant.E		EV-S-NB 24.4 kbit/s	376500 1882.5 MHz	40 MHz	DFT-s-OFDM QPSK	1/1	23.2	17.49	1.95	1.90	7.47	
WB	Max - 1	NR Band n26	Ant.D	EV-S-WB 24.4 kbit/s	166300 831.5 MHz	20 MHz	DFT-s-OFDM QPSK	1/1	23.2	18.68	2.06	2.40	6.71	
NB	Max - 1		Ant.D	EV-S-NB 24.4 kbit/s	166300 831.5 MHz	20 MHz	DFT-s-OFDM QPSK	1/1	23.2	17.50	2.00	1.90	8.10	
WB	Max - 1	NR Band n30	Ant.E	EV-S-WB 24.4 kbit/s	462000 2310 MHz	10 MHz	DFT-s-OFDM QPSK	1/1	23.2	18.55	2.28	2.50	6.99	
NB	Max - 1		Ant.E	EV-S-NB 24.4 kbit/s	462000 2310 MHz	10 MHz	DFT-s-OFDM QPSK	1/1	23.2	17.38	2.00	1.73	5.68	
WB	Max - 1	NR Band n66	Ant.E	EV-S-WB 24.4 kbit/s	349000 1745 MHz	40 MHz	DFT-s-OFDM QPSK	1/1	23.2	18.55	2.15	2.60	8.49	
NB	Max - 1		Ant.E	EV-S-NB 24.4 kbit/s	349000 1745 MHz	40 MHz	DFT-s-OFDM QPSK	1/1	23.2	17.41	1.98	1.84	6.38	
WB	Max - 1	NR Band n70	Ant.E	EV-S-WB 24.4 kbit/s	340500 1702.5 MHz	15 MHz	DFT-s-OFDM QPSK	1/1	23.2	18.58	2.14	2.60	5.99	
NB	Max - 1		Ant.E	EV-S-NB 24.4 kbit/s	340500 1702.5 MHz	15 MHz	DFT-s-OFDM QPSK	1/1	23.2	17.42	1.91	1.69	5.87	
WB	Max - 1	NR Band n71	Ant.D	EV-S-WB 24.4 kbit/s	136100 680.5 MHz	20 MHz	DFT-s-OFDM QPSK	1/1	23.2	18.61	2.23	2.50	6.20	
NB	Max - 1		Ant.D	EV-S-NB 24.4 kbit/s	136100 680.5 MHz	20 MHz	DFT-s-OFDM QPSK	1/1	23.2	17.51	2.07	1.86	6.52	

2N Mounting Force – VoNR TDD

Codec (NB or WB)	Volume Control Level	Mode / Band	Antenna	Voice Codec / Codec bitrate (kbps)	Channel and Frequency	Bandwidth	Waveform / Modulation	RB (Allocation/ Offset)	Volume Control Results				
									2N				
									Noise (LAF_MAX) (dBA)	Conversational Gain (dB)	Frequency Response Margin (dB)		PN-SDNR margin (dB)
FF	DF												
NB	Max - 1	NR Band n41 PC2	Ant.E	EV-S-NB 24.4 kbit/s	518598 2592.99 MHz	100 MHz	DFT-s-OFDM QPSK	1/1	25.3	17.60	2.11	1.91	7.98
NB	Max - 1		Ant.B	EV-S-NB 24.4 kbit/s	518598 2592.99 MHz	100 MHz	DFT-s-OFDM QPSK	1/1	25.3	17.62	2.25	2.03	8.09
NB	Max - 1		Ant.E	EV-S-NB 24.4 kbit/s	518598 2592.99 MHz	100 MHz	DFT-s-OFDM QPSK	1/136	24.1	17.76	2.22	1.89	7.18
NB	Max - 1		Ant.E	EV-S-NB 24.4 kbit/s	518598 2592.99 MHz	100 MHz	DFT-s-OFDM QPSK	1/271	24.1	17.71	2.21	1.98	9.17
NB	Max - 1		Ant.E	EV-S-NB 24.4 kbit/s	518598 2592.99 MHz	100 MHz	DFT-s-OFDM QPSK	135/0	24.1	17.73	2.19	2.01	7.18
NB	Max - 1		Ant.E	EV-S-NB 24.4 kbit/s	518598 2592.99 MHz	100 MHz	DFT-s-OFDM QPSK	135/69	24.1	17.70	2.15	1.86	8.58
NB	Max - 1		Ant.E	EV-S-NB 24.4 kbit/s	518598 2592.99 MHz	100 MHz	DFT-s-OFDM QPSK	135/138	24.1	17.66	2.16	1.84	7.93
NB	Max - 1		Ant.E	EV-S-NB 24.4 kbit/s	518598 2592.99 MHz	100 MHz	DFT-s-OFDM QPSK	270/0	24.1	17.69	2.13	1.88	8.50
NB	Max - 1		Ant.E	EV-S-NB 24.4 kbit/s	518598 2592.99 MHz	100 MHz	DFT-s-OFDM p1/2 BPSK	1/1	24.1	17.68	2.13	1.97	6.49
NB	Max - 1		Ant.E	EV-S-NB 24.4 kbit/s	518598 2592.99 MHz	100 MHz	DFT-s-OFDM 16QAM	1/1	24.1	17.70	2.12	2.01	8.39
NB	Max - 1		Ant.E	EV-S-NB 24.4 kbit/s	518598 2592.99 MHz	100 MHz	DFT-s-OFDM 64QAM	1/1	24.1	17.63	2.20	1.93	7.30
NB	Max - 1		Ant.E	EV-S-NB 24.4 kbit/s	518598 2592.99 MHz	100 MHz	DFT-s-OFDM 256QAM	1/1	24.1	17.68	2.05	1.95	6.29
NB	Max - 1		Ant.E	EV-S-NB 24.4 kbit/s	518598 2592.99 MHz	100 MHz	CP-OFDM QPSK	1/1	24.1	17.70	2.26	1.97	7.05
NB	Max - 1		Ant.E	EV-S-NB 24.4 kbit/s	518598 2592.99 MHz	100 MHz	CP-OFDM QPSK	1/136	24.1	17.67	2.14	1.86	6.39
NB	Max - 1		Ant.E	EV-S-NB 24.4 kbit/s	518598 2592.99 MHz	100 MHz	CP-OFDM QPSK	1/271	24.1	17.65	2.10	1.91	7.24
NB	Max - 1		Ant.E	EV-S-NB 24.4 kbit/s	518598 2592.99 MHz	100 MHz	CP-OFDM QPSK	135/0	24.1	17.65	2.14	1.79	7.85
NB	Max - 1		Ant.E	EV-S-NB 24.4 kbit/s	518598 2592.99 MHz	100 MHz	CP-OFDM QPSK	135/69	24.1	17.67	2.08	1.82	5.51
NB	Max - 1		Ant.E	EV-S-NB 24.4 kbit/s	518598 2592.99 MHz	100 MHz	CP-OFDM QPSK	135/138	24.1	17.69	2.11	1.94	8.82
NB	Max - 1		Ant.E	EV-S-NB 24.4 kbit/s	518598 2592.99 MHz	100 MHz	CP-OFDM QPSK	270/0	24.1	17.64	2.16	2.02	5.19
NB	Max - 1		Ant.E	EV-S-NB 24.4 kbit/s	518598 2592.99 MHz	100 MHz	CP-OFDM 16QAM	1/1	24.1	17.69	2.19	1.97	7.41
NB	Max - 1		Ant.E	EV-S-NB 24.4 kbit/s	518598 2592.99 MHz	100 MHz	CP-OFDM 64QAM	1/1	24.1	17.69	2.12	1.91	8.98
NB	Max - 1		Ant.E	EV-S-NB 24.4 kbit/s	518598 2592.99 MHz	100 MHz	CP-OFDM 256QAM	1/1	24.1	17.64	2.13	1.92	5.13
NB	Max - 1		Ant.E	EV-S-NB 24.4 kbit/s	518598 2592.99 MHz	90 MHz	DFT-s-OFDM QPSK	1/1	24.1	17.69	2.16	1.92	8.50
NB	Max - 1		Ant.E	EV-S-NB 24.4 kbit/s	518598 2592.99 MHz	80 MHz	DFT-s-OFDM QPSK	1/1	24.1	17.65	2.25	1.99	8.43
NB	Max - 1		Ant.E	EV-S-NB 24.4 kbit/s	518598 2592.99 MHz	70 MHz	DFT-s-OFDM QPSK	1/1	24.1	17.62	2.14	1.88	5.33
NB	Max - 1		Ant.E	EV-S-NB 24.4 kbit/s	518598 2592.99 MHz	60 MHz	DFT-s-OFDM QPSK	1/1	24.1	17.63	2.14	2.03	9.12
NB	Max - 1		Ant.E	EV-S-NB 24.4 kbit/s	518598 2592.99 MHz	50 MHz	DFT-s-OFDM QPSK	1/1	24.1	17.66	2.23	2.06	7.07
NB	Max - 1		Ant.E	EV-S-NB 24.4 kbit/s	518598 2592.99 MHz	40 MHz	DFT-s-OFDM QPSK	1/1	24.1	17.74	2.20	1.90	9.77
NB	Max - 1		Ant.E	EV-S-NB 24.4 kbit/s	518598 2592.99 MHz	30 MHz	DFT-s-OFDM QPSK	1/1	24.1	17.66	2.20	1.87	6.56
NB	Max - 1		Ant.E	EV-S-NB 24.4 kbit/s	518598 2592.99 MHz	25 MHz	DFT-s-OFDM QPSK	1/1	24.1	17.73	2.10	1.90	8.14
NB	Max - 1		Ant.E	EV-S-NB 24.4 kbit/s	518598 2592.99 MHz	20 MHz	DFT-s-OFDM QPSK	1/1	24.1	17.64	2.17	1.86	8.50
NB	Max - 1		Ant.E	EV-S-NB 24.4 kbit/s	518598 2592.99 MHz	15 MHz	DFT-s-OFDM QPSK	1/1	24.1	17.64	2.24	1.92	8.85
NB	Max - 1	Ant.E	EV-S-NB 24.4 kbit/s	518598 2592.99 MHz	10 MHz	DFT-s-OFDM QPSK	1/1	24.1	17.65	2.07	1.89	7.73	
NB	Max - 1	Ant.E	EV-S-NB 24.4 kbit/s	509202 2546.01 MHz	100 MHz	DFT-s-OFDM QPSK	1/1	24.1	17.67	2.11	1.84	9.72	
NB	Max - 1	Ant.E	EV-S-NB 24.4 kbit/s	528000 2640 MHz	100 MHz	DFT-s-OFDM QPSK	1/1	24.1	17.62	2.16	1.91	8.36	
WB	Max - 1	NR Band n48	Ant.E	EV-S-WB 24.4 kbit/s	641666 3624.99 MHz	40 MHz	DFT-s-OFDM QPSK	1/1	24.1	18.76	2.23	2.70	5.85
NB	Max - 1		Ant.E	EV-S-NB 24.4 kbit/s	641666 3624.99 MHz	40 MHz	DFT-s-OFDM QPSK	1/1	24.1	17.67	2.02	1.90	6.48
WB	Max - 1	NR Band n77	Ant.E	EV-S-WB 24.4 kbit/s	650000 3750 MHz	100 MHz	DFT-s-OFDM QPSK	1/1	24.1	18.78	2.31	2.60	8.06
NB	Max - 1		Ant.E	EV-S-NB 24.4 kbit/s	650000 3750 MHz	100 MHz	DFT-s-OFDM QPSK	1/1	24.1	17.60	2.10	1.82	6.85

2N Mounting Force – VoWiFi

Codec (NB or WB)	Volume Control Level	Mode / Band	Antenna	Voice Codec / Codec bitrate (kbps)	Channel and Frequency	Bandwidth	Waveform / Modulation	RB (Allocation/ Offset)	Volume Control Results				
									2N				
									Noise (LAF_MAX) (dBA)	Conversational Gain (dB)	Frequency Response Margin (dB)		PN-SDNR margin (dB)
FF	DF												
NB	Max - 1	WiFi 2.4GHz 802.11b	MIMO	EV-S-NB 24.4 kbit/s	CH.6 2437 MHz	20 MHz	DSSS 1 Mbps	N/A	23.9	16.80	2.24	1.91	6.81
NB	Max - 1		SISO Ant.1	EV-S-NB 24.4 kbit/s	CH.6 2437 MHz	20 MHz	DSSS 1 Mbps	N/A	23.9	17.03	2.17	1.86	8.54
NB	Max - 1		SISO Ant.2	EV-S-NB 24.4 kbit/s	CH.6 2437 MHz	20 MHz	DSSS 1 Mbps	N/A	23.9	17.00	2.13	1.82	9.96
NB	Max - 1		MIMO	EV-S-NB 24.4 kbit/s	CH.6 2437 MHz	20 MHz	CCK 5.5 Mbps	N/A	23.9	17.00	2.19	1.86	11.16
NB	Max - 1		MIMO	EV-S-NB 24.4 kbit/s	CH.6 2437 MHz	20 MHz	CCK 11 Mbps	N/A	23.9	17.01	2.27	1.93	8.28
NB	Max - 1		MIMO	EV-S-NB 24.4 kbit/s	CH.1 2412 MHz	20 MHz	DSSS 1 Mbps	N/A	23.9	16.99	2.19	1.86	6.34
NB	Max - 1		MIMO	EV-S-NB 24.4 kbit/s	CH.11 2462 MHz	20 MHz	DSSS 1 Mbps	N/A	23.9	16.98	2.24	1.93	8.96
WB	Max - 1	WiFi 2.4GHz 802.11g	MIMO	EV-S-WB 24.4 kbit/s	CH.6 2437 MHz	20 MHz	BPSK 6 Mbps	N/A	23.9	17.89	2.18	2.20	7.67
NB	Max - 1		MIMO	EV-S-NB 24.4 kbit/s	CH.6 2437 MHz	20 MHz	BPSK 6 Mbps	N/A	23.9	17.00	2.17	1.86	10.40
WB	Max - 1	WiFi 2.4GHz 802.11n HT20	MIMO	EV-S-WB 24.4 kbit/s	CH.6 2437 MHz	20 MHz	MCS 7 65 Mbps	N/A	23.9	17.85	2.17	2.30	5.19
NB	Max - 1		MIMO	EV-S-NB 24.4 kbit/s	CH.6 2437 MHz	20 MHz	MCS 7 65 Mbps	N/A	23.9	17.03	2.21	1.88	11.93
WB	Max - 1	WiFi 2.4GHz 802.11ac VHT20	MIMO	EV-S-WB 24.4 kbit/s	CH.6 2437 MHz	20 MHz	MCS 8 78 Mbps	N/A	25.7	18.05	2.25	2.30	5.66
NB	Max - 1		MIMO	EV-S-NB 24.4 kbit/s	CH.6 2437 MHz	20 MHz	MCS 8 78 Mbps	N/A	25.7	17.13	2.30	1.97	9.17
WB	Max - 1	WiFi 2.4GHz 802.11ax HE20	MIMO	EV-S-WB 24.4 kbit/s	CH.6 2437 MHz	20 MHz	MCS 6 77 Mbps	N/A	25.7	18.06	2.17	2.20	5.35
NB	Max - 1		MIMO	EV-S-NB 24.4 kbit/s	CH.6 2437 MHz	20 MHz	MCS 6 77 Mbps	N/A	25.7	17.18	2.25	1.95	9.55
NB	Max - 1	WiFi 5GHz 802.11a U-NII-1	MIMO	EV-S-NB 24.4 kbit/s	CH.40 5200 MHz	20 MHz	BPSK 6 Mbps	N/A	25.7	16.98	2.26	1.93	10.73
NB	Max - 1		SISO Ant.1	EV-S-NB 24.4 kbit/s	CH.40 5200 MHz	20 MHz	BPSK 6 Mbps	N/A	23.3	17.13	2.24	1.92	12.52
NB	Max - 1		SISO Ant.2	EV-S-NB 24.4 kbit/s	CH.40 5200 MHz	20 MHz	BPSK 6 Mbps	N/A	23.3	17.08	2.23	1.93	11.41
NB	Max - 1		MIMO	EV-S-NB 24.4 kbit/s	CH.40 5200 MHz	20 MHz	QPSK 18 Mbps	N/A	23.3	17.11	2.22	1.89	11.14
NB	Max - 1		MIMO	EV-S-NB 24.4 kbit/s	CH.40 5200 MHz	20 MHz	64QAM 54 Mbps	N/A	23.3	17.09	2.26	1.93	10.10
NB	Max - 1		MIMO	EV-S-NB 24.4 kbit/s	CH.36 5180 MHz	20 MHz	BPSK 6 Mbps	N/A	23.3	17.10	2.27	1.94	9.96
NB	Max - 1		MIMO	EV-S-NB 24.4 kbit/s	CH.48 5240 MHz	20 MHz	BPSK 6 Mbps	N/A	23.3	17.11	2.23	1.92	8.15
NB	Max - 1		MIMO	EV-S-NB 24.4 kbit/s	CH.40 5200 MHz	20 MHz	MCS 0 6.5 Mbps	N/A	23.3	17.13	2.21	1.88	10.16
NB	Max - 1		MIMO	EV-S-NB 24.4 kbit/s	CH.40 5200 MHz	20 MHz	MCS 3 26 Mbps	N/A	23.3	17.07	2.25	1.94	10.59
NB	Max - 1		MIMO	EV-S-NB 24.4 kbit/s	CH.40 5200 MHz	20 MHz	MCS 7 65 Mbps	N/A	23.3	17.06	2.30	1.99	7.43
WB	Max - 1	MIMO	EV-S-WB 24.4 kbit/s	CH.40 5200 MHz	20 MHz	MCS 7 65 Mbps	N/A	23.3	17.99	2.24	2.30	5.89	
NB	Max - 1	WiFi 5GHz 802.11n HT40 U-NII-1	MIMO	EV-S-NB 24.4 kbit/s	CH.38 5190 MHz	40 MHz	MCS 0 13.5 Mbps	N/A	23.3	17.07	2.24	1.93	10.74
NB	Max - 1		MIMO	EV-S-NB 24.4 kbit/s	CH.38 5190 MHz	40 MHz	MCS 3 54 Mbps	N/A	23.3	17.05	2.24	1.93	8.23
NB	Max - 1		MIMO	EV-S-NB 24.4 kbit/s	CH.38 5190 MHz	40 MHz	MCS 7 135 Mbps	N/A	23.3	17.04	2.27	1.95	9.04
WB	Max - 1		MIMO	EV-S-WB 24.4 kbit/s	CH.38 5190 MHz	40 MHz	MCS 7 135 Mbps	N/A	23.3	17.92	2.16	2.20	6.96

2N Mounting Force – VoWiFi (Continued)

Codec (NB or WB)	Volume Control Level	Mode / Band	Antenna	Voice Codec / Codec bitrate (kbps)	Channel and Frequency	Bandwidth	Waveform / Modulation	RB (Allocation/ Offset)	Volume Control Results				
									Noise (LAF_MAX) (dBA)	Conversational Gain (dB)	Frequency Response Margin (dB)		PN-SDNR margin (dB)
											FF	DF	
NB	Max - 1	WiFi 5GHz 802.11ac VHT20 U-NII-1	MIMO	EV-S-NB 24.4 kbit/s	CH.40 5200 MHz	20 MHz	MCS 0 6.5 Mbps	N/A	23.3	17.11	2.23	1.90	10.55
NB	Max - 1		MIMO	EV-S-NB 24.4 kbit/s	CH.40 5200 MHz	20 MHz	MCS 4 39 Mbps	N/A	23.3	17.09	2.27	1.94	11.32
NB	Max - 1		MIMO	EV-S-NB 24.4 kbit/s	CH.40 5200 MHz	20 MHz	MCS 8 78 Mbps	N/A	23.3	17.08	2.24	1.93	8.64
WB	Max - 1		MIMO	EV-S-WB 24.4 kbit/s	CH.40 5200 MHz	20 MHz	MCS 8 78 Mbps	N/A	23.3	17.94	2.17	2.20	5.82
NB	Max - 1	WiFi 5GHz 802.11ac VHT40 U-NII-1	MIMO	EV-S-NB 24.4 kbit/s	CH.38 5190 MHz	40 MHz	MCS 0 13.5 Mbps	N/A	23.3	17.04	2.31	1.99	10.15
NB	Max - 1		MIMO	EV-S-NB 24.4 kbit/s	CH.38 5190 MHz	40 MHz	MCS 4 108 Mbps	N/A	23.3	17.05	2.28	1.95	9.45
NB	Max - 1		MIMO	EV-S-NB 24.4 kbit/s	CH.38 5190 MHz	40 MHz	MCS 9 180 Mbps	N/A	23.3	17.05	2.23	1.89	6.73
WB	Max - 1		MIMO	EV-S-WB 24.4 kbit/s	CH.38 5190 MHz	40 MHz	MCS 0 13.5 Mbps	N/A	23.3	17.95	2.26	2.30	5.12
NB	Max - 1	WiFi 5GHz 802.11ac VHT80 U-NII-1	MIMO	EV-S-NB 24.4 kbit/s	CH.42 5210 MHz	80 MHz	MCS 0 29.3 Mbps	N/A	23.3	17.03	2.25	1.94	10.91
NB	Max - 1		MIMO	EV-S-NB 24.4 kbit/s	CH.42 5210 MHz	80 MHz	MCS 4 175.5 Mbps	N/A	23.3	17.01	2.27	1.96	8.65
NB	Max - 1		MIMO	EV-S-NB 24.4 kbit/s	CH.42 5210 MHz	80 MHz	MCS 9 390 Mbps	N/A	25.7	17.16	2.22	1.92	11.54
WB	Max - 1		MIMO	EV-S-WB 24.4 kbit/s	CH.42 5210 MHz	80 MHz	MCS 4 175.5 Mbps	N/A	25.7	17.99	2.28	2.30	7.38
NB	Max - 1	WiFi 5GHz 802.11ac VHT160 U-NII-1&2A	MIMO	EV-S-NB 24.4 kbit/s	CH.50 5250 MHz	160 MHz	MCS 0 58.5 Mbps	N/A	25.7	17.14	2.26	1.93	9.29
NB	Max - 1		MIMO	EV-S-NB 24.4 kbit/s	CH.50 5250 MHz	160 MHz	MCS 4 351 Mbps	N/A	23.3	17.47	2.31	1.98	8.51
NB	Max - 1		MIMO	EV-S-NB 24.4 kbit/s	CH.50 5250 MHz	160 MHz	MCS 9 780 Mbps	N/A	23.3	17.50	2.22	1.91	9.34
WB	Max - 1		MIMO	EV-S-WB 24.4 kbit/s	CH.50 5250 MHz	160 MHz	MCS 0 58.5 Mbps	N/A	25.7	18.05	2.24	2.30	7.88
NB	Max - 1	WiFi 5GHz 802.11ax HE20 U-NII-1	MIMO	EV-S-NB 24.4 kbit/s	CH.40 5200 MHz	20 MHz	MCS 0 8.6 Mbps	N/A	23.3	17.48	2.25	1.94	9.71
NB	Max - 1		MIMO	EV-S-NB 24.4 kbit/s	CH.40 5200 MHz	20 MHz	MCS 6 77 Mbps	N/A	23.3	17.47	2.33	2.00	12.04
NB	Max - 1		MIMO	EV-S-NB 24.4 kbit/s	CH.40 5200 MHz	20 MHz	MCS 11 143 Mbps	N/A	23.3	17.52	2.18	1.88	11.76
WB	Max - 1		MIMO	EV-S-WB 24.4 kbit/s	CH.40 5200 MHz	20 MHz	MCS 6 77 Mbps	N/A	23.3	18.37	2.14	2.20	8.99
NB	Max - 1	WiFi 5GHz 802.11ax HE40 U-NII-1	MIMO	EV-S-NB 24.4 kbit/s	CH.38 5190 MHz	40 MHz	MCS 0 17.2 Mbps	N/A	23.3	17.52	2.23	1.92	8.85
NB	Max - 1		MIMO	EV-S-NB 24.4 kbit/s	CH.38 5190 MHz	40 MHz	MCS 6 155 Mbps	N/A	23.3	17.50	2.21	1.88	10.18
NB	Max - 1		MIMO	EV-S-NB 24.4 kbit/s	CH.38 5190 MHz	40 MHz	MCS 11 287 Mbps	N/A	23.3	17.56	2.15	1.85	6.88
WB	Max - 1		MIMO	EV-S-WB 24.4 kbit/s	CH.38 5190 MHz	40 MHz	MCS 6 155 Mbps	N/A	23.3	18.39	2.20	2.20	7.41
NB	Max - 1	WiFi 5GHz 802.11ax HE80 U-NII-1	MIMO	EV-S-NB 24.4 kbit/s	CH.42 5210 MHz	80 MHz	MCS 0 36 Mbps	N/A	23.3	17.55	2.25	1.95	10.02
NB	Max - 1		MIMO	EV-S-NB 24.4 kbit/s	CH.42 5210 MHz	80 MHz	MCS 6 324 Mbps	N/A	23.3	17.57	2.20	1.89	10.34
NB	Max - 1		MIMO	EV-S-NB 24.4 kbit/s	CH.42 5210 MHz	80 MHz	MCS 11 600 Mbps	N/A	23.3	17.58	2.26	1.95	10.61
WB	Max - 1		MIMO	EV-S-WB 24.4 kbit/s	CH.42 5210 MHz	80 MHz	MCS 0 36 Mbps	N/A	23.3	18.38	2.20	2.20	7.26
NB	Max - 1	WiFi 5GHz 802.11ax HE160 U-NII-1&2A	MIMO	EV-S-NB 24.4 kbit/s	CH.50 5250 MHz	160 MHz	MCS 0 72.1 Mbps	N/A	23.3	17.40	2.11	1.80	12.04
NB	Max - 1		MIMO	EV-S-NB 24.4 kbit/s	CH.50 5250 MHz	160 MHz	MCS 6 648.5 Mbps	N/A	23.3	17.28	2.08	1.77	10.30
NB	Max - 1		MIMO	EV-S-NB 24.4 kbit/s	CH.50 5250 MHz	160 MHz	MCS 11 1201 Mbps	N/A	23.3	17.69	2.08	1.77	11.86
WB	Max - 1		MIMO	EV-S-WB 24.4 kbit/s	CH.50 5250 MHz	160 MHz	MCS 6 648.5 Mbps	N/A	23.3	18.48	2.16	2.20	5.76
WB	Max - 1	WiFi 5GHz 802.11a U-NII-2A	MIMO	EV-S-WB 24.4 kbit/s	CH.56 5280 MHz	20 MHz	BPSK 6 Mbps	N/A	25.7	18.09	2.22	2.20	5.53
NB	Max - 1	WiFi 5GHz 802.11a U-NII-2C	MIMO	EV-S-NB 24.4 kbit/s	CH.56 5280 MHz	20 MHz	BPSK 6 Mbps	N/A	25.7	17.27	2.19	1.86	10.97
WB	Max - 1		MIMO	EV-S-WB 24.4 kbit/s	CH.120 5600 MHz	20 MHz	BPSK 6 Mbps	N/A	25.7	18.03	2.22	2.20	5.98
NB	Max - 1	WiFi 5GHz 802.11a U-NII-3	MIMO	EV-S-NB 24.4 kbit/s	CH.120 5600 MHz	20 MHz	BPSK 6 Mbps	N/A	25.7	17.23	2.22	1.92	6.65
WB	Max - 1		MIMO	EV-S-WB 24.4 kbit/s	CH.157 5785 MHz	20 MHz	BPSK 6 Mbps	N/A	25.7	18.04	2.20	2.30	5.66
NB	Max - 1	WiFi 5GHz 802.11a U-NII-4	MIMO	EV-S-NB 24.4 kbit/s	CH.157 5785 MHz	20 MHz	BPSK 6 Mbps	N/A	25.7	17.17	2.28	1.97	10.50
WB	Max - 1		MIMO	EV-S-WB 24.4 kbit/s	CH.173 5865 MHz	20 MHz	BPSK 6 Mbps	N/A	25.7	18.06	2.10	2.10	6.87
NB	Max - 1	WiFi 5GHz 802.11ax U-NII-5	MIMO	EV-S-NB 24.4 kbit/s	CH.173 5865 MHz	20 MHz	BPSK 6 Mbps	N/A	25.7	17.21	2.29	1.98	10.73
WB	Max - 1		MIMO	EV-S-WB 24.4 kbit/s	CH.5 5975 MHz	20 MHz	BPSK 6 Mbps	N/A	26.2	18.28	2.03	2.20	6.20
NB	Max - 1		MIMO	EV-S-NB 24.4 kbit/s	CH.5 5975 MHz	20 MHz	BPSK 6 Mbps	N/A	26.2	17.34	1.87	1.56	8.20

8N Mounting Force – VoLTE FDD

Codec (NB or WB)	Volume Control Level	Mode / Band	Antenna	Voice Codec / Codec bitrate (kbps)	Channel and Frequency	Bandwidth	Waveform / Modulation	RB (Allocation/ Offset)	Volume Control Results					
									8N					
									Noise (LAF_MAX) (dBA)	Conversational Gain (dB)	Frequency Response Margin (dB)		PN-SDNR margin (dB)	
FF	DF													
NB	Max - 1	LTE Band 66	Ant.B	EV-S-NB 24.4 kbit/s	132322 1745 MHz	20 MHz	QPSK	1/0	24.6	19.99	2.09	1.88	10.70	
NB	Max - 1		Ant.E	EV-S-NB 24.4 kbit/s	132322 1745 MHz	20 MHz	QPSK	1/0	24.6	20.06	2.06	1.80	6.00	
NB	Max - 1		Ant.B	EV-S-NB 24.4 kbit/s	132322 1745 MHz	20 MHz	QPSK	1/49	24.6	20.03	2.06	1.98	10.80	
NB	Max - 1		Ant.B	EV-S-NB 24.4 kbit/s	132322 1745 MHz	20 MHz	QPSK	1/99	24.6	20.04	2.24	1.88	11.90	
NB	Max - 1		Ant.B	EV-S-NB 24.4 kbit/s	132322 1745 MHz	20 MHz	QPSK	50/0	24.6	20.01	2.17	1.83	11.70	
NB	Max - 1		Ant.B	EV-S-NB 24.4 kbit/s	132322 1745 MHz	20 MHz	QPSK	50/24	24.6	20.03	2.19	1.88	11.50	
NB	Max - 1		Ant.B	EV-S-NB 24.4 kbit/s	132322 1745 MHz	20 MHz	QPSK	50/50	24.6	20.01	2.19	1.88	10.40	
NB	Max - 1		Ant.B	EV-S-NB 24.4 kbit/s	132322 1745 MHz	20 MHz	QPSK	100/0	24.6	20.00	2.12	1.86	10.90	
NB	Max - 1		Ant.B	EV-S-NB 24.4 kbit/s	132322 1745 MHz	20 MHz	16QAM	1/0	24.6	20.01	2.11	1.87	11.10	
NB	Max - 1		Ant.B	EV-S-NB 24.4 kbit/s	132322 1745 MHz	20 MHz	64QAM	1/0	24.6	20.09	2.04	1.95	11.20	
NB	Max - 1		Ant.B	EV-S-NB 24.4 kbit/s	132322 1745 MHz	20 MHz	256QAM	1/0	24.6	20.02	2.04	1.84	9.20	
NB	Max - 1		Ant.B	EV-S-NB 24.4 kbit/s	132322 1745 MHz	15 MHz	QPSK	1/0	24.6	20.15	2.16	1.90	12.00	
NB	Max - 1		Ant.B	EV-S-NB 24.4 kbit/s	132322 1745 MHz	10 MHz	QPSK	1/0	24.6	20.07	2.03	1.81	11.80	
NB	Max - 1		Ant.B	EV-S-NB 24.4 kbit/s	132322 1745 MHz	5 MHz	QPSK	1/0	24.6	20.08	1.95	1.76	11.30	
NB	Max - 1		Ant.B	EV-S-NB 24.4 kbit/s	132322 1745 MHz	3 MHz	QPSK	1/0	24.6	20.13	2.07	1.82	10.80	
NB	Max - 1		Ant.B	EV-S-NB 24.4 kbit/s	132322 1745 MHz	1.4 MHz	QPSK	1/0	24.6	20.15	2.04	1.84	10.20	
NB	Max - 1		Ant.B	EV-S-NB 24.4 kbit/s	132072 1720 MHz	20 MHz	QPSK	1/0	24.6	20.13	2.05	1.78	10.50	
NB	Max - 1		Ant.B	EV-S-NB 24.4 kbit/s	132572 1770 MHz	20 MHz	QPSK	1/0	24.6	20.06	2.15	1.85	11.90	
WB	Max - 1		LTE Band 7	Ant.B	EV-S-WB 24.4 kbit/s	21100 2535 MHz	20 MHz	QPSK	1/0	24.6	20.78	2.17	2.00	6.10
NB	Max - 1			Ant.B	EV-S-NB 24.4 kbit/s	21100 2535 MHz	20 MHz	QPSK	1/0	24.6	20.03	1.91	1.75	8.90
WB	Max - 1	LTE Band 12	Ant.A	EV-S-WB 24.4 kbit/s	23095 707.5 MHz	10 MHz	QPSK	1/0	24.6	21.07	2.31	2.20	6.30	
NB	Max - 1		Ant.A	EV-S-NB 24.4 kbit/s	23095 707.5 MHz	10 MHz	QPSK	1/0	24.6	20.17	2.06	1.83	12.40	
WB	Max - 1	LTE Band 13	Ant.A	EV-S-WB 24.4 kbit/s	23230 782 MHz	10 MHz	QPSK	1/0	24.6	20.85	2.24	2.00	6.90	
NB	Max - 1		Ant.A	EV-S-NB 24.4 kbit/s	23230 782 MHz	10 MHz	QPSK	1/0	24.6	20.07	1.99	1.78	11.20	
WB	Max - 1	LTE Band 14	Ant.A	EV-S-WB 24.4 kbit/s	23330 793 MHz	10 MHz	QPSK	1/0	24.6	20.76	2.16	2.00	7.50	
NB	Max - 1		Ant.A	EV-S-NB 24.4 kbit/s	23330 793 MHz	10 MHz	QPSK	1/0	24.6	20.02	2.02	1.78	11.70	
WB	Max - 1	LTE Band 25	Ant.B	EV-S-WB 24.4 kbit/s	26365 1882.5 MHz	20 MHz	QPSK	1/0	24.6	20.77	2.18	2.00	5.20	
NB	Max - 1		Ant.B	EV-S-NB 24.4 kbit/s	26365 1882.5 MHz	20 MHz	QPSK	1/0	24.6	20.00	2.00	1.91	7.90	
WB	Max - 1	LTE Band 26	Ant.A	EV-S-WB 24.4 kbit/s	26865 831.5 MHz	15 MHz	QPSK	1/0	24.6	20.71	2.13	2.00	7.10	
NB	Max - 1		Ant.A	EV-S-NB 24.4 kbit/s	26865 831.5 MHz	15 MHz	QPSK	1/0	24.6	20.03	2.14	1.83	10.50	
WB	Max - 1	LTE Band 30	Ant.B	EV-S-WB 24.4 kbit/s	27710 2310 MHz	10 MHz	QPSK	1/0	24.6	20.72	2.20	2.00	5.40	
NB	Max - 1		Ant.B	EV-S-NB 24.4 kbit/s	27710 2310 MHz	10 MHz	QPSK	1/0	24.6	19.93	2.12	1.82	10.20	
WB	Max - 1	LTE Band 71	Ant.A	EV-S-WB 24.4 kbit/s	133297 680.5 MHz	20 MHz	QPSK	1/0	24.6	20.76	2.16	2.00	5.40	
NB	Max - 1		Ant.A	EV-S-NB 24.4 kbit/s	133297 680.5 MHz	20 MHz	QPSK	1/0	24.6	20.03	2.12	1.79	8.10	

8N Mounting Force – VoLTE TDD

Codec (NB or WB)	Volume Control Level	Mode / Band	Antenna	Voice Codec / Codec bitrate (kbps)	Channel and Frequency	Bandwidth	Waveform / Modulation	RB (Allocation/ Offset)	Volume Control Results				
									8N				
									Noise (LAF_MAX) (dBA)	Conversational Gain (dB)	Frequency Response Margin (dB)		PN-SDNR margin (dB)
FF	DF												
NB	Max - 1	LTE Band 41 PC2	Ant.B	EV-S-NB 24.4 kbit/s	40620 2593 MHz	20 MHz	QPSK	1/0	24.4	19.95	2.10	1.95	12.40
NB	Max - 1		Ant.B	EV-S-NB 24.4 kbit/s	40620 2593 MHz	20 MHz	QPSK	1/49	24.4	20.02	2.01	1.94	11.50
NB	Max - 1		Ant.B	EV-S-NB 24.4 kbit/s	40620 2593 MHz	20 MHz	QPSK	1/99	24.4	20.03	2.12	1.86	12.70
NB	Max - 1		Ant.B	EV-S-NB 24.4 kbit/s	40620 2593 MHz	20 MHz	QPSK	50/0	24.4	20.00	1.99	1.84	7.30
NB	Max - 1		Ant.B	EV-S-NB 24.4 kbit/s	40620 2593 MHz	20 MHz	QPSK	50/24	24.4	20.04	2.00	1.89	11.10
NB	Max - 1		Ant.B	EV-S-NB 24.4 kbit/s	40620 2593 MHz	20 MHz	QPSK	50/50	24.4	20.01	1.97	1.84	11.20
NB	Max - 1		Ant.B	EV-S-NB 24.4 kbit/s	40620 2593 MHz	20 MHz	QPSK	100/0	24.4	19.99	1.92	1.92	10.90
NB	Max - 1		Ant.B	EV-S-NB 24.4 kbit/s	40620 2593 MHz	20 MHz	16QAM	1/0	24.4	20.03	2.22	1.93	11.30
NB	Max - 1		Ant.B	EV-S-NB 24.4 kbit/s	40620 2593 MHz	20 MHz	64QAM	1/0	24.4	19.99	2.10	1.91	11.10
NB	Max - 1		Ant.B	EV-S-NB 24.4 kbit/s	40620 2593 MHz	20 MHz	256QAM	1/0	24.4	20.02	1.98	1.87	8.70
NB	Max - 1		Ant.B	EV-S-NB 24.4 kbit/s	40620 2593 MHz	15 MHz	QPSK	1/0	24.4	20.00	2.11	1.93	11.60
NB	Max - 1		Ant.B	EV-S-NB 24.4 kbit/s	40620 2593 MHz	10 MHz	QPSK	1/0	24.4	19.99	1.90	1.89	11.80
NB	Max - 1		Ant.B	EV-S-NB 24.4 kbit/s	40620 2593 MHz	5 MHz	QPSK	1/0	24.4	19.96	2.20	2.00	11.30
NB	Max - 1		Ant.B	EV-S-NB 24.4 kbit/s	39750 2506 MHz	20 MHz	QPSK	1/0	24.4	19.99	2.01	1.86	11.40
NB	Max - 1		Ant.B	EV-S-NB 24.4 kbit/s	40185 2549.5 MHz	20 MHz	QPSK	1/0	24.4	20.04	1.80	1.87	10.20
NB	Max - 1		Ant.B	EV-S-NB 24.4 kbit/s	41055 2636.5 MHz	20 MHz	QPSK	1/0	24.4	20.01	1.87	1.86	10.50
NB	Max - 1		Ant.B	EV-S-NB 24.4 kbit/s	41490 2680 MHz	20 MHz	QPSK	1/0	24.4	19.98	1.89	1.94	10.90
WB	Max - 1		LTE Band 41 PC3	Ant.B	EV-S-WB 24.4 kbit/s	40620 2593 MHz	20 MHz	QPSK	1/0	24.6	20.99	2.25	2.20
NB	Max - 1	Ant.B		EV-S-NB 24.4 kbit/s	40620 2593 MHz	20 MHz	QPSK	1/0	24.6	20.26	2.09	1.93	12.50
WB	Max - 1	LTE Band 48	Ant.E	EV-S-WB 24.4 kbit/s	55773 3603.3 MHz	20 MHz	QPSK	1/0	24.6	20.93	2.17	2.20	7.90
NB	Max - 1		Ant.E	EV-S-NB 24.4 kbit/s	55773 3603.3 MHz	20 MHz	QPSK	1/0	24.6	20.14	2.27	1.94	8.50

8N Mounting Force – VoNR FDD

Codec (NB or WB)	Volume Control Level	Mode / Band	Antenna	Voice Codec / Codec bitrate (kbps)	Channel and Frequency	Bandwidth	Waveform / Modulation	RB (Allocation/ Offset)	Volume Control Results					
									8N					
									Noise (LAF_MAX) (dBA)	Conversational Gain (dB)	Frequency Response Margin (dB)		PN-SDNR margin (dB)	
		FF	DF											
NB	Max - 1	NR Band n12	Ant.D	EV-S-NB 24.4 kbit/s	141500 707.5 MHz	15 MHz	DFT-s-OFDM QPSK	1/1	22.4	20.31	1.92	1.70	4.80	
NB	Max - 1		Ant.A+B	EV-S-NB 24.4 kbit/s	141500 707.5 MHz	15 MHz	DFT-s-OFDM QPSK	1/1	26.2	20.39	2.01	1.80	9.60	
NB	Max - 1		Ant.A	EV-S-NB 24.4 kbit/s	141500 707.5 MHz	15 MHz	DFT-s-OFDM QPSK	1/1	23.2	20.68	2.08	1.69	8.50	
NB	Max - 1		Ant.D	EV-S-NB 24.4 kbit/s	141500 707.5 MHz	15 MHz	DFT-s-OFDM QPSK	1/39	26.2	20.41	2.01	1.78	5.30	
NB	Max - 1		Ant.D	EV-S-NB 24.4 kbit/s	141500 707.5 MHz	15 MHz	DFT-s-OFDM QPSK	1/77	26.2	20.42	1.99	1.64	7.80	
NB	Max - 1		Ant.D	EV-S-NB 24.4 kbit/s	141500 707.5 MHz	15 MHz	DFT-s-OFDM QPSK	36/0	26.2	20.44	1.99	1.75	8.50	
NB	Max - 1		Ant.D	EV-S-NB 24.4 kbit/s	141500 707.5 MHz	15 MHz	DFT-s-OFDM QPSK	36/21	26.2	20.37	2.00	1.78	4.70	
NB	Max - 1		Ant.D	EV-S-NB 24.4 kbit/s	141500 707.5 MHz	15 MHz	DFT-s-OFDM QPSK	36/43	26.2	20.40	2.04	1.82	9.10	
NB	Max - 1		Ant.D	EV-S-NB 24.4 kbit/s	141500 707.5 MHz	15 MHz	DFT-s-OFDM QPSK	75/0	26.2	20.34	2.04	1.74	9.20	
NB	Max - 1		Ant.D	EV-S-NB 24.4 kbit/s	141500 707.5 MHz	15 MHz	DFT-s-OFDM pi/2 BPSK	1/1	26.2	20.63	2.04	1.80	5.90	
NB	Max - 1		Ant.D	EV-S-NB 24.4 kbit/s	141500 707.5 MHz	15 MHz	DFT-s-OFDM 16QAM	1/1	26.2	20.66	2.05	1.72	4.70	
NB	Max - 1		Ant.D	EV-S-NB 24.4 kbit/s	141500 707.5 MHz	15 MHz	DFT-s-OFDM 64QAM	1/1	26.2	20.59	2.09	1.75	6.80	
NB	Max - 1		Ant.D	EV-S-NB 24.4 kbit/s	141500 707.5 MHz	15 MHz	DFT-s-OFDM 256QAM	1/1	26.2	20.73	2.06	1.72	8.40	
NB	Max - 1		Ant.D	EV-S-NB 24.4 kbit/s	141500 707.5 MHz	15 MHz	CP-OFDM QPSK	1/1	26.2	20.64	2.08	1.73	9.60	
NB	Max - 1		Ant.D	EV-S-NB 24.4 kbit/s	141500 707.5 MHz	15 MHz	CP-OFDM QPSK	1/39	26.2	20.69	2.03	1.76	6.90	
NB	Max - 1		Ant.D	EV-S-NB 24.4 kbit/s	141500 707.5 MHz	15 MHz	CP-OFDM QPSK	1/77	26.2	20.59	2.01	1.64	6.80	
NB	Max - 1		Ant.D	EV-S-NB 24.4 kbit/s	141500 707.5 MHz	15 MHz	CP-OFDM QPSK	36/0	26.2	20.53	2.04	1.81	8.90	
NB	Max - 1		Ant.D	EV-S-NB 24.4 kbit/s	141500 707.5 MHz	15 MHz	CP-OFDM QPSK	36/21	26.2	20.56	1.99	1.71	5.80	
NB	Max - 1		Ant.D	EV-S-NB 24.4 kbit/s	141500 707.5 MHz	15 MHz	CP-OFDM QPSK	36/43	26.2	20.57	2.10	1.82	8.00	
NB	Max - 1		Ant.D	EV-S-NB 24.4 kbit/s	141500 707.5 MHz	15 MHz	CP-OFDM QPSK	75/0	26.2	20.48	2.08	1.78	8.20	
NB	Max - 1		Ant.D	EV-S-NB 24.4 kbit/s	141500 707.5 MHz	15 MHz	CP-OFDM 16QAM	1/1	26.2	20.48	2.03	1.72	6.70	
NB	Max - 1		Ant.D	EV-S-NB 24.4 kbit/s	141500 707.5 MHz	15 MHz	CP-OFDM 64QAM	1/1	26.2	20.50	1.94	1.73	9.20	
NB	Max - 1		Ant.D	EV-S-NB 24.4 kbit/s	141500 707.5 MHz	15 MHz	CP-OFDM 256QAM	1/1	26.2	20.56	2.05	1.83	9.20	
NB	Max - 1		Ant.D	EV-S-NB 24.4 kbit/s	141500 707.5 MHz	10 MHz	DFT-s-OFDM QPSK	1/1	26.2	20.51	2.01	1.79	6.90	
NB	Max - 1		Ant.D	EV-S-NB 24.4 kbit/s	141500 707.5 MHz	5 MHz	DFT-s-OFDM QPSK	1/1	26.2	20.49	1.95	1.73	5.80	
NB	Max - 1		Ant.D	EV-S-NB 24.4 kbit/s	141300 706.5 MHz	15 MHz	DFT-s-OFDM QPSK	1/1	26.2	20.41	1.98	1.78	10.90	
NB	Max - 1		Ant.D	EV-S-NB 24.4 kbit/s	141700 708.5 MHz	15 MHz	DFT-s-OFDM QPSK	1/1	26.2	20.47	2.11	1.92	6.20	
WB	Max - 1		NR Band n7	Ant.E	EV-S-WB 24.4 kbit/s	507000 2535 MHz	40 MHz	DFT-s-OFDM QPSK	1/1	26.2	21.48	2.24	2.60	6.90
NB	Max - 1			Ant.E	EV-S-NB 24.4 kbit/s	507000 2535 MHz	40 MHz	DFT-s-OFDM QPSK	1/1	26.2	20.36	2.02	1.77	7.60
WB	Max - 1		NR Band n25	Ant.E	EV-S-WB 24.4 kbit/s	376500 1882.5 MHz	40 MHz	DFT-s-OFDM QPSK	1/1	26.2	21.46	2.21	2.60	5.40
NB	Max - 1	Ant.E		EV-S-NB 24.4 kbit/s	376500 1882.5 MHz	40 MHz	DFT-s-OFDM QPSK	1/1	26.2	20.29	1.99	1.60	7.50	
WB	Max - 1	NR Band n26	Ant.D	EV-S-WB 24.4 kbit/s	166300 831.5 MHz	20 MHz	DFT-s-OFDM QPSK	1/1	26.2	21.46	2.17	2.50	6.00	
NB	Max - 1		Ant.D	EV-S-NB 24.4 kbit/s	166300 831.5 MHz	20 MHz	DFT-s-OFDM QPSK	1/1	26.2	20.33	1.92	1.69	8.50	
WB	Max - 1	NR Band n30	Ant.E	EV-S-WB 24.4 kbit/s	462000 2310 MHz	10 MHz	DFT-s-OFDM QPSK	1/1	23.2	21.76	2.13	2.50	6.10	
NB	Max - 1		Ant.E	EV-S-NB 24.4 kbit/s	462000 2310 MHz	10 MHz	DFT-s-OFDM QPSK	1/1	23.2	20.52	2.02	1.79	8.20	
WB	Max - 1	NR Band n66	Ant.E	EV-S-WB 24.4 kbit/s	349000 1745 MHz	40 MHz	DFT-s-OFDM QPSK	1/1	23.2	21.47	2.14	2.40	6.10	
NB	Max - 1		Ant.E	EV-S-NB 24.4 kbit/s	349000 1745 MHz	40 MHz	DFT-s-OFDM QPSK	1/1	23.2	20.37	2.05	1.75	8.40	
WB	Max - 1	NR Band n70	Ant.E	EV-S-WB 24.4 kbit/s	340500 1702.5 MHz	15 MHz	DFT-s-OFDM QPSK	1/1	23.2	21.49	2.25	2.50	5.90	
NB	Max - 1		Ant.E	EV-S-NB 24.4 kbit/s	340500 1702.5 MHz	15 MHz	DFT-s-OFDM QPSK	1/1	23.2	20.45	2.05	1.76	5.90	
WB	Max - 1	NR Band n71	Ant.D	EV-S-WB 24.4 kbit/s	136100 680.5 MHz	20 MHz	DFT-s-OFDM QPSK	1/1	23.2	21.62	2.24	2.50	5.20	
NB	Max - 1		Ant.D	EV-S-NB 24.4 kbit/s	136100 680.5 MHz	20 MHz	DFT-s-OFDM QPSK	1/1	23.2	20.50	2.12	1.76	5.70	

8N Mounting Force – VoNR TDD

Codec (NB or WB)	Volume Control Level	Mode / Band	Antenna	Voice Codec / Codec bitrate (kbps)	Channel and Frequency	Bandwidth	Waveform / Modulation	RB (Allocation/ Offset)	Volume Control Results				
									8N				
									Noise (LAF_MAX) (dBA)	Conversational Gain (dB)	Frequency Response Margin (dB)		PN-SDNR margin (dB)
		FF	DF										
NB	Max - 1	NR Band n41 PC2	Ant.E	EV-S-NB 24.4 kbit/s	518598 2592.99 MHz	100 MHz	DFT-s-OFDM QPSK	1/1	22.4	20.34	2.06	1.85	7.50
NB	Max - 1		Ant.B	EV-S-NB 24.4 kbit/s	518598 2592.99 MHz	100 MHz	DFT-s-OFDM QPSK	1/1	24.1	20.49	2.06	1.70	5.50
NB	Max - 1		Ant.E	EV-S-NB 24.4 kbit/s	518598 2592.99 MHz	100 MHz	DFT-s-OFDM QPSK	1/136	24.1	20.48	2.04	1.83	6.90
NB	Max - 1		Ant.E	EV-S-NB 24.4 kbit/s	518598 2592.99 MHz	100 MHz	DFT-s-OFDM QPSK	1/271	24.1	20.42	2.04	1.83	5.20
NB	Max - 1		Ant.E	EV-S-NB 24.4 kbit/s	518598 2592.99 MHz	100 MHz	DFT-s-OFDM QPSK	135/0	24.1	20.47	2.04	1.86	7.90
NB	Max - 1		Ant.E	EV-S-NB 24.4 kbit/s	518598 2592.99 MHz	100 MHz	DFT-s-OFDM QPSK	135/69	24.1	20.49	1.93	1.76	4.90
NB	Max - 1		Ant.E	EV-S-NB 24.4 kbit/s	518598 2592.99 MHz	100 MHz	DFT-s-OFDM QPSK	135/138	24.1	20.53	2.00	1.74	8.20
NB	Max - 1		Ant.E	EV-S-NB 24.4 kbit/s	518598 2592.99 MHz	100 MHz	DFT-s-OFDM QPSK	270/0	24.1	20.47	2.04	1.83	8.90
NB	Max - 1		Ant.E	EV-S-NB 24.4 kbit/s	518598 2592.99 MHz	100 MHz	DFT-s-OFDM p1/2 BPSK	1/1	22.4	20.63	2.00	1.73	6.50
NB	Max - 1		Ant.E	EV-S-NB 24.4 kbit/s	518598 2592.99 MHz	100 MHz	DFT-s-OFDM 16QAM	1/1	24.1	20.46	2.06	1.75	8.30
NB	Max - 1		Ant.E	EV-S-NB 24.4 kbit/s	518598 2592.99 MHz	100 MHz	DFT-s-OFDM 64QAM	1/1	22.4	20.70	2.09	1.87	7.30
NB	Max - 1		Ant.E	EV-S-NB 24.4 kbit/s	518598 2592.99 MHz	100 MHz	DFT-s-OFDM 256QAM	1/1	22.4	20.64	2.00	1.83	7.10
NB	Max - 1		Ant.E	EV-S-NB 24.4 kbit/s	518598 2592.99 MHz	100 MHz	CP-OFDM QPSK	1/1	22.4	20.62	1.98	1.84	6.20
NB	Max - 1		Ant.E	EV-S-NB 24.4 kbit/s	518598 2592.99 MHz	100 MHz	CP-OFDM QPSK	1/136	22.4	20.47	2.01	1.82	7.80
NB	Max - 1		Ant.E	EV-S-NB 24.4 kbit/s	518598 2592.99 MHz	100 MHz	CP-OFDM QPSK	1/271	22.4	20.52	2.02	1.87	6.30
NB	Max - 1		Ant.E	EV-S-NB 24.4 kbit/s	518598 2592.99 MHz	100 MHz	CP-OFDM QPSK	135/0	22.4	20.49	2.03	1.77	9.60
NB	Max - 1		Ant.E	EV-S-NB 24.4 kbit/s	518598 2592.99 MHz	100 MHz	CP-OFDM QPSK	135/69	22.4	20.54	2.06	1.82	8.20
NB	Max - 1		Ant.E	EV-S-NB 24.4 kbit/s	518598 2592.99 MHz	100 MHz	CP-OFDM QPSK	135/138	22.4	20.52	2.02	1.85	6.70
NB	Max - 1		Ant.E	EV-S-NB 24.4 kbit/s	518598 2592.99 MHz	100 MHz	CP-OFDM QPSK	270/0	22.4	20.50	1.94	1.79	5.60
NB	Max - 1		Ant.E	EV-S-NB 24.4 kbit/s	518598 2592.99 MHz	100 MHz	CP-OFDM 16QAM	1/1	22.4	20.57	2.11	1.84	7.00
NB	Max - 1		Ant.E	EV-S-NB 24.4 kbit/s	518598 2592.99 MHz	100 MHz	CP-OFDM 64QAM	1/1	22.4	20.53	1.94	1.86	7.00
NB	Max - 1		Ant.E	EV-S-NB 24.4 kbit/s	518598 2592.99 MHz	100 MHz	CP-OFDM 256QAM	1/1	22.4	20.63	2.09	1.75	6.00
NB	Max - 1		Ant.E	EV-S-NB 24.4 kbit/s	518598 2592.99 MHz	90 MHz	DFT-s-OFDM QPSK	1/1	22.4	20.65	1.99	1.77	7.80
NB	Max - 1		Ant.E	EV-S-NB 24.4 kbit/s	518598 2592.99 MHz	80 MHz	DFT-s-OFDM QPSK	1/1	22.4	20.59	2.02	1.80	7.40
NB	Max - 1		Ant.E	EV-S-NB 24.4 kbit/s	518598 2592.99 MHz	70 MHz	DFT-s-OFDM QPSK	1/1	22.4	20.53	2.10	1.72	10.40
NB	Max - 1		Ant.E	EV-S-NB 24.4 kbit/s	518598 2592.99 MHz	60 MHz	DFT-s-OFDM QPSK	1/1	22.4	20.55	1.94	1.72	8.20
NB	Max - 1		Ant.E	EV-S-NB 24.4 kbit/s	518598 2592.99 MHz	50 MHz	DFT-s-OFDM QPSK	1/1	22.4	20.53	1.87	1.65	6.60
NB	Max - 1		Ant.E	EV-S-NB 24.4 kbit/s	518598 2592.99 MHz	40 MHz	DFT-s-OFDM QPSK	1/1	22.4	20.50	1.96	1.73	7.10
NB	Max - 1		Ant.E	EV-S-NB 24.4 kbit/s	518598 2592.99 MHz	30 MHz	DFT-s-OFDM QPSK	1/1	22.4	20.46	1.95	1.78	7.20
NB	Max - 1		Ant.E	EV-S-NB 24.4 kbit/s	518598 2592.99 MHz	25 MHz	DFT-s-OFDM QPSK	1/1	22.4	20.52	2.07	1.76	6.90
NB	Max - 1		Ant.E	EV-S-NB 24.4 kbit/s	518598 2592.99 MHz	20 MHz	DFT-s-OFDM QPSK	1/1	22.4	20.42	2.00	1.78	8.50
NB	Max - 1		Ant.E	EV-S-NB 24.4 kbit/s	518598 2592.99 MHz	15 MHz	DFT-s-OFDM QPSK	1/1	22.4	20.56	1.97	1.77	7.70
NB	Max - 1	Ant.E	EV-S-NB 24.4 kbit/s	518598 2592.99 MHz	10 MHz	DFT-s-OFDM QPSK	1/1	22.4	20.37	2.03	1.80	6.70	
NB	Max - 1	Ant.E	EV-S-NB 24.4 kbit/s	509202 2546.01 MHz	100 MHz	DFT-s-OFDM QPSK	1/1	22.4	20.46	2.05	1.82	7.90	
NB	Max - 1	Ant.E	EV-S-NB 24.4 kbit/s	528000 2640 MHz	100 MHz	DFT-s-OFDM QPSK	1/1	22.4	20.41	1.93	1.77	7.20	
WB	Max - 1	NR Band n48	Ant.E	EV-S-WB 24.4 kbit/s	641666 3624.99 MHz	40 MHz	DFT-s-OFDM QPSK	1/1	24.1	21.64	2.25	2.50	8.40
NB	Max - 1		Ant.E	EV-S-NB 24.4 kbit/s	641666 3624.99 MHz	40 MHz	DFT-s-OFDM QPSK	1/1	24.1	20.48	2.07	1.76	6.10
WB	Max - 1	NR Band n77	Ant.E	EV-S-WB 24.4 kbit/s	650000 3750 MHz	100 MHz	DFT-s-OFDM QPSK	1/1	24.1	21.59	2.24	2.40	9.50
NB	Max - 1		Ant.E	EV-S-NB 24.4 kbit/s	650000 3750 MHz	100 MHz	DFT-s-OFDM QPSK	1/1	24.1	20.43	1.95	1.85	7.20

8N Mounting Force – VoWiFi

Codec (NB or WB)	Volume Control Level	Mode / Band	Antenna	Voice Codec / Codec bitrate (kbps)	Channel and Frequency	Bandwidth	Waveform / Modulation	RB (Allocation/ Offset)	Volume Control Results				
									8N				
									Noise (LAF_MAX) (dBA)	Conversational Gain (dB)	Frequency Response Margin (dB)		PN-SDNR margin (dB)
FF	DF												
NB	Max - 1	WiFi 2.4GHz 802.11b	MIMO	EV-S-NB 24.4 kbit/s	CH.6 2437 MHz	20 MHz	DSSS 1 Mbps	N/A	26.1	20.25	2.12	1.89	9.80
NB	Max - 1		SISO Ant.1	EV-S-NB 24.4 kbit/s	CH.6 2437 MHz	20 MHz	DSSS 1 Mbps	N/A	26.1	20.37	1.99	2.07	9.70
NB	Max - 1		SISO Ant.2	EV-S-NB 24.4 kbit/s	CH.6 2437 MHz	20 MHz	DSSS 1 Mbps	N/A	26.1	20.30	2.35	2.02	11.40
NB	Max - 1		MIMO	EV-S-NB 24.4 kbit/s	CH.6 2437 MHz	20 MHz	CCK 5.5 Mbps	N/A	26.1	20.29	2.10	2.01	10.20
NB	Max - 1		MIMO	EV-S-NB 24.4 kbit/s	CH.6 2437 MHz	20 MHz	CCK 11 Mbps	N/A	26.1	20.30	2.00	2.00	9.60
NB	Max - 1		MIMO	EV-S-NB 24.4 kbit/s	CH.1 2412 MHz	20 MHz	DSSS 1 Mbps	N/A	26.1	20.29	2.11	2.02	8.70
NB	Max - 1		MIMO	EV-S-NB 24.4 kbit/s	CH.11 2462 MHz	20 MHz	DSSS 1 Mbps	N/A	26.1	20.32	1.96	2.00	10.40
WB	Max - 1	WiFi 2.4GHz 802.11g	MIMO	EV-S-WB 24.4 kbit/s	CH.6 2437 MHz	20 MHz	BPSK 6 Mbps	N/A	26.1	21.12	2.36	2.40	5.60
NB	Max - 1		MIMO	EV-S-NB 24.4 kbit/s	CH.6 2437 MHz	20 MHz	BPSK 6 Mbps	N/A	26.1	20.27	2.15	1.95	11.40
WB	Max - 1	WiFi 2.4GHz 802.11n HT20	MIMO	EV-S-WB 24.4 kbit/s	CH.6 2437 MHz	20 MHz	MCS 0 6.5 Mbps	N/A	26.1	21.15	2.19	2.30	5.90
NB	Max - 1		MIMO	EV-S-NB 24.4 kbit/s	CH.6 2437 MHz	20 MHz	MCS 0 6.5 Mbps	N/A	26.1	20.32	2.31	1.97	11.60
WB	Max - 1	WiFi 2.4GHz 802.11ac VHT20	MIMO	EV-S-WB 24.4 kbit/s	CH.6 2437 MHz	20 MHz	MCS 0 6.5 Mbps	N/A	26.1	21.13	2.36	2.40	5.80
NB	Max - 1		MIMO	EV-S-NB 24.4 kbit/s	CH.6 2437 MHz	20 MHz	MCS 0 6.5 Mbps	N/A	26.1	20.30	2.13	1.94	11.00
WB	Max - 1	WiFi 2.4GHz 802.11ax HE20	MIMO	EV-S-WB 24.4 kbit/s	CH.6 2437 MHz	20 MHz	MCS 6 77 Mbps	N/A	26.1	21.17	2.28	2.30	6.80
NB	Max - 1		MIMO	EV-S-NB 24.4 kbit/s	CH.6 2437 MHz	20 MHz	MCS 6 77 Mbps	N/A	26.1	20.28	2.22	2.04	8.90
NB	Max - 1	WiFi 5GHz 802.11a U-NII-1	MIMO	EV-S-NB 24.4 kbit/s	CH.40 5200 MHz	20 MHz	BPSK 6 Mbps	N/A	26.1	20.17	2.09	1.95	12.40
NB	Max - 1		SISO Ant.1	EV-S-NB 24.4 kbit/s	CH.40 5200 MHz	20 MHz	BPSK 6 Mbps	N/A	25.7	20.37	2.08	1.95	10.70
NB	Max - 1		SISO Ant.2	EV-S-NB 24.4 kbit/s	CH.40 5200 MHz	20 MHz	BPSK 6 Mbps	N/A	25.7	20.33	2.01	1.92	9.10
NB	Max - 1		MIMO	EV-S-NB 24.4 kbit/s	CH.40 5200 MHz	20 MHz	QPSK 18 Mbps	N/A	25.7	20.27	2.00	1.97	9.90
NB	Max - 1		MIMO	EV-S-NB 24.4 kbit/s	CH.40 5200 MHz	20 MHz	64QAM 54 Mbps	N/A	25.7	20.31	1.94	1.93	12.30
NB	Max - 1		MIMO	EV-S-NB 24.4 kbit/s	CH.36 5180 MHz	20 MHz	BPSK 6 Mbps	N/A	25.7	20.32	1.90	1.92	10.80
NB	Max - 1		MIMO	EV-S-NB 24.4 kbit/s	CH.48 5240 MHz	20 MHz	BPSK 6 Mbps	N/A	25.7	20.28	1.80	2.00	11.10
NB	Max - 1		MIMO	EV-S-NB 24.4 kbit/s	CH.40 5200 MHz	20 MHz	MCS 0 6.5 Mbps	N/A	25.7	20.21	2.04	1.97	10.70
NB	Max - 1	WiFi 5GHz 802.11n HT20 U-NII-1	MIMO	EV-S-NB 24.4 kbit/s	CH.40 5200 MHz	20 MHz	MCS 3 26 Mbps	N/A	25.7	20.25	2.18	1.96	9.90
NB	Max - 1		MIMO	EV-S-NB 24.4 kbit/s	CH.40 5200 MHz	20 MHz	MCS 7 65 Mbps	N/A	25.7	20.22	1.89	1.90	7.90
NB	Max - 1		MIMO	EV-S-NB 24.4 kbit/s	CH.40 5200 MHz	20 MHz	MCS 0 6.5 Mbps	N/A	25.7	21.05	2.26	2.30	6.30
WB	Max - 1		MIMO	EV-S-WB 24.4 kbit/s	CH.40 5200 MHz	20 MHz	MCS 0 6.5 Mbps	N/A	25.7	21.05	2.26	2.30	6.30
NB	Max - 1	WiFi 5GHz 802.11n HT40 U-NII-1	MIMO	EV-S-NB 24.4 kbit/s	CH.38 5190 MHz	40 MHz	MCS 0 6.5 Mbps	N/A	25.7	20.29	1.88	1.93	9.30
NB	Max - 1		MIMO	EV-S-NB 24.4 kbit/s	CH.38 5190 MHz	40 MHz	MCS 3 54 Mbps	N/A	25.7	20.32	2.02	2.01	10.20
NB	Max - 1		MIMO	EV-S-NB 24.4 kbit/s	CH.38 5190 MHz	40 MHz	MCS 7 135 Mbps	N/A	25.7	20.31	1.85	1.90	7.70
WB	Max - 1		MIMO	EV-S-WB 24.4 kbit/s	CH.38 5190 MHz	40 MHz	MCS 0 13.5 Mbps	N/A	25.7	21.05	2.22	2.40	7.10

8N Mounting Force – VoWiFi (Continued)

Codec (NB or WB)	Volume Control Level	Mode / Band	Antenna	Voice Codec / Codec bitrate (kbps)	Channel and Frequency	Bandwidth	Waveform / Modulation	RB (Allocation/ Offset)	Volume Control Results				
									8N				
									Noise (LAF_MAX) (dBA)	Conversational Gain (dB)	Frequency Response Margin (dB)		PN-SDNR margin (dB)
FF	DF												
NB	Max - 1	WiFi 5GHz 802.11ac VHT20 U-NII-1	MIMO	EV-S-NB 24.4 kbit/s	CH.40 5200 MHz	20 MHz	MCS 0 6.5 Mbps	N/A	25.7	20.25	2.09	2.02	11.80
NB	Max - 1		MIMO	EV-S-NB 24.4 kbit/s	CH.40 5200 MHz	20 MHz	MCS 4 39 Mbps	N/A	25.7	20.27	2.17	2.07	9.20
NB	Max - 1		MIMO	EV-S-NB 24.4 kbit/s	CH.40 5200 MHz	20 MHz	MCS 8 78 Mbps	N/A	25.7	20.26	2.33	2.02	11.80
WB	Max - 1		MIMO	EV-S-WB 24.4 kbit/s	CH.40 5200 MHz	20 MHz	MCS 0 6.5 Mbps	N/A	25.7	21.10	2.28	2.40	5.30
NB	Max - 1	WiFi 5GHz 802.11ac VHT40 U-NII-1	MIMO	EV-S-NB 24.4 kbit/s	CH.38 5190 MHz	40 MHz	MCS 0 13.5 Mbps	N/A	25.7	20.22	2.04	1.92	10.10
NB	Max - 1		MIMO	EV-S-NB 24.4 kbit/s	CH.38 5190 MHz	40 MHz	MCS 4 108 Mbps	N/A	25.7	20.24	1.93	1.96	9.50
NB	Max - 1		MIMO	EV-S-NB 24.4 kbit/s	CH.38 5190 MHz	40 MHz	MCS 9 180 Mbps	N/A	25.7	20.28	1.90	2.00	9.00
WB	Max - 1		MIMO	EV-S-WB 24.4 kbit/s	CH.38 5190 MHz	40 MHz	MCS 0 13.5 Mbps	N/A	25.7	21.08	2.39	2.40	5.50
NB	Max - 1	WiFi 5GHz 802.11ac VHT80 U-NII-1	MIMO	EV-S-NB 24.4 kbit/s	CH.42 5210 MHz	80 MHz	MCS 0 29.3 Mbps	N/A	25.7	20.29	1.92	1.99	10.30
NB	Max - 1		MIMO	EV-S-NB 24.4 kbit/s	CH.42 5210 MHz	80 MHz	MCS 4 175.5 Mbps	N/A	25.7	20.31	2.13	2.01	10.10
NB	Max - 1		MIMO	EV-S-NB 24.4 kbit/s	CH.42 5210 MHz	80 MHz	MCS 9 390 Mbps	N/A	25.7	20.28	2.04	1.96	11.80
WB	Max - 1		MIMO	EV-S-WB 24.4 kbit/s	CH.42 5210 MHz	80 MHz	MCS 9 390 Mbps	N/A	25.7	21.11	2.32	2.40	6.00
NB	Max - 1	WiFi 5GHz 802.11ac VHT160 U-NII-1&2A	MIMO	EV-S-NB 24.4 kbit/s	CH.50 5250 MHz	160 MHz	MCS 0 58.5 Mbps	N/A	25.7	20.30	1.99	1.94	10.70
NB	Max - 1		MIMO	EV-S-NB 24.4 kbit/s	CH.50 5250 MHz	160 MHz	MCS 4 351 Mbps	N/A	25.7	20.29	2.33	1.99	12.00
NB	Max - 1		MIMO	EV-S-NB 24.4 kbit/s	CH.50 5250 MHz	160 MHz	MCS 9 780 Mbps	N/A	25.7	20.28	2.18	1.94	10.90
WB	Max - 1		MIMO	EV-S-WB 24.4 kbit/s	CH.50 5250 MHz	160 MHz	MCS 9 780 Mbps	N/A	25.7	21.17	2.30	2.50	6.10
NB	Max - 1	WiFi 5GHz 802.11ax HE20 U-NII-1	MIMO	EV-S-NB 24.4 kbit/s	CH.40 5200 MHz	20 MHz	MCS 0 8.6 Mbps	N/A	26.1	20.37	1.93	2.00	8.50
NB	Max - 1		MIMO	EV-S-NB 24.4 kbit/s	CH.40 5200 MHz	20 MHz	MCS 6 77 Mbps	N/A	26.1	20.33	1.99	1.96	9.10
NB	Max - 1		MIMO	EV-S-NB 24.4 kbit/s	CH.40 5200 MHz	20 MHz	MCS 11 143 Mbps	N/A	26.1	20.39	2.38	2.06	10.30
WB	Max - 1		MIMO	EV-S-WB 24.4 kbit/s	CH.40 5200 MHz	20 MHz	MCS 6 77 Mbps	N/A	26.1	21.19	2.38	2.30	7.20
NB	Max - 1	WiFi 5GHz 802.11ax HE40 U-NII-1	MIMO	EV-S-NB 24.4 kbit/s	CH.38 5190 MHz	40 MHz	MCS 0 17.2 Mbps	N/A	25.7	20.22	2.26	1.95	9.60
NB	Max - 1		MIMO	EV-S-NB 24.4 kbit/s	CH.38 5190 MHz	40 MHz	MCS 6 155 Mbps	N/A	25.7	20.25	2.07	1.93	9.20
NB	Max - 1		MIMO	EV-S-NB 24.4 kbit/s	CH.38 5190 MHz	40 MHz	MCS 11 287 Mbps	N/A	25.7	20.23	2.03	1.91	12.50
WB	Max - 1		MIMO	EV-S-WB 24.4 kbit/s	CH.38 5190 MHz	40 MHz	MCS 0 17.2 Mbps	N/A	25.7	21.03	2.39	2.40	5.70
NB	Max - 1	WiFi 5GHz 802.11ax HE80 U-NII-1	MIMO	EV-S-NB 24.4 kbit/s	CH.42 5210 MHz	80 MHz	MCS 0 36 Mbps	N/A	25.7	20.25	1.95	1.99	10.10
NB	Max - 1		MIMO	EV-S-NB 24.4 kbit/s	CH.42 5210 MHz	80 MHz	MCS 6 324 Mbps	N/A	25.7	20.30	1.93	1.97	11.20
NB	Max - 1		MIMO	EV-S-NB 24.4 kbit/s	CH.42 5210 MHz	80 MHz	MCS 11 600 Mbps	N/A	25.7	20.29	2.06	1.98	9.80
WB	Max - 1		MIMO	EV-S-WB 24.4 kbit/s	CH.42 5210 MHz	80 MHz	MCS 0 36 Mbps	N/A	25.7	21.12	2.38	2.40	6.90
NB	Max - 1	WiFi 5GHz 802.11ax HE160 U-NII-1&2A	MIMO	EV-S-NB 24.4 kbit/s	CH.50 5250 MHz	160 MHz	MCS 0 72.1 Mbps	N/A	25.7	20.23	2.03	1.96	12.50
NB	Max - 1		MIMO	EV-S-NB 24.4 kbit/s	CH.50 5250 MHz	160 MHz	MCS 6 648.5 Mbps	N/A	25.7	20.29	2.31	2.00	10.40
NB	Max - 1		MIMO	EV-S-NB 24.4 kbit/s	CH.50 5250 MHz	160 MHz	MCS 11 1201 Mbps	N/A	25.7	20.22	1.96	1.91	9.20
WB	Max - 1		MIMO	EV-S-WB 24.4 kbit/s	CH.50 5250 MHz	160 MHz	MCS 0 72.1 Mbps	N/A	25.7	21.10	2.41	2.20	5.70
WB	Max - 1	WiFi 5GHz 802.11a U-NII-2A	MIMO	EV-S-WB 24.4 kbit/s	CH.56 5280 MHz	20 MHz	BPSK 6 Mbps	N/A	26.1	21.19	2.21	2.20	5.40
NB	Max - 1	WiFi 5GHz 802.11a U-NII-2C	MIMO	EV-S-NB 24.4 kbit/s	CH.56 5280 MHz	20 MHz	BPSK 6 Mbps	N/A	26.1	20.43	1.89	1.95	9.80
WB	Max - 1		MIMO	EV-S-WB 24.4 kbit/s	CH.120 5600 MHz	20 MHz	BPSK 6 Mbps	N/A	26.1	21.18	2.37	2.30	5.20
NB	Max - 1	WiFi 5GHz 802.11a U-NII-3	MIMO	EV-S-NB 24.4 kbit/s	CH.120 5600 MHz	20 MHz	BPSK 6 Mbps	N/A	26.1	20.37	1.99	2.00	8.90
WB	Max - 1		MIMO	EV-S-WB 24.4 kbit/s	CH.157 5785 MHz	20 MHz	BPSK 6 Mbps	N/A	26.1	21.16	2.36	2.40	4.40
NB	Max - 1	WiFi 5GHz 802.11a U-NII-4	MIMO	EV-S-NB 24.4 kbit/s	CH.157 5785 MHz	20 MHz	BPSK 6 Mbps	N/A	26.1	20.33	2.08	1.95	9.90
WB	Max - 1		MIMO	EV-S-WB 24.4 kbit/s	CH.173 5865 MHz	20 MHz	BPSK 6 Mbps	N/A	26.1	21.17	2.34	2.50	5.40
NB	Max - 1	WiFi 5GHz 802.11ax U-NII-5	MIMO	EV-S-NB 24.4 kbit/s	CH.173 5865 MHz	20 MHz	BPSK 6 Mbps	N/A	26.1	20.33	2.03	1.87	6.50
WB	Max - 1		MIMO	EV-S-WB 24.4 kbit/s	CH.5 5975 MHz	20 MHz	BPSK 6 Mbps	N/A	26.2	21.26	1.88	2.00	6.20
NB	Max - 1	MIMO	EV-S-NB 24.4 kbit/s	CH.5 5975 MHz	20 MHz	BPSK 6 Mbps	N/A	26.2	20.34	1.82	1.50	11.60	

9.3. Other Voice Codecs Investigation for GSM/WCDMA/VoLTE/VoNR/VoWiFi

An investigation between the various other voice codecs configurations (Low/Mid/High bit rates for Narrowband and Wideband) and conversational gain is documented to evaluate conversational gain for each voice service type. The table below compares the varying codec configurations.

A codec investigation was performed of each GSM, W-CDMA, LTE FDD/TDD, NR FDD/TDD and VoWiFi.

2N Mounting Force

Codec (NB or WB)	Volume Control Level	Mode / Band	Antenna	Voice Codec / Codec bitrate (kbps)	Channel and Frequency	Bandwidth	Waveform / Modulation	RB (Allocation/ Offset)	Volume Control Results					
									2N					
									Noise (LAF_MAX) (dBA)	Conversational Gain (dB)	Frequency Response Margin (dB)		FN-SDNR margin (dB)	
FF	DF													
NB	Max - 1	GSM 850	Ant.D	FR V1	190 836.6 MHz	N/A	N/A	N/A	23.9	17.24	N/A	N/A	N/A	
NB	Max - 1		Ant.D	FR V2	190 836.6 MHz	N/A	N/A	N/A	23.9	17.50	N/A	N/A	N/A	
NB	Max - 1		Ant.D	HR V1	190 836.6 MHz	N/A	N/A	N/A	23.9	17.51	N/A	N/A	N/A	
NB	Max - 1		Ant.A+B	FR V1	190 836.6 MHz	N/A	N/A	N/A	23.9	17.29	N/A	N/A	N/A	
NB	Max - 1	GSM 1900	Ant.A	FR V1	190 836.6 MHz	N/A	N/A	N/A	26.2	17.63	N/A	N/A	N/A	
NB	Max - 1		Ant.B	FR V1	661 1880 MHz	N/A	N/A	N/A	23.9	17.30	N/A	N/A	N/A	
NB	Max - 1	WCDMA Band V	Ant.D	AMR-NB 4.75 kbps	4183 836.6 MHz	N/A	N/A	N/A	23.9	16.44	N/A	N/A	N/A	
NB	Max - 1		Ant.D	AMR-NB 7.4 kbps	4183 836.6 MHz	N/A	N/A	N/A	23.9	16.90	N/A	N/A	N/A	
NB	Max - 1		Ant.D	AMR-NB 12.2 kbps	4183 836.6 MHz	N/A	N/A	N/A	23.9	17.19	N/A	N/A	N/A	
WB	Max - 1		Ant.D	AMR-WB 6.6 kbps	4183 836.6 MHz	N/A	N/A	N/A	23.9	17.44	N/A	N/A	N/A	
WB	Max - 1		Ant.D	AMR-WB 12.65 kbps	4183 836.6 MHz	N/A	N/A	N/A	23.9	17.95	N/A	N/A	N/A	
WB	Max - 1		Ant.D	AMR-WB 23.85 kbps	4183 836.6 MHz	N/A	N/A	N/A	23.9	18.12	N/A	N/A	N/A	
NB	Max - 1		Ant.A+B	AMR-NB 4.75 kbps	4183 836.6 MHz	N/A	N/A	N/A	23.9	16.52	N/A	N/A	N/A	
NB	Max - 1		Ant.A	AMR-NB 4.75 kbps	4183 836.6 MHz	N/A	N/A	N/A	26.2	16.92	N/A	N/A	N/A	
NB	Max - 1		WCDMA Band II	Ant.B	AMR-NB 4.75 kbps	9400 1880.0 MHz	N/A	N/A	N/A	23.9	16.59	N/A	N/A	N/A
NB	Max - 1		WCDMA Band IV	Ant.B	AMR-NB 4.75 kbps	1413 1732.6 MHz	N/A	N/A	N/A	23.9	16.54	N/A	N/A	N/A
NB	Max - 1	LTE Band 66	Ant.B	AMR-NB 4.75 kbps	132322 1745 MHz	20 MHz	QPSK	1/0	23.5	16.50	N/A	N/A	N/A	
NB	Max - 1		Ant.B	AMR-NB 7.4 kbps	132322 1745 MHz	20 MHz	QPSK	1/0	23.5	16.90	N/A	N/A	N/A	
NB	Max - 1		Ant.B	AMR-NB 12.2 kbps	132322 1745 MHz	20 MHz	QPSK	1/0	23.5	17.20	N/A	N/A	N/A	
WB	Max - 1		Ant.B	AMR-WB 6.6 kbps	132322 1745 MHz	20 MHz	QPSK	1/0	23.5	17.38	N/A	N/A	N/A	
WB	Max - 1		Ant.B	AMR-WB 12.65 kbps	132322 1745 MHz	20 MHz	QPSK	1/0	23.5	17.74	N/A	N/A	N/A	
WB	Max - 1		Ant.B	AMR-WB 23.85 kbps	132322 1745 MHz	20 MHz	QPSK	1/0	23.5	17.92	N/A	N/A	N/A	
NB	Max - 1		Ant.B	EV-S-NB 5.9 kbps	132322 1745 MHz	20 MHz	QPSK	1/0	23.5	16.61	N/A	N/A	N/A	
NB	Max - 1		Ant.B	EV-S-NB 13.2 kbps	132322 1745 MHz	20 MHz	QPSK	1/0	23.5	16.74	N/A	N/A	N/A	
WB	Max - 1		Ant.B	EV-S-WB 5.9 kbps	132322 1745 MHz	20 MHz	QPSK	1/0	23.5	17.23	N/A	N/A	N/A	
WB	Max - 1		Ant.B	EV-S-WB 64 kbps	132322 1745 MHz	20 MHz	QPSK	1/0	23.5	17.90	N/A	N/A	N/A	
WB	Max - 1		Ant.B	EV-S-WB 128 kbps	132322 1745 MHz	20 MHz	QPSK	1/0	23.5	18.26	N/A	N/A	N/A	
NB	Max - 1		LTE Band 41 PC2	Ant.B	AMR-NB 4.75 kbps	40620 2593 MHz	20 MHz	QPSK	1/0	23.5	16.56	N/A	N/A	N/A
NB	Max - 1			Ant.B	AMR-NB 7.4 kbps	40620 2593 MHz	20 MHz	QPSK	1/0	23.5	17.07	N/A	N/A	N/A
NB	Max - 1			Ant.B	AMR-NB 12.2 kbps	40620 2593 MHz	20 MHz	QPSK	1/0	23.5	17.31	N/A	N/A	N/A
WB	Max - 1	Ant.B		AMR-WB 6.6 kbps	40620 2593 MHz	20 MHz	QPSK	1/0	23.5	17.32	N/A	N/A	N/A	
WB	Max - 1	Ant.B		AMR-WB 12.65 kbps	40620 2593 MHz	20 MHz	QPSK	1/0	23.5	17.77	N/A	N/A	N/A	
WB	Max - 1	Ant.B		AMR-WB 23.85 kbps	40620 2593 MHz	20 MHz	QPSK	1/0	23.5	17.88	N/A	N/A	N/A	
NB	Max - 1	Ant.B		EV-S-NB 5.9 kbps	40620 2593 MHz	20 MHz	QPSK	1/0	23.5	16.64	N/A	N/A	N/A	
NB	Max - 1	Ant.B		EV-S-NB 13.2 kbps	40620 2593 MHz	20 MHz	QPSK	1/0	23.5	16.93	N/A	N/A	N/A	
WB	Max - 1	Ant.B		EV-S-WB 5.9 kbps	40620 2593 MHz	20 MHz	QPSK	1/0	23.5	17.28	N/A	N/A	N/A	
WB	Max - 1	Ant.B		EV-S-WB 64 kbps	40620 2593 MHz	20 MHz	QPSK	1/0	23.5	17.95	N/A	N/A	N/A	
WB	Max - 1	Ant.B		EV-S-WB 128 kbps	40620 2593 MHz	20 MHz	QPSK	1/0	23.5	18.30	N/A	N/A	N/A	

2N Mounting Force (Continued)

Codec (NB or WB)	Volume Control Level	Mode / Band	Antenna	Voice Codec / Codec bitrate (kbps)	Channel and Frequency	Bandwidth	Waveform / Modulation	RB (Allocation/ Offset)	Volume Control Results				
									2N				
									Noise (LAF_MAX) (dBA)	Conversational Gain (dB)	Frequency Response Margin (dB)		PN-SDNR margin (dB)
FF	DF												
NB	Max - 1	NR Band n12	Ant.D	AMR-NB 4.75 kbps	141500 707.5 MHz	15 MHz	DFT-s-OFDM QPSK	1/1	26.2	16.79	N/A	N/A	N/A
NB	Max - 1		Ant.D	AMR-NB 7.4 kbps	141500 707.5 MHz	15 MHz	DFT-s-OFDM QPSK	1/1	26.2	17.50	N/A	N/A	N/A
NB	Max - 1		Ant.D	AMR-NB 12.2 kbps	141500 707.5 MHz	15 MHz	DFT-s-OFDM QPSK	1/1	26.2	17.70	N/A	N/A	N/A
WB	Max - 1		Ant.D	AMR-WB 6.6 kbps	141500 707.5 MHz	15 MHz	DFT-s-OFDM QPSK	1/1	26.2	18.38	N/A	N/A	N/A
WB	Max - 1		Ant.D	AMR-WB 12.65 kbps	141500 707.5 MHz	15 MHz	DFT-s-OFDM QPSK	1/1	26.2	18.81	N/A	N/A	N/A
WB	Max - 1		Ant.D	AMR-WB 23.85 kbps	141500 707.5 MHz	15 MHz	DFT-s-OFDM QPSK	1/1	26.2	18.95	N/A	N/A	N/A
NB	Max - 1		Ant.D	EV-S-NB 5.9 kbps	141500 707.5 MHz	15 MHz	DFT-s-OFDM QPSK	1/1	26.2	17.13	N/A	N/A	N/A
NB	Max - 1		Ant.D	EV-S-NB 13.2 kbps	141500 707.5 MHz	15 MHz	DFT-s-OFDM QPSK	1/1	26.2	17.43	N/A	N/A	N/A
WB	Max - 1		Ant.D	EV-S-WB 5.9 kbps	141500 707.5 MHz	15 MHz	DFT-s-OFDM QPSK	1/1	26.2	18.27	N/A	N/A	N/A
WB	Max - 1		Ant.D	EV-S-WB 64 kbps	141500 707.5 MHz	15 MHz	DFT-s-OFDM QPSK	1/1	26.2	18.90	N/A	N/A	N/A
WB	Max - 1	Ant.D	EV-S-WB 128 kbps	141500 707.5 MHz	15 MHz	DFT-s-OFDM QPSK	1/1	26.2	19.27	N/A	N/A	N/A	
NB	Max - 1	NR Band n41 PC2	Ant.E	AMR-NB 4.75 kbps	518598 2592.99 MHz	100 MHz	DFT-s-OFDM QPSK	1/1	22.4	16.73	N/A	N/A	N/A
NB	Max - 1		Ant.E	AMR-NB 7.4 kbps	518598 2592.99 MHz	100 MHz	DFT-s-OFDM QPSK	1/1	22.4	17.33	N/A	N/A	N/A
NB	Max - 1		Ant.E	AMR-NB 12.2 kbps	518598 2592.99 MHz	100 MHz	DFT-s-OFDM QPSK	1/1	22.4	17.64	N/A	N/A	N/A
WB	Max - 1		Ant.E	AMR-WB 6.6 kbps	518598 2592.99 MHz	100 MHz	DFT-s-OFDM QPSK	1/1	22.4	18.21	N/A	N/A	N/A
WB	Max - 1		Ant.E	AMR-WB 12.65 kbps	518598 2592.99 MHz	100 MHz	DFT-s-OFDM QPSK	1/1	22.4	18.84	N/A	N/A	N/A
WB	Max - 1		Ant.E	AMR-WB 23.85 kbps	518598 2592.99 MHz	100 MHz	DFT-s-OFDM QPSK	1/1	22.4	18.85	N/A	N/A	N/A
NB	Max - 1		Ant.E	EV-S-NB 5.9 kbps	518598 2592.99 MHz	100 MHz	DFT-s-OFDM QPSK	1/1	22.4	16.92	N/A	N/A	N/A
NB	Max - 1		Ant.E	EV-S-NB 13.2 kbps	518598 2592.99 MHz	100 MHz	DFT-s-OFDM QPSK	1/1	22.4	17.39	N/A	N/A	N/A
WB	Max - 1		Ant.E	EV-S-WB 5.9 kbps	518598 2592.99 MHz	100 MHz	DFT-s-OFDM QPSK	1/1	22.4	18.13	N/A	N/A	N/A
WB	Max - 1		Ant.E	EV-S-WB 64 kbps	518598 2592.99 MHz	100 MHz	DFT-s-OFDM QPSK	1/1	22.4	18.85	N/A	N/A	N/A
WB	Max - 1	Ant.E	EV-S-WB 128 kbps	518598 2592.99 MHz	100 MHz	DFT-s-OFDM QPSK	1/1	22.4	19.15	N/A	N/A	N/A	
NB	Max - 1	WiFi 2.4GHz 802.11b	MIMO	AMR-NB 4.75 kbps	CH.6 2437 MHz	20 MHz	DSSS 1 Mbps	N/A	23.9	16.43	N/A	N/A	N/A
NB	Max - 1		MIMO	AMR-NB 7.4 kbps	CH.6 2437 MHz	20 MHz	DSSS 1 Mbps	N/A	23.9	17.08	N/A	N/A	N/A
NB	Max - 1		MIMO	AMR-NB 12.2 kbps	CH.6 2437 MHz	20 MHz	DSSS 1 Mbps	N/A	23.9	17.29	N/A	N/A	N/A
WB	Max - 1		MIMO	AMR-WB 6.6 kbps	CH.6 2437 MHz	20 MHz	DSSS 1 Mbps	N/A	23.9	17.68	N/A	N/A	N/A
WB	Max - 1		MIMO	AMR-WB 12.65 kbps	CH.6 2437 MHz	20 MHz	DSSS 1 Mbps	N/A	23.9	18.09	N/A	N/A	N/A
WB	Max - 1		MIMO	AMR-WB 23.85 kbps	CH.6 2437 MHz	20 MHz	DSSS 1 Mbps	N/A	23.9	18.22	N/A	N/A	N/A
NB	Max - 1		MIMO	EV-S-NB 5.9 kbps	CH.6 2437 MHz	20 MHz	DSSS 1 Mbps	N/A	23.9	16.64	N/A	N/A	N/A
NB	Max - 1		MIMO	EV-S-NB 13.2 kbps	CH.6 2437 MHz	20 MHz	DSSS 1 Mbps	N/A	23.9	16.96	N/A	N/A	N/A
WB	Max - 1		MIMO	EV-S-WB 5.9 kbps	CH.6 2437 MHz	20 MHz	DSSS 1 Mbps	N/A	23.9	17.52	N/A	N/A	N/A
WB	Max - 1		MIMO	EV-S-WB 64 kbps	CH.6 2437 MHz	20 MHz	DSSS 1 Mbps	N/A	23.9	18.22	N/A	N/A	N/A
WB	Max - 1	MIMO	EV-S-WB 128 kbps	CH.6 2437 MHz	20 MHz	DSSS 1 Mbps	N/A	23.9	18.55	N/A	N/A	N/A	
NB	Max - 1	WiFi 5GHz 802.11a	MIMO	AMR-NB 4.75 kbps	CH.40 5200 MHz	20 MHz	BPSK 6 Mbps	N/A	23.9	16.58	N/A	N/A	N/A
NB	Max - 1		MIMO	AMR-NB 7.4 kbps	CH.40 5200 MHz	20 MHz	BPSK 6 Mbps	N/A	23.9	17.16	N/A	N/A	N/A
NB	Max - 1		MIMO	AMR-NB 12.2 kbps	CH.40 5200 MHz	20 MHz	BPSK 6 Mbps	N/A	23.9	17.36	N/A	N/A	N/A
WB	Max - 1		MIMO	AMR-WB 6.6 kbps	CH.40 5200 MHz	20 MHz	BPSK 6 Mbps	N/A	23.9	17.66	N/A	N/A	N/A
WB	Max - 1		MIMO	AMR-WB 12.65 kbps	CH.40 5200 MHz	20 MHz	BPSK 6 Mbps	N/A	23.9	18.23	N/A	N/A	N/A
WB	Max - 1		MIMO	AMR-WB 23.85 kbps	CH.40 5200 MHz	20 MHz	BPSK 6 Mbps	N/A	23.9	18.38	N/A	N/A	N/A
NB	Max - 1		MIMO	EV-S-NB 5.9 kbps	CH.40 5200 MHz	20 MHz	BPSK 6 Mbps	N/A	23.9	16.68	N/A	N/A	N/A
NB	Max - 1		MIMO	EV-S-NB 13.2 kbps	CH.40 5200 MHz	20 MHz	BPSK 6 Mbps	N/A	23.9	16.99	N/A	N/A	N/A
WB	Max - 1		MIMO	EV-S-WB 5.9 kbps	CH.40 5200 MHz	20 MHz	BPSK 6 Mbps	N/A	23.9	17.55	N/A	N/A	N/A
WB	Max - 1		MIMO	EV-S-WB 64 kbps	CH.40 5200 MHz	20 MHz	BPSK 6 Mbps	N/A	23.9	18.33	N/A	N/A	N/A
WB	Max - 1	MIMO	EV-S-WB 128 kbps	CH.40 5200 MHz	20 MHz	BPSK 6 Mbps	N/A	23.9	18.86	N/A	N/A	N/A	

8N Mounting Force

Codec (NB or WB)	Volume Control Level	Mode / Band	Antenna	Voice Codec / Codec bitrate (kbps)	Channel and Frequency	Bandwidth	Waveform / Modulation	RB (Allocation/ Offset)	Volume Control Results					
									8N					
									Noise (LAF_MAX) (dBA)	Conversational Gain (dB)	Frequency Response Margin (dB)		PN-SDNR margin (dB)	
FF	DF													
NB	Max - 1	GSM 850	Ant.D	FR V1	190 836.6 MHz	N/A	N/A	N/A	23.5	19.96	N/A	N/A	N/A	
NB	Max - 1		Ant.D	FR V2	190 836.6 MHz	N/A	N/A	N/A	23.5	20.21	N/A	N/A	N/A	
NB	Max - 1		Ant.D	HR V1	190 836.6 MHz	N/A	N/A	N/A	23.5	20.38	N/A	N/A	N/A	
NB	Max - 1		Ant.A+B	FR V1	190 836.6 MHz	N/A	N/A	N/A	23.5	20.01	N/A	N/A	N/A	
NB	Max - 1		Ant.A	FR V1	190 836.6 MHz	N/A	N/A	N/A	26.2	20.72	N/A	N/A	N/A	
NB	Max - 1	GSM 1900	Ant.B	FR V1	661 1880 MHz	N/A	N/A	N/A	23.5	20.03	N/A	N/A	N/A	
NB	Max - 1	WCDMA Band V	Ant.D	AMR-NB 4.75 kbps	4183 836.6 MHz	N/A	N/A	N/A	23.5	19.39	N/A	N/A	N/A	
NB	Max - 1		Ant.D	AMR-NB 7.4 kbps	4183 836.6 MHz	N/A	N/A	N/A	23.5	19.84	N/A	N/A	N/A	
NB	Max - 1		Ant.D	AMR-NB 12.2 kbps	4183 836.6 MHz	N/A	N/A	N/A	23.5	20.05	N/A	N/A	N/A	
WB	Max - 1		Ant.D	AMR-WB 6.6 kbps	4183 836.6 MHz	N/A	N/A	N/A	23.5	20.38	N/A	N/A	N/A	
WB	Max - 1		Ant.D	AMR-WB 12.65 kbps	4183 836.6 MHz	N/A	N/A	N/A	23.5	20.80	N/A	N/A	N/A	
WB	Max - 1		Ant.D	AMR-WB 23.85 kbps	4183 836.6 MHz	N/A	N/A	N/A	23.5	20.97	N/A	N/A	N/A	
NB	Max - 1		Ant.A+B	AMR-NB 4.75 kbps	4183 836.6 MHz	N/A	N/A	N/A	23.5	19.49	N/A	N/A	N/A	
NB	Max - 1		Ant.A	AMR-NB 4.75 kbps	4183 836.6 MHz	N/A	N/A	N/A	26.2	19.98	N/A	N/A	N/A	
NB	Max - 1		WCDMA Band II	Ant.B	AMR-NB 4.75 kbps	9400 1880.0 MHz	N/A	N/A	N/A	23.5	19.36	N/A	N/A	N/A
NB	Max - 1		WCDMA Band IV	Ant.B	AMR-NB 4.75 kbps	1413 1732.6 MHz	N/A	N/A	N/A	23.5	19.28	N/A	N/A	N/A
NB	Max - 1	LTE Band 66	Ant.B	AMR-NB 4.75 kbps	132322 1745 MHz	20 MHz	QPSK	1/0	23.5	19.24	N/A	N/A	N/A	
NB	Max - 1		Ant.B	AMR-NB 7.4 kbps	132322 1745 MHz	20 MHz	QPSK	1/0	23.5	19.71	N/A	N/A	N/A	
NB	Max - 1		Ant.B	AMR-NB 12.2 kbps	132322 1745 MHz	20 MHz	QPSK	1/0	23.5	19.97	N/A	N/A	N/A	
WB	Max - 1		Ant.B	AMR-WB 6.6 kbps	132322 1745 MHz	20 MHz	QPSK	1/0	23.5	20.30	N/A	N/A	N/A	
WB	Max - 1		Ant.B	AMR-WB 12.65 kbps	132322 1745 MHz	20 MHz	QPSK	1/0	23.5	20.75	N/A	N/A	N/A	
WB	Max - 1		Ant.B	AMR-WB 23.85 kbps	132322 1745 MHz	20 MHz	QPSK	1/0	23.5	20.89	N/A	N/A	N/A	
NB	Max - 1		Ant.B	EV-S-NB 5.9 kbps	132322 1745 MHz	20 MHz	QPSK	1/0	23.5	19.30	N/A	N/A	N/A	
NB	Max - 1		Ant.B	EV-S-NB 13.2 kbps	132322 1745 MHz	20 MHz	QPSK	1/0	23.5	19.59	N/A	N/A	N/A	
WB	Max - 1		Ant.B	EV-S-WB 5.9 kbps	132322 1745 MHz	20 MHz	QPSK	1/0	23.5	20.22	N/A	N/A	N/A	
WB	Max - 1		Ant.B	EV-S-WB 64 kbps	132322 1745 MHz	20 MHz	QPSK	1/0	23.5	20.81	N/A	N/A	N/A	
WB	Max - 1		Ant.B	EV-S-WB 128 kbps	132322 1745 MHz	20 MHz	QPSK	1/0	23.5	21.13	N/A	N/A	N/A	
NB	Max - 1		LTE Band 41 PC2	Ant.B	AMR-NB 4.75 kbps	40620 2593 MHz	20 MHz	QPSK	1/0	23.5	19.34	N/A	N/A	N/A
NB	Max - 1			Ant.B	AMR-NB 7.4 kbps	40620 2593 MHz	20 MHz	QPSK	1/0	23.5	19.85	N/A	N/A	N/A
NB	Max - 1			Ant.B	AMR-NB 12.2 kbps	40620 2593 MHz	20 MHz	QPSK	1/0	23.5	20.11	N/A	N/A	N/A
WB	Max - 1	Ant.B		AMR-WB 6.6 kbps	40620 2593 MHz	20 MHz	QPSK	1/0	23.5	20.38	N/A	N/A	N/A	
WB	Max - 1	Ant.B		AMR-WB 12.65 kbps	40620 2593 MHz	20 MHz	QPSK	1/0	23.5	20.80	N/A	N/A	N/A	
WB	Max - 1	Ant.B		AMR-WB 23.85 kbps	40620 2593 MHz	20 MHz	QPSK	1/0	23.5	20.86	N/A	N/A	N/A	
NB	Max - 1	Ant.B		EV-S-NB 5.9 kbps	40620 2593 MHz	20 MHz	QPSK	1/0	23.5	19.42	N/A	N/A	N/A	
NB	Max - 1	Ant.B		EV-S-NB 13.2 kbps	40620 2593 MHz	20 MHz	QPSK	1/0	23.5	19.63	N/A	N/A	N/A	
WB	Max - 1	Ant.B		EV-S-WB 5.9 kbps	40620 2593 MHz	20 MHz	QPSK	1/0	23.5	20.21	N/A	N/A	N/A	
WB	Max - 1	Ant.B		EV-S-WB 64 kbps	40620 2593 MHz	20 MHz	QPSK	1/0	23.5	20.88	N/A	N/A	N/A	
WB	Max - 1	Ant.B		EV-S-WB 128 kbps	40620 2593 MHz	20 MHz	QPSK	1/0	23.5	21.22	N/A	N/A	N/A	

8N Mounting Force (Continued)

Codec (NB or WB)	Volume Control Level	Mode / Band	Antenna	Voice Codec / Codec bitrate (kbps)	Channel and Frequency	Bandwidth	Waveform / Modulation	RB (Allocation/ Offset)	Volume Control Results				
									8N				
									Noise (LAF_MAX) (dBA)	Conversational Gain (dB)	Frequency Response Margin (dB)		PN-SDNR margin (dB)
FF	DF												
NB	Max - 1	NR Band n12	Ant.D	AMR-NB 4.75 kbps	141500 707.5 MHz	15 MHz	DFT-s-OFDM QPSK	1/1	26.2	19.94	N/A	N/A	N/A
NB	Max - 1		Ant.D	AMR-NB 7.4 kbps	141500 707.5 MHz	15 MHz	DFT-s-OFDM QPSK	1/1	26.2	20.45	N/A	N/A	N/A
NB	Max - 1		Ant.D	AMR-NB 12.2 kbps	141500 707.5 MHz	15 MHz	DFT-s-OFDM QPSK	1/1	26.2	20.75	N/A	N/A	N/A
WB	Max - 1		Ant.D	AMR-WB 6.6 kbps	141500 707.5 MHz	15 MHz	DFT-s-OFDM QPSK	1/1	26.2	21.32	N/A	N/A	N/A
WB	Max - 1		Ant.D	AMR-WB 12.65 kbps	141500 707.5 MHz	15 MHz	DFT-s-OFDM QPSK	1/1	26.2	21.69	N/A	N/A	N/A
WB	Max - 1		Ant.D	AMR-WB 23.85 kbps	141500 707.5 MHz	15 MHz	DFT-s-OFDM QPSK	1/1	26.2	21.82	N/A	N/A	N/A
NB	Max - 1		Ant.D	EV-S-NB 5.9 kbps	141500 707.5 MHz	15 MHz	DFT-s-OFDM QPSK	1/1	26.2	20.08	N/A	N/A	N/A
NB	Max - 1		Ant.D	EV-S-NB 13.2 kbps	141500 707.5 MHz	15 MHz	DFT-s-OFDM QPSK	1/1	26.2	20.39	N/A	N/A	N/A
WB	Max - 1		Ant.D	EV-S-WB 5.9 kbps	141500 707.5 MHz	15 MHz	DFT-s-OFDM QPSK	1/1	26.2	21.79	N/A	N/A	N/A
WB	Max - 1		Ant.D	EV-S-WB 64 kbps	141500 707.5 MHz	15 MHz	DFT-s-OFDM QPSK	1/1	26.2	21.81	N/A	N/A	N/A
WB	Max - 1	Ant.D	EV-S-WB 128 kbps	141500 707.5 MHz	15 MHz	DFT-s-OFDM QPSK	1/1	26.2	21.79	N/A	N/A	N/A	
NB	Max - 1	NR Band n41 PC2	Ant.E	AMR-NB 4.75 kbps	518598 2592.99 MHz	100 MHz	DFT-s-OFDM QPSK	1/1	22.4	19.85	N/A	N/A	N/A
NB	Max - 1		Ant.E	AMR-NB 7.4 kbps	518598 2592.99 MHz	100 MHz	DFT-s-OFDM QPSK	1/1	22.4	20.32	N/A	N/A	N/A
NB	Max - 1		Ant.E	AMR-NB 12.2 kbps	518598 2592.99 MHz	100 MHz	DFT-s-OFDM QPSK	1/1	22.4	20.57	N/A	N/A	N/A
WB	Max - 1		Ant.E	AMR-WB 6.6 kbps	518598 2592.99 MHz	100 MHz	DFT-s-OFDM QPSK	1/1	22.4	21.23	N/A	N/A	N/A
WB	Max - 1		Ant.E	AMR-WB 12.65 kbps	518598 2592.99 MHz	100 MHz	DFT-s-OFDM QPSK	1/1	22.4	21.66	N/A	N/A	N/A
WB	Max - 1		Ant.E	AMR-WB 23.85 kbps	518598 2592.99 MHz	100 MHz	DFT-s-OFDM QPSK	1/1	22.4	21.97	N/A	N/A	N/A
NB	Max - 1		Ant.E	EV-S-NB 5.9 kbps	518598 2592.99 MHz	100 MHz	DFT-s-OFDM QPSK	1/1	22.4	20.01	N/A	N/A	N/A
NB	Max - 1		Ant.E	EV-S-NB 13.2 kbps	518598 2592.99 MHz	100 MHz	DFT-s-OFDM QPSK	1/1	22.4	20.31	N/A	N/A	N/A
WB	Max - 1		Ant.E	EV-S-WB 5.9 kbps	518598 2592.99 MHz	100 MHz	DFT-s-OFDM QPSK	1/1	22.4	21.21	N/A	N/A	N/A
WB	Max - 1		Ant.E	EV-S-WB 64 kbps	518598 2592.99 MHz	100 MHz	DFT-s-OFDM QPSK	1/1	22.4	22.01	N/A	N/A	N/A
WB	Max - 1	Ant.E	EV-S-WB 128 kbps	518598 2592.99 MHz	100 MHz	DFT-s-OFDM QPSK	1/1	22.4	22.20	N/A	N/A	N/A	
NB	Max - 1	WiFi 2.4GHz 802.11b	MIMO	AMR-NB 4.75 kbps	CH.6 2437 MHz	20 MHz	DSSS 1 Mbps	N/A	23.9	19.67	N/A	N/A	N/A
NB	Max - 1		MIMO	AMR-NB 7.4 kbps	CH.6 2437 MHz	20 MHz	DSSS 1 Mbps	N/A	23.9	20.05	N/A	N/A	N/A
NB	Max - 1		MIMO	AMR-NB 12.2 kbps	CH.6 2437 MHz	20 MHz	DSSS 1 Mbps	N/A	23.9	20.34	N/A	N/A	N/A
WB	Max - 1		MIMO	AMR-WB 6.6 kbps	CH.6 2437 MHz	20 MHz	DSSS 1 Mbps	N/A	23.9	20.67	N/A	N/A	N/A
WB	Max - 1		MIMO	AMR-WB 12.65 kbps	CH.6 2437 MHz	20 MHz	DSSS 1 Mbps	N/A	23.9	21.14	N/A	N/A	N/A
WB	Max - 1		MIMO	AMR-WB 23.85 kbps	CH.6 2437 MHz	20 MHz	DSSS 1 Mbps	N/A	23.9	21.24	N/A	N/A	N/A
NB	Max - 1		MIMO	EV-S-NB 5.9 kbps	CH.6 2437 MHz	20 MHz	DSSS 1 Mbps	N/A	23.9	19.90	N/A	N/A	N/A
NB	Max - 1		MIMO	EV-S-NB 13.2 kbps	CH.6 2437 MHz	20 MHz	DSSS 1 Mbps	N/A	23.9	19.75	N/A	N/A	N/A
WB	Max - 1		MIMO	EV-S-WB 5.9 kbps	CH.6 2437 MHz	20 MHz	DSSS 1 Mbps	N/A	23.9	20.52	N/A	N/A	N/A
WB	Max - 1		MIMO	EV-S-WB 64 kbps	CH.6 2437 MHz	20 MHz	DSSS 1 Mbps	N/A	23.9	21.23	N/A	N/A	N/A
WB	Max - 1	MIMO	EV-S-WB 128 kbps	CH.6 2437 MHz	20 MHz	DSSS 1 Mbps	N/A	23.9	21.59	N/A	N/A	N/A	
NB	Max - 1	WiFi 5GHz 802.11a	MIMO	AMR-NB 4.75 kbps	CH.40 5200 MHz	20 MHz	BPSK 6 Mbps	N/A	23.9	19.72	N/A	N/A	N/A
NB	Max - 1		MIMO	AMR-NB 7.4 kbps	CH.40 5200 MHz	20 MHz	BPSK 6 Mbps	N/A	23.9	20.16	N/A	N/A	N/A
NB	Max - 1		MIMO	AMR-NB 12.2 kbps	CH.40 5200 MHz	20 MHz	BPSK 6 Mbps	N/A	23.9	20.41	N/A	N/A	N/A
WB	Max - 1		MIMO	AMR-WB 6.6 kbps	CH.40 5200 MHz	20 MHz	BPSK 6 Mbps	N/A	23.9	20.80	N/A	N/A	N/A
WB	Max - 1		MIMO	AMR-WB 12.65 kbps	CH.40 5200 MHz	20 MHz	BPSK 6 Mbps	N/A	23.9	21.20	N/A	N/A	N/A
WB	Max - 1		MIMO	AMR-WB 23.85 kbps	CH.40 5200 MHz	20 MHz	BPSK 6 Mbps	N/A	23.9	21.34	N/A	N/A	N/A
NB	Max - 1		MIMO	EV-S-NB 5.9 kbps	CH.40 5200 MHz	20 MHz	BPSK 6 Mbps	N/A	23.9	19.79	N/A	N/A	N/A
NB	Max - 1		MIMO	EV-S-NB 13.2 kbps	CH.40 5200 MHz	20 MHz	BPSK 6 Mbps	N/A	23.9	20.06	N/A	N/A	N/A
WB	Max - 1		MIMO	EV-S-WB 5.9 kbps	CH.40 5200 MHz	20 MHz	BPSK 6 Mbps	N/A	23.9	20.66	N/A	N/A	N/A
WB	Max - 1		MIMO	EV-S-WB 64 kbps	CH.40 5200 MHz	20 MHz	BPSK 6 Mbps	N/A	23.9	21.32	N/A	N/A	N/A
WB	Max - 1	MIMO	EV-S-WB 128 kbps	CH.40 5200 MHz	20 MHz	BPSK 6 Mbps	N/A	23.9	21.67	N/A	N/A	N/A	

9.4. HAC (Volume Control) Test Results

2N Mounting Force – Summary

Codec (NB or WB)	Volume Control Level	Mode / Band	Antenna	Voice Codec / Codec bitrate (kbps)	Channel and Frequency	Bandwidth	Waveform / Modulation	RB (Allocation/Offset)	Volume Control Results					Plot No.
									Noise (LAF, MAX) (dB)	Conversational Gain (dB)	2N		FN-SDNR margin (dB)	
											Frequency Response Margin (dB)			
				FF	DF									
NB	Max - 1	GSM 850	Ant.D	FR V1	190 836.6 MHz	N/A	N/A	N/A	23.9	17.24	N/A	N/A	N/A	
NB	Max - 1	GSM 1900	Ant.B	FR V1	661 1880 MHz	N/A	N/A	N/A	23.9	17.30	N/A	N/A	N/A	
NB	Max - 1	WCDMA Band V	Ant.D	AMR-NB 4.75 kbps	4183 836.6 MHz	N/A	N/A	N/A	23.9	16.44	N/A	N/A	N/A	
NB	Max - 1	WCDMA Band II	Ant.B	AMR-NB 4.75 kbps	9400 1880.0 MHz	N/A	N/A	N/A	23.9	16.59	N/A	N/A	N/A	
NB	Max - 1	WCDMA Band IV	Ant.B	AMR-NB 4.75 kbps	1413 1732.6 MHz	N/A	N/A	N/A	23.9	16.54	N/A	N/A	N/A	
NB	Max - 1	LTE Band 7	Ant.B	EV-S-NB 24.4 kbit/s	21100 2535 MHz	20 MHz	QPSK	1/0	23.9	16.93	2.06	1.75	8.65	1
NB	Max - 1	LTE Band 12	Ant.A	EV-S-NB 24.4 kbit/s	23095 707.5 MHz	10 MHz	QPSK	1/0	23.9	16.78	2.06	1.76	11.54	2
NB	Max - 1	LTE Band 13	Ant.A	EV-S-NB 24.4 kbit/s	23230 782 MHz	10 MHz	QPSK	1/0	23.9	16.91	2.19	1.89	7.50	3
NB	Max - 1	LTE Band 14	Ant.A	EV-S-NB 24.4 kbit/s	23330 793 MHz	10 MHz	QPSK	1/0	23.9	16.86	2.09	1.79	11.53	4
NB	Max - 1	LTE Band 25	Ant.B	EV-S-NB 24.4 kbit/s	26365 1882.5 MHz	20 MHz	QPSK	1/0	23.9	16.82	2.08	1.77	11.39	5
NB	Max - 1	LTE Band 26	Ant.A	EV-S-NB 24.4 kbit/s	26865 831.5 MHz	15 MHz	QPSK	1/0	23.9	16.82	2.10	1.79	11.69	6
NB	Max - 1	LTE Band 30	Ant.B	EV-S-NB 24.4 kbit/s	27710 2310 MHz	10 MHz	QPSK	1/0	23.9	16.86	2.02	1.71	9.19	7
NB	Max - 1	LTE Band 66	Ant.B	AMR-NB 4.75 kbps	132322 1745 MHz	20 MHz	QPSK	1/0	23.5	16.50	N/A	N/A	N/A	
NB	Max - 1	LTE Band 66	Ant.B	EV-S-NB 24.4 kbit/s	132322 1745 MHz	20 MHz	QPSK	1/0	23.9	16.77	2.11	1.81	12.06	8
NB	Max - 1	LTE Band 71	Ant.A	EV-S-NB 24.4 kbit/s	133297 680.5 MHz	20 MHz	QPSK	1/0	23.9	16.99	2.15	1.82	8.17	9
NB	Max - 1	LTE Band 41 PC2	Ant.B	AMR-NB 4.75 kbps	40620 2593 MHz	20 MHz	QPSK	1/0	23.5	16.56	N/A	N/A	N/A	
NB	Max - 1	LTE Band 41 PC2	Ant.B	EV-S-NB 24.4 kbit/s	41490 2680 MHz	20 MHz	QPSK	1/0	24.4	16.81	2.21	1.90	11.48	10
NB	Max - 1	LTE Band 41 PC3	Ant.B	EV-S-NB 24.4 kbit/s	40620 2593 MHz	20 MHz	QPSK	1/0	24.4	16.73	2.11	1.80	11.51	11
NB	Max - 1	LTE Band 48	Ant.E	EV-S-NB 24.4 kbit/s	55773 3603.3 MHz	20 MHz	QPSK	1/0	24.4	16.75	2.20	1.89	8.96	12
NB	Max - 1	NR Band n7	Ant.E	EV-S-NB 24.4 kbit/s	507000 2535 MHz	40 MHz	DFT-s-OFDM QPSK	1/1	23.2	17.52	2.00	1.77	8.12	13
NB	Max - 1	NR Band n12	Ant.D	AMR-NB 4.75 kbps	141500 707.5 MHz	15 MHz	DFT-s-OFDM QPSK	1/1	26.2	16.79	N/A	N/A	N/A	
NB	Max - 1	NR Band n12	Ant.D	EV-S-NB 24.4 kbit/s	141500 707.5 MHz	15 MHz	DFT-s-OFDM QPSK	1/1	22.4	17.46	2.10	1.88	8.81	14
NB	Max - 1	NR Band n25	Ant.E	EV-S-NB 24.4 kbit/s	376500 1882.5 MHz	40 MHz	DFT-s-OFDM QPSK	1/1	23.2	17.49	1.95	1.90	7.47	15
NB	Max - 1	NR Band n26	Ant.D	EV-S-NB 24.4 kbit/s	166300 831.5 MHz	20 MHz	DFT-s-OFDM QPSK	1/1	23.2	17.50	2.00	1.90	8.10	16
NB	Max - 1	NR Band n30	Ant.E	EV-S-NB 24.4 kbit/s	462000 2310 MHz	10 MHz	DFT-s-OFDM QPSK	1/1	23.2	17.38	2.00	1.73	5.68	17
NB	Max - 1	NR Band n66	Ant.E	EV-S-NB 24.4 kbit/s	349000 1745 MHz	40 MHz	DFT-s-OFDM QPSK	1/1	23.2	17.41	1.98	1.84	6.38	18
NB	Max - 1	NR Band n70	Ant.E	EV-S-NB 24.4 kbit/s	340500 1702.5 MHz	15 MHz	DFT-s-OFDM QPSK	1/1	23.2	17.42	1.91	1.69	5.87	19
NB	Max - 1	NR Band n71	Ant.D	EV-S-NB 24.4 kbit/s	136100 680.5 MHz	20 MHz	DFT-s-OFDM QPSK	1/1	23.2	17.51	2.07	1.86	6.52	20
NB	Max - 1	NR Band n41 PC2	Ant.E	EV-S-NB 24.4 kbit/s	518598 2592.99 MHz	100 MHz	DFT-s-OFDM QPSK	1/1	25.3	17.60	2.11	1.91	7.98	21
NB	Max - 1	NR Band n48	Ant.E	EV-S-NB 24.4 kbit/s	641666 3624.99 MHz	40 MHz	DFT-s-OFDM QPSK	1/1	24.1	17.67	2.02	1.90	6.48	22
NB	Max - 1	NR Band n77	Ant.E	EV-S-NB 24.4 kbit/s	650000 3750 MHz	100 MHz	DFT-s-OFDM QPSK	1/1	24.1	17.60	2.10	1.82	6.85	23
NB	Max - 1	WiFi 2.4GHz 802.11b	MIMO	AMR-NB 4.75 kbps	CH6 2437 MHz	20 MHz	DSSS 1 Mbps	N/A	23.9	16.43	N/A	N/A	N/A	
NB	Max - 1	WiFi 2.4GHz 802.11b	MIMO	EV-S-NB 24.4 kbit/s	CH6 2437 MHz	20 MHz	DSSS 1 Mbps	N/A	23.9	16.80	2.24	1.91	6.81	24
NB	Max - 1	WiFi 5GHz 802.11a	MIMO	AMR-NB 4.75 kbps	CH40 5200 MHz	20 MHz	BPSK 6 Mbps	N/A	23.9	16.58	N/A	N/A	N/A	
NB	Max - 1	WiFi 5GHz 802.11a U-NII-1	MIMO	EV-S-NB 24.4 kbit/s	CH40 5200 MHz	20 MHz	BPSK 6 Mbps	N/A	25.7	16.98	2.26	1.93	10.73	25
NB	Max - 1	WiFi 5GHz 802.11a U-NII-2A	MIMO	EV-S-NB 24.4 kbit/s	CH156 5280 MHz	20 MHz	BPSK 6 Mbps	N/A	25.7	17.27	2.19	1.86	10.97	26
NB	Max - 1	WiFi 5GHz 802.11a U-NII-2C	MIMO	EV-S-NB 24.4 kbit/s	CH120 5600 MHz	20 MHz	BPSK 6 Mbps	N/A	25.7	17.23	2.22	1.92	6.65	27
NB	Max - 1	WiFi 5GHz 802.11a U-NII-3	MIMO	EV-S-NB 24.4 kbit/s	CH157 5785 MHz	20 MHz	BPSK 6 Mbps	N/A	25.7	17.17	2.28	1.97	10.50	28
NB	Max - 1	WiFi 5GHz 802.11a U-NII-4	MIMO	EV-S-NB 24.4 kbit/s	CH173 5865 MHz	20 MHz	BPSK 6 Mbps	N/A	25.7	17.21	2.29	1.98	10.73	29
NB	Max - 1	WiFi 5GHz 802.11ax U-NII-5	MIMO	EV-S-NB 24.4 kbit/s	CH15 5975 MHz	20 MHz	BPSK 6 Mbps	N/A	26.2	17.34	1.87	1.56	8.20	30

Note:

- Under the waiver, at least one of the device's narrowband and one of the device's wideband codecs need to be chosen for the distortion and frequency response testing. Testing of the chosen narrowband and wideband codecs for the distortion/noise and frequency response is limited to one bit rate and only those air interfaces associated with the chosen codecs-EVS NB 24.4 kbps & EVS WB 24.4 kbps. The other narrowband and wideband codecs used for the 2N and 8N force level conversational gain tests are not required to undergo distortion/noise and frequency response testing. This codec is therefore not subjected to the distortion and frequency response testing.
- Worst conversational gain for 2N mounting force is 16.43 dB.

8N Mounting Force – Summary

Codec (NB or WB)	Volume Control Level	Mode / Band	Antenna	Voice Codec / Codec bitrate (kbps)	Channel and Frequency	Bandwidth	Waveform / Modulation	RB (Allocation/ Offset)	Volume Control Results					Plot No.
									8N					
									Noise (LAF_MAX) (dBA)	Conversational Gain (dB)	Frequency Response Margin (dB)		FN-SDNR margin (dB)	
		FF	DF											
NB	Max - 1	GSM 850	Ant.D	FR V1	190 836.6 MHz	N/A	N/A	N/A	23.5	19.96	N/A	N/A	N/A	
NB	Max - 1	GSM 1900	Ant.B	FR V1	661 1880 MHz	N/A	N/A	N/A	23.5	20.03	N/A	N/A	N/A	
NB	Max - 1	WCDMA Band V	Ant.D	AMR-NB 4.75 kbps	4183 836.6 MHz	N/A	N/A	N/A	23.5	19.39	N/A	N/A	N/A	
NB	Max - 1	WCDMA Band II	Ant.B	AMR-NB 4.75 kbps	9400 1880.0 MHz	N/A	N/A	N/A	23.5	19.36	N/A	N/A	N/A	
NB	Max - 1	WCDMA Band IV	Ant.B	AMR-NB 4.75 kbps	1413 1732.6 MHz	N/A	N/A	N/A	23.5	19.28	N/A	N/A	N/A	
NB	Max - 1	LTE Band 7	Ant.B	EVS-NB 24.4 kbit/s	21100 2535 MHz	20 MHz	QPSK	1/0	24.6	20.03	1.91	1.75	8.90	31
NB	Max - 1	LTE Band 12	Ant.A	EVS-NB 24.4 kbit/s	23095 707.5 MHz	10 MHz	QPSK	1/0	24.6	20.17	2.06	1.83	12.40	32
NB	Max - 1	LTE Band 13	Ant.A	EVS-NB 24.4 kbit/s	23230 782 MHz	10 MHz	QPSK	1/0	24.6	20.07	1.99	1.78	11.20	33
NB	Max - 1	LTE Band 14	Ant.A	EVS-NB 24.4 kbit/s	23330 793 MHz	10 MHz	QPSK	1/0	24.6	20.02	2.02	1.78	11.70	34
NB	Max - 1	LTE Band 25	Ant.B	EVS-NB 24.4 kbit/s	26365 1882.6 MHz	20 MHz	QPSK	1/0	24.6	20.00	2.00	1.91	7.90	35
NB	Max - 1	LTE Band 26	Ant.A	EVS-NB 24.4 kbit/s	26865 831.5 MHz	15 MHz	QPSK	1/0	24.6	20.03	2.14	1.83	10.50	36
NB	Max - 1	LTE Band 30	Ant.B	EVS-NB 24.4 kbit/s	27710 2310 MHz	10 MHz	QPSK	1/0	24.6	19.93	2.12	1.82	10.20	37
NB	Max - 1	LTE Band 66	Ant.B	AMR-NB 4.75 kbps	132322 1745 MHz	20 MHz	QPSK	1/0	23.5	19.24	N/A	N/A	N/A	
NB	Max - 1	LTE Band 66	Ant.B	EVS-NB 24.4 kbit/s	132322 1745 MHz	20 MHz	QPSK	1/0	24.6	19.99	2.09	1.88	10.70	38
NB	Max - 1	LTE Band 71	Ant.A	EVS-NB 24.4 kbit/s	133297 680.5 MHz	20 MHz	QPSK	1/0	24.6	20.03	2.12	1.79	8.10	39
NB	Max - 1	LTE Band 41 PC2	Ant.B	AMR-NB 4.75 kbps	40620 2593 MHz	20 MHz	QPSK	1/0	23.5	19.34	N/A	N/A	N/A	
NB	Max - 1	LTE Band 41 PC2	Ant.B	EVS-NB 24.4 kbit/s	40620 2593 MHz	20 MHz	QPSK	1/0	24.4	19.95	2.10	1.95	12.40	40
NB	Max - 1	LTE Band 41 PC3	Ant.B	EVS-NB 24.4 kbit/s	40620 2593 MHz	20 MHz	QPSK	1/0	24.6	20.26	2.09	1.93	12.50	41
NB	Max - 1	LTE Band 48	Ant.E	EVS-NB 24.4 kbit/s	55773 3603.3 MHz	20 MHz	QPSK	1/0	24.6	20.14	2.27	1.94	8.50	42
NB	Max - 1	NR Band n7	Ant.E	EVS-NB 24.4 kbit/s	507000 2535 MHz	40 MHz	DFT-s-OFDM QPSK	1/1	26.2	20.36	2.02	1.77	7.60	43
NB	Max - 1	NR Band n12	Ant.D	AMR-NB 4.75 kbps	141500 707.5 MHz	15 MHz	DFT-s-OFDM QPSK	1/1	26.2	19.94	N/A	N/A	N/A	
NB	Max - 1	NR Band n12	Ant.D	EVS-NB 24.4 kbit/s	141500 707.5 MHz	15 MHz	DFT-s-OFDM QPSK	1/1	22.4	20.31	1.92	1.70	4.80	44
NB	Max - 1	NR Band n25	Ant.E	EVS-NB 24.4 kbit/s	376500 1882.5 MHz	40 MHz	DFT-s-OFDM QPSK	1/1	26.2	20.29	1.99	1.60	7.50	45
NB	Max - 1	NR Band n26	Ant.D	EVS-NB 24.4 kbit/s	166300 831.5 MHz	20 MHz	DFT-s-OFDM QPSK	1/1	26.2	20.33	1.92	1.69	8.50	46
NB	Max - 1	NR Band n30	Ant.E	EVS-NB 24.4 kbit/s	462000 2310 MHz	10 MHz	DFT-s-OFDM QPSK	1/1	23.2	20.52	2.02	1.79	8.20	47
NB	Max - 1	NR Band n66	Ant.E	EVS-NB 24.4 kbit/s	349000 1745 MHz	40 MHz	DFT-s-OFDM QPSK	1/1	23.2	20.37	2.05	1.75	8.40	48
NB	Max - 1	NR Band n70	Ant.E	EVS-NB 24.4 kbit/s	340500 1702.5 MHz	15 MHz	DFT-s-OFDM QPSK	1/1	23.2	20.45	2.05	1.76	5.90	49
NB	Max - 1	NR Band n71	Ant.D	EVS-NB 24.4 kbit/s	136100 680.5 MHz	20 MHz	DFT-s-OFDM QPSK	1/1	23.2	20.50	2.12	1.76	5.70	50
NB	Max - 1	NR Band n41 PC2	Ant.E	AMR-NB 4.75 kbps	518598 2592.99 MHz	100 MHz	DFT-s-OFDM QPSK	1/1	22.4	19.85	N/A	N/A	N/A	
NB	Max - 1	NR Band n41 PC2	Ant.E	EVS-NB 24.4 kbit/s	518598 2592.99 MHz	100 MHz	DFT-s-OFDM QPSK	1/1	22.4	20.34	2.06	1.85	7.50	51
NB	Max - 1	NR Band n48	Ant.E	EVS-NB 24.4 kbit/s	641666 3624.99 MHz	40 MHz	DFT-s-OFDM QPSK	1/1	24.1	20.48	2.07	1.76	6.10	52
NB	Max - 1	NR Band n77	Ant.E	EVS-NB 24.4 kbit/s	650000 3750 MHz	100 MHz	DFT-s-OFDM QPSK	1/1	24.1	20.43	1.95	1.85	7.20	53
NB	Max - 1	WiFi 2.4GHz 802.11b	MIMO	AMR-NB 4.75 kbps	CH6 2437 MHz	20 MHz	DSSS 1 Mbps	N/A	23.9	19.67	N/A	N/A	N/A	
NB	Max - 1	WiFi 2.4GHz 802.11b	MIMO	EVS-NB 24.4 kbit/s	CH6 2437 MHz	20 MHz	DSSS 1 Mbps	N/A	26.1	20.25	2.12	1.89	9.80	54
NB	Max - 1	WiFi 5GHz 802.11a	MIMO	AMR-NB 4.75 kbps	CH40 5200 MHz	20 MHz	BPSK 6 Mbps	N/A	23.9	19.72	N/A	N/A	N/A	
NB	Max - 1	WiFi 5GHz 802.11a UNII-1	MIMO	EVS-NB 24.4 kbit/s	CH40 5200 MHz	20 MHz	BPSK 6 Mbps	N/A	26.1	20.17	2.09	1.95	12.40	55
NB	Max - 1	WiFi 5GHz 802.11a UNII-2A	MIMO	EVS-NB 24.4 kbit/s	CH56 5280 MHz	20 MHz	BPSK 6 Mbps	N/A	26.1	20.43	1.89	1.95	9.80	56
NB	Max - 1	WiFi 5GHz 802.11a UNII-2C	MIMO	EVS-NB 24.4 kbit/s	CH120 5600 MHz	20 MHz	BPSK 6 Mbps	N/A	26.1	20.37	1.99	2.00	8.90	57
NB	Max - 1	WiFi 5GHz 802.11a UNII-3	MIMO	EVS-NB 24.4 kbit/s	CH157 5785 MHz	20 MHz	BPSK 6 Mbps	N/A	26.1	20.33	2.08	1.95	9.90	58
NB	Max - 1	WiFi 5GHz 802.11a UNII-4	MIMO	EVS-NB 24.4 kbit/s	CH173 5865 MHz	20 MHz	BPSK 6 Mbps	N/A	26.1	20.33	2.03	1.87	6.50	59
NB	Max - 1	WiFi 5GHz 802.11ax UNII-5	MIMO	EVS-NB 24.4 kbit/s	CH5 5975 MHz	20 MHz	BPSK 6 Mbps	N/A	26.2	20.34	1.82	1.50	11.60	60

Note:

- Under the waiver, at least one of the device's narrowband and one of the device's wideband codecs need to be chosen for the distortion and frequency response testing. Testing of the chosen narrowband and wideband codecs for the distortion/noise and frequency response is limited to one bit rate and only those air interfaces associated with the chosen codecs-EVS NB 24.4 kbps & EVS WB 24.4 kbps. The other narrowband and wideband codecs used for the 2N and 8N force level conversational gain tests are not required to undergo distortion/noise and frequency response testing. This codec is therefore not subjected to the distortion and frequency response testing.
- Worst conversational gain for 8N mounting force is 19.24 dB.

2N Mounting Force – Folder Opened Configuration

Codec (NB or WB)	Volume Control Level	Mode / Band	Antenna	Voice Codec / Codec bitrate (kbps)	Channel and Frequency	Bandwidth	Waveform / Modulation	RB (Allocation / Offset)	Volume Control Results					Plot No.
									2N					
									Noise (LAF_MAX) (dBA)	Conversational Gain (dB)	Frequency Response Margin (dB)		FN-SDNR margin (dB)	
		FF	DF											
NB	Max - 1	LTE Band 66	Ant.B	EVS-NB 24.4 kbit/s	132322 1745 MHz	20 MHz	QPSK	1/0	23.9	18.66	1.99	1.96	7.17	61
WB	Max - 1	LTE Band 66	Ant.B	EVS-WB 24.4 kbit/s	132322 1745 MHz	20 MHz	QPSK	1/0	23.9	19.39	1.74	2.00	7.34	62
NB	Max - 1	LTE Band 41 PC2	Ant.B	EVS-NB 24.4 kbit/s	40620 2593 MHz	20 MHz	QPSK	1/0	23.9	18.70	1.88	1.72	6.59	63
WB	Max - 1	LTE Band 41 PC2	Ant.B	EVS-WB 24.4 kbit/s	40620 2593 MHz	20 MHz	QPSK	1/0	23.9	19.58	1.77	2.00	8.12	64
NB	Max - 1	NR Band n12	Ant.D	EVS-NB 24.4 kbit/s	141500 707.5 MHz	15 MHz	DFT-s-OFDM QPSK	1/1	25.3	18.79	1.96	1.90	7.65	65
WB	Max - 1	NR Band n12	Ant.D	EVS-WB 24.4 kbit/s	141500 707.5 MHz	15 MHz	DFT-s-OFDM QPSK	1/1	25.3	19.97	2.14	2.40	7.56	66
NB	Max - 1	NR Band n41 PC2	Ant.E	EVS-NB 24.4 kbit/s	518598 2592.99 MHz	100 MHz	DFT-s-OFDM QPSK	1/1	25.3	18.70	2.17	2.05	8.84	67
WB	Max - 1	NR Band n41 PC2	Ant.E	EVS-WB 24.4 kbit/s	518598 2592.99 MHz	100 MHz	DFT-s-OFDM QPSK	1/1	25.3	19.82	1.93	2.10	4.83	68
NB	Max - 1	WiFi 2.4GHz 802.11b	MIMO	EVS-NB 24.4 kbit/s	CH6 2437 MHz	20 MHz	DSSS 1 Mbps	NA	23.9	18.71	1.90	1.94	7.35	69
WB	Max - 1	WiFi 2.4GHz 802.11b	MIMO	EVS-WB 24.4 kbit/s	CH6 2437 MHz	20 MHz	DSSS 1 Mbps	NA	23.9	19.60	1.84	2.10	7.16	70
NB	Max - 1	WiFi 5GHz 802.11a	MIMO	EVS-NB 24.4 kbit/s	CH40 5200 MHz	20 MHz	BPSK 6 Mbps	NA	23.9	18.74	1.83	1.99	8.57	71
WB	Max - 1	WiFi 5GHz 802.11a	MIMO	EVS-WB 24.4 kbit/s	CH40 5200 MHz	20 MHz	BPSK 6 Mbps	NA	23.9	19.67	1.90	2.00	5.35	72
NB	Max - 1	WiFi 2.4GHz 802.11b	MIMO	AMR-NB 4.75 kbps	CH6 2437 MHz	20 MHz	DSSS 1 Mbps	NA	23.9	18.28	N/A	N/A	N/A	

8N Mounting Force – Folder Opened Configuration

Codec (NB or WB)	Volume Control Level	Mode / Band	Antenna	Voice Codec / Codec bitrate (kbps)	Channel and Frequency	Bandwidth	Waveform / Modulation	RB (Allocation / Offset)	Volume Control Results					Plot No.
									8N					
									Noise (LAF_MAX) (dBA)	Conversational Gain (dB)	Frequency Response Margin (dB)		FN-SDNR margin (dB)	
		FF	DF											
NB	Max - 1	LTE Band 66	Ant.B	EVS-NB 24.4 kbit/s	132322 1745 MHz	20 MHz	QPSK	1/0	23.9	19.66	1.95	1.85	8.00	73
WB	Max - 1	LTE Band 66	Ant.B	EVS-WB 24.4 kbit/s	132322 1745 MHz	20 MHz	QPSK	1/0	23.9	20.49	1.36	1.60	5.20	74
NB	Max - 1	LTE Band 41 PC2	Ant.B	EVS-NB 24.4 kbit/s	40620 2593 MHz	20 MHz	QPSK	1/0	23.9	19.72	1.98	1.87	10.50	75
WB	Max - 1	LTE Band 41 PC2	Ant.B	EVS-WB 24.4 kbit/s	40620 2593 MHz	20 MHz	QPSK	1/0	23.9	20.53	1.56	1.80	10.60	76
NB	Max - 1	NR Band n12	Ant.D	EVS-NB 24.4 kbit/s	141500 707.5 MHz	15 MHz	DFT-s-OFDM QPSK	1/1	25.3	20.12	2.06	1.90	8.70	77
WB	Max - 1	NR Band n12	Ant.D	EVS-WB 24.4 kbit/s	141500 707.5 MHz	15 MHz	DFT-s-OFDM QPSK	1/1	25.3	21.26	2.09	2.30	8.50	78
NB	Max - 1	NR Band n41 PC2	Ant.E	EVS-NB 24.4 kbit/s	518598 2592.99 MHz	100 MHz	DFT-s-OFDM QPSK	1/1	25.3	20.10	1.99	1.83	7.80	79
WB	Max - 1	NR Band n41 PC2	Ant.E	EVS-WB 24.4 kbit/s	518598 2592.99 MHz	100 MHz	DFT-s-OFDM QPSK	1/1	25.3	21.29	1.75	1.80	5.40	80
NB	Max - 1	WiFi 2.4GHz 802.11b	MIMO	EVS-NB 24.4 kbit/s	CH6 2437 MHz	20 MHz	DSSS 1 Mbps	NA	23.9	19.89	1.97	1.78	12.80	81
WB	Max - 1	WiFi 2.4GHz 802.11b	MIMO	EVS-WB 24.4 kbit/s	CH6 2437 MHz	20 MHz	DSSS 1 Mbps	NA	23.9	20.80	1.37	1.50	7.50	82
NB	Max - 1	WiFi 5GHz 802.11a	MIMO	EVS-NB 24.4 kbit/s	CH40 5200 MHz	20 MHz	BPSK 6 Mbps	NA	23.9	19.87	1.84	1.77	8.20	83
WB	Max - 1	WiFi 5GHz 802.11a	MIMO	EVS-WB 24.4 kbit/s	CH40 5200 MHz	20 MHz	BPSK 6 Mbps	NA	23.9	20.76	1.49	1.60	7.00	84
NB	Max - 1	LTE Band 66	Ant.B	AMR-NB 4.75 kbps	132322 1745 MHz	20 MHz	QPSK	1/0	23.9	19.33	N/A	N/A	N/A	

Note:

- Under the waiver, at least one of the device’s narrowband and one of the device’s wideband codecs need to be chosen for the distortion and frequency response testing. Testing of the chosen narrowband and wideband codecs for the distortion/noise and frequency response is limited to one bit rate and only those air interfaces associated with the chosen codecs-EVS NB 24.4 kbps & EVS WB 24.4 kbps. The other narrowband and wideband codecs used for the 2N and 8N force level conversational gain tests are not required to undergo distortion/noise and frequency response testing. This codec is therefore not subjected to the distortion and frequency response testing.
- Additional tests were performed with folder opened condition using worst case in folder closed for each technology.

9.5. Worst Case Volume Control Test Plot

2N Mounting Force – VoWiFi 2.4GHz 802.11b_MIMO_AMR-NB 4.75 kbps_ch.6

Conversational Gain 16.43 dB (tested conversational gain only)

2N Mounting Force – VoLTE Band B41 PC3_Ant.B_EVS-NB 24.4 kbps_ch.40620

Conversational Gain 16.73 dB



TIA-5050 Receive Volume Control Measurements - 2N

Device Under Test:	L41_PC3_EVS-NB24.4_2N
Bandwidth:	Narrowband
Test Date:	2024-04-05

Receive Volume Control Performance

TIA-5050	Test	Measured	Limits	Result	Reference
Clause 5.1	Recv output level dB SPL 2N	86.73 dB	info only		
	Recv conversational gain 2N	16.73 dB	6.00	PASS	

Receive Distortion and Noise Performance

TIA-5050	Test	Margin	Limits	Result	Reference
Clause 5.2	Recv PN-SDNR 2N	11.51 dB	Absolute Limits	PASS	

Note: SDNR includes noise and distortion products.

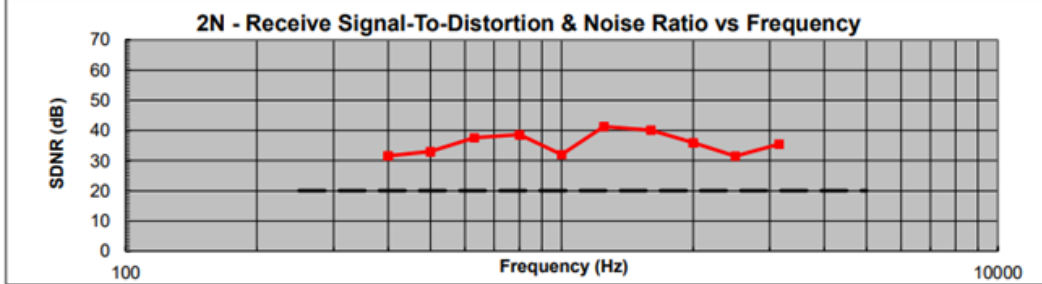

Receive Acoustic Frequency Response Performance

TIA-5050	Test	Margin	Limits	Result	Reference
Clause 5.3	Recv resp FF 2N	2.11 dB	Floating Limits	PASS	
	Recv resp DF 2N	1.8 dB	Floating Limits	PASS	

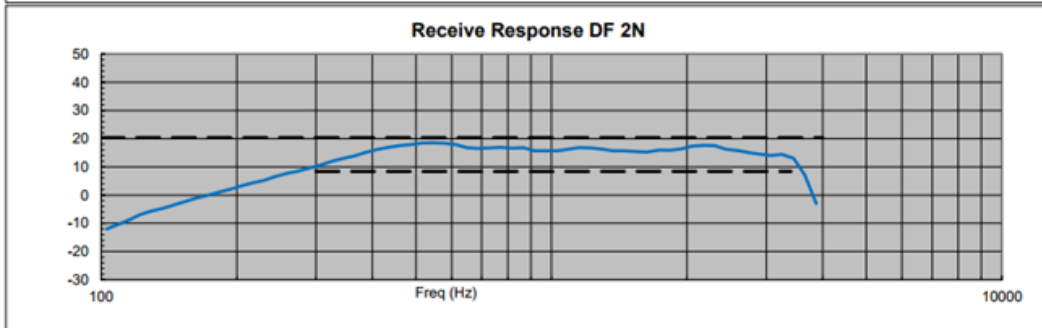
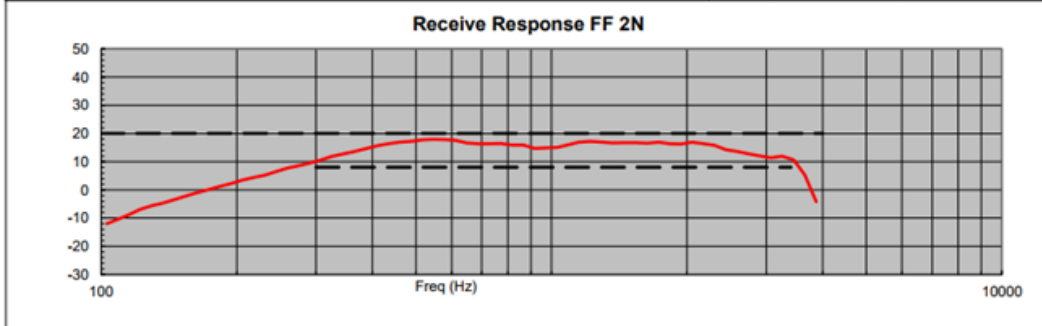

8N Mounting Force – VoLTE FDD Band 66_Ant.B_AMR-NB 4.75 kbps_ch.132322

Conversational Gain 19.24 dB (tested conversational gain only)

8N Mounting Force – VoLTE FDD Band 30_Ant.B_EVS-NB 24.4 kbps_ch.27710

Conversational Gain 19.93 dB



TIA-5050 Receive Volume Control Measurements - 8N

Device Under Test:	L30_EVS-NB24.4_8N
---------------------------	-------------------

Bandwidth	Narrowband
------------------	------------

Test Date:	2024-04-08
-------------------	------------

Receive Volume Control Performance

TIA-5050	Test	Measured	Limits	Result	Reference
Clause 5.1	Recv output level dB SPL 8N	89.93 dB	info only		
	Recv conversational gain 8N	19.93 dB	18.00	PASS	

Receive Distortion and Noise Performance

TIA-5050	Test	Margin	Limits	Result	Reference
Clause 5.2	Recv PN-SDNR 8N	10.2 dB	Absolute Limits	PASS	

Note: SDNR includes noise and distortion products.

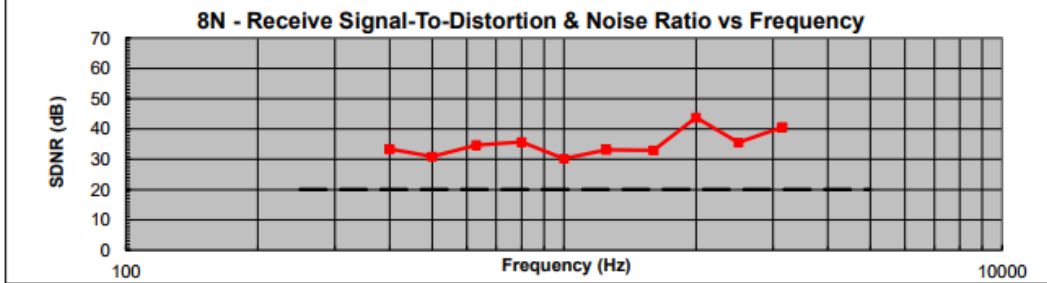

Receive Acoustic Frequency Response Performance

TIA-5050	Test	Margin	Limits	Result	Reference
Clause 5.3	Recv resp FF 8N	2.12 dB	Floating Limits	PASS	
	Recv resp DF 8N	1.82 dB	Floating Limits	PASS	

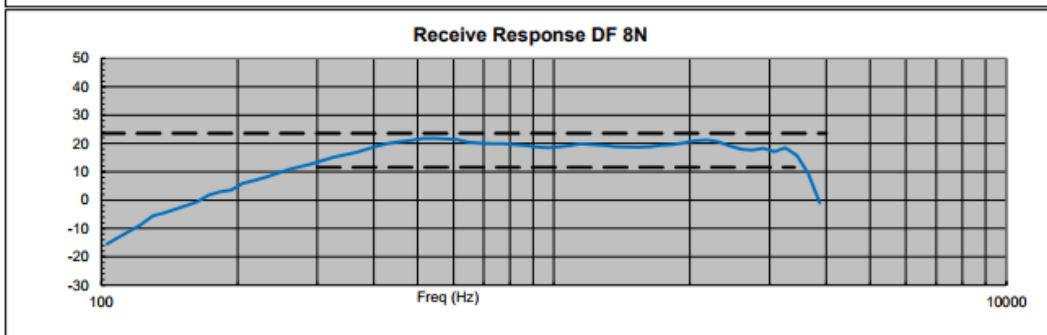
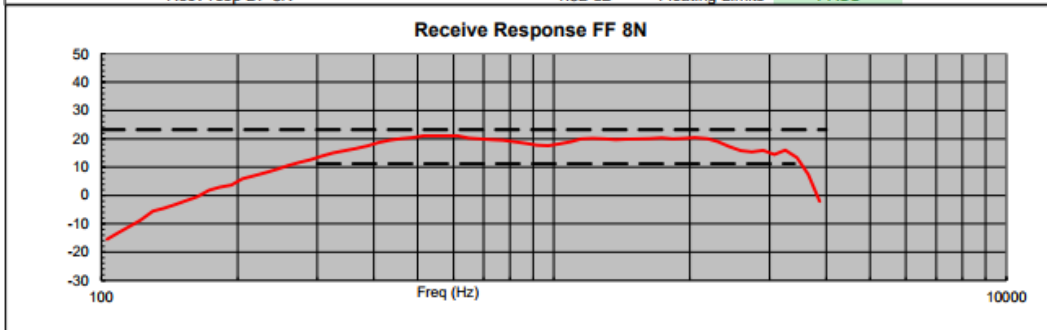

Appendix

Refer to separated files for the following appendixes

4790976523-S7 Appendix A_Setup Photo

4790976523-S7 Appendix B_Test Plots

END OF REPORT