

HEARING AID COMPATIBILITY

Applicant Name:
Samsung Electronics Co., Ltd.
129, Samsung-ro, Maetan dong,
Yeongtong-gu, Suwon-si
Gyeonggi-do 16677, Korea

Date of Testing:
4/25/2022 - 6/2/2022
Test Site/Location:
Element Washington DC LLC,
Columbia, MD, USA
Test Report Serial No.:
1M2204010046-24-R2.A3L
Date of Issue:
6/24/2022

FCC ID: A3LSMF936U

APPLICANT: SAMSUNG ELECTRONICS CO., LTD.

Scope of Test: Audio Band Magnetic Testing (T-Coil)
Application Type: Certification
FCC Rule Part(s): CFR §20.19(b)
HAC Standard: ANSI C63.19-2011
285076 D01 HAC Guidance v05
285076 D02 T-Coil testing for CMRS IP v03
DUT Type: Portable Handset
Model: SM-F936U
Additional Model(s): SM-F936U1
Test Device Serial No.: Pre-Production Sample [S/N: 1802M, 1809M]

C63.19-2011 HAC Category: T3 (SIGNAL TO NOISE CATEGORY)

Note: This revised Test Report (S/N: 1M2204010046-24-R2.A3L) supersedes and replaces the previously issued test report on the same subject device for the same type of testing as indicated. Please discard or destroy the previously issued test report(s) and dispose of it accordingly.

This wireless portable device has been shown to be hearing-aid compatible under the above rated category, specified in ANSI/IEEE Std. C63.19-2011 and has been tested in accordance with the specified measurement procedures. Test results reported herein relate only to the item(s) tested. Hearing-Aid Compatibility is based on the assumption that all production units will be designed electrically identical to the device tested in this report. North American Bands only.

I attest to the accuracy of data. All measurements reported herein were performed by me or were made under my supervision and are correct to the best of my knowledge and belief. I assume full responsibility for the completeness of these measurements and vouch for the qualifications of all persons taking them.

RJ Ortanez
Executive Vice President



FCC ID: A3LSMF936U		HAC (T-COIL) TEST REPORT	Approved by: Managing Director
Filename: 1M2204010046-24-R2.A3L	Test Dates: 4/25/2022 – 6/2/2022	DUT Type: Portable Handset	Page 1 of 120

REV 4.2.M
3/29/2022

TABLE OF CONTENTS

1.	INTRODUCTION	3
2.	DUT DESCRIPTION.....	4
3.	ANSI C63.19-2011 PERFORMANCE CATEGORIES	6
4.	METHOD OF MEASUREMENT	8
5.	VOLTE TEST SYSTEM SETUP AND DUT CONFIGURATION	18
6.	VONR TEST SYSTEM SETUP AND DUT CONFIGURATION.....	23
7.	VOWIFI TEST SYSTEM SETUP AND DUT CONFIGURATION	27
8.	OTT VOIP TEST SYSTEM AND DUT CONFIGURATION	32
9.	FCC 3G MEASUREMENTS	38
10.	T-COIL TEST SUMMARY	39
11.	MEASUREMENT UNCERTAINTY	67
12.	EQUIPMENT LIST	68
13.	TEST DATA.....	69
14.	CALIBRATION CERTIFICATES.....	104
15.	CONCLUSION.....	111
16.	REFERENCES	112
17.	TEST SETUP PHOTOGRAPHS	114

FCC ID: A3LSMF936U		HAC (T-COIL) TEST REPORT	Approved by: Managing Director
Filename: 1M2204010046-24-R2.A3L	Test Dates: 4/25/2022 – 6/2/2022	DUT Type: Portable Handset	Page 2 of 120

REV 4.2.M
3/29/2022

1. INTRODUCTION

On July 10, 2003, the Federal Communications Commission (FCC) adopted new rules requiring wireless manufacturers and service providers to provide digital wireless phones that are compatible with hearing aids. The FCC has modified the exemption for wireless phones under the Hearing Aid Compatibility Act of 1998 (HAC Act) in WT Docket 01-309 RM-8658¹ to extend the benefits of wireless telecommunications to individuals with hearing disabilities. These benefits encompass business, social and emergency communications, which increase the value of the wireless network for everyone. An estimated more than 10% of the population in the United States show signs of hearing impairment and of that fraction, almost 80% use hearing aids. Approximately 500 million people worldwide and 30 million people in the United States suffer from hearing loss.

Compatibility Tests Involved:

The standard calls for wireless communications devices to be measured for:

- RF Electric-field emissions
- T-coil mode, magnetic-signal strength in the audio band
- T-coil mode, magnetic-signal frequency response through the audio band
- T-coil mode, magnetic-signal and noise articulation index

The hearing aid must be measured for:

- RF immunity in microphone mode
- RF immunity in T-coil mode

In the following tests and results, this report includes the evaluation for a wireless communications device.

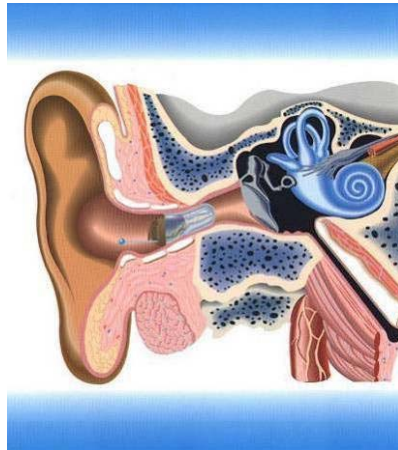



Figure 1-1 Hearing Aid *in-vitu*

¹ FCC Rule & Order, WT Docket 01-309 RM-8658

FCC ID: A3LSMF936U		HAC (T-COIL) TEST REPORT	Approved by: Managing Director
Filename: 1M2204010046-24-R2.A3L	Test Dates: 4/25/2022 – 6/2/2022	DUT Type: Portable Handset	Page 3 of 120

REV 4.2.M
3/29/2022

2. DUT DESCRIPTION

FCC ID: A3LSMF936U
Applicant: Samsung Electronics Co., Ltd.
129, Samsung-ro, Maetan dong,
Yeongtong-gu, Suwon-si
Gyeonggi-do 16677, Korea
Model: SM-F936U
Additional Model(s): SM-F936U1
Serial Number: 1802M, 1809M
HW Version: REV1.0
SW Version: F936U.001
Antenna: Internal Antenna
DUT Type: Portable Handset

I. LTE Band Selection

This device supports LTE capabilities with overlapping transmission frequency ranges. When the supported frequency range of an LTE band falls completely within an LTE band with a larger transmission frequency range, both LTE bands have the same target power (or the band with the larger transmission frequency range has a higher target power), and both LTE bands share the same transmission path and signal characteristics, hearing-aid compatibility compliance was only assessed for the band with the larger transmission frequency range. However, overlapped LTE bands which are anchor bands for dual connectivity (EN-DC) scenarios between LTE and NR were evaluated as independent LTE bands.

II. NR Band Selection

This device supports NR capabilities with overlapping transmission frequency ranges. When the supported frequency range of an NR band falls completely within an NR band with a larger transmission frequency range, both NR bands have the same target power (or the band with the larger transmission frequency range has a higher target power), and both NR bands share the same transmission path and signal characteristics, hearing-aid compatibility compliance was only assessed for the band with the larger transmission frequency range.

III. Device Serial Numbers

Several samples with identical hardware were used to support HAC testing. The manufacturer has confirmed that the device(s) tested have the same physical, mechanical, and thermal characteristics are within operational tolerances expected for production units. The serial numbers used for each test are indicated alongside the results in Section 10.

FCC ID: A3LSMF936U		HAC (T-COIL) TEST REPORT	Approved by: Managing Director
Filename: 1M2204010046-24-R2.A3L	Test Dates: 4/25/2022 – 6/2/2022	DUT Type: Portable Handset	Page 4 of 120

REV 4.2.M

3/29/2022

**Table 2-1
A3LSMF936U HAC Air Interfaces**

Air-Interface	Band (MHz)	Type Transport	HAC Tested	Simultaneous But Not Tested	Name of Voice Service	Audio Codec Evaluated
GSM	850	VO	Yes	Yes: WIFI or BT	CMRS Voice ¹	EFR
	1900					
	GPRS/EDGE	VD	Yes	Yes: WIFI or BT	Google Duo ²	OPUS
UMTS	850	VD	Yes	Yes: WIFI or BT	CMRS Voice ¹	NB AMR, WB AMR
	1700					
	1900	VD	Yes	Yes: WIFI or BT	Google Duo ²	OPUS
HSPA						
LTE (FDD)	680 (B71)	VD	Yes ³	Yes: NR, WIFI or BT	VoLTE ¹ , Google Duo ²	VoLTE: NB AMR, WB AMR, EVS Google Duo: OPUS
	700 (B12)					
	780 (B13)					
	790 (B14)					
	850 (B5)					
	850 (B26)					
	1700 (B4)					
	1700 (B66)					
	1900 (B2)					
	1900 (B25)					
	2300 (B30)					
2500 (B7)						
LTE (TDD)	2600 (B41)	VD	Yes	Yes: NR, WIFI or BT	VoLTE ¹ , Google Duo ²	VoLTE: NB AMR, WB AMR, EVS Google Duo: OPUS
	2600 (B38)					
	3600 (B48)					
NR (FDD)	680 (n71)	VD	Yes ³	Yes: LTE, WIFI or BT	VoNR ⁷ , Google Duo ²	VoNR: NB AMR, WB AMR, EVS Google Duo: OPUS
	700 (n12)					
	850 (n5)					
	1700 (n66)					
	1900 (n2)					
	1900 (n25)					
	2300 (n30)					
2500 (n7)						
NR (TDD)	2600 (n41)	VD	Yes	Yes: LTE, WIFI or BT	VoNR ⁷ , Google Duo ²	VoNR: NB AMR, WB AMR, EVS Google Duo: OPUS
	2600 (n38)					
	3500 (n77, DoD)					
	3600 (n78)					
	3600 (n48)		No ⁴		Google Duo ²	OPUS
	3700 (n77)					
	26000 (n258)					
	28000 (n261)					
39000 (n260)						
WIFI	2450	VD	Yes	Yes: GSM, UMTS, LTE, or NR	VoWIFI ² , Google Duo ²	VoWIFI: NB AMR, WB AMR, EVS Google Duo: OPUS
	5200 (U-NII 1)					
	5300 (U-NII 2A)					
	5500 (U-NII 2C)					
	5800 (U-NII 3)		Yes ⁵			
	5900 (U-NII 4)					
	6175 (U-NII 5)					
	6475 (U-NII 6)					
6700 (U-NII 7)	No ⁶					
7000 (U-NII 8)						
BT	2450	DT	No	Yes: GSM, UMTS, LTE, or NR	N/A	N/A
Type Transport VO = Voice Only DT = Digital Data - Not intended for Voice Services VD = CMRS and/or IP Voice over Data Transport			Notes: 1. Reference level in accordance with 7.4.2.1 of ANSI C63.19-2011 and July 2012 C63 VoLTE Interpretation. 2. Reference level is -20dBm0 in accordance with FCC KDB 285076 D02 3. LTE B71 and NR n71, while outside the scope of ANSI C63.19 and FCC HAC regulations, were additionally tested according to the existing HAC procedures with currently available test equipment. 4. NR FR2 bands are currently outside the scope of ANSI C63.19 and FCC HAC regulations therefore they were not evaluated. 5. WIFI U-NII band 5 was evaluated for operations which are entirely below 6 GHz. Operations partially or entirely above 6 GHz were not evaluated due to equipment limitations and being outside of the current scope of ANSI C63.19 and FCC HAC regulations. 6. WIFI U-NII bands 6 through 8 were not evaluated due to equipment limitations and being outside the scope of ANSI C63.19 and FCC HAC regulations. 7. Reference level is -16dBm0 in accordance with FCC guidance and manufacturer attestation.			

FCC ID: A3LSMF936U		HAC (T-COIL) TEST REPORT	Approved by: Managing Director
Filename: 1M2204010046-24-R2.A3L	Test Dates: 4/25/2022 – 6/2/2022	DUT Type: Portable Handset	Page 5 of 120

REV 4.2.M
3/29/2022

3. ANSI C63.19-2011 PERFORMANCE CATEGORIES

I. MAGNETIC COUPLING

Axial and Radial Field Intensity

All orientations of the magnetic field, in the axial and radial position along the measurement plane shall be ≥ -18 dB(A/m) at 1 kHz in a 1/3 octave band filter per §8.3.1.

Frequency Response

The frequency response of the axial component of the magnetic field shall follow the response curve specified in EIA RS-504-1983, over the frequency range 300 Hz – 3000 Hz per §8.3.2.

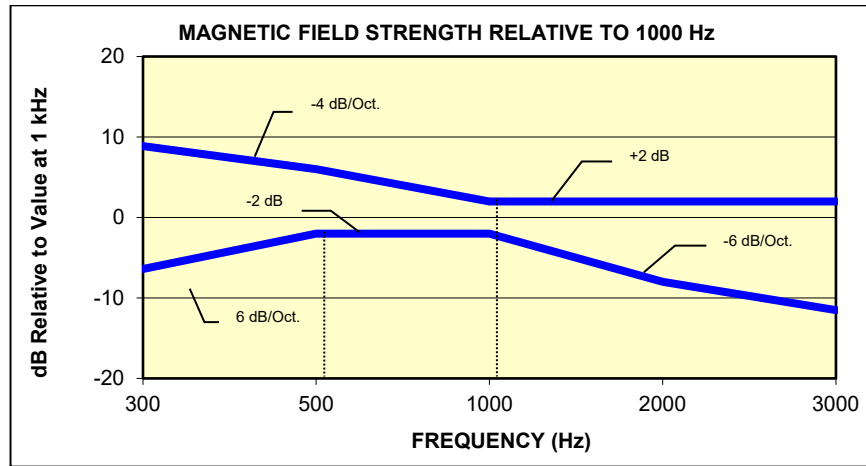

Figure 3-1
Magnetic field frequency response for Wireless Devices with an axial field ≤ -15 dB(A/m) at 1 kHz

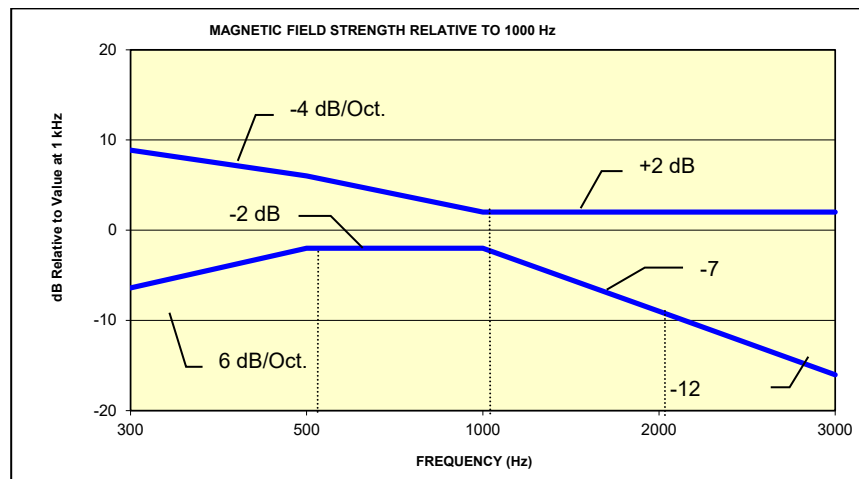



Figure 3-2
Magnetic Field frequency response for wireless devices with an axial field that exceeds -15 dB(A/m) at 1 kHz

FCC ID: A3LSMF936U		HAC (T-COIL) TEST REPORT	Approved by: Managing Director
Filename: 1M2204010046-24-R2.A3L	Test Dates: 4/25/2022 – 6/2/2022	DUT Type: Portable Handset	Page 6 of 120

REV 4.2.M
3/29/2022

Signal Quality

The table below provides the signal quality requirement for the intended audio magnetic signal from a wireless device. Only the RF immunity of the hearing aid is measured in T-coil mode. It is assumed that a hearing aid can have no immunity to an interference signal in the audio band, which is the intended reception band for this mode. The only criterion that can be measured is the RF immunity in T-coil mode. This is measured using the same procedure as the audio coupling mode at the same levels.

The signal quality of the axial and radial components of the magnetic field was used to determine the T-coil mode category.

Category	Telephone RF Parameters
	Wireless Device Signal Quality [(Signal + Noise)-to-noise ratio in dB]
T1	0 to 10 dB
T2	10 to 20 dB
T3	20 to 30 dB
T4	> 30 dB

Table 3-1
Magnetic Coupling Parameters

Note: The FCC limit for SNNR is 20dB and the test data margins will indicate a margin from the FCC limit for compliance.

FCC ID: A3LSMF936U	 element	HAC (T-COIL) TEST REPORT	Approved by: Managing Director
Filename: 1M2204010046-24-R2.A3L	Test Dates: 4/25/2022 – 6/2/2022	DUT Type: Portable Handset	Page 7 of 120

REV 4.2.M
3/29/2022

4. METHOD OF MEASUREMENT

I. Test Setup

The equipment was connected as shown in an RF-shielded chamber:

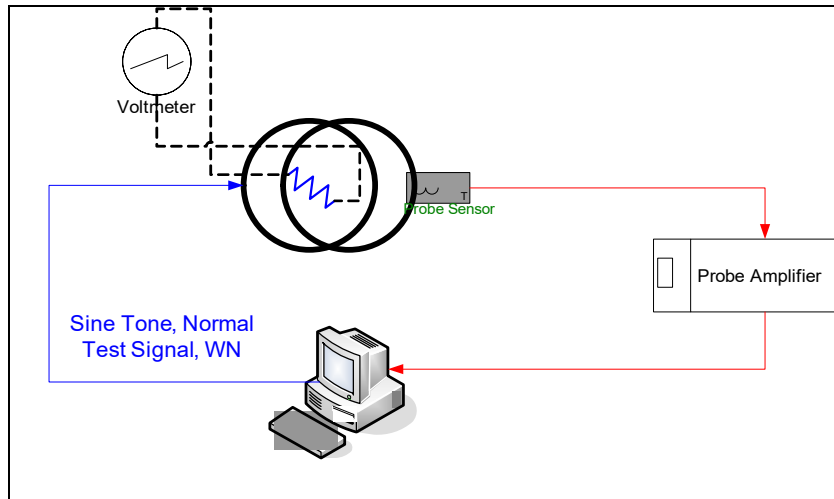

Figure 4-1
Validation Setup with Helmholtz Coil

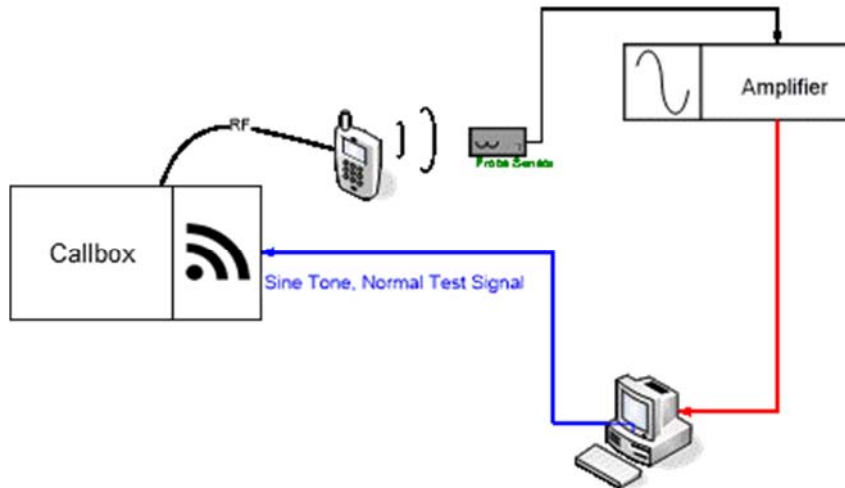



Figure 4-2
T-Coil Test Setup

FCC ID: A3LSMF936U		HAC (T-COIL) TEST REPORT	Approved by: Managing Director
Filename: 1M2204010046-24-R2.A3L	Test Dates: 4/25/2022 – 6/2/2022	DUT Type: Portable Handset	Page 8 of 120

REV 4.2.M
3/29/2022

II. Scanning Mechanism

Manufacturer:	TEM
Accuracy:	± 0.83 cm/meter
Minimum Step Size:	0.1 mm
Maximum speed	6.1 cm/sec
Line Voltage:	115 VAC
Line Frequency:	60 Hz
Material Composite:	Delrin (Acetal)
Data Control:	Parallel Port
Dynamic Range (X-Y-Z):	45 x 31.75 x 47 cm
Dimensions:	36" x 25" x 38"
Operating Area:	36" x 49" x 55"
Reflections:	< -20 dB (in anechoic chamber)

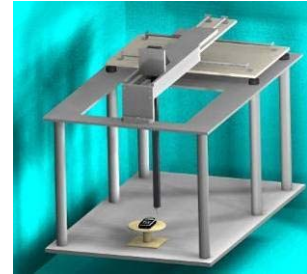

Figure 4-3
RF Near-Field Scanner

III. 3GPP2 Normal Test Signal (Speech)

Manufacturer:	3GPP2 (TIA 1042 §3.3.1)
Stimulus Type:	Modified-IRS weighted, multi-talker speech signal, 4 Male and 4 Female speakers (alternating)
Single Sample Duration:	51.62 seconds
Activity Level:	77.4%

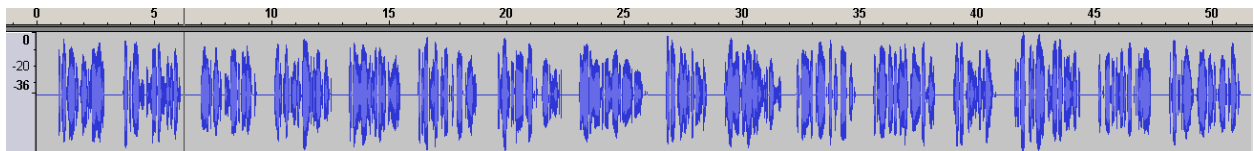

Figure 4-4
Temporal Characteristic of Normal Test Signal

FCC ID: A3LSMF936U	element	HAC (T-COIL) TEST REPORT	Approved by: Managing Director
Filename: 1M2204010046-24-R2.A3L	Test Dates: 4/25/2022 – 6/2/2022	DUT Type: Portable Handset	Page 9 of 120

REV 4.2.M

3/29/2022

ABM1 Measurement Block Diagram:

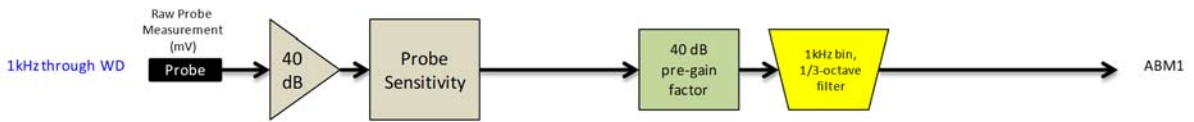

ABM2 Measurement Block Diagram:

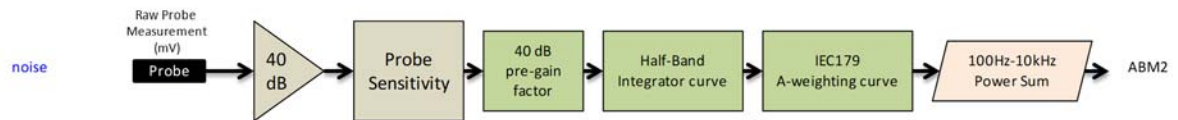

Figure 4-5 Magnetic Measurement Processing Steps

IV. Test Procedure

1. Ambient Noise Check per C63.19 §7.3.1
 - a. Ambient interference was monitored using a Real-Time Analyzer between 100-10,000 Hz with 1/3 octave filtering.
 - b. “A-weighting” and Half-Band Integration was applied to the measurements.
 - c. Since this measurement was measured in the same method as ABM2 measurements, this level was verified to be more than 10 dB below the lowest measurement signal (which is the highest ABM2 measurement for a T4 WD). Therefore the maximum noise level for a T4 WD with an ABM1 = -18 dBA/m is:

$$-18 - 30 - 10 = -58 \text{ dBA/m}$$
2. Measurement System Validation (See Figure 4-1)
 - a. The measurement system including the probe, pre-amplifier and acquisition system were validated as an entire system to ensure the reliability of test measurements.
 - b. ABM1 Validation
 The magnetic field at the center of the Helmholtz coil is given by the equation (per C63.19 Annex D.10.1):

$$H_c = \frac{NI}{r\sqrt{1.25^3}} = \frac{N\left(\frac{V}{R}\right)}{r\sqrt{1.25^3}}$$

Where H_c = magnetic field strength in amperes per meter

N = number of turns per coil

For Helmholtz Coil SN: SBI 1052, $N=20$; $r=0.13\text{m}$; $R=10.193\Omega$ and using $V=29\text{mV}$:

$$H_c = \frac{20 \cdot \left(\frac{0.029}{10.193}\right)}{0.13 \cdot \sqrt{1.25^3}} = 0.316 \text{ A/m} \approx -10 \text{ dB(A/m)}$$

Therefore a pure tone of 1kHz was applied into the coils such that 29mV was observed across the resistor. The voltmeter used for measurement was verified to be capable of measurements in the audio band range. This theoretically generates an expected field of -10 dB(A/m) in the center of the Helmholtz coil which was used to validate the probe

FCC ID: A3LSMF936U		HAC (T-COIL) TEST REPORT	Approved by: Managing Director
Filename: 1M2204010046-24-R2.A3L	Test Dates: 4/25/2022 – 6/2/2022	DUT Type: Portable Handset	Page 10 of 120

REV 4.2.M

3/29/2022

measurement at -10dB(A/m). This was verified to be within ± 0.5 dB of the -10dB(A/m) value (see Page 62).

c. Frequency Response Validation

The frequency response through the Helmholtz Coil was verified to be within 0.5 dB relative to 1kHz, between 300 – 3000 Hz using the Normal signal as shown below:



Figure 4-6 Frequency Response Validation

d. ABM2 Measurement Validation

WD noise measurements are filtered with A-weighting and Half-Band Integration over a frequency range of 100Hz – 10kHz to process ABM2 measurements. Below is the verification of the system processing A-weighting and Half-Band integration between system input to output within 0.5 dB of the theoretical result:

**Table 4-1
ABM2 Frequency Response Validation**

f (Hz)	HBI, A - Measured (dB re 1kHz)	HBI, A - Theoretical (dB re 1kHz)	dB Var.
100	-16.180	-16.170	-0.010
125	-13.257	-13.250	-0.007
160	-10.347	-10.340	-0.007
200	-8.017	-8.010	-0.007
250	-5.925	-5.920	-0.005
315	-4.045	-4.040	-0.005
400	-2.405	-2.400	-0.005
500	-1.212	-1.210	-0.002
630	-0.349	-0.350	0.001
800	0.071	0.070	0.001
1000	0.000	0.000	0.000
1250	-0.503	-0.500	-0.003
1600	-1.513	-1.510	-0.003
2000	-2.778	-2.780	0.002
2500	-4.316	-4.320	0.004
3150	-6.166	-6.170	0.004
4000	-8.322	-8.330	0.008
5000	-10.573	-10.590	0.017
6300	-13.178	-13.200	0.022
8000	-16.241	-16.270	0.029
10000	-19.495	-19.520	0.025

FCC ID: A3LSMF936U		HAC (T-COIL) TEST REPORT	Approved by: Managing Director
Filename: 1M2204010046-24-R2.A3L	Test Dates: 4/25/2022 – 6/2/2022	DUT Type: Portable Handset	Page 11 of 120

REV 4.2.M
3/29/2022

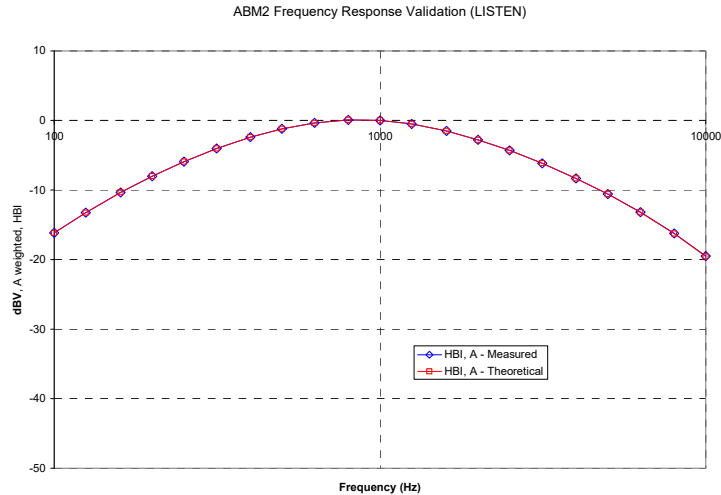

Figure 4-7
ABM2 Frequency Response Validation

The ABM2 result is a power sum from 100Hz to 10kHz with half-band integration and A-weighting. To verify the power sum measurement, a power sum over the full band was measured and verified to track with the source level (See Figure 4-8). Therefore the setup in this step was used to verify the power sum post-processing for ABM2 measurements. See below block diagram:

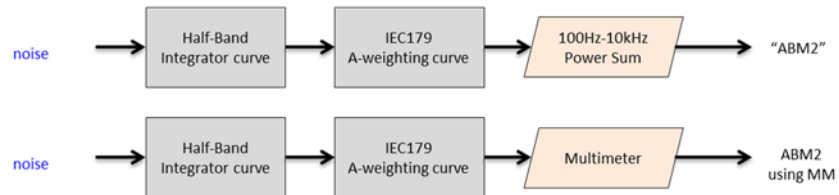

Figure 4-8
ABM2 Validation Block Diagram

The power summed output results for a known input were compared to the multi-meter results to verify any deviation in the post-processing implemented with the power-sum.

Table 4-2
ABM2 Power Sum Validation

WN Input (dBV)	Power Sum (dBV)	Multimeter-Full (dBV)	Dev (dB)
-60	-60.36	-60.2	0.16
-50	-50.19	-50.13	0.06
-40	-40.14	-40.03	0.11
-30	-30.13	-30.01	0.12
-20	-20.12	-20	0.12
-10	-10.14	-10	0.14

FCC ID: A3LSMF936U		HAC (T-COIL) TEST REPORT	Approved by: Managing Director
Filename: 1M2204010046-24-R2.A3L	Test Dates: 4/25/2022 – 6/2/2022	DUT Type: Portable Handset	Page 12 of 120

REV 4.2.M
3/29/2022

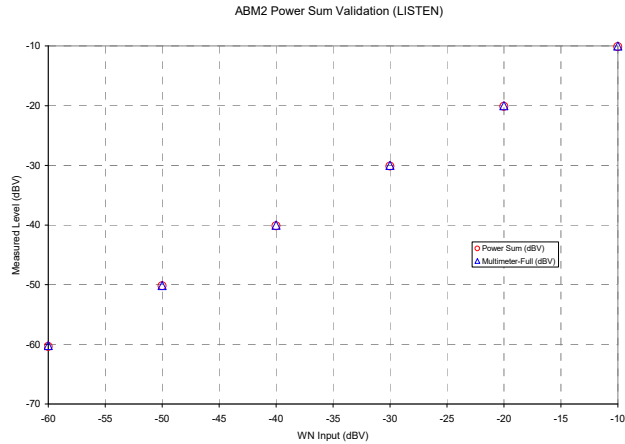

Figure 4-9
ABM2 Power Sum Validation

3. Measurement Test Setup

a. Fine scan above the WD (TEM)

- i. A multitone signal was applied to the handset such that the phone acoustic output was stable within 1dB over the probe settling time and with the acoustic output level at the C63.19 specified levels (below). The measurement step size was in 2 mm increments at a distance of 10 mm between the surface of the wireless device as shown below (note that in Figure 4-11, the grid is not to scale but merely a graphical representation of the coordinate system in use):

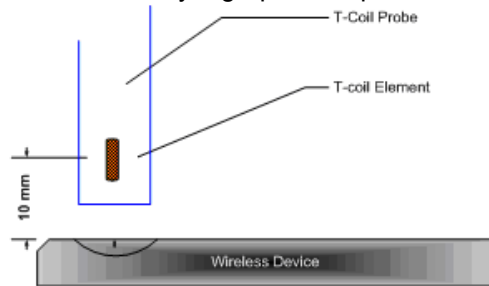

Figure 4-10
Measurement Distance

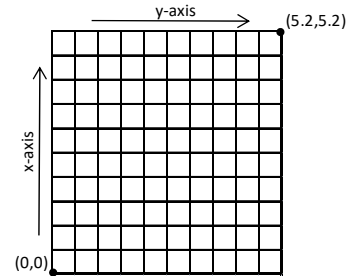

Figure 4-11
Measurement Grid

- ii. After scanning, the planar field maximum point was determined. The position of the probe was moved to this location to setup the test using the SoundCheck system.
 - iii. These steps were repeated for all T-coil orientations (axial and radial) per Figure 4-13 after a T-coil orientation was fully measured with the SoundCheck system.
- b. Speech Signal Setup to Base Station Simulator
- i. C63.19 Table 7-1 states audio reference input levels for various technologies:

Standard	Technology	Input Level (dBm0)
TIA/EIA/IS-2000	CDMA	-18
J-STD-007	GSM (217)	-16
T1/T1P1/3GPP	UMTS (WCDMA)	-16
IDEN™	TDMA (22 and 11 Hz)	-18

FCC ID: A3LSMF936U	element	HAC (T-COIL) TEST REPORT	Approved by: Managing Director
Filename: 1M2204010046-24-R2.A3L	Test Dates: 4/25/2022 – 6/2/2022	DUT Type: Portable Handset	Page 13 of 120

REV 4.2.M
3/29/2022

- ii. See Section 5 and 7 for more information regarding CMW500 audio level settings for Voice Over LTE (VoLTE) and Voice Over WIFI (VoWIFI) testing.
 - iii. See Section 6 for more information regarding CMW500 and CMX500 audio level settings for Voice Over NR (VoNR) testing.
 - iv. See Section 8 for more information regarding audio level settings for Over-The-Top (OTT) Voice Over IP (VoIP) Testing.
 - c. Real-Time Analyzer (RTA)
 - i. The Real-Time Analyzer was configured to analyze measurements using 1/3 Octave band weighted filtering.
 - d. WD Radio Configuration Selection
 - i. The device was chosen to be tested in the worst-case ABM2 condition (See Section 9 for more information regarding worst-case configurations for UMTS. LTE configuration information can be found in Section 5 and 8. NR Configuration can be found in Section 6 and 8. WIFI configuration information can be found in Section 7 and 8.)
 - ii. Supported GSM vocoders were investigated for the worst-case ABM2 condition. GSM-EFR was deemed the worst-case condition for the GSM air interface.
- 4. Signal Quality Data Analysis
 - a. Narrow-band Magnetic Intensity
 - i. The standard specifies a 1kHz 1/3 octave band minimum field intensity for a sine tone. The ABM1 measurements were evaluated at 1kHz with 1/3 octave band filtering over an averaged period of 10 seconds.
 - b. Frequency Response
 - i. The appropriate frequency response curve was measured to curves in Figure 3-1 or Figure 3-2 between 300 – 3000 Hz using digital linear averaging (limit lines chosen according to measurement found in step 4a). A linear average over 3x the length of the artificial voice signal (3x sampling) was performed. A 10 second delay was configured in the measurement process of the stimulus to ensure handset vocoder latency effects and echo cancellation devices (if any) were appropriately stabilized during measurements.
 - ii. The appropriate post-processing was applied according to the system processing chain illustrated in Figure 4-6. All R10 frequencies were plotted with respect to 0dB at 1kHz value and aligned with respect to the EIA-504 mask.
 - iii. The margin is represented by the closest measured data point on the curve to the EIA-504 limit lines, in dB.
 - c. Signal Quality Index
 - i. Ensuring the WD was at maximum RF power, maximum volume, backlight off, display on, maximum contrast setting, keypad lights on (when possible) with no audio signal through the vocoder, the WD was measured over at least 100 Hz – 10,000 Hz, maximized over 5 seconds with a 50ms sample time for the ABM2 measurement (5 second time period is used in noise measurements under standards such as IEEE 269, etc.).
 - ii. After applying half-band integration and A-weighting to the result, a power sum was applied over each 1/3 octave bandwidth frequency for an ABM2 value.
 - iii. This result was subtracted from the ABM1 result in step a, to obtain the Signal Quality.

FCC ID: A3LSMF936U		HAC (T-COIL) TEST REPORT	Approved by: Managing Director
Filename: 1M2204010046-24-R2.A3L	Test Dates: 4/25/2022 – 6/2/2022	DUT Type: Portable Handset	Page 14 of 120

REV 4.2.M
3/29/2022

V. Test Setup

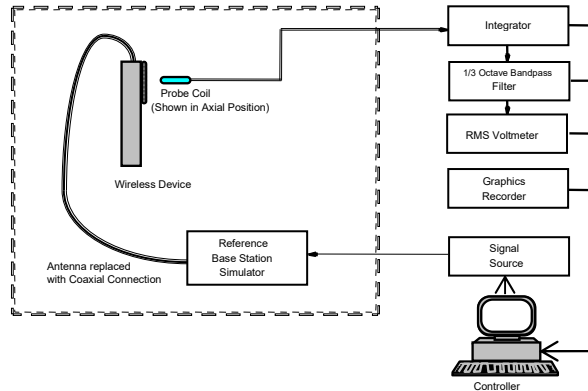

**Figure 4-12
Audio Magnetic Field Test Setup**

Environmental conditions such as temperature and relative humidity are monitored to ensure there are no impacts on system specifications. Proper voltage and power line frequency conditions are maintained with three phase power sources. Environmental noise and reflections are monitored through system checks.

VI. Deviation from C63.19 Test Procedure

Non-conducted RF connection due to inaccessible RF ports.

VII. Air Interface Technologies Tested

All air interfaces which support voice capabilities over a managed CMRS or pre-installed OTT VoIP applications were tested for T-coil unless otherwise noted. See Table 2-1 for more details regarding which modes were tested.

FCC ID: A3LSMF936U		HAC (T-COIL) TEST REPORT	Approved by: Managing Director
Filename: 1M2204010046-24-R2.A3L	Test Dates: 4/25/2022 – 6/2/2022	DUT Type: Portable Handset	Page 15 of 120

REV 4.2.M
3/29/2022

VIII. Wireless Device Channels and Frequencies

1. 2G/3G Modes

The frequencies listed in the table below are those that lie in the center of the bands used for cellular telephony. Low, middle and high channels were tested in each band for FCC compliance evaluation to ensure the maximum emission is captured across the entire band. Only middle channels were evaluated for data modes.

**Table 4-3
Center Channels and Frequencies**

Test frequencies & associated channels	
Channel	Frequency (MHz)
Cellular 850	
190 (GSM)	836.60
4183 (UMTS)	836.60
AWS 1750	
1412 (UMTS)	1730.40
PCS 1900	
661 (GSM)	1880
9400 (UMTS)	1880

2. 4G (LTE) Modes

The middle channel for every band and bandwidth combination was tested for each probe orientation. The band and bandwidth combination from each probe orientation resulting in the worst-case SNNR was additionally tested using low and high channels for that band and bandwidth combination. Low-mid and mid-high channels were additionally tested for LTE TDD. The middle channels and supported bandwidths from the worst-case bands according to Tables 8-6 and 8-7 were additionally evaluated with OTT VoIP for each probe orientation. See Tables 10-6 to 10-34 as well as 10-64 and 10-65 for LTE bandwidths and channels.

3. 5G (NR) Modes

The middle channel for every band and bandwidth combination was tested for each probe orientation. The band and bandwidth combination from each probe orientation resulting in the worst-case SNNR was additionally tested using low and high channels for that band and bandwidth combination. Low-mid and mid-high channels were additionally tested for NR TDD. The middle channel and supported bandwidths from the worst-case NR FDD band according to Table 8-10 was evaluated with OTT VoIP for each probe orientation. NR TDD was additionally evaluated with OTT VoIP for each probe orientation according to Table 8-11. See Tables 10-35 to 10-54 as well as Tables 10-66 and 10-67 for NR bandwidths and channels.

4. WIFI

The middle channel for each IEEE 802.11 standard was tested for each probe orientation. The 2.4GHz IEEE 802.11 standard from each probe orientation resulting in the worst-case SNNR was additionally tested using low and high channels. The 5GHz IEEE 802.11 standard from each probe orientation resulting in the worst-case SNNR was additionally tested on higher U-NII bands as well as applicable low and high channels. See Tables 10-55 to 10-59 as well as 10-68 to 10-72 for WIFI standards and channels.

FCC ID: A3LSMF936U		HAC (T-COIL) TEST REPORT	Approved by: Managing Director
Filename: 1M2204010046-24-R2.A3L	Test Dates: 4/25/2022 – 6/2/2022	DUT Type: Portable Handset	Page 16 of 120

REV 4.2.M
3/29/2022

IX. Test Flow

The flow diagram below was followed (From C63.19):

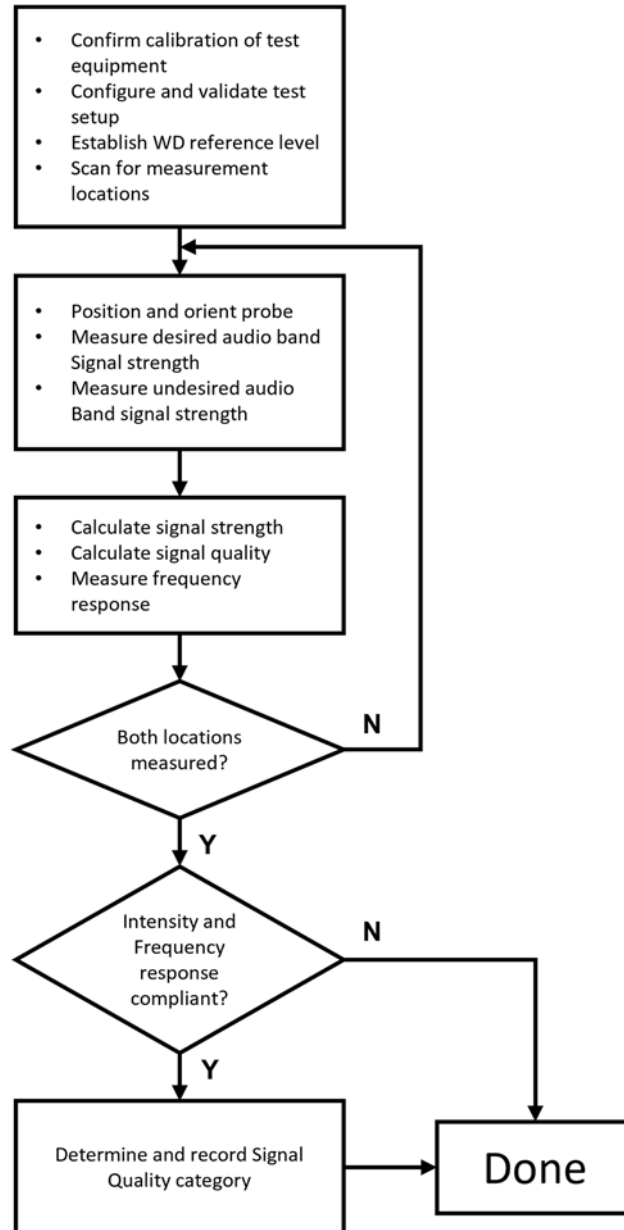



Figure 4-13
C63.19 T-Coil Signal Test Process

FCC ID: A3LSMF936U		HAC (T-COIL) TEST REPORT	Approved by: Managing Director
Filename: 1M2204010046-24-R2.A3L	Test Dates: 4/25/2022 – 6/2/2022	DUT Type: Portable Handset	Page 17 of 120

REV 4.2.M
3/29/2022

5. VOLTE TEST SYSTEM SETUP AND DUT CONFIGURATION

I. Test System Setup for VoLTE over IMS T-coil Testing

1. Equipment Setup

The general test setup used for VoLTE over IMS is shown below. The callbox used when performing VoLTE over IMS T-coil measurements is a CMW500. The Data Application Unit (DAU) of the CMW500 was used to simulate the IP Multimedia Subsystem (IMS) server.

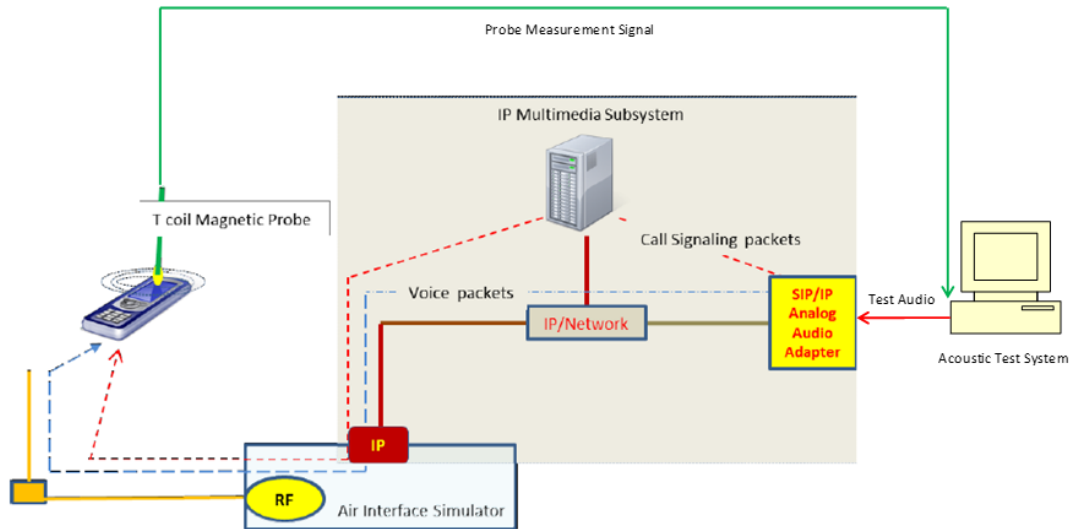

Figure 5-1
Test Setup for VoLTE over IMS T-Coil Measurements

2. Audio Level Settings

According to the July 2012 interpretations by the C63 Committee regarding the appropriate audio levels to be used for VoLTE over IMS T-coil testing, -16dBm0 shall be used for the normal speech input level*. The CMW500 base station simulator was manually configured to ensure that the settings for speech input and full scale levels resulted in the -16dBm0 speech input level to the DUT for the VoLTE over IMS connection.

* http://c63.org/documents/misc/posting/new_interpretations.htm

FCC ID: A3LSMF936U	element	HAC (T-COIL) TEST REPORT	Approved by: Managing Director
Filename: 1M2204010046-24-R2.A3L	Test Dates: 4/25/2022 – 6/2/2022	DUT Type: Portable Handset	Page 18 of 120

REV 4.2.M
3/29/2022

II. DUT Configuration for VoLTE over IMS T-coil Testing

1. Radio Configuration

An investigation was performed to determine the modulation and RB configuration to be used for testing. The effects of modulation and RB configuration were found to be independent of band and bandwidth; therefore, only one band and bandwidth were used for this investigation. 16QAM, 1RB, 99%RB offset was used for the testing as the worst-case configuration for the handset. See below table for SNNR comparison between different radio configurations:

Table 5-1
VoLTE over IMS SNNR by Radio Configuration

Band	Frequency [MHz]	Channel	Bandwidth [MHz]	Modulation	RB Size	RB Offset	ABM1 [dB(A/m)]	ABM2 [dB(A/m)]	SNNR [dB]
66	1745.0	132322	20	QPSK	1	0	5.72	-45.14	50.86
66	1745.0	132322	20	QPSK	1	50	5.74	-43.55	49.29
66	1745.0	132322	20	QPSK	1	99	5.79	-43.41	49.20
66	1745.0	132322	20	QPSK	50	0	5.70	-49.33	55.03
66	1745.0	132322	20	QPSK	50	25	5.99	-49.82	55.81
66	1745.0	132322	20	QPSK	50	50	6.00	-49.60	55.60
66	1745.0	132322	20	QPSK	100	0	5.51	-47.54	53.05
66	1745.0	132322	20	16QAM	1	0	5.72	-38.56	44.28
66	1745.0	132322	20	16QAM	1	50	5.76	-36.64	42.40
66	1745.0	132322	20	16QAM	1	99	5.75	-36.38	42.13
66	1745.0	132322	20	16QAM	50	0	5.63	-49.03	54.66
66	1745.0	132322	20	16QAM	50	25	5.62	-48.28	53.90
66	1745.0	132322	20	16QAM	50	50	5.94	-48.25	54.19
66	1745.0	132322	20	16QAM	100	0	5.79	-48.90	54.69
66	1745.0	132322	20	64QAM	1	0	5.90	-40.45	46.35
66	1745.0	132322	20	64QAM	1	50	5.61	-37.34	42.95
66	1745.0	132322	20	64QAM	1	99	5.54	-36.85	42.39
66	1745.0	132322	20	64QAM	50	0	5.67	-48.90	54.57
66	1745.0	132322	20	64QAM	50	25	5.67	-48.10	53.77
66	1745.0	132322	20	64QAM	50	50	5.50	-47.56	53.06
66	1745.0	132322	20	64QAM	100	0	5.51	-48.58	54.09
66	1745.0	132322	20	256QAM	1	0	5.63	-45.51	51.14
66	1745.0	132322	20	256QAM	1	50	5.77	-40.98	46.75
66	1745.0	132322	20	256QAM	1	99	5.61	-40.69	46.30
66	1745.0	132322	20	256QAM	50	0	5.90	-49.14	55.04
66	1745.0	132322	20	256QAM	50	25	6.15	-49.32	55.47
66	1745.0	132322	20	256QAM	50	50	5.82	-49.34	55.16
66	1745.0	132322	20	256QAM	100	0	5.72	-48.09	53.81

FCC ID: A3LSMF936U		HAC (T-COIL) TEST REPORT	Approved by: Managing Director
Filename: 1M2204010046-24-R2.A3L	Test Dates: 4/25/2022 – 6/2/2022	DUT Type: Portable Handset	Page 19 of 120

REV 4.2.M

3/29/2022

2. Codec Configuration

An investigation was performed to determine the audio codec configuration to be used for testing. The effects of codec configuration were found to be independent of radio configuration; therefore, only one radio configuration was used for this investigation. The WB AMR 6.60kbps setting was used for the audio codec on the CMW500 for VoLTE over IMS T-coil testing. See below table for comparisons between different codecs and codec data rates:

Table 5-2
AMR Codec Investigation – VoLTE over IMS

Codec Setting:	WB AMR 23.85kbps	WB AMR 6.60kbps	NB AMR 12.2kbps	NB AMR 4.75kbps	Orientation	Band / BW	Channel
ABM1 (dBA/m)	6.88	6.12	7.77	7.76	Axial	Band 66 20MHz	132322
ABM2 (dBA/m)	-36.67	-36.40	-36.89	-36.98			
Frequency Response	Pass	Pass	Pass	Pass			
S+N/N (dB)	43.55	42.52	44.66	44.74			

Table 5-3
EVS Codec Investigation - VoLTE over IMS

Codec Setting:	EVS Primary SWB 13.2kbps	EVS Primary SWB 9.6kbps	EVS Primary WB 13.2kbps	EVS Primary WB 5.9kbps	EVS Primary NB 13.2kbps	EVS Primary NB 5.9kbps	Orientation	Band / BW	Channel
ABM1 (dBA/m)	8.66	8.00	7.03	6.62	7.41	8.20	Axial	Band 66 20MHz	132322
ABM2 (dBA/m)	-36.44	-36.40	-36.31	-36.41	-36.29	-36.32			
Frequency Response	Pass	Pass	Pass	Pass	Pass	Pass			
S+N/N (dB)	45.10	44.40	43.34	43.03	43.70	44.52			

- Mute on; Backlight off; Max Volume; Max Contrast
- TPC = “Max Power”

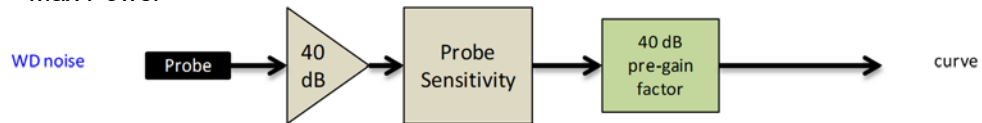

Figure 5-2
Audio Band Magnetic Curve Measurement Block Diagram

FCC ID: A3LSMF936U	element	HAC (T-COIL) TEST REPORT	Approved by: Managing Director
Filename: 1M2204010046-24-R2.A3L	Test Dates: 4/25/2022 – 6/2/2022	DUT Type: Portable Handset	Page 20 of 120

REV 4.2.M
3/29/2022

3. LTE TDD Uplink-Downlink Configuration Investigation for VoLTE over IMS

An investigation was performed to determine the worst-case Uplink-Downlink configuration for VoLTE over IMS T-Coil testing.

Per 3GPP TS 36.211, the total frame length for each TDD radio frame of length $T_f = 307200 \cdot T_s = 10$ ms, where T_s is a number of time units equal to $1/(15000 \times 2048)$ seconds. Additionally, each radio frame consists of 10 subframes, each of length $30720 \cdot T_s = 1$ ms, and subframes can be designated as uplink (U), downlink (D), or special subframe (S), depending on the Uplink-Downlink configuration as indicated in Table 4.2-2 of 3GPP TS 36.211. In the transmission duty factor calculation, the special subframe configuration with the shortest UpPTS duration within the special subframe is used and will be applied for measurement. From 3GPP TS 36.211 Table 4.2-1, the shortest UpPTS is $2192 \cdot T_s$ which occurs in the normal cyclic prefix and special subframe configuration 4.

See table below outlining the calculated transmission duty cycles for each Uplink-Downlink configuration:

Table 5-4
Uplink-Downlink Configurations for Type 2 Frame Structures

Uplink-downlink configuration	Downlink-to-Uplink Switch-point periodicity	Subframe number										Calculated Transmission Duty Cycle (%)
		0	1	2	3	4	5	6	7	8	9	
0	5 ms	D	S	U	U	U	D	S	U	U	U	61.4%
1	5 ms	D	S	U	U	D	D	S	U	U	D	41.4%
2	5 ms	D	S	U	D	D	D	S	U	D	D	21.4%
3	10 ms	D	S	U	U	U	D	D	D	D	D	30.7%
4	10 ms	D	S	U	U	D	D	D	D	D	D	20.7%
5	10 ms	D	S	U	D	D	D	D	D	D	D	10.7%
6	5 ms	D	S	U	U	U	D	S	U	U	D	51.4%

a. Power Class 3 Uplink-Downlink Configuration Investigation

Power Class 3 was evaluated with the following radio configuration: channel 40620, 20MHz BW, 16QAM, 1RB, 99%RB offset. For Power Class 3, all configurations (0-6) are supported. The configuration which resulted in the worst SNNR was used for full testing. Uplink-Downlink configuration 0 was used as the worst-case configuration for Power Class 3 VoLTE over IMS T-Coil testing. See table below for the SNNR comparison between each Uplink-Downlink configuration:

Table 5-5
Power Class 3 VoLTE over IMS SNNR by UL-DL Configuration

Frequency [MHz]	Channel	Bandwidth [MHz]	Modulation	RB Size	RB Offset	UL-DL Configuration	ABM1 [dB(A/m)]	ABM2 [dB(A/m)]	SNNR [dB]
2593.0	40620	20	16QAM	1	99	0	5.51	-30.98	36.49
2593.0	40620	20	16QAM	1	99	1	5.93	-31.33	37.26
2593.0	40620	20	16QAM	1	99	2	5.24	-31.66	36.90
2593.0	40620	20	16QAM	1	99	3	5.55	-33.93	39.48
2593.0	40620	20	16QAM	1	99	4	5.61	-34.16	39.77
2593.0	40620	20	16QAM	1	99	5	5.33	-33.60	38.93
2593.0	40620	20	16QAM	1	99	6	5.54	-31.31	36.85

FCC ID: A3LSMF936U		HAC (T-COIL) TEST REPORT	Approved by: Managing Director
Filename: 1M2204010046-24-R2.A3L	Test Dates: 4/25/2022 – 6/2/2022	DUT Type: Portable Handset	Page 21 of 120

REV 4.2.M
3/29/2022

b. Power Class 2 Uplink-Downlink Configuration Investigation

Power Class 2 was evaluated with the following radio configuration: channel 40620, 20MHz BW, 16QAM, 1RB, 99%RB offset. For Power Class 2, configurations 1-5 are supported. The configuration which resulted in the worst SNNR was used for full testing. Uplink-Downlink configuration 1 was used as the worst-case configuration for Power Class 2 VoLTE over IMS T-Coil testing. See table below for the SNNR comparison between each Uplink-Downlink configuration:

**Table 5-6
Power Class 2 VoLTE over IMS SNNR by UL-DL Configuration**

Frequency [MHz]	Channel	Bandwidth [MHz]	Modulation	RB Size	RB Offset	UL-DL Configuration	ABM1 [dB(A/m)]	ABM2 [dB(A/m)]	SNNR [dB]
2593.0	40620	20	16QAM	1	99	1	5.44	-29.86	35.30
2593.0	40620	20	16QAM	1	99	2	5.33	-30.26	35.59
2593.0	40620	20	16QAM	1	99	3	5.29	-32.33	37.62
2593.0	40620	20	16QAM	1	99	4	5.20	-32.64	37.84
2593.0	40620	20	16QAM	1	99	5	5.27	-32.12	37.39

Note: LTE TDD B41 Power Class 2 only supports UL-DL configurations 1-5, not 0 or 6.

c. Conclusion

Per the investigations above, UL-DL Configuration 0 was used to evaluate Power Class 3 VoLTE over IMS. UL-DL Configuration 1 was used to evaluate Power Class 2 VoLTE over IMS.

FCC ID: A3LSMF936U		HAC (T-COIL) TEST REPORT	Approved by: Managing Director
Filename: 1M2204010046-24-R2.A3L	Test Dates: 4/25/2022 – 6/2/2022	DUT Type: Portable Handset	Page 22 of 120

REV 4.2.M
3/29/2022

6. VONR TEST SYSTEM SETUP AND DUT CONFIGURATION

I. Test System Setup for VoNR over IMS T-coil Testing

1. Equipment Setup

The general test setup used for VoNR over IMS is shown below. The callboxes used when performing VoNR over IMS T-coil measurements are CMW500 and CMX500. The Data Application Unit (DAU) of the CMW500 was used to simulate the IP Multimedia Subsystem (IMS) server. The CMX500 provided the baseband signal to perform NR signaling. An external USB audio interface is used to perform the A/D conversion and ensure proper speech input level to the DUT.

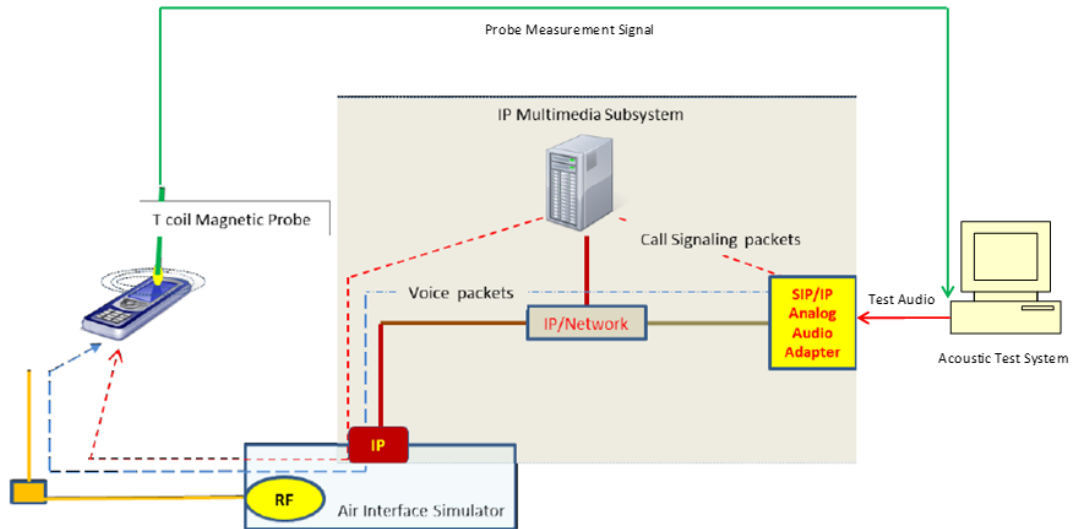



Figure 6-1
Test Setup for VoNR over IMS T-Coil Measurements

2. Audio Level Settings

According to FCC guidance and manufacturer attestation, -16dBm0 was used for the normal speech input level. The acoustic test system was manually configured to ensure that the settings for speech input and full scale levels resulted in the -16dBm0 speech input level to the DUT for the VoNR over IMS connection.

FCC ID: A3LSMF936U		HAC (T-COIL) TEST REPORT	Approved by: Managing Director
Filename: 1M2204010046-24-R2.A3L	Test Dates: 4/25/2022 – 6/2/2022	DUT Type: Portable Handset	Page 23 of 120

REV 4.2.M

3/29/2022

II. DUT Configuration for VoNR over IMS T-coil Testing

1. Radio Configuration

An investigation was performed to determine the waveform, modulation, and RB configuration to be used for testing. The effects of waveform, modulation, and RB configuration were found to be independent of band and bandwidth; therefore, only one band and bandwidth were used for this investigation. CP-OFDM, 16QAM, 1RB, 1RB offset was used for the testing as the worst-case configuration for the handset. See below table for SNNR comparison between different radio configurations:

Table 6-1
VoNR over IMS SNNR by Radio Configuration (CP-OFDM)

Band	Frequency [MHz]	Channel	Bandwidth [MHz]	Waveform	Modulation	RB Size	RB Offset	ABM1 [dB(A/m)]	ABM2 [dB(A/m)]	SNNR [dB]
n5	836.5	167300	20	CP-OFDM	QPSK	1	1	5.22	-44.29	49.51
n5	836.5	167300	20	CP-OFDM	QPSK	1	53	5.05	-45.62	50.67
n5	836.5	167300	20	CP-OFDM	QPSK	1	104	4.93	-44.79	49.72
n5	836.5	167300	20	CP-OFDM	QPSK	53	0	4.93	-47.75	52.68
n5	836.5	167300	20	CP-OFDM	QPSK	53	26	4.74	-47.08	51.82
n5	836.5	167300	20	CP-OFDM	QPSK	53	53	4.78	-47.11	51.89
n5	836.5	167300	20	CP-OFDM	QPSK	106	0	4.77	-47.66	52.43
n5	836.5	167300	20	CP-OFDM	16QAM	1	1	5.01	-42.81	47.82
n5	836.5	167300	20	CP-OFDM	16QAM	1	53	5.21	-44.13	49.34
n5	836.5	167300	20	CP-OFDM	16QAM	1	104	5.17	-43.08	48.25
n5	836.5	167300	20	CP-OFDM	16QAM	53	0	5.18	-47.23	52.41
n5	836.5	167300	20	CP-OFDM	16QAM	53	26	5.22	-47.18	52.40
n5	836.5	167300	20	CP-OFDM	16QAM	53	53	5.25	-47.17	52.42
n5	836.5	167300	20	CP-OFDM	16QAM	106	0	5.03	-47.51	52.54
n5	836.5	167300	20	CP-OFDM	64QAM	1	1	4.78	-44.21	48.99
n5	836.5	167300	20	CP-OFDM	64QAM	1	53	4.77	-45.30	50.07
n5	836.5	167300	20	CP-OFDM	64QAM	1	104	5.21	-44.43	49.64
n5	836.5	167300	20	CP-OFDM	64QAM	53	0	5.21	-47.62	52.83
n5	836.5	167300	20	CP-OFDM	64QAM	53	26	5.26	-47.04	52.30
n5	836.5	167300	20	CP-OFDM	64QAM	53	53	5.03	-46.89	51.92
n5	836.5	167300	20	CP-OFDM	64QAM	106	0	5.19	-47.55	52.74
n5	836.5	167300	20	CP-OFDM	256QAM	1	1	5.15	-47.28	52.43
n5	836.5	167300	20	CP-OFDM	256QAM	1	53	5.17	-46.72	51.89
n5	836.5	167300	20	CP-OFDM	256QAM	1	104	5.16	-45.93	51.09
n5	836.5	167300	20	CP-OFDM	256QAM	53	0	5.16	-47.22	52.38
n5	836.5	167300	20	CP-OFDM	256QAM	53	26	5.20	-47.87	53.07
n5	836.5	167300	20	CP-OFDM	256QAM	53	53	5.18	-48.08	53.26
n5	836.5	167300	20	CP-OFDM	256QAM	106	0	5.11	-47.41	52.52

FCC ID: A3LSMF936U		HAC (T-COIL) TEST REPORT	Approved by: Managing Director
Filename: 1M2204010046-24-R2.A3L	Test Dates: 4/25/2022 – 6/2/2022	DUT Type: Portable Handset	Page 24 of 120

REV 4.2.M
3/29/2022

**Table 6-2
VoNR over IMS SNNR by Radio Configuration (DFT-s-OFDM)**

Band	Frequency [MHz]	Channel	Bandwidth [MHz]	Waveform	Modulation	RB Size	RB Offset	ABM1 [dB(A/m)]	ABM2 [dB(A/m)]	SNNR [dB]
n5	836.5	167300	20	DFT-s-OFDM	$\pi/2$ -BPSK	1	1	4.82	-45.23	50.05
n5	836.5	167300	20	DFT-s-OFDM	$\pi/2$ -BPSK	1	53	4.92	-45.56	50.48
n5	836.5	167300	20	DFT-s-OFDM	$\pi/2$ -BPSK	1	104	4.90	-45.42	50.32
n5	836.5	167300	20	DFT-s-OFDM	$\pi/2$ -BPSK	50	0	4.97	-45.17	50.14
n5	836.5	167300	20	DFT-s-OFDM	$\pi/2$ -BPSK	50	28	4.93	-46.72	51.65
n5	836.5	167300	20	DFT-s-OFDM	$\pi/2$ -BPSK	50	53	5.05	-46.76	51.81
n5	836.5	167300	20	DFT-s-OFDM	$\pi/2$ -BPSK	100	0	4.96	-47.29	52.25
n5	836.5	167300	20	DFT-s-OFDM	QPSK	1	1	5.16	-46.29	51.45
n5	836.5	167300	20	DFT-s-OFDM	QPSK	1	53	4.99	-46.41	51.40
n5	836.5	167300	20	DFT-s-OFDM	QPSK	1	104	5.14	-46.05	51.19
n5	836.5	167300	20	DFT-s-OFDM	QPSK	50	0	5.19	-47.87	53.06
n5	836.5	167300	20	DFT-s-OFDM	QPSK	50	28	5.11	-47.45	52.56
n5	836.5	167300	20	DFT-s-OFDM	QPSK	50	53	5.17	-47.38	52.55
n5	836.5	167300	20	DFT-s-OFDM	QPSK	100	0	5.04	-47.26	52.30
n5	836.5	167300	20	DFT-s-OFDM	16QAM	1	1	4.77	-43.66	48.43
n5	836.5	167300	20	DFT-s-OFDM	16QAM	1	53	5.01	-45.41	50.42
n5	836.5	167300	20	DFT-s-OFDM	16QAM	1	104	5.01	-43.84	48.85
n5	836.5	167300	20	DFT-s-OFDM	16QAM	50	0	4.82	-47.22	52.04
n5	836.5	167300	20	DFT-s-OFDM	16QAM	50	28	5.04	-47.34	52.38
n5	836.5	167300	20	DFT-s-OFDM	16QAM	50	53	5.19	-45.34	50.53
n5	836.5	167300	20	DFT-s-OFDM	16QAM	100	0	4.98	-47.56	52.54
n5	836.5	167300	20	DFT-s-OFDM	64QAM	1	1	5.12	-44.24	49.36
n5	836.5	167300	20	DFT-s-OFDM	64QAM	1	53	5.10	-45.55	50.65
n5	836.5	167300	20	DFT-s-OFDM	64QAM	1	104	5.16	-44.54	49.70
n5	836.5	167300	20	DFT-s-OFDM	64QAM	50	0	5.00	-47.70	52.70
n5	836.5	167300	20	DFT-s-OFDM	64QAM	50	28	5.10	-48.11	53.21
n5	836.5	167300	20	DFT-s-OFDM	64QAM	50	53	5.10	-47.42	52.52
n5	836.5	167300	20	DFT-s-OFDM	64QAM	100	0	5.21	-47.32	52.53
n5	836.5	167300	20	DFT-s-OFDM	256QAM	1	1	5.09	-45.46	50.55
n5	836.5	167300	20	DFT-s-OFDM	256QAM	1	53	5.08	-46.45	51.53
n5	836.5	167300	20	DFT-s-OFDM	256QAM	1	104	5.04	-45.86	50.90
n5	836.5	167300	20	DFT-s-OFDM	256QAM	50	0	5.10	-47.18	52.28
n5	836.5	167300	20	DFT-s-OFDM	256QAM	50	28	5.00	-47.12	52.12
n5	836.5	167300	20	DFT-s-OFDM	256QAM	50	53	5.03	-47.09	52.12
n5	836.5	167300	20	DFT-s-OFDM	256QAM	100	0	5.08	-47.53	52.61

FCC ID: A3LSMF936U		HAC (T-COIL) TEST REPORT	Approved by: Managing Director
Filename: 1M2204010046-24-R2.A3L	Test Dates: 4/25/2022 – 6/2/2022	DUT Type: Portable Handset	Page 25 of 120

REV 4.2.M
3/29/2022

2. Codec Configuration

An investigation was performed to determine the audio codec configuration to be used for testing. The effects of codec configuration were found to be independent of radio configuration; therefore, only one radio configuration was used for this investigation. The WB AMR 6.60kbps setting was used for the audio codec on the CMX500/CMW500 for VoNR over IMS T-coil testing. See below table for comparisons between different codecs and codec data rates:

Table 6-3
AMR Codec Investigation – VoNR over IMS

Codec Setting:	WB AMR 23.85kbps	WB AMR 6.60kbps	NB AMR 12.2kbps	NB AMR 4.75kbps	Orientation	Band / BW	Channel
ABM1 (dBA/m)	6.36	5.32	7.11	6.78	Axial	NR n5 20MHz	167300
ABM2 (dBA/m)	-43.98	-44.21	-43.72	-43.88			
Frequency Response	Pass	Pass	Pass	Pass			
S+N/N (dB)	50.34	49.53	50.83	50.66			

Table 6-4
EVS Codec Investigation - VoNR over IMS

Codec Setting:	EVS Primary SWB 128kbps	EVS Primary SWB 9.6kbps	EVS Primary WB 128kbps	EVS Primary WB 5.9kbps	EVS Primary NB 24.4kbps	EVS Primary NB 5.9kbps	Orientation	Band / BW	Channel
ABM1 (dBA/m)	7.84	8.02	7.01	6.67	6.80	7.84	Axial	NR n5 20MHz	167300
ABM2 (dBA/m)	-43.88	-43.77	-43.90	-43.60	-44.13	-43.05			
Frequency Response	Pass	Pass	Pass	Pass	Pass	Pass			
S+N/N (dB)	51.72	51.79	50.91	50.27	50.93	50.89			

- Mute on; Backlight off; Max Volume; Max Contrast
- TPC = “Max Power”

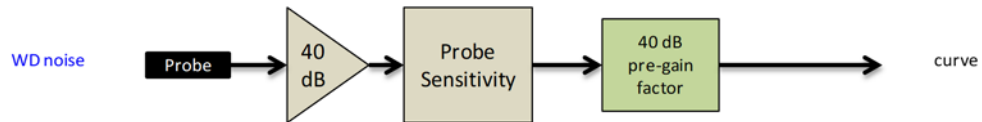

Figure 6-2
Audio Band Magnetic Curve Measurement Block Diagram

FCC ID: A3LSMF936U	element	HAC (T-COIL) TEST REPORT	Approved by: Managing Director
Filename: 1M2204010046-24-R2.A3L	Test Dates: 4/25/2022 – 6/2/2022	DUT Type: Portable Handset	Page 26 of 120

REV 4.2.M
3/29/2022

7. VOWIFI TEST SYSTEM SETUP AND DUT CONFIGURATION

I. Test System Setup for VoWIFI over IMS T-coil Testing

1. Equipment Setup

The general test setup used for VoWIFI over IMS, or CMRS WIFI Calling, is shown below. The callbox used when performing VoWIFI over IMS T-coil measurements is a CMW500. The Data Application Unit (DAU) of the CMW500 was used to simulate the IP Multimedia Subsystem (IMS) server.

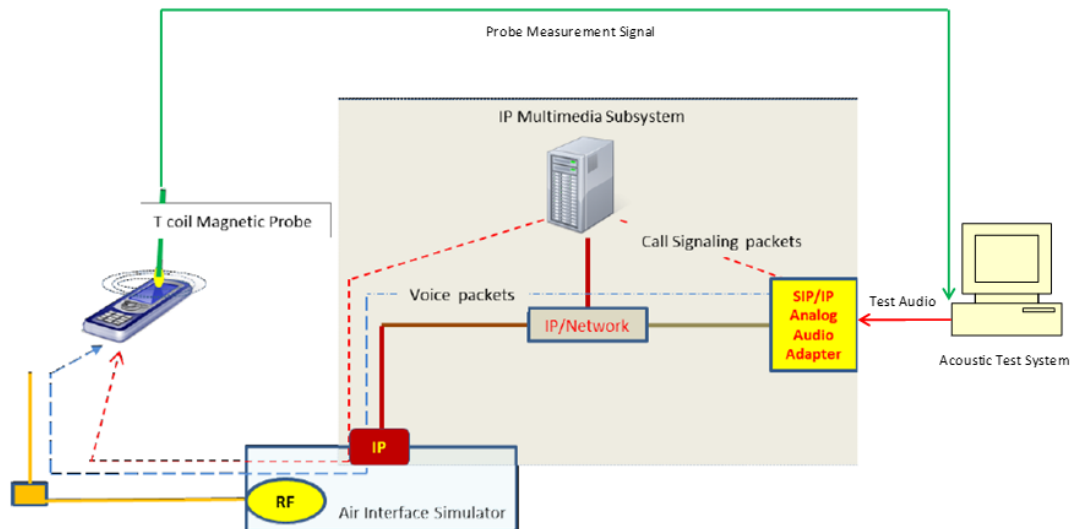



Figure 7-1
Test Setup for VoWIFI over IMS T-Coil Measurements

2. Audio Level Settings

According to KDB 285076 D02 released by the FCC OET regarding the appropriate audio levels to be used for VoWIFI over IMS T-Coil testing, -20dBm0 shall be used for the normal speech input level². The CMW500 base station simulator was manually configured to ensure that the settings for speech input and full scale levels resulted in the -20dBm0 speech input level to the DUT for the VoWIFI over IMS connection.

² FCC Office of Engineering and Technology KDB, "285076 D02 T-Coil Testing for CMRS IP v03," September 13, 2017

FCC ID: A3LSMF936U		HAC (T-COIL) TEST REPORT	Approved by: Managing Director
Filename: 1M2204010046-24-R2.A3L	Test Dates: 4/25/2022 – 6/2/2022	DUT Type: Portable Handset	Page 27 of 120

REV 4.2.M

3/29/2022

II. DUT Configuration for VoWiFi over IMS T-coil Testing

1. Radio Configuration

An investigation was performed on all applicable data rates and modulations to determine the radio configuration to be used for testing. See tables below for SNNR comparison between radio configurations in each IEEE 802.11 standard:

**Table 7-1
IEEE 802.11b SNNR by Radio Configuration**

Mode	Channel	Modulation	Data Rate [Mbps]	ABM1 [dB(A/m)]	ABM2 [dB(A/m)]	SNNR [dB]
IEEE 802.11b	6	DSSS	1	1.68	-31.57	33.25
IEEE 802.11b	6	DSSS	2	1.90	-32.50	34.40
IEEE 802.11b	6	CCK	5.5	1.70	-32.28	33.98
IEEE 802.11b	6	CCK	11	1.69	-32.92	34.61

**Table 7-2
IEEE 802.11g/a SNNR by Radio Configuration**

Mode	Channel	Modulation	Data Rate [Mbps]	ABM1 [dB(A/m)]	ABM2 [dB(A/m)]	SNNR [dB]
IEEE 802.11g	6	BPSK	6	1.68	-34.46	36.14
IEEE 802.11g	6	BPSK	9	1.97	-34.49	36.46
IEEE 802.11g	6	QPSK	12	1.78	-36.60	38.38
IEEE 802.11g	6	QPSK	18	1.54	-35.02	36.56
IEEE 802.11g	6	16QAM	24	1.76	-36.43	38.19
IEEE 802.11g	6	16QAM	36	1.55	-35.52	37.07
IEEE 802.11g	6	64QAM	48	1.67	-36.63	38.30
IEEE 802.11g	6	64QAM	54	1.81	-36.64	38.45

**Table 7-3
IEEE 802.11n/ac 20MHz BW SNNR by Radio Configuration**

Mode	Bandwidth [MHz]	Channel	Modulation	MCS Index	ABM1 [dB(A/m)]	ABM2 [dB(A/m)]	SNNR [dB]
IEEE 802.11n	20	40	BPSK	0	1.52	-35.43	36.95
IEEE 802.11n	20	40	QPSK	1	1.39	-35.87	37.26
IEEE 802.11n	20	40	QPSK	2	1.84	-36.27	38.11
IEEE 802.11n	20	40	16QAM	3	1.85	-35.73	37.58
IEEE 802.11n	20	40	16QAM	4	1.91	-35.61	37.52
IEEE 802.11n	20	40	64QAM	5	1.62	-36.03	37.65
IEEE 802.11n	20	40	64QAM	6	1.37	-36.04	37.41
IEEE 802.11n	20	40	64QAM	7	1.69	-37.83	39.52
IEEE 802.11ac	20	40	256QAM	8	1.55	-35.58	37.13

FCC ID: A3LSMF936U		HAC (T-COIL) TEST REPORT	Approved by: Managing Director
Filename: 1M2204010046-24-R2.A3L	Test Dates: 4/25/2022 – 6/2/2022	DUT Type: Portable Handset	Page 28 of 120

REV 4.2.M
3/29/2022

Table 7-4
IEEE 802.11ax SU 20MHz BW SNNR by Radio Configuration

Mode	Bandwidth [MHz]	Channel	Modulation	MCS Index	ABM1 [dB(A/m)]	ABM2 [dB(A/m)]	SNNR [dB]
IEEE 802.11ax SU	20	40	BPSK	0	1.47	-38.40	39.87
IEEE 802.11ax SU	20	40	QPSK	1	1.72	-38.82	40.54
IEEE 802.11ax SU	20	40	QPSK	2	1.74	-39.90	41.64
IEEE 802.11ax SU	20	40	16QAM	3	1.66	-39.76	41.42
IEEE 802.11ax SU	20	40	16QAM	4	1.73	-40.53	42.26
IEEE 802.11ax SU	20	40	64QAM	5	1.53	-39.15	40.68
IEEE 802.11ax SU	20	40	64QAM	6	1.64	-40.15	41.79
IEEE 802.11ax SU	20	40	64QAM	7	1.64	-40.52	42.16
IEEE 802.11ax SU	20	40	256QAM	8	1.61	-39.01	40.62
IEEE 802.11ax SU	20	40	256QAM	9	1.52	-39.65	41.17
IEEE 802.11ax SU	20	40	1024QAM	10	1.62	-40.23	41.85
IEEE 802.11ax SU	20	40	1024QAM	11	1.55	-38.89	40.44

Table 7-5
IEEE 802.11ax RU 20MHz BW SNNR by Radio Configuration

Mode	Bandwidth [MHz]	Channel	Modulation	MCS Index	RU Index	ABM1 [dB(A/m)]	ABM2 [dB(A/m)]	SNNR [dB]
IEEE 802.11ax RU	20	40	BPSK	0	0	1.60	-39.16	40.76
IEEE 802.11ax RU	20	40	BPSK	0	8	1.54	-38.86	40.40
IEEE 802.11ax RU	20	40	BPSK	0	37	1.60	-38.99	40.59
IEEE 802.11ax RU	20	40	BPSK	0	40	1.59	-38.82	40.41
IEEE 802.11ax RU	20	40	BPSK	0	53	1.69	-38.97	40.66
IEEE 802.11ax RU	20	40	BPSK	0	54	1.63	-38.53	40.16
IEEE 802.11ax RU	20	40	BPSK	0	61	1.55	-38.90	40.45

Table 7-6
IEEE 802.11n/ac 40MHz BW SNNR by Radio Configuration

Mode	Bandwidth [MHz]	Channel	Modulation	MCS Index	ABM1 [dB(A/m)]	ABM2 [dB(A/m)]	SNNR [dB]
IEEE 802.11n	40	38	BPSK	0	1.60	-35.51	37.11
IEEE 802.11n	40	38	QPSK	1	1.65	-35.79	37.44
IEEE 802.11n	40	38	QPSK	2	1.48	-36.30	37.78
IEEE 802.11n	40	38	16QAM	3	1.54	-36.45	37.99
IEEE 802.11n	40	38	16QAM	4	1.54	-37.14	38.68
IEEE 802.11n	40	38	64QAM	5	1.60	-37.12	38.72
IEEE 802.11n	40	38	64QAM	6	1.68	-37.07	38.75
IEEE 802.11n	40	38	64QAM	7	1.72	-37.71	39.43
IEEE 802.11ac	40	38	256QAM	8	1.68	-37.66	39.34
IEEE 802.11ac	40	38	256QAM	9	1.42	-37.29	38.71

FCC ID: A3LSMF936U		HAC (T-COIL) TEST REPORT	Approved by: Managing Director
Filename: 1M2204010046-24-R2.A3L	Test Dates: 4/25/2022 – 6/2/2022	DUT Type: Portable Handset	Page 29 of 120

REV 4.2.M
3/29/2022

Unless otherwise specified, no part of this report may be reproduced or utilized in any part, form or by any means, electronic or mechanical, including photocopying and microfilm, without permission in writing from Element. If you have any questions about this or have an enquiry about obtaining additional rights to this report or assembly of contents thereof, please contact CT.INFO@ELEMENT.COM.

Table 7-7
IEEE 802.11ax SU 40MHz BW SNNR by Radio Configuration

Mode	Bandwidth [MHz]	Channel	Modulation	MCS Index	ABM1 [dB(A/m)]	ABM2 [dB(A/m)]	SNNR [dB]
IEEE 802.11ax SU	40	38	BPSK	0	1.53	-38.88	40.41
IEEE 802.11ax SU	40	38	QPSK	1	1.59	-39.40	40.99
IEEE 802.11ax SU	40	38	QPSK	2	1.52	-40.55	42.07
IEEE 802.11ax SU	40	38	16QAM	3	1.64	-40.91	42.55
IEEE 802.11ax SU	40	38	16QAM	4	1.43	-40.84	42.27
IEEE 802.11ax SU	40	38	64QAM	5	1.76	-38.99	40.75
IEEE 802.11ax SU	40	38	64QAM	6	1.51	-41.11	42.62
IEEE 802.11ax SU	40	38	64QAM	7	1.45	-40.71	42.16
IEEE 802.11ax SU	40	38	256QAM	8	1.48	-40.33	41.81
IEEE 802.11ax SU	40	38	256QAM	9	1.59	-40.25	41.84
IEEE 802.11ax SU	40	38	1024QAM	10	1.64	-40.57	42.21
IEEE 802.11ax SU	40	38	1024QAM	11	1.59	-39.70	41.29

Table 7-8
IEEE 802.11ax RU 40MHz BW SNNR by Radio Configuration

Mode	Bandwidth [MHz]	Channel	Modulation	MCS Index	RU Index	ABM1 [dB(A/m)]	ABM2 [dB(A/m)]	SNNR [dB]
IEEE 802.11ax RU	40	38	BPSK	0	0	1.49	-39.58	41.07
IEEE 802.11ax RU	40	38	BPSK	0	17	1.62	-39.08	40.70
IEEE 802.11ax RU	40	38	BPSK	0	37	1.36	-40.06	41.42
IEEE 802.11ax RU	40	38	BPSK	0	44	1.54	-38.87	40.41
IEEE 802.11ax RU	40	38	BPSK	0	53	1.47	-38.57	40.04
IEEE 802.11ax RU	40	38	BPSK	0	56	1.56	-38.57	40.13
IEEE 802.11ax RU	40	38	BPSK	0	61	1.46	-38.10	39.56
IEEE 802.11ax RU	40	38	BPSK	0	62	1.70	-38.65	40.35
IEEE 802.11ax RU	40	38	BPSK	0	65	1.51	-38.55	40.06

2. Codec Configuration

An investigation was performed to determine the audio codec configuration to be used for testing. The effects of codec configuration were found to be independent of radio configuration; therefore, only one radio configuration was used for this investigation. The WB AMR 6.60kbps setting was used for the audio codec on the CMW500 for VoWiFi over IMS T-coil testing. See below table for comparisons between different codecs and codec data rates:

Table 7-9
AMR Codec Investigation – VoWiFi over IMS

Codec Setting:	WB AMR 23.85kbps	WB AMR 6.60kbps	NB AMR 12.2kbps	NB AMR 4.75kbps	Orientation	Band	Standard	Channel
ABM1 (dBA/m)	2.89	1.58	3.60	3.51	Axial	2.4GHz	IEEE 802.11b	6
ABM2 (dBA/m)	-34.06	-33.94	-33.77	-33.60				
Frequency Response	Pass	Pass	Pass	Pass				
S+N/N (dB)	36.95	35.52	37.37	37.11				

FCC ID: A3LSMF936U		HAC (T-COIL) TEST REPORT	Approved by: Managing Director
Filename: 1M2204010046-24-R2.A3L	Test Dates: 4/25/2022 – 6/2/2022	DUT Type: Portable Handset	Page 30 of 120

REV 4.2.M
3/29/2022

**Table 7-10
EVS Codec Investigation – VoWiFi over IMS**

Codec Setting:	EVS Primary SWB 13.2kbps	EVS Primary SWB 9.6kbps	EVS Primary WB 13.2kbps	EVS Primary WB 5.9kbps	EVS Primary NB 13.2kbps	EVS Primary NB 5.9kbps	Orientation	Band	Standard	Channel
ABM1 (dBA/m)	4.78	4.09	3.01	2.62	3.34	3.02	Axial	2.4GHz	IEEE 802.11b	6
ABM2 (dBA/m)	-34.09	-33.94	-34.13	-34.34	-34.59	-34.34				
Frequency Response	Pass	Pass	Pass	Pass	Pass	Pass				
S+N/N (dB)	38.87	38.03	37.14	36.96	37.93	37.36				

- Mute on; Backlight off; Max Volume; Max Contrast

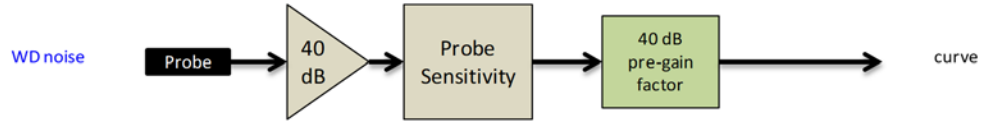

**Figure 7-2
Audio Band Magnetic Curve Measurement Block Diagram**

FCC ID: A3LSMF936U		HAC (T-COIL) TEST REPORT	Approved by: Managing Director
Filename: 1M2204010046-24-R2.A3L	Test Dates: 4/25/2022 – 6/2/2022	DUT Type: Portable Handset	Page 31 of 120

REV 4.2.M
3/29/2022

8. OTT VOIP TEST SYSTEM AND DUT CONFIGURATION

I. Test System Setup for OTT VoIP T-Coil Testing

1. OTT VoIP Application

Google Duo is a pre-installed application on the DUT which allows for VoIP calls in a held-to-ear scenario. Duo uses the OPUS audio codec and supports a bitrate range of 6kb/s to 75kb/s. All air interfaces capable of a data connection were evaluated with Google Duo.

2. Equipment Setup

A CMW500 callbox was used to perform OTT VoIP T-coil measurements. The Data Application Unit (DAU) of the CMW500 was connected to the internet and allowed for an IP data connection on the DUT. An auxiliary VoIP unit was used to initiate an OTT VoIP call to the DUT. The auxiliary VoIP unit allowed for the configuration and monitoring of the OTT VoIP codec bitrate during a call. Both high and low bitrate settings were evaluated in to determine the worst-case configuration.

3. Audio Level Settings

According to KDB 285076 D02, the average speech level of -20dBm0 shall be used for protocols not specifically listed in Table 7.1 of ANSI C63.19-2011 or the ANSI C63.19-2011 VoLTE interpretation³. The auxiliary VoIP unit allowed for monitoring the signal input level to ensure that the settings for speech input and full scale levels resulted in the -20dBm0 speech input level to the DUT for the OTT VoIP call.

II. DUT Configuration for OTT VoIP T-Coil Testing

1. Codec Configuration

An investigation was performed for each applicable data mode to determine the audio codec configuration to be used for testing. The effects of codec configuration were found to be independent of radio configuration; therefore, only one radio configuration for each applicable data mode was used for these investigations. The 6kbps codec setting was used for the audio codec on the auxiliary VoIP unit for OTT VoIP T-Coil testing. See below tables for comparisons between codec data rates on all applicable data modes:

³ FCC Office of Engineering and Technology KDB, "285076 D02 T-Coil Testing for CMRS IP v03," September 13, 2017

FCC ID: A3LSMF936U		HAC (T-COIL) TEST REPORT	Approved by: Managing Director
Filename: 1M2204010046-24-R2.A3L	Test Dates: 4/25/2022 – 6/2/2022	DUT Type: Portable Handset	Page 32 of 120

REV 4.2.M

3/29/2022

**Table 8-1
Codec Investigation – OTT VoIP (EDGE)**

Codec Setting:	75kbps	6kbps	Orientation	Channel
ABM1 (dBA/m)	14.82	14.64	Axial	190
ABM2 (dBA/m)	-30.46	-30.24		
Frequency Response	Pass	Pass		
S+N/N (dB)	45.28	44.88		

**Table 8-2
Codec Investigation – OTT VoIP (HSPA)**

Codec Setting:	75kbps	6kbps	Orientation	Channel
ABM1 (dBA/m)	14.26	14.57	Axial	4183
ABM2 (dBA/m)	-46.99	-46.12		
Frequency Response	Pass	Pass		
S+N/N (dB)	61.25	60.69		

**Table 8-3
Codec Investigation – OTT VoIP (LTE)**

Codec Setting:	75kbps	6kbps	Orientation	Band / BW	Channel
ABM1 (dBA/m)	14.78	14.33	Axial	Band 66 20MHz	132322
ABM2 (dBA/m)	-35.94	-35.90			
Frequency Response	Pass	Pass			
S+N/N (dB)	50.72	50.23			

FCC ID: A3LSMF936U		HAC (T-COIL) TEST REPORT	Approved by: Managing Director
Filename: 1M2204010046-24-R2.A3L	Test Dates: 4/25/2022 – 6/2/2022	DUT Type: Portable Handset	Page 33 of 120

REV 4.2.M
3/29/2022

**Table 8-4
Codec Investigation – OTT VoIP (NR)**

Codec Setting:	75kbps	6kbps	Orientation	Band / BW	Channel
ABM1 (dBA/m)	14.69	14.71	Axial	NR n5 20MHz	167300
ABM2 (dBA/m)	-35.61	-34.90			
Frequency Response	Pass	Pass			
S+N/N (dB)	50.30	49.61			

**Table 8-5
Codec Investigation – OTT VoIP (WIFI)**

Codec Setting:	75kbps	6kbps	Orientation	Band	Standard	Channel
ABM1 (dBA/m)	14.38	14.31	Axial	2.4GHz	IEEE 802.11b	6
ABM2 (dBA/m)	-30.23	-30.13				
Frequency Response	Pass	Pass				
S+N/N (dB)	44.61	44.44				

- Mute on; Backlight off; Max Volume; Max Contrast
- Radio Configurations can be found in Section 10.II.0

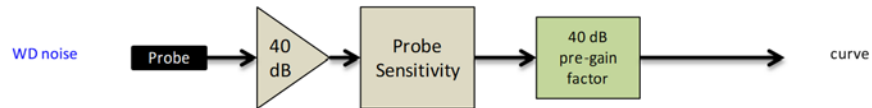

**Figure 8-1
Audio Band Magnetic Curve Measurement Block Diagram**

FCC ID: A3LSMF936U		HAC (T-COIL) TEST REPORT	Approved by: Managing Director
Filename: 1M2204010046-24-R2.A3L	Test Dates: 4/25/2022 – 6/2/2022	DUT Type: Portable Handset	Page 34 of 120

REV 4.2.M
3/29/2022

2. Radio Configuration for OTT VoIP (LTE)

An investigation was performed to determine the worst-case LTE FDD band to be used for OTT VoIP testing. LTE FDD Band 66 - ANT B was used for the testing as the worst-case configuration for the handset. See below table for SNNR comparison between different LTE FDD bands:

Table 8-6
OTT VoIP (LTE FDD) SNNR by LTE Band

Band	Frequency [MHz]	Channel	Bandwidth [MHz]	Modulation	RB Size	RB Offset	ABM1 [dB(A/m)]	ABM2 [dB(A/m)]	SNNR [dB]
71 - M1+M2	680.5	133297	20	16QAM	1	99	14.85	-40.04	54.89
71 - M1	680.5	133297	20	16QAM	1	99	14.85	-40.53	55.38
12 - M1+M2	707.5	23095	10	16QAM	1	49	14.58	-41.86	56.44
12 - M1	707.5	23095	10	16QAM	1	49	14.87	-40.50	55.37
13 - M1+M2	782.0	23230	10	16QAM	1	49	14.05	-39.34	53.39
13 - M1	782.0	23230	10	16QAM	1	49	14.87	-38.31	53.18
14 - M1+M2	793.0	23330	10	16QAM	1	49	14.65	-39.00	53.65
14 - M1	793.0	23330	10	16QAM	1	49	14.87	-38.49	53.36
26 - M1+M2	831.5	26865	15	16QAM	1	74	14.65	-42.85	57.50
26 - M1	831.5	26865	15	16QAM	1	74	14.79	-42.95	57.74
5 - M1+M2	836.5	20525	10	16QAM	1	49	14.57	-41.42	55.99
5 - M1	836.5	20525	10	16QAM	1	49	14.86	-40.93	55.79
4 - ANT B	1732.5	20175	20	16QAM	1	99	14.60	-37.07	51.67
4 - ANT F	1732.5	20175	20	16QAM	1	99	14.86	-38.68	53.54
66 - ANT B	1745.0	132322	20	16QAM	1	99	14.54	-35.55	50.09
66 - ANT F	1745.0	132322	20	16QAM	1	99	14.75	-40.30	55.05
2 - ANT B	1880.0	18900	20	16QAM	1	99	14.69	-36.00	50.69
2 - ANT F	1880.0	18900	20	16QAM	1	99	14.62	-41.79	56.41
25 - ANT B	1882.5	26365	20	16QAM	1	99	14.85	-35.34	50.19
25 - ANT F	1882.5	26365	20	16QAM	1	99	14.85	-41.69	56.54
30 - ANT B	2310.0	27710	10	16QAM	1	49	14.53	-37.53	52.06
30 - ANT F	2310.0	27710	10	16QAM	1	49	14.71	-42.51	57.22
7 - ANT B	2535.0	21100	20	16QAM	1	99	14.73	-38.44	53.17
7 - ANT F	2535.0	21100	20	16QAM	1	99	14.43	-39.77	54.20

An investigation was performed to determine the worst-case LTE TDD band to be used for OTT VoIP testing. LTE TDD Band 41 (PC2) - ANT B was used for the testing as the worst-case configuration for the handset. See below table for SNNR comparison between different LTE TDD bands:

Table 8-7
OTT VoIP (LTE TDD) SNNR by LTE Band

Band	Frequency [MHz]	Channel	Bandwidth [MHz]	Modulation	RB Size	RB Offset	ABM1 [dB(A/m)]	ABM2 [dB(A/m)]	SNNR [dB]
41 (PC3) - ANT B	2593.0	40620	20	16QAM	1	99	14.48	-30.07	44.55
41 (PC3) - ANT F	2593.0	40620	20	16QAM	1	99	14.42	-30.81	45.23
41 (PC2) - ANT B	2593.0	40620	20	16QAM	1	99	14.28	-28.80	43.08
41 (PC2) - ANT F	2593.0	40620	20	16QAM	1	99	14.64	-31.79	46.43
48	3625.0	55990	20	16QAM	1	99	14.25	-31.58	45.83

FCC ID: A3LSMF936U		HAC (T-COIL) TEST REPORT	Approved by: Managing Director
Filename: 1M2204010046-24-R2.A3L	Test Dates: 4/25/2022 – 6/2/2022	DUT Type: Portable Handset	Page 35 of 120

REV 4.2.M
3/29/2022

3. LTE FDD Uplink Carrier Aggregation for OTT VoIP

LTE FDD ULCA was evaluated to ensure LTE FDD standalone was the worst-case scenario. The configurations in Table 8-8 were determined from Table 8-6 and satisfy the configuration requirements as defined in 3GPP 36.101.

Table 8-8
LTE FDD SNNR for OTT VoIP Uplink Carrier Aggregation

Combination	PCC							SCC							ABM1 [dB(A/m)]	ABM2 [dB(A/m)]	SNNR [dB]
	PCC Band	PCC Bandwidth [MHz]	PCC (UL) Channel	PCC (UL) Frequency [MHz]	Modulation	PCC UL# RB	PCC UL RB Offset	SCC Band	SCC Bandwidth [MHz]	SCC (UL) Channel	SCC (UL) Frequency [MHz]	Modulation	SCC UL# RB	SCC UL RB Offset			
CA_5B	LTE B5	10	20525	836.5	16QAM	1	0	LTE B5	5	20453	829.3	16QAM	1	24	14.35	-44.09	58.44
CA_66B	LTE B66	10	132322	1745.0	16QAM	1	0	LTE B66	10	132223	1735.1	16QAM	1	49	14.00	-36.45	50.45
CA_66C	LTE B66	20	132322	1745.0	16QAM	1	0	LTE B66	20	132124	1725.5	16QAM	1	99	13.91	-36.40	50.31

4. LTE TDD Uplink Carrier Aggregation for OTT VoIP

LTE TDD ULCA was evaluated to ensure LTE TDD standalone was the worst-case scenario. The configurations in Table 8-9 were determined from Table 8-7 and satisfy the configuration requirements as defined in 3GPP 36.101.

Table 8-9
LTE TDD SNNR for OTT VoIP Uplink Carrier Aggregation

Combination	PCC							SCC							ABM1 [dB(A/m)]	ABM2 [dB(A/m)]	SNNR [dB]
	PCC Band	PCC Bandwidth [MHz]	PCC (UL/DL) Channel	PCC (UL/DL) Frequency [MHz]	Modulation	PCC UL# RB	PCC UL RB Offset	SCC Band	SCC Bandwidth [MHz]	SCC (UL/DL) Channel	SCC (UL/DL) Frequency [MHz]	Modulation	SCC UL# RB	SCC UL RB Offset			
CA_41C (PC3)	LTE B41	20	40620	2593.0	16QAM	1	0	LTE B41	20	40422	2573.2	16QAM	1	99	14.03	-32.31	46.34
CA_41C (PC2)	LTE B41	20	40620	2593.0	16QAM	1	0	LTE B41	20	40422	2573.2	16QAM	1	99	14.05	-31.18	45.23
CA_48C	LTE B48	20	55990	3625.0	16QAM	1	0	LTE B48	20	55792	3605.2	16QAM	1	99	13.83	-32.29	46.12

FCC ID: A3LSMF936U		HAC (T-COIL) TEST REPORT	Approved by: Managing Director
Filename: 1M2204010046-24-R2.A3L	Test Dates: 4/25/2022 – 6/2/2022	DUT Type: Portable Handset	Page 36 of 120

REV 4.2.M
3/29/2022

5. Radio Configuration for OTT VoIP (NR)

An investigation was performed to determine the worst-case NR FDD band to be used for OTT VoIP testing. NR FDD Band n66 - ANT F was used for the testing as the worst-case configuration for the handset. See below table for SNNR comparison between different NR FDD bands:

Table 8-10
OTT VoIP (NR FDD) SNNR by NR Band

Band	Frequency [MHz]	Channel	Bandwidth [MHz]	Waveform	Modulation	RB Size	RB Offset	ABM1 _{LTE} [dB(A/m)]	ABM2 _{NR} [dB(A/m)]	SNNR _{NR} [dB]
n71 - M1 + M2	680.5	136100	20	CP-OFDM	16QAM	1	1	14.46	-40.18	54.64
n71 - M1	680.5	136100	20	CP-OFDM	16QAM	1	1	14.41	-42.23	56.64
n12 - M1 + M2	707.5	141500	15	CP-OFDM	16QAM	1	1	14.39	-39.09	53.48
n12 - M1	707.5	141500	15	CP-OFDM	16QAM	1	1	14.39	-40.89	55.28
n5 - M1 + M2	836.5	167300	20	CP-OFDM	16QAM	1	1	14.45	-39.99	54.44
n5 - M1	836.5	167300	20	CP-OFDM	16QAM	1	1	14.19	-41.25	55.44
n66 - ANT B	1745.0	349000	40	CP-OFDM	16QAM	1	1	14.43	-35.94	50.37
n66 - ANT F	1745.0	349000	40	CP-OFDM	16QAM	1	1	14.54	-34.85	49.39
n25 - ANT B	1882.5	376500	40	CP-OFDM	16QAM	1	1	14.38	-36.86	51.24
n25 - ANT F	1882.5	376500	40	CP-OFDM	16QAM	1	1	14.46	-36.24	50.70
n30 - ANT B	2310.0	462000	10	CP-OFDM	16QAM	1	1	14.54	-37.83	52.37
n30 - ANT F	2310.0	462000	10	CP-OFDM	16QAM	1	1	14.36	-37.09	51.45
n7 - ANT B	2535.0	507000	40	CP-OFDM	16QAM	1	1	14.41	-37.12	51.53
n7 - ANT F	2535.0	507000	40	CP-OFDM	16QAM	1	1	14.27	-37.06	51.33

An investigation was performed to determine the worst-case NR TDD band to be used for OTT VoIP testing. NR TDD Band n77, DoD (PC2) - ANT E was used for the testing as the worst-case configuration for the handset. See below table for SNNR comparison between different NR TDD bands:

Table 8-11
OTT VoIP (NR TDD) SNNR by NR Band

Band	Frequency [MHz]	Channel	Bandwidth [MHz]	Waveform	Modulation	RB Size	RB Offset	ABM1 _{LTE} [dB(A/m)]	ABM2 _{NR} [dB(A/m)]	SNNR _{NR} [dB]
n41 (PC2)	2592.99	518598	100	CP-OFDM	16QAM	1	1	14.40	-36.26	50.66
n77, DoD (PC2)	3500.01	633334	100	CP-OFDM	16QAM	1	1	14.35	-34.13	48.48
n77, DoD (PC2) ANT E	3500.01	633334	100	CP-OFDM	16QAM	1	1	14.39	-33.92	48.31
n48	3624.99	641666	40	CP-OFDM	16QAM	1	1	14.39	-38.26	52.65
n77 (PC2)	3840.00	656000	100	CP-OFDM	16QAM	1	1	14.42	-35.05	49.47
n77 (PC2) ANT E	3840.00	656000	100	CP-OFDM	16QAM	1	1	14.77	-35.10	49.87

FCC ID: A3LSMF936U		HAC (T-COIL) TEST REPORT	Approved by: Managing Director
Filename: 1M2204010046-24-R2.A3L	Test Dates: 4/25/2022 – 6/2/2022	DUT Type: Portable Handset	Page 37 of 120

REV 4.2.M
3/29/2022

9. FCC 3G MEASUREMENTS

I. UMTS Test Configurations

WB AMR 6.60kbps, 13.6kbps SRB was used for the testing as the worst-case configuration for the handset.

Table 9-1
Codec Investigation - UMTS

Codec Setting:	WB AMR 23.85kbps	WB AMR 6.60kbps	NB AMR 12.2kbps	NB AMR 4.75kbps	Orientation	Channel
ABM1 (dBA/m)	6.97	5.89	7.72	7.40	Axial	9400
ABM2 (dBA/m)	-49.84	-49.33	-49.09	-49.13		
Frequency Response	Pass	Pass	Pass	Pass		
S+N/N (dB)	56.81	55.22	56.81	56.53		

- Mute on; Backlight off; Max Volume; Max Contrast
- TPC="All 1s"

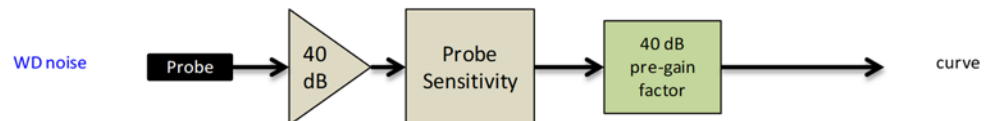

Figure 9-1
Audio Band Magnetic Curve Measurement Block Diagram

FCC ID: A3LSMF936U	element	HAC (T-COIL) TEST REPORT	Approved by: Managing Director
Filename: 1M2204010046-24-R2.A3L	Test Dates: 4/25/2022 – 6/2/2022	DUT Type: Portable Handset	Page 38 of 120

REV 4.2.M
3/29/2022

10. T-COIL TEST SUMMARY

**Table 10-1
Consolidated Tabled Results**

C63.19 Section	Freq. Response Margin		Magnetic Intensity Verdict		FCC SNNR Verdict		Margin from FCC Limit (dB)	C63.19-2011 Rating
	8.3.2		8.3.1		8.3.4			
	Axial	Radial	Axial	Radial	Axial	Radial		
GSM	Cellular	PASS	NA	PASS	PASS	PASS	-8.59	T3
	PCS	PASS	NA	PASS	PASS	PASS		
EDGE (OTT VoIP)	Cellular	PASS	NA	PASS	PASS	PASS	-22.04	T4
	PCS	PASS	NA	PASS	PASS	PASS		
UMTS	Cellular	PASS	NA	PASS	PASS	PASS	-30.38	T4
	AWS	PASS	NA	PASS	PASS	PASS		
	PCS	PASS	NA	PASS	PASS	PASS		
HSPA (OTT VoIP)	Cellular	PASS	NA	PASS	PASS	PASS	-36.95	T4
	AWS	PASS	NA	PASS	PASS	PASS		
	PCS	PASS	NA	PASS	PASS	PASS		
LTE FDD	B71	PASS	NA	PASS	PASS	PASS	-21.44	T4
	B12	PASS	NA	PASS	PASS	PASS		
	B17	PASS	NA	PASS	PASS	PASS		
	B13	PASS	NA	PASS	PASS	PASS		
	B14	PASS	NA	PASS	PASS	PASS		
	B26	PASS	NA	PASS	PASS	PASS		
	B5	PASS	NA	PASS	PASS	PASS		
	B4	PASS	NA	PASS	PASS	PASS		
	B66	PASS	NA	PASS	PASS	PASS		
	B2	PASS	NA	PASS	PASS	PASS		
	B25	PASS	NA	PASS	PASS	PASS		
	B30	PASS	NA	PASS	PASS	PASS		
	B7	PASS	NA	PASS	PASS	PASS		
LTE FDD (OTT VoIP)	B66	PASS	NA	PASS	PASS	PASS	-28.87	T4
LTE TDD	B38	PASS	NA	PASS	PASS	PASS	-14.80	T4
	B41 (PC3)	PASS	NA	PASS	PASS	PASS		
	B41 (PC2)	PASS	NA	PASS	PASS	PASS		
	B48	PASS	NA	PASS	PASS	PASS		
LTE TDD (OTT VoIP)	B41 (PC2)	PASS	NA	PASS	PASS	PASS	-24.40	T4
NR FDD	n71	PASS	NA	PASS	PASS	PASS	-19.35	T4
	n12	PASS	NA	PASS	PASS	PASS		
	n5	PASS	NA	PASS	PASS	PASS		
	n66	PASS	NA	PASS	PASS	PASS		
	B2	PASS	NA	PASS	PASS	PASS		
	n25	PASS	NA	PASS	PASS	PASS		
	n30	PASS	NA	PASS	PASS	PASS		
	n7	PASS	NA	PASS	PASS	PASS		
NR FDD (OTT VoIP)	n66	PASS	NA	PASS	PASS	PASS	-29.37	T4
NR TDD	n41	PASS	NA	PASS	PASS	PASS	-16.82	T4
	n77, DoD	PASS	NA	PASS	PASS	PASS		
	n48	PASS	NA	PASS	PASS	PASS		
	n77	PASS	NA	PASS	PASS	PASS		
NR TDD (OTT VoIP)	n77, DoD	PASS	NA	PASS	PASS	PASS	-26.69	T4
WLAN	IEEE 802.11b	PASS	NA	PASS	PASS	PASS	-9.97	T3
	IEEE 802.11g	PASS	NA	PASS	PASS	PASS		
	IEEE 802.11n	PASS	NA	PASS	PASS	PASS		
	IEEE 802.11ax SU	PASS	NA	PASS	PASS	PASS		
	IEEE 802.11ax RU	PASS	NA	PASS	PASS	PASS		
WLAN (OTT VoIP)	IEEE 802.11b	PASS	NA	PASS	PASS	PASS	-21.72	T4
	IEEE 802.11g	PASS	NA	PASS	PASS	PASS		
	IEEE 802.11n	PASS	NA	PASS	PASS	PASS		
	IEEE 802.11ax SU	PASS	NA	PASS	PASS	PASS		
	IEEE 802.11ax RU	PASS	NA	PASS	PASS	PASS		
U-NI	IEEE 802.11a	PASS	NA	PASS	PASS	PASS	-16.34	T4
	IEEE 802.11n	PASS	NA	PASS	PASS	PASS		
	IEEE 802.11ac	PASS	NA	PASS	PASS	PASS		
	IEEE 802.11ax SU	PASS	NA	PASS	PASS	PASS		
	IEEE 802.11ax RU	PASS	NA	PASS	PASS	PASS		
U-NI (OTT VoIP)	IEEE 802.11a	PASS	NA	PASS	PASS	PASS	-28.03	T4
	IEEE 802.11n	PASS	NA	PASS	PASS	PASS		
	IEEE 802.11ac	PASS	NA	PASS	PASS	PASS		
	IEEE 802.11ax SU	PASS	NA	PASS	PASS	PASS		
	IEEE 802.11ax RU	PASS	NA	PASS	PASS	PASS		

FCC ID: A3LSMF936U		HAC (T-COIL) TEST REPORT	Approved by: Managing Director
Filename: 1M2204010046-24-R2.A3L	Test Dates: 4/25/2022 – 6/2/2022	DUT Type: Portable Handset	Page 39 of 120

REV 4.2.M
3/29/2022

I. Raw Handset Data

Table 10-2
Raw Data Results for GSM - M1+M2

Mode	Orientation	Channel	Device S/N	ABM1 [dB(A/m)]	ABM2 [dB(A/m)]	Ambient Noise [dB(A/m)]	Frequency Response Margin (dB)	S+N/N (dB)	FCC Limit (dB)	Margin from FCC Limit (dB)	C63.19-2011 Rating	Test Coordinates
GSM850	Axial	128	1802M	7.82	-23.57	-63.19	1.66	31.39	20.00	-11.39	T4	1.6, 1.8
		190	1802M	7.99	-24.84		1.72	32.83	20.00	-12.83	T4	
		251	1802M	7.99	-25.03		1.72	33.02	20.00	-13.02	T4	
	Radial	128	1802M	1.46	-33.11	-61.29	N/A	34.57	20.00	-14.57	T4	1.6, 2.6
		190	1802M	1.47	-33.71			35.18	20.00	-15.18	T4	
		251	1802M	1.45	-34.09			35.54	20.00	-15.54	T4	
GSM1900	Axial	512	1802M	7.81	-26.17	-63.19	1.74	33.98	20.00	-13.98	T4	1.6, 1.8
		661	1802M	7.82	-26.61		1.69	34.43	20.00	-14.43	T4	
		810	1802M	7.81	-25.59		1.67	33.40	20.00	-13.40	T4	
	Radial	512	1802M	1.30	-45.08	-61.29	N/A	46.38	20.00	-26.38	T4	1.6, 2.6
		661	1802M	1.76	-46.09			47.85	20.00	-27.85	T4	
		810	1802M	1.42	-45.45			46.87	20.00	-26.87	T4	

Table 10-3
Raw Data Results for GSM - M1

Mode	Orientation	Channel	Device SN	ABM1 [dB(A/m)]	ABM2 [dB(A/m)]	Ambient Noise [dB(A/m)]	Frequency Response Margin (dB)	S+N/N (dB)	FCC Limit (dB)	Margin from FCC Limit (dB)	C63.19-2011 Rating	Test Coordinates
GSM850	Axial	128	1802M	7.90	-22.58	-61.94	1.66	30.48	20.00	-10.48	T4	1.6, 1.8
		190	1802M	7.97	-23.77		1.72	31.74	20.00	-11.74	T4	
		251	1802M	7.87	-24.46		1.75	32.33	20.00	-12.33	T4	
	Radial	128	1802M	1.40	-33.88	-61.57	N/A	35.28	20.00	-15.28	T4	1.6, 2.6
		190	1802M	1.80	-34.91			36.71	20.00	-16.71	T4	
		251	1802M	1.79	-35.53			37.32	20.00	-17.32	T4	

Table 10-4
Raw Data Results for UMTS - M1+M2

Mode	Orientation	Channel	Device S/N	ABM1 [dB(A/m)]	ABM2 [dB(A/m)]	Ambient Noise [dB(A/m)]	Frequency Response Margin (dB)	S+N/N (dB)	FCC Limit (dB)	Margin from FCC Limit (dB)	C63.19-2011 Rating	Test Coordinates
UMTS V	Axial	4132	1802M	5.17	-49.74	-61.69	1.75	54.91	20.00	-34.91	T4	1.6, 1.8
		4183	1802M	5.47	-49.97		1.77	55.44	20.00	-35.44	T4	
		4233	1802M	5.47	-49.79		1.75	55.26	20.00	-35.26	T4	
	Radial	4132	1802M	-1.32	-51.70	-61.29	N/A	50.38	20.00	-30.38	T4	1.6, 2.6
		4183	1802M	-0.89	-51.78			50.89	20.00	-30.89	T4	
		4233	1802M	-0.83	-52.40			51.57	20.00	-31.57	T4	
UMTS IV	Axial	1312	1802M	5.25	-49.77	-61.69	1.88	55.02	20.00	-35.02	T4	1.6, 1.8
		1412	1802M	5.46	-50.34		1.70	55.80	20.00	-35.80	T4	
		1513	1802M	5.13	-49.69		1.74	54.82	20.00	-34.82	T4	
	Radial	1312	1802M	-0.57	-53.41	-61.29	N/A	52.84	20.00	-32.84	T4	1.6, 2.6
		1412	1802M	-0.65	-52.61			51.96	20.00	-31.96	T4	
		1513	1802M	-0.56	-51.88			51.32	20.00	-31.32	T4	
UMTS II	Axial	9262	1802M	5.15	-49.19	-61.69	1.80	54.34	20.00	-34.34	T4	1.6, 1.8
		9400	1802M	5.61	-49.82		1.88	55.43	20.00	-35.43	T4	
		9538	1802M	5.43	-49.82		1.79	55.25	20.00	-35.25	T4	
	Radial	9262	1802M	-0.80	-53.25	-61.29	N/A	52.45	20.00	-32.45	T4	1.6, 2.6
		9400	1802M	-0.99	-52.73			51.74	20.00	-31.74	T4	
		9538	1802M	-1.10	-53.25			52.15	20.00	-32.15	T4	

Table 10-5
Raw Data Results for UMTS - M1

Mode	Orientation	Channel	Device SN	ABM1 [dB(A/m)]	ABM2 [dB(A/m)]	Ambient Noise [dB(A/m)]	Frequency Response Margin (dB)	S+N/N (dB)	FCC Limit (dB)	Margin from FCC Limit (dB)	C63.19-2011 Rating	Test Coordinates
UMTS V	Axial	4132	1802M	5.28	-50.47	-61.94	1.83	55.75	20.00	-35.75	T4	1.6, 1.8
		4183	1802M	5.33	-50.37		1.67	55.70	20.00	-35.70	T4	
		4233	1802M	5.22	-51.19		1.74	56.41	20.00	-36.41	T4	
	Radial	4132	1802M	-0.84	-54.31	-61.57	N/A	53.47	20.00	-33.47	T4	1.6, 2.6
		4183	1802M	-0.68	-53.88			53.20	20.00	-33.20	T4	
		4233	1802M	-0.66	-54.00			53.34	20.00	-33.34	T4	

FCC ID: A3LSMF936U		HAC (T-COIL) TEST REPORT	Approved by: Managing Director
Filename: 1M2204010046-24-R2.A3L	Test Dates: 4/25/2022 – 6/2/2022	DUT Type: Portable Handset	Page 40 of 120

REV 4.2.M
3/29/2022

Table 10-6
Raw Data Results for LTE B71 - M1+M2

Mode	Orientation	Bandwidth	Channel	Device S/N	ABM1 [dB(A/m)]	ABM2 [dB(A/m)]	Ambient Noise [dB(A/m)]	Frequency Response Margin (dB)	S+N/N (dB)	FCC Limit (dB)	Margin from FCC Limit (dB)	C63.19-2011 Rating	Test Coordinates
LTE Band 71	Axial	20MHz	133297	1802M	5.76	-41.71	-61.69	1.87	47.47	20.00	-27.47	T4	1.6, 1.8
		15MHz	133297	1802M	5.83	-41.48		1.69	47.31	20.00	-27.31	T4	
		10MHz	133297	1802M	5.95	-40.93		1.58	46.88	20.00	-26.88	T4	
		5MHz	133297	1802M	5.85	-43.95		1.81	49.80	20.00	-29.80	T4	
	Radial	20MHz	133297	1802M	-1.29	-47.72	-61.29	N/A	46.43	20.00	-26.43	T4	1.6, 2.6
		15MHz	133297	1802M	-0.98	-47.67			46.69	20.00	-26.69	T4	
		10MHz	133297	1802M	-0.92	-48.29			47.37	20.00	-27.37	T4	
		5MHz	133297	1802M	-1.11	-49.36			48.25	20.00	-28.25	T4	

Table 10-7
Raw Data Results for LTE B71 - M1

Mode	Orientation	Bandwidth	Channel	Device SN	ABM1 [dB(A/m)]	ABM2 [dB(A/m)]	Ambient Noise [dB(A/m)]	Frequency Response Margin (dB)	S+N/N (dB)	FCC Limit (dB)	Margin from FCC Limit (dB)	C63.19-2011 Rating	Test Coordinates
LTE Band 71	Axial	20MHz	133297	1802M	5.64	-42.01	-61.94	1.82	47.65	20.00	-27.65	T4	1.6, 1.8
		15MHz	133297	1802M	5.85	-42.84		1.83	48.69	20.00	-28.69	T4	
		10MHz	133297	1802M	5.52	-42.78		1.75	48.30	20.00	-28.30	T4	
		5MHz	133297	1802M	5.71	-42.70		1.79	48.41	20.00	-28.41	T4	
	Radial	20MHz	133297	1802M	-1.16	-49.61	-61.57	N/A	48.45	20.00	-28.45	T4	1.6, 2.6
		15MHz	133297	1802M	-0.95	-50.55			49.60	20.00	-29.60	T4	
		10MHz	133297	1802M	-1.20	-50.80			49.60	20.00	-29.60	T4	
		5MHz	133297	1802M	-1.19	-50.23			49.04	20.00	-29.04	T4	

Table 10-8
Raw Data Results for LTE B12 - M1+M2

Mode	Orientation	Bandwidth	Channel	Device S/N	ABM1 [dB(A/m)]	ABM2 [dB(A/m)]	Ambient Noise [dB(A/m)]	Frequency Response Margin (dB)	S+N/N (dB)	FCC Limit (dB)	Margin from FCC Limit (dB)	C63.19-2011 Rating	Test Coordinates
LTE Band 12	Axial	10MHz	23095	1802M	5.67	-43.01	-61.69	1.76	48.68	20.00	-28.68	T4	1.6, 1.8
		5MHz	23095	1802M	5.60	-42.44		1.69	48.04	20.00	-28.04	T4	
		3MHz	23095	1802M	5.72	-42.46		1.93	48.18	20.00	-28.18	T4	
		1.4MHz	23095	1802M	5.89	-42.92		1.90	48.81	20.00	-28.81	T4	
	Radial	10MHz	23095	1802M	-1.25	-51.89	-61.29	N/A	50.64	20.00	-30.64	T4	1.6, 2.6
		5MHz	23095	1802M	-1.14	-48.57			47.43	20.00	-27.43	T4	
		3MHz	23095	1802M	-1.37	-48.43			47.06	20.00	-27.06	T4	
		1.4MHz	23095	1802M	-1.20	-51.17			49.97	20.00	-29.97	T4	

Table 10-9
Raw Data Results for LTE B12 - M1

Mode	Orientation	Bandwidth	Channel	Device SN	ABM1 [dB(A/m)]	ABM2 [dB(A/m)]	Ambient Noise [dB(A/m)]	Frequency Response Margin (dB)	S+N/N (dB)	FCC Limit (dB)	Margin from FCC Limit (dB)	C63.19-2011 Rating	Test Coordinates
LTE Band 12	Axial	10MHz	23095	1802M	5.51	-42.10	-61.94	1.73	47.61	20.00	-27.61	T4	1.6, 1.8
		5MHz	23095	1802M	5.52	-41.47		1.87	46.99	20.00	-26.99	T4	
		3MHz	23095	1802M	5.60	-43.60		1.66	49.20	20.00	-29.20	T4	
		1.4MHz	23095	1802M	5.64	-43.92		1.65	49.56	20.00	-29.56	T4	
	Radial	10MHz	23095	1802M	-1.08	-49.34	-61.57	N/A	48.26	20.00	-28.26	T4	1.6, 2.6
		5MHz	23095	1802M	-0.94	-50.24			49.30	20.00	-29.30	T4	
		3MHz	23095	1802M	-1.14	-50.87			49.73	20.00	-29.73	T4	
		1.4MHz	23095	1802M	-1.27	-51.08			49.81	20.00	-29.81	T4	

Table 10-10
Raw Data Results for LTE B13 - M1+M2

Mode	Orientation	Bandwidth	Channel	Device S/N	ABM1 [dB(A/m)]	ABM2 [dB(A/m)]	Ambient Noise [dB(A/m)]	Frequency Response Margin (dB)	S+N/N (dB)	FCC Limit (dB)	Margin from FCC Limit (dB)	C63.19-2011 Rating	Test Coordinates
LTE Band 13	Axial	10MHz	23230	1802M	5.77	-40.29	-61.69	1.81	46.06	20.00	-26.06	T4	1.6, 1.8
		5MHz	23230	1802M	5.74	-39.52		1.75	45.26	20.00	-25.26	T4	
	Radial	10MHz	23230	1802M	-1.43	-52.02	-61.29	N/A	50.59	20.00	-30.59	T4	1.6, 2.6
		5MHz	23230	1802M	-1.13	-50.33			49.20	20.00	-29.20	T4	

FCC ID: A3LSMF936U		HAC (T-COIL) TEST REPORT	Approved by: Managing Director
Filename: 1M2204010046-24-R2.A3L	Test Dates: 4/25/2022 – 6/2/2022	DUT Type: Portable Handset	Page 41 of 120

REV 4.2.M
3/29/2022

Unless otherwise specified, no part of this report may be reproduced or utilized in any part, form or by any means, electronic or mechanical, including photocopying and microfilm, without permission in writing from Element. If you have any questions about this or have an enquiry about obtaining additional rights to this report or assembly of contents thereof, please contact CT.INFO@ELEMENT.COM.

Table 10-11
Raw Data Results for LTE B13 - M1

Mode	Orientation	Bandwidth	Channel	Device SN	ABM1 [dB(A/m)]	ABM2 [dB(A/m)]	Ambient Noise [dB(A/m)]	Frequency Response Margin (dB)	S+N/N (dB)	FCC Limit (dB)	Margin from FCC Limit (dB)	C63.19-2011 Rating	Test Coordinates	
LTE Band 13	Axial	10MHz	23230	1802M	5.91	-39.38	-61.94	1.74	45.29	20.00	-25.29	T4	1.6, 1.8	
		5MHz	23230	1802M	5.59	-39.05		1.69	44.64	20.00	-24.64	T4		
	Radial	10MHz	23230	1802M	-1.16	-47.99	-61.57	N/A	46.83	20.00	-26.83	T4		1.6, 2.6
		5MHz	23230	1802M	-1.07	-47.84			46.77	20.00	-26.77	T4		

Table 10-12
Raw Data Results for LTE B14 - M1+M2

Mode	Orientation	Bandwidth	Channel	Device S/N	ABM1 [dB(A/m)]	ABM2 [dB(A/m)]	Ambient Noise [dB(A/m)]	Frequency Response Margin (dB)	S+N/N (dB)	FCC Limit (dB)	Margin from FCC Limit (dB)	C63.19-2011 Rating	Test Coordinates	
LTE Band 14	Axial	10MHz	23330	1802M	5.63	-39.75	-61.69	1.75	45.38	20.00	-25.38	T4	1.6, 1.8	
		5MHz	23330	1802M	5.98	-39.41		1.72	45.39	20.00	-25.39	T4		
	Radial	10MHz	23330	1802M	-1.07	-51.93	-61.29	N/A	50.86	20.00	-30.86	T4		1.6, 2.6
		5MHz	23330	1802M	-1.09	-47.18			46.09	20.00	-26.09	T4		

Table 10-13
Raw Data Results for LTE B14 - M1

Mode	Orientation	Bandwidth	Channel	Device SN	ABM1 [dB(A/m)]	ABM2 [dB(A/m)]	Ambient Noise [dB(A/m)]	Frequency Response Margin (dB)	S+N/N (dB)	FCC Limit (dB)	Margin from FCC Limit (dB)	C63.19-2011 Rating	Test Coordinates	
LTE Band 14	Axial	10MHz	23330	1802M	5.79	-39.77	-61.94	1.69	45.56	20.00	-25.56	T4	1.6, 1.8	
		5MHz	23330	1802M	5.61	-40.12		1.56	45.73	20.00	-25.73	T4		
	Radial	10MHz	23330	1802M	-0.99	-48.21	-61.57	N/A	47.22	20.00	-27.22	T4		1.6, 2.6
		5MHz	23330	1802M	-1.28	-48.57			47.29	20.00	-27.29	T4		

Table 10-14
Raw Data Results for LTE B26 - M1+M2

Mode	Orientation	Bandwidth	Channel	Device S/N	ABM1 [dB(A/m)]	ABM2 [dB(A/m)]	Ambient Noise [dB(A/m)]	Frequency Response Margin (dB)	S+N/N (dB)	FCC Limit (dB)	Margin from FCC Limit (dB)	C63.19-2011 Rating	Test Coordinates
LTE Band 26	Axial	15MHz	26865	1802M	5.78	-42.72	-61.69	1.74	48.50	20.00	-28.50	T4	1.6, 1.8
		10MHz	26865	1802M	6.00	-45.47		1.66	51.47	20.00	-31.47	T4	
		5MHz	26865	1802M	6.01	-45.11		1.63	51.12	20.00	-31.12	T4	
		3MHz	26865	1802M	6.09	-44.73		1.79	50.82	20.00	-30.82	T4	
		1.4MHz	26865	1802M	6.01	-44.56		1.78	50.57	20.00	-30.57	T4	
		1.4MHz	26865	1802M	6.01	-44.56		1.78	50.57	20.00	-30.57	T4	
	Radial	15MHz	26865	1802M	-1.06	-51.25	-61.29	N/A	50.19	20.00	-30.19	T4	1.6, 2.6
		10MHz	26865	1802M	-1.65	-52.88			51.23	20.00	-31.23	T4	
		5MHz	26865	1802M	-1.08	-52.34			51.26	20.00	-31.26	T4	
		3MHz	26865	1802M	-1.10	-51.66			50.56	20.00	-30.56	T4	
		1.4MHz	26865	1802M	-1.02	-52.39			51.37	20.00	-31.37	T4	
		1.4MHz	26865	1802M	-1.02	-52.39			51.37	20.00	-31.37	T4	

Table 10-15
Raw Data Results for LTE B26 - M1

Mode	Orientation	Bandwidth	Channel	Device SN	ABM1 [dB(A/m)]	ABM2 [dB(A/m)]	Ambient Noise [dB(A/m)]	Frequency Response Margin (dB)	S+N/N (dB)	FCC Limit (dB)	Margin from FCC Limit (dB)	C63.19-2011 Rating	Test Coordinates
LTE Band 26	Axial	15MHz	26865	1802M	5.52	-45.23	-61.94	1.87	50.75	20.00	-30.75	T4	1.6, 1.8
		10MHz	26865	1802M	5.92	-45.00		1.75	50.92	20.00	-30.92	T4	
		5MHz	26865	1802M	5.72	-44.59		1.92	50.31	20.00	-30.31	T4	
		3MHz	26865	1802M	5.72	-44.29		1.70	50.01	20.00	-30.01	T4	
		1.4MHz	26865	1802M	5.55	-44.18		1.84	49.73	20.00	-29.73	T4	
		1.4MHz	26865	1802M	5.55	-44.18		1.84	49.73	20.00	-29.73	T4	
	Radial	15MHz	26865	1802M	-1.16	-49.17	-61.57	N/A	48.01	20.00	-28.01	T4	1.6, 2.6
		10MHz	26865	1802M	-1.00	-50.34			49.34	20.00	-29.34	T4	
		5MHz	26865	1802M	-1.09	-51.52			50.43	20.00	-30.43	T4	
		3MHz	26865	1802M	-1.19	-51.46			50.27	20.00	-30.27	T4	
		1.4MHz	26865	1802M	-1.10	-51.25			50.15	20.00	-30.15	T4	
		1.4MHz	26865	1802M	-1.10	-51.25			50.15	20.00	-30.15	T4	

FCC ID: A3LSMF936U		HAC (T-COIL) TEST REPORT	Approved by: Managing Director
Filename: 1M2204010046-24-R2.A3L	Test Dates: 4/25/2022 – 6/2/2022	DUT Type: Portable Handset	Page 42 of 120

REV 4.2.M
3/29/2022

Unless otherwise specified, no part of this report may be reproduced or utilized in any part, form or by any means, electronic or mechanical, including photocopying and microfilm, without permission in writing from Element. If you have any questions about this or have an enquiry about obtaining additional rights to this report or assembly of contents thereof, please contact CT.INFO@ELEMENT.COM.

Table 10-16
Raw Data Results for LTE B5 - M1+M2

Mode	Orientation	Bandwidth	Channel	Device S/N	ABM1 [dB(A/m)]	ABM2 [dB(A/m)]	Ambient Noise [dB(A/m)]	Frequency Response Margin (dB)	S+N/N (dB)	FCC Limit (dB)	Margin from FCC Limit (dB)	C63.19-2011 Rating	Test Coordinates
LTE Band 5	Axial	10MHz	20525	1802M	5.84	-42.41	-61.69	1.68	48.25	20.00	-28.25	T4	1.6, 1.8
		5MHz	20525	1802M	5.81	-43.82		1.79	49.63	20.00	-29.63	T4	
		3MHz	20525	1802M	5.96	-44.87		1.69	50.83	20.00	-30.83	T4	
		1.4MHz	20525	1802M	5.72	-45.27		1.77	50.99	20.00	-30.99	T4	
	Radial	10MHz	20525	1802M	-1.32	-51.57	-61.29	N/A	50.25	20.00	-30.25	T4	1.6, 2.6
		5MHz	20525	1802M	-1.08	-48.94			47.86	20.00	-27.86	T4	
		3MHz	20525	1802M	-1.03	-52.42			51.39	20.00	-31.39	T4	
		1.4MHz	20525	1802M	-1.10	-50.35			49.25	20.00	-29.25	T4	

Table 10-17
Raw Data Results for LTE B5 - M1

Mode	Orientation	Bandwidth	Channel	Device SN	ABM1 [dB(A/m)]	ABM2 [dB(A/m)]	Ambient Noise [dB(A/m)]	Frequency Response Margin (dB)	S+N/N (dB)	FCC Limit (dB)	Margin from FCC Limit (dB)	C63.19-2011 Rating	Test Coordinates
LTE Band 5	Axial	10MHz	20525	1802M	5.76	-43.71	-61.94	1.64	49.47	20.00	-29.47	T4	1.6, 1.8
		5MHz	20525	1802M	5.50	-44.62		1.73	50.12	20.00	-30.12	T4	
		3MHz	20525	1802M	5.52	-45.24		1.72	50.76	20.00	-30.76	T4	
		1.4MHz	20525	1802M	5.53	-45.30		1.85	50.83	20.00	-30.83	T4	
	Radial	10MHz	20525	1802M	-1.03	-50.90	-61.57	N/A	49.87	20.00	-29.87	T4	1.6, 2.6
		5MHz	20525	1802M	-0.84	-48.34			47.50	20.00	-27.50	T4	
		3MHz	20525	1802M	-0.84	-51.73			50.89	20.00	-30.89	T4	
		1.4MHz	20525	1802M	-1.08	-51.70			50.62	20.00	-30.62	T4	

Table 10-18
Raw Data Results for LTE B66 - ANT B

Mode	Orientation	Bandwidth	Channel	Device S/N	ABM1 [dB(A/m)]	ABM2 [dB(A/m)]	Ambient Noise [dB(A/m)]	Frequency Response Margin (dB)	S+N/N (dB)	FCC Limit (dB)	Margin from FCC Limit (dB)	C63.19-2011 Rating	Test Coordinates
LTE Band 66	Axial	20MHz	132322	1802M	6.04	-36.15	-61.69	1.73	42.19	20.00	-22.19	T4	1.6, 1.8
		15MHz	132322	1802M	5.88	-35.99		1.60	41.87	20.00	-21.87	T4	
		10MHz	132322	1802M	5.81	-36.08		1.71	41.89	20.00	-21.89	T4	
		5MHz	132322	1802M	5.85	-35.95		1.69	41.80	20.00	-21.80	T4	
		3MHz	132322	1802M	5.93	-36.24		1.82	42.17	20.00	-22.17	T4	
		1.4MHz	132665	1802M	6.16	-36.29		1.70	42.45	20.00	-22.45	T4	
		1.4MHz	132322	1802M	5.91	-35.53		1.79	41.44	20.00	-21.44	T4	
		1.4MHz	131979	1802M	5.59	-36.26		1.64	41.85	20.00	-21.85	T4	
	Radial	20MHz	132322	1802M	-1.05	-52.04	-61.29	N/A	50.99	20.00	-30.99	T4	1.6, 2.6
		15MHz	132322	1802M	-1.11	-49.02			47.91	20.00	-27.91	T4	
		10MHz	132322	1802M	-0.90	-52.23			51.33	20.00	-31.33	T4	
		5MHz	132322	1802M	-1.02	-51.49			50.47	20.00	-30.47	T4	
		3MHz	132322	1802M	-1.12	-51.31			50.19	20.00	-30.19	T4	
		1.4MHz	132322	1802M	-0.87	-51.01			50.14	20.00	-30.14	T4	

Table 10-19
Raw Data Results for LTE B66 - ANT F

Mode	Orientation	Bandwidth	Channel	Device SN	ABM1 [dB(A/m)]	ABM2 [dB(A/m)]	Ambient Noise [dB(A/m)]	Frequency Response Margin (dB)	S+N/N (dB)	FCC Limit (dB)	Margin from FCC Limit (dB)	C63.19-2011 Rating	Test Coordinates
LTE Band 66	Axial	20MHz	132322	1802M	5.69	-41.87	-61.94	1.63	47.56	20.00	-27.56	T4	1.6, 1.8
		15MHz	132322	1802M	5.86	-42.56		1.70	48.42	20.00	-28.42	T4	
		10MHz	132322	1802M	5.85	-43.23		1.73	49.08	20.00	-29.08	T4	
		5MHz	132322	1802M	5.74	-43.73		1.60	49.47	20.00	-29.47	T4	
		3MHz	132322	1802M	5.86	-43.97		1.72	49.83	20.00	-29.83	T4	
		1.4MHz	132322	1802M	5.74	-43.83		1.67	49.57	20.00	-29.57	T4	
		Radial	20MHz	132322	1802M	-0.66		-46.80	-61.57	N/A	46.14	20.00	
	15MHz		132322	1802M	-1.12	-47.50	46.38	20.00			-26.38	T4	
	10MHz		132322	1802M	-1.15	-47.86	46.71	20.00			-26.71	T4	
	5MHz		132322	1802M	-0.97	-48.38	47.41	20.00			-27.41	T4	
	3MHz		132322	1802M	-1.29	-48.47	47.18	20.00			-27.18	T4	
	1.4MHz		132322	1802M	-0.70	-48.42	47.72	20.00			-27.72	T4	

FCC ID: A3LSMF936U		HAC (T-COIL) TEST REPORT	Approved by: Managing Director
Filename: 1M2204010046-24-R2.A3L	Test Dates: 4/25/2022 – 6/2/2022	DUT Type: Portable Handset	Page 43 of 120

REV 4.2.M
3/29/2022

Unless otherwise specified, no part of this report may be reproduced or utilized in any part, form or by any means, electronic or mechanical, including photocopying and microfilm, without permission in writing from Element. If you have any questions about this or have an enquiry about obtaining additional rights to this report or assembly of contents thereof, please contact CT.INFO@ELEMENT.COM.

Table 10-20
Raw Data Results for LTE B4 - ANT B

Mode	Orientation	Bandwidth	Channel	Device S/N	ABM1 [dB(A/m)]	ABM2 [dB(A/m)]	Ambient Noise [dB(A/m)]	Frequency Response Margin (dB)	S+N/N (dB)	FCC Limit (dB)	Margin from FCC Limit (dB)	C63.19-2011 Rating	Test Coordinates
LTE Band 4	Axial	20MHz	20175	1802M	5.69	-36.92	-61.69	1.75	42.61	20.00	-22.61	T4	1.6, 1.8
		15MHz	20175	1802M	5.91	-37.33		1.69	43.24	20.00	-23.24	T4	
		10MHz	20175	1802M	5.71	-37.58		1.86	43.29	20.00	-23.29	T4	
		5MHz	20175	1802M	5.57	-37.26		1.75	42.83	20.00	-22.83	T4	
		3MHz	20175	1802M	5.76	-37.30		1.87	43.06	20.00	-23.06	T4	
		1.4MHz	20175	1802M	5.72	-37.27		1.83	42.99	20.00	-22.99	T4	
	Radial	20MHz	20175	1802M	-1.08	-52.95	-61.29	N/A	51.87	20.00	-31.87	T4	1.6, 2.6
		15MHz	20175	1802M	-1.68	-52.96		51.28	20.00	-31.28	T4		
		10MHz	20175	1802M	-1.12	-51.85		50.73	20.00	-30.73	T4		
		5MHz	20175	1802M	-1.45	-51.28		49.83	20.00	-29.83	T4		
		3MHz	20175	1802M	-1.25	-52.33		51.08	20.00	-31.08	T4		
		1.4MHz	20175	1802M	-1.27	-51.01		49.74	20.00	-29.74	T4		

Table 10-21
Raw Data Results for LTE B4 - ANT F

Mode	Orientation	Bandwidth	Channel	Device SN	ABM1 [dB(A/m)]	ABM2 [dB(A/m)]	Ambient Noise [dB(A/m)]	Frequency Response Margin (dB)	S+N/N (dB)	FCC Limit (dB)	Margin from FCC Limit (dB)	C63.19-2011 Rating	Test Coordinates
LTE Band 4	Axial	20MHz	20175	1802M	5.54	-42.90	-61.94	1.60	48.44	20.00	-28.44	T4	1.6, 1.8
		15MHz	20175	1802M	5.47	-43.18		1.67	48.65	20.00	-28.65	T4	
		10MHz	20175	1802M	5.98	-42.81		1.65	48.79	20.00	-28.79	T4	
		5MHz	20175	1802M	5.60	-41.93		1.79	47.53	20.00	-27.53	T4	
		3MHz	20175	1802M	5.48	-41.74		1.67	47.22	20.00	-27.22	T4	
		1.4MHz	20175	1802M	5.65	-41.54		1.74	47.19	20.00	-27.19	T4	
	Radial	20MHz	20175	1802M	-1.06	-48.60	-61.57	N/A	47.54	20.00	-27.54	T4	1.6, 2.6
		15MHz	20175	1802M	-1.30	-48.09		46.79	20.00	-26.79	T4		
		10MHz	20175	1802M	-1.26	-47.76		46.50	20.00	-26.50	T4		
		5MHz	20175	1802M	-1.29	-46.60		45.31	20.00	-25.31	T4		
		3MHz	20175	1802M	-0.72	-46.62		45.90	20.00	-25.90	T4		
		1.4MHz	20175	1802M	-0.69	-46.38		45.69	20.00	-25.69	T4		

Table 10-22
Raw Data Results for LTE B25 - Ant B

Mode	Orientation	Bandwidth	Channel	Device S/N	ABM1 [dB(A/m)]	ABM2 [dB(A/m)]	Ambient Noise [dB(A/m)]	Frequency Response Margin (dB)	S+N/N (dB)	FCC Limit (dB)	Margin from FCC Limit (dB)	C63.19-2011 Rating	Test Coordinates
LTE Band 25	Axial	20MHz	26365	1802M	5.55	-36.63	-61.69	1.77	42.18	20.00	-22.18	T4	1.6, 1.8
		15MHz	26365	1802M	5.58	-37.06		1.67	42.64	20.00	-22.64	T4	
		10MHz	26365	1802M	5.71	-37.71		1.72	43.42	20.00	-23.42	T4	
		5MHz	26365	1802M	5.81	-38.08		1.66	43.89	20.00	-23.89	T4	
		3MHz	26365	1802M	5.63	-38.50		1.67	44.13	20.00	-24.13	T4	
		1.4MHz	26365	1802M	5.45	-37.90		1.80	43.35	20.00	-23.35	T4	
	Radial	20MHz	26365	1802M	-0.91	-50.43	-61.29	N/A	49.52	20.00	-29.52	T4	1.6, 2.6
		15MHz	26365	1802M	-1.40	-50.85		49.45	20.00	-29.45	T4		
		10MHz	26365	1802M	-1.01	-51.10		50.09	20.00	-30.09	T4		
		5MHz	26365	1802M	-1.41	-51.36		49.95	20.00	-29.95	T4		
		3MHz	26365	1802M	-1.07	-51.41		50.34	20.00	-30.34	T4		
		1.4MHz	26365	1802M	-1.05	-51.39		50.34	20.00	-30.34	T4		

Table 10-23
Raw Data Results for LTE B25 - ANT F

Mode	Orientation	Bandwidth	Channel	Device SN	ABM1 [dB(A/m)]	ABM2 [dB(A/m)]	Ambient Noise [dB(A/m)]	Frequency Response Margin (dB)	S+N/N (dB)	FCC Limit (dB)	Margin from FCC Limit (dB)	C63.19-2011 Rating	Test Coordinates
LTE Band 25	Axial	20MHz	26365	1802M	6.01	-44.41	-61.94	1.68	50.42	20.00	-30.42	T4	1.6, 1.8
		15MHz	26365	1802M	5.79	-43.40		1.77	49.19	20.00	-29.19	T4	
		10MHz	26365	1802M	6.04	-43.00		1.66	49.04	20.00	-29.04	T4	
		5MHz	26365	1802M	5.61	-42.71		1.73	48.32	20.00	-28.32	T4	
		3MHz	26365	1802M	5.66	-42.53		1.77	48.19	20.00	-28.19	T4	
		1.4MHz	26365	1802M	5.50	-42.55		1.82	48.05	20.00	-28.05	T4	
	Radial	20MHz	26365	1802M	-0.73	-49.17	-61.57	N/A	48.44	20.00	-28.44	T4	1.6, 2.6
		15MHz	26365	1802M	-0.96	-48.02		47.06	20.00	-27.06	T4		
		10MHz	26365	1802M	-0.72	-48.04		47.32	20.00	-27.32	T4		
		5MHz	26365	1802M	-0.62	-47.56		46.94	20.00	-26.94	T4		
		3MHz	26365	1802M	-0.69	-47.42		46.73	20.00	-26.73	T4		
		1.4MHz	26365	1802M	-0.64	-47.37		46.73	20.00	-26.73	T4		

FCC ID: A3LSMF936U		HAC (T-COIL) TEST REPORT	Approved by: Managing Director
Filename: 1M2204010046-24-R2.A3L	Test Dates: 4/25/2022 – 6/2/2022	DUT Type: Portable Handset	Page 44 of 120

Table 10-24
Raw Data Results for LTE B2 - ANT B

Mode	Orientation	Bandwidth	Channel	Device S/N	ABM1 [dB(A/m)]	ABM2 [dB(A/m)]	Ambient Noise [dB(A/m)]	Frequency Response Margin (dB)	S+N/N (dB)	FCC Limit (dB)	Margin from FCC Limit (dB)	C63.19-2011 Rating	Test Coordinates	
LTE Band 2	Axial	20MHz	18900	1802M	5.56	-35.91	-61.69	1.76	41.47	20.00	-21.47	T4	1.6, 1.8	
		15MHz	18900	1802M	5.94	-36.54		1.89	42.48	20.00	-22.48	T4		
		10MHz	18900	1802M	5.58	-36.77		1.75	42.35	20.00	-22.35	T4		
		5MHz	18900	1802M	5.67	-36.99		1.78	42.66	20.00	-22.66	T4		
		3MHz	18900	1802M	5.50	-37.81		1.76	43.31	20.00	-23.31	T4		
		1.4MHz	18900	1802M	5.49	-38.58		1.75	44.07	20.00	-24.07	T4		
	Radial	20MHz	18900	1802M	-1.07	-51.02	-61.29	N/A	49.95	20.00	20.00	-29.95	T4	1.6, 2.6
		15MHz	18900	1802M	-1.08	-51.15			50.07	20.00	20.00	-30.07	T4	
		10MHz	18900	1802M	-1.01	-51.65			50.64	20.00	20.00	-30.64	T4	
		5MHz	18900	1802M	-1.39	-52.05			50.66	20.00	20.00	-30.66	T4	
		3MHz	18900	1802M	-1.04	-50.97			49.93	20.00	20.00	-29.93	T4	
		1.4MHz	18900	1802M	-1.10	-51.33			50.23	20.00	20.00	-30.23	T4	

Table 10-25
Raw Data Results for LTE B2 - ANT F

Mode	Orientation	Bandwidth	Channel	Device SN	ABM1 [dB(A/m)]	ABM2 [dB(A/m)]	Ambient Noise [dB(A/m)]	Frequency Response Margin (dB)	S+N/N (dB)	FCC Limit (dB)	Margin from FCC Limit (dB)	C63.19-2011 Rating	Test Coordinates	
LTE Band 2	Axial	20MHz	18900	1802M	5.70	-43.66	-61.94	1.69	49.36	20.00	-29.36	T4	1.6, 1.8	
		15MHz	18900	1802M	5.83	-42.98		1.82	48.81	20.00	-28.81	T4		
		10MHz	18900	1802M	5.70	-43.10		1.70	48.80	20.00	-28.80	T4		
		5MHz	18900	1802M	5.76	-42.94		1.77	48.70	20.00	-28.70	T4		
		3MHz	18900	1802M	5.75	-42.82		1.62	48.57	20.00	-28.57	T4		
		1.4MHz	18900	1802M	5.70	-43.05		1.70	48.75	20.00	-28.75	T4		
	Radial	20MHz	18900	1802M	-0.92	-48.34	-61.57	N/A	47.42	20.00	20.00	-27.42	T4	1.6, 2.6
		15MHz	18900	1802M	-0.60	-47.92			47.32	20.00	20.00	-27.32	T4	
		10MHz	18900	1802M	-0.66	-47.84			47.18	20.00	20.00	-27.18	T4	
		5MHz	18900	1802M	-0.60	-47.46			46.86	20.00	20.00	-26.86	T4	
		3MHz	18900	1802M	-0.63	-47.54			46.91	20.00	20.00	-26.91	T4	
		1.4MHz	18900	1802M	-0.66	-47.47			46.81	20.00	20.00	-26.81	T4	

Table 10-26
Raw Data Results for LTE B30 - ANT B

Mode	Orientation	Bandwidth	Channel	Device S/N	ABM1 [dB(A/m)]	ABM2 [dB(A/m)]	Ambient Noise [dB(A/m)]	Frequency Response Margin (dB)	S+N/N (dB)	FCC Limit (dB)	Margin from FCC Limit (dB)	C63.19-2011 Rating	Test Coordinates	
LTE Band 30	Axial	10MHz	27710	1802M	5.82	-38.00	-61.69	1.64	43.82	20.00	-23.82	T4	1.6, 1.8	
		5MHz	27710	1802M	5.88	-37.95		1.85	43.83	20.00	-23.83	T4		
	Radial	10MHz	27710	1802M	-1.22	-51.23	-61.29	N/A	50.01	20.00	20.00	-30.01	T4	1.6, 2.6
		5MHz	27710	1802M	-0.95	-51.09			50.14	20.00	20.00	-30.14	T4	

Table 10-27
Raw Data Results for LTE B30 - ANT F

Mode	Orientation	Bandwidth	Channel	Device SN	ABM1 [dB(A/m)]	ABM2 [dB(A/m)]	Ambient Noise [dB(A/m)]	Frequency Response Margin (dB)	S+N/N (dB)	FCC Limit (dB)	Margin from FCC Limit (dB)	C63.19-2011 Rating	Test Coordinates	
LTE Band 30	Axial	10MHz	27710	1802M	5.60	-46.37	-61.94	1.78	51.97	20.00	-31.97	T4	1.6, 1.8	
		5MHz	27710	1802M	5.88	-46.37		1.78	52.25	20.00	-32.25	T4		
	Radial	10MHz	27710	1802M	-0.60	-49.86	-61.57	N/A	49.26	20.00	20.00	-29.26	T4	1.6, 2.6
		5MHz	27710	1802M	-0.96	-50.01			49.05	20.00	20.00	-29.05	T4	

Table 10-28
Raw Data Results for LTE B7 - ANT B

Mode	Orientation	Bandwidth	Channel	Device S/N	ABM1 [dB(A/m)]	ABM2 [dB(A/m)]	Ambient Noise [dB(A/m)]	Frequency Response Margin (dB)	S+N/N (dB)	FCC Limit (dB)	Margin from FCC Limit (dB)	C63.19-2011 Rating	Test Coordinates	
LTE Band 7	Axial	20MHz	21100	1802M	5.68	-39.56	-61.69	1.69	45.24	20.00	-25.24	T4	1.6, 1.8	
		15MHz	21100	1802M	5.80	-39.45		1.80	45.25	20.00	-25.25	T4		
		10MHz	21100	1802M	5.70	-38.79		1.61	44.49	20.00	-24.49	T4		
		5MHz	21100	1802M	5.65	-38.73		1.60	44.38	20.00	-24.38	T4		
	Radial	20MHz	21100	1802M	-1.03	-51.65	-61.29	N/A	50.62	20.00	20.00	-30.62	T4	1.6, 2.6
		15MHz	21100	1802M	-1.07	-51.51			50.44	20.00	20.00	-30.44	T4	
		10MHz	21100	1802M	-1.01	-51.43			50.42	20.00	20.00	-30.42	T4	
		5MHz	21100	1802M	-0.78	-51.48			50.70	20.00	20.00	-30.70	T4	

FCC ID: A3LSMF936U		HAC (T-COIL) TEST REPORT	Approved by: Managing Director
Filename: 1M2204010046-24-R2.A3L	Test Dates: 4/25/2022 – 6/2/2022	DUT Type: Portable Handset	Page 45 of 120

REV 4.2.M
3/29/2022

Unless otherwise specified, no part of this report may be reproduced or utilized in any part, form or by any means, electronic or mechanical, including photocopying and microfilm, without permission in writing from Element. If you have any questions about this or have an enquiry about obtaining additional rights to this report or assembly of contents thereof, please contact CT.INFO@ELEMENT.COM.

Table 10-29
Raw Data Results for LTE B7 - ANT F

Mode	Orientation	Bandwidth	Channel	Accessory	ABM1 [dB(A/m)]	ABM2 [dB(A/m)]	Ambient Noise [dB(A/m)]	Frequency Response Margin (dB)	S+N/N (dB)	FCC Limit (dB)	Margin from FCC Limit (dB)	C63.19-2011 Rating	Test Coordinates
LTE Band 7	Axial	20MHz	21100	1802M	5.54	-44.11	-61.94	1.64	49.65	20.00	-29.65	T4	1.6, 1.8
		15MHz	21100	1802M	6.00	-43.63		1.68	49.63	20.00	-29.63	T4	
		10MHz	21100	1802M	5.63	-43.45		1.70	49.08	20.00	-29.08	T4	
		5MHz	21100	1802M	5.63	-43.88		1.77	49.51	20.00	-29.51	T4	
	Radial	20MHz	21100	1802M	-0.72	-46.27	-61.57	N/A	45.55	20.00	-25.55	T4	1.6, 2.6
		15MHz	21100	1802M	-0.69	-45.95			45.26	20.00	-25.26	T4	
		10MHz	21100	1802M	-0.66	-45.22			44.56	20.00	-24.56	T4	
		5MHz	21425	1802M	-1.02	-47.75			46.73	20.00	-26.73	T4	
		5MHz	21100	1802M	-1.09	-45.60			44.51	20.00	-24.51	T4	
		5MHz	20775	1802M	-1.07	-46.21			45.14	20.00	-25.14	T4	

Table 10-30
Raw Data Results for LTE B41 Power Class 3 - ANT B

Mode	Orientation	Bandwidth	Channel	Device S/N	ABM1 [dB(A/m)]	ABM2 [dB(A/m)]	Ambient Noise [dB(A/m)]	Frequency Response Margin (dB)	S+N/N (dB)	FCC Limit (dB)	Margin from FCC Limit (dB)	C63.19-2011 Rating	Test Coordinates
LTE Band 41 (PC3)	Axial	20MHz	40620	1802M	5.64	-31.22	-61.06	1.74	36.86	20.00	-16.86	T4	1.6, 1.8
		15MHz	40620	1802M	5.66	-31.22		1.78	36.88	20.00	-16.88	T4	
		10MHz	40620	1802M	5.81	-31.31		1.78	37.12	20.00	-17.12	T4	
		5MHz	40620	1802M	5.52	-31.08		1.73	36.60	20.00	-16.60	T4	
	Radial	20MHz	40620	1802M	-0.93	-49.04	-60.60	N/A	48.11	20.00	-28.11	T4	1.6, 2.6
		15MHz	40620	1802M	-0.96	-49.29			48.33	20.00	-28.33	T4	
		10MHz	40620	1802M	-0.83	-48.99			48.16	20.00	-28.16	T4	
		5MHz	40620	1802M	-0.90	-49.43			48.53	20.00	-28.53	T4	

Table 10-31
Raw Data Results for LTE B41 Power Class 3 - ANT F

Mode	Orientation	Bandwidth	Channel	Accessory	ABM1 [dB(A/m)]	ABM2 [dB(A/m)]	Ambient Noise [dB(A/m)]	Frequency Response Margin (dB)	S+N/N (dB)	FCC Limit (dB)	Margin from FCC Limit (dB)	C63.19-2011 Rating	Test Coordinates
LTE Band 41 (PC3)	Axial	20MHz	40620	1802M	5.68	-41.35	-61.94	1.89	47.03	20.00	-27.03	T4	1.6, 1.8
		15MHz	40620	1802M	5.86	-41.18		1.74	47.04	20.00	-27.04	T4	
		10MHz	40620	1802M	5.53	-41.35		1.79	46.88	20.00	-26.88	T4	
		5MHz	40620	1802M	5.90	-40.74		1.77	46.64	20.00	-26.64	T4	
	Radial	20MHz	40620	1802M	-0.73	-44.04	-61.57	N/A	43.31	20.00	-23.31	T4	1.6, 2.6
		15MHz	40620	1802M	-0.70	-44.13			43.43	20.00	-23.43	T4	
		10MHz	40620	1802M	-0.93	-44.10			43.17	20.00	-23.17	T4	
		5MHz	40620	1802M	-1.01	-43.56			42.55	20.00	-22.55	T4	

Table 10-32
Raw Data Results for LTE B41 Power Class 2 - ANT B

Mode	Orientation	Bandwidth	Channel	Device S/N	ABM1 [dB(A/m)]	ABM2 [dB(A/m)]	Ambient Noise [dB(A/m)]	Frequency Response Margin (dB)	S+N/N (dB)	FCC Limit (dB)	Margin from FCC Limit (dB)	C63.19-2011 Rating	Test Coordinates
LTE Band 41 (PC2)	Axial	20MHz	41490	1802M	6.00	-28.93	-61.06	1.73	34.93	20.00	-14.93	T4	1.6, 1.8
		20MHz	41055	1802M	5.72	-30.57		1.62	36.29	20.00	-16.29	T4	
		20MHz	40620	1802M	5.70	-29.30		1.71	35.00	20.00	-15.00	T4	
		20MHz	40185	1802M	5.51	-30.01		1.79	35.52	20.00	-15.52	T4	
		20MHz	39750	1802M	5.80	-29.00		1.61	34.80	20.00	-14.80	T4	
		15MHz	40620	1802M	5.83	-29.21		1.68	35.04	20.00	-15.04	T4	
		10MHz	40620	1802M	5.73	-29.49		1.68	35.22	20.00	-15.22	T4	
		5MHz	40620	1802M	5.71	-29.32		1.78	35.03	20.00	-15.03	T4	
	Radial	20MHz	40620	1802M	-1.36	-48.94	-60.60	N/A	47.58	20.00	-27.58	T4	1.6, 2.6
		15MHz	40620	1802M	-0.86	-49.22			48.36	20.00	-28.36	T4	
		10MHz	40620	1802M	-0.97	-49.12			48.15	20.00	-28.15	T4	
		5MHz	40620	1802M	-0.96	-49.08			48.12	20.00	-28.12	T4	

Table 10-33
Raw Data Results for LTE B41 Power Class 2 - ANT F

Mode	Orientation	Bandwidth	Channel	Device SN	ABM1 [dB(A/m)]	ABM2 [dB(A/m)]	Ambient Noise [dB(A/m)]	Frequency Response Margin (dB)	S+N/N (dB)	FCC Limit (dB)	Margin from FCC Limit (dB)	C63.19-2011 Rating	Test Coordinates
LTE Band 41 (PC2)	Axial	20MHz	40620	1802M	5.71	-40.75	-61.94	1.77	46.46	20.00	-26.46	T4	1.6, 1.8
		15MHz	40620	1802M	5.69	-40.42		1.59	46.11	20.00	-26.11	T4	
		10MHz	40620	1802M	5.72	-40.11		1.78	45.83	20.00	-25.83	T4	
		5MHz	40620	1802M	5.89	-39.59		1.81	45.48	20.00	-25.48	T4	
	Radial	20MHz	40620	1802M	-1.12	-43.66	-61.57	N/A	42.54	20.00	-22.54	T4	1.6, 2.6
		15MHz	40620	1802M	-0.60	-43.27			42.67	20.00	-22.67	T4	
		10MHz	40620	1802M	-0.63	-42.93			42.30	20.00	-22.30	T4	
		5MHz	40620	1802M	-0.97	-42.35			41.38	20.00	-21.38	T4	

FCC ID: A3LSMF936U		HAC (T-COIL) TEST REPORT	Approved by: Managing Director
Filename: 1M2204010046-24-R2.A3L	Test Dates: 4/25/2022 – 6/2/2022	DUT Type: Portable Handset	Page 46 of 120

Table 10-34
Raw Data Results for LTE B48

Mode	Orientation	Bandwidth	Channel	Device S/N	ABM1 [dB(A/m)]	ABM2 [dB(A/m)]	Ambient Noise [dB(A/m)]	Frequency Response Margin (dB)	S+N/N (dB)	FCC Limit (dB)	Margin from FCC Limit (dB)	C63.19-2011 Rating	Test Coordinates
LTE Band 48	Axial	20MHz	55990	1802M	5.78	-31.74	-61.06	1.75	37.52	20.00	-17.52	T4	1.6, 1.8
		15MHz	55990	1802M	6.15	-31.62		1.70	37.77	20.00	-17.77	T4	
		10MHz	55990	1802M	5.95	-32.07		1.77	38.02	20.00	-18.02	T4	
		5MHz	55990	1802M	5.86	-32.16		1.83	38.02	20.00	-18.02	T4	
	Radial	20MHz	56640	1802M	-1.08	-40.58	-60.60	N/A	39.50	20.00	-19.50	T4	1.6, 2.6
		20MHz	55990	1802M	-1.23	-39.86			38.63	20.00	-18.63	T4	
		20MHz	55340	1802M	-1.17	-40.94			39.77	20.00	-19.77	T4	
		15MHz	55990	1802M	-1.38	-41.47			40.09	20.00	-20.09	T4	
		10MHz	55990	1802M	-1.38	-41.15			39.77	20.00	-19.77	T4	
		5MHz	55990	1802M	-1.02	-41.46			40.44	20.00	-20.44	T4	

Table 10-35
Raw Data Results for NR n71 - M1 + M2

Mode	Orientation	Bandwidth	Channel	Device SN	ABM1 [dB(A/m)]	ABM2 [dB(A/m)]	Ambient Noise [dB(A/m)]	Frequency Response Margin (dB)	S+N/N (dB)	FCC Limit (dB)	Margin from FCC Limit (dB)	C63.19-2011 Rating	Test Coordinates
NR n71	Axial	20MHz	136100	1809M	4.94	-40.10	-59.60	2.00	45.04	20.00	-25.04	T4	1.6, 1.8
		15MHz	136100	1809M	5.07	-40.60		2.00	45.67	20.00	-25.67	T4	
		10MHz	136100	1809M	4.88	-41.96		2.00	46.84	20.00	-26.84	T4	
		5MHz	136100	1809M	5.06	-39.67		2.00	44.73	20.00	-24.73	T4	
	Radial	20MHz	136100	1809M	-1.62	-48.39	-59.06	N/A	46.77	20.00	-26.77	T4	1.6, 2.6
		15MHz	136100	1809M	-1.48	-49.36			47.88	20.00	-27.88	T4	
		10MHz	136100	1809M	-1.62	-49.98			48.36	20.00	-28.36	T4	
		5MHz	136100	1809M	-1.62	-49.31			47.69	20.00	-27.69	T4	

Table 10-36
Raw Data Results for NR n71 - M1

Mode	Orientation	Bandwidth	Channel	Device SN	ABM1 [dB(A/m)]	ABM2 [dB(A/m)]	Ambient Noise [dB(A/m)]	Frequency Response Margin (dB)	S+N/N (dB)	FCC Limit (dB)	Margin from FCC Limit (dB)	C63.19-2011 Rating	Test Coordinates
NR n71	Axial	20MHz	136100	1809M	5.04	-41.87	-59.60	2.00	46.91	20.00	-26.91	T4	1.6, 1.8
		15MHz	136100	1809M	5.14	-39.56		2.00	44.70	20.00	-24.70	T4	
		10MHz	136100	1809M	5.18	-39.19		2.00	44.37	20.00	-24.37	T4	
		5MHz	136100	1809M	5.14	-39.59		2.00	44.73	20.00	-24.73	T4	
	Radial	20MHz	136100	1809M	-1.57	-49.32	-59.06	N/A	47.75	20.00	-27.75	T4	1.6, 2.6
		15MHz	136100	1809M	-1.52	-47.99			46.47	20.00	-26.47	T4	
		10MHz	136100	1809M	-1.54	-47.04			45.50	20.00	-25.50	T4	
		5MHz	136100	1809M	-1.42	-47.00			45.58	20.00	-25.58	T4	

Table 10-37
Raw Data Results for NR n12 - M1 + M2

Mode	Orientation	Bandwidth	Channel	Device SN	ABM1 [dB(A/m)]	ABM2 [dB(A/m)]	Ambient Noise [dB(A/m)]	Frequency Response Margin (dB)	S+N/N (dB)	FCC Limit (dB)	Margin from FCC Limit (dB)	C63.19-2011 Rating	Test Coordinates
NR n12	Axial	15MHz	141500	1809M	4.98	-42.35	-59.60	2.00	47.33	20.00	-27.33	T4	1.6, 1.8
		10MHz	141500	1809M	4.93	-41.71		2.00	46.64	20.00	-26.64	T4	
		5MHz	141500	1809M	4.96	-42.98		2.00	47.94	20.00	-27.94	T4	
	Radial	15MHz	141500	1809M	-1.54	-50.35	-59.06	N/A	48.81	20.00	-28.81	T4	1.6, 2.6
		10MHz	141500	1809M	-1.63	-49.56			47.93	20.00	-27.93	T4	
		5MHz	141500	1809M	-1.49	-48.49			47.00	20.00	-27.00	T4	

Table 10-38
Raw Data Results for NR n12 - M1

Mode	Orientation	Bandwidth	Channel	Device SN	ABM1 [dB(A/m)]	ABM2 [dB(A/m)]	Ambient Noise [dB(A/m)]	Frequency Response Margin (dB)	S+N/N (dB)	FCC Limit (dB)	Margin from FCC Limit (dB)	C63.19-2011 Rating	Test Coordinates
NR n12	Axial	15MHz	141500	1809M	5.15	-40.81	-59.60	2.00	45.96	20.00	-25.96	T4	1.6, 1.8
		10MHz	141500	1809M	5.10	-40.65		2.00	45.75	20.00	-25.75	T4	
		5MHz	141500	1809M	5.09	-41.71		2.00	46.80	20.00	-26.80	T4	
	Radial	15MHz	141500	1809M	-1.38	-50.10	-59.06	N/A	48.72	20.00	-28.72	T4	1.6, 2.6
		10MHz	141500	1809M	-1.48	-49.77			48.29	20.00	-28.29	T4	
		5MHz	141500	1809M	-1.50	-49.74			48.24	20.00	-28.24	T4	

FCC ID: A3LSMF936U		HAC (T-COIL) TEST REPORT	Approved by: Managing Director
Filename: 1M2204010046-24-R2.A3L	Test Dates: 4/25/2022 – 6/2/2022	DUT Type: Portable Handset	Page 47 of 120

REV 4.2.M
3/29/2022

Unless otherwise specified, no part of this report may be reproduced or utilized in any part, form or by any means, electronic or mechanical, including photocopying and microfilm, without permission in writing from Element. If you have any questions about this or have an enquiry about obtaining additional rights to this report or assembly of contents thereof, please contact CT.INFO@ELEMENT.COM.

**Table 10-39
Raw Data Results for NR n5 - M1 + M2**

Mode	Orientation	Bandwidth	Channel	Device SN	ABM1 [dB(A/m)]	ABM2 [dB(A/m)]	Ambient Noise [dB(A/m)]	Frequency Response Margin (dB)	S+N/N (dB)	FCC Limit (dB)	Margin from FCC Limit (dB)	C63.19-2011 Rating	Test Coordinates
NR n5	Axial	20MHz	167300	1809M	5.00	-43.07	-59.60	2.00	48.07	20.00	-28.07	T4	1.6, 1.8
		15MHz	167300	1809M	5.19	-42.42		2.00	47.61	20.00	-27.61	T4	
		10MHz	167300	1809M	5.16	-43.91		2.00	49.07	20.00	-29.07	T4	
		5MHz	167300	1809M	4.97	-43.67		2.00	48.64	20.00	-28.64	T4	
	Radial	20MHz	167300	1809M	-1.59	-50.29	-59.06	N/A	48.70	20.00	-28.70	T4	1.6, 2.6
		15MHz	167300	1809M	-1.55	-50.01			48.46	20.00	-28.46	T4	
		10MHz	167300	1809M	-1.57	-50.85			49.28	20.00	-29.28	T4	
		5MHz	167300	1809M	-1.58	-51.05			49.47	20.00	-29.47	T4	

**Table 10-40
Raw Data Results for NR n5 - M1**

Mode	Orientation	Bandwidth	Channel	Device SN	ABM1 [dB(A/m)]	ABM2 [dB(A/m)]	Ambient Noise [dB(A/m)]	Frequency Response Margin (dB)	S+N/N (dB)	FCC Limit (dB)	Margin from FCC Limit (dB)	C63.19-2011 Rating	Test Coordinates
NR n5	Axial	20MHz	167300	1809M	4.98	-40.23	-59.60	2.00	45.21	20.00	-25.21	T4	1.6, 1.8
		15MHz	167300	1809M	5.14	-40.57		2.00	45.71	20.00	-25.71	T4	
		10MHz	167300	1809M	4.98	-43.78		2.00	48.76	20.00	-28.76	T4	
		5MHz	167300	1809M	5.12	-41.29		2.00	46.41	20.00	-26.41	T4	
	Radial	20MHz	167300	1809M	-1.52	-49.65	-59.06	N/A	48.13	20.00	-28.13	T4	1.6, 2.6
		15MHz	167300	1809M	-1.50	-49.61			48.11	20.00	-28.11	T4	
		10MHz	167300	1809M	-1.46	-49.24			47.78	20.00	-27.78	T4	
		5MHz	167300	1809M	-1.48	-49.22			47.74	20.00	-27.74	T4	

**Table 10-41
Raw Data Results for NR n66 - ANT B**

Mode	Orientation	Bandwidth	Channel	Device SN	ABM1 [dB(A/m)]	ABM2 [dB(A/m)]	Ambient Noise [dB(A/m)]	Frequency Response Margin (dB)	S+N/N (dB)	FCC Limit (dB)	Margin from FCC Limit (dB)	C63.19-2011 Rating	Test Coordinates
NR n66	Axial	40MHz	349000	1809M	4.99	-35.36	-59.60	2.00	40.35	20.00	-20.35	T4	1.6, 1.8
		30MHz	349000	1809M	5.01	-35.40		2.00	40.41	20.00	-20.41	T4	
		20MHz	349000	1809M	5.02	-37.26		2.00	42.28	20.00	-22.28	T4	
		15MHz	349000	1809M	4.99	-37.92		2.00	42.91	20.00	-22.91	T4	
		10MHz	349000	1809M	4.91	-37.91		2.00	42.82	20.00	-22.82	T4	
		5MHz	349000	1809M	5.03	-36.69		2.00	41.72	20.00	-21.72	T4	
	Radial	40MHz	349000	1809M	-1.54	-50.07	-59.06	N/A	48.53	20.00	-28.53	T4	1.6, 2.6
		30MHz	349000	1809M	-1.45	-49.60			48.15	20.00	-28.15	T4	
		20MHz	349000	1809M	-1.47	-50.07			48.60	20.00	-28.60	T4	
		15MHz	349000	1809M	-1.48	-50.05			48.57	20.00	-28.57	T4	
		10MHz	349000	1809M	-1.56	-50.36			48.80	20.00	-28.80	T4	
		5MHz	349000	1809M	-1.56	-49.79			48.23	20.00	-28.23	T4	

**Table 10-42
Raw Data Results for NR n66 - ANT F**

Mode	Orientation	Bandwidth	Channel	Device SN	ABM1 [dB(A/m)]	ABM2 [dB(A/m)]	Ambient Noise [dB(A/m)]	Frequency Response Margin (dB)	S+N/N (dB)	FCC Limit (dB)	Margin from FCC Limit (dB)	C63.19-2011 Rating	Test Coordinates
NR n66	Axial	40MHz	349000	1809M	5.02	-35.36	-59.60	2.00	40.38	20.00	-20.38	T4	1.6, 1.8
		30MHz	349000	1809M	5.00	-38.84		2.00	43.84	20.00	-23.84	T4	
		20MHz	349000	1809M	4.93	-37.57		2.00	42.50	20.00	-22.50	T4	
		15MHz	349000	1809M	5.01	-39.54		2.00	44.55	20.00	-24.55	T4	
		10MHz	349000	1809M	4.93	-37.65		2.00	42.58	20.00	-22.58	T4	
		5MHz	349000	1809M	4.97	-38.67		2.00	43.64	20.00	-23.64	T4	
	Radial	40MHz	349000	1809M	-1.39	-45.63	-59.06	N/A	44.24	20.00	-24.24	T4	1.6, 2.6
		30MHz	353000	1809M	-1.52	-45.47			43.95	20.00	-23.95	T4	
		30MHz	349000	1809M	-1.46	-45.35			43.89	20.00	-23.89	T4	
		30MHz	345000	1809M	-1.50	-45.92			44.42	20.00	-24.42	T4	
		20MHz	349000	1809M	-1.54	-45.73			44.19	20.00	-24.19	T4	
		15MHz	349000	1809M	-1.46	-46.57			45.11	20.00	-25.11	T4	
		10MHz	349000	1809M	-1.35	-46.76			45.41	20.00	-25.41	T4	
		5MHz	349000	1809M	-1.39	-47.85			46.46	20.00	-26.46	T4	

FCC ID: A3LSMF936U		HAC (T-COIL) TEST REPORT	Approved by: Managing Director
Filename: 1M2204010046-24-R2.A3L	Test Dates: 4/25/2022 – 6/2/2022	DUT Type: Portable Handset	Page 48 of 120

REV 4.2.M
3/29/2022

Unless otherwise specified, no part of this report may be reproduced or utilized in any part, form or by any means, electronic or mechanical, including photocopying and microfilm, without permission in writing from Element. If you have any questions about this or have an enquiry about obtaining additional rights to this report or assembly of contents thereof, please contact CT.INFO@ELEMENT.COM.

**Table 10-43
Raw Data Results for NR n25 - ANT B**

Mode	Orientation	Bandwidth	Channel	Device SN	ABM1 [dB(A/m)]	ABM2 [dB(A/m)]	Ambient Noise [dB(A/m)]	Frequency Response Margin (dB)	S+N/N (dB)	FCC Limit (dB)	Margin from FCC Limit (dB)	C63.19-2011 Rating	Test Coordinates
NR n25	Axial	40MHz	376500	1809M	4.91	-35.27	-59.60	2.00	40.18	20.00	-20.18	T4	1.6, 1.8
		30MHz	376500	1809M	4.85	-35.51		2.00	40.36	20.00	-20.36	T4	
		25MHz	376500	1809M	4.81	-35.26		2.00	40.07	20.00	-20.07	T4	
		20MHz	376500	1809M	4.77	-34.88		2.00	39.65	20.00	-19.65	T4	
		15MHz	381500	1809M	4.40	-35.91		2.00	40.31	20.00	-20.31	T4	
		15MHz	376500	1809M	4.84	-34.51		2.00	39.35	20.00	-19.35	T4	
		15MHz	371500	1809M	4.71	-37.00		2.00	41.71	20.00	-21.71	T4	
		10MHz	376500	1809M	4.82	-36.28		2.00	41.10	20.00	-21.10	T4	
	5MHz	376500	1809M	4.73	-36.39	2.00	41.12	20.00	-21.12	T4			
	Radial	40MHz	376500	1809M	-1.54	-50.24	-59.06	N/A	48.70	20.00	-28.70	T4	1.6, 2.6
		30MHz	376500	1809M	-1.62	-50.07			48.45	20.00	-28.45	T4	
		25MHz	376500	1809M	-1.65	-49.25			47.60	20.00	-27.60	T4	
		20MHz	376500	1809M	-1.66	-49.44			47.78	20.00	-27.78	T4	
		15MHz	376500	1809M	-1.58	-49.38			47.80	20.00	-27.80	T4	
		10MHz	376500	1809M	-1.67	-49.12			47.45	20.00	-27.45	T4	
		5MHz	376500	1809M	-1.57	-49.87			48.30	20.00	-28.30	T4	

**Table 10-44
Raw Data Results for NR n25 - ANT F**

Mode	Orientation	Bandwidth	Channel	Device SN	ABM1 [dB(A/m)]	ABM2 [dB(A/m)]	Ambient Noise [dB(A/m)]	Frequency Response Margin (dB)	S+N/N (dB)	FCC Limit (dB)	Margin from FCC Limit (dB)	C63.19-2011 Rating	Test Coordinates
NR n25	Axial	40MHz	376500	1809M	5.05	-39.49	-59.60	2.00	44.54	20.00	-24.54	T4	1.6, 1.8
		30MHz	376500	1809M	5.01	-40.00		2.00	45.01	20.00	-25.01	T4	
		25MHz	376500	1809M	5.15	-39.60		2.00	44.75	20.00	-24.75	T4	
		20MHz	376500	1809M	5.07	-39.24		2.00	44.31	20.00	-24.31	T4	
		15MHz	376500	1809M	5.16	-39.75		2.00	44.91	20.00	-24.91	T4	
		10MHz	376500	1809M	5.09	-38.48		2.00	43.57	20.00	-23.57	T4	
		5MHz	376500	1809M	5.14	-38.98		2.00	44.12	20.00	-24.12	T4	
		Radial	40MHz	376500	1809M	-1.46		-47.55	-59.06	N/A	46.09	20.00	
	30MHz		376500	1809M	-1.33	-48.38	47.05	20.00			-27.05	T4	
	25MHz		376500	1809M	-1.39	-47.76	46.37	20.00			-26.37	T4	
	20MHz		376500	1809M	-1.50	-47.06	45.56	20.00			-25.56	T4	
	15MHz		376500	1809M	-1.33	-46.73	45.40	20.00			-25.40	T4	
	10MHz		376500	1809M	-1.34	-46.49	45.15	20.00			-25.15	T4	
	5MHz		376500	1809M	-1.38	-46.45	45.07	20.00			-25.07	T4	

**Table 10-45
Raw Data Results for NR n30 - ANT B**

Mode	Orientation	Bandwidth	Channel	Device SN	ABM1 [dB(A/m)]	ABM2 [dB(A/m)]	Ambient Noise [dB(A/m)]	Frequency Response Margin (dB)	S+N/N (dB)	FCC Limit (dB)	Margin from FCC Limit (dB)	C63.19-2011 Rating	Test Coordinates
NR n30	Axial	10MHz	462000	1809M	4.72	-34.76	-59.60	2.00	39.48	20.00	-19.48	T4	1.6, 1.8
		5MHz	462000	1809M	4.66	-35.68		2.00	40.34	20.00	-20.34	T4	
	Radial	10MHz	462000	1809M	-1.62	-49.68	-59.06	N/A	48.06	20.00	-28.06	T4	1.6, 2.6
		5MHz	462000	1809M	-1.57	-49.66			48.09	20.00	-28.09	T4	

**Table 10-46
Raw Data Results for NR n30 - ANT F**

Mode	Orientation	Bandwidth	Channel	Device SN	ABM1 [dB(A/m)]	ABM2 [dB(A/m)]	Ambient Noise [dB(A/m)]	Frequency Response Margin (dB)	S+N/N (dB)	FCC Limit (dB)	Margin from FCC Limit (dB)	C63.19-2011 Rating	Test Coordinates
NR n30	Axial	10MHz	462000	1809M	5.07	-38.14	-59.60	2.00	43.21	20.00	-23.21	T4	1.6, 1.8
		5MHz	462000	1809M	4.93	-37.74		2.00	42.67	20.00	-22.67	T4	
	Radial	10MHz	462000	1809M	-1.48	-46.40	-59.06	N/A	44.92	20.00	-24.92	T4	1.6, 2.6
		5MHz	462000	1809M	-1.50	-46.97			45.47	20.00	-25.47	T4	

FCC ID: A3LSMF936U		HAC (T-COIL) TEST REPORT	Approved by: Managing Director
Filename: 1M2204010046-24-R2.A3L	Test Dates: 4/25/2022 – 6/2/2022	DUT Type: Portable Handset	Page 49 of 120

REV 4.2.M
3/29/2022

**Table 10-47
Raw Data Results for NR n7 - ANT B**

Mode	Orientation	Bandwidth	Channel	Device SN	ABM1 [dB(A/m)]	ABM2 [dB(A/m)]	Ambient Noise [dB(A/m)]	Frequency Response Margin (dB)	S+N/N (dB)	FCC Limit (dB)	Margin from FCC Limit (dB)	C63.19-2011 Rating	Test Coordinates
NR n7	Axial	40MHz	507000	1809M	4.68	-36.04	-59.60	2.00	40.72	20.00	-20.72	T4	1.6, 1.8
		30MHz	507000	1809M	4.71	-35.24		2.00	39.95	20.00	-19.95	T4	
		25MHz	507000	1809M	4.66	-36.20		2.00	40.86	20.00	-20.86	T4	
		20MHz	507000	1809M	4.74	-36.93		2.00	41.67	20.00	-21.67	T4	
		15MHz	507000	1809M	4.76	-36.73		2.00	41.49	20.00	-21.49	T4	
		10MHz	507000	1809M	4.83	-36.15		2.00	40.98	20.00	-20.98	T4	
		5MHz	507000	1809M	4.85	-36.71		2.00	41.56	20.00	-21.56	T4	
	Radial	40MHz	507000	1809M	-1.72	-49.88	-59.06	NA	48.16	20.00	-28.16	T4	1.6, 2.6
		30MHz	507000	1809M	-1.62	-49.00			47.38	20.00	-27.38	T4	
		25MHz	507000	1809M	-1.62	-49.07			47.45	20.00	-27.45	T4	
		20MHz	507000	1809M	-1.64	-49.93			48.29	20.00	-28.29	T4	
		15MHz	507000	1809M	-1.74	-49.68			47.94	20.00	-27.94	T4	
		10MHz	507000	1809M	-1.65	-49.17			47.52	20.00	-27.52	T4	
		5MHz	507000	1809M	-1.73	-48.86			47.13	20.00	-27.13	T4	

**Table 10-48
Raw Data Results for NR n7 - ANT F**

Mode	Orientation	Bandwidth	Channel	Device SN	ABM1 [dB(A/m)]	ABM2 [dB(A/m)]	Ambient Noise [dB(A/m)]	Frequency Response Margin (dB)	S+N/N (dB)	FCC Limit (dB)	Margin from FCC Limit (dB)	C63.19-2011 Rating	Test Coordinates
NR n7	Axial	40MHz	507000	1809M	5.15	-39.69	-59.60	2.00	44.84	20.00	-24.84	T4	1.6, 1.8
		30MHz	507000	1809M	5.09	-40.15		2.00	45.24	20.00	-25.24	T4	
		25MHz	507000	1809M	5.00	-40.52		2.00	45.52	20.00	-25.52	T4	
		20MHz	507000	1809M	4.93	-41.54		2.00	46.47	20.00	-26.47	T4	
		15MHz	507000	1809M	5.20	-39.28		2.00	44.48	20.00	-24.48	T4	
		10MHz	507000	1809M	5.00	-40.99		2.00	45.99	20.00	-25.99	T4	
		5MHz	507000	1809M	5.10	-39.04		2.00	44.14	20.00	-24.14	T4	
	Radial	40MHz	507000	1809M	-1.52	-48.43	-59.06	NA	46.91	20.00	-26.91	T4	1.6, 2.6
		30MHz	507000	1809M	-1.86	-47.38			45.52	20.00	-25.52	T4	
		25MHz	507000	1809M	-1.67	-45.97			44.30	20.00	-24.30	T4	
		20MHz	507000	1809M	-1.65	-46.34			44.69	20.00	-24.69	T4	
		15MHz	507000	1809M	-1.75	-46.99			45.24	20.00	-25.24	T4	
		10MHz	507000	1809M	-1.70	-46.54			44.84	20.00	-24.84	T4	
		5MHz	507000	1809M	-1.94	-46.34			44.40	20.00	-24.40	T4	

**Table 10-49
Raw Data Results for NR n41 (PC2)**

Mode	Orientation	Bandwidth	Channel	Device SN	ABM1 [dB(A/m)]	ABM2 [dB(A/m)]	Ambient Noise [dB(A/m)]	Frequency Response Margin (dB)	S+N/N (dB)	FCC Limit (dB)	Margin from FCC Limit (dB)	C63.19-2011 Rating	Test Coordinates
NR n41 (PC2)	Axial	100MHz	518598	1809M	5.08	-35.36	-59.60	2.00	40.44	20.00	-20.44	T4	1.6, 1.8
		90MHz	518598	1809M	5.18	-34.51		2.00	39.69	20.00	-19.69	T4	
		80MHz	518598	1809M	5.02	-35.85		2.00	40.87	20.00	-20.87	T4	
		70MHz	518598	1809M	5.11	-35.65		2.00	40.76	20.00	-20.76	T4	
		60MHz	518598	1809M	5.08	-35.93		2.00	41.01	20.00	-21.01	T4	
		50MHz	518598	1809M	5.06	-35.73		2.00	40.79	20.00	-20.79	T4	
		40MHz	518598	1809M	4.91	-35.75		2.00	40.66	20.00	-20.66	T4	
		30MHz	518598	1809M	5.04	-35.79		2.00	40.83	20.00	-20.83	T4	
		20MHz	518598	1809M	5.04	-36.72		2.00	41.76	20.00	-21.76	T4	
		Radial	100MHz	518598	1809M	-1.54		-41.41	-59.06	NA	39.87	20.00	
	90MHz		518598	1809M	-1.70	-40.70	39.00	20.00			-19.00	T4	
	80MHz		518598	1809M	-1.69	-40.61	38.92	20.00			-18.92	T4	
	70MHz		518598	1809M	-1.67	-40.39	38.72	20.00			-18.72	T4	
	60MHz		531996	1809M	-1.64	-41.65	40.01	20.00			-20.01	T4	
	60MHz		525300	1809M	-1.70	-41.97	40.27	20.00			-20.27	T4	
	60MHz		518598	1809M	-1.70	-39.88	38.18	20.00			-18.18	T4	
	60MHz		511902	1809M	-1.70	-42.43	40.73	20.00			-20.73	T4	
	60MHz		505200	1809M	-1.64	-39.00	37.36	20.00			-17.36	T4	
	50MHz		518598	1809M	-1.59	-39.80	38.21	20.00			-18.21	T4	
	40MHz		518598	1809M	-1.71	-39.98	38.27	20.00			-18.27	T4	
	30MHz		518598	1809M	-1.59	-40.36	38.77	20.00			-18.77	T4	
	20MHz		518598	1809M	-1.54	-40.36	38.82	20.00			-18.82	T4	

FCC ID: A3LSMF936U		HAC (T-COIL) TEST REPORT	Approved by: Managing Director
Filename: 1M2204010046-24-R2.A3L	Test Dates: 4/25/2022 – 6/2/2022	DUT Type: Portable Handset	Page 50 of 120

Table 10-50
Raw Data Results for NR n77 (DoD, PC2) - ANT F

Mode	Orientation	Bandwidth	Channel	Device SN	ABM1 [dB(A/m)]	ABM2 [dB(A/m)]	Ambient Noise [dB(A/m)]	Frequency Response Margin (dB)	S+N/N (dB)	FCC Limit (dB)	Margin from FCC Limit (dB)	C63.19-2011 Rating	Test Coordinates
NR n77, DOD	Axial	100MHz	633334	1809M	4.84	-32.41	-59.60	2.00	37.25	20.00	-17.25	T4	1.6, 1.8
		90MHz	633334	1809M	4.85	-32.49		2.00	37.34	20.00	-17.34	T4	
		80MHz	633334	1809M	4.91	-32.33		2.00	37.24	20.00	-17.24	T4	
		70MHz	633334	1809M	4.86	-32.26		2.00	37.12	20.00	-17.12	T4	
		60MHz	633334	1809M	4.87	-32.50		2.00	37.37	20.00	-17.37	T4	
		50MHz	633334	1809M	4.57	-32.67		2.00	37.24	20.00	-17.24	T4	
		40MHz	633334	1809M	4.91	-32.73		2.00	37.64	20.00	-17.64	T4	
		30MHz	635666	1809M	5.17	-33.61		2.00	38.78	20.00	-18.78	T4	
		30MHz	634500	1809M	5.00	-33.11		2.00	38.11	20.00	-18.11	T4	
		30MHz	633334	1809M	4.75	-32.07		2.00	36.82	20.00	-16.82	T4	
		30MHz	632166	1809M	5.13	-33.10		2.00	38.23	20.00	-18.23	T4	
		30MHz	631000	1809M	5.22	-32.98		2.00	38.20	20.00	-18.20	T4	
		20MHz	633334	1809M	5.14	-34.19		2.00	39.33	20.00	-19.33	T4	
		15MHz	633334	1809M	5.17	-34.16		2.00	39.33	20.00	-19.33	T4	
	10MHz	633334	1809M	5.21	-33.62	2.00	38.83	20.00	-18.83	T4			
	Radial	100MHz	633334	1809M	-1.73	-44.62	-59.06	N/A	42.89	20.00	-22.89	T4	1.6, 2.6
		90MHz	633334	1809M	-1.63	-44.55			42.92	20.00	-22.92	T4	
		80MHz	633334	1809M	-1.65	-44.31			42.66	20.00	-22.66	T4	
		70MHz	633334	1809M	-1.62	-44.37			42.75	20.00	-22.75	T4	
		60MHz	633334	1809M	-1.74	-44.45			42.71	20.00	-22.71	T4	
		50MHz	633334	1809M	-1.74	-44.41			42.67	20.00	-22.67	T4	
		40MHz	633334	1809M	-1.71	-44.14			42.43	20.00	-22.43	T4	
		30MHz	633334	1809M	-1.67	-44.17			42.50	20.00	-22.50	T4	
		20MHz	633334	1809M	-1.68	-44.20			42.52	20.00	-22.52	T4	
		15MHz	633334	1809M	-1.69	-44.61			42.92	20.00	-22.92	T4	
		10MHz	633334	1809M	-1.70	-44.69			42.99	20.00	-22.99	T4	

Table 10-51
Raw Data Results for NR n77 (DoD, PC2) - ANT E

Mode	Orientation	Bandwidth	Channel	Device SN	ABM1 [dB(A/m)]	ABM2 [dB(A/m)]	Ambient Noise [dB(A/m)]	Frequency Response Margin (dB)	S+N/N (dB)	FCC Limit (dB)	Margin from FCC Limit (dB)	C63.19-2011 Rating	Test Coordinates			
NR n77, DOD	Axial	100MHz	633334	1809M	5.13	-33.09	-59.60	2.00	38.22	20.00	-18.22	T4	1.6, 1.8			
		90MHz	633334	1809M	4.72	-33.38		2.00	38.10	20.00	-18.10	T4				
		80MHz	633334	1809M	4.67	-33.66		2.00	38.33	20.00	-18.33	T4				
		70MHz	633334	1809M	4.74	-33.39		2.00	38.13	20.00	-18.13	T4				
		60MHz	633334	1809M	4.82	-33.43		2.00	38.25	20.00	-18.25	T4				
		50MHz	633334	1809M	4.77	-33.65		2.00	38.42	20.00	-18.42	T4				
		40MHz	633334	1809M	4.81	-33.62		2.00	38.43	20.00	-18.43	T4				
		30MHz	633334	1809M	5.02	-33.74		2.00	38.76	20.00	-18.76	T4				
		20MHz	633334	1809M	5.02	-34.33		2.00	39.35	20.00	-19.35	T4				
		15MHz	633334	1809M	4.92	-33.73		2.00	38.65	20.00	-18.65	T4				
		10MHz	633334	1809M	4.85	-33.60		2.00	38.45	20.00	-18.45	T4				
		Radial	100MHz	633334	1809M	-1.52		-44.34	-59.06	N/A	42.82	20.00		-22.82	T4	1.6, 2.6
			90MHz	633334	1809M	-1.50		-44.31			42.81	20.00		-22.81	T4	
			80MHz	633334	1809M	-1.50		-44.44			42.94	20.00		-22.94	T4	
	70MHz		633334	1809M	-1.52	-44.78	43.26	20.00			-23.26	T4				
	60MHz		633334	1809M	-1.69	-44.60	42.91	20.00			-22.91	T4				
	50MHz		633334	1809M	-1.54	-45.00	43.46	20.00			-23.46	T4				
	40MHz		633334	1809M	-1.50	-44.74	43.24	20.00			-23.24	T4				
	30MHz		633334	1809M	-1.52	-45.09	43.57	20.00			-23.57	T4				
	20MHz		633334	1809M	-1.48	-45.21	43.73	20.00			-23.73	T4				
	15MHz		633334	1809M	-1.33	-44.82	43.49	20.00			-23.49	T4				
	10MHz		633334	1809M	-1.24	-44.78	43.54	20.00			-23.54	T4				

Table 10-52
Raw Data Results for NR n48

Mode	Orientation	Bandwidth	Channel	Device SN	ABM1 [dB(A/m)]	ABM2 [dB(A/m)]	Ambient Noise [dB(A/m)]	Frequency Response Margin (dB)	S+N/N (dB)	FCC Limit (dB)	Margin from FCC Limit (dB)	C63.19-2011 Rating	Test Coordinates
NR n48	Axial	40MHz	641666	1809M	4.73	-38.25	-59.60	2.00	42.98	20.00	-22.98	T4	1.6, 1.8
		30MHz	641666	1809M	4.83	-39.09		2.00	43.92	20.00	-23.92	T4	
		20MHz	641666	1809M	4.82	-38.20		2.00	43.02	20.00	-23.02	T4	
		10MHz	641666	1809M	4.83	-38.67		2.00	43.50	20.00	-23.50	T4	
	Radial	40MHz	641666	1809M	-1.60	-48.48	-59.06	N/A	46.88	20.00	-26.88	T4	1.6, 2.6
		30MHz	641666	1809M	-1.56	-46.81			45.25	20.00	-25.25	T4	
		20MHz	641666	1809M	-1.76	-48.08			46.32	20.00	-26.32	T4	
		10MHz	641666	1809M	-1.73	-48.23			46.50	20.00	-26.50	T4	

FCC ID: A3LSMF936U		HAC (T-COIL) TEST REPORT	Approved by: Managing Director
Filename: 1M2204010046-24-R2.A3L	Test Dates: 4/25/2022 – 6/2/2022	DUT Type: Portable Handset	Page 51 of 120

REV 4.2.M
3/29/2022

Unless otherwise specified, no part of this report may be reproduced or utilized in any part, form or by any means, electronic or mechanical, including photocopying and microfilm, without permission in writing from Element. If you have any questions about this or have an enquiry about obtaining additional rights to this report or assembly of contents thereof, please contact CT.INFO@ELEMENT.COM.

**Table 10-53
Raw Data Results for NR n77 (PC2) – ANT F**

Mode	Orientation	Bandwidth	Channel	Device SN	ABM1 [dB(A/m)]	ABM2 [dB(A/m)]	Ambient Noise [dB(A/m)]	Frequency Response Margin (dB)	S+N/N (dB)	FCC Limit (dB)	Margin from FCC Limit (dB)	C63.19-2011 Rating	Test Coordinates
NR n77 (PC2)	Axial	100MHz	656000	1809M	4.90	-34.36	-59.60	2.00	39.26	20.00	-19.26	T4	1.6, 1.8
		90MHz	656000	1809M	4.99	-34.22		2.00	39.21	20.00	-19.21	T4	
		80MHz	656000	1809M	4.87	-34.49		2.00	39.36	20.00	-19.36	T4	
		70MHz	656000	1809M	4.81	-34.39		2.00	39.20	20.00	-19.20	T4	
		60MHz	656000	1809M	4.93	-34.42		2.00	39.35	20.00	-19.35	T4	
		50MHz	656000	1809M	4.91	-34.96		2.00	39.87	20.00	-19.87	T4	
		40MHz	656000	1809M	4.87	-34.43		2.00	39.30	20.00	-19.30	T4	
		30MHz	656000	1809M	4.95	-34.61		2.00	39.56	20.00	-19.56	T4	
		20MHz	656000	1809M	4.95	-35.11		2.00	40.06	20.00	-20.06	T4	
		15MHz	656000	1809M	4.90	-35.03		2.00	39.93	20.00	-19.93	T4	
	10MHz	656000	1809M	5.00	-34.95	2.00	39.95	20.00	-19.95	T4			
	Radial	100MHz	656000	1809M	-1.61	-45.94	-59.06	N/A	44.33	20.00	-24.33	T4	1.6, 2.6
		90MHz	656000	1809M	-1.64	-45.75		N/A	44.11	20.00	-24.11	T4	
		80MHz	656000	1809M	-1.63	-45.90		N/A	44.27	20.00	-24.27	T4	
		70MHz	656000	1809M	-1.55	-45.74		N/A	44.19	20.00	-24.19	T4	
		60MHz	656000	1809M	-1.63	-45.63		N/A	44.00	20.00	-24.00	T4	
		50MHz	656000	1809M	-1.71	-45.92		N/A	44.21	20.00	-24.21	T4	
		40MHz	656000	1809M	-1.77	-45.88		N/A	44.11	20.00	-24.11	T4	
		30MHz	656000	1809M	-1.60	-45.36		N/A	43.76	20.00	-23.76	T4	
		20MHz	656000	1809M	-1.71	-45.83		N/A	44.12	20.00	-24.12	T4	
15MHz		656000	1809M	-1.67	-45.66	N/A		43.99	20.00	-23.99	T4		
10MHz	656000	1809M	-1.64	-45.54	N/A	43.90	20.00	-23.90	T4				

**Table 10-54
Raw Data Results for NR n77 (PC2) – ANT E**

Mode	Orientation	Bandwidth	Channel	Device SN	ABM1 [dB(A/m)]	ABM2 [dB(A/m)]	Ambient Noise [dB(A/m)]	Frequency Response Margin (dB)	S+N/N (dB)	FCC Limit (dB)	Margin from FCC Limit (dB)	C63.19-2011 Rating	Test Coordinates
NR n77, DOD	Axial	100MHz	633334	1809M	5.13	-33.09	-59.60	2.00	38.22	20.00	-18.22	T4	1.6, 1.8
		90MHz	633334	1809M	4.72	-33.38		2.00	38.10	20.00	-18.10	T4	
		80MHz	633334	1809M	4.67	-33.66		2.00	38.33	20.00	-18.33	T4	
		70MHz	633334	1809M	4.74	-33.39		2.00	38.13	20.00	-18.13	T4	
		60MHz	633334	1809M	4.82	-33.43		2.00	38.25	20.00	-18.25	T4	
		50MHz	633334	1809M	4.77	-33.65		2.00	38.42	20.00	-18.42	T4	
		40MHz	633334	1809M	4.81	-33.62		2.00	38.43	20.00	-18.43	T4	
		30MHz	633334	1809M	5.02	-33.74		2.00	38.76	20.00	-18.76	T4	
		20MHz	633334	1809M	5.02	-34.33		2.00	39.35	20.00	-19.35	T4	
		15MHz	633334	1809M	4.92	-33.73		2.00	38.65	20.00	-18.65	T4	
	10MHz	633334	1809M	4.85	-33.60	2.00	38.45	20.00	-18.45	T4			
	Radial	100MHz	633334	1809M	-1.52	-44.34	-59.06	N/A	42.82	20.00	-22.82	T4	1.6, 2.6
		90MHz	633334	1809M	-1.50	-44.31		N/A	42.81	20.00	-22.81	T4	
		80MHz	633334	1809M	-1.50	-44.44		N/A	42.94	20.00	-22.94	T4	
		70MHz	633334	1809M	-1.52	-44.78		N/A	43.26	20.00	-23.26	T4	
		60MHz	633334	1809M	-1.69	-44.60		N/A	42.91	20.00	-22.91	T4	
		50MHz	633334	1809M	-1.54	-45.00		N/A	43.46	20.00	-23.46	T4	
		40MHz	633334	1809M	-1.50	-44.74		N/A	43.24	20.00	-23.24	T4	
		30MHz	633334	1809M	-1.52	-45.09		N/A	43.57	20.00	-23.57	T4	
		20MHz	633334	1809M	-1.48	-45.21		N/A	43.73	20.00	-23.73	T4	
15MHz		633334	1809M	-1.33	-44.82	N/A		43.49	20.00	-23.49	T4		
10MHz	633334	1809M	-1.24	-44.78	N/A	43.54	20.00	-23.54	T4				

FCC ID: A3LSMF936U		HAC (T-COIL) TEST REPORT	Approved by: Managing Director
Filename: 1M2204010046-24-R2.A3L	Test Dates: 4/25/2022 – 6/2/2022	DUT Type: Portable Handset	Page 52 of 120

REV 4.2.M
3/29/2022

Unless otherwise specified, no part of this report may be reproduced or utilized in any part, form or by any means, electronic or mechanical, including photocopying and microfilm, without permission in writing from Element. If you have any questions about this or have an enquiry about obtaining additional rights to this report or assembly of contents thereof, please contact CT.INFO@ELEMENT.COM.

Table 10-55
Raw Data Results for 2.4GHz WIFI

Mode	Orientation	Channel	Device S/N	ABM1 [dB(A/m)]	ABM2 [dB(A/m)]	Ambient Noise [dB(A/m)]	Frequency Response Margin (dB)	S+N/N (dB)	FCC Limit (dB)	Margin from FCC Limit (dB)	C63.19-2011 Rating	Test Coordinates
IEEE 802.11b	Axial	1	1802M	1.34	-32.85	-61.94	2.00	34.19	20.00	-14.19	T4	1.6,1.8
		6	1802M	1.52	-32.67		2.00	34.19	20.00	-14.19	T4	
		11	1802M	1.54	-32.60		2.00	34.14	20.00	-14.14	T4	
	Radial	1	1802M	-5.00	-35.06	-61.57	N/A	30.06	20.00	-10.06	T4	1.6,2.6
		6	1802M	-4.84	-34.88			30.04	20.00	-10.04	T4	
		11	1802M	-5.09	-35.06			29.97	20.00	-9.97	T3	
IEEE 802.11g	Axial	6	1802M	1.43	-36.52	-61.94	2.00	37.95	20.00	-17.95	T4	1.6,1.8
	Radial	6	1802M	-4.99	-39.55	-61.57	N/A	34.56	20.00	-14.56	T4	1.6,2.6
IEEE 802.11n	Axial	6	1802M	1.44	-35.58	-61.94	2.00	37.02	20.00	-17.02	T4	1.6,1.8
	Radial	6	1802M	-4.94	-38.62	-61.57	N/A	33.68	20.00	-13.68	T4	1.6,2.6
IEEE 802.11ax SU	Axial	6	1802M	1.23	-36.30	-61.94	2.00	37.53	20.00	-17.53	T4	1.6,1.8
	Radial	6	1802M	-4.86	-43.76	-61.57	N/A	38.90	20.00	-18.90	T4	1.6,2.6
IEEE 802.11ax RU	Axial	6	1802M	1.32	-36.00	-61.94	2.00	37.32	20.00	-17.32	T4	1.6,1.8
	Radial	6	1802M	-4.93	-40.04	-61.57	N/A	35.11	20.00	-15.11	T4	1.6,2.6

Table 10-56
Raw Data Results for 5GHz WIFI IEEE 802.11a

Mode	Orientation	Bandwidth	U-NII	Channel	Device S/N	ABM1 [dB(A/m)]	ABM2 [dB(A/m)]	Ambient Noise [dB(A/m)]	Frequency Response Margin (dB)	S+N/N (dB)	FCC Limit (dB)	Margin from FCC Limit (dB)	C63.19-2011 Rating	Test Coordinates
IEEE 802.11a	Axial	20MHz	1	40	1802M	1.51	-36.17	-61.94	1.98	37.68	20.00	-17.68	T4	1.6,1.8
	Radial	20MHz	1	36	1802M	-5.01	-42.59	-61.57	N/A	37.58	20.00	-17.58	T4	1.6,2.6
			1	40	1802M	-4.96	-41.30			36.34	20.00	-16.34	T4	
		1	48	1802M	-4.98	-42.96	37.98			20.00	-17.98	T4		
		2A	56	1802M	-4.96	-42.73	37.77			20.00	-17.77	T4		
		2C	120	1802M	-4.99	-42.14	37.15			20.00	-17.15	T4		
		3	157	1802M	-4.93	-42.03	37.10			20.00	-17.10	T4		
		4	177	1802M	-5.27	-42.78	37.51			20.00	-17.51	T4		

Table 10-57
Raw Data Results for 5GHz WIFI IEEE 802.11n

Mode	Orientation	Bandwidth	U-NII	Channel	Device S/N	ABM1 [dB(A/m)]	ABM2 [dB(A/m)]	Ambient Noise [dB(A/m)]	Frequency Response Margin (dB)	S+N/N (dB)	FCC Limit (dB)	Margin from FCC Limit (dB)	C63.19-2011 Rating	Test Coordinates			
IEEE 802.11n	Axial	40MHz	1	38	1802M	1.39	-36.58	-61.94	1.96	37.97	20.00	-17.97	T4	1.6,1.8			
		20MHz	1	40	1802M	1.36	-36.15		2.00	37.51	20.00	-17.51	T4				
		40MHz	2A	54	1802M	1.36	-36.54		2.00	37.90	20.00	-17.90	T4				
		20MHz	2A	56	1802M	1.58	-35.81		2.00	37.39	20.00	-17.39	T4				
		40MHz	2C	102	1802M	1.31	-35.64		2.00	36.95	20.00	-16.95	T4				
		40MHz	2C	118	1802M	1.44	-35.09		1.99	36.53	20.00	-16.53	T4				
		40MHz	2C	142	1802M	1.40	-35.93		2.00	37.33	20.00	-17.33	T4				
		20MHz	2C	120	1802M	1.30	-35.40		2.00	36.70	20.00	-16.70	T4				
		40MHz	3	151	1802M	1.34	-35.41		2.00	36.75	20.00	-16.75	T4				
		20MHz	3	157	1802M	1.63	-34.99		2.00	36.62	20.00	-16.62	T4				
		40MHz	4	175	1802M	1.39	-36.37		1.96	37.76	20.00	-17.76	T4				
		20MHz	4	177	1802M	1.20	-37.10		2.00	38.30	20.00	-18.30	T4				
		Radial	40MHz	1	38	1802M	-4.84		-42.54	-61.57	N/A	37.70	20.00		-17.70	T4	1.6,2.6
			20MHz	1	40	1802M	-4.81		-41.59			36.78	20.00		-16.78	T4	

Table 10-58
Raw Data Results for 5GHz WIFI IEEE 802.11ac

Mode	Orientation	Bandwidth	U-NII	Channel	Device S/N	ABM1 [dB(A/m)]	ABM2 [dB(A/m)]	Ambient Noise [dB(A/m)]	Frequency Response Margin (dB)	S+N/N (dB)	FCC Limit (dB)	Margin from FCC Limit (dB)	C63.19-2011 Rating	Test Coordinates	
IEEE 802.11ac	Axial	40MHz	1	38	1802M	1.41	-36.86	-61.94	2.00	38.27	20.00	-18.27	T4	1.6,1.8	
		20MHz	1	40	1802M	1.45	-36.72		2.00	38.17	20.00	-18.17	T4		
	Radial	40MHz	1	38	1802M	-4.79	-42.04		-61.57	N/A	37.25	20.00	-17.25	T4	1.6,2.6
		20MHz	1	40	1802M	-4.87	-41.84				36.97	20.00	-16.97	T4	

FCC ID: A3LSMF936U		HAC (T-COIL) TEST REPORT	Approved by: Managing Director
Filename: 1M2204010046-24-R2.A3L	Test Dates: 4/25/2022 – 6/2/2022	DUT Type: Portable Handset	Page 53 of 120

REV 4.2.M
3/29/2022

Unless otherwise specified, no part of this report may be reproduced or utilized in any part, form or by any means, electronic or mechanical, including photocopying and microfilm, without permission in writing from Element. If you have any questions about this or have an enquiry about obtaining additional rights to this report or assembly of contents thereof, please contact CT.INFO@ELEMENT.COM.

Table 10-59
Raw Data Results for 5GHz WIFI IEEE 802.11ax

Mode	Orientation	Bandwidth	U-NII	Channel	Device S/N	ABM1 [dB(A/m)]	ABM2 [dB(A/m)]	Ambient Noise [dB(A/m)]	Frequency Response Margin (dB)	S+N/N (dB)	FCC Limit (dB)	Margin from FCC Limit (dB)	C63.19-2011 Rating	Test Coordinates
IEEE 802.11ax SU	Axial	40MHz	1	38	1802M	1.36	-38.48	-61.94	2.00	39.84	20.00	-19.84	T4	1.6,1.8
		20MHz	1	40	1802M	1.39	-38.70		2.00	40.09	20.00	-20.09	T4	
		40MHz	5	3	1802M	1.14	-38.85		2.00	39.99	20.00	-19.99	T4	
		20MHz	5	5	1802M	1.16	-38.76		1.92	39.92	20.00	-19.92	T4	
	Radial	40MHz	1	38	1802M	-4.88	-47.23	-61.57	NA	42.35	20.00	-22.35	T4	1.6,2.6
		20MHz	1	40	1802M	-4.84	-46.52			41.68	20.00	-21.68	T4	
		40MHz	5	3	1802M	-5.26	-47.20			41.94	20.00	-21.94	T4	
		20MHz	5	5	1802M	-4.94	-46.42			41.48	20.00	-21.48	T4	
IEEE 802.11ax RU	Axial	40MHz	1	38	1802M	1.56	-38.23	-61.94	2.00	39.79	20.00	-19.79	T4	1.6,1.8
		20MHz	1	40	1802M	1.40	-38.45		2.00	39.85	20.00	-19.85	T4	
		40MHz	5	3	1802M	1.07	-38.78		1.86	39.85	20.00	-19.85	T4	
		20MHz	5	5	1802M	1.11	-39.16		1.98	40.27	20.00	-20.27	T4	
	Radial	40MHz	1	38	1802M	-5.37	-44.94	-61.57	NA	39.57	20.00	-19.57	T4	1.6,2.6
		20MHz	1	40	1802M	-4.92	-45.58			40.66	20.00	-20.66	T4	
		40MHz	5	3	1802M	-5.18	-47.29			42.11	20.00	-22.11	T4	
		20MHz	5	5	1802M	-4.92	-46.71			41.79	20.00	-21.79	T4	

Table 10-60
Raw Data Results for EDGE - M1+M2 (OTT VoIP)

Mode	Orientation	Channel	Device SN	ABM1 [dB(A/m)]	ABM2 [dB(A/m)]	Ambient Noise [dB(A/m)]	Frequency Response Margin (dB)	S+N/N (dB)	FCC Limit (dB)	Margin from FCC Limit (dB)	C63.19-2011 Rating	Test Coordinates
EDGE850	Axial	190	1802M	14.28	-27.76	-59.60	2.00	42.04	20.00	-22.04	T4	1.6, 1.8
	Radial	190	1802M	8.57	-36.27	-59.06	N/A	44.84	20.00	-24.84	T4	1.6, 2.6
EDGE1900	Axial	661	1802M	14.43	-27.70	-59.60	2.00	42.13	20.00	-22.13	T4	1.6, 1.8
	Radial	661	1802M	9.01	-44.84	-59.06	N/A	53.85	20.00	-33.85	T4	1.6, 2.6

Table 10-61
Raw Data Results for EDGE - M1 (OTT VoIP)

Mode	Orientation	Channel	Device SN	ABM1 [dB(A/m)]	ABM2 [dB(A/m)]	Ambient Noise [dB(A/m)]	Frequency Response Margin (dB)	S+N/N (dB)	FCC Limit (dB)	Margin from FCC Limit (dB)	C63.19-2011 Rating	Test Coordinates
EDGE850	Axial	190	1802M	14.61	-29.33	-61.94	2.00	43.94	20.00	-23.94	T4	1.6, 1.8
	Radial	190	1802M	8.64	-35.74	-59.06	N/A	44.38	20.00	-24.38	T4	1.6, 2.6

Table 10-62
Raw Data Results for HSPA - M1+M2 (OTT VoIP)

Mode	Orientation	Channel	Device SN	ABM1 [dB(A/m)]	ABM2 [dB(A/m)]	Ambient Noise [dB(A/m)]	Frequency Response Margin (dB)	S+N/N (dB)	FCC Limit (dB)	Margin from FCC Limit (dB)	C63.19-2011 Rating	Test Coordinates
HSPA V	Axial	4183	1802M	14.46	-42.49	-59.60	2.00	56.95	20.00	-36.95	T4	1.6, 1.8
	Radial	4183	1802M	8.80	-51.32	-59.06	N/A	60.12	20.00	-40.12	T4	1.6, 2.6
HSPA IV	Axial	1412	1802M	14.17	-46.78	-59.60	2.00	60.95	20.00	-40.95	T4	1.6, 1.8
	Radial	1412	1802M	8.75	-51.71	-59.06	N/A	60.46	20.00	-40.46	T4	1.6, 2.6
HSPA II	Axial	9400	1802M	14.20	-46.81	-59.60	2.00	61.01	20.00	-41.01	T4	1.6, 1.8
	Radial	9400	1802M	8.76	-51.46	-59.06	N/A	60.22	20.00	-40.22	T4	1.6, 2.6

Table 10-63
Raw Data Results for HSPA - M1 (OTT VoIP)

Mode	Orientation	Channel	Device SN	ABM1 [dB(A/m)]	ABM2 [dB(A/m)]	Ambient Noise [dB(A/m)]	Frequency Response Margin (dB)	S+N/N (dB)	FCC Limit (dB)	Margin from FCC Limit (dB)	C63.19-2011 Rating	Test Coordinates
HSPA V	Axial	4183	1802M	14.27	-46.01	-61.94	2.00	60.28	20.00	-40.28	T4	1.6, 1.8
	Radial	4183	1802M	9.34	-50.86	-61.57	N/A	60.20	20.00	-40.20	T4	1.6, 2.6

FCC ID: A3LSMF936U		HAC (T-COIL) TEST REPORT	Approved by: Managing Director
Filename: 1M2204010046-24-R2.A3L	Test Dates: 4/25/2022 – 6/2/2022	DUT Type: Portable Handset	Page 54 of 120

REV 4.2.M
3/29/2022

Table 10-64
Raw Data Results for LTE FDD B66 - M1+M2 (OTT VoIP)

Mode	Orientation	Bandwidth	Channel	Device S/N	ABM1 [dB(A/m)]	ABM2 [dB(A/m)]	Ambient Noise [dB(A/m)]	Frequency Response Margin (dB)	S+N/N (dB)	FCC Limit (dB)	Margin from FCC Limit (dB)	C63.19-2011 Rating	Test Coordinates
LTE Band 66	Axial	20MHz	132322	1802M	14.34	-34.84	-61.06	2.00	49.18	20.00	-29.18	T4	1.6, 1.8
		15MHz	132322	1802M	14.28	-35.25		2.00	49.53	20.00	-29.53	T4	
		10MHz	132322	1802M	14.50	-35.01		2.00	49.51	20.00	-29.51	T4	
		5MHz	132647	1802M	14.66	-35.54		2.00	50.20	20.00	-30.20	T4	
		5MHz	132322	1802M	14.23	-34.64		2.00	48.87	20.00	-28.87	T4	
		5MHz	131997	1802M	14.24	-35.60		2.00	49.84	20.00	-29.84	T4	
		3MHz	132322	1802M	14.22	-35.10		2.00	49.32	20.00	-29.32	T4	
		1.4MHz	132322	1802M	14.36	-35.14		2.00	49.50	20.00	-29.50	T4	
		20MHz	132572	1802M	9.07	-49.22		-60.60	N/A	58.29	20.00	-38.29	
	20MHz	132322	1802M	9.28	-49.10	58.38	20.00			-38.38	T4		
	20MHz	132072	1802M	9.13	-49.54	58.67	20.00			-38.67	T4		
	15MHz	132322	1802M	9.35	-49.29	58.64	20.00			-38.64	T4		
	10MHz	132322	1802M	9.16	-49.45	58.61	20.00			-38.61	T4		
	5MHz	132322	1802M	9.26	-49.38	58.64	20.00			-38.64	T4		
	3MHz	132322	1802M	9.33	-49.44	58.77	20.00			-38.77	T4		
	1.4MHz	132322	1802M	9.16	-49.27	58.43	20.00			-38.43	T4		

Table 10-65
Raw Data Results for LTE TDD B41 - M1+M2 (PC2) (OTT VoIP)

Mode	Orientation	Bandwidth	Channel	Device S/N	ABM1 [dB(A/m)]	ABM2 [dB(A/m)]	Ambient Noise [dB(A/m)]	Frequency Response Margin (dB)	S+N/N (dB)	FCC Limit (dB)	Margin from FCC Limit (dB)	C63.19-2011 Rating	Test Coordinates
LTE Band 41 (PC2)	Axial	20MHz	40620	1802M	14.57	-30.14	-61.06	2.00	44.71	20.00	-24.71	T4	1.6, 1.8
		15MHz	41490	1802M	14.67	-29.73		2.00	44.40	20.00	-24.40	T4	
		15MHz	41055	1802M	15.03	-31.16		2.00	46.19	20.00	-26.19	T4	
		15MHz	40620	1802M	14.51	-30.16		2.00	44.67	20.00	-24.67	T4	
		15MHz	40185	1802M	14.91	-30.84		2.00	45.75	20.00	-25.75	T4	
		15MHz	39750	1802M	14.65	-30.05		2.00	44.70	20.00	-24.70	T4	
		10MHz	40620	1802M	14.77	-30.17		2.00	44.94	20.00	-24.94	T4	
		5MHz	40620	1802M	14.62	-30.11		2.00	44.73	20.00	-24.73	T4	
		20MHz	40620	1802M	9.18	-46.04		-60.60	N/A	55.22	20.00	-35.22	
	15MHz	41490	1802M	9.15	-46.05	55.20	20.00			-35.20	T4		
	15MHz	41055	1802M	9.16	-47.16	56.32	20.00			-36.32	T4		
	15MHz	40620	1802M	9.12	-46.01	55.13	20.00			-35.13	T4		
	15MHz	40185	1802M	9.35	-47.05	56.40	20.00			-36.40	T4		
	15MHz	39750	1802M	9.30	-46.47	55.77	20.00			-35.77	T4		
	10MHz	40620	1802M	9.11	-46.21	55.32	20.00			-35.32	T4		
	5MHz	40620	1802M	9.16	-46.20	55.36	20.00			-35.36	T4		

Table 10-66
Raw Data Results for NR FDD n66 - ANT F (OTT VoIP)

Mode	Orientation	Bandwidth	Channel	Device SN	ABM1 [dB(A/m)]	ABM2 [dB(A/m)]	Ambient Noise [dB(A/m)]	Frequency Response Margin (dB)	S+N/N (dB)	FCC Limit (dB)	Margin from FCC Limit (dB)	C63.19-2011 Rating	Test Coordinates
NR n66	Axial	40MHz	349000	1809M	14.29	-36.14	0.00	2.00	50.43	20.00	-30.43	T4	1.6, 1.8
		30MHz	349000	1809M	14.35	-36.48		2.00	50.83	20.00	-30.83	T4	
		20MHz	349000	1809M	14.21	-37.70		2.00	51.91	20.00	-31.91	T4	
		15MHz	354500	1809M	14.50	-38.46		2.00	52.96	20.00	-32.96	T4	
		15MHz	349000	1809M	14.17	-35.20		2.00	49.37	20.00	-29.37	T4	
		15MHz	343500	1809M	14.45	-37.32		2.00	51.77	20.00	-31.77	T4	
		10MHz	349000	1809M	14.24	-37.51		2.00	51.75	20.00	-31.75	T4	
		5MHz	349000	1809M	14.12	-35.72		2.00	49.84	20.00	-29.84	T4	
		40MHz	352000	1809M	8.18	-48.98		0.00	N/A	57.16	20.00	-37.16	
	40MHz	349000	1809M	8.46	-47.43	55.89	20.00			-35.89	T4		
	40MHz	346000	1809M	8.40	-50.03	58.43	20.00			-38.43	T4		
	30MHz	349000	1809M	8.27	-49.48	57.75	20.00			-37.75	T4		
	20MHz	349000	1809M	8.37	-49.52	57.89	20.00			-37.89	T4		
	15MHz	349000	1809M	8.44	-49.07	57.51	20.00			-37.51	T4		
	10MHz	349000	1809M	8.30	-50.41	58.71	20.00			-38.71	T4		
	5MHz	349000	1809M	8.31	-49.36	57.67	20.00			-37.67	T4		

FCC ID: A3LSMF936U		HAC (T-COIL) TEST REPORT	Approved by: Managing Director
Filename: 1M2204010046-24-R2.A3L	Test Dates: 4/25/2022 – 6/2/2022	DUT Type: Portable Handset	Page 55 of 120

Table 10-67
Raw Data Results for NR TDD n77 (DoD, PC2) – ANT E (OTT VoIP)

Mode	Orientation	Bandwidth	Channel	Accessory	ABM1 [dB(A/m)]	ABM2 [dB(A/m)]	Ambient Noise [dB(A/m)]	Frequency Response Margin (dB)	S+N/N (dB)	FCC Limit (dB)	Margin from FCC Limit (dB)	C63.19-2011 Rating	Test Coordinates			
NR n77, DoD	Axial	100MHz	633334	1809M	14.27	-34.02	-62.31	2.00	48.29	20.00	-28.29	T4	1.6, 1.8			
		90MHz	633334	1809M	14.05	-33.94		2.00	47.99	20.00	-27.99	T4				
		80MHz	634000	1809M	14.15	-33.97		2.00	48.12	20.00	-28.12	T4				
		80MHz	633666	1809M	14.17	-32.52		2.00	46.69	20.00	-26.69	T4				
		80MHz	633334	1809M	14.19	-33.70		2.00	47.89	20.00	-27.89	T4				
		80MHz	633000	1809M	14.18	-33.65		2.00	47.83	20.00	-27.83	T4				
		80MHz	632666	1809M	14.21	-33.61		2.00	47.82	20.00	-27.82	T4				
		70MHz	633334	1809M	14.34	-33.79		2.00	48.13	20.00	-28.13	T4				
		60MHz	633334	1809M	14.28	-33.83		2.00	48.11	20.00	-28.11	T4				
		50MHz	633334	1809M	14.06	-33.95		2.00	48.01	20.00	-28.01	T4				
		40MHz	633334	1809M	14.12	-33.96		2.00	48.08	20.00	-28.08	T4				
		30MHz	633334	1809M	14.24	-33.94		2.00	48.18	20.00	-28.18	T4				
		20MHz	633334	1809M	14.25	-34.09		2.00	48.34	20.00	-28.34	T4				
		15MHz	633334	1809M	14.05	-34.37		2.00	48.42	20.00	-28.42	T4				
		10MHz	633334	1809M	14.03	-34.49		2.00	48.52	20.00	-28.52	T4				
		Radial	100MHz	633334	1809M	7.94		-44.16	-62.47	N/A	52.10	20.00		-32.10	T4	1.6, 2.6
			90MHz	633334	1809M	8.27		-43.80			52.07	20.00		-32.07	T4	
			80MHz	633334	1809M	8.22		-43.62			51.84	20.00		-31.84	T4	
	70MHz		633334	1809M	8.11	-43.82	51.93	20.00			-31.93	T4				
	60MHz		633334	1809M	8.21	-43.64	51.85	20.00			-31.85	T4				
	50MHz		633334	1809M	8.11	-43.92	52.03	20.00			-32.03	T4				
	40MHz		635332	1809M	8.12	-43.59	51.71	20.00			-31.71	T4				
	40MHz		634334	1809M	8.14	-43.60	51.74	20.00			-31.74	T4				
	40MHz		633334	1809M	8.12	-43.53	51.65	20.00			-31.65	T4				
	40MHz		632334	1809M	8.13	-43.41	51.54	20.00			-31.54	T4				
	40MHz		631334	1809M	7.97	-43.55	51.52	20.00			-31.52	T4				
	30MHz		633334	1809M	8.12	-43.58	51.70	20.00			-31.70	T4				
	20MHz		633334	1809M	8.00	-43.87	51.87	20.00			-31.87	T4				
	15MHz		633334	1809M	8.10	-43.72	51.82	20.00			-31.82	T4				
	10MHz		633334	1809M	8.05	-43.65	51.70	20.00			-31.70	T4				

Table 10-68
Raw Data Results for 2.4GHz WIFI (OTT VoIP)

Mode	Orientation	Channel	Device S/N	ABM1 [dB(A/m)]	ABM2 [dB(A/m)]	Ambient Noise [dB(A/m)]	Frequency Response Margin (dB)	S+N/N (dB)	FCC Limit (dB)	Margin from FCC Limit (dB)	C63.19-2011 Rating	Test Coordinates
IEEE 802.11b	Axial	1	1802M	14.35	-33.52	-61.94	2.00	47.87	20.00	-27.87	T4	1.6, 1.8
		6	1802M	14.18	-32.04		2.00	46.22	20.00	-26.22	T4	
		11	1802M	14.17	-31.64		2.00	45.81	20.00	-25.81	T4	
	Radial	1	1802M	8.35	-33.75	-61.57	N/A	42.10	20.00	-22.10	T4	1.6, 2.6
		6	1802M	8.23	-34.24			42.47	20.00	-22.47	T4	
		11	1802M	8.28	-33.44			41.72	20.00	-21.72	T4	
IEEE 802.11g	Axial	6	1802M	14.50	-36.12	-61.94	2.00	50.62	20.00	-30.62	T4	1.6, 1.8
	Radial	6	1802M	8.61	-38.57	-61.57	N/A	47.18	20.00	-27.18	T4	1.6, 2.6
IEEE 802.11n	Axial	6	1802M	14.33	-35.44	-61.94	2.00	49.77	20.00	-29.77	T4	1.6, 1.8
	Radial	6	1802M	8.41	-38.24	-61.57	N/A	46.65	20.00	-26.65	T4	1.6, 2.6
IEEE 802.11ax SU	Axial	6	1802M	14.31	-35.87	-61.94	2.00	50.18	20.00	-30.18	T4	1.6, 1.8
	Radial	6	1802M	8.48	-40.44	-61.57	N/A	48.92	20.00	-28.92	T4	1.6, 2.6
IEEE 802.11ax RU	Axial	6	1802M	14.44	-34.84	-61.94	2.00	49.28	20.00	-29.28	T4	1.6, 1.8
	Radial	6	1802M	8.42	-39.90	-61.57	N/A	48.32	20.00	-28.32	T4	1.6, 2.6

Table 10-69
Raw Data Results for 5GHz WIFI IEEE 802.11a (OTT VoIP)

Mode	Orientation	Bandwidth	U-NII	Channel	Device S/N	ABM1 [dB(A/m)]	ABM2 [dB(A/m)]	Ambient Noise [dB(A/m)]	Frequency Response Margin (dB)	S+N/N (dB)	FCC Limit (dB)	Margin from FCC Limit (dB)	C63.19-2011 Rating	Test Coordinates
IEEE 802.11a	Axial	20MHz	1	40	1802M	14.38	-35.49	-61.94	2.00	49.87	20.00	-29.87	T4	1.6, 1.8
	Radial	20MHz	1	40	1802M	8.33	-41.83	-61.57	N/A	50.16	20.00	-30.16	T4	1.6, 2.6

FCC ID: A3LSMF936U		HAC (T-COIL) TEST REPORT	Approved by: Managing Director
Filename: 1M2204010046-24-R2.A3L	Test Dates: 4/25/2022 – 6/2/2022	DUT Type: Portable Handset	Page 56 of 120

REV 4.2.M
3/29/2022

Unless otherwise specified, no part of this report may be reproduced or utilized in any part, form or by any means, electronic or mechanical, including photocopying and microfilm, without permission in writing from Element. If you have any questions about this or have an enquiry about obtaining additional rights to this report or assembly of contents thereof, please contact CT.INFO@ELEMENT.COM.

Table 10-70
Raw Data Results for 5GHz WIFI IEEE 802.11n (OTT VoIP)

Mode	Orientation	Bandwidth	U-NII	Channel	Device S/N	ABM1 [dB(A/m)]	ABM2 [dB(A/m)]	Ambient Noise [dB(A/m)]	Frequency Response Margin (dB)	S+N/N (dB)	FCC Limit (dB)	Margin from FCC Limit (dB)	C63.19-2011 Rating	Test Coordinates				
IEEE 802.11n	Axial	40MHz	1	38	1802M	14.29	-34.94	-61.94	2.00	49.23	20.00	-29.23	T4	1.6,1.8				
		20MHz	1	40	1802M	14.25	-35.30		2.00	49.55	20.00	-29.55	T4					
		40MHz	2A	54	1802M	14.29	-36.58		2.00	50.87	20.00	-30.87	T4					
		20MHz	2A	56	1802M	14.22	-35.60		2.00	49.82	20.00	-29.82	T4					
		40MHz	2C	118	1802M	14.38	-34.98		2.00	49.36	20.00	-29.36	T4					
		20MHz	2C	100	1802M	14.37	-34.88		2.00	49.25	20.00	-29.25	T4					
		20MHz	2C	120	1802M	14.35	-34.62		2.00	48.97	20.00	-28.97	T4					
		20MHz	2C	144	1802M	14.35	-35.04		2.00	49.39	20.00	-29.39	T4					
		40MHz	3	151	1802M	14.39	-34.93		2.00	49.32	20.00	-29.32	T4					
		20MHz	3	157	1802M	14.27	-34.95		2.00	49.22	20.00	-29.22	T4					
		40MHz	4	175	1802M	14.18	-35.85		2.00	50.03	20.00	-30.03	T4					
		20MHz	4	177	1802M	14.04	-36.48		2.00	50.52	20.00	-30.52	T4					
		IEEE 802.11n	Radial	40MHz	1	38	1802M		8.32	-41.81	-61.57	N/A	50.13		20.00	-30.13	T4	1.6,2.6
				20MHz	1	40	1802M		8.33	-41.39		N/A	49.72		20.00	-29.72	T4	

Table 10-71
Raw Data Results for 5GHz WIFI IEEE 802.11ac (OTT VoIP)

Mode	Orientation	Bandwidth	U-NII	Channel	Device S/N	ABM1 [dB(A/m)]	ABM2 [dB(A/m)]	Ambient Noise [dB(A/m)]	Frequency Response Margin (dB)	S+N/N (dB)	FCC Limit (dB)	Margin from FCC Limit (dB)	C63.19-2011 Rating	Test Coordinates	
IEEE 802.11ac	Axial	40MHz	1	38	1802M	14.43	-36.63	-61.94	2.00	51.06	20.00	-31.06	T4	1.6,1.8	
		20MHz	1	40	1802M	14.31	-35.16		2.00	49.47	20.00	-29.47	T4		
	IEEE 802.11ac	Radial	40MHz	1	38	1802M	8.31	-41.52	-61.57	N/A	49.83	20.00	-29.83	T4	1.6,2.6
			20MHz	1	40	1802M	8.37	-40.39			48.76	20.00	-28.76	T4	
			40MHz	2A	54	1802M	8.23	-41.86			50.09	20.00	-30.09	T4	
			20MHz	2A	56	1802M	8.40	-41.17			49.57	20.00	-29.57	T4	
			40MHz	2C	118	1802M	8.35	-41.21			49.56	20.00	-29.56	T4	
			20MHz	2C	120	1802M	8.38	-40.06			48.44	20.00	-28.44	T4	
			40MHz	3	151	1802M	8.35	-40.58			48.93	20.00	-28.93	T4	
			20MHz	3	149	1802M	8.38	-39.70			48.08	20.00	-28.08	T4	
			20MHz	3	157	1802M	8.51	-39.80			48.31	20.00	-28.31	T4	
			20MHz	3	165	1802M	8.38	-39.65			48.03	20.00	-28.03	T4	
			40MHz	4	175	1802M	7.99	-43.89			51.88	20.00	-31.88	T4	
			20MHz	4	177	1802M	8.22	-42.00			50.22	20.00	-30.22	T4	

Table 10-72
Raw Data Results for 5GHz WIFI IEEE 802.11ax (OTT VoIP)

Mode	Orientation	Bandwidth	U-NII	Channel	Device S/N	ABM1 [dB(A/m)]	ABM2 [dB(A/m)]	Ambient Noise [dB(A/m)]	Frequency Response Margin (dB)	S+N/N (dB)	FCC Limit (dB)	Margin from FCC Limit (dB)	C63.19-2011 Rating	Test Coordinates	
IEEE 802.11ax SU	Axial	40MHz	1	38	1802M	14.33	-39.12	-61.94	2.00	53.45	20.00	-33.45	T4	1.6,1.8	
		20MHz	1	40	1802M	14.38	-39.63		2.00	54.01	20.00	-34.01	T4		
		40MHz	5	3	1802M	13.96	-38.16		2.00	52.12	20.00	-32.12	T4		
		20MHz	5	5	1802M	13.88	-38.58		2.00	52.46	20.00	-32.46	T4		
	IEEE 802.11ax SU	Radial	40MHz	1	38	1802M	8.31	-46.79	-61.57	N/A	55.10	20.00	-35.10	T4	1.6,2.6
			20MHz	1	40	1802M	8.32	-46.12			54.44	20.00	-34.44	T4	
			40MHz	5	3	1802M	7.83	-45.88			53.71	20.00	-33.71	T4	
			20MHz	5	5	1802M	8.46	-45.21			53.67	20.00	-33.67	T4	
IEEE 802.11ax RU	Axial	40MHz	1	38	1802M	14.37	-37.29	-61.94	2.00	51.66	20.00	-31.66	T4	1.6,1.8	
		20MHz	1	40	1802M	14.33	-38.42		2.00	52.75	20.00	-32.75	T4		
		40MHz	5	3	1802M	13.83	-38.45		2.00	52.28	20.00	-32.28	T4		
		20MHz	5	5	1802M	13.94	-38.77		2.00	52.71	20.00	-32.71	T4		
	IEEE 802.11ax RU	Radial	40MHz	1	38	1802M	8.42	-45.05	-61.57	N/A	53.47	20.00	-33.47	T4	1.6,2.6
			20MHz	1	40	1802M	8.35	-44.67			53.02	20.00	-33.02	T4	
			40MHz	5	3	1802M	7.81	-45.72			53.53	20.00	-33.53	T4	
			20MHz	5	5	1802M	8.06	-45.38			53.44	20.00	-33.44	T4	

Table 10-73
Raw Data Results for GSM - M1 – OPEN

Mode	Orientation	Channel	Device Configuration	Device S/N	ABM1 [dB(A/m)]	ABM2 [dB(A/m)]	Ambient Noise [dB(A/m)]	Frequency Response Margin (dB)	S+N/N (dB)	FCC Limit (dB)	Margin from FCC Limit (dB)	C63.19-2011 Rating	Test Coordinates
GSM850	Axial	128	OPEN - FRONT	1802M	3.67	-26.09	-61.52	1.81	29.76	20.00	-9.76	T3	1.6, 3.4
		128	OPEN - BACK	1802M	7.34	-21.25		1.97	28.59	20.00	-8.59	T3	1.6, 1.8

FCC ID: A3LSMF936U		HAC (T-COIL) TEST REPORT	Approved by: Managing Director
Filename: 1M2204010046-24-R2.A3L	Test Dates: 4/25/2022 – 6/2/2022	DUT Type: Portable Handset	Page 57 of 120

REV 4.2.M
3/29/2022

Unless otherwise specified, no part of this report may be reproduced or utilized in any part, form or by any means, electronic or mechanical, including photocopying and microfilm, without permission in writing from Element. If you have any questions about this or have an enquiry about obtaining additional rights to this report or assembly of contents thereof, please contact CT.INFO@ELEMENT.COM.

**Table 10-74
Raw Data Results for 2.4GHz WIFI – OPEN**

Mode	Orientation	Channel	Device Configuration	Device S/N	ABM1 [dB(A/m)]	ABM2 [dB(A/m)]	Ambient Noise [dB(A/m)]	Frequency Response Margin (dB)	S+N/N (dB)	FCC Limit (dB)	Margin from FCC Limit (dB)	C63.19-2011 Rating	Test Coordinates
IEEE 802.11b	Radial	11	OPEN - FRONT	1802M	-7.55	-46.19	-61.51	N/A	38.64	20.00	-18.64	T4	1.6, 2.6
		11	OPEN - BACK	1802M	-5.12	-44.73			39.61	20.00	-19.61	T4	

II. Test Notes

A. General

1. Phone Condition: Mute on; Backlight off; Max Volume; Max Contrast
2. 'Radial' orientation refers to radial transverse.
3. 'OPEN – FRONT' and 'OPEN – BACK' device configurations refer to the device in an unfolded config. When folded OPEN, 'FRONT' refers to the side of the device with the large touchscreen display, while 'BACK' refers to the side of the device without the large touchscreen display.
4. The worst-case test configurations from CLOSED testing, for both Axial and Radial, were additionally tested with OPEN – FRONT and OPEN – BACK. GSM850 (M1) was the worst-case for Axial, and IEEE 802.11b VoWIFI was the worst-case for Radial.
5. Hearing Aid Mode (**Phone → Call settings → Other call settings → Hearing aid compatibility**) was set to ON for Frequency Response compliance
6. Speech Signal: 3GPP2 Normal Test Signal
7. Bluetooth and WIFI were disabled while testing 2G/3G/4G/5G modes.
8. Licensed data modes and Bluetooth were disabled while testing WIFI modes.
9. The Margin from FCC limit column indicates a margin from the FCC limit for compliance (T3).

B. GSM

1. Power Configuration: GSM850: PCL=5, GSM1900: PCL=0;
2. Vocoder Configuration: EFR (GSM);

C. UMTS

1. Power Configuration: TPC= "All 1s";
2. Vocoder Configuration: WB AMR 6.60kbps (UMTS);

D. LTE FDD

1. Power Configuration: TPC = "Max Power"
2. Radio Configuration: 16QAM, 1RB, 99%RB offset
3. Vocoder Configuration: WB AMR 6.60kbps
4. The worst-case band and bandwidth combination for each probe orientation is additionally tested on the low and high channels for those combinations. LTE Band 66 - ANT B at 1.4MHz is the worst-case for the Axial probe orientation. LTE Band 7 - ANT F at 5MHz is the worst-case for the Radial probe orientation.

E. LTE TDD

1. Power Configuration: TPC = "Max Power"
2. Radio Configuration: 16QAM, 1RB, 99%RB offset
3. Power Class 3 Uplink-Downlink configuration: 0
4. Power Class 2 Uplink-Downlink configuration: 1
5. Vocoder Configuration: WB AMR 6.60kbps
6. The worst-case band and bandwidth combination for each probe orientation is additionally tested on the low, low-mid, high-mid, and high channels for those combinations. LTE Band 41 - ANT B (Power Class 2) at 20MHz is the worst-case for the Axial probe orientation. LTE Band 48 at 20MHz is the worst-case for the Radial probe orientation.

FCC ID: A3LSMF936U		HAC (T-COIL) TEST REPORT	Approved by: Managing Director
Filename: 1M2204010046-24-R2.A3L	Test Dates: 4/25/2022 – 6/2/2022	DUT Type: Portable Handset	Page 58 of 120

REV 4.2.M
3/29/2022

F. NR FDD

1. Power Configuration: TPC = "Max Power"
2. Radio Configuration: CP-OFDM, 16QAM, 1RB, 1RB offset
3. Vocoder Configuration: WB AMR 6.60kbps
4. The worst-case band and bandwidth combination for each probe orientation is additionally tested on the low and high channels for those combinations. NR n25 - ANT B at 15MHz is the worst-case for the Axial probe orientation. NR n66 - ANT F at 30MHz is the worst-case for the Radial probe orientation.

G. NR TDD

1. Power Configuration: TPC = "Max Power"
2. Radio Configuration: CP-OFDM, 16QAM, 1RB, 1RB offset
3. Vocoder Configuration: WB AMR 6.60kbps
4. The worst-case band and bandwidth combination for each probe orientation is additionally tested on the low, low-mid, high-mid, and high channels for those combinations. NR n77, DoD (Power Class 2) at 30MHz is the worst-case for the Axial probe orientation. NR n41 (Power Class 2) at 60MHz is the worst-case for the Radial probe orientation.

H. WIFI

1. Radio Configuration
 - a. IEEE 802.11b: DSSS, 1Mbps
 - b. IEEE 802.11g/a: BPSK, 6Mbps
 - c. IEEE 802.11n/ac 20MHz: BPSK, MCS 0
 - d. IEEE 802.11ax SU 20MHz: BPSK, MCS 0
 - e. IEEE 802.11n/ac 40MHz: BPSK, MCS 0
 - f. IEEE 802.11ax SU 40MHz: BPSK, MCS 0
2. RU Index
 - a. IEEE 802.11ax RU 20MHz: RU Index 54
 - b. IEEE 802.11ax RU 40MHz: RU Index 61
3. Vocoder Configuration: WB AMR 6.60kbps
4. The worst-case standard for 2.4GHz WIFI in each probe orientation is additionally tested on the low and high channels. IEEE 802.11b is the worst-case for both the Axial and Radial probe orientations.
5. The worst-case standard for 5GHz WIFI in each probe orientation is additionally tested on higher U-NII bands as well as applicable low and high channels. IEEE 802.11n 40MHz (U-NII 2C) is the worst-case for the Axial probe orientation. IEEE 802.11a 20MHz (U-NII 1) is the worst-case for the Radial probe orientation.
6. U-NII 5 testing was performed using IEEE 802.11ax because no other IEEE standard supported U-NII 5 operations.

FCC ID: A3LSMF936U		HAC (T-COIL) TEST REPORT	Approved by: Managing Director
Filename: 1M2204010046-24-R2.A3L	Test Dates: 4/25/2022 – 6/2/2022	DUT Type: Portable Handset	Page 59 of 120

REV 4.2.M
3/29/2022

- I. OTT VoIP
 1. Vocoder Configuration: 6kbps
 2. EDGE Configuration
 - a. MCS Index: 7
 - b. Number of TX slots: 2
 3. HSPA Configuration:
 - a. Release: 6
 - b. 3GPP 34.121 Subtest 1
 4. LTE FDD Configuration:
 - a. Power Configuration: TPC = "Max Power"
 - b. Radio Configuration: 16QAM, 1RB, 99%RB offset
 - c. LTE Band 66 - ANT B was the worst-case band from Table 8-6 and was used to test both Axial and Radial probe orientations.
 - d. The worst-case band and bandwidth combination for each probe orientation is additionally tested on the low and high channels for those combinations. LTE Band 66 at 5MHz is the worst-case for the Axial probe orientation. LTE Band 66 at 20MHz is the worst-case for the Radial probe orientation.
 5. LTE TDD Configuration:
 - a. Power Configuration: TPC = "Max Power"
 - b. Radio Configuration: 16QAM, 1RB, 99%RB offset
 - c. Power Class 3 Uplink-Downlink configuration: 0
 - d. Power Class 2 Uplink-Downlink configuration: 1
 - e. LTE Band 41 - ANT B (PC2) was the worst-case band from Table 8-7 and was used to test both Axial and Radial probe orientations.
 - f. The worst-case band and bandwidth combination for each probe orientation is additionally tested on the low, low-mid, high-mid, and high channels for those combinations. LTE Band 41 (Power Class 2) at 15MHz is the worst-case for both the Axial and Radial probe orientations.
 6. NR FDD Configuration:
 - a. Power Configuration: TPC = "Max Power"
 - b. Radio Configuration: CP-OFDM, 16QAM, 1RB, 1RB offset
 - c. NR FDD Band n66 - ANT F was the worst-case band from Table 8-10 and was used to test both Axial and Radial probe orientations.
 - d. The worst-case band and bandwidth combination for each probe orientation is additionally tested on the low and high channels for those combinations. NR FDD Band n66 - ANT F at 15MHz is the worst-case for the Axial probe orientation. NR FDD Band n66 - ANT F at 40MHz is the worst-case for the Radial probe orientation.
 7. NR TDD Configuration:
 - a. Power Configuration: TPC = "Max Power"
 - b. Radio Configuration: CP-OFDM, 16QAM, 1RB, 1RB offset
 - c. NR TDD band n77, DoD (Power Class 2) – ANT E was the worst-case band from Table 8-11 and was used to test both Axial and Radial probe orientations.
 - d. The worst-case band and bandwidth combination for each probe orientation is additionally tested on the low, low-mid, high-mid, and high channels for those combinations. NR TDD Band n77, DoD (Power Class 2) at 80MHz is the worst-case for the Axial probe orientation. NR TDD Band n77, DoD (Power Class 2) at 40MHz is the worst-case for the Radial probe orientation.

FCC ID: A3LSMF936U	 element	HAC (T-COIL) TEST REPORT	Approved by: Managing Director
Filename: 1M2204010046-24-R2.A3L	Test Dates: 4/25/2022 – 6/2/2022	DUT Type: Portable Handset	Page 60 of 120

REV 4.2.M
3/29/2022

8. WIFI Configuration:

a. Radio Configuration

- i. IEEE 802.11b: DSSS, 1Mbps
- ii. IEEE 802.11g/a: BPSK, 6Mbps
- iii. IEEE 802.11n/ac 20MHz: BPSK, MCS 0
- iv. IEEE 802.11ax SU 20MHz: BPSK, MCS 0
- v. IEEE 802.11n/ac 40MHz: BPSK, MCS 0
- vi. IEEE 802.11ax SU 40MHz: BPSK, MCS 0

b. RU Index

- i. IEEE 802.11ax RU 20MHz: RU Index 54
- ii. IEEE 802.11ax RU 40MHz: RU Index 61

c. The worst-case standard for 2.4GHz WIFI in each probe orientation is additionally tested on the low and high channels. IEEE 802.11b is the worst-case for both the Axial and Radial probe orientations.

d. The worst-case standard for 5GHz WIFI in each probe orientation is additionally tested on higher U-NII bands as well as applicable low and high channels. IEEE 802.11n 20MHz (U-NII 2C) is the worst-case for the Axial probe orientation. IEEE 802.11ac 20MHz (U-NII 3) is the worst-case for the Radial probe orientation.

e. U-NII 5 testing was performed using IEEE 802.11ax because no other IEEE standard supported U-NII 5 operations.

III. 1 kHz Vocoder Application Check

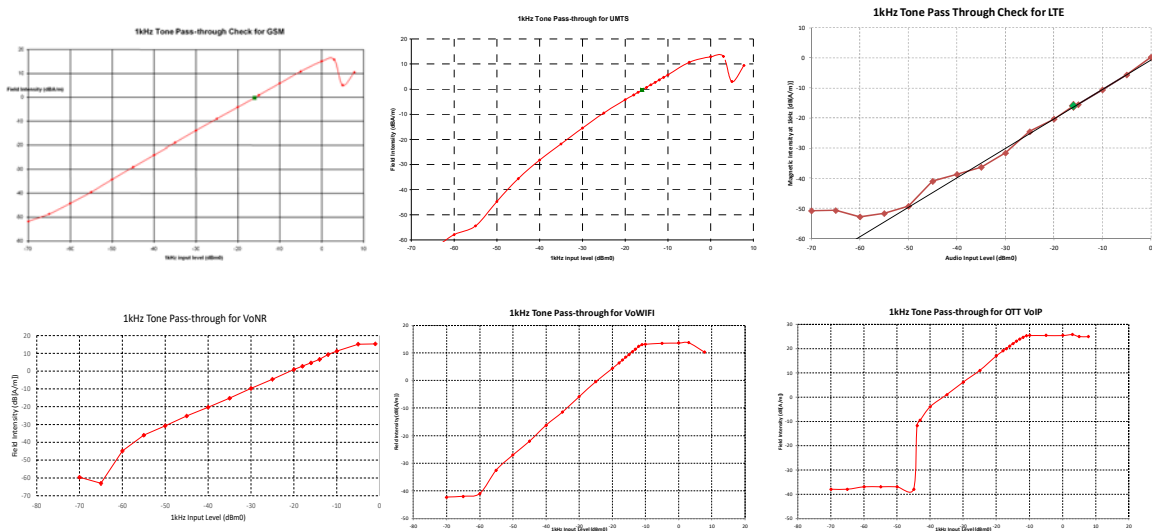

This model was verified to be within the linear region for ABM1 measurements at -16 dBm0 for GSM, UMTS, VoLTE over IMS, and VoNR over IMS. This model was verified to be within the linear region for ABM1 measurements at -20 dBm0 for VoWiFi over IMS and OTT VoIP. This measurement was taken in the axial configuration above the maximum location.

FCC ID: A3LSMF936U		HAC (T-COIL) TEST REPORT	Approved by: Managing Director
Filename: 1M2204010046-24-R2.A3L	Test Dates: 4/25/2022 – 6/2/2022	DUT Type: Portable Handset	Page 61 of 120

REV 4.2.M
3/29/2022

IV. T-Coil Validation Test Results

**Table 10-75
Helmholtz Coil Verification Table of Results – 4/25/2022**

Item	Target	Result	Verdict
Axial			
Magnetic Intensity, -10 dBA/m	-10 ± 0.5 dB	-10.037	PASS
Environmental Noise	< -58 dBA/m	-63.19	PASS
Frequency Response, from limits	> 0 dB	0.70	PASS

**Table 10-76
Helmholtz Coil Verification Table of Results – 5/2/2022**

Item	Target	Result	Verdict
Axial			
Magnetic Intensity, -10 dBA/m	-10 ± 0.5 dB	-10.008	PASS
Environmental Noise	< -58 dBA/m	-61.69	PASS
Frequency Response, from limits	> 0 dB	0.70	PASS
Radial			
Magnetic Intensity, -10 dBA/m	-10 ± 0.5 dB	-10.226	PASS
Environmental Noise	< -58 dBA/m	-61.29	PASS
Frequency Response, from limits	> 0 dB	0.70	PASS

**Table 10-77
Helmholtz Coil Verification Table of Results – 5/9/2022**

Item	Target	Result	Verdict
Axial			
Magnetic Intensity, -10 dBA/m	-10 ± 0.5 dB	-10.082	PASS
Environmental Noise	< -58 dBA/m	-61.06	PASS
Frequency Response, from limits	> 0 dB	0.70	PASS
Radial			
Magnetic Intensity, -10 dBA/m	-10 ± 0.5 dB	-10.157	PASS
Environmental Noise	< -58 dBA/m	-60.60	PASS
Frequency Response, from limits	> 0 dB	0.70	PASS

FCC ID: A3LSMF936U		HAC (T-COIL) TEST REPORT	Approved by: Managing Director
Filename: 1M2204010046-24-R2.A3L	Test Dates: 4/25/2022 – 6/2/2022	DUT Type: Portable Handset	Page 62 of 120

REV 4.2.M
3/29/2022

**Table 10-78
Helmholtz Coil Verification Table of Results – 5/16/2022**

Item	Target	Result	Verdict
Axial			
Magnetic Intensity, -10 dBA/m	-10 ± 0.5 dB	-10.178	PASS
Environmental Noise	< -58 dBA/m	-61.94	PASS
Frequency Response, from limits	> 0 dB	0.70	PASS
Radial			
Magnetic Intensity, -10 dBA/m	-10 ± 0.5 dB	-10.265	PASS
Environmental Noise	< -58 dBA/m	-61.57	PASS
Frequency Response, from limits	> 0 dB	0.70	PASS

**Table 10-79
Helmholtz Coil Verification Table of Results – 5/23/2022**

Item	Target	Result	Verdict
Axial			
Magnetic Intensity, -10 dBA/m	-10 ± 0.5 dB	-10.082	PASS
Environmental Noise	< -58 dBA/m	-59.60	PASS
Frequency Response, from limits	> 0 dB	0.70	PASS
Radial			
Magnetic Intensity, -10 dBA/m	-10 ± 0.5 dB	-10.236	PASS
Environmental Noise	< -58 dBA/m	-59.06	PASS
Frequency Response, from limits	> 0 dB	0.70	PASS

**Table 10-80
Helmholtz Coil Verification Table of Results – 5/31/2022**

Item	Target	Result	Verdict
Axial			
Magnetic Intensity, -10 dBA/m	-10 ± 0.5 dB	-10.044	PASS
Environmental Noise	< -58 dBA/m	-61.52	PASS
Frequency Response, from limits	> 0 dB	0.70	PASS

FCC ID: A3LSMF936U		HAC (T-COIL) TEST REPORT	Approved by: Managing Director
Filename: 1M2204010046-24-R2.A3L	Test Dates: 4/25/2022 – 6/2/2022	DUT Type: Portable Handset	Page 63 of 120

REV 4.2.M
3/29/2022

V. ABM1 Magnetic Field Distribution Scan Overlays

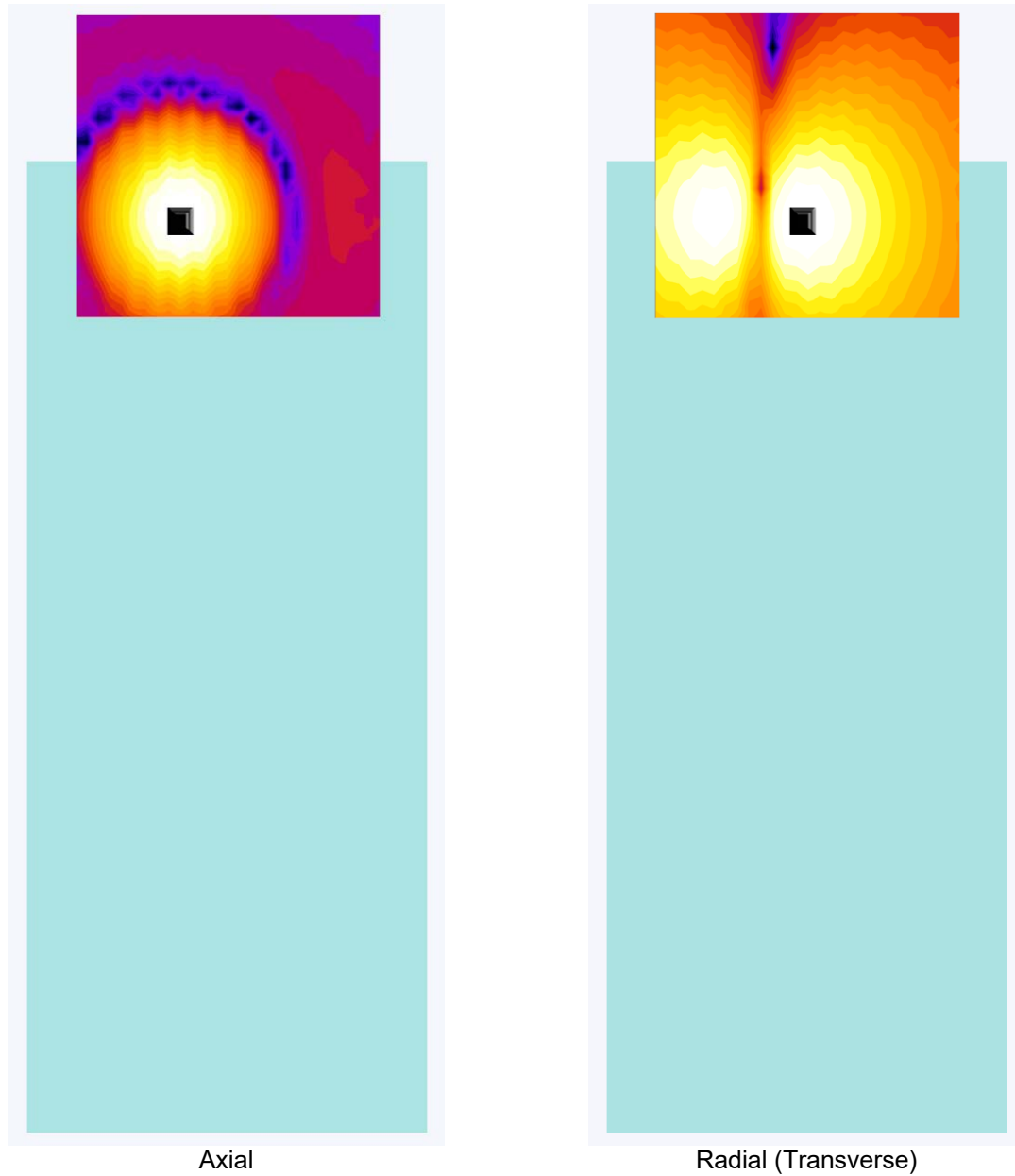

**Figure 10-1
T-Coil Scan Overlay Magnetic Field Distributions**

Notes:

1. Final measurement locations are indicated by a cursor on the contour plots.
2. See Test Setup Photographs for actual WD overlay.

FCC ID: A3LSMF936U		HAC (T-COIL) TEST REPORT	Approved by: Managing Director
Filename: 1M2204010046-24-R2.A3L	Test Dates: 4/25/2022 – 6/2/2022	DUT Type: Portable Handset	Page 64 of 120

REV 4.2.M
3/29/2022

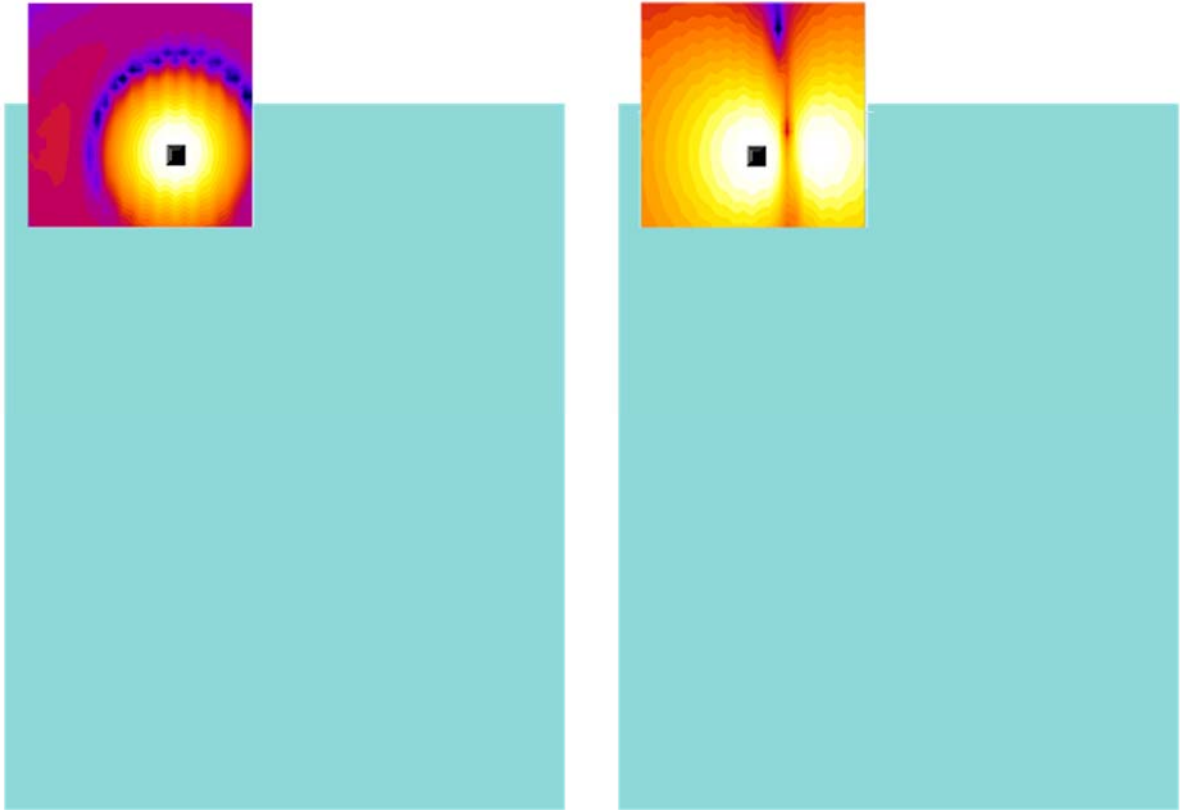

Axial

Radial (Transverse)

Figure 10-2
T-Coil Scan Overlay Magnetic Field Distributions (OPEN – FRONT)

Notes:

1. Final measurement locations are indicated by a cursor on the contour plots.
2. See Test Setup Photographs for actual WD overlay.

FCC ID: A3LSMF936U		HAC (T-COIL) TEST REPORT	Approved by: Managing Director
Filename: 1M2204010046-24-R2.A3L	Test Dates: 4/25/2022 – 6/2/2022	DUT Type: Portable Handset	Page 65 of 120

REV 4.2.M
3/29/2022

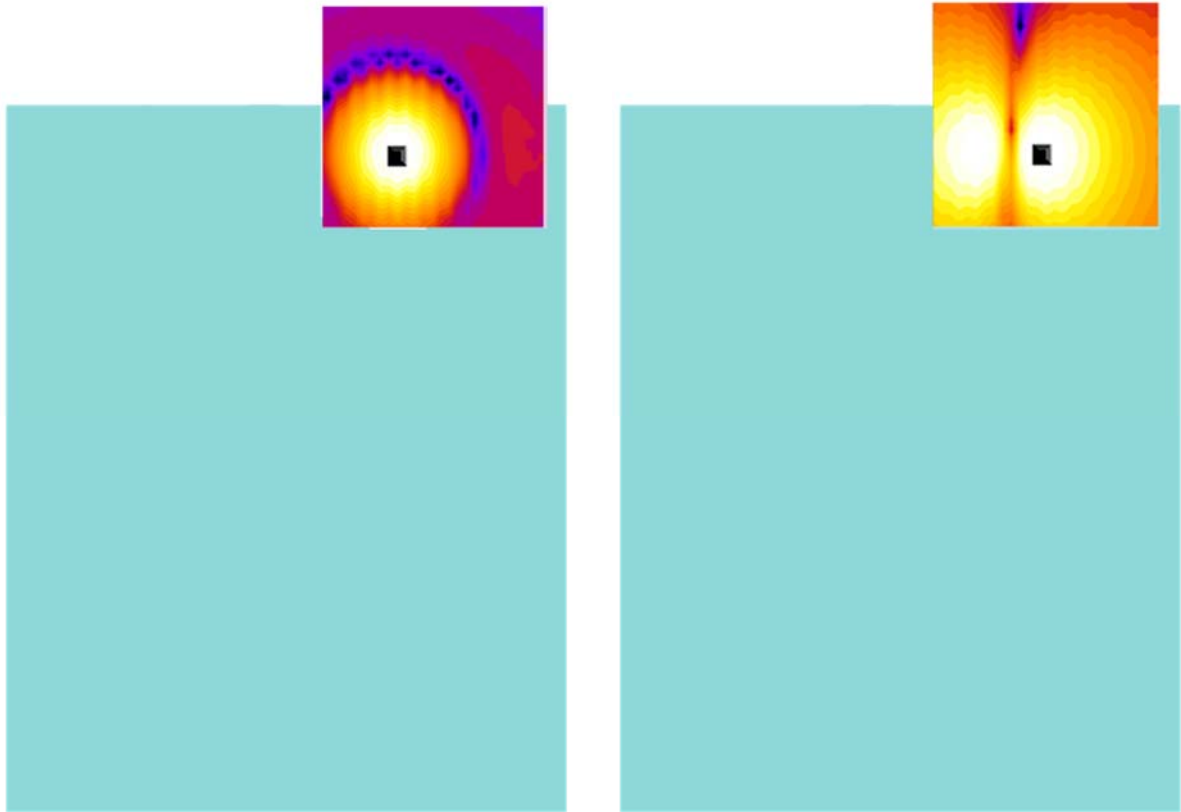

Axial

Radial (Transverse)

Figure 10-3
T-Coil Scan Overlay Magnetic Field Distributions (OPEN – BACK)

Notes:

1. Final measurement locations are indicated by a cursor on the contour plots.
2. See Test Setup Photographs for actual WD overlay.

FCC ID: A3LSMF936U		HAC (T-COIL) TEST REPORT	Approved by: Managing Director
Filename: 1M2204010046-24-R2.A3L	Test Dates: 4/25/2022 – 6/2/2022	DUT Type: Portable Handset	Page 66 of 120

REV 4.2.M
3/29/2022

11. MEASUREMENT UNCERTAINTY

**Table 11-1
Uncertainty Estimation Table**

Contribution	Data +/- %	Data +/- dB	Data Type	Probability distribution	Divisor	Standard uncertainty	Standard Uncertainty (dB)
ABM Noise	7.0%	0.29	Std. Dev.	Normal k=1	1.00	7.0%	
RF Reflections	4.7%	0.20	Specification	Rectangular	1.73	2.7%	
Reference Signal Level	12.2%	0.50	Specification	Rectangular	1.73	7.0%	
Positioning Accuracy	10.0%	0.41	Uncertainty	Rectangular	1.73	5.8%	
Probe Coil Sensitivity	12.2%	0.50	Specification	Rectangular	1.73	7.0%	
Probe Linearity	2.4%	0.10	Std. Dev.	Normal k=1	1.00	2.4%	
Cable Loss	2.8%	0.12	Specification	Rectangular	1.73	1.6%	
Frequency Analyzer	5.0%	0.21	Specification	Rectangular	1.73	2.9%	
System Repeatability	5.0%	0.21	Std. Dev.	Normal k=1	1.00	5.0%	
WD Repeatability	9.0%	0.37	Std. Dev.	Normal k=1	1.00	9.0%	
Positioner Accuracy	1.0%	0.04	Specification	Rectangular	1.73	0.6%	
Combined standard uncertainty, uc (k=1)						17.7%	0.71
Expanded uncertainty (k=2), 95% confidence level						35.3%	1.31

Notes:

1. Test equipments are calibrated according to techniques outlined in NIS81, NIS3003 and NIST Tech Note 1297.
2. All equipments have traceability according to NIST. Measurement Uncertainties are defined in further detail in NIS 81 and NIST Tech Note 1297 and UKAS M3003.

Measurement uncertainty reflects the quality and accuracy of a measured result as compared to the true value. Such statements are generally required when stating results of measurements so that it is clear to the intended audience that the results may differ when reproduced by different facilities. Measurement results vary due to the measurement uncertainty of the instrumentation, measurement technique, and test engineer. Most uncertainties are calculated using the tolerances of the instrumentation used in the measurement, the measurement setup variability, and the technique used in performing the test. While not generally included, the variability of the equipment under test also figures into the overall measurement uncertainty. Another component of the overall uncertainty is based on the variability of repeated measurements (so-called Type A uncertainty). This may mean that the Hearing Aid compatibility tests may have to be repeated by taking down the test setup and resetting it up so that there are a statistically significant number of repeat measurements to identify the measurement uncertainty. By combining the repeat measurement results with that of the instrumentation chain using the technique contained in NIS 81 and NIS 3003, the overall measurement uncertainty was estimated.

FCC ID: A3LSMF936U		HAC (T-COIL) TEST REPORT	Approved by: Managing Director
Filename: 1M2204010046-24-R2.A3L	Test Dates: 4/25/2022 – 6/2/2022	DUT Type: Portable Handset	Page 67 of 120

REV 4.2.M

3/29/2022

12. EQUIPMENT LIST

**Table 12-1
Equipment List**

Manufacturer	Model	Description	Cal Date	Cal Interval	Cal Due	Serial Number
Listen	SoundConnect	Microphone Power Supply	9/24/2020	Biennial	9/24/2022	0899-PS150
RME	Fireface UC	Soundcheck Acoustic Analyzer External Audio Interface	9/29/2020	Biennial	9/29/2022	23792992
Rohde & Schwarz	CMW500	Wideband Radio Communication Tester	2/17/2022	Annual	2/17/2023	161662
Rohde & Schwarz	CMW500	Wideband Radio Communication Tester	4/8/2022	Annual	4/8/2023	162125
Rohde & Schwarz	CMW500	Radio Communication Tester	9/30/2021	Annual	9/30/2022	140144
Rohde & Schwarz	CMW500	Radio Communication Tester	7/19/2021	Annual	7/19/2022	128635
Rohde & Schwarz	CMW500	Wideband Radio Communication Tester	9/24/2021	Annual	9/24/2022	167286
Rohde & Schwarz	CMX500	Radio Communication Tester	N/A		N/A	100298
Seekonk	NC-100	Torque Wrench (8" lb)	8/4/2020	Biennial	8/4/2022	21053
TEM	Axial T-Coil Probe	Axial T-Coil Probe	9/23/2020	Biennial	9/23/2022	TEM-1123
TEM	Radial T-Coil Probe	Radial T-Coil Probe	9/23/2020	Biennial	9/23/2022	TEM-1129
TEM		HAC Positioner	N/A		N/A	N/A
TEM		HAC System Controller with Software	N/A		N/A	N/A
TEM	Helmholtz Coil	Helmholtz Coil	9/23/2020	Biennial	9/23/2022	SBI 1052
YellowTec	YT4211	USB Audio Interface	N/A		N/A	20000365
Control Company	4040	Therm./ Clock/ Humidity Monitor	3/12/2021	Biennial	3/12/2023	210202053
Netgear	XS708E	Ethernet Switch	N/A		N/A	4FU3875C001A8

FCC ID: A3LSMF936U	 element	HAC (T-COIL) TEST REPORT	Approved by: Managing Director
Filename: 1M2204010046-24-R2.A3L	Test Dates: 4/25/2022 – 6/2/2022	DUT Type: Portable Handset	Page 68 of 120

REV 4.2.M
3/29/2022

Unless otherwise specified, no part of this report may be reproduced or utilized in any part, form or by any means, electronic or mechanical, including photocopying and microfilm, without permission in writing from Element. If you have any questions about this or have an enquiry about obtaining additional rights to this report or assembly of contents thereof, please contact CT.INFO@ELEMENT.COM.

13. TEST DATA

FCC ID: A3LSMF936U		HAC (T-COIL) TEST REPORT	Approved by: Managing Director
Filename: 1M2204010046-24-R2.A3L	Test Dates: 4/25/2022 – 6/2/2022	DUT Type: Portable Handset	Page 69 of 120

REV 4.2.M
3/29/2022



Element Hearing-Aid Compatibility Facility

DUT: HH Coil – SN: SBI 1052

Type: HH Coil
Serial: SBI 1052

Measurement Standard: ANSI C63.19-2011

Equipment:

- Probe: Axial T-Coil Probe – SN: TEM-1123; Calibrated: 9/23/2020
- Helmholtz Coil – SN: SBI 1052; Calibrated: 9/23/2020

Noise Spectrum

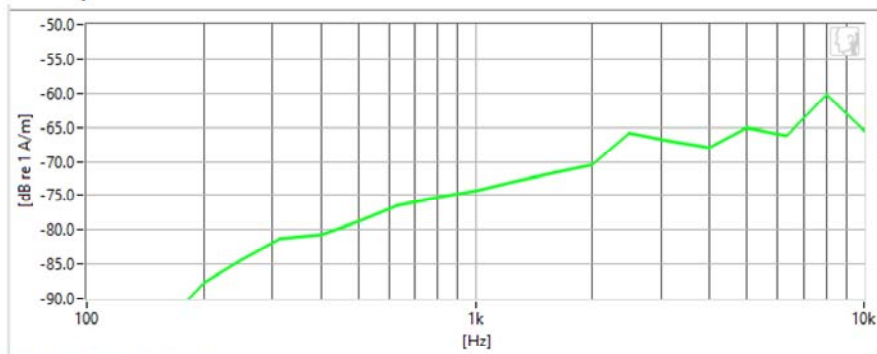

Frequency Response

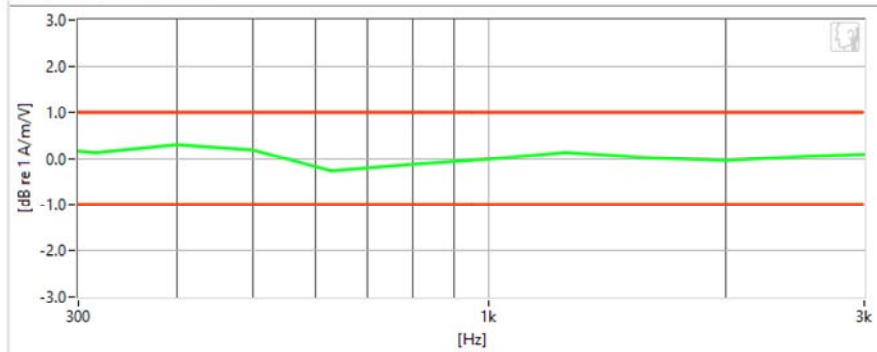

Results

Verification 1kHz Intensity	-10.037 dB	✓	Max/Min	-9.5/-10.5
Verification ABM2	-63.19 dB	✓	Maximum	-58.0
Frequency Response Margin	700m dB	✓	Tolerance curves	Aligned Data

FCC ID: A3LSMF936U		HAC (T-COIL) TEST REPORT	Approved by: Managing Director
Filename: 1M2204010046-24-R2.A3L	Test Dates: 4/25/2022 – 6/2/2022	DUT Type: Portable Handset	Page 70 of 120

REV 4.2.M
3/29/2022



Element Hearing-Aid Compatibility Facility

DUT: HH Coil – SN: SBI 1052

Type: HH Coil
Serial: SBI 1052

Measurement Standard: ANSI C63.19-2011

Equipment:

- Probe: Axial T-Coil Probe – SN: TEM-1123; Calibrated: 9/23/2020
- Helmholtz Coil – SN: SBI 1052; Calibrated: 9/23/2020

Noise Spectrum

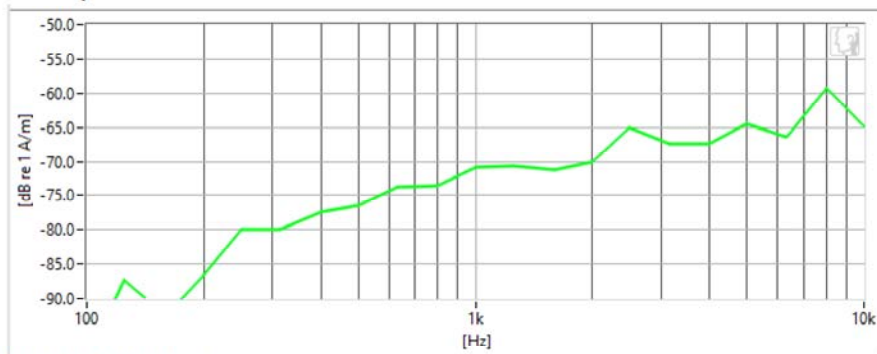

Frequency Response

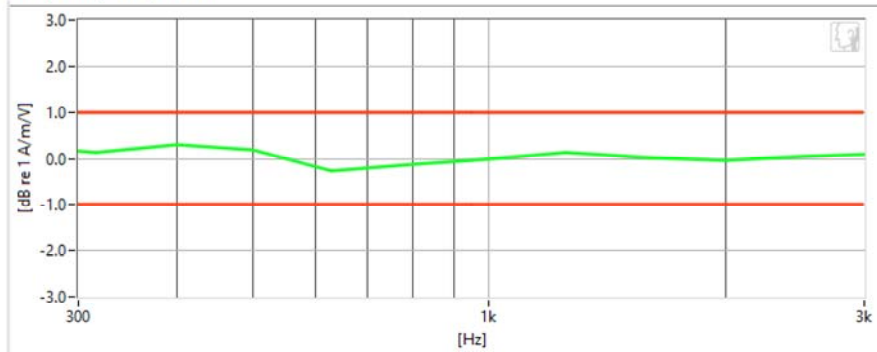

Results

Verification 1kHz Intensity	-10.008 dB	✓	Max/Min	-9.5/-10.5
Verification ABM2	-61.69 dB	✓	Maximum	-58.0
Frequency Response Margin	700m dB	✓	Tolerance curves	Aligned Data

FCC ID: A3LSMF936U		HAC (T-COIL) TEST REPORT	Approved by: Managing Director
Filename: 1M2204010046-24-R2.A3L	Test Dates: 4/25/2022 – 6/2/2022	DUT Type: Portable Handset	Page 71 of 120

REV 4.2.M
3/29/2022



Element Hearing-Aid Compatibility Facility

DUT: HH Coil – SN: SBI 1052

Type: HH Coil
Serial: SBI 1052

Measurement Standard: ANSI C63.19-2011

Equipment:

- Probe: Axial T-Coil Probe – SN: TEM-1123; Calibrated: 9/23/2020
- Helmholtz Coil – SN: SBI 1052; Calibrated: 9/23/2020

Noise Spectrum

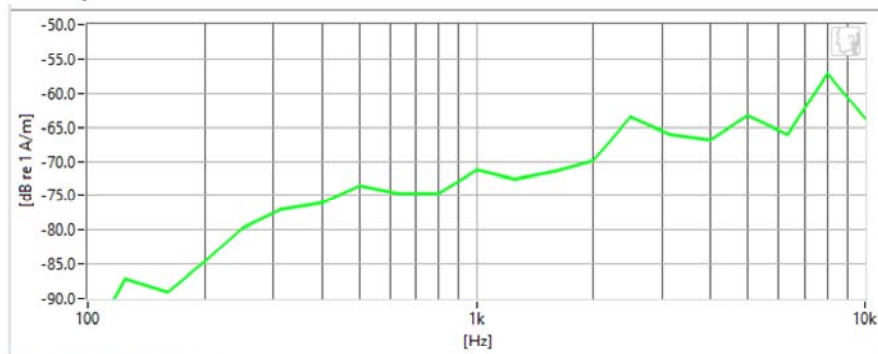

Frequency Response

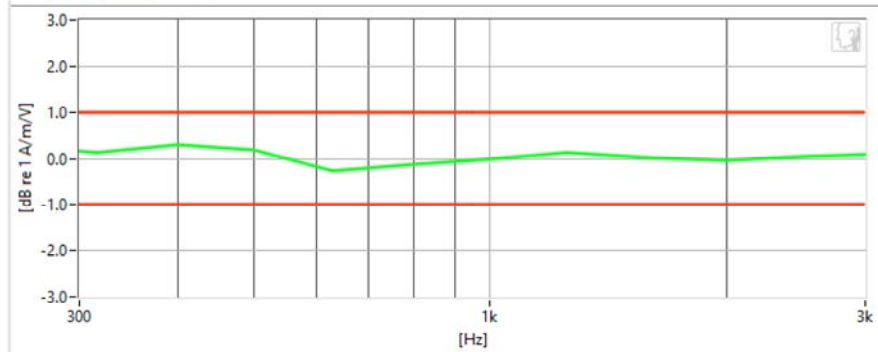

Results

Verification 1kHz Intensity	-10.082 dB	✓	Max/Min	-9.5/-10.5
Verification ABM2	-61.06 dB	✓	Maximum	-58.0
Frequency Response Margin	700m dB	✓	Tolerance curves	Aligned Data

FCC ID: A3LSMF936U		HAC (T-COIL) TEST REPORT	Approved by: Managing Director
Filename: 1M2204010046-24-R2.A3L	Test Dates: 4/25/2022 – 6/2/2022	DUT Type: Portable Handset	Page 72 of 120

REV 4.2.M
3/29/2022



Element Hearing-Aid Compatibility Facility

DUT: HH Coil – SN: SBI 1052

Type: HH Coil
Serial: SBI 1052

Measurement Standard: ANSI C63.19-2011

Equipment:

- Probe: Axial T-Coil Probe – SN: TEM-1123; Calibrated: 9/23/2020
- Helmholtz Coil – SN: SBI 1052; Calibrated: 9/23/2020

Noise Spectrum

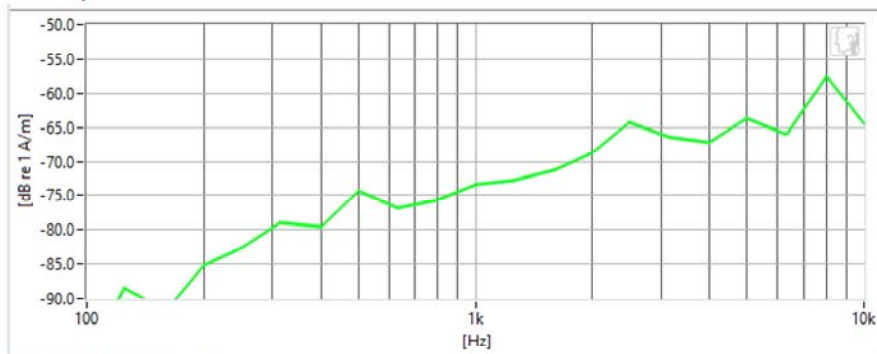

Frequency Response

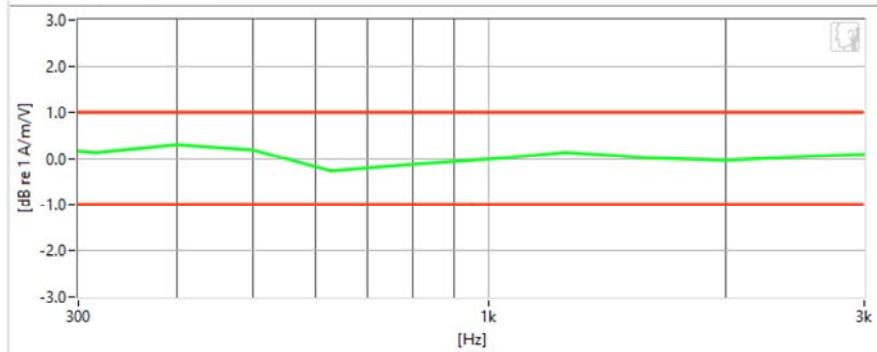

Results

Verification 1kHz Intensity	-10.178 dB	✓	Max/Min	-9.5/-10.5
Verification ABM2	-61.94 dB	✓	Maximum	-58.0
Frequency Response Margin	700m dB	✓	Tolerance curves	Aligned Data

FCC ID: A3LSMF936U		HAC (T-COIL) TEST REPORT	Approved by: Managing Director
Filename: 1M2204010046-24-R2.A3L	Test Dates: 4/25/2022 – 6/2/2022	DUT Type: Portable Handset	Page 73 of 120

REV 4.2.M
3/29/2022



Element Hearing-Aid Compatibility Facility

DUT: HH Coil – SN: SBI 1052

Type: HH Coil
Serial: SBI 1052

Measurement Standard: ANSI C63.19-2011

Equipment:

- Probe: Axial T-Coil Probe – SN: TEM-1123; Calibrated: 9/23/2020
- Helmholtz Coil – SN: SBI 1052; Calibrated: 9/23/2020

Noise Spectrum

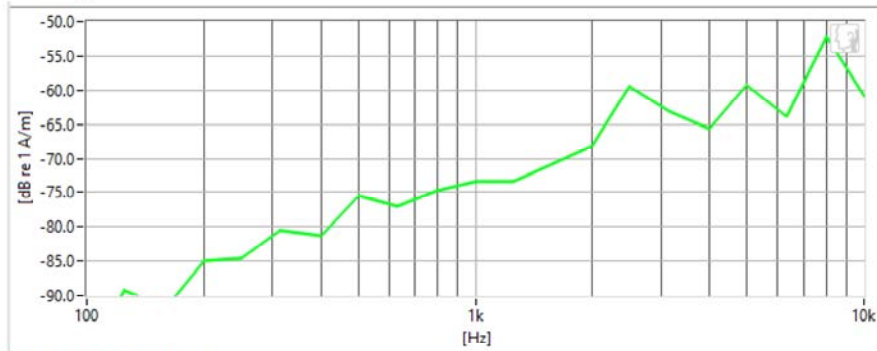

Frequency Response

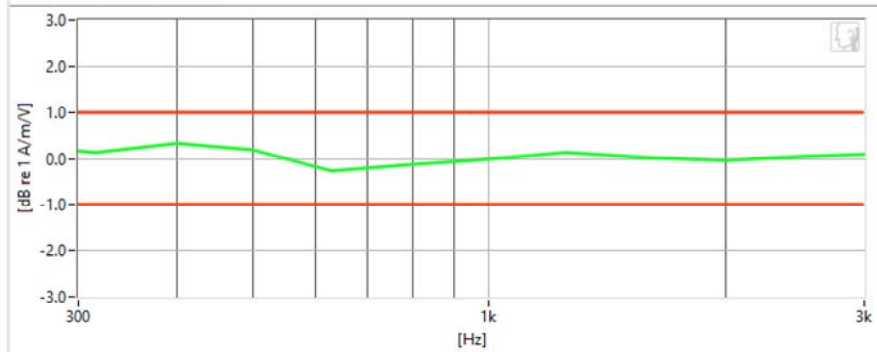

Results

Verification 1kHz Intensity	-10.082 dB	✓	Max/Min	-9.5/-10.5
Verification ABM2	-59.6 dB	✓	Maximum	-58.0
Frequency Response Margin	700m dB	✓	Tolerance curves	Aligned Data

FCC ID: A3LSMF936U		HAC (T-COIL) TEST REPORT	Approved by: Managing Director
Filename: 1M2204010046-24-R2.A3L	Test Dates: 4/25/2022 – 6/2/2022	DUT Type: Portable Handset	Page 74 of 120

REV 4.2.M
3/29/2022



Element Hearing-Aid Compatibility Facility

DUT: HH Coil – SN: SBI 1052

Type: HH Coil
Serial: SBI 1052

Measurement Standard: ANSI C63.19-2011

Equipment:

- Probe: Axial T-Coil Probe – SN: TEM-1123; Calibrated: 9/23/2020
- Helmholtz Coil – SN: SBI 1052; Calibrated: 9/23/2020

Noise Spectrum

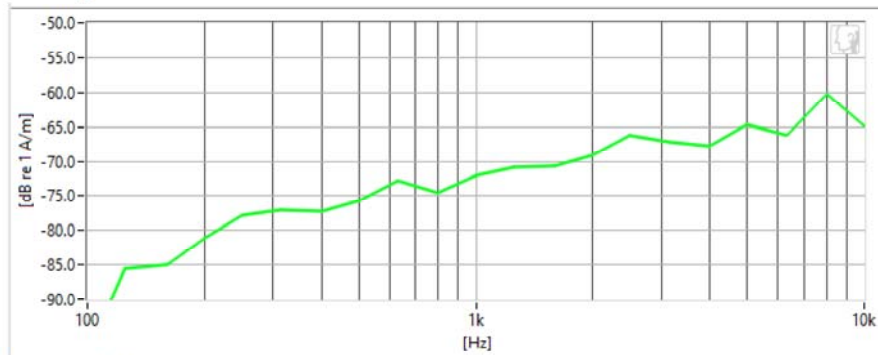

Frequency Response

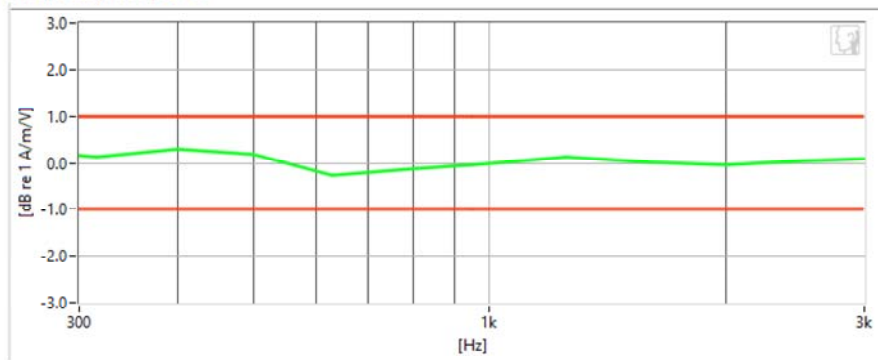

Results

Verification 1kHz Intensity	-10.044 dB	✓	Max/Min	-9.5/-10.5
Verification ABM2	-61.52 dB	✓	Maximum	-58.0
Frequency Response Margin	700m dB	✓	Tolerance curves	Aligned Data

FCC ID: A3LSMF936U		HAC (T-COIL) TEST REPORT	Approved by: Managing Director
Filename: 1M2204010046-24-R2.A3L	Test Dates: 4/25/2022 – 6/2/2022	DUT Type: Portable Handset	Page 75 of 120

REV 4.2.M
3/29/2022



Element Hearing-Aid Compatibility Facility

DUT: HH Coil – SN: SBI 1052

Type: HH Coil
Serial: SBI 1052

Measurement Standard: ANSI C63.19-2011

Equipment:

- Probe: Radial T-Coil Probe – SN: TEM-1129; Calibrated: 9/23/2020
- Helmholtz Coil – SN: SBI 1052; Calibrated: 9/23/2020

Noise Spectrum

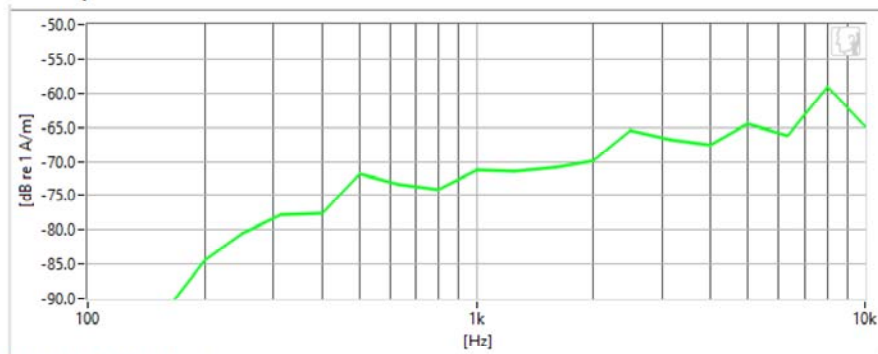

Frequency Response

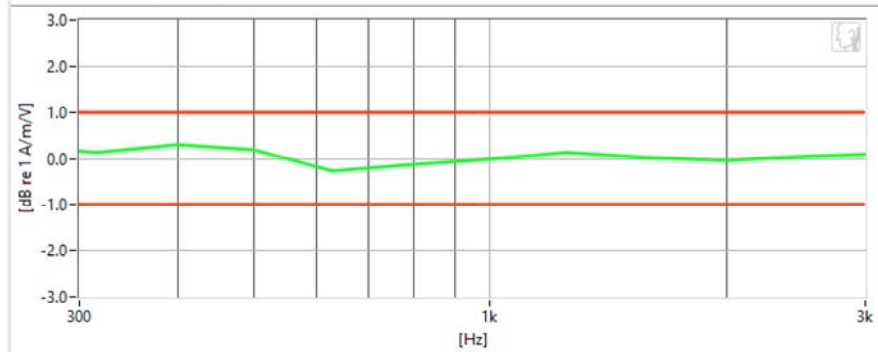

Results

Verification 1kHz Intensity	-10.226 dB	✓	Max/Min	-9.5/-10.5
Verification ABM2	-61.29 dB	✓	Maximum	-58.0
Frequency Response Margin	700m dB	✓	Tolerance curves	Aligned Data

FCC ID: A3LSMF936U		HAC (T-COIL) TEST REPORT	Approved by: Managing Director
Filename: 1M2204010046-24-R2.A3L	Test Dates: 4/25/2022 – 6/2/2022	DUT Type: Portable Handset	Page 76 of 120

REV 4.2.M
3/29/2022



Element Hearing-Aid Compatibility Facility

DUT: HH Coil – SN: SBI 1052

Type: HH Coil
Serial: SBI 1052

Measurement Standard: ANSI C63.19-2011

Equipment:

- Probe: Radial T-Coil Probe – SN: TEM-1129; Calibrated: 9/23/2020
- Helmholtz Coil – SN: SBI 1052; Calibrated: 9/23/2020

Noise Spectrum

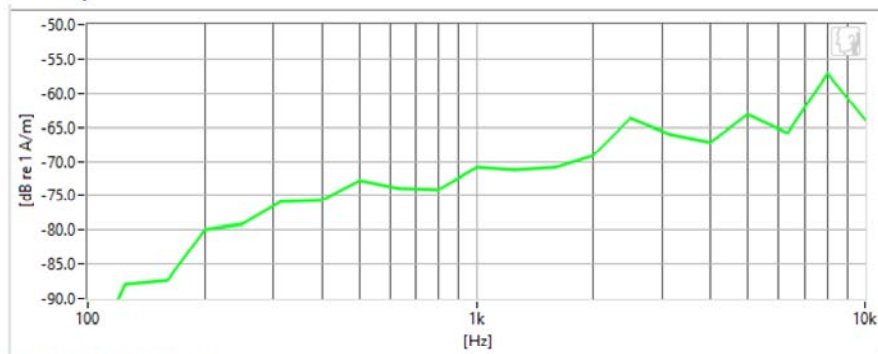

Frequency Response

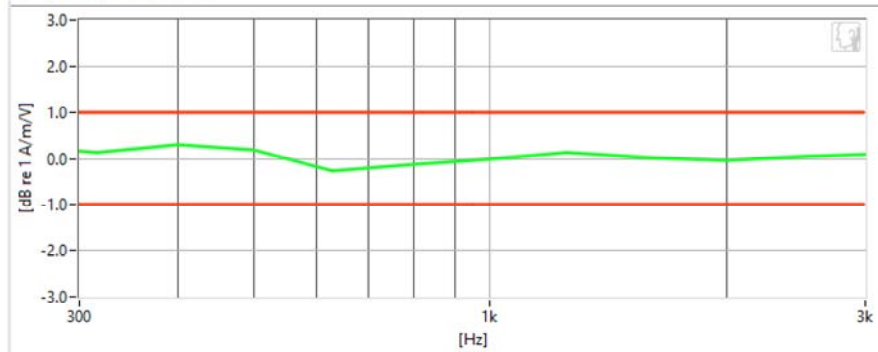

Results

Verification 1kHz Intensity	-10.157 dB	✓	Max/Min	-9.5/-10.5
Verification ABM2	-60.6 dB	✓	Maximum	-58.0
Frequency Response Margin	700m dB	✓	Tolerance curves	Aligned Data

FCC ID: A3LSMF936U		HAC (T-COIL) TEST REPORT	Approved by: Managing Director
Filename: 1M2204010046-24-R2.A3L	Test Dates: 4/25/2022 – 6/2/2022	DUT Type: Portable Handset	Page 77 of 120

REV 4.2.M
3/29/2022



Element Hearing-Aid Compatibility Facility

DUT: HH Coil – SN: SBI 1052

Type: HH Coil
Serial: SBI 1052

Measurement Standard: ANSI C63.19-2011

Equipment:

- Probe: Radial T-Coil Probe – SN: TEM-1129; Calibrated: 9/23/2020
- Helmholtz Coil – SN: SBI 1052; Calibrated: 9/23/2020

Noise Spectrum

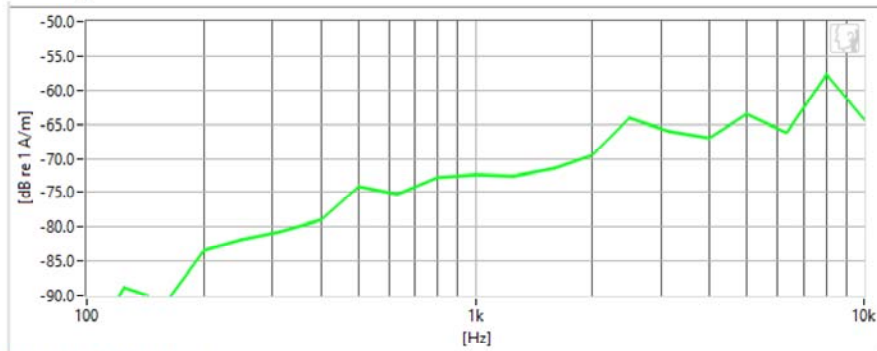

Frequency Response

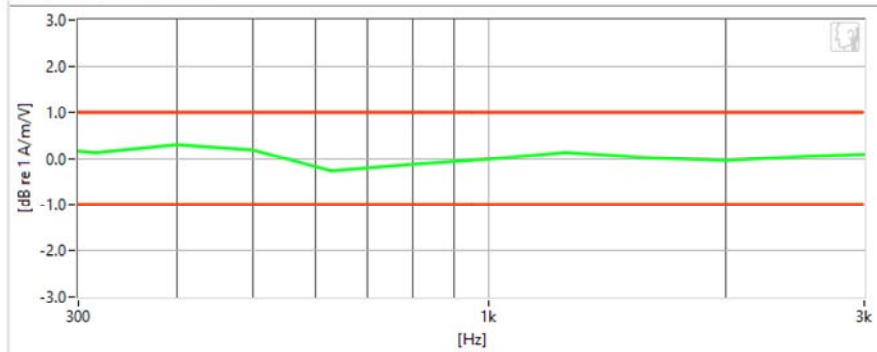

Results

Verification 1kHz Intensity	-10.265 dB	✓	Max/Min	-9.5/-10.5
Verification ABM2	-61.57 dB	✓	Maximum	-58.0
Frequency Response Margin	700m dB	✓	Tolerance curves	Aligned Data

FCC ID: A3LSMF936U		HAC (T-COIL) TEST REPORT	Approved by: Managing Director
Filename: 1M2204010046-24-R2.A3L	Test Dates: 4/25/2022 – 6/2/2022	DUT Type: Portable Handset	Page 78 of 120

REV 4.2.M
3/29/2022



Element Hearing-Aid Compatibility Facility

DUT: HH Coil – SN: SBI 1052

Type: HH Coil
Serial: SBI 1052

Measurement Standard: ANSI C63.19-2011

Equipment:

- Probe: Radial T-Coil Probe – SN: TEM-1129; Calibrated: 9/23/2020
- Helmholtz Coil – SN: SBI 1052; Calibrated: 9/23/2020

Noise Spectrum

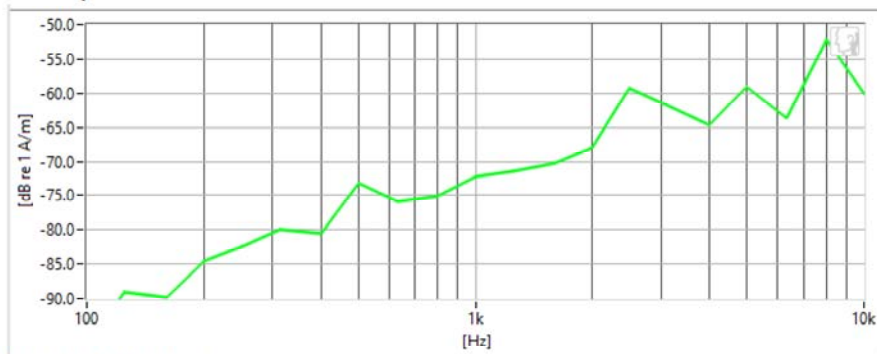

Frequency Response

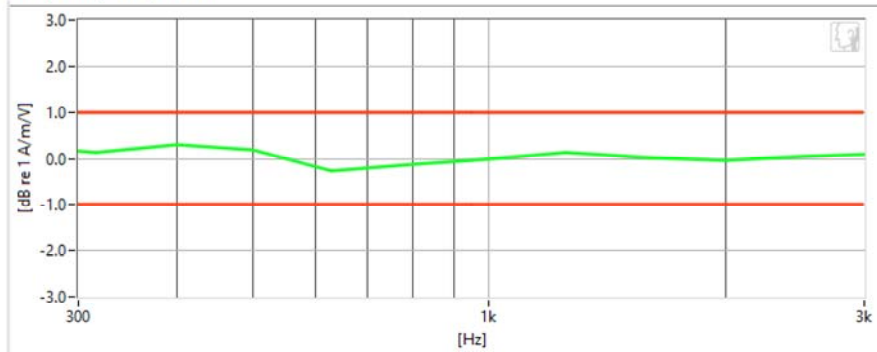

Results

Verification 1kHz Intensity	-10.236 dB	✓	Max/Min	-9.5/-10.5
Verification ABM2	-59.06 dB	✓	Maximum	-58.0
Frequency Response Margin	700m dB	✓	Tolerance curves	Aligned Data

FCC ID: A3LSMF936U		HAC (T-COIL) TEST REPORT	Approved by: Managing Director
Filename: 1M2204010046-24-R2.A3L	Test Dates: 4/25/2022 – 6/2/2022	DUT Type: Portable Handset	Page 79 of 120

REV 4.2.M
3/29/2022



Element Hearing-Aid Compatibility Facility

DUT: A3LSMF936U

Type: Portable Handset
Serial: 1802M

Measurement Standard: ANSI C63.19-2011

Equipment:

- Probe: Axial T-Coil Probe – SN: TEM-1123; Calibrated: 9/23/2020

Test Configuration:

- Mode: GSM850
- Channel: 128
- Device Posture / Side: Flat - Back
- Speech Signal: 3GPP2 Normal Test Signal

Noise Spectrum

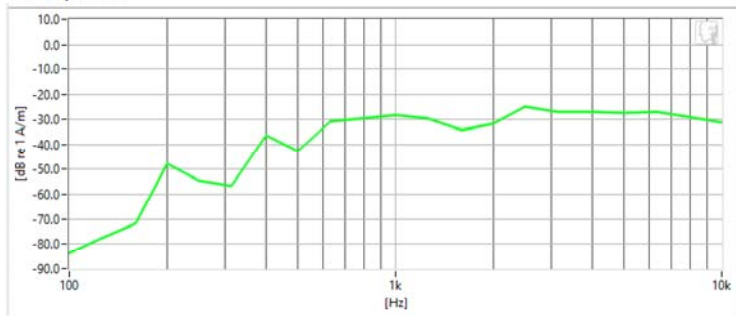

Frequency Response

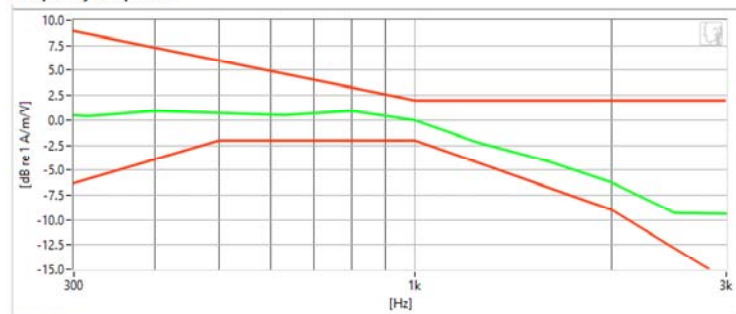

Results

ABM1	7.34 dB	✓	Minimum	-18.0
ABM2	-21.26 dB	✓	Maximum	0.0
SNNR	28.59 dB	✓	Minimum	20.0
Aligned Response - Normal	1.97 dB	✓	Tolerance curves	Aligned Data

FCC ID: A3LSMF936U		HAC (T-COIL) TEST REPORT	Approved by: Managing Director
Filename: 1M2204010046-24-R2.A3L	Test Dates: 4/25/2022 – 6/2/2022	DUT Type: Portable Handset	Page 80 of 120

REV 4.2.M
3/29/2022



Element Hearing-Aid Compatibility Facility

DUT: A3LSMF936U

Type: Portable Handset
Serial: 1802M

Measurement Standard: ANSI C63.19-2011

Equipment:

- Probe: Axial T-Coil Probe – SN: TEM-1123; Calibrated: 9/23/2020

Test Configuration:

- Mode: GSM1900
- Channel: 810
- Speech Signal: 3GPP2 Normal Test Signal

Noise Spectrum

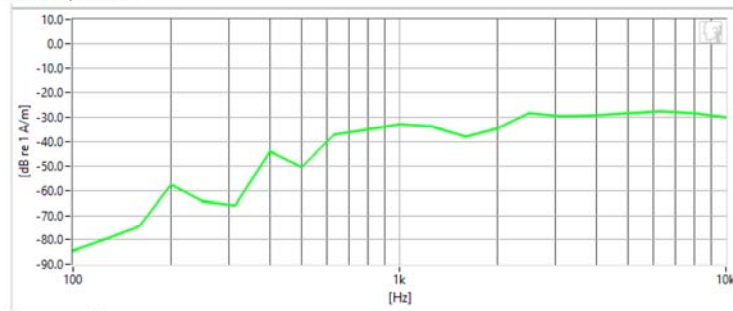

Frequency Response

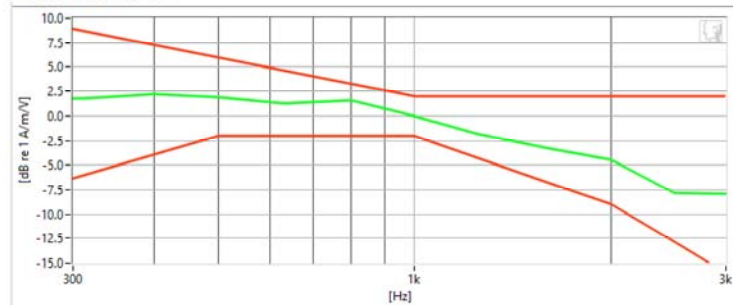

Results

ABM1	7.81 dB	✓	Minimum	-18.0
ABM2	-25.59 dB	✓	Maximum	0.0
SNNR	33.4 dB	✓	Minimum	20.0
Aligned Response - Normal	1.67 dB	✓	Tolerance curves	Aligned Data

FCC ID: A3LSMF936U		HAC (T-COIL) TEST REPORT	Approved by: Managing Director
Filename: 1M2204010046-24-R2.A3L	Test Dates: 4/25/2022 – 6/2/2022	DUT Type: Portable Handset	Page 81 of 120

REV 4.2.M
3/29/2022



Element Hearing-Aid Compatibility Facility

DUT: A3LSMF936U

Type: Portable Handset
Serial: 1802M

Measurement Standard: ANSI C63.19-2011

Equipment:

- Probe: Axial T-Coil Probe – SN: TEM-1123; Calibrated: 9/23/2020

Test Configuration:

- Mode: UMTS V
- Channel: 4132
- Speech Signal: 3GPP2 Normal Test Signal

Noise Spectrum

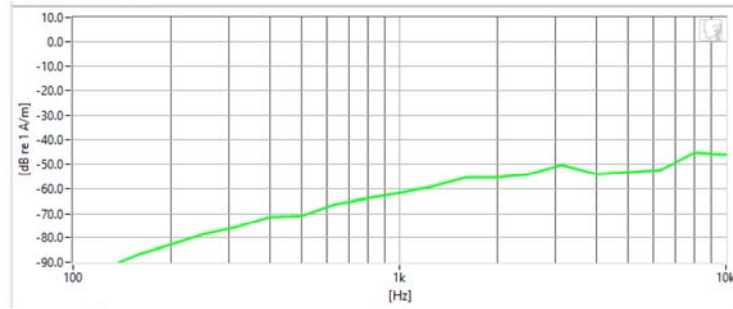

Frequency Response

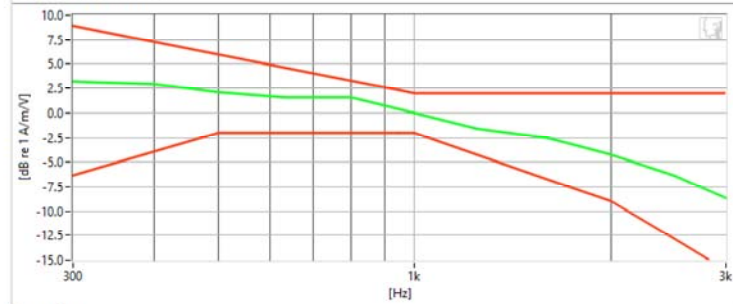

Results

ABM1	5.17 dB	✓	Minimum	-18.0
ABM2	-49.75 dB	✓	Maximum	0.0
SNNR	54.91 dB	✓	Minimum	20.0
Aligned Response - Normal	1.75 dB	✓	Tolerance curves	Aligned Data

FCC ID: A3LSMF936U		HAC (T-COIL) TEST REPORT	Approved by: Managing Director
Filename: 1M2204010046-24-R2.A3L	Test Dates: 4/25/2022 – 6/2/2022	DUT Type: Portable Handset	Page 82 of 120

REV 4.2.M
3/29/2022



Element Hearing-Aid Compatibility Facility

DUT: A3LSMF936U

Type: Portable Handset
Serial: 1802M

Measurement Standard: ANSI C63.19-2011

Equipment:

- Probe: Axial T-Coil Probe – SN: TEM-1123; Calibrated: 9/23/2020

Test Configuration:

- Mode: UMTS IV
- Channel: 1513
- Speech Signal: 3GPP2 Normal Test Signal

Noise Spectrum

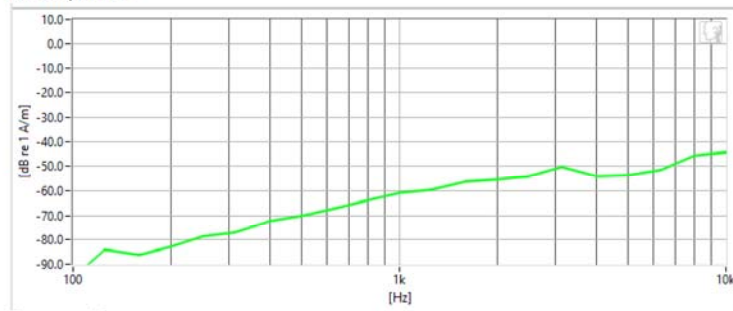

Frequency Response

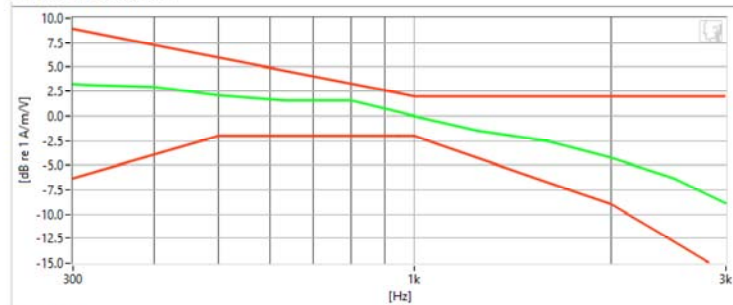

Results

ABM1	5.13 dB	✓	Minimum	-18.0
ABM2	-49.7 dB	✓	Maximum	0.0
SNNR	54.82 dB	✓	Minimum	20.0
Aligned Response - Normal	1.74 dB	✓	Tolerance curves	Aligned Data

FCC ID: A3LSMF936U		HAC (T-COIL) TEST REPORT	Approved by: Managing Director
Filename: 1M2204010046-24-R2.A3L	Test Dates: 4/25/2022 – 6/2/2022	DUT Type: Portable Handset	Page 83 of 120

REV 4.2.M
3/29/2022



Element Hearing-Aid Compatibility Facility

DUT: A3LSMF936U

Type: Portable Handset
Serial: 1802M

Measurement Standard: ANSI C63.19-2011

Equipment:

- Probe: Axial T-Coil Probe – SN: TEM-1123; Calibrated: 9/23/2020

Test Configuration:

- Mode: UMTS II
- Channel: 9262
- Speech Signal: 3GPP2 Normal Test Signal

Noise Spectrum

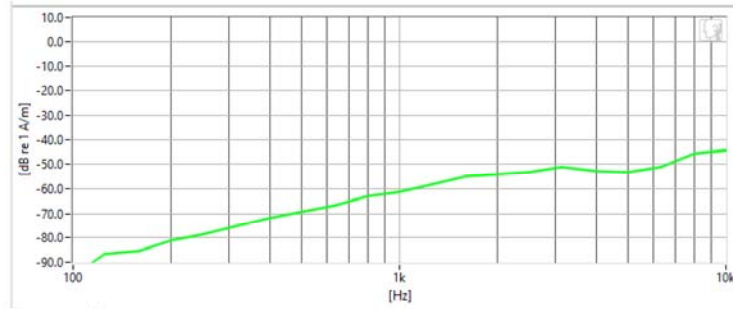

Frequency Response

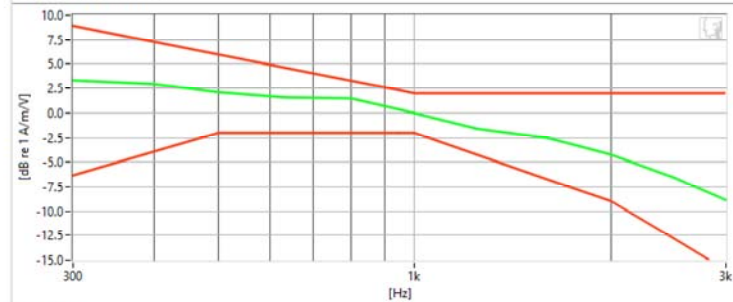

Results

ABM1	5.15 dB	✓	Minimum	-18.0
ABM2	-49.19 dB	✓	Maximum	0.0
SNNR	54.34 dB	✓	Minimum	20.0
Aligned Response - Normal	1.8 dB	✓	Tolerance curves	Aligned Data

FCC ID: A3LSMF936U		HAC (T-COIL) TEST REPORT	Approved by: Managing Director
Filename: 1M2204010046-24-R2.A3L	Test Dates: 4/25/2022 – 6/2/2022	DUT Type: Portable Handset	Page 84 of 120

REV 4.2.M
3/29/2022



Element Hearing-Aid Compatibility Facility

DUT: A3LSMF936U

Type: Portable Handset
Serial: 1802M

Measurement Standard: ANSI C63.19-2011

Equipment:

- Probe: Axial T-Coil Probe – SN: TEM-1123; Calibrated: 9/23/2020

Test Configuration:

- Mode: LTE FDD Band 66
- Bandwidth: 1.4MHz
- Channel: 132322
- Speech Signal: 3GPP2 Normal Test Signal

Noise Spectrum

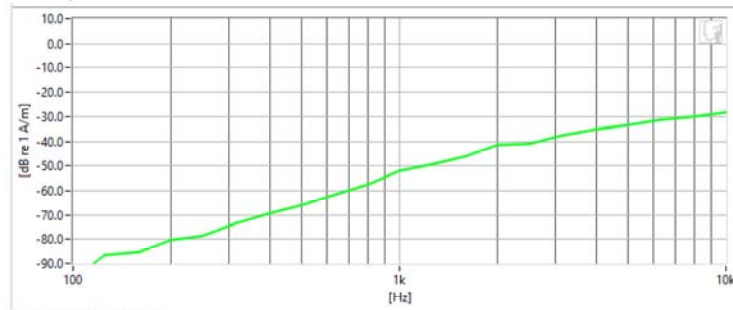

Frequency Response

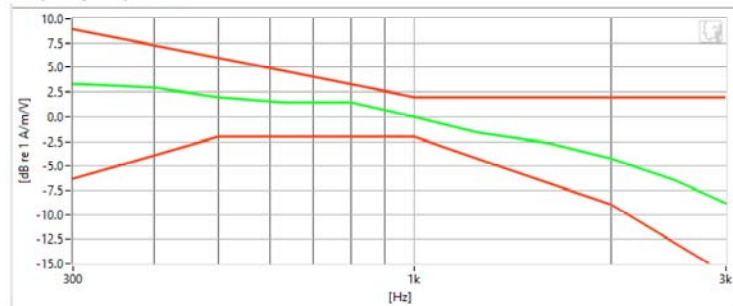

Results

ABM1	5.91 dB	✓	Minimum	-18.0
ABM2	-35.53 dB	✓	Maximum	0.0
SNNR	41.44 dB	✓	Minimum	20.0
Aligned Response - Normal	1.79 dB	✓	Tolerance curves	Aligned Data

FCC ID: A3LSMF936U		HAC (T-COIL) TEST REPORT	Approved by: Managing Director
Filename: 1M2204010046-24-R2.A3L	Test Dates: 4/25/2022 – 6/2/2022	DUT Type: Portable Handset	Page 85 of 120

REV 4.2.M
3/29/2022



Element Hearing-Aid Compatibility Facility

DUT: A3LSMF936U

Type: Portable Handset
Serial: 1802M

Measurement Standard: ANSI C63.19-2011

Equipment:

- Probe: Axial T-Coil Probe – SN: TEM-1123; Calibrated: 9/23/2020

Test Configuration:

- Mode: LTE TDD Band 41 (PC2)
- Bandwidth: 20MHz
- Channel: 39750
- Speech Signal: 3GPP2 Normal Test Signal

Noise Spectrum

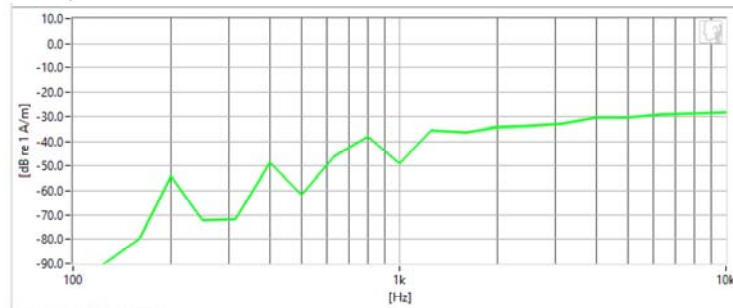

Frequency Response

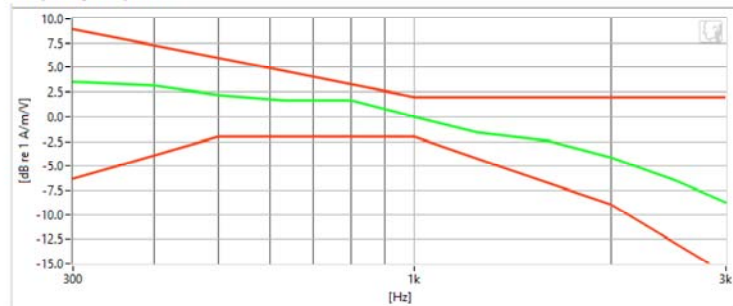

Results

ABM1	5.8 dB	✓	Minimum	-18.0
ABM2	-29 dB	✓	Maximum	0.0
SNNR	34.8 dB	✓	Minimum	20.0
Aligned Response - Normal	1.61 dB	✓	Tolerance curves	Aligned Data

FCC ID: A3LSMF936U		HAC (T-COIL) TEST REPORT	Approved by: Managing Director
Filename: 1M2204010046-24-R2.A3L	Test Dates: 4/25/2022 – 6/2/2022	DUT Type: Portable Handset	Page 86 of 120

REV 4.2.M
3/29/2022



Element Hearing-Aid Compatibility Facility

DUT: A3LSMF936U

Type: Portable Handset
Serial: 1809M

Measurement Standard: ANSI C63.19-2011

Equipment:

- Probe: Axial T-Coil Probe – SN: TEM-1123; Calibrated: 9/23/2020

Test Configuration:

- Mode: NR n25
- Bandwidth: 15MHz
- Channel: 376500
- Speech Signal: 3GPP2 Normal Test Signal

Noise Spectrum

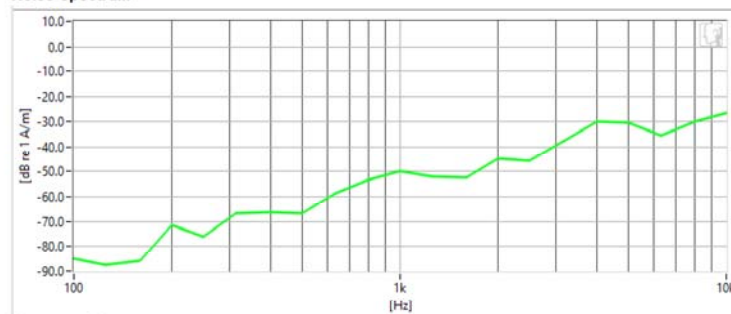

Frequency Response

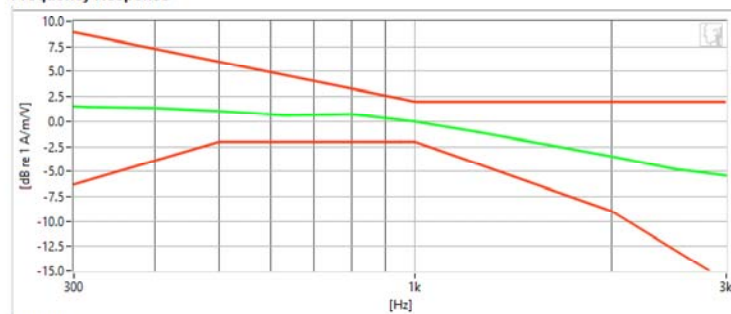

Results

ABM1	4.84 dB	✓	Minimum	-18.0
ABM2	-34.51 dB	✓	Maximum	0.0
SNNR	39.35 dB	✓	Minimum	20.0
Aligned Response - Normal	2 dB	✓	Tolerance curves	Aligned Data

FCC ID: A3LSMF936U		HAC (T-COIL) TEST REPORT	Approved by: Managing Director
Filename: 1M2204010046-24-R2.A3L	Test Dates: 4/25/2022 – 6/2/2022	DUT Type: Portable Handset	Page 87 of 120

REV 4.2.M
3/29/2022



Element Hearing-Aid Compatibility Facility

DUT: A3LSMF936U

Type: Portable Handset
Serial: 1809M

Measurement Standard: ANSI C63.19-2011

Equipment:

- Probe: Axial T-Coil Probe – SN: TEM-1123; Calibrated: 9/23/2020

Test Configuration:

- Mode: NR n77 DoD
- Bandwidth: 30MHz
- Channel: 633334
- Speech Signal: 3GPP2 Normal Test Signal

Noise Spectrum

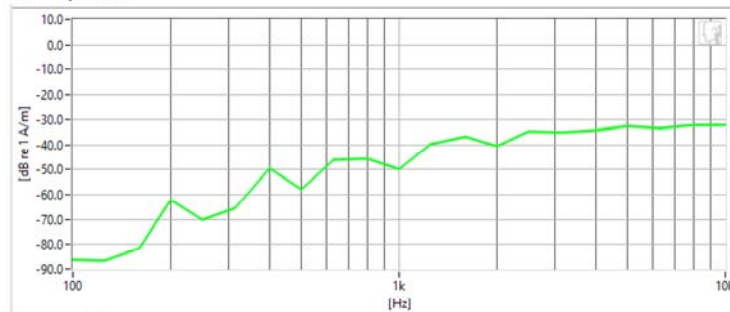

Frequency Response

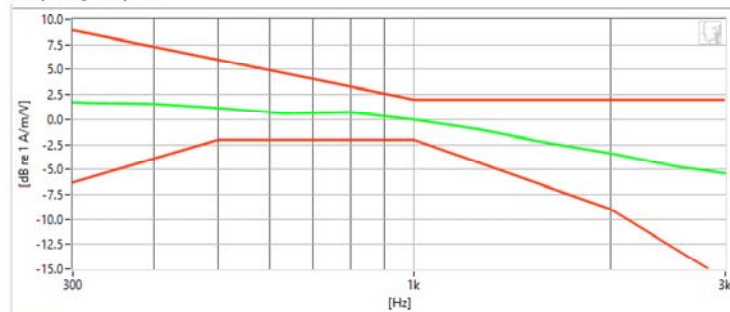

Results

ABM1	4.75 dB	✓	Minimum	-18.0
ABM2	-32.07 dB	✓	Maximum	0.0
SNNR	36.82 dB	✓	Minimum	20.0
Aligned Response - Normal	2 dB	✓	Tolerance curves	Aligned Data

FCC ID: A3LSMF936U		HAC (T-COIL) TEST REPORT	Approved by: Managing Director
Filename: 1M2204010046-24-R2.A3L	Test Dates: 4/25/2022 – 6/2/2022	DUT Type: Portable Handset	Page 88 of 120

REV 4.2.M
3/29/2022



Element Hearing-Aid Compatibility Facility

DUT: A3LSMF936U

Type: Portable Handset
Serial: 1802M

Measurement Standard: ANSI C63.19-2011

Equipment:

- Probe: Axial T-Coil Probe – SN: TEM-1123; Calibrated: 9/23/2020

Test Configuration:

- Mode: 2.4GHz WLAN
- Standard: IEEE 802.11b
- Channel: 11
- Speech Signal: 3GPP2 Normal Test Signal

Noise Spectrum

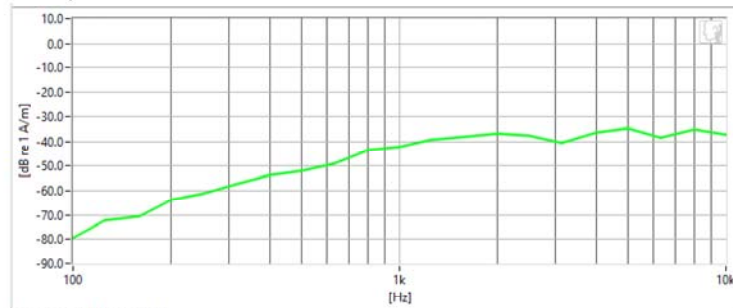

Frequency Response

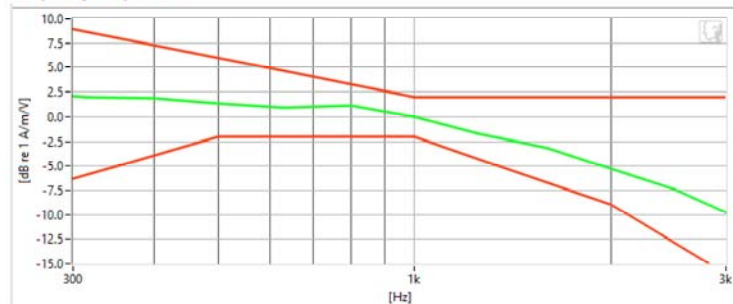

Results

ABM1	1.54 dB	✓	Minimum	-18.0
ABM2	-32.6 dB	✓	Maximum	0.0
SNNR	34.14 dB	✓	Minimum	20.0
Aligned Response - Normal	2 dB	✓	Tolerance curves	Aligned Data

FCC ID: A3LSMF936U		HAC (T-COIL) TEST REPORT	Approved by: Managing Director
Filename: 1M2204010046-24-R2.A3L	Test Dates: 4/25/2022 – 6/2/2022	DUT Type: Portable Handset	Page 89 of 120

REV 4.2.M
3/29/2022



Element Hearing-Aid Compatibility Facility

DUT: A3LSMF936U

Type: Portable Handset
Serial: 1802M

Measurement Standard: ANSI C63.19-2011

Equipment:

- Probe: Axial T-Coil Probe – SN: TEM-1123; Calibrated: 9/23/2020

Test Configuration:

- Mode: 5GHz WLAN
- Standard: IEEE 802.11n
- Bandwidth: 40MHz
- Channel: 118
- Speech Signal: 3GPP2 Normal Test Signal

Noise Spectrum

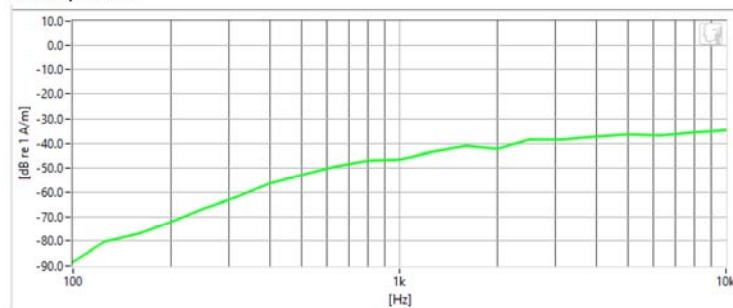

Frequency Response

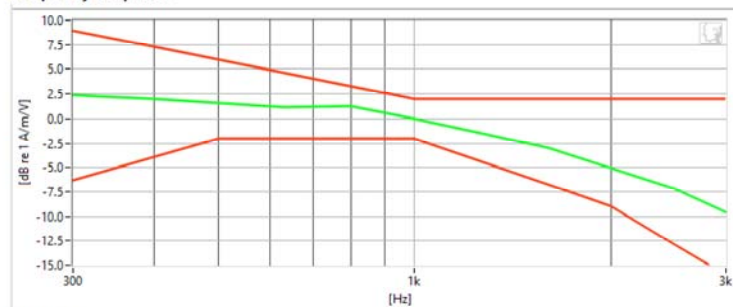

Results

ABM1	1.44 dB	✓	Minimum	-18.0
ABM2	-35.09 dB	✓	Maximum	0.0
SNNR	36.53 dB	✓	Minimum	20.0
Aligned Response - Normal	1.99 dB	✓	Tolerance curves	Aligned Data

FCC ID: A3LSMF936U		HAC (T-COIL) TEST REPORT	Approved by: Managing Director
Filename: 1M2204010046-24-R2.A3L	Test Dates: 4/25/2022 – 6/2/2022	DUT Type: Portable Handset	Page 90 of 120

REV 4.2.M
3/29/2022



Element Hearing-Aid Compatibility Facility

DUT: A3LSMF936U

Type: Portable Handset
Serial: 1802M

Measurement Standard: ANSI C63.19-2011

Equipment:

- Probe: Axial T-Coil Probe – SN: TEM-1123; Calibrated: 9/23/2020

Test Configuration:

- VoIP Application: Google Duo
- Mode: EDGE850
- Channel: 190
- Speech Signal: 3GPP2 Normal Test Signal

Noise Spectrum

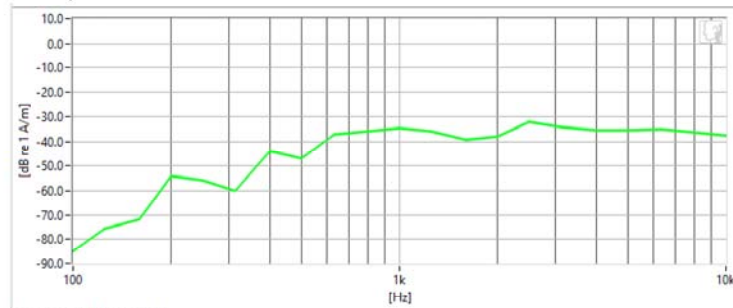

Frequency Response

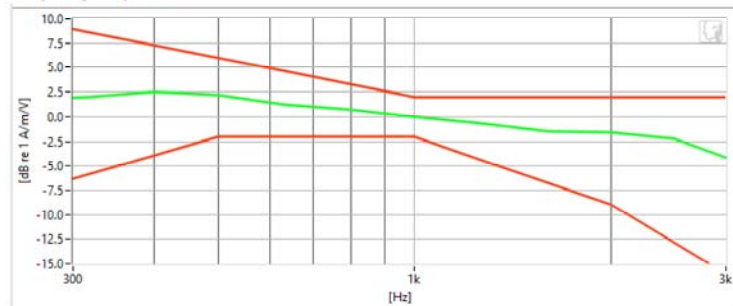

Results

ABM1	14.28 dB	✓	Minimum	-18.0
ABM2	-27.76 dB	✓	Maximum	0.0
SNNR	42.04 dB	✓	Minimum	20.0
Aligned Response - Normal	2 dB	✓	Tolerance curves	Aligned Data

FCC ID: A3LSMF936U		HAC (T-COIL) TEST REPORT	Approved by: Managing Director
Filename: 1M2204010046-24-R2.A3L	Test Dates: 4/25/2022 – 6/2/2022	DUT Type: Portable Handset	Page 91 of 120

REV 4.2.M
3/29/2022



Element Hearing-Aid Compatibility Facility

DUT: A3LSMF936U

Type: Portable Handset
Serial: 1802M

Measurement Standard: ANSI C63.19-2011

Equipment:

- Probe: Radial T-Coil Probe – SN: TEM-1129; Calibrated: 9/23/2020

Test Configuration:

- Mode: GSM850
- Channel: 128

Noise Spectrum

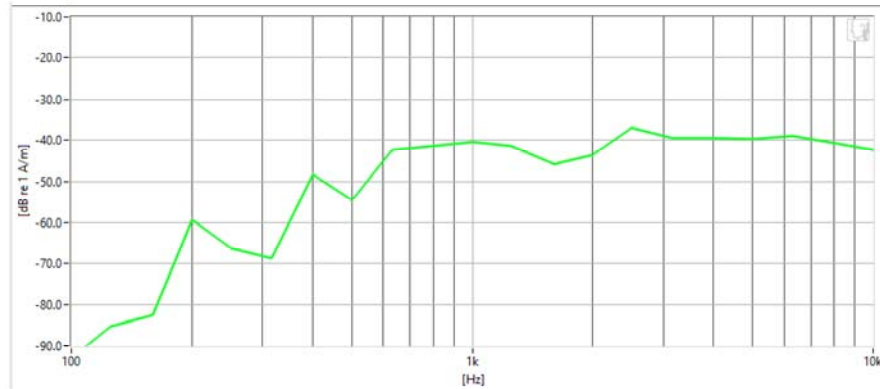

Results

ABM1	1.46 dB	✓	Minimum	-18.0
ABM2	-33.11 dB	✓	Maximum	0.0
SNNR	34.57 dB	✓	Minimum	20.0

FCC ID: A3LSMF936U		HAC (T-COIL) TEST REPORT	Approved by: Managing Director
Filename: 1M2204010046-24-R2.A3L	Test Dates: 4/25/2022 – 6/2/2022	DUT Type: Portable Handset	Page 92 of 120

REV 4.2.M
3/29/2022



Element Hearing-Aid Compatibility Facility

DUT: A3LSMF936U

Type: Portable Handset
Serial: 1802M

Measurement Standard: ANSI C63.19-2011

Equipment:

- Probe: Radial T-Coil Probe – SN: TEM-1129; Calibrated: 9/23/2020

Test Configuration:

- Mode: GSM1900
- Channel: 512

Noise Spectrum

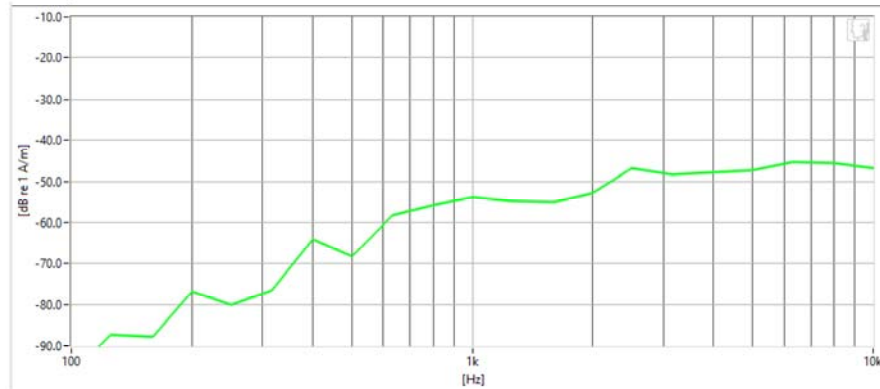

Results

ABM1	1.3 dB	✓	Minimum	-18.0
ABM2	-45.08 dB	✓	Maximum	0.0
SNNR	46.38 dB	✓	Minimum	20.0

FCC ID: A3LSMF936U		HAC (T-COIL) TEST REPORT	Approved by: Managing Director
Filename: 1M2204010046-24-R2.A3L	Test Dates: 4/25/2022 – 6/2/2022	DUT Type: Portable Handset	Page 93 of 120

REV 4.2.M
3/29/2022



Element Hearing-Aid Compatibility Facility

DUT: A3LSMF936U

Type: Portable Handset
Serial: 1802M

Measurement Standard: ANSI C63.19-2011

Equipment:

- Probe: Radial T-Coil Probe – SN: TEM-1129; Calibrated: 9/23/2020

Test Configuration:

- Mode: UMTS V
- Channel: 4132

Noise Spectrum

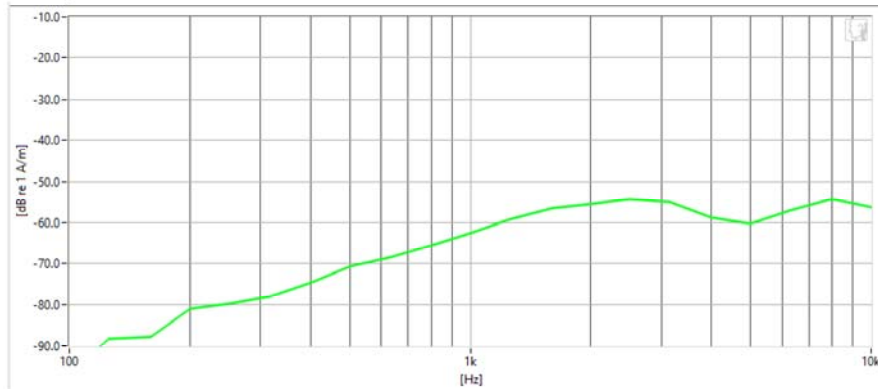

Results

ABM1	-1.32 dB	✓	Minimum	-18.0
ABM2	-51.71 dB	✓	Maximum	0.0
SNNR	50.38 dB	✓	Minimum	20.0

FCC ID: A3LSMF936U		HAC (T-COIL) TEST REPORT		Approved by: Managing Director
Filename: 1M2204010046-24-R2.A3L	Test Dates: 4/25/2022 – 6/2/2022	DUT Type: Portable Handset	Page 94 of 120	

REV 4.2.M
3/29/2022



Element Hearing-Aid Compatibility Facility

DUT: A3LSMF936U

Type: Portable Handset
Serial: 1802M

Measurement Standard: ANSI C63.19-2011

Equipment:

- Probe: Radial T-Coil Probe – SN: TEM-1129; Calibrated: 9/23/2020

Test Configuration:

- Mode: UMTS IV
- Channel: 1513

Noise Spectrum

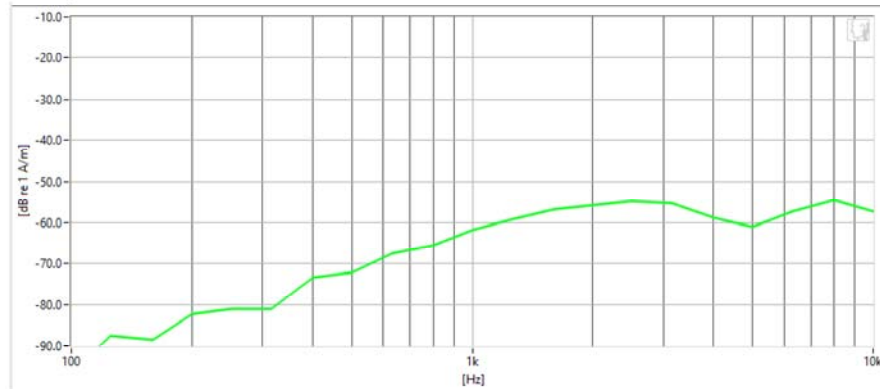

Results

ABM1	-560m dB	✓	Minimum	-18.0
ABM2	-51.88 dB	✓	Maximum	0.0
SNNR	51.32 dB	✓	Minimum	20.0

FCC ID: A3LSMF936U		HAC (T-COIL) TEST REPORT		Approved by: Managing Director
Filename: 1M2204010046-24-R2.A3L	Test Dates: 4/25/2022 – 6/2/2022	DUT Type: Portable Handset	Page 95 of 120	

REV 4.2.M
3/29/2022



Element Hearing-Aid Compatibility Facility

DUT: A3LSMF936U

Type: Portable Handset
Serial: 1802M

Measurement Standard: ANSI C63.19-2011

Equipment:

- Probe: Radial T-Coil Probe – SN: TEM-1129; Calibrated: 9/23/2020

Test Configuration:

- Mode: UMTS II
- Channel: 9400

Noise Spectrum

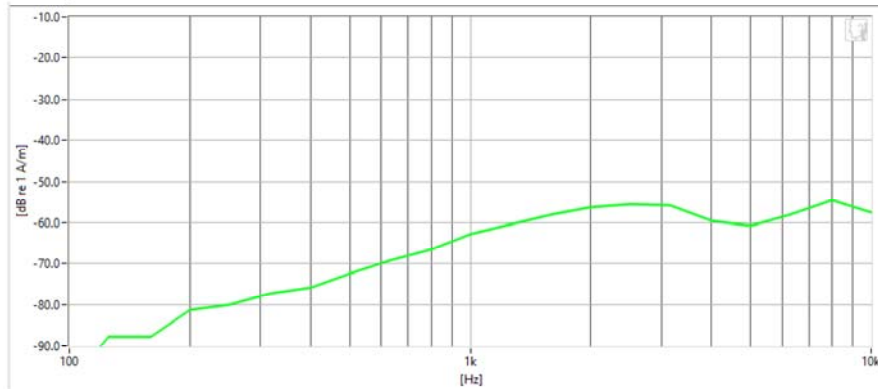

Results

ABM1	-990m dB	✓	Minimum	-18.0
ABM2	-52.73 dB	✓	Maximum	0.0
SNNR	51.74 dB	✓	Minimum	20.0

FCC ID: A3LSMF936U		HAC (T-COIL) TEST REPORT		Approved by: Managing Director
Filename: 1M2204010046-24-R2.A3L	Test Dates: 4/25/2022 – 6/2/2022	DUT Type: Portable Handset	Page 96 of 120	

REV 4.2.M
3/29/2022



Element Hearing-Aid Compatibility Facility

DUT: A3LSMF936U

Type: Portable Handset
Serial: 1802M

Measurement Standard: ANSI C63.19-2011

Equipment:

- Probe: Radial T-Coil Probe – SN: TEM-1129; Calibrated: 9/23/2020

Test Configuration:

- Mode: LTE FDD Band 7
- Bandwidth: 5MHz
- Channel: 21100

Noise Spectrum

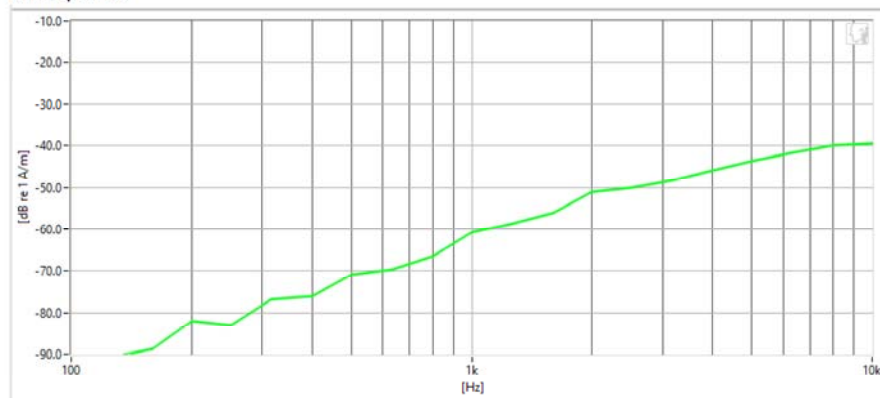

Results

ABM1	-1.09 dB	✓	Minimum	-18.0
ABM2	-45.6 dB	✓	Maximum	0.0
SNNR	44.51 dB	✓	Minimum	20.0

FCC ID: A3LSMF936U		HAC (T-COIL) TEST REPORT	Approved by: Managing Director
Filename: 1M2204010046-24-R2.A3L	Test Dates: 4/25/2022 – 6/2/2022	DUT Type: Portable Handset	Page 97 of 120

REV 4.2.M
3/29/2022



Element Hearing-Aid Compatibility Facility

DUT: A3LSMF936U

Type: Portable Handset
Serial: 1802M

Measurement Standard: ANSI C63.19-2011

Equipment:

- Probe: Radial T-Coil Probe – SN: TEM-1129; Calibrated: 9/23/2020

Test Configuration:

- Mode: LTE TDD Band 48
- Bandwidth: 20MHz
- Channel: 55990

Noise Spectrum

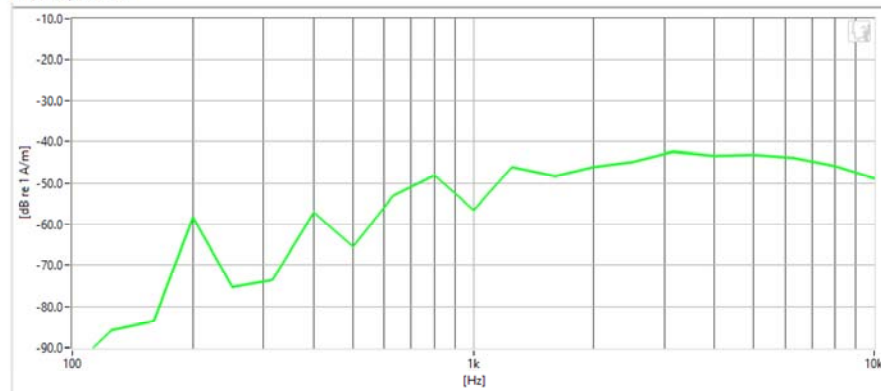

Results

ABM1	-1.23 dB	✓	Minimum	-18.0
ABM2	-39.86 dB	✓	Maximum	0.0
SNNR	38.63 dB	✓	Minimum	20.0

FCC ID: A3LSMF936U		HAC (T-COIL) TEST REPORT	Approved by: Managing Director
Filename: 1M2204010046-24-R2.A3L	Test Dates: 4/25/2022 – 6/2/2022	DUT Type: Portable Handset	Page 98 of 120

REV 4.2.M
3/29/2022



Element Hearing-Aid Compatibility Facility

DUT: A3LSMF936U

Type: Portable Handset
Serial: 1809M

Measurement Standard: ANSI C63.19-2011

Equipment:

- Probe: Radial T-Coil Probe – SN: TEM-1129; Calibrated: 9/23/2020

Test Configuration:

- Mode: NR n66
- Bandwidth: 30MHz
- Channel: 349000

Noise Spectrum

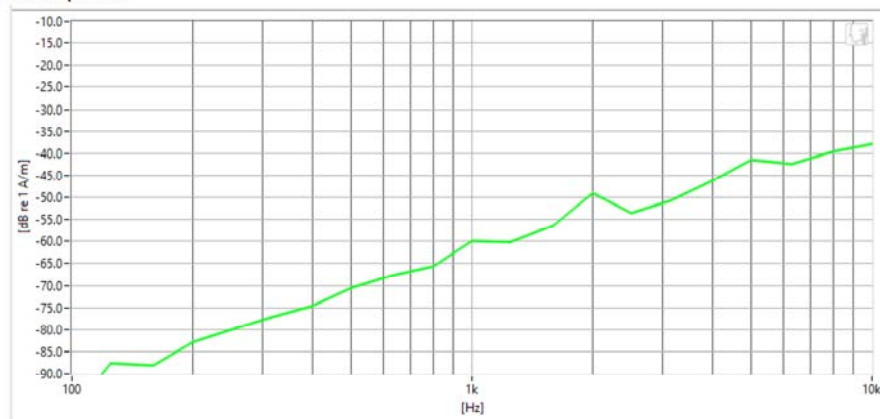

Results

ABM1	-1.46 dB	✓	Minimum	-18.0
ABM2	-45.35 dB	✓	Maximum	0.0
SNNR	43.89 dB	✓	Minimum	20.0

FCC ID: A3LSMF936U		HAC (T-COIL) TEST REPORT	Approved by: Managing Director
Filename: 1M2204010046-24-R2.A3L	Test Dates: 4/25/2022 – 6/2/2022	DUT Type: Portable Handset	Page 99 of 120

REV 4.2.M
3/29/2022



Element Hearing-Aid Compatibility Facility

DUT: A3LSMF936U

Type: Portable Handset
Serial: 1809M

Measurement Standard: ANSI C63.19-2011

Equipment:

- Probe: Radial T-Coil Probe – SN: TEM-1129; Calibrated: 9/23/2020

Test Configuration:

- Mode: NR n41
- Bandwidth: 60MHz
- Channel: 505200

Noise Spectrum

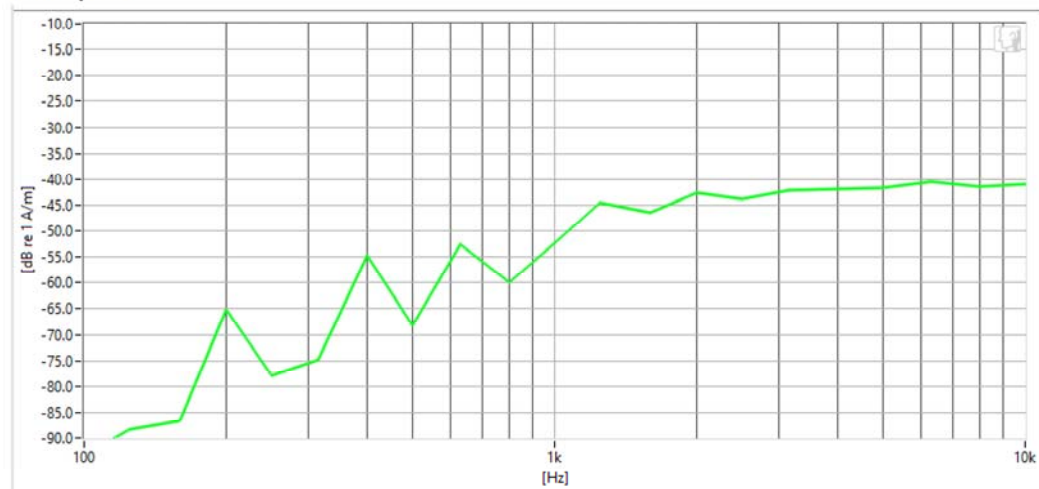

Results

ABM1	-1.64 dB	✓	Minimum	-18.0
ABM2	-39 dB	✓	Maximum	0.0
SNNR	37.36 dB	✓	Minimum	20.0

FCC ID: A3LSMF936U		HAC (T-COIL) TEST REPORT	Approved by: Managing Director
Filename: 1M2204010046-24-R2.A3L	Test Dates: 4/25/2022 – 6/2/2022	DUT Type: Portable Handset	Page 100 of 120

REV 4.2.M
3/29/2022



Element Hearing-Aid Compatibility Facility

DUT: A3LSMF936U

Type: Portable Handset
Serial: 1802M

Measurement Standard: ANSI C63.19-2011

Equipment:

- Probe: Radial T-Coil Probe – SN: TEM-1129; Calibrated: 9/23/2020

Test Configuration:

- Mode: 2.4GHz WLAN
- Standard: IEEE 802.11b
- Channel: 11

Noise Spectrum

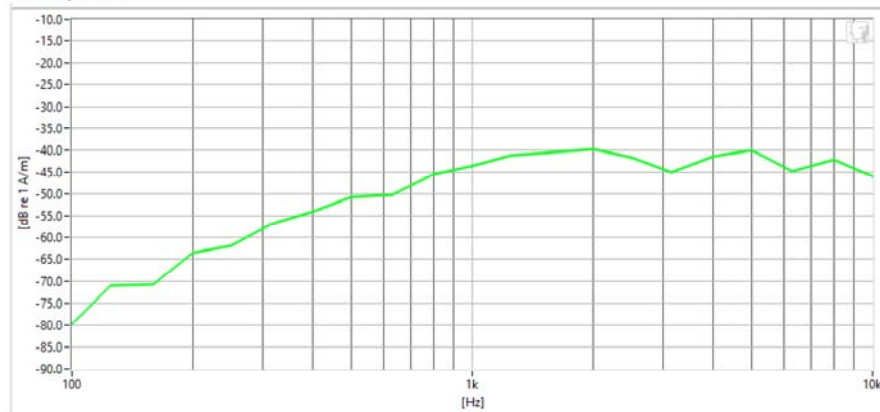

Results

ABM1	-5.09 dB	✓	Minimum	-18.0
ABM2	-35.06 dB	✓	Maximum	0.0
SNNR	29.97 dB	✓	Minimum	20.0

FCC ID: A3LSMF936U		HAC (T-COIL) TEST REPORT	Approved by: Managing Director
Filename: 1M2204010046-24-R2.A3L	Test Dates: 4/25/2022 – 6/2/2022	DUT Type: Portable Handset	Page 101 of 120

REV 4.2.M
3/29/2022



Element Hearing-Aid Compatibility Facility

DUT: A3LSMF936U

Type: Portable Handset
Serial: 1802M

Measurement Standard: ANSI C63.19-2011

Equipment:

- Probe: Radial T-Coil Probe – SN: TEM-1129; Calibrated: 9/23/2020

Test Configuration:

- Mode: 5GHz WLAN
- Standard: IEEE 802.11a
- Channel: 40

Noise Spectrum

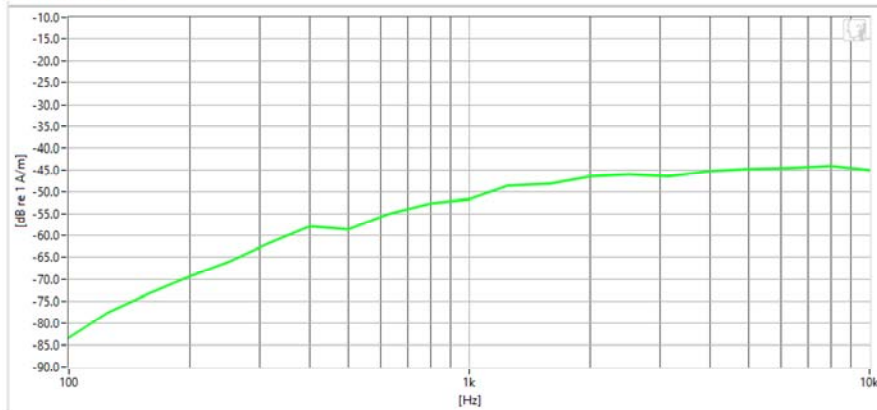

Results

ABM1	-4.96 dB	✓	Minimum	-18.0
ABM2	-41.3 dB	✓	Maximum	0.0
SNNR	36.34 dB	✓	Minimum	20.0

FCC ID: A3LSMF936U		HAC (T-COIL) TEST REPORT	Approved by: Managing Director
Filename: 1M2204010046-24-R2.A3L	Test Dates: 4/25/2022 – 6/2/2022	DUT Type: Portable Handset	Page 102 of 120

REV 4.2.M
3/29/2022



Element Hearing-Aid Compatibility Facility

DUT: A3LSMF936U

Type: Portable Handset
Serial: 1802M

Measurement Standard: ANSI C63.19-2011

Equipment:

- Probe: Radial T-Coil Probe – SN: TEM-1129; Calibrated: 9/23/2020

Test Configuration:

- VoIP Application: Google Duo
- Mode: 2.4GHz WLAN
- Standard: IEEE 802.11b
- Channel: 11

Noise Spectrum

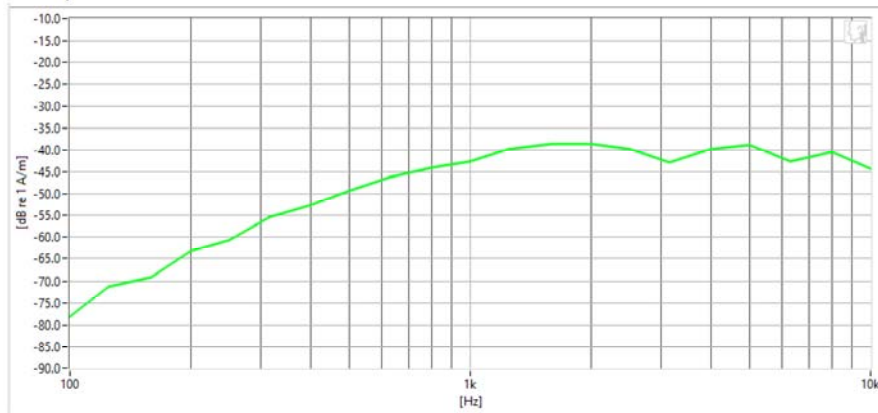

Results

ABM1	8.28 dB	✓	Minimum	-18.0
ABM2	-33.43 dB	✓	Maximum	0.0
SNNR	41.72 dB	✓	Minimum	20.0

FCC ID: A3LSMF936U		HAC (T-COIL) TEST REPORT	Approved by: Managing Director
Filename: 1M2204010046-24-R2.A3L	Test Dates: 4/25/2022 – 6/2/2022	DUT Type: Portable Handset	Page 103 of 120

REV 4.2.M
3/29/2022

14. CALIBRATION CERTIFICATES

FCC ID: A3LSMF936U	 element	HAC (T-COIL) TEST REPORT	Approved by: Managing Director
Filename: 1M2204010046-24-R2.A3L	Test Dates: 4/25/2022 – 6/2/2022	DUT Type: Portable Handset	Page 104 of 120

REV 4.2.M
3/29/2022

West Caldwell Calibration Laboratories Inc.

Certificate of Conformance

for

AXIAL T COIL PROBE

Manufactured by: TEM CONSULTING
 Model No: AXIAL T COIL PROBE
 Serial No: TEM-1123
 Calibration Recall No: 31288

Submitted By:

Customer: ANDREW HARWELL
 Company: PCTEST ENGINEERING LAB
 Address: 6660-B DOBBIN ROAD
 COLUMBIA MD 21045

The subject instrument was calibrated to the indicated specification using standards traceable to the SI through the National Institute of Standards and Technology or to accepted values of natural physical constants. This document certifies that the instrument met the following specification upon its return to the submitter.

West Caldwell Calibration Laboratories Procedure No. AXIAL T C TEM C

✓
10/13/2020

Upon receipt for Calibration, the instrument was found to be:

Within (X)

tolerance of the indicated specification. See attached Report of Calibration.

The information supplied relates to the calibrated item listed above and statement of conformance for ALL given specifications and standards fall under the decision rule: $A=(L-(U95))$, where A is acceptance limit, L is manufacturer specifications and U95 is confidence level of 95% at k=2. This includes but not limited to: 1. Measured value does not meet manufacturer's tolerance, 2. Manufacturer's tolerance is too small compared to calibration and measurement capability uncertainties, 3. Test uncertainty ratio does not meet the 4:1 ratio due to test instrumentation limitations. The decision rule has been communicated and approved by customer during contract

West Caldwell Calibration Laboratories' calibration control system meets the following requirements, ISO 10012-1 MIL STD 45662A, ANSI/NCSL Z540-1, IEC Guide 25, ISO 9001:2015, and ISO 17025

Note: With this Certificate, Report of Calibration is included.

Approved by:

Calibration Date: 23-Sep-20

James Zhu

Certificate No: 31288 - 2

Quality Manager
ISO/IEC 17025:2017

QA Doc. #1051 Rev. 3.0 5/29/20

Certificate Page 1 of 1

West Caldwell Calibration Laboratories, Inc.
 uncompromised calibration
 1575 State Route 96, Victor, NY 14564, U.S.A.



Calibration Lab. Cert. # 1533.01

FCC ID: A3LSMF936U		HAC (T-COIL) TEST REPORT	Approved by: Managing Director
Filename: 1M2204010046-24-R2.A3L	Test Dates: 4/25/2022 – 6/2/2022	DUT Type: Portable Handset	Page 105 of 120

REV 4.2.M
3/29/2022



REPORT OF CALIBRATION

for

TEM Consulting LP Axial T Coil Probe
Company: PCTest Engineering Lab

Model No.: Axial T Coil Probe

Serial No.: TEM-1123
I. D. No.: XXXX

Calibration results:				
Probe Sensitivity measured with Helmholtz Coil		Before & after data same: ...X...		
<i>Helmholtz Coil;</i>				
the number of turns on each coil;	10	No.		
the radius of each coil, in meters;	0.204	m	Laboratory Environment:	
the current in the coils, in amperes.;	0.08	A	Ambient Temperature: 20.7 °C	
<i>Helmholtz Coil Constant;</i>		7.04	A/m/V	Ambient Humidity: 42.1 % RH
<i>Helmholtz Coil magnetic field;</i>		5.71	A/m	Ambient Pressure: 99.094 kPa
Probe Sensitivity at		1000	Hz.	Calibration Date: 23-Sep-2020
was	-60.24	dBV/A/m		Calibration Due:
	0.972	mV/A/m		Report Number: 31288 -2
Probe resistance	898	Ohms		Control Number: 31288
The above listed instrument meets or exceeds the tested manufacturer's specifications.				
This Calibration is traceable through NIST test numbers:		684.07/O-0000001126-20		
The expanded uncertainty of calibration: 0.30dB at 95% confidence level with a coverage factor of k=2.				
Graph represents Probes Frequency Response.				

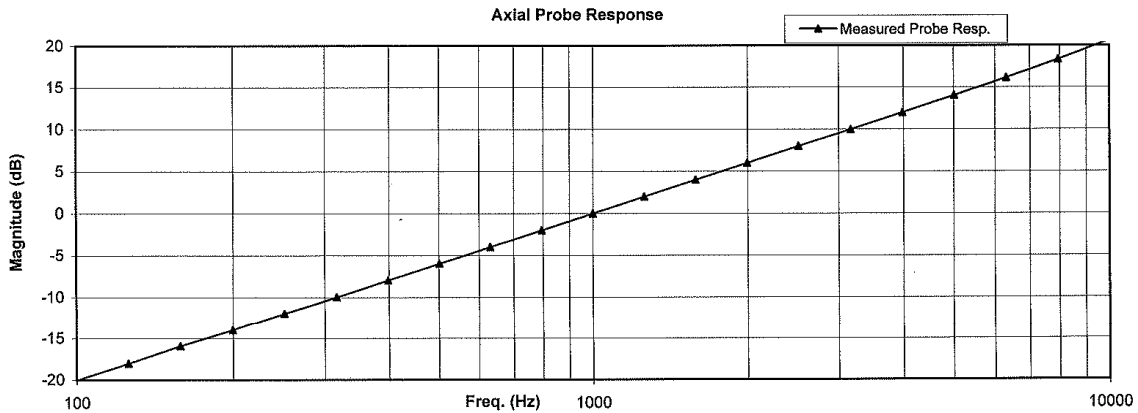

The above listed instrument was checked using calibration procedure documented in West Caldwell Calibration Laboratories Inc. procedure : **Rev. 7.0 Jan. 24, 2014 Doc. # 1038 HCATEMC**
 Calibration was performed by West Caldwell Calibration Laboratories Inc. under Operating Procedures intended to implement the requirements of ISO10012-1, IEC Guide 25, ANSI/NCCL Z540-1, (MIL-STD-45662A) and ISO 9001:2015, ISO 17025

Cal. Date: 23-Sep-2020
Calibrated on WCCL system type 9700

Measurements performed by: *James Zhu*
James Zhu

This document shall not be reproduced, except in full, without the written approval from West Caldwell Cal. Labs, Inc.

Rev. 7.0 Jan. 24, 2014 Doc. # 1038 HCATEMC

FCC ID: A3LSMF936U		HAC (T-COIL) TEST REPORT	Approved by: Managing Director
Filename: 1M2204010046-24-R2.A3L	Test Dates: 4/25/2022 – 6/2/2022	DUT Type: Portable Handset	Page 106 of 120

West Caldwell Calibration Laboratories Inc.

1575 State Route 96, Victor NY 14564
Tel. (585) 586-3900 FAX (585) 586-4327

Calibration Data Record

TEM Consulting LP Axial T Coil Probe
Company: PCTest Engineering Lab

for
Model No.: Axial T Coil Probe

Serial No.: TEM-1123

Test	Function	Tolerance	Measured values			
			Before	Out	Remarks	
1.0	Probe Sensitivity at	1000 Hz. dBV/A/m	-60.24			
2.0	Probe Level Linearity					
			6	6.03		
		Ref. (0 dB)	0	0.00		
			-6	-6.03		
			-12	-12.05		
3.0	Probe Frequency Response					
			Hz			
			100	-20.0		
			126	-18.0		
			158	-15.9		
			200	-14.0		
			251	-12.0		
			316	-10.0		
			398	-8.0		
			501	-6.0		
			631	-4.0		
			794	-2.0		
			Ref. (0 dB)	1000	0.0	
				1259	2.0	
				1585	4.0	
				1995	6.0	
				2512	8.0	
		3162	10.0			
		3981	12.0			
		5012	14.0			
		6310	16.1			
		7943	18.3			
		10000	20.7			

Instruments used for calibration:	S/N	Date of Cal.	Traceability No.	Due Date
HP 34401A	S/N US360641	2-Jul-2020	,610119	2-Jul-2021
HP 34401A	S/N US361024	2-Jul-2020	,610119	2-Jul-2021
HP 33120A	S/N US360437	2-Jul-2020	,610119	2-Jul-2021
B&K 2133	S/N 1583254	1-Jul-2020	684.07/O-0000001126-20	1-Jul-2021

Cal. Date: 23-Sep-2020
Calibrated on WCCL system type 9700

Tested by: James Zhu

This document shall not be reproduced, except in full, without the written approval from West Caldwell Cal. Labs. Inc.

Rev. 7.0 Jan. 24, 2014 Doc. # 1038 HCATEMC

FCC ID: A3LSMF936U		HAC (T-COIL) TEST REPORT	Approved by: Managing Director
Filename: 1M2204010046-24-R2.A3L	Test Dates: 4/25/2022 – 6/2/2022	DUT Type: Portable Handset	Page 107 of 120

West Caldwell Calibration Laboratories Inc.

Certificate of Conformance

for

RADIAL T COIL PROBE

Manufactured by: TEM CONSULTING
Model No: RADIAL T COIL PROBE
Serial No: TEM-1129
Calibration Recall No: 31288

Submitted By:

Customer: ANDREW HARWELL
Company: PCTEST ENGINEERING LAB
Address: 6660-B DOBBIN ROAD
COLUMBIA MD 21045

The subject instrument was calibrated to the indicated specification using standards traceable to the SI through the National Institute of Standards and Technology or to accepted values of natural physical constants. This document certifies that the instrument met the following specification upon its return to the submitter.

West Caldwell Calibration Laboratories Procedure No. RADIAL T TEM C

Upon receipt for Calibration, the instrument was found to be:

Within (X)

tolerance of the indicated specification. See attached Report of Calibration.

The information supplied relates to the calibrated item listed above and statement of conformance for ALL given specifications and standards fall under the decision rule: $A=(L-(U95))$, where A is acceptance limit, L is manufacturer specifications and U95 is confidence level of 95% at $k=2$. This includes but not limited to: 1. Measured value does not meet manufacturer's tolerance, 2. Manufacturer's tolerance is too small compared to calibration and measurement capability uncertainties, 3. Test uncertainty ratio does not meet the 4:1 ratio due to test instrumentation limitations. The decision rule has been communicated and approved by customer during contract

West Caldwell Calibration Laboratories' calibration control system meets the following requirements, ISO 10012-1 MIL STD 45662A, ANSI/NCSL Z540-1, IEC Guide 25, ISO 9001:2015, and ISO 17025

Note: With this Certificate, Report of Calibration is included.

Approved by:

Calibration Date: 23-Sep-20

James Zhu

Certificate No: 31288 - 1

Quality Manager
ISO/IEC 17025:2017

QA Doc. #1051 Rev. 3.0 5/29/20

Certificate Page 1 of 1

West Caldwell Calibration Laboratories, Inc.
uncompromised calibration
1575 State Route 96, Victor, NY 14564, U.S.A.



Calibration Lab. Cert. # 1533.01

FCC ID: A3LSMF936U		HAC (T-COIL) TEST REPORT	Approved by: Managing Director
Filename: 1M2204010046-24-R2.A3L	Test Dates: 4/25/2022 – 6/2/2022	DUT Type: Portable Handset	Page 108 of 120

REV 4.2.M
3/29/2022

Unless otherwise specified, no part of this report may be reproduced or utilized in any part, form or by any means, electronic or mechanical, including photocopying and microfilm, without permission in writing from Element. If you have any questions about this or have an enquiry about obtaining additional rights to this report or assembly of contents thereof, please contact CT.INFO@ELEMENT.COM.



REPORT OF CALIBRATION

for

TEM Consulting LP Radial T Coil Probe
Company: PCTest Engineering Lab

Model No.: Radial T Coil Probe

Serial No.: TEM-1129
I. D. No.: XXXX

Calibration results:

Probe Sensitivity measured with Helmholtz Coil

Helmholtz Coil;
the number of turns on each coil; 10 No.
the radius of each coil, in meters; 0.204 m
the current in the coils, in amperes.; 0.08 A
Helmholtz Coil Constant; 7.04 A/m/V
Helmholtz Coil magnetic field; 5.70 A/m

Before & after data same: ...X...

Laboratory Environment:
Ambient Temperature: 20.7 °C
Ambient Humidity: 42.1 % RH
Ambient Pressure: 99.094 kPa
Calibration Date: 23-Sep-2020

Probe Sensitivity at 1000 Hz.
was -60.37 dBV/A/m
0.959 mV/A/m
Probe resistance 897 Ohms

Re-calibration Due:
Report Number: 31288 -1
Control Number: 31288

The above listed instrument meets or exceeds the tested manufacturer's specifications.

This Calibration is traceable through NIST test numbers: 684.07/O-0000001126-20

The expanded uncertainty of calibration: 0.30dB at 95% confidence level with a coverage factor of k=2.

Graph represents Probes Frequency Response.

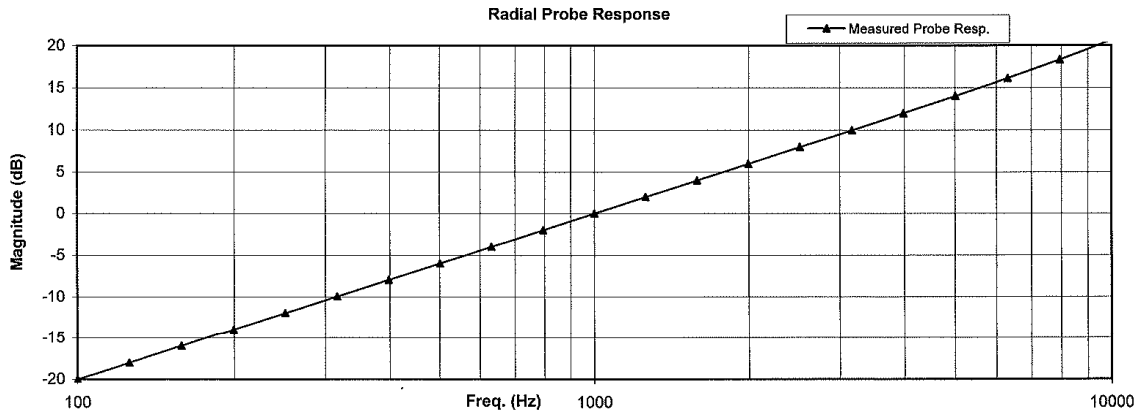

The above listed instrument was checked using calibration procedure documented in West Caldwell

Calibration Laboratories Inc. procedure :

Rev. 7.0 Jan. 24, 2014 Doc. # 1038 HCRTEMC

Calibration was performed by West Caldwell Calibration Laboratories Inc. under Operating Procedures

intended to implement the requirements of ISO10012-1, IEC Guide 25, ANSI/NCCL Z540-1, (MIL-STD-45662A) and ISO 9001:2015, ISO 17025

Cal. Date: 23-Sep-2020

Measurements performed by: *[Signature]*

Calibrated on WCCL system type 9700

James Zhu

This document shall not be reproduced, except in full, without the written approval from West Caldwell Cal. Labs. Inc.

Rev. 7.0 Jan. 24, 2014 Doc. # 1038 HCRTEMC

FCC ID: A3LSMF936U		HAC (T-COIL) TEST REPORT	Approved by: Managing Director
Filename: 1M2204010046-24-R2.A3L	Test Dates: 4/25/2022 – 6/2/2022	DUT Type: Portable Handset	Page 109 of 120

HCRTEM_Cal-1129_Sep-23-2020

West Caldwell Calibration Laboratories Inc.

1575 State Route 96, Victor NY 14564
Tel. (585) 586-3900 FAX (585) 586-4327

Calibration Data Record

TEM Consulting LP Radial T Coil Probe
Company: PCTest Engineering Lab

for
Model No.: Radial T Coil Probe

Serial No.: TEM-1129

Test	Function	Tolerance	Measured values		
			Before	Out	Remarks
1.0	Probe Sensitivity at	1000 Hz. dBV/A/m	-60.37		
2.0	Probe Level Linearity	Ref. (0 dB)	6	6.04	
			0	0.00	
			-6	-6.03	
			-12	-12.05	
3.0	Probe Frequency Response	Ref. (0 dB)	100	-20.0	
			126	-18.0	
			158	-16.0	
			200	-14.0	
			251	-12.0	
			316	-10.0	
			398	-8.0	
			501	-6.0	
			631	-4.0	
			794	-2.0	
			1000	0.0	
			1259	2.0	
			1585	4.0	
			1995	6.0	
			2512	8.0	
			3162	10.0	
3981	12.0				
5012	14.0				
6310	16.1				
7943	18.3				
10000	20.7				

Instruments used for calibration:			Date of Cal.	Traceability No.	Due Date
HP	34401A	S/N US360641	2-Jul-2020	,610119	2-Jul-2021
HP	34401A	S/N US361024	2-Jul-2020	,610119	2-Jul-2021
HP	33120A	S/N US360437	2-Jul-2020	,610119	2-Jul-2021
B&K	2133	S/N 1583254	1-Jul-2020	684.07/O-0000001126-20	1-Jul-2021

Cal. Date: 23-Sep-2020
Calibrated on WCCL system type 9700

Tested by: James Zhu

This document shall not be reproduced, except in full, without the written approval from West Caldwell Cal. Labs, Inc.

Rev. 7.0 Jan. 24, 2014 Doc. # 1038 HCRTEM_C

FCC ID: A3LSMF936U		HAC (T-COIL) TEST REPORT	Approved by: Managing Director
Filename: 1M2204010046-24-R2.A3L	Test Dates: 4/25/2022 – 6/2/2022	DUT Type: Portable Handset	Page 110 of 120

REV 4.2.M
3/29/2022

15. CONCLUSION

The measurements indicate that the wireless communications device complies with the HAC limits specified in accordance with the ANSI C63.19 Standard and FCC WT Docket No. 01-309 RM-8658. Precise laboratory measures were taken to assure repeatability of the tests. The tested device complies with the requirements in respect to all parameters specific to the test. The test results and statements relate only to the item(s) tested.

The measurement system and techniques presented in this evaluation are proposed in the ANSI standard as a means of best approximating wireless device compatibility with a hearing-aid. The literature is under continual re-construction.

FCC ID: A3LSMF936U		HAC (T-COIL) TEST REPORT	Approved by: Managing Director
Filename: 1M2204010046-24-R2.A3L	Test Dates: 4/25/2022 – 6/2/2022	DUT Type: Portable Handset	Page 111 of 120

REV 4.2.M
3/29/2022

16. REFERENCES

1. ANSI C63.19-2011, American National Standard for Methods of Measurement of Compatibility between Wireless communication devices and Hearing Aids.", New York, NY, IEEE, May 2011
2. FCC Office of Engineering and Technology KDB, "285076 D01 HAC Guidance v05," September 13, 2017
3. FCC Office of Engineering and Technology KDB, "285076 D02 T-Coil Testing for CMRS IP v03," September 13, 2017
4. FCC Public Notice DA 06-1215, *Wireless Telecommunications Bureau and Office of Engineering and Technology Clarify Use of Revised Wireless Phone Hearing Aid Compatibility Standard*, June 6, 2006
5. FCC 3G Review Guidance, Laboratory Division OET FCC, May/June 2006
6. Berger, H. S., "Compatibility Between Hearing Aids and Wireless Devices," Electronic Industries Forum, Boston, MA, May, 1997
7. Berger, H. S., "Hearing Aid and Cellular Phone Compatibility: Working Toward Solutions," Wireless Telephones and Hearing Aids: New Challenges for Audiology, Gallaudet University, Washington, D.C., May, 1997 (To be reprinted in the American Journal of Audiology).
8. Berger, H. S., "Hearing Aid Compatibility with Wireless Communications Devices," IEEE International Symposium on Electromagnetic Compatibility, Austin, TX, August, 1997.
9. Bronaugh, E. L., "Simplifying EMI Immunity (Susceptibility) Tests in TEM Cells," in the 1990 IEEE International Symposium on Electromagnetic Compatibility Symposium Record, Washington, D.C., August 1990, pp. 488-491
10. Byrne, D. and Dillon, H., The National Acoustics Laboratory (NAL) New Procedure for Selecting the Gain and Frequency Response of a Hearing Aid, Ear and Hearing 7:257-265, 1986.
11. Crawford, M. L., "Measurement of Electromagnetic Radiation from Electronic Equipment using TEM Transmission Cells," U.S. Department of Commerce, National Bureau of Standards, NBSIR 73-306, Feb. 1973.
12. Crawford, M. L., and Workman, J. L., "Using a TEM Cell for EMC Measurements of Electronic Equipment," U.S. Department of Commerce, National Bureau of Standards. Technical Note 1013, July 1981.
13. EHIMA GSM Project, Development phase, Project Report (1st part) Revision A. Technical-Audiological Laboratory and Telecom Denmark, October 1993.
14. EHIMA GSM Project, Development phase, Part II Project Report. Technical-Audiological Laboratory and Telecom Denmark, June 1994.
15. EHIMA GSM Project Final Report, Hearing Aids and GSM Mobile Telephones: Interference Problems, Methods of Measurement and Levels of Immunity. Technical-Audiological Laboratory and Telecom Denmark, 1995.

FCC ID: A3LSMF936U	 element	HAC (T-COIL) TEST REPORT	Approved by: Managing Director
Filename: 1M2204010046-24-R2.A3L	Test Dates: 4/25/2022 – 6/2/2022	DUT Type: Portable Handset	Page 112 of 120

REV 4.2.M

3/29/2022

16. HAMPIS Report, Comparison of Mobile phone electromagnetic near field with an upscaled electromagnetic far field, using hearing aid as reference, 21 October 1999.
17. Hearing Aids/GSM, Report from OTWIDAM, Technical-Audiological Laboratory and Telecom Denmark, April 1993.
18. IEEE 100, The Authoritative Dictionary of IEEE Standards Terms, Seventh Edition.
19. Joyner, K. H., et. al., Interference to Hearing Aids by the New Digital Mobile Telephone System, Global System for Mobile (GSM) Communication Standard, National Acoustic Laboratory, Australian Hearing Series, Sydney 1993.
20. Joyner, K. H., et. al., Interference to Hearing Aids by the Digital Mobile Telephone System, Global System for Mobile Communications (GSM), NAL Report #131, National Acoustic Laboratory, Australian Hearing Series, Sydney, 1995.
21. Kecker, W. T., Crawford, M. L., and Wilson, W. A., "Construction of a Transverse Electromagnetic Cell", U.S. Department of Commerce, National Bureau of Standards, Technical Note 1011, Nov. 1978.
22. Konigstein, D., and Hansen, D., "A New Family of TEM Cells with enlarged bandwidth and Optimized working Volume," in the Proceedings of the 7th International Symposium on EMC, Zurich, Switzerland, March 1987; 50:9, pp. 127-132.
23. Kuk, F., and Hjorstgaard, N. K., "Factors affecting interference from digital cellular telephones," Hearing Journal, 1997; 50:9, pp 32-34.
24. Ma, M. A., and Kanda, M., "Electromagnetic Compatibility and Interference Metrology," U.S. Department of Commerce, National Bureau of Standards, Technical Note 1099, July 1986, pp. 17-43.
25. Ma, M. A., Sreenivashiah, I. , and Chang, D. C., "A Method of Determining the Emission and Susceptibility Levels of Electrically Small Objects Using a TEM Cell," U.S. Department of Commerce, National Bureau of Standards, Technical Note 1040, July 1981.
26. McCandless, G. A., and Lyregaard, P. E., Prescription of Gain/Output (POGO) for Hearing Aids, Hearing Instruments 1:16-21, 1983
27. Skopec, M., "Hearing Aid Electromagnetic Interference from Digital Wireless Telephones," IEEE Transactions on Rehabilitation Engineering, vol. 6, no. 2, pp. 235-239, June 1998.
28. Technical Report, GSM 05.90, GSM EMC Considerations, European Telecommunications Standards Institute, January 1993.
29. Victorian, T. A., "Digital Cellular Telephone Interference and Hearing Aid Compatibility—An Update," Hearing Journal 1998; 51:10, pp. 53-60
30. Wong, G. S. K., and Embleton, T. F. W., eds., AIP Handbook of Condenser Microphones: Theory, Calibration and Measurements, AIP Press.

FCC ID: A3LSMF936U		HAC (T-COIL) TEST REPORT	Approved by: Managing Director
Filename: 1M2204010046-24-R2.A3L	Test Dates: 4/25/2022 – 6/2/2022	DUT Type: Portable Handset	Page 113 of 120

REV 4.2.M
3/29/2022