



SAR EVALUATION REPORT

Applicant Name:
 Samsung Electronics Co., Ltd.
 129, Samsung-ro, Maetan dong,
 Yeongtong-gu, Suwon-si
 Gyeonggi-do, 16677, Korea

Date of Testing:
 06/28/20 - 08/24/20
Test Site/Location:
 PCTEST Lab, Columbia, MD, USA
Document Serial No.:
 1M2005200087-01-R2.A3L

FCC ID: A3LSMF916U

APPLICANT: SAMSUNG ELECTRONICS CO., LTD.

DUT Type: Portable Handset
Application Type: Certification
FCC Rule Part(s): CFR §2.1093
Model: SM-F916U
Additional Models: SM-F916U1, SM-F916W

Equipment Class	Band & Mode	Tx Frequency	SAR					
			1g Head (W/kg)	1g Body-Worn (W/kg)	1g Hotspot (W/kg)	10g Phablet (W/kg)	UMPC Body 1g (W/kg)	UMPC Extremity 10g (W/kg)
PCE	CDMA/EVDO BC10 (990S)	817.90 - 823.10 MHz	0.25	0.34	0.69	N/A	0.71	1.44
PCE	CDMA/EVDO BC0 (822H)	824.70 - 848.31 MHz	0.28	0.40	0.83	N/A	0.83	1.61
PCE	PCS CDMA/EVDO	1851.25 - 1908.75 MHz	< 0.1	0.41	0.89	2.72	0.99	3.15
PCE	GSM/GPRS/EDGE 850	824.20 - 848.80 MHz	0.17	0.20	0.91	N/A	0.82	2.02
PCE	GSM/GPRS/EDGE 1900	1850.20 - 1909.80 MHz	< 0.1	0.23	0.69	1.76	0.60	2.27
PCE	UMTS 850	826.40 - 846.60 MHz	0.29	0.26	0.58	N/A	1.01	2.39
PCE	UMTS 1750	1712.4 - 1752.6 MHz	< 0.1	0.99	1.01	2.84	1.16	3.15
PCE	UMTS 1900	1852.4 - 1907.6 MHz	< 0.1	0.60	0.99	2.83	1.15	3.14
PCE	LTE Band 71	665.5 - 695.5 MHz	0.14	0.24	0.50	N/A	0.66	1.53
PCE	LTE Band 12	699.7 - 715.3 MHz	0.11	0.14	0.39	N/A	0.46	1.32
PCE	LTE Band 13	779.5 - 784.5 MHz	0.28	0.34	0.78	N/A	0.75	1.86
PCE	LTE Band 14	790.5 - 795.5 MHz	0.27	0.30	0.68	N/A	0.78	2.17
PCE	LTE Band 28 (Cell)	814.7 - 848.3 MHz	0.28	0.32	0.61	N/A	0.79	2.07
PCE	LTE Band 5 (Cell)	824.7 - 848.3 MHz	0.29	0.31	0.77	N/A	0.93	2.37
PCE	LTE Band 66 (AWS)	1710.7 - 1779.3 MHz	< 0.1	1.14	0.80	2.33	0.88	3.15
PCE	LTE Band 4 (AWS)	1710.7 - 1754.3 MHz	N/A	N/A	N/A	N/A	N/A	N/A
PCE	LTE Band 25 (PCS)	1850.7 - 1914.3 MHz	< 0.1	0.47	0.81	2.62	1.07	2.94
PCE	LTE Band 2 (PCS)	1850.7 - 1909.3 MHz	N/A	N/A	N/A	N/A	N/A	N/A
PCE	LTE Band 30	2307.5 - 2312.5 MHz	< 0.1	0.63	1.06	3.14	0.77	2.90
PCE	LTE Band 7	2502.5 - 2567.5 MHz	0.24	0.52	1.06	2.71	1.19	2.72
CBE	LTE Band 48	3552.5 - 3697.5 MHz	0.16	0.25	0.49	N/A	0.38	1.91
PCE	LTE Band 41	2498.5 - 2687.5 MHz	< 0.1	0.47	0.95	2.87	1.26	2.52
PCE	LTE Band 38	2572.5 - 2617.5 MHz	N/A	N/A	N/A	N/A	N/A	N/A
PCE	NR Band n71	665.5 - 695.5 MHz	0.16	0.21	0.49	N/A	0.44	1.23
PCE	NR Band n5 (Cell)	826.5 - 846.5 MHz	0.23	0.32	0.66	N/A	0.65	1.89
PCE	NR Band n66 (AWS)	1712.5 - 1777.5 MHz	< 0.1	0.75	0.94	2.78	1.01	3.06
PCE	NR Band n25 (PCS)	1852.5 - 1912.5 MHz	< 0.1	0.49	0.77	2.10	0.98	2.75
PCE	NR Band n2 (PCS)	1852.5 - 1907.5 MHz	N/A	N/A	N/A	N/A	N/A	N/A
PCE	NR Band n41	2506.02 - 2679.99 MHz	< 0.1	< 0.1	0.18	N/A	0.23	1.27
DTS	2.4 GHz WLAN	2412 - 2462 MHz	0.35	< 0.1	0.64	N/A	0.63	1.34
NI	U-NI-1	5180 - 5240 MHz	N/A	N/A	N/A	N/A	N/A	N/A
NI	U-NI-2A	5260 - 5320 MHz	< 0.1	< 0.1	N/A	1.48	0.30	1.44
NI	U-NI-2C	5300 - 5720 MHz	< 0.1	< 0.1	N/A	2.29	0.19	1.29
NI	U-NI-3	5745 - 5825 MHz	0.12	< 0.1	0.28	N/A	0.32	1.41
DS/SDTS	Bluetooth	2402 - 2480 MHz	0.32	< 0.1	0.30	N/A	0.56	0.89
Simultaneous SAR per KDB 690783 D01v01r03:			1.06	1.20	1.59	3.86	1.59	3.99

Note: This revised Test Report (S/N: 1M2005200087-01-R2.A3L) supersedes and replaces the previously issued test report on the same subject device for the same type of testing as indicated. Please discard or destroy the previously issued test report(s) and dispose of it accordingly.

This wireless portable device has been shown to be capable of compliance for localized specific absorption rate (SAR) for uncontrolled environment/general population exposure limits specified in ANSI/IEEE C95.1-1992 and has been tested in accordance with the measurement procedures specified in Section 1.9 of this report; for North American frequency bands only.

I attest to the accuracy of data. All measurements reported herein were performed by me or were made under my supervision and are correct to the best of my knowledge and belief. I assume full responsibility for the completeness of these measurements and vouch for the qualifications of all persons taking them. Test results reported herein relate only to the item(s) tested.

 Randy Ortanez
 President



The SAR Tick is an initiative of the Mobile & Wireless Forum (MWF). While a product may be considered eligible, use of the SAR Tick logo requires an agreement with the MWF. Further details can be obtained by emailing: sartick@mwfai.info.





FCC ID: A3LSMF916U	 SAR EVALUATION REPORT	 Approved by: Quality Manager
Document S/N: 1M2005200087-01-R2.A3L	Test Dates: 06/28/20-08/24/20	DUT Type: Portable Handset
		Page 1 of 267

TABLE OF CONTENTS

1	DEVICE UNDER TEST	3
2	LTE AND NR INFORMATION	18
3	INTRODUCTION	20
4	DOSIMETRIC ASSESSMENT	21
5	DEFINITION OF REFERENCE POINTS.....	22
6	TEST CONFIGURATION POSITIONS.....	23
7	RF EXPOSURE LIMITS	27
8	FCC MEASUREMENT PROCEDURES.....	28
9	RF CONDUCTED POWERS	36
10	SYSTEM VERIFICATION.....	115
11	SAR DATA SUMMARY	127
12	FCC MULTI-TX AND ANTENNA SAR CONSIDERATIONS.....	196
13	SAR MEASUREMENT VARIABILITY	251
14	ADDITIONAL TESTING PER FCC GUIDANCE	253
15	EQUIPMENT LIST.....	263
16	MEASUREMENT UNCERTAINTIES.....	264
17	CONCLUSION.....	265
18	REFERENCES	266



- APPENDIX A: SAR TEST PLOTS
- APPENDIX B: SAR DIPOLE VERIFICATION PLOTS
- APPENDIX C: SAR TISSUE SPECIFICATIONS
- APPENDIX D: SAR SYSTEM VALIDATION
- APPENDIX E: DUT ANTENNA DIAGRAM & SAR TEST SETUP PHOTOGRAPHS
- APPENDIX F: DOWNLINK LTE CA RF CONDUCTED POWERS
- APPENDIX G: POWER REDUCTION VERIFICATION
- APPENDIX H: 802.11ax RU SAR EXCLUSION
- APPENDIX I: PROBE AND DIPOLE CALIBRATION CERTIFICATES

FCC ID: A3LSMF916U	 <small>Proud to be part of Samsung</small>	SAR EVALUATION REPORT		Approved by: Quality Manager
Document S/N: 1M2005200087-01-R2.A3L	Test Dates: 06/28/20-08/24/20	DUT Type: Portable Handset	Page 2 of 267	

1 DEVICE UNDER TEST

1.1 Device Overview

Band & Mode	Operating Modes	Tx Frequency
CDMA/EVDO BC10 (§90S)	Voice/Data	817.90 - 823.10 MHz
CDMA/EVDO BC0 (§22HS)	Voice/Data	824.70 - 848.31 MHz
PCS CDMA/EVDO	Voice/Data	1851.25 - 1908.75 MHz
GSM/GPRS/EDGE 850	Voice/Data	824.20 - 848.80 MHz
GSM/GPRS/EDGE 1900	Voice/Data	1850.20 - 1909.80 MHz
UMTS 850	Voice/Data	826.40 - 846.60 MHz
UMTS 1750	Voice/Data	1712.4 - 1752.6 MHz
UMTS 1900	Voice/Data	1852.4 - 1907.6 MHz
LTE Band 71	Voice/Data	665.5 - 695.5 MHz
LTE Band 12	Voice/Data	699.7 - 715.3 MHz
LTE Band 13	Voice/Data	779.5 - 784.5 MHz
LTE Band 14	Voice/Data	790.5 - 795.5 MHz
LTE Band 26 (Cell)	Voice/Data	814.7 - 848.3 MHz
LTE Band 5 (Cell)	Voice/Data	824.7 - 848.3 MHz
LTE Band 66 (AWS)	Voice/Data	1710.7 - 1779.3 MHz
LTE Band 4 (AWS)	Voice/Data	1710.7 - 1754.3 MHz
LTE Band 25 (PCS)	Voice/Data	1850.7 - 1914.3 MHz
LTE Band 2 (PCS)	Voice/Data	1850.7 - 1909.3 MHz
LTE Band 30	Voice/Data	2307.5 - 2312.5 MHz
LTE Band 7	Voice/Data	2502.5 - 2567.5 MHz
LTE Band 48	Voice/Data	3552.5 - 3697.5 MHz
LTE Band 41	Voice/Data	2498.5 - 2687.5 MHz
LTE Band 38	Voice/Data	2572.5 - 2617.5 MHz
NR Band n71	Data	665.5 - 695.5 MHz
NR Band n5	Data	826.5 - 846.5 MHz
NR Band n66	Data	1712.5 - 1777.5 MHz
NR Band n2	Data	1852.5 - 1907.5 MHz
NR Band n25	Data	1852.5 - 1912.5 MHz
NR Band n41	Data	2506.02 - 2679.99 MHz
2.4 GHz WLAN	Voice/Data	2412 - 2462 MHz
U-NII-1	Voice/Data	5180 - 5240 MHz
U-NII-2A	Voice/Data	5260 - 5320 MHz
U-NII-2C	Voice/Data	5500 - 5720 MHz
U-NII-3	Voice/Data	5745 - 5825 MHz
Bluetooth	Data	2402 - 2480 MHz
NFC	Data	13.56 MHz
MST	Data	555 Hz - 8.33 kHz
NR Band n260	Data	37000 - 40000 MHz
NR Band n261	Data	27500 - 28350 MHz

FCC ID: A3LSMF916U	 PCTEST <small>Proud to be part of Samsung</small>	SAR EVALUATION REPORT		Approved by: Quality Manager
Document S/N: 1M2005200087-01-R2.A3L	Test Dates: 06/28/20-08/24/20	DUT Type: Portable Handset	Page 3 of 267	

1.2 Time-Averaging Algorithm for RF Exposure Compliance

The equipment under test (EUT) contains Qualcomm® SDX55M modem supporting 5G NR.

The Qualcomm® SDX55M modem is enabled with Qualcomm® Smart Transmit feature. This feature performs time averaging algorithm in real time to control and manage transmitting power and ensure the time-averaged RF exposure is in compliance with FCC requirements all the time. Refer to Compliance Summary document for detailed description of Qualcomm® Smart Transmit feature (report SN can be found in Section 1.11 – Bibliography).

Note that WLAN operations are not enabled with Smart Transmit.

The Smart Transmit algorithm maintains the time-averaged transmit power, in turn, time-averaged RF exposure of *SAR_design_target* or *PD_design_target*, below the predefined time-averaged power limit (i.e., P_{limit} for sub-6 radio, and *input.power.limit* for 5G mmW NR), for each characterized technology and band (see RF Exposure Part 0 Test Report, report SN can be found in Section 1.11 - Bibliography).

Smart Transmit allows the device to transmit at higher power instantaneously, as high as P_{max} , when needed, but enforces power limiting to maintain time-averaged transmit power to P_{limit} . Below table shows P_{limit} EFS settings and maximum tune up output power P_{max} configured for this EUT for various transmit conditions (Device State Index DSI). Note that the device uncertainty for sub-6GHz WWAN is 1.0dB for this EUT.

Exposure Scenario:	Folder Open U MPC	Folder Closed Body-Worn	Folder Open U MPC	Folder Closed Phablet	Folder Open U MPC	Folder Closed Phablet	Folder Open Head	Folder Closed Head	Folder Open U MPC	Folder Closed Hotspot	Folder Open Earjack	Folder Closed Earjack	Maximum Tune-up Output Power*
Averaging Volume:	1g	1g	10g	10g	10g	10g	1g	1g	1g	1g	10g	10g	
Spacing:	10, 12, 16 mm	15 mm	12, 9, 16 mm	10, 12 mm	0 mm	0 mm	0 mm	0 mm	10 mm	10 mm	0 mm	0 mm	
DSI:	0	0	0	0	1	2	3	4	5	6	7	8	
Technology/Band													Pmax
CDMA/EVDO BC10			28.0			27.2		32.1		27.5		27.2	25.0
CDMA/EVDO BC0 Antenna A			28.0			26.8		31.6		26.8		26.8	25.0
CDMA/EVDO BC0 Antenna B			29.8			27.0		36.0		28.1		27.0	23.5
CDMA/EVDO BC1			23.0			19.0		23.0		19.0		19.0	24.0
GSM/GPRS/EDGE 850 MHz Antenna A			27.5			26.5		32.0		26.5		26.5	25.3
GSM/GPRS/EDGE 850 MHz Antenna B			33.4			29.6		35.5		29.6		29.6	24.3
GSM/GPRS/EDGE 1900 MHz			26.0			18.8		36.9		18.8		18.8	22.1
UMTS B5			26.8			25.8		31.2		25.8		25.8	24.8
UMTS B4			24.9			19.0		37.0		19.0		19.0	24.5
UMTS B2			23.5			19.0		23.5		19.0		19.0	24.5
LTE FDD B71			28.6			27.6		34.2		27.6		27.6	24.8
LTE FDD B12			28.3			28.3		35.3		28.9		28.3	24.8
LTE FDD B13 Antenna A			27.1			26.9		31.3		26.9		26.9	24.8
LTE FDD B13 Antenna B			27.7			26.2		37.3		30.4		26.2	22.8
LTE FDD B14 Antenna A			27.0			26.3		31.1		26.9		26.3	24.8
LTE FDD B14 Antenna B			27.7			25.9		35.6		29.9		25.9	22.8
LTE FDD B26			27.7			26.4		31.4		26.8		26.4	24.8
LTE FDD B5			27.2			26.1		31.1		26.1		26.1	24.8
LTE FDD B66/4			24.5			19.0		37.3		19.0		19.0	24.0
LTE FDD B25/2			25.2			19.0		38.0		19.0		19.0	24.5
LTE FDD B30			26.1			19.5		37.0		19.5		19.5	24.0
LTE FDD B7			21.0			18.5		21.0		18.5		18.5	24.0
LTE TDD B48			17.5			17.5		16.5		17.5		17.5	22.0
LTE TDD B41/38 PC3			20.5			17.0		20.5		17.0		17.0	22.0
LTE TDD B41 PC2			20.5			17.0		20.5		17.0		17.0	23.4
NR FDD n71			29.6			28.6		33.5		28.6		28.6	24.5
NR FDD n5			28.6			26.7		31.9		27.3		26.7	24.5
NR FDD n66			24.4			18.5		37.5		18.5		18.5	23.5
NR FDD n25/2			24.0			20.4		36.2		18.5		18.5	23.5
NR TDD n41			20.4			20.4		29.9		25.4		20.4	18.0



*Note all P_{limit} EFS and maximum tune up output power P_{max} levels entered in above Table correspond to average power levels after accounting for duty cycle in the case of TDD modulation schemes (for e.g., GSM & LTE TDD).

*Maximum tune up output power P_{max} is used to configure EUT during RF tune up procedure. The maximum allowed output power is equal to maximum Tune up output power + 1dB device design uncertainty.

The maximum time-averaged output power (dBm) for any 2G/3G/4G/5G Sub6 WWAN technology, band, and DSI = minimum of " P_{limit} EFS" and "Maximum tune up output power P_{max} " + 1dB device uncertainty. SAR values in this report were scaled to this maximum time-averaged output power to determine compliance per KDB Publication 447498 D01v06.

The purpose of this report (Part 1 test) is to demonstrate that the EUT meets FCC SAR limits when transmitting in static transmission scenario at maximum allowable time-averaged power levels.

Measurement Condition: All conducted power and SAR measurements in this report (Part 1 test) were performed by setting *Reserve_power_margin* (Smart Transmit EFS entry) to 0dB.

FCC ID: A3LSMF916U	 PCTEST Proud to be part of Samsung	SAR EVALUATION REPORT		Approved by: Quality Manager
Document S/N: 1M2005200087-01-R2.A3L	Test Dates: 06/28/20-08/24/20	DUT Type: Portable Handset		Page 4 of 267

1.3 Power Reduction for SAR



This device uses an independent fixed level power reduction mechanism for WLAN/BT operations during voice or VoIP held to ear scenarios, and WLAN operations when 5G NR is active. Per FCC Guidance, the held-to-ear exposure conditions were evaluated at reduced power according to the head SAR positions described in IEEE 1528-2013. Detailed descriptions of the power reduction mechanism are included in the operational description.

1.4 Nominal and Maximum Output Power Specifications

This device operates using the following maximum and nominal output power specifications. SAR values were scaled to the maximum allowed power to determine compliance per KDB Publication 447498 D01v06.

1.4.1 2G/3G/4G/5G Output Power



CDMA BC10 (815 MHz)				
Power Level		Modulated Average Output Power (in dBm)		
		1x-RTT	EVDO Rev 0	EVDO Rev A
Pmax, DSI = 0-8	Max allowed power	26.0	26.0	26.0
	Nominal	25.0	25.0	25.0
CDMA BC0 (835 MHz) Antenna A				
Power Level		Modulated Average Output Power (in dBm)		
		1x-RTT	EVDO Rev 0	EVDO Rev A
Pmax, DSI = 0-8	Max allowed power	26.0	26.0	26.0
	Nominal	25.0	25.0	25.0
CDMA BC0 (835 MHz) Antenna B				
Power Level		Modulated Average Output Power (in dBm)		
		1x-RTT	EVDO Rev 0	EVDO Rev A
Pmax, DSI = 0-8	Max allowed power	24.5	24.5	24.5
	Nominal	23.5	23.5	23.5
CDMA BC1 (1900 MHz)				
Power Level		Modulated Average Output Power (in dBm)		
		1x-RTT	EVDO Rev 0	EVDO Rev A
Pmax	Max allowed power	25.0	25.0	25.0
	Nominal	24.0	24.0	24.0
DSI = 0 (Folder open/close - Max)	Max allowed power	24.0	24.0	24.0
	Nominal	23.0	23.0	23.0
DSI = 1 (Folder open - Grip sensor)	Max allowed power	20.0	20.0	20.0
	Nominal	19.0	19.0	19.0
DSI = 2 (Folder close - Grip sensor)	Max allowed power	24.0	24.0	24.0
	Nominal	23.0	23.0	23.0
DSI = 3 (Folder open - RCV)	Max allowed power	20.0	20.0	20.0
	Nominal	19.0	19.0	19.0
DSI = 4 (Folder close - RCV)	Max allowed power	20.0	20.0	20.0
	Nominal	19.0	19.0	19.0
DSI = 5 (Folder open - Hotspot)	Max allowed power	20.0	20.0	20.0
	Nominal	19.0	19.0	19.0
DSI = 6 (Folder close - Hotspot)	Max allowed power	20.0	20.0	20.0
	Nominal	19.0	19.0	19.0
DSI = 7 (Folder open - Earjack)	Max allowed power	20.0	20.0	20.0
	Nominal	19.0	19.0	19.0
DSI = 8 (Folder close - Earjack)	Max allowed power	20.0	20.0	20.0
	Nominal	19.0	19.0	19.0

FCC ID: A3LSMF916U	 PCTEST <small>Prove it. Do your part. Do it right.</small>	SAR EVALUATION REPORT		Approved by: Quality Manager
Document S/N: 1M2005200087-01-R2.A3L	Test Dates: 06/28/20-08/24/20	DUT Type: Portable Handset	Page 5 of 267	

GSM/GPRS/EDGE 850 Antenna A										
Power Level		Voice (in dBm)	Data - Burst Average GMSK (in dBm)				Data - Burst Average 8-PSK (in dBm)			
		1 TX Slot	1 TX Slots	2 TX Slots	3 TX Slots	4 TX Slots	1 TX Slots	2 TX Slots	3 TX Slots	4 TX Slots
Pmax, DSI = 0-8	Max allowed power	33.5	33.5	32.5	30.5	28.5	28.0	26.0	24.0	23.0
	Nominal	32.5	32.5	31.5	29.5	27.5	27.0	25.0	23.0	22.0
GSM/GPRS/EDGE 850 Antenna B										
Power Level		Voice (in dBm)	Data - Burst Average GMSK (in dBm)				Data - Burst Average 8-PSK (in dBm)			
		1 TX Slot	1 TX Slots	2 TX Slots	3 TX Slots	4 TX Slots	1 TX Slots	2 TX Slots	3 TX Slots	4 TX Slots
Pmax, DSI = 0, 2, 4, 6, 8	Max allowed power	32.5	32.5	31.5	29.5	27.5	27.0	25.0	23.0	22.0
	Nominal	31.5	31.5	30.5	28.5	26.5	26.0	24.0	22.0	21.0
GSM/GPRS/EDGE 1900										
Power Level		Voice (in dBm)	Data - Burst Average GMSK (in dBm)				Data - Burst Average 8-PSK (in dBm)			
		1 TX Slot	1 TX Slots	2 TX Slots	3 TX Slots	4 TX Slots	1 TX Slots	2 TX Slots	3 TX Slots	4 TX Slots
Pmax	Max allowed power	30.5	30.5	29.0	27.5	25.5	27.0	25.0	23.0	22.0
	Nominal	29.5	29.5	28.0	26.5	24.5	26.0	24.0	22.0	21.0
DSI = 0 (Folder open/close - Max)	Max allowed power	30.5	30.5	29.0	27.5	25.5	27.0	25.0	23.0	22.0
	Nominal	29.5	29.5	28.0	26.5	24.5	26.0	24.0	22.0	21.0
DSI = 1 (Folder open - Grip sensor)	Max allowed power	29.0	29.0	26.0	24.2	23.0	27.0	25.0	23.0	22.0
	Nominal	28.0	28.0	25.0	23.2	22.0	26.0	24.0	22.0	21.0
DSI = 2 (Folder close - Grip sensor)	Max allowed power	30.5	30.5	29.0	27.5	25.5	27.0	25.0	23.0	22.0
	Nominal	29.5	29.5	28.0	26.5	24.5	26.0	24.0	22.0	21.0
DSI = 3 (Folder open - RCV)	Max allowed power	N/A	29.0	26.0	24.2	23.0	27.0	25.0	23.0	22.0
	Nominal	N/A	28.0	25.0	23.2	22.0	26.0	24.0	22.0	21.0
DSI = 4 (Folder close - RCV)	Max allowed power	N/A	29.0	26.0	24.2	23.0	27.0	25.0	23.0	22.0
	Nominal	N/A	28.0	25.0	23.2	22.0	26.0	24.0	22.0	21.0
DSI = 5 (Folder open - Hotspot)	Max allowed power	29.0	29.0	26.0	24.2	23.0	27.0	25.0	23.0	22.0
	Nominal	28.0	28.0	25.0	23.2	22.0	26.0	24.0	22.0	21.0
DSI = 6 (Folder close - Hotspot)	Max allowed power	29.0	29.0	26.0	24.2	23.0	27.0	25.0	23.0	22.0
	Nominal	28.0	28.0	25.0	23.2	22.0	26.0	24.0	22.0	21.0
DSI = 7 (Folder open - Earjack)	Max allowed power	29.0	29.0	26.0	24.2	23.0	27.0	25.0	23.0	22.0
	Nominal	28.0	28.0	25.0	23.2	22.0	26.0	24.0	22.0	21.0
DSI = 8 (Folder close - Earjack)	Max allowed power	29.0	29.0	26.0	24.2	23.0	27.0	25.0	23.0	22.0
	Nominal	28.0	28.0	25.0	23.2	22.0	26.0	24.0	22.0	21.0

For GSM, the above powers listed are GSM burst average values.



UMTS Band 5 (850 MHz)					
Power Level		Modulated Average Output Power (in dBm)			
		3GPP WCDMA Rel 99	3GPP HSDPA Rel 5	3GPP HSUPA Rel 6	3GPP DC-HSDPA Rel 8
Pmax, DSI = 0-8	Max allowed power	25.8	24.8	24.8	24.8
	Nominal	24.8	23.8	23.8	23.8
UMTS Band 4 (1750 MHz)					
Power Level		Modulated Average Output Power (in dBm)			
		3GPP WCDMA Rel 99	3GPP HSDPA Rel 5	3GPP HSUPA Rel 6	3GPP DC-HSDPA Rel 8
Pmax	Max allowed power	25.5	24.5	24.5	24.5
	Nominal	24.5	23.5	23.5	23.5
DSI = 0 (Folder open/close - Max)	Max allowed power	25.5	24.5	24.5	24.5
	Nominal	24.5	23.5	23.5	23.5
DSI = 1 (Folder open - Grip sensor)	Max allowed power	20.0	19.0	19.0	19.0
	Nominal	19.0	18.0	18.0	18.0
DSI = 2 (Folder close - Grip sensor)	Max allowed power	25.5	24.5	24.5	24.5
	Nominal	24.5	23.5	23.5	23.5
DSI = 3 (Folder open - RCV)	Max allowed power	25.5	24.5	24.5	24.5
	Nominal	24.5	23.5	23.5	23.5
DSI = 4 (Folder close - RCV)	Max allowed power	25.5	24.5	24.5	24.5
	Nominal	24.5	23.5	23.5	23.5
DSI = 5 (Folder open - Hotspot)	Max allowed power	20.0	19.0	19.0	19.0
	Nominal	19.0	18.0	18.0	18.0
DSI = 6 (Folder close - Hotspot)	Max allowed power	20.0	19.0	19.0	19.0
	Nominal	19.0	18.0	18.0	18.0
DSI = 7 (Folder open - Earjack)	Max allowed power	20.0	19.0	19.0	19.0
	Nominal	19.0	18.0	18.0	18.0
DSI = 8 (Folder close - Earjack)	Max allowed power	20.0	19.0	19.0	19.0
	Nominal	19.0	18.0	18.0	18.0
UMTS Band 2 (1900 MHz)					
Power Level		Modulated Average Output Power (in dBm)			
		3GPP WCDMA Rel 99	3GPP HSDPA Rel 5	3GPP HSUPA Rel 6	3GPP DC-HSDPA Rel 8
Pmax	Max allowed power	25.5	24.5	24.5	24.5
	Nominal	24.5	23.5	23.5	23.5
DSI = 0 (Folder open/close - Max)	Max allowed power	25.5	24.5	24.5	24.5
	Nominal	24.5	23.5	23.5	23.5
DSI = 1 (Folder open - Grip sensor)	Max allowed power	20.0	19.0	19.0	19.0
	Nominal	19.0	18.0	18.0	18.0
DSI = 2 (Folder close - Grip sensor)	Max allowed power	25.5	24.5	24.5	24.5
	Nominal	24.5	23.5	23.5	23.5
DSI = 3 (Folder open - RCV)	Max allowed power	25.5	24.5	24.5	24.5
	Nominal	24.5	23.5	23.5	23.5
DSI = 4 (Folder close - RCV)	Max allowed power	25.5	24.5	24.5	24.5
	Nominal	24.5	23.5	23.5	23.5
DSI = 5 (Folder open - Hotspot)	Max allowed power	20.0	19.0	19.0	19.0
	Nominal	19.0	18.0	18.0	18.0
DSI = 6 (Folder close - Hotspot)	Max allowed power	20.0	19.0	19.0	19.0
	Nominal	19.0	18.0	18.0	18.0
DSI = 7 (Folder open - Earjack)	Max allowed power	20.0	19.0	19.0	19.0
	Nominal	19.0	18.0	18.0	18.0
DSI = 8 (Folder close - Earjack)	Max allowed power	20.0	19.0	19.0	19.0
	Nominal	19.0	18.0	18.0	18.0

FCC ID: A3LSMF916U	 PCTEST Proud to be part of Samsung	SAR EVALUATION REPORT		Approved by: Quality Manager
Document S/N: 1M2005200087-01-R2.A3L	Test Dates: 06/28/20-08/24/20	DUT Type: Portable Handset		Page 6 of 267

Mode / Band		Modulated Average Output Power (in dBm)					
		Pmax	DSI = 0 (Folder open/close - Max)	DSI = 1 (Folder open - Grip sensor) DSI = 2 (Folder close - Grip sensor)	DSI = 3 (Folder open - RCV) DSI = 4 (Folder close - RCV)	DSI = 5 (Folder open - Hotspot) DSI = 6 (Folder close - Hotspot)	DSI = 7 (Folder open - Earjack) DSI = 8 (Folder close - Earjack)
LTE FDD Band 71	Max allowed power	25.8	25.8	25.8	25.8	25.8	25.8
	Nominal	24.8	24.8	24.8	24.8	24.8	24.8
LTE FDD Band 12	Max allowed power	25.8	25.8	25.8	25.8	25.8	25.8
	Nominal	24.8	24.8	24.8	24.8	24.8	24.8
LTE FDD Band 13 Antenna A	Max allowed power	25.8	25.8	25.8	25.8	25.8	25.8
	Nominal	24.8	24.8	24.8	24.8	24.8	24.8
LTE FDD Band 13 Antenna B	Max allowed power	23.8	23.8	23.8	23.8	23.8	23.8
	Nominal	22.8	22.8	22.8	22.8	22.8	22.8
LTE FDD Band 14 Antenna A	Max allowed power	25.8	25.8	25.8	25.8	25.8	25.8
	Nominal	24.8	24.8	24.8	24.8	24.8	24.8
LTE FDD Band 14 Antenna B	Max allowed power	23.8	23.8	23.8	23.8	23.8	23.8
	Nominal	22.8	22.8	22.8	22.8	22.8	22.8
LTE FDD Band 26	Max allowed power	25.8	25.8	25.8	25.8	25.8	25.8
	Nominal	24.8	24.8	24.8	24.8	24.8	24.8
LTE FDD Band 5	Max allowed power	25.8	25.8	25.8	25.8	25.8	25.8
	Nominal	24.8	24.8	24.8	24.8	24.8	24.8
LTE FDD Band 66	Max allowed power	25.0	25.0	20.0	25.0	20.0	20.0
	Nominal	24.0	24.0	19.0	24.0	19.0	19.0
LTE FDD Band 4	Max allowed power	25.0	25.0	20.0	25.0	20.0	20.0
	Nominal	24.0	24.0	19.0	24.0	19.0	19.0
LTE FDD Band 25	Max allowed power	25.5	25.5	20.0	25.5	20.0	20.0
	Nominal	24.5	24.5	19.0	24.5	19.0	19.0
LTE FDD Band 2	Max allowed power	25.5	25.5	20.0	25.5	20.0	20.0
	Nominal	24.5	24.5	19.0	24.5	19.0	19.0
LTE FDD Band 30	Max allowed power	25.0	25.0	20.5	25.0	20.5	20.5
	Nominal	24.0	24.0	19.5	24.0	19.5	19.5
LTE FDD Band 7	Max allowed power	25.0	22.0	19.5	22.0	19.5	19.5
	Nominal	24.0	21.0	18.5	21.0	18.5	18.5
LTE TDD Band 48	Max allowed power	25.0	20.5	20.5	20.5	20.5	20.5
	Nominal	24.0	19.5	19.5	18.5	19.5	19.5
LTE TDD Band 41 (PC3)	Max allowed power	25.0	23.5	20.0	23.5	20.0	20.0
	Nominal	24.0	22.5	19.0	22.5	19.0	19.0
LTE TDD Band 41 (PC2)	Max allowed power	28.0	25.1	21.6	25.1	21.6	21.6
	Nominal	27.0	24.1	20.6	24.1	20.6	20.6
LTE TDD Band 38	Max allowed power	25.0	23.5	20.0	23.5	20.0	20.0
	Nominal	24.0	22.5	19.0	22.5	19.0	19.0

Mode / Band		Modulated Average Output Power (in dBm)					
		Pmax	DSI = 0 (Folder open/close - Max)	DSI = 1 (Folder open - Grip sensor) DSI = 2 (Folder close - Grip sensor)	DSI = 3 (Folder open - RCV) DSI = 4 (Folder close - RCV)	DSI = 5 (Folder open - Hotspot) DSI = 6 (Folder close - Hotspot)	DSI = 7 (Folder open - Earjack) DSI = 8 (Folder close - Earjack)
NR FDD Band 71	Max allowed power	25.5	25.5	25.5	25.5	25.5	25.5
	Nominal	24.5	24.5	24.5	24.5	24.5	24.5
NR FDD Band 5	Max allowed power	25.5	25.5	25.5	25.5	25.5	25.5
	Nominal	24.5	24.5	24.5	24.5	24.5	24.5
NR FDD Band 66	Max allowed power	24.5	24.5	19.5	24.5	19.5	19.5
	Nominal	23.5	23.5	18.5	23.5	18.5	18.5
NR FDD Band 25	Max allowed power	24.5	24.5	19.5	24.5	19.5	19.5
	Nominal	23.5	23.5	18.5	23.5	18.5	18.5
NR FDD Band 2	Max allowed power	24.5	24.5	19.5	24.5	19.5	19.5
	Nominal	23.5	23.5	18.5	23.5	18.5	18.5
NR TDD Band 41	Max allowed power	25.0	25.0	25.0	25.0	25.0	25.0
	Nominal	24.0	24.0	24.0	24.0	24.0	24.0

For LTE TDD and NR TDD, the above powers listed are TDD burst average values.

FCC ID: A3LSMF916U	 PCTEST <small>Proud to be part of Samsung</small>	SAR EVALUATION REPORT		Approved by: Quality Manager
Document S/N: 1M2005200087-01-R2.A3L	Test Dates: 06/28/20-08/24/20	DUT Type: Portable Handset	Page 7 of 267	

1.4.2 2.4 GHz Maximum Bluetooth and SISO/MIMO WLAN Output Power

Note: Targets for 802.11ax RU operations can be found in Appendix H

Mode	Band	IEEE 802.11 (in dBm)															
		SISO								MIMO							
		Antenna 1 & Antenna 2															
		b		g		n		ax (SU)		b (CDD + STBC)		g (CDD + STBC)		n (CDD + STBC, SDM)		ax (SU) (CDD + STBC, SDM)	
Nominal	Max	Nominal	Max	Nominal	Max	Nominal	Max	Nominal	Max	Nominal	Max	Nominal	Max	Nominal	Max		
2.4 GHz WiFi	2.45 GHz	18.0	19.0	17.0	18.0	17.0 ch. 1: 15.5 ch. 11: 15.0	18.0 ch. 1: 16.5 ch. 11: 16.0	17.0 ch. 1: 16.0 ch. 11: 15.0	18.0 ch. 1: 17.0 ch. 11: 16.0	21.0	22.0	20.0	21.0	20.0 ch. 1: 18.5 ch. 11: 18.0	21.0 ch. 1: 19.5 ch. 11: 19.0	20.0 ch. 1: 19.0 ch. 11: 18.0	21.0 ch. 1: 20.0 ch. 11: 19.0

(Upper tolerance: target + 1.0 dB)

Mode / Band		Modulated Average - Antenna 1 & Antenna 2 (dBm)
Bluetooth	Maximum	20.0
	Nominal	19.0
Bluetooth EDR	Maximum	16.5
	Nominal	15.5
Bluetooth LE 2 Mbps	Maximum	9.0
	Nominal	8.0
Bluetooth LE 1 Mbps, 125/500Kbps	Maximum	9.0
	Nominal	8.0

(Upper tolerance: target + 1.0 dB)

1.4.3 2.4 GHz Reduced Bluetooth and SISO/MIMO WLAN Output Power

Note: Targets for 802.11ax RU operations can be found in Appendix H

The below table is applicable in the following conditions:

- Simultaneous conditions with 5 GHz WLAN

Mode	Band	IEEE 802.11 (in dBm)															
		SISO								MIMO							
		Antenna 1 & Antenna 2															
		b		g		n		ax (SU)		b (CDD + STBC)		g (CDD + STBC)		n (CDD + STBC, SDM)		ax (SU) (CDD + STBC, SDM)	
Nominal	Max	Nominal	Max	Nominal	Max	Nominal	Max	Nominal	Max	Nominal	Max	Nominal	Max	Nominal	Max		
2.4 GHz WiFi	2.45 GHz	16.0	17.0	16.0	17.0	16.0 ch. 1: 15.5 ch. 11: 15.0	17.0 ch. 1: 16.5 ch. 11: 16.0	16.0 ch. 1: 15.0 ch. 11: 16.0	17.0 ch. 1: 16.0 ch. 11: 16.0	19.0	20.0	19.0	20.0	19.0 ch. 1: 18.5 ch. 11: 18.0	20.0 ch. 1: 19.5 ch. 11: 19.0	19.0 ch. 1: 18.0 ch. 11: 19.0	20.0 ch. 1: 19.0 ch. 11: 19.0



(Upper tolerance: target + 1.0 dB)

The below table is applicable in the following conditions:

- Head Conditions
- Head Conditions during simultaneous conditions with 5 GHz WLAN
- Head Conditions during simultaneous conditions with mmWave and/or 5 GHz WLAN
- Simultaneous conditions with mmWave

Mode	Band	IEEE 802.11 (in dBm)															
		SISO								MIMO							
		Antenna 1 & Antenna 2															
		b		g		n		ax (SU)		b (CDD + STBC)		g (CDD + STBC)		n (CDD + STBC, SDM)		ax (SU) (CDD + STBC, SDM)	
Nominal	Max	Nominal	Max	Nominal	Max	Nominal	Max	Nominal	Max	Nominal	Max	Nominal	Max	Nominal	Max		
2.4 GHz WiFi	2.45 GHz	12.0	13.0	12.0	13.0	12.0	13.0	12.0	13.0	15.0	16.0	15.0	16.0	15.0	16.0	15.0	16.0

(Upper tolerance: target + 1.0 dB)

FCC ID: A3LSMF916U	 PCTEST <small> Proud to be part of Samsung </small>	SAR EVALUATION REPORT		Approved by: Quality Manager
Document S/N: 1M2005200087-01-R2.A3L	Test Dates: 06/28/20-08/24/20	DUT Type: Portable Handset	Page 8 of 267	

The below table is applicable in the following conditions:

- Head Conditions

Mode / Band		Modulated Average - Antenna 1 & Antenna 2 (dBm)
Bluetooth	Maximum	14.0
	Nominal	13.0
Bluetooth EDR	Maximum	10.0
	Nominal	9.0
Bluetooth LE 2 Mbps	Maximum	9.0
	Nominal	8.0
Bluetooth LE 1 Mbps, 125/500Kbps	Maximum	9.0
	Nominal	8.0



(Upper tolerance: target + 1.0 dB)

1.4.4 5 GHz Maximum SISO/MIMO WLAN Output Power

Note: Targets for 802.11ax RU operations can be found in Appendix H

Mode	Band	IEEE 802.11 (in dBm)																			
		SISO								MIMO											
		Antenna 1 & Antenna 2								a				n				ac			
		a		n		ac		ax (SU)		(CDD + STBC)		(CDD + STBC, SDM)		(CDD + STBC, SDM)		(CDD + STBC, SDM)					
Nominal	Max	Nominal	Max	Nominal	Max	Nominal	Max	Nominal	Max	Nominal	Max	Nominal	Max	Nominal	Max	Nominal	Max				
5 GHz WiFi (20MHz BW)	5200 MHz	17.0	18.0	17.0	18.0	17.0	18.0	17.0	18.0	20.0	21.0	20.0	21.0	20.0	21.0	20.0	21.0				
	5300 MHz	17.0	18.0	17.0	18.0	17.0	18.0	17.0	18.0	20.0	21.0	20.0	21.0	20.0	21.0	20.0	21.0				
	5500 MHz	17.0	18.0	17.0	18.0	17.0	18.0	17.0	18.0	20.0	21.0	20.0	21.0	20.0	21.0	20.0	21.0				
	5800 MHz	17.0	18.0	17.0	18.0	17.0	18.0	17.0	18.0	20.0	21.0	20.0	21.0	20.0	21.0	20.0	21.0				
5 GHz WiFi (40MHz BW)	5200 MHz			16.0	17.0	16.0	17.0	16.0	17.0			19.0	20.0	19.0	20.0	19.0	20.0				
	5300 MHz			16.0	17.0	16.0	17.0	16.0	17.0			19.0	20.0	19.0	20.0	19.0	20.0				
	5500 MHz			16.0	17.0	16.0	17.0	16.0	17.0			19.0	20.0	19.0	20.0	19.0	20.0				
	5800 MHz			16.0	17.0	16.0	17.0	16.0	17.0			19.0	20.0	19.0	20.0	19.0	20.0				
5 GHz WiFi (80MHz BW)	5200 MHz					15.0	16.0	15.0	16.0					18.0	19.0	18.0	19.0				
	5300 MHz					15.0	16.0	15.0	16.0					18.0	19.0	18.0	19.0				
	5500 MHz					15.0	16.0	15.0	16.0					18.0	19.0	18.0	19.0				
	5800 MHz					15.0	16.0	15.0	16.0					18.0	19.0	18.0	19.0				

(Upper tolerance: target + 1.0 dB)

FCC ID: A3LSMF916U	 PCTEST <small>Proud to be part of Samsung</small>	SAR EVALUATION REPORT		Approved by: Quality Manager
Document S/N: 1M2005200087-01-R2.A3L	Test Dates: 06/28/20-08/24/20	DUT Type: Portable Handset		Page 9 of 267

1.4.5 5 GHz Reduced WLAN Output Power

Note: Targets for 802.11ax RU operations can be found in Appendix H

The below table is applicable in the following conditions:

- Simultaneous conditions with 2.4 GHz WLAN and/or 2.4 GHz Bluetooth

Mode	Band	IEEE 802.11 (in dBm)																	
		SISO								MIMO									
		Antenna 1 & Antenna 2								a				n		ac		ax (SU)	
		a		n		ac		ax (SU)		(CDD + STBC)		(CDD + STBC, SDM)		(CDD + STBC, SDM)		ax (SU) (CDD + STBC, SDM)			
Nominal	Max	Nominal	Max	Nominal	Max	Nominal	Max	Nominal	Max	Nominal	Max	Nominal	Max	Nominal	Max	Nominal	Max		
5 GHz WiFi (20MHz BW)	5200 MHz	13.0	14.0	13.0	14.0	13.0	14.0	13.0	14.0	16.0	17.0	16.0	17.0	16.0	17.0	16.0	17.0		
	5300 MHz	13.0	14.0	13.0	14.0	13.0	14.0	13.0	14.0	16.0	17.0	16.0	17.0	16.0	17.0	16.0	17.0		
	5500 MHz	13.0	14.0	13.0	14.0	13.0	14.0	13.0	14.0	16.0	17.0	16.0	17.0	16.0	17.0	16.0	17.0		
	5800 MHz	13.0	14.0	13.0	14.0	13.0	14.0	13.0	14.0	16.0	17.0	16.0	17.0	16.0	17.0	16.0	17.0		
5 GHz WiFi (40MHz BW)	5200 MHz			13.0	14.0	13.0	14.0	13.0	14.0			16.0	17.0	16.0	17.0	16.0	17.0		
	5300 MHz			13.0	14.0	13.0	14.0	13.0	14.0			16.0	17.0	16.0	17.0	16.0	17.0		
	5500 MHz			13.0	14.0	13.0	14.0	13.0	14.0			16.0	17.0	16.0	17.0	16.0	17.0		
	5800 MHz			13.0	14.0	13.0	14.0	13.0	14.0			16.0	17.0	16.0	17.0	16.0	17.0		
5 GHz WiFi (80MHz BW)	5200 MHz					13.0	14.0	13.0	14.0					16.0	17.0	16.0	17.0		
	5300 MHz					13.0	14.0	13.0	14.0					16.0	17.0	16.0	17.0		
	5500 MHz					13.0	14.0	13.0	14.0					16.0	17.0	16.0	17.0		
	5800 MHz					13.0	14.0	13.0	14.0					16.0	17.0	16.0	17.0		



(Upper tolerance: target + 1.0 dB)

The below table is applicable in the following conditions:

- Head Conditions
- Head Conditions during simultaneous conditions with 2.4 GHz WLAN
- Head Conditions during simultaneous conditions with mmWave and/or 2.4 GHz WLAN
- Simultaneous conditions with mmWave

Mode	Band	IEEE 802.11 (in dBm)																	
		SISO								MIMO									
		Antenna 1 & Antenna 2								a				n		ac		ax (SU)	
		a		n		ac		ax (SU)		(CDD + STBC)		(CDD + STBC, SDM)		(CDD + STBC, SDM)		ax (SU) (CDD + STBC, SDM)			
Nominal	Max	Nominal	Max	Nominal	Max	Nominal	Max	Nominal	Max	Nominal	Max	Nominal	Max	Nominal	Max	Nominal	Max		
5 GHz WiFi (20MHz BW)	5200 MHz	10.0	11.0	10.0	11.0	10.0	11.0	10.0	11.0	13.0	14.0	13.0	14.0	13.0	14.0	13.0	14.0		
	5300 MHz	10.0	11.0	10.0	11.0	10.0	11.0	10.0	11.0	13.0	14.0	13.0	14.0	13.0	14.0	13.0	14.0		
	5500 MHz	10.0	11.0	10.0	11.0	10.0	11.0	10.0	11.0	13.0	14.0	13.0	14.0	13.0	14.0	13.0	14.0		
	5800 MHz	10.0	11.0	10.0	11.0	10.0	11.0	10.0	11.0	13.0	14.0	13.0	14.0	13.0	14.0	13.0	14.0		
5 GHz WiFi (40MHz BW)	5200 MHz			10.0	11.0	10.0	11.0	10.0	11.0			13.0	14.0	13.0	14.0	13.0	14.0		
	5300 MHz			10.0	11.0	10.0	11.0	10.0	11.0			13.0	14.0	13.0	14.0	13.0	14.0		
	5500 MHz			10.0	11.0	10.0	11.0	10.0	11.0			13.0	14.0	13.0	14.0	13.0	14.0		
	5800 MHz			10.0	11.0	10.0	11.0	10.0	11.0			13.0	14.0	13.0	14.0	13.0	14.0		
5 GHz WiFi (80MHz BW)	5200 MHz					10.0	11.0	10.0	11.0					13.0	14.0	13.0	14.0		
	5300 MHz					10.0	11.0	10.0	11.0					13.0	14.0	13.0	14.0		
	5500 MHz					10.0	11.0	10.0	11.0					13.0	14.0	13.0	14.0		
	5800 MHz					10.0	11.0	10.0	11.0					13.0	14.0	13.0	14.0		

(Upper tolerance: target + 1.0 dB)



FCC ID: A3LSMF916U	 PCTEST <small>Provided to be part of Samsung</small>	SAR EVALUATION REPORT		Approved by: Quality Manager
Document S/N: 1M2005200087-01-R2.A3L	Test Dates: 06/28/20-08/24/20	DUT Type: Portable Handset	Page 10 of 267	

1.5 DUT Antenna Locations

The overall dimensions of this device are > 9 x 5 cm. A diagram showing the location of the device antennas can be found in Appendix E. This device is considered a "phablet" when it is in closed configuration and a "UMPC mini-tablet" when it is in open configuration. Exact antenna dimensions and separation distances are shown in the Technical Descriptions in the FCC filing

**Table 1-1
Device Edges/Sides for Closed Configuration SAR Testing**



Mode	Back	Front	Top	Bottom	Right	Left
EVDO BC10 (§90S)	Yes	Yes	No	Yes	Yes	No
EVDO BC0 (§22H) Ant A	Yes	Yes	No	Yes	Yes	No
EVDO BC0 (§22H) Ant B	Yes	Yes	No	Yes	Yes	Yes
PCS EVDO	Yes	Yes	No	Yes	Yes	Yes
GPRS 850 Ant A	Yes	Yes	No	Yes	Yes	No
GPRS 850 Ant B	Yes	Yes	No	Yes	Yes	Yes
GPRS 1900	Yes	Yes	No	Yes	Yes	Yes
UMTS 850	Yes	Yes	No	Yes	Yes	No
UMTS 1750	Yes	Yes	No	Yes	Yes	Yes
UMTS 1900	Yes	Yes	No	Yes	Yes	Yes
LTE Band 71	Yes	Yes	No	Yes	Yes	No
LTE Band 12	Yes	Yes	No	Yes	Yes	No
LTE Band 13 Ant A	Yes	Yes	No	Yes	Yes	No
LTE Band 13 Ant B	Yes	Yes	No	Yes	Yes	Yes
LTE Band 14 Ant A	Yes	Yes	No	Yes	Yes	No
LTE Band 14 Ant B	Yes	Yes	No	Yes	Yes	Yes
LTE Band 26 (Cell)	Yes	Yes	No	Yes	Yes	No
LTE Band 5 (Cell)	Yes	Yes	No	Yes	Yes	No
LTE Band 66 (AWS)	Yes	Yes	No	Yes	Yes	Yes
LTE Band 25 (PCS)	Yes	Yes	No	Yes	Yes	Yes
LTE Band 30	Yes	Yes	No	Yes	Yes	Yes
LTE Band 7	Yes	Yes	No	Yes	Yes	Yes
LTE Band 48	Yes	Yes	Yes	No	No	Yes
LTE Band 41	Yes	Yes	No	Yes	Yes	Yes
NR Band n71	Yes	Yes	No	Yes	Yes	No
NR Band n5 (Cell)	Yes	Yes	No	Yes	Yes	No
NR Band n66 (AWS)	Yes	Yes	No	Yes	Yes	Yes
NR Band n25 (PCS)	Yes	Yes	No	Yes	Yes	Yes
NR Band n41	Yes	Yes	Yes	No	No	Yes
2.4 GHz WLAN Ant 1	Yes	Yes	Yes	No	No	Yes
2.4 GHz WLAN Ant 2	Yes	Yes	Yes	No	Yes	Yes
5 GHz WLAN Ant 1	Yes	Yes	Yes	No	No	Yes
5 GHz WLAN Ant 2	Yes	Yes	Yes	No	Yes	Yes
5 GHz WLAN MIMO	Yes	Yes	Yes	No	Yes	Yes
Bluetooth Ant 1	Yes	Yes	Yes	No	No	Yes
Bluetooth Ant 2	Yes	Yes	Yes	No	Yes	Yes

FCC ID: A3LSMF916U	 PCTEST <small>Proud to be part of Samsung</small>	SAR EVALUATION REPORT		Approved by: Quality Manager
Document S/N: 1M2005200087-01-R2.A3L	Test Dates: 06/28/20-08/24/20	DUT Type: Portable Handset	Page 11 of 267	

**Table 1-2
Device Edges/Sides for Open Configuration SAR Testing**

Mode	Back	Front	Top	Bottom	Right	Left
EVDO BC10 (§90S)	Yes	Yes	No	Yes	Yes	No
EVDO BC0 (§22H) Ant A	Yes	Yes	No	Yes	Yes	No
EVDO BC0 (§22H) Ant B	Yes	Yes	No	Yes	Yes	No
PCS EVDO	Yes	Yes	No	Yes	Yes	No
GPRS 850 Ant A	Yes	Yes	No	Yes	Yes	No
GPRS 1900	Yes	Yes	No	Yes	Yes	No
UMTS 850	Yes	Yes	No	Yes	Yes	No
UMTS 1750	Yes	Yes	No	Yes	Yes	No
UMTS 1900	Yes	Yes	No	Yes	Yes	No
LTE Band 71	Yes	Yes	No	Yes	Yes	No
LTE Band 12	Yes	Yes	No	Yes	Yes	No
LTE Band 13 Ant A	Yes	Yes	No	Yes	Yes	No
LTE Band 13 Ant B	Yes	Yes	No	Yes	Yes	No
LTE Band 14 Ant A	Yes	Yes	No	Yes	Yes	No
LTE Band 14 Ant B	Yes	Yes	No	Yes	Yes	No
LTE Band 26 (Cell)	Yes	Yes	No	Yes	Yes	No
LTE Band 5 (Cell)	Yes	Yes	No	Yes	Yes	No
LTE Band 66 (AWS)	Yes	Yes	No	Yes	Yes	No
LTE Band 25 (PCS)	Yes	Yes	No	Yes	Yes	No
LTE Band 30	Yes	Yes	No	Yes	Yes	No
LTE Band 7	Yes	Yes	No	Yes	Yes	No
LTE Band 48	Yes	Yes	Yes	No	Yes	No
LTE Band 41	Yes	Yes	No	Yes	Yes	No
NR Band n71	Yes	Yes	No	Yes	Yes	No
NR Band n5 (Cell)	Yes	Yes	No	Yes	Yes	No
NR Band n66 (AWS)	Yes	Yes	No	Yes	Yes	No
NR Band n25 (PCS)	Yes	Yes	No	Yes	Yes	No
NR Band n41	Yes	Yes	Yes	No	No	No
2.4 GHz WLAN Ant 1	Yes	Yes	Yes	No	No	No
2.4 GHz WLAN Ant 2	Yes	Yes	Yes	No	No	Yes
2.4 GHz WLAN MIMO	Yes	Yes	Yes	No	No	Yes
5 GHz WLAN Ant 1	Yes	Yes	Yes	No	No	No
5 GHz WLAN Ant 2	Yes	Yes	Yes	No	No	Yes
5 GHz WLAN MIMO	Yes	Yes	Yes	No	No	Yes
Bluetooth Ant 1	Yes	Yes	Yes	No	No	No
Bluetooth Ant 2	Yes	Yes	Yes	No	No	Yes

Note: Particular DUT edges were not required to be evaluated for wireless router SAR, phablet SAR or UMPC mini-tablet SAR if the edges were greater than 2.5 cm from the transmitting antenna according to FCC KDB Publication 941225 D06v02r01 Section III, FCC KDB Publication 941225 D07v01r02 and FCC KDB Publication 648474 D04v01r03. The distances between the transmit antennas and the edges of the device are included in the filing. When wireless router mode is enabled, U-NII-1, U-NII-2A, U-NII-2C operations are disabled.

FCC ID: A3LSMF916U	 <small>Proud to be part of Samsung</small>	SAR EVALUATION REPORT		Approved by: Quality Manager
Document S/N: 1M2005200087-01-R2.A3L	Test Dates: 06/28/20-08/24/20	DUT Type: Portable Handset	Page 12 of 267	



1.6 Near Field Communications (NFC) Antenna

This DUT has NFC operations. The NFC antenna is integrated into the device for this model. Therefore, all SAR tests were performed with the device which already incorporates the NFC antenna. A diagram showing the location of the NFC antenna can be found in Appendix E.

1.7 Simultaneous Transmission Capabilities

According to FCC KDB Publication 447498 D01v06, transmitters are considered to be operating simultaneously when there is overlapping transmission, with the exception of transmissions during network hand-offs with maximum hand-off duration less than 30 seconds.



This device contains multiple transmitters that may operate simultaneously, and therefore requires a simultaneous transmission analysis according to FCC KDB Publication 447498 D01v06 4.3.2 procedures.

FCC ID: A3LSMF916U	 PCTEST <small>Proud to be part of Samsung</small>	SAR EVALUATION REPORT		Approved by: Quality Manager
Document S/N: 1M2005200087-01-R2.A3L	Test Dates: 06/28/20-08/24/20	DUT Type: Portable Handset	Page 13 of 267	

**Table 1-3
Simultaneous Transmission Scenarios**

No.	Capable Transmit Configuration	Head	Body-Worn Accessory	Wireless Router	Phablet	UMPC Body	UMPC Exeremy	Notes
1	1x CDMA voice + 2.4 GHz Bluetooth Ant 1	Yes ^A	Yes	N/A	Yes	Yes	Yes	^A Bluetooth Tethering is considered
2	1x CDMA voice + 2.4 GHz Bluetooth Ant 2	Yes ^A	Yes	N/A	Yes	Yes	Yes	^A Bluetooth Tethering is considered
3	1x CDMA voice + 2.4 GHz Wi-Fi MIMO	Yes	Yes	N/A	Yes	Yes	Yes	
4	1x CDMA voice + 5 GHz Wi-Fi MIMO	Yes	Yes	N/A	Yes	Yes	Yes	
5	1x CDMA voice + 2.4 GHz Wi-Fi MIMO + 5 GHz Wi-Fi MIMO	Yes	Yes	N/A	Yes	Yes	Yes	
6	1x CDMA voice + 2.4 GHz Bluetooth Ant 1 + 5 GHz Wi-Fi MIMO	Yes ^A	Yes	N/A	Yes	Yes	Yes	^A Bluetooth Tethering is considered
7	1x CDMA voice + 2.4 GHz Bluetooth Ant 2 + 5 GHz Wi-Fi MIMO	Yes ^A	Yes	N/A	Yes	Yes	Yes	^A Bluetooth Tethering is considered
8	1x CDMA voice + 2.4 GHz Bluetooth Ant 1 + 2.4 GHz Wi-Fi Ant 2 + 5 GHz Wi-Fi MIMO	Yes ^A	Yes	N/A	Yes	Yes	Yes	^A Bluetooth Tethering is considered
9	GSM voice + 2.4 GHz Bluetooth Ant 1	Yes ^A	Yes	N/A	Yes	Yes	Yes	^A Bluetooth Tethering is considered
10	GSM voice + 2.4 GHz Bluetooth Ant 2	Yes ^A	Yes	N/A	Yes	Yes	Yes	^A Bluetooth Tethering is considered
11	GSM voice + 2.4 GHz Wi-Fi MIMO	Yes	Yes	N/A	Yes	Yes	Yes	
12	GSM voice + 5 GHz Wi-Fi MIMO	Yes	Yes	N/A	Yes	Yes	Yes	
13	GSM voice + 2.4 GHz Wi-Fi MIMO + 5 GHz Wi-Fi MIMO	Yes	Yes	N/A	Yes	Yes	Yes	
14	GSM voice + 2.4 GHz Bluetooth Ant 1 + 5 GHz Wi-Fi MIMO	Yes ^A	Yes	N/A	Yes	Yes	Yes	^A Bluetooth Tethering is considered
15	GSM voice + 2.4 GHz Bluetooth Ant 2 + 5 GHz Wi-Fi MIMO	Yes ^A	Yes	N/A	Yes	Yes	Yes	^A Bluetooth Tethering is considered
16	GSM voice + 2.4 GHz Bluetooth Ant 1 + 2.4 GHz Wi-Fi Ant 2 + 5 GHz Wi-Fi MIMO	Yes ^A	Yes	N/A	Yes	Yes	Yes	^A Bluetooth Tethering is considered
17	UMTS + 2.4 GHz Bluetooth Ant 1	Yes ^A	Yes	Yes ^A	Yes	Yes	Yes	^A Bluetooth Tethering is considered
18	UMTS + 2.4 GHz Bluetooth Ant 2	Yes ^A	Yes	Yes ^A	Yes	Yes	Yes	^A Bluetooth Tethering is considered
19	UMTS + 2.4 GHz Wi-Fi MIMO	Yes	Yes	Yes	Yes	Yes	Yes	
20	UMTS + 5 GHz Wi-Fi MIMO	Yes	Yes	Yes	Yes	Yes	Yes	
21	UMTS + 2.4 GHz Wi-Fi MIMO + 5 GHz Wi-Fi MIMO	Yes	Yes	Yes	Yes	Yes	Yes	
22	UMTS + 2.4 GHz Bluetooth Ant 1 + 5 GHz Wi-Fi MIMO	Yes ^A	Yes	Yes ^A	Yes	Yes	Yes	^A Bluetooth Tethering is considered
23	UMTS + 2.4 GHz Bluetooth Ant 2 + 5 GHz Wi-Fi MIMO	Yes ^A	Yes	Yes ^A	Yes	Yes	Yes	^A Bluetooth Tethering is considered
24	UMTS + 2.4 GHz Bluetooth Ant 1 + 2.4 GHz Wi-Fi Ant 2 + 5 GHz Wi-Fi MIMO	Yes ^A	Yes	Yes ^A	Yes	Yes	Yes	^A Bluetooth Tethering is considered
25	LTE + 2.4 GHz Bluetooth Ant 1	Yes ^A	Yes	Yes ^A	Yes	Yes	Yes	^A Bluetooth Tethering is considered
26	LTE + 2.4 GHz Bluetooth Ant 2	Yes ^A	Yes	Yes ^A	Yes	Yes	Yes	^A Bluetooth Tethering is considered
27	LTE + 2.4 GHz Wi-Fi MIMO	Yes	Yes	Yes	Yes	Yes	Yes	
28	LTE + 5 GHz Wi-Fi MIMO	Yes	Yes	Yes	Yes	Yes	Yes	
29	LTE + 2.4 GHz Wi-Fi MIMO + 5 GHz Wi-Fi MIMO	Yes	Yes	Yes	Yes	Yes	Yes	
30	LTE + 2.4 GHz Bluetooth Ant 1 + 5 GHz Wi-Fi MIMO	Yes ^A	Yes	Yes ^A	Yes	Yes	Yes	^A Bluetooth Tethering is considered
31	LTE + 2.4 GHz Bluetooth Ant 2 + 5 GHz Wi-Fi MIMO	Yes ^A	Yes	Yes ^A	Yes	Yes	Yes	^A Bluetooth Tethering is considered
32	LTE + 2.4 GHz Bluetooth Ant 1 + 2.4 GHz Wi-Fi Ant 2 + 5 GHz Wi-Fi MIMO	Yes ^A	Yes	Yes ^A	Yes	Yes	Yes	^A Bluetooth Tethering is considered
33	LTE + NR	Yes	Yes	N/A	Yes	Yes	Yes	
34	LTE + NR + 2.4 GHz Bluetooth Ant 1	Yes ^A	Yes	Yes ^A	Yes	Yes	Yes	^A Bluetooth Tethering is considered
35	LTE + NR + 2.4 GHz Bluetooth Ant 2	Yes ^A	Yes	Yes ^A	Yes	Yes	Yes	^A Bluetooth Tethering is considered
36	LTE + NR + 2.4 GHz Wi-Fi MIMO	Yes	Yes	Yes	Yes	Yes	Yes	
37	LTE + NR + 5 GHz Wi-Fi MIMO	Yes	Yes	Yes	Yes	Yes	Yes	
38	LTE + NR + 2.4 GHz Wi-Fi MIMO + 5 GHz Wi-Fi MIMO	Yes	Yes	Yes	Yes	Yes	Yes	
39	LTE + NR + 2.4 GHz Bluetooth Ant 1 + 5 GHz Wi-Fi MIMO	Yes ^A	Yes	Yes ^A	Yes	Yes	Yes	^A Bluetooth Tethering is considered
40	LTE + NR + 2.4 GHz Bluetooth Ant 2 + 5 GHz Wi-Fi MIMO	Yes ^A	Yes	Yes ^A	Yes	Yes	Yes	^A Bluetooth Tethering is considered
41	LTE + NR + 2.4 GHz Bluetooth Ant 1 + 2.4 GHz Wi-Fi Ant 2 + 5 GHz Wi-Fi MIMO	Yes ^A	Yes	Yes ^A	Yes	Yes	Yes	^A Bluetooth Tethering is considered
42	CDMA/EVDO data + 2.4 GHz Bluetooth Ant 1	Yes ^A	Yes [*]	Yes ^A	Yes	Yes	Yes	[*] Pre-installed VOIP applications are considered ^A Bluetooth Tethering is considered
43	CDMA/EVDO data + 2.4 GHz Bluetooth Ant 2	Yes ^A	Yes [*]	Yes ^A	Yes	Yes	Yes	[*] Pre-installed VOIP applications are considered ^A Bluetooth Tethering is considered
44	CDMA/EVDO data + 2.4 GHz Wi-Fi MIMO	Yes [*]	Yes [*]	Yes	Yes	Yes	Yes	[*] Pre-installed VOIP applications are considered
45	CDMA/EVDO data + 5 GHz Wi-Fi MIMO	Yes [*]	Yes [*]	Yes	Yes	Yes	Yes	[*] Pre-installed VOIP applications are considered
46	CDMA/EVDO data + 2.4 GHz Wi-Fi MIMO + 5 GHz Wi-Fi MIMO	Yes [*]	Yes [*]	Yes	Yes	Yes	Yes	[*] Pre-installed VOIP applications are considered
47	CDMA/EVDO data + 2.4 GHz Bluetooth Ant 1 + 5 GHz Wi-Fi MIMO	Yes ^A	Yes [*]	Yes ^A	Yes	Yes	Yes	[*] Pre-installed VOIP applications are considered ^A Bluetooth Tethering is considered
48	CDMA/EVDO data + 2.4 GHz Bluetooth Ant 2 + 5 GHz Wi-Fi MIMO	Yes ^A	Yes [*]	Yes ^A	Yes	Yes	Yes	[*] Pre-installed VOIP applications are considered ^A Bluetooth Tethering is considered
49	CDMA/EVDO data + 2.4 GHz Bluetooth Ant 1 + 2.4 GHz Wi-Fi Ant 2 + 5 GHz Wi-Fi MIMO	Yes ^A	Yes [*]	Yes ^A	Yes	Yes	Yes	[*] Pre-installed VOIP applications are considered ^A Bluetooth Tethering is considered
50	GPRS/EDGE + 2.4 GHz Bluetooth Ant 1	N/A	N/A	Yes ^A	Yes	Yes	Yes	^A Bluetooth Tethering is considered
51	GPRS/EDGE + 2.4 GHz Bluetooth Ant 2	N/A	N/A	Yes ^A	Yes	Yes	Yes	^A Bluetooth Tethering is considered
52	GPRS/EDGE + 2.4 GHz Wi-Fi MIMO	N/A	N/A	Yes	Yes	Yes	Yes	
53	GPRS/EDGE + 5 GHz Wi-Fi MIMO	N/A	N/A	Yes	Yes	Yes	Yes	
54	GPRS/EDGE + 2.4 GHz Wi-Fi MIMO + 5 GHz Wi-Fi MIMO	N/A	N/A	Yes	Yes	Yes	Yes	
55	GPRS/EDGE + 2.4 GHz Bluetooth Ant 1 + 5 GHz Wi-Fi MIMO	N/A	N/A	Yes ^A	Yes	Yes	Yes	^A Bluetooth Tethering is considered
56	GPRS/EDGE + 2.4 GHz Bluetooth Ant 2 + 5 GHz Wi-Fi MIMO	N/A	N/A	Yes ^A	Yes	Yes	Yes	^A Bluetooth Tethering is considered
57	GPRS/EDGE + 2.4 GHz Bluetooth Ant 1 + 2.4 GHz Wi-Fi Ant 2 + 5 GHz Wi-Fi MIMO	N/A	N/A	Yes ^A	Yes	Yes	Yes	^A Bluetooth Tethering is considered

- 2.4 GHz WLAN ant 1, and 2.4 GHz Bluetooth 1 share the same antenna path and cannot transmit simultaneously.
- 2.4 GHz Bluetooth can simultaneously transmit with 5 GHz WLAN MIMO, not 5 GHz WLAN SISO.
- All licensed modes cannot transmit simultaneously with 2.4/5 GHz WLAN SISO
- All licensed modes share the same antenna path and cannot transmit simultaneously.
- When the user utilizes multiple services in UMTS 3G mode it uses multi-Radio Access Bearer or multi-RAB. The power control is based on a physical control channel (Dedicated Physical Control Channel [DPCCH]) and power control will be adjusted to meet the needs of both services. Therefore, the UMTS+WLAN scenario also represents the UMTS Voice/DATA + WLAN Hotspot scenario.

FCC ID: A3LSMF916U		SAR EVALUATION REPORT		Approved by: Quality Manager
Document S/N: 1M2005200087-01-R2.A3L	Test Dates: 06/28/20-08/24/20	DUT Type: Portable Handset	Page 14 of 267	

6. Per the manufacturer, WIFI Direct is not expected to be used in conjunction with a held-to-ear or body-worn accessory voice call. Therefore, there are no simultaneous transmission scenarios involving WIFI direct beyond that listed in the above table.
7. 5 GHz Wireless Router is only supported for the U-NII-3 by S/W, therefore U-NII-1, U-NII-2A, and U-NII-2C were not evaluated for wireless router conditions.
8. This device supports 2x2 MIMO Tx for WLAN 802.11a/g/n/ac/ax. 802.11a/g/n/ac/ax supports CDD and STBC and 802.11n/ac/ax additionally supports SDM. Each WLAN antenna can transmit independently or together when operating with MIMO.
9. This device supports VOLTE.
10. This device supports VOWIFI.
11. This device supports Bluetooth Tethering.
12. LTE + 5G NR FR1 Scenarios are limited to LTE Anchor Bands, LTE B2/5/7/12/13/14/25/30/41/48/66.
13. 5G NR FR2 n260 and n261 cannot transmit simultaneously.
14. LTE + 5G NR FR2 n260 and n261 operations are possible only with LTE 2/5/12/13/14/30/48/66 under EN-DC mode.

1.8 Miscellaneous SAR Test Considerations

(A) WIFI/BT

Since U-NII-1 and U-NII-2A bands have the same maximum output power and the highest reported SAR for U-NII-2A is less than 1.2 W/kg, SAR is not required for U-NII-1 band according to FCC KDB Publication 248227 D01v02r02.

Since Wireless Router operations are not allowed by the chipset firmware using U-NII-1, U-NII-2A & U-NII-2C WIFI, only 2.4 GHz WLAN, 2.4 GHz Bluetooth, and U-NII-3 WIFI Hotspot SAR tests and combinations are considered for SAR with respect to Wireless Router configurations according to FCC KDB 941225 D06v02r01.

This device supports IEEE 802.11ax with the following features:



- a) Up to 80 MHz Bandwidth only for 5 GHz
- b) Up to 20 MHz Bandwidth only for 2.4 GHz
- c) No aggregate channel configurations
- d) 2 Tx antenna output
- e) Up to 1024 QAM is supported
- f) TDWR and Band gap channels are supported for 5 GHz
- g) MU-MIMO UL Operations are not supported

Per FCC KDB Publication 648474 D04v01r03, this device is considered a "phablet" when it is in a closed configuration since the diagonal dimension is greater than 160mm and less than 200mm. Phablet SAR tests are required when wireless router mode does not apply or if wireless router 1g SAR > 1.2 W/kg. Because wireless router operations are not supported for U-NII-1, U-NII-2A & U-NII-2C WLAN, phablet SAR tests were performed. Phablet SAR was not evaluated for 2.4 GHz WLAN, 2.4 GHz Bluetooth, and U-NII-3 WLAN operations since wireless router 1g SAR was < 1.2 W/kg.

Per April 2019 TCB Workshop Notes, SAR testing was not required for 802.11ax when applying the initial test configuration procedures of KDB 248227, with 802.11ax considered a higher order 802.11 mode.

(B) Licensed Transmitter(s)

GSM/GPRS/EDGE DTM is not supported for US bands. Therefore, the GSM Voice modes in this report do not transmit simultaneously with GPRS/EDGE Data.

FCC ID: A3LSMF916U	 PCTEST <small>Proud to be part of Samsung</small>	SAR EVALUATION REPORT		Approved by: Quality Manager
Document S/N: 1M2005200087-01-R2.A3L	Test Dates: 06/28/20-08/24/20	DUT Type: Portable Handset	Page 15 of 267	

This device is only capable of QPSK HSUPA in the uplink. Therefore, no additional SAR tests are required beyond that described for devices with HSUPA in KDB 941225 D01v03r01.

LTE SAR for the higher modulations and lower bandwidths were not tested since the maximum average output power of all required channels and configurations was not more than 0.5 dB higher than the highest bandwidth; and the reported LTE SAR for the highest bandwidth was less than 1.45 W/kg for all configurations according to FCC KDB 941225 D05v02r04.

CDMA 1X Advanced technology was not required for SAR since the maximum allowed output powers for 1x Advanced was not more than 0.25 dB higher than the maximum powers for 1x and the measured SAR in any 1x mode exposure conditions was not greater than 1.2 W/kg per FCC KDB Publication 941225 D01v03r01.

This device supports LTE Carrier Aggregation (CA) in the downlink. All uplink communications are identical to Release 8 specifications. Per FCC KDB Publication 941225 D05A v01r02, SAR for LTE CA operations was not needed since the maximum average output power in LTE CA mode was not >0.25 dB higher than the maximum output power when downlink carrier aggregation was inactive. The downlink carrier aggregation exclusion analysis can be found in Appendix F.

Per FCC KDB Publication 648474 D04v01r03, this device is considered a "phablet" when it is closed configuration since the diagonal dimension is greater than 160mm and less than 200mm. Therefore, phablet SAR tests are required when wireless router mode does not apply or if wireless router 1g SAR > 1.2 W/kg.



This device supports downlink 4x4 MIMO operations for some LTE Bands. Per May 2017 TCB Workshop Notes, SAR for 4x4 DL MIMO was not needed since the maximum average output power in 4x4 DL MIMO mode was not more than 0.25 dB higher than the maximum output power with 4x4 DL MIMO inactive. Additionally, SAR for 4x4 MIMO Downlink Carrier Aggregation was not needed since the maximum average output power in 4x4 MIMO Downlink Carrier Aggregation mode was not more than 0.25 dB higher than the maximum output power with 4x4 MIMO Downlink and downlink carrier aggregation inactive.

This device supports LTE/NR FR1 capabilities with overlapping transmission frequency ranges. When the supported frequency range of an LTE/NR Band falls completely within an LTE/NR band with a larger transmission frequency range, both LTE/NR bands have the same target power (or the band with the larger transmission frequency range has a higher target power), and both LTE/NR bands share the same transmission path and signal characteristics, SAR was only assessed for the band with the larger transmission frequency range.

This device supports both Power Class 2 (PC2) and Power Class 3 (PC3) for LTE Band 41. Per May 2017 TCB Workshop Notes, SAR tests were performed with Power Class 3 (given the specific UL/DL limitations for Power Class 2). Additionally, SAR testing for the power class condition was evaluated for the highest configuration in Power Class 3 for each test configuration to confirm the results were scalable linearly (See Section 14.2).

This device supports LTE Carrier Aggregation (CA) for LTE Band 41, LTE Band 5, LTE Band 66, and LTE Band 48 with two component carriers in the uplink. SAR Measurements and conducted powers were evaluated per 2017 Fall TCB Workshop Notes.

This device supports 64QAM and 256QAM on the uplink and 256QAM on the downlink for LTE Operations. Conducted powers for 64QAM and 256QAM uplink configurations were measured per Section 5.1 of FCC KDB Publication 941225D05v02r05. SAR was not required for 64QAM or 256QAM since the highest maximum output power for 64QAM and 256QAM is $\leq \frac{1}{2}$ dB higher than the same configuration in QPSK and the reported SAR for the QPSK configuration is ≤ 1.45 W/kg, per Section 5.2.4 of FCC KDB Publication 941225 D05v02r05.

FCC ID: A3LSMF916U	 <small>Proud to be part of Samsung</small>	SAR EVALUATION REPORT		Approved by: Quality Manager
Document S/N: 1M2005200087-01-R2.A3L	Test Dates: 06/28/20-08/24/20	DUT Type: Portable Handset	Page 16 of 267	

This device supports 5G NR for Bands n260, and n261. RF Exposure assessment and simultaneous transmission analysis for these bands can be found in the Near Field PD Report (report SN can be found in Section 1.11 – Bibliography).

NR implementation of n71, n5, n66, n2, n25, and n41 is limited to EN-DC operations only, with LTE Band 2/66/5/12/13/14/30/48 acting as the anchor band. Per FCC Guidance, SAR tests were performed separately for NR Bands and LTE Anchor Bands. Please see Section 11 for more details.

For UMPC conditions, GSM/GPRS/EDGE 850 Antenna B operations have been disabled.

1.9 Guidance Applied



- IEEE 1528-2013
- FCC KDB Publication 941225 D01v03r01, D05v02r04, D05Av01r02, D06v02r01 (2G/3G/4G and Hotspot)
- FCC KDB Publication 248227 D01v02r02 (SAR Considerations for 802.11 Devices)
- FCC KDB Publication 447498 D01v06 (General SAR Guidance)
- FCC KDB Publication 865664 D01v01r04, D02v01r02 (SAR Measurements up to 6 GHz)
- FCC KDB Publication 648474 D04v01r03 (Phablet Procedures)
- FCC KDB Publication 616217 D04v01r02 (Tablet, Proximity Sensor)
- October 2013 TCB Workshop Notes (GPRS Testing Considerations)
- May 2017 TCB Workshop Notes (LTE 4x4 Downlink MIMO, LTE Band 41 Power Class 2/3)
- April 2018 TCB Workshop Notes (LTE Carrier Aggregation)
- April 2019 TCB Workshop Notes (IEEE 802.11ax, Dynamic Antenna Tuning)
- FCC KDB Publication 941225 D07v01r02 (UMPC Mini-Tablet Devices)

1.10 Device Serial Numbers



Several samples with identical hardware were used to support SAR testing. The manufacturer has confirmed that the device(s) tested have the same physical, mechanical and thermal characteristics and are within operational tolerances expected for production units. The serial numbers used for each test are indicated alongside the results in Section 11.

1.11 Bibliography



Report Type	Report Serial Number
PD Exposure Part 0 Test Report	Revision B
Near Field PD Report (Part 1)	1M2005200087-21-R2.A3L
RF Exposure Part 0 Test Report	1M2005200087-26-R1.A3L
RF Exposure Part 2 Test Report	1M2005200087-22-R1.A3L
RF Exposure Compliance Summary Report	1M2005200087-23.A3L

FCC ID: A3LSMF916U	 PCTEST <small>Proud to be part of Samsung</small>	SAR EVALUATION REPORT		Approved by: Quality Manager
Document S/N: 1M2005200087-01-R2.A3L	Test Dates: 06/28/20-08/24/20	DUT Type: Portable Handset	Page 17 of 267	

LTE Information						
Form Factor	Portable Handset					
Frequency Range of each LTE transmission band	LTE Band 71 (665.5 - 695.5 MHz)					
	LTE Band 12 (699.7 - 713.3 MHz)					
	LTE Band 13 (779.5 - 784.5 MHz)					
	LTE Band 14 (790.5 - 795.5 MHz)					
	LTE Band 26 (Cell) (814.7 - 848.3 MHz)					
	LTE Band 5 (Cell) (824.7 - 848.3 MHz)					
	LTE Band 66 (AWS) (1710.7 - 1779.3 MHz)					
	LTE Band 4 (AWS) (1710.7 - 1754.3 MHz)					
	LTE Band 25 (PCS) (1850.7 - 1914.3 MHz)					
	LTE Band 2 (PCS) (1850.7 - 1909.3 MHz)					
	LTE Band 30 (2307.5 - 2312.5 MHz)					
	LTE Band 7 (2502.5 - 2567.5 MHz)					
	LTE Band 48 (3552.5 - 3697.5 MHz)					
	LTE Band 41 (2498.5 - 2687.5 MHz)					
	LTE Band 38 (2672.5 - 2617.5 MHz)					
	Channel Bandwidths	LTE Band 71: 5 MHz, 10 MHz, 15 MHz, 20 MHz				
		LTE Band 12: 1.4 MHz, 3 MHz, 5 MHz, 10 MHz				
LTE Band 13: 5 MHz, 10 MHz						
LTE Band 14: 5 MHz, 10 MHz						
LTE Band 26 (Cell): 1.4 MHz, 3 MHz, 5 MHz, 10 MHz, 15 MHz						
LTE Band 5 (Cell): 1.4 MHz, 3 MHz, 5 MHz, 10 MHz						
LTE Band 66 (AWS): 1.4 MHz, 3 MHz, 5 MHz, 10 MHz, 15 MHz, 20 MHz						
LTE Band 4 (AWS): 1.4 MHz, 3 MHz, 5 MHz, 10 MHz, 15 MHz, 20 MHz						
LTE Band 25 (PCS): 1.4 MHz, 3 MHz, 5 MHz, 10 MHz, 15 MHz, 20 MHz						
LTE Band 2 (PCS): 1.4 MHz, 3 MHz, 5 MHz, 10 MHz, 15 MHz, 20 MHz						
LTE Band 30: 5 MHz, 10 MHz						
LTE Band 7: 5 MHz, 10 MHz, 15 MHz, 20 MHz						
LTE Band 48: 5 MHz, 10 MHz, 15 MHz, 20 MHz						
LTE Band 41: 5 MHz, 10 MHz, 15 MHz, 20 MHz						
LTE Band 38: 5 MHz, 10 MHz, 15 MHz, 20 MHz						
Channel Numbers and Frequencies (MHz)		Low	Low-Mid	Mid	Mid-High	High
		LTE Band 71: 5 MHz				
LTE Band 71: 10 MHz						
LTE Band 71: 15 MHz						
LTE Band 71: 20 MHz						
LTE Band 12: 1.4 MHz						
LTE Band 12: 3 MHz						
LTE Band 12: 5 MHz						
LTE Band 12: 10 MHz						
LTE Band 13: 5 MHz						
LTE Band 13: 10 MHz						
LTE Band 14: 5 MHz						
LTE Band 14: 10 MHz						
LTE Band 26 (Cell): 1.4 MHz						
LTE Band 26 (Cell): 3 MHz						
LTE Band 26 (Cell): 5 MHz						
LTE Band 26 (Cell): 10 MHz						
LTE Band 26 (Cell): 15 MHz						
LTE Band 5 (Cell): 1.4 MHz						
LTE Band 5 (Cell): 3 MHz						
LTE Band 5 (Cell): 5 MHz						
LTE Band 5 (Cell): 10 MHz						
LTE Band 66 (AWS): 1.4 MHz						
LTE Band 66 (AWS): 3 MHz						
LTE Band 66 (AWS): 5 MHz						
LTE Band 66 (AWS): 10 MHz						
LTE Band 66 (AWS): 15 MHz						
LTE Band 66 (AWS): 20 MHz						
LTE Band 4 (AWS): 1.4 MHz						
LTE Band 4 (AWS): 3 MHz						
LTE Band 4 (AWS): 5 MHz						
LTE Band 4 (AWS): 10 MHz						
LTE Band 4 (AWS): 15 MHz						
LTE Band 4 (AWS): 20 MHz						
LTE Band 25 (PCS): 1.4 MHz						
LTE Band 25 (PCS): 3 MHz						
LTE Band 25 (PCS): 5 MHz						
LTE Band 25 (PCS): 10 MHz						
LTE Band 25 (PCS): 15 MHz						
LTE Band 25 (PCS): 20 MHz						
LTE Band 2 (PCS): 1.4 MHz						
LTE Band 2 (PCS): 3 MHz						
LTE Band 2 (PCS): 5 MHz						
LTE Band 2 (PCS): 10 MHz						
LTE Band 2 (PCS): 15 MHz						
LTE Band 2 (PCS): 20 MHz						
LTE Band 30: 5 MHz						
LTE Band 30: 10 MHz						
LTE Band 7: 5 MHz						
LTE Band 7: 10 MHz						
LTE Band 7: 15 MHz						
LTE Band 7: 20 MHz						
LTE Band 48: 5 MHz						
LTE Band 48: 10 MHz						
LTE Band 48: 15 MHz						
LTE Band 48: 20 MHz						
LTE Band 41: 5 MHz						
LTE Band 41: 10 MHz						
LTE Band 41: 15 MHz						
LTE Band 41: 20 MHz						
LTE Band 38: 5 MHz						
LTE Band 38: 10 MHz						
LTE Band 38: 15 MHz						
LTE Band 38: 20 MHz						
LTE Category						
Modulations Supported in UL						
LTE MPR Permanently implemented per 3GPP TS 36.101 section 6.2.3-6.2.5? (manufacturer attestation to be provided)						
A-MPR (Additional MPR) disabled for SAR Testing?						
LTE Carrier Aggregation Possible Combinations						
LTE Additional Information						

FCC ID: A3LSMF916U		SAR EVALUATION REPORT		Approved by: Quality Manager
Document S/N: 1M2005200087-01-R2.A3L	Test Dates: 06/28/20-08/24/20	DUT Type: Portable Handset	Page 18 of 267	

NR Information					
Form Factor	Portable Handset				
Frequency Range of each NR transmission band	NR Band n71 (665.5 - 695.5 MHz)				
	NR Band n5 (Cell) (826.5 - 846.5 MHz)				
	NR Band n66 (AWS) (1712.5 - 1777.5 MHz)				
	NR Band n25 (PCS) (1852.5 - 1912.5 MHz)				
	NR Band n2 (PCS) (1852.5 - 1907.5 MHz)				
	NR Band n41 (2506.02 - 2679.99 MHz)				
Channel Bandwidths	NR Band n71: 5 MHz, 10 MHz, 15 MHz, 20 MHz				
	NR Band n5 (Cell): 5 MHz, 10 MHz, 15 MHz, 20 MHz				
	NR Band n66 (AWS): 5 MHz, 10 MHz, 15 MHz, 20 MHz				
	NR Band n25 (PCS): 5 MHz, 10 MHz, 15 MHz, 20 MHz				
	NR Band n2 (PCS): 5 MHz, 10 MHz, 15 MHz, 20 MHz				
	NR Band n41: 20 MHz, 40 MHz, 50 MHz, 60 MHz, 80 MHz, 90 MHz, 100 MHz				
Channel Numbers and Frequencies (MHz)	Low	Low-Mid	Mid	Mid-High	High
NR Band n71: 5 MHz	665.5 (133100)		680.5 (136100)		695.5 (139100)
NR Band n71: 10 MHz	668 (133600)		680.5 (136100)		693 (138600)
NR Band n71: 15 MHz	670.5 (134100)		680.5 (136100)		690.5 (138100)
NR Band n71: 20 MHz	673 (134600)		680.5 (136100)		688 (137600)
NR Band n5 (Cell): 5 MHz	826.5 (165300)		836.5 (167300)		846.5 (169300)
NR Band n5 (Cell): 10 MHz	829 (165800)		836.5 (167300)		844 (168800)
NR Band n5 (Cell): 15 MHz	831.5 (166300)		836.5 (167300)		841.5 (168300)
NR Band n5 (Cell): 20 MHz	834 (166800)		836.5 (167300)		839 (167800)
NR Band n66 (AWS): 5 MHz	1712.5 (342500)		1745 (349000)		1777.5 (355500)
NR Band n66 (AWS): 10 MHz	1715 (343000)		1745 (349000)		1775 (355000)
NR Band n66 (AWS): 15 MHz	1717.5 (343500)		1745 (349000)		1772.5 (354500)
NR Band n66 (AWS): 20 MHz	1720 (344000)		1745 (349000)		1770 (354000)
NR Band n25 (PCS): 5 MHz	1852.5 (370500)		1882.5 (376500)		1912.5 (382500)
NR Band n25 (PCS): 10 MHz	1855 (371000)		1882.5 (376500)		1910 (382000)
NR Band n25 (PCS): 15 MHz	1857.5 (371500)		1882.5 (376500)		1907.5 (381500)
NR Band n25 (PCS): 20 MHz	1860 (372000)		1882.5 (376500)		1905 (381000)
NR Band n2 (PCS): 5 MHz	1852.5 (386500)		1880 (392000)		1907.5 (397500)
NR Band n2 (PCS): 10 MHz	1855 (387000)		1880 (392000)		1905 (397000)
NR Band n2 (PCS): 15 MHz	1857.5 (387500)		1880 (392000)		1902.5 (396500)
NR Band n2 (PCS): 20 MHz	1860 (388000)		1880 (392000)		1900 (396000)
NR Band n41: 20 MHz	2506.02 (501204)	2549.49 (509898)	2592.99 (518598)	2636.49 (527298)	2679.99 (535998)
NR Band n41: 40 MHz	2516.01 (503202)	2567.34 (513468)	N/A	2618.67 (523734)	2670 (534000)
NR Band n41: 50 MHz	2521.02 (504204)		2592.99 (518598)	2664.99 (532998)	
NR Band n41: 60 MHz	2526 (505200)		2592.99 (518598)	2659.98 (531996)	
NR Band n41: 80 MHz	2536.02 (507204)		N/A	2649.99 (529998)	
NR Band n41: 90 MHz	2541 (508200)		N/A	2644.98 (528996)	
NR Band n41: 100 MHz	2546.01 (509202)		2592.99 (518598)	2640 (528000)	
SCS for NR Band n71/n5/n66/n25/n2	15 kHz				
SCS for NR Band n41	30 kHz				
Modulations Supported in UL	DFT-s-OFDM: $\pi/2$ BPSK, QPSK, 16QAM, 64QAM, 256QAM CP-OFDM: QPSK, 16QAM, 64QAM, 256QAM				
NR MPR Permanently implemented per 3GPP TS	YES				
A-MPR (Additional MPR) disabled for SAR Testing?	YES				
EN-DC Carrier Aggregation Possible Combinations	The technical description includes all the possible carrier aggregation combinations				
LTE Anchor Bands for NR Band n71	LTE Band 2/66				
LTE Anchor Bands for NR Band n5 (Cell)	LTE Band 2/30/66				
LTE Anchor Bands for NR Band n66 (AWS)	LTE Band 5/12/13/14/48				
LTE Anchor Bands for NR Band n25 (PCS)	LTE Band 12				
LTE Anchor Bands for NR Band n2 (PCS)	LTE Band 5/12/13/14				
LTE Anchor Bands for NR Band n41	LTE Band 2/66				

FCC ID: A3LSMF916U	 PCTEST Proud to be part of Samsung	SAR EVALUATION REPORT		Approved by: Quality Manager
Document S/N: 1M2005200087-01-R2.A3L	Test Dates: 06/28/20-08/24/20	DUT Type: Portable Handset	Page 19 of 267	

3 INTRODUCTION

The FCC and Innovation, Science, and Economic Development Canada have adopted the guidelines for evaluating the environmental effects of radio frequency (RF) radiation in ET Docket 93-62 on Aug. 6, 1996 and Health Canada Safety Code 6 to protect the public and workers from the potential hazards of RF emissions due to FCC-regulated portable devices. [1]

The safety limits used for the environmental evaluation measurements are based on the criteria published by the American National Standards Institute (ANSI) for localized specific absorption rate (SAR) in IEEE/ANSI C95.1-1992 Standard for Safety Levels with Respect to Human Exposure to Radio Frequency Electromagnetic Fields, 3 kHz to 300 GHz [3] and Health Canada RF Exposure Guidelines Safety Code 6 [22]. The measurement procedure described in IEEE/ANSI C95.3-2002 Recommended Practice for the Measurement of Potentially Hazardous Electromagnetic Fields - RF and Microwave [4] is used for guidance in measuring the Specific Absorption Rate (SAR) due to the RF radiation exposure from the Equipment Under Test (EUT). These criteria for SAR evaluation are similar to those recommended by the International Committee for Non-Ionizing Radiation Protection (ICNIRP) in Biological Effects and Exposure Criteria for Radiofrequency Electromagnetic Fields,” Report No. Vol 74. SAR is a measure of the rate of energy absorption due to exposure to an RF transmitting source. SAR values have been related to threshold levels for potential biological hazards.

3.1 SAR Definition

Specific Absorption Rate is defined as the time derivative (rate) of the incremental energy (dU) absorbed by (dissipated in) an incremental mass (dm) contained in a volume element (dV) of a given density (ρ). It is also defined as the rate of RF energy absorption per unit mass at a point in an absorbing body (see Equation 3-1).

Equation 3-1
SAR Mathematical Equation

$$SAR = \frac{d}{dt} \left(\frac{dU}{dm} \right) = \frac{d}{dt} \left(\frac{dU}{\rho dv} \right)$$



SAR is expressed in units of Watts per Kilogram (W/kg).

$$SAR = \frac{\sigma \cdot E^2}{\rho}$$

where:

- σ = conductivity of the tissue-simulating material (S/m)
- ρ = mass density of the tissue-simulating material (kg/m³)
- E = Total RMS electric field strength (V/m)

NOTE: The primary factors that control rate of energy absorption were found to be the wavelength of the incident field in relation to the dimensions and geometry of the irradiated organism, the orientation of the organism in relation to the polarity of field vectors, the presence of reflecting surfaces, and whether conductive contact is made by the organism with a ground plane.[6]

FCC ID: A3LSMF916U	 PCTEST <small>Proud to be part of Samsung</small>	SAR EVALUATION REPORT		Approved by: Quality Manager
Document S/N: 1M2005200087-01-R2.A3L	Test Dates: 06/28/20-08/24/20	DUT Type: Portable Handset	Page 20 of 267	

4 DOSIMETRIC ASSESSMENT

4.1 Measurement Procedure

The evaluation was performed using the following procedure compliant to FCC KDB Publication 865664 D01v01r04 and IEEE 1528-2013:

1. The SAR distribution at the exposed side of the head or body was measured at a distance no greater than 5.0 mm from the inner surface of the shell. The area covered the entire dimension of the device-head and body interface and the horizontal grid resolution was determined per FCC KDB Publication 865664 D01v01r04 (See Table 4-1) and IEEE 1528-2013.
2. The point SAR measurement was taken at the maximum SAR region determined from Step 1 to enable the monitoring of SAR fluctuations/drifts during the 1g/10g cube evaluation. SAR at this fixed point was measured and used as a reference value.
3. Based on the area scan data, the peak of the region with maximum SAR was determined by spline interpolation. Around this point, a volume was assessed according to the measurement resolution and volume size requirements of FCC KDB Publication 865664 D01v01r04 (See Table 4-1) and IEEE 1528-2013. On the basis of this data set, the spatial peak SAR value was evaluated with the following procedure (see references or the DASY manual online for more details):
 - a. SAR values at the inner surface of the phantom are extrapolated from the measured values along the line away from the surface with spacing no greater than that in Table 4-1. The extrapolation was based on a least-squares algorithm. A polynomial of the fourth order was calculated through the points in the z-axis (normal to the phantom shell).
 - b. After the maximum interpolated values were calculated between the points in the cube, the SAR was averaged over the spatial volume (1g or 10g) using a 3D-Spline interpolation algorithm. The 3D-spline is composed of three one-dimensional splines with the “Not a knot” condition (in x, y, and z directions). The volume was then integrated with the trapezoidal algorithm. One thousand points (10 x 10 x 10) were obtained through interpolation, in order to calculate the averaged SAR.
 - c. All neighboring volumes were evaluated until no neighboring volume with a higher average value was found.
4. The SAR reference value, at the same location as step 2, was re-measured after the zoom scan was complete to calculate the SAR drift. If the drift deviated by more than 5%, the SAR test and drift measurements were repeated.

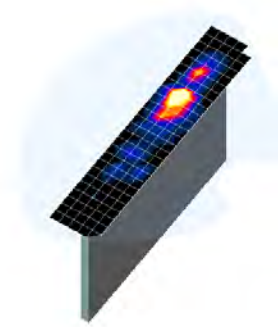



Figure 4-1
Sample SAR Area Scan

Table 4-1
Area and Zoom Scan Resolutions per FCC KDB Publication 865664 D01v01r04*

Frequency	Maximum Area Scan Resolution (mm) ($\Delta x_{\text{area}}, \Delta y_{\text{area}}$)	Maximum Zoom Scan Resolution (mm) ($\Delta x_{\text{zoom}}, \Delta y_{\text{zoom}}$)	Maximum Zoom Scan Spatial Resolution (mm)			Minimum Zoom Scan Volume (mm) (x,y,z)
			Uniform Grid	Graded Grid		
			$\Delta z_{\text{zoom}}(n)$	$\Delta z_{\text{zoom}}(1)^*$	$\Delta z_{\text{zoom}}(n>1)^*$	
≤ 2 GHz	≤ 15	≤ 8	≤ 5	≤ 4	≤ 1.5* $\Delta z_{\text{zoom}}(n-1)$	≥ 30
2-3 GHz	≤ 12	≤ 5	≤ 5	≤ 4	≤ 1.5* $\Delta z_{\text{zoom}}(n-1)$	≥ 30
3-4 GHz	≤ 12	≤ 5	≤ 4	≤ 3	≤ 1.5* $\Delta z_{\text{zoom}}(n-1)$	≥ 28
4-5 GHz	≤ 10	≤ 4	≤ 3	≤ 2.5	≤ 1.5* $\Delta z_{\text{zoom}}(n-1)$	≥ 25
5-6 GHz	≤ 10	≤ 4	≤ 2	≤ 2	≤ 1.5* $\Delta z_{\text{zoom}}(n-1)$	≥ 22

*Also compliant to IEEE 1528-2013 Table 6

FCC ID: A3LSMF916U	 PCTEST <small>Practical to be part of solutions</small>	SAR EVALUATION REPORT		Approved by: Quality Manager
Document S/N: 1M2005200087-01-R2.A3L	Test Dates: 06/28/20-08/24/20	DUT Type: Portable Handset		Page 21 of 267

5 DEFINITION OF REFERENCE POINTS

5.1 EAR REFERENCE POINT

Figure 5-2 shows the front, back and side views of the SAM Twin Phantom. The point “M” is the reference point for the center of the mouth, “LE” is the left ear reference point (ERP), and “RE” is the right ERP. The ERP is 15mm posterior to the entrance to the ear canal (EEC) along the B-M line (Back-Mouth), as shown in Figure 5-1. The plane passing through the two ear canals and M is defined as the Reference Plane. The line N-F (Neck-Front), also called the Reference Pivoting Line, is not perpendicular to the reference plane (see Figure 5-1). Line B-M is perpendicular to the N-F line. Both N-F and B-M lines are marked on the external phantom shell to facilitate handset positioning [5].

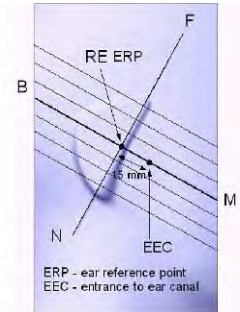

Figure 5-1
Close-Up Side view of ERP

5.2 HANDSET REFERENCE POINTS

Two imaginary lines on the handset were established: the vertical centerline and the horizontal line. The test device was placed in a normal operating position with the acoustic output located along the “vertical centerline” on the front of the device aligned to the “ear reference point” (See Figure 5-3). The acoustic output was then located at the same level as the center of the ear reference point. The test device was positioned so that the “vertical centerline” was bisecting the front surface of the handset at its top and bottom edges, positioning the “ear reference point” on the outer surface of the both the left and right head phantoms on the ear reference point.



Figure 5-2
Front, back and side view of SAM Twin Phantom

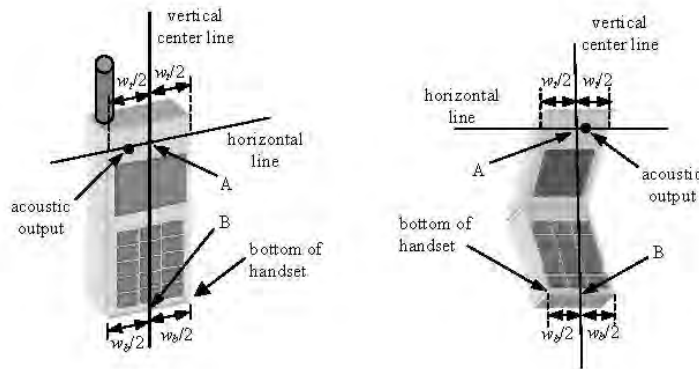



Figure 5-3
Handset Vertical Center & Horizontal Line Reference Points

FCC ID: A3LSMF916U	 PCTEST Proud to be part of Samsung	SAR EVALUATION REPORT		Approved by: Quality Manager
Document S/N: 1M2005200087-01-R2.A3L	Test Dates: 06/28/20-08/24/20	DUT Type: Portable Handset		Page 22 of 267

6 TEST CONFIGURATION POSITIONS

6.1 Device Holder

The device holder is made out of low-loss POM material having the following dielectric parameters: relative permittivity $\epsilon = 3$ and loss tangent $\delta = 0.02$.

6.2 Positioning for Cheek

1. The test device was positioned with the device close to the surface of the phantom such that point A is on the (virtual) extension of the line passing through points RE and LE on the phantom (see Figure 6-1), such that the plane defined by the vertical center line and the horizontal line of the phone is approximately parallel to the sagittal plane of the phantom.





Figure 6-1 Front, Side and Top View of Cheek Position

2. The handset was translated towards the phantom along the line passing through RE & LE until the handset touches the pinna.
3. While maintaining the handset in this plane, the handset was rotated around the LE-RE line until the vertical centerline was in the reference plane.
4. The phone was then rotated around the vertical centerline until the phone (horizontal line) was symmetrical with respect to the line NF.
5. While maintaining the vertical centerline in the reference plane, keeping point A on the line passing through RE and LE, and maintaining the device contact with the ear, the device was rotated about the NF line until any point on the handset made contact with a phantom point below the ear (cheek) (See Figure 6-2).

6.3 Positioning for Ear / 15° Tilt

With the test device aligned in the “Cheek Position”:

1. While maintaining the orientation of the phone, the phone was retracted parallel to the reference plane far enough to enable a rotation of the phone by 15 degrees.
2. The phone was then rotated around the horizontal line by 15 degrees.
3. While maintaining the orientation of the phone, the phone was moved parallel to the reference plane until any part of the handset touched the head. (In this position, point A was located on the line RE-LE). The tilted position is obtained when the contact is on the pinna. If the contact was at any location other than the pinna, the angle of the phone would then be reduced. In this situation, the tilted position was obtained when any part of the phone was in contact of the ear as well as a second part of the phone was in contact with the head (see Figure 6-2).

FCC ID: A3LSMF916U	 PCTEST Proud to be part of Samsung	SAR EVALUATION REPORT		Approved by: Quality Manager
Document S/N: 1M2005200087-01-R2.A3L	Test Dates: 06/28/20-08/24/20	DUT Type: Portable Handset		Page 23 of 267

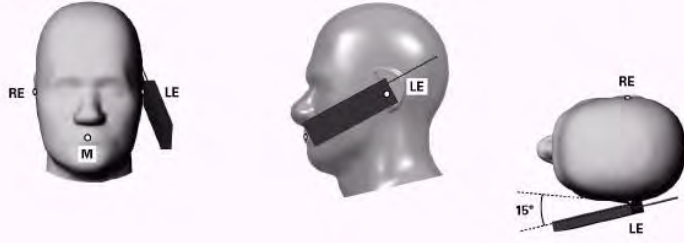

Figure 6-2 Front, Side and Top View of Ear/15° Tilt Position

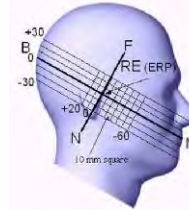

Figure 6-3 Side view w/ relevant markings

6.4 SAR Evaluations near the Mouth/Jaw Regions of the SAM Phantom

Antennas located near the bottom of a phone may require SAR measurements around the mouth and jaw regions of the SAM head phantom. This typically applies to clam-shell style phones that are generally longer in the unfolded normal use positions or to certain older style long rectangular phones. Per IEEE 1528-2013, a rotated SAM phantom is necessary to allow probe access to such regions. Both SAM heads of the TwinSAM-Chin20 are rotated 20 degrees around the NF line. Each head can be removed from the table for emptying and cleaning.

Under these circumstances, the following procedures apply, adopted from the FCC guidance on SAR handsets document FCC KDB Publication 648474 D04v01r03. The SAR required in these regions of SAM should be measured using a flat phantom. The phone should be positioned with a separation distance of 4 mm between the ear reference point (ERP) and the outer surface of the flat phantom shell. While maintaining this distance at the ERP location, the low (bottom) edge of the phone should be lowered from the phantom to establish the same separation distance between the peak SAR location identified by the truncated partial SAR distribution measured with the SAM phantom. The distance from the peak SAR location to the phone is determined by the straight line passing perpendicularly through the phantom surface. When it is not feasible to maintain 4 mm separation at the ERP while also establishing the required separation at the peak SAR location, the top edge of the phone will be allowed to touch the phantom with a separation < 4 mm at the ERP. The phone should not be tilted to the left or right while placed in this inclined position to the flat phantom.

6.5 Body-Worn Accessory Configurations

Body-worn operating configurations are tested with the belt-clips and holsters attached to the device and positioned against a flat phantom in a normal use configuration (see Figure 6-4). Per FCC KDB Publication 648474 D04v01r03, Body-worn accessory exposure is typically related to voice mode operations when handsets are carried in body-worn accessories. The body-worn accessory procedures in FCC KDB Publication 447498 D01v06 should be used to test for body-worn accessory SAR compliance, without a headset connected to it. This enables the test results for such configuration to be compatible with that required for hotspot mode when the body-worn accessory test separation distance is greater than or equal to that required for hotspot mode, when applicable. When the reported SAR for a body-worn accessory, measured without a headset connected to the handset, is > 1.2 W/kg, the highest reported SAR configuration for that wireless mode and frequency band should be repeated for that body-worn accessory with a headset attached to the handset.

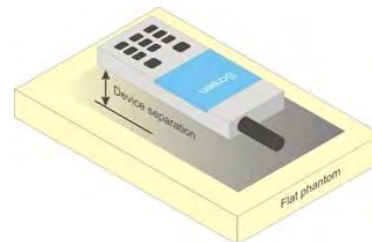

Figure 6-4 Sample Body-Worn Diagram

Accessories for Body-worn operation configurations are divided into two categories: those that do not contain metallic components and those that do contain metallic components. When multiple accessories that do not

FCC ID: A3LSMF916U	PCTEST Proud to be part of Samsung	SAR EVALUATION REPORT		Approved by: Quality Manager
Document S/N: 1M2005200087-01-R2.A3L	Test Dates: 06/28/20-08/24/20	DUT Type: Portable Handset		Page 24 of 267

contain metallic components are supplied with the device, the device is tested with only the accessory that dictates the closest spacing to the body. Then multiple accessories that contain metallic components are tested with the device with each accessory. If multiple accessories share an identical metallic component (i.e. the same metallic belt-clip used with different holsters with no other metallic components) only the accessory that dictates the closest spacing to the body is tested.

Body-worn accessories may not always be supplied or available as options for some devices intended to be authorized for body-worn use. In this case, a test configuration with a separation distance between the back of the device and the flat phantom is used. Test position spacing was documented. Transmitters that are designed to operate in front of a person’s face, as in push-to-talk configurations, are tested for SAR compliance with the front of the device positioned to face the flat phantom in head fluid. For devices that are carried next to the body such as a shoulder, waist or chest-worn transmitters, SAR compliance is tested with the accessories, including headsets and microphones, attached to the device and positioned against a flat phantom in a normal use configuration.

6.6 Extremity Exposure Configurations

Devices that are designed or intended for use on extremities or mainly operated in extremity only exposure conditions; i.e., hands, wrists, feet and ankles, may require extremity SAR evaluation. When the device also operates in close proximity to the user’s body, SAR compliance for the body is also required. The 1g body and 10g extremity SAR Exclusion Thresholds found in KDB Publication 447498 D01v06 should be applied to determine SAR test requirements.

Per KDB Publication 447498 D01v06, Cell phones (handsets) are not normally designed to be used on extremities or operated in extremity only exposure conditions. The maximum output power levels of handsets generally do not require extremity SAR testing to show compliance. Therefore, extremity SAR was not evaluated for this device.



6.7 Wireless Router Configurations

Some battery-operated handsets have the capability to transmit and receive user data through simultaneous transmission of WIFI simultaneously with a separate licensed transmitter. The FCC has provided guidance in FCC KDB Publication 941225 D06v02r01 where SAR test considerations for handsets (L x W ≥ 9 cm x 5 cm) are based on a composite test separation distance of 10 mm from the front, back and edges of the device containing transmitting antennas within 2.5 cm of their edges, determined from general mixed use conditions for this type of devices. Since the hotspot SAR results may overlap with the body-worn accessory SAR requirements, the more conservative configurations can be considered, thus excluding some body-worn accessory SAR tests.

When the user enables the personal wireless router functions for the handset, actual operations include simultaneous transmission of both the WIFI transmitter and another licensed transmitter. Both transmitters often do not transmit at the same transmitting frequency and thus cannot be evaluated for SAR under actual use conditions due to the limitations of the SAR assessment probes. Therefore, SAR must be evaluated for each frequency transmission and mode separately and spatially summed with the WIFI transmitter according to FCC KDB Publication 447498 D01v06 procedures. The “Portable Hotspot” feature on the handset was NOT activated during SAR assessments, to ensure the SAR measurements were evaluated for a single transmission frequency RF signal at a time.

6.8 Phablet Configurations

For smart phones with a display diagonal dimension > 150 mm or an overall diagonal dimension > 160 mm that provide similar mobile web access and multimedia support found in mini-tablets or UMPC mini-tablets that

FCC ID: A3LSMF916U	 PCTEST <small>Proud to be part of</small> 	SAR EVALUATION REPORT	Approved by: Quality Manager
Document S/N: 1M2005200087-01-R2.A3L	Test Dates: 06/28/20-08/24/20	DUT Type: Portable Handset	Page 25 of 267

support voice calls next to the ear, the phablets procedures outlined in KDB Publication 648474 D04v01r03 should be applied to evaluate SAR compliance. A device marketed as phablets, regardless of form factors and operating characteristics must be tested as a phablet to determine SAR compliance. In addition to the normally required head and body-worn accessory SAR test procedures required for handsets, the UMPC mini-tablet procedures must also be applied to test the SAR of all surfaces and edges with an antenna ≤ 25 mm from that surface or edge, in direct contact with the phantom, for 10g SAR. The UMPC mini-tablet 1g SAR at 5 mm is not required. When hotspot mode applies, 10g SAR is required only for the surfaces and edges with hotspot mode 1g SAR > 1.2 W/kg.

6.9 Proximity Sensor Considerations

This device uses a power reduction mechanism to reduce output powers in certain use conditions when the device is used close the user's body.



When the device's antenna is within a certain distance of the user, the sensor activates and reduces the maximum allowed output power. However, the sensor is not active when the device is moved beyond the sensor triggering distance and the maximum output power is no longer limited. Therefore, additional evaluation is needed in the vicinity of the triggering distance to ensure SAR is compliant when the device is allowed to operate at a non-reduced output power level. FCC KDB Publication 616217 D04v01r02 Section 6 was used as a guideline for selecting SAR test distances for this device at these additional test positions. Sensor triggering distance summary data is included in Appendix G.

The sensor is designed to support sufficient detection range and sensitivity to cover regions of the sensors in all applicable directions since the sensor entirely covers the antennas.

6.10 UMPC Mini-Tablet Configurations

Small hand-held tablets (and devices of similar form factors that are designed primarily for interactive hand-held use next to or near the body of users) require body SAR and extremity SAR evaluation. These types of mini-tablets are normally optimized for mobile web access and multimedia use. UMPC test procedures are applicable for devices with displays and overall diagonal dimension ≤ 20 cm. Devices are to be set up according to KDB publication 941225 D07v01r02 requirements and are configured with maximum output power during SAR assessment for a worst case SAR evaluation.

Per KDB Publication 941225 D07v01r02, UMPC mini-tablet devices must be tested for all surfaces and edges ≤ 25 mm from a transmitting antenna. A test separation distance of 10 mm may be considered for 1g SAR, with the addition of 10g SAR measurement at 0 mm test separation distance for all measured 1g SAR (at 10 mm) configurations to address hand exposure.

FCC ID: A3LSMF916U	 PCTEST <small>Proud to be part of Samsung</small>	SAR EVALUATION REPORT		Approved by: Quality Manager
Document S/N: 1M2005200087-01-R2.A3L	Test Dates: 06/28/20-08/24/20	DUT Type: Portable Handset	Page 26 of 267	

7 RF EXPOSURE LIMITS

7.1 Uncontrolled Environment

UNCONTROLLED ENVIRONMENTS are defined as locations where there is the exposure of individuals who have no knowledge or control of their exposure. The general population/uncontrolled exposure limits are applicable to situations in which the general public may be exposed or in which persons who are exposed as a consequence of their employment may not be made fully aware of the potential for exposure or cannot exercise control over their exposure. Members of the general public would come under this category when exposure is not employment-related; for example, in the case of a wireless transmitter that exposes persons in its vicinity.



7.2 Controlled Environment

CONTROLLED ENVIRONMENTS are defined as locations where there is exposure that may be incurred by persons who are aware of the potential for exposure, (i.e. as a result of employment or occupation). In general, occupational/controlled exposure limits are applicable to situations in which persons are exposed as a consequence of their employment, who have been made fully aware of the potential for exposure and can exercise control over their exposure. This exposure category is also applicable when the exposure is of a transient nature due to incidental passage through a location where the exposure levels may be higher than the general population/uncontrolled limits, but the exposed person is fully aware of the potential for exposure and can exercise control over his or her exposure by leaving the area or by some other appropriate means.

**Table 7-1
SAR Human Exposure Specified in ANSI/IEEE C95.1-1992 and Health Canada Safety Code 6**

HUMAN EXPOSURE LIMITS		
	UNCONTROLLED ENVIRONMENT <i>General Population</i> (W/kg) or (mW/g)	CONTROLLED ENVIRONMENT <i>Occupational</i> (W/kg) or (mW/g)
Peak Spatial Average SAR Head	1.6	8.0
Whole Body SAR	0.08	0.4
Peak Spatial Average SAR Hands, Feet, Ankle, Wrists, etc.	4.0	20

1. The Spatial Peak value of the SAR averaged over any 1 gram of tissue (defined as a tissue volume in the shape of a cube) and over the appropriate averaging time.
2. The Spatial Average value of the SAR averaged over the whole body.
3. The Spatial Peak value of the SAR averaged over any 10 grams of tissue (defined as a tissue volume in the shape of a cube) and over the appropriate averaging time.

FCC ID: A3LSMF916U	 PCTEST <small>Proud to be part of Samsung</small>	SAR EVALUATION REPORT		Approved by: Quality Manager
Document S/N: 1M2005200087-01-R2.A3L	Test Dates: 06/28/20-08/24/20	DUT Type: Portable Handset	Page 27 of 267	

8 FCC MEASUREMENT PROCEDURES

Power measurements for licensed transmitters are performed using a base station simulator under digital average power.

8.1 Measured and Reported SAR

Per FCC KDB Publication 447498 D01v06, when SAR is not measured at the maximum power level allowed for production units, the results must be scaled to the maximum tune-up tolerance limit according to the power applied to the individual channels tested to determine compliance. For simultaneous transmission, the measured aggregate SAR must be scaled according to the sum of the differences between the maximum tune-up tolerance and actual power used to test each transmitter. When SAR is measured at or scaled to the maximum tune-up tolerance limit, the results are referred to as *reported* SAR. The highest *reported* SAR results are identified on the grant of equipment authorization according to procedures in KDB 690783 D01v01r03.

8.2 3G SAR Test Reduction Procedure

In FCC KDB Publication 941225 D01v03r01, certain transmission modes within a frequency band and wireless mode evaluated for SAR are defined as primary modes. The equivalent modes considered for SAR test reduction are denoted as secondary modes. When the maximum output power including tune-up tolerance specified for production units in a secondary mode is ≤ 0.25 dB higher than the primary mode or when the highest reported SAR of the primary mode, scaled by the ratio of specified maximum output power and tune-up tolerance of secondary to primary mode, is ≤ 1.2 W/kg, SAR measurements are not required for the secondary mode. These criteria are referred to as the 3G SAR test reduction procedure. When the 3G SAR test reduction procedure is not satisfied, SAR measurements are additionally required for the secondary mode.

8.3 Procedures Used to Establish RF Signal for SAR

The following procedures are according to FCC KDB Publication 941225 D01v03r01 “3G SAR Measurement Procedures.”



The device is placed into a simulated call using a base station simulator in a RF shielded chamber. Establishing connections in this manner ensure a consistent means for testing SAR and are recommended for evaluating SAR [4]. Devices under test are evaluated prior to testing, with a fully charged battery and were configured to operate at maximum output power. In order to verify that the device is tested throughout the SAR test at maximum output power, the SAR measurement system measures a “point SAR” at an arbitrary reference point at the start and end of the 1 gram SAR evaluation, to assess for any power drifts during the evaluation. If the power drift deviates by more than 5%, the SAR test and drift measurements are repeated.

8.4 SAR Measurement Conditions for CDMA2000

The following procedures were performed according to FCC KDB Publication 941225 D01v03r01 “3G SAR Measurement Procedures.”

8.4.1 Output Power Verification

See 3GPP2 C.S0011/TIA-98-E as recommended by FCC KDB Publication 941225 D01v03r01 “3G SAR Measurement Procedures.” Maximum output power is verified on the High, Middle and Low channels according to procedures in section 4.4.5.2 of 3GPP2 C.S0011/TIA-98-E. SO55 tests were measured with power control bits in the “All Up” condition.

FCC ID: A3LSMF916U	 PCTEST <small>Proud to be part of Samsung</small>	SAR EVALUATION REPORT		Approved by: Quality Manager
Document S/N: 1M2005200087-01-R2.A3L	Test Dates: 06/28/20-08/24/20	DUT Type: Portable Handset		Page 28 of 267

1. If the mobile station (MS) supports Reverse TCH RC 1 and Forward TCH RC 1, set up a call using Fundamental Channel Test Mode 1 (RC=1/1) with 9600 bps data rate only.
2. Under RC1, C.S0011 Table 4.4.5.2-1, Table 8-1 parameters were applied.
3. If the MS supports the RC 3 Reverse FCH, RC3 Reverse SCH₀ and demodulation of RC 3,4, or 5, set up a call using Supplemental Channel Test Mode 3 (RC 3/3) with 9600 bps Fundamental Channel and 9600 bps SCH₀ data rate.
4. Under RC3, C.S0011 Table 4.4.5.2-2, Table 8-2 was applied.

Table 8-1
Parameters for Max. Power for RC1

Parameter	Units	Value
$\frac{I_{or}}{I_{or}}$	dBm/1.23 MHz	-104
$\frac{Pilot E_c}{I_{or}}$	dB	-7
$\frac{Traffic E_c}{I_{or}}$	dB	-7.4

Table 8-2
Parameters for Max. Power for RC3

Parameter	Units	Value
$\frac{I_{or}}{I_{or}}$	dBm/1.23 MHz	-86
$\frac{Pilot E_c}{I_{or}}$	dB	-7
$\frac{Traffic E_c}{I_{or}}$	dB	-7.4

5. FCHs were configured at full rate for maximum SAR with “All Up” power control bits.

8.4.2 Head SAR Measurements

SAR for next to the ear head exposure is measured in RC3 with the handset configured to transmit at fullrate in SO55. The 3G SAR test reduction procedure is applied to RC1 with RC3 as the primary mode; otherwise, SAR is required for the channel with maximum measured output in RC1 using the head exposure configuration that results in the highest reported SAR in RC3.

Head SAR is additionally evaluated using EVDO Rev. A to support compliance for VoIP operations. See Section 8.4.5 for EVDO Rev. A configuration parameters.

8.4.3 Body-worn SAR Measurements



SAR for body-worn exposure configurations is measured in RC3 with the DUT configured to transmit at full rate on FCH with all other code channels disabled using TDSO / SO32. The 3G SAR test reduction procedure is applied to the multiple code channel configuration (FCH+SCH_n), with FCH only as the primary mode. Otherwise, SAR is required for multiple code channel configuration (FCH + SCH_n), with FCH at full rate and SCH₀ enabled at 9600 bps, using the highest reported SAR configuration for FCH only. When multiple code channels are enabled, the transmitter output can shift by more than 0.5 dB and may lead to higher SAR drifts and SCH dropouts.

The 3G SAR test reduction procedure is applied to body-worn accessory SAR in RC1 with RC3 as the primary mode. Otherwise, SAR is required for RC1, with SO55 and full rate, using the highest reported SAR configuration for body-worn accessory exposure in RC3.

8.4.4 Body-worn SAR Measurements for EVDO Devices

For handsets with EVDO capabilities, the 3G SAR test reduction procedure is applied to EVDO Rev. 0 with 1x RTT RC3 as the primary mode to determine body-worn accessory test requirements. Otherwise, body-worn accessory SAR is required for Rev. 0, at 153.6 kbps, using the highest reported SAR configuration for body-worn accessory exposure in RC3.

The 3G SAR test reduction procedure is applied to Rev. A, with Rev. 0 as the primary mode to determine body-worn accessory SAR test requirements. When SAR is not required for Rev. 0, the 3G SAR test reduction is applied with 1x RTT RC3 as the primary mode.

FCC ID: A3LSMF916U	 PCTEST <small>PROUD TO BE PART OF SAMSUNG</small>	SAR EVALUATION REPORT		Approved by: Quality Manager
Document S/N: 1M2005200087-01-R2.A3L	Test Dates: 06/28/20-08/24/20	DUT Type: Portable Handset	Page 29 of 267	

When SAR is required for EVDO Rev. A, SAR is measured with a Reverse Data Channel payload size of 4096 bits and a Termination Target of 16 slots defined for Subtype 2 Physical Layer configurations, using the highest reported SAR configuration for body-worn accessory exposure in Rev. 0 or 1x RTT RC3, as appropriate.

8.4.5 Body SAR Measurements for EVDO Hotspot

Hotspot Body SAR is measured using Subtype 0/1 Physical Layer configurations for Rev. 0. The 3G SAR test reduction procedure is applied to Rev. A, Subtype 2 Physical layer configuration, with Rev. 0 as the primary mode; otherwise, SAR is measured for Rev. A using the highest reported SAR configuration for body-worn accessory exposure in Rev. 0. The AT is tested with a Reverse Data Channel rate of 153.6 kbps in Subtype 0/1 Physical Layer configurations; and a Reverse Data Channel payload size of 4096 bits and Termination Target of 16 slots in Subtype 2 Physical Layer configurations.

For EVDO data devices that also support 1x RTT voice and/or data operations, the 3G SAR test reduction procedure is applied to 1x RTT RC3 and RC1 with EVDO Rev. 0 and Rev. A as the respective primary modes. Otherwise, the 'Body-Worn Accessory SAR' procedures in the '3GPP2 CDMA 2000 1x Handsets' section are applied.

8.4.6 CDMA2000 1x Advanced

This device additionally supports 1x Advanced. Conducted powers are measured using SO75 with RC8 on the uplink and RC11 on the downlink per FCC KDB Publication 941225 D01v03r01. Smart blanking is disabled for all measurements. The EUT is configured with forward power control Mode 000 and reverse power control at 400 bps. Conducted powers are measured on an Agilent 8960 Series 10 Wireless Communications Test Set, Model E5515C using the CDMA2000 1x Advanced application, Option E1962B-410.

The 3G SAR test reduction procedure is applied to the 1x-Advanced transmission mode with 1x RTT RC3 as the primary mode. When SAR measurement is required, the 1x-Advanced power measurement configurations are used. The 1x Advanced SAR procedures are applied separately to head, body-worn accessory and other exposure conditions.



8.5 SAR Measurement Conditions for UMTS

8.5.1 Output Power Verification

Maximum output power is verified on the High, Middle and Low channels according to the general descriptions in section 5.2 of 3GPP TS 34.121, using the appropriate RMC with TPC (transmit power control) set to all "1s" or applying the required inner loop power control procedures to maintain maximum output power while HSUPA is active. Results for all applicable physical channel configurations (DPCCH, DPDCHn and spreading codes, HS-DPCCH etc) are tabulated in this test report. All configurations that are not supported by the DUT or cannot be measured due to technical or equipment limitations are identified.

8.5.2 Head SAR Measurements

SAR for next to the ear head exposure is measured using a 12.2 kbps RMC with TPC bits configured to all "1's". The 3G SAR test reduction procedure is applied to AMR configurations with 12.2 kbps RMC as the

FCC ID: A3LSMF916U	 PCTEST <small>Proud to be part of Samsung</small>	SAR EVALUATION REPORT		Approved by: Quality Manager
Document S/N: 1M2005200087-01-R2.A3L	Test Dates: 06/28/20-08/24/20	DUT Type: Portable Handset	Page 30 of 267	

primary mode. Otherwise, SAR is measured for 12.2 kbps AMR in 3.4 kbps SRB (signaling radio bearer) using the highest reported SAR configuration in 12.2 kbps RMC for head exposure.

8.5.3 Body SAR Measurements

SAR for body exposure configurations is measured using the 12.2 kbps RMC with the TPC bits all “1s”. The 3G SAR test reduction procedure is applied to other spreading codes and multiple DPDCH_n configurations supported by the handset with 12.2 kbps RMC as the primary mode. Otherwise, SAR is measured using an applicable RMC configuration with the corresponding spreading code or DPDCH_n, for the highest reported SAR configuration in 12.2 kbps RMC.

8.5.4 SAR Measurements with Rel 5 HSDPA

The 3G SAR test reduction procedure is applied to HSDPA body configurations with 12.2 kbps RMC as the primary mode. Otherwise, Body SAR for HSDPA is measured using an FRC with H-Set 1 in Sub-test 1 and a 12.2 kbps RMC configured in Test Loop Mode 1, for the highest reported SAR configuration in 12.2 kbps RMC without HSDPA. Handsets with both HSDPA and HSUPA are tested according to Release 6 HSPA test procedures.

8.5.5 SAR Measurements with Rel 6 HSUPA

The 3G SAR test reduction procedure is applied to HSPA (HSUPA/HSDPA with RMC) body configurations with 12.2 kbps RMC as the primary mode. Otherwise, Body SAR for HSPA is measured with E-DCH Sub-test 5, using H-Set 1 and QPSK for FRC and a 12.2 kbps RMC configured in Test Loop Mode 1 and power control algorithm 2, according to the highest reported body SAR configuration in 12.2 kbps RMC without HSPA.

When VOIP applies to head exposure, the 3G SAR test reduction procedure is applied with 12.2 kbps RMC as the primary mode; otherwise, the same HSPA configuration used for body SAR measurements are applied to head exposure testing.

8.5.6 SAR Measurement Conditions for DC-HSDPA



SAR is required for Rel. 8 DC-HSDPA when SAR is required for Rel. 5 HSDPA; otherwise, the 3G SAR test reduction procedure is applied to DC-HSDPA with 12.2 kbps RMC as the primary mode. Power is measured for DC-HSDPA according to the H-Set 12, FRC configuration in Table C.8.1.12 of 3GPP TS 34.121-1 to determine SAR test reduction. A primary and a secondary serving HS-DSCH Cell are required to perform the power measurement and for the results to be acceptable.

8.6 SAR Measurement Conditions for LTE

LTE modes are tested according to FCC KDB 941225 D05v02r04 publication. Establishing connections with base station simulators ensure a consistent means for testing SAR and are recommended for evaluating SAR [4]. The R&S CMW500 or Anritsu MT8820C simulators are used for LTE output power measurements and SAR testing. Closed loop power control was used so the UE transmits with maximum output power during SAR testing. SAR tests were performed with the same number of RB and RB offsets transmitting on all TTI frames (maximum TTI).

8.6.1 Spectrum Plots for RB Configurations

A properly configured base station simulator was used for SAR tests and power measurements. Therefore, spectrum plots for RB configurations were not required to be included in this report.

FCC ID: A3LSMF916U	 PCTEST <small>Proud to be part of Samsung</small>	SAR EVALUATION REPORT		Approved by: Quality Manager
Document S/N: 1M2005200087-01-R2.A3L	Test Dates: 06/28/20-08/24/20	DUT Type: Portable Handset	Page 31 of 267	

8.6.2 MPR

MPR is permanently implemented for this device by the manufacturer. The specific manufacturer target MPR is indicated alongside the SAR results. MPR is enabled for this device, according to 3GPP TS36.101 Section 6.2.3 – 6.2.5 under Table 6.2.3-1.

8.6.3 A-MPR

A-MPR (Additional MPR) has been disabled for all SAR tests by setting NS=01 on the base station simulator.

8.6.4 Required RB Size and RB Offsets for SAR Testing

According to FCC KDB 941225 D05v02r04:



- a. Per Section 5.2.1, SAR is required for QPSK 1 RB Allocation for the largest bandwidth
 - i. The required channel and offset combination with the highest maximum output power is required for SAR.
 - ii. When the reported SAR is ≤ 0.8 W/kg, testing of the remaining RB offset configurations and required test channels is not required. Otherwise, SAR is required for the remaining required test channels using the RB offset configuration with highest output power for that channel.
 - iii. When the reported SAR for a required test channel is > 1.45 W/kg, SAR is required for all RB offset configurations for that channel.
- b. Per Section 5.2.2, SAR is required for 50% RB allocation using the largest bandwidth following the same procedures outlined in Section 5.2.1.
- c. Per Section 5.2.3, QPSK SAR is not required for the 100% allocation when the highest maximum output power for the 100% allocation is less than the highest maximum output power of the 1 RB and 50% RB allocations and the reported SAR for the 1 RB and 50% RB allocations is < 0.8 W/kg.
- d. Per Section 5.2.4 and 5.3, SAR tests for higher order modulations and lower bandwidths configurations are not required when the conducted power of the required test configurations determined by Sections 5.2.1 through 5.2.3 is less than or equal to $\frac{1}{2}$ dB higher than the equivalent configuration using QPSK modulation and when the QPSK SAR for those configurations is < 1.45 W/kg.

8.6.5 TDD

LTE TDD testing is performed using the SAR test guidance provided in FCC KDB 941225 D05v02r04. TDD is tested at the highest duty factor using UL-DL configuration 0 with special subframe configuration 6 and applying the FDD LTE procedures in KDB 941225 D05v02r04. SAR testing is performed using the extended cyclic prefix listed in 3GPP TS 36.211 Section 4.

8.6.6 Downlink Only Carrier Aggregation

Conducted power measurements with LTE Carrier Aggregation (CA) (downlink only) active are made in accordance to KDB Publication 941225 D05Av01r02. The RRC connection is only handled by one cell, the primary component carrier (PCC) for downlink and uplink communications. After making a data connection to the PCC, the UE device adds secondary component carrier(s) (SCC) on the downlink only. All uplink communications and acknowledgements remain identical to specifications when downlink carrier aggregation is inactive on the PCC. Additional conducted output powers are measured with the downlink carrier aggregation active for the configuration with highest measured maximum conducted power with downlink carrier aggregation inactive measured among the channel bandwidth, modulation, and RB combinations in each frequency band. Per FCC KDB Publication 941225 D05Av01r02, no SAR measurements are required for downlink only carrier aggregation configurations when the average output

FCC ID: A3LSMF916U	 PCTEST <small>Proud to be part of Samsung</small>	SAR EVALUATION REPORT		Approved by: Quality Manager
Document S/N: 1M2005200087-01-R2.A3L	Test Dates: 06/28/20-08/24/20	DUT Type: Portable Handset		Page 32 of 267

power with downlink only carrier aggregation active is not more than 0.25 dB higher than the average output power with downlink only carrier aggregation inactive.

8.7 SAR Testing with 802.11 Transmitters

The normal network operating configurations of 802.11 transmitters are not suitable for SAR measurements. Unpredictable fluctuations in network traffic and antenna diversity conditions can introduce undesirable variations in SAR results. The SAR for these devices should be measured using chipset based test mode software to ensure the results are consistent and reliable. See KDB Publication 248227 D01v02r02 for more details.

8.7.1 General Device Setup

Chipset based test mode software is hardware dependent and generally varies among manufacturers. The device operating parameters established in test mode for SAR measurements must be identical to those programmed in production units, including output power levels, amplifier gain settings and other RF performance tuning parameters.

A periodic duty factor is required for current generation SAR systems to measure SAR. When 802.11 frame gaps are accounted for in the transmission, a maximum transmission duty factor of 92 - 96% is typically achievable in most test mode configurations. A minimum transmission duty factor of 85% is required to avoid certain hardware and device implementation issues related to wide range SAR scaling. The reported SAR is scaled to 100% transmission duty factor to determine compliance at the maximum tune-up tolerance limit.

8.7.2 U-NII-1 and U-NII-2A



For devices that operate in both U-NII-1 and U-NII-2A bands, when the same maximum output power is specified for both bands, SAR measurement using OFDM SAR test procedures is not required for U-NII-1 unless the highest reported SAR for U-NII-2A is > 1.2 W/kg. When different maximum output powers are specified for the bands, SAR measurement for the U-NII band with the lower maximum output power is not required unless the highest reported SAR for the U-NII band with the higher maximum output power, adjusted by the ratio of lower to higher specified maximum output power for the two bands, is > 1.2 W/kg. When 10g SAR measurement is considered, a factor of 2.5 is applied to the thresholds above.

8.7.3 U-NII-2C and U-NII-3

The frequency range covered by U-NII-2C and U-NII-3 is 380 MHz (5.47 – 5.85 GHz), which requires a minimum of at least two SAR probe calibration frequency points to support SAR measurements. When Terminal Doppler Weather Radar (TDWR) restriction applies, the channels at 5.60 – 5.65 GHz in U-NII-2C band must be disabled with acceptable mechanisms and documented in the equipment certification. Unless band gap channels are permanently disabled, SAR must be considered for these channels. Each band is tested independently according to the normally required OFDM SAR measurement and probe calibration frequency points requirements.

8.7.4 Initial Test Position Procedure

For exposure conditions with multiple test positions, such as handset operating next to the ear, devices with hotspot mode or UMPC mini-tablet, procedures for initial test position can be applied. Using the transmission mode determined by the DSSS procedure or initial test configuration, area scans are measured for all positions in an exposure condition. The test position with the highest extrapolated (peak) SAR is used as the initial test position. When reported SAR for the initial test position is ≤ 0.4 W/kg, no additional testing for the remaining test positions is required. Otherwise, SAR is evaluated at the subsequent highest peak SAR

FCC ID: A3LSMF916U	 PCTEST <small>Proud to be part of Samsung</small>	SAR EVALUATION REPORT		Approved by: Quality Manager
Document S/N: 1M2005200087-01-R2.A3L	Test Dates: 06/28/20-08/24/20	DUT Type: Portable Handset	Page 33 of 267	

positions until the reported SAR result is ≤ 0.8 W/kg or all test positions are measured. When 10g SAR measurement is considered, a factor of 2.5 is applied to the thresholds above.

8.7.5 2.4 GHz SAR Test Requirements

SAR is measured for 2.4 GHz 802.11b DSSS using either the fixed test position or, when applicable, the initial test position procedure. SAR test reduction is determined according to the following:

- 1) When the reported SAR of the highest measured maximum output power channel for the exposure configuration is ≤ 0.8 W/kg, no further SAR testing is required for 802.11b DSSS in that exposure configuration.
- 2) When the reported SAR is > 0.8 W/kg, SAR is required for that position using the next highest measured output power channel. When any reported SAR is > 1.2 W/kg, SAR is required for the third channel; i.e., all channels require testing.

2.4 GHz 802.11 g/n/ax OFDM are additionally evaluated for SAR if the highest reported SAR for 802.11b, adjusted by the ratio of the OFDM to DSSS specified maximum output power, is > 1.2 W/kg. When SAR is required for OFDM modes in 2.4 GHz band, the Initial Test Configuration Procedures should be followed. When 10g SAR measurement is considered, a factor of 2.5 is applied to the thresholds above.



8.7.6 OFDM Transmission Mode and SAR Test Channel Selection

When the same maximum output power was specified for multiple OFDM transmission mode configurations in a frequency band or aggregated band, SAR is measured using the configuration with the largest channel bandwidth, lowest order modulation and lowest data rate. When the maximum output power of a channel is the same for equivalent OFDM configurations; for example, 802.11a, 802.11n and 802.11ac or 802.11g and 802.11n with the same channel bandwidth, modulation and data rate etc., the lower order 802.11 mode i.e., 802.11a, then 802.11n and 802.11ac or 802.11g then 802.11n, is used for SAR measurement. Per April 2019 TCB Workshop guidance, 802.11ax was considered the highest order 802.11 mode. When the maximum output power are the same for multiple test channels, either according to the default or additional power measurement requirements, SAR is measured using the channel closest to the middle of the frequency band or aggregated band. When there are multiple channels with the same maximum output power, SAR is measured using the higher number channel.

8.7.7 Initial Test Configuration Procedure

For OFDM, an initial test configuration is determined for each frequency band and aggregated band, according to the transmission mode with the highest maximum output power specified for SAR measurements. When the same maximum output power is specified for multiple OFDM transmission mode configurations in a frequency band or aggregated band, SAR is measured using the configuration(s) with the largest channel bandwidth, lowest order modulation, lowest data rate and lowest order IEEE 802.11 mode. The channel of the transmission mode with the highest average RF output conducted power will be the initial test configuration.

When the reported SAR is ≤ 0.8 W/kg, no additional measurements on other test channels are required. Otherwise, SAR is evaluated using the subsequent highest average RF output channel until the reported SAR result is ≤ 1.2 W/kg or all channels are measured. When there are multiple untested channels having the same subsequent highest average RF output power, the channel with higher frequency from the lowest 802.11 mode is considered for SAR measurements (See Section 8.7.6). When 10g SAR measurement is considered, a factor of 2.5 is applied to the thresholds above.



FCC ID: A3LSMF916U	 PCTEST <small>Prove it to be part of Samsung</small>	SAR EVALUATION REPORT		Approved by: Quality Manager
Document S/N: 1M2005200087-01-R2.A3L	Test Dates: 06/28/20-08/24/20	DUT Type: Portable Handset	Page 34 of 267	

8.7.8 Subsequent Test Configuration Procedures

For OFDM configurations in each frequency band and aggregated band, SAR is evaluated for initial test configuration using the fixed test position or the initial test position procedure. When the highest reported SAR (for the initial test configuration), adjusted by the ratio of the specified maximum output power of the subsequent test configuration to initial test configuration, is ≤ 1.2 W/kg, no additional SAR tests for the subsequent test configurations are required. When 10g SAR measurement is considered, a factor of 2.5 is applied to the thresholds above.

8.7.9 MIMO SAR considerations

Per KDB Publication 248227 D01v02r02, the simultaneous SAR provisions in KDB Publication 447498 D01v06 should be applied to determine simultaneous transmission SAR test exclusion for WIFI MIMO. If the sum of 1g single transmission chain SAR measurements is < 1.6 W/kg, no additional SAR measurements for MIMO are required. Alternatively, SAR for MIMO can be measured with all antennas transmitting simultaneously at the specified maximum output power of MIMO operation. When 10g SAR measurement is considered, a factor of 2.5 is applied to the thresholds above.

FCC ID: A3LSMF916U	 PCTEST <small>Proud to be part of Samsung</small>	SAR EVALUATION REPORT		Approved by: Quality Manager
Document S/N: 1M2005200087-01-R2.A3L	Test Dates: 06/28/20-08/24/20	DUT Type: Portable Handset	Page 35 of 267	

9 RF CONDUCTED POWERS

9.1 CDMA Conducted Powers

Table 9-1

Measured P_{max} for all DSI for CDMA BC10 and CDMA BC0 Ant A

Measured P_{limit} for DSI = 0 (Body-worn, or Phablet/UMPC with grip sensor inactive), or DSI = 3/4 (Head) CDMA BC1

Band	Channel	Rule Part	Frequency	SO55 [dBm]	SO55 [dBm]	SO75 [dBm]	TDSO SO32 [dBm]	TDSO SO32 [dBm]	1x EvDO Rev. 0 [dBm]	1x EvDO Rev. A [dBm]
	F-RC		MHz	RC1	RC3	RC11	FCH+SCH	FCH	(RTAP)	(RETAP)
Cellular	564	90S	820.1	25.09	25.11	25.24	25.11	25.11	25.15	25.18
Cellular	1013	22H	824.7	25.13	25.13	25.29	25.14	25.15	25.19	25.22
	384	22H	836.52	25.13	25.12	25.27	25.12	25.12	25.16	25.17
	777	22H	848.31	25.05	25.04	25.20	25.03	25.04	25.08	25.07
PCS	25	24E	1851.25	22.82	22.82	22.97	22.81	22.81	23.14	23.04
	600	24E	1880	22.87	22.87	23.01	22.89	22.87	23.16	23.19
	1175	24E	1908.75	22.92	22.91	23.17	22.92	22.91	23.23	23.18

Table 9-2

Measured P_{max} for all DSI for CDMA BC0 Ant B

Band	Channel	Rule Part	Frequency	SO55 [dBm]	SO55 [dBm]	SO75 [dBm]	TDSO SO32 [dBm]	TDSO SO32 [dBm]	1x EvDO Rev. 0 [dBm]	1x EvDO Rev. A [dBm]
	F-RC		MHz	RC1	RC3	RC11	FCH+SCH	FCH	(RTAP)	(RETAP)
Cellular	1013	22H	824.7	23.52	23.53	23.49	23.54	23.52	23.55	23.57
	384	22H	836.52	23.48	23.45	23.44	23.52	23.47	23.51	23.54
	777	22H	848.31	23.33	23.32	23.30	23.32	23.31	23.39	23.34



FCC ID: A3LSMF916U	 PCTEST <small> Proud to be part of Samsung</small>	SAR EVALUATION REPORT		Approved by: Quality Manager
Document S/N: 1M2005200087-01-R2.A3L	Test Dates: 06/28/20-08/24/20	DUT Type: Portable Handset		Page 36 of 267

Table 9-3



Measured P_{limit} for DSI = 1/2 (Phablet or UMPC Extremity with grip sensor active), or DSI = 5/6 (Hotspot Mode), and/or DSI = 7/8 (Earjack active)

Band	Channel	Rule Part	Frequency	SO55 [dBm]	SO55 [dBm]	SO75 [dBm]	TDSO SO32 [dBm]	TDSO SO32 [dBm]	1x EvDO Rev. 0 [dBm]	1x EvDO Rev. A [dBm]
	F-RC		MHz	RC1	RC3	RC11	FCH+SCH	FCH	(RTAP)	(RETAP)
PCS	25	24E	1851.25	19.00	18.95	18.91	18.96	18.97	19.02	18.98
	600	24E	1880	18.48	18.46	18.41	18.48	18.47	18.58	18.52
	1175	24E	1908.75	18.64	18.64	18.60	18.64	18.65	18.95	18.66

Note: RC1 is only applicable for IS-95 compatibility. For FCC Rule Part 90S, Per FCC KDB Publication 447498 D01v06 4.1.g), only one channel is required since the device operates within the transmission range of 817.90 – 823.10 MHz.



Figure 9-1
Power Measurement Setup

FCC ID: A3LSMF916U	 PCTEST <small>PROUD TO BE PART OF SAMSUNG</small>	SAR EVALUATION REPORT		Approved by: Quality Manager
Document S/N: 1M2005200087-01-R2.A3L	Test Dates: 06/28/20-08/24/20	DUT Type: Portable Handset		Page 37 of 267

9.2 GSM Conducted Powers

Table 9-4
Measured P_{max} for all DSI for GSM 850 Ant A

Measured P_{max} for DSI = 0 (Body-worn, or Phablet/UMPC with grip sensor inactive), or DSI = 3/4 (Head) for GSM 1900

Maximum Burst-Averaged Output Power										
Band	Channel	Voice	GPRS/EDGE Data (GMSK)				EDGE Data (8-PSK)			
		GSM [dBm] CS (1 Slot)	GPRS [dBm] 1 Tx Slot	GPRS [dBm] 2 Tx Slot	GPRS [dBm] 3 Tx Slot	GPRS [dBm] 4 Tx Slot	EDGE [dBm] 1 Tx Slot	EDGE [dBm] 2 Tx Slot	EDGE [dBm] 3 Tx Slot	EDGE [dBm] 4 Tx Slot
GSM 850	128	33.18	32.33	31.02	28.76	26.91	26.46	24.72	22.16	21.32
	190	33.05	32.42	31.06	28.88	26.92	26.61	25.16	22.55	21.48
	251	33.14	32.51	31.32	29.08	26.98	26.63	25.13	22.77	21.52
GSM 1900	512	29.38	29.45	28.21	26.58	24.55	25.79	24.16	21.78	20.42
	661	28.89	29.40	28.38	26.72	24.68	25.92	24.22	21.68	20.91
	810	29.20	29.80	28.58	26.98	24.79	26.12	24.39	22.35	21.06

Calculated Maximum Frame-Averaged Output Power										
Band	Channel	Voice	GPRS/EDGE Data (GMSK)				EDGE Data (8-PSK)			
		GSM [dBm] CS (1 Slot)	GPRS [dBm] 1 Tx Slot	GPRS [dBm] 2 Tx Slot	GPRS [dBm] 3 Tx Slot	GPRS [dBm] 4 Tx Slot	EDGE [dBm] 1 Tx Slot	EDGE [dBm] 2 Tx Slot	EDGE [dBm] 3 Tx Slot	EDGE [dBm] 4 Tx Slot
GSM 850	128	23.98	23.13	24.83	24.33	23.73	17.26	18.53	17.73	18.14
	190	23.85	23.22	24.87	24.45	23.74	17.41	18.97	18.12	18.30
	251	23.94	23.31	25.13	24.65	23.80	17.43	18.94	18.34	18.34
GSM 1900	512	20.18	20.25	22.02	22.15	21.37	16.59	17.97	17.35	17.24
	661	19.69	20.20	22.19	22.29	21.50	16.72	18.03	17.25	17.73
	810	20.00	20.60	22.39	22.55	21.61	16.92	18.20	17.92	17.88

GSM 850	Frame	23.30	23.30	25.31	25.07	24.32	17.80	18.81	18.57	18.82
GSM 1900	Avg.Targets:	20.30	20.30	21.81	22.07	21.32	16.80	17.81	17.57	17.82



FCC ID: A3LSMF916U	 PCTEST Proud to be part of Samsung	SAR EVALUATION REPORT		Approved by: Quality Manager
Document S/N: 1M2005200087-01-R2.A3L	Test Dates: 06/28/20-08/24/20	DUT Type: Portable Handset		Page 38 of 267

Table 9-5
Measured P_{max} for all DSI for GSM 850 Ant B

Maximum Burst-Averaged Output Power										
Band	Channel	Voice	GPRS/EDGE Data (GMSK)				EDGE Data (8-PSK)			
		GSM [dBm] CS (1 Slot)	GPRS [dBm] 1 Tx Slot	GPRS [dBm] 2 Tx Slot	GPRS [dBm] 3 Tx Slot	GPRS [dBm] 4 Tx Slot	EDGE [dBm] 1 Tx Slot	EDGE [dBm] 2 Tx Slot	EDGE [dBm] 3 Tx Slot	EDGE [dBm] 4 Tx Slot
GSM 850	128	31.42	31.45	30.21	28.32	26.17	25.80	24.32	22.01	20.93
	190	31.18	31.24	30.34	28.29	26.36	25.90	24.31	22.31	20.86
	251	31.41	31.56	30.13	28.17	26.17	25.65	23.92	22.14	20.31

Calculated Maximum Frame-Averaged Output Power										
Band	Channel	Voice	GPRS/EDGE Data (GMSK)				EDGE Data (8-PSK)			
		GSM [dBm] CS (1 Slot)	GPRS [dBm] 1 Tx Slot	GPRS [dBm] 2 Tx Slot	GPRS [dBm] 3 Tx Slot	GPRS [dBm] 4 Tx Slot	EDGE [dBm] 1 Tx Slot	EDGE [dBm] 2 Tx Slot	EDGE [dBm] 3 Tx Slot	EDGE [dBm] 4 Tx Slot
GSM 850	128	22.22	22.25	24.02	23.89	22.99	16.60	18.13	17.58	17.75
	190	21.98	22.04	24.15	23.86	23.18	16.70	18.12	17.88	17.68
	251	22.21	22.36	23.94	23.74	22.99	16.45	17.73	17.71	17.13

GSM 850	Frame Avg.Targets:	22.30	22.30	24.31	24.07	23.32	16.80	17.81	17.57	17.82
----------------	---------------------------	-------	-------	-------	--------------	-------	-------	-------	-------	-------



FCC ID: A3LSMF916U	 PCTEST <small>Prove it to be part of Samsung</small>	SAR EVALUATION REPORT		Approved by: Quality Manager
Document S/N: 1M2005200087-01-R2.A3L	Test Dates: 06/28/20-08/24/20	DUT Type: Portable Handset		Page 39 of 267

Table 9-6

Measured P_{limit} for DSI = 1/2 (Phablet or UMPC Extremity with grip sensor active), or DSI = 5/6 (Hotspot Mode), and/or DSI = 7/8 (Earjack active)

Maximum Burst-Averaged Output Power										
Band	Channel	Voice	GPRS/EDGE Data (GMSK)				EDGE Data (8-PSK)			
		GSM [dBm] CS (1 Slot)	GPRS [dBm] 1 Tx Slot	GPRS [dBm] 2 Tx Slot	GPRS [dBm] 3 Tx Slot	GPRS [dBm] 4 Tx Slot	EDGE [dBm] 1 Tx Slot	EDGE [dBm] 2 Tx Slot	EDGE [dBm] 3 Tx Slot	EDGE [dBm] 4 Tx Slot
GSM 1900	512	27.99	27.98	24.73	23.26	21.84	25.79	24.16	21.78	20.42
	661	28.07	28.02	24.57	23.03	21.82	25.92	24.22	21.68	20.91
	810	27.94	27.91	24.74	23.02	21.69	26.12	24.39	22.35	21.06

Calculated Maximum Frame-Averaged Output Power										
Band	Channel	Voice	GPRS/EDGE Data (GMSK)				EDGE Data (8-PSK)			
		GSM [dBm] CS (1 Slot)	GPRS [dBm] 1 Tx Slot	GPRS [dBm] 2 Tx Slot	GPRS [dBm] 3 Tx Slot	GPRS [dBm] 4 Tx Slot	EDGE [dBm] 1 Tx Slot	EDGE [dBm] 2 Tx Slot	EDGE [dBm] 3 Tx Slot	EDGE [dBm] 4 Tx Slot
GSM 1900	512	18.79	18.78	18.54	18.83	18.66	16.59	17.97	17.35	17.24
	661	18.87	18.82	18.38	18.60	18.64	16.72	18.03	17.25	17.73
	810	18.74	18.71	18.55	18.59	18.51	16.92	18.20	17.92	17.88

GSM 1900	Frame Avg. Targets:	18.80	18.80	18.81	18.77	18.82	16.80	17.81	17.57	17.82
-----------------	----------------------------	-------	-------	-------	-------	-------	-------	-------	-------	-------

Note:

- Both burst-averaged and calculated frame-averaged powers are included. Frame-averaged power was calculated from the measured burst-averaged power by converting the slot powers into linear units and calculating the energy over 8 timeslots.
- GPRS/EDGE (GMSK) output powers were measured with coding scheme setting of 1 (CS1) on the base station simulator. CS1 was configured to measure GPRS output power measurements and SAR to ensure GMSK modulation in the signal. Our Investigation has shown that CS1 - CS4 settings do not have any impact on the output levels or modulation in the GPRS modes.
- EDGE (8-PSK) output powers were measured with MCS7 on the base station simulator. MCS7 coding scheme was used to measure the output powers for EDGE since investigation has shown that choosing MCS7 coding scheme will ensure 8-PSK modulation. It has been shown that MCS levels that produce 8-PSK modulation do not have an impact on output power.

GSM Class: B
GPRS Multislot class: 33 (Max 4 Tx uplink slots)
EDGE Multislot class: 33 (Max 4 Tx uplink slots)
DTM Multislot Class: N/A



Figure 9-2
Power Measurement Setup

FCC ID: A3LSMF916U		SAR EVALUATION REPORT		Approved by: Quality Manager
Document S/N: 1M2005200087-01-R2.A3L	Test Dates: 06/28/20-08/24/20	DUT Type: Portable Handset		Page 40 of 267

9.3 UMTS Conducted Powers

Table 9-7

Measured P_{max} for all DSI for UMTS 850

Measured P_{max} for DSI = 0 (Body-worn, or Phablet/UMPC with grip sensor inactive), or DSI = 3/4 (Head) for UMTS Band 4
 Measured P_{limit} for DSI = 0 (Body-worn, or Phablet/UMPC with grip sensor inactive), or DSI = 3/4 (Head) UMTS Band 2

3GPP Release Version	Mode	3GPP 34.121 Subtest	Cellular Band [dBm]			AWS Band [dBm]			PCS Band [dBm]			3GPP MPR [dB]
			4132	4183	4233	1312	1412	1513	9262	9400	9538	
99	WCDMA	12.2 kbps RMC	24.31	24.32	24.25	24.11	24.24	23.53	23.60	23.81	23.82	-
99		12.2 kbps AMR	24.60	24.49	24.46	24.25	24.22	23.5	23.51	23.76	23.85	-
6	HSDPA	Subtest 1	23.25	23.36	23.14	22.24	22.50	22.45	22.43	22.66	22.70	0
6		Subtest 2	23.49	23.38	23.29	22.25	22.51	22.45	22.40	22.61	22.71	0
6		Subtest 3	22.95	22.73	22.79	21.80	21.98	21.93	22.00	22.19	22.21	0.5
6		Subtest 4	22.93	22.88	22.76	21.75	22.01	21.86	21.89	22.12	22.19	0.5
6	HSUPA	Subtest 1	23.53	23.46	23.40	22.38	22.60	22.50	22.53	22.71	22.66	0
6		Subtest 2	21.55	21.48	21.40	20.39	20.59	20.52	20.37	20.63	20.63	2
6		Subtest 3	21.95	21.90	21.81	21.37	21.56	21.50	21.30	21.62	21.67	1
6		Subtest 4	20.92	20.88	20.80	20.40	20.58	20.50	20.36	20.60	20.64	2
6		Subtest 5	23.54	23.50	23.39	22.51	22.72	22.61	22.33	22.61	22.66	0
8	DC-HSDPA	Subtest 1	23.51	23.48	23.40	22.41	22.60	22.50	22.35	22.66	22.68	0
8		Subtest 2	23.55	23.40	23.42	22.34	22.62	22.52	22.36	21.64	22.62	0
8		Subtest 3	23.05	22.98	22.88	21.87	22.11	22.00	21.89	22.13	22.30	0.5
8		Subtest 4	23.05	22.96	22.88	21.84	22.12	22.02	21.87	22.16	22.20	0.5

Table 9-8

Measured P_{limit} for DSI = 1/2 (Phablet or UMPC Extremity with grip sensor active), or DSI = 5/6 (Hotspot Mode), and/or DSI = 7/8 (Earjack active)

3GPP Release Version	Mode	3GPP 34.121 Subtest	AWS Band [dBm]			PCS Band [dBm]			3GPP MPR [dB]
			1312	1412	1513	9262	9400	9538	
99	WCDMA	12.2 kbps RMC	18.75	18.93	18.90	19.01	18.63	18.94	-
99		12.2 kbps AMR	18.69	18.80	18.85	19.07	18.58	18.71	-
6	HSDPA	Subtest 1	17.65	17.91	17.96	18.04	17.45	17.79	0
6		Subtest 2	17.72	17.80	17.85	18.10	17.66	17.72	0
6		Subtest 3	17.22	17.44	17.46	17.43	17.18	17.38	0.5
6		Subtest 4	17.23	17.38	17.49	17.70	17.19	17.34	0.5
6	HSUPA	Subtest 1	17.68	17.90	17.96	18.17	17.67	17.88	0
6		Subtest 2	15.67	15.90	15.94	16.20	15.65	15.88	2
6		Subtest 3	16.72	16.88	16.93	17.20	16.68	16.91	1
6		Subtest 4	15.72	15.91	15.95	16.25	15.68	15.91	2
6		Subtest 5	17.72	17.93	17.92	18.23	17.73	17.89	0
8	DC-HSDPA	Subtest 1	17.66	17.93	17.95	18.23	17.69	17.90	0
8		Subtest 2	17.67	17.91	17.95	18.21	17.67	17.86	0
8		Subtest 3	17.19	17.38	17.42	17.71	17.18	17.37	0.5
8		Subtest 4	17.18	17.41	17.45	17.72	17.19	17.38	0.5

DC-HSDPA considerations

- 3GPP Specification 34.121-1 Release 8 Ver 8.10.0 was used for DC-HSDPA guidance
- H-Set 12 (QPSK) was confirmed to be used during DC-HSDPA measurements
- The DUT supports UE category 24 for HSDPA

It is expected by the manufacturer that MPR for some HSPA subtests may be up to 2 dB more than specified by 3GPP, but also as low as 0 dB according to the chipset implementation in this model.

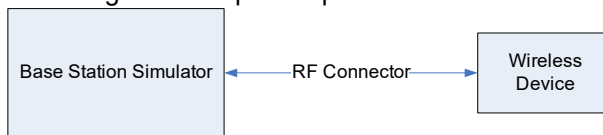

Figure 9-3
Power Measurement Setup

FCC ID: A3LSMF916U		SAR EVALUATION REPORT		Approved by: Quality Manager
Document S/N: 1M2005200087-01-R2.A3L	Test Dates: 06/28/20-08/24/20	DUT Type: Portable Handset	Page 41 of 267	

9.4 LTE Conducted Powers

9.4.1

LTE Band 71

Table 9-9

LTE Band 71 Measured P_{Max} for all DSI - 20 MHz Bandwidth

LTE Band 71 20 MHz Bandwidth					
Modulation	RB Size	RB Offset	Mid Channel	MPR Allowed per 3GPP [dB]	MPR [dB]
			133297 (680.5 MHz)		
			Conducted Power [dBm]		
QPSK	1	0	24.67	0	0
	1	50	24.62		0
	1	99	24.63		0
	50	0	23.73	0-1	1
	50	25	23.75		1
	50	50	23.77		1
	100	0	23.70		1
16QAM	1	0	24.23	0-1	1
	1	50	24.19		1
	1	99	24.23		1
	50	0	22.79	0-2	2
	50	25	22.82		2
	50	50	22.79		2
	100	0	22.74		2
64QAM	1	0	22.94	0-2	2
	1	50	23.02		2
	1	99	22.99		2
	50	0	21.84	0-3	3
	50	25	21.85		3
	50	50	21.83		3
	100	0	21.74		3
256QAM	1	0	19.61	0-5	5
	1	50	19.74		5
	1	99	19.62		5
	50	0	19.69		5
	50	25	19.86		5
	50	50	19.81		5
	100	0	19.77		5

Note: LTE Band 71 at 20 MHz bandwidth does not support three non-overlapping channels. Per KDB Publication 941225 D05v02, when a device supports overlapping channel assignment in a channel bandwidth configuration, the middle channel of the group of overlapping channels should be selected for testing.

Table 9-10

LTE Band 71 Measured P_{Max} for all DSI - 15 MHz Bandwidth

LTE Band 71 15 MHz Bandwidth					
Modulation	RB Size	RB Offset	Mid Channel	MPR Allowed per 3GPP [dB]	MPR [dB]
			133297 (680.5 MHz)		
			Conducted Power [dBm]		
QPSK	1	0	24.40	0	0
	1	36	24.32		0
	1	74	24.25		0
	36	0	23.47	0-1	1
	36	18	23.24		1
	36	37	23.38		1
	75	0	23.40		1
16QAM	1	0	23.80	0-1	1
	1	36	23.61		1
	1	74	23.50		1
	36	0	22.48	0-2	2
	36	18	22.37		2
	36	37	22.33		2
	75	0	22.39		2
64QAM	1	0	22.66	0-2	2
	1	36	22.62		2
	1	74	22.47		2
	36	0	21.50	0-3	3
	36	18	21.41		3
	36	37	21.34		3
	75	0	21.47		3
256QAM	1	0	19.32	0-5	5
	1	36	19.37		5
	1	74	19.49		5
	36	0	19.32		5
	36	18	19.42		5
	36	37	19.58		5
	75	0	19.45		5

Note: LTE Band 71 at 15 MHz bandwidth does not support three non-overlapping channels. Per KDB Publication 941225 D05v02, when a device supports overlapping channel assignment in a channel bandwidth configuration, the middle channel of the group of overlapping channels should be selected for testing.





FCC ID: A3LSMF916U	 PCTEST Proud to be part of Samsung	SAR EVALUATION REPORT		Approved by: Quality Manager
Document S/N: 1M2005200087-01-R2.A3L	Test Dates: 06/28/20-08/24/20	DUT Type: Portable Handset		Page 42 of 267

Table 9-11
LTE Band 71 Measured P_{Max} for all DSI - 10 MHz Bandwidth

LTE Band 71 10 MHz Bandwidth								
Modulation	RB Size	RB Offset	Low Channel	Mid Channel	High Channel	MPR Allowed per 3GPP [dB]	MPR [dB]	
			133172 (668.0 MHz)	133297 (680.5 MHz)	133422 (693.0 MHz)			
			Conducted Power [dBm]					
QPSK	1	0	24.50	24.30	24.41	0	0	
	1	25	24.28	24.37	24.33		0	
	1	49	24.29	24.34	24.36		0	
	QPSK	25	0	23.52	23.40	23.42	0-1	1
		25	12	23.41	23.34	23.35		1
		25	25	23.33	23.30	23.48		1
		50	0	23.43	23.37	23.39		1
50		0	23.83	23.73	23.91	1		
16QAM	1	0	23.72	23.67	23.78	0-1	1	
	1	25	23.82	23.76	23.79		1	
	1	49	23.82	23.76	23.79		1	
	16QAM	25	0	22.43	22.43	22.44	0-2	2
		25	12	22.51	22.35	22.40		2
		25	25	22.55	22.45	22.42		2
		50	0	22.50	22.47	22.34		2
50		0	22.86	22.63	22.63	2		
64QAM	1	0	22.57	22.63	22.60	0-2	2	
	1	25	22.64	22.74	22.74		2	
	1	49	22.64	22.74	22.74		2	
	64QAM	25	0	21.44	21.50	21.50	0-3	3
		25	12	21.56	21.45	21.56		3
		25	25	21.35	21.39	21.49		3
		50	0	21.40	21.50	21.41		3
50		0	21.40	21.50	21.41	3		
256QAM	1	0	19.46	19.22	19.66	0-5	5	
	1	25	19.56	19.50	19.50		5	
	1	49	19.37	19.49	19.50		5	
	25	0	19.41	19.34	19.38		5	
	25	12	19.49	19.41	19.43		5	
	25	25	19.44	19.43	19.30		5	
	50	0	19.38	19.47	19.43		5	

Table 9-12
LTE Band 71 Measured P_{Max} for all DSI - 5 MHz Bandwidth

LTE Band 71 5 MHz Bandwidth								
Modulation	RB Size	RB Offset	Low Channel	Mid Channel	High Channel	MPR Allowed per 3GPP [dB]	MPR [dB]	
			133147 (665.5 MHz)	133297 (680.5 MHz)	133447 (695.5 MHz)			
			Conducted Power [dBm]					
QPSK	1	0	24.42	24.30	24.30	0	0	
	1	12	24.47	24.37	24.49		0	
	1	24	24.35	24.35	24.41		0	
	QPSK	12	0	23.48	23.35	23.44	0-1	1
		12	6	23.50	23.45	23.48		1
		12	13	23.47	23.50	23.52		1
		25	0	23.51	23.47	23.52		1
25		0	23.74	23.57	23.61	1		
16QAM	1	0	23.81	23.87	24.10	0-1	1	
	1	12	23.72	23.56	23.78		1	
	1	24	23.72	23.56	23.78		1	
	16QAM	12	0	22.58	22.47	22.56	0-2	2
		12	6	22.65	22.50	22.55		2
		12	13	22.59	22.49	22.66		2
		25	0	22.50	22.45	22.40		2
25		0	22.50	22.45	22.40	2		
64QAM	1	0	22.78	22.56	22.56	0-2	2	
	1	12	22.72	22.60	22.75		2	
	1	24	22.70	22.62	22.63		2	
	64QAM	12	0	21.51	21.35	21.50	0-3	3
		12	6	21.61	21.49	21.50		3
		12	13	21.55	21.47	21.55		3
		25	0	21.49	21.50	21.46		3
25		0	21.49	21.50	21.46	3		
256QAM	1	0	19.62	19.50	19.53	0-5	5	
	1	12	19.80	19.48	19.72		5	
	1	24	19.53	19.52	19.60		5	
	12	0	19.55	19.41	19.44		5	
	12	6	19.56	19.40	19.50		5	
	12	13	19.59	19.53	19.55		5	
	25	0	19.53	19.44	19.50		5	

FCC ID: A3LSMF916U	 PCTEST <small> Proud to be part of Samsung </small>	SAR EVALUATION REPORT		Approved by: Quality Manager
Document S/N: 1M2005200087-01-R2.A3L	Test Dates: 06/28/20-08/24/20	DUT Type: Portable Handset		Page 43 of 267

9.4.2

LTE Band 12

Table 9-13

LTE Band 12 Measured P_{Max} for all DSI - 10 MHz Bandwidth

LTE Band 12 10 MHz Bandwidth						
Modulation	RB Size	RB Offset	Mid Channel	MPR Allowed per 3GPP [dB]	MPR [dB]	
			23095 (70.5 MHz)			
			Conducted Power [dBm]			
QPSK	1	0	25.06	0	0	
	1	25	25.04		0	
	1	49	25.10		0	
	25	0	23.96	0-1	1	
	25	12	24.05		1	
	25	25	24.06		1	
16QAM	50	0	24.03	0-1	1	
	1	0	24.09		1	
	1	25	24.01		1	
	1	49	24.07	0-2	1	
	25	0	23.03		2	
	25	12	23.11		2	
64QAM	25	25	23.12	0-2	2	
	50	0	23.00		2	
	1	0	23.31		2	
	1	25	23.49	0-2	2	
	1	49	23.46		2	
	25	0	22.08		0-3	3
25	12	22.19	3			
25	25	22.17	3			
256QAM	50	0	22.07	0-3	3	
	1	0	20.33		0-5	5
	1	25	20.50			5
	1	49	20.42	5		
	25	0	20.01	5		
	25	12	20.16	5		
25	25	20.11	5			
50	0	20.07	5			

Note: LTE Band 12 at 10 MHz bandwidth does not support three non-overlapping channels. Per KDB Publication 941225 D05v02, when a device supports overlapping channel assignment in a channel bandwidth configuration, the middle channel of the group of overlapping channels should be selected for testing.

Table 9-14

LTE Band 12 Measured P_{Max} for all DSI - 5 MHz Bandwidth

LTE Band 12 5 MHz Bandwidth							
Modulation	RB Size	RB Offset	Low Channel	Mid Channel	High Channel	MPR Allowed per 3GPP [dB]	MPR [dB]
			23035 (70.5 MHz)	23095 (70.5 MHz)	23155 (713.5 MHz)		
			Conducted Power [dBm]				
QPSK	1	0	24.55	24.76	24.80	0	0
	1	12	24.59	24.84	24.82		0
	1	24	24.56	24.85	24.83		0
	12	0	23.71	23.86	23.85	0-1	1
	12	6	23.75	23.93	23.81		1
	12	13	23.73	23.85	23.97		1
16QAM	25	0	23.74	23.92	23.84	0-1	1
	1	0	23.90	24.01	24.03		1
	1	12	24.15	24.10	24.30		1
	1	24	24.07	24.30	24.11	0-2	1
	12	0	22.75	22.90	22.98		2
	12	6	22.80	23.01	22.98		2
64QAM	12	13	22.85	22.93	22.95	0-2	2
	25	0	22.80	22.87	22.94		2
	1	0	22.83	22.93	23.44		0-2
	1	12	22.89	22.86	23.06	2	
	1	24	22.90	23.09	23.14	2	
	256QAM	12	0	21.76	21.89	21.92	0-3
12		6	21.85	22.00	21.97	3	
12		13	21.82	21.92	21.89	3	
25		0	21.74	21.77	21.84	0-5	3
1		0	19.81	19.75	19.97		5
1		12	19.86	19.82	20.17		5
256QAM	1	24	19.80	19.97	19.91	0-5	5
	12	0	19.66	19.84	19.90		5
	12	6	19.82	19.96	19.93		5
	12	13	19.73	19.88	19.86	5	
	25	0	19.73	19.85	19.91	5	





FCC ID: A3LSMF916U	 PCTEST <small>Practical to be part of the solution</small>	SAR EVALUATION REPORT		Approved by: Quality Manager
Document S/N: 1M2005200087-01-R2.A3L	Test Dates: 06/28/20-08/24/20	DUT Type: Portable Handset		Page 44 of 267

Table 9-15
LTE Band 12 Measured P_{Max} for all DSI) - 3 MHz Bandwidth

LTE Band 12 3 MHz Bandwidth								
Modulation	RB Size	RB Offset	Low Channel	Mid Channel	High Channel	MPR Allowed per 3GPP [dB]	MPR [dB]	
			23025 (700.5 MHz)	23095 (707.5 MHz)	23165 (714.5 MHz)			
Conducted Power [dBm]								
QPSK	1	0	24.54	24.70	24.74	0	0	
	1	7	24.63	24.71	24.63		0	
	1	14	24.63	24.75	24.78		0	
	8	0	23.62	23.79	23.98	0-1	1	
	8	4	23.76	23.92	23.65		1	
	8	7	23.69	23.86	23.71		1	
16QAM	15	0	23.72	23.87	23.64	0-1	1	
	1	0	23.90	24.41	24.01		1	
	1	7	24.04	23.99	24.12		1	
	1	14	23.93	24.15	23.96	0-2	1	
	8	0	22.67	22.88	23.01		2	
	8	4	22.83	22.96	22.87		2	
	8	7	22.88	22.96	22.92	0-2	2	
	15	0	22.70	22.87	22.79		2	
	1	0	22.88	23.01	22.85		2	
	64QAM	1	7	22.85	22.95	23.05	0-2	2
1		14	22.88	23.06	23.00	2		
8		0	21.65	21.81	21.90	3		
8		4	21.82	21.90	21.78	0-3	3	
8		7	21.76	21.91	21.88		3	
15		0	21.78	21.95	21.91		3	
256QAM		1	0	19.81	19.89	19.78	0-5	5
		1	7	19.82	19.97	19.85		5
	1	14	19.72	19.90	19.96	5		
	8	0	19.65	19.79	19.74	0-5	5	
	8	4	19.77	19.77	19.76		5	
	8	7	19.81	19.89	19.79		5	
	15	0	19.78	19.80	19.80	5		

Table 9-16
LTE Band 12 Measured P_{Max} for all DSI - 1.4 MHz Bandwidth

LTE Band 12 1.4 MHz Bandwidth								
Modulation	RB Size	RB Offset	Low Channel	Mid Channel	High Channel	MPR Allowed per 3GPP [dB]	MPR [dB]	
			23017 (699.7 MHz)	23095 (707.5 MHz)	23173 (715.3 MHz)			
Conducted Power [dBm]								
QPSK	1	0	24.50	24.64	24.67	0	0	
	1	2	24.55	24.68	24.71		0	
	1	5	24.55	24.70	24.70		0	
	3	0	24.43	24.65	24.67	0-1	0	
	3	2	24.60	24.70	24.70		0	
	3	3	24.49	24.73	24.71		0	
16QAM	6	0	23.59	23.77	23.73	0-1	1	
	1	0	23.82	23.95	24.05		1	
	1	2	23.85	24.08	23.99		1	
	1	5	23.88	24.01	23.95	0-1	1	
	3	0	23.66	23.89	23.87		1	
	3	2	23.77	23.99	23.96		1	
	3	3	23.72	23.96	23.90	0-2	1	
	6	0	22.66	22.87	22.88		2	
1	0	22.80	22.91	22.86	2			
64QAM	1	2	22.86	23.01	23.03	0-2	2	
	1	5	22.77	23.00	23.11		2	
	3	0	22.63	22.81	22.83		2	
	3	2	22.75	22.94	22.71	0-2	2	
	3	3	22.74	22.88	22.92		2	
	6	0	21.71	21.80	22.08		3	
	256QAM	1	0	19.71	19.75	19.84	0-3	5
		1	2	19.60	19.67	20.01		5
1		5	19.70	19.88	19.77	5		
3		0	19.70	19.85	19.90	0-5	5	
3		2	19.75	19.77	19.73		5	
3		3	19.70	19.88	19.92		5	
6		0	19.76	19.78	19.77	5		

FCC ID: A3LSMF916U	 PCTEST <small>Prove it to be part of it</small>	SAR EVALUATION REPORT		Approved by: Quality Manager
Document S/N: 1M2005200087-01-R2.A3L	Test Dates: 06/28/20-08/24/20	DUT Type: Portable Handset	Page 45 of 267	

9.4.3

LTE Band 13

Table 9-17

LTE Band 13 Antenna A Measured P_{Max} for all DSI - 10 MHz Bandwidth

LTE Band 13 10 MHz Bandwidth					
Modulation	RB Size	RB Offset	Mid Channel	MPR Allowed per 3GPP [dB]	MPR [dB]
			23230 (782.0 MHz) Conducted Power [dBm]		
QPSK	1	0	24.00	0	0
	1	25	23.85		0
	1	49	24.15		0
	25	0	23.35	0-1	1
	25	12	23.28		1
	25	25	23.21		1
16QAM	50	0	23.19	0-1	1
	1	0	23.39		1
	1	25	23.28		1
	1	49	23.16	0-2	1
	25	0	22.43		2
	25	12	22.37		2
64QAM	25	25	22.31	0-2	2
	50	0	22.24		2
	1	0	22.61		0-2
	1	25	22.56	2	
	1	49	22.43	2	
	256QAM	25	0	21.36	0-3
25		12	21.39	3	
25		25	21.32	3	
50		0	21.29	0-5	3
1		0	18.99		5
1		25	18.96		5
256QAM	1	49	18.88	0-5	5
	25	0	19.38		5
	25	12	19.41		5
	25	25	19.32	5	
	50	0	19.25	5	

Table 9-18

LTE Band 13 Antenna A Measured P_{Max} for all DSI - 5 MHz Bandwidth

LTE Band 13 5 MHz Bandwidth					
Modulation	RB Size	RB Offset	Mid Channel	MPR Allowed per 3GPP [dB]	MPR [dB]
			23230 (782.0 MHz) Conducted Power [dBm]		
QPSK	1	0	24.12	0	0
	1	12	24.08		0
	1	24	24.05		0
	12	0	23.23	0-1	1
	12	6	23.26		1
	12	13	23.21		1
16QAM	25	0	23.24	0-1	1
	1	0	23.53		1
	1	12	23.42		1
	1	24	23.36	0-2	1
	12	0	22.35		2
	12	6	22.38		2
64QAM	12	13	22.32	0-2	2
	25	0	22.28		2
	1	0	22.27		0-2
	1	12	22.26	2	
	1	24	22.24	2	
	256QAM	12	0	21.34	0-3
12		6	21.36	3	
12		13	21.32	3	
25		0	21.29	0-5	3
1		0	18.90		5
1		12	18.93		5
256QAM	1	24	18.91	0-5	5
	12	0	19.24		5
	12	6	19.30		5
	12	13	19.29	5	
	25	0	19.32	5	

Note: LTE Band 13 at 5 MHz bandwidth does not support three non-overlapping channels. Per KDB Publication 941225 D05v02, when a device supports overlapping channel assignment in a channel bandwidth configuration, the middle channel of the group of overlapping channels should be selected for testing.



FCC ID: A3LSMF916U	 PCTEST <small>Proud to be part of the elements</small>	SAR EVALUATION REPORT		Approved by: Quality Manager
Document S/N: 1M2005200087-01-R2.A3L	Test Dates: 06/28/20-08/24/20	DUT Type: Portable Handset		Page 46 of 267



Table 9-19
LTE Band 13 Antenna B Measured P_{Max} for all DSI - 10 MHz Bandwidth

LTE Band 13 10 MHz Bandwidth					
Modulation	RB Size	RB Offset	Mid Channel	MPR Allowed per 3GPP [dB]	MPR [dB]
			23230 (782.0 MHz)		
			Conducted Power [dBm]		
QPSK	1	0	22.33	0	0
	1	25	22.25		0
	1	49	22.25		0
	25	0	21.48	0-1	1
	25	12	21.42		1
	25	25	21.34		1
	50	0	21.47		1
16QAM	1	0	21.91	0-1	1
	1	25	21.76		1
	1	49	21.73		1
	25	0	20.52	0-2	2
	25	12	20.48		2
	25	25	20.48		2
	50	0	20.37		2
64QAM	1	0	20.42	0-2	2
	1	25	20.21		2
	1	49	20.21		2
	25	0	19.00	0-3	3
	25	12	19.12		3
	25	25	19.09		3
	50	0	19.10		3
256QAM	1	0	17.02	0-5	5
	1	25	17.14		5
	1	49	16.93		5
	25	0	17.15		5
	25	12	17.10		5
	25	25	17.09		5
	50	0	17.09		5

Table 9-20
LTE Band 13 Antenna B Measured P_{Max} for all DSI - 5 MHz Bandwidth

LTE Band 13 5 MHz Bandwidth					
Modulation	RB Size	RB Offset	Mid Channel	MPR Allowed per 3GPP [dB]	MPR [dB]
			23230 (782.0 MHz)		
			Conducted Power [dBm]		
QPSK	1	0	22.35	0	0
	1	12	22.22		0
	1	24	22.20		0
	12	0	21.51	0-1	1
	12	6	21.53		1
	12	13	21.44		1
	25	0	21.30		1
16QAM	1	0	21.88	0-1	1
	1	12	21.80		1
	1	24	21.85		1
	12	0	20.65	0-2	2
	12	6	20.52		2
	12	13	20.53		2
	25	0	20.40		2
64QAM	1	0	20.38	0-2	2
	1	12	20.35		2
	1	24	20.37		2
	12	0	19.32	0-3	3
	12	6	19.33		3
	12	13	19.22		3
	25	0	19.15		3
256QAM	1	0	17.25	0-5	5
	1	12	17.33		5
	1	24	17.28		5
	12	0	17.20		5
	12	6	17.18		5
	12	13	17.25		5
	25	0	17.33		5

Note: LTE Band 13 at 5 MHz bandwidth does not support three non-overlapping channels. Per KDB Publication 941225 D05v02, when a device supports overlapping channel assignment in a channel bandwidth configuration, the middle channel of the group of overlapping channels should be selected for testing.

FCC ID: A3LSMF916U	 PCTEST <small>Proud to be part of Samsung</small>	SAR EVALUATION REPORT		Approved by: Quality Manager
Document S/N: 1M2005200087-01-R2.A3L	Test Dates: 06/28/20-08/24/20	DUT Type: Portable Handset		Page 47 of 267

9.4.4

LTE Band 14

Table 9-21

LTE Band 14 Antenna A Measured P_{Max} for all DSI - 10 MHz Bandwidth

LTE Band 14 10 MHz Bandwidth						
Modulation	RB Size	RB Offset	Mid Channel	MPR Allowed per 3GPP [dB]	MPR [dB]	
			23330 (793.0 MHz) Conducted Power [dBm]			
QPSK	1	0	24.11	0	0	
	1	25	24.08		0	
	1	49	23.95		0	
	25	0	23.07	0-1	1	
	25	12	23.14		1	
	25	25	23.08		1	
16QAM	50	0	23.04	0-1	1	
	1	0	23.21		1	
	1	25	23.09		1	
	1	49	23.01	0-2	1	
	25	0	22.12		2	
	25	12	22.22		2	
64QAM	25	25	22.17	0-2	2	
	50	0	22.06		2	
	1	0	22.61		2	
	1	25	22.41	0-2	2	
	1	49	22.49		2	
	25	0	21.17		0-3	3
25	12	21.23	3			
25	25	21.16	3			
256QAM	50	0	21.11	0-3	3	
	1	0	19.42		0-5	5
	1	25	19.67			5
	1	49	19.45	5		
	25	0	19.16	5		
	25	12	19.19	5		
25	25	19.12	5			
	50	0	19.13	5		

Table 9-22

LTE Band 14 Antenna A Measured P_{Max} for all DSI - 5 MHz Bandwidth

LTE Band 14 5 MHz Bandwidth						
Modulation	RB Size	RB Offset	Mid Channel	MPR Allowed per 3GPP [dB]	MPR [dB]	
			23330 (793.0 MHz) Conducted Power [dBm]			
QPSK	1	0	24.00	0	0	
	1	12	24.15		0	
	1	24	24.09		0	
	12	0	23.19	0-1	1	
	12	6	23.20		1	
	12	13	23.16		1	
16QAM	25	0	23.13	0-1	1	
	1	0	23.23		1	
	1	12	23.41		1	
	1	24	23.36	0-2	1	
	12	0	22.26		2	
	12	6	22.27		2	
64QAM	12	13	22.21	0-2	2	
	25	0	22.13		2	
	1	0	22.33		2	
	1	12	22.46	0-2	2	
	1	24	22.45		2	
	12	0	21.25		0-3	3
12	6	21.27	3			
12	13	21.23	3			
256QAM	25	0	21.15	0-3	3	
	1	0	19.02		0-5	5
	1	12	19.13			5
	1	24	19.03	5		
	12	0	19.26	5		
	12	6	19.27	5		
12	13	19.23	5			
	25	0	19.16	5		

Note: LTE Band 14 at 5 MHz bandwidth does not support three non-overlapping channels. Per KDB Publication 941225 D05v02, when a device supports overlapping channel assignment in a channel bandwidth configuration, the middle channel of the group of overlapping channels should be selected for testing.



FCC ID: A3LSMF916U	 PCTEST <small> Proud to be part of Samsung </small>	SAR EVALUATION REPORT		Approved by: Quality Manager
Document S/N: 1M2005200087-01-R2.A3L	Test Dates: 06/28/20-08/24/20	DUT Type: Portable Handset		Page 48 of 267



Table 9-23
LTE Band 14 Antenna B Measured P_{Max} for all DSI - 10 MHz Bandwidth

LTE Band 14 10 MHz Bandwidth					
Modulation	RB Size	RB Offset	Mid Channel	MPR Allowed per 3GPP [dB]	MPR [dB]
			23330 (793.0 MHz) Conducted Power [dBm]		
QPSK	1	0	22.42	0	0
	1	25	22.22		0
	1	49	22.29		0
	25	0	21.32	0-1	1
	25	12	21.36		1
	25	25	21.31		1
16QAM	50	0	21.28	0-1	1
	1	0	21.55		1
	1	25	21.44		1
	1	49	21.46	0-2	1
	25	0	20.43		2
	25	12	20.47		2
64QAM	25	25	20.40	0-2	2
	50	0	20.30		2
	1	0	20.21		2
	1	25	20.22	0-3	2
	1	49	20.06		2
	25	0	19.00		3
256QAM	25	12	19.15	0-3	3
	25	25	18.96		3
	50	0	19.04		3
	1	0	17.01	0-5	5
	1	25	17.14		5
	1	49	16.99		5
25	0	16.93	5		
25	12	16.99	5		
25	25	16.92	5		
50	0	16.92	5		

Table 9-24
LTE Band 14 Antenna B Measured P_{Max} for all DSI - 5 MHz Bandwidth

LTE Band 14 5 MHz Bandwidth					
Modulation	RB Size	RB Offset	Mid Channel	MPR Allowed per 3GPP [dB]	MPR [dB]
			23330 (793.0 MHz) Conducted Power [dBm]		
QPSK	1	0	22.44	0	0
	1	12	22.31		0
	1	24	22.35		0
	12	0	21.28	0-1	1
	12	6	21.22		1
	12	13	21.19		1
16QAM	25	0	21.22	0-1	1
	1	0	21.35		1
	1	12	21.38		1
	1	24	21.39	0-2	1
	12	0	20.45		2
	12	6	20.39		2
64QAM	12	13	20.35	0-2	2
	25	0	20.22		2
	1	0	20.33		2
	1	12	20.27	0-3	2
	1	24	20.21		2
	12	0	19.22		3
256QAM	12	6	19.28	0-3	3
	12	13	19.33		3
	25	0	19.21		3
	1	0	17.23	0-5	5
	1	12	17.21		5
	1	24	17.33		5
12	0	17.25	5		
12	6	17.18	5		
12	13	17.29	5		
25	0	17.20	5		

Note: LTE Band 14 at 5 MHz bandwidth does not support three non-overlapping channels. Per KDB Publication 941225 D05v02, when a device supports overlapping channel assignment in a channel bandwidth configuration, the middle channel of the group of overlapping channels should be selected for testing.

FCC ID: A3LSMF916U	 PCTEST <small>Prove it to be part of it</small>	SAR EVALUATION REPORT		Approved by: Quality Manager
Document S/N: 1M2005200087-01-R2.A3L	Test Dates: 06/28/20-08/24/20	DUT Type: Portable Handset		Page 49 of 267

9.4.5

LTE Band 26

Table 9-25

LTE Band 26 (Cell) Measured P_{Max} for all DSI - 15 MHz Bandwidth

LTE Band 26 (Cell) 15 MHz Bandwidth					
Modulation	RB Size	RB Offset	Mid Channel	MPR Allowed per 3GPP [dB]	MPR [dB]
			26865 (831.5 MHz)		
			Conducted Power [dBm]		
QPSK	1	0	24.67	0	0
	1	36	24.74		0
	1	74	24.71		0
	36	0	23.69	0-1	1
	36	18	23.81		1
	36	37	23.84		1
	75	0	23.72		1
16QAM	1	0	23.76	0-1	1
	1	36	23.81		1
	1	74	23.77		1
	36	0	22.69	0-2	2
	36	18	22.82		2
	36	37	22.83		2
	75	0	22.76		2
64QAM	1	0	23.00	0-2	2
	1	36	23.04		2
	1	74	23.11		2
	36	0	21.76	0-3	3
	36	18	21.88		3
	36	37	21.90		3
	75	0	21.81		3
256QAM	1	0	19.82	0-5	5
	1	36	20.14		5
	1	74	20.07		5
	36	0	19.72		5
	36	18	19.85		5
	36	37	19.82		5
	75	0	19.77		5

Note: LTE Band 26 at 15 MHz bandwidth does not support three non-overlapping channels. Per KDB Publication 941225 D05v02, when a device supports overlapping channel assignment in a channel bandwidth configuration, the middle channel of the group of overlapping channels should be selected for testing.

Table 9-26

LTE Band 26 (Cell) Measured P_{Max} for all DSI - 10 MHz Bandwidth

LTE Band 26 (Cell) 10 MHz Bandwidth							
Modulation	RB Size	RB Offset	Low Channel	Mid Channel	High Channel	MPR Allowed per 3GPP [dB]	MPR [dB]
			26740 (819.0 MHz)	26865 (831.5 MHz)	26990 (844.0 MHz)		
			Conducted Power [dBm]				
QPSK	1	0	24.49	24.51	24.57	0	0
	1	25	24.51	24.50	24.48		0
	1	49	24.58	24.47	24.49		0
	25	0	23.40	23.51	23.45	0-1	1
	25	12	23.57	23.65	23.61		1
	25	25	23.51	23.62	23.54		1
	50	0	23.49	23.58	23.47		1
16QAM	1	0	24.15	24.21	24.09	0-1	1
	1	25	24.16	24.26	24.06		1
	1	49	24.26	24.22	23.94		1
	25	0	22.44	22.59	22.44	0-2	2
	25	12	22.65	22.74	22.61		2
	25	25	22.59	22.70	22.51		2
	50	0	22.53	22.59	22.46		2
64QAM	1	0	23.07	23.01	23.02	0-2	2
	1	25	23.17	23.09	23.03		2
	1	49	23.21	23.09	23.08		2
	25	0	21.40	21.56	21.54	0-3	3
	25	12	21.60	21.65	21.68		3
	25	25	21.52	21.65	21.58		3
	50	0	21.49	21.57	21.54		3
256QAM	1	0	19.50	19.51	19.71	0-5	5
	1	25	19.85	20.16	20.03		5
	1	49	19.76	19.83	19.89		5
	25	0	19.44	19.52	19.53		5
	25	12	19.64	19.62	19.78		5
	25	25	19.55	19.65	19.64		5
	50	0	19.52	19.56	19.62		5



FCC ID: A3LSMF916U	 PCTEST <small>Prove it to be part of it</small>	SAR EVALUATION REPORT		Approved by: Quality Manager
Document S/N: 1M2005200087-01-R2.A3L	Test Dates: 06/28/20-08/24/20	DUT Type: Portable Handset	Page 50 of 267	

Table 9-27
LTE Band 26 (Cell) Measured P_{Max} for all DSI - 5 MHz Bandwidth

LTE Band 26 (Cell) 5 MHz Bandwidth								
Modulation	RB Size	RB Offset	Low Channel	Mid Channel	High Channel	MPR Allowed per 3GPP [dB]	MPR [dB]	
			26715 (816.5 MHz)	26865 (831.5 MHz)	27015 (846.5 MHz)			
Conducted Power [dBm]								
QPSK	1	0	24.37	24.52	24.47	0	0	
	1	12	24.55	24.60	24.44		0	
	1	24	24.52	24.59	24.41		0	
	12	0	23.44	23.60	23.52	0-1	1	
	12	6	23.59	23.69	23.61		1	
	12	13	23.55	23.69	23.59		1	
16QAM	25	0	23.51	23.64	23.55	0-1	1	
	1	0	24.19	24.14	24.26		1	
	1	12	24.34	24.24	24.29		1	
	1	24	24.35	24.21	24.27	0-2	1	
	12	0	22.50	22.80	22.60		2	
	12	6	22.60	22.85	22.63		2	
64QAM	12	13	22.57	22.87	22.65	0-2	2	
	25	0	22.48	22.71	22.53		2	
	1	0	22.74	23.13	22.92		2	
	1	12	22.84	23.17	22.92	0-2	2	
	1	24	22.86	23.18	22.83		2	
	12	0	21.53	21.70	21.60		0-3	3
12	6	21.66	21.76	21.72	3			
12	13	21.65	21.78	21.68	3			
256QAM	25	0	21.52	21.66	21.61	0-3	3	
	1	0	20.02	20.18	19.62		0-5	5
	1	12	20.19	20.27	19.71			5
	1	24	20.20	20.20	19.67	5		
	12	0	19.36	19.56	19.58	5		
	12	6	19.51	19.63	19.70	5		
12	13	19.47	19.68	19.64	5			
25	0	19.50	19.65	19.62	5			

Table 9-28
LTE Band 26 (Cell) Measured P_{Max} for all DSI - 3 MHz Bandwidth

LTE Band 26 (Cell) 3 MHz Bandwidth								
Modulation	RB Size	RB Offset	Low Channel	Mid Channel	High Channel	MPR Allowed per 3GPP [dB]	MPR [dB]	
			26705 (815.5 MHz)	26865 (831.5 MHz)	27025 (847.5 MHz)			
Conducted Power [dBm]								
QPSK	1	0	24.35	24.50	24.59	0	0	
	1	7	24.42	24.56	24.50		0	
	1	14	24.45	24.61	24.55		0	
	8	0	23.41	23.63	23.56	0-1	1	
	8	4	23.54	23.64	23.58		1	
	8	7	23.50	23.71	23.59		1	
16QAM	15	0	23.55	23.61	23.61	0-1	1	
	1	0	24.00	24.13	24.18		0-1	1
	1	7	24.07	24.16	24.13			1
	1	14	24.10	24.20	24.18	0-2		1
	8	0	22.46	22.68	22.59		2	
	8	4	22.59	22.71	22.62		2	
64QAM	8	7	22.55	22.73	22.59	0-2	2	
	15	0	22.56	22.73	22.64		2	
	1	0	23.00	23.12	23.16		0-2	2
	1	7	22.99	23.17	23.10	2		
	1	14	23.10	23.16	23.18	2		
	256QAM	8	0	21.56	21.74	21.74	0-3	3
8		4	21.68	21.80	21.77	3		
8		7	21.62	21.78	21.71	3		
15		0	21.52	21.74	21.61	0-5	3	
1		0	19.83	20.01	19.91		5	
1		7	19.84	20.05	19.89		5	
256QAM	1	14	19.87	20.09	19.89	0-5	5	
	8	0	19.50	19.74	19.68		5	
	8	4	19.60	19.79	19.73		5	
	8	7	19.60	19.81	19.69	5		
	15	0	19.60	19.66	19.78	5		





FCC ID: A3LSMF916U	 PCTEST <small>Prove it to be part of it</small>	SAR EVALUATION REPORT		Approved by: Quality Manager
Document S/N: 1M2005200087-01-R2.A3L	Test Dates: 06/28/20-08/24/20	DUT Type: Portable Handset	Page 51 of 267	

Table 9-29
LTE Band 26 (Cell) Measured P_{Max} for all DSI - 1.4 MHz Bandwidth

LTE Band 26 (Cell) 1.4 MHz Bandwidth							
Modulation	RB Size	RB Offset	Low Channel	Mid Channel	High Channel	MPR Allowed per 3GPP [dB]	MPR [dB]
			2697 (814.7 MHz)	2685 (831.5 MHz)	2703 (848.3 MHz)		
Conducted Power [dBm]							
QPSK	1	0	24.22	24.57	24.49	0	0
	1	2	24.31	24.63	24.49		0
	1	5	24.26	24.62	24.50		0
	3	0	24.33	24.45	24.40		0
	3	2	24.34	24.52	24.40		0
	3	3	24.36	24.47	24.36		0
16QAM	6	0	23.44	23.63	23.54	0-1	1
	1	0	23.96	24.03	24.09	0-1	1
	1	2	24.04	24.18	24.14		1
	1	5	24.01	24.07	24.07		1
	3	0	23.51	23.76	23.64		1
	3	2	23.59	23.87	23.68		1
3	3	23.54	23.82	23.65	1		
64QAM	6	0	22.51	22.47	22.61	0-2	2
	1	0	22.74	23.05	23.06	0-2	2
	1	2	22.88	23.18	23.18		2
	1	5	22.83	23.08	23.09		2
	3	0	22.50	22.60	22.63		2
	3	2	22.54	22.91	22.73		2
3	3	22.53	22.88	22.68	2		
256QAM	6	0	21.50	21.62	21.47	0-3	3
	1	0	19.72	20.01	20.05	0-5	5
	1	2	19.85	20.12	20.13		5
	1	5	19.81	20.06	20.08		5
	3	0	19.36	19.63	19.64		5
	3	2	19.42	19.72	19.72		5
3	3	19.35	19.69	19.63	5		
	6	0	19.39	19.27	19.67		5

FCC ID: A3LSMF916U	 PCTEST <small>Prove it to be part of Samsung</small>	SAR EVALUATION REPORT		Approved by: Quality Manager
Document S/N: 1M2005200087-01-R2.A3L	Test Dates: 06/28/20-08/24/20	DUT Type: Portable Handset		Page 52 of 267

9.4.6

LTE Band 5

Table 9-30
 LTE Band 5 (Cell) Measured P_{Max} for all DSI - 10 MHz Bandwidth

LTE Band 5 (Cell) 10 MHz Bandwidth					
Modulation	RB Size	RB Offset	Mid Channel	MPR Allowed per 3GPP [dB]	MPR [dB]
			20525 (836.5 MHz)		
			Conducted Power [dBm]		
QPSK	1	0	24.85	0	0
	1	25	24.72		0
	1	49	24.69		0
	25	0	23.88	0-1	1
	25	12	23.98		1
	25	25	23.67		1
16QAM	50	0	23.78	0-1	1
	1	0	23.97		1
	1	25	23.87		1
	1	49	23.90	0-2	1
	25	0	22.99		2
	25	12	23.05		2
64QAM	25	25	22.98	0-2	2
	50	0	22.84		2
	1	0	23.06		2
	1	25	23.14	0-3	2
	1	49	23.09		2
	25	0	21.99		3
256QAM	25	12	22.04	0-3	3
	25	25	22.01		3
	50	0	21.85		3
	1	0	19.64	0-5	5
	1	25	19.75		5
	1	49	19.67		5
25	0	19.91	5		
25	12	20.08	5		
25	25	19.94	5		
50	0	19.83	5		

Note: LTE Band 5 at 10 MHz bandwidth does not support three non-overlapping channels. Per KDB Publication 941225 D05v02, when a device supports overlapping channel assignment in a channel bandwidth configuration, the middle channel of the group of overlapping channels should be selected for testing.

Table 9-31
 LTE Band 5 (Cell) Measured P_{Max} for all DSI - 5 MHz Bandwidth

LTE Band 5 (Cell) 5 MHz Bandwidth							
Modulation	RB Size	RB Offset	Low Channel	Mid Channel	High Channel	MPR Allowed per 3GPP [dB]	MPR [dB]
			20425 (826.5 MHz)	20525 (836.5 MHz)	20625 (846.5 MHz)		
			Conducted Power [dBm]				
QPSK	1	0	24.58	24.60	24.53	0	0
	1	12	24.80	24.74	24.61		0
	1	24	24.71	24.61	24.63		0
	12	0	23.80	23.70	23.62	0-1	1
	12	6	23.91	23.83	23.72		1
	12	13	23.84	23.74	23.66		1
	25	0	23.75	23.82	23.69		1
16QAM	1	0	23.98	23.90	23.91	0-1	1
	1	12	23.83	24.08	23.92		1
	1	24	23.88	23.98	23.81		1
	12	0	22.84	22.76	22.70	0-2	2
	12	6	22.91	22.81	22.85		2
	12	13	22.71	22.80	22.67		2
	25	0	22.85	22.77	22.67		2
64QAM	1	0	22.86	22.85	22.78	0-2	2
	1	12	23.02	23.04	22.46		2
	1	24	22.95	22.92	22.75		2
	12	0	21.80	22.01	21.70	0-3	3
	12	6	21.91	21.87	21.75		3
	12	13	21.83	21.80	21.76		3
	25	0	21.80	21.80	21.79		3
256QAM	1	0	19.78	19.80	19.68	0-5	5
	1	12	19.88	19.85	19.75		5
	1	24	19.85	19.87	19.77		5
	12	0	19.75	19.75	19.67		5
	12	6	19.84	19.98	19.87		5
	12	13	19.74	19.70	19.60		5
	25	0	19.81	19.73	19.71		5





FCC ID: A3LSMF916U	 PCTEST <small>Prove it. Do your part. Do it right.</small>	SAR EVALUATION REPORT		Approved by: Quality Manager
Document S/N: 1M2005200087-01-R2.A3L	Test Dates: 06/28/20-08/24/20	DUT Type: Portable Handset	Page 53 of 267	

Table 9-32
LTE Band 5 (Cell) Measured P_{Max} for all DSI - 3 MHz Bandwidth

LTE Band 5 (Cell) 3 MHz Bandwidth							
Modulation	RB Size	RB Offset	Low Channel	Mid Channel	High Channel	MPR Allowed per 3GPP [dB]	MPR [dB]
			20415 (825.5 MHz)	20525 (836.5 MHz)	20635 (847.5 MHz)		
Conducted Power [dBm]							
QPSK	1	0	24.58	24.60	24.56	0	0
	1	7	24.77	24.76	24.40		0
	1	14	24.72	24.70	24.62		0
	8	0	23.72	23.74	23.62	0-1	1
	8	4	23.81	23.75	23.70		1
	8	7	23.82	23.75	23.66		1
16QAM	15	0	23.79	23.78	23.70		1
	1	0	23.89	24.08	23.91	0-1	1
	1	7	23.75	24.10	23.82		1
	1	14	23.92	24.03	23.94		1
	8	0	22.80	22.82	22.70	0-2	2
	8	4	22.92	22.87	22.84		2
8	7	22.96	22.86	22.76	2		
64QAM	15	0	22.80	22.81	22.75		2
	1	0	22.93	22.86	22.95	0-2	2
	1	7	22.95	22.90	22.90		2
	1	14	22.86	22.92	22.78		2
	8	0	21.77	21.80	21.63	0-3	3
	8	4	21.91	21.97	21.77		3
8	7	21.84	21.80	21.63	3		
256QAM	15	0	21.93	21.81	21.69		3
	1	0	19.75	19.75	19.79	0-5	5
	1	7	19.83	19.90	19.86		5
	1	14	19.89	20.08	20.09		5
	8	0	19.80	19.70	19.71	5	
	8	4	19.85	19.87	19.81	5	
8	7	19.90	19.79	19.76	5		
	15	0	19.91	19.81	19.78		5

Table 9-33
LTE Band 5 (Cell) Measured P_{Max} for all DSI - 1.4 MHz Bandwidth

LTE Band 5 (Cell) 1.4 MHz Bandwidth							
Modulation	RB Size	RB Offset	Low Channel	Mid Channel	High Channel	MPR Allowed per 3GPP [dB]	MPR [dB]
			20407 (824.7 MHz)	20525 (836.5 MHz)	20643 (848.3 MHz)		
Conducted Power [dBm]							
QPSK	1	0	24.49	24.61	24.56	0	0
	1	2	24.50	24.67	24.51		0
	1	5	24.54	24.64	24.71		0
	3	0	24.60	24.56	24.54	0-1	0
	3	2	24.70	24.66	24.60		0
	3	3	24.64	24.63	24.43		0
16QAM	6	0	23.71	23.72	23.56		1
	1	0	23.99	24.04	23.91	0-1	1
	1	2	23.96	24.22	23.90		1
	1	5	23.99	24.00	23.92		1
	3	0	23.83	23.80	23.77	0-2	1
	3	2	23.68	23.98	23.77		1
3	3	23.81	23.81	23.78	1		
64QAM	6	0	22.80	22.68	22.54		2
	1	0	22.80	22.99	22.79	0-2	2
	1	2	22.72	22.84	22.89		2
	1	5	22.85	22.90	22.80		2
	3	0	22.78	22.86	22.65	0-3	2
	3	2	22.86	22.93	22.70		2
3	3	23.03	22.88	22.74	2		
256QAM	6	0	21.78	21.70	21.63		3
	1	0	19.55	19.78	19.63	0-5	5
	1	2	19.89	19.62	19.85		5
	1	5	19.67	19.71	19.70		5
	3	0	19.74	19.86	19.71	5	
	3	2	19.82	19.87	19.70	5	
3	3	19.97	19.81	19.92	5		
	6	0	19.70	19.70	19.61		5

FCC ID: A3LSMF916U	 PCTEST <small>Practical to be part of solutions</small>	SAR EVALUATION REPORT		Approved by: Quality Manager
Document S/N: 1M2005200087-01-R2.A3L	Test Dates: 06/28/20-08/24/20	DUT Type: Portable Handset		Page 54 of 267

9.4.7

LTE Band 66

Table 9-34

LTE Band 66 (AWS) Measured P_{Max} for DSI = 0 (Body-worn, or Phablet/UMPC with grip sensor inactive), or DSI = 3/4 (Head) - 20 MHz Bandwidth

LTE Band 66 (AWS) 20 MHz Bandwidth							
Modulation	RB Size	RB Offset	Low Channel	Mid Channel	High Channel	MPR Allowed per 3GPP [dB]	MPR [dB]
			132072 (1720.0 MHz)	132322 (1745.0 MHz)	132572 (1770.0 MHz)		
Conducted Power [dBm]							
QPSK	1	0	23.53	23.86	24.22	0	0
	1	50	23.71	24.13	24.27		0
	1	99	23.59	23.99	24.30		0
	50	0	22.94	23.14	23.25	0-1	1
	50	25	23.10	23.19	23.32		1
	50	50	22.97	23.16	23.29		1
16QAM	100	0	23.03	23.12	23.21	0-1	1
	1	0	23.12	23.39	23.70		1
	1	50	23.44	23.69	23.69		1
	1	99	23.29	23.53	23.71	0-2	1
	50	0	21.96	22.17	22.29		2
	50	25	22.10	22.21	22.30		2
64QAM	50	50	22.03	22.20	22.27	0-2	2
	100	0	22.03	22.16	22.27		2
	1	0	22.28	22.16	22.47		2
	1	50	22.52	22.52	22.53	0-2	2
	1	99	22.51	22.36	22.56		2
	50	0	20.99	21.25	21.33		3
256QAM	50	25	21.11	21.30	21.38	0-3	3
	50	50	21.14	21.27	21.34		3
	100	0	21.02	21.17	21.31		3
	1	0	18.81	19.08	19.05	0-5	5
	1	50	19.14	19.42	19.35		5
	1	99	19.03	19.22	19.15		5
50	0	18.97	19.18	19.36	5		
50	25	19.13	19.25	19.36	5		
50	50	19.04	19.21	19.38	5		
100	0	19.04	19.16	19.32	5		

Table 9-35

LTE Band 66 (AWS) Measured P_{Max} for DSI = 0 (Body-worn, or Phablet/UMPC with grip sensor inactive), or DSI = 3/4 (Head) - 15 MHz Bandwidth

LTE Band 66 (AWS) 15 MHz Bandwidth								
Modulation	RB Size	RB Offset	Low Channel	Mid Channel	High Channel	MPR Allowed per 3GPP [dB]	MPR [dB]	
			132047 (1717.5 MHz)	132322 (1745.0 MHz)	132597 (1772.5 MHz)			
Conducted Power [dBm]								
QPSK	1	0	23.40	23.60	23.79	0	0	
	1	36	23.55	23.73	23.80		0	
	1	74	23.50	23.58	23.76		0	
	36	0	22.56	22.75	22.77	0-1	1	
	36	18	22.66	22.80	22.80		1	
	36	37	22.71	22.87	22.85		1	
16QAM	75	0	22.67	22.75	22.80	0-1	1	
	1	0	22.74	22.88	23.12		1	
	1	36	22.85	23.08	23.15		1	
	1	74	22.91	22.89	23.07	0-2	1	
	36	0	21.60	21.79	21.85		2	
	36	18	21.66	21.82	21.87		2	
64QAM	36	37	21.67	21.91	21.90	0-2	2	
	75	0	21.63	21.75	21.82		2	
	1	0	21.64	21.82	22.03		2	
	1	36	21.84	22.03	22.08	0-2	2	
	1	74	21.81	21.85	22.10		2	
	36	0	20.64	20.82	20.93		0-3	3
36	18	20.73	20.81	20.88	3			
36	37	20.69	20.91	20.92	3			
256QAM	75	0	20.65	20.75	20.87	0-3	3	
	1	0	18.52	18.75	18.81		0-5	5
	1	36	18.76	18.95	19.00			5
	1	74	18.70	18.85	18.64	5		
	36	0	18.58	18.81	18.89	5		
	36	18	18.80	18.82	18.89	5		
36	37	18.67	18.85	19.05	5			
75	0	18.68	18.80	18.84	5			



FCC ID: A3LSMF916U	 PCTEST Proud to be part of Samsung	SAR EVALUATION REPORT		Approved by: Quality Manager
Document S/N: 1M2005200087-01-R2.A3L	Test Dates: 06/28/20-08/24/20	DUT Type: Portable Handset	Page 55 of 267	

Table 9-36
LTE Band 66 (AWS) Measured P_{Max} for DSI = 0 (Body-worn, or Phablet/UMPC with grip sensor inactive), or DSI = 3/4 (Head) - 10 MHz Bandwidth

LTE Band 66 (AWS) 10 MHz Bandwidth							
Modulation	RB Size	RB Offset	Low Channel	Mid Channel	High Channel	MPR Allowed per 3GPP [dB]	MPR [dB]
			132022 (1715.0 MHz)	132322 (1745.0 MHz)	132622 (1775.0 MHz)		
Conducted Power [dBm]							
QPSK	1	0	23.50	23.63	23.72	0	0
	1	25	23.69	23.86	24.00		0
	1	49	23.55	23.70	23.80		0
	25	0	22.70	22.90	23.11	0-1	1
	25	12	22.83	23.01	23.21		1
	25	25	22.71	22.90	23.15		1
16QAM	50	0	22.72	22.95	23.08	0-1	1
	1	0	22.87	22.93	22.93		1
	1	25	23.19	23.11	23.15		1
	1	49	22.92	22.82	23.05	0-2	1
	25	0	21.75	21.72	21.85		2
	25	12	21.75	21.76	21.93		2
64QAM	25	25	21.82	21.77	21.96	0-2	2
	50	0	21.69	21.73	21.94		2
	1	0	21.63	21.56	21.74		2
	1	25	22.05	21.99	22.07	0-3	2
	1	49	21.80	21.69	21.88		2
	25	0	20.66	20.68	20.89		3
256QAM	25	12	20.77	20.84	20.94	0-3	3
	25	25	20.72	20.76	20.89		3
	50	0	20.73	20.72	20.95		3
	1	0	18.55	18.55	18.71	0-5	5
	1	25	18.82	18.90	19.09		5
	1	49	18.75	18.73	18.87		5
256QAM	25	0	18.72	18.76	18.84	0-5	5
	25	12	18.80	18.79	18.91		5
	25	25	18.72	18.80	18.93		5
	50	0	18.70	18.67	18.90	5	

Table 9-37
LTE Band 66 (AWS) Measured P_{Max} for DSI = 0 (Body-worn, or Phablet/UMPC with grip sensor inactive), or DSI = 3/4 (Head) - 5 MHz Bandwidth

LTE Band 66 (AWS) 5 MHz Bandwidth							
Modulation	RB Size	RB Offset	Low Channel	Mid Channel	High Channel	MPR Allowed per 3GPP [dB]	MPR [dB]
			131997 (1712.5 MHz)	132322 (1745.0 MHz)	132647 (1777.5 MHz)		
Conducted Power [dBm]							
QPSK	1	0	23.49	23.69	23.80	0	0
	1	12	23.59	23.86	23.86		0
	1	24	23.51	23.71	23.72		0
	12	0	22.64	22.85	22.94	0-1	1
	12	6	22.68	22.85	22.89		1
	12	13	22.65	22.78	22.89		1
16QAM	25	0	22.63	22.79	22.95	0-1	1
	1	0	22.83	23.09	23.12		1
	1	12	22.84	23.12	23.17		1
	1	24	22.83	23.04	23.09	0-2	1
	12	0	21.68	21.87	22.00		2
	12	6	21.72	21.90	21.98		2
64QAM	12	13	21.69	21.91	22.00	0-2	2
	25	0	21.65	21.80	21.94		2
	1	0	21.73	21.97	22.01		2
	1	12	21.83	22.02	22.11	0-3	2
	1	24	21.74	21.96	22.06		2
	12	0	20.65	20.90	20.94		3
256QAM	12	6	20.74	20.97	20.99	0-3	3
	12	13	20.63	20.87	20.93		3
	25	0	20.64	20.79	20.96		3
	1	0	18.61	18.88	18.97	0-5	5
	1	12	18.76	18.97	19.06		5
	1	24	18.72	18.88	19.00		5
256QAM	12	0	18.62	18.82	18.90	0-5	5
	12	6	18.74	18.82	18.91		5
	12	13	18.55	18.80	18.93		5
	25	0	18.62	18.83	18.97	5	



FCC ID: A3LSMF916U	 PCTEST Proud to be part of Samsung	SAR EVALUATION REPORT		Approved by: Quality Manager
Document S/N: 1M2005200087-01-R2.A3L	Test Dates: 06/28/20-08/24/20	DUT Type: Portable Handset	Page 56 of 267	

Table 9-38
LTE Band 66 (AWS) Measured P_{Max} for DSI = 0 (Body-worn, or Phablet/UMPC with grip sensor inactive),
or DSI = 3/4 (Head) - 3 MHz Bandwidth

LTE Band 66 (AWS) 3 MHz Bandwidth								
Modulation	RB Size	RB Offset	Low Channel	Mid Channel	High Channel	MPR Allowed per 3GPP [dB]	MPR [dB]	
			131987 (1711.5 MHz)	132322 (1745.0 MHz)	132657 (1778.5 MHz)			
Conducted Power [dBm]								
QPSK	1	0	23.56	23.78	23.80	0	0	
	1	7	23.49	23.80	23.85		0	
	1	14	23.52	23.70	23.78		0	
	8	0	22.66	22.79	22.92	0-1	1	
	8	4	22.66	22.87	22.97		1	
	8	7	22.62	22.75	22.94		1	
16QAM	15	0	22.66	22.75	23.00	0-1	1	
	1	0	22.92	23.07	23.18		1	
	1	7	22.86	23.08	23.18		1	
	1	14	22.88	23.08	23.22	0-2	1	
	8	0	21.78	21.90	22.02		2	
	8	4	21.76	21.90	22.09		2	
64QAM	8	7	21.76	21.89	22.06	0-2	2	
	15	0	21.64	21.83	22.01		2	
	1	0	21.84	21.92	22.11		0-2	2
	1	7	21.80	21.97	22.11	2		
	1	14	21.77	22.04	22.33	2		
	256QAM	8	0	20.73	20.89	20.98	0-3	3
8		4	20.76	20.90	21.01	3		
8		7	20.66	20.83	20.97	3		
15		0	20.77	20.85	20.98	0-3	3	
1		0	18.73	18.97	19.06		0-5	5
1		7	18.75	19.00	19.13			5
1	14	18.72	18.92	19.02	5			
8	0	18.67	18.85	18.97	5			
8	4	18.72	18.94	19.00	5			
8	7	18.70	18.91	18.95	5			
15	0	18.67	18.83	18.97	5			

Table 9-39
LTE Band 66 (AWS) Measured P_{Max} for DSI = 0 (Body-worn, or Phablet/UMPC with grip sensor inactive), or
DSI = 3/4 (Head) - 1.4 MHz Bandwidth

LTE Band 66 (AWS) 1.4 MHz Bandwidth								
Modulation	RB Size	RB Offset	Low Channel	Mid Channel	High Channel	MPR Allowed per 3GPP [dB]	MPR [dB]	
			131979 (1710.7 MHz)	132322 (1745.0 MHz)	132665 (1779.3 MHz)			
Conducted Power [dBm]								
QPSK	1	0	23.43	23.63	23.82	0	0	
	1	2	23.55	23.74	23.82		0	
	1	5	23.46	23.64	23.72		0	
	3	0	23.55	23.61	23.83	0-1	0	
	3	2	23.60	23.77	23.84		0	
	3	3	23.46	23.67	23.77		0	
16QAM	6	0	22.53	22.75	22.89	0-1	1	
	1	0	22.82	23.00	23.11		1	
	1	2	22.91	23.09	23.05		1	
	1	5	22.78	23.03	23.04	0-1	1	
	3	0	22.71	22.82	23.03		1	
	3	2	22.73	22.86	23.00		1	
64QAM	3	3	22.63	22.82	22.95	0-1	1	
	6	0	21.67	21.81	21.97		0-2	2
	1	0	21.73	21.87	22.09			0-2
	1	2	21.81	21.74	21.91	2		
	1	5	21.70	21.85	21.98	2		
	3	0	21.68	21.77	21.98	2		
3	2	21.75	21.94	21.97	2			
3	3	21.75	21.81	21.97	2			
256QAM	6	0	20.64	20.74	20.89	0-3	3	
	1	0	18.65	18.82	19.00		0-5	5
	1	2	18.76	18.98	19.11			5
	1	5	18.69	18.83	18.96	5		
	3	0	18.67	18.86	19.00	5		
	3	2	18.75	18.95	19.06	5		
3	3	18.70	18.90	18.99	5			
6	0	18.62	18.80	18.88	5			



FCC ID: A3LSMF916U	 PCTEST <small>Proud to be part of Samsung</small>	SAR EVALUATION REPORT		Approved by: Quality Manager
Document S/N: 1M2005200087-01-R2.A3L	Test Dates: 06/28/20-08/24/20	DUT Type: Portable Handset	Page 57 of 267	

Table 9-40

LTE Band 66 (AWS) Measured P_{limit} for DSI = 1/2 (Phablet or UMPC Extremity with grip sensor active), or DSI = 5/6 (Hotspot Mode), and/or DSI = 7/8 (Earjack active) - 20 MHz Bandwidth

LTE Band 66 (AWS) 20 MHz Bandwidth							
Modulation	RB Size	RB Offset	Low Channel	Mid Channel	High Channel	MPR Allowed per 3GPP [dB]	MPR [dB]
			132072 (1720.0 MHz)	132322 (1745.0 MHz)	132572 (1770.0 MHz)		
Conducted Power [dBm]							
QPSK	1	0	18.89	18.90	19.35	0	0
	1	50	18.92	19.26	19.41		0
	1	99	18.91	19.16	19.53		0
	50	0	19.26	19.26	19.50	0-1	0
	50	25	19.28	19.47	19.54		0
	50	50	19.26	19.39	19.53		0
16QAM	100	0	19.27	19.30	19.47	0-1	0
	1	0	19.15	19.35	19.75		0
	1	50	19.46	19.51	19.78		0
	1	99	19.28	19.42	19.85	0-2	0
	50	0	19.25	19.31	19.47		0
	50	25	19.38	19.36	19.49		0
64QAM	50	50	19.31	19.37	19.54	0-2	0
	100	0	19.28	19.32	19.40		0
	1	0	19.19	19.24	19.65		0-2
	1	50	19.46	19.65	19.70	0	
	1	99	19.34	19.37	19.75	0	
	256QAM	50	0	19.29	19.38	19.50	0-3
50		25	19.41	19.48	19.58	0	
50		50	19.28	19.40	19.53	0	
100		0	19.36	19.36	19.46	0-5	0
1		0	18.82	19.02	19.05		0
1		50	19.12	19.34	19.37		0
256QAM	1	99	19.02	19.17	19.22	0-5	0
	50	0	18.60	18.82	18.85		0
	50	25	18.74	18.85	18.89		0
	50	50	18.65	18.82	18.87	0	
	100	0	18.66	18.77	18.87	0	

Table 9-41

LTE Band 66 (AWS) Measured P_{limit} for DSI = 1/2 (Phablet or UMPC Extremity with grip sensor active), or DSI = 5/6 (Hotspot Mode), and/or DSI = 7/8 (Earjack active) - 15 MHz Bandwidth

LTE Band 66 (AWS) 15 MHz Bandwidth							
Modulation	RB Size	RB Offset	Low Channel	Mid Channel	High Channel	MPR Allowed per 3GPP [dB]	MPR [dB]
			132047 (1717.5 MHz)	132322 (1745.0 MHz)	132597 (1772.5 MHz)		
Conducted Power [dBm]							
QPSK	1	0	18.88	19.01	19.27	0	0
	1	36	18.97	19.16	19.30		0
	1	74	18.93	19.10	19.42		0
	36	0	19.13	19.24	19.44	0-1	0
	36	18	19.21	19.25	19.41		0
	36	37	19.17	19.28	19.45		0
16QAM	75	0	19.19	19.30	19.38	0-1	0
	1	0	19.32	19.34	19.63		0
	1	36	19.39	19.48	19.74		0
	1	74	19.34	19.47	19.70	0-2	0
	36	0	19.09	19.22	19.39		0
	36	18	19.22	19.23	19.41		0
64QAM	36	37	19.20	19.25	19.48	0-2	0
	75	0	19.17	19.31	19.43		0
	1	0	19.17	19.33	19.60		0-2
	1	36	19.28	19.52	19.57	0	
	1	74	19.17	19.45	19.39	0	
	256QAM	36	0	19.15	19.30	19.51	0-3
36		18	19.26	19.26	19.47	0	
36		37	19.24	19.34	19.52	0	
75		0	19.20	19.35	19.46	0-5	0
1		0	18.60	18.72	18.88		0
1		36	18.70	18.92	18.98		0
256QAM	1	74	18.64	18.90	18.74	0-5	0
	36	0	18.63	18.77	18.90		0
	36	18	18.78	18.80	18.92		0
	36	37	18.70	18.84	18.98	0	
	75	0	18.71	18.83	18.91	0	



FCC ID: A3LSMF916U	 PCTEST Proud to be part of Samsung	SAR EVALUATION REPORT		Approved by: Quality Manager
Document S/N: 1M2005200087-01-R2.A3L	Test Dates: 06/28/20-08/24/20	DUT Type: Portable Handset	Page 58 of 267	

Table 9-42

LTE Band 66 (AWS) Measured P_{limit} for DSI = 1/2 (Phablet or UMPC Extremity with grip sensor active), or DSI = 5/6 (Hotspot Mode), and/or DSI = 7/8 (Earjack active) - 10 MHz Bandwidth

LTE Band 66 (AWS) 10 MHz Bandwidth							
Modulation	RB Size	RB Offset	Low Channel	Mid Channel	High Channel	MPR Allowed per 3GPP [dB]	MPR [dB]
			132022 (1715.0 MHz)	132322 (1745.0 MHz)	132622 (1775.0 MHz)		
Conducted Power [dBm]							
QPSK	1	0	18.88	18.95	19.22	0	0
	1	25	19.13	19.25	19.48		0
	1	49	18.92	19.03	19.32		0
	25	0	19.13	19.22	19.51	0-1	0
	25	12	19.28	19.40	19.56		0
	25	25	19.17	19.35	19.58		0
16QAM	50	0	19.20	19.30	19.45	0-1	0
	1	0	19.20	19.35	19.58		0
	1	25	19.46	19.65	19.80		0
	1	49	19.30	19.47	19.65	0-2	0
	25	0	19.08	19.26	19.37		0
	25	12	19.22	19.37	19.48		0
64QAM	25	25	19.18	19.29	19.42	0-2	0
	50	0	19.14	19.32	19.37		0
	1	0	18.92	19.13	19.28		0-2
	1	25	19.35	19.35	19.69	0	
	1	49	19.12	19.22	19.48	0	
	256QAM	25	0	19.08	19.23	19.41	0-3
25		12	19.28	19.43	19.49	0	
25		25	19.16	19.30	19.49	0	
50		0	19.19	19.31	19.39	0-5	0
1		0	18.50	18.65	18.80		0
1		25	18.77	19.23	19.11		0
256QAM	1	49	18.51	18.74	18.87	0-5	0
	25	0	18.55	18.72	18.95		0
	25	12	18.78	18.87	18.99		0
	25	25	18.61	18.72	18.96	0	
	50	0	18.66	18.82	18.91	0	

Table 9-43

LTE Band 66 (AWS) Measured P_{limit} for DSI = 1/2 (Phablet or UMPC Extremity with grip sensor active), or DSI = 5/6 (Hotspot Mode), and/or DSI = 7/8 (Earjack active) - 5 MHz Bandwidth

LTE Band 66 (AWS) 5 MHz Bandwidth								
Modulation	RB Size	RB Offset	Low Channel	Mid Channel	High Channel	MPR Allowed per 3GPP [dB]	MPR [dB]	
			131997 (1712.5 MHz)	132322 (1745.0 MHz)	132647 (1777.5 MHz)			
Conducted Power [dBm]								
QPSK	1	0	19.00	19.20	19.37	0	0	
	1	12	19.08	19.26	19.37		0	
	1	24	19.01	19.23	19.36		0	
	12	0	19.12	19.27	19.45	0-1	0	
	12	6	19.21	19.37	19.55		0	
	12	13	19.10	19.30	19.51		0	
16QAM	25	0	19.13	19.33	19.48	0-1	0	
	1	0	19.36	19.47	19.66		0	
	1	12	19.35	19.48	19.71		0-2	0
	1	24	19.40	19.53	19.68	0		
	12	0	19.25	19.40	19.56	0		
	64QAM	12	6	19.26	19.43	19.66	0-2	0
12		13	19.20	19.39	19.53	0		
25		0	19.21	19.36	19.52	0		
256QAM		1	0	19.30	19.40	19.65	0-2	0
		1	12	19.30	19.46	19.76		0
		1	24	19.36	19.45	19.71		0-3
	12	0	19.20	19.38	19.54	0		
	12	6	19.31	19.41	19.61	0		
	12	13	19.25	19.32	19.59	0		
256QAM	25	0	19.23	19.35	19.54	0-5	0	
	1	0	18.75	18.83	19.04		0	
	1	12	18.82	18.91	19.11		0	
	1	24	18.77	18.85	19.05	0-5	0	
	12	0	18.69	18.83	19.02		0	
	12	6	18.78	18.90	19.05		0	
12	13	18.77	18.78	18.98	0			
25	0	18.74	18.87	19.03	0			



FCC ID: A3LSMF916U	 PCTEST Proud to be part of Samsung	SAR EVALUATION REPORT		Approved by: Quality Manager
Document S/N: 1M2005200087-01-R2.A3L	Test Dates: 06/28/20-08/24/20	DUT Type: Portable Handset	Page 59 of 267	

Table 9-44



LTE Band 66 (AWS) Measured P_{limit} for DSI = 1/2 (Phablet or UMPC Extremity with grip sensor active), or DSI = 5/6 (Hotspot Mode), and/or DSI = 7/8 (Earjack active) - 3 MHz Bandwidth

LTE Band 66 (AWS) 3 MHz Bandwidth							
Modulation	RB Size	RB Offset	Low Channel	Mid Channel	High Channel	MPR Allowed per 3GPP [dB]	MPR [dB]
			131987 (1711.5 MHz)	132322 (1745.0 MHz)	132657 (1778.5 MHz)		
Conducted Power [dBm]							
QPSK	1	0	19.03	19.27	19.43	0	0
	1	7	18.95	19.24	19.44		0
	1	14	19.04	19.18	19.35		0
	8	0	19.20	19.28	19.48	0-1	0
	8	4	19.20	19.31	19.56		0
	8	7	19.11	19.30	19.49		0
16QAM	15	0	19.17	19.32	19.46	0-1	0
	1	0	19.40	19.63	19.81		0
	1	7	19.24	19.53	19.78		0
	1	14	19.32	19.55	19.79	0-2	0
	8	0	19.27	19.40	19.63		0
	8	4	19.26	19.43	19.64		0
64QAM	8	7	19.19	19.40	19.62	0-2	0
	15	0	19.20	19.36	19.52		0
	1	0	19.35	19.51	19.84		0-2
	1	7	19.35	19.55	19.71	0	
	1	14	19.32	19.52	19.74	0	
	256QAM	8	0	19.21	19.37	19.54	0-3
8		4	19.28	19.47	19.64	0	
8		7	19.15	19.40	19.57	0	
15		0	19.24	19.41	19.56	0-3	0
1		0	18.72	18.92	19.07		0
1		7	18.69	18.93	19.13		0
256QAM	1	14	18.80	18.87	19.08	0-5	0
	8	0	18.61	18.85	19.00		0
	8	4	18.67	18.94	19.12		0
	8	7	18.69	18.86	19.02	0-5	0
	15	0	18.74	18.91	18.96		0

Table 9-45

LTE Band 66 (AWS) Measured P_{limit} for DSI = 1/2 (Phablet or UMPC Extremity with grip sensor active), or DSI = 5/6 (Hotspot Mode), and/or DSI = 7/8 (Earjack active) - 1.4 MHz Bandwidth

LTE Band 66 (AWS) 1.4 MHz Bandwidth								
Modulation	RB Size	RB Offset	Low Channel	Mid Channel	High Channel	MPR Allowed per 3GPP [dB]	MPR [dB]	
			131979 (1710.7 MHz)	132322 (1745.0 MHz)	132665 (1779.3 MHz)			
Conducted Power [dBm]								
QPSK	1	0	18.94	19.09	19.35	0	0	
	1	2	19.05	19.22	19.46		0	
	1	5	18.95	19.16	19.32		0	
	3	0	19.05	19.11	19.32	0-1	0	
	3	2	19.05	19.24	19.41		0	
	3	3	19.00	19.11	19.42		0	
16QAM	6	0	19.06	19.27	19.58	0-1	0	
	1	0	19.42	19.41	19.65		0	
	1	2	19.37	19.61	19.76		0	
	1	5	19.37	19.36	19.74	0-1	0	
	3	0	19.34	19.36	19.38		0	
	3	2	19.22	19.44	19.64		0	
64QAM	3	3	19.23	19.35	19.65	0-2	0	
	6	0	19.14	19.40	19.70		0	
	1	0	19.23	19.35	19.63		0-2	0
	1	2	19.17	19.60	19.80	0		
	1	5	19.24	19.45	19.62	0		
	256QAM	3	0	19.23	19.31	19.52	0-2	0
3		2	19.26	19.48	19.60	0		
3		3	19.18	19.31	19.53	0		
6		0	19.19	19.32	19.56	0-3	0	
1		0	18.78	18.87	19.05		0-5	0
1		2	18.82	18.99	19.16			0
1	5	18.55	18.81	19.08	0			
256QAM	3	0	18.74	18.87	19.06	0-5	0	
	3	2	18.79	18.91	19.12		0	
	3	3	18.69	18.87	19.05		0	
	6	0	18.61	18.74	18.98	0-5	0	

FCC ID: A3LSMF916U	 PCTEST <small>PROUD TO BE PART OF SAMSUNG</small>	SAR EVALUATION REPORT		Approved by: Quality Manager
Document S/N: 1M2005200087-01-R2.A3L	Test Dates: 06/28/20-08/24/20	DUT Type: Portable Handset		Page 60 of 267

9.4.8

LTE Band 25

Table 9-46

LTE Band 25 (PCS) Measured P_{Max} for DSI = 0 (Body-worn, or Phablet/UMPC with grip sensor inactive), or DSI = 3/4 (Head) - 20 MHz Bandwidth

LTE Band 25 (PCS) 20 MHz Bandwidth							
Modulation	RB Size	RB Offset	Low Channel	Mid Channel	High Channel	MPR Allowed per 3GPP [dB]	MPR [dB]
			26140 (1860.0 MHz)	26365 (1882.5 MHz)	26590 (1905.0 MHz)		
Conducted Power [dBm]							
QPSK	1	0	24.47	24.04	24.06	0	0
	1	50	24.36	23.96	24.12		0
	1	99	24.22	24.05	24.22		0
	50	0	23.68	23.30	23.31	0-1	1
	50	25	23.59	23.26	23.35		1
	50	50	23.52	23.29	23.39		1
16QAM	100	0	23.51	23.20	23.33	0-1	1
	1	0	24.00	23.76	23.78		1
	1	50	23.99	23.65	23.85		1
	1	99	23.84	23.77	23.98	0-2	1
	50	0	22.74	22.32	22.36		2
	50	25	22.63	22.34	22.37		2
64QAM	50	50	22.55	22.33	22.44	0-2	2
	100	0	22.51	22.22	22.32		2
	1	0	23.00	22.94	22.92		0-2
	1	50	22.95	22.85	23.00	2	
	1	99	22.90	22.96	22.86	2	
	256QAM	50	0	21.74	21.35	21.39	0-3
50		25	21.66	21.36	21.43	3	
50		50	21.58	21.33	21.47	3	
100		0	21.52	21.23	21.34	0-5	3
1		0	19.45	19.16	19.06		5
1		50	19.76	19.36	19.53		5
256QAM	1	99	19.33	19.26	19.38	0-5	5
	50	0	19.61	19.21	19.30		5
	50	25	19.60	19.34	19.41		5
	50	50	19.56	19.29	19.46	0-5	5
	100	0	19.52	19.26	19.36		5

Table 9-47

LTE Band 25 (PCS) Measured P_{Max} for DSI = 0 (Body-worn, or Phablet/UMPC with grip sensor inactive), or DSI = 3/4 (Head) - 15 MHz Bandwidth

LTE Band 25 (PCS) 15 MHz Bandwidth							
Modulation	RB Size	RB Offset	Low Channel	Mid Channel	High Channel	MPR Allowed per 3GPP [dB]	MPR [dB]
			26115 (1857.5 MHz)	26365 (1882.5 MHz)	26615 (1907.5 MHz)		
Conducted Power [dBm]							
QPSK	1	0	24.31	24.04	24.16	0	0
	1	36	24.58	23.99	24.24		0
	1	74	24.29	23.97	24.16		0
	36	0	23.56	23.07	23.21	0-1	1
	36	18	23.59	23.29	23.35		1
	36	37	23.52	23.22	23.39		1
16QAM	75	0	23.49	23.15	23.35	0-1	1
	1	0	23.82	23.68	23.74		1
	1	36	24.11	23.66	23.83		1
	1	74	23.89	23.70	23.83	0-2	1
	36	0	22.64	22.03	22.28		2
	36	18	22.69	22.21	22.38		2
64QAM	36	37	22.59	22.20	22.45	0-2	2
	75	0	22.50	22.17	22.36		2
	1	0	22.80	22.59	22.62		0-2
	1	36	23.04	22.57	22.77	2	
	1	74	22.79	22.62	22.71	2	
	256QAM	36	0	21.66	21.03	21.24	0-3
36		18	21.67	21.25	21.38	3	
36		37	21.62	21.20	21.41	3	
75		0	21.54	21.20	21.36	0-5	3
1		0	19.70	18.90	18.85		5
1		36	19.93	19.10	19.21		5
256QAM	1	74	19.66	19.10	19.02	0-5	5
	36	0	19.62	19.03	19.27		5
	36	18	19.63	19.26	19.39		5
	36	37	19.54	19.23	19.41	0-5	5
	75	0	19.55	19.16	19.41		5



FCC ID: A3LSMF916U	 PCTEST <small>Prøvet til det beste af alle</small>	SAR EVALUATION REPORT		Approved by: Quality Manager
Document S/N: 1M2005200087-01-R2.A3L	Test Dates: 06/28/20-08/24/20	DUT Type: Portable Handset		Page 61 of 267

Table 9-48

LTE Band 25 (PCS) Measured P_{Max} for DSI = 0 (Body-worn, or Phablet/UMPC with grip sensor inactive), or DSI = 3/4 (Head) - 10 MHz Bandwidth

LTE Band 25 (PCS) 10 MHz Bandwidth							
Modulation	RB Size	RB Offset	Low Channel	Mid Channel	High Channel	MPR Allowed per 3GPP [dB]	MPR [dB]
			26090 (1855.0 MHz)	26365 (1882.5 MHz)	26640 (1910.0 MHz)		
			Conducted Power [dBm]				
QPSK	1	0	24.38	23.76	24.22	0	0
	1	25	24.57	23.94	24.18		0
	1	49	24.33	23.76	24.24		0
	25	0	23.55	23.01	23.15	0-1	1
	25	12	23.61	23.21	23.23		1
	25	25	23.58	23.13	23.31		1
16QAM	50	0	23.57	23.11	23.22	0-1	1
	1	0	24.07	23.47	23.69		1
	1	25	24.21	23.66	23.75		1
	1	49	24.00	23.46	23.80	0-2	1
	25	0	22.60	22.09	22.15		2
	25	12	22.70	22.24	22.26		2
64QAM	25	25	22.61	22.16	22.32	0-2	2
	50	0	22.57	22.12	22.20		2
	1	0	23.00	22.30	22.67		0-2
	1	25	23.15	22.48	22.76	2	
	1	49	22.92	22.34	22.55	0-3	
	25	0	21.53	20.99	21.21		3
25	12	21.68	21.16	21.35	3		
256QAM	25	25	21.55	21.11	21.34	0-3	3
	50	0	21.60	21.12	21.24		3
	1	0	19.45	18.78	18.85		0-5
	1	25	19.60	18.99	19.07	5	
	1	49	19.53	18.87	18.95	5	
	25	0	19.59	19.01	19.25	0-5	5
25	12	19.65	19.18	19.38	5		
25	25	19.60	19.10	19.37	5		
50	0	19.60	19.12	19.31		5	

Table 9-49

LTE Band 25 (PCS) Measured P_{Max} for DSI = 0 (Body-worn, or Phablet/UMPC with grip sensor inactive), or DSI = 3/4 (Head) - 5 MHz Bandwidth

LTE Band 25 (PCS) 5 MHz Bandwidth								
Modulation	RB Size	RB Offset	Low Channel	Mid Channel	High Channel	MPR Allowed per 3GPP [dB]	MPR [dB]	
			26065 (1852.5 MHz)	26365 (1882.5 MHz)	26665 (1912.5 MHz)			
			Conducted Power [dBm]					
QPSK	1	0	24.38	23.92	24.14	0	0	
	1	12	24.46	24.03	24.12		0	
	1	24	24.41	24.02	24.17		0	
	12	0	23.62	23.03	23.21	0-1	1	
	12	6	23.63	23.16	23.31		1	
	12	13	23.65	23.19	23.38		1	
16QAM	25	0	23.67	23.19	23.28	0-1	1	
	1	0	23.99	23.65	23.60		1	
	1	12	24.01	23.72	23.72		1	
	64QAM	1	24	24.03	23.76	23.73	0-1	1
		12	0	22.69	22.15	22.33		2
		12	6	22.72	22.28	22.35		2
12		13	22.68	22.30	22.44	0-2	2	
25		0	22.63	22.18	22.25		2	
1		0	23.00	22.49	22.41		0-2	2
256QAM	1	12	23.01	22.56	22.44	0-2		2
	1	24	23.08	22.62	22.12			2
	12	0	21.66	21.08	21.35		0-3	3
	12	6	21.74	21.22	21.40	3		
	12	13	21.68	21.23	21.42	3		
	256QAM	25	0	21.64	21.18	21.29	0-3	3
1		0	19.77	19.15	19.08	0-5		5
1		12	19.79	19.20	19.15			5
1		24	19.83	19.28	18.97		5	
12		0	19.53	19.02	19.34	0-5	5	
12		6	19.54	19.12	19.40		5	
12	13	19.57	19.14	19.42	5			
25	0	19.60	19.17	19.33		5		



FCC ID: A3LSMF916U	 PCTEST <small>Prove to be part of Samsung</small>	SAR EVALUATION REPORT		Approved by: Quality Manager
Document S/N: 1M2005200087-01-R2.A3L	Test Dates: 06/28/20-08/24/20	DUT Type: Portable Handset	Page 62 of 267	

Table 9-50

LTE Band 25 (PCS) Measured P_{Max} for DSI = 0 (Body-worn, or Phablet/UMPC with grip sensor inactive), or DSI = 3/4 (Head) - 3 MHz Bandwidth

LTE Band 25 (PCS) 3 MHz Bandwidth							
Modulation	RB Size	RB Offset	Low Channel	Mid Channel	High Channel	MPR Allowed per 3GPP [dB]	MPR [dB]
			26055 (1851.5 MHz)	26365 (1882.5 MHz)	26675 (1913.5 MHz)		
			Conducted Power [dBm]				
QPSK	1	0	24.48	24.05	24.08	0	0
	1	7	24.44	24.10	24.17		0
	1	14	24.51	24.14	24.23		0
	8	0	23.59	23.06	23.30	0-1	1
	8	4	23.63	23.20	23.36		1
	8	7	23.66	23.18	23.41		1
16QAM	15	0	23.60	23.18	23.38	0-1	1
	1	0	24.12	23.64	23.82		1
	1	7	24.06	23.69	23.81		1
	1	14	24.16	23.82	23.84	0-2	1
	8	0	22.80	22.15	22.40		2
	8	4	22.85	22.21	22.46		2
64QAM	8	7	22.82	22.22	22.47	0-2	2
	15	0	22.66	22.18	22.34		2
	1	0	23.00	22.28	22.77		0-2
	1	7	22.94	22.30	22.72	2	
	1	14	23.04	22.40	22.49	0-3	
	8	0	21.82	21.08	21.30		3
8	4	21.84	21.20	21.38	3		
256QAM	8	7	21.84	21.18	21.27	0-3	3
	15	0	21.67	21.20	21.34		3
	1	0	19.96	19.49	19.57		0-5
	1	7	19.90	19.48	19.60	5	
	1	14	19.99	19.58	19.70	5	
	8	0	19.68	19.21	19.35	0-5	5
8	4	19.72	19.28	19.48	5		
8	7	19.67	19.30	19.47	5		
15	0	19.68	19.15	19.55		5	

Table 9-51

LTE Band 25 (PCS) Measured P_{Max} for DSI = 0 (Body-worn, or Phablet/UMPC with grip sensor inactive), or DSI = 3/4 (Head) - 1.4 MHz Bandwidth

LTE Band 25 (PCS) 1.4 MHz Bandwidth								
Modulation	RB Size	RB Offset	Low Channel	Mid Channel	High Channel	MPR Allowed per 3GPP [dB]	MPR [dB]	
			26047 (1850.7 MHz)	26365 (1882.5 MHz)	26683 (1914.3 MHz)			
			Conducted Power [dBm]					
QPSK	1	0	24.42	23.98	24.24	0	0	
	1	2	24.44	24.04	24.26		0	
	1	5	24.40	24.01	24.23		0	
	3	0	24.47	23.86	24.09	0-1	0	
	3	2	24.49	23.91	24.15		0	
	3	3	24.43	23.89	24.12		0	
16QAM	6	0	23.54	23.09	23.25	0-1	1	
	1	0	24.11	23.46	23.80		1	
	1	2	24.18	23.57	23.84		1	
	1	5	24.15	23.50	23.75	0-1	1	
	3	0	23.65	23.24	23.37		1	
	3	2	23.68	23.23	23.39		1	
64QAM	3	3	23.65	23.21	23.41	0-2	1	
	6	0	22.65	21.98	22.37		2	
	1	0	22.93	22.72	22.64		0-2	2
	1	2	22.98	22.73	22.64	2		
	1	5	22.96	22.70	22.47	2		
	256QAM	3	0	22.61	22.25	22.22	0-2	2
3		2	22.70	22.29	22.18	2		
3		3	22.65	22.24	22.10	2		
6		0	21.62	21.06	21.08	0-3	3	
1		0	19.45	19.42	19.10		0-5	5
1		2	19.55	19.46	19.18			5
1	5	19.51	19.46	19.15	5			
3	0	19.55	19.13	19.16	0-5	5		
3	2	19.64	19.21	19.23		5		
3	3	19.60	19.18	19.23		5		
6	0	19.20	19.16	19.24		5		



FCC ID: A3LSMF916U	 PCTEST <small>Practical to be part of the solution</small>	SAR EVALUATION REPORT		Approved by: Quality Manager
Document S/N: 1M2005200087-01-R2.A3L	Test Dates: 06/28/20-08/24/20	DUT Type: Portable Handset		Page 63 of 267

Table 9-52

LTE Band 25 (PCS) Measured P_{limit} for DSI = 1/2 (Phablet or UMPC Extremity with grip sensor active), or DSI = 5/6 (Hotspot Mode), and/or DSI = 7/8 (Earjack active) - 20 MHz Bandwidth

LTE Band 25 (PCS) 20 MHz Bandwidth									
Modulation	RB Size	RB Offset	Low Channel	Mid Channel	High Channel	MPR Allowed per 3GPP [dB]	MPR [dB]		
			26140 (1860.0 MHz)	26365 (1882.5 MHz)	26590 (1905.0 MHz)				
Conducted Power [dBm]									
QPSK	1	0	19.22	18.76	18.85	0	0		
	1	50	19.16	18.61	18.91		0		
	1	99	19.02	18.72	18.99		0		
	QPSK	50	0	19.21	18.88	18.90	0-1	0	
		50	25	19.13	18.86	18.91		0	
		50	50	19.09	18.84	18.99		0	
		100	0	19.07	18.77	18.88		0	
16QAM		1	0	19.47	19.41	19.14		0-1	0
		1	50	19.41	19.24	19.18			0
	1	99	19.27	19.42	19.27	0			
	16QAM	50	0	19.25	18.88	18.94	0-2	0	
		50	25	19.19	18.87	18.95		0	
		50	50	19.12	18.85	19.01		0	
		100	0	19.08	18.78	18.85		0	
64QAM		1	0	19.09	19.15	18.49		0-2	0
	1	50	19.10	18.88	18.66	0			
	1	99	19.08	19.17	18.71	0			
	64QAM	50	0	19.06	18.92	18.93	0-3	0	
		50	25	19.07	18.90	18.93		0	
		50	50	19.09	18.89	18.99		0	
		100	0	19.05	18.84	18.86		0	
256QAM	1	0	19.28	18.68	18.91	0-5	0		
	1	50	19.65	18.95	19.36		0		
	1	99	19.22	18.82	19.25		0		
	50	0	19.16	18.73	18.82		0		
	50	25	19.20	18.86	18.88		0		
	50	50	19.10	18.81	18.97		0		
	100	0	19.11	18.84	18.89		0		

Table 9-53

LTE Band 25 (PCS) Measured P_{limit} for DSI = 1/2 (Phablet or UMPC Extremity with grip sensor active), or DSI = 5/6 (Hotspot Mode), and/or DSI = 7/8 (Earjack active) - 15 MHz Bandwidth

LTE Band 25 (PCS) 15 MHz Bandwidth								
Modulation	RB Size	RB Offset	Low Channel	Mid Channel	High Channel	MPR Allowed per 3GPP [dB]	MPR [dB]	
			26115 (1857.5 MHz)	26365 (1882.5 MHz)	26615 (1907.5 MHz)			
Conducted Power [dBm]								
QPSK	1	0	18.92	18.66	18.78	0	0	
	1	36	19.13	18.65	18.79		0	
	1	74	18.95	18.62	18.83		0	
	QPSK	36	0	19.04	18.61	18.77	0-1	0
		36	18	19.15	18.78	18.89		0
		36	37	19.02	18.77	18.94		0
		75	0	18.96	18.70	18.88		0
16QAM		1	0	19.21	19.26	19.05		0-1
	1	36	19.41	19.18	19.04	0		
	1	74	19.27	19.23	19.04	0		
	16QAM	36	0	19.13	18.61	18.75	0-2	0
		36	18	19.22	18.80	18.89		0
		36	37	19.11	18.79	18.96		0
		75	0	19.06	18.76	18.92		0
64QAM		1	0	19.38	18.77	18.75		0-2
	1	36	19.60	18.67	18.80	0		
	1	74	19.38	18.79	18.83	0		
	64QAM	36	0	19.15	18.66	18.90	0-3	0
		36	18	19.18	18.83	19.00		0
		36	37	19.09	18.83	19.07		0
		75	0	19.07	18.77	18.95		0
256QAM		1	0	19.30	19.06	18.48		0-5
	1	36	19.48	19.26	18.80	0		
	1	74	19.25	19.20	18.73	0		
	36	0	19.09	18.65	18.79	0		
	36	18	19.22	18.80	18.85	0		
	36	37	19.08	18.79	18.92	0		
	75	0	19.05	18.77	18.88	0		



FCC ID: A3LSMF916U	 PCTEST <small>Prove to be part of Samsung</small>	SAR EVALUATION REPORT		Approved by: Quality Manager
Document S/N: 1M2005200087-01-R2.A3L	Test Dates: 06/28/20-08/24/20	DUT Type: Portable Handset	Page 64 of 267	

Table 9-54

LTE Band 25 (PCS) Measured P_{limit} for DSI = 1/2 (Phablet or UMPC Extremity with grip sensor active), or DSI = 5/6 (Hotspot Mode), and/or DSI = 7/8 (Earjack active) - 10 MHz Bandwidth

LTE Band 25 (PCS) 10 MHz Bandwidth							
Modulation	RB Size	RB Offset	Low Channel	Mid Channel	High Channel	MPR Allowed per 3GPP [dB]	MPR [dB]
			26090 (1855.0 MHz)	26365 (1882.5 MHz)	26640 (1910.0 MHz)		
			Conducted Power [dBm]				
QPSK	1	0	19.22	18.31	18.80	0	0
	1	25	19.22	18.60	18.80		0
	1	49	19.22	18.36	18.79		0
	25	0	19.20	18.57	18.81	0-1	0
	25	12	19.18	18.75	18.81		0
	25	25	19.19	18.67	18.82		0
50	0	19.22	18.69	18.82	0	0	
16QAM	1	0	19.24	18.88	18.80	0-1	0
	1	25	19.24	19.14	18.82		0
	1	49	19.22	18.93	18.80		0
	25	0	19.23	18.65	18.80	0-2	0
	25	12	19.23	18.79	18.83		0
	25	25	19.22	18.80	18.82		0
50	0	19.21	18.69	18.82	0	0	
64QAM	1	0	19.18	18.87	18.81	0-2	0
	1	25	19.20	18.92	18.81		0
	1	49	19.22	18.79	18.78		0
	25	0	19.23	18.65	18.83	0-3	0
	25	12	19.23	18.82	18.82		0
	25	25	19.21	18.75	18.81		0
50	0	19.20	18.72	18.81	0	0	
256QAM	1	0	18.85	18.97	18.47	0-5	0
	1	25	19.04	19.30	18.74		0
	1	49	18.88	19.09	18.55		0
	25	0	19.25	18.66	18.78	0-5	0
	25	12	19.32	18.83	18.88		0
	25	25	19.25	18.79	18.90		0
50	0	19.18	18.80	18.77	0	0	

Table 9-55

LTE Band 25 (PCS) Measured P_{limit} for DSI = 1/2 (Phablet or UMPC Extremity with grip sensor active), or DSI = 5/6 (Hotspot Mode), and/or DSI = 7/8 (Earjack active) - 5 MHz Bandwidth

LTE Band 25 (PCS) 5 MHz Bandwidth							
Modulation	RB Size	RB Offset	Low Channel	Mid Channel	High Channel	MPR Allowed per 3GPP [dB]	MPR [dB]
			26065 (1852.5 MHz)	26365 (1882.5 MHz)	26665 (1912.5 MHz)		
			Conducted Power [dBm]				
QPSK	1	0	19.22	18.59	18.81	0	0
	1	12	19.24	18.65	18.86		0
	1	24	19.25	18.71	18.90		0
	12	0	19.24	18.61	18.80	0-1	0
	12	6	19.24	18.77	18.85		0
	12	13	19.24	18.78	18.92		0
25	0	19.24	18.71	18.81	0	0	
16QAM	1	0	19.23	18.70	19.15	0-1	0
	1	12	19.23	18.80	19.22		0
	1	24	19.24	18.88	19.26		0
	12	0	19.24	18.68	18.97	0-2	0
	12	6	19.23	18.74	19.06		0
	12	13	19.24	18.75	19.13		0
25	0	19.24	18.77	18.88	0	0	
64QAM	1	0	19.24	18.93	18.90	0-2	0
	1	12	19.23	19.02	18.97		0
	1	24	19.25	19.05	18.96		0
	12	0	19.23	18.77	18.78	0-3	0
	12	6	19.31	18.84	18.86		0
	12	13	19.30	18.88	18.93		0
25	0	19.23	18.79	18.85	0	0	
256QAM	1	0	19.07	18.55	18.97	0-5	0
	1	12	19.08	18.58	19.08		0
	1	24	19.13	18.71	19.11		0
	12	0	19.29	18.77	18.87	0-5	0
	12	6	19.33	18.91	18.96		0
	12	13	19.35	18.90	19.04		0
25	0	19.23	18.82	18.89	0	0	



FCC ID: A3LSMF916U	 PCTEST <small>Prized to be part of Samsung</small>	SAR EVALUATION REPORT		Approved by: Quality Manager
Document S/N: 1M2005200087-01-R2.A3L	Test Dates: 06/28/20-08/24/20	DUT Type: Portable Handset		Page 65 of 267

Table 9-56



LTE Band 25 (PCS) Measured P_{limit} for DSI = 1/2 (Phablet or UMPC Extremity with grip sensor active), or DSI = 5/6 (Hotspot Mode), and/or DSI = 7/8 (Earjack active) - 3 MHz Bandwidth

LTE Band 25 (PCS) 3 MHz Bandwidth							
Modulation	RB Size	RB Offset	Low Channel	Mid Channel	High Channel	MPR Allowed per 3GPP [dB]	MPR [dB]
			26055 (1851.5 MHz)	26365 (1882.5 MHz)	26675 (1913.5 MHz)		
Conducted Power [dBm]							
QPSK	1	0	19.31	18.46	18.69	0	0
	1	7	18.98	18.47	18.77		0
	1	14	19.06	18.59	18.86		0
	8	0	19.13	18.60	18.81	0-1	0
	8	4	19.19	18.66	18.92		0
	8	7	19.17	18.72	18.92		0
16QAM	1	0	19.16	18.73	18.90	0-1	0
	1	7	19.52	18.95	18.97		0
	1	14	19.37	18.96	19.01		0
	8	0	19.43	19.10	19.08	0-2	0
	8	4	19.27	18.79	18.85		0
	8	7	19.32	18.85	18.98		0
64QAM	1	0	19.30	18.86	18.98	0-2	0
	1	7	19.30	18.84	18.90		0
	1	14	19.37	18.87	18.70		0-3
	8	0	19.39	18.88	18.77	0	
	8	4	19.40	18.93	18.84	0	
	256QAM	8	0	19.21	18.65	18.92	0-5
8		4	19.22	18.80	18.97	0	
8		7	19.22	18.79	19.00	0	
15		0	19.26	18.81	19.04	0	
1		0	19.26	18.56	18.75	0-5	0
1		7	19.08	18.61	18.80		0
1	14	19.12	18.71	18.86	0		
256QAM	8	0	19.28	18.73	18.81	0-5	0
	8	4	19.32	18.85	18.90		0
	8	7	19.28	18.86	18.92		0
	15	0	19.26	18.78	19.00	0	

Table 9-57

LTE Band 25 (PCS) Measured P_{limit} for DSI = 1/2 (Phablet or UMPC Extremity with grip sensor active), or DSI = 5/6 (Hotspot Mode), and/or DSI = 7/8 (Earjack active) - 1.4 MHz Bandwidth

LTE Band 25 (PCS) 1.4 MHz Bandwidth									
Modulation	RB Size	RB Offset	Low Channel	Mid Channel	High Channel	MPR Allowed per 3GPP [dB]	MPR [dB]		
			26047 (1850.7 MHz)	26365 (1882.5 MHz)	26683 (1914.3 MHz)				
Conducted Power [dBm]									
QPSK	1	0	19.00	18.47	18.72	0	0		
	1	2	19.09	18.53	18.79		0		
	1	5	19.08	18.49	18.78		0		
	3	0	19.02	18.54	18.73	0-1	0		
	3	2	19.05	18.61	18.80		0		
	3	3	19.05	18.55	18.77		0		
16QAM	6	0	19.11	18.60	18.83	0-1	0		
	1	0	19.26	18.91	18.94		0		
	1	2	19.35	19.01	19.05		0		
	64QAM	1	5	19.32	18.98	19.01	0-1	0	
		3	0	19.27	18.67	18.97		0	
		3	2	19.31	18.73	19.02		0	
256QAM		3	3	19.30	18.69	18.99	0-2	0	
		6	0	19.10	18.70	18.79		0	
		1	0	19.02	18.82	18.74		0-3	0
	1	2	19.10	18.85	18.80	0			
	1	5	19.01	18.88	18.78	0			
	256QAM	3	0	19.16	18.73	18.91	0-2	0	
3		2	19.24	18.80	18.94	0			
3		3	19.24	18.77	18.93	0			
256QAM		6	0	19.16	18.72	18.85	0-3	0	
		1	0	19.03	18.52	18.74		0-5	0
		1	2	19.05	18.61	18.75			0
	256QAM	1	5	19.08	18.57	18.77	0-5		0
		3	0	19.20	18.66	18.90		0	
		3	2	19.25	18.79	18.95		0	
256QAM		3	3	19.22	18.77	18.94	0-5	0	
		6	0	19.18	18.73	18.90		0	

FCC ID: A3LSMF916U	 PCTEST <small>Prøvet til det beste af Samsung</small>	SAR EVALUATION REPORT		Approved by: Quality Manager
Document S/N: 1M2005200087-01-R2.A3L	Test Dates: 06/28/20-08/24/20	DUT Type: Portable Handset		Page 66 of 267

9.4.9

LTE Band 30

Table 9-58

LTE Band 30 Measured P_{Max} for DSI = 0 (Body-worn, or Phablet/UMPC with grip sensor inactive), or DSI = 3/4 (Head) - 10 MHz Bandwidth

LTE Band 30 10 MHz Bandwidth					
Modulation	RB Size	RB Offset	Mid Channel	MPR Allowed per 3GPP [dB]	MPR [dB]
			27710 (2310.0 MHz) Conducted Power [dBm]		
QPSK	1	0	23.84	0	0
	1	25	23.82		0
	1	49	23.75		0
	25	0	22.86	0-1	1
	25	12	22.92		1
	25	25	22.84		1
16QAM	50	0	22.85	0-1	1
	1	0	23.07		1
	1	25	22.97		1
	1	49	22.88	0-2	1
	25	0	21.99		2
	25	12	22.03		2
64QAM	25	25	21.90	0-2	2
	50	0	21.88		2
	1	0	22.33		0-2
	1	25	22.29	2	
	1	49	22.05	2	
	256QAM	25	0	20.99	0-3
25		12	21.01	3	
25		25	20.93	3	
50		0	20.86	0-5	3
1		0	18.62		5
1		25	18.89		5
256QAM	1	49	18.53	0-5	5
	25	0	19.02		5
	25	12	19.07		5
	25	25	18.95	0-5	5
	50	0	18.91		5

Table 9-59

LTE Band 30 Measured P_{Max} for DSI = 0 (Body-worn, or Phablet/UMPC with grip sensor inactive), or DSI = 3/4 (Head) - 5 MHz Bandwidth

LTE Band 30 5 MHz Bandwidth					
Modulation	RB Size	RB Offset	Mid Channel	MPR Allowed per 3GPP [dB]	MPR [dB]
			27710 (2310.0 MHz) Conducted Power [dBm]		
QPSK	1	0	23.82	0	0
	1	12	23.94		0
	1	24	23.87		0
	12	0	22.89	0-1	1
	12	6	22.92		1
	12	13	22.91		1
16QAM	25	0	22.94	0-1	1
	1	0	23.38		1
	1	12	23.53		1
	1	24	23.36	0-2	1
	12	0	22.06		2
	12	6	22.07		2
64QAM	12	13	22.02	0-2	2
	25	0	21.99		2
	1	0	22.17		0-2
	1	12	22.31	2	
	1	24	22.16	2	
	256QAM	12	0	20.91	0-3
12		6	20.93	3	
12		13	20.86	3	
25		0	20.94	0-5	3
1		0	19.06		5
1		12	19.16		5
256QAM	1	24	19.05	0-5	5
	12	0	19.01		5
	12	6	19.03		5
	12	13	18.97	0-5	5
	25	0	18.95		5

Note: LTE Band 30 at 5 MHz bandwidth does not support three non-overlapping channels. Per KDB Publication 941225 D05v02, when a device supports overlapping channel assignment in a channel bandwidth configuration, the middle channel of the group of overlapping channels should be selected for testing.



FCC ID: A3LSMF916U	 PCTEST Proud to be part of Samsung	SAR EVALUATION REPORT		Approved by: Quality Manager
Document S/N: 1M2005200087-01-R2.A3L	Test Dates: 06/28/20-08/24/20	DUT Type: Portable Handset		Page 67 of 267

Table 9-60

LTE Band 30 Measured P_{limit} for DSI = 1/2 (Phablet or UMPC Extremity with grip sensor active), or DSI = 5/6 (Hotspot Mode), and/or DSI = 7/8 (Earjack active) - 10 MHz Bandwidth



LTE Band 30 10 MHz Bandwidth					
Modulation	RB Size	RB Offset	Mid Channel	MPR Allowed per 3GPP [dB]	MPR [dB]
			27710 (2310.0 MHz) Conducted Power [dBm]		
QPSK	1	0	18.89	0	0
	1	25	18.90		0
	1	49	18.86		0
	25	0	18.81	0-1	0
	25	12	18.99		0
	25	25	18.84		0
16QAM	50	0	18.87	0-1	0
	1	0	19.18		0
	1	25	19.27		0
	1	49	19.20	0-2	0
	25	0	18.84		0
	25	12	18.90		0
64QAM	25	25	18.88	0-2	0
	50	0	18.80		0
	1	0	19.33		0
	1	25	19.37	0-3	0
	1	49	19.38		0
	25	0	18.83		0
256QAM	25	12	18.91	0-3	0
	25	25	18.88		0
	50	0	18.86		0
	1	0	18.66	0-5	0.5
	1	25	19.00		0.5
	1	49	18.75		0.5
25	0	18.41	0.5		
25	12	18.53	0.5		
25	25	18.45	0.5		
	50	0	18.36		0.5

Table 9-61

LTE Band 30 Measured P_{limit} for DSI = 1/2 (Phablet or UMPC Extremity with grip sensor active), or DSI = 5/6 (Hotspot Mode), and/or DSI = 7/8 (Earjack active) - 5 MHz Bandwidth

LTE Band 30 5 MHz Bandwidth					
Modulation	RB Size	RB Offset	Mid Channel	MPR Allowed per 3GPP [dB]	MPR [dB]
			27710 (2310.0 MHz) Conducted Power [dBm]		
QPSK	1	0	18.79	0	0
	1	12	18.86		0
	1	24	18.85		0
	12	0	18.83	0-1	0
	12	6	18.86		0
	12	13	18.86		0
16QAM	25	0	18.81	0-1	0
	1	0	19.09		0
	1	12	19.22		0
	1	24	19.18	0-2	0
	12	0	19.05		0
	12	6	19.11		0
64QAM	12	13	19.09	0-2	0
	25	0	18.82		0
	1	0	18.85		0
	1	12	18.99	0-3	0
	1	24	18.90		0
	12	0	18.83		0
256QAM	12	6	18.85	0-3	0
	12	13	18.89		0
	25	0	18.85		0
	1	0	18.43	0-5	0.5
	1	12	18.61		0.5
	1	24	18.51		0.5
12	0	18.40	0.5		
12	6	18.46	0.5		
	12	13	18.41		0.5
	25	0	18.36		0.5

Note: LTE Band 30 at 5 MHz bandwidth does not support three non-overlapping channels. Per KDB Publication 941225 D05v02, when a device supports overlapping channel assignment in a channel bandwidth configuration, the middle channel of the group of overlapping channels should be selected for testing.

FCC ID: A3LSMF916U	 PCTEST <small>Proud to be part of Samsung</small>	SAR EVALUATION REPORT		Approved by: Quality Manager
Document S/N: 1M2005200087-01-R2.A3L	Test Dates: 06/28/20-08/24/20	DUT Type: Portable Handset		Page 68 of 267

9.4.10

LTE Band 7

Table 9-62
LTE Band 7 Measured P_{Max} - 20 MHz Bandwidth

LTE Band 7 20 MHz Bandwidth								
Modulation	RB Size	RB Offset	Low Channel	Mid Channel	High Channel	MPR Allowed per 3GPP [dB]	MPR [dB]	
			20850 (2510.0 MHz)	21100 (2535.0 MHz)	21350 (2560.0 MHz)			
Conducted Power [dBm]								
QPSK	1	0	23.63	23.71	23.92	0	0	
	1	50	23.61	23.73	23.77		0	
	1	99	23.67	23.78	23.70		0	
	16QAM	50	0	22.85	22.98	23.10	0-1	1
		50	25	22.96	23.08	23.09		1
		50	50	22.91	23.05	22.95		1
		64QAM	100	0	22.89	22.99	22.99	0-1
1			0	23.16	23.41	23.55	1	
1			50	23.34	23.44	23.45	1	
256QAM			1	99	23.42	23.53	23.39	0-2
	50		0	21.87	22.08	22.14	2	
	50		25	21.95	22.10	22.13	2	
	64QAM		50	50	21.98	22.14	21.97	0-2
		100	0	21.89	22.01	22.01	2	
		1	0	22.48	22.53	22.64	2	
		16QAM	1	50	22.56	22.52	22.56	0-2
1			99	22.59	22.68	22.45	2	
50			0	20.92	21.02	21.14	3	
256QAM			50	25	21.03	21.12	21.13	0-3
	50		50	21.01	21.08	21.03	3	
	100		0	20.90	21.00	21.06	3	
	QPSK		1	0	18.61	18.88	19.11	0-5
		1	50	19.02	19.12	19.12	5	
		1	99	18.87	19.00	18.72	5	
		16QAM	50	0	18.79	18.96	19.11	0-5
50			25	18.99	19.09	19.14	5	
50			50	18.94	19.01	18.89	5	
64QAM			100	0	18.89	19.02	19.04	0-5
	1		0	18.61	18.88	19.11	5	
	1		50	19.02	19.12	19.12	5	

Table 9-63
LTE Band 7 Measured P_{Max} - 15 MHz Bandwidth

LTE Band 7 15 MHz Bandwidth								
Modulation	RB Size	RB Offset	Low Channel	Mid Channel	High Channel	MPR Allowed per 3GPP [dB]	MPR [dB]	
			20825 (2507.5 MHz)	21100 (2535.0 MHz)	21375 (2562.5 MHz)			
Conducted Power [dBm]								
QPSK	1	0	23.58	23.85	23.90	0	0	
	1	36	23.55	23.81	23.85		0	
	1	74	23.60	23.90	23.87		0	
	16QAM	36	0	22.72	22.88	23.02	0-1	1
		36	18	22.85	23.01	23.00		1
		36	37	22.88	22.97	22.98		1
		64QAM	75	0	22.70	22.90	22.91	0-1
1			0	23.11	23.22	23.50	1	
1			36	23.28	23.35	23.48	1	
256QAM			1	74	23.25	23.45	23.42	0-2
	36		0	21.75	22.00	22.05	2	
	36		18	21.90	22.02	22.04	2	
	QPSK		36	37	21.92	22.00	22.00	0-2
		75	0	21.75	22.00	22.05	2	
		1	0	22.25	22.45	22.55	2	
		16QAM	1	36	22.30	22.41	22.39	0-2
1			74	22.26	22.55	22.42	2	
36			0	21.00	21.05	21.02	3	
64QAM			36	18	20.95	21.11	21.01	0-3
	36		37	20.98	21.00	21.15	3	
	75		0	20.91	20.98	21.00	3	
	256QAM		1	0	18.88	18.95	19.15	0-5
		1	36	18.95	19.07	19.07	5	
		1	74	18.97	19.05	19.00	5	
		QPSK	36	0	18.75	19.00	19.09	0-5
36			18	18.88	19.01	19.10	5	
36			37	18.91	19.05	19.00	5	
16QAM			75	0	18.90	19.11	19.02	0-5
	1		0	18.88	18.95	19.15	5	
	1		36	18.95	19.07	19.07	5	



FCC ID: A3LSMF916U	 PCTEST <small>Prove to be part of the solution</small>	SAR EVALUATION REPORT		Approved by: Quality Manager
Document S/N: 1M2005200087-01-R2.A3L	Test Dates: 06/28/20-08/24/20	DUT Type: Portable Handset		Page 69 of 267

Table 9-64
LTE Band 7 Measured P_{Max} - 10 MHz Bandwidth

LTE Band 7 10 MHz Bandwidth								
Modulation	RB Size	RB Offset	Low Channel	Mid Channel	High Channel	MPR Allowed per 3GPP [dB]	MPR [dB]	
			20800 (2505.0 MHz)	21100 (2535.0 MHz)	21400 (2565.0 MHz)			
Conducted Power [dBm]								
QPSK	1	0	23.61	23.88	23.92	0	0	
	1	25	23.52	23.85	23.90		0	
	1	49	23.55	23.80	23.88		0	
	25	0	22.68	22.79	22.99	0-1	1	
	25	12	22.77	22.95	23.05		1	
	25	25	22.65	22.98	23.00		1	
16QAM	1	0	22.65	22.88	22.98	0-1	1	
	1	25	22.65	22.88	22.98		1	
	1	49	23.22	23.27	23.40		1	
	25	0	21.88	22.11	22.15	0-2	2	
	25	12	21.91	22.08	22.11		2	
	25	25	21.81	22.15	22.05		2	
64QAM	50	0	21.80	21.99	22.08	0-2	2	
	1	0	22.28	22.38	22.48		0-3	2
	1	25	22.22	22.40	22.40			2
	1	49	22.27	22.48	22.38	2		
	25	0	21.05	21.10	21.15	0-3	3	
	25	12	21.10	21.15	21.07		3	
25	25	20.90	21.08	21.15	3			
256QAM	50	0	20.95	21.11	21.21	0-5	3	
	1	0	18.99	19.08	19.11		0-5	5
	1	25	18.91	19.11	19.15			5
	1	49	18.88	19.00	19.05	5		
	25	0	18.80	19.05	19.07	0-5	5	
	25	12	18.91	19.15	19.00		5	
25	25	18.85	18.99	19.10	5			
50	0	18.91	18.85	19.11	5			

Table 9-65
LTE Band 7 Measured P_{Max} - 5 MHz Bandwidth

LTE Band 7 5 MHz Bandwidth								
Modulation	RB Size	RB Offset	Low Channel	Mid Channel	High Channel	MPR Allowed per 3GPP [dB]	MPR [dB]	
			20775 (2502.5 MHz)	21100 (2535.0 MHz)	21425 (2567.5 MHz)			
Conducted Power [dBm]								
QPSK	1	0	23.70	23.75	23.95	0	0	
	1	12	23.65	23.80	23.84		0	
	1	24	23.61	23.71	23.90		0	
	12	0	22.88	22.91	23.05	0-1	1	
	12	6	22.91	22.95	23.01		1	
	12	13	22.93	22.85	23.11		1	
16QAM	25	0	22.77	22.80	23.00	0-1	1	
	1	0	23.21	23.35	23.41		0-2	1
	1	12	23.35	23.35	23.35			1
	1	24	23.39	23.40	23.39	1		
	12	0	21.91	22.11	22.22	0-2	2	
	12	6	21.85	22.05	22.18		2	
12	13	21.90	22.15	22.01	2			
64QAM	25	0	21.77	21.99	22.05	0-2	2	
	1	0	22.39	22.50	22.61		0-3	2
	1	12	22.48	22.44	22.45			2
	1	24	22.52	22.61	22.58	2		
	12	0	21.15	21.20	21.30	0-3	3	
	12	6	21.08	21.11	21.44		3	
12	13	20.99	21.00	21.28	3			
256QAM	25	0	20.95	20.99	21.12	0-5	3	
	1	0	18.88	18.99	19.22		0-5	5
	1	12	18.92	18.95	19.11			5
	1	24	18.90	18.88	18.86	5		
	12	0	18.75	19.00	19.05	0-5	5	
	12	6	19.00	19.10	19.10		5	
12	13	18.85	19.14	19.07	5			
25	0	18.78	19.11	19.20	5			



FCC ID: A3LSMF916U	 PCTEST <small>Proud to be part of Samsung</small>	SAR EVALUATION REPORT		Approved by: Quality Manager
Document S/N: 1M2005200087-01-R2.A3L	Test Dates: 06/28/20-08/24/20	DUT Type: Portable Handset	Page 70 of 267	

Table 9-66
LTE Band 7 Measured P_{Limit} for DSI = 0 (Body-worn, or Phablet/UMPC with grip sensor inactive), or DSI = 3/4 (Head) - 20 MHz Bandwidth

LTE Band 7 20 MHz Bandwidth								
Modulation	RB Size	RB Offset	Low Channel	Mid Channel	High Channel	MPR Allowed per 3GPP [dB]	MPR [dB]	
			20850 (2510.0 MHz)	21100 (2535.0 MHz)	21350 (2560.0 MHz)			
Conducted Power [dBm]								
QPSK	1	0	21.92	21.78	21.59	0	0	
	1	50	21.83	21.61	21.48		0	
	1	99	21.82	21.68	21.46		0	
	QPSK	50	0	21.83	21.88	21.62	0-1	0
		50	25	22.00	21.82	21.67		0
		50	50	21.90	21.75	21.66		0
		100	0	21.90	21.78	21.68		0
1		0	21.98	21.83	21.90	0		
16QAM	1	50	21.70	21.80	21.88	0-1	0	
	1	99	21.77	21.73	21.90		0	
	50	0	21.96	21.85	21.68		0	
	16QAM	50	25	21.97	21.89	21.72	0-2	0
		50	50	21.97	21.87	21.71		0
		100	0	21.87	21.76	21.62		0
		1	0	22.00	21.90	21.59		0
64QAM	1	50	21.97	21.90	21.54	0-2	0	
	1	99	21.92	21.85	21.60		0	
	50	0	21.12	21.09	20.90		0	
	64QAM	50	25	21.17	21.15	20.95	0-3	0
		50	50	21.09	21.14	20.90		0
		100	0	21.00	21.04	20.93		0
		1	0	19.42	19.50	19.06		0-5
256QAM	1	50	19.62	19.58	19.21	2		
	1	99	19.42	19.38	19.01	2		
	50	0	19.03	19.06	19.01	2		
	50	25	19.14	19.09	19.18	2		
	50	50	19.07	18.90	19.02	2		
	100	0	19.01	19.03	19.18	2		

Table 9-67
LTE Band 7 Measured P_{Limit} for DSI = 0 (Body-worn, or Phablet/UMPC with grip sensor inactive), or DSI = 3/4 (Head) - 15 MHz Bandwidth

LTE Band 7 15 MHz Bandwidth								
Modulation	RB Size	RB Offset	Low Channel	Mid Channel	High Channel	MPR Allowed per 3GPP [dB]	MPR [dB]	
			20825 (2507.5 MHz)	21100 (2535.0 MHz)	21375 (2562.5 MHz)			
Conducted Power [dBm]								
QPSK	1	0	21.84	21.66	21.63	0	0	
	1	36	21.65	21.70	21.67		0	
	1	74	21.83	21.82	21.51		0	
	QPSK	36	0	21.87	21.84	21.64	0-1	0
		36	18	21.96	21.90	21.71		0
		36	37	21.92	21.90	21.73		0
		75	0	21.85	21.76	21.73		0
1		0	21.98	21.88	21.69	0		
16QAM	1	36	21.77	21.73	21.37	0-1	0	
	1	74	21.97	21.90	21.59		0	
	36	0	21.78	21.90	21.62		0	
	16QAM	36	18	21.78	21.83	21.67	0-2	0
		36	37	21.94	21.85	21.73		0
		75	0	21.93	21.82	21.69		0
		1	0	21.78	21.92	21.85		0
64QAM	1	36	21.88	21.78	21.85	0-2	0	
	1	74	21.98	21.89	21.72		0	
	36	0	21.18	20.96	20.87		0	
	64QAM	36	18	21.20	20.97	20.96	0-3	0
		36	37	21.15	20.97	20.90		0
		75	0	21.13	21.05	20.93		0
		1	0	19.02	18.93	18.85		0-5
256QAM	1	36	19.30	19.00	18.95	2		
	1	74	19.08	18.96	19.12	2		
	36	0	19.03	19.04	18.90	2		
	36	18	19.11	19.07	19.06	2		
	36	37	19.13	19.01	18.87	2		
	75	0	19.12	19.10	18.93	2		



FCC ID: A3LSMF916U	 PCTEST <small>Proud to be part of Samsung</small>	SAR EVALUATION REPORT		Approved by: Quality Manager
Document S/N: 1M2005200087-01-R2.A3L	Test Dates: 06/28/20-08/24/20	DUT Type: Portable Handset	Page 71 of 267	

Table 9-68
LTE Band 7 Measured P_{Limit} for DSI = 0 (Body-worn, or Phablet/UMPC with grip sensor inactive), or DSI = 3/4 (Head) - 10 MHz Bandwidth

LTE Band 7 10 MHz Bandwidth							
Modulation	RB Size	RB Offset	Low Channel	Mid Channel	High Channel	MPR Allowed per 3GPP [dB]	MPR [dB]
			20800 (2505.0 MHz)	21100 (2535.0 MHz)	21400 (2565.0 MHz)		
			Conducted Power [dBm]				
QPSK	1	0	21.87	21.82	21.64	0	0
	1	25	21.74	21.70	21.62		0
	1	49	21.93	21.69	21.62		0
	25	0	21.92	21.90	21.70	0-1	0
	25	12	21.91	21.93	21.63		0
	25	25	21.88	21.90	21.72		0
16QAM	50	0	21.82	21.86	21.59	0-1	0
	1	0	21.85	21.85	21.91		0
	1	25	21.88	21.88	21.89		0
	1	49	21.90	21.89	21.91	0-2	0
	25	0	21.85	21.92	21.68		0
	25	12	21.82	21.93	21.71		0
64QAM	25	25	21.93	21.91	21.77	0-2	0
	50	0	21.83	21.87	21.62		0
	1	0	21.92	21.95	21.88		0-2
	1	25	21.74	21.89	21.90	0	
	1	49	21.78	21.91	21.90	0	
	256QAM	25	0	21.14	21.08	20.91	0-3
25		12	21.20	21.23	20.92	0	
25		25	21.04	21.14	20.94	0	
50		0	21.11	21.11	20.99	0-5	0
1		0	18.97	19.42	18.98		2
1		25	18.95	19.23	19.03		2
256QAM	1	49	18.93	19.00	19.09	0-5	2
	25	0	19.20	19.12	18.93		2
	25	12	19.18	19.13	18.96		2
	25	25	18.94	18.96	18.96	2	
	50	0	19.09	19.07	18.94	2	

Table 9-69
LTE Band 7 Measured P_{Limit} for DSI = 0 (Body-worn, or Phablet/UMPC with grip sensor inactive), or DSI = 3/4 (Head) - 5 MHz Bandwidth

LTE Band 7 5 MHz Bandwidth							
Modulation	RB Size	RB Offset	Low Channel	Mid Channel	High Channel	MPR Allowed per 3GPP [dB]	MPR [dB]
			20775 (2502.5 MHz)	21100 (2535.0 MHz)	21425 (2567.5 MHz)		
			Conducted Power [dBm]				
QPSK	1	0	21.88	21.78	21.68	0	0
	1	12	21.84	21.78	21.81		0
	1	24	21.88	21.72	21.69		0
	12	0	21.91	21.91	21.75	0-1	0
	12	6	21.93	21.91	21.76		0
	12	13	21.91	21.86	21.69		0
16QAM	25	0	21.88	21.84	21.70	0-1	0
	1	0	21.87	21.95	21.80		0
	1	12	21.93	21.87	21.62		0
	1	24	21.90	21.75	21.41	0-2	0
	12	0	21.92	21.92	21.77		0
	12	6	21.93	21.87	21.85		0
64QAM	12	13	21.93	21.82	21.64	0-2	0
	25	0	21.93	21.90	21.74		0
	1	0	21.76	21.95	21.90		0-3
	1	12	21.86	21.90	21.83	0	
	1	24	21.92	21.93	21.90	0	
	256QAM	12	0	20.93	21.12	21.06	0-5
12		6	21.04	21.16	20.95	0	
12		13	21.21	20.95	20.95	0	
25		0	21.09	21.10	20.98	0-5	0
1		0	19.35	19.05	19.02		2
1		12	19.62	19.06	18.99		2
256QAM	1	24	19.24	19.03	19.01	0-5	2
	12	0	19.15	19.09	19.00		2
	12	6	19.26	19.17	19.06		2
	12	13	19.18	19.06	19.05	2	
	25	0	19.19	19.11	18.90	2	



FCC ID: A3LSMF916U	 PCTEST <small>Prøvet to be part of Samsung</small>	SAR EVALUATION REPORT		Approved by: Quality Manager
Document S/N: 1M2005200087-01-R2.A3L	Test Dates: 06/28/20-08/24/20	DUT Type: Portable Handset		Page 72 of 267

Table 9-70

LTE Band 7 Measured P_{limit} for DSI = 1/2 (Phablet or UMPC Extremity with grip sensor active), or DSI = 5/6 (Hotspot Mode), and/or DSI = 7/8 (Earjack active) - 20 MHz Bandwidth

LTE Band 7 20 MHz Bandwidth								
Modulation	RB Size	RB Offset	Low Channel	Mid Channel	High Channel	MPR Allowed per 3GPP [dB]	MPR [dB]	
			20850 (2510.0 MHz)	21100 (2535.0 MHz)	21350 (2560.0 MHz)			
Conducted Power [dBm]								
QPSK	1	0	17.99	18.34	18.67	0	0	
	1	50	18.11	18.51	18.65		0	
	1	99	18.41	18.65	18.55		0	
	QPSK	50	0	18.11	18.62	18.73	0-1	0
		50	25	18.50	18.74	18.80		0
		50	50	18.33	18.72	18.75		0
		100	0	18.20	18.64	18.66		0
1		0	18.60	18.84	18.72	0		
16QAM	1	50	18.45	18.79	18.58	0-1	0	
	1	99	18.75	18.71	18.59		0	
	50	0	18.11	18.61	18.66		0	
	16QAM	50	25	18.24	18.74	18.71	0-2	0
		50	50	18.27	18.73	18.73		0
		100	0	18.22	18.71	18.62		0
		1	0	18.32	18.95	18.96		0
64QAM	1	50	18.36	18.81	18.92	0-2	0	
	1	99	18.42	18.77	18.95		0	
	50	0	18.12	18.62	18.70		0	
	64QAM	50	25	18.32	18.68	18.85	0-3	0
		50	50	18.44	18.79	18.67		0
		100	0	18.25	18.56	18.63		0
		1	0	17.83	18.38	18.75		0
256QAM	1	50	18.32	18.75	18.88	0-5	0	
	1	99	18.36	18.47	18.21		0	
	50	0	18.22	18.59	18.72		0	
	256QAM	50	25	18.35	18.73	18.87	0-5	0
		50	50	18.26	18.62	18.64		0
		100	0	18.25	18.67	18.75		0
		1	0	18.25	18.67	18.75		0

Table 9-71

LTE Band 7 Measured P_{limit} for DSI = 1/2 (Phablet or UMPC Extremity with grip sensor active), or DSI = 5/6 (Hotspot Mode), and/or DSI = 7/8 (Earjack active) - 15 MHz Bandwidth

LTE Band 7 15 MHz Bandwidth								
Modulation	RB Size	RB Offset	Low Channel	Mid Channel	High Channel	MPR Allowed per 3GPP [dB]	MPR [dB]	
			20825 (2507.5 MHz)	21100 (2535.0 MHz)	21375 (2562.5 MHz)			
Conducted Power [dBm]								
QPSK	1	0	18.03	18.44	18.28	0	0	
	1	36	18.12	18.35	18.21		0	
	1	74	18.12	18.34	18.23		0	
	QPSK	36	0	18.25	18.49	18.30	0-1	0
		36	18	18.26	18.52	18.37		0
		36	37	18.25	18.44	18.35		0
		75	0	18.20	18.42	18.32		0
1		0	18.52	18.83	18.64	0		
16QAM	1	36	18.31	18.69	18.50	0-1	0	
	1	74	18.29	18.50	18.46		0	
	36	0	18.30	18.57	18.35		0	
	16QAM	36	18	18.21	18.54	18.47	0-2	0
		36	37	18.22	18.47	18.47		0
		75	0	18.20	18.44	18.32		0
		1	0	18.46	18.69	18.52		0
64QAM	1	36	18.47	18.68	18.51	0-2	0	
	1	74	18.50	18.51	18.55		0	
	36	0	18.33	18.60	18.36		0	
	64QAM	36	18	18.35	18.53	18.42	0-3	0
		36	37	18.28	18.50	18.38		0
		75	0	18.26	18.59	18.37		0
		1	0	18.25	18.48	18.38		0
256QAM	1	36	18.39	18.60	18.47	0-5	0	
	1	74	18.34	18.18	18.28		0	
	36	0	18.24	18.55	18.34		0	
	256QAM	36	18	18.32	18.60	18.40	0-5	0
		36	37	18.30	18.45	18.37		0
		75	0	18.28	18.49	18.43		0
		1	0	18.25	18.48	18.38		0



FCC ID: A3LSMF916U	 PCTEST <small>Proud to be part of Samsung</small>	SAR EVALUATION REPORT		Approved by: Quality Manager
Document S/N: 1M2005200087-01-R2.A3L	Test Dates: 06/28/20-08/24/20	DUT Type: Portable Handset	Page 73 of 267	

Table 9-72



LTE Band 7 Measured P_{limit} for DSI = 1/2 (Phablet or UMPC Extremity with grip sensor active), or DSI = 5/6 (Hotspot Mode), and/or DSI = 7/8 (Earjack active) - 10 MHz Bandwidth

LTE Band 7 10 MHz Bandwidth							
Modulation	RB Size	RB Offset	Low Channel	Mid Channel	High Channel	MPR Allowed per 3GPP [dB]	MPR [dB]
			20800 (2505.0 MHz)	21100 (2535.0 MHz)	21400 (2565.0 MHz)		
Conducted Power [dBm]							
QPSK	1	0	18.23	18.43	18.20	0	0
	1	25	18.16	18.41	18.26		0
	1	49	18.20	18.42	18.22		0
	25	0	18.33	18.54	18.28	0-1	0
	25	12	18.20	18.59	18.30		0
	25	25	18.17	18.52	18.35		0
16QAM	1	0	18.21	18.48	18.22	0-1	0
	1	25	18.70	19.03	18.70		0
	1	49	18.61	18.86	18.68		0
	25	0	18.32	18.57	18.32	0-2	0
	25	12	18.22	18.54	18.29		0
	25	25	18.20	18.60	18.44		0
64QAM	1	0	18.18	18.53	18.23	0-2	0
	1	25	18.46	18.83	18.55		0
	1	49	18.45	18.69	18.52		0
	25	0	18.32	18.66	18.56	0-3	0
	25	12	18.36	18.62	18.58		0
	25	25	18.31	18.65	18.50		0
256QAM	1	0	18.23	18.58	18.39	0-5	0
	1	25	18.21	18.56	18.33		0
	1	49	18.18	18.44	18.13		0
	25	0	18.37	18.71	18.49	0-5	0
	25	12	18.07	18.44	18.26		0
	25	25	18.26	18.54	18.26		0
256QAM	1	0	18.27	18.61	18.26	0-5	0
	1	25	18.17	18.49	18.31		0
	1	49	18.19	18.61	18.26		0

Table 9-73

LTE Band 7 Measured P_{limit} for DSI = 1/2 (Phablet or UMPC Extremity with grip sensor active), or DSI = 5/6 (Hotspot Mode), and/or DSI = 7/8 (Earjack active) - 5 MHz Bandwidth

LTE Band 7 5 MHz Bandwidth							
Modulation	RB Size	RB Offset	Low Channel	Mid Channel	High Channel	MPR Allowed per 3GPP [dB]	MPR [dB]
			20775 (2502.5 MHz)	21100 (2535.0 MHz)	21425 (2567.5 MHz)		
Conducted Power [dBm]							
QPSK	1	0	18.17	18.45	18.29	0	0
	1	12	18.13	18.49	18.22		0
	1	24	18.14	18.44	18.24		0
	12	0	18.20	18.53	18.36	0-1	0
	12	6	18.25	18.56	18.41		0
	12	13	18.21	18.50	18.38		0
16QAM	25	0	18.14	18.52	18.33	0-1	0
	1	0	18.43	18.91	18.75		0
	1	12	18.49	18.71	18.57		0
	1	24	18.46	18.80	18.57	0-2	0
	12	0	18.30	18.60	18.46		0
	12	6	18.38	18.69	18.45		0
64QAM	12	13	18.30	18.61	18.41	0-2	0
	25	0	18.24	18.55	18.40		0
	1	0	18.42	18.84	18.72		0-3
	1	12	18.42	18.77	18.52	0	
	1	24	18.43	18.75	18.56	0	
	256QAM	12	0	18.26	18.66	18.45	0-3
12		6	18.33	18.66	18.45	0	
12		13	18.22	18.57	18.40	0	
25		0	18.25	18.56	18.40	0-5	0
1		0	18.36	18.64	18.46		0
1		12	18.31	18.71	18.54		0
256QAM	1	24	18.23	18.57	18.63	0-5	0
	12	0	18.24	18.60	18.36		0
	12	6	18.30	18.60	18.37		0
	12	13	18.26	18.54	18.50	0-5	0
	25	0	18.24	18.53	18.39		0

FCC ID: A3LSMF916U	 PCTEST <small>Practical to be part of solutions</small>	SAR EVALUATION REPORT		Approved by: Quality Manager
Document S/N: 1M2005200087-01-R2.A3L	Test Dates: 06/28/20-08/24/20	DUT Type: Portable Handset	Page 74 of 267	

9.4.11

LTE Band 48

Table 9-74
LTE Band 48 Measured P_{Max} - 20 MHz Bandwidth

LTE Band 48 20 MHz Bandwidth								
Modulation	RB Size	RB Offset	Low Channel	Low-Mid Channel	Mid-High Channel	High Channel	MPR Allowed per 3GPP [dB]	MPR [dB]
			55340 (3560.0 MHz)	55773 (3603.3 MHz)	56207 (3646.7 MHz)	56640 (3690.0 MHz)		
Conducted Power [dBm]								
QPSK	1	0	23.79	24.25	23.67	23.82	0	0
	1	50	23.84	24.38	23.90	24.04		0
	1	99	24.26	24.03	23.66	23.65		0
	50	0	23.16	23.59	23.37	23.14	0-1	1
	50	25	23.36	23.56	23.11	23.08		1
	50	50	23.48	23.28	23.02	23.00		1
16QAM	100	0	23.20	23.43	23.07	23.08	0-1	1
	1	0	23.07	23.44	22.77	22.86		1
	1	50	23.14	23.50	23.01	23.09		1
	1	99	23.19	23.06	22.78	22.81	0-2	1
	50	0	22.32	22.62	22.04	22.12		2
	50	25	22.48	22.55	22.15	22.16		2
64QAM	50	50	22.40	22.40	22.08	22.08	0-2	2
	100	0	22.43	22.49	22.08	22.12		2
	1	0	21.80	21.98	21.45	21.55		0-2
	1	50	21.97	22.21	21.70	21.85	2	
	1	99	22.30	21.92	21.85	21.46	2	
	256QAM	50	0	20.80	21.63	21.20	21.20	0-3
50		25	20.73	21.65	21.21	21.22	3	
50		50	20.96	21.45	21.15	21.15	3	
100		0	20.85	21.46	21.08	21.06	0-5	3
1		0	19.04	19.32	18.95	18.78		5
1		50	19.34	19.40	18.97	18.95		5
256QAM	1	99	19.10	19.81	18.89	18.63	0-5	5
	50	0	19.43	19.70	19.18	19.16		5
	50	25	19.57	19.63	19.25	19.22		5
	50	50	19.44	19.42	19.12	19.10	5	
	100	0	19.50	19.49	19.08	19.10	5	

Table 9-75
LTE Band 48 Measured P_{Max} - 15 MHz Bandwidth

LTE Band 48 15 MHz Bandwidth								
Modulation	RB Size	RB Offset	Low Channel	Low-Mid Channel	Mid-High Channel	High Channel	MPR Allowed per 3GPP [dB]	MPR [dB]
			55315 (3557.5 MHz)	55765 (3602.5 MHz)	56215 (3647.5 MHz)	56665 (3692.5 MHz)		
Conducted Power [dBm]								
QPSK	1	0	23.75	23.75	23.80	24.10	0	0
	1	36	23.90	23.75	23.98	24.18		0
	1	74	23.71	23.58	23.82	24.12		0
	36	0	23.02	22.94	22.83	23.18	0-1	1
	36	18	22.96	22.86	23.10	23.25		1
	36	37	22.95	22.77	23.02	23.29		1
16QAM	75	0	22.99	22.81	22.97	23.18	0-1	1
	1	0	22.76	22.74	22.87	22.97		1
	1	36	23.01	22.85	22.90	23.19		1
	1	74	22.82	22.67	22.78	23.19	0-2	1
	36	0	22.00	21.88	22.00	22.23		2
	36	18	22.04	21.94	22.10	22.30		2
64QAM	36	37	21.87	21.76	22.09	22.38	0-2	2
	75	0	21.98	21.81	21.96	22.14		2
	1	0	21.58	21.53	21.54	21.85		0-2
	1	36	21.76	21.64	21.72	22.06	2	
	1	74	21.62	21.40	21.64	22.00	2	
	256QAM	36	0	21.11	20.94	21.05	21.27	0-3
36		18	20.92	20.94	21.07	21.22	3	
36		37	21.04	20.82	21.04	21.42	3	
75		0	21.06	20.90	21.06	21.18	0-5	3
1		0	18.80	18.83	18.72	19.07		5
1		36	19.01	18.71	19.00	19.21		5
256QAM	1	74	18.76	18.51	18.73	19.10	0-5	5
	36	0	19.11	19.03	19.01	19.25		5
	36	18	19.05	18.95	19.10	19.26		5
	36	37	18.95	18.90	19.04	19.46	5	
	75	0	18.91	18.90	19.01	19.18	5	



FCC ID: A3LSMF916U	 PCTEST <small>Proud to be part of the Samsung family</small>	SAR EVALUATION REPORT		Approved by: Quality Manager
Document S/N: 1M2005200087-01-R2.A3L	Test Dates: 06/28/20-08/24/20	DUT Type: Portable Handset	Page 75 of 267	

Table 9-76
LTE Band 48 Measured P_{Max} - 10 MHz Bandwidth

LTE Band 48 10 MHz Bandwidth								
Modulation	RB Size	RB Offset	Low Channel	Low-Mid Channel	Mid-High Channel	High Channel	MPR Allowed per 3GPP [dB]	MPR [dB]
			55290 (3555.0 MHz)	55757 (3601.7 MHz)	56223 (3648.3 MHz)	56690 (3695.0 MHz)		
Conducted Power [dBm]								
QPSK	1	0	23.88	23.60	23.70	23.85	0	0
	1	25	24.16	23.94	23.96	24.16		0
	1	49	23.80	23.72	23.90	24.36		0
	25	0	23.02	22.83	22.84	23.20	0-1	1
	25	12	23.12	22.95	23.00	23.37		1
	25	25	22.94	22.87	23.00	23.33		1
16QAM	50	0	22.98	22.92	22.91	23.22	0-1	1
	1	0	22.94	22.73	22.63	23.03		1
	1	25	23.03	22.90	23.10	23.32		1
	1	49	23.05	22.72	23.09	23.27	0-2	1
	25	0	22.04	21.89	21.94	22.20		2
	25	12	22.20	22.04	22.04	22.45		2
64QAM	25	25	22.01	21.89	21.99	22.32	0-2	2
	50	0	21.91	21.91	21.98	22.23		2
	1	0	21.64	21.48	21.44	21.79		0-2
	1	25	21.92	21.76	21.91	22.27	2	
	1	49	21.69	21.50	21.71	22.12	2	
	256QAM	25	0	20.99	20.93	20.96	21.25	0-3
25		12	21.16	21.00	21.01	21.50	3	
25		25	20.89	20.90	21.02	21.52	3	
50		0	21.07	21.00	20.94	21.33	0-5	3
1		0	18.74	18.51	18.63	18.82		5
1		25	19.07	18.87	18.86	19.35		5
256QAM	1	49	18.77	18.63	18.81	19.20	0-5	5
	25	0	19.08	18.99	18.91	19.18		5
	25	12	19.13	19.09	19.06	19.49		5
	25	25	19.04	18.99	19.08	19.42	5	
	50	0	18.99	19.05	19.01	19.28	5	

Table 9-77
LTE Band 48 Measured P_{Max} - 5 MHz Bandwidth

LTE Band 48 5 MHz Bandwidth								
Modulation	RB Size	RB Offset	Low Channel	Low-Mid Channel	Mid-High Channel	High Channel	MPR Allowed per 3GPP [dB]	MPR [dB]
			55265 (3552.5 MHz)	55748 (3600.8 MHz)	56232 (3649.2 MHz)	56715 (3697.5 MHz)		
Conducted Power [dBm]								
QPSK	1	0	23.89	23.83	23.86	24.31	0	0
	1	12	23.95	23.93	24.01	24.36		0
	1	24	23.90	23.79	24.00	24.40		0
	12	0	22.97	22.96	23.00	23.40	0-1	1
	12	6	23.11	22.95	23.08	23.46		1
	12	13	23.10	22.94	23.13	23.46		1
16QAM	25	0	23.04	22.91	23.05	23.43	0-1	1
	1	0	22.87	22.83	22.81	23.31		1
	1	12	22.95	22.96	22.93	23.35		1
	1	24	23.01	22.88	22.93	23.43	0-2	1
	12	0	22.00	21.93	22.02	22.40		2
	12	6	22.04	21.87	22.10	22.42		2
64QAM	12	13	22.04	21.87	22.10	22.42	0-2	2
	25	0	22.06	21.86	22.13	22.45		2
	1	0	21.73	21.67	21.73	22.11		0-2
	1	12	22.00	21.71	21.86	22.23	2	
	1	24	21.87	21.68	21.87	22.23	2	
	256QAM	12	0	21.06	20.99	21.01	21.37	0-3
12		6	21.16	20.93	21.13	21.46	3	
12		13	21.17	20.97	21.09	21.48	3	
25		0	21.12	20.98	21.12	21.55	0-5	3
1		0	18.85	18.74	18.81	19.22		5
1		12	18.94	18.89	18.95	19.28		5
256QAM	1	24	18.89	18.71	18.95	19.34	0-5	5
	12	0	19.08	18.95	19.04	19.47		5
	12	6	19.13	18.98	19.14	19.47		5
	12	13	19.12	18.93	19.12	19.45	5	
	25	0	19.19	19.02	19.13	19.50	5	



FCC ID: A3LSMF916U	 PCTEST <small>Prove it to be part of Samsung</small>	SAR EVALUATION REPORT		Approved by: Quality Manager
Document S/N: 1M2005200087-01-R2.A3L	Test Dates: 06/28/20-08/24/20	DUT Type: Portable Handset	Page 76 of 267	

Table 9-78

LTE Band 48 Measured P_{Limit} for DSI = 0 (Body-worn, or Phablet/UMPC with grip sensor inactive), DSI = 1/2 (Phablet or UMPC Extremity with grip sensor active), or DSI = 5/6 (Hotspot Mode), and/or DSI = 7/8 (Earjack active) - 20 MHz Bandwidth 20 MHz Bandwidth

LTE Band 48 20 MHz Bandwidth									
Modulation	RB Size	RB Offset	Low Channel	Low-Mid Channel	Mid-High Channel	High Channel	MPR Allowed per 3GPP [dB]	MPR [dB]	
			55340 (3560.0 MHz)	55773 (3603.3 MHz)	56207 (3646.7 MHz)	56640 (3690.0 MHz)			
Conducted Power [dBm]									
QPSK	1	0	19.70	19.70	19.83	20.28	0	0	
	1	50	20.01	19.85	20.20	20.34		0	
	1	99	19.71	19.46	19.86	20.17		0	
	16QAM	50	0	19.98	19.98	20.07	20.49	0-1	0
		50	25	20.00	19.93	20.21	20.45		0
		50	50	19.93	19.80	20.20	20.41		0
		64QAM	100	0	19.94	19.85	20.11	20.33	0-1
1			0	19.79	19.78	19.54	19.89	0	
1			50	20.02	19.90	19.93	20.16	0	
256QAM			1	99	19.80	19.56	19.54	19.86	0-2
	50		0	19.95	19.97	20.06	20.47	0	
	50		25	19.99	19.93	20.19	20.43	0	
	64QAM		50	50	19.92	19.81	20.19	20.42	0-2
		100	0	19.88	19.83	20.09	20.46	0	
		1	0	19.92	19.87	20.01	20.46	0	
		256QAM	1	50	20.25	20.15	20.46	20.43	0-2
1			99	19.97	19.76	20.17	20.45	0	
50			0	20.03	19.99	20.12	20.50	0	
64QAM			50	25	20.01	19.97	20.23	20.45	0-3
	50		50	19.94	19.83	20.22	20.42	0	
	100		0	19.92	19.87	20.12	20.48	0	
	256QAM		1	0	18.85	19.18	19.10	19.43	0-5
		1	50	18.95	19.16	19.09	19.77	0.5	
		1	99	19.16	18.74	18.96	19.55	0.5	
		50	0	19.16	19.01	19.18	19.57	0.5	
50		25	19.11	19.03	19.30	19.72	0.5		
50		50	19.16	18.98	19.37	19.61	0.5		
100		0	19.05	19.04	19.11	19.60	0.5		

Table 9-79

LTE Band 48 Measured P_{Limit} for DSI = 0 (Body-worn, or Phablet/UMPC with grip sensor inactive), DSI = 1/2 (Phablet or UMPC Extremity with grip sensor active), or DSI = 5/6 (Hotspot Mode), and/or DSI = 7/8 (Earjack active) - 15 MHz Bandwidth

LTE Band 48 15 MHz Bandwidth									
Modulation	RB Size	RB Offset	Low Channel	Low-Mid Channel	Mid-High Channel	High Channel	MPR Allowed per 3GPP [dB]	MPR [dB]	
			55315 (3557.5 MHz)	55765 (3602.5 MHz)	56215 (3647.5 MHz)	56665 (3692.5 MHz)			
Conducted Power [dBm]									
QPSK	1	0	19.92	19.82	19.74	20.16	0	0	
	1	36	20.09	19.83	20.06	20.34		0	
	1	74	19.88	19.52	19.83	20.13		0	
	16QAM	36	0	20.09	20.05	20.00	20.31	0-1	0
		36	18	20.07	20.08	20.10	20.32		0
		36	37	20.01	19.89	20.10	20.41		0
		64QAM	75	0	20.07	19.87	20.08	20.31	0-1
1			0	20.01	19.89	19.89	20.12	0	
1			36	20.16	19.68	20.02	20.35	0	
256QAM			1	74	20.01	19.94	19.87	20.28	0-2
	36		0	20.14	20.04	20.02	20.32	0	
	36		18	20.17	19.88	20.21	20.40	0	
	64QAM		36	37	20.03	19.86	20.17	20.46	0-2
		75	0	20.04	19.93	20.09	20.36	0	
		1	0	20.01	19.70	19.94	19.91	0	
		256QAM	1	36	20.06	19.68	20.04	20.13	0-2
1			74	20.09	19.43	19.86	20.08	0	
36			0	20.13	20.06	20.01	20.37	0	
64QAM			36	18	20.11	20.07	20.18	20.35	0-3
	36		37	20.10	19.83	20.09	20.43	0	
	75		0	20.06	20.02	20.09	20.37	0	
	256QAM		1	0	18.76	19.05	18.93	19.08	0-5
		1	36	19.00	19.03	18.85	19.23	0.5	
		1	74	18.74	18.85	18.92	19.03	0.5	
		36	0	19.12	18.95	18.93	19.25	0.5	
36		18	19.01	18.98	19.14	19.25	0.5		
36		37	18.97	18.75	19.10	19.40	0.5		
75		0	18.88	18.88	19.01	19.22	0.5		



FCC ID: A3LSMF916U	 PCTEST <small> Proud to be part of Samsung </small>	SAR EVALUATION REPORT		Approved by: Quality Manager
Document S/N: 1M2005200087-01-R2.A3L	Test Dates: 06/28/20-08/24/20	DUT Type: Portable Handset	Page 77 of 267	

Table 9-80

LTE Band 48 Measured P_{Limit} for DSI = 0 (Body-worn, or Phablet/UMPC with grip sensor inactive), DSI = 1/2 (Phablet or UMPC Extremity with grip sensor active), or DSI = 5/6 (Hotspot Mode), and/or DSI = 7/8 (Earjack active) - 10 MHz Bandwidth

LTE Band 48 10 MHz Bandwidth								
Modulation	RB Size	RB Offset	Low Channel	Low-Mid Channel	Mid-High Channel	High Channel	MPR Allowed per 3GPP [dB]	MPR [dB]
			55290 (3555.0 MHz)	55757 (3601.7 MHz)	56223 (3648.3 MHz)	56690 (3695.0 MHz)		
Conducted Power [dBm]								
QPSK	1	0	19.69	19.76	19.61	20.03	0	0
	1	25	20.08	20.03	20.12	20.33		0
	1	49	20.00	19.78	19.88	20.28		0
	25	0	19.98	19.96	19.94	20.25	0-1	0
	25	12	20.17	20.08	20.00	20.37		0
	25	25	20.05	19.91	20.22	20.48		0
16QAM	50	0	19.99	20.00	20.07	20.39	0-1	0
	1	0	19.82	19.90	19.72	20.22		0
	1	25	20.31	20.11	20.27	20.32		0
	1	49	20.15	19.77	19.97	20.39	0-2	0
	25	0	20.16	20.03	20.07	20.38		0
	25	12	20.31	20.14	20.10	20.49		0
64QAM	25	25	20.14	19.97	20.17	20.43	0-2	0
	50	0	20.15	20.02	20.11	20.47		0
	1	0	19.73	19.52	19.54	19.97		0-2
	1	25	19.93	19.83	19.94	20.27	0	
	1	49	19.70	19.62	19.76	20.25	0	
	256QAM	25	0	20.13	19.93	19.99	20.32	0-3
25		12	20.25	20.05	20.22	20.32	0	
25		25	20.09	20.04	20.14	20.32	0	
50		0	20.16	20.06	20.05	20.40	0-5	0
1		0	18.91	18.85	18.88	19.13		0.5
1		25	18.82	18.87	18.97	19.42		0.5
256QAM	1	49	19.00	18.94	18.80	19.21	0-5	0.5
	25	0	19.11	18.97	19.08	19.37		0.5
	25	12	19.20	19.08	19.07	19.58		0.5
	25	25	19.03	18.94	19.17	19.54	0.5	
	50	0	19.00	19.02	18.96	19.38	0.5	

Table 9-81

LTE Band 48 Measured P_{Limit} for DSI = 0 (Body-worn, or Phablet/UMPC with grip sensor inactive), DSI = 1/2 (Phablet or UMPC Extremity with grip sensor active), or DSI = 5/6 (Hotspot Mode), and/or DSI = 7/8 (Earjack active) - 5 MHz Bandwidth

LTE Band 48 5 MHz Bandwidth								
Modulation	RB Size	RB Offset	Low Channel	Low-Mid Channel	Mid-High Channel	High Channel	MPR Allowed per 3GPP [dB]	MPR [dB]
			55265 (3552.5 MHz)	55748 (3600.8 MHz)	56232 (3649.2 MHz)	56715 (3697.5 MHz)		
Conducted Power [dBm]								
QPSK	1	0	20.04	19.99	20.07	20.36	0	0
	1	12	20.11	20.12	20.17	20.43		0
	1	24	20.09	20.03	20.16	20.50		0
	12	0	20.11	20.06	20.12	20.36	0-1	0
	12	6	20.29	20.09	20.29	20.31		0
	12	13	20.19	20.08	20.24	20.32		0
16QAM	25	0	20.16	20.01	20.25	20.48	0-1	0
	1	0	20.08	20.01	20.06	20.43		0
	1	12	20.15	20.04	20.19	20.42		0-2
	1	24	20.13	19.96	20.11	20.42	0	
	12	0	20.21	20.04	20.13	20.49	0	
	64QAM	12	6	20.29	20.12	20.32	20.44	0-2
12		13	20.28	20.07	20.20	20.44	0	
25		0	20.29	20.06	20.30	20.50	0	
1		0	19.85	19.76	19.85	20.29	0-2	0
1		12	19.93	19.89	19.96	20.38		0
1		24	19.90	19.84	19.98	20.40		0
256QAM	12	0	20.20	20.07	20.08	20.35	0-3	0
	12	6	20.23	20.11	20.26	20.35		0
	12	13	20.22	20.05	20.21	20.35		0
	25	0	20.25	20.16	20.27	20.43	0-5	0
	1	0	18.84	18.75	19.03	19.21		0.5
	1	12	19.07	18.92	18.94	19.34		0.5
256QAM	1	24	18.92	18.75	18.96	19.33	0-5	0.5
	12	0	19.10	18.99	19.03	19.46		0.5
	12	6	19.14	19.03	19.18	19.33		0.5
	12	13	19.12	18.96	19.17	19.49	0.5	
	25	0	19.16	18.95	19.12	19.49	0.5	



FCC ID: A3LSMF916U	 PCTEST <small> Proud to be part of Samsung </small>	SAR EVALUATION REPORT		Approved by: Quality Manager
Document S/N: 1M2005200087-01-R2.A3L	Test Dates: 06/28/20-08/24/20	DUT Type: Portable Handset	Page 78 of 267	

Table 9-82
LTE Band 48 Measured P_{limit} for DSI = 3/4 (Head) - 20 MHz Bandwidth

LTE Band 48 20 MHz Bandwidth									
Modulation	RB Size	RB Offset	Low Channel	Low-Mid Channel	Mid-High Channel	High Channel	MPR Allowed per 3GPP [dB]	MPR [dB]	
			55340 (3560.0 MHz)	55773 (3603.3 MHz)	56207 (3646.7 MHz)	56640 (3690.0 MHz)			
Conducted Power [dBm]									
QPSK	1	0	18.68	19.03	18.51	18.07	0	0	
	1	50	19.05	19.15	18.70	18.23		0	
	1	99	19.00	18.74	18.22	17.87		0	
	16QAM	50	0	19.09	19.24	18.82	18.37	0-1	0
		50	25	19.21	19.21	18.89	18.41		0
		50	50	19.09	19.08	18.70	18.26		0
		64QAM	100	0	19.14	19.11	18.77	18.30	0-1
1			0	18.93	19.02	18.78	18.33	0	
1			50	19.26	19.19	18.97	18.47	0	
256QAM			1	99	19.12	18.79	18.46	18.12	0-2
	50		0	19.16	19.25	18.88	18.42	0	
	50		25	19.30	19.24	18.93	18.45	0	
	16QAM		50	50	19.15	19.09	18.80	18.31	0-2
		100	0	19.15	19.14	18.80	18.33	0	
		1	0	18.39	19.08	18.20	17.77	0	
		64QAM	1	50	18.73	19.22	18.39	17.96	0-2
1			99	18.57	18.78	17.97	17.62	0	
50			0	19.11	19.36	18.84	18.38	0	
256QAM			50	25	19.29	19.32	18.88	18.45	0-3
	50		50	19.12	19.19	18.76	18.33	0	
	100		0	19.20	19.21	18.81	18.35	0	
	16QAM		1	0	19.19	19.22	18.82	18.37	0-5
		1	50	19.20	19.20	18.82	18.38	0	
		1	99	19.18	19.23	18.82	18.39	0	
		64QAM	50	0	19.19	19.23	18.81	18.38	0-5
50			25	19.19	19.20	18.83	18.35	0	
50			50	19.20	19.25	18.84	18.39	0	
256QAM			100	0	19.19	19.21	18.82	18.38	0

Table 9-83
LTE Band 48 Measured P_{limit} for DSI = 3/4 (Head) - 15 MHz Bandwidth

LTE Band 48 15 MHz Bandwidth									
Modulation	RB Size	RB Offset	Low Channel	Low-Mid Channel	Mid-High Channel	High Channel	MPR Allowed per 3GPP [dB]	MPR [dB]	
			55315 (3557.5 MHz)	55765 (3602.5 MHz)	56215 (3647.5 MHz)	56665 (3692.5 MHz)			
Conducted Power [dBm]									
QPSK	1	0	18.83	18.98	18.56	18.13	0	0	
	1	36	18.96	18.92	18.81	18.29		0	
	1	74	18.77	18.76	18.53	18.14		0	
	16QAM	36	0	19.15	19.08	18.77	18.34	0-1	0
		36	18	19.08	19.15	18.77	18.44		0
		36	37	18.94	18.92	18.73	18.36		0
		64QAM	75	0	19.00	19.10	18.73	18.43	0-1
1			0	19.00	19.04	18.57	18.16	0	
1			36	19.04	19.07	18.69	18.38	0	
256QAM			1	74	19.13	18.80	18.53	18.26	0-2
	36		0	19.15	19.15	18.67	18.31	0	
	36		18	19.18	19.19	18.82	18.44	0	
	16QAM		36	37	18.94	19.17	18.83	18.45	0-2
		75	0	19.06	19.13	18.78	18.44	0	
		1	0	18.69	18.77	18.39	17.95	0	
		64QAM	1	36	18.93	18.84	18.50	18.14	0-2
1			74	18.67	18.68	18.41	18.05	0	
36			0	19.20	19.14	18.82	18.44	0	
256QAM			36	18	19.23	19.17	18.83	18.48	0-3
	36		37	18.97	19.04	18.82	18.48	0	
	75		0	19.11	19.15	18.75	18.53	0	
	16QAM		1	0	18.88	19.00	18.48	18.18	0-5
		1	36	19.02	18.98	18.65	18.31	0	
		1	74	18.76	18.68	18.46	18.17	0	
		64QAM	36	0	19.21	19.19	18.74	18.31	0-5
36			18	19.22	19.10	18.84	18.60	0	
36			37	19.05	19.04	18.86	18.47	0	
256QAM			75	0	19.13	19.06	18.76	18.40	0





FCC ID: A3LSMF916U	 PCTEST <small>Proud to be part of Samsung</small>	SAR EVALUATION REPORT		Approved by: Quality Manager
Document S/N: 1M2005200087-01-R2.A3L	Test Dates: 06/28/20-08/24/20	DUT Type: Portable Handset	Page 79 of 267	

Table 9-84
LTE Band 48 Measured P_{limit} for DSI = 3/4 (Head) - 10 MHz Bandwidth

LTE Band 48 10 MHz Bandwidth								
Modulation	RB Size	RB Offset	Low Channel	Low-Mid Channel	Mid-High Channel	High Channel	MPR Allowed per 3GPP [dB]	MPR [dB]
			55290 (3555.0 MHz)	55757 (3601.7 MHz)	56223 (3648.3 MHz)	56690 (3695.0 MHz)		
Conducted Power [dBm]								
QPSK	1	0	18.94	18.74	18.29	17.92	0	0
	1	25	19.29	19.04	18.65	18.38		0
	1	49	18.86	18.95	18.48	18.16		0
	25	0	19.19	18.93	18.63	18.32	0-1	0
	25	12	19.13	19.07	18.79	18.41		0
	25	25	19.15	19.03	18.71	18.49		0
16QAM	50	0	19.11	18.89	18.65	18.52	0-1	0
	1	0	19.04	18.98	18.42	18.01		0
	1	25	19.31	19.06	18.74	18.21		0
	1	49	19.19	18.87	18.46	18.62	0-2	0
	25	0	19.09	19.02	18.65	18.25		0
	25	12	19.15	19.08	18.86	18.53		0
64QAM	25	25	19.09	19.02	18.76	18.58	0-2	0
	50	0	18.86	18.97	18.78	18.48		0
	1	0	18.68	18.60	18.25	17.90		0-2
	1	25	19.06	19.06	18.46	18.22	0	
	1	49	18.76	18.76	18.65	18.20	0	
	256QAM	25	0	19.25	19.01	18.82	18.42	0-3
25		12	19.33	19.00	18.53	18.64	0	
25		25	19.11	19.00	18.76	18.46	0	
50		0	19.21	18.97	18.33	18.46	0-5	0
1		0	18.66	19.40	18.64	18.02		0
1		25	18.63	18.98	18.48	18.37		0
256QAM	1	49	18.92	18.76	18.75	18.25	0-5	0
	25	0	19.27	19.06	18.89	18.51		0
	25	12	19.33	19.06	18.78	18.62		0
	25	25	19.27	19.08	18.80	18.56	0	
	50	0	19.30	18.99	18.74	18.41	0	

Table 9-85
LTE Band 48 Measured P_{limit} for DSI = 3/4 (Head) - 5 MHz Bandwidth

LTE Band 48 5 MHz Bandwidth								
Modulation	RB Size	RB Offset	Low Channel	Low-Mid Channel	Mid-High Channel	High Channel	MPR Allowed per 3GPP [dB]	MPR [dB]
			55265 (3552.5 MHz)	55748 (3600.8 MHz)	56232 (3649.2 MHz)	56715 (3697.5 MHz)		
Conducted Power [dBm]								
QPSK	1	0	18.93	18.95	18.54	18.30	0	0
	1	12	19.00	19.11	18.59	18.35		0
	1	24	18.98	19.01	18.64	18.43		0
	12	0	19.06	19.12	18.73	18.37	0-1	0
	12	6	19.17	19.18	18.77	18.53		0
	12	13	19.11	19.06	18.78	18.51		0
16QAM	25	0	19.14	19.17	18.73	18.45	0-1	0
	1	0	18.93	18.99	18.67	18.31		0
	1	12	19.10	19.04	18.69	18.39		0
	1	24	18.99	19.05	18.68	18.40	0-2	0
	12	0	19.13	19.09	18.69	18.40		0
	12	6	19.21	19.14	18.75	18.55		0
64QAM	12	13	19.09	19.13	18.72	18.52	0-2	0
	25	0	19.12	19.20	18.73	18.45		0
	1	0	18.80	18.84	18.48	18.07		0-2
	1	12	18.85	18.97	18.51	18.34	0	
	1	24	18.86	18.87	18.50	18.24	0	
	256QAM	12	0	19.03	19.11	18.75	18.46	0-3
12		6	19.19	19.16	18.82	18.54	0	
12		13	19.19	19.15	18.74	18.55	0	
25		0	19.16	19.22	18.89	18.60	0-5	0
1		0	18.90	18.88	18.54	18.27		0
1		12	18.97	19.06	18.60	18.36		0
256QAM	1	24	18.94	18.92	18.55	18.33	0-5	0
	12	0	19.13	19.10	18.78	18.51		0
	12	6	19.16	19.15	18.77	18.55		0
	12	13	19.16	19.11	18.78	18.54	0	
	25	0	19.20	19.19	18.71	18.50	0	

FCC ID: A3LSMF916U		SAR EVALUATION REPORT		Approved by: Quality Manager
Document S/N: 1M2005200087-01-R2.A3L	Test Dates: 06/28/20-08/24/20	DUT Type: Portable Handset	Page 80 of 267	

9.4.12

LTE Band 41

Table 9-86

LTE Band 41 PC3 Measured P_{Max} - 20 MHz Bandwidth

LTE Band 41 20 MHz Bandwidth									
Modulation	RB Size	RB Offset	Low Channel	Low-Mid Channel	Mid Channel	Mid-High Channel	High Channel	MPR Allowed per 3GPP [dB]	MPR [dB]
			39750 (2506.0 MHz)	40185 (2549.5 MHz)	40620 (2593.0 MHz)	41055 (2636.5 MHz)	41490 (2680.0 MHz)		
Conducted Power [dBm]									
QPSK	1	0	23.99	24.08	24.10	24.28	24.14	0	0
	1	50	24.00	24.15	24.25	24.41	24.43		0
	1	99	23.86	24.12	24.24	24.02	24.41		0
	50	0	23.05	23.10	23.23	23.48	23.35	0-1	1
	50	25	23.10	23.24	23.37	23.46	23.59		1
	50	50	23.02	23.15	23.32	23.44	23.54		1
100	0	22.96	23.12	23.26	23.41	23.42	1		
16QAM	1	0	22.72	22.85	22.80	23.00	22.90	0-1	1
	1	50	22.66	22.88	23.15	23.28	23.27		1
	1	99	22.63	23.10	23.21	22.77	22.95		1
	50	0	22.03	22.14	22.33	22.48	22.38	0-2	2
	50	25	22.05	22.24	22.53	22.52	22.64		2
	50	50	22.02	22.24	22.44	22.50	22.58		2
100	0	21.97	22.13	22.37	22.43	22.42	2		
64QAM	1	0	21.99	22.16	21.93	22.42	22.05	0-2	2
	1	50	21.96	22.21	22.41	22.14	22.48		2
	1	99	21.92	22.06	22.07	22.44	22.22		2
	50	0	21.07	21.10	21.31	21.56	21.39	0-3	3
	50	25	21.10	21.30	21.56	21.50	21.63		3
	50	50	21.08	21.20	21.47	21.45	21.60		3
100	0	21.00	21.14	21.46	21.47	21.18	3		
256QAM	1	0	18.88	18.91	19.10	19.38	19.15	0-5	5
	1	50	19.18	19.31	19.57	19.66	19.63		5
	1	99	18.81	18.89	19.20	19.14	19.50		5
	50	0	19.00	19.05	19.40	19.50	19.40	5	
	50	25	19.14	19.24	19.54	19.57	19.65	5	
	50	50	19.01	19.14	19.46	19.45	19.58	5	
100	0	18.99	19.14	19.45	19.42	19.46	5		

Table 9-87

LTE Band 41 PC3 Measured P_{Max} - 15 MHz Bandwidth

LTE Band 41 15 MHz Bandwidth									
Modulation	RB Size	RB Offset	Low Channel	Low-Mid Channel	Mid Channel	Mid-High Channel	High Channel	MPR Allowed per 3GPP [dB]	MPR [dB]
			39750 (2506.0 MHz)	40185 (2549.5 MHz)	40620 (2593.0 MHz)	41055 (2636.5 MHz)	41490 (2680.0 MHz)		
Conducted Power [dBm]									
QPSK	1	0	23.90	23.89	23.92	24.25	24.13	0	0
	1	36	23.84	24.02	24.10	24.28	24.37		0
	1	74	23.86	23.73	23.97	24.00	24.25		0
	36	0	22.95	22.97	23.12	23.35	23.29	0-1	1
	36	18	22.95	23.10	23.19	23.35	23.38		1
	36	37	22.93	22.97	23.23	23.31	23.42		1
75	0	22.91	22.99	23.21	23.29	23.37	1		
16QAM	1	0	22.94	23.01	23.07	23.31	23.24	0-1	1
	1	36	22.85	23.03	23.21	23.39	23.39		1
	1	74	22.96	22.77	23.09	23.14	23.33		1
	36	0	21.87	21.95	22.07	22.30	22.26	0-2	2
	36	18	21.87	22.04	22.15	22.28	22.32		2
	36	37	21.88	21.94	22.20	22.30	22.38		2
75	0	21.92	22.02	22.23	22.32	22.41	2		
64QAM	1	0	21.64	21.58	21.67	21.95	21.86	0-2	2
	1	36	21.56	21.74	21.91	21.99	22.08		2
	1	74	21.60	21.44	21.77	21.80	22.01		2
	36	0	20.96	21.03	21.15	21.40	21.35	0-3	3
	36	18	20.97	21.09	21.22	21.38	21.41		3
	36	37	20.94	21.02	21.28	21.35	21.44		3
75	0	20.93	21.07	21.27	21.33	21.48	3		
256QAM	1	0	18.61	18.74	18.88	19.14	19.04	0-5	5
	1	36	18.77	18.94	19.10	19.21	19.36		5
	1	74	18.71	18.65	18.92	18.97	19.28		5
	36	0	18.92	18.97	19.15	19.37	19.33	5	
	36	18	19.00	19.13	19.22	19.41	19.44	5	
	36	37	18.98	19.01	19.28	19.35	19.46	5	
75	0	18.95	19.03	19.26	19.34	19.45	5		



FCC ID: A3LSMF916U	 PCTEST <small>Prove to be part of Samsung</small>	SAR EVALUATION REPORT		Approved by: Quality Manager
Document S/N: 1M2005200087-01-R2.A3L	Test Dates: 06/28/20-08/24/20	DUT Type: Portable Handset	Page 81 of 267	

Table 9-88
LTE Band 41 PC3 Measured P_{Max} - 10 MHz Bandwidth

LTE Band 41 10 MHz Bandwidth									
Modulation	RB Size	RB Offset	Low Channel	Low-Mid Channel	Mid Channel	Mid-High Channel	High Channel	MPR Allowed per 3GPP [dB]	MPR [dB]
			39750 (2506.0 MHz)	40185 (2549.5 MHz)	40620 (2593.0 MHz)	41055 (2636.5 MHz)	41490 (2680.0 MHz)		
Conducted Power [dBm]									
QPSK	1	0	23.97	23.95	24.00	24.23	24.14	0	0
	1	25	23.90	24.06	24.23	24.40	24.34		0
	1	49	23.92	23.81	23.90	24.13	24.08		0
	25	0	22.99	23.06	23.19	23.35	23.37	0-1	1
	25	12	23.06	23.06	23.36	23.44	23.55		1
	25	25	23.05	23.12	23.25	23.38	23.40		1
50	0	22.95	23.11	23.27	23.34	23.46	1		
16QAM	1	0	23.10	23.02	23.16	23.33	23.37	0-1	1
	1	25	23.11	23.30	23.37	23.52	23.54		1
	1	49	23.12	22.92	23.13	23.25	23.23		1
	25	0	22.04	22.06	22.20	22.38	22.38	0-2	2
	25	12	22.04	22.22	22.38	22.46	22.54		2
	25	25	22.05	22.08	22.25	22.41	22.38		2
50	0	22.06	22.16	22.32	22.42	22.50	2		
64QAM	1	0	21.66	21.63	21.69	21.86	21.94	0-2	2
	1	25	21.52	21.80	21.94	22.12	22.17		2
	1	49	21.61	21.38	21.71	21.88	21.88		2
	25	0	21.01	21.01	21.16	21.36	21.39	0-3	3
	25	12	21.06	21.21	21.35	21.43	21.56		3
	25	25	21.01	21.06	21.22	21.37	21.38		3
50	0	21.02	21.20	21.33	21.44	21.55	3		
256QAM	1	0	18.56	18.70	18.92	19.16	19.12	0-5	5
	1	25	18.80	18.96	19.21	19.37	19.39		5
	1	49	18.59	18.65	18.97	19.02	19.20		5
	25	0	19.09	19.18	19.29	19.57	19.51	0-5	5
	25	12	19.11	19.32	19.44	19.46	19.64		5
	25	25	19.06	19.20	19.32	19.50	19.52		5
50	0	19.07	19.21	19.36	19.64	19.56	5		

Table 9-89
LTE Band 41 PC3 Measured P_{Max} - 5 MHz Bandwidth

LTE Band 41 5 MHz Bandwidth									
Modulation	RB Size	RB Offset	Low Channel	Low-Mid Channel	Mid Channel	Mid-High Channel	High Channel	MPR Allowed per 3GPP [dB]	MPR [dB]
			39750 (2506.0 MHz)	40185 (2549.5 MHz)	40620 (2593.0 MHz)	41055 (2636.5 MHz)	41490 (2680.0 MHz)		
Conducted Power [dBm]									
QPSK	1	0	23.96	24.09	24.23	24.36	24.39	0	0
	1	12	23.89	24.11	24.22	24.37	24.37		0
	1	24	23.92	24.04	24.18	24.35	24.32		0
	12	0	23.03	23.19	23.28	23.43	23.44	0-1	1
	12	6	23.00	23.21	23.24	23.46	23.57		1
	12	13	22.99	23.19	23.31	23.49	23.50		1
25	0	23.02	23.16	23.32	23.48	23.48	1		
16QAM	1	0	23.04	23.13	23.27	23.42	23.49	0-1	1
	1	12	23.05	23.16	23.31	23.41	23.56		1
	1	24	23.03	23.10	23.30	23.45	23.51		1
	12	0	21.94	22.12	22.17	22.38	22.45	0-2	2
	12	6	21.98	22.16	22.21	22.42	22.46		2
	12	13	21.95	22.11	22.31	22.45	22.42		2
25	0	22.09	22.24	22.34	22.48	22.56	2		
64QAM	1	0	21.70	21.77	21.89	22.06	22.10	0-2	2
	1	12	21.69	21.88	22.02	22.23	22.14		2
	1	24	21.68	21.78	21.96	22.10	22.11		2
	12	0	21.01	21.19	21.25	21.42	21.44	0-3	3
	12	6	21.02	21.16	21.26	21.44	21.53		3
	12	13	21.01	21.15	21.30	21.50	21.49		3
25	0	21.02	21.25	21.37	21.45	21.55	3		
256QAM	1	0	18.88	18.98	19.08	19.28	19.30	0-5	5
	1	12	18.87	19.02	19.15	19.32	19.40		5
	1	24	18.84	18.96	19.11	19.30	19.33		5
	12	0	19.13	19.32	19.11	19.58	19.60	0-5	5
	12	6	19.19	19.28	19.43	19.59	19.67		5
	12	13	19.13	19.27	19.42	19.63	19.62		5
25	0	19.09	19.24	19.38	19.47	19.59	5		



FCC ID: A3LSMF916U	 PCTEST <small>Prove it to be part of Samsung</small>	SAR EVALUATION REPORT		Approved by: Quality Manager
Document S/N: 1M2005200087-01-R2.A3L	Test Dates: 06/28/20-08/24/20	DUT Type: Portable Handset	Page 82 of 267	

Table 9-90
LTE Band 41 PC3 Measured P_{Limit} for DSI = 0 (Body-worn, or Phablet/UMPC with grip sensor inactive), or DSI = 3/4 (Head) - 20 MHz Bandwidth

LTE Band 41 20 MHz Bandwidth									
Modulation	RB Size	RB Offset	Low Channel	Low-Mid Channel	Mid Channel	Mid-High Channel	High Channel	MPR Allowed per 3GPP [dB]	MPR [dB]
			39750 (2506.0 MHz)	40185 (2549.5 MHz)	40620 (2593.0 MHz)	41055 (2636.5 MHz)	41490 (2680.0 MHz)		
Conducted Power [dBm]									
QPSK	1	0	22.19	22.33	22.37	22.30	22.45	0	0
	1	50	22.19	22.38	22.41	22.54	22.89		0
	1	99	22.25	22.24	22.21	22.13	22.86		0
	50	0	22.44	22.36	22.30	22.53	22.79	0-1	0
	50	25	22.39	22.34	22.61	22.63	22.92		0
	50	50	22.38	22.35	22.56	22.47	23.05		0
100	0	22.27	22.32	22.46	22.56	22.85	0		
16QAM	1	0	22.43	22.16	22.80	22.39	22.80	0-1	0
	1	50	22.40	22.18	22.89	22.61	23.21		0
	1	99	22.38	22.24	22.81	22.21	23.14		0
	50	0	21.85	21.71	21.77	21.91	22.19	0-2	0.5
	50	25	21.83	21.82	21.86	22.07	22.28		0.5
	50	50	21.80	21.85	21.97	21.93	22.38		0.5
100	0	21.73	21.68	21.84	22.05	22.26	0.5		
64QAM	1	0	21.72	21.80	21.60	21.67	21.80	0-2	0.5
	1	50	21.55	21.75	21.90	21.81	22.14		0.5
	1	99	21.35	21.75	21.66	21.60	22.09		0.5
	50	0	20.74	20.80	20.77	20.99	21.16	0-3	1.5
	50	25	20.72	20.87	20.97	21.11	21.30		1.5
	50	50	20.94	20.82	20.95	21.03	21.30		1.5
100	0	20.74	20.77	20.91	21.03	21.30	1.5		
256QAM	1	0	18.65	18.56	18.56	18.95	18.94	0-5	3.5
	1	50	18.84	19.07	18.63	18.80	19.38		3.5
	1	99	18.67	18.55	18.70	18.39	19.18		3.5
	50	0	18.67	18.62	18.75	19.01	19.00	0-5	3.5
	50	25	18.70	18.88	19.03	19.10	19.24		3.5
	50	50	18.72	18.65	18.93	18.98	19.25		3.5
100	0	18.74	18.73	18.91	18.98	19.22	3.5		

Table 9-91
LTE Band 41 PC3 Measured P_{Limit} for DSI = 0 (Body-worn, or Phablet/UMPC with grip sensor inactive), or DSI = 3/4 (Head) - 15 MHz Bandwidth

LTE Band 41 15 MHz Bandwidth									
Modulation	RB Size	RB Offset	Low Channel	Low-Mid Channel	Mid Channel	Mid-High Channel	High Channel	MPR Allowed per 3GPP [dB]	MPR [dB]
			39750 (2506.0 MHz)	40185 (2549.5 MHz)	40620 (2593.0 MHz)	41055 (2636.5 MHz)	41490 (2680.0 MHz)		
Conducted Power [dBm]									
QPSK	1	0	22.16	22.22	22.24	22.45	22.51	0	0
	1	36	22.21	22.36	22.37	22.56	22.74		0
	1	74	22.28	22.22	22.33	22.34	22.76		0
	36	0	22.36	22.39	22.43	22.62	22.69	0-1	0
	36	18	22.43	22.56	22.54	22.64	22.86		0
	36	37	22.32	22.36	22.61	22.56	22.83		0
75	0	22.28	22.47	22.58	22.59	22.86	0		
16QAM	1	0	22.30	22.40	22.34	22.53	22.61	0-1	0
	1	36	22.31	22.37	22.55	22.61	22.76		0
	1	74	22.26	22.22	22.38	22.60	22.65		0
	36	0	21.73	21.88	21.84	22.04	22.04	0-2	0.5
	36	18	21.81	21.97	21.88	22.04	22.30		0.5
	36	37	21.70	21.86	21.95	22.03	22.23		0.5
75	0	21.71	21.87	21.92	22.01	22.29	0.5		
64QAM	1	0	21.56	21.42	21.55	21.62	21.65	0-2	0.5
	1	36	21.47	21.69	21.76	21.79	21.95		0.5
	1	74	21.55	21.33	21.55	21.46	21.85		0.5
	36	0	20.86	20.80	20.87	21.01	21.15	0-3	1.5
	36	18	20.67	20.95	20.99	20.98	21.35		1.5
	36	37	20.77	20.87	21.00	21.00	21.21		1.5
75	0	20.73	20.88	21.10	21.07	21.29	1.5		
256QAM	1	0	18.51	18.62	18.60	18.84	18.85	0-5	3.5
	1	36	18.57	18.78	18.79	18.89	19.08		3.5
	1	74	18.54	18.47	18.82	18.69	18.94		3.5
	36	0	18.75	18.90	18.81	18.97	19.21	0-5	3.5
	36	18	18.78	18.99	19.03	19.08	19.31		3.5
	36	37	18.75	18.80	19.07	19.02	19.19		3.5
75	0	18.70	18.96	19.01	19.07	19.22	3.5		



FCC ID: A3LSMF916U		SAR EVALUATION REPORT		Approved by: Quality Manager
Document S/N: 1M2005200087-01-R2.A3L	Test Dates: 06/28/20-08/24/20	DUT Type: Portable Handset		Page 83 of 267

Table 9-92
LTE Band 41 PC3 Measured P_{Limit} for DSI = 0 (Body-worn, or Phablet/UMPC with grip sensor inactive), or DSI = 3/4 (Head) - 10 MHz Bandwidth

LTE Band 41 10 MHz Bandwidth									
Modulation	RB Size	RB Offset	Low Channel	Low-Mid Channel	Mid Channel	Mid-High Channel	High Channel	MPR Allowed per 3GPP [dB]	MPR [dB]
			39750 (2506.0 MHz)	40185 (2549.5 MHz)	40620 (2593.0 MHz)	41055 (2636.5 MHz)	41490 (2680.0 MHz)		
Conducted Power [dBm]									
QPSK	1	0	22.17	22.22	22.34	22.30	22.43	0	0
	1	25	22.34	22.41	22.58	22.55	22.69		0
	1	49	22.30	22.11	22.37	22.25	22.46		0
	25	0	22.31	22.40	22.57	22.58	22.71	0-1	0
	25	12	22.40	22.45	22.68	22.69	22.84		0
	25	25	22.34	22.36	22.51	22.59	22.74		0
16QAM	50	0	22.31	22.40	22.56	22.64	22.77	0-1	0
	1	0	22.48	22.20	22.56	22.52	22.83		0
	1	25	22.37	22.48	22.74	22.76	22.69		0
	1	49	22.57	22.33	22.59	22.57	22.44	0-2	0
	25	0	21.78	21.95	21.96	22.04	22.08		0.5
	25	12	21.90	22.01	22.15	22.16	21.76		0.5
64QAM	25	25	21.88	21.84	22.03	21.95	22.00	0-2	0.5
	50	0	21.76	21.98	22.11	22.04	21.54		0.5
	1	0	21.56	21.36	21.53	21.43	21.74		0-2
	1	25	21.44	21.64	21.78	21.80	22.07	0.5	
	1	49	21.54	21.30	21.62	21.48	21.73	0.5	
	256QAM	25	0	20.70	20.80	21.00	21.00	21.21	0-3
25		12	20.92	21.02	21.08	21.19	21.32	1.5	
25		25	20.84	20.93	21.06	21.03	21.16	1.5	
50		0	20.80	20.96	21.11	21.13	21.21	0-5	1.5
1		0	18.41	18.24	18.56	18.63	18.75		3.5
1		25	18.59	18.59	18.89	18.88	18.91		3.5
256QAM	1	49	18.36	18.25	18.65	18.36	18.84	0-5	3.5
	25	0	18.88	18.84	19.05	19.01	19.13		3.5
	25	12	18.89	18.83	19.12	19.20	19.37		3.5
	25	25	18.83	18.86	19.00	19.00	19.29	0-5	3.5
	50	0	18.82	18.91	19.11	19.14	19.20		3.5

Table 9-93
LTE Band 41 PC3 Measured P_{Limit} for DSI = 0 (Body-worn, or Phablet/UMPC with grip sensor inactive), or DSI = 3/4 (Head) - 5 MHz Bandwidth

LTE Band 41 5 MHz Bandwidth									
Modulation	RB Size	RB Offset	Low Channel	Low-Mid Channel	Mid Channel	Mid-High Channel	High Channel	MPR Allowed per 3GPP [dB]	MPR [dB]
			39750 (2506.0 MHz)	40185 (2549.5 MHz)	40620 (2593.0 MHz)	41055 (2636.5 MHz)	41490 (2680.0 MHz)		
Conducted Power [dBm]									
QPSK	1	0	22.32	22.18	22.43	22.53	22.68	0	0
	1	12	22.21	22.36	22.47	22.62	22.70		0
	1	24	22.31	22.26	22.52	22.58	22.65		0
	12	0	22.44	22.44	22.49	22.51	22.76	0-1	0
	12	6	22.36	22.40	22.63	22.64	22.90		0
	12	13	22.40	22.35	22.60	22.55	22.74		0
16QAM	25	0	22.44	22.40	22.53	22.61	22.84	0-1	0
	1	0	22.38	22.28	22.46	22.41	22.71		0
	1	12	22.17	21.97	22.43	22.25	22.70		0
	1	24	22.37	22.27	22.40	22.44	22.71	0-2	0
	12	0	21.74	21.76	21.90	21.93	22.13		0.5
	12	6	21.77	21.85	21.97	22.02	22.23		0.5
64QAM	12	13	21.73	21.81	22.00	21.98	22.24	0-2	0.5
	25	0	21.81	21.88	21.97	22.02	22.12		0.5
	1	0	21.61	21.51	21.69	21.62	22.27		0-3
	1	12	21.47	21.53	21.72	21.68	22.00	0.5	
	1	24	21.59	21.54	21.68	21.74	21.98	0.5	
	256QAM	12	0	20.81	20.81	20.91	20.96	21.20	0-3
12		6	20.80	20.89	21.04	21.05	21.28	1.5	
12		13	20.80	20.81	20.91	21.03	21.22	1.5	
25		0	20.80	20.92	21.02	21.06	21.26	0-5	1.5
1		0	18.61	18.56	18.75	18.78	19.05		3.5
1		12	18.46	18.62	18.76	18.83	19.00		3.5
256QAM	1	24	18.55	18.64	18.79	18.79	19.07	0-5	3.5
	12	0	18.85	18.77	18.88	18.91	19.20		3.5
	12	6	18.79	18.82	19.01	19.02	19.24		3.5
	12	13	18.72	18.87	18.95	18.98	19.22	0-5	3.5
	25	0	18.80	18.88	19.02	19.03	19.32		3.5



FCC ID: A3LSMF916U		SAR EVALUATION REPORT		Approved by: Quality Manager
Document S/N: 1M2005200087-01-R2.A3L	Test Dates: 06/28/20-08/24/20	DUT Type: Portable Handset		Page 84 of 267

Table 9-94

LTE Band 41 PC3 Measured P_{limit} for DSI = 1/2 (Phablet or UMPC Extremity with grip sensor active), or DSI = 5/6 (Hotspot Mode), and/or DSI = 7/8 (Earjack active) - 20 MHz Bandwidth

LTE Band 41 20 MHz Bandwidth										
Modulation	RB Size	RB Offset	Low Channel	Low-Mid Channel	Mid Channel	Mid-High Channel	High Channel	MPR Allowed per 3GPP [dB]	MPR [dB]	
			39750 (2506.0 MHz)	40185 (2549.5 MHz)	40620 (2593.0 MHz)	41055 (2636.5 MHz)	41490 (2680.0 MHz)			
Conducted Power [dBm]										
QPSK	1	0	18.70	18.75	18.66	18.92	18.80	0	0	
	1	50	18.65	18.73	18.93	19.08	19.39		0	
	1	99	18.66	18.71	18.68	18.59	19.02		0	
	16QAM	50	0	18.87	18.88	18.93	19.18	19.11	0-1	0
		50	25	18.85	18.99	19.12	19.27	19.47		0
		50	50	18.82	18.93	19.03	19.10	19.27		0
64QAM		100	0	18.80	18.85	19.01	19.15	19.38	0-1	0
		1	0	18.99	19.14	18.82	19.11	18.94		0
		1	50	18.84	19.04	19.16	19.32	19.20		0
	256QAM	1	99	18.96	18.91	19.01	18.82	19.08	0-2	0
		50	0	18.89	18.96	19.03	19.21	19.16		0
		50	25	18.88	19.08	19.17	19.32	19.42		0
64QAM		50	50	18.86	19.02	19.16	19.16	19.36	0-2	0
		100	0	18.82	18.91	19.06	19.26	19.33		0
		1	0	18.55	18.67	18.40	18.66	18.64		0
	256QAM	1	50	18.46	18.66	18.83	18.98	19.00	0-2	0
		1	99	18.50	18.65	18.48	18.48	18.85		0
		50	0	18.97	18.97	19.03	19.27	19.23		0
64QAM		50	25	18.93	19.08	19.24	19.28	19.41	0-3	0
		50	50	18.87	18.94	19.14	19.22	19.37		0
		100	0	18.83	18.96	19.12	19.26	19.30		0
	256QAM	1	0	19.10	19.23	18.93	18.78	18.62	0-5	0
		1	50	19.04	19.18	19.32	18.75	19.02		0
		1	99	19.11	19.17	19.02	18.57	18.87		0
64QAM		50	0	18.96	19.01	19.00	19.14	19.10	0-5	0
		50	25	18.92	19.09	19.16	19.30	19.38		0
		50	50	18.90	18.92	19.13	19.07	19.28		0
	256QAM	100	0	18.81	18.87	19.03	19.15	19.20	0-5	0

Table 9-95

LTE Band 41 PC3 Measured P_{limit} for DSI = 1/2 (Phablet or UMPC Extremity with grip sensor active), or DSI = 5/6 (Hotspot Mode), and/or DSI = 7/8 (Earjack active) - 15 MHz Bandwidth

LTE Band 41 15 MHz Bandwidth										
Modulation	RB Size	RB Offset	Low Channel	Low-Mid Channel	Mid Channel	Mid-High Channel	High Channel	MPR Allowed per 3GPP [dB]	MPR [dB]	
			39750 (2506.0 MHz)	40185 (2549.5 MHz)	40620 (2593.0 MHz)	41055 (2636.5 MHz)	41490 (2680.0 MHz)			
Conducted Power [dBm]										
QPSK	1	0	18.93	18.79	18.84	18.70	18.90	0	0	
	1	36	18.73	18.86	19.09	18.83	19.10		0	
	1	74	18.75	18.62	18.93	18.62	19.00		0	
	16QAM	36	0	18.88	18.90	19.06	18.63	19.14	0-1	0
		36	18	18.81	19.02	19.03	19.00	19.32		0
		36	37	18.82	18.92	19.23	18.85	19.26		0
64QAM		75	0	18.83	18.98	19.17	18.98	19.22	0-1	0
		1	0	18.86	18.84	19.00	18.77	18.95		0
		1	36	18.75	18.95	19.08	19.00	19.25		0
	256QAM	1	74	18.79	18.66	18.91	18.73	19.12	0-2	0
		36	0	18.86	18.97	19.00	18.87	19.17		0
		36	18	18.88	19.06	19.20	19.01	19.34		0
64QAM		36	37	18.93	19.09	19.16	18.86	19.29	0-2	0
		75	0	18.78	19.02	19.16	18.97	19.27		0
		1	0	18.70	18.56	18.62	18.67	18.89		0
	256QAM	1	36	18.55	18.75	18.85	18.69	18.95	0-2	0
		1	74	18.66	18.47	18.84	18.53	18.93		0
		36	0	18.92	18.96	19.09	18.94	19.17		0
64QAM		36	18	18.95	19.10	19.20	19.01	19.33	0-3	0
		36	37	18.93	19.08	19.28	18.97	19.34		0
		75	0	18.86	18.96	19.20	18.99	19.27		0
	256QAM	1	0	18.78	18.83	18.91	18.83	18.73	0-5	0
		1	36	18.85	19.00	19.20	18.95	19.00		0
		1	74	18.64	18.79	18.94	18.83	18.96		0
64QAM		36	0	18.96	19.07	19.17	19.08	19.03	0-5	0
		36	18	19.11	19.26	19.35	19.16	19.23		0
		36	37	19.09	19.12	19.35	19.07	19.23		0
	256QAM	75	0	18.95	19.12	19.32	19.12	19.20	0-5	0



FCC ID: A3LSMF916U	 PCTEST <small>Proud to be part of Samsung</small>	SAR EVALUATION REPORT		Approved by: Quality Manager
Document S/N: 1M2005200087-01-R2.A3L	Test Dates: 06/28/20-08/24/20	DUT Type: Portable Handset		Page 85 of 267

Table 9-96

LTE Band 41 PC3 Measured P_{limit} for DSI = 1/2 (Phablet or UMPC Extremity with grip sensor active), or DSI = 5/6 (Hotspot Mode), and/or DSI = 7/8 (Earjack active) - 10 MHz Bandwidth

LTE Band 41 10 MHz Bandwidth											
Modulation	RB Size	RB Offset	Low Channel	Low-Mid Channel	Mid Channel	Mid-High Channel	High Channel	MPR Allowed per 3GPP [dB]	MPR [dB]		
			39750 (2506.0 MHz)	40185 (2549.5 MHz)	40620 (2593.0 MHz)	41055 (2636.5 MHz)	41490 (2680.0 MHz)				
Conducted Power [dBm]											
QPSK	1	0	18.70	18.61	18.69	18.78	18.93	0	0		
	1	25	18.75	18.85	18.88	18.96	18.95		0		
	1	49	18.65	18.70	18.64	18.79	18.80		0		
	16QAM	25	0	18.77	18.85	18.85	19.04	19.23	0-1	0	
		25	12	18.84	19.04	19.04	19.15	19.29		0	
		25	25	19.07	18.89	18.92	19.05	19.15		0	
64QAM		50	0	18.71	18.91	18.97	19.06	19.18	0-1	0	
		1	0	18.81	18.76	19.00	18.88	19.26		0	
		1	25	18.71	19.05	18.99	19.10	19.09		0	
	256QAM	1	49	18.94	18.65	18.74	19.07	19.11	0-2	0	
		25	0	18.94	18.92	18.86	19.10	19.23		0	
		25	12	18.81	19.19	19.08	19.28	19.31		0	
64QAM		25	25	18.86	19.02	18.97	19.03	19.22	0-2	0	
		50	0	18.85	19.04	19.05	19.18	19.28		0	
		1	0	18.59	18.55	18.55	18.66	18.86		0-2	0
	16QAM	1	25	18.60	18.92	18.89	19.04	19.11	0-3		0
		1	49	18.64	18.55	18.67	18.75	18.74			0
		25	0	18.88	18.89	19.06	19.11	19.23		0	
256QAM		25	12	18.99	19.11	19.17	19.29	19.33	0-3	0	
		25	25	18.80	18.97	19.01	19.10	19.25		0	
		50	0	18.83	19.03	19.11	19.18	19.28		0	
	16QAM	1	0	18.35	18.47	18.49	18.47	18.71	0-5	0	
		1	25	18.60	18.76	18.79	18.96	19.04		0	
		1	49	18.35	18.55	18.53	18.42	18.45		0	
64QAM		25	0	18.79	18.84	18.93	19.05	19.15	0-5	0	
		25	12	18.85	19.03	19.06	19.12	19.21		0	
		25	25	18.74	18.85	19.03	18.96	19.12		0	
	256QAM	50	0	18.76	18.97	18.90	19.11	19.14	0-5	0	

Table 9-97

LTE Band 41 PC3 Measured P_{limit} for DSI = 1/2 (Phablet or UMPC Extremity with grip sensor active), or DSI = 5/6 (Hotspot Mode), and/or DSI = 7/8 (Earjack active) - 5 MHz Bandwidth

LTE Band 41 5 MHz Bandwidth											
Modulation	RB Size	RB Offset	Low Channel	Low-Mid Channel	Mid Channel	Mid-High Channel	High Channel	MPR Allowed per 3GPP [dB]	MPR [dB]		
			39750 (2506.0 MHz)	40185 (2549.5 MHz)	40620 (2593.0 MHz)	41055 (2636.5 MHz)	41490 (2680.0 MHz)				
Conducted Power [dBm]											
QPSK	1	0	18.68	18.80	19.01	19.02	19.08	0	0		
	1	12	18.63	18.98	18.98	19.06	19.00		0		
	1	24	18.65	18.97	19.01	19.11	19.12		0		
	16QAM	12	0	18.81	18.99	19.01	19.11	19.22	0-1	0	
		12	6	18.78	19.02	19.06	19.25	19.32		0	
		12	13	18.83	19.01	19.10	19.14	19.23		0	
64QAM		25	0	18.75	19.03	19.08	19.13	19.31	0-1	0	
		1	0	18.78	18.95	18.78	19.08	19.12		0	
		1	12	18.66	18.85	18.94	19.24	19.15		0	
	256QAM	1	24	18.76	18.92	18.96	19.10	19.18	0-1	0	
		12	0	18.76	18.98	18.96	19.10	19.23		0	
		12	6	18.83	19.01	19.08	19.21	19.21		0-2	0
12		13	18.78	19.05	19.02	19.18	19.31	0			
25		0	18.81	19.05	19.11	19.20	18.92	0			
64QAM		1	0	18.66	18.72	18.80	18.94	18.98	0-2	0	
	1	12	18.59	18.75	18.76	18.89	19.02	0			
	1	24	18.59	18.79	18.81	18.95	19.24	0			
	256QAM	12	0	18.84	19.07	19.05	19.19	19.27	0-2	0	
		12	6	18.86	19.11	19.06	19.24	19.21		0-3	0
		12	13	18.85	19.09	19.06	19.23	19.33			0
64QAM		25	0	18.93	19.11	19.12	19.29	18.92	0-3		0
		1	0	18.63	18.77	18.73	18.83	18.95		0-5	0
		1	12	18.53	18.82	18.72	18.89	18.96			0
	256QAM	1	24	18.50	18.73	18.75	18.98	19.11	0-5		0
		12	0	18.72	18.96	18.88	18.92	19.26		0	
		12	6	18.79	19.01	19.01	19.12	19.13		0-5	0
12		13	18.75	18.85	18.96	19.08	19.20	0			
25		0	18.76	18.97	18.96	19.08	18.92	0			



FCC ID: A3LSMF916U		SAR EVALUATION REPORT		Approved by: Quality Manager
Document S/N: 1M2005200087-01-R2.A3L	Test Dates: 06/28/20-08/24/20	DUT Type: Portable Handset		Page 86 of 267

Table 9-98
LTE Band 41 PC2 Measured P_{Max} - 20 MHz Bandwidth



LTE Band 41 20 MHz Bandwidth									
Modulation	RB Size	RB Offset	Low Channel	Low-Mid Channel	Mid Channel	Mid-High Channel	High Channel	MPR Allowed per 3GPP [dB]	MPR [dB]
			39750 (2506.0 MHz)	40185 (2549.5 MHz)	40620 (2593.0 MHz)	41055 (2636.5 MHz)	41490 (2680.0 MHz)		
Conducted Power [dBm]									
QPSK	1	0	26.37	27.11	26.88	27.06	27.10	0	0
	1	50	26.79	27.17	27.30	27.37	27.00		0
	1	99	26.78	27.14	26.96	26.87	26.45		0
	50	0	25.80	26.08	26.35	26.43	26.11	0-1	1
	50	25	26.04	26.18	26.49	26.54	26.02		1
	50	50	25.98	26.13	26.45	26.40	25.92		1
	100	0	25.97	26.08	26.45	26.41	25.96		1

Table 9-99
LTE Band 41 PC2 Measured P_{Limit} for DSI = 0 (Body-worn, or Phablet/UMPC with grip sensor inactive), or DSI = 3/4 (Head) - 20 MHz Bandwidth

LTE Band 41 20 MHz Bandwidth									
Modulation	RB Size	RB Offset	Low Channel	Low-Mid Channel	Mid Channel	Mid-High Channel	High Channel	MPR Allowed per 3GPP [dB]	MPR [dB]
			39750 (2506.0 MHz)	40185 (2549.5 MHz)	40620 (2593.0 MHz)	41055 (2636.5 MHz)	41490 (2680.0 MHz)		
Conducted Power [dBm]									
QPSK	1	0	24.05	23.90	23.74	24.00	24.27	0	0
	1	50	23.94	23.85	23.90	24.10	24.58		0
	1	99	24.01	23.87	23.76	23.93	24.46		0
	50	0	24.20	24.00	23.89	23.87	24.50	0-1	0
	50	25	24.17	24.02	24.07	24.23	24.66		0
	50	50	24.11	23.99	24.00	24.14	24.70		0
	100	0	24.07	23.93	23.98	24.15	24.57		0

Table 9-100
LTE Band 41 PC2 Measured P_{limit} for DSI = 1/2 (Phablet or UMPC Extremity with grip sensor active), or DSI = 5/6 (Hotspot Mode), and/or DSI = 7/8 (Earjack active) - 20 MHz Bandwidth

LTE Band 41 20 MHz Bandwidth									
Modulation	RB Size	RB Offset	Low Channel	Low-Mid Channel	Mid Channel	Mid-High Channel	High Channel	MPR Allowed per 3GPP [dB]	MPR [dB]
			39750 (2506.0 MHz)	40185 (2549.5 MHz)	40620 (2593.0 MHz)	41055 (2636.5 MHz)	41490 (2680.0 MHz)		
Conducted Power [dBm]									
QPSK	1	0	20.37	20.55	20.31	20.61	20.49	0	0
	1	50	20.41	20.46	20.62	20.62	20.89		0
	1	99	20.39	20.45	20.35	20.33	20.63		0
	50	0	20.46	20.53	20.57	20.86	20.84	0-1	0
	50	25	20.46	20.69	20.77	20.96	21.04		0
	50	50	20.43	20.62	20.74	20.80	20.89		0
	100	0	20.41	20.55	20.70	20.87	20.88		0

FCC ID: A3LSMF916U	 PCTEST <small> Proud to be part of Samsung</small>	SAR EVALUATION REPORT		Approved by: Quality Manager
Document S/N: 1M2005200087-01-R2.A3L	Test Dates: 06/28/20-08/24/20	DUT Type: Portable Handset		Page 87 of 267

9.4.13 LTE Uplink Carrier Aggregation Conducted Powers

Table 9-101
LTE Uplink Carrier Aggregation Measured P_{max}

Combination	PCC									SCC							Power			
	PCC Band	PCC Bandwidth [MHz]	PCC UL Channel	PCC UL Frequency [MHz]	PCC DL Channel	PCC DL Frequency [MHz]	Modulation	PCC UL# RB	PCC UL RB Offset	SCC Band	SCC Bandwidth [MHz]	SCC UL Channel	SCC UL Frequency [MHz]	SCC DL Channel	SCC DL Frequency [MHz]	Modulation	SCC UL# RB	SCC UL RB Offset	LTE Tx.Power with UL CA Enabled (dBm)	LTE Single Carrier Tx Power (dBm)
CA_5B	LTE B5	10	20525	836.5	2525	881.5	QPSK	1	0	LTE B5	5	20453	829.3	2453	874.3	QPSK	1	24	24.26	24.85
Combination	PCC Band	PCC Bandwidth [MHz]	PCC (UL) Channel	PCC (UL) Frequency [MHz]	PCC DL Channel	PCC DL Frequency [MHz]	Modulation	PCC UL# RB	PCC UL RB Offset	SCC Band	SCC Bandwidth [MHz]	SCC (UL) Channel	SCC (UL) Frequency [MHz]	SCC (DL) Channel	SCC (DL) Frequency [MHz]	Modulation	SCC UL# RB	SCC UL RB Offset	LTE Tx.Power with UL CA Enabled (dBm)	LTE Single Carrier Tx Power (dBm)
CA_66C	LTE B66	20	132072	1720.0	66536	2120.0	QPSK	1	99	LTE B66	20	132270	1739.8	66734	2139.8	QPSK	1	0	23.73	23.59
CA_66C	LTE B66	20	132572	1770.0	67036	2170.0	QPSK	1	0	LTE B66	20	132374	1750.2	66838	2150.2	QPSK	1	99	23.85	24.22
CA_66B	LTE B66	10	132022	1715.0	66486	2115.0	QPSK	1	49	LTE B66	10	132121	1724.9	66585	2124.9	QPSK	1	0	23.96	23.55
CA_66B	LTE B66	10	132622	1775.0	67086	2175.0	QPSK	1	0	LTE B66	10	132523	1765.1	66987	2165.1	QPSK	1	49	24.00	23.72
Combination	PCC Band	PCC Bandwidth [MHz]	PCC (UL/DL) Channel	PCC (UL/DL) Frequency [MHz]	Modulation	PCC UL# RB	PCC UL RB Offset	SCC Band	SCC Bandwidth [MHz]	SCC (UL/DL) Channel	SCC (UL/DL) Frequency [MHz]	Modulation	SCC UL# RB	SCC UL RB Offset	LTE Tx.Power with UL CA Enabled (dBm)	LTE Single Carrier Tx Power (dBm)				
CA_41C	LTE B41	20	41490	2680.0	QPSK	1	0	LTE B41	20	41292	2660.2	QPSK	1	99	24.16	24.14				
Combination	PCC Band	PCC Bandwidth [MHz]	PCC (UL/DL) Channel	PCC (UL/DL) Frequency [MHz]	Modulation	PCC UL# RB	PCC UL RB Offset	SCC Band	SCC Bandwidth [MHz]	SCC (UL/DL) Channel	SCC (UL/DL) Frequency [MHz]	Modulation	SCC UL# RB	SCC UL RB Offset	LTE Tx.Power with UL CA Enabled (dBm)	LTE Single Carrier Tx Power (dBm)				
CA_41C	LTE B41 PC2	20	41490	2680.0	QPSK	1	0	LTE B41 PC2	20	41292	2660.2	QPSK	1	99	27.81	27.10				

Table 9-102

LTE Uplink Carrier Aggregation Measured P_{limit}

LTE Band 48 for DSI = 0 (Body-worn, or Phablet/UMPC with grip sensor not triggered), or DSI = 1/2 (Phablet or UMPC Extremity with grip sensor active), or DSI = 5/6 (Hotspot mode), and/or DSI = 7/8 (Earjack active)

Combination	PCC								SCC						Power	
	PCC Band	PCC Bandwidth [MHz]	PCC (UL/DL) Channel	PCC (UL/DL) Frequency [MHz]	Modulation	PCC UL# RB	PCC UL RB Offset	SCC Band	SCC Bandwidth [MHz]	SCC (UL/DL) Channel	SCC (UL/DL) Frequency [MHz]	Modulation	SCC UL# RB	SCC UL RB Offset	LTE Tx.Power with UL CA Enabled (dBm)	LTE Single Carrier Tx Power (dBm)
CA_48C	LTE B48	20	56640	3690.0	QPSK	1	0	LTE B48	20	56442	3670.2	QPSK	1	99	20.45	20.28
CA_48C	LTE B48	20	56640	3690.0	QPSK	100	0	LTE B48	20	56442	3670.2	QPSK	100	0	20.50	20.33

Table 9-103

LTE Uplink Carrier Aggregation Measured P_{limit} for DSI = 3/4 (Head)

Combination	PCC								SCC						Power	
	PCC Band	PCC Bandwidth [MHz]	PCC (UL/DL) Channel	PCC (UL/DL) Frequency [MHz]	Modulation	PCC UL# RB	PCC UL RB Offset	SCC Band	SCC Bandwidth [MHz]	SCC (UL/DL) Channel	SCC (UL/DL) Frequency [MHz]	Modulation	SCC UL# RB	SCC UL RB Offset	LTE Tx.Power with UL CA Enabled (dBm)	LTE Single Carrier Tx Power (dBm)
CA_48C	LTE B48	20	55773	3603.3	QPSK	50	0	LTE B48	20	55575	3583.5	QPSK	50	50	19.24	19.24



FCC ID: A3LSMF916U	 PCTEST <small>Providing the best of all elements</small>	SAR EVALUATION REPORT		Approved by: Quality Manager
Document S/N: 1M2005200087-01-R2.A3L	Test Dates: 06/28/20-08/24/20	DUT Type: Portable Handset		Page 88 of 267

Table 9-104

LTE Uplink Carrier Aggregation Measured P_{limit} for DSI = 1/2 (Phablet or UMPC Extremity with grip sensor active), or DSI = 5/6 (Hotspot Mode), and/or DSI = 7/8 (Earjack active)

Combination	PCC								SCC								Power			
	PCC Band	PCC Bandwidth [MHz]	PCC (UL) Channel	PCC (UL) Frequency [MHz]	PCC DL Channel	PCC DL Frequency [MHz]	Modulation	PCC UL# RB	PCC UL RB Offset	SCC Band	SCC Bandwidth [MHz]	SCC (UL) Channel	SCC (UL) Frequency [MHz]	SCC (DL) Channel	SCC (DL) Frequency [MHz]	Modulation	SCC UL# RB	SCC UL RB Offset	LTE Tx.Power with UL CA Enabled (dBm)	LTE Single Carrier Tx Power (dBm)
CA_66C	LTE B66	20	132572	1770.0	67036	2170.0	QPSK	50	0	LTE B66	20	132374	1750.2	66838	2150.2	QPSK	50	50	19.92	19.50
CA_66B	LTE B66	10	132622	1775.0	67086	2175.0	QPSK	25	0	LTE B66	10	132523	1765.1	66987	2165.1	QPSK	25	25	19.72	19.51

Combination	PCC								SCC								Power	
	PCC Band	PCC Bandwidth [MHz]	PCC (UL/DL) Channel	PCC (UL/DL) Frequency [MHz]	Modulation	PCC UL# RB	PCC UL RB Offset	SCC Band	SCC Bandwidth [MHz]	SCC (UL/DL) Channel	SCC (UL/DL) Frequency [MHz]	Modulation	SCC UL# RB	SCC UL RB Offset	LTE Tx.Power with UL CA Enabled (dBm)	LTE Single Carrier Tx Power (dBm)		
CA_41C	LTE B41	20	41490	2680.0	QPSK	1	0	LTE B41	20	41292	2660.2	QPSK	1	99	19.30	18.80		
CA_41C	LTE B41	20	41490	2680	QPSK	100	0	LTE B41	20	41292	2660.2	QPSK	100	0	19.56	19.38		



Combination	PCC								SCC								Power	
	PCC Band	PCC Bandwidth [MHz]	PCC (UL/DL) Channel	PCC (UL/DL) Frequency [MHz]	Modulation	PCC UL# RB	PCC UL RB Offset	SCC Band	SCC Bandwidth [MHz]	SCC (UL/DL) Channel	SCC (UL/DL) Frequency [MHz]	Modulation	SCC UL# RB	SCC UL RB Offset	LTE Tx.Power with UL CA Enabled (dBm)	LTE Single Carrier Tx Power (dBm)		
CA_41C	LTE B41 PC2	20	41490	2680.0	QPSK	1	0	LTE B41 PC2	20	41292	2660.2	QPSK	1	99	21.07	20.49		
CA_41C	LTE B41 PC2	20	41490	2680	QPSK	100	0	LTE B41 PC2	20	41292	2660.2	QPSK	100	0	21.15	20.88		

Notes:

1. This device supports uplink carrier aggregation for LTE CA_5B, LTE CA_66B, LTE CA_66C, LTE CA_48C, and LTE CA_41C with a maximum of two component carriers. For intraband contiguous carrier aggregation scenarios, 3GPP 36.101 Table 6.2.2A-1 specifies that the aggregate maximum allowed output power is equivalent to the single carrier scenario. 3GPP 36.101 6.2.3A allows for several dB of MPR to be applied when non-contiguous RB allocation is implemented. The conducted powers and MPR settings in this device are permanently implemented per the above 3GPP requirements.
2. Per FCC Guidance, the output power with uplink CA active was measured for the configuration with the highest reported SAR with single carrier for each exposure condition. The power was measured with wideband signal integration over both component carriers.



Figure 9-4
Power Measurement Setup

FCC ID: A3LSMF916U	 PCTEST <small>Provided to be part of Samsung</small>	SAR EVALUATION REPORT		Approved by: Quality Manager
Document S/N: 1M2005200087-01-R2.A3L	Test Dates: 06/28/20-08/24/20	DUT Type: Portable Handset	Page 89 of 267	

9.5 NR Conducted Powers

9.5.1

NR Band n71

Table 9-105
NR Band n71 Measured P_{max} for all DSI - 20 MHz Bandwidth

NR Band n71 20 MHz Bandwidth					
Modulation	RB Size	RB Offset	Channel	MPR Allowed per 3GPP [dB]	MPR [dB]
			136100 (680.5 MHz) Conducted Power [dBm]		
DFT-s-OFDM $\pi/2$ BPSK	1	1	25.49	0	0.0
	1	53	25.50		0.0
	1	104	25.25		0.0
	50	0	24.96	0-0.5	0.5
	50	28	25.45	0	0.0
	50	56	24.82	0-0.5	0.5
	100	0	24.93		0.5
DFT-s-OFDM QPSK	1	1	25.41	0	0.0
	1	53	25.42		0.0
	1	104	25.29		0.0
	50	0	24.50	0-1	1.0
	50	28	25.44	0	0.0
	50	56	24.41	0-1	1.0
	100	0	24.48		1.0
DFT-s-OFDM 16QAM	1	1	24.46	0-1	1.0
CP-OFDM QPSK	1	1	24.00	0-1.5	1.5

Note: NR Band n71 at 20 MHz bandwidth does not support non-overlapping channels. Per FCC Guidance, when a device supports overlapping channel assignment in a channel bandwidth configuration, the middle channel of the group of overlapping channels should be selected for testing.

Table 9-106
NR Band n71 Measured P_{max} for all DSI - 15 MHz Bandwidth

NR Band n71 15 MHz Bandwidth					
Modulation	RB Size	RB Offset	Channel	MPR Allowed per 3GPP [dB]	MPR [dB]
			136100 (680.5 MHz) Conducted Power [dBm]		
DFT-s-OFDM $\pi/2$ BPSK	1	1	25.41	0	0.0
	1	40	25.39		0.0
	1	77	25.24		0.0
	36	0	24.97	0-0.5	0.5
	36	22	25.37	0	0.0
	36	43	24.76	0-0.5	0.5
	75	0	24.92		0.5
DFT-s-OFDM QPSK	1	1	25.42	0	0.0
	1	40	25.44		0.0
	1	77	25.32		0.0
	36	0	24.50	0-1	1.0
	36	22	25.34	0	0.0
	36	43	24.35	0-1	1.0
	75	0	24.48		1.0
DFT-s-OFDM 16QAM	1	1	24.45	0-1	1.0
CP-OFDM QPSK	1	1	23.99	0-1.5	1.5

Note: NR Band n71 at 15 MHz bandwidth does not support non-overlapping channels. Per FCC Guidance, when a device supports overlapping channel assignment in a channel bandwidth configuration, the middle channel of the group of overlapping channels should be selected for testing.





FCC ID: A3LSMF916U	 PCTEST <small>Proud to be part of Samsung</small>	SAR EVALUATION REPORT		Approved by: Quality Manager
Document S/N: 1M2005200087-01-R2.A3L	Test Dates: 06/28/20-08/24/20	DUT Type: Portable Handset		Page 90 of 267

Table 9-107
NR Band n71 Measured P_{max} for all DSI - 10 MHz Bandwidth

NR Band n71 10 MHz Bandwidth								
Modulation	RB Size	RB Offset	Channel			MPR Allowed per 3GPP [dB]	MPR [dB]	
			133600 (668 MHz)	136100 (680.5 MHz)	138600 (693 MHz)			
			Conducted Power [dBm]					
DFT-s-OFDM $\pi/2$ BPSK	1	1	25.33	25.27	24.78	0	0.0	
	1	26	25.44	25.24	24.85		0.0	
	1	50	25.21	25.11	24.65		0.0	
		25	0	24.95	24.74	24.34	0-0.5	0.5
		25	14	24.94	25.12	24.74	0	0.0
		25	27	24.70	24.54	24.13	0-0.5	0.5
		50	0	24.72	24.58	24.24		0.5
DFT-s-OFDM QPSK	1	1	24.92	25.13	24.77	0	0.0	
	1	26	25.32	25.13	24.78		0.0	
	1	50	24.86	25.05	24.62		0.0	
		25	0	24.50	24.32	23.90	0-1	1.0
		25	14	25.35	25.15	24.79	0	0.0
		25	27	24.31	24.16	23.71	0-1	1.0
		50	0	24.41	24.28	23.83		1.0
DFT-s-OFDM 16QAM	1	1	24.39	24.41	24.19	0-1	1.0	
CP-OFDM QPSK	1	1	23.65	23.81	23.42	0-1.5	1.5	

Table 9-108
NR Band n71 Measured P_{max} for all DSI - 5 MHz Bandwidth

NR Band n71 5 MHz Bandwidth								
Modulation	RB Size	RB Offset	Channel			MPR Allowed per 3GPP [dB]	MPR [dB]	
			133100 (665.5 MHz)	136100 (680.5 MHz)	139100 (695.5 MHz)			
			Conducted Power [dBm]					
DFT-s-OFDM $\pi/2$ BPSK	1	1	25.23	25.29	24.75	0	0.0	
	1	13	25.17	25.11	24.72		0.0	
	1	23	25.05	25.07	24.55		0.0	
		12	0	24.70	24.70	24.19	0-0.5	0.5
		12	7	25.15	25.15	24.65	0	0.0
		12	13	24.59	24.56	24.09	0-0.5	0.5
		25	0	24.62	24.58	24.15		0.5
DFT-s-OFDM QPSK	1	1	25.25	25.29	24.81	0	0.0	
	1	13	25.14	25.16	24.63		0.0	
	1	23	25.16	25.14	24.64		0.0	
		12	0	24.29	24.26	23.78	0-1	1.0
		12	7	25.18	25.16	24.68	0	0.0
		12	13	24.20	24.17	23.64	0-1	1.0
		25	0	24.24	24.24	23.73		1.0
DFT-s-OFDM 16QAM	1	1	24.43	24.42	23.86	0-1	1.0	
CP-OFDM QPSK	1	1	23.69	23.79	23.22	0-1.5	1.5	

FCC ID: A3LSMF916U	 PCTEST <small>Proud to be part of Samsung</small>	SAR EVALUATION REPORT		Approved by: Quality Manager
Document S/N: 1M2005200087-01-R2.A3L	Test Dates: 06/28/20-08/24/20	DUT Type: Portable Handset		Page 91 of 267

9.5.2

NR Band n5

Table 9-109
NR Band n5 Measured P_{max} for all DSI - 20 MHz Bandwidth

NR Band n5 20 MHz Bandwidth					
Modulation	RB Size	RB Offset	Channel	MPR Allowed per 3GPP [dB]	MPR [dB]
			167300 (836.5 MHz) Conducted Power [dBm]		
DFT-s-OFDM $\pi/2$ BPSK	1	1	24.97	0	0.0
	1	53	25.17		0.0
	1	104	24.89		0.0
	50	0	24.42	0-0.5	0.5
	50	28	25.01	0	0.0
	50	56	24.41	0-0.5	0.5
	100	0	24.52		0.5
DFT-s-OFDM QPSK	1	1	24.83	0	0.0
	1	53	25.03		0.0
	1	104	24.80		0.0
	50	0	24.03	0-1	1.0
	50	28	25.01	0	0.0
	50	56	24.02	0-1	1.0
	100	0	24.14		1.0
DFT-s-OFDM 16QAM	1	1	24.03	0-1	1.0
CP-OFDM QPSK	1	1	23.52	0-1.5	1.5

Note: NR Band n5 (Cell) at 20 MHz bandwidth does not support non-overlapping channels. Per FCC Guidance, when a device supports overlapping channel assignment in a channel bandwidth configuration, the middle channel of the group of overlapping channels should be selected for testing.

Table 9-110
NR Band n5 Measured P_{max} for all DSI - 15 MHz Bandwidth

NR Band n5 15 MHz Bandwidth					
Modulation	RB Size	RB Offset	Channel	MPR Allowed per 3GPP [dB]	MPR [dB]
			167300 (836.5 MHz) Conducted Power [dBm]		
DFT-s-OFDM $\pi/2$ BPSK	1	1	24.91	0	0.0
	1	40	25.00		0.0
	1	77	24.89		0.0
	36	0	24.24	0-0.5	0.5
	36	22	24.83	0	0.0
	36	43	24.32	0-0.5	0.5
	75	0	24.34		0.5
DFT-s-OFDM QPSK	1	1	24.93	0	0.0
	1	40	24.99		0.0
	1	77	24.93		0.0
	36	0	23.95	0-1	1.0
	36	22	24.89	0	0.0
	36	43	23.94	0-1	1.0
	75	0	24.01		1.0
DFT-s-OFDM 16QAM	1	1	24.11	0-1	1.0
CP-OFDM QPSK	1	1	23.30	0-1.5	1.5

Note: NR Band n5 (Cell) at 15 MHz bandwidth does not support non-overlapping channels. Per FCC Guidance, when a device supports overlapping channel assignment in a channel bandwidth configuration, the middle channel of the group of overlapping channels should be selected for testing.



FCC ID: A3LSMF916U	 PCTEST <small>Prove it. Do your part. © Samsung</small>	SAR EVALUATION REPORT		Approved by: Quality Manager
Document S/N: 1M2005200087-01-R2.A3L	Test Dates: 06/28/20-08/24/20	DUT Type: Portable Handset		Page 92 of 267



Table 9-111
NR Band n5 Measured P_{max} for all DSI - 10 MHz Bandwidth

NR Band n5 10 MHz Bandwidth						
Modulation	RB Size	RB Offset	Channel		MPR Allowed per 3GPP [dB]	MPR [dB]
			167300 (836.5 MHz)	Conducted Power [dBm]		
DFT-s-OFDM $\pi/2$ BPSK	1	1		24.92	0	0.0
	1	26		25.13		0.0
	1	50		24.93		0.0
	25	0		24.39	0-0.5	0.5
	25	14		24.88	0	0.0
	25	27		24.33	0-0.5	0.5
	50	0		24.43		0.5
DFT-s-OFDM QPSK	1	1		24.84	0	0.0
	1	26		24.93		0.0
	1	50		24.79		0.0
	25	0		24.02	0-1	1.0
	25	14		24.92	0	0.0
	25	27		23.93	0-1	1.0
	50	0		23.99		1.0
DFT-s-OFDM 16QAM	1	1		24.07	0-1	1.0
CP-OFDM QPSK	1	1		23.22	0-1.5	1.5

Note: NR Band n5 (Cell) at 10 MHz bandwidth does not support non-overlapping channels. Per FCC Guidance, when a device supports overlapping channel assignment in a channel bandwidth configuration, the middle channel of the group of overlapping channels should be selected for testing.

Table 9-112
NR Band n5 Measured P_{max} for all DSI - 5 MHz Bandwidth

NR Band n5 5 MHz Bandwidth							
Modulation	RB Size	RB Offset	Channel			MPR Allowed per 3GPP [dB]	MPR [dB]
			165300 (826.5 MHz)	167300 (836.5 MHz)	169300 (846.5 MHz)		
			Conducted Power [dBm]				
DFT-s-OFDM $\pi/2$ BPSK	1	1	24.99	25.00	24.93	0	0.0
	1	13	24.93	24.99	24.91		0.0
	1	23	24.84	24.94	24.78		0.0
	12	0	24.37	24.36	24.30	0-0.5	0.5
	12	7	24.79	24.85	24.78	0	0.0
	12	13	24.26	24.29	24.25	0-0.5	0.5
	25	0	24.37	24.37	24.30		0.5
DFT-s-OFDM QPSK	1	1	24.93	25.10	24.89	0	0.0
	1	13	24.86	24.99	24.72		0.0
	1	23	24.72	24.94	24.70		0.0
	12	0	23.95	24.37	23.93	0-1	1.0
	12	7	24.82	24.88	24.76	0	0.0
	12	13	23.83	24.31	23.83	0-1	1.0
	25	0	23.94	24.36	23.87		1.0
DFT-s-OFDM 16QAM	1	1	24.16	24.19	24.08	0-1	1.0
CP-OFDM QPSK	1	1	23.35	23.34	23.37	0-1.5	1.5

FCC ID: A3LSMF916U	 PCTEST <small>Prove it to be part of Samsung</small>	SAR EVALUATION REPORT		Approved by: Quality Manager
Document S/N: 1M2005200087-01-R2.A3L	Test Dates: 06/28/20-08/24/20	DUT Type: Portable Handset		Page 93 of 267

9.5.3

NR Band n66

Table 9-113

NR Band n66 Measured P_{max} DSI = 0 (Body-worn, or Phablet/UMPC with grip sensor not triggered), or DSI = 3/4 (Head) - 20 MHz Bandwidth

NR Band n66 20 MHz Bandwidth							
Modulation	RB Size	RB Offset	Channel			MPR Allowed per 3GPP [dB]	MPR [dB]
			344000 (1720 MHz)	349000 (1745 MHz)	354000 (1770 MHz)		
			Conducted Power [dBm]				
DFT-s-OFDM $\pi/2$ BPSK	1	1	23.35	23.46	23.74	0	0.0
	1	53	23.31	23.49	23.70		0.0
	1	104	23.45	23.58	23.85		0.0
	50	0	22.74	22.88	23.10	0-0.5	0.5
	50	28	23.34	23.51	23.71	0	0.0
	50	56	22.66	22.86	23.12	0-0.5	0.5
DFT-s-OFDM QPSK	100	0	22.76	22.89	23.09	0-0.5	0.5
	1	1	23.29	23.50	23.68	0	0.0
	1	53	23.33	23.35	23.73		0.0
	1	104	23.36	23.58	23.84		0.0
	50	0	22.33	22.54	22.80	0-1	1.0
	50	28	23.35	23.46	23.73	0	0.0
50	56	22.34	22.44	22.67	0-1	1.0	
DFT-s-OFDM 16QAM	100	0	22.31	22.45	22.72	0-1	1.0
CP-OFDM QPSK	1	1	21.84	22.08	22.27	0-1.5	1.5

Table 9-114

NR Band n66 Measured P_{max} DSI = 0 (Body-worn, or Phablet/UMPC with grip sensor not triggered), or DSI = 3/4 (Head) - 15 MHz Bandwidth

NR Band n66 15 MHz Bandwidth							
Modulation	RB Size	RB Offset	Channel			MPR Allowed per 3GPP [dB]	MPR [dB]
			343500 (1717.5 MHz)	349000 (1745 MHz)	354500 (1772.5 MHz)		
			Conducted Power [dBm]				
DFT-s-OFDM $\pi/2$ BPSK	1	1	23.23	23.44	23.64	0	0.0
	1	40	23.27	23.46	23.66		0.0
	1	77	23.41	23.56	23.79		0.0
	36	0	22.59	22.83	23.05	0-0.5	0.5
	36	22	23.19	23.35	23.63	0	0.0
	36	43	22.58	22.76	23.07	0-0.5	0.5
DFT-s-OFDM QPSK	75	0	22.60	22.75	23.05	0-0.5	0.5
	1	1	23.28	23.35	23.67	0	0.0
	1	40	23.29	23.34	23.66		0.0
	1	77	23.35	23.46	23.80		0.0
	36	0	22.63	22.43	22.70	0-1	1.0
	36	22	23.22	23.38	23.65	0	0.0
36	43	22.60	22.36	22.65	0-1	1.0	
75	0	22.63	22.44	22.68	0-1	1.0	
DFT-s-OFDM 16QAM	1	1	22.33	22.52	22.82	0-1	1.0
CP-OFDM QPSK	1	1	21.49	21.63	21.97	0-1.5	1.5



FCC ID: A3LSMF916U	 PCTEST Proud to be part of Samsung	SAR EVALUATION REPORT		Approved by: Quality Manager
Document S/N: 1M2005200087-01-R2.A3L	Test Dates: 06/28/20-08/24/20	DUT Type: Portable Handset		Page 94 of 267

Table 9-115

NR Band n66 Measured P_{max} DSI = 0 (Body-worn, or Phablet/UMPC with grip sensor not triggered), or DSI = 3/4 (Head) - 10 MHz Bandwidth

NR Band n66 10 MHz Bandwidth							
Modulation	RB Size	RB Offset	Channel			MPR Allowed per 3GPP [dB]	MPR [dB]
			343000 (1715 MHz)	349000 (1745 MHz)	355000 (1775 MHz)		
			Conducted Power [dBm]				
DFT-s-OFDM $\pi/2$ BPSK	1	1	23.33	23.51	23.73	0	0.0
	1	26	23.59	23.74	24.03		0.0
	1	50	23.39	23.50	23.80		0.0
	25	0	22.69	22.85	23.05	0-0.5	0.5
	25	14	23.25	23.44	23.70	0	0.0
	25	27	22.66	22.83	23.02	0-0.5	0.5
50	0	22.72	22.89	23.09	0.5		
DFT-s-OFDM QPSK	1	1	23.35	23.52	23.77	0	0.0
	1	26	23.34	23.53	23.78		0.0
	1	50	23.30	23.49	23.75		0.0
	25	0	22.30	22.51	22.73	0-1	1.0
	25	14	23.33	23.47	23.74	0	0.0
	25	27	22.30	22.46	22.66	0-1	1.0
50	0	22.23	22.42	22.70	1.0		
DFT-s-OFDM 16QAM	1	1	22.36	22.61	22.84	0-1	1.0
CP-OFDM QPSK	1	1	21.55	21.84	22.08	0-1.5	1.5

Table 9-116

NR Band n66 Measured P_{max} DSI = 0 (Body-worn, or Phablet/UMPC with grip sensor not triggered), or DSI = 3/4 (Head) - 5 MHz Bandwidth

NR Band n66 5 MHz Bandwidth							
Modulation	RB Size	RB Offset	Channel			MPR Allowed per 3GPP [dB]	MPR [dB]
			342500 (1712.5 MHz)	349000 (1745 MHz)	355500 (1777.5 MHz)		
			Conducted Power [dBm]				
DFT-s-OFDM $\pi/2$ BPSK	1	1	23.16	23.51	23.88	0	0.0
	1	13	23.35	23.58	23.91		0.0
	1	23	23.26	23.53	23.82		0.0
	12	0	22.51	22.77	23.13	0-0.5	0.5
	12	7	23.14	23.41	23.75	0	0.0
	12	13	22.55	22.85	23.08	0-0.5	0.5
25	0	22.59	22.80	23.14	0.5		
DFT-s-OFDM QPSK	1	1	23.20	23.46	23.75	0	0.0
	1	13	23.23	23.47	23.70		0.0
	1	23	23.15	23.34	23.72		0.0
	12	0	22.16	22.38	22.76	0-1	1.0
	12	7	23.21	23.43	23.77	0	0.0
	12	13	22.16	22.38	22.72	0-1	1.0
25	0	22.17	22.43	22.68	1.0		
DFT-s-OFDM 16QAM	1	1	22.28	22.44	22.82	0-1	1.0
CP-OFDM QPSK	1	1	21.49	21.63	21.89	0-1.5	1.5



FCC ID: A3LSMF916U	 PCTEST <small>Proud to be part of Samsung</small>	SAR EVALUATION REPORT		Approved by: Quality Manager
Document S/N: 1M2005200087-01-R2.A3L	Test Dates: 06/28/20-08/24/20	DUT Type: Portable Handset		Page 95 of 267

Table 9-117

NR Band n66 Measured P_{limit} for DSI = 1/2 (Phablet or UMPC Extremity with grip sensor active), or DSI = 5/6 (Hotspot Mode), and/or DSI = 7/8 (Earjack active) - 20 MHz Bandwidth

NR Band n66 20 MHz Bandwidth							
Modulation	RB Size	RB Offset	Channel			MPR Allowed per 3GPP [dB]	MPR [dB]
			344000 (1720 MHz)	349000 (1745 MHz)	354000 (1770 MHz)		
			Conducted Power [dBm]				
DFT-s-OFDM $\pi/2$ BPSK	1	1	19.24	19.40	19.50	0	0.0
	1	53	19.29	19.35	19.43		0.0
	1	104	19.34	19.41	19.50		0.0
	50	0	19.22	19.33	19.45	0-0.5	0.0
	50	28	19.12	19.28	19.49	0	0.0
	50	56	19.12	19.27	19.47	0-0.5	0.0
100	0	19.16	19.31	19.42	0.0		
DFT-s-OFDM QPSK	1	1	19.20	19.36	19.45	0	0.0
	1	53	19.18	19.33	19.46		0.0
	1	104	19.21	19.29	19.49		0.0
	50	0	19.20	19.43	19.45	0-1	0.0
	50	28	19.18	19.38	19.42	0	0.0
	50	56	19.14	19.23	19.44	0-1	0.0
100	0	19.15	19.28	19.41	0.0		
DFT-s-OFDM 16QAM	1	1	19.17	19.35	19.41	0-1	0.0
CP-OFDM QPSK	1	1	19.38	19.48	19.50	0-1.5	0.0

Table 9-118

NR Band n66 Measured P_{limit} for DSI = 1/2 (Phablet or UMPC Extremity with grip sensor active), or DSI = 5/6 (Hotspot Mode), and/or DSI = 7/8 (Earjack active) - 15 MHz Bandwidth

NR Band n66 15 MHz Bandwidth							
Modulation	RB Size	RB Offset	Channel			MPR Allowed per 3GPP [dB]	MPR [dB]
			343500 (1717.5 MHz)	349000 (1745 MHz)	354500 (1772.5 MHz)		
			Conducted Power [dBm]				
DFT-s-OFDM $\pi/2$ BPSK	1	1	18.99	19.32	19.49	0	0.0
	1	40	18.98	19.30	19.44		0.0
	1	77	19.10	19.43	19.48		0.0
	36	0	18.99	19.26	19.41	0-0.5	0.0
	36	22	18.92	19.23	19.36	0	0.0
	36	43	18.94	19.22	19.38	0-0.5	0.0
75	0	18.95	19.24	19.34	0.0		
DFT-s-OFDM QPSK	1	1	18.97	19.20	19.35	0	0.0
	1	40	18.99	19.23	19.39		0.0
	1	77	19.04	19.33	19.42		0.0
	36	0	19.00	19.29	19.47	0-1	0.0
	36	22	18.97	19.19	19.39	0	0.0
	36	43	18.98	19.17	19.40	0-1	0.0
75	0	18.97	19.25	19.43	0.0		
DFT-s-OFDM 16QAM	1	1	19.11	19.32	19.44	0-1	0.0
CP-OFDM QPSK	1	1	18.94	19.28	19.24	0-1.5	0.0



FCC ID: A3LSMF916U	 PCTEST <small> Proud to be part of Samsung </small>	SAR EVALUATION REPORT		Approved by: Quality Manager
Document S/N: 1M2005200087-01-R2.A3L	Test Dates: 06/28/20-08/24/20	DUT Type: Portable Handset		Page 96 of 267

Table 9-119



NR Band n66 Measured P_{limit} for DSI = 1/2 (Phablet or UMPC Extremity with grip sensor active), or DSI = 5/6 (Hotspot Mode), and/or DSI = 7/8 (Earjack active) - 10 MHz Bandwidth

NR Band n66 10 MHz Bandwidth							
Modulation	RB Size	RB Offset	Channel			MPR Allowed per 3GPP [dB]	MPR [dB]
			343000 (1715 MHz)	349000 (1745 MHz)	355000 (1775 MHz)		
			Conducted Power [dBm]				
DFT-s-OFDM $\pi/2$ BPSK	1	1	19.02	19.37	19.48	0	0.0
	1	26	19.25	19.44	19.50		0.0
	1	50	19.11	19.30	19.46		0.0
	25	0	19.03	19.26	19.47	0-0.5	0.0
	25	14	18.99	19.25	19.50	0	0.0
	25	27	18.95	19.19	19.45	0-0.5	0.0
50	0	19.00	19.25	19.41	0.0		
DFT-s-OFDM QPSK	1	1	19.08	19.33	19.46	0	0.0
	1	26	19.04	19.37	19.50		0.0
	1	50	19.03	19.23	19.45		0.0
	25	0	19.02	19.26	19.41	0-1	0.0
	25	14	19.02	19.27	19.46	0	0.0
	25	27	18.95	19.18	19.44	0-1	0.0
50	0	18.99	19.29	19.50	0.0		
DFT-s-OFDM 16QAM	1	1	19.12	19.42	19.50	0-1	0.0
CP-OFDM QPSK	1	1	18.99	19.24	19.42	0-1.5	0.0

Table 9-120

NR Band n66 Measured P_{limit} for DSI = 1/2 (Phablet or UMPC Extremity with grip sensor active), or DSI = 5/6 (Hotspot Mode), and/or DSI = 7/8 (Earjack active) - 5 MHz Bandwidth

NR Band n66 5 MHz Bandwidth							
Modulation	RB Size	RB Offset	Channel			MPR Allowed per 3GPP [dB]	MPR [dB]
			342500 (1712.5 MHz)	349000 (1745 MHz)	355500 (1777.5 MHz)		
			Conducted Power [dBm]				
DFT-s-OFDM $\pi/2$ BPSK	1	1	19.11	19.40	19.42	0	0.0
	1	13	19.18	19.35	19.41		0.0
	1	23	19.05	19.32	19.40		0.0
	12	0	18.96	19.20	19.43	0-0.5	0.0
	12	7	18.97	19.24	19.40	0	0.0
	12	13	18.97	19.18	19.41	0-0.5	0.0
25	0	19.00	19.26	19.47	0.0		
DFT-s-OFDM QPSK	1	1	19.01	19.25	19.43	0	0.0
	1	13	19.03	19.18	19.45		0.0
	1	23	18.88	19.28	19.41		0.0
	12	0	18.92	19.24	19.44	0-1	0.0
	12	7	18.99	19.30	19.46	0	0.0
	12	13	19.00	19.25	19.43	0-1	0.0
25	0	19.00	19.27	19.44	0.0		
DFT-s-OFDM 16QAM	1	1	19.19	19.36	19.42	0-1	0.0
CP-OFDM QPSK	1	1	18.94	19.15	19.40	0-1.5	0.0

FCC ID: A3LSMF916U	 PCTEST <small> Proud to be part of Samsung</small>	SAR EVALUATION REPORT		Approved by: Quality Manager
Document S/N: 1M2005200087-01-R2.A3L	Test Dates: 06/28/20-08/24/20	DUT Type: Portable Handset		Page 97 of 267

NR Band n25

Table 9-121

NR Band n25 Measured P_{max} DSI = 0 (Body-worn, or Phablet/UMPC with grip sensor not triggered), or DSI = 3/4 (Head) - 20 MHz Bandwidth

NR Band n25 20 MHz Bandwidth							
Modulation	RB Size	RB Offset	Channel			MPR Allowed per 3GPP [dB]	MPR [dB]
			372000 (1860 MHz)	376500 (1882.5 MHz)	381000 (1905 MHz)		
			Conducted Power [dBm]				
DFT-s-OFDM $\pi/2$ BPSK	1	1	23.85	23.88	23.83	0	0.0
	1	53	24.02	24.05	24.09		0.0
	1	104	23.70	23.72	23.53		0.0
	50	0	23.17	23.78	23.07	0-0.5	0.5
	50	28	23.73	23.68	23.70	0	0.0
	50	56	23.02	23.00	23.30	0-0.5	0.5
DFT-s-OFDM QPSK	100	0	23.06	23.14	23.10	0-0.5	0.5
	1	1	23.75	23.75	23.73	0	0.0
	1	53	23.80	23.86	23.74		0.0
	1	104	23.74	23.77	23.43		0.0
	50	0	22.75	22.81	22.65	0-1	1.0
	50	28	23.75	23.76	23.57	0	0.0
50	56	22.72	22.76	22.63	0-1	1.0	
100	0	22.81	22.80	22.52		1.0	
DFT-s-OFDM 16QAM	1	1	23.08	22.95	22.82	0-1	1.0
CP-OFDM QPSK	1	1	22.44	22.27	22.16	0-1.5	1.5

Table 9-122

NR Band n25 Measured P_{max} DSI = 0 (Body-worn, or Phablet/UMPC with grip sensor not triggered), or DSI = 3/4 (Head) - 15 MHz Bandwidth

NR Band n25 15 MHz Bandwidth							
Modulation	RB Size	RB Offset	Channel			MPR Allowed per 3GPP [dB]	MPR [dB]
			371500 (1857.5 MHz)	376500 (1882.5 MHz)	381500 (1907.5 MHz)		
			Conducted Power [dBm]				
DFT-s-OFDM $\pi/2$ BPSK	1	1	23.49	23.76	23.63	0	0.0
	1	40	23.46	23.69	23.58		0.0
	1	77	23.38	23.78	23.62		0.0
	36	0	22.86	23.65	23.08	0-0.5	0.5
	36	22	23.37	23.79	23.61	0	0.0
	36	43	22.72	23.15	22.96	0-0.5	0.5
DFT-s-OFDM QPSK	75	0	22.81	23.14	23.07	0-0.5	0.5
	1	1	23.57	23.81	23.78	0	0.0
	1	40	23.50	23.87	23.76		0.0
	1	77	23.56	23.83	22.99		0.0
	36	0	22.43	22.83	22.72	0-1	1.0
	36	22	23.45	23.81	23.65	0	0.0
36	43	22.36	22.75	22.57	0-1	1.0	
75	0	22.36	22.86	22.67		1.0	
DFT-s-OFDM 16QAM	1	1	22.65	22.99	22.98	0-1	1.0
CP-OFDM QPSK	1	1	22.12	22.29	22.29	0-1.5	1.5



FCC ID: A3LSMF916U		SAR EVALUATION REPORT		Approved by: Quality Manager
Document S/N: 1M2005200087-01-R2.A3L	Test Dates: 06/28/20-08/24/20	DUT Type: Portable Handset		Page 98 of 267

Table 9-123

NR Band n25 Measured P_{max} DSI = 0 (Body-worn, or Phablet/UMPC with grip sensor not triggered), or DSI = 3/4 (Head) - 10 MHz Bandwidth

NR Band n25 10 MHz Bandwidth							
Modulation	RB Size	RB Offset	Channel			MPR Allowed per 3GPP [dB]	MPR [dB]
			371000 (1855 MHz)	376500 (1882.5 MHz)	382000 (1910 MHz)		
			Conducted Power [dBm]				
DFT-s-OFDM $\pi/2$ BPSK	1	1	23.41	23.79	23.66	0	0.0
	1	26	23.74	24.09	23.84		0.0
	1	50	23.45	23.80	23.36		0.0
	25	0	22.89	23.71	23.00	0-0.5	0.5
	25	14	23.52	23.86	23.59	0	0.0
	25	27	22.94	23.27	23.06	0-0.5	0.5
50	0	22.90	23.29	23.02	0.5		
DFT-s-OFDM QPSK	1	1	23.59	23.88	23.32	0	0.0
	1	26	23.67	24.02	23.49		0.0
	1	50	23.52	23.86	23.30		0.0
	25	0	22.49	22.89	22.65	0-1	1.0
	25	14	23.56	23.88	23.61	0	0.0
	25	27	22.50	22.85	22.26	0-1	1.0
50	0	22.48	22.89	22.65	1.0		
DFT-s-OFDM 16QAM	1	1	22.72	22.97	22.77	0-1	1.0
CP-OFDM QPSK	1	1	22.12	22.32	22.10	0-1.5	1.5

Table 9-124

NR Band n25 Measured P_{max} DSI = 0 (Body-worn, or Phablet/UMPC with grip sensor not triggered), or DSI = 3/4 (Head) - 5 MHz Bandwidth

NR Band n25 5 MHz Bandwidth							
Modulation	RB Size	RB Offset	Channel			MPR Allowed per 3GPP [dB]	MPR [dB]
			370500 (1852.5 MHz)	376500 (1882.5 MHz)	382500 (1912.5 MHz)		
			Conducted Power [dBm]				
DFT-s-OFDM $\pi/2$ BPSK	1	1	23.81	23.68	23.92	0	0.0
	1	13	23.87	23.80	23.90		0.0
	1	23	23.83	23.75	23.64		0.0
	12	0	23.12	23.05	23.12	0-0.5	0.5
	12	7	23.85	23.74	23.81	0	0.0
	12	13	23.22	23.08	23.05	0-0.5	0.5
25	0	23.20	23.06	23.17	0.5		
DFT-s-OFDM QPSK	1	1	23.84	23.66	23.61	0	0.0
	1	13	23.79	23.78	23.60		0.0
	1	23	23.81	23.72	23.07		0.0
	12	0	22.75	22.64	22.65	0-1	1.0
	12	7	23.77	23.69	23.42	0	0.0
	12	13	22.83	23.03	22.19	0-1	1.0
25	0	22.79	22.95	22.41	1.0		
DFT-s-OFDM 16QAM	1	1	22.72	22.93	22.79	0-1	1.0
CP-OFDM QPSK	1	1	22.47	22.51	22.25	0-1.5	1.5



FCC ID: A3LSMF916U	 PCTEST <small>Provided to be part of Samsung</small>	SAR EVALUATION REPORT		Approved by: Quality Manager
Document S/N: 1M2005200087-01-R2.A3L	Test Dates: 06/28/20-08/24/20	DUT Type: Portable Handset		Page 99 of 267

Table 9-125

NR Band n25 Measured P_{limit} for DSI = 1/2 (Phablet or UMPC Extremity with grip sensor active), or DSI = 5/6 (Hotspot Mode), and/or DSI = 7/8 (Earjack active) - 20 MHz Bandwidth

NR Band n25 20 MHz Bandwidth							
Modulation	RB Size	RB Offset	Channel			MPR Allowed per 3GPP [dB]	MPR [dB]
			372000 (1860 MHz)	376500 (1882.5 MHz)	381000 (1905 MHz)		
			Conducted Power [dBm]				
DFT-s-OFDM $\pi/2$ BPSK	1	1	18.63	18.92	18.63	0	0.0
	1	53	18.59	19.05	18.76		0.0
	1	104	18.58	18.82	18.52		0.0
	50	0	18.47	18.97	18.65	0-0.5	0.0
	50	28	18.48	19.00	18.67	0	0.0
	50	56	18.52	18.86	18.56	0-0.5	0.0
	100	0	18.48	18.93	18.56		0.0
DFT-s-OFDM QPSK	1	1	18.70	18.94	18.64	0	0.0
	1	53	18.51	18.89	18.68		0.0
	1	104	18.63	18.78	18.51		0.0
	50	0	18.65	19.02	18.62	0-1	0.0
	50	28	18.57	18.92	18.60	0	0.0
	50	56	18.50	18.86	18.53	0-1	0.0
	100	0	18.53	18.92	18.59		0.0
DFT-s-OFDM 16QAM	1	1	18.57	18.83	18.57	0-1	0.0
CP-OFDM QPSK	1	1	18.81	19.11	18.94	0-1.5	0.0

Table 9-126

NR Band n2 Measured P_{limit} for DSI = 1/2 (Phablet or UMPC Extremity with grip sensor active), or DSI = 5/6 (Hotspot Mode), and/or DSI = 7/8 (Earjack active) - 15 MHz Bandwidth

NR Band n25 15 MHz Bandwidth							
Modulation	RB Size	RB Offset	Channel			MPR Allowed per 3GPP [dB]	MPR [dB]
			371500 (1857.5 MHz)	376500 (1882.5 MHz)	381500 (1907.5 MHz)		
			Conducted Power [dBm]				
DFT-s-OFDM $\pi/2$ BPSK	1	1	18.40	18.76	18.65	0	0.0
	1	40	18.38	18.83	18.58		0.0
	1	77	18.42	18.79	18.53		0.0
	36	0	18.41	18.87	18.62	0-0.5	0.0
	36	22	18.39	18.85	18.51	0	0.0
	36	43	18.31	18.78	18.41	0-0.5	0.0
	75	0	18.37	18.80	18.51		0.0
DFT-s-OFDM QPSK	1	1	18.50	18.81	18.70	0	0.0
	1	40	18.45	18.84	18.59		0.0
	1	77	18.51	18.81	18.49		0.0
	36	0	18.42	18.90	18.61	0-1	0.0
	36	22	18.41	18.85	18.57	0	0.0
	36	43	18.38	18.74	18.43	0-1	0.0
	75	0	18.39	18.81	18.56		0.0
DFT-s-OFDM 16QAM	1	1	18.71	19.01	18.91	0-1	0.0
CP-OFDM QPSK	1	1	18.59	18.87	18.70	0-1.5	0.0



FCC ID: A3LSMF916U	 PCTEST <small>Practical to be part of Samsung</small>	SAR EVALUATION REPORT		Approved by: Quality Manager
Document S/N: 1M2005200087-01-R2.A3L	Test Dates: 06/28/20-08/24/20	DUT Type: Portable Handset		Page 100 of 267

Table 9-127



NR Band n25 Measured P_{limit} for DSI = 1/2 (Phablet or UMPC Extremity with grip sensor active), or DSI = 5/6 (Hotspot Mode), and/or DSI = 7/8 (Earjack active) - 10 MHz Bandwidth

NR Band n25 10 MHz Bandwidth							
Modulation	RB Size	RB Offset	Channel			MPR Allowed per 3GPP [dB]	MPR [dB]
			371000 (1855 MHz)	376500 (1882.5 MHz)	382000 (1910 MHz)		
			Conducted Power [dBm]				
DFT-s-OFDM $\pi/2$ BPSK	1	1	18.39	18.81	18.46	0	0.0
	1	26	18.69	19.07	18.70		0.0
	1	50	18.41	18.72	18.43		0.0
	25	0	18.40	18.80	18.48	0-0.5	0.0
	25	14	18.40	18.82	18.46	0	0.0
	25	27	18.40	18.81	18.45	0-0.5	0.0
50	0	18.43	18.85	18.45	0.0		
DFT-s-OFDM QPSK	1	1	18.45	18.78	18.52	0	0.0
	1	26	18.51	18.91	18.64		0.0
	1	50	18.44	18.81	18.44		0.0
	25	0	18.47	18.78	18.45	0-1	0.0
	25	14	18.39	18.80	18.49	0	0.0
	25	27	18.48	18.85	18.52	0-1	0.0
50	0	18.42	18.82	18.51	0.0		
DFT-s-OFDM 16QAM	1	1	18.69	19.07	18.69	0-1	0.0
CP-OFDM QPSK	1	1	18.57	18.95	18.70	0-1.5	0.0

Table 9-128

NR Band n25 Measured P_{limit} for DSI = 1/2 (Phablet or UMPC Extremity with grip sensor active), or DSI = 5/6 (Hotspot Mode), and/or DSI = 7/8 (Earjack active) - 5 MHz Bandwidth

NR Band n25 5 MHz Bandwidth							
Modulation	RB Size	RB Offset	Channel			MPR Allowed per 3GPP [dB]	MPR [dB]
			370500 (1852.5 MHz)	376500 (1882.5 MHz)	382500 (1912.5 MHz)		
			Conducted Power [dBm]				
DFT-s-OFDM $\pi/2$ BPSK	1	1	18.72	19.00	18.63	0	0.0
	1	13	18.71	19.06	18.73		0.0
	1	23	18.80	18.91	18.71		0.0
	12	0	18.68	18.91	18.59	0-0.5	0.0
	12	7	18.71	18.97	18.64	0	0.0
	12	13	18.73	18.96	18.65	0-0.5	0.0
25	0	18.66	18.97	18.61	0.0		
DFT-s-OFDM QPSK	1	1	18.65	18.94	18.69	0	0.0
	1	13	18.76	18.95	18.70		0.0
	1	23	18.70	18.99	18.66		0.0
	12	0	18.66	18.90	18.60	0-1	0.0
	12	7	18.69	18.92	18.62	0	0.0
	12	13	18.73	19.01	18.63	0-1	0.0
25	0	18.69	18.94	18.60	0.0		
DFT-s-OFDM 16QAM	1	1	18.68	18.87	18.60	0-1	0.0
CP-OFDM QPSK	1	1	18.80	19.06	18.75	0-1.5	0.0

FCC ID: A3LSMF916U	 PCTEST <small> Proud to be part of Samsung </small>	SAR EVALUATION REPORT		Approved by: Quality Manager
Document S/N: 1M2005200087-01-R2.A3L	Test Dates: 06/28/20-08/24/20	DUT Type: Portable Handset		Page 101 of 267

9.5.4

NR Band n41

Table 9-129
NR Band n41 Measured P_{max} for all DSI - 100 MHz Bandwidth

NR Band n41 100 MHz Bandwidth						
Modulation	RB Size	RB Offset	Channel		MPR Allowed per 3GPP [dB]	MPR [dB]
			518598 (2592.99 MHz)	Conducted Power [dBm]		
DFT-s-OFDM $\pi/2$ BPSK	1	1	24.12	0	0.0	
	1	137	24.04		0.0	
	1	271	24.03		0.0	
	135	0	23.53	0-0.5	0.5	
	135	69	23.83	0	0.0	
	135	138	23.47	0-0.5	0.5	
	270	0	23.46	0-0.5	0.5	
DFT-s-OFDM QPSK	1	1	24.16	0	0.0	
	1	137	24.05		0.0	
	1	271	24.08		0.0	
	135	0	22.99	0-1	1.0	
	135	69	23.87	0	0.0	
	135	138	22.81	0-1	1.0	
	270	0	23.01		1.0	
DFT-s-OFDM 16QAM	1	1	23.33	0-1	1.0	
CP-OFDM QPSK	1	1	22.79	0-1.5	1.5	

Note: NR Band n41 at 100 MHz bandwidth does not support non-overlapping channels. Per FCC Guidance, when a device supports overlapping channel assignment in a channel bandwidth configuration, the middle channel of the group of overlapping channels should be selected for testing.

Table 9-130
NR Band n41 Measured P_{max} for all DSI - 90 MHz Bandwidth

NR Band n41 90 MHz Bandwidth						
Modulation	RB Size	RB Offset	Channel		MPR Allowed per 3GPP [dB]	MPR [dB]
			508200 (2541 MHz)	528996 (2644.98 MHz)		
			Conducted Power [dBm]			
DFT-s-OFDM $\pi/2$ BPSK	1	1	24.11	23.69	0	0.0
	1	123	23.72	24.12		0.0
	1	243	23.80	23.65		0.0
	120	0	23.46	23.29	0-0.5	0.5
	120	63	23.75	24.06	0	0.0
	120	125	23.39	23.25	0-0.5	0.5
	243	0	23.36	23.57		0.5
DFT-s-OFDM QPSK	1	1	24.06	23.58	0	0.0
	1	123	23.88	24.23		0.0
	1	243	23.90	23.73		0.0
	120	0	22.93	23.36	0-1	1.0
	120	63	23.79	24.02	0	0.0
	120	125	22.82	23.15	0-1	1.0
	243	0	22.87	23.08		1.0
DFT-s-OFDM 16QAM	1	1	23.15	22.68	0-1	1.0
CP-OFDM QPSK	1	1	22.57	22.14	0-1.5	1.5



FCC ID: A3LSMF916U	 PCTEST <small>Product to be tested at PCTEST</small>	SAR EVALUATION REPORT		Approved by: Quality Manager
Document S/N: 1M2005200087-01-R2.A3L	Test Dates: 06/28/20-08/24/20	DUT Type: Portable Handset		Page 102 of 267

Table 9-131
NR Band n41 Measured P_{max} for all DSI - 80 MHz Bandwidth

NR Band n41 80 MHz Bandwidth						
Modulation	RB Size	RB Offset	Channel		MPR Allowed per 3GPP [dB]	MPR [dB]
			507204 (2536.02 MHz)	529998 (2649.99 MHz)		
			Conducted Power [dBm]			
DFT-s-OFDM $\pi/2$ BPSK	1	1	23.82	23.43	0	0.0
	1	109	23.71	24.19		0.0
	1	215	23.85	23.69		0.0
	108	0	23.39	23.72	0-0.5	0.5
	108	55	23.68	24.04	0	0.0
	108	109	23.35	23.38	0-0.5	0.5
	216	0	23.48	23.29		0.5
DFT-s-OFDM QPSK	1	1	23.79	23.33	0	0.0
	1	109	23.77	24.08		0.0
	1	215	23.86	23.47		0.0
	108	0	22.84	23.23	0-1	1.0
	108	55	23.78	24.12	0	0.0
	108	109	22.81	23.33	0-1	1.0
	216	0	22.78	23.17		1.0
DFT-s-OFDM 16QAM	1	1	22.68	22.37	0-1	1.0
CP-OFDM QPSK	1	1	22.61	22.23	0-1.5	1.5

Table 9-132
NR Band n41 Measured P_{max} for all DSI - 60 MHz Bandwidth

NR Band n41 60 MHz Bandwidth							
Modulation	RB Size	RB Offset	Channel			MPR Allowed per 3GPP [dB]	MPR [dB]
			505200 (2526 MHz)	518598 (2592.99 MHz)	531996 (2659.98 MHz)		
			Conducted Power [dBm]				
DFT-s-OFDM $\pi/2$ BPSK	1	1	23.81	24.23	23.75	0	0.0
	1	81	23.79	24.34	24.29		0.0
	1	160	23.97	24.20	23.91		0.0
	81	0	23.69	23.66	23.64	0-0.5	0.5
	81	41	23.75	24.08	24.07	0	0.0
	81	81	23.42	23.41	23.66	0-0.5	0.5
	162	0	23.19	23.14	22.92		0.5
DFT-s-OFDM QPSK	1	1	24.13	23.84	23.62	0	0.0
	1	81	23.84	24.17	23.96		0.0
	1	160	24.18	23.94	23.77		0.0
	81	0	23.03	23.34	23.31	0-1	1.0
	81	41	23.69	24.06	24.07	0	0.0
	81	81	22.82	23.35	23.40	0-1	1.0
	162	0	22.87	23.10	23.33		1.0
DFT-s-OFDM 16QAM	1	1	22.81	23.36	22.81	0-1	1.0
CP-OFDM QPSK	1	1	21.93	22.90	22.46	0-1.5	1.5



FCC ID: A3LSMF916U	 PCTEST <small> Proud to be part of Samsung</small>	SAR EVALUATION REPORT		Approved by: Quality Manager
Document S/N: 1M2005200087-01-R2.A3L	Test Dates: 06/28/20-08/24/20	DUT Type: Portable Handset	Page 103 of 267	

Table 9-133
NR Band n41 Measured P_{max} for all DSI - 50 MHz Bandwidth

NR Band n41 50 MHz Bandwidth							
Modulation	RB Size	RB Offset	Channel			MPR Allowed per 3GPP [dB]	MPR [dB]
			504204 (2521.02 MHz)	518598 (2592.99 MHz)	532998 (2664.99 MHz)		
			Conducted Power [dBm]				
DFT-s-OFDM $\pi/2$ BPSK	1	1	23.96	24.19	24.22	0	0.0
	1	67	24.11	24.36	24.31		0.0
	1	131	24.02	23.88	24.05		0.0
	64	0	23.61	23.70	23.82	0-0.5	0.5
	64	35	23.85	24.18	24.26	0	0.0
	64	69	23.44	23.48	23.69	0-0.5	0.5
	128	0	22.72	23.39	23.07		0.5
DFT-s-OFDM QPSK	1	1	24.12	24.04	23.73	0	0.0
	1	67	23.83	24.10	24.26		0.0
	1	131	23.81	24.12	23.80		0.0
	64	0	22.94	23.26	23.42	0-1	1.0
	64	35	23.84	24.17	24.25	0	0.0
	64	69	22.82	23.29	23.54	0-1	1.0
	128	0	22.87	23.38	23.42		1.0
DFT-s-OFDM 16QAM	1	1	23.05	23.54	22.99	0-1	1.0
CP-OFDM QPSK	1	1	22.63	22.84	22.62	0-1.5	1.5

Table 9-134
NR Band n41 Measured P_{max} for all DSI - 40 MHz Bandwidth

NR Band n41 40 MHz Bandwidth								
Modulation	RB Size	RB Offset	Channel				MPR Allowed per 3GPP [dB]	MPR Allowed per 3GPP [dB]
			503202 (2516.01 MHz)	513468 (2567.34 MHz)	523734 (2618.67 MHz)	534000 (2670 MHz)		
			Conducted Power [dBm]					
DFT-s-OFDM $\pi/2$ BPSK	1	1	23.93	24.36	24.12	24.47	0	0.0
	1	53	24.26	24.34	24.44	24.56		0.0
	1	104	24.38	24.28	24.38	23.94		0.0
	50	0	23.64	24.23	24.07	24.12	0-0.5	0.5
	50	28	24.07	24.39	24.30	24.48	0	0.0
	50	56	23.68	24.05	24.02	24.12	0-0.5	0.5
	100	0	23.66	23.39	23.73	23.35		0.5
DFT-s-OFDM QPSK	1	1	23.77	24.10	24.59	24.50	0	0.0
	1	53	24.32	24.16	24.42	24.46		0.0
	1	104	24.25	23.92	24.38	24.21		0.0
	50	0	23.29	23.69	23.58	23.68	0-1	1.0
	50	28	24.18	24.22	24.35	24.31	0	0.0
	50	56	23.11	23.49	23.56	23.62	0-1	1.0
	100	0	23.14	23.56	23.52	23.84		1.0
DFT-s-OFDM 16QAM	1	1	22.98	23.87	23.25	23.42	0-1	1.0
CP-OFDM QPSK	1	1	22.46	23.14	22.87	23.17	0-1.5	1.5



FCC ID: A3LSMF916U	 PCTEST <small>Prove it to be part of Samsung</small>	SAR EVALUATION REPORT		Approved by: Quality Manager
Document S/N: 1M2005200087-01-R2.A3L	Test Dates: 06/28/20-08/24/20	DUT Type: Portable Handset	Page 104 of 267	

Table 9-135
NR Band n41 Measured P_{max} for all DSI - 20 MHz Bandwidth

NR Band n41 20 MHz Bandwidth										
Modulation	RB Size	RB Offset	Channel					MPR Allowed per 3GPP [dB]	MPR [dB]	
			501204 (2506.02 MHz)	509898 (2549.49 MHz)	518598 (2592.99 MHz)	527298 (2636.49 MHz)	535998 (2679.99 MHz)			
			Conducted Power [dBm]							
DFT-s-OFDM $\pi/2$ BPSK	1	1	24.12	24.18	24.12	24.22	24.29	0	0.0	
	1	26	24.17	24.09	24.31	24.24	23.91		0.0	
	1	49	24.01	24.11	23.97	24.09	23.96		0.0	
	DFT-s-OFDM QPSK	25	0	23.62	23.44	23.62	23.65	24.11	0-0.5	0.5
		25	13	24.06	23.99	24.07	24.08	24.32	0	0.0
		25	26	23.72	23.48	23.72	23.63	24.12	0-0.5	0.5
		50	0	23.69	23.53	23.76	23.67	23.93		0.5
1		1	23.97	23.87	24.17	24.04	24.34	0	0.0	
1	26	24.08	23.94	24.02	24.19	24.23	0.0			
1	49	23.89	23.92	24.06	24.12	23.87	0.0			
DFT-s-OFDM 16QAM	25	0	23.18	23.01	23.31	23.30	23.49	0-1	1.0	
	25	13	24.06	24.03	24.07	24.09	24.35	0	0.0	
	25	26	22.96	22.85	23.29	23.24	23.48	0-1	1.0	
50	0	23.07	22.96	23.24	23.25	23.53	1.0			
DFT-s-OFDM 16QAM	1	1	23.22	23.15	23.42	23.31	23.32	0-1	1.0	
CP-OFDM QPSK	1	1	22.58	22.49	22.82	22.62	23.11	0-1.5	1.5	

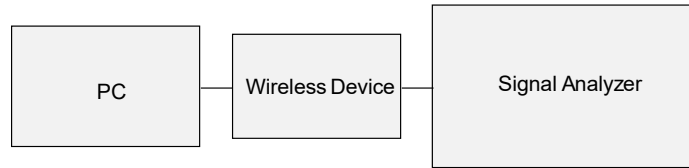

Figure 9-5
Power Measurement Setup

FCC ID: A3LSMF916U	PCTEST <small>Prove it to be part of Samsung</small>	SAR EVALUATION REPORT		Approved by: Quality Manager
Document S/N: 1M2005200087-01-R2.A3L	Test Dates: 06/28/20-08/24/20	DUT Type: Portable Handset	Page 105 of 267	

9.6 WLAN Conducted Powers

Table 9-136
2.4 GHz WLAN Maximum Average RF Power – Ant 1

2.4GHz Conducted Power [dBm]					
Freq [MHz]	Channel	IEEE Transmission Mode			
		802.11b	802.11g	802.11n	802.11ax
		Average	Average	Average	Average
2412	1	18.87	17.99	16.05	16.59
2417	2	N/A	N/A	17.74	17.94
2437	6	18.99	17.61	17.99	17.99
2457	10	N/A	N/A	17.77	17.80
2462	11	18.78	17.86	15.61	15.64

Table 9-137
2.4 GHz WLAN Maximum Average RF Power – Ant 2

2.4GHz Conducted Power [dBm]					
Freq [MHz]	Channel	IEEE Transmission Mode			
		802.11b	802.11g	802.11n	802.11ax
		Average	Average	Average	Average
2412	1	18.76	17.72	16.16	16.69
2417	2			17.83	17.87
2437	6	18.92	17.85	17.68	17.78
2457	10			17.74	17.99
2462	11	18.94	17.74	15.72	15.78

Table 9-138
2.4 GHz WLAN Maximum Average RF Power – MIMO

2.4GHz 802.11b Conducted Power [dBm]				
Freq [MHz]	Channel	ANT1	ANT2	MIMO
2412	1	18.87	18.76	21.83
2437	6	18.99	18.92	21.97
2462	11	18.78	18.94	21.87



FCC ID: A3LSMF916U	 PCTEST <small>Proud to be part of Samsung</small>	SAR EVALUATION REPORT		Approved by: Quality Manager
Document S/N: 1M2005200087-01-R2.A3L	Test Dates: 06/28/20-08/24/20	DUT Type: Portable Handset		Page 106 of 267

Table 9-139
5 GHz WLAN Maximum Average RF Power – Ant 1

5GHz (20MHz) Conducted Power [dBm]					
Freq [MHz]	Channel	IEEE Transmission Mode			
		802.11a	802.11n	802.11ac	802.11ax
		Average	Average	Average	Average
5180	36	17.67	17.48	17.51	17.54
5200	40	17.63	17.40	17.99	17.45
5220	44	17.99	17.87	17.84	17.99
5240	48	17.97	17.83	17.76	17.77
5260	52	17.47	17.96	17.90	17.39
5280	56	17.42	17.94	17.89	17.96
5300	60	17.99	17.82	17.81	17.82
5320	64	17.72	17.99	17.94	17.66
5500	100	17.99	17.99	17.86	17.92
5600	120	17.76	17.98	17.93	17.99
5620	124	17.99	17.91	17.91	17.99
5720	144	17.71	17.94	17.84	17.99
5745	149	17.71	17.99	17.90	17.51
5785	157	17.93	17.78	17.72	17.82
5825	165	17.58	17.83	17.85	17.53

Table 9-140
5 GHz WLAN Maximum Average RF Power – Ant 2

5GHz (20MHz) Conducted Power [dBm]					
Freq [MHz]	Channel	IEEE Transmission Mode			
		802.11a	802.11n	802.11ac	802.11ax
		Average	Average	Average	Average
5180	36	17.95	17.83	17.93	17.91
5200	40	17.91	17.81	17.70	17.84
5220	44	17.72	17.53	17.57	17.75
5240	48	17.65	17.53	17.55	17.71
5260	52	17.41	17.95	17.96	17.99
5280	56	17.37	17.78	17.86	17.83
5300	60	17.95	17.75	17.87	17.84
5320	64	17.81	17.67	17.72	17.62
5500	100	17.65	17.87	17.52	17.58
5600	120	17.62	17.52	17.51	17.60
5620	124	17.51	17.99	17.91	17.47
5720	144	17.72	17.65	17.68	17.71
5745	149	17.55	17.34	17.95	17.45
5785	157	17.98	17.81	17.91	17.92
5825	165	17.69	17.58	17.63	17.56



FCC ID: A3LSMF916U	 PCTEST <small>Proud to be part of Samsung</small>	SAR EVALUATION REPORT		Approved by: Quality Manager
Document S/N: 1M2005200087-01-R2.A3L	Test Dates: 06/28/20-08/24/20	DUT Type: Portable Handset		Page 107 of 267

Table 9-141
5 GHz WLAN Maximum Average RF Power – MIMO

5GHz (20MHz) 802.11n Conducted Power [dBm]				
Freq [MHz]	Channel	ANT1	ANT2	MIMO
5180	36	17.48	17.83	20.67
5200	40	17.40	17.81	20.62
5220	44	17.87	17.53	20.71
5240	48	17.83	17.53	20.69
5260	52	17.96	17.95	20.97
5280	56	17.94	17.78	20.87
5300	60	17.82	17.75	20.80
5320	64	17.99	17.67	20.84
5500	100	17.99	17.87	20.94
5600	120	17.98	17.52	20.77
5620	124	17.91	17.99	20.96
5720	144	17.94	17.65	20.81
5745	149	17.99	17.34	20.69
5785	157	17.78	17.81	20.81
5825	165	17.83	17.58	20.72

Table 9-142
2.4 GHz WLAN Reduced Average RF Power for conditions with RCV active or mmWave active – Ant 1

2.4GHz Conducted Power [dBm]					
Freq [MHz]	Channel	IEEE Transmission Mode			
		802.11b	802.11g	802.11n	802.11ax
		Average	Average	Average	Average
2412	1	12.49	12.33	12.61	12.50
2437	6	12.72	12.77	12.37	12.66
2462	11	12.51	12.37	12.25	12.33

Table 9-143
2.4 GHz WLAN Reduced Average RF Power for conditions with RCV active or mmWave active – Ant 2

2.4GHz Conducted Power [dBm]					
Freq [MHz]	Channel	IEEE Transmission Mode			
		802.11b	802.11g	802.11n	802.11ax
		Average	Average	Average	Average
2412	1	12.72	12.62	12.52	12.64
2437	6	12.53	12.91	12.63	12.72
2462	11	12.88	12.83	12.77	12.94



FCC ID: A3LSMF916U	 PCTEST <small>Proud to be part of Samsung</small>	SAR EVALUATION REPORT		Approved by: Quality Manager
Document S/N: 1M2005200087-01-R2.A3L	Test Dates: 06/28/20-08/24/20	DUT Type: Portable Handset		Page 108 of 267

Table 9-144
Maximum Output Powers During Conditions with 2.4 GHz and 5 GHz WLAN

2.4GHz 802.11n Conducted Power [dBm]			
Freq [MHz]	Channel	ANT1	ANT2
2412	1	16.11	16.06
2417	2	16.84	16.62
2437	6	16.93	16.91
2457	10	16.92	16.84
2462	11	15.70	15.54

Table 9-145
Maximum Output Powers During Conditions with 5G mmWave Active - MIMO

2.4GHz 802.11n Conducted Power [dBm]				
Freq [MHz]	Channel	ANT1	ANT2	MIMO
2412	1	12.61	12.52	15.58
2437	6	12.37	12.63	15.51
2462	11	12.25	12.77	15.53

Table 9-146
5 GHz WLAN Reduced Average RF Power for conditions with RCV active or mmWave active – Ant 1

5GHz (80MHz) Conducted Power [dBm]			
Freq [MHz]	Channel	IEEE Transmission Mode	
		802.11ac	802.11ax
		Average	Average
5210	42	10.64	10.48
5290	58	10.37	10.52
5530	106	10.56	10.72
5610	122	10.44	10.57
5690	138	10.28	10.43
5775	155	10.82	10.33

Table 9-147
5 GHz WLAN Reduced Average RF Power for conditions with RCV active or mmWave active – Ant 2

5GHz (80MHz) Conducted Power [dBm]			
Freq [MHz]	Channel	IEEE Transmission Mode	
		802.11ac	802.11ax
		Average	Average
5210	42	10.67	10.79
5290	58	10.67	10.75
5530	106	10.75	10.99
5610	122	10.57	10.93
5690	138	10.69	10.85
5775	155	10.76	10.73



FCC ID: A3LSMF916U	 <small>Proud to be part of Samsung</small>	SAR EVALUATION REPORT		Approved by: Quality Manager
Document S/N: 1M2005200087-01-R2.A3L	Test Dates: 06/28/20-08/24/20	DUT Type: Portable Handset		Page 109 of 267

Table 9-148
Reduced Output Powers During Conditions with 2.4 GHz and 5 GHz WLAN

5GHz (80MHz) 802.11ac Conducted Power [dBm]			
Freq [MHz]	Channel	ANT1	ANT2
5210	42	13.66	13.55
5290	58	13.60	13.85
5530	106	13.34	13.62
5610	122	13.37	13.59
5690	138	13.59	13.68
5775	155	13.87	13.80

Table 9-149
Reduced Output Powers During Conditions with 5G mmWave active - MIMO

5GHz (80MHz) 802.11ac Conducted Power [dBm]				
Freq [MHz]	Channel	ANT1	ANT2	MIMO
5210	42	10.64	10.67	13.67
5290	58	10.37	10.67	13.53
5530	106	10.56	10.75	13.67
5610	122	10.44	10.57	13.52
5690	138	10.28	10.69	13.50
5775	155	10.82	10.76	13.80

Justification for test configurations for WLAN per KDB Publication 248227 D01v02r02:

- Power measurements were performed for the transmission mode configuration with the highest maximum output power specified for production units.
- For transmission modes with the same maximum output power specification, powers were measured for the largest channel bandwidth, lowest order modulation and lowest data rate.
- For transmission modes with identical maximum specified output power, channel bandwidth, modulation and data rates, power measurements were required for all identical configurations.
- For each transmission mode configuration, powers were measured for the highest and lowest channels; and at the mid-band channel(s) when there were at least 3 channels supported. For configurations with multiple mid-band channels, due to an even number of channels, both channels were measured.

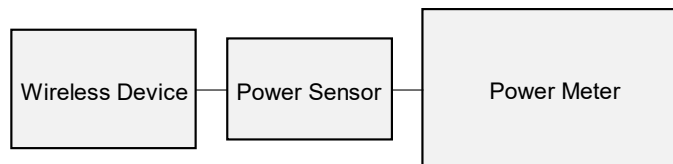



Figure 9-6
Power Measurement Setup

FCC ID: A3LSMF916U	 <small>Proud to be part of Samsung</small>	SAR EVALUATION REPORT		Approved by: Quality Manager
Document S/N: 1M2005200087-01-R2.A3L	Test Dates: 06/28/20-08/24/20	DUT Type: Portable Handset	Page 110 of 267	

9.7 Bluetooth Conducted Powers

Table 9-150
Bluetooth Maximum Average RF Power Ant 1

Frequency [MHz]	Data Rate [Mbps]	Mod.	Power Scheme	Channel No.	Avg Conducted Power	
					[dBm]	[mW]
2402	1.0	GFSK	ePA	0	19.23	83.657
2441	1.0	GFSK	ePA	39	19.53	89.660
2480	1.0	GFSK	ePA	78	18.28	67.220
2402	2.0	$\pi/4$ -DQPSK	ePA	0	15.60	36.266
2441	2.0	$\pi/4$ -DQPSK	ePA	39	16.06	40.365
2480	2.0	$\pi/4$ -DQPSK	ePA	78	14.73	29.724
2402	3.0	8DPSK	ePA	0	15.65	36.737
2441	3.0	8DPSK	ePA	39	16.06	40.355
2480	3.0	8DPSK	ePA	78	14.77	30.019

Table 9-151
Bluetooth Maximum Average RF Power Ant 2

Frequency [MHz]	Data Rate [Mbps]	Mod.	Power Scheme	Channel No.	Avg Conducted Power	
					[dBm]	[mW]
2402	1.0	GFSK	ePA	0	19.01	79.524
2441	1.0	GFSK	ePA	39	19.23	83.811
2480	1.0	GFSK	ePA	78	18.11	64.655
2402	2.0	$\pi/4$ -DQPSK	ePA	0	15.41	34.754
2441	2.0	$\pi/4$ -DQPSK	ePA	39	15.70	37.154
2480	2.0	$\pi/4$ -DQPSK	ePA	78	14.44	27.765
2402	3.0	8DPSK	ePA	0	15.49	35.367
2441	3.0	8DPSK	ePA	39	15.74	37.497
2480	3.0	8DPSK	ePA	78	14.46	27.893



FCC ID: A3LSMF916U	 PCTEST <small>Proud to be part of Samsung</small>	SAR EVALUATION REPORT		Approved by: Quality Manager
Document S/N: 1M2005200087-01-R2.A3L	Test Dates: 06/28/20-08/24/20	DUT Type: Portable Handset		Page 111 of 267

Table 9-152
Bluetooth Reduced Average RF Power Ant 1

Frequency [MHz]	Data Rate [Mbps]	Mod.	Power Scheme	Channel No.	Avg Conducted Power	
					[dBm]	[mW]
2402	1.0	GFSK	ePA	0	13.18	20.816
2441	1.0	GFSK	ePA	39	13.47	22.238
2480	1.0	GFSK	ePA	78	12.38	17.310
2402	2.0	$\pi/4$ -DQPSK	ePA	0	9.30	8.502
2441	2.0	$\pi/4$ -DQPSK	ePA	39	9.64	9.215
2480	2.0	$\pi/4$ -DQPSK	ePA	78	8.56	7.181
2402	3.0	8DPSK	ePA	0	9.36	8.638
2441	3.0	8DPSK	ePA	39	9.72	9.375
2480	3.0	8DPSK	ePA	78	8.62	7.281

Table 9-153
Bluetooth Reduced Average RF Power Ant 2

Frequency [MHz]	Data Rate [Mbps]	Mod.	Power Scheme	Channel No.	Avg Conducted Power	
					[dBm]	[mW]
2402	1.0	GFSK	ePA	0	13.24	21.062
2441	1.0	GFSK	ePA	39	13.62	23.009
2480	1.0	GFSK	ePA	78	12.31	17.006
2402	2.0	$\pi/4$ -DQPSK	ePA	0	9.33	8.571
2441	2.0	$\pi/4$ -DQPSK	ePA	39	9.76	9.472
2480	2.0	$\pi/4$ -DQPSK	ePA	78	8.47	7.028
2402	3.0	8DPSK	ePA	0	9.42	8.750
2441	3.0	8DPSK	ePA	39	9.84	9.630
2480	3.0	8DPSK	ePA	78	8.55	7.161



FCC ID: A3LSMF916U	 <small> Proud to be part of Samsung</small>	SAR EVALUATION REPORT		Approved by: Quality Manager
Document S/N: 1M2005200087-01-R2.A3L	Test Dates: 06/28/20-08/24/20	DUT Type: Portable Handset		Page 112 of 267

Figure 9-7
Bluetooth Transmission Plot Ant 1



Equation 9-1
Bluetooth Duty Cycle Calculation Ant 1

$$Duty\ Cycle = \frac{Pulse\ Width}{Period} * 100\% = \frac{2.92ms}{3.75ms} * 100\% = 77.9\%$$

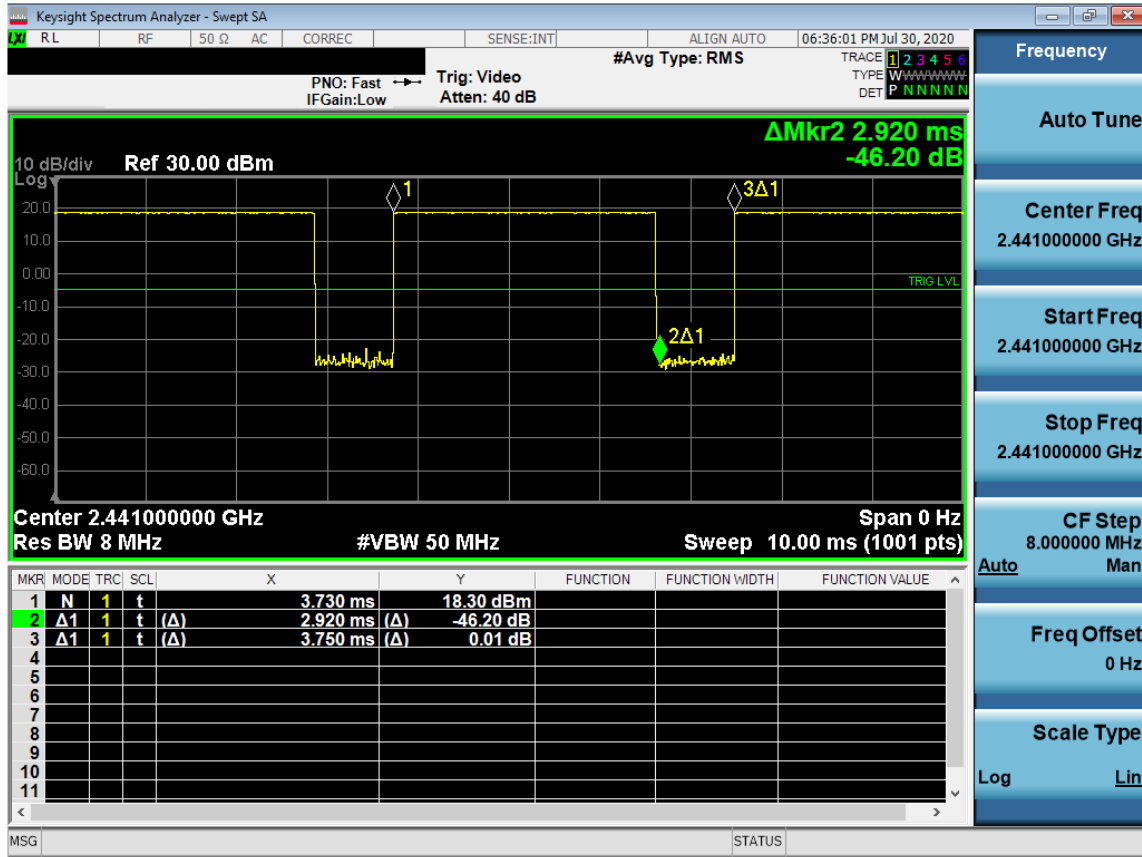

FCC ID: A3LSMF916U	 PCTEST <small>Prove it to be part of it</small>	SAR EVALUATION REPORT		Approved by: Quality Manager
Document S/N: 1M2005200087-01-R2.A3L	Test Dates: 06/28/20-08/24/20	DUT Type: Portable Handset		Page 113 of 267

Figure 9-8
Bluetooth Transmission Plot Ant 2



Equation 9-2
Bluetooth Duty Cycle Calculation Ant 2

$$Duty\ Cycle = \frac{Pulse\ Width}{Period} * 100\% = \frac{2.90ms}{3.75ms} * 100\% = 77.3\%$$

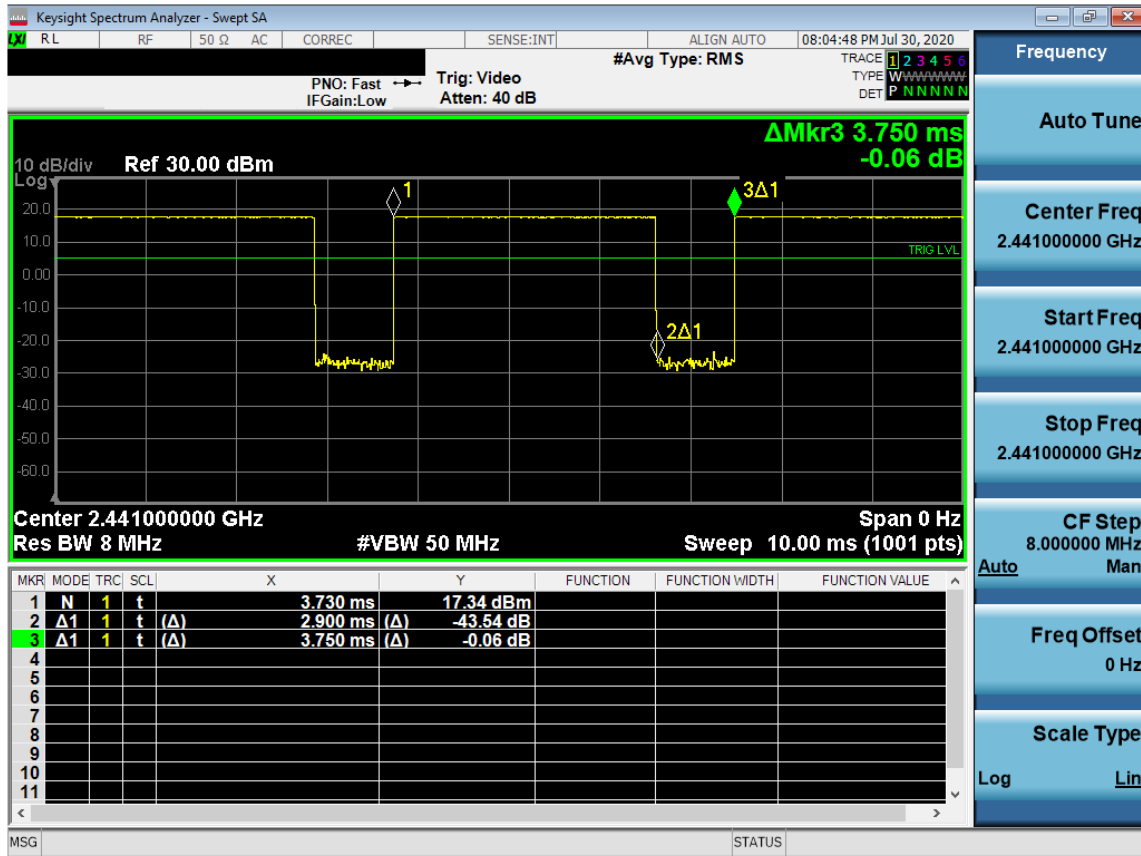
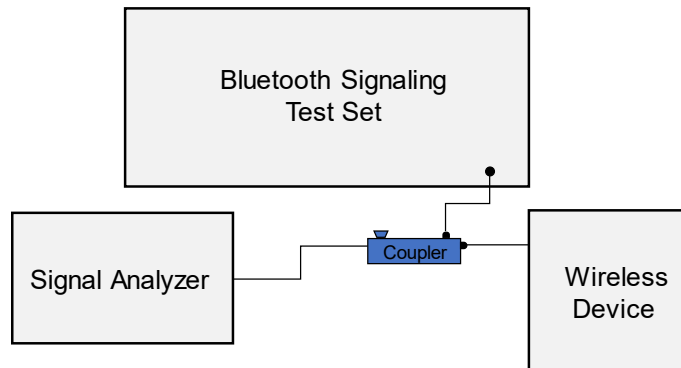

Figure 9-9
Power Measurement Setup



FCC ID: A3L5MF916U	PCTEST Proud to be part of Samsung	SAR EVALUATION REPORT		Approved by: Quality Manager
Document S/N: 1M2005200087-01-R2.A3L	Test Dates: 06/28/20-08/24/20	DUT Type: Portable Handset		Page 114 of 267

10 SYSTEM VERIFICATION

10.1 Tissue Verification

**Table 10-1
Measured Head Tissue Properties**

Calibrated for Tests Performed on:	Tissue Type	Tissue Temp During Calibration (°C)	Measured Frequency (MHz)	Measured Conductivity, σ (S/m)	Measured Dielectric Constant, ϵ	TARGET Conductivity, σ (S/m)	TARGET Dielectric Constant, ϵ	% dev σ	% dev ϵ
07/05/2020	750H	21.9	680	0.855	43.225	0.888	42.305	-3.72%	2.17%
			695	0.862	43.179	0.889	42.227	-3.04%	2.25%
			750	0.883	43.064	0.894	41.942	-1.23%	2.68%
07/23/2020	750H	24.2	680	0.851	43.279	0.888	42.305	-4.17%	2.30%
			695	0.856	43.234	0.889	42.227	-3.71%	2.38%
			700	0.857	43.213	0.889	42.201	-3.60%	2.40%
			710	0.860	43.180	0.890	42.149	-3.37%	2.45%
			750	0.873	43.074	0.894	41.942	-2.35%	2.70%
			770	0.880	43.037	0.895	41.838	-1.68%	2.87%
			785	0.885	42.999	0.896	41.760	-1.23%	2.97%
			800	0.891	42.950	0.897	41.682	-0.67%	3.04%
06/29/2020	835H	22.1	820	0.891	41.952	0.899	41.578	-0.89%	0.90%
			835	0.906	41.748	0.900	41.500	0.67%	0.60%
			850	0.922	41.546	0.916	41.500	0.66%	0.11%
07/06/2020	835H	23.0	820	0.897	42.804	0.899	41.578	-0.22%	2.95%
			835	0.903	42.758	0.900	41.500	0.33%	3.03%
			850	0.909	42.721	0.916	41.500	-0.76%	2.94%
07/02/2020	1750H	22.7	1710	1.289	40.843	1.348	40.142	-4.38%	1.75%
			1720	1.296	40.827	1.354	40.126	-4.28%	1.75%
			1745	1.311	40.800	1.368	40.087	-4.17%	1.78%
			1750	1.314	40.794	1.371	40.079	-4.16%	1.78%
			1770	1.325	40.764	1.383	40.047	-4.19%	1.79%
07/11/2020	1750H	22.5	1710	1.300	41.079	1.348	40.142	-3.56%	2.33%
			1720	1.306	41.066	1.354	40.126	-3.55%	2.34%
			1745	1.319	41.032	1.368	40.087	-3.58%	2.36%
			1750	1.321	41.025	1.371	40.079	-3.65%	2.36%
			1770	1.333	40.996	1.383	40.047	-3.62%	2.37%
07/03/2020	1900H	21.3	1850	1.340	40.157	1.400	40.000	-4.29%	0.39%
			1860	1.346	40.142	1.400	40.000	-3.86%	0.36%
			1880	1.359	40.110	1.400	40.000	-2.93%	0.27%
			1900	1.371	40.081	1.400	40.000	-2.07%	0.20%
			1905	1.374	40.076	1.400	40.000	-1.86%	0.19%
08/05/2020	1900H	21.8	1910	1.377	40.069	1.400	40.000	-1.64%	0.17%
			1860	1.350	41.515	1.400	40.000	-3.57%	3.79%
			1880	1.362	41.487	1.400	40.000	-2.71%	3.72%
			1900	1.373	41.464	1.400	40.000	-1.93%	3.66%
			1905	1.376	41.459	1.400	40.000	-1.71%	3.65%
08/17/2020	2300H	24.0	2300	1.636	40.799	1.670	39.500	-2.04%	3.29%
			2310	1.643	40.783	1.679	39.480	-2.14%	3.30%
			2320	1.650	40.767	1.687	39.460	-2.19%	3.31%
06/28/2020	2450-2600H	22.3	2450	1.821	41.109	1.800	39.200	1.17%	4.87%
			2500	1.857	41.050	1.855	39.136	0.11%	4.89%
			2510	1.867	41.036	1.866	39.123	0.05%	4.89%
			2535	1.890	40.996	1.893	39.092	-0.16%	4.87%
			2550	1.900	40.981	1.909	39.073	-0.47%	4.88%
			2560	1.910	40.956	1.920	39.060	-0.52%	4.85%
			2600	1.941	40.903	1.964	39.009	-1.17%	4.86%
			2650	1.984	40.813	2.018	38.945	-1.68%	4.80%
			2680	2.010	40.760	2.051	38.907	-2.00%	4.76%



FCC ID: A3LSMF916U	 PCTEST <small> Proud to be part of Samsung</small>	SAR EVALUATION REPORT		Approved by: Quality Manager
Document S/N: 1M2005200087-01-R2.A3L	Test Dates: 06/28/20-08/24/20	DUT Type: Portable Handset		Page 115 of 267

**Table 10-2
Measured Head Tissue Properties Continued**

Calibrated for Tests Performed on:	Tissue Type	Tissue Temp During Calibration (°C)	Measured Frequency (MHz)	Measured Conductivity, σ (S/m)	Measured Dielectric Constant, ϵ	TARGET Conductivity, σ (S/m)	TARGET Dielectric Constant, ϵ	% dev σ	% dev ϵ
07/20/2020	2450H	22.0	2400	1.746	40.788	1.756	39.289	-0.57%	3.82%
			2450	1.788	40.696	1.800	39.200	-0.67%	3.82%
			2480	1.809	40.656	1.833	39.162	-1.31%	3.81%
08/04/2020	2450H	24.1	2400	1.807	38.963	1.756	39.289	2.90%	-0.83%
			2450	1.867	38.764	1.800	39.200	3.72%	-1.11%
			2480	1.903	38.630	1.833	39.162	3.82%	-1.36%
07/24/2020	3600H	22.4	3500	2.872	39.373	2.913	37.929	-1.41%	3.81%
			3550	2.913	39.313	2.964	37.871	-1.72%	3.81%
			3560	2.922	39.303	2.974	37.860	-1.75%	3.81%
			3600	2.953	39.244	3.015	37.814	-2.06%	3.78%
			3650	2.997	39.191	3.066	37.757	-2.25%	3.80%
			3690	3.028	39.119	3.107	37.711	-2.54%	3.73%
07/13/2020	5200-5800H	21.7	3700	3.037	39.104	3.117	37.700	-2.57%	3.72%
			5250	4.583	36.641	4.706	35.929	-2.61%	1.98%
			5290	4.632	36.563	4.748	35.883	-2.44%	1.90%
			5530	4.867	36.119	4.994	35.609	-2.54%	1.43%
			5600	4.938	35.953	5.065	35.529	-2.51%	1.19%
			5750	5.092	35.667	5.219	35.357	-2.43%	0.88%
			5775	5.112	35.633	5.245	35.329	-2.54%	0.86%



**Table 10-3
Measured Body Tissue Properties**

Calibrated for Tests Performed on:	Tissue Type	Tissue Temp During Calibration (°C)	Measured Frequency (MHz)	Measured Conductivity, σ (S/m)	Measured Dielectric Constant, ϵ	TARGET Conductivity, σ (S/m)	TARGET Dielectric Constant, ϵ	% dev σ	% dev ϵ
7/1/2020	750B	21.8	680	0.929	54.129	0.958	55.804	-3.03%	-3.00%
			695	0.934	54.096	0.959	55.745	-2.61%	-2.96%
			750	0.955	53.959	0.964	55.531	-0.93%	-2.83%
7/21/2020	750B	21.5	680	0.924	54.277	0.958	55.804	-3.55%	-2.74%
			695	0.929	54.260	0.959	55.745	-3.13%	-2.66%
			700	0.931	54.252	0.959	55.726	-2.92%	-2.65%
			710	0.935	54.233	0.960	55.687	-2.60%	-2.61%
			750	0.951	54.099	0.964	55.531	-1.35%	-2.58%
7/26/2020	750B	21.6	680	0.941	53.750	0.958	55.804	-1.77%	-3.68%
			695	0.946	53.711	0.959	55.745	-1.36%	-3.65%
			750	0.967	53.555	0.964	55.531	0.31%	-3.56%
			770	0.975	53.493	0.965	55.453	1.04%	-3.53%
7/28/2020	750B	21.9	785	0.981	53.455	0.966	55.395	1.55%	-3.50%
			750	0.969	53.190	0.964	55.531	0.52%	-4.22%
			800	0.988	53.067	0.967	55.336	2.17%	-4.10%
7/30/2020	750B	21.4	680	0.938	53.959	0.958	55.804	-2.09%	-3.31%
			695	0.944	53.921	0.959	55.745	-1.56%	-3.27%
			700	0.945	53.910	0.959	55.726	-1.46%	-3.26%
			710	0.949	53.880	0.960	55.687	-1.15%	-3.24%
			750	0.964	53.772	0.964	55.531	0.00%	-3.17%
			770	0.972	53.721	0.965	55.453	0.73%	-3.12%
8/3/2020	750B	21.9	785	0.978	53.689	0.966	55.395	1.24%	-3.08%
			680	0.947	53.700	0.958	55.804	-1.15%	-3.77%
			695	0.952	53.668	0.959	55.745	-0.73%	-3.73%
			750	0.973	53.556	0.964	55.531	0.93%	-3.56%
			770	0.981	53.499	0.965	55.453	1.66%	-3.52%
08/24/2020	750B	21.7	785	0.987	53.459	0.966	55.395	2.17%	-3.49%
			800	0.993	53.419	0.967	55.336	2.69%	-3.46%
			680	0.921	53.650	0.958	55.804	-3.86%	-3.86%
			695	0.926	53.613	0.959	55.745	-3.44%	-3.82%
			750	0.947	53.467	0.964	55.531	-1.76%	-3.72%

FCC ID: A3LSMF916U	 PCTEST <small>Proud to be part of Samsung</small>	SAR EVALUATION REPORT		Approved by: Quality Manager
Document S/N: 1M2005200087-01-R2.A3L	Test Dates: 06/28/20-08/24/20	DUT Type: Portable Handset		Page 116 of 267



**Table 10-4
Measured Body Tissue Properties Continued**

Calibrated for Tests Performed on:	Tissue Type	Tissue Temp During Calibration (°C)	Measured Frequency (MHz)	Measured Conductivity, σ (S/m)	Measured Dielectric Constant, ϵ	TARGET Conductivity, σ (S/m)	TARGET Dielectric Constant, ϵ	% dev σ	% dev ϵ
7/19/2020	835B	21.4	820	0.944	54.450	0.969	55.258	-2.58%	-1.46%
			835	0.960	54.305	0.970	55.200	-1.03%	-1.62%
			850	0.975	54.157	0.988	55.154	-1.32%	-1.81%
7/30/2020	835B	22.8	820	0.940	54.085	0.969	55.258	-2.99%	-2.12%
			835	0.955	53.949	0.970	55.200	-1.55%	-2.27%
			850	0.970	53.808	0.988	55.154	-1.82%	-2.44%
7/30/2020	835B	21.4	820	0.991	53.604	0.969	55.258	2.27%	-2.99%
			835	0.997	53.562	0.970	55.200	2.78%	-2.97%
			850	1.004	53.529	0.988	55.154	1.62%	-2.95%
8/2/2020	835B	22.1	820	0.951	53.778	0.969	55.258	-1.86%	-2.68%
			835	0.967	53.620	0.970	55.200	-0.31%	-2.86%
			850	0.981	53.461	0.988	55.154	-0.71%	-3.07%
8/4/2020	835B	22.0	820	0.996	53.002	0.969	55.258	2.79%	-4.08%
			835	1.002	52.962	0.970	55.200	3.30%	-4.05%
			850	1.008	52.922	0.988	55.154	2.02%	-4.05%
8/7/2020	835B	22.1	820	0.937	54.773	0.969	55.258	-3.30%	-0.88%
			835	0.952	54.633	0.970	55.200	-1.86%	-1.03%
			850	0.968	54.483	0.988	55.154	-2.02%	-1.22%
8/10/2020	835B	23.3	820	0.941	53.313	0.969	55.258	-2.89%	-3.52%
			835	0.956	53.169	0.970	55.200	-1.44%	-3.68%
			850	0.971	53.018	0.988	55.154	-1.72%	-3.87%
07/01/2020	1750B	21.4	1710	1.459	51.490	1.463	53.537	-0.27%	-3.82%
			1720	1.472	51.448	1.469	53.511	0.20%	-3.86%
			1745	1.501	51.347	1.485	53.445	1.08%	-3.93%
			1750	1.507	51.327	1.488	53.432	1.28%	-3.94%
			1770	1.528	51.241	1.501	53.379	1.80%	-4.01%
07/16/2020	1750B	21.1	1710	1.470	51.143	1.463	53.537	0.48%	-4.47%
			1720	1.482	51.101	1.469	53.511	0.88%	-4.50%
			1745	1.510	51.001	1.485	53.445	1.68%	-4.57%
			1750	1.515	50.982	1.488	53.432	1.81%	-4.59%
			1770	1.537	50.907	1.501	53.379	2.40%	-4.63%
07/20/2020	1750B	23.2	1710	1.485	51.958	1.463	53.537	1.50%	-2.95%
			1720	1.497	51.927	1.469	53.511	1.91%	-2.96%
			1745	1.526	51.848	1.485	53.445	2.76%	-2.99%
			1750	1.532	51.829	1.488	53.432	2.96%	-3.00%
			1770	1.552	51.733	1.501	53.379	3.40%	-3.08%
07/22/2020	1750B	21.5	1710	1.480	51.601	1.463	53.537	1.16%	-3.62%
			1720	1.492	51.558	1.469	53.511	1.57%	-3.65%
			1745	1.520	51.456	1.485	53.445	2.36%	-3.72%
			1750	1.526	51.434	1.488	53.432	2.55%	-3.74%
			1770	1.547	51.349	1.501	53.379	3.06%	-3.80%
07/23/2020	1750B	21.5	1710	1.476	51.270	1.463	53.537	0.89%	-4.23%
			1720	1.487	51.238	1.469	53.511	1.23%	-4.25%
			1745	1.516	51.154	1.485	53.445	2.09%	-4.29%
			1750	1.522	51.137	1.488	53.432	2.28%	-4.30%
			1770	1.545	51.070	1.501	53.379	2.93%	-4.33%
07/26/2020	1750B	21.4	1710	1.469	51.295	1.463	53.537	0.41%	-4.19%
			1720	1.481	51.251	1.469	53.511	0.82%	-4.22%
			1745	1.508	51.136	1.485	53.445	1.55%	-4.32%
			1750	1.514	51.115	1.488	53.432	1.75%	-4.34%
			1770	1.535	51.035	1.501	53.379	2.27%	-4.39%
07/29/2020	1750B	22.0	1720	1.460	51.241	1.469	53.511	-0.61%	-4.24%
			1745	1.488	51.138	1.485	53.445	0.20%	-4.32%
			1750	1.493	51.117	1.488	53.432	0.34%	-4.33%
			1770	1.515	51.035	1.501	53.379	0.93%	-4.39%

FCC ID: A3LSMF916U	 PCTEST <small>Proud to be part of Samsung</small>	SAR EVALUATION REPORT		Approved by: Quality Manager
Document S/N: 1M2005200087-01-R2.A3L	Test Dates: 06/28/20-08/24/20	DUT Type: Portable Handset		Page 117 of 267



**Table 10-5
Measured Body Tissue Properties Continued**

Calibrated for Tests Performed on:	Tissue Type	Tissue Temp During Calibration (°C)	Measured Frequency (MHz)	Measured Conductivity, σ (S/m)	Measured Dielectric Constant, ϵ	TARGET Conductivity, σ (S/m)	TARGET Dielectric Constant, ϵ	% dev σ	% dev ϵ
06/29/2020	1900B	23.8	1850	1.528	51.458	1.520	53.300	0.53%	-3.46%
			1860	1.539	51.424	1.520	53.300	1.25%	-3.52%
			1880	1.561	51.358	1.520	53.300	2.70%	-3.64%
			1900	1.583	51.289	1.520	53.300	4.14%	-3.77%
			1905	1.589	51.270	1.520	53.300	4.54%	-3.81%
1910	1.594	51.251	1.520	53.300	4.87%	-3.84%			
07/01/2020	1900B	23.5	1850	1.529	52.474	1.520	53.300	0.59%	-1.55%
			1860	1.539	52.461	1.520	53.300	1.25%	-1.57%
			1880	1.563	52.387	1.520	53.300	2.83%	-1.71%
			1900	1.584	52.325	1.520	53.300	4.21%	-1.83%
			1905	1.589	52.322	1.520	53.300	4.54%	-1.83%
1910	1.595	52.303	1.520	53.300	4.93%	-1.87%			
07/06/2020	1900B	23.5	1850	1.520	51.807	1.520	53.300	0.00%	-2.80%
			1860	1.531	51.769	1.520	53.300	0.72%	-2.87%
			1880	1.553	51.691	1.520	53.300	2.17%	-3.02%
			1900	1.575	51.624	1.520	53.300	3.62%	-3.14%
			1905	1.581	51.608	1.520	53.300	4.01%	-3.17%
1910	1.587	51.590	1.520	53.300	4.41%	-3.21%			
07/11/2020	1900B	23.6	1860	1.516	52.894	1.520	53.300	-0.26%	-0.76%
			1880	1.539	52.837	1.520	53.300	1.25%	-0.87%
			1900	1.562	52.779	1.520	53.300	2.76%	-0.98%
			1905	1.567	52.763	1.520	53.300	3.09%	-1.01%
07/14/2020	1900B	23.1	1850	1.500	52.884	1.520	53.300	-1.32%	-0.78%
			1860	1.512	52.850	1.520	53.300	-0.53%	-0.84%
			1880	1.534	52.790	1.520	53.300	0.92%	-0.96%
			1900	1.556	52.729	1.520	53.300	2.37%	-1.07%
			1905	1.562	52.713	1.520	53.300	2.76%	-1.10%
1910	1.568	52.697	1.520	53.300	3.16%	-1.13%			
07/17/2020	1900B	23.6	1860	1.509	53.969	1.520	53.300	-0.72%	1.26%
			1880	1.532	53.910	1.520	53.300	0.79%	1.14%
			1900	1.555	53.847	1.520	53.300	2.30%	1.03%
			1905	1.561	53.829	1.520	53.300	2.70%	0.99%
07/20/2020	1900B	23.7	1850	1.500	54.200	1.520	53.300	-1.32%	1.69%
			1860	1.510	54.163	1.520	53.300	-0.66%	1.62%
			1880	1.532	54.098	1.520	53.300	0.79%	1.50%
			1900	1.554	54.033	1.520	53.300	2.24%	1.38%
			1905	1.560	54.013	1.520	53.300	2.63%	1.34%
1910	1.565	53.995	1.520	53.300	2.96%	1.30%			
07/27/2020	1900B	24.5	1850	1.468	52.960	1.520	53.300	-3.42%	-0.64%
			1860	1.478	52.927	1.520	53.300	-2.76%	-0.70%
			1880	1.499	52.867	1.520	53.300	-1.38%	-0.81%
			1900	1.521	52.810	1.520	53.300	0.07%	-0.92%
			1905	1.526	52.797	1.520	53.300	0.39%	-0.94%
1910	1.532	52.783	1.520	53.300	0.79%	-0.97%			
07/30/2020	1900B	23.3	1850	1.495	51.222	1.520	53.300	-1.64%	-3.90%
			1860	1.506	51.187	1.520	53.300	-0.92%	-3.96%
			1880	1.528	51.120	1.520	53.300	0.53%	-4.09%
			1900	1.550	51.060	1.520	53.300	1.97%	-4.20%
			1905	1.556	51.048	1.520	53.300	2.37%	-4.23%
1910	1.562	51.035	1.520	53.300	2.76%	-4.25%			
07/30/2020	1900B	23.3	1860	1.520	52.123	1.520	53.300	0.00%	-2.21%
			1880	1.541	52.064	1.520	53.300	1.38%	-2.32%
			1900	1.562	51.999	1.520	53.300	2.76%	-2.44%
			1905	1.567	51.983	1.520	53.300	3.09%	-2.47%

FCC ID: A3LSMF916U	 PCTEST <small>Proud to be part of Samsung</small>	SAR EVALUATION REPORT		Approved by: Quality Manager
Document S/N: 1M2005200087-01-R2.A3L	Test Dates: 06/28/20-08/24/20	DUT Type: Portable Handset		Page 118 of 267



**Table 10-6
Measured Body Tissue Properties Continued**

Calibrated for Tests Performed on:	Tissue Type	Tissue Temp During Calibration (°C)	Measured Frequency (MHz)	Measured Conductivity, σ (S/m)	Measured Dielectric Constant, ϵ	TARGET Conductivity, σ (S/m)	TARGET Dielectric Constant, ϵ	% dev σ	% dev ϵ
08/03/2020	1900B	24.6	1850	1.485	51.868	1.520	53.300	-2.30%	-2.69%
			1860	1.495	51.837	1.520	53.300	-1.64%	-2.74%
			1880	1.517	51.774	1.520	53.300	-0.20%	-2.86%
			1900	1.539	51.711	1.520	53.300	1.25%	-2.98%
			1905	1.544	51.695	1.520	53.300	1.58%	-3.01%
			1910	1.550	51.680	1.520	53.300	1.97%	-3.04%
08/06/2020	1900B	23.8	1850	1.488	52.497	1.520	53.300	-2.11%	-1.51%
			1860	1.499	52.465	1.520	53.300	-1.38%	-1.57%
			1880	1.520	52.403	1.520	53.300	0.00%	-1.68%
			1900	1.541	52.348	1.520	53.300	1.38%	-1.79%
			1905	1.547	52.334	1.520	53.300	1.78%	-1.81%
			1910	1.552	52.321	1.520	53.300	2.11%	-1.84%
07/11/2020	2300B	23.0	2300	1.824	51.870	1.809	52.900	0.83%	-1.95%
			2310	1.832	51.838	1.816	52.887	0.88%	-1.98%
			2320	1.844	51.811	1.826	52.873	0.99%	-2.01%
07/14/2020	2300B	22.6	2300	1.870	51.376	1.809	52.900	3.37%	-2.88%
			2310	1.881	51.350	1.816	52.887	3.58%	-2.91%
			2320	1.893	51.326	1.826	52.873	3.67%	-2.93%
08/17/2020	2300B	23.1	2300	1.875	53.389	1.809	52.900	3.65%	0.92%
			2310	1.886	53.361	1.816	52.887	3.85%	0.90%
			2320	1.897	53.334	1.826	52.873	3.89%	0.87%
07/12/2020	2450B	23.1	2400	1.926	51.956	1.902	52.767	1.26%	-1.54%
			2450	1.990	51.778	1.950	52.700	2.05%	-1.75%
			2480	2.033	51.663	1.993	52.662	2.01%	-1.90%
07/20/2020	2450-2600B	23.6	2450	2.034	51.503	1.950	52.700	4.31%	-2.27%
			2510	2.107	51.321	2.035	52.623	3.54%	-2.47%
			2535	2.137	51.247	2.071	52.592	3.19%	-2.56%
			2560	2.168	51.176	2.106	52.560	2.94%	-2.63%
			2600	2.216	51.051	2.163	52.509	2.45%	-2.78%
			2400	1.968	50.879	1.902	52.767	3.47%	-3.58%
07/23/2020	2450-2600B	23.0	2450	2.027	50.733	1.950	52.700	3.95%	-3.73%
			2480	2.060	50.647	1.993	52.662	3.36%	-3.83%
			2510	2.095	50.546	2.035	52.623	2.95%	-3.95%
			2535	2.125	50.469	2.071	52.592	2.61%	-4.04%
			2560	2.156	50.412	2.106	52.560	2.37%	-4.09%
			2600	2.201	50.296	2.163	52.509	1.76%	-4.21%
07/27/2020	2450B	21.9	2400	1.986	51.443	1.902	52.767	4.42%	-2.51%
			2450	2.046	51.291	1.950	52.700	4.92%	-2.67%
			2480	2.080	51.200	1.993	52.662	4.37%	-2.78%
07/27/2020	2450-2600B	22.3	2450	1.990	51.723	1.950	52.700	2.05%	-1.85%
			2510	2.068	51.480	2.035	52.623	1.62%	-2.17%
			2535	2.104	51.385	2.071	52.592	1.59%	-2.30%
			2560	2.136	51.301	2.106	52.560	1.42%	-2.40%
			2600	2.189	51.129	2.163	52.509	1.20%	-2.63%
07/30/2020	2450-2600B	23.4	2450	1.992	50.790	1.950	52.700	2.15%	-3.62%
			2510	2.075	50.563	2.035	52.623	1.97%	-3.91%
			2535	2.109	50.465	2.071	52.592	1.83%	-4.04%
			2560	2.144	50.362	2.106	52.560	1.80%	-4.18%
			2600	2.202	50.211	2.163	52.509	1.80%	-4.38%
07/31/2020	2450-2600B	24.0	2450	2.045	51.557	1.950	52.700	4.87%	-2.17%
			2500	2.097	51.387	2.021	52.636	3.76%	-2.37%
			2510	2.109	51.357	2.035	52.623	3.64%	-2.41%
			2535	2.141	51.292	2.071	52.592	3.38%	-2.47%
			2550	2.160	51.259	2.092	52.573	3.25%	-2.50%
			2560	2.172	51.240	2.106	52.560	3.13%	-2.51%
			2600	2.214	51.127	2.163	52.509	2.36%	-2.63%
			2650	2.276	50.954	2.234	52.445	1.88%	-2.84%
2680	2.316	50.878	2.277	52.407	1.71%	-2.92%			

FCC ID: A3LSMF916U	 PCTEST <small>Proud to be part of Samsung</small>	SAR EVALUATION REPORT		Approved by: Quality Manager
Document S/N: 1M2005200087-01-R2.A3L	Test Dates: 06/28/20-08/24/20	DUT Type: Portable Handset		Page 119 of 267

**Table 10-7
Measured Body Tissue Properties Continued**



Calibrated for Tests Performed on:	Tissue Type	Tissue Temp During Calibration (°C)	Measured Frequency (MHz)	Measured Conductivity, σ (S/m)	Measured Dielectric Constant, ϵ	TARGET Conductivity, σ (S/m)	TARGET Dielectric Constant, ϵ	% dev σ	% dev ϵ
08/03/2020	2450-2600B	23.0	2450	2.029	52.269	1.950	52.700	4.05%	-0.82%
			2500	2.089	52.123	2.021	52.636	3.36%	-0.97%
			2510	2.098	52.092	2.035	52.623	3.10%	-1.01%
			2535	2.129	52.028	2.071	52.592	2.80%	-1.07%
			2550	2.147	51.999	2.092	52.573	2.63%	-1.09%
			2560	2.161	51.973	2.106	52.560	2.61%	-1.12%
			2600	2.210	51.841	2.163	52.509	2.17%	-1.27%
			2650	2.268	51.680	2.234	52.445	1.52%	-1.46%
08/03/2020	2450-2600B	23.8	2400	1.959	51.741	1.902	52.767	3.00%	-1.94%
			2450	2.026	51.539	1.950	52.700	3.90%	-2.20%
			2480	2.067	51.418	1.993	52.662	3.71%	-2.36%
			2510	2.108	51.308	2.035	52.623	3.59%	-2.50%
			2535	2.141	51.203	2.071	52.592	3.38%	-2.64%
			2560	2.176	51.087	2.106	52.560	3.32%	-2.80%
			2600	2.233	50.936	2.163	52.509	3.24%	-3.00%
			08/10/2020	2450B	21.6	2400	1.974	51.902	1.902
2450	2.044	51.681				1.950	52.700	4.82%	-1.93%
2480	2.087	51.579				1.993	52.662	4.72%	-2.06%
2500	2.112	51.504				2.021	52.636	4.50%	-2.15%
2510	2.125	51.464				2.035	52.623	4.42%	-2.20%
07/27/2020	3600B	21.6	3500	3.392	49.974	3.314	51.321	2.35%	-2.62%
			3550	3.445	49.890	3.372	51.254	2.16%	-2.66%
			3560	3.457	49.883	3.384	51.240	2.16%	-2.65%
			3600	3.497	49.819	3.431	51.186	1.92%	-2.67%
			3650	3.552	49.743	3.489	51.118	1.81%	-2.69%
			3690	3.592	49.697	3.536	51.063	1.58%	-2.68%
			3700	3.604	49.678	3.548	51.050	1.58%	-2.69%
08/04/2020	3600B	22.5	3500	3.373	49.517	3.314	51.321	1.78%	-3.52%
			3550	3.424	49.431	3.372	51.254	1.54%	-3.56%
			3560	3.435	49.422	3.384	51.240	1.51%	-3.55%
			3600	3.476	49.377	3.431	51.186	1.31%	-3.53%
			3650	3.529	49.292	3.489	51.118	1.15%	-3.57%
			3690	3.571	49.223	3.536	51.063	0.99%	-3.60%
			3700	3.580	49.214	3.548	51.050	0.90%	-3.60%
07/05/2020	5200-5800B	21.7	5250	5.434	46.826	5.358	48.947	1.42%	-4.33%
			5260	5.449	46.811	5.369	48.933	1.49%	-4.34%
			5290	5.489	46.785	5.404	48.892	1.57%	-4.31%
			5300	5.499	46.776	5.416	48.879	1.53%	-4.30%
			5600	5.891	46.256	5.766	48.471	2.17%	-4.57%
			5620	5.921	46.210	5.790	48.444	2.26%	-4.61%
			5690	6.008	46.109	5.872	48.349	2.32%	-4.63%
			5720	6.047	46.050	5.907	48.309	2.37%	-4.68%
			5750	6.096	46.020	5.942	48.268	2.59%	-4.66%
			5775	6.125	45.988	5.971	48.234	2.58%	-4.66%
			5785	6.138	45.969	5.982	48.220	2.61%	-4.67%
07/13/2020	5200-5800B	22.6	5250	5.460	46.788	5.358	48.947	1.90%	-4.41%
			5300	5.521	46.693	5.416	48.879	1.94%	-4.47%
			5600	5.929	46.207	5.766	48.471	2.83%	-4.67%
			5620	5.950	46.171	5.790	48.444	2.76%	-4.69%
			5720	6.085	46.010	5.907	48.309	3.01%	-4.76%
			5750	6.107	45.951	5.942	48.268	2.78%	-4.80%
			5785	6.165	45.864	5.982	48.220	3.06%	-4.89%

FCC ID: A3LSMF916U	 PCTEST <small>Proud to be part of Samsung</small>	SAR EVALUATION REPORT		Approved by: Quality Manager
Document S/N: 1M2005200087-01-R2.A3L	Test Dates: 06/28/20-08/24/20	DUT Type: Portable Handset	Page 120 of 267	

**Table 10-8
Measured Body Tissue Properties Continued**

Calibrated for Tests Performed on:	Tissue Type	Tissue Temp During Calibration (°C)	Measured Frequency (MHz)	Measured Conductivity, σ (S/m)	Measured Dielectric Constant, ϵ	TARGET Conductivity, σ (S/m)	TARGET Dielectric Constant, ϵ	% dev σ	% dev ϵ
07/19/2020	5200-5800B	23.5	5250	5.469	47.002	5.358	48.947	2.07%	-3.97%
			5260	5.484	46.985	5.369	48.933	2.14%	-3.98%
			5290	5.534	46.968	5.404	48.892	2.41%	-3.94%
			5300	5.547	46.956	5.416	48.879	2.42%	-3.93%
			5500	5.801	46.600	5.650	48.607	2.67%	-4.13%
			5600	5.937	46.434	5.766	48.471	2.97%	-4.20%
			5620	5.964	46.402	5.790	48.444	3.01%	-4.22%
			5690	6.053	46.286	5.872	48.349	3.08%	-4.27%
			5720	6.101	46.241	5.907	48.309	3.28%	-4.28%
			5745	6.136	46.202	5.936	48.275	3.37%	-4.29%
			5750	6.143	46.198	5.942	48.268	3.38%	-4.29%
			5775	6.175	46.171	5.971	48.234	3.42%	-4.28%
			5785	6.187	46.154	5.982	48.220	3.43%	-4.28%
5825	6.244	46.074	6.029	48.166	3.57%	-4.34%			
07/27/2020	5200-5800B	22.6	5250	5.467	46.929	5.358	48.947	2.03%	-4.12%
			5260	5.485	46.900	5.369	48.933	2.16%	-4.15%
			5300	5.538	46.875	5.416	48.879	2.25%	-4.10%
			5500	5.791	46.499	5.650	48.607	2.50%	-4.34%
			5600	5.931	46.352	5.766	48.471	2.86%	-4.37%
			5620	5.958	46.320	5.790	48.444	2.90%	-4.38%
			5720	6.088	46.151	5.907	48.309	3.06%	-4.47%
			5750	6.139	46.119	5.942	48.268	3.32%	-4.45%

The above measured tissue parameters were used in the DASY software. The DASY software was used to perform interpolation to determine the dielectric parameters at the SAR test device frequencies (per KDB Publication 865664 D01v01r04 and IEEE 1528-2013 6.6.1.2). The tissue parameters listed in the SAR test plots may slightly differ from the table above due to significant digit rounding in the software.



FCC ID: A3LSMF916U	 PCTEST <small>Proud to be part of Samsung</small>	SAR EVALUATION REPORT		Approved by: Quality Manager
Document S/N: 1M2005200087-01-R2.A3L	Test Dates: 06/28/20-08/24/20	DUT Type: Portable Handset		Page 121 of 267

10.2 Test System Verification

Prior to SAR assessment, the system is verified to $\pm 10\%$ of the SAR measurement on the reference dipole at the time of calibration by the calibration facility. Full system validation status and result summary can be found in Appendix D.



Table 10-9
System Verification Results – Head 1g

System Verification TARGET & MEASURED												
SAR System #	Tissue Frequency (MHz)	Tissue Type	Date	Amb. Temp (°C)	Liquid Temp (°C)	Input Power (W)	Source SN	Probe SN	Measured SAR _{1g} (W/kg)	1 W Target SAR _{1g} (W/kg)	1 W Normalized SAR _{1g} (W/kg)	Deviation _{1g} (%)
E	750	HEAD	07/05/2020	20.3	21.9	0.200	1003	3589	1.670	8.780	8.350	-4.90%
E	750	HEAD	07/23/2020	22.9	22.7	0.200	1003	3589	1.630	8.780	8.150	-7.18%
L	835	HEAD	06/29/2020	23.1	21.9	0.200	4d132	7410	1.920	9.650	9.600	-0.52%
L	835	HEAD	07/06/2020	24.9	22.5	0.200	4d132	7406	1.930	9.650	9.650	0.00%
E	1750	HEAD	07/02/2020	23.1	22.7	0.100	1150	3589	3.390	36.500	33.900	-7.12%
L	1750	HEAD	07/11/2020	23.1	22.5	0.100	1150	7406	3.760	36.500	37.600	3.01%
L	1900	HEAD	07/03/2020	23.4	21.3	0.100	5d148	7410	4.170	39.100	41.700	6.65%
L	1900	HEAD	08/05/2020	24.6	22.1	0.100	5d148	7406	4.230	39.100	42.300	8.18%
P	2300	HEAD	08/17/2020	22.7	22.0	0.100	1073	7551	4.690	49.200	46.900	-4.67%
E	2450	HEAD	06/28/2020	22.9	22.3	0.100	719	3589	5.340	53.100	53.400	0.56%
E	2450	HEAD	07/20/2020	22.7	21.7	0.100	797	3589	5.110	52.700	51.100	-3.04%
E	2450	HEAD	08/04/2020	22.8	22.3	0.100	719	3589	5.280	53.100	52.800	-0.56%
E	2600	HEAD	06/28/2020	22.9	22.3	0.100	1064	3589	5.800	58.100	58.000	-0.17%
D	3500	HEAD	07/24/2020	22.8	22.4	0.100	1059	7488	6.180	64.600	61.800	-4.33%
D	3700	HEAD	07/24/2020	22.8	22.4	0.100	1018	7488	6.340	65.800	63.400	-3.65%
H	5250	HEAD	07/13/2020	21.7	21.8	0.050	1057	7357	3.820	79.200	76.400	-3.54%
H	5600	HEAD	07/13/2020	21.7	21.8	0.050	1057	7357	3.870	84.100	77.400	-7.97%
H	5750	HEAD	07/13/2020	21.7	21.8	0.050	1057	7357	3.890	80.500	77.800	-3.35%

FCC ID: A3LSMF916U	 PCTEST <small> Proud to be part of Samsung</small>	SAR EVALUATION REPORT		Approved by: Quality Manager
Document S/N: 1M2005200087-01-R2.A3L	Test Dates: 06/28/20-08/24/20	DUT Type: Portable Handset	Page 122 of 267	



**Table 10-10
System Verification Results – Body 1g**

System Verification TARGET & MEASURED												
SAR System #	Tissue Frequency (MHz)	Tissue Type	Date	Amb. Temp (°C)	Liquid Temp (°C)	Input Power (W)	Source SN	Probe SN	Measured SAR _{1g} (W/kg)	1 W Target SAR _{1g} (W/kg)	1 W Normalized SAR _{1g} (W/kg)	Deviation _{1g} (%)
L	750	BODY	07/01/2020	23.7	22.0	0.200	1054	7410	1.800	8.530	9.000	5.51%
P	750	BODY	07/21/2020	23.9	21.5	0.200	1054	7551	1.710	8.530	8.550	0.23%
P	750	BODY	07/26/2020	21.7	21.6	0.200	1054	7551	1.760	8.530	8.800	3.17%
P	750	BODY	07/28/2020	21.5	21.9	0.200	1054	7551	1.760	8.530	8.800	3.17%
P	750	BODY	07/30/2020	23.5	21.9	0.200	1054	7551	1.710	8.530	8.550	0.23%
P	750	BODY	08/03/2020	23.9	21.9	0.200	1054	7551	1.780	8.530	8.900	4.34%
D	835	BODY	07/19/2020	22.1	21.4	0.200	4d047	7488	1.820	9.470	9.100	-3.91%
D	835	BODY	07/30/2020	23.1	22.8	0.200	4d047	7488	1.900	9.470	9.500	0.32%
D	835	BODY	08/02/2020	23.0	22.1	0.200	4d047	7488	1.980	9.470	9.900	4.54%
P	835	BODY	08/04/2020	22.0	22.8	0.200	4d132	7551	1.990	9.960	9.950	-0.10%
P	835	BODY	08/07/2020	23.7	22.4	0.200	4d132	7551	2.000	9.960	10.000	0.40%
D	835	BODY	08/10/2020	24.1	23.3	0.200	4d133	7488	1.910	9.750	9.550	-2.05%
I	1750	BODY	07/01/2020	20.7	21.4	0.100	1008	7570	3.470	37.400	34.700	-7.22%
I	1750	BODY	07/16/2020	21.9	21.1	0.100	1008	7570	3.940	37.400	39.400	5.35%
I	1750	BODY	07/22/2020	21.2	21.5	0.100	1008	7570	3.980	37.400	39.800	6.42%
L	1750	BODY	07/23/2020	23.7	21.5	0.100	1150	7406	3.870	36.600	38.700	5.74%
L	1750	BODY	07/26/2020	22.5	21.8	0.100	1148	7406	3.890	36.300	38.900	7.16%
J	1900	BODY	06/29/2020	22.5	23.8	0.100	5d149	7571	4.280	39.400	42.800	8.63%
J	1900	BODY	07/01/2020	23.0	23.0	0.100	5d149	7571	4.200	39.400	42.000	6.60%
J	1900	BODY	07/06/2020	22.5	23.0	0.100	5d080	7571	4.260	39.200	42.600	8.67%
J	1900	BODY	07/11/2020	23.4	23.6	0.100	5d080	7571	4.230	39.200	42.300	7.91%
J	1900	BODY	07/14/2020	24.0	23.1	0.100	5d080	7571	4.160	39.200	41.600	6.12%
J	1900	BODY	07/17/2020	23.1	23.6	0.100	5d080	7571	4.230	39.200	42.300	7.91%
J	1900	BODY	08/06/2020	22.1	21.9	0.100	5d149	7571	4.230	39.400	42.300	7.36%

FCC ID: A3LSMF916U	 <small>Proud to be part of Samsung</small>	SAR EVALUATION REPORT		Approved by: Quality Manager
Document S/N: 1M2005200087-01-R2.A3L	Test Dates: 06/28/20-08/24/20	DUT Type: Portable Handset	Page 123 of 267	



**Table 10-11
System Verification Results – Body 1g continued**

System Verification TARGET & MEASURED												
SAR System #	Tissue Frequency (MHz)	Tissue Type	Date	Amb. Temp (°C)	Liquid Temp (°C)	Input Power (W)	Source SN	Probe SN	Measured SAR _{1g} (W/kg)	1 W Target SAR _{1g} (W/kg)	1 W Normalized SAR _{1g} (W/kg)	Deviation _{1g} (%)
K	2300	BODY	07/11/2020	23.5	22.4	0.100	1073	7409	5.070	47.700	50.700	6.29%
K	2300	BODY	07/14/2020	23.0	21.6	0.100	1073	7409	5.020	47.700	50.200	5.24%
K	2300	BODY	08/17/2020	22.0	22.0	0.100	1073	7409	5.120	47.700	51.200	7.34%
O	2450	BODY	07/12/2020	22.5	22.3	0.100	981	7552	5.110	50.900	51.100	0.39%
K	2450	BODY	07/20/2020	23.6	23.6	0.100	719	7409	5.290	50.800	52.900	4.13%
K	2450	BODY	07/23/2020	22.4	22.8	0.100	719	7409	5.370	50.800	53.700	5.71%
O	2450	BODY	07/27/2020	24.5	22.3	0.100	981	7552	5.170	50.900	51.700	1.57%
O	2450	BODY	07/30/2020	24.5	23.4	0.100	981	7552	5.120	50.900	51.200	0.59%
K	2450	BODY	07/31/2020	23.1	24.0	0.100	719	7409	5.370	50.800	53.700	5.71%
K	2450	BODY	08/03/2020	22.0	22.0	0.100	719	7409	5.300	50.800	53.000	4.33%
O	2450	BODY	08/03/2020	23.1	22.8	0.100	981	7552	4.930	50.900	49.300	-3.14%
O	2450	BODY	08/10/2020	23.0	21.9	0.100	797	7552	4.880	51.100	48.800	-4.50%
K	2600	BODY	07/20/2020	23.6	23.6	0.100	1064	7409	5.630	55.600	56.300	1.26%
O	2600	BODY	07/27/2020	24.5	22.3	0.100	1004	7552	5.770	54.800	57.700	5.29%
O	2600	BODY	07/30/2020	24.5	23.4	0.100	1004	7552	5.420	54.800	54.200	-1.09%
K	2600	BODY	07/31/2020	23.1	24.0	0.100	1064	7409	5.610	55.600	56.100	0.90%
K	2600	BODY	08/03/2020	22.0	22.0	0.100	1064	7409	5.470	55.600	54.700	-1.62%
D	3500	BODY	07/27/2020	22.4	21.6	0.100	1059	7488	6.530	65.100	65.300	0.31%
D	3700	BODY	07/27/2020	22.4	21.6	0.100	1018	7488	6.610	64.300	66.100	2.80%
D	3500	BODY	08/04/2020	23.7	22.5	0.100	1059	7488	6.420	65.100	64.200	-1.38%
D	3700	BODY	08/04/2020	23.7	22.5	0.100	1018	7488	6.760	64.300	67.600	5.13%
G	5250	BODY	07/05/2020	24.0	22.0	0.050	1237	7538	3.810	75.600	76.200	0.79%
G	5600	BODY	07/05/2020	24.0	22.0	0.050	1237	7538	3.990	78.500	79.800	1.66%
G	5750	BODY	07/05/2020	24.0	22.0	0.050	1237	7538	3.660	75.900	73.200	-3.56%
G	5250	BODY	07/13/2020	23.0	22.1	0.050	1237	7538	3.660	75.600	73.200	-3.17%
G	5600	BODY	07/13/2020	23.0	22.1	0.050	1237	7538	3.790	78.500	75.800	-3.44%
G	5750	BODY	07/13/2020	23.0	22.1	0.050	1237	7538	3.660	75.900	73.200	-3.56%

FCC ID: A3LSMF916U	 PCTEST <small>Proud to be part of Samsung</small>	SAR EVALUATION REPORT		Approved by: Quality Manager
Document S/N: 1M2005200087-01-R2.A3L	Test Dates: 06/28/20-08/24/20	DUT Type: Portable Handset	Page 124 of 267	

**Table 10-12
System Verification Results – 10g**

System Verification TARGET & MEASURED												
SAR System #	Tissue Frequency (MHz)	Tissue Type	Date	Amb. Temp (°C)	Liquid Temp (°C)	Input Power (W)	Source SN	Probe SN	Measured SAR _{10g} (W/kg)	1 W Target SAR _{10g} (W/kg)	1 W Normalized SAR _{10g} (W/kg)	Deviation _{10g} (%)
L	750	BODY	07/01/2020	23.7	22.0	0.200	1054	7410	1.190	5.630	5.950	5.68%
P	750	BODY	07/30/2020	23.5	21.9	0.200	1054	7551	1.130	5.630	5.650	0.36%
P	750	BODY	08/03/2020	23.9	21.9	0.200	1054	7551	1.170	5.630	5.850	3.91%
E	750	BODY	08/24/2020	23.1	21.7	0.200	1161	3589	1.180	5.550	5.900	6.31%
P	835	BODY	07/30/2020	23.5	21.9	0.200	4d132	7551	1.400	6.640	7.000	5.42%
P	835	BODY	08/04/2020	22.0	22.8	0.200	4d132	7551	1.290	6.640	6.450	-2.86%
P	835	BODY	08/07/2020	23.7	22.4	0.200	4d132	7551	1.320	6.640	6.600	-0.60%
D	835	BODY	08/10/2020	24.1	23.3	0.200	4d133	7488	1.250	6.400	6.250	-2.34%
I	1750	BODY	07/01/2020	20.7	21.4	0.100	1008	7570	1.850	19.900	18.500	-7.04%
I	1750	BODY	07/20/2020	20.9	21.2	0.100	1008	7570	2.050	19.900	20.500	3.02%
I	1750	BODY	07/22/2020	21.2	21.5	0.100	1008	7570	2.080	19.900	20.800	4.52%
L	1750	BODY	07/23/2020	23.7	21.5	0.100	1150	7406	2.040	19.400	20.400	5.15%
L	1750	BODY	07/29/2020	23.1	22.0	0.100	1148	7406	1.930	19.300	19.300	0.00%
J	1900	BODY	07/01/2020	23.0	23.0	0.100	5d149	7571	2.160	20.700	21.600	4.35%
J	1900	BODY	07/06/2020	22.5	23.0	0.100	5d080	7571	2.190	20.600	21.900	6.31%
J	1900	BODY	07/11/2020	23.4	23.6	0.100	5d080	7571	2.180	20.600	21.800	5.83%
J	1900	BODY	07/14/2020	24.0	23.1	0.100	5d080	7571	2.140	20.600	21.400	3.88%
J	1900	BODY	07/17/2020	23.1	23.6	0.100	5d080	7571	2.180	20.600	21.800	5.83%
J	1900	BODY	07/20/2020	22.5	23.7	0.100	5d080	7571	2.140	20.600	21.400	3.88%
J	1900	BODY	07/27/2020	22.7	22.5	0.100	5d080	7571	2.150	20.600	21.500	4.37%
H	1900	BODY	07/30/2020	24.0	23.3	0.100	5d149	7357	2.170	20.700	21.700	4.83%
J	1900	BODY	07/30/2020	21.7	21.4	0.100	5d080	7571	2.060	20.600	20.600	0.00%
J	1900	BODY	08/03/2020	21.1	22.6	0.100	5d080	7571	2.080	20.600	20.800	0.97%
K	2300	BODY	07/11/2020	23.5	22.4	0.100	1073	7409	2.390	23.200	23.900	3.02%
K	2300	BODY	07/14/2020	23.0	21.6	0.100	1073	7409	2.380	23.200	23.800	2.59%
K	2300	BODY	08/17/2020	22.0	22.0	0.100	1073	7409	2.430	23.200	24.300	4.74%
K	2450	BODY	07/23/2020	22.4	22.8	0.100	719	7409	2.450	24.000	24.500	2.08%
K	2450	BODY	07/27/2020	22.4	21.9	0.100	719	7409	2.470	24.000	24.700	2.92%
K	2450	BODY	08/03/2020	22.0	22.0	0.100	719	7409	2.430	24.000	24.300	1.25%
O	2450	BODY	08/03/2020	23.1	22.8	0.100	981	7552	2.260	24.200	22.600	-6.61%
O	2450	BODY	08/10/2020	23.0	21.9	0.100	797	7552	2.250	24.200	22.500	-7.02%

FCC ID: A3LSMF916U	 PCTEST <small>Proud to be part of Samsung</small>	SAR EVALUATION REPORT		Approved by: Quality Manager
Document S/N: 1M2005200087-01-R2.A3L	Test Dates: 06/28/20-08/24/20	DUT Type: Portable Handset	Page 125 of 267	

**Table 10-13
System Verification Results – 10g continued**

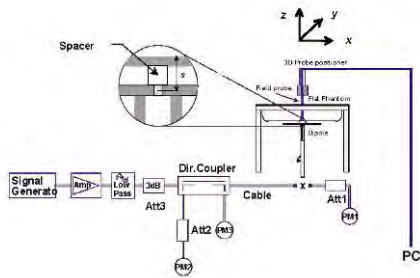

System Verification TARGET & MEASURED												
SAR System #	Tissue Frequency (MHz)	Tissue Type	Date	Amb. Temp (°C)	Liquid Temp (°C)	Input Power (W)	Source SN	Probe SN	Measured SAR _{10g} (W/kg)	1 W Target SAR _{10g} (W/kg)	1 W Normalized SAR _{10g} (W/kg)	Deviation _{10g} (%)
K	2600	BODY	07/23/2020	22.4	22.8	0.100	1064	7409	2.420	25.000	24.200	-3.20%
O	2600	BODY	07/30/2020	24.5	23.4	0.100	1004	7552	2.440	24.700	24.400	-1.21%
K	2600	BODY	08/03/2020	22.0	22.0	0.100	1064	7409	2.400	25.000	24.000	-4.00%
O	2600	BODY	08/03/2020	23.1	22.8	0.100	1004	7552	2.340	24.700	23.400	-5.26%
D	3500	BODY	08/04/2020	23.7	22.5	0.100	1059	7488	2.400	24.200	24.000	-0.83%
D	3700	BODY	08/04/2020	23.7	22.5	0.100	1018	7488	2.440	23.100	24.400	5.63%
G	5250	BODY	07/19/2020	21.1	22.7	0.050	1237	7538	1.030	21.200	20.600	-2.83%
G	5600	BODY	07/19/2020	21.1	22.7	0.050	1237	7538	1.100	22.000	22.000	0.00%
G	5750	BODY	07/19/2020	21.1	22.7	0.050	1237	7538	1.010	21.200	20.200	-4.72%
G	5250	BODY	07/27/2020	21.9	22.4	0.050	1237	7538	1.030	21.200	20.600	-2.83%
G	5600	BODY	07/27/2020	21.9	22.4	0.050	1237	7538	1.110	22.000	22.200	0.91%
G	5750	BODY	07/27/2020	21.9	22.4	0.050	1237	7538	1.050	21.200	21.000	-0.94%



**Figure 10-1
System Verification Setup Diagram**



**Figure 10-2
System Verification Setup Photo**

FCC ID: A3LSMF916U	 <small>Proud to be part of Samsung</small>	SAR EVALUATION REPORT		Approved by: Quality Manager
Document S/N: 1M2005200087-01-R2.A3L	Test Dates: 06/28/20-08/24/20	DUT Type: Portable Handset	Page 126 of 267	

11 SAR DATA SUMMARY



11.1 Standalone Head SAR Data

**Table 11-1
CDMA BC10 (\$90S) Head SAR**

MEASUREMENT RESULTS																
FREQUENCY		Mode	Service	Maximum Allowed Power [dBm]	Conducted Power [dBm]	Power Drift [dB]	Side	Test Position	Antenna Config.	Tune State	Device Serial Number	Duty Cycle	SAR (1g)	Scaling Factor	Reported SAR (1g)	Plot #
MHz	Ch.												(W/kg)		(W/kg)	
820.10	564	CDMA BC10 (\$90S)	RC3 / SO55	26.0	25.11	0.03	Right	Cheek	Ant A	1	1136M	1:1	0.189	1.227	0.232	
820.10	564	CDMA BC10 (\$90S)	RC3 / SO55	26.0	25.11	-0.01	Right	Tilt	Ant A	1	1136M	1:1	0.093	1.227	0.114	
820.10	564	CDMA BC10 (\$90S)	RC3 / SO55	26.0	25.11	0.02	Left	Cheek	Ant A	1	1136M	1:1	0.184	1.227	0.226	
820.10	564	CDMA BC10 (\$90S)	RC3 / SO55	26.0	25.11	-0.10	Left	Tilt	Ant A	1	1136M	1:1	0.090	1.227	0.110	
820.10	564	CDMA BC10 (\$90S)	EVDO Rev. A	26.0	25.18	0.04	Right	Cheek	Ant A	1	1136M	1:1	0.199	1.208	0.240	
820.10	564	CDMA BC10 (\$90S)	EVDO Rev. A	26.0	25.18	-0.03	Right	Tilt	Ant A	1	1136M	1:1	0.093	1.208	0.112	
820.10	564	CDMA BC10 (\$90S)	EVDO Rev. A	26.0	25.18	0.02	Left	Cheek	Ant A	1	1136M	1:1	0.205	1.208	0.248	A1
820.10	564	CDMA BC10 (\$90S)	EVDO Rev. A	26.0	25.18	0.06	Left	Tilt	Ant A	1	1136M	1:1	0.097	1.208	0.117	
ANSI / IEEE C95.1 1992 - SAFETY LIMIT Spatial Peak Uncontrolled Exposure/General Population									Head 1.6 W/kg (mW/g) averaged over 1 gram							

**Table 11-2
CDMA BC0 (\$22H) Head SAR**

MEASUREMENT RESULTS																
FREQUENCY		Mode	Service	Maximum Allowed Power [dBm]	Conducted Power [dBm]	Power Drift [dB]	Side	Test Position	Antenna Config.	Tune State	Device Serial Number	Duty Cycle	SAR (1g)	Scaling Factor	Reported SAR (1g)	Plot #
MHz	Ch.												(W/kg)		(W/kg)	
836.52	384	CDMA BC0 (\$22H)	RC3 / SO55	26.0	25.12	0.00	Right	Cheek	Ant A	1	1136M	1:1	0.217	1.225	0.266	
836.52	384	CDMA BC0 (\$22H)	RC3 / SO55	26.0	25.12	0.05	Right	Tilt	Ant A	1	1136M	1:1	0.095	1.225	0.116	
836.52	384	CDMA BC0 (\$22H)	RC3 / SO55	26.0	25.12	-0.05	Left	Cheek	Ant A	1	1136M	1:1	0.161	1.225	0.197	
836.52	384	CDMA BC0 (\$22H)	RC3 / SO55	26.0	25.12	-0.02	Left	Tilt	Ant A	1	1136M	1:1	0.082	1.225	0.100	
836.52	384	CDMA BC0 (\$22H)	EVDO Rev. A	26.0	25.17	0.02	Right	Cheek	Ant A	1	1136M	1:1	0.228	1.211	0.276	A2
836.52	384	CDMA BC0 (\$22H)	EVDO Rev. A	26.0	25.17	0.03	Right	Tilt	Ant A	1	1136M	1:1	0.092	1.211	0.111	
836.52	384	CDMA BC0 (\$22H)	EVDO Rev. A	26.0	25.17	0.16	Left	Cheek	Ant A	1	1136M	1:1	0.182	1.211	0.220	
836.52	384	CDMA BC0 (\$22H)	EVDO Rev. A	26.0	25.17	0.08	Left	Tilt	Ant A	1	1136M	1:1	0.087	1.211	0.105	
836.52	384	CDMA BC0 (\$22H)	RC3 / SO55	24.5	23.45	0.04	Right	Cheek	Ant B	N/A	0897M	1:1	0.055	1.274	0.070	
836.52	384	CDMA BC0 (\$22H)	RC3 / SO55	24.5	23.45	0.07	Right	Tilt	Ant B	N/A	0897M	1:1	0.024	1.274	0.031	
836.52	384	CDMA BC0 (\$22H)	RC3 / SO55	24.5	23.45	0.15	Left	Cheek	Ant B	N/A	0897M	1:1	0.054	1.274	0.069	
836.52	384	CDMA BC0 (\$22H)	RC3 / SO55	24.5	23.45	0.03	Left	Tilt	Ant B	N/A	0897M	1:1	0.025	1.274	0.032	
836.52	384	CDMA BC0 (\$22H)	EVDO Rev. A	24.5	23.54	0.09	Right	Cheek	Ant B	N/A	0897M	1:1	0.057	1.247	0.071	
836.52	384	CDMA BC0 (\$22H)	EVDO Rev. A	24.5	23.54	0.06	Right	Tilt	Ant B	N/A	0897M	1:1	0.024	1.247	0.030	
836.52	384	CDMA BC0 (\$22H)	EVDO Rev. A	24.5	23.54	0.07	Left	Cheek	Ant B	N/A	0897M	1:1	0.055	1.247	0.069	
836.52	384	CDMA BC0 (\$22H)	EVDO Rev. A	24.5	23.54	0.11	Left	Tilt	Ant B	N/A	0897M	1:1	0.025	1.247	0.031	
ANSI / IEEE C95.1 1992 - SAFETY LIMIT Spatial Peak Uncontrolled Exposure/General Population									Head 1.6 W/kg (mW/g) averaged over 1 gram							

FCC ID: A3LSMF916U	 PCTEST Proud to be part of Samsung	SAR EVALUATION REPORT		Approved by: Quality Manager
Document S/N: 1M2005200087-01-R2.A3L	Test Dates: 06/28/20-08/24/20	DUT Type: Portable Handset	Page 127 of 267	

**Table 11-3
PCS CDMA Head SAR**



MEASUREMENT RESULTS															
FREQUENCY		Mode	Service	Maximum Allowed Power [dBm]	Conducted Power [dBm]	Power Drift [dB]	Side	Test Position	Antenna Config.	Device Serial Number	Duty Cycle	SAR (1g)	Scaling Factor	Reported SAR (1g)	Plot #
MHz	Ch.											(W/kg)		(W/kg)	
1880.00	600	PCS CDMA	RC3 / SO55	24.0	22.87	0.02	Right	Cheek	Ant B	1134M	1:1	0.029	1.297	0.038	
1880.00	600	PCS CDMA	RC3 / SO55	24.0	22.87	0.12	Right	Tilt	Ant B	1134M	1:1	0.027	1.297	0.035	
1880.00	600	PCS CDMA	RC3 / SO55	24.0	22.87	0.12	Left	Cheek	Ant B	1134M	1:1	0.056	1.297	0.073	A3
1880.00	600	PCS CDMA	RC3 / SO55	24.0	22.87	0.17	Left	Tilt	Ant B	1134M	1:1	0.039	1.297	0.051	
1880.00	600	PCS CDMA	EVDO Rev. A	24.0	23.19	-0.10	Right	Cheek	Ant B	1134M	1:1	0.040	1.205	0.048	
1880.00	600	PCS CDMA	EVDO Rev. A	24.0	23.19	0.02	Right	Tilt	Ant B	1134M	1:1	0.028	1.205	0.034	
1880.00	600	PCS CDMA	EVDO Rev. A	24.0	23.19	0.13	Left	Cheek	Ant B	1134M	1:1	0.050	1.205	0.060	
1880.00	600	PCS CDMA	EVDO Rev. A	24.0	23.19	0.06	Left	Tilt	Ant B	1134M	1:1	0.032	1.205	0.039	
ANSI / IEEE C95.1 1992 - SAFETY LIMIT Spatial Peak Uncontrolled Exposure/General Population							Head 1.6 W/kg (mW/g) averaged over 1 gram								

**Table 11-4
GSM 850 Head SAR**

MEASUREMENT RESULTS															
FREQUENCY		Mode	Service	Maximum Allowed Power [dBm]	Conducted Power [dBm]	Power Drift [dB]	Side	Test Position	Antenna Config.	Device Serial Number	Duty Cycle	SAR (1g)	Scaling Factor	Reported SAR (1g)	Plot #
MHz	Ch.											(W/kg)		(W/kg)	
836.60	190	GSM 850	GSM	33.5	33.05	-0.02	Right	Cheek	Ant A	1136M	1:8.3	0.155	1.109	0.172	A4
836.60	190	GSM 850	GSM	33.5	33.05	0.04	Right	Tilt	Ant A	1136M	1:8.3	0.065	1.109	0.072	
836.60	190	GSM 850	GSM	33.5	33.05	0.12	Left	Cheek	Ant A	1136M	1:8.3	0.112	1.109	0.124	
836.60	190	GSM 850	GSM	33.5	33.05	0.10	Left	Tilt	Ant A	1136M	1:8.3	0.050	1.109	0.055	
836.60	190	GSM 850	GSM	32.5	31.18	0.04	Right	Cheek	Ant B	0897M	1:8.3	0.044	1.355	0.060	
836.60	190	GSM 850	GSM	32.5	31.18	0.06	Right	Tilt	Ant B	0897M	1:8.3	0.017	1.355	0.023	
836.60	190	GSM 850	GSM	32.5	31.18	0.03	Left	Cheek	Ant B	0897M	1:8.3	0.041	1.355	0.056	
836.60	190	GSM 850	GSM	32.5	31.18	0.19	Left	Tilt	Ant B	0897M	1:8.3	0.019	1.355	0.026	
ANSI / IEEE C95.1 1992 - SAFETY LIMIT Spatial Peak Uncontrolled Exposure/General Population							Head 1.6 W/kg (mW/g) averaged over 1 gram								

**Table 11-5
GSM 1900 Head SAR**

MEASUREMENT RESULTS															
FREQUENCY		Mode	Service	Maximum Allowed Power [dBm]	Conducted Power [dBm]	Power Drift [dB]	Side	Test Position	Antenna Config.	Device Serial Number	Duty Cycle	SAR (1g)	Scaling Factor	Reported SAR (1g)	Plot #
MHz	Ch.											(W/kg)		(W/kg)	
1880.00	661	GSM 1900	GSM	30.5	28.89	-0.09	Right	Cheek	Ant B	1134M	1:8.3	0.013	1.449	0.019	
1880.00	661	GSM 1900	GSM	30.5	28.89	0.06	Right	Tilt	Ant B	1134M	1:8.3	0.011	1.449	0.016	
1880.00	661	GSM 1900	GSM	30.5	28.89	0.04	Left	Cheek	Ant B	1134M	1:8.3	0.019	1.449	0.028	A5
1880.00	661	GSM 1900	GSM	30.5	28.89	0.09	Left	Tilt	Ant B	1134M	1:8.3	0.013	1.449	0.019	
ANSI / IEEE C95.1 1992 - SAFETY LIMIT Spatial Peak Uncontrolled Exposure/General Population							Head 1.6 W/kg (mW/g) averaged over 1 gram								

FCC ID: A3LSMF916U	 PCTEST <small> Proud to be part of Samsung </small>	SAR EVALUATION REPORT		Approved by: Quality Manager
Document S/N: 1M2005200087-01-R2.A3L	Test Dates: 06/28/20-08/24/20	DUT Type: Portable Handset		Page 128 of 267

**Table 11-6
UMTS 850 Head SAR**



MEASUREMENT RESULTS																
FREQUENCY		Mode	Service	Maximum Allowed Power [dBm]	Conducted Power [dBm]	Power Drift [dB]	Side	Test Position	Antenna Config.	Tune State	Device Serial Number	Duty Cycle	SAR (1g)	Scaling Factor	Reported SAR (1g)	Plot #
MHz	Ch.												(W/kg)		(W/kg)	
836.60	4183	UMTS 850	RMC	25.8	24.32	0.00	Right	Cheek	Ant A	1	1136M	1:1	0.207	1.406	0.291	A6
836.60	4183	UMTS 850	RMC	25.8	24.32	-0.04	Right	Tilt	Ant A	1	1136M	1:1	0.084	1.406	0.118	
836.60	4183	UMTS 850	RMC	25.8	24.32	0.05	Left	Cheek	Ant A	1	1136M	1:1	0.163	1.406	0.229	
836.60	4183	UMTS 850	RMC	25.8	24.32	0.01	Left	Tilt	Ant A	1	1136M	1:1	0.084	1.406	0.118	
ANSI / IEEE C95.1 1992 - SAFETY LIMIT Spatial Peak Uncontrolled Exposure/General Population							Head 1.6 W/kg (mW/g) averaged over 1 gram									

**Table 11-7
UMTS 1750 Head SAR**

MEASUREMENT RESULTS															
FREQUENCY		Mode	Service	Maximum Allowed Power [dBm]	Conducted Power [dBm]	Power Drift [dB]	Side	Test Position	Antenna Config.	Device Serial Number	Duty Cycle	SAR (1g)	Scaling Factor	Reported SAR (1g)	Plot #
MHz	Ch.											(W/kg)		(W/kg)	
1732.40	1412	UMTS 1750	RMC	25.5	24.24	0.03	Right	Cheek	Ant B	1134M	1:1	0.053	1.337	0.071	A7
1732.40	1412	UMTS 1750	RMC	25.5	24.24	0.02	Right	Tilt	Ant B	1134M	1:1	0.044	1.337	0.059	
1732.40	1412	UMTS 1750	RMC	25.5	24.24	0.02	Left	Cheek	Ant B	1134M	1:1	0.039	1.337	0.052	
1732.40	1412	UMTS 1750	RMC	25.5	24.24	0.03	Left	Tilt	Ant B	1134M	1:1	0.045	1.337	0.060	
ANSI / IEEE C95.1 1992 - SAFETY LIMIT Spatial Peak Uncontrolled Exposure/General Population							Head 1.6 W/kg (mW/g) averaged over 1 gram								

**Table 11-8
UMTS 1900 Head SAR**

MEASUREMENT RESULTS															
FREQUENCY		Mode	Service	Maximum Allowed Power [dBm]	Conducted Power [dBm]	Power Drift [dB]	Side	Test Position	Antenna Config.	Device Serial Number	Duty Cycle	SAR (1g)	Scaling Factor	Reported SAR (1g)	Plot #
MHz	Ch.											(W/kg)		(W/kg)	
1880.00	9400	UMTS 1900	RMC	24.5	23.81	0.03	Right	Cheek	Ant B	1134M	1:1	0.052	1.172	0.061	
1880.00	9400	UMTS 1900	RMC	24.5	23.81	0.05	Right	Tilt	Ant B	1134M	1:1	0.036	1.172	0.042	
1880.00	9400	UMTS 1900	RMC	24.5	23.81	0.07	Left	Cheek	Ant B	1134M	1:1	0.071	1.172	0.083	A8
1880.00	9400	UMTS 1900	RMC	24.5	23.81	-0.01	Left	Tilt	Ant B	1134M	1:1	0.034	1.172	0.040	
ANSI / IEEE C95.1 1992 - SAFETY LIMIT Spatial Peak Uncontrolled Exposure/General Population							Head 1.6 W/kg (mW/g) averaged over 1 gram								

FCC ID: A3LSMF916U	 PCTEST <small> Proud to be part of Samsung</small>	SAR EVALUATION REPORT		Approved by: Quality Manager
Document S/N: 1M2005200087-01-R2.A3L	Test Dates: 06/28/20-08/24/20	DUT Type: Portable Handset		Page 129 of 267

**Table 11-9
LTE Band 71 Head SAR**



MEASUREMENT RESULTS																					
FREQUENCY		Mode	Bandwidth [MHz]	Tune State	Maximum Allowed Power [dBm]	Conducted Power [dBm]	Power Drift [dB]	MPR [dB]	Side	Test Position	Antenna Config.	Modulation	RB Size	RB Offset	Device Serial Number	Duty Cycle	SAR (1g)	Scaling Factor	Reported SAR (1g)	Plot #	
MHz	Ch.																(W/kg)		(W/kg)		
680.50	133297	Mid	LTE Band 71	20	9	25.8	24.67	-0.05	0	Right	Cheek	Ant A	QPSK	1	0	0069M	1:1	0.107	1.297	0.139	A9
680.50	133297	Mid	LTE Band 71	20	9	24.8	23.77	0.08	1	Right	Cheek	Ant A	QPSK	50	50	0069M	1:1	0.090	1.268	0.114	
680.50	133297	Mid	LTE Band 71	20	9	25.8	24.67	0.03	0	Right	Tilt	Ant A	QPSK	1	0	0069M	1:1	0.056	1.297	0.073	
680.50	133297	Mid	LTE Band 71	20	9	24.8	23.77	0.14	1	Right	Tilt	Ant A	QPSK	50	50	0069M	1:1	0.053	1.268	0.067	
680.50	133297	Mid	LTE Band 71	20	9	25.8	24.67	0.04	0	Left	Cheek	Ant A	QPSK	1	0	0069M	1:1	0.088	1.297	0.114	
680.50	133297	Mid	LTE Band 71	20	9	24.8	23.77	0.02	1	Left	Cheek	Ant A	QPSK	50	50	0069M	1:1	0.072	1.268	0.091	
680.50	133297	Mid	LTE Band 71	20	9	25.8	24.67	0.11	0	Left	Tilt	Ant A	QPSK	1	0	0069M	1:1	0.047	1.297	0.061	
680.50	133297	Mid	LTE Band 71	20	9	24.8	23.77	0.04	1	Left	Tilt	Ant A	QPSK	50	50	0069M	1:1	0.036	1.268	0.046	
ANSI / IEEE C95.1 1992 - SAFETY LIMIT Spatial Peak Uncontrolled Exposure/General Population										Head 1.6 W/kg (mW/g) averaged over 1 gram											

**Table 11-10
LTE Band 12 Head SAR**

MEASUREMENT RESULTS																					
FREQUENCY		Mode	Bandwidth [MHz]	Tune State	Maximum Allowed Power [dBm]	Conducted Power [dBm]	Power Drift [dB]	MPR [dB]	Side	Test Position	Antenna Config.	Modulation	RB Size	RB Offset	Device Serial Number	Duty Cycle	SAR (1g)	Scaling Factor	Reported SAR (1g)	Plot #	
MHz	Ch.																(W/kg)		(W/kg)		
707.50	23095	Mid	LTE Band 12	10	27	25.8	25.10	0.04	0	Right	Cheek	Ant A	QPSK	1	49	0069M	1:1	0.092	1.175	0.108	A10
707.50	23095	Mid	LTE Band 12	10	27	24.8	24.06	-0.10	1	Right	Cheek	Ant A	QPSK	25	25	0069M	1:1	0.075	1.186	0.089	
707.50	23095	Mid	LTE Band 12	10	27	25.8	25.10	0.03	0	Right	Tilt	Ant A	QPSK	1	49	0069M	1:1	0.060	1.175	0.071	
707.50	23095	Mid	LTE Band 12	10	27	24.8	24.06	-0.10	1	Right	Tilt	Ant A	QPSK	25	25	0069M	1:1	0.042	1.186	0.050	
707.50	23095	Mid	LTE Band 12	10	27	25.8	25.10	0.07	0	Left	Cheek	Ant A	QPSK	1	49	0069M	1:1	0.089	1.175	0.105	
707.50	23095	Mid	LTE Band 12	10	27	24.8	24.06	0.06	1	Left	Cheek	Ant A	QPSK	25	25	0069M	1:1	0.075	1.186	0.089	
707.50	23095	Mid	LTE Band 12	10	27	25.8	25.10	-0.07	0	Left	Tilt	Ant A	QPSK	1	49	0069M	1:1	0.041	1.175	0.048	
707.50	23095	Mid	LTE Band 12	10	27	24.8	24.06	0.03	1	Left	Tilt	Ant A	QPSK	25	25	0069M	1:1	0.034	1.186	0.040	
ANSI / IEEE C95.1 1992 - SAFETY LIMIT Spatial Peak Uncontrolled Exposure/General Population										Head 1.6 W/kg (mW/g) averaged over 1 gram											

**Table 11-11
LTE Band 13 Head SAR**

MEASUREMENT RESULTS																					
FREQUENCY		Mode	Bandwidth [MHz]	Tune State	Maximum Allowed Power [dBm]	Conducted Power [dBm]	Power Drift [dB]	MPR [dB]	Side	Test Position	Antenna Config.	Modulation	RB Size	RB Offset	Device Serial Number	Duty Cycle	SAR (1g)	Scaling Factor	Reported SAR (1g)	Plot #	
MHz	Ch.																(W/kg)		(W/kg)		
782.00	23230	Mid	LTE Band 13	10	10	25.8	24.15	0.06	0	Right	Cheek	Ant A	QPSK	1	49	0069M	1:1	0.194	1.462	0.284	A11
782.00	23230	Mid	LTE Band 13	10	10	24.8	23.35	0.05	1	Right	Cheek	Ant A	QPSK	25	0	0069M	1:1	0.123	1.396	0.172	
782.00	23230	Mid	LTE Band 13	10	10	25.8	24.15	0.02	0	Right	Tilt	Ant A	QPSK	1	49	0069M	1:1	0.089	1.462	0.130	
782.00	23230	Mid	LTE Band 13	10	10	24.8	23.35	0.01	1	Right	Tilt	Ant A	QPSK	25	0	0069M	1:1	0.056	1.396	0.078	
782.00	23230	Mid	LTE Band 13	10	10	25.8	24.15	0.04	0	Left	Cheek	Ant A	QPSK	1	49	0069M	1:1	0.140	1.462	0.205	
782.00	23230	Mid	LTE Band 13	10	10	24.8	23.35	0.12	1	Left	Cheek	Ant A	QPSK	25	0	0069M	1:1	0.086	1.396	0.120	
782.00	23230	Mid	LTE Band 13	10	10	25.8	24.15	0.02	0	Left	Tilt	Ant A	QPSK	1	49	0069M	1:1	0.070	1.462	0.102	
782.00	23230	Mid	LTE Band 13	10	10	24.8	23.35	0.09	1	Left	Tilt	Ant A	QPSK	25	0	0069M	1:1	0.043	1.396	0.060	
782.00	23230	Mid	LTE Band 13	10	N/A	23.8	22.33	0.10	0	Right	Cheek	Ant B	QPSK	1	0	0069M	1:1	0.030	1.403	0.042	
782.00	23230	Mid	LTE Band 13	10	N/A	22.8	21.48	0.03	1	Right	Cheek	Ant B	QPSK	25	0	0069M	1:1	0.026	1.355	0.035	
782.00	23230	Mid	LTE Band 13	10	N/A	23.8	22.33	0.07	0	Right	Tilt	Ant B	QPSK	1	0	0069M	1:1	0.014	1.403	0.020	
782.00	23230	Mid	LTE Band 13	10	N/A	22.8	21.48	0.09	1	Right	Tilt	Ant B	QPSK	25	0	0069M	1:1	0.011	1.355	0.015	
782.00	23230	Mid	LTE Band 13	10	N/A	23.8	22.33	0.03	0	Left	Cheek	Ant B	QPSK	1	0	0069M	1:1	0.028	1.403	0.039	
782.00	23230	Mid	LTE Band 13	10	N/A	22.8	21.48	0.09	1	Left	Cheek	Ant B	QPSK	25	0	0069M	1:1	0.026	1.355	0.035	
782.00	23230	Mid	LTE Band 13	10	N/A	23.8	22.33	0.03	0	Left	Tilt	Ant B	QPSK	1	0	0069M	1:1	0.016	1.403	0.022	
782.00	23230	Mid	LTE Band 13	10	N/A	22.8	21.48	0.01	1	Left	Tilt	Ant B	QPSK	25	0	0069M	1:1	0.014	1.355	0.019	
ANSI / IEEE C95.1 1992 - SAFETY LIMIT Spatial Peak Uncontrolled Exposure/General Population										Head 1.6 W/kg (mW/g) averaged over 1 gram											

FCC ID: A3LSMF916U		SAR EVALUATION REPORT		Approved by: Quality Manager
Document S/N: 1M2005200087-01-R2.A3L	Test Dates: 06/28/20-08/24/20	DUT Type: Portable Handset	Page 130 of 267	

**Table 11-12
LTE Band 14 Head SAR**

MEASUREMENT RESULTS																					
FREQUENCY		Mode	Bandwidth [MHz]	Tune State	Maximum Allowed Power [dBm]	Conducted Power [dBm]	Power Drift [dB]	MPR [dB]	Side	Test Position	Antenna Config.	Modulation	RB Size	RB Offset	Device Serial Number	Duty Cycle	SAR (1g)	Scaling Factor	Reported SAR (1g)	Plot #	
MHz	Ch.																(W/kg)		(W/kg)		
793.00	23330	Mid	LTE Band 14	10	9	25.8	24.11	0.01	0	Right	Cheek	Ant A	QPSK	1	0	0069M	1:1	0.181	1.476	0.267	A12
793.00	23330	Mid	LTE Band 14	10	9	24.8	23.14	0.04	1	Right	Cheek	Ant A	QPSK	25	12	0069M	1:1	0.160	1.466	0.235	
793.00	23330	Mid	LTE Band 14	10	9	25.8	24.11	-0.07	0	Right	Tilt	Ant A	QPSK	1	0	0069M	1:1	0.075	1.476	0.111	
793.00	23330	Mid	LTE Band 14	10	9	24.8	23.14	-0.07	1	Right	Tilt	Ant A	QPSK	25	12	0069M	1:1	0.063	1.466	0.092	
793.00	23330	Mid	LTE Band 14	10	9	25.8	24.11	-0.04	0	Left	Cheek	Ant A	QPSK	1	0	0069M	1:1	0.131	1.476	0.193	
793.00	23330	Mid	LTE Band 14	10	9	24.8	23.14	-0.09	1	Left	Cheek	Ant A	QPSK	25	12	0069M	1:1	0.116	1.466	0.170	
793.00	23330	Mid	LTE Band 14	10	9	25.8	24.11	-0.16	0	Left	Tilt	Ant A	QPSK	1	0	0069M	1:1	0.070	1.476	0.103	
793.00	23330	Mid	LTE Band 14	10	9	24.8	23.14	-0.04	1	Left	Tilt	Ant A	QPSK	25	12	0069M	1:1	0.055	1.466	0.081	
793.00	23330	Mid	LTE Band 14	10	N/A	23.8	22.42	0.15	0	Right	Cheek	Ant B	QPSK	1	0	0069M	1:1	0.041	1.374	0.056	
793.00	23330	Mid	LTE Band 14	10	N/A	22.8	21.36	0.07	1	Right	Cheek	Ant B	QPSK	25	12	0069M	1:1	0.038	1.393	0.053	
793.00	23330	Mid	LTE Band 14	10	N/A	23.8	22.42	0.09	0	Right	Tilt	Ant B	QPSK	1	0	0069M	1:1	0.020	1.374	0.027	
793.00	23330	Mid	LTE Band 14	10	N/A	22.8	21.36	0.06	1	Right	Tilt	Ant B	QPSK	25	12	0069M	1:1	0.019	1.393	0.026	
793.00	23330	Mid	LTE Band 14	10	N/A	23.8	22.42	0.11	0	Left	Cheek	Ant B	QPSK	1	0	0069M	1:1	0.048	1.374	0.066	
793.00	23330	Mid	LTE Band 14	10	N/A	22.8	21.36	0.02	1	Left	Cheek	Ant B	QPSK	25	12	0069M	1:1	0.037	1.393	0.052	
793.00	23330	Mid	LTE Band 14	10	N/A	23.8	22.42	0.02	0	Left	Tilt	Ant B	QPSK	1	0	0069M	1:1	0.021	1.374	0.029	
793.00	23330	Mid	LTE Band 14	10	N/A	22.8	21.36	0.18	1	Left	Tilt	Ant B	QPSK	25	12	0069M	1:1	0.017	1.393	0.024	
ANSI / IEEE C95.1 1992 - SAFETY LIMIT Spatial Peak Uncontrolled Exposure/General Population										Head 1.6 W/kg (mW/g) averaged over 1 gram											

**Table 11-13
LTE Band 26 (Cell) Head SAR**

MEASUREMENT RESULTS																					
FREQUENCY		Mode	Bandwidth [MHz]	Tune State	Maximum Allowed Power [dBm]	Conducted Power [dBm]	Power Drift [dB]	MPR [dB]	Side	Test Position	Antenna Config.	Modulation	RB Size	RB Offset	Device Serial Number	Duty Cycle	SAR (1g)	Scaling Factor	Reported SAR (1g)	Plot #	
MHz	Ch.																(W/kg)		(W/kg)		
831.50	26865	Mid	LTE Band 26 (Cell)	15	36	25.8	24.74	-0.06	0	Right	Cheek	Ant A	QPSK	1	36	1114M	1:1	0.218	1.276	0.278	A13
831.50	26865	Mid	LTE Band 26 (Cell)	15	36	24.8	23.84	0.00	1	Right	Cheek	Ant A	QPSK	36	37	1114M	1:1	0.177	1.247	0.221	
831.50	26865	Mid	LTE Band 26 (Cell)	15	36	25.8	24.74	0.06	0	Right	Tilt	Ant A	QPSK	1	36	1114M	1:1	0.097	1.276	0.124	
831.50	26865	Mid	LTE Band 26 (Cell)	15	36	24.8	23.84	0.10	1	Right	Tilt	Ant A	QPSK	36	37	1114M	1:1	0.069	1.247	0.086	
831.50	26865	Mid	LTE Band 26 (Cell)	15	36	25.8	24.74	0.07	0	Left	Cheek	Ant A	QPSK	1	36	1114M	1:1	0.172	1.276	0.219	
831.50	26865	Mid	LTE Band 26 (Cell)	15	36	24.8	23.84	0.10	1	Left	Cheek	Ant A	QPSK	36	37	1114M	1:1	0.136	1.247	0.170	
831.50	26865	Mid	LTE Band 26 (Cell)	15	36	25.8	24.74	0.03	0	Left	Tilt	Ant A	QPSK	1	36	1114M	1:1	0.079	1.276	0.101	
831.50	26865	Mid	LTE Band 26 (Cell)	15	36	24.8	23.84	0.10	1	Left	Tilt	Ant A	QPSK	36	37	1114M	1:1	0.063	1.247	0.079	
ANSI / IEEE C95.1 1992 - SAFETY LIMIT Spatial Peak Uncontrolled Exposure/General Population										Head 1.6 W/kg (mW/g) averaged over 1 gram											

**Table 11-14
LTE Band 5 (Cell) Head SAR**

MEASUREMENT RESULTS																							
1 CC Uplink / 2 CC Uplink	Component Carrier	FREQUENCY		Mode	Bandwidth [MHz]	Tune State	Maximum Allowed Power [dBm]	Conducted Power [dBm]	Power Drift [dB]	MPR [dB]	Side	Test Position	Antenna Config.	Modulation	RB Size	RB Offset	Device Serial Number	Duty Cycle	SAR (1g)	Scaling Factor	Reported SAR (1g)	Plot #	
		MHz	Ch.																(W/kg)		(W/kg)		
1 CC Uplink	N/A	836.50	20525	Mid	LTE Band 5 (Cell)	10	0	25.8	24.85	-0.19	0	Right	Cheek	Ant A	QPSK	1	0	1105M	1:1	0.232	1.245	0.289	A14
1 CC Uplink	N/A	836.50	20525	Mid	LTE Band 5 (Cell)	10	0	24.8	23.98	0.03	1	Right	Cheek	Ant A	QPSK	25	12	1105M	1:1	0.196	1.208	0.237	
2CC Uplink	PCC	836.50	20525	Mid	LTE Band 5 (Cell)	10	0	25.8	24.26	0.08	0	Right	Cheek	Ant A	QPSK	1	0	1105M	1:1	0.205	1.426	0.292	
	SCC	829.30	20453			5	0															24	
1 CC Uplink	N/A	836.50	20525	Mid	LTE Band 5 (Cell)	10	0	25.8	24.85	-0.07	0	Right	Tilt	Ant A	QPSK	1	0	1105M	1:1	0.097	1.245	0.121	
1 CC Uplink	N/A	836.50	20525	Mid	LTE Band 5 (Cell)	10	0	24.8	23.98	-0.03	1	Right	Tilt	Ant A	QPSK	25	12	1105M	1:1	0.078	1.208	0.094	
1 CC Uplink	N/A	836.50	20525	Mid	LTE Band 5 (Cell)	10	0	25.8	24.85	0.03	0	Left	Cheek	Ant A	QPSK	1	0	1105M	1:1	0.194	1.245	0.242	
1 CC Uplink	N/A	836.50	20525	Mid	LTE Band 5 (Cell)	10	0	24.8	23.98	0.02	1	Left	Cheek	Ant A	QPSK	25	12	1105M	1:1	0.151	1.208	0.182	
1 CC Uplink	N/A	836.50	20525	Mid	LTE Band 5 (Cell)	10	0	25.8	24.85	0.06	0	Left	Tilt	Ant A	QPSK	1	0	1105M	1:1	0.087	1.245	0.108	
1 CC Uplink	N/A	836.50	20525	Mid	LTE Band 5 (Cell)	10	0	24.8	23.98	0.17	1	Left	Tilt	Ant A	QPSK	25	12	1105M	1:1	0.069	1.208	0.083	
ANSI / IEEE C95.1 1992 - SAFETY LIMIT Spatial Peak Uncontrolled Exposure/General Population										Head 1.6 W/kg (mW/g) averaged over 1 gram													



FCC ID: A3LSMF916U	 <small>Prove it to be part of the solution.</small>	SAR EVALUATION REPORT		Approved by: Quality Manager
Document S/N: 1M2005200087-01-R2.A3L	Test Dates: 06/28/20-08/24/20	DUT Type: Portable Handset	Page 131 of 267	

Table 11-15
LTE Band 66 (AWS) Head SAR



MEASUREMENT RESULTS																					
1 CC Uplink / 2 CC Uplink	Component Carrier	FREQUENCY		Mode	Bandwidth [MHz]	Maximum Allowed Power [dBm]	Conducted Power [dBm]	Power Drift [dB]	MPR [dB]	Side	Test Position	Antenna Config.	Modulation	RB Size	RB Offset	Device Serial Number	Duty Cycle	SAR (1g)	Scaling Factor	Reported SAR (1g)	Plot #
		MHz	Ch.															(W/kg)		(W/kg)	
1 CC Uplink	N/A	1770.00	132572	High	20	25.0	24.22	0.10	0	Right	Cheek	Ant B	QPSK	1	0	1133M	1:1	0.050	1.197	0.060	A15
1 CC Uplink	N/A	1770.00	132572	High	20	25.0	24.30	0.10	0	Right	Cheek	Ant B	QPSK	1	0	1133M	1:1	0.048	1.175	0.056	
1 CC Uplink	N/A	1775.00	132622	High	10	25.0	23.72	0.07	0	Right	Cheek	Ant B	QPSK	1	0	1133M	1:1	0.042	1.343	0.056	
1 CC Uplink	N/A	1770.00	132572	High	20	24.0	23.32	0.14	1	Right	Cheek	Ant B	QPSK	50	25	1133M	1:1	0.033	1.169	0.039	
2 CC Uplink 66C	PCC	1770.00	132572	High	20	25.0	23.85	-0.06	0	Right	Cheek	Ant B	QPSK	1	0	1133M	1:1	0.047	1.303	0.061	
	SCC	1750.20	132374																		
2 CC Uplink 66B	PCC	1775.00	132622	High	10	25.0	24.00	0.06	0	Right	Cheek	Ant B	QPSK	1	0	1133M	1:1	0.047	1.259	0.059	
	SCC	1765.10	132523																		
1 CC Uplink	N/A	1770.00	132572	High	20	25.0	24.30	-0.12	0	Right	Tilt	Ant B	QPSK	1	99	1133M	1:1	0.034	1.175	0.040	
1 CC Uplink	N/A	1770.00	132572	High	20	24.0	23.32	0.15	1	Right	Tilt	Ant B	QPSK	50	25	1133M	1:1	0.024	1.169	0.028	
1 CC Uplink	N/A	1770.00	132572	High	20	25.0	24.30	-0.12	0	Left	Cheek	Ant B	QPSK	1	99	1133M	1:1	0.043	1.175	0.051	
1 CC Uplink	N/A	1770.00	132572	High	20	24.0	23.32	-0.09	1	Left	Cheek	Ant B	QPSK	50	25	1133M	1:1	0.040	1.169	0.047	
1 CC Uplink	N/A	1770.00	132572	High	20	25.0	24.30	0.12	0	Left	Tilt	Ant B	QPSK	1	99	1133M	1:1	0.028	1.175	0.033	
1 CC Uplink	N/A	1770.00	132572	High	20	24.0	23.32	0.04	1	Left	Tilt	Ant B	QPSK	50	25	1133M	1:1	0.021	1.169	0.025	
ANSI / IEEE C95.1 1992 - SAFETY LIMIT										Head											
Spatial Peak										1.6 W/kg (mW/g)											
Uncontrolled Exposure/General Population										averaged over 1 gram											

Table 11-16
LTE Band 25 (PCS) Head SAR

MEASUREMENT RESULTS																				
FREQUENCY		Mode	Bandwidth [MHz]	Maximum Allowed Power [dBm]	Conducted Power [dBm]	Power Drift [dB]	MPR [dB]	Side	Test Position	Antenna Config.	Modulation	RB Size	RB Offset	Device Serial Number	Duty Cycle	SAR (1g)	Scaling Factor	Reported SAR (1g)	Plot #	
MHz	Ch.															(W/kg)		(W/kg)		
1860.00	26140	Low	LTE Band 25 (PCS)	20	25.5	24.47	-0.13	0	Right	Cheek	Ant B	QPSK	1	0	1132M	1:1	0.044	1.268	0.056	A16
1860.00	26140	Low	LTE Band 25 (PCS)	20	24.5	23.68	0.16	1	Right	Cheek	Ant B	QPSK	50	0	1132M	1:1	0.028	1.208	0.034	
1860.00	26140	Low	LTE Band 25 (PCS)	20	25.5	24.47	0.03	0	Right	Tilt	Ant B	QPSK	1	0	1132M	1:1	0.017	1.268	0.022	
1860.00	26140	Low	LTE Band 25 (PCS)	20	24.5	23.68	0.08	1	Right	Tilt	Ant B	QPSK	50	0	1132M	1:1	0.013	1.208	0.016	
1860.00	26140	Low	LTE Band 25 (PCS)	20	25.5	24.47	-0.04	0	Left	Cheek	Ant B	QPSK	1	0	1132M	1:1	0.022	1.268	0.028	
1860.00	26140	Low	LTE Band 25 (PCS)	20	24.5	23.68	0.03	1	Left	Cheek	Ant B	QPSK	50	0	1132M	1:1	0.019	1.208	0.023	
1860.00	26140	Low	LTE Band 25 (PCS)	20	25.5	24.47	-0.19	0	Left	Tilt	Ant B	QPSK	1	0	1132M	1:1	0.016	1.268	0.020	
1860.00	26140	Low	LTE Band 25 (PCS)	20	24.5	23.68	-0.04	1	Left	Tilt	Ant B	QPSK	50	0	1132M	1:1	0.015	1.208	0.018	
ANSI / IEEE C95.1 1992 - SAFETY LIMIT										Head										
Spatial Peak										1.6 W/kg (mW/g)										
Uncontrolled Exposure/General Population										averaged over 1 gram										

Table 11-17
LTE Band 30 Head SAR

MEASUREMENT RESULTS																				
FREQUENCY		Mode	Bandwidth [MHz]	Maximum Allowed Power [dBm]	Conducted Power [dBm]	Power Drift [dB]	MPR [dB]	Side	Test Position	Antenna Config.	Modulation	RB Size	RB Offset	Device Serial Number	Duty Cycle	SAR (1g)	Scaling Factor	Reported SAR (1g)	Plot #	
MHz	Ch.															(W/kg)		(W/kg)		
2310.00	27710	Mid	LTE Band 30	10	25.0	23.84	0.05	0	Right	Cheek	Ant B	QPSK	1	0	1119M	1:1	0.036	1.306	0.047	
2310.00	27710	Mid	LTE Band 30	10	24.0	22.92	0.04	1	Right	Cheek	Ant B	QPSK	25	12	1119M	1:1	0.025	1.282	0.032	
2310.00	27710	Mid	LTE Band 30	10	25.0	23.84	0.13	0	Right	Tilt	Ant B	QPSK	1	0	1119M	1:1	0.019	1.306	0.025	
2310.00	27710	Mid	LTE Band 30	10	24.0	22.92	0.17	1	Right	Tilt	Ant B	QPSK	25	12	1119M	1:1	0.011	1.282	0.014	
2310.00	27710	Mid	LTE Band 30	10	25.0	23.84	0.03	0	Left	Cheek	Ant B	QPSK	1	0	1119M	1:1	0.043	1.306	0.056	A17
2310.00	27710	Mid	LTE Band 30	10	24.0	22.92	0.05	1	Left	Cheek	Ant B	QPSK	25	12	1119M	1:1	0.039	1.282	0.050	
2310.00	27710	Mid	LTE Band 30	10	25.0	23.84	0.19	0	Left	Tilt	Ant B	QPSK	1	0	1119M	1:1	0.018	1.306	0.024	
2310.00	27710	Mid	LTE Band 30	10	24.0	22.92	0.14	1	Left	Tilt	Ant B	QPSK	25	12	1119M	1:1	0.015	1.282	0.019	
ANSI / IEEE C95.1 1992 - SAFETY LIMIT										Head										
Spatial Peak										1.6 W/kg (mW/g)										
Uncontrolled Exposure/General Population										averaged over 1 gram										

FCC ID: A3LSMF916U		SAR EVALUATION REPORT		Approved by: Quality Manager
Document S/N: 1M2005200087-01-R2.A3L	Test Dates: 06/28/20-08/24/20	DUT Type: Portable Handset	Page 132 of 267	

**Table 11-18
LTE Band 7 Head SAR**

MEASUREMENT RESULTS																				
FREQUENCY		Mode	Bandwidth [MHz]	Maximum Allowed Power [dBm]	Conducted Power [dBm]	Power Drift [dB]	MPR [dB]	Side	Test Position	Antenna Config.	Modulation	RB Size	RB Offset	Device Serial Number	Duty Cycle	SAR (1g) (W/kg)	Scaling Factor	Reported SAR (1g) (W/kg)	Plot #	
MHz	Ch.																			
2560.00	21350	High	LTE Band 7	20	25.0	23.92	-0.11	0	Right	Cheek	Ant B	QPSK	1	0	1118M	1:1	0.164	1.282	0.210	
2560.00	21350	High	LTE Band 7	20	24.0	23.10	0.00	1	Right	Cheek	Ant B	QPSK	50	0	1118M	1:1	0.129	1.230	0.159	
2560.00	21350	High	LTE Band 7	20	25.0	23.92	-0.04	0	Right	Tilt	Ant B	QPSK	1	0	1118M	1:1	0.059	1.282	0.076	
2560.00	21350	High	LTE Band 7	20	24.0	23.10	-0.03	1	Right	Tilt	Ant B	QPSK	50	0	1118M	1:1	0.046	1.230	0.057	
2560.00	21350	High	LTE Band 7	20	25.0	23.92	0.05	0	Left	Cheek	Ant B	QPSK	1	0	1118M	1:1	0.184	1.282	0.236	A18
2560.00	21350	High	LTE Band 7	20	24.0	23.10	0.08	1	Left	Cheek	Ant B	QPSK	50	0	1118M	1:1	0.141	1.230	0.173	
2560.00	21350	High	LTE Band 7	20	25.0	23.92	0.07	0	Left	Tilt	Ant B	QPSK	1	0	1118M	1:1	0.079	1.282	0.101	
2560.00	21350	High	LTE Band 7	20	24.0	23.10	0.07	1	Left	Tilt	Ant B	QPSK	50	0	1118M	1:1	0.069	1.230	0.085	
ANSI / IEEE C95.1 1992 - SAFETY LIMIT Spatial Peak Uncontrolled Exposure/General Population										Head 1.6 W/kg (mW/g) averaged over 1 gram										

Note: LTE B7 Head SAR was tested at Pmax which is a more conservative measurement than Plimit DSI 3



**Table 11-19
LTE Band 48 Head SAR**

MEASUREMENT RESULTS																						
1 CC Uplink 2 CC Uplink	Component Carrier	FREQUENCY		Mode	Bandwidth [MHz]	Maximum Allowed Power [dBm]	Conducted Power [dBm]	Power Drift [dB]	MPR [dB]	Side	Test Position	Antenna Config.	Modulation	RB Size	RB Offset	Device Serial Number	Duty Cycle	SAR (1g) (W/kg)	Scaling Factor	Reported SAR (1g) (W/kg)	Plot #	
		MHz	Ch.																			
1 CC Uplink	N/A	3603.30	55773	Low-Mid	LTE Band 48	20	19.5	19.15	0.07	0	Right	Cheek	Ant F	QPSK	1	50	0075M	1:1.58	0.092	1.084	0.100	
1 CC Uplink	N/A	3603.30	55773	Low-Mid	LTE Band 48	20	19.5	19.24	-0.01	0	Right	Cheek	Ant F	QPSK	50	0	0075M	1:1.58	0.093	1.062	0.099	
1 CC Uplink	N/A	3603.30	55773	Low-Mid	LTE Band 48	20	19.5	19.15	-0.01	0	Right	Tilt	Ant F	QPSK	1	50	0075M	1:1.58	0.142	1.084	0.154	
1 CC Uplink	N/A	3603.30	55773	Low-Mid	LTE Band 48	20	19.5	19.24	0.03	0	Right	Tilt	Ant F	QPSK	50	0	0075M	1:1.58	0.148	1.062	0.157	
2 CC Uplink	PCC	3603.30	55773	Low-Mid	LTE Band 48	20	19.5	19.24	0.03	0	Right	Tilt	Ant F	QPSK	50	0	0075M	1:1.58	0.152	1.062	0.161	A19
	SCC	3583.50	55575											50								
1 CC Uplink	N/A	3603.30	55773	Low-Mid	LTE Band 48	20	19.5	19.15	0.15	0	Left	Cheek	Ant F	QPSK	1	50	0075M	1:1.58	0.091	1.084	0.099	
1 CC Uplink	N/A	3603.30	55773	Low-Mid	LTE Band 48	20	19.5	19.24	-0.07	0	Left	Cheek	Ant F	QPSK	50	0	0075M	1:1.58	0.089	1.062	0.095	
1 CC Uplink	N/A	3603.30	55773	Low-Mid	LTE Band 48	20	19.5	19.15	0.01	0	Left	Tilt	Ant F	QPSK	1	50	0075M	1:1.58	0.123	1.084	0.133	
1 CC Uplink	N/A	3603.30	55773	Low-Mid	LTE Band 48	20	19.5	19.24	0.07	0	Left	Tilt	Ant F	QPSK	50	0	0075M	1:1.58	0.125	1.062	0.133	
ANSI / IEEE C95.1 1992 - SAFETY LIMIT Spatial Peak Uncontrolled Exposure/General Population										Head 1.6 W/kg (mW/g) averaged over 1 gram												

**Table 11-20
LTE Band 41 Head SAR**

MEASUREMENT RESULTS																						
1 CC Uplink 2 CC Uplink, Power Class	Component Carrier	FREQUENCY		Mode	Bandwidth [MHz]	Maximum Allowed Power [dBm]	Conducted Power [dBm]	Power Drift [dB]	MPR [dB]	Side	Test Position	Antenna Config.	Modulation	RB Size	RB Offset	Device Serial Number	Duty Cycle	SAR (1g) (W/kg)	Scaling Factor	Reported SAR (1g) (W/kg)	Plot #	
		MHz	Ch.																			
1 CC Uplink - Power Class 3	N/A	2680.00	41490	High	LTE Band 41	20	25.0	24.43	0.05	0	Right	Cheek	Ant B	QPSK	1	50	1122M	1:1.58	0.013	1.140	0.015	
1 CC Uplink - Power Class 3	N/A	2680.00	41490	High	LTE Band 41	20	24.0	23.59	0.11	1	Right	Cheek	Ant B	QPSK	50	25	1122M	1:1.58	0.008	1.099	0.009	
1 CC Uplink - Power Class 3	N/A	2680.00	41490	High	LTE Band 41	20	25.0	24.43	0.16	0	Right	Tilt	Ant B	QPSK	1	50	1122M	1:1.58	0.010	1.140	0.011	
1 CC Uplink - Power Class 3	N/A	2680.00	41490	High	LTE Band 41	20	24.0	23.59	0.13	1	Right	Tilt	Ant B	QPSK	50	25	1122M	1:1.58	0.005	1.099	0.005	
1 CC Uplink - Power Class 3	N/A	2680.00	41490	High	LTE Band 41	20	25.0	24.14	-0.01	0	Left	Cheek	Ant B	QPSK	1	0	1122M	1:1.58	0.045	1.219	0.055	
1 CC Uplink - Power Class 3	N/A	2680.00	41490	High	LTE Band 41	20	25.0	24.43	0.04	0	Left	Cheek	Ant B	QPSK	1	50	1122M	1:1.58	0.040	1.140	0.046	
1 CC Uplink - Power Class 3	N/A	2680.00	41490	High	LTE Band 41	20	24.0	23.59	0.10	1	Left	Cheek	Ant B	QPSK	50	25	1122M	1:1.58	0.029	1.099	0.032	
1 CC Uplink - Power Class 2	N/A	2680.00	41490	High	LTE Band 41	20	28.0	27.10	0.06	0	Left	Cheek	Ant B	QPSK	1	0	1122M	1:2.31	0.057	1.230	0.070	
1 CC Uplink - Power Class 2	N/A	2680.00	41490	High	LTE Band 41	20	28.0	27.00	-0.12	0	Left	Cheek	Ant B	QPSK	1	50	1122M	1:2.31	0.050	1.259	0.063	
2 CC Uplink - Power Class 3	PCC	2680.00	41490	High	LTE Band 41	20	25.0	24.16	-0.04	0	Left	Cheek	Ant B	QPSK	1	0	1122M	1:1.58	0.043	1.213	0.052	
	SCC	2660.20	41292											99								
2 CC Uplink - Power Class 2	PCC	2680.00	41490	High	LTE Band 41	20	28.0	27.81	-0.03	0	Left	Cheek	Ant B	QPSK	1	0	1122M	1:2.31	0.064	1.045	0.067	A20
	SCC	2660.20	41292											99								
1 CC Uplink - Power Class 3	N/A	2680.00	41490	High	LTE Band 41	20	25.0	24.43	0.12	0	Left	Tilt	Ant B	QPSK	1	50	1122M	1:1.58	0.007	1.140	0.008	
1 CC Uplink - Power Class 3	N/A	2680.00	41490	High	LTE Band 41	20	24.0	23.59	0.08	1	Left	Tilt	Ant B	QPSK	50	25	1122M	1:1.58	0.003	1.099	0.003	
ANSI / IEEE C95.1 1992 - SAFETY LIMIT Spatial Peak Uncontrolled Exposure/General Population										Head 1.6 W/kg (mW/g) averaged over 1 gram												

Note: LTE B41 Head SAR was tested at Pmax which is a more conservative measurement than Plimit DSI 3

FCC ID: A3LSMF916U		SAR EVALUATION REPORT		Approved by: Quality Manager
Document S/N: 1M2005200087-01-R2-A3L	Test Dates: 06/28/20-08/24/20	DUT Type: Portable Handset		Page 133 of 267

**Table 11-21
NR Band n71 Head SAR**



MEASUREMENT RESULTS																				
FREQUENCY		Mode	Bandwidth [MHz]	Maximum Allowed Power [dBm]	Conducted Power [dBm]	Power Drift [dB]	MPR [dB]	Side	Test Position	Antenna Config.	Modulation	RB Size	RB Offset	Device Serial Number	Duty Cycle	SAR (1g)	Scaling Factor	Reported SAR (1g)	Plot #	
MHz	Ch.															(W/kg)		(W/kg)		
680.50	136100	Mid	NR Band n71	20	25.5	25.42	0.04	0	Right	Cheek	Ant A	DFT-S-OFDM QPSK	1	53	1126M	1:1	0.155	1.019	0.158	A21
680.50	136100	Mid	NR Band n71	20	25.5	25.44	0.07	0	Right	Cheek	Ant A	DFT-S-OFDM QPSK	50	28	1126M	1:1	0.129	1.014	0.131	
680.50	136100	Mid	NR Band n71	20	24.0	24.00	0.14	1.5	Right	Cheek	Ant A	CP-OFDM QPSK	1	1	1126M	1:1	0.087	1.000	0.087	
680.50	136100	Mid	NR Band n71	20	25.5	25.42	-0.06	0	Right	Tilt	Ant A	DFT-S-OFDM QPSK	1	53	1126M	1:1	0.085	1.019	0.087	
680.50	136100	Mid	NR Band n71	20	25.5	25.44	-0.15	0	Right	Tilt	Ant A	DFT-S-OFDM QPSK	50	28	1126M	1:1	0.058	1.014	0.059	
680.50	136100	Mid	NR Band n71	20	25.5	25.42	0.10	0	Left	Cheek	Ant A	DFT-S-OFDM QPSK	1	53	1126M	1:1	0.091	1.019	0.093	
680.50	136100	Mid	NR Band n71	20	25.5	25.44	0.11	0	Left	Cheek	Ant A	DFT-S-OFDM QPSK	50	28	1126M	1:1	0.074	1.014	0.075	
680.50	136100	Mid	NR Band n71	20	25.5	25.42	-0.04	0	Left	Tilt	Ant A	DFT-S-OFDM QPSK	1	53	1126M	1:1	0.046	1.019	0.047	
680.50	136100	Mid	NR Band n71	20	25.5	25.44	0.04	0	Left	Tilt	Ant A	DFT-S-OFDM QPSK	50	28	1126M	1:1	0.031	1.014	0.031	
ANSI / IEEE C95.1 1992 - SAFETY LIMIT Spatial Peak Uncontrolled Exposure/General Population										Head 1.6 W/kg (mW/g) averaged over 1 gram										

**Table 11-22
NR Band n5 (cell) Head SAR**

MEASUREMENT RESULTS																				
FREQUENCY		Mode	Bandwidth [MHz]	Maximum Allowed Power [dBm]	Conducted Power [dBm]	Power Drift [dB]	MPR [dB]	Side	Test Position	Antenna Config.	Modulation	RB Size	RB Offset	Device Serial Number	Duty Cycle	SAR (1g)	Scaling Factor	Reported SAR (1g)	Plot #	
MHz	Ch.															(W/kg)		(W/kg)		
836.50	167300	Mid	NR Band n5 (Cell)	20	25.5	25.03	0.13	0	Right	Cheek	Ant A	DFT-S-OFDM QPSK	1	53	1109M	1:1	0.206	1.114	0.229	A22
836.50	167300	Mid	NR Band n5 (Cell)	20	25.5	25.01	0.01	0	Right	Cheek	Ant A	DFT-S-OFDM QPSK	50	28	1109M	1:1	0.197	1.119	0.220	
836.50	167300	Mid	NR Band n5 (Cell)	20	24.0	23.52	-0.10	1.5	Right	Cheek	Ant A	CP-OFDM QPSK	1	1	1109M	1:1	0.138	1.117	0.154	
836.50	167300	Mid	NR Band n5 (Cell)	20	25.5	25.03	0.03	0	Right	Tilt	Ant A	DFT-S-OFDM QPSK	1	53	1109M	1:1	0.078	1.114	0.087	
836.50	167300	Mid	NR Band n5 (Cell)	20	25.5	25.01	0.05	0	Right	Tilt	Ant A	DFT-S-OFDM QPSK	50	28	1109M	1:1	0.076	1.119	0.085	
836.50	167300	Mid	NR Band n5 (Cell)	20	25.5	25.03	-0.08	0	Left	Cheek	Ant A	DFT-S-OFDM QPSK	1	53	1109M	1:1	0.162	1.114	0.180	
836.50	167300	Mid	NR Band n5 (Cell)	20	25.5	25.01	-0.04	0	Left	Cheek	Ant A	DFT-S-OFDM QPSK	50	28	1109M	1:1	0.180	1.119	0.201	
836.50	167300	Mid	NR Band n5 (Cell)	20	25.5	25.03	0.07	0	Left	Tilt	Ant A	DFT-S-OFDM QPSK	1	53	1109M	1:1	0.071	1.114	0.079	
836.50	167300	Mid	NR Band n5 (Cell)	20	25.5	25.01	-0.08	0	Left	Tilt	Ant A	DFT-S-OFDM QPSK	50	28	1109M	1:1	0.077	1.119	0.086	
ANSI / IEEE C95.1 1992 - SAFETY LIMIT Spatial Peak Uncontrolled Exposure/General Population										Head 1.6 W/kg (mW/g) averaged over 1 gram										

**Table 11-23
NR Band n66 (AWS) Head SAR**

MEASUREMENT RESULTS																				
FREQUENCY		Mode	Bandwidth [MHz]	Maximum Allowed Power [dBm]	Conducted Power [dBm]	Power Drift [dB]	MPR [dB]	Side	Test Position	Antenna Config.	Modulation	RB Size	RB Offset	Device Serial Number	Duty Cycle	SAR (1g)	Scaling Factor	Reported SAR (1g)	Plot #	
MHz	Ch.															(W/kg)		(W/kg)		
1770.00	354000	High	NR Band n66 (AWS)	20	24.5	23.84	-0.02	0	Right	Cheek	Ant B	DFT-S-OFDM QPSK	1	104	1110M	1:1	0.043	1.164	0.050	A23
1770.00	354000	High	NR Band n66 (AWS)	20	24.5	23.73	0.03	0	Right	Cheek	Ant B	DFT-S-OFDM QPSK	50	28	1110M	1:1	0.041	1.194	0.049	
1770.00	354000	High	NR Band n66 (AWS)	20	23.0	22.27	-0.06	1.5	Right	Cheek	Ant B	CP-OFDM QPSK	1	1	1110M	1:1	0.027	1.183	0.032	
1770.00	354000	High	NR Band n66 (AWS)	20	24.5	23.84	0.11	0	Right	Tilt	Ant B	DFT-S-OFDM QPSK	1	104	1110M	1:1	0.027	1.164	0.031	
1770.00	354000	High	NR Band n66 (AWS)	20	24.5	23.73	0.00	0	Right	Tilt	Ant B	DFT-S-OFDM QPSK	50	28	1110M	1:1	0.025	1.194	0.030	
1770.00	354000	High	NR Band n66 (AWS)	20	24.5	23.84	-0.01	0	Left	Cheek	Ant B	DFT-S-OFDM QPSK	1	104	1110M	1:1	0.043	1.164	0.050	
1770.00	354000	High	NR Band n66 (AWS)	20	24.5	23.73	0.14	0	Left	Cheek	Ant B	DFT-S-OFDM QPSK	50	28	1110M	1:1	0.040	1.194	0.048	
1770.00	354000	High	NR Band n66 (AWS)	20	24.5	23.84	0.04	0	Left	Tilt	Ant B	DFT-S-OFDM QPSK	1	104	1110M	1:1	0.020	1.164	0.023	
1770.00	354000	High	NR Band n66 (AWS)	20	24.5	23.73	0.06	0	Left	Tilt	Ant B	DFT-S-OFDM QPSK	50	28	1110M	1:1	0.021	1.194	0.025	
ANSI / IEEE C95.1 1992 - SAFETY LIMIT Spatial Peak Uncontrolled Exposure/General Population										Head 1.6 W/kg (mW/g) averaged over 1 gram										

FCC ID: A3LSMF916U	 <small>Proud to be part of Samsung</small>	SAR EVALUATION REPORT		Approved by: Quality Manager
Document S/N: 1M2005200087-01-R2.A3L	Test Dates: 06/28/20-08/24/20	DUT Type: Portable Handset	Page 134 of 267	

**Table 11-24
NR Band n25 (PCS) Head SAR**



MEASUREMENT RESULTS																				
FREQUENCY		Mode	Bandwidth [MHz]	Maximum Allowed Power [dBm]	Conducted Power [dBm]	Power Drift [dB]	MPR [dB]	Side	Test Position	Antenna Config.	Modulation	RB Size	RB Offset	Device Serial Number	Duty Cycle	SAR (1g)	Scaling Factor	Reported SAR (1g)	Plot #	
Mhz	Ch.															(W/kg)		(W/kg)		
1882.50	376500	Mid	NR Band n25 (PCS)	20	24.5	23.86	0.03	0	Right	Cheek	Ant B	DFT-S-OFDM QPSK	1	53	1130M	1:1	0.031	1.159	0.036	
1882.50	376500	Mid	NR Band n25 (PCS)	20	24.5	23.76	0.02	0	Right	Cheek	Ant B	DFT-S-OFDM QPSK	50	28	1130M	1:1	0.031	1.186	0.037	
1882.50	376500	Mid	NR Band n25 (PCS)	20	24.5	23.86	-0.09	0	Right	Tilt	Ant B	DFT-S-OFDM QPSK	1	53	1130M	1:1	0.014	1.159	0.016	
1882.50	376500	Mid	NR Band n25 (PCS)	20	24.5	23.76	0.08	0	Right	Tilt	Ant B	DFT-S-OFDM QPSK	50	28	1130M	1:1	0.013	1.186	0.015	
1882.50	376500	Mid	NR Band n25 (PCS)	20	24.5	23.86	0.05	0	Left	Cheek	Ant B	DFT-S-OFDM QPSK	1	53	1130M	1:1	0.045	1.159	0.052	A24
1882.50	376500	Mid	NR Band n25 (PCS)	20	24.5	23.76	0.18	0	Left	Cheek	Ant B	DFT-S-OFDM QPSK	50	28	1130M	1:1	0.044	1.186	0.052	
1860.00	372000	Low	NR Band n25 (PCS)	20	23.0	22.44	0.07	1.5	Left	Cheek	Ant B	CP-OFDM QPSK	1	1	1130M	1:1	0.042	1.138	0.048	
1882.50	376500	Mid	NR Band n25 (PCS)	20	24.5	23.86	0.08	0	Left	Tilt	Ant B	DFT-S-OFDM QPSK	1	53	1130M	1:1	0.013	1.159	0.015	
1882.50	376500	Mid	NR Band n25 (PCS)	20	24.5	23.76	-0.18	0	Left	Tilt	Ant B	DFT-S-OFDM QPSK	50	28	1130M	1:1	0.013	1.186	0.015	
ANSI / IEEE C95.1 1992 - SAFETY LIMIT Spatial Peak Uncontrolled Exposure/General Population										Head 1.6 W/kg (mW/g) averaged over 1 gram										

**Table 11-25
NR Band n41 Head SAR**

MEASUREMENT RESULTS																				
FREQUENCY		Mode	Bandwidth [MHz]	Maximum Allowed Power [dBm]	Conducted Power [dBm]	Power Drift [dB]	MPR [dB]	Side	Test Position	Antenna Config.	Modulation	RB Size	RB Offset	Device Serial Number	Duty Cycle	SAR (1g)	Scaling Factor	Reported SAR (1g)	Plot #	
Mhz	Ch.															(W/kg)		(W/kg)		
2592.99	518598	Mid	NR Band n41	100	25.0	24.16	0.04	0	Right	Cheek	Ant F	DFT-S-OFDM QPSK	1	1	1117M	1:4	0.066	1.213	0.080	
2592.99	518598	Mid	NR Band n41	100	25.0	23.87	0.03	0	Right	Cheek	Ant F	DFT-S-OFDM QPSK	135	69	1117M	1:4	0.060	1.297	0.078	
2592.99	518598	Mid	NR Band n41	100	25.0	24.16	0.03	0	Right	Tilt	Ant F	DFT-S-OFDM QPSK	1	1	1117M	1:4	0.059	1.213	0.072	
2592.99	518598	Mid	NR Band n41	100	25.0	23.87	0.09	0	Right	Tilt	Ant F	DFT-S-OFDM QPSK	135	69	1117M	1:4	0.062	1.297	0.080	
2592.99	518598	Mid	NR Band n41	100	25.0	24.16	-0.10	0	Left	Cheek	Ant F	DFT-S-OFDM QPSK	1	1	1117M	1:4	0.053	1.213	0.064	
2592.99	518598	Mid	NR Band n41	100	25.0	23.87	0.05	0	Left	Cheek	Ant F	DFT-S-OFDM QPSK	135	69	1117M	1:4	0.045	1.297	0.058	
2592.99	518598	Mid	NR Band n41	100	25.0	24.16	0.03	0	Left	Tilt	Ant F	DFT-S-OFDM QPSK	1	1	1117M	1:4	0.067	1.213	0.081	A25
2592.99	518598	Mid	NR Band n41	100	25.0	23.87	0.06	0	Left	Tilt	Ant F	DFT-S-OFDM QPSK	135	69	1117M	1:4	0.054	1.297	0.070	
2592.99	518598	Mid	NR Band n41	100	23.5	22.79	-0.06	1.5	Left	Tilt	Ant F	CP-OFDM QPSK	1	1	1117M	1:4	0.040	1.178	0.047	
ANSI / IEEE C95.1 1992 - SAFETY LIMIT Spatial Peak Uncontrolled Exposure/General Population										Head 1.6 W/kg (mW/g) averaged over 1 gram										

**Table 11-26
DTS Head SAR**

MEASUREMENT RESULTS																			
FREQUENCY		Mode	Service	Bandwidth [MHz]	Maximum Allowed Power [dBm]	Conducted Power [dBm]	Power Drift [dB]	Side	Test Position	Antenna Config.	Device Serial Number	Data Rate (Mbps)	Duty Cycle (%)	Peak SAR of Area Scan	SAR (1g)	Scaling Factor (Power)	Scaling Factor (Duty Cycle)	Reported SAR (1g)	Plot #
Mhz	Ch.													W/kg	(W/kg)			(W/kg)	
2437	6	802.11b	DSSS	22	13.0	12.72	0.10	Right	Cheek	1	1345M	1	99.8	0.700	-	1.067	1.002	-	
2437	6	802.11b	DSSS	22	13.0	12.72	0.16	Right	Tilt	1	1345M	1	99.8	0.510	-	1.067	1.002	-	
2437	6	802.11b	DSSS	22	13.0	12.72	-0.05	Left	Cheek	1	1345M	1	99.8	0.481	-	1.067	1.002	-	
2437	6	802.11b	DSSS	22	13.0	12.72	0.12	Left	Tilt	1	1345M	1	99.8	0.738	0.329	1.067	1.002	0.352	A26
2462	11	802.11b	DSSS	22	13.0	12.88	0.15	Right	Cheek	2	1345M	1	99.9	0.172	-	1.028	1.001	-	
2462	11	802.11b	DSSS	22	13.0	12.88	-0.19	Right	Tilt	2	1345M	1	99.9	0.147	-	1.028	1.001	-	
2462	11	802.11b	DSSS	22	13.0	12.88	0.03	Left	Cheek	2	1345M	1	99.9	0.359	-	1.028	1.001	-	
2462	11	802.11b	DSSS	22	13.0	12.88	-0.08	Left	Tilt	2	1345M	1	99.9	0.470	0.231	1.028	1.001	0.238	
ANSI / IEEE C95.1 1992 - SAFETY LIMIT Spatial Peak Uncontrolled Exposure/General Population										Head 1.6 W/kg (mW/g) averaged over 1 gram									



FCC ID: A3LSMF916U		SAR EVALUATION REPORT		Approved by: Quality Manager
Document S/N: 1M2005200087-01-R2.A3L	Test Dates: 06/28/20-08/24/20	DUT Type: Portable Handset	Page 135 of 267	

**Table 11-27
NII Head SAR**

MEASUREMENT RESULTS																			
FREQUENCY		Mode	Service	Bandwidth [MHz]	Maximum Allowed Power [dBm]	Conducted Power [dBm]	Power Drift [dB]	Side	Test Position	Antenna Config.	Device Serial Number	Data Rate (Mbps)	Duty Cycle (%)	Peak SAR of Area Scan	SAR (1g)	Scaling Factor (Power)	Scaling Factor (Duty Cycle)	Reported SAR (1g)	Plot #
MHz	Ch.													W/kg	(W/kg)			(W/kg)	
5290	58	802.11ac	OFDM	80	11.0	10.37	0.03	Right	Cheek	1	0815M	29.3	99.8	0.115	-	1.156	1.002	-	
5290	58	802.11ac	OFDM	80	11.0	10.37	0.03	Right	Tilt	1	0815M	29.3	99.8	0.147	0.059	1.156	1.002	0.068	
5290	58	802.11ac	OFDM	80	11.0	10.37	-0.10	Left	Cheek	1	0815M	29.3	99.8	0.057	-	1.156	1.002	-	
5290	58	802.11ac	OFDM	80	11.0	10.37	0.06	Left	Tilt	1	0815M	29.3	99.8	0.051	-	1.156	1.002	-	
5290	58	802.11ac	OFDM	80	11.0	10.67	0.08	Right	Cheek	2	0815M	29.3	99.8	0.086	-	1.079	1.002	-	
5290	58	802.11ac	OFDM	80	11.0	10.67	0.02	Right	Tilt	2	0815M	29.3	99.8	0.076	-	1.079	1.002	-	
5290	58	802.11ac	OFDM	80	11.0	10.67	0.19	Left	Cheek	2	0815M	29.3	99.8	0.087	0.056	1.079	1.002	0.061	
5290	58	802.11ac	OFDM	80	11.0	10.67	0.18	Left	Tilt	2	0815M	29.3	99.8	0.076	-	1.079	1.002	-	
5530	106	802.11ac	OFDM	80	11.0	10.56	0.09	Right	Cheek	1	0815M	29.3	99.8	0.128	0.046	1.107	1.002	0.051	
5530	106	802.11ac	OFDM	80	11.0	10.56	0.09	Right	Tilt	1	0815M	29.3	99.8	0.106	-	1.107	1.002	-	
5530	106	802.11ac	OFDM	80	11.0	10.56	0.03	Left	Cheek	1	0815M	29.3	99.8	0.041	-	1.107	1.002	-	
5530	106	802.11ac	OFDM	80	11.0	10.56	0.19	Left	Tilt	1	0815M	29.3	99.8	0.032	-	1.107	1.002	-	
5530	106	802.11ac	OFDM	80	11.0	10.75	-0.08	Right	Cheek	2	0815M	29.3	99.8	0.059	-	1.059	1.002	-	
5530	106	802.11ac	OFDM	80	11.0	10.75	0.04	Right	Tilt	2	0815M	29.3	99.8	0.055	-	1.059	1.002	-	
5530	106	802.11ac	OFDM	80	11.0	10.75	0.03	Left	Cheek	2	0815M	29.3	99.8	0.080	0.040	1.059	1.002	0.042	
5530	106	802.11ac	OFDM	80	11.0	10.75	0.04	Left	Tilt	2	0815M	29.3	99.8	0.060	-	1.059	1.002	-	
5775	155	802.11ac	OFDM	80	11.0	10.82	0.02	Right	Cheek	1	0815M	29.3	99.8	0.292	0.113	1.042	1.002	0.118	A27
5775	155	802.11ac	OFDM	80	11.0	10.82	0.02	Right	Tilt	1	0815M	29.3	99.8	0.238	-	1.042	1.002	-	
5775	155	802.11ac	OFDM	80	11.0	10.82	0.04	Left	Cheek	1	0815M	29.3	99.8	0.134	-	1.042	1.002	-	
5775	155	802.11ac	OFDM	80	11.0	10.82	0.19	Left	Tilt	1	0815M	29.3	99.8	0.126	-	1.042	1.002	-	
5775	155	802.11ac	OFDM	80	11.0	10.76	0.02	Right	Cheek	2	0815M	29.3	99.8	0.057	-	1.057	1.002	-	
5775	155	802.11ac	OFDM	80	11.0	10.76	0.19	Right	Tilt	2	0815M	29.3	99.8	0.065	-	1.057	1.002	-	
5775	155	802.11ac	OFDM	80	11.0	10.76	0.04	Left	Cheek	2	0815M	29.3	99.8	0.075	0.032	1.057	1.002	0.034	
5775	155	802.11ac	OFDM	80	11.0	10.76	0.03	Left	Tilt	2	0815M	29.3	99.8	0.044	-	1.057	1.002	-	
ANSI / IEEE C95.1 1992 - SAFETY LIMIT Spatial Peak Uncontrolled Exposure/General Population										Head 1.6 W/kg (mW/g) averaged over 1 gram									

**Table 11-28
DSS Head SAR**



MEASUREMENT RESULTS																			
FREQUENCY		Mode	Service	Maximum Allowed Power [dBm]	Conducted Power [dBm]	Power Drift [dB]	Side	Test Position	Antenna Config.	Device Serial Number	Data Rate (Mbps)	Duty Cycle (%)	SAR (1g)	Scaling Factor (Cond Power)	Scaling Factor (Duty Cycle)	Reported SAR (1g)	Plot #		
MHz	Ch.												(W/kg)			(W/kg)			
2441.00	39	Bluetooth	FHSS	14.0	13.47	-0.09	Right	Cheek	1	1346M	1	77.9	0.189	1.130	1.284	0.274			
2441.00	39	Bluetooth	FHSS	14.0	13.47	0.11	Right	Tilt	1	1346M	1	77.9	0.222	1.130	1.284	0.322	A28		
2441.00	39	Bluetooth	FHSS	14.0	13.47	0.00	Left	Cheek	1	1346M	1	77.9	0.133	1.130	1.284	0.193			
2441.00	39	Bluetooth	FHSS	14.0	13.47	0.04	Left	Tilt	1	1346M	1	77.9	0.176	1.130	1.284	0.255			
2441.00	39	Bluetooth	FHSS	14.0	13.62	-0.01	Right	Cheek	2	1346M	1	77.3	0.066	1.091	1.294	0.072			
2441.00	39	Bluetooth	FHSS	14.0	13.62	-0.08	Right	Tilt	2	1346M	1	77.3	0.045	1.091	1.294	0.049			
2441.00	39	Bluetooth	FHSS	14.0	13.62	-0.01	Left	Cheek	2	1346M	1	77.3	0.092	1.091	1.294	0.100			
2441.00	39	Bluetooth	FHSS	14.0	13.62	-0.03	Left	Tilt	2	1346M	1	77.3	0.083	1.091	1.294	0.091			
ANSI / IEEE C95.1 1992 - SAFETY LIMIT Spatial Peak Uncontrolled Exposure/General Population										Head 1.6 W/kg (mW/g) averaged over 1 gram									

FCC ID: A3LSMF916U		SAR EVALUATION REPORT		Approved by: Quality Manager
Document S/N: 1M2005200087-01-R2.A3L	Test Dates: 06/28/20-08/24/20	DUT Type: Portable Handset	Page 136 of 267	

11.2 Standalone Body-Worn SAR Data

**Table 11-29
GSM/UMTS/CDMA Body-Worn SAR Data**

MEASUREMENT RESULTS																
FREQUENCY		Mode	Service	Maximum Allowed Power [dBm]	Conducted Power [dBm]	Power Drift [dB]	Spacing	Antenna Config.	Tune State	Device Serial Number	Duty Cycle	Side	SAR (1g)	Scaling Factor	Reported SAR (1g)	Plot #
MHz	Ch.												(W/kg)		(W/kg)	
820.10	564	CDMA BC10 (\$90S)	TDSO / SO32	26.0	25.11	0.04	15 mm	Ant A	11	0744M	1:1	back	0.274	1.227	0.336	A29
836.52	384	CDMA BC0 (\$22H)	TDSO / SO32	26.0	25.12	0.01	15 mm	Ant A	0	0744M	1:1	back	0.327	1.225	0.401	A31
836.52	384	CDMA BC0 (\$22H)	TDSO / SO32	24.5	23.47	0.10	15 mm	Ant B	N/A	0744M	1:1	back	0.110	1.268	0.139	
1880.00	600	PCS CDMA	TDSO / SO32	24.0	22.87	0.03	15 mm	Ant B	N/A	1102M	1:1	back	0.313	1.297	0.406	A33
836.60	190	GSM 850	GSM	33.5	33.05	0.01	15 mm	Ant A	N/A	0897M	1:1	back	0.181	1.109	0.201	A35
836.60	190	GSM 850	GSM	32.5	31.18	0.03	15 mm	Ant B	N/A	0897M	1:1	back	0.073	1.355	0.099	
1880.00	661	GSM 1900	GSM	30.5	28.89	-0.06	15 mm	Ant B	N/A	0018M	1:1	back	0.160	1.449	0.232	A37
836.60	4183	UMTS 850	RMC	25.8	24.32	-0.03	15 mm	Ant A	0	0897M	1:1	back	0.186	1.406	0.262	A39
1712.40	1312	UMTS 1750	RMC	25.5	24.11	0.03	15 mm	Ant B	N/A	1134M	1:1	back	0.643	1.377	0.885	
1732.40	1412	UMTS 1750	RMC	25.5	24.24	0.00	15 mm	Ant B	N/A	1134M	1:1	back	0.743	1.337	0.993	A41
1752.60	1513	UMTS 1750	RMC	25.5	23.53	0.00	15 mm	Ant B	N/A	1134M	1:1	back	0.580	1.574	0.913	
1880.00	9400	UMTS 1900	RMC	24.5	23.81	-0.05	15 mm	Ant B	N/A	1102M	1:1	back	0.511	1.172	0.599	A43
ANSI / IEEE C95.1 1992 - SAFETY LIMIT Spatial Peak Uncontrolled Exposure/General Population							Body 1.6 W/kg (mW/g) averaged over 1 gram									



FCC ID: A3LSMF916U	 PCTEST <small>Practical to be part of the solution</small>	SAR EVALUATION REPORT		Approved by: Quality Manager
Document S/N: 1M2005200087-01-R2.A3L	Test Dates: 06/28/20-08/24/20	DUT Type: Portable Handset		Page 137 of 267

**Table 11-30
LTE Body-Worn SAR**

MEASUREMENT RESULTS																					
FREQUENCY		Mode	Bandwidth [MHz]	Tune State	Maximum Allowed Power [dBm]	Conducted Power [dBm]	Power Drift [dB]	MPR [dB]	Antenna Config.	Device Serial Number	Modulation	RB Size	RB Offset	Spacing	Side	Duty Cycle	SAR (1g) (W/kg)	Scaling Factor	Reported SAR (1g) (W/kg)	Plot #	
MHz	Ch.																				
680.50	133297	Mid	LTE Band 71	20	9	25.8	24.67	-0.01	0	Ant A	0069M	QPSK	1	0	15 mm	back	1:1	0.186	1.297	0.241	A45
680.50	133297	Mid	LTE Band 71	20	9	24.8	23.77	0.03	1	Ant A	0069M	QPSK	50	50	15 mm	back	1:1	0.135	1.268	0.171	
707.50	23095	Mid	LTE Band 12	10	9	25.8	25.10	-0.03	0	Ant A	0069M	QPSK	1	49	15 mm	back	1:1	0.118	1.175	0.139	A47
707.50	23095	Mid	LTE Band 12	10	9	24.8	24.06	-0.05	1	Ant A	0069M	QPSK	25	25	15 mm	back	1:1	0.099	1.186	0.117	
782.00	23230	Mid	LTE Band 13	10	10	25.8	24.15	-0.03	0	Ant A	0896M	QPSK	1	49	15 mm	back	1:1	0.234	1.462	0.342	A49
782.00	23230	Mid	LTE Band 13	10	10	24.8	23.35	0.01	1	Ant A	0896M	QPSK	25	0	15 mm	back	1:1	0.178	1.396	0.248	
782.00	23230	Mid	LTE Band 13	10	N/A	23.8	22.33	-0.03	0	Ant B	0069M	QPSK	1	0	15 mm	back	1:1	0.036	1.403	0.051	
782.00	23230	Mid	LTE Band 13	10	N/A	22.8	21.48	0.12	1	Ant B	0069M	QPSK	25	0	15 mm	back	1:1	0.032	1.355	0.043	
793.00	23330	Mid	LTE Band 14	10	9	25.8	24.11	0.02	0	Ant A	0896M	QPSK	1	0	15 mm	back	1:1	0.205	1.476	0.303	A51
793.00	23330	Mid	LTE Band 14	10	9	24.8	23.14	-0.03	1	Ant A	0896M	QPSK	25	12	15 mm	back	1:1	0.168	1.466	0.246	
793.00	23330	Mid	LTE Band 14	10	N/A	23.8	22.42	-0.04	0	Ant B	0069M	QPSK	1	0	15 mm	back	1:1	0.040	1.374	0.055	
793.00	23330	Mid	LTE Band 14	10	N/A	22.8	21.36	0.08	1	Ant B	0069M	QPSK	25	12	15 mm	back	1:1	0.034	1.393	0.047	
831.50	26865	Mid	LTE Band 26 (Cell)	15	0	25.8	24.74	-0.02	0	Ant A	0069M	QPSK	1	36	15 mm	back	1:1	0.248	1.276	0.316	A53
831.50	26865	Mid	LTE Band 26 (Cell)	15	0	24.8	23.84	0.03	1	Ant A	0069M	QPSK	36	37	15 mm	back	1:1	0.205	1.247	0.256	
836.50	20525	Mid	LTE Band 5 (Cell)	10	0	25.8	24.85	-0.01	0	Ant A	0069M	QPSK	1	0	15 mm	back	1:1	0.245	1.245	0.305	A55
836.50	20525	Mid	LTE Band 5 (Cell)	10	0	24.8	23.98	0.03	1	Ant A	0069M	QPSK	25	12	15 mm	back	1:1	0.196	1.208	0.237	
1860.00	26140	Low	LTE Band 25 (PCS)	20	N/A	25.5	24.47	-0.03	0	Ant B	1138M	QPSK	1	0	15 mm	back	1:1	0.370	1.268	0.469	A59
1860.00	26140	Low	LTE Band 25 (PCS)	20	N/A	24.5	23.68	0.00	1	Ant B	1138M	QPSK	50	0	15 mm	back	1:1	0.283	1.208	0.342	
2310.00	27710	Mid	LTE Band 30	10	N/A	25.0	23.84	0.03	0	Ant B	0072M	QPSK	1	0	15 mm	back	1:1	0.480	1.306	0.627	A61
2310.00	27710	Mid	LTE Band 30	10	N/A	24.0	22.92	0.16	1	Ant B	0072M	QPSK	25	12	15 mm	back	1:1	0.377	1.282	0.483	
2510.00	20850	Low	LTE Band 7	20	N/A	22.0	21.92	0.01	0	Ant B	0909M	QPSK	1	0	15 mm	back	1:1	0.510	1.019	0.520	
2510.00	20850	Low	LTE Band 7	20	N/A	22.0	22.00	-0.01	0	Ant B	0909M	QPSK	50	25	15 mm	back	1:1	0.519	1.000	0.519	A63
2680.00	41490	High	LTE Band 41	20	N/A	23.5	22.89	0.02	0	Ant B	0901M	QPSK	1	50	15 mm	back	1:1.58	0.409	1.151	0.471	A67
2680.00	41490	High	LTE Band 41	20	N/A	23.5	23.05	0.10	0	Ant B	0901M	QPSK	50	50	15 mm	back	1:1.58	0.353	1.109	0.391	
3690.00	56640	High	LTE Band 48	20	N/A	20.5	20.34	0.03	0	Ant F	0075M	QPSK	1	50	15 mm	back	1:1.58	0.239	1.038	0.248	
3690.00	56640	High	LTE Band 48	20	N/A	20.5	20.49	-0.04	0	Ant F	0075M	QPSK	50	0	15 mm	back	1:1.58	0.244	1.002	0.244	A65
ANSI / IEEE C95.1 1992 - SAFETY LIMIT										Body											
Spatial Peak										1.6 W/kg (mW/g)											
Uncontrolled Exposure/General Population										averaged over 1 gram											

**Table 11-31
LTE Band 66 Body-Worn SAR**

MEASUREMENT RESULTS																						
1 CC Uplink 2 CC Uplink	Component Carrier	FREQUENCY		Mode	Bandwidth [MHz]	Maximum Allowed Power [dBm]	Conducted Power [dBm]	Power Drift [dB]	MPR [dB]	Antenna Config.	Device Serial Number	Modulation	RB Size	RB Offset	Spacing	Side	Duty Cycle	SAR (1g) (W/kg)	Scaling Factor	Reported SAR (1g) (W/kg)	Plot #	
		MHz	Ch.																			
1 CC Uplink	N/A	1720.00	132072	Low	LTE Band 66 (AWS)	20	25.0	23.71	-0.03	0	Ant B	0065M	QPSK	1	50	15 mm	back	1:1	0.843	1.346	1.135	
1 CC Uplink	N/A	1720.00	132072	Low	LTE Band 66 (AWS)	20	25.0	23.59	0.00	0	Ant B	0065M	QPSK	1	99	15 mm	back	1:1	0.741	1.384	1.026	
1 CC Uplink	N/A	1715.00	132022	Low	LTE Band 66 (AWS)	10	25.0	23.55	0.02	0	Ant B	0065M	QPSK	1	49	15 mm	back	1:1	0.785	1.396	1.096	
1 CC Uplink	N/A	1745.00	132322	Mid	LTE Band 66 (AWS)	20	25.0	24.13	0.00	0	Ant B	0065M	QPSK	1	50	15 mm	back	1:1	0.723	1.222	0.884	
1 CC Uplink	N/A	1770.00	132572	High	LTE Band 66 (AWS)	20	25.0	24.30	-0.01	0	Ant B	0065M	QPSK	1	99	15 mm	back	1:1	0.695	1.175	0.817	
1 CC Uplink	N/A	1770.00	132572	High	LTE Band 66 (AWS)	20	24.0	23.32	0.04	1	Ant B	0065M	QPSK	50	25	15 mm	back	1:1	0.584	1.169	0.683	
1 CC Uplink	N/A	1770.00	132572	High	LTE Band 66 (AWS)	20	24.0	23.21	0.01	1	Ant B	0065M	QPSK	100	0	15 mm	back	1:1	0.572	1.199	0.686	
2 CC Uplink 66C	PCC	1720.00	132072	Low	LTE Band 66 (AWS)	20	25.0	23.73	-0.03	0	Ant B	0065M	QPSK	1	99	15 mm	back	1:1	0.774	1.340	1.037	
	SCC	1739.80	132270																			
2 CC Uplink 66B	PCC	1715.00	132022	Low	LTE Band 66 (AWS)	10	25.0	23.96	0.04	0	Ant B	0065M	QPSK	1	49	15 mm	back	1:1	0.848	1.271	1.078	A57
	SCC	1724.90	132121																			
ANSI / IEEE C95.1 1992 - SAFETY LIMIT										Body												
Spatial Peak										1.6 W/kg (mW/g)												
Uncontrolled Exposure/General Population										averaged over 1 gram												

FCC ID: A3LSMF916U	 <small>Proceed to be part of a Samsung</small>	SAR EVALUATION REPORT		Approved by: Quality Manager
Document S/N: 1M2005200087-01-R2.A3L	Test Dates: 06/28/20-08/24/20	DUT Type: Portable Handset	Page 138 of 267	

**Table 11-32
NR Body-Worn SAR**



MEASUREMENT RESULTS																				
FREQUENCY		Mode	Bandwidth [MHz]	Maximum Allowed Power [dBm]	Conducted Power [dBm]	Power Drift [dB]	MPR [dB]	Antenna Config.	Device Serial Number	Modulation	RB Size	RB Offset	Spacing	Side	Duty Cycle	SAR (1g)	Scaling Factor	Reported SAR (1g)	Plot #	
MHz	Ch.															(W/kg)		(W/kg)		
680.50	136100	Mid	NR Band n71	20	25.5	25.42	0.00	0	Ant A	1126M	DFT-S-OFDM QPSK	1	53	15 mm	back	1:1	0.205	1.019	0.209	A69
680.50	136100	Mid	NR Band n71	20	25.5	25.44	-0.01	0	Ant A	1126M	DFT-S-OFDM QPSK	50	28	15 mm	back	1:1	0.196	1.014	0.199	
680.50	136100	Mid	NR Band n71	20	24.0	24.00	0.12	1.5	Ant A	1126M	CP-OFDM QPSK	1	1	15 mm	back	1:1	0.139	1.000	0.139	
836.50	167300	Mid	NR Band n5 (Cell)	20	25.5	25.03	0.05	0	Ant A	1109M	DFT-S-OFDM QPSK	1	53	15 mm	back	1:1	0.287	1.114	0.320	A71
836.50	167300	Mid	NR Band n5 (Cell)	20	25.5	25.01	-0.01	0	Ant A	1109M	DFT-S-OFDM QPSK	50	28	15 mm	back	1:1	0.270	1.119	0.302	
836.50	167300	Mid	NR Band n5 (Cell)	20	24.0	23.52	0.05	1.5	Ant A	1109M	CP-OFDM QPSK	1	1	15 mm	back	1:1	0.197	1.117	0.220	
1770.00	354000	High	NR Band n66 (AWS)	20	24.5	23.84	-0.08	0	Ant B	0898M	DFT-S-OFDM QPSK	1	104	15 mm	back	1:1	0.534	1.164	0.622	
1720.00	344000	Low	NR Band n66 (AWS)	20	24.5	23.35	0.04	0	Ant B	0898M	DFT-S-OFDM QPSK	50	28	15 mm	back	1:1	0.572	1.303	0.745	
1745.00	349000	Mid	NR Band n66 (AWS)	20	24.5	23.46	0.00	0	Ant B	0898M	DFT-S-OFDM QPSK	50	28	15 mm	back	1:1	0.588	1.271	0.747	
1770.00	354000	High	NR Band n66 (AWS)	20	24.5	23.73	-0.04	0	Ant B	0898M	DFT-S-OFDM QPSK	50	28	15 mm	back	1:1	0.601	1.194	0.718	A73
1770.00	354000	High	NR Band n66 (AWS)	20	23.0	22.27	-0.07	1.5	Ant B	0898M	CP-OFDM QPSK	1	1	15 mm	back	1:1	0.354	1.183	0.419	
1882.50	376500	Mid	NR Band n25 (PCS)	20	24.5	23.86	0.06	0	Ant B	0895M	DFT-S-OFDM QPSK	1	53	15 mm	back	1:1	0.421	1.159	0.488	A75
1882.50	376500	Mid	NR Band n25 (PCS)	20	24.5	23.76	0.03	0	Ant B	0895M	DFT-S-OFDM QPSK	50	28	15 mm	back	1:1	0.411	1.186	0.487	
1860.00	372000	Low	NR Band n25 (PCS)	20	23.0	22.44	-0.02	1.5	Ant B	0895M	CP-OFDM QPSK	1	1	15 mm	back	1:1	0.328	1.138	0.373	
2592.99	518598	Mid	NR Band n41	100	25.0	24.16	-0.02	0	Ant F	1296M	DFT-S-OFDM QPSK	1	1	15 mm	back	1:4	0.028	1.213	0.034	A77
2592.99	518598	Mid	NR Band n41	100	25.0	23.87	0.14	0	Ant F	1296M	DFT-S-OFDM QPSK	135	69	15 mm	back	1:4	0.025	1.297	0.032	
2592.99	518598	Mid	NR Band n41	100	23.5	22.79	-0.17	1.5	Ant F	1296M	CP-OFDM QPSK	1	1	15 mm	back	1:4	0.020	1.178	0.024	
ANSI / IEEE C95.1 1992 - SAFETY LIMIT Spatial Peak Uncontrolled Exposure/General Population										Body 1.6 W/kg (mW/g) averaged over 1 gram										

**Table 11-33
DTS Body-Worn SAR**

MEASUREMENT RESULTS																			
FREQUENCY		Mode	Service	Bandwidth [MHz]	Maximum Allowed Power [dBm]	Conducted Power [dBm]	Power Drift [dB]	Spacing	Antenna Config.	Device Serial Number	Data Rate (Mbps)	Side	Duty Cycle (%)	Peak SAR of Area Scan	SAR (1g)	Scaling Factor (Power)	Scaling Factor (Duty Cycle)	Reported SAR (1g)	Plot #
MHz	Ch.													(W/kg)	(W/kg)	(W/kg)	(W/kg)		
2437	6	802.11b	DSSS	22	19.0	18.99	0.06	15 mm	1	0815M	1	back	99.8	0.041	0.028	1.002	1.002	0.028	A79
2462	11	802.11b	DSSS	22	19.0	18.94	0.03	15 mm	2	0815M	1	back	99.9	0.022	0.015	1.014	1.001	0.015	
ANSI / IEEE C95.1 1992 - SAFETY LIMIT Spatial Peak Uncontrolled Exposure/General Population										Body 1.6 W/kg (mW/g) averaged over 1 gram									

**Table 11-34
NII Body-Worn SAR**

MEASUREMENT RESULTS																			
FREQUENCY		Mode	Service	Bandwidth [MHz]	Maximum Allowed Power [dBm]	Conducted Power [dBm]	Power Drift [dB]	Spacing	Antenna Config.	Device Serial Number	Data Rate (Mbps)	Side	Duty Cycle (%)	Peak SAR of Area Scan	SAR (1g)	Scaling Factor (Power)	Scaling Factor (Duty Cycle)	Reported SAR (1g)	Plot #
MHz	Ch.													(W/kg)	(W/kg)	(W/kg)	(W/kg)		
5300	60	802.11a	OFDM	20	18.0	17.99	-0.05	15 mm	1	0876M	6	back	99.2	0.023	0.007	1.002	1.008	0.007	
5300	60	802.11a	OFDM	20	18.0	17.95	-0.10	15 mm	2	0876M	6	back	99.4	0.012	0.003	1.012	1.006	0.003	
5620	124	802.11a	OFDM	20	18.0	17.99	0.02	15 mm	1	0876M	6	back	99.2	0.042	0.011	1.002	1.008	0.011	
5720	144	802.11a	OFDM	20	18.0	17.72	-0.02	15 mm	2	0876M	6	back	99.4	0.026	0.009	1.067	1.006	0.010	
5785	157	802.11a	OFDM	20	18.0	17.93	0.12	15 mm	1	0876M	6	back	99.2	0.047	0.016	1.016	1.008	0.016	A81
5785	157	802.11a	OFDM	20	18.0	17.98	-0.05	15 mm	2	0876M	6	back	99.4	0.025	0.010	1.005	1.006	0.010	
ANSI / IEEE C95.1 1992 - SAFETY LIMIT Spatial Peak Uncontrolled Exposure/General Population										Body 1.6 W/kg (mW/g) averaged over 1 gram									

FCC ID: A3LSMF916U	 <small>Proud to be part of Samsung</small>	SAR EVALUATION REPORT		Approved by: Quality Manager
Document S/N: 1M2005200087-01-R2.A3L	Test Dates: 06/28/20-08/24/20	DUT Type: Portable Handset	Page 139 of 267	



**Table 11-35
DSS Body-Worn SAR**

MEASUREMENT RESULTS																	
FREQUENCY		Mode	Service	Maximum Allowed Power [dBm]	Conducted Power [dBm]	Power Drift [dB]	Spacing	Antenna Config.	Device Serial Number	Data Rate (Mbps)	Side	Duty Cycle (%)	SAR (1g)	Scaling Factor (Cond Power)	Scaling Factor (Duty Cycle)	Reported SAR (1g)	Plot #
MHz	Ch.												(W/kg)			(W/kg)	
2441	39	Bluetooth	FHSS	20.0	19.53	0.03	15 mm	1	1356M	1	back	77.9	0.009	1.115	1.284	0.013	
2441	39	Bluetooth	FHSS	20.0	19.23	0.06	15 mm	2	1356M	1.00	back	77.3	0.010	1.193	1.294	0.015	A83
ANSI / IEEE C95.1 1992 - SAFETY LIMIT Spatial Peak Uncontrolled Exposure/General Population							Body 1.6 W/kg (mW/g) averaged over 1 gram										

11.3 Standalone Hotspot SAR Data



**Table 11-36
CDMA Hotspot SAR Data**

MEASUREMENT RESULTS																
FREQUENCY		Mode	Service	Maximum Allowed Power [dBm]	Conducted Power [dBm]	Power Drift [dB]	Spacing	Antenna Config.	Tune State	Device Serial Number	Duty Cycle	Side	SAR (1g)	Scaling Factor	Reported SAR (1g)	Plot #
MHz	Ch.												(W/kg)		(W/kg)	
820.10	564	CDMA BC10 (§90S)	EVDO Rev. 0	26.0	25.15	0.03	10 mm	Ant A	11	0744M	1:1	back	0.571	1.216	0.694	A30
820.10	564	CDMA BC10 (§90S)	EVDO Rev. 0	26.0	25.15	0.03	10 mm	Ant A	11	0744M	1:1	front	0.153	1.216	0.186	
820.10	564	CDMA BC10 (§90S)	EVDO Rev. 0	26.0	25.15	-0.02	10 mm	Ant A	11	0744M	1:1	bottom	0.278	1.216	0.338	
820.10	564	CDMA BC10 (§90S)	EVDO Rev. 0	26.0	25.15	-0.03	10 mm	Ant A	11	0744M	1:1	right	0.361	1.216	0.439	
824.70	1013	CDMA BC0 (§22H)	EVDO Rev. 0	26.0	25.19	-0.03	10 mm	Ant A	0	0744M	1:1	back	0.622	1.205	0.750	
836.52	384	CDMA BC0 (§22H)	EVDO Rev. 0	26.0	25.16	0.00	10 mm	Ant A	0	0744M	1:1	back	0.686	1.213	0.832	A32
848.31	777	CDMA BC0 (§22H)	EVDO Rev. 0	26.0	25.08	-0.01	10 mm	Ant A	0	0744M	1:1	back	0.655	1.236	0.810	
836.52	384	CDMA BC0 (§22H)	EVDO Rev. 0	26.0	25.16	-0.03	10 mm	Ant A	0	0744M	1:1	front	0.147	1.213	0.178	
836.52	384	CDMA BC0 (§22H)	EVDO Rev. 0	26.0	25.16	-0.10	10 mm	Ant A	0	0744M	1:1	bottom	0.307	1.213	0.372	
836.52	384	CDMA BC0 (§22H)	EVDO Rev. 0	26.0	25.16	-0.08	10 mm	Ant A	0	0744M	1:1	right	0.391	1.213	0.474	
836.52	384	CDMA BC0 (§22H)	EVDO Rev. 0	24.5	23.51	0.07	10 mm	Ant B	N/A	0744M	1:1	back	0.277	1.256	0.348	
836.52	384	CDMA BC0 (§22H)	EVDO Rev. 0	24.5	23.51	-0.17	10 mm	Ant B	N/A	0744M	1:1	front	0.035	1.256	0.044	
836.52	384	CDMA BC0 (§22H)	EVDO Rev. 0	24.5	23.51	-0.01	10 mm	Ant B	N/A	0744M	1:1	bottom	0.100	1.256	0.126	
836.52	384	CDMA BC0 (§22H)	EVDO Rev. 0	24.5	23.51	0.03	10 mm	Ant B	N/A	0744M	1:1	right	0.044	1.256	0.055	
836.52	384	CDMA BC0 (§22H)	EVDO Rev. 0	24.5	23.51	0.05	10 mm	Ant B	N/A	0744M	1:1	left	0.057	1.256	0.072	
1880.00	600	PCS CDMA	EVDO Rev. 0	20.0	18.58	-0.03	10 mm	Ant B	N/A	1102M	1:1	back	0.281	1.387	0.390	
1880.00	600	PCS CDMA	EVDO Rev. 0	20.0	18.58	0.03	10 mm	Ant B	N/A	1102M	1:1	front	0.065	1.387	0.090	
1851.25	25	PCS CDMA	EVDO Rev. 0	20.0	19.02	-0.09	10 mm	Ant B	N/A	1102M	1:1	bottom	0.670	1.253	0.840	A34
1880.00	600	PCS CDMA	EVDO Rev. 0	20.0	18.58	-0.06	10 mm	Ant B	N/A	1102M	1:1	bottom	0.642	1.387	0.890	
1908.75	1175	PCS CDMA	EVDO Rev. 0	20.0	18.95	-0.12	10 mm	Ant B	N/A	1102M	1:1	bottom	0.663	1.274	0.845	
1880.00	600	PCS CDMA	EVDO Rev. 0	20.0	18.58	0.00	10 mm	Ant B	N/A	1102M	1:1	right	0.160	1.387	0.222	
1880.00	600	PCS CDMA	EVDO Rev. 0	20.0	18.58	0.11	10 mm	Ant B	N/A	1102M	1:1	left	0.042	1.387	0.058	
ANSI / IEEE C95.1 1992 - SAFETY LIMIT Spatial Peak Uncontrolled Exposure/General Population							Body 1.6 W/kg (mW/g) averaged over 1 gram									

FCC ID: A3LSMF916U	 <small>Proud to be part of Samsung</small>	SAR EVALUATION REPORT		Approved by: Quality Manager
Document S/N: 1M2005200087-01-R2.A3L	Test Dates: 06/28/20-08/24/20	DUT Type: Portable Handset	Page 140 of 267	

**Table 11-37
GPRS Hotspot SAR Data**

MEASUREMENT RESULTS																
FREQUENCY		Mode	Service	Maximum Allowed Power [dBm]	Conducted Power [dBm]	Power Drift [dB]	Spacing	Antenna Config.	Device Serial Number	# of Time Slots	Duty Cycle	Side	SAR (1g)	Scaling Factor	Reported SAR (1g)	Plot #
MHz	Ch.												(W/kg)		(W/kg)	
824.20	128	GSM 850	GPRS	30.5	28.76	0.12	10 mm	Ant A	0897M	3	1:2.76	back	0.598	1.493	0.893	
836.60	190	GSM 850	GPRS	30.5	28.88	-0.04	10 mm	Ant A	0897M	3	1:2.76	back	0.628	1.452	0.912	A36
848.80	251	GSM 850	GPRS	30.5	29.08	0.12	10 mm	Ant A	0897M	3	1:2.76	back	0.473	1.387	0.656	
836.60	190	GSM 850	GPRS	30.5	28.88	-0.09	10 mm	Ant A	0897M	3	1:2.76	front	0.109	1.452	0.158	
836.60	190	GSM 850	GPRS	30.5	28.88	-0.08	10 mm	Ant A	0897M	3	1:2.76	bottom	0.227	1.452	0.330	
836.60	190	GSM 850	GPRS	30.5	28.88	0.04	10 mm	Ant A	0897M	3	1:2.76	right	0.367	1.452	0.533	
836.60	190	GSM 850	GPRS	29.5	28.29	-0.08	10 mm	Ant B	0897M	3	1:2.76	back	0.265	1.321	0.350	
836.60	190	GSM 850	GPRS	29.5	28.29	0.04	10 mm	Ant B	0897M	3	1:2.76	front	0.037	1.321	0.049	
836.60	190	GSM 850	GPRS	29.5	28.29	-0.08	10 mm	Ant B	0897M	3	1:2.76	bottom	0.104	1.321	0.137	
836.60	190	GSM 850	GPRS	29.5	28.29	0.05	10 mm	Ant B	0897M	3	1:2.76	right	0.058	1.321	0.077	
836.60	190	GSM 850	GPRS	29.5	28.29	0.05	10 mm	Ant B	0897M	3	1:2.76	left	0.071	1.321	0.094	
1880.00	661	GSM 1900	GPRS	23.0	21.82	-0.05	10 mm	Ant B	0018M	4	1:2.076	back	0.200	1.312	0.262	
1880.00	661	GSM 1900	GPRS	23.0	21.82	0.05	10 mm	Ant B	0018M	4	1:2.076	front	0.053	1.312	0.070	
1850.20	512	GSM 1900	GPRS	23.0	21.84	-0.03	10 mm	Ant B	0018M	4	1:2.076	bottom	0.420	1.306	0.549	
1880.00	661	GSM 1900	GPRS	23.0	21.82	-0.03	10 mm	Ant B	0018M	4	1:2.076	bottom	0.498	1.312	0.653	
1909.80	810	GSM 1900	GPRS	23.0	21.69	0.05	10 mm	Ant B	0018M	4	1:2.076	bottom	0.510	1.352	0.690	A38
1880.00	661	GSM 1900	GPRS	23.0	21.82	-0.02	10 mm	Ant B	0018M	4	1:2.076	right	0.168	1.312	0.220	
1880.00	661	GSM 1900	GPRS	23.0	21.82	-0.08	10 mm	Ant B	0018M	4	1:2.076	left	0.035	1.312	0.046	
ANSI / IEEE C95.1 1992 - SAFETY LIMIT							Body									
Spatial Peak							1.6 W/kg (mW/g)									
Uncontrolled Exposure/General Population							averaged over 1 gram									



FCC ID: A3LSMF916U	 PCTEST <small>Proud to be part of Samsung</small>	SAR EVALUATION REPORT		Approved by: Quality Manager
Document S/N: 1M2005200087-01-R2.A3L	Test Dates: 06/28/20-08/24/20	DUT Type: Portable Handset		Page 141 of 267

**Table 11-38
UMTS Hotspot SAR Data**

MEASUREMENT RESULTS																
FREQUENCY		Mode	Service	Maximum Allowed Power [dBm]	Conducted Power [dBm]	Power Drift [dB]	Spacing	Antenna Config.	Tune State	Device Serial Number	Duty Cycle	Side	SAR (1g) (W/kg)	Scaling Factor	Reported SAR (1g) (W/kg)	Plot #
MHz	Ch.															
836.60	4183	UMTS 850	RMC	25.8	24.32	-0.02	10 mm	Ant A	0	0897M	1:1	back	0.409	1.406	0.575	A40
836.60	4183	UMTS 850	RMC	25.8	24.32	-0.01	10 mm	Ant A	0	0897M	1:1	front	0.133	1.406	0.187	
836.60	4183	UMTS 850	RMC	25.8	24.32	0.02	10 mm	Ant A	0	0897M	1:1	bottom	0.227	1.406	0.319	
836.60	4183	UMTS 850	RMC	25.8	24.32	-0.06	10 mm	Ant A	0	0897M	1:1	right	0.344	1.406	0.484	
1732.40	1412	UMTS 1750	RMC	20.0	18.93	-0.01	10 mm	Ant B	N/A	1134M	1:1	back	0.506	1.279	0.647	
1732.40	1412	UMTS 1750	RMC	20.0	18.93	0.01	10 mm	Ant B	N/A	1134M	1:1	front	0.098	1.279	0.125	
1712.40	1312	UMTS 1750	RMC	20.0	18.75	0.00	10 mm	Ant B	N/A	1134M	1:1	bottom	0.687	1.334	0.916	
1732.40	1412	UMTS 1750	RMC	20.0	18.93	-0.01	10 mm	Ant B	N/A	1134M	1:1	bottom	0.786	1.279	1.005	A42
1752.60	1513	UMTS 1750	RMC	20.0	18.90	-0.04	10 mm	Ant B	N/A	1134M	1:1	bottom	0.778	1.288	1.002	
1732.40	1412	UMTS 1750	RMC	20.0	18.93	0.03	10 mm	Ant B	N/A	1134M	1:1	right	0.102	1.279	0.130	
1732.40	1412	UMTS 1750	RMC	20.0	18.93	0.08	10 mm	Ant B	N/A	1134M	1:1	left	0.061	1.279	0.078	
1880.00	9400	UMTS 1900	RMC	20.0	18.63	-0.05	10 mm	Ant B	N/A	1102M	1:1	back	0.303	1.371	0.415	
1880.00	9400	UMTS 1900	RMC	20.0	18.63	0.00	10 mm	Ant B	N/A	1102M	1:1	front	0.068	1.371	0.093	
1852.40	9262	UMTS 1900	RMC	20.0	19.01	-0.06	10 mm	Ant B	N/A	1102M	1:1	bottom	0.693	1.256	0.870	A44
1880.00	9400	UMTS 1900	RMC	20.0	18.63	-0.09	10 mm	Ant B	N/A	1102M	1:1	bottom	0.649	1.371	0.890	
1907.60	9538	UMTS 1900	RMC	20.0	18.94	-0.07	10 mm	Ant B	N/A	1102M	1:1	bottom	0.678	1.276	0.865	
1880.00	9400	UMTS 1900	RMC	20.0	18.63	-0.06	10 mm	Ant B	N/A	1102M	1:1	right	0.152	1.371	0.208	
1880.00	9400	UMTS 1900	RMC	20.0	18.63	-0.03	10 mm	Ant B	N/A	1102M	1:1	left	0.058	1.371	0.080	
ANSI / IEEE C95.1 1992 - SAFETY LIMIT Spatial Peak Uncontrolled Exposure/General Population							Body 1.6 W/kg (mW/g) averaged over 1 gram									

**Table 11-39
LTE Band 71 Hotspot SAR**

MEASUREMENT RESULTS																					
FREQUENCY		Mode	Bandwidth [MHz]	Tune State	Maximum Allowed Power [dBm]	Conducted Power [dBm]	Power Drift [dB]	MPR [dB]	Antenna Config.	Device Serial Number	Modulation	RB Size	RB Offset	Spacing	Side	Duty Cycle	SAR (1g) (W/kg)	Scaling Factor	Reported SAR (1g) (W/kg)	Plot #	
MHz	Ch.																				
680.50	133297	Mid	LTE Band 71	20	9	25.8	24.67	-0.06	0	Ant A	0069M	QPSK	1	0	10 mm	back	1:1	0.347	1.297	0.450	
680.50	133297	Mid	LTE Band 71	20	9	24.8	23.77	-0.04	1	Ant A	0069M	QPSK	50	50	10 mm	back	1:1	0.295	1.268	0.374	
680.50	133297	Mid	LTE Band 71	20	9	25.8	24.67	0.10	0	Ant A	0069M	QPSK	1	0	10 mm	front	1:1	0.144	1.297	0.187	
680.50	133297	Mid	LTE Band 71	20	9	24.8	23.77	0.01	1	Ant A	0069M	QPSK	50	50	10 mm	front	1:1	0.124	1.268	0.157	
680.50	133297	Mid	LTE Band 71	20	9	25.8	24.67	-0.07	0	Ant A	0069M	QPSK	1	0	10 mm	bottom	1:1	0.224	1.297	0.291	
680.50	133297	Mid	LTE Band 71	20	9	24.8	23.77	0.04	1	Ant A	0069M	QPSK	50	50	10 mm	bottom	1:1	0.171	1.268	0.217	
680.50	133297	Mid	LTE Band 71	20	9	25.8	24.67	-0.01	0	Ant A	0069M	QPSK	1	0	10 mm	right	1:1	0.386	1.297	0.501	A46
680.50	133297	Mid	LTE Band 71	20	9	24.8	23.77	-0.08	1	Ant A	0069M	QPSK	50	50	10 mm	right	1:1	0.312	1.268	0.396	
ANSI / IEEE C95.1 1992 - SAFETY LIMIT Spatial Peak Uncontrolled Exposure/General Population							Body 1.6 W/kg (mW/g) averaged over 1 gram														



FCC ID: A3LSMF916U	 <small>Proud to be part of Samsung</small>	SAR EVALUATION REPORT		Approved by: Quality Manager
Document S/N: 1M2005200087-01-R2.A3L	Test Dates: 06/28/20-08/24/20	DUT Type: Portable Handset	Page 142 of 267	

**Table 11-40
LTE Band 12 Hotspot SAR**

MEASUREMENT RESULTS																					
FREQUENCY		Mode	Bandwidth [MHz]	Tune State	Maximum Allowed Power [dBm]	Conducted Power [dBm]	Power Drift [dB]	MPR [dB]	Antenna Config.	Device Serial Number	Modulation	RB Size	RB Offset	Spacing	Side	Duty Cycle	SAR (1g)	Scaling Factor	Reported SAR (1g)	Plot #	
MHz	Ch.																(W/kg)		(W/kg)		
707.50	23095	Mid	LTE Band 12	10	9	25.8	25.10	-0.05	0	Ant A	0069M	QPSK	1	49	10 mm	back	1:1	0.237	1.175	0.278	
707.50	23095	Mid	LTE Band 12	10	9	24.8	24.06	-0.01	1	Ant A	0069M	QPSK	25	25	10 mm	back	1:1	0.199	1.186	0.236	
707.50	23095	Mid	LTE Band 12	10	9	25.8	25.10	0.07	0	Ant A	0069M	QPSK	1	49	10 mm	front	1:1	0.100	1.175	0.118	
707.50	23095	Mid	LTE Band 12	10	9	24.8	24.06	0.11	1	Ant A	0069M	QPSK	25	25	10 mm	front	1:1	0.084	1.186	0.100	
707.50	23095	Mid	LTE Band 12	10	9	25.8	25.10	0.03	0	Ant A	0069M	QPSK	1	49	10 mm	bottom	1:1	0.159	1.175	0.187	
707.50	23095	Mid	LTE Band 12	10	9	24.8	24.06	-0.02	1	Ant A	0069M	QPSK	25	25	10 mm	bottom	1:1	0.134	1.186	0.159	
707.50	23095	Mid	LTE Band 12	10	9	25.8	25.10	-0.12	0	Ant A	0069M	QPSK	1	49	10 mm	right	1:1	0.331	1.175	0.389	A48
707.50	23095	Mid	LTE Band 12	10	9	24.8	24.06	0.01	1	Ant A	0069M	QPSK	25	25	10 mm	right	1:1	0.272	1.186	0.323	
ANSI / IEEE C95.1 1992 - SAFETY LIMIT Spatial Peak Uncontrolled Exposure/General Population										Body 1.6 W/kg (mW/g) averaged over 1 gram											

**Table 11-41
LTE Band 13 Hotspot SAR**

MEASUREMENT RESULTS																					
FREQUENCY		Mode	Bandwidth [MHz]	Tune State	Maximum Allowed Power [dBm]	Conducted Power [dBm]	Power Drift [dB]	MPR [dB]	Antenna Config.	Device Serial Number	Modulation	RB Size	RB Offset	Spacing	Side	Duty Cycle	SAR (1g)	Scaling Factor	Reported SAR (1g)	Plot #	
MHz	Ch.																(W/kg)		(W/kg)		
782.00	23230	Mid	LTE Band 13	10	10	25.8	24.15	0.00	0	Ant A	0896M	QPSK	1	49	10 mm	back	1:1	0.535	1.462	0.782	A50
782.00	23230	Mid	LTE Band 13	10	10	24.8	23.35	0.02	1	Ant A	0896M	QPSK	25	0	10 mm	back	1:1	0.397	1.396	0.554	
782.00	23230	Mid	LTE Band 13	10	10	25.8	24.15	0.02	0	Ant A	0896M	QPSK	1	49	10 mm	front	1:1	0.184	1.462	0.269	
782.00	23230	Mid	LTE Band 13	10	10	24.8	23.35	-0.04	1	Ant A	0896M	QPSK	25	0	10 mm	front	1:1	0.142	1.396	0.198	
782.00	23230	Mid	LTE Band 13	10	10	25.8	24.15	0.05	0	Ant A	0896M	QPSK	1	49	10 mm	bottom	1:1	0.222	1.462	0.325	
782.00	23230	Mid	LTE Band 13	10	10	24.8	23.35	0.04	1	Ant A	0896M	QPSK	25	0	10 mm	bottom	1:1	0.174	1.396	0.243	
782.00	23230	Mid	LTE Band 13	10	10	25.8	24.15	-0.01	0	Ant A	0896M	QPSK	1	49	10 mm	right	1:1	0.436	1.462	0.637	
782.00	23230	Mid	LTE Band 13	10	10	24.8	23.35	-0.02	1	Ant A	0896M	QPSK	25	0	10 mm	right	1:1	0.324	1.396	0.452	
782.00	23230	Mid	LTE Band 13	10	N/A	23.8	22.33	0.00	0	Ant B	0069M	QPSK	1	0	10 mm	back	1:1	0.152	1.403	0.213	
782.00	23230	Mid	LTE Band 13	10	N/A	22.8	21.48	-0.01	1	Ant B	0069M	QPSK	25	0	10 mm	back	1:1	0.128	1.355	0.173	
782.00	23230	Mid	LTE Band 13	10	N/A	23.8	22.33	0.10	0	Ant B	0069M	QPSK	1	0	10 mm	front	1:1	0.043	1.403	0.060	
782.00	23230	Mid	LTE Band 13	10	N/A	22.8	21.48	0.05	1	Ant B	0069M	QPSK	25	0	10 mm	front	1:1	0.035	1.355	0.047	
782.00	23230	Mid	LTE Band 13	10	N/A	23.8	22.33	-0.08	0	Ant B	0069M	QPSK	1	0	10 mm	bottom	1:1	0.070	1.403	0.098	
782.00	23230	Mid	LTE Band 13	10	N/A	22.8	21.48	0.01	1	Ant B	0069M	QPSK	25	0	10 mm	bottom	1:1	0.061	1.355	0.083	
782.00	23230	Mid	LTE Band 13	10	N/A	23.8	22.33	0.13	0	Ant B	0069M	QPSK	1	0	10 mm	right	1:1	0.049	1.403	0.069	
782.00	23230	Mid	LTE Band 13	10	N/A	22.8	21.48	0.16	1	Ant B	0069M	QPSK	25	0	10 mm	right	1:1	0.039	1.355	0.053	
782.00	23230	Mid	LTE Band 13	10	N/A	23.8	22.33	0.19	0	Ant B	0069M	QPSK	1	0	10 mm	left	1:1	0.061	1.403	0.086	
782.00	23230	Mid	LTE Band 13	10	N/A	22.8	21.48	0.01	1	Ant B	0069M	QPSK	25	0	10 mm	left	1:1	0.050	1.355	0.068	
ANSI / IEEE C95.1 1992 - SAFETY LIMIT Spatial Peak Uncontrolled Exposure/General Population										Body 1.6 W/kg (mW/g) averaged over 1 gram											

FCC ID: A3LSMF916U		SAR EVALUATION REPORT		Approved by: Quality Manager
Document S/N: 1M2005200087-01-R2.A3L	Test Dates: 06/28/20-08/24/20	DUT Type: Portable Handset	Page 143 of 267	

**Table 11-42
LTE Band 14 Hotspot SAR**

MEASUREMENT RESULTS																					
FREQUENCY		Mode	Bandwidth [MHz]	Tune State	Maximum Allowed Power [dBm]	Conducted Power [dBm]	Power Drift [dB]	MPR [dB]	Antenna Config.	Device Serial Number	Modulation	RB Size	RB Offset	Spacing	Side	Duty Cycle	SAR (1g)	Scaling Factor	Reported SAR (1g)	Plot #	
MHz	Ch.																(W/kg)		(W/kg)		
793.00	23330	Mid	LTE Band 14	10	9	25.8	24.11	-0.07	0	Ant A	0896M	QPSK	1	0	10 mm	back	1:1	0.460	1.476	0.679	A52
793.00	23330	Mid	LTE Band 14	10	9	24.8	23.14	-0.04	1	Ant A	0896M	QPSK	25	12	10 mm	back	1:1	0.368	1.466	0.539	
793.00	23330	Mid	LTE Band 14	10	9	25.8	24.11	-0.05	0	Ant A	0896M	QPSK	1	0	10 mm	front	1:1	0.190	1.476	0.280	
793.00	23330	Mid	LTE Band 14	10	9	24.8	23.14	0.03	1	Ant A	0896M	QPSK	25	12	10 mm	front	1:1	0.139	1.466	0.204	
793.00	23330	Mid	LTE Band 14	10	9	25.8	24.11	-0.04	0	Ant A	0896M	QPSK	1	0	10 mm	bottom	1:1	0.237	1.476	0.350	
793.00	23330	Mid	LTE Band 14	10	9	24.8	23.14	-0.02	1	Ant A	0896M	QPSK	25	12	10 mm	bottom	1:1	0.185	1.466	0.271	
793.00	23330	Mid	LTE Band 14	10	9	25.8	24.11	-0.04	0	Ant A	0896M	QPSK	1	0	10 mm	right	1:1	0.416	1.476	0.614	
793.00	23330	Mid	LTE Band 14	10	9	24.8	23.14	-0.02	1	Ant A	0896M	QPSK	25	12	10 mm	right	1:1	0.306	1.466	0.449	
793.00	23330	Mid	LTE Band 14	10	N/A	23.8	22.42	0.01	0	Ant B	0069M	QPSK	1	0	10 mm	back	1:1	0.109	1.374	0.150	
793.00	23330	Mid	LTE Band 14	10	N/A	22.8	21.36	0.08	1	Ant B	0069M	QPSK	25	12	10 mm	back	1:1	0.094	1.393	0.131	
793.00	23330	Mid	LTE Band 14	10	N/A	23.8	22.42	0.03	0	Ant B	0069M	QPSK	1	0	10 mm	front	1:1	0.030	1.374	0.041	
793.00	23330	Mid	LTE Band 14	10	N/A	22.8	21.36	0.11	1	Ant B	0069M	QPSK	25	12	10 mm	front	1:1	0.026	1.393	0.036	
793.00	23330	Mid	LTE Band 14	10	N/A	23.8	22.42	0.08	0	Ant B	0069M	QPSK	1	0	10 mm	bottom	1:1	0.056	1.374	0.077	
793.00	23330	Mid	LTE Band 14	10	N/A	22.8	21.36	-0.01	1	Ant B	0069M	QPSK	25	12	10 mm	bottom	1:1	0.047	1.393	0.065	
793.00	23330	Mid	LTE Band 14	10	N/A	23.8	22.42	0.05	0	Ant B	0069M	QPSK	1	0	10 mm	right	1:1	0.037	1.374	0.051	
793.00	23330	Mid	LTE Band 14	10	N/A	22.8	21.36	0.16	1	Ant B	0069M	QPSK	25	12	10 mm	right	1:1	0.030	1.393	0.042	
793.00	23330	Mid	LTE Band 14	10	N/A	23.8	22.42	0.07	0	Ant B	0069M	QPSK	1	0	10 mm	left	1:1	0.043	1.374	0.059	
793.00	23330	Mid	LTE Band 14	10	N/A	22.8	21.36	0.14	1	Ant B	0069M	QPSK	25	12	10 mm	left	1:1	0.037	1.393	0.052	
ANSI / IEEE C95.1 1992 - SAFETY LIMIT Spatial Peak Uncontrolled Exposure/General Population										Body 1.6 W/kg (mW/g) averaged over 1 gram											

**Table 11-43
LTE Band 26 (Cell) Hotspot SAR**

MEASUREMENT RESULTS																					
FREQUENCY		Mode	Bandwidth [MHz]	Tune State	Maximum Allowed Power [dBm]	Conducted Power [dBm]	Power Drift [dB]	MPR [dB]	Antenna Config.	Device Serial Number	Modulation	RB Size	RB Offset	Spacing	Side	Duty Cycle	SAR (1g)	Scaling Factor	Reported SAR (1g)	Plot #	
MHz	Ch.																(W/kg)		(W/kg)		
831.50	26865	Mid	LTE Band 26 (Cell)	15	0	25.8	24.74	0.00	0	Ant A	0069M	QPSK	1	36	10 mm	back	1:1	0.480	1.276	0.612	A54
831.50	26865	Mid	LTE Band 26 (Cell)	15	0	24.8	23.84	-0.03	1	Ant A	0069M	QPSK	36	37	10 mm	back	1:1	0.392	1.247	0.489	
831.50	26865	Mid	LTE Band 26 (Cell)	15	0	25.8	24.74	0.04	0	Ant A	0069M	QPSK	1	36	10 mm	front	1:1	0.124	1.276	0.158	
831.50	26865	Mid	LTE Band 26 (Cell)	15	0	24.8	23.84	-0.01	1	Ant A	0069M	QPSK	36	37	10 mm	front	1:1	0.093	1.247	0.116	
831.50	26865	Mid	LTE Band 26 (Cell)	15	0	25.8	24.74	0.04	0	Ant A	0069M	QPSK	1	36	10 mm	bottom	1:1	0.259	1.276	0.330	
831.50	26865	Mid	LTE Band 26 (Cell)	15	0	24.8	23.84	0.04	1	Ant A	0069M	QPSK	36	37	10 mm	bottom	1:1	0.199	1.247	0.248	
831.50	26865	Mid	LTE Band 26 (Cell)	15	0	25.8	24.74	-0.12	0	Ant A	0069M	QPSK	1	36	10 mm	right	1:1	0.321	1.276	0.410	
831.50	26865	Mid	LTE Band 26 (Cell)	15	0	24.8	23.84	-0.04	1	Ant A	0069M	QPSK	36	37	10 mm	right	1:1	0.260	1.247	0.324	
ANSI / IEEE C95.1 1992 - SAFETY LIMIT Spatial Peak Uncontrolled Exposure/General Population										Body 1.6 W/kg (mW/g) averaged over 1 gram											





FCC ID: A3LSMF916U	 PCTEST <small> Proud to be part of Samsung </small>	SAR EVALUATION REPORT		Approved by: Quality Manager
Document S/N: 1M2005200087-01-R2.A3L	Test Dates: 06/28/20-08/24/20	DUT Type: Portable Handset	Page 144 of 267	

Table 11-44
LTE Band 5 (Cell) Hotspot SAR

MEASUREMENT RESULTS																					
FREQUENCY		Mode	Bandwidth [MHz]	Tune State	Maximum Allowed Power [dBm]	Conducted Power [dBm]	Power Drift [dB]	MPR [dB]	Antenna Config.	Device Serial Number	Modulation	RB Size	RB Offset	Spacing	Side	Duty Cycle	SAR (1g)	Scaling Factor	Reported SAR (1g)	Plot #	
MHz	Ch.																(W/kg)		(W/kg)		
836.50	20525	Mid	LTE Band 5 (Cell)	10	0	25.8	24.85	0.10	0	Ant A	0069M	QPSK	1	0	10 mm	back	1:1	0.620	1.245	0.772	A56
836.50	20525	Mid	LTE Band 5 (Cell)	10	0	24.8	23.98	0.08	1	Ant A	0069M	QPSK	25	12	10 mm	back	1:1	0.499	1.208	0.603	
836.50	20525	Mid	LTE Band 5 (Cell)	10	0	25.8	24.85	0.05	0	Ant A	0069M	QPSK	1	0	10 mm	front	1:1	0.128	1.245	0.159	
836.50	20525	Mid	LTE Band 5 (Cell)	10	0	24.8	23.98	0.00	1	Ant A	0069M	QPSK	25	12	10 mm	front	1:1	0.096	1.208	0.116	
836.50	20525	Mid	LTE Band 5 (Cell)	10	0	25.8	24.85	0.02	0	Ant A	0069M	QPSK	1	0	10 mm	bottom	1:1	0.266	1.245	0.331	
836.50	20525	Mid	LTE Band 5 (Cell)	10	0	24.8	23.98	0.05	1	Ant A	0069M	QPSK	25	12	10 mm	bottom	1:1	0.209	1.208	0.252	
836.50	20525	Mid	LTE Band 5 (Cell)	10	0	25.8	24.85	-0.06	0	Ant A	0069M	QPSK	1	0	10 mm	right	1:1	0.361	1.245	0.449	
836.50	20525	Mid	LTE Band 5 (Cell)	10	0	24.8	23.98	-0.05	1	Ant A	0069M	QPSK	25	12	10 mm	right	1:1	0.282	1.208	0.341	
ANSI / IEEE C95.1 1992 - SAFETY LIMIT Spatial Peak Uncontrolled Exposure/General Population										Body 1.6 W/kg (mW/g) averaged over 1 gram											

Table 11-45
LTE Band 66 (AWS) Hotspot SAR

MEASUREMENT RESULTS																				
FREQUENCY		Mode	Bandwidth [MHz]	Maximum Allowed Power [dBm]	Conducted Power [dBm]	Power Drift [dB]	MPR [dB]	Antenna Config.	Device Serial Number	Modulation	RB Size	RB Offset	Spacing	Side	Duty Cycle	SAR (1g)	Scaling Factor	Reported SAR (1g)	Plot #	
MHz	Ch.															(W/kg)		(W/kg)		
1770.00	132572	High	LTE Band 66 (AWS)	20	20.0	19.53	0.02	0	Ant B	0065M	QPSK	1	99	10 mm	back	1:1	0.454	1.114	0.506	
1770.00	132572	High	LTE Band 66 (AWS)	20	20.0	19.54	0.04	0	Ant B	0065M	QPSK	50	25	10 mm	back	1:1	0.462	1.112	0.514	
1770.00	132572	High	LTE Band 66 (AWS)	20	20.0	19.53	0.06	0	Ant B	0065M	QPSK	1	99	10 mm	front	1:1	0.081	1.114	0.090	
1770.00	132572	High	LTE Band 66 (AWS)	20	20.0	19.54	0.02	0	Ant B	0065M	QPSK	50	25	10 mm	front	1:1	0.082	1.112	0.091	
1770.00	132572	High	LTE Band 66 (AWS)	20	20.0	19.53	-0.02	0	Ant B	0065M	QPSK	1	99	10 mm	bottom	1:1	0.607	1.114	0.676	
1720.00	132072	Low	LTE Band 66 (AWS)	20	20.0	19.28	0.07	0	Ant B	0065M	QPSK	50	25	10 mm	bottom	1:1	0.676	1.180	0.798	
1745.00	132322	Mid	LTE Band 66 (AWS)	20	20.0	19.47	-0.03	0	Ant B	0065M	QPSK	50	25	10 mm	bottom	1:1	0.677	1.130	0.765	A58
1770.00	132572	High	LTE Band 66 (AWS)	20	20.0	19.54	-0.03	0	Ant B	0065M	QPSK	50	25	10 mm	bottom	1:1	0.622	1.112	0.692	
1770.00	132572	High	LTE Band 66 (AWS)	20	20.0	19.53	0.00	0	Ant B	0065M	QPSK	1	99	10 mm	right	1:1	0.122	1.114	0.136	
1770.00	132572	High	LTE Band 66 (AWS)	20	20.0	19.54	0.05	0	Ant B	0065M	QPSK	50	25	10 mm	right	1:1	0.123	1.112	0.137	
1770.00	132572	High	LTE Band 66 (AWS)	20	20.0	19.53	0.09	0	Ant B	0065M	QPSK	1	99	10 mm	left	1:1	0.040	1.114	0.045	
1770.00	132572	High	LTE Band 66 (AWS)	20	20.0	19.54	-0.07	0	Ant B	0065M	QPSK	50	25	10 mm	left	1:1	0.041	1.112	0.046	
ANSI / IEEE C95.1 1992 - SAFETY LIMIT Spatial Peak Uncontrolled Exposure/General Population										Body 1.6 W/kg (mW/g) averaged over 1 gram										



FCC ID: A3LSMF916U		SAR EVALUATION REPORT		Approved by: Quality Manager
Document S/N: 1M2005200087-01-R2.A3L	Test Dates: 06/28/20-08/24/20	DUT Type: Portable Handset	Page 145 of 267	

**Table 11-46
LTE Band 25 (PCS) Hotspot SAR**

MEASUREMENT RESULTS																				
FREQUENCY		Mode	Bandwidth [MHz]	Maximum Allowed Power [dBm]	Conducted Power [dBm]	Power Drift [dB]	MPR [dB]	Antenna Config.	Device Serial Number	Modulation	RB Size	RB Offset	Spacing	Side	Duty Cycle	SAR (1g)	Scaling Factor	Reported SAR (1g)	Plot #	
MHz	Ch.															(W/kg)		(W/kg)		
1860.00	26140	Low	LTE Band 25 (PCS)	20	20.0	19.22	-0.09	0	Ant B	1138M	QPSK	1	0	10 mm	back	1:1	0.260	1.197	0.311	
1860.00	26140	Low	LTE Band 25 (PCS)	20	20.0	19.21	-0.08	0	Ant B	1138M	QPSK	50	0	10 mm	back	1:1	0.252	1.199	0.302	
1860.00	26140	Low	LTE Band 25 (PCS)	20	20.0	19.22	0.07	0	Ant B	1138M	QPSK	1	0	10 mm	front	1:1	0.059	1.197	0.071	
1860.00	26140	Low	LTE Band 25 (PCS)	20	20.0	19.21	0.11	0	Ant B	1138M	QPSK	50	0	10 mm	front	1:1	0.056	1.199	0.067	
1860.00	26140	Low	LTE Band 25 (PCS)	20	20.0	19.22	-0.05	0	Ant B	1138M	QPSK	1	0	10 mm	bottom	1:1	0.621	1.197	0.743	
1860.00	26140	Low	LTE Band 25 (PCS)	20	20.0	19.21	-0.03	0	Ant B	1138M	QPSK	50	0	10 mm	bottom	1:1	0.629	1.199	0.754	
1882.50	26365	Mid	LTE Band 25 (PCS)	20	20.0	18.88	-0.06	0	Ant B	1138M	QPSK	50	0	10 mm	bottom	1:1	0.517	1.294	0.669	
1905.00	26590	High	LTE Band 25 (PCS)	20	20.0	18.99	-0.02	0	Ant B	1138M	QPSK	50	50	10 mm	bottom	1:1	0.643	1.262	0.811	A60
1860.00	26140	Low	LTE Band 25 (PCS)	20	20.0	19.07	0.00	0	Ant B	1138M	QPSK	100	0	10 mm	bottom	1:1	0.608	1.239	0.753	
1860.00	26140	Low	LTE Band 25 (PCS)	20	20.0	19.22	-0.02	0	Ant B	1138M	QPSK	1	0	10 mm	right	1:1	0.237	1.197	0.284	
1860.00	26140	Low	LTE Band 25 (PCS)	20	20.0	19.21	0.03	0	Ant B	1138M	QPSK	50	0	10 mm	right	1:1	0.228	1.199	0.273	
1860.00	26140	Low	LTE Band 25 (PCS)	20	20.0	19.22	0.09	0	Ant B	1138M	QPSK	1	0	10 mm	left	1:1	0.030	1.197	0.036	
1860.00	26140	Low	LTE Band 25 (PCS)	20	20.0	19.21	0.14	0	Ant B	1138M	QPSK	50	0	10 mm	left	1:1	0.030	1.199	0.036	
ANSI / IEEE C95.1 1992 - SAFETY LIMIT Spatial Peak Uncontrolled Exposure/General Population									Body 1.6 W/kg (mW/g) averaged over 1 gram											

**Table 11-47
LTE Band 30 Hotspot SAR**

MEASUREMENT RESULTS																				
FREQUENCY		Mode	Bandwidth [MHz]	Maximum Allowed Power [dBm]	Conducted Power [dBm]	Power Drift [dB]	MPR [dB]	Antenna Config.	Device Serial Number	Modulation	RB Size	RB Offset	Spacing	Side	Duty Cycle	SAR (1g)	Scaling Factor	Reported SAR (1g)	Plot #	
MHz	Ch.															(W/kg)		(W/kg)		
2310.00	27710	Mid	LTE Band 30	10	20.5	18.90	0.06	0	Ant B	0072M	QPSK	1	25	10 mm	back	1:1	0.297	1.445	0.429	
2310.00	27710	Mid	LTE Band 30	10	20.5	18.99	-0.01	0	Ant B	0072M	QPSK	25	12	10 mm	back	1:1	0.302	1.416	0.428	
2310.00	27710	Mid	LTE Band 30	10	20.5	18.90	0.10	0	Ant B	0072M	QPSK	1	25	10 mm	front	1:1	0.081	1.445	0.117	
2310.00	27710	Mid	LTE Band 30	10	20.5	18.99	-0.01	0	Ant B	0072M	QPSK	25	12	10 mm	front	1:1	0.085	1.416	0.120	
2310.00	27710	Mid	LTE Band 30	10	20.5	18.90	-0.03	0	Ant B	0072M	QPSK	1	25	10 mm	bottom	1:1	0.727	1.445	1.051	
2310.00	27710	Mid	LTE Band 30	10	20.5	18.99	-0.04	0	Ant B	0072M	QPSK	25	12	10 mm	bottom	1:1	0.741	1.416	1.049	A62
2310.00	27710	Mid	LTE Band 30	10	20.5	18.87	-0.08	0	Ant B	0072M	QPSK	50	0	10 mm	bottom	1:1	0.730	1.455	1.062	
2310.00	27710	Mid	LTE Band 30	10	20.5	18.90	0.07	0	Ant B	0072M	QPSK	1	25	10 mm	right	1:1	0.115	1.445	0.166	
2310.00	27710	Mid	LTE Band 30	10	20.5	18.99	0.14	0	Ant B	0072M	QPSK	25	12	10 mm	right	1:1	0.117	1.416	0.166	
2310.00	27710	Mid	LTE Band 30	10	20.5	18.90	0.04	0	Ant B	0072M	QPSK	1	25	10 mm	left	1:1	0.043	1.445	0.062	
2310.00	27710	Mid	LTE Band 30	10	20.5	18.99	0.04	0	Ant B	0072M	QPSK	25	12	10 mm	left	1:1	0.045	1.416	0.064	
ANSI / IEEE C95.1 1992 - SAFETY LIMIT Spatial Peak Uncontrolled Exposure/General Population									Body 1.6 W/kg (mW/g) averaged over 1 gram											



FCC ID: A3LSMF916U		SAR EVALUATION REPORT		Approved by: Quality Manager
Document S/N: 1M2005200087-01-R2.A3L	Test Dates: 06/28/20-08/24/20	DUT Type: Portable Handset	Page 146 of 267	

**Table 11-48
LTE Band 7 Hotspot SAR**

MEASUREMENT RESULTS																				
FREQUENCY		Mode	Bandwidth [MHz]	Maximum Allowed Power [dBm]	Conducted Power [dBm]	Power Drift [dB]	MPR [dB]	Antenna Config.	Device Serial Number	Modulation	RB Size	RB Offset	Spacing	Side	Duty Cycle	SAR (1g)	Scaling Factor	Reported SAR (1g)	Plot #	
MHz	Ch.															(W/kg)		(W/kg)		
2560.00	21350	High	LTE Band 7	20	19.5	18.67	0.04	0	Ant B	0909M	QPSK	1	0	10 mm	back	1:1	0.277	1.211	0.335	
2560.00	21350	High	LTE Band 7	20	19.5	18.80	0.03	0	Ant B	0909M	QPSK	50	25	10 mm	back	1:1	0.268	1.175	0.315	
2560.00	21350	High	LTE Band 7	20	19.5	18.67	0.03	0	Ant B	0909M	QPSK	1	0	10 mm	front	1:1	0.183	1.211	0.222	
2560.00	21350	High	LTE Band 7	20	19.5	18.80	0.07	0	Ant B	0909M	QPSK	50	25	10 mm	front	1:1	0.187	1.175	0.220	
2510.00	20850	Low	LTE Band 7	20	19.5	18.41	-0.09	0	Ant B	0909M	QPSK	1	99	10 mm	bottom	1:1	0.793	1.285	1.019	
2535.00	21100	Mid	LTE Band 7	20	19.5	18.65	-0.10	0	Ant B	0909M	QPSK	1	99	10 mm	bottom	1:1	0.797	1.216	0.969	
2560.00	21350	High	LTE Band 7	20	19.5	18.67	-0.11	0	Ant B	0909M	QPSK	1	0	10 mm	bottom	1:1	0.804	1.211	0.974	
2510.00	20850	Low	LTE Band 7	20	19.5	18.50	-0.07	0	Ant B	0909M	QPSK	50	25	10 mm	bottom	1:1	0.841	1.259	1.059	A64
2535.00	21100	Mid	LTE Band 7	20	19.5	18.74	-0.10	0	Ant B	0909M	QPSK	50	25	10 mm	bottom	1:1	0.834	1.191	0.993	
2560.00	21350	High	LTE Band 7	20	19.5	18.80	-0.11	0	Ant B	0909M	QPSK	50	25	10 mm	bottom	1:1	0.806	1.175	0.947	
2560.00	21350	High	LTE Band 7	20	19.5	18.66	-0.08	0	Ant B	0909M	QPSK	100	0	10 mm	bottom	1:1	0.797	1.213	0.967	
2560.00	21350	High	LTE Band 7	20	19.5	18.67	0.05	0	Ant B	0909M	QPSK	1	0	10 mm	right	1:1	0.045	1.211	0.054	
2560.00	21350	High	LTE Band 7	20	19.5	18.80	0.04	0	Ant B	0909M	QPSK	50	25	10 mm	right	1:1	0.048	1.175	0.056	
2560.00	21350	High	LTE Band 7	20	19.5	18.67	-0.10	0	Ant B	0909M	QPSK	1	0	10 mm	left	1:1	0.033	1.211	0.040	
2560.00	21350	High	LTE Band 7	20	19.5	18.80	0.03	0	Ant B	0909M	QPSK	50	25	10 mm	left	1:1	0.034	1.175	0.040	
ANSI / IEEE C95.1 1992 - SAFETY LIMIT Spatial Peak Uncontrolled Exposure/General Population									Body 1.6 W/kg (mW/g) averaged over 1 gram											

**Table 11-49
LTE Band 48 Hotspot SAR**

MEASUREMENT RESULTS																						
1 CC Uplink 2 CC Uplink	Component Carrier	FREQUENCY		Mode	Bandwidth [MHz]	Maximum Allowed Power [dBm]	Conducted Power [dBm]	Power Drift [dB]	MPR [dB]	Antenna Config.	Device Serial Number	Modulation	RB Size	RB Offset	Spacing	Side	Duty Cycle	SAR (1g)	Scaling Factor	Reported SAR (1g)	Plot #	
		MHz	Ch.															(W/kg)		(W/kg)		
1 CC Uplink	N/A	3690.00	56640	High	LTE Band 48	20	20.5	20.34	0.06	0	Ant F	0075M	QPSK	1	50	10 mm	back	1:1.58	0.348	1.038	0.361	
1 CC Uplink	N/A	3690.00	56640	High	LTE Band 48	20	20.5	20.49	-0.02	0	Ant F	0075M	QPSK	50	0	10 mm	back	1:1.58	0.344	1.002	0.345	
1 CC Uplink	N/A	3690.00	56640	High	LTE Band 48	20	20.5	20.34	0.03	0	Ant F	0075M	QPSK	1	50	10 mm	front	1:1.58	0.070	1.038	0.073	
1 CC Uplink	N/A	3690.00	56640	High	LTE Band 48	20	20.5	20.49	0.09	0	Ant F	0075M	QPSK	50	0	10 mm	front	1:1.58	0.071	1.002	0.071	
1 CC Uplink	N/A	3690.00	56640	High	LTE Band 48	20	20.5	20.28	-0.08	0	Ant F	0075M	QPSK	1	0	10 mm	top	1:1.58	0.438	1.052	0.461	
1 CC Uplink	N/A	3690.00	56640	High	LTE Band 48	20	20.5	20.34	-0.12	0	Ant F	0075M	QPSK	1	50	10 mm	top	1:1.58	0.475	1.038	0.493	A66
1 CC Uplink	N/A	3690.00	56640	High	LTE Band 48	20	20.5	20.49	-0.10	0	Ant F	0075M	QPSK	50	0	10 mm	top	1:1.58	0.464	1.002	0.465	
2 CC Uplink	SCC	3690.00	56640	High	LTE Band 48	20	20.5	20.45	-0.06	0	Ant F	0075M	QPSK	1	0	10 mm	top	1:1.58	0.445	1.012	0.450	
		3670.20	56442											99								
1 CC Uplink	N/A	3690.00	56640	High	LTE Band 48	20	20.5	20.34	0.03	0	Ant F	0075M	QPSK	1	50	10 mm	left	1:1.58	0.049	1.038	0.051	
1 CC Uplink	N/A	3690.00	56640	High	LTE Band 48	20	20.5	20.49	0.03	0	Ant F	0075M	QPSK	50	0	10 mm	left	1:1.58	0.048	1.002	0.048	
ANSI / IEEE C95.1 1992 - SAFETY LIMIT Spatial Peak Uncontrolled Exposure/General Population									Body 1.6 W/kg (mW/g) averaged over 1 gram													



FCC ID: A3LSMF916U	 <small>Proud to be part of Samsung</small>	SAR EVALUATION REPORT		Approved by: Quality Manager
Document S/N: 1M2005200087-01-R2.A3L	Test Dates: 06/28/20-08/24/20	DUT Type: Portable Handset	Page 147 of 267	

**Table 11-50
LTE Band 41 Hotspot SAR**

MEASUREMENT RESULTS																				
FREQUENCY		Mode	Bandwidth [MHz]	Maximum Allowed Power [dBm]	Conducted Power [dBm]	Power Drift [dB]	MPR [dB]	Antenna Config.	Device Serial Number	Modulation	RB Size	RB Offset	Spacing	Side	Duty Cycle	SAR (1g)	Scaling Factor	Reported SAR (1g)	Plot #	
MHz	Ch.															(W/kg)		(W/kg)		
2680.00	41490	High	LTE Band 41	20	20.0	19.39	0.12	0	Ant B	0901M	QPSK	1	50	10 mm	back	1:1.58	0.400	1.151	0.460	
2680.00	41490	High	LTE Band 41	20	20.0	19.47	0.12	0	Ant B	0901M	QPSK	50	25	10 mm	back	1:1.58	0.397	1.130	0.449	
2680.00	41490	High	LTE Band 41	20	20.0	19.39	0.07	0	Ant B	0901M	QPSK	1	50	10 mm	front	1:1.58	0.101	1.151	0.116	
2680.00	41490	High	LTE Band 41	20	20.0	19.47	0.05	0	Ant B	0901M	QPSK	50	25	10 mm	front	1:1.58	0.099	1.130	0.112	
2506.00	39750	Low	LTE Band 41	20	20.0	18.70	-0.02	0	Ant B	0901M	QPSK	1	0	10 mm	bottom	1:1.58	0.476	1.349	0.642	
2549.50	40185	Low-Mid	LTE Band 41	20	20.0	18.75	-0.18	0	Ant B	0901M	QPSK	1	0	10 mm	bottom	1:1.58	0.537	1.334	0.716	
2593.00	40620	Mid	LTE Band 41	20	20.0	18.93	-0.03	0	Ant B	0901M	QPSK	1	50	10 mm	bottom	1:1.58	0.549	1.279	0.702	
2636.50	41055	Mid-High	LTE Band 41	20	20.0	19.08	-0.06	0	Ant B	0901M	QPSK	1	50	10 mm	bottom	1:1.58	0.688	1.236	0.850	
2680.00	41490	High	LTE Band 41	20	20.0	19.39	-0.07	0	Ant B	0901M	QPSK	1	50	10 mm	bottom	1:1.58	0.825	1.151	0.950	
2506.00	39750	Low	LTE Band 41	20	20.0	18.87	-0.03	0	Ant B	0901M	QPSK	50	0	10 mm	bottom	1:1.58	0.496	1.297	0.643	
2549.50	40185	Low-Mid	LTE Band 41	20	20.0	18.99	-0.18	0	Ant B	0901M	QPSK	50	25	10 mm	bottom	1:1.58	0.550	1.262	0.694	
2593.00	40620	Mid	LTE Band 41	20	20.0	19.12	-0.03	0	Ant B	0901M	QPSK	50	25	10 mm	bottom	1:1.58	0.564	1.225	0.691	
2636.50	41055	Mid-High	LTE Band 41	20	20.0	19.27	-0.08	0	Ant B	0901M	QPSK	50	25	10 mm	bottom	1:1.58	0.692	1.183	0.819	
2680.00	41490	High	LTE Band 41	20	20.0	19.47	-0.04	0	Ant B	0901M	QPSK	50	25	10 mm	bottom	1:1.58	0.835	1.130	0.944	A68
2680.00	41490	High	LTE Band 41	20	20.0	19.38	-0.06	0	Ant B	0901M	QPSK	100	0	10 mm	bottom	1:1.58	0.821	1.153	0.947	
2680.00	41490	High	LTE Band 41	20	20.0	19.39	0.08	0	Ant B	0901M	QPSK	1	50	10 mm	right	1:1.58	0.054	1.151	0.062	
2680.00	41490	High	LTE Band 41	20	20.0	19.47	0.00	0	Ant B	0901M	QPSK	50	25	10 mm	right	1:1.58	0.055	1.130	0.062	
2680.00	41490	High	LTE Band 41	20	20.0	19.39	-0.09	0	Ant B	0901M	QPSK	1	50	10 mm	left	1:1.58	0.044	1.151	0.051	
2680.00	41490	High	LTE Band 41	20	20.0	19.47	0.05	0	Ant B	0901M	QPSK	50	25	10 mm	left	1:1.58	0.045	1.130	0.051	
ANSI / IEEE C95.1 1992 - SAFETY LIMIT Spatial Peak Uncontrolled Exposure/General Population									Body 1.6 W/kg (mW/g) averaged over 1 gram											

**Table 11-51
NR Band n71 Hotspot SAR**

MEASUREMENT RESULTS																				
FREQUENCY		Mode	Bandwidth [MHz]	Maximum Allowed Power [dBm]	Conducted Power [dBm]	Power Drift [dB]	MPR [dB]	Antenna Config.	Device Serial Number	Modulation	RB Size	RB Offset	Spacing	Side	Duty Cycle	SAR (1g)	Scaling Factor	Reported SAR (1g)	Plot #	
MHz	Ch.															(W/kg)		(W/kg)		
680.50	136100	Mid	NR Band n71	20	25.5	25.42	-0.05	0	Ant A	1126M	DFT-S-OFDM QPSK	1	53	10 mm	back	1:1	0.365	1.019	0.372	
680.50	136100	Mid	NR Band n71	20	25.5	25.44	-0.07	0	Ant A	1126M	DFT-S-OFDM QPSK	50	28	10 mm	back	1:1	0.357	1.014	0.362	
680.50	136100	Mid	NR Band n71	20	25.5	25.42	0.03	0	Ant A	1126M	DFT-S-OFDM QPSK	1	53	10 mm	front	1:1	0.138	1.019	0.141	
680.50	136100	Mid	NR Band n71	20	25.5	25.44	0.06	0	Ant A	1126M	DFT-S-OFDM QPSK	50	28	10 mm	front	1:1	0.135	1.014	0.137	
680.50	136100	Mid	NR Band n71	20	25.5	25.42	-0.11	0	Ant A	1126M	DFT-S-OFDM QPSK	1	53	10 mm	bottom	1:1	0.206	1.019	0.210	
680.50	136100	Mid	NR Band n71	20	25.5	25.44	0.02	0	Ant A	1126M	DFT-S-OFDM QPSK	50	28	10 mm	bottom	1:1	0.200	1.014	0.203	
680.50	136100	Mid	NR Band n71	20	25.5	25.42	-0.02	0	Ant A	1126M	DFT-S-OFDM QPSK	1	53	10 mm	right	1:1	0.465	1.019	0.474	
680.50	136100	Mid	NR Band n71	20	25.5	25.44	0.03	0	Ant A	1126M	DFT-S-OFDM QPSK	50	28	10 mm	right	1:1	0.478	1.014	0.485	A70
680.50	136100	Mid	NR Band n71	20	24.0	24.00	0.04	1.5	Ant A	1126M	CP-OFDM QPSK	1	1	10 mm	right	1:1	0.325	1.000	0.325	
ANSI / IEEE C95.1 1992 - SAFETY LIMIT Spatial Peak Uncontrolled Exposure/General Population									Body 1.6 W/kg (mW/g) averaged over 1 gram											

FCC ID: A3LSMF916U		SAR EVALUATION REPORT		Approved by: Quality Manager
Document S/N: 1M2005200087-01-R2.A3L	Test Dates: 06/28/20-08/24/20	DUT Type: Portable Handset	Page 148 of 267	



**Table 11-52
NR Band n5 (Cell) Hotspot SAR**

MEASUREMENT RESULTS																				
FREQUENCY		Mode	Bandwidth [MHz]	Maximum Allowed Power [dBm]	Conducted Power [dBm]	Power Drift [dB]	MPR [dB]	Antenna Config.	Device Serial Number	Modulation	RB Size	RB Offset	Spacing	Side	Duty Cycle	SAR (1g)	Scaling Factor	Reported SAR (1g)	Plot #	
MHz	Ch.															(W/kg)		(W/kg)		
836.50	167300	Mid	NR Band n5 (Cell)	20	25.5	25.03	0.07	0	Ant A	1109M	DFT-S-OFDM QPSK	1	53	10 mm	back	1:1	0.593	1.114	0.661	A72
836.50	167300	Mid	NR Band n5 (Cell)	20	25.5	25.01	0.01	0	Ant A	1109M	DFT-S-OFDM QPSK	50	28	10 mm	back	1:1	0.582	1.119	0.651	
836.50	167300	Mid	NR Band n5 (Cell)	20	24.0	23.52	0.00	1.5	Ant A	1109M	CP-OFDM QPSK	1	1	10 mm	back	1:1	0.418	1.117	0.467	
836.50	167300	Mid	NR Band n5 (Cell)	20	25.5	25.03	0.03	0	Ant A	1109M	DFT-S-OFDM QPSK	1	53	10 mm	front	1:1	0.123	1.114	0.137	
836.50	167300	Mid	NR Band n5 (Cell)	20	25.5	25.01	0.01	0	Ant A	1109M	DFT-S-OFDM QPSK	50	28	10 mm	front	1:1	0.120	1.119	0.134	
836.50	167300	Mid	NR Band n5 (Cell)	20	25.5	25.03	0.02	0	Ant A	1109M	DFT-S-OFDM QPSK	1	53	10 mm	bottom	1:1	0.240	1.114	0.267	
836.50	167300	Mid	NR Band n5 (Cell)	20	25.5	25.01	0.11	0	Ant A	1109M	DFT-S-OFDM QPSK	50	28	10 mm	bottom	1:1	0.230	1.119	0.257	
836.50	167300	Mid	NR Band n5 (Cell)	20	25.5	25.03	0.00	0	Ant A	1109M	DFT-S-OFDM QPSK	1	53	10 mm	right	1:1	0.328	1.114	0.365	
836.50	167300	Mid	NR Band n5 (Cell)	20	25.5	25.01	-0.02	0	Ant A	1109M	DFT-S-OFDM QPSK	50	28	10 mm	right	1:1	0.289	1.119	0.323	
ANSI / IEEE C95.1 1992 - SAFETY LIMIT Spatial Peak Uncontrolled Exposure/General Population									Body 1.6 W/kg (mW/g) averaged over 1 gram											

**Table 11-53
NR Band n66 (AWS) Hotspot SAR**

MEASUREMENT RESULTS																				
FREQUENCY		Mode	Bandwidth [MHz]	Maximum Allowed Power [dBm]	Conducted Power [dBm]	Power Drift [dB]	MPR [dB]	Antenna Config.	Device Serial Number	Modulation	RB Size	RB Offset	Spacing	Side	Duty Cycle	SAR (1g)	Scaling Factor	Reported SAR (1g)	Plot #	
MHz	Ch.															(W/kg)		(W/kg)		
1770.00	354000	High	NR Band n66 (AWS)	20	19.5	19.49	0.00	0	Ant B	0898M	DFT-S-OFDM QPSK	1	104	10 mm	back	1:1	0.534	1.002	0.535	
1770.00	354000	High	NR Band n66 (AWS)	20	19.5	19.45	0.02	0	Ant B	0898M	DFT-S-OFDM QPSK	50	0	10 mm	back	1:1	0.545	1.012	0.552	
1770.00	354000	High	NR Band n66 (AWS)	20	19.5	19.49	0.18	0	Ant B	0898M	DFT-S-OFDM QPSK	1	104	10 mm	front	1:1	0.088	1.002	0.088	
1770.00	354000	High	NR Band n66 (AWS)	20	19.5	19.45	0.15	0	Ant B	0898M	DFT-S-OFDM QPSK	50	0	10 mm	front	1:1	0.087	1.012	0.088	
1720.00	344000	Low	NR Band n66 (AWS)	20	19.5	19.21	-0.05	0	Ant B	0898M	DFT-S-OFDM QPSK	1	104	10 mm	bottom	1:1	0.832	1.069	0.889	
1745.00	349000	Mid	NR Band n66 (AWS)	20	19.5	19.36	-0.12	0	Ant B	0898M	DFT-S-OFDM QPSK	1	1	10 mm	bottom	1:1	0.855	1.033	0.883	
1770.00	354000	High	NR Band n66 (AWS)	20	19.5	19.49	-0.07	0	Ant B	0898M	DFT-S-OFDM QPSK	1	104	10 mm	bottom	1:1	0.843	1.002	0.845	
1720.00	344000	Low	NR Band n66 (AWS)	20	19.5	19.20	-0.02	0	Ant B	0898M	DFT-S-OFDM QPSK	50	0	10 mm	bottom	1:1	0.874	1.072	0.937	
1745.00	349000	Mid	NR Band n66 (AWS)	20	19.5	19.43	-0.10	0	Ant B	0898M	DFT-S-OFDM QPSK	50	0	10 mm	bottom	1:1	0.862	1.016	0.876	
1770.00	354000	High	NR Band n66 (AWS)	20	19.5	19.45	-0.11	0	Ant B	0898M	DFT-S-OFDM QPSK	50	0	10 mm	bottom	1:1	0.883	1.012	0.894	A74
1770.00	354000	High	NR Band n66 (AWS)	20	19.5	19.41	-0.02	0	Ant B	0898M	DFT-S-OFDM QPSK	100	0	10 mm	bottom	1:1	0.850	1.021	0.868	
1770.00	354000	High	NR Band n66 (AWS)	20	19.5	19.50	-0.05	0	Ant B	0898M	CP-OFDM QPSK	1	1	10 mm	bottom	1:1	0.870	1.000	0.870	
1770.00	354000	High	NR Band n66 (AWS)	20	19.5	19.49	-0.01	0	Ant B	0898M	DFT-S-OFDM QPSK	1	104	10 mm	right	1:1	0.185	1.002	0.185	
1770.00	354000	High	NR Band n66 (AWS)	20	19.5	19.45	0.05	0	Ant B	0898M	DFT-S-OFDM QPSK	50	0	10 mm	right	1:1	0.171	1.012	0.173	
1770.00	354000	High	NR Band n66 (AWS)	20	19.5	19.49	0.09	0	Ant B	0898M	DFT-S-OFDM QPSK	1	104	10 mm	left	1:1	0.054	1.002	0.054	
1770.00	354000	High	NR Band n66 (AWS)	20	19.5	19.45	0.17	0	Ant B	0898M	DFT-S-OFDM QPSK	50	0	10 mm	left	1:1	0.058	1.012	0.059	
1770.00	354000	High	NR Band n66 (AWS)	20	19.5	19.45	-0.03	0	Ant B	0898M	DFT-S-OFDM QPSK	50	0	10 mm	bottom	1:1	0.810	1.012	0.820	
ANSI / IEEE C95.1 1992 - SAFETY LIMIT Spatial Peak Uncontrolled Exposure/General Population									Body 1.6 W/kg (mW/g) averaged over 1 gram											

Note: Blue entry represents variability measurement



FCC ID: A3LSMF916U	 <small>Proud to be part of Samsung</small>	SAR EVALUATION REPORT		Approved by: Quality Manager
Document S/N: 1M2005200087-01-R2.A3L	Test Dates: 06/28/20-08/24/20	DUT Type: Portable Handset	Page 149 of 267	

**Table 11-54
NR Band n25 (PCS) Hotspot SAR**

MEASUREMENT RESULTS																				
FREQUENCY		Mode	Bandwidth [MHz]	Maximum Allowed Power [dBm]	Conducted Power [dBm]	Power Drift [dB]	MPR [dB]	Antenna Config.	Device Serial Number	Modulation	RB Size	RB Offset	Spacing	Side	Duty Cycle	SAR (1g)	Scaling Factor	Reported SAR (1g)	Plot #	
MHz	Ch.															(W/kg)		(W/kg)		
1882.50	376500	Mid	NR Band n25 (PCS)	20	19.5	18.94	-0.03	0	Ant B	0895M	DFT-S-OFDM QPSK	1	1	10 mm	back	1:1	0.300	1.138	0.341	
1882.50	376500	Mid	NR Band n25 (PCS)	20	19.5	19.02	0.03	0	Ant B	0895M	DFT-S-OFDM QPSK	50	0	10 mm	back	1:1	0.297	1.117	0.332	
1882.50	376500	Mid	NR Band n25 (PCS)	20	19.5	18.94	-0.08	0	Ant B	0895M	DFT-S-OFDM QPSK	1	1	10 mm	front	1:1	0.054	1.138	0.061	
1882.50	376500	Mid	NR Band n25 (PCS)	20	19.5	19.02	0.00	0	Ant B	0895M	DFT-S-OFDM QPSK	50	0	10 mm	front	1:1	0.054	1.117	0.060	
1860.00	372000	Low	NR Band n25 (PCS)	20	19.5	18.70	-0.13	0	Ant B	0895M	DFT-S-OFDM QPSK	1	1	10 mm	bottom	1:1	0.590	1.202	0.709	
1882.50	376500	Mid	NR Band n25 (PCS)	20	19.5	18.94	-0.01	0	Ant B	0895M	DFT-S-OFDM QPSK	1	1	10 mm	bottom	1:1	0.616	1.138	0.701	
1905.00	381000	High	NR Band n25 (PCS)	20	19.5	18.68	-0.06	0	Ant B	0895M	DFT-S-OFDM QPSK	1	53	10 mm	bottom	1:1	0.639	1.208	0.772	A76
1905.00	376500	Mid	NR Band n25 (PCS)	20	19.5	19.02	-0.02	0	Ant B	0895M	DFT-S-OFDM QPSK	50	0	10 mm	bottom	1:1	0.625	1.117	0.698	
1882.50	376500	Mid	NR Band n25 (PCS)	20	19.5	19.11	-0.03	0	Ant B	0895M	CP-OFDM QPSK	1	1	10 mm	bottom	1:1	0.612	1.094	0.670	
1882.50	376500	Mid	NR Band n25 (PCS)	20	19.5	18.94	-0.01	0	Ant B	0895M	DFT-S-OFDM QPSK	1	1	10 mm	right	1:1	0.145	1.138	0.165	
1882.50	376500	Mid	NR Band n25 (PCS)	20	19.5	19.02	-0.08	0	Ant B	0895M	DFT-S-OFDM QPSK	50	0	10 mm	right	1:1	0.136	1.117	0.152	
1882.50	376500	Mid	NR Band n25 (PCS)	20	19.5	18.94	-0.12	0	Ant B	0895M	DFT-S-OFDM QPSK	1	1	10 mm	left	1:1	0.039	1.138	0.044	
1882.50	376500	Mid	NR Band n25 (PCS)	20	19.5	19.02	-0.01	0	Ant B	0895M	DFT-S-OFDM QPSK	50	0	10 mm	left	1:1	0.040	1.117	0.045	
ANSI / IEEE C95.1 1992 - SAFETY LIMIT Spatial Peak Uncontrolled Exposure/General Population											Body 1.6 W/kg (mW/g) averaged over 1 gram									

**Table 11-55
NR Band n41 Hotspot SAR**

MEASUREMENT RESULTS																				
FREQUENCY		Mode	Bandwidth [MHz]	Maximum Allowed Power [dBm]	Conducted Power [dBm]	Power Drift [dB]	MPR [dB]	Antenna Config.	Device Serial Number	Modulation	RB Size	RB Offset	Spacing	Side	Duty Cycle	SAR (1g)	Scaling Factor	Reported SAR (1g)	Plot #	
MHz	Ch.															(W/kg)		(W/kg)		
2592.99	518598	Mid	NR Band n41	100	25.0	24.16	0.09	0	Ant F	1296M	DFT-S-OFDM QPSK	1	1	10 mm	back	1:4	0.070	1.213	0.085	
2592.99	518598	Mid	NR Band n41	100	25.0	23.87	-0.03	0	Ant F	1296M	DFT-S-OFDM QPSK	135	69	10 mm	back	1:4	0.081	1.297	0.105	
2592.99	518598	Mid	NR Band n41	100	25.0	24.16	0.18	0	Ant F	1296M	DFT-S-OFDM QPSK	1	1	10 mm	front	1:4	0.024	1.213	0.029	
2592.99	518598	Mid	NR Band n41	100	25.0	23.87	0.12	0	Ant F	1296M	DFT-S-OFDM QPSK	135	69	10 mm	front	1:4	0.020	1.297	0.026	
2592.99	518598	Mid	NR Band n41	100	25.0	24.16	0.11	0	Ant F	1296M	DFT-S-OFDM QPSK	1	1	10 mm	top	1:4	0.149	1.213	0.181	A78
2592.99	518598	Mid	NR Band n41	100	25.0	23.87	0.03	0	Ant F	1296M	DFT-S-OFDM QPSK	135	69	10 mm	top	1:4	0.116	1.297	0.150	
2592.99	518598	Mid	NR Band n41	100	23.5	22.79	0.11	1.5	Ant F	1296M	CP-OFDM QPSK	1	1	10 mm	top	1:4	0.099	1.178	0.117	
2592.99	518598	Mid	NR Band n41	100	25.0	24.16	0.01	0	Ant F	1296M	DFT-S-OFDM QPSK	1	1	10 mm	left	1:4	0.025	1.213	0.030	
2592.99	518598	Mid	NR Band n41	100	25.0	23.87	0.06	0	Ant F	1296M	DFT-S-OFDM QPSK	135	69	10 mm	left	1:4	0.019	1.297	0.025	
ANSI / IEEE C95.1 1992 - SAFETY LIMIT Spatial Peak Uncontrolled Exposure/General Population											Body 1.6 W/kg (mW/g) averaged over 1 gram									

FCC ID: A3LSMF916U	 PCTEST <small>Prove to be part of Samsung</small>	SAR EVALUATION REPORT		Approved by: Quality Manager
Document S/N: 1M2005200087-01-R2.A3L	Test Dates: 06/28/20-08/24/20	DUT Type: Portable Handset	Page 150 of 267	

**Table 11-56
WLAN Hotspot SAR**

MEASUREMENT RESULTS																			
FREQUENCY	Mode	Service	Bandwidth [MHz]	Maximum Allowed Power [dBm]	Conducted Power [dBm]	Power Drift [dB]	Spacing	Antenna Config.	Device Serial Number	Data Rate (Mbps)	Side	Duty Cycle (%)	Peak SAR of Area Scan	SAR (1g)	Scaling Factor (Power)	Scaling Factor (Duty Cycle)	Reported SAR (1g)	Plot #	
													W/kg	(W/kg)			(W/kg)		
2437	6	802.11b	DSSS	22	19.0	18.99	-0.01	10 mm	1	0815M	1	back	99.8	0.065	0.045	1.002	1.002	0.045	
2437	6	802.11b	DSSS	22	19.0	18.99	0.12	10 mm	1	0815M	1	front	99.8	0.514	0.306	1.002	1.002	0.307	
2412	1	802.11b	DSSS	22	19.0	18.87	-0.09	10 mm	1	0815M	1	top	99.8	0.617	0.397	1.030	1.002	0.410	
2437	6	802.11b	DSSS	22	19.0	18.99	0.00	10 mm	1	0815M	1	top	99.8	1.004	0.632	1.002	1.002	0.635	A80
2462	11	802.11b	DSSS	22	19.0	18.78	-0.02	10 mm	1	0815M	1	top	99.8	0.813	0.508	1.052	1.002	0.535	
2437	6	802.11b	DSSS	22	19.0	18.99	0.02	10 mm	1	0815M	1	left	99.8	0.154	0.094	1.002	1.002	0.094	
2462	11	802.11b	DSSS	22	19.0	18.94	0.18	10 mm	2	0815M	1	back	99.9	0.040	0.027	1.014	1.001	0.027	
2462	11	802.11b	DSSS	22	19.0	18.94	-0.02	10 mm	2	0815M	1	front	99.9	0.191	0.129	1.014	1.001	0.131	
2462	11	802.11b	DSSS	22	19.0	18.94	0.10	10 mm	2	0815M	1	top	99.9	0.142	0.081	1.014	1.001	0.082	
2462	11	802.11b	DSSS	22	19.0	18.94	0.01	10 mm	2	0815M	1	right	99.9	0.154	0.147	1.014	1.001	0.149	
2462	11	802.11b	DSSS	22	19.0	18.94	0.03	10 mm	2	0815M	1	left	99.9	0.007	0.005	1.014	1.001	0.005	
5785	157	802.11a	OFDM	20	18.0	17.93	0.09	10 mm	1	0876M	6	back	99.2	0.052	0.019	1.016	1.008	0.019	
5785	157	802.11a	OFDM	20	18.0	17.93	-0.04	10 mm	1	0876M	6	front	99.2	0.608	0.289	1.016	1.008	0.275	A82
5785	157	802.11a	OFDM	20	18.0	17.93	0.06	10 mm	1	0876M	6	top	99.2	0.570	0.280	1.016	1.008	0.266	
5785	157	802.11a	OFDM	20	18.0	17.93	0.10	10 mm	1	0876M	6	left	99.2	0.118	0.046	1.016	1.008	0.047	
5785	157	802.11a	OFDM	20	18.0	17.98	-0.10	10 mm	2	0876M	6	back	99.4	0.029	0.011	1.005	1.006	0.011	
5785	157	802.11a	OFDM	20	18.0	17.98	-0.08	10 mm	2	0876M	6	front	99.4	0.254	0.104	1.005	1.006	0.105	
5785	157	802.11a	OFDM	20	18.0	17.98	0.07	10 mm	2	0876M	6	top	99.4	0.198	0.089	1.005	1.006	0.090	
5785	157	802.11a	OFDM	20	18.0	17.98	0.02	10 mm	2	0876M	6	right	99.4	0.126	-	1.005	1.006	-	
5785	157	802.11a	OFDM	20	18.0	17.98	0.00	10 mm	2	0876M	6	left	99.4	0.031	0.015	1.005	1.006	0.015	
ANSI / IEEE C95.1 1992 - SAFETY LIMIT									Body										
Spatial Peak									1.6 W/kg (mW/g)										
Uncontrolled Exposure/General Population									averaged over 1 gram										

**Table 11-57
2.4 GHz WLAN MIMO Hotspot SAR for Conditions mmWave Active**



MEASUREMENT RESULTS																					
FREQUENCY	Mode	Service	Bandwidth [MHz]	Maximum Allowed Power (Ant 1) [dBm]	Conducted Power (Ant 1) [dBm]	Maximum Allowed Power (Ant 2) [dBm]	Conducted Power (Ant 2) [dBm]	Power Drift [dB]	Spacing	Antenna Config.	Device Serial Number	Data Rate (Mbps)	Side	Duty Cycle (%)	Peak SAR of Area Scan	SAR (1g)	Scaling Factor (Power)	Scaling Factor (Duty Cycle)	Reported SAR (1g)	Plot #	
															W/kg	(W/kg)			(W/kg)		
2412	1	802.11n	OFDM	20	13.0	12.61	13.0	12.52	-0.11	10 mm	MIMO	0815M	13	back	98.7	0.068	0.045	1.117	1.013	0.051	
2412	1	802.11n	OFDM	20	13.0	12.61	13.0	12.52	-0.04	10 mm	MIMO	0815M	13	front	98.7	0.212	0.153	1.117	1.013	0.173	
2412	1	802.11n	OFDM	20	13.0	12.61	13.0	12.52	-0.12	10 mm	MIMO	0815M	13	top	98.7	0.303	0.179	1.117	1.013	0.203	
2412	1	802.11n	OFDM	20	13.0	12.61	13.0	12.52	0.03	10 mm	MIMO	0815M	13	right	98.7	0.190	0.126	1.117	1.013	0.143	
2412	1	802.11n	OFDM	20	13.0	12.61	13.0	12.52	0.04	10 mm	MIMO	0815M	13	left	98.7	0.070	0.048	1.117	1.013	0.054	
ANSI / IEEE C95.1 1992 - SAFETY LIMIT									Body												
Spatial Peak									1.6 W/kg (mW/g)												
Uncontrolled Exposure/General Population									averaged over 1 gram												

Note: To achieve the 16.0 dBm maximum allowed MIMO power shown in the documentation, each antenna transmits at a maximum allowed power of 13.0 dBm.

**Table 11-58
5 GHz WLAN MIMO Hotspot SAR for Conditions mmWave Active**

MEASUREMENT RESULTS																					
FREQUENCY	Mode	Service	Bandwidth [MHz]	Maximum Allowed Power (Ant 1) [dBm]	Conducted Power (Ant 1) [dBm]	Maximum Allowed Power (Ant 2) [dBm]	Conducted Power (Ant 2) [dBm]	Power Drift [dB]	Spacing	Antenna Config.	Device Serial Number	Data Rate (Mbps)	Side	Duty Cycle (%)	Peak SAR of Area Scan	SAR (1g)	Scaling Factor (Power)	Scaling Factor (Duty Cycle)	Reported SAR (1g)	Plot #	
															W/kg	(W/kg)			(W/kg)		
5775	155	802.11ac	OFDM	80	11.0	10.82	11.0	10.76	0.00	10 mm	MIMO	0876M	58.5	back	90.9	0.003	-	1.057	1.101	-	
5775	155	802.11ac	OFDM	80	11.0	10.82	11.0	10.76	0.09	10 mm	MIMO	0876M	58.5	front	90.9	0.035	0.012	1.057	1.101	0.014	
5775	155	802.11ac	OFDM	80	11.0	10.82	11.0	10.76	0.00	10 mm	MIMO	0876M	58.5	top	90.9	0.027	-	1.057	1.101	-	
5775	155	802.11ac	OFDM	80	11.0	10.82	11.0	10.76	0.11	10 mm	MIMO	0876M	58.5	right	90.9	0.012	0.004	1.057	1.101	0.005	
5775	155	802.11ac	OFDM	80	11.0	10.82	11.0	10.76	-0.03	10 mm	MIMO	0876M	58.5	left	90.9	0.003	-	1.057	1.101	-	
ANSI / IEEE C95.1 1992 - SAFETY LIMIT									Body												
Spatial Peak									1.6 W/kg (mW/g)												
Uncontrolled Exposure/General Population									averaged over 1 gram												

Note: To achieve the 14.0 dBm maximum allowed MIMO power shown in the documentation, each antenna transmits at a maximum allowed power of 11.0 dBm.

FCC ID: A3LSMF916U	 <small>Proud to be part of Samsung</small>	SAR EVALUATION REPORT		Approved by: Quality Manager
Document S/N: 1M2005200087-01-R2.A3L	Test Dates: 06/28/20-08/24/20	DUT Type: Portable Handset	Page 151 of 267	



**Table 11-59
DSS Hotspot SAR**

MEASUREMENT RESULTS																	
FREQUENCY		Mode	Service	Maximum Allowed Power [dBm]	Conducted Power [dBm]	Power Drift [dB]	Spacing	Antenna Config.	Device Serial Number	Data Rate (Mbps)	Side	Duty Cycle (%)	SAR (1g)	Scaling Factor (Cond Power)	Scaling Factor (Duty Cycle)	Reported SAR (1g)	Plot #
MHz	Ch.												(W/kg)			(W/kg)	
2441	39	Bluetooth	FHSS	20.0	19.53	-0.03	10 mm	1	1356M	1	back	77.9	0.017	1.115	1.284	0.024	
2441	39	Bluetooth	FHSS	20.0	19.53	0.04	10 mm	1	1356M	1	front	77.9	0.099	1.115	1.284	0.142	
2441	39	Bluetooth	FHSS	20.0	19.53	0.00	10 mm	1	1356M	1	top	77.9	0.209	1.115	1.284	0.299	A84
2441	39	Bluetooth	FHSS	20.0	19.53	0.10	10 mm	1	1356M	1	left	77.9	0.035	1.115	1.284	0.050	
2441	39	Bluetooth	FHSS	20.0	19.23	0.07	10 mm	2	1356M	1	back	77.3	0.016	1.193	1.294	0.025	
2441	39	Bluetooth	FHSS	20.0	19.23	0.04	10 mm	2	1356M	1	front	77.3	0.060	1.193	1.294	0.092	
2441	39	Bluetooth	FHSS	20.0	19.23	-0.02	10 mm	2	1356M	1	top	77.3	0.067	1.193	1.294	0.103	
2441	39	Bluetooth	FHSS	20.0	19.23	0.03	10 mm	2	1356M	1	right	77.3	0.065	1.193	1.294	0.100	
2441	39	Bluetooth	FHSS	20.0	19.23	-0.03	10 mm	2	1356M	1	left	77.3	0.001	1.193	1.294	0.002	
ANSI / IEEE C95.1 1992 - SAFETY LIMIT Spatial Peak Uncontrolled Exposure/General Population							Body 1.6 W/kg (mW/g) averaged over 1 gram										

11.4 Standalone Phablet SAR Data

**Table 11-60
CDMA BC1 Phablet SAR Data**

MEASUREMENT RESULTS																
FREQUENCY		Mode	Service	Maximum Allowed Power [dBm]	Conducted Power [dBm]	Power Drift [dB]	Spacing	Antenna Config.	Device Serial Number	Duty Cycle	Side	SAR (10g)	Scaling Factor	Reported SAR (10g)	Plot #	
MHz	Ch.											(W/kg)		(W/kg)		
1880.00	600	PCS CDMA	EVDO Rev. 0	24.0	23.16	-0.07	10 mm	Ant B	0018M	1:1	back	0.447	1.213	0.542		
1880.00	600	PCS CDMA	EVDO Rev. 0	24.0	23.16	-0.08	0 mm	Ant B	0018M	1:1	front	0.599	1.213	0.727		
1880.00	600	PCS CDMA	EVDO Rev. 0	24.0	23.16	-0.05	12 mm	Ant B	0018M	1:1	bottom	0.705	1.213	0.855		
1851.25	25	PCS CDMA	EVDO Rev. 0	24.0	23.14	0.12	0 mm	Ant B	0018M	1:1	right	1.760	1.219	2.145		
1880.00	600	PCS CDMA	EVDO Rev. 0	24.0	23.16	0.17	0 mm	Ant B	0018M	1:1	right	1.970	1.213	2.390		
1908.75	1175	PCS CDMA	EVDO Rev. 0	24.0	23.23	0.01	0 mm	Ant B	0018M	1:1	right	2.040	1.194	2.436		
1880.00	600	PCS CDMA	EVDO Rev. 0	24.0	23.16	0.02	0 mm	Ant B	0018M	1:1	left	0.313	1.213	0.380		
1880.00	600	PCS CDMA	EVDO Rev. 0	20.0	18.58	0.02	0 mm	Ant B	0018M	1:1	back	1.290	1.387	1.789		
1851.25	25	PCS CDMA	EVDO Rev. 0	20.0	19.02	0.02	0 mm	Ant B	0018M	1:1	bottom	2.170	1.253	2.719	A85	
1880.00	600	PCS CDMA	EVDO Rev. 0	20.0	18.58	-0.02	0 mm	Ant B	0018M	1:1	bottom	1.770	1.387	2.455		
1908.75	1175	PCS CDMA	EVDO Rev. 0	20.0	18.95	0.09	0 mm	Ant B	0018M	1:1	bottom	2.120	1.274	2.701		
ANSI / IEEE C95.1 1992 - SAFETY LIMIT Spatial Peak Uncontrolled Exposure/General Population							Phablet 4.0 W/kg (mW/g) averaged over 10 grams									



FCC ID: A3LSMF916U	 PCTEST <small>Provided to be part of Samsung</small>	SAR EVALUATION REPORT		Approved by: Quality Manager
Document S/N: 1M2005200087-01-R2.A3L	Test Dates: 06/28/20-08/24/20	DUT Type: Portable Handset	Page 152 of 267	

**Table 11-61
GPRS 1900 Phablet SAR Data**

MEASUREMENT RESULTS																
FREQUENCY		Mode	Service	Maximum Allowed Power [dBm]	Conducted Power [dBm]	Power Drift [dB]	Spacing	Antenna Config.	Device Serial Number	# of Time Slots	Duty Cycle	Side	SAR (10g)	Scaling Factor	Reported SAR (10g)	Plot #
MHz	Ch.												(W/kg)		(W/kg)	
1880.00	661	GSM 1900	GPRS	27.5	26.72	-0.05	10 mm	Ant B	0018M	3	1:2.76	back	0.270	1.197	0.323	
1880.00	661	GSM 1900	GPRS	27.5	26.72	-0.15	0 mm	Ant B	0018M	3	1:2.76	front	0.291	1.197	0.348	
1880.00	661	GSM 1900	GPRS	27.5	26.72	-0.01	12 mm	Ant B	0018M	3	1:2.76	bottom	0.479	1.197	0.573	
1880.00	661	GSM 1900	GPRS	27.5	26.72	-0.03	0 mm	Ant B	0018M	3	1:2.76	right	1.060	1.197	1.269	
1880.00	661	GSM 1900	GPRS	27.5	26.72	0.02	0 mm	Ant B	0018M	3	1:2.76	left	0.147	1.197	0.176	
1880.00	661	GSM 1900	GPRS	23.0	21.82	-0.10	0 mm	Ant B	0018M	4	1:2.076	back	0.628	1.312	0.824	
1850.20	512	GSM 1900	GPRS	23.0	21.84	-0.09	0 mm	Ant B	0018M	4	1:2.076	bottom	1.350	1.306	1.763	A86
1880.00	661	GSM 1900	GPRS	23.0	21.82	-0.04	0 mm	Ant B	0018M	4	1:2.076	bottom	1.010	1.312	1.325	
1909.80	810	GSM 1900	GPRS	23.0	21.69	-0.03	0 mm	Ant B	0018M	4	1:2.076	bottom	0.951	1.352	1.286	
ANSI / IEEE C95.1 1992 - SAFETY LIMIT Spatial Peak Uncontrolled Exposure/General Population								Phablet 4.0 W/kg (mW/g) averaged over 10 grams								

**Table 11-62
UMTS Band 4 Phablet SAR Data**

MEASUREMENT RESULTS															
FREQUENCY		Mode	Service	Maximum Allowed Power [dBm]	Conducted Power [dBm]	Power Drift [dB]	Spacing	Antenna Config.	Device Serial Number	Duty Cycle	Side	SAR (10g)	Scaling Factor	Reported SAR (10g)	Plot #
MHz	Ch.											(W/kg)		(W/kg)	
1732.40	1412	UMTS 1750	RMC	25.5	24.24	0.03	10 mm	Ant B	0018M	1:1	back	0.835	1.337	1.116	
1732.40	1412	UMTS 1750	RMC	25.5	24.24	0.04	0 mm	Ant B	0018M	1:1	front	0.581	1.337	0.777	
1732.40	1412	UMTS 1750	RMC	25.5	24.24	0.01	12 mm	Ant B	0018M	1:1	bottom	0.780	1.337	1.043	
1732.40	1412	UMTS 1750	RMC	25.5	24.24	0.02	0 mm	Ant B	0018M	1:1	right	1.130	1.337	1.511	
1732.40	1412	UMTS 1750	RMC	25.5	24.24	-0.02	0 mm	Ant B	0018M	1:1	left	0.255	1.337	0.341	
1712.40	1312	UMTS 1750	RMC	20.0	18.75	0.05	0 mm	Ant B	0018M	1:1	back	1.950	1.334	2.601	
1732.40	1412	UMTS 1750	RMC	20.0	18.93	0.06	0 mm	Ant B	0018M	1:1	back	1.830	1.279	2.341	
1752.60	1513	UMTS 1750	RMC	20.0	18.90	0.04	0 mm	Ant B	0018M	1:1	back	1.760	1.288	2.267	
1712.40	1312	UMTS 1750	RMC	20.0	18.75	-0.07	0 mm	Ant B	0018M	1:1	bottom	2.130	1.334	2.841	A87
1732.40	1412	UMTS 1750	RMC	20.0	18.93	-0.07	0 mm	Ant B	0018M	1:1	bottom	1.900	1.279	2.430	
1752.60	1513	UMTS 1750	RMC	20.0	18.90	-0.08	0 mm	Ant B	0018M	1:1	bottom	1.800	1.288	2.318	
ANSI / IEEE C95.1 1992 - SAFETY LIMIT Spatial Peak Uncontrolled Exposure/General Population								Phablet 4.0 W/kg (mW/g) averaged over 10 grams							



FCC ID: A3LSMF916U		SAR EVALUATION REPORT		Approved by: Quality Manager
Document S/N: 1M2005200087-01-R2.A3L	Test Dates: 06/28/20-08/24/20	DUT Type: Portable Handset		Page 153 of 267

**Table 11-63
UMTS Band 2 Phablet SAR Data**

MEASUREMENT RESULTS															
FREQUENCY		Mode	Service	Maximum Allowed Power [dBm]	Conducted Power [dBm]	Power Drift [dB]	Spacing	Antenna Config.	Device Serial Number	Duty Cycle	Side	SAR (10g)	Scaling Factor	Reported SAR (10g)	Plot #
MHz	Ch.											(W/kg)		(W/kg)	
1880.00	9400	UMTS 1900	RMC	24.5	23.81	0.00	10 mm	Ant B	0018M	1:1	back	0.604	1.172	0.708	
1880.00	9400	UMTS 1900	RMC	24.5	23.81	-0.08	0 mm	Ant B	0018M	1:1	front	0.572	1.172	0.670	
1880.00	9400	UMTS 1900	RMC	24.5	23.81	-0.09	12 mm	Ant B	0018M	1:1	bottom	0.840	1.172	0.984	
1852.40	9262	UMTS 1900	RMC	24.5	23.60	0.06	0 mm	Ant B	0018M	1:1	right	1.640	1.230	2.017	
1880.00	9400	UMTS 1900	RMC	24.5	23.81	0.01	0 mm	Ant B	0018M	1:1	right	1.780	1.172	2.086	
1907.60	9538	UMTS 1900	RMC	24.5	23.82	0.04	0 mm	Ant B	0018M	1:1	right	2.050	1.169	2.396	A88
1880.00	9400	UMTS 1900	RMC	24.5	23.81	0.14	0 mm	Ant B	0018M	1:1	left	0.288	1.172	0.338	
1880.00	9400	UMTS 1900	RMC	20.0	18.63	-0.08	0 mm	Ant B	1102M	1:1	back	1.330	1.371	1.823	
1852.40	9262	UMTS 1900	RMC	20.0	19.01	-0.08	0 mm	Ant B	1102M	1:1	bottom	1.930	1.256	2.424	
1880.00	9400	UMTS 1900	RMC	20.0	18.63	0.10	0 mm	Ant B	1102M	1:1	bottom	1.920	1.371	2.632	
1907.60	9538	UMTS 1900	RMC	20.0	18.94	-0.03	0 mm	Ant B	1102M	1:1	bottom	1.930	1.276	2.463	
ANSI / IEEE C95.1 1992 - SAFETY LIMIT Spatial Peak Uncontrolled Exposure/General Population								Phablet 4.0 W/kg (mW/g) averaged over 10 grams							

**Table 11-64
LTE Band 66 (AWS) Phablet SAR**

MEASUREMENT RESULTS																				
FREQUENCY		Mode	Bandwidth [MHz]	Maximum Allowed Power [dBm]	Conducted Power [dBm]	Power Drift [dB]	MPR [dB]	Antenna Config.	Serial Number	Modulation	RB Size	RB Offset	Spacing	Side	Duty Cycle	SAR (10g)	Scaling Factor	Reported SAR (10g)	Plot #	
MHz	Ch.															(W/kg)		(W/kg)		
1770.00	132572	High	LTE Band 66 (AWS)	20	25.0	24.30	-0.05	0	Ant B	0065M	QPSK	1	99	10 mm	back	1:1	0.956	1.175	1.123	
1770.00	132572	High	LTE Band 66 (AWS)	20	24.0	23.32	-0.04	1	Ant B	0065M	QPSK	50	25	10 mm	back	1:1	0.801	1.169	0.936	
1770.00	132572	High	LTE Band 66 (AWS)	20	25.0	24.30	0.00	0	Ant B	0065M	QPSK	1	99	0 mm	front	1:1	0.573	1.175	0.673	
1770.00	132572	High	LTE Band 66 (AWS)	20	24.0	23.32	0.01	1	Ant B	0065M	QPSK	50	25	0 mm	front	1:1	0.483	1.169	0.565	
1770.00	132572	High	LTE Band 66 (AWS)	20	25.0	24.30	0.01	0	Ant B	0065M	QPSK	1	99	12 mm	bottom	1:1	0.797	1.175	0.936	
1770.00	132572	High	LTE Band 66 (AWS)	20	24.0	23.32	-0.01	1	Ant B	0065M	QPSK	50	25	12 mm	bottom	1:1	0.663	1.169	0.775	
1770.00	132572	High	LTE Band 66 (AWS)	20	25.0	24.30	0.00	0	Ant B	0065M	QPSK	1	99	0 mm	right	1:1	1.100	1.175	1.293	
1770.00	132572	High	LTE Band 66 (AWS)	20	24.0	23.32	0.01	1	Ant B	0065M	QPSK	50	25	0 mm	right	1:1	0.914	1.169	1.068	
1770.00	132572	High	LTE Band 66 (AWS)	20	25.0	24.30	0.07	0	Ant B	0065M	QPSK	1	99	0 mm	left	1:1	0.272	1.175	0.320	
1770.00	132572	High	LTE Band 66 (AWS)	20	24.0	23.32	0.06	1	Ant B	0065M	QPSK	50	25	0 mm	left	1:1	0.222	1.169	0.260	
1770.00	132572	High	LTE Band 66 (AWS)	20	20.0	19.53	-0.03	0	Ant B	0065M	QPSK	1	99	0 mm	back	1:1	1.660	1.114	1.849	
1770.00	132572	High	LTE Band 66 (AWS)	20	20.0	19.54	-0.05	0	Ant B	0065M	QPSK	50	25	0 mm	back	1:1	1.670	1.112	1.857	
1770.00	132572	High	LTE Band 66 (AWS)	20	20.0	19.53	-0.05	0	Ant B	0065M	QPSK	1	99	0 mm	bottom	1:1	1.670	1.114	1.860	
1720.00	132072	Low	LTE Band 66 (AWS)	20	20.0	19.28	-0.07	0	Ant B	0065M	QPSK	50	25	0 mm	bottom	1:1	1.970	1.180	2.325	A89
1745.00	132322	Mid	LTE Band 66 (AWS)	20	20.0	19.47	-0.05	0	Ant B	0065M	QPSK	50	25	0 mm	bottom	1:1	1.870	1.130	2.113	
1770.00	132572	High	LTE Band 66 (AWS)	20	20.0	19.54	-0.06	0	Ant B	0065M	QPSK	50	25	0 mm	bottom	1:1	1.750	1.112	1.946	
1770.00	132572	High	LTE Band 66 (AWS)	20	20.0	19.47	-0.06	0	Ant B	0065M	QPSK	100	0	0 mm	bottom	1:1	1.720	1.130	1.944	
ANSI / IEEE C95.1 1992 - SAFETY LIMIT Spatial Peak Uncontrolled Exposure/General Population										Phablet 4.0 W/kg (mW/g) averaged over 10 grams										

FCC ID: A3LSMF916U		SAR EVALUATION REPORT		Approved by: Quality Manager
Document S/N: 1M2005200087-01-R2.A3L	Test Dates: 06/28/20-08/24/20	DUT Type: Portable Handset	Page 154 of 267	

**Table 11-65
LTE Band 25 (PCS) Phablet SAR**

MEASUREMENT RESULTS																				
FREQUENCY		Mode	Bandwidth [MHz]	Maximum Allowed Power [dBm]	Conducted Power [dBm]	Power Drift [dB]	MPR [dB]	Antenna Config.	Serial Number	Modulation	RB Size	RB Offset	Spacing	Side	Duty Cycle	SAR (10g) (W/kg)	Scaling Factor	Reported SAR (10g) (W/kg)	Plot #	
MHz	Ch.																			
1860.00	26140	Low	LTE Band 25 (PCS)	20	25.5	24.47	-0.06	0	Ant B	0890M	QPSK	1	0	10 mm	back	1:1	0.463	1.268	0.587	
1860.00	26140	Low	LTE Band 25 (PCS)	20	24.5	23.68	0.01	1	Ant B	0890M	QPSK	50	0	10 mm	back	1:1	0.355	1.208	0.429	
1860.00	26140	Low	LTE Band 25 (PCS)	20	25.5	24.47	0.03	0	Ant B	0890M	QPSK	1	0	0 mm	front	1:1	0.478	1.268	0.606	
1860.00	26140	Low	LTE Band 25 (PCS)	20	24.5	23.68	0.11	1	Ant B	0890M	QPSK	50	0	0 mm	front	1:1	0.374	1.208	0.452	
1860.00	26140	Low	LTE Band 25 (PCS)	20	25.5	24.47	-0.16	0	Ant B	0890M	QPSK	1	0	12 mm	bottom	1:1	0.754	1.268	0.956	
1860.00	26140	Low	LTE Band 25 (PCS)	20	24.5	23.68	-0.02	1	Ant B	0890M	QPSK	50	0	12 mm	bottom	1:1	0.612	1.208	0.739	
1860.00	26140	Low	LTE Band 25 (PCS)	20	25.5	24.47	-0.04	0	Ant B	0890M	QPSK	1	0	0 mm	right	1:1	1.960	1.268	2.485	A90
1882.50	26365	Mid	LTE Band 25 (PCS)	20	25.5	24.05	0.14	0	Ant B	0890M	QPSK	1	99	0 mm	right	1:1	1.880	1.396	2.624	
1905.00	26590	High	LTE Band 25 (PCS)	20	25.5	24.22	0.08	0	Ant B	0890M	QPSK	1	99	0 mm	right	1:1	1.330	1.343	1.786	
1860.00	26140	Low	LTE Band 25 (PCS)	20	24.5	23.68	0.05	1	Ant B	0890M	QPSK	50	0	0 mm	right	1:1	1.620	1.208	1.957	
1860.00	26140	Low	LTE Band 25 (PCS)	20	24.5	23.51	0.01	1	Ant B	0890M	QPSK	100	0	0 mm	right	1:1	1.580	1.256	1.984	
1860.00	26140	Low	LTE Band 25 (PCS)	20	25.5	24.47	0.04	0	Ant B	0890M	QPSK	1	0	0 mm	left	1:1	0.214	1.268	0.271	
1860.00	26140	Low	LTE Band 25 (PCS)	20	24.5	23.68	0.11	1	Ant B	0890M	QPSK	50	0	0 mm	left	1:1	0.158	1.208	0.191	
1860.00	26140	Low	LTE Band 25 (PCS)	20	20.0	19.22	-0.05	0	Ant B	0072M	QPSK	1	0	0 mm	back	1:1	0.947	1.197	1.134	
1860.00	26140	Low	LTE Band 25 (PCS)	20	20.0	19.21	-0.03	0	Ant B	0072M	QPSK	50	0	0 mm	back	1:1	0.974	1.199	1.168	
1860.00	26140	Low	LTE Band 25 (PCS)	20	20.0	19.22	-0.06	0	Ant B	0072M	QPSK	1	0	0 mm	bottom	1:1	1.690	1.197	2.023	
1882.50	26365	Mid	LTE Band 25 (PCS)	20	20.0	18.76	0.03	0	Ant B	0072M	QPSK	1	0	0 mm	bottom	1:1	1.300	1.330	1.729	
1905.00	26590	High	LTE Band 25 (PCS)	20	20.0	18.99	0.03	0	Ant B	0072M	QPSK	1	99	0 mm	bottom	1:1	1.360	1.262	1.716	
1860.00	26140	Low	LTE Band 25 (PCS)	20	20.0	19.21	-0.06	0	Ant B	0072M	QPSK	50	0	0 mm	bottom	1:1	1.740	1.199	2.086	
1882.50	26365	Mid	LTE Band 25 (PCS)	20	20.0	18.88	0.04	0	Ant B	0072M	QPSK	50	0	0 mm	bottom	1:1	1.350	1.294	1.747	
1905.00	26590	High	LTE Band 25 (PCS)	20	20.0	18.99	0.02	0	Ant B	0072M	QPSK	50	50	0 mm	bottom	1:1	1.500	1.262	1.893	
1860.00	26140	Low	LTE Band 25 (PCS)	20	20.0	19.07	0.03	0	Ant B	0072M	QPSK	100	0	0 mm	bottom	1:1	1.740	1.239	2.156	
ANSI / IEEE C95.1 1992 - SAFETY LIMIT								Phablet												
Spatial Peak								4.0 W/kg (mW/g)												
Uncontrolled Exposure/General Population								averaged over 10 grams												



FCC ID: A3LSMF916U		SAR EVALUATION REPORT		Approved by: Quality Manager
Document S/N: 1M2005200087-01-R2.A3L	Test Dates: 06/28/20-08/24/20	DUT Type: Portable Handset	Page 155 of 267	

Table 11-66
LTE Band 30 Phablet SAR



MEASUREMENT RESULTS																				
FREQUENCY		Mode	Bandwidth [MHz]	Maximum Allowed Power [dBm]	Conducted Power [dBm]	Power Drift [dB]	MPR [dB]	Antenna Config.	Serial Number	Modulation	RB Size	RB Offset	Spacing	Side	Duty Cycle	SAR (10g)	Scaling Factor	Reported SAR (10g)	Plot #	
MHz	Ch.															(W/kg)		(W/kg)		
2310.00	27710	Mid	LTE Band 30	10	25.0	23.84	0.03	0	Ant B	0072M	QPSK	1	0	10 mm	back	1:1	0.629	1.306	0.821	
2310.00	27710	Mid	LTE Band 30	10	24.0	22.92	0.01	1	Ant B	0072M	QPSK	25	12	10 mm	back	1:1	0.500	1.282	0.641	
2310.00	27710	Mid	LTE Band 30	10	25.0	23.84	0.15	0	Ant B	0072M	QPSK	1	0	0 mm	front	1:1	0.481	1.306	0.628	
2310.00	27710	Mid	LTE Band 30	10	24.0	22.92	0.19	1	Ant B	0072M	QPSK	25	12	0 mm	front	1:1	0.378	1.282	0.485	
2310.00	27710	Mid	LTE Band 30	10	25.0	23.84	-0.03	0	Ant B	0072M	QPSK	1	0	12 mm	bottom	1:1	0.792	1.306	1.034	
2310.00	27710	Mid	LTE Band 30	10	24.0	22.92	-0.02	1	Ant B	0072M	QPSK	25	12	12 mm	bottom	1:1	0.632	1.282	0.810	
2310.00	27710	Mid	LTE Band 30	10	25.0	23.84	0.03	0	Ant B	0072M	QPSK	1	0	0 mm	right	1:1	0.932	1.306	1.217	
2310.00	27710	Mid	LTE Band 30	10	24.0	22.92	0.05	1	Ant B	0072M	QPSK	25	12	0 mm	right	1:1	0.759	1.282	0.973	
2310.00	27710	Mid	LTE Band 30	10	25.0	23.84	-0.06	0	Ant B	0072M	QPSK	1	0	0 mm	left	1:1	0.315	1.306	0.411	
2310.00	27710	Mid	LTE Band 30	10	24.0	22.92	0.10	1	Ant B	0072M	QPSK	25	12	0 mm	left	1:1	0.240	1.282	0.308	
2310.00	27710	Mid	LTE Band 30	10	20.5	18.90	-0.12	0	Ant B	0072M	QPSK	1	25	0 mm	back	1:1	1.150	1.445	1.662	
2310.00	27710	Mid	LTE Band 30	10	20.5	18.99	-0.11	0	Ant B	0072M	QPSK	25	12	0 mm	back	1:1	1.160	1.416	1.643	
2310.00	27710	Mid	LTE Band 30	10	20.5	18.90	0.04	0	Ant B	0072M	QPSK	1	25	0 mm	bottom	1:1	2.130	1.445	3.078	
2310.00	27710	Mid	LTE Band 30	10	20.5	18.99	0.03	0	Ant B	0072M	QPSK	25	12	0 mm	bottom	1:1	2.210	1.416	3.129	A91
2310.00	27710	Mid	LTE Band 30	10	20.5	18.87	-0.02	0	Ant B	0072M	QPSK	50	0	0 mm	bottom	1:1	2.160	1.455	3.143	
2310.00	27710	Mid	LTE Band 30	10	20.5	18.99	-0.08	0	Ant B	0072M	QPSK	25	12	0 mm	bottom	1:1	2.200	1.416	3.115	
ANSI / IEEE C95.1 1992 - SAFETY LIMIT Spatial Peak Uncontrolled Exposure/General Population											Phablet 4.0 W/kg (mW/g) averaged over 10 grams									

Note: Blue entry represents variability measurement

Table 11-67
LTE Band 7 Phablet SAR

MEASUREMENT RESULTS																				
FREQUENCY		Mode	Bandwidth [MHz]	Maximum Allowed Power [dBm]	Conducted Power [dBm]	Power Drift [dB]	MPR [dB]	Antenna Config.	Serial Number	Modulation	RB Size	RB Offset	Spacing	Side	Duty Cycle	SAR (10g)	Scaling Factor	Reported SAR (10g)	Plot #	
MHz	Ch.															(W/kg)		(W/kg)		
2510.00	20850	Low	LTE Band 7	20	22.0	21.92	-0.07	0	Ant B	0909M	QPSK	1	0	10 mm	back	1:1	0.519	1.019	0.529	
2510.00	20850	Low	LTE Band 7	20	22.0	22.00	-0.03	0	Ant B	0909M	QPSK	50	25	10 mm	back	1:1	0.524	1.000	0.524	
2510.00	20850	Low	LTE Band 7	20	22.0	21.92	0.03	0	Ant B	0909M	QPSK	1	0	0 mm	front	1:1	1.140	1.019	1.162	
2510.00	20850	Low	LTE Band 7	20	22.0	22.00	0.02	0	Ant B	0909M	QPSK	50	25	0 mm	front	1:1	1.240	1.000	1.240	
2510.00	20850	Low	LTE Band 7	20	22.0	21.92	-0.04	0	Ant B	0909M	QPSK	1	0	12 mm	bottom	1:1	0.636	1.019	0.648	
2510.00	20850	Low	LTE Band 7	20	22.0	22.00	-0.02	0	Ant B	0909M	QPSK	50	25	12 mm	bottom	1:1	0.665	1.000	0.665	
2510.00	20850	Low	LTE Band 7	20	22.0	21.92	-0.06	0	Ant B	0909M	QPSK	1	0	0 mm	right	1:1	0.371	1.019	0.378	
2510.00	20850	Low	LTE Band 7	20	22.0	22.00	-0.14	0	Ant B	0909M	QPSK	50	25	0 mm	right	1:1	0.394	1.000	0.394	
2510.00	20850	Low	LTE Band 7	20	22.0	21.92	0.03	0	Ant B	0909M	QPSK	1	0	0 mm	left	1:1	0.284	1.019	0.289	
2510.00	20850	Low	LTE Band 7	20	22.0	22.00	0.02	0	Ant B	0909M	QPSK	50	25	0 mm	left	1:1	0.294	1.000	0.294	
2560.00	21350	High	LTE Band 7	20	19.5	18.67	-0.07	0	Ant B	0909M	QPSK	1	0	0 mm	back	1:1	1.320	1.211	1.599	
2560.00	21350	High	LTE Band 7	20	19.5	18.80	-0.05	0	Ant B	0909M	QPSK	50	25	0 mm	back	1:1	1.350	1.175	1.586	
2510.00	20850	Low	LTE Band 7	20	19.5	18.41	0.01	0	Ant B	0909M	QPSK	1	99	0 mm	bottom	1:1	1.810	1.285	2.326	
2535.00	21100	Mid	LTE Band 7	20	19.5	18.65	0.04	0	Ant B	0909M	QPSK	1	99	0 mm	bottom	1:1	1.630	1.216	1.982	
2560.00	21350	High	LTE Band 7	20	19.5	18.67	0.07	0	Ant B	0909M	QPSK	1	0	0 mm	bottom	1:1	1.660	1.211	2.010	
2510.00	20850	Low	LTE Band 7	20	19.5	18.50	0.18	0	Ant B	0909M	QPSK	50	25	0 mm	bottom	1:1	2.150	1.259	2.707	A92
2535.00	21100	Mid	LTE Band 7	20	19.5	18.74	0.06	0	Ant B	0909M	QPSK	50	25	0 mm	bottom	1:1	1.770	1.191	2.108	
2560.00	21350	High	LTE Band 7	20	19.5	18.80	0.07	0	Ant B	0909M	QPSK	50	25	0 mm	bottom	1:1	1.630	1.175	1.915	
2560.00	21350	High	LTE Band 7	20	19.5	18.66	0.06	0	Ant B	0909M	QPSK	100	0	0 mm	bottom	1:1	1.640	1.213	1.989	
2510.00	20850	Low	LTE Band 7	20	19.5	18.50	0.03	0	Ant B	0909M	QPSK	50	25	0 mm	bottom	1:1	2.150	1.259	2.707	
ANSI / IEEE C95.1 1992 - SAFETY LIMIT Spatial Peak Uncontrolled Exposure/General Population											Phablet 4.0 W/kg (mW/g) averaged over 10 grams									



Note: Blue entry represents variability measurement

FCC ID: A3LSMF916U		SAR EVALUATION REPORT		Approved by: Quality Manager
Document S/N: 1M2005200087-01-R2.A3L	Test Dates: 06/28/20-08/24/20	DUT Type: Portable Handset	Page 156 of 267	

**Table 11-68
LTE Band 41 Phablet SAR**

MEASUREMENT RESULTS																					
1 CC Uplink / 2 CC Uplink, Power Class	Component Carrier	FREQUENCY		Mode	Bandwidth (MHz)	Maximum Allowed Power (dBm)	Conducted Power (dBm)	Power Drift (dB)	MPR (dB)	Serial Number	Modulation	RB Size	RB Offset	Spacing	Side	Duty Cycle	SAR (10g)	Scaling Factor	Reported SAR	Plot #	
		MHz	Ch.														(W/kg)		(W/kg)		
1 CC Uplink - Power Class 3	N/A	2680.00	41490	High	LTE Band 41	20	23.5	22.89	-0.09	0	0901M	QPSK	1	50	10 mm	back	1:1.58	0.478	1.151	0.550	
1 CC Uplink - Power Class 3	N/A	2680.00	41490	High	LTE Band 41	20	23.5	23.05	-0.03	0	0901M	QPSK	50	50	10 mm	back	1:1.58	0.469	1.109	0.520	
1 CC Uplink - Power Class 3	N/A	2680.00	41490	High	LTE Band 41	20	23.5	22.89	-0.16	0	0901M	QPSK	1	50	0 mm	front	1:1.58	0.169	1.151	0.195	
1 CC Uplink - Power Class 3	N/A	2680.00	41490	High	LTE Band 41	20	23.5	23.05	-0.14	0	0901M	QPSK	50	50	0 mm	front	1:1.58	0.170	1.109	0.189	
1 CC Uplink - Power Class 3	N/A	2680.00	41490	High	LTE Band 41	20	23.5	22.89	-0.07	0	0901M	QPSK	1	50	12 mm	bottom	1:1.58	0.947	1.151	1.090	
1 CC Uplink - Power Class 3	N/A	2680.00	41490	High	LTE Band 41	20	23.5	23.05	-0.07	0	0901M	QPSK	50	50	12 mm	bottom	1:1.58	0.938	1.109	1.040	
1 CC Uplink - Power Class 3	N/A	2680.00	41490	High	LTE Band 41	20	23.5	22.89	-0.14	0	0901M	QPSK	1	50	0 mm	right	1:1.58	0.406	1.151	0.467	
1 CC Uplink - Power Class 3	N/A	2680.00	41490	High	LTE Band 41	20	23.5	23.05	-0.11	0	0901M	QPSK	50	50	0 mm	right	1:1.58	0.414	1.109	0.459	
1 CC Uplink - Power Class 3	N/A	2680.00	41490	High	LTE Band 41	20	23.5	22.89	0.04	0	0901M	QPSK	1	50	0 mm	left	1:1.58	0.205	1.151	0.236	
1 CC Uplink - Power Class 3	N/A	2680.00	41490	High	LTE Band 41	20	23.5	23.05	0.06	0	0901M	QPSK	50	50	0 mm	left	1:1.58	0.195	1.109	0.216	
1 CC Uplink - Power Class 3	N/A	2506.00	39750	Low	LTE Band 41	20	20.0	18.70	-0.03	0	0901M	QPSK	1	0	0 mm	back	1:1.58	1.400	1.349	1.889	
1 CC Uplink - Power Class 3	N/A	2549.50	40185	Low-Mid	LTE Band 41	20	20.0	18.75	-0.03	0	0901M	QPSK	1	0	0 mm	back	1:1.58	1.430	1.334	1.908	
1 CC Uplink - Power Class 3	N/A	2593.00	40620	Mid	LTE Band 41	20	20.0	18.93	-0.03	0	0901M	QPSK	1	50	0 mm	back	1:1.58	1.720	1.279	2.200	
1 CC Uplink - Power Class 3	N/A	2636.50	41055	Mid-High	LTE Band 41	20	20.0	19.08	-0.03	0	0901M	QPSK	1	50	0 mm	back	1:1.58	1.960	1.236	2.423	
1 CC Uplink - Power Class 3	N/A	2680.00	41490	High	LTE Band 41	20	20.0	19.39	-0.02	0	0901M	QPSK	1	50	0 mm	back	1:1.58	2.080	1.151	2.394	
1 CC Uplink - Power Class 3	N/A	2506.00	39750	Low	LTE Band 41	20	20.0	18.87	-0.03	0	0901M	QPSK	50	0	0 mm	back	1:1.58	1.460	1.297	1.894	
1 CC Uplink - Power Class 3	N/A	2549.50	40185	Low-Mid	LTE Band 41	20	20.0	18.99	-0.03	0	0901M	QPSK	50	25	0 mm	back	1:1.58	1.490	1.262	1.880	
1 CC Uplink - Power Class 3	N/A	2593.00	40620	Mid	LTE Band 41	20	20.0	19.12	-0.03	0	0901M	QPSK	50	25	0 mm	back	1:1.58	1.790	1.225	2.193	
1 CC Uplink - Power Class 3	N/A	2636.50	41055	Mid-High	LTE Band 41	20	20.0	19.27	-0.03	0	0901M	QPSK	50	25	0 mm	back	1:1.58	2.000	1.183	2.366	
1 CC Uplink - Power Class 3	N/A	2680.00	41490	High	LTE Band 41	20	20.0	19.47	-0.19	0	0901M	QPSK	50	25	0 mm	back	1:1.58	2.120	1.130	2.396	
1 CC Uplink - Power Class 3	N/A	2680.00	41490	High	LTE Band 41	20	20.0	19.38	-0.03	0	0901M	QPSK	100	0	0 mm	back	1:1.58	2.110	1.153	2.433	
1 CC Uplink - Power Class 3	N/A	2506.00	39750	Low	LTE Band 41	20	20.0	18.70	-0.08	0	0901M	QPSK	1	0	0 mm	bottom	1:1.58	1.720	1.349	2.320	
1 CC Uplink - Power Class 3	N/A	2549.50	40185	Low-Mid	LTE Band 41	20	20.0	18.75	0.00	0	0901M	QPSK	1	0	0 mm	bottom	1:1.58	1.710	1.334	2.281	
1 CC Uplink - Power Class 3	N/A	2593.00	40620	Mid	LTE Band 41	20	20.0	18.93	-0.06	0	0901M	QPSK	1	50	0 mm	bottom	1:1.58	1.930	1.279	2.468	
1 CC Uplink - Power Class 3	N/A	2636.50	41055	Mid-High	LTE Band 41	20	20.0	19.08	-0.05	0	0901M	QPSK	1	50	0 mm	bottom	1:1.58	2.030	1.236	2.509	
1 CC Uplink - Power Class 3	N/A	2680.00	41490	High	LTE Band 41	20	20.0	19.39	-0.01	0	0901M	QPSK	1	50	0 mm	bottom	1:1.58	2.110	1.151	2.429	
1 CC Uplink - Power Class 3	N/A	2506.00	39750	Low	LTE Band 41	20	20.0	18.87	-0.03	0	0901M	QPSK	50	0	0 mm	bottom	1:1.58	1.800	1.297	2.335	
1 CC Uplink - Power Class 3	N/A	2549.50	40185	Low-Mid	LTE Band 41	20	20.0	18.99	0.03	0	0901M	QPSK	50	25	0 mm	bottom	1:1.58	1.830	1.262	2.309	
1 CC Uplink - Power Class 3	N/A	2593.00	40620	Mid	LTE Band 41	20	20.0	19.12	-0.07	0	0901M	QPSK	50	25	0 mm	bottom	1:1.58	1.990	1.225	2.438	
1 CC Uplink - Power Class 3	N/A	2636.50	41055	Mid-High	LTE Band 41	20	20.0	19.27	-0.06	0	0901M	QPSK	50	25	0 mm	bottom	1:1.58	2.100	1.183	2.484	
1 CC Uplink - Power Class 3	N/A	2680.00	41490	High	LTE Band 41	20	20.0	19.47	-0.01	0	0901M	QPSK	50	25	0 mm	bottom	1:1.58	2.150	1.130	2.430	
1 CC Uplink - Power Class 3	N/A	2680.00	41490	High	LTE Band 41	20	20.0	19.38	-0.03	0	0901M	QPSK	100	0	0 mm	bottom	1:1.58	2.370	1.153	2.733	
1 CC Uplink - Power Class 2	N/A	2680.00	41490	High	LTE Band 41	20	21.6	20.88	-0.03	0	0901M	QPSK	100	0	0 mm	bottom	1:2.31	2.260	1.180	2.667	
2 CC Uplink - Power Class 3	PCC	2680.00	41490	High	LTE Band 41	20	20.0	19.56	-0.03	0	0901M	QPSK	100	0	0 mm	bottom	1:1.58	2.590	1.107	2.867	A93
	SCC	2660.20	41292											0							
2 CC Uplink - Power Class 2	PCC	2680.00	41490	High	LTE Band 41	20	21.6	21.15	-0.03	0	0901M	QPSK	100	0	0 mm	bottom	1:2.31	2.510	1.109	2.784	
	SCC	2660.20	41292											0							
2 CC Uplink - Power Class 3	PCC	2680.00	41490	High	LTE Band 41	20	20.0	19.56	-0.03	0	0901M	QPSK	100	0	0 mm	bottom	1:1.58	2.560	1.107	2.834	
	SCC	2660.20	41292											0							

Note: Blue entry represents variability measurement



FCC ID: A3L5MF916U	 PCTEST <small> Proud to be part of Samsung </small>	SAR EVALUATION REPORT		Approved by: Quality Manager
Document S/N: 1M2005200087-01-R2.A3L	Test Dates: 06/28/20-08/24/20	DUT Type: Portable Handset		Page 157 of 267

**Table 11-69
NR Band n66 (AWS) Phablet SAR**

MEASUREMENT RESULTS																					
FREQUENCY		Mode	Bandwidth [MHz]	Cover Type	Maximum Allowed Power [dBm]	Conducted Power [dBm]	Power Drift [dB]	MPR [dB]	Antenna Config.	Serial Number	Modulation	RB Size	RB Offset	Spacing	Side	Duty Cycle	SAR (10g) (W/kg)	Scaling Factor	Reported SAR (10g) (W/kg)	Plot #	
MHz	Ch.																				
1770.00	354000	High	NR Band n66 (AWS)	20	0	24.5	23.84	0.04	0	Ant B	0898M	DFT-S-OFDM QPSK	1	104	10 mm	back	1:1	0.397	1.164	0.462	
1770.00	354000	High	NR Band n66 (AWS)	20	0	24.5	23.73	-0.13	0	Ant B	0898M	DFT-S-OFDM QPSK	50	28	10 mm	back	1:1	0.421	1.194	0.503	
1770.00	354000	High	NR Band n66 (AWS)	20	0	24.5	23.84	-0.01	0	Ant B	0898M	DFT-S-OFDM QPSK	1	104	0 mm	front	1:1	0.372	1.164	0.433	
1770.00	354000	High	NR Band n66 (AWS)	20	0	24.5	23.73	-0.04	0	Ant B	0898M	DFT-S-OFDM QPSK	50	28	0 mm	front	1:1	0.380	1.194	0.454	
1770.00	354000	High	NR Band n66 (AWS)	20	0	24.5	23.84	-0.03	0	Ant B	0898M	DFT-S-OFDM QPSK	1	104	12 mm	bottom	1:1	0.712	1.164	0.829	
1770.00	354000	High	NR Band n66 (AWS)	20	0	24.5	23.73	-0.08	0	Ant B	0898M	DFT-S-OFDM QPSK	50	28	12 mm	bottom	1:1	0.752	1.194	0.898	
1770.00	354000	High	NR Band n66 (AWS)	20	0	24.5	23.84	0.04	0	Ant B	0898M	DFT-S-OFDM QPSK	1	104	0 mm	right	1:1	1.080	1.164	1.257	
1770.00	354000	High	NR Band n66 (AWS)	20	0	24.5	23.73	0.09	0	Ant B	0898M	DFT-S-OFDM QPSK	50	28	0 mm	right	1:1	1.120	1.194	1.337	
1770.00	354000	High	NR Band n66 (AWS)	20	0	24.5	23.84	-0.07	0	Ant B	0898M	DFT-S-OFDM QPSK	1	104	0 mm	left	1:1	0.249	1.164	0.290	
1770.00	354000	High	NR Band n66 (AWS)	20	0	24.5	23.73	0.16	0	Ant B	0898M	DFT-S-OFDM QPSK	50	28	0 mm	left	1:1	0.257	1.194	0.307	
1770.00	354000	High	NR Band n66 (AWS)	20	0	19.5	19.49	0.06	0	Ant B	0898M	DFT-S-OFDM QPSK	1	104	0 mm	back	1:1	1.910	1.002	1.914	
1720.00	344000	Low	NR Band n66 (AWS)	20	0	19.5	19.20	-0.08	0	Ant B	0898M	DFT-S-OFDM QPSK	50	0	0 mm	back	1:1	1.900	1.072	2.037	
1745.00	349000	Mid	NR Band n66 (AWS)	20	0	19.5	19.43	-0.02	0	Ant B	0898M	DFT-S-OFDM QPSK	50	0	0 mm	back	1:1	1.920	1.016	1.951	
1770.00	354000	High	NR Band n66 (AWS)	20	0	19.5	19.45	0.08	0	Ant B	0898M	DFT-S-OFDM QPSK	50	0	0 mm	back	1:1	2.050	1.012	2.075	
1770.00	354000	High	NR Band n66 (AWS)	20	0	19.5	19.41	-0.03	0	Ant B	0898M	DFT-S-OFDM QPSK	100	0	0 mm	back	1:1	2.010	1.021	2.052	
1720.00	344000	Low	NR Band n66 (AWS)	20	0	19.5	19.21	0.00	0	Ant B	0898M	DFT-S-OFDM QPSK	1	104	0 mm	bottom	1:1	2.430	1.069	2.598	
1745.00	349000	Mid	NR Band n66 (AWS)	20	0	19.5	19.36	-0.06	0	Ant B	0898M	DFT-S-OFDM QPSK	1	1	0 mm	bottom	1:1	2.450	1.033	2.531	
1770.00	354000	High	NR Band n66 (AWS)	20	0	19.5	19.49	0.05	0	Ant B	0898M	DFT-S-OFDM QPSK	1	104	0 mm	bottom	1:1	2.370	1.002	2.375	
1720.00	344000	Low	NR Band n66 (AWS)	20	0	19.5	19.20	0.06	0	Ant B	0898M	DFT-S-OFDM QPSK	50	0	0 mm	bottom	1:1	2.590	1.072	2.776	A84
1745.00	349000	Mid	NR Band n66 (AWS)	20	0	19.5	19.43	-0.04	0	Ant B	0898M	DFT-S-OFDM QPSK	50	0	0 mm	bottom	1:1	2.470	1.016	2.510	
1770.00	354000	High	NR Band n66 (AWS)	20	0	19.5	19.45	-0.02	0	Ant B	0898M	DFT-S-OFDM QPSK	50	0	0 mm	bottom	1:1	2.450	1.012	2.479	
1770.00	354000	High	NR Band n66 (AWS)	20	0	19.5	19.41	0.14	0	Ant B	0898M	DFT-S-OFDM QPSK	100	0	0 mm	bottom	1:1	2.440	1.021	2.491	
1770.00	354000	High	NR Band n66 (AWS)	20	0	19.5	19.50	0.01	0	Ant B	0898M	CP-OFDM QPSK	1	1	0 mm	bottom	1:1	2.380	1.000	2.380	
ANSI / IEEE C95.1 1992 - SAFETY LIMIT Spatial Peak Uncontrolled Exposure/General Population										Phablet 4.0 W/kg (mW/g) averaged over 10 grams											

**Table 11-70
NR Band n25 (PCS) Phablet SAR**

MEASUREMENT RESULTS																				
FREQUENCY		Mode	Bandwidth [MHz]	Maximum Allowed Power [dBm]	Conducted Power [dBm]	Power Drift [dB]	MPR [dB]	Antenna Config.	Serial Number	Modulation	RB Size	RB Offset	Spacing	Side	Duty Cycle	SAR (10g) (W/kg)	Scaling Factor	Reported SAR (10g) (W/kg)	Plot #	
MHz	Ch.																			
1882.50	376500	Mid	NR Band n25 (PCS)	20	24.5	23.86	0.00	0	Ant B	0895M	DFT-S-OFDM QPSK	1	53	10 mm	back	1:1	0.504	1.159	0.584	
1882.50	376500	Mid	NR Band n25 (PCS)	20	24.5	23.76	0.10	0	Ant B	0895M	DFT-S-OFDM QPSK	50	0	10 mm	back	1:1	0.494	1.186	0.586	
1882.50	376500	Mid	NR Band n25 (PCS)	20	24.5	23.86	0.01	0	Ant B	0895M	DFT-S-OFDM QPSK	1	53	0 mm	front	1:1	0.449	1.159	0.520	
1882.50	376500	Mid	NR Band n25 (PCS)	20	24.5	23.76	0.09	0	Ant B	0895M	DFT-S-OFDM QPSK	50	0	0 mm	front	1:1	0.420	1.186	0.498	
1882.50	376500	Mid	NR Band n25 (PCS)	20	24.5	23.86	-0.08	0	Ant B	0895M	DFT-S-OFDM QPSK	1	53	12 mm	bottom	1:1	0.833	1.159	0.965	
1882.50	376500	Mid	NR Band n25 (PCS)	20	24.5	23.76	-0.01	0	Ant B	0895M	DFT-S-OFDM QPSK	50	0	12 mm	bottom	1:1	0.781	1.186	0.926	
1882.50	376500	Mid	NR Band n25 (PCS)	20	24.5	23.86	-0.01	0	Ant B	0895M	DFT-S-OFDM QPSK	1	53	0 mm	right	1:1	1.620	1.159	1.878	
1882.50	376500	Mid	NR Band n25 (PCS)	20	24.5	23.76	0.07	0	Ant B	0895M	DFT-S-OFDM QPSK	50	0	0 mm	right	1:1	1.550	1.186	1.838	
1882.50	376500	Mid	NR Band n25 (PCS)	20	24.5	23.86	0.12	0	Ant B	0895M	DFT-S-OFDM QPSK	1	53	0 mm	left	1:1	0.314	1.159	0.364	
1882.50	376500	Mid	NR Band n25 (PCS)	20	24.5	23.76	0.15	0	Ant B	0895M	DFT-S-OFDM QPSK	50	0	0 mm	left	1:1	0.289	1.186	0.343	
1882.50	376500	Mid	NR Band n25 (PCS)	20	19.5	18.94	-0.15	0	Ant B	0895M	DFT-S-OFDM QPSK	1	1	0 mm	back	1:1	1.210	1.138	1.377	
1882.50	376500	Mid	NR Band n25 (PCS)	20	19.5	19.02	-0.15	0	Ant B	0895M	DFT-S-OFDM QPSK	50	0	0 mm	back	1:1	1.220	1.117	1.363	
1860.00	372000	Low	NR Band n25 (PCS)	20	19.5	18.70	0.02	0	Ant B	0895M	DFT-S-OFDM QPSK	1	1	0 mm	bottom	1:1	1.720	1.202	2.067	
1882.50	376500	Mid	NR Band n25 (PCS)	20	19.5	18.94	-0.04	0	Ant B	0895M	DFT-S-OFDM QPSK	1	1	0 mm	bottom	1:1	1.740	1.138	1.980	
1905.00	381000	High	NR Band n25 (PCS)	20	19.5	18.68	-0.04	0	Ant B	0895M	DFT-S-OFDM QPSK	1	53	0 mm	bottom	1:1	1.730	1.208	2.090	
1882.50	376500	Mid	NR Band n25 (PCS)	20	19.5	19.02	-0.04	0	Ant B	0895M	DFT-S-OFDM QPSK	50	0	0 mm	bottom	1:1	1.710	1.117	1.910	
1882.50	376500	Mid	NR Band n25 (PCS)	20	19.5	18.92	0.00	0	Ant B	0895M	DFT-S-OFDM QPSK	100	0	0 mm	bottom	1:1	1.650	1.143	1.886	
1882.50	376500	Mid	NR Band n25 (PCS)	20	19.5	19.11	-0.10	0	Ant B	0895M	CP-OFDM QPSK	1	1	0 mm	bottom	1:1	1.920	1.094	2.100	A95
ANSI / IEEE C95.1 1992 - SAFETY LIMIT Spatial Peak Uncontrolled Exposure/General Population										Phablet 4.0 W/kg (mW/g) averaged over 10 grams										

FCC ID: A3LSMF916U		SAR EVALUATION REPORT		Approved by: Quality Manager
Document S/N: 1M2005200087-01-R2.A3L	Test Dates: 06/28/20-08/24/20	DUT Type: Portable Handset	Page 158 of 267	

**Table 11-71
WLAN Phablet SAR**



MEASUREMENT RESULTS																			
FREQUENCY		Mode	Service	Bandwidth [MHz]	Maximum Allowed Power [dBm]	Conducted Power [dBm]	Power Drift [dB]	Spacing	Antenna Config.	Device Serial Number	Data Rate (Mbps)	Side	Duty Cycle (%)	Peak SAR of Area Scan	SAR (10g)	Scaling Factor (Power)	Scaling Factor (Duty Cycle)	Reported SAR (10g)	Plot #
MHz	Ch.													W/kg	(W/kg)			(W/kg)	
5300	60	802.11a	OFDM	20	18.0	17.99	0.11	0 mm	1	0876M	6	back	99.2	0.122	0.014	1.002	1.008	0.014	
5300	60	802.11a	OFDM	20	18.0	17.99	0.04	0 mm	1	0876M	6	front	99.2	10.990	1.340	1.002	1.008	1.353	
5300	60	802.11a	OFDM	20	18.0	17.99	-0.08	0 mm	1	0876M	6	top	99.2	18.034	1.460	1.002	1.008	1.475	
5300	60	802.11a	OFDM	20	18.0	17.99	0.09	0 mm	1	0876M	6	left	99.2	0.628	0.086	1.002	1.008	0.087	
5300	60	802.11a	OFDM	20	18.0	17.95	0.09	0 mm	2	0876M	6	back	99.4	0.135	0.012	1.012	1.006	0.012	
5300	60	802.11a	OFDM	20	18.0	17.95	-0.11	0 mm	2	0876M	6	front	99.4	7.216	0.726	1.012	1.006	0.739	
5300	60	802.11a	OFDM	20	18.0	17.95	-0.05	0 mm	2	0876M	6	top	99.4	4.226	0.523	1.012	1.006	0.532	
5300	60	802.11a	OFDM	20	18.0	17.95	0.16	0 mm	2	0876M	6	right	99.4	2.450	0.388	1.012	1.006	0.395	
5300	60	802.11a	OFDM	20	18.0	17.95	0.11	0 mm	2	0876M	6	left	99.4	0.183	0.023	1.012	1.006	0.023	
5620	124	802.11a	OFDM	20	18.0	17.99	0.19	0 mm	1	0876M	6	back	99.2	0.156	0.022	1.002	1.008	0.022	
5500	100	802.11a	OFDM	20	18.0	17.99	0.03	0 mm	1	0876M	6	front	99.2	13.252	1.490	1.002	1.008	1.505	
5620	124	802.11a	OFDM	20	18.0	17.99	0.02	0 mm	1	0876M	6	front	99.2	11.603	1.610	1.002	1.008	1.626	
5720	144	802.11a	OFDM	20	18.0	17.71	0.17	0 mm	1	0876M	6	front	99.2	14.882	2.070	1.069	1.008	2.231	
5620	124	802.11a	OFDM	20	18.0	17.99	-0.04	0 mm	1	0876M	6	top	99.2	16.344	1.390	1.002	1.008	1.404	
5620	124	802.11a	OFDM	20	18.0	17.99	0.01	0 mm	1	0876M	6	left	99.2	0.400	0.055	1.002	1.008	0.056	
5720	144	802.11a	OFDM	20	18.0	17.72	0.15	0 mm	2	0876M	6	back	99.4	0.122	0.012	1.067	1.006	0.013	
5720	144	802.11a	OFDM	20	18.0	17.72	0.08	0 mm	2	0876M	6	front	99.4	12.725	0.937	1.067	1.006	1.006	
5720	144	802.11a	OFDM	20	18.0	17.72	0.02	0 mm	2	0876M	6	top	99.4	5.696	0.520	1.067	1.006	0.558	
5720	144	802.11a	OFDM	20	18.0	17.72	-0.02	0 mm	2	0876M	6	right	99.4	2.322	0.231	1.067	1.006	0.248	
5720	144	802.11a	OFDM	20	18.0	17.72	-0.10	0 mm	2	0876M	6	left	99.4	0.036	0.001	1.067	1.006	0.001	
ANSI / IEEE C95.1 1992 - SAFETY LIMIT Spatial Peak Uncontrolled Exposure/General Population										Phablet 4.0 W/kg (mW/g) averaged over 10 grams									

**Table 11-72
WLAN MIMO Phablet SAR**

MEASUREMENT RESULTS																					
FREQUENCY		Mode	Service	Bandwidth [MHz]	Maximum Allowed Power (Ant 1) [dBm]	Maximum Allowed Power (Ant 2) [dBm]	Conducted Power (Ant 1) [dBm]	Conducted Power (Ant 2) [dBm]	Power Drift [dB]	Spacing	Antenna Config.	Device Serial Number	Data Rate (Mbps)	Side	Duty Cycle (%)	Peak SAR of Area Scan	SAR (10g)	Scaling Factor (Power)	Scaling Factor (Duty Cycle)	Reported SAR (10g)	Plot #
MHz	Ch.															W/kg	(W/kg)			(W/kg)	
5260	52	802.11n	OFDM	20	18.0	17.96	18.0	17.95	-0.03	0 mm	MIMO	0876M	13	back	98.6	0.194	0.014	1.012	1.014	0.014	
5260	52	802.11n	OFDM	20	18.0	17.96	18.0	17.95	-0.03	0 mm	MIMO	0876M	13	front	98.6	9.848	1.510	1.012	1.014	1.550	
5260	52	802.11n	OFDM	20	18.0	17.96	18.0	17.95	-0.03	0 mm	MIMO	0876M	13	top	98.6	13.246	1.420	1.012	1.014	1.457	
5260	52	802.11n	OFDM	20	18.0	17.96	18.0	17.95	0.03	0 mm	MIMO	0876M	13	right	98.6	2.779	0.403	1.012	1.014	0.414	
5260	52	802.11n	OFDM	20	18.0	17.96	18.0	17.95	0.03	0 mm	MIMO	0876M	13	left	98.6	0.658	0.089	1.012	1.014	0.091	
5620	124	802.11n	OFDM	20	18.0	17.91	18.0	17.99	0.05	0 mm	MIMO	0876M	13	back	98.6	0.317	0.041	1.021	1.014	0.042	
5500	100	802.11n	OFDM	20	18.0	17.99	18.0	17.87	0.10	0 mm	MIMO	0876M	13	front	98.6	18.422	2.110	1.030	1.014	2.204	
5620	124	802.11n	OFDM	20	18.0	17.91	18.0	17.99	0.02	0 mm	MIMO	0876M	13	front	98.6	17.013	2.230	1.021	1.014	2.309	
5720	144	802.11n	OFDM	20	18.0	17.94	18.0	17.65	0.01	0 mm	MIMO	0876M	13	front	98.6	19.470	2.380	1.084	1.014	2.616	A96
5620	124	802.11n	OFDM	20	18.0	17.91	18.0	17.99	0.03	0 mm	MIMO	0876M	13	top	98.6	17.424	1.640	1.021	1.014	1.698	
5620	124	802.11n	OFDM	20	18.0	17.91	18.0	17.99	0.12	0 mm	MIMO	0876M	13	right	98.6	3.501	0.429	1.021	1.014	0.444	
5620	124	802.11n	OFDM	20	18.0	17.91	18.0	17.99	0.03	0 mm	MIMO	0876M	13	left	98.6	0.387	0.063	1.021	1.014	0.065	
5620	124	802.11n	OFDM	20	18.0	17.91	18.0	17.99	0.19	0 mm	MIMO	0876M	13	front	98.6	14.113	2.120	1.021	1.014	2.195	
5720	144	802.11n	OFDM	20	18.0	17.94	18.0	17.65	0.03	0 mm	MIMO	0876M	13	front	98.6	18.565	2.350	1.084	1.014	2.583	
ANSI / IEEE C95.1 1992 - SAFETY LIMIT Spatial Peak Uncontrolled Exposure/General Population										Phablet 4.0 W/kg (mW/g) averaged over 10 grams											

Note:

- Blue entries represent variability measurement
- To achieve the 21.0 dBm maximum allowed MIMO power shown in the documentation, each antenna transmits at a maximum allowed power of 18.0 dBm.

FCC ID: A3LSMF916U		SAR EVALUATION REPORT		Approved by: Quality Manager
Document S/N: 1M2005200087-01-R2.A3L	Test Dates: 06/28/20-08/24/20	DUT Type: Portable Handset	Page 159 of 267	

**Table 11-73
5 GHz WLAN Phablet SAR for Conditions mmWave Active**

MEASUREMENT RESULTS																					
FREQUENCY		Mode	Service	Bandwidth [MHz]	Maximum Allowed Power (Ant 1) [dBm]	Conducted Power (Ant 1) [dBm]	Maximum Allowed Power (Ant 2) [dBm]	Conducted Power (Ant 2) [dBm]	Power Drift [dB]	Spacing	Antenna Config.	Device Serial Number	Data Rate (Mbps)	Side	Duty Cycle (%)	Peak SAR of Area Scan	SAR (1g)	Scaling Factor (Power)	Scaling Factor (Duty Cycle)	Reported SAR (1g)	Plot #
MHz	Ch.															W/kg	(W/kg)	(W/kg)	(W/kg)		
5290	58	802.11ac	OFDM	80	11.0	10.37	11.0	10.67	0.09	0 mm	MIMO	0876M	58.5	back	90.9	0.015	-	1.156	1.101	-	-
5290	58	802.11ac	OFDM	80	11.0	10.37	11.0	10.67	0.17	0 mm	MIMO	0876M	58.5	front	90.9	0.925	0.119	1.156	1.101	0.151	-
5290	58	802.11ac	OFDM	80	11.0	10.37	11.0	10.67	0.09	0 mm	MIMO	0876M	58.5	top	90.9	0.091	-	1.156	1.101	-	-
5290	58	802.11ac	OFDM	80	11.0	10.37	11.0	10.67	0.00	0 mm	MIMO	0876M	58.5	left	90.9	0.031	-	1.156	1.101	-	-
5530	106	802.11ac	OFDM	80	11.0	10.56	11.0	10.75	0.00	0 mm	MIMO	0876M	58.5	back	90.9	0.015	-	1.107	1.101	-	-
5530	106	802.11ac	OFDM	80	11.0	10.56	11.0	10.75	0.16	0 mm	MIMO	0876M	58.5	front	90.9	1.405	0.172	1.107	1.101	0.210	-
5530	106	802.11ac	OFDM	80	11.0	10.56	11.0	10.75	-0.09	0 mm	MIMO	0876M	58.5	top	90.9	1.278	-	1.107	1.101	-	-
5530	106	802.11ac	OFDM	80	11.0	10.56	11.0	10.75	0.00	0 mm	MIMO	0876M	58.5	left	90.9	0.015	-	1.107	1.101	-	-
ANSI / IEEE C95.1 1992 - SAFETY LIMIT Spatial Peak Uncontrolled Exposure/General Population											Phablet 4.0 W/kg (mW/g) averaged over 10 grams										

Note: To achieve the 14.0 dBm maximum allowed MIMO power shown in the documentation, each antenna transmits at a maximum allowed power of 11.0 dBm.



11.5 Standalone UMPC Body SAR

**Table 11-74
CDMA BC10 (§90S) UMPC Body SAR**

MEASUREMENT RESULTS																
FREQUENCY		Mode	Service	Maximum Allowed Power [dBm]	Conducted Power [dBm]	Power Drift [dB]	Spacing	Antenna Config.	Tune State	Device Serial Number	Duty Cycle	Side	SAR (1g)	Scaling Factor	Reported SAR (1g)	Plot #
MHz	Ch.												(W/kg)		(W/kg)	
820.10	564	CDMA BC10 (§90S)	EVDO Rev. 0	26.0	25.15	0.01	10 mm	Ant A	11	0744M	1:1	back	0.586	1.216	0.713	A97
820.10	564	CDMA BC10 (§90S)	EVDO Rev. 0	26.0	25.15	-0.05	10 mm	Ant A	11	0744M	1:1	front	0.434	1.216	0.528	-
820.10	564	CDMA BC10 (§90S)	EVDO Rev. 0	26.0	25.15	-0.02	10 mm	Ant A	11	0744M	1:1	bottom	0.287	1.216	0.349	-
820.10	564	CDMA BC10 (§90S)	EVDO Rev. 0	26.0	25.15	-0.04	10 mm	Ant A	11	0744M	1:1	right	0.271	1.216	0.330	-
ANSI / IEEE C95.1 1992 - SAFETY LIMIT Spatial Peak Uncontrolled Exposure/General Population											Body 1.6 W/kg (mW/g) averaged over 1 gram					

**Table 11-75
CDMA BC0 (§22H) UMPC Body SAR**

MEASUREMENT RESULTS																
FREQUENCY		Mode	Service	Maximum Allowed Power [dBm]	Conducted Power [dBm]	Power Drift [dB]	Spacing	Antenna Config.	Tune State	Device Serial Number	Duty Cycle	Side	SAR (1g)	Scaling Factor	Reported SAR (1g)	Plot #
MHz	Ch.												(W/kg)		(W/kg)	
824.70	1013	CDMA BC0 (§22H)	EVDO Rev. 0	26.0	25.19	-0.10	10 mm	Ant A	0	0744M	1:1	back	0.598	1.205	0.721	-
836.52	384	CDMA BC0 (§22H)	EVDO Rev. 0	26.0	25.16	-0.04	10 mm	Ant A	0	0744M	1:1	back	0.653	1.213	0.792	-
848.31	777	CDMA BC0 (§22H)	EVDO Rev. 0	26.0	25.08	-0.02	10 mm	Ant A	0	0744M	1:1	back	0.668	1.236	0.826	A98
836.52	384	CDMA BC0 (§22H)	EVDO Rev. 0	26.0	25.16	-0.02	10 mm	Ant A	0	0744M	1:1	front	0.431	1.213	0.523	-
836.52	384	CDMA BC0 (§22H)	EVDO Rev. 0	26.0	25.16	-0.01	10 mm	Ant A	0	0744M	1:1	bottom	0.328	1.213	0.398	-
836.52	384	CDMA BC0 (§22H)	EVDO Rev. 0	26.0	25.16	-0.11	10 mm	Ant A	0	0744M	1:1	right	0.334	1.213	0.405	-
836.52	384	CDMA BC0 (§22H)	EVDO Rev. 0	24.5	23.51	0.07	10 mm	Ant B	N/A	0744M	1:1	back	0.351	1.256	0.441	-
836.52	384	CDMA BC0 (§22H)	EVDO Rev. 0	24.5	23.51	0.01	10 mm	Ant B	N/A	0744M	1:1	front	0.201	1.256	0.252	-
836.52	384	CDMA BC0 (§22H)	EVDO Rev. 0	24.5	23.51	-0.05	10 mm	Ant B	N/A	0744M	1:1	bottom	0.336	1.256	0.422	-
836.52	384	CDMA BC0 (§22H)	EVDO Rev. 0	24.5	23.51	-0.01	10 mm	Ant B	N/A	0744M	1:1	right	0.048	1.256	0.060	-
ANSI / IEEE C95.1 1992 - SAFETY LIMIT Spatial Peak Uncontrolled Exposure/General Population											Body 1.6 W/kg (mW/g) averaged over 1 gram					



FCC ID: A3LSMF916U		SAR EVALUATION REPORT		Approved by: Quality Manager
Document S/N: 1M2005200087-01-R2.A3L	Test Dates: 06/28/20-08/24/20	DUT Type: Portable Handset	Page 160 of 267	

**Table 11-76
PCS CDMA UMPC Body SAR**

MEASUREMENT RESULTS															
FREQUENCY		Mode	Service	Maximum Allowed Power [dBm]	Conducted Power [dBm]	Power Drift [dB]	Spacing	Antenna Config.	Device Serial Number	Duty Cycle	Side	SAR (1g)	Scaling Factor	Reported SAR (1g)	Plot #
MHz	Ch.											(W/kg)		(W/kg)	
1880.00	600	PCS CDMA	EVDO Rev. 0	24.0	23.16	-0.02	12 mm	Ant B	1102M	1:1	back	0.600	1.213	0.728	
1880.00	600	PCS CDMA	EVDO Rev. 0	24.0	23.16	0.09	10 mm	Ant B	1102M	1:1	front	0.602	1.213	0.730	
1851.25	25	PCS CDMA	EVDO Rev. 0	24.0	23.14	-0.01	16 mm	Ant B	1102M	1:1	bottom	0.810	1.219	0.987	A99
1880.00	600	PCS CDMA	EVDO Rev. 0	24.0	23.16	-0.03	16 mm	Ant B	1102M	1:1	bottom	0.716	1.213	0.869	
1908.75	1175	PCS CDMA	EVDO Rev. 0	24.0	23.23	-0.05	16 mm	Ant B	1102M	1:1	bottom	0.599	1.194	0.715	
1880.00	600	PCS CDMA	EVDO Rev. 0	24.0	23.16	0.05	10 mm	Ant B	1102M	1:1	right	0.543	1.213	0.659	
1880.00	600	PCS CDMA	EVDO Rev. 0	20.0	18.58	0.01	10 mm	Ant B	1102M	1:1	back	0.329	1.387	0.456	
1851.25	25	PCS CDMA	EVDO Rev. 0	20.0	19.02	-0.07	10 mm	Ant B	1102M	1:1	bottom	0.704	1.253	0.882	
1880.00	600	PCS CDMA	EVDO Rev. 0	20.0	18.58	-0.08	10 mm	Ant B	1102M	1:1	bottom	0.618	1.387	0.857	
1908.75	1175	PCS CDMA	EVDO Rev. 0	20.0	18.95	-0.07	10 mm	Ant B	1102M	1:1	bottom	0.581	1.274	0.740	
ANSI / IEEE C95.1 1992 - SAFETY LIMIT Spatial Peak Uncontrolled Exposure/General Population								Body 1.6 W/kg (mW/g) averaged over 1 gram							

**Table 11-77
GSM 850 UMPC Body SAR**

MEASUREMENT RESULTS																
FREQUENCY		Mode	Service	Maximum Allowed Power [dBm]	Conducted Power [dBm]	Power Drift [dB]	Spacing	Antenna Config.	Device Serial Number	# of Time Slots	Duty Cycle	Side	SAR (1g)	Scaling Factor	Reported SAR (1g)	Plot #
MHz	Ch.												(W/kg)		(W/kg)	
824.20	128	GSM850	GPRS	30.5	28.76	-0.09	10 mm	Ant A	0897M	3	1:2.76	back	0.441	1.493	0.658	
836.60	190	GSM850	GPRS	30.5	28.88	-0.03	10 mm	Ant A	0897M	3	1:2.76	back	0.565	1.452	0.820	A100
848.80	251	GSM850	GPRS	30.5	29.08	0.03	10 mm	Ant A	0897M	3	1:2.76	back	0.559	1.387	0.775	
836.60	190	GSM850	GPRS	30.5	28.88	0.02	10 mm	Ant A	0897M	3	1:2.76	front	0.493	1.452	0.716	
836.60	190	GSM850	GPRS	30.5	28.88	-0.03	10 mm	Ant A	0897M	3	1:2.76	bottom	0.339	1.452	0.492	
836.60	190	GSM850	GPRS	30.5	28.88	0.00	10 mm	Ant A	0897M	3	1:2.76	right	0.382	1.452	0.555	
ANSI / IEEE C95.1 1992 - SAFETY LIMIT Spatial Peak Uncontrolled Exposure/General Population								Body 1.6 W/kg (mW/g) averaged over 1 gram								

FCC ID: A3LSMF916U		SAR EVALUATION REPORT		Approved by: Quality Manager
Document S/N: 1M2005200087-01-R2.A3L	Test Dates: 06/28/20-08/24/20	DUT Type: Portable Handset		Page 161 of 267

**Table 11-78
GSM 1900 UMPC Body SAR**



MEASUREMENT RESULTS																
FREQUENCY		Mode	Service	Maximum Allowed Power [dBm]	Conducted Power [dBm]	Power Drift [dB]	Spacing	Antenna Config.	Device Serial Number	# of Time Slots	Duty Cycle	Side	SAR (1g)	Scaling Factor	Reported SAR (1g)	Plot #
MHz	Ch.												(W/kg)		(W/kg)	
1880.00	661	GSM 1900	GPRS	27.5	26.72	-0.07	12 mm	Ant B	1102M	3	1:2.76	back	0.335	1.197	0.401	
1880.00	661	GSM 1900	GPRS	27.5	26.72	-0.03	10 mm	Ant B	1102M	3	1:2.76	front	0.315	1.197	0.377	
1880.00	661	GSM 1900	GPRS	27.5	26.72	0.01	16 mm	Ant B	1102M	3	1:2.76	bottom	0.387	1.197	0.463	
1880.00	661	GSM 1900	GPRS	27.5	26.72	-0.03	10 mm	Ant B	1102M	3	1:2.76	right	0.283	1.197	0.339	
1880.00	661	GSM 1900	GPRS	23.0	21.82	0.00	10 mm	Ant B	1102M	4	1:2.076	back	0.248	1.312	0.325	
1880.00	661	GSM 1900	GPRS	23.0	21.82	0.00	10 mm	Ant B	1102M	4	1:2.076	bottom	0.456	1.312	0.598	A101
ANSI / IEEE C95.1 1992 - SAFETY LIMIT Spatial Peak Uncontrolled Exposure/General Population							Body 1.6 W/kg (mW/g) averaged over 1 gram									

**Table 11-79
UMTS 850 UMPC Body SAR**

MEASUREMENT RESULTS																
FREQUENCY		Mode	Service	Maximum Allowed Power [dBm]	Conducted Power [dBm]	Power Drift [dB]	Spacing	Antenna Config.	Tune State	Device Serial Number	Duty Cycle	Side	SAR (1g)	Scaling Factor	Reported SAR (1g)	Plot #
MHz	Ch.												(W/kg)		(W/kg)	
826.40	4132	UMTS 850	RMC	25.8	24.31	-0.01	10 mm	Ant A	0	0744M	1:1	back	0.640	1.409	0.902	
836.60	4183	UMTS 850	RMC	25.8	24.32	0.01	10 mm	Ant A	0	0744M	1:1	back	0.677	1.406	0.952	
846.60	4233	UMTS 850	RMC	25.8	24.25	0.00	10 mm	Ant A	0	0744M	1:1	back	0.705	1.429	1.007	A102
836.60	4183	UMTS 850	RMC	25.8	24.32	0.01	10 mm	Ant A	0	0744M	1:1	front	0.457	1.406	0.643	
836.60	4183	UMTS 850	RMC	25.8	24.32	-0.03	10 mm	Ant A	0	0744M	1:1	bottom	0.299	1.406	0.420	
836.60	4183	UMTS 850	RMC	25.8	24.32	0.00	10 mm	Ant A	0	0744M	1:1	right	0.347	1.406	0.488	
ANSI / IEEE C95.1 1992 - SAFETY LIMIT Spatial Peak Uncontrolled Exposure/General Population							Body 1.6 W/kg (mW/g) averaged over 1 gram									

**Table 11-80
UMTS 1750 UMPC Body SAR**

MEASUREMENT RESULTS															
FREQUENCY		Mode	Service	Maximum Allowed Power [dBm]	Conducted Power [dBm]	Power Drift [dB]	Spacing	Antenna Config.	Device Serial Number	Duty Cycle	Side	SAR (1g)	Scaling Factor	Reported SAR (1g)	Plot #
MHz	Ch.											(W/kg)		(W/kg)	
1712.40	1312	UMTS 1750	RMC	25.5	24.11	0.00	12 mm	Ant B	1134M	1:1	back	0.820	1.377	1.129	
1732.40	1412	UMTS 1750	RMC	25.5	24.24	-0.02	12 mm	Ant B	1134M	1:1	back	0.867	1.337	1.159	A103
1752.60	1513	UMTS 1750	RMC	25.5	23.53	-0.01	12 mm	Ant B	1134M	1:1	back	0.667	1.574	1.050	
1712.40	1312	UMTS 1750	RMC	25.5	24.11	0.06	10 mm	Ant B	1134M	1:1	front	0.667	1.377	0.918	
1732.40	1412	UMTS 1750	RMC	25.5	24.24	0.08	10 mm	Ant B	1134M	1:1	front	0.729	1.337	0.975	
1752.60	1513	UMTS 1750	RMC	25.5	23.53	0.07	10 mm	Ant B	1134M	1:1	front	0.566	1.574	0.891	
1712.40	1312	UMTS 1750	RMC	25.5	24.11	-0.01	16 mm	Ant B	1134M	1:1	bottom	0.673	1.377	0.927	
1732.40	1412	UMTS 1750	RMC	25.5	24.24	0.00	16 mm	Ant B	1134M	1:1	bottom	0.712	1.337	0.952	
1752.60	1513	UMTS 1750	RMC	25.5	23.53	0.00	16 mm	Ant B	1134M	1:1	bottom	0.586	1.574	0.922	
1732.40	1412	UMTS 1750	RMC	25.5	24.24	0.01	10 mm	Ant B	1134M	1:1	right	0.396	1.337	0.529	
1732.40	1412	UMTS 1750	RMC	20.0	18.93	-0.03	10 mm	Ant B	1134M	1:1	back	0.430	1.279	0.550	
1732.40	1412	UMTS 1750	RMC	20.0	18.93	0.03	10 mm	Ant B	1134M	1:1	bottom	0.481	1.279	0.615	
ANSI / IEEE C95.1 1992 - SAFETY LIMIT Spatial Peak Uncontrolled Exposure/General Population							Body 1.6 W/kg (mW/g) averaged over 1 gram								

FCC ID: A3LSMF916U		SAR EVALUATION REPORT		Approved by: Quality Manager
Document S/N: 1M2005200087-01-R2.A3L	Test Dates: 06/28/20-08/24/20	DUT Type: Portable Handset	Page 162 of 267	



**Table 11-81
UMTS 1900 UMPC Body SAR**

MEASUREMENT RESULTS															
FREQUENCY		Mode	Service	Maximum Allowed Power [dBm]	Conducted Power [dBm]	Power Drift [dB]	Spacing	Antenna Config.	Device Serial Number	Duty Cycle	Side	SAR (1g)	Scaling Factor	Reported SAR (1g)	Plot #
MHz	Ch.											(W/kg)		(W/kg)	
1852.40	9262	UMTS 1900	RMC	24.5	23.60	-0.02	12 mm	Ant B	1102M	1:1	back	0.843	1.230	1.037	
1880.00	9400	UMTS 1900	RMC	24.5	23.81	-0.03	12 mm	Ant B	1102M	1:1	back	0.734	1.172	0.860	
1907.60	9538	UMTS 1900	RMC	24.5	23.82	-0.06	12 mm	Ant B	1102M	1:1	back	0.739	1.169	0.864	
1880.00	9400	UMTS 1900	RMC	24.5	23.81	-0.03	10 mm	Ant B	1102M	1:1	front	0.583	1.172	0.683	
1852.40	9262	UMTS 1900	RMC	24.5	23.60	-0.03	16 mm	Ant B	1102M	1:1	bottom	0.932	1.230	1.146	A104
1880.00	9400	UMTS 1900	RMC	24.5	23.81	-0.08	16 mm	Ant B	1102M	1:1	bottom	0.788	1.172	0.924	
1907.60	9538	UMTS 1900	RMC	24.5	23.82	-0.02	16 mm	Ant B	1102M	1:1	bottom	0.646	1.169	0.755	
1880.00	9400	UMTS 1900	RMC	24.5	23.81	-0.09	10 mm	Ant B	1102M	1:1	right	0.659	1.172	0.772	
1880.00	9400	UMTS 1900	RMC	20.0	18.63	-0.06	10 mm	Ant B	1102M	1:1	back	0.375	1.371	0.514	
1852.40	9262	UMTS 1900	RMC	20.0	19.01	-0.01	10 mm	Ant B	1102M	1:1	bottom	0.710	1.256	0.892	
1880.00	9400	UMTS 1900	RMC	20.0	18.63	-0.05	10 mm	Ant B	1102M	1:1	bottom	0.621	1.371	0.851	
1907.60	9538	UMTS 1900	RMC	20.0	18.94	-0.12	10 mm	Ant B	1102M	1:1	bottom	0.574	1.276	0.732	
1852.40	9262	UMTS 1900	RMC	24.5	23.60	-0.01	16 mm	Ant B	1102M	1:1	bottom	0.921	1.230	1.133	
ANSI / IEEE C95.1 1992 - SAFETY LIMIT Spatial Peak Uncontrolled Exposure/General Population								Body 1.6 W/kg (mW/g) averaged over 1 gram							

Note: Blue entry represents variability measurement

**Table 11-82
LTE Band 71 UMPC Body SAR**

MEASUREMENT RESULTS																					
FREQUENCY		Mode	Bandwidth [MHz]	Tune State	Maximum Allowed Power [dBm]	Conducted Power [dBm]	Power Drift [dB]	MPR [dB]	Antenna Config.	Device Serial Number	Modulation	RB Size	RB Offset	Spacing	Side	Duty Cycle	SAR (1g)	Scaling Factor	Reported SAR (1g)	Plot #	
MHz	Ch.																(W/kg)		(W/kg)		
680.50	133297	Mid	LTE Band 71	20	9	25.8	24.67	0.01	0	Ant A	0069M	QPSK	1	0	10 mm	back	1:1	0.505	1.297	0.655	A105
680.50	133297	Mid	LTE Band 71	20	9	24.8	23.77	0.01	1	Ant A	0069M	QPSK	50	50	10 mm	back	1:1	0.380	1.268	0.482	
680.50	133297	Mid	LTE Band 71	20	9	25.8	24.67	-0.04	0	Ant A	0069M	QPSK	1	0	10 mm	front	1:1	0.287	1.297	0.372	
680.50	133297	Mid	LTE Band 71	20	9	24.8	23.77	-0.03	1	Ant A	0069M	QPSK	50	50	10 mm	front	1:1	0.253	1.268	0.321	
680.50	133297	Mid	LTE Band 71	20	9	25.8	24.67	0.11	0	Ant A	0069M	QPSK	1	0	10 mm	bottom	1:1	0.246	1.297	0.319	
680.50	133297	Mid	LTE Band 71	20	9	24.8	23.77	0.00	1	Ant A	0069M	QPSK	50	50	10 mm	bottom	1:1	0.182	1.268	0.231	
680.50	133297	Mid	LTE Band 71	20	9	25.8	24.67	0.04	0	Ant A	0069M	QPSK	1	0	10 mm	right	1:1	0.345	1.297	0.447	
680.50	133297	Mid	LTE Band 71	20	9	24.8	23.77	-0.05	1	Ant A	0069M	QPSK	50	50	10 mm	right	1:1	0.270	1.268	0.342	
ANSI / IEEE C95.1 1992 - SAFETY LIMIT Spatial Peak Uncontrolled Exposure/General Population								Body 1.6 W/kg (mW/g) averaged over 1 gram													



FCC ID: A3LSMF916U	 PCTEST <small> Proud to be part of Samsung </small>	SAR EVALUATION REPORT		Approved by: Quality Manager
Document S/N: 1M2005200087-01-R2.A3L	Test Dates: 06/28/20-08/24/20	DUT Type: Portable Handset	Page 163 of 267	

**Table 11-83
LTE Band 12 UMPC Body SAR**

MEASUREMENT RESULTS																					
FREQUENCY		Mode	Bandwidth [MHz]	Tune State	Maximum Allowed Power [dBm]	Conducted Power [dBm]	Power Drift [dB]	MPR [dB]	Antenna Config.	Device Serial Number	Modulation	RB Size	RB Offset	Spacing	Side	Duty Cycle	SAR (1g)	Scaling Factor	Reported SAR (1g)	Plot #	
MHz	Ch.																(W/kg)		(W/kg)		
707.50	23095	Mid	LTE Band 12	10	9	25.8	25.10	-0.04	0	Ant A	0069M	QPSK	1	49	10 mm	back	1:1	0.388	1.175	0.456	A106
707.50	23095	Mid	LTE Band 12	10	9	24.8	24.06	0.04	1	Ant A	0069M	QPSK	25	25	10 mm	back	1:1	0.326	1.186	0.387	
707.50	23095	Mid	LTE Band 12	10	9	25.8	25.10	-0.01	0	Ant A	0069M	QPSK	1	49	10 mm	front	1:1	0.310	1.175	0.364	
707.50	23095	Mid	LTE Band 12	10	9	24.8	24.06	-0.01	1	Ant A	0069M	QPSK	25	25	10 mm	front	1:1	0.264	1.186	0.313	
707.50	23095	Mid	LTE Band 12	10	9	25.8	25.10	-0.01	0	Ant A	0069M	QPSK	1	49	10 mm	bottom	1:1	0.256	1.175	0.301	
707.50	23095	Mid	LTE Band 12	10	9	24.8	24.06	0.02	1	Ant A	0069M	QPSK	25	25	10 mm	bottom	1:1	0.206	1.186	0.244	
707.50	23095	Mid	LTE Band 12	10	9	25.8	25.10	-0.11	0	Ant A	0069M	QPSK	1	49	10 mm	right	1:1	0.297	1.175	0.349	
707.50	23095	Mid	LTE Band 12	10	9	24.8	24.06	-0.02	1	Ant A	0069M	QPSK	25	25	10 mm	right	1:1	0.255	1.186	0.302	
ANSI / IEEE C95.1 1992 - SAFETY LIMIT Spatial Peak Uncontrolled Exposure/General Population										Body 1.6 W/kg (mW/g) averaged over 1 gram											

**Table 11-84
LTE Band 13 UMPC Body SAR**

MEASUREMENT RESULTS																					
FREQUENCY		Mode	Bandwidth [MHz]	Tune State	Maximum Allowed Power [dBm]	Conducted Power [dBm]	Power Drift [dB]	MPR [dB]	Antenna Config.	Device Serial Number	Modulation	RB Size	RB Offset	Spacing	Side	Duty Cycle	SAR (1g)	Scaling Factor	Reported SAR (1g)	Plot #	
MHz	Ch.																(W/kg)		(W/kg)		
782.00	23230	Mid	LTE Band 13	10	10	25.8	24.15	0.00	0	Ant A	0069M	QPSK	1	49	10 mm	back	1:1	0.513	1.462	0.750	A107
782.00	23230	Mid	LTE Band 13	10	10	24.8	23.35	-0.09	1	Ant A	0069M	QPSK	25	0	10 mm	back	1:1	0.408	1.396	0.570	
782.00	23230	Mid	LTE Band 13	10	10	25.8	24.15	-0.01	0	Ant A	0069M	QPSK	1	49	10 mm	front	1:1	0.416	1.462	0.608	
782.00	23230	Mid	LTE Band 13	10	10	24.8	23.35	0.02	1	Ant A	0069M	QPSK	25	0	10 mm	front	1:1	0.286	1.396	0.399	
782.00	23230	Mid	LTE Band 13	10	10	25.8	24.15	-0.03	0	Ant A	0069M	QPSK	1	49	10 mm	bottom	1:1	0.255	1.462	0.373	
782.00	23230	Mid	LTE Band 13	10	10	24.8	23.35	-0.03	1	Ant A	0069M	QPSK	25	0	10 mm	bottom	1:1	0.190	1.396	0.265	
782.00	23230	Mid	LTE Band 13	10	10	25.8	24.15	0.03	0	Ant A	0069M	QPSK	1	49	10 mm	right	1:1	0.313	1.462	0.458	
782.00	23230	Mid	LTE Band 13	10	10	24.8	23.35	-0.03	1	Ant A	0069M	QPSK	25	0	10 mm	right	1:1	0.231	1.396	0.322	
782.00	23230	Mid	LTE Band 13	10	N/A	23.8	22.33	0.04	0	Ant B	0069M	QPSK	1	0	10 mm	back	1:1	0.113	1.403	0.159	
782.00	23230	Mid	LTE Band 13	10	N/A	22.8	21.48	0.01	1	Ant B	0069M	QPSK	25	0	10 mm	back	1:1	0.098	1.355	0.133	
782.00	23230	Mid	LTE Band 13	10	N/A	23.8	22.33	-0.09	0	Ant B	0069M	QPSK	1	0	10 mm	front	1:1	0.062	1.403	0.087	
782.00	23230	Mid	LTE Band 13	10	N/A	22.8	21.48	0.04	1	Ant B	0069M	QPSK	25	0	10 mm	front	1:1	0.051	1.355	0.069	
782.00	23230	Mid	LTE Band 13	10	N/A	23.8	22.33	-0.08	0	Ant B	0069M	QPSK	1	0	10 mm	bottom	1:1	0.097	1.403	0.136	
782.00	23230	Mid	LTE Band 13	10	N/A	22.8	21.48	-0.03	1	Ant B	0069M	QPSK	25	0	10 mm	bottom	1:1	0.083	1.355	0.112	
782.00	23230	Mid	LTE Band 13	10	N/A	23.8	22.33	0.14	0	Ant B	0069M	QPSK	1	0	10 mm	right	1:1	0.013	1.403	0.018	
782.00	23230	Mid	LTE Band 13	10	N/A	22.8	21.48	0.04	1	Ant B	0069M	QPSK	25	0	10 mm	right	1:1	0.011	1.355	0.015	
ANSI / IEEE C95.1 1992 - SAFETY LIMIT Spatial Peak Uncontrolled Exposure/General Population										Body 1.6 W/kg (mW/g) averaged over 1 gram											



FCC ID: A3LSMF916U		SAR EVALUATION REPORT		Approved by: Quality Manager
Document S/N: 1M2005200087-01-R2.A3L	Test Dates: 06/28/20-08/24/20	DUT Type: Portable Handset	Page 164 of 267	

**Table 11-85
LTE Band 14 UMPC Body SAR**

MEASUREMENT RESULTS																					
FREQUENCY		Mode	Bandwidth [MHz]	Tune State	Maximum Allowed Power [dBm]	Conducted Power [dBm]	Power Drift [dB]	MPR [dB]	Antenna Config.	Device Serial Number	Modulation	RB Size	RB Offset	Spacing	Side	Duty Cycle	SAR (1g)	Scaling Factor	Reported SAR (1g)	Plot #	
MHz	Ch.																(W/kg)		(W/kg)		
793.00	23330	Mid	LTE Band 14	10	9	25.8	24.11	-0.03	0	Ant A	0069M	QPSK	1	0	10 mm	back	1:1	0.528	1.476	0.779	A108
793.00	23330	Mid	LTE Band 14	10	9	24.8	23.14	-0.04	1	Ant A	0069M	QPSK	25	12	10 mm	back	1:1	0.416	1.466	0.610	
793.00	23330	Mid	LTE Band 14	10	9	25.8	24.11	-0.02	0	Ant A	0069M	QPSK	1	0	10 mm	front	1:1	0.403	1.476	0.595	
793.00	23330	Mid	LTE Band 14	10	9	24.8	23.14	-0.03	1	Ant A	0069M	QPSK	25	12	10 mm	front	1:1	0.314	1.466	0.460	
793.00	23330	Mid	LTE Band 14	10	9	25.8	24.11	-0.16	0	Ant A	0069M	QPSK	1	0	10 mm	bottom	1:1	0.288	1.476	0.425	
793.00	23330	Mid	LTE Band 14	10	9	24.8	23.14	0.03	1	Ant A	0069M	QPSK	25	12	10 mm	bottom	1:1	0.220	1.466	0.323	
793.00	23330	Mid	LTE Band 14	10	9	25.8	24.11	-0.06	0	Ant A	0069M	QPSK	1	0	10 mm	right	1:1	0.340	1.476	0.502	
793.00	23330	Mid	LTE Band 14	10	9	24.8	23.14	0.03	1	Ant A	0069M	QPSK	25	12	10 mm	right	1:1	0.256	1.466	0.375	
793.00	23330	Mid	LTE Band 14	10	N/A	23.8	22.42	0.01	0	Ant B	0069M	QPSK	1	0	10 mm	back	1:1	0.168	1.374	0.231	
793.00	23330	Mid	LTE Band 14	10	N/A	22.8	21.36	0.03	1	Ant B	0069M	QPSK	25	12	10 mm	back	1:1	0.141	1.393	0.196	
793.00	23330	Mid	LTE Band 14	10	N/A	23.8	22.42	-0.02	0	Ant B	0069M	QPSK	1	0	10 mm	front	1:1	0.097	1.374	0.133	
793.00	23330	Mid	LTE Band 14	10	N/A	22.8	21.36	0.00	1	Ant B	0069M	QPSK	25	12	10 mm	front	1:1	0.081	1.393	0.113	
793.00	23330	Mid	LTE Band 14	10	N/A	23.8	22.42	0.00	0	Ant B	0069M	QPSK	1	0	10 mm	bottom	1:1	0.170	1.374	0.234	
793.00	23330	Mid	LTE Band 14	10	N/A	22.8	21.36	-0.07	1	Ant B	0069M	QPSK	25	12	10 mm	bottom	1:1	0.140	1.393	0.195	
793.00	23330	Mid	LTE Band 14	10	N/A	23.8	22.42	0.02	0	Ant B	0069M	QPSK	1	0	10 mm	right	1:1	0.018	1.374	0.025	
793.00	23330	Mid	LTE Band 14	10	N/A	22.8	21.36	-0.16	1	Ant B	0069M	QPSK	25	12	10 mm	right	1:1	0.015	1.393	0.021	
ANSI / IEEE C95.1 1992 - SAFETY LIMIT Spatial Peak Uncontrolled Exposure/General Population										Body 1.6 W/kg (mW/g) averaged over 1 gram											

**Table 11-86
LTE Band 26 (Cell) UMPC Body SAR**

MEASUREMENT RESULTS																					
FREQUENCY		Mode	Bandwidth [MHz]	Tune State	Maximum Allowed Power [dBm]	Conducted Power [dBm]	Power Drift [dB]	MPR [dB]	Antenna Config.	Device Serial Number	Modulation	RB Size	RB Offset	Spacing	Side	Duty Cycle	SAR (1g)	Scaling Factor	Reported SAR (1g)	Plot #	
MHz	Ch.																(W/kg)		(W/kg)		
831.50	26865	Mid	LTE Band 26 (Cell)	15	0	25.8	24.74	-0.04	0	Ant A	0069M	QPSK	1	36	10 mm	back	1:1	0.619	1.276	0.790	A109
831.50	26865	Mid	LTE Band 26 (Cell)	15	0	24.8	23.84	-0.02	1	Ant A	0069M	QPSK	36	37	10 mm	back	1:1	0.490	1.247	0.611	
831.50	26865	Mid	LTE Band 26 (Cell)	15	0	25.8	24.74	0.02	0	Ant A	0069M	QPSK	1	36	10 mm	front	1:1	0.455	1.276	0.581	
831.50	26865	Mid	LTE Band 26 (Cell)	15	0	24.8	23.84	0.00	1	Ant A	0069M	QPSK	36	37	10 mm	front	1:1	0.361	1.247	0.450	
831.50	26865	Mid	LTE Band 26 (Cell)	15	0	25.8	24.74	0.04	0	Ant A	0069M	QPSK	1	36	10 mm	bottom	1:1	0.299	1.276	0.382	
831.50	26865	Mid	LTE Band 26 (Cell)	15	0	24.8	23.84	-0.07	1	Ant A	0069M	QPSK	36	37	10 mm	bottom	1:1	0.227	1.247	0.283	
831.50	26865	Mid	LTE Band 26 (Cell)	15	0	25.8	24.74	-0.10	0	Ant A	0069M	QPSK	1	36	10 mm	right	1:1	0.313	1.276	0.399	
831.50	26865	Mid	LTE Band 26 (Cell)	15	0	24.8	23.84	0.01	1	Ant A	0069M	QPSK	36	37	10 mm	right	1:1	0.246	1.247	0.307	
ANSI / IEEE C95.1 1992 - SAFETY LIMIT Spatial Peak Uncontrolled Exposure/General Population										Body 1.6 W/kg (mW/g) averaged over 1 gram											



FCC ID: A3LSMF916U		SAR EVALUATION REPORT		Approved by: Quality Manager
Document S/N: 1M2005200087-01-R2.A3L	Test Dates: 06/28/20-08/24/20	DUT Type: Portable Handset	Page 165 of 267	

**Table 11-87
LTE Band 5 (Cell) UMPC Body SAR**

MEASUREMENT RESULTS																							
1 CC Uplink 2 CC Uplink	Component Carrier	FREQUENCY		Mode	Bandwidth [MHz]	Tune State	Maximum Allowed Power [dBm]	Conducted Power [dBm]	Power Drift [dB]	MPR [dB]	Antenna Config.	Device Serial Number	Modulation	RB Size	RB Offset	Spacing	Side	Duty Cycle	SAR (1g)	Scaling Factor	Reported SAR (1g)	Plot #	
		MHz	Ch.																(W/kg)		(W/kg)		
1 CC Uplink	NA	836.50	20525	Mid	LTE Band 5 (Cell)	10	0	25.8	24.85	0.01	0	Ant A	0905M	QPSK	1	0	10 mm	back	1:1	0.718	1.245	0.894	A110
1 CC Uplink	NA	836.50	20525	Mid	LTE Band 5 (Cell)	10	0	24.8	23.98	-0.02	1	Ant A	0905M	QPSK	25	12	10 mm	back	1:1	0.594	1.208	0.718	
1 CC Uplink	NA	836.50	20525	Mid	LTE Band 5 (Cell)	10	0	24.8	23.78	0.01	1	Ant A	0905M	QPSK	50	0	10 mm	back	1:1	0.587	1.265	0.743	
2 CC Uplink	PCC	836.50	20525	Mid	LTE Band 5 (Cell)	10	0	25.8	24.26	0.01	0	Ant A	0905M	QPSK	1	0	10 mm	back	1:1	0.651	1.426	0.928	
	SCC	829.30	20453			5																	
1 CC Uplink	NA	836.50	20525	Mid	LTE Band 5 (Cell)	10	0	25.8	24.85	-0.03	0	Ant A	0905M	QPSK	1	0	10 mm	front	1:1	0.465	1.245	0.579	
1 CC Uplink	NA	836.50	20525	Mid	LTE Band 5 (Cell)	10	0	24.8	23.98	0.02	1	Ant A	0905M	QPSK	25	12	10 mm	front	1:1	0.378	1.208	0.457	
1 CC Uplink	NA	836.50	20525	Mid	LTE Band 5 (Cell)	10	0	25.8	24.85	0.01	0	Ant A	0905M	QPSK	1	0	10 mm	bottom	1:1	0.323	1.245	0.402	
1 CC Uplink	NA	836.50	20525	Mid	LTE Band 5 (Cell)	10	0	24.8	23.98	-0.08	1	Ant A	0905M	QPSK	25	12	10 mm	bottom	1:1	0.242	1.208	0.292	
1 CC Uplink	NA	836.50	20525	Mid	LTE Band 5 (Cell)	10	0	25.8	24.85	0.01	0	Ant A	0905M	QPSK	1	0	10 mm	right	1:1	0.337	1.245	0.420	
1 CC Uplink	NA	836.50	20525	Mid	LTE Band 5 (Cell)	10	0	24.8	23.98	0.00	1	Ant A	0905M	QPSK	25	12	10 mm	right	1:1	0.265	1.208	0.320	
ANSI / IEEE C95.1 1992 - SAFETY LIMIT Spatial Peak Uncontrolled Exposure/General Population										Body 1.6 W/kg (mW/g) averaged over 1 gram													

**Table 11-88
LTE Band 66 (AWS) UMPC Body SAR**

MEASUREMENT RESULTS																				
MHz	Ch.	Mode	Bandwidth [MHz]	Maximum Allowed Power [dBm]	Conducted Power [dBm]	Power Drift [dB]	MPR [dB]	Antenna Config.	Device Serial Number	Modulation	RB Size	RB Offset	Spacing	Side	Duty Cycle	SAR (1g)	Scaling Factor	Reported SAR (1g)	Plot #	
																(W/kg)		(W/kg)		
1770.00	132572	High	LTE Band 66 (AWS)	20	25.0	24.30	-0.02	0	Ant B	1133M	QPSK	1	99	12 mm	back	1:1	0.616	1.175	0.724	
1770.00	132572	High	LTE Band 66 (AWS)	20	24.0	23.32	-0.05	1	Ant B	1133M	QPSK	50	25	12 mm	back	1:1	0.507	1.169	0.593	
1720.00	132072	Low	LTE Band 66 (AWS)	20	25.0	23.71	0.14	0	Ant B	1133M	QPSK	1	50	10 mm	front	1:1	0.632	1.346	0.851	
1745.00	132322	Mid	LTE Band 66 (AWS)	20	25.0	24.13	0.15	0	Ant B	1133M	QPSK	1	50	10 mm	front	1:1	0.666	1.222	0.814	
1770.00	132572	High	LTE Band 66 (AWS)	20	25.0	24.30	0.06	0	Ant B	1133M	QPSK	1	99	10 mm	front	1:1	0.746	1.175	0.877	A111
1770.00	132572	High	LTE Band 66 (AWS)	20	24.0	23.32	-0.01	1	Ant B	1133M	QPSK	50	25	10 mm	front	1:1	0.594	1.169	0.694	
1770.00	132572	High	LTE Band 66 (AWS)	20	24.0	23.21	0.14	1	Ant B	1133M	QPSK	100	0	10 mm	front	1:1	0.554	1.199	0.664	
1770.00	132572	High	LTE Band 66 (AWS)	20	25.0	24.30	-0.02	0	Ant B	1133M	QPSK	1	99	16 mm	bottom	1:1	0.580	1.175	0.682	
1770.00	132572	High	LTE Band 66 (AWS)	20	24.0	23.32	-0.02	1	Ant B	1133M	QPSK	50	25	16 mm	bottom	1:1	0.476	1.169	0.556	
1770.00	132572	High	LTE Band 66 (AWS)	20	25.0	24.30	0.00	0	Ant B	1133M	QPSK	1	99	10 mm	right	1:1	0.364	1.175	0.428	
1770.00	132572	High	LTE Band 66 (AWS)	20	24.0	23.32	0.01	1	Ant B	1133M	QPSK	50	25	10 mm	right	1:1	0.288	1.169	0.337	
1770.00	132572	High	LTE Band 66 (AWS)	20	20.0	19.53	0.04	0	Ant B	1133M	QPSK	1	99	10 mm	back	1:1	0.406	1.114	0.452	
1770.00	132572	High	LTE Band 66 (AWS)	20	20.0	19.54	0.05	0	Ant B	1133M	QPSK	50	25	10 mm	back	1:1	0.416	1.112	0.463	
1770.00	132572	High	LTE Band 66 (AWS)	20	20.0	19.53	0.03	0	Ant B	1133M	QPSK	1	99	10 mm	bottom	1:1	0.571	1.114	0.636	
1770.00	132572	High	LTE Band 66 (AWS)	20	20.0	19.54	-0.01	0	Ant B	1133M	QPSK	50	25	10 mm	bottom	1:1	0.586	1.112	0.652	
ANSI / IEEE C95.1 1992 - SAFETY LIMIT Spatial Peak Uncontrolled Exposure/General Population										Body 1.6 W/kg (mW/g) averaged over 1 gram										



FCC ID: A3LSMF916U		SAR EVALUATION REPORT		Approved by: Quality Manager
Document S/N: 1M2005200087-01-R2.A3L	Test Dates: 06/28/20-08/24/20	DUT Type: Portable Handset	Page 166 of 267	

**Table 11-89
LTE Band 25 (PCS) UMPC Body SAR**

MEASUREMENT RESULTS																				
FREQUENCY		Mode	Bandwidth [MHz]	Maximum Allowed Power [dBm]	Conducted Power [dBm]	Power Drift [dB]	MPR [dB]	Antenna Config.	Device Serial Number	Modulation	RB Size	RB Offset	Spacing	Side	Duty Cycle	SAR (1g)	Scaling Factor	Reported SAR (1g)	Plot #	
MHz	Ch.															(W/kg)		(W/kg)		
1860.00	26140	Low	LTE Band 25 (PCS)	20	25.5	24.47	-0.04	0	Ant B	1138M	QPSK	1	0	12 mm	back	1:1	0.680	1.268	0.862	
1882.50	26365	Mid	LTE Band 25 (PCS)	20	25.5	24.05	-0.02	0	Ant B	1138M	QPSK	1	99	12 mm	back	1:1	0.605	1.396	0.845	
1905.00	26590	High	LTE Band 25 (PCS)	20	25.5	24.22	-0.05	0	Ant B	1138M	QPSK	1	99	12 mm	back	1:1	0.797	1.343	1.070	
1860.00	26140	Low	LTE Band 25 (PCS)	20	24.5	23.68	-0.07	1	Ant B	1138M	QPSK	50	0	12 mm	back	1:1	0.527	1.208	0.637	
1860.00	26140	Low	LTE Band 25 (PCS)	20	24.5	23.51	-0.03	1	Ant B	1138M	QPSK	100	0	12 mm	back	1:1	0.506	1.256	0.636	
1860.00	26140	Low	LTE Band 25 (PCS)	20	25.5	24.47	-0.02	0	Ant B	1138M	QPSK	1	0	10 mm	front	1:1	0.589	1.268	0.747	
1860.00	26140	Low	LTE Band 25 (PCS)	20	24.5	23.68	0.01	1	Ant B	1138M	QPSK	50	0	10 mm	front	1:1	0.466	1.208	0.563	
1860.00	26140	Low	LTE Band 25 (PCS)	20	25.5	24.47	-0.09	0	Ant B	1138M	QPSK	1	0	16 mm	bottom	1:1	0.592	1.268	0.751	
1860.00	26140	Low	LTE Band 25 (PCS)	20	24.5	23.68	0.01	1	Ant B	1138M	QPSK	50	0	16 mm	bottom	1:1	0.475	1.208	0.574	
1860.00	26140	Low	LTE Band 25 (PCS)	20	25.5	24.47	0.06	0	Ant B	1138M	QPSK	1	0	10 mm	right	1:1	0.804	1.268	1.019	A112
1882.50	26365	Mid	LTE Band 25 (PCS)	20	25.5	24.05	-0.09	0	Ant B	1138M	QPSK	1	99	10 mm	right	1:1	0.637	1.396	0.889	
1905.00	26590	High	LTE Band 25 (PCS)	20	25.5	24.22	-0.03	0	Ant B	1138M	QPSK	1	99	10 mm	right	1:1	0.461	1.343	0.619	
1860.00	26140	Low	LTE Band 25 (PCS)	20	24.5	23.68	0.06	1	Ant B	1138M	QPSK	50	0	10 mm	right	1:1	0.651	1.208	0.786	
1860.00	26140	Low	LTE Band 25 (PCS)	20	24.5	23.51	-0.10	1	Ant B	1138M	QPSK	100	0	10 mm	right	1:1	0.632	1.256	0.794	
1860.00	26140	Low	LTE Band 25 (PCS)	20	20.0	19.22	-0.04	0	Ant B	1138M	QPSK	1	0	10 mm	back	1:1	0.273	1.197	0.327	
1860.00	26140	Low	LTE Band 25 (PCS)	20	20.0	19.21	0.00	0	Ant B	1138M	QPSK	50	0	10 mm	back	1:1	0.267	1.199	0.320	
1860.00	26140	Low	LTE Band 25 (PCS)	20	20.0	19.22	-0.04	0	Ant B	1138M	QPSK	1	0	10 mm	bottom	1:1	0.481	1.197	0.576	
1860.00	26140	Low	LTE Band 25 (PCS)	20	20.0	19.21	-0.06	0	Ant B	1138M	QPSK	50	0	10 mm	bottom	1:1	0.480	1.199	0.576	
ANSI / IEEE C95.1 1992 - SAFETY LIMIT Spatial Peak Uncontrolled Exposure/General Population									Body 1.6 W/kg (mW/g) averaged over 1 gram											

**Table 11-90
LTE Band 30 UMPC Body SAR**

MEASUREMENT RESULTS																				
FREQUENCY		Mode	Bandwidth [MHz]	Maximum Allowed Power [dBm]	Conducted Power [dBm]	Power Drift [dB]	MPR [dB]	Antenna Config.	Device Serial Number	Modulation	RB Size	RB Offset	Spacing	Side	Duty Cycle	SAR (1g)	Scaling Factor	Reported SAR (1g)	Plot #	
MHz	Ch.															(W/kg)		(W/kg)		
2310.00	27710	Mid	LTE Band 30	10	25.0	23.84	0.03	0	Ant B	1121M	QPSK	1	0	12 mm	back	1:1	0.486	1.306	0.635	
2310.00	27710	Mid	LTE Band 30	10	24.0	22.92	0.00	1	Ant B	1121M	QPSK	25	12	12 mm	back	1:1	0.383	1.282	0.491	
2310.00	27710	Mid	LTE Band 30	10	25.0	23.84	0.02	0	Ant B	1121M	QPSK	1	0	10 mm	front	1:1	0.496	1.306	0.648	
2310.00	27710	Mid	LTE Band 30	10	24.0	22.92	-0.02	1	Ant B	1121M	QPSK	25	12	10 mm	front	1:1	0.386	1.282	0.495	
2310.00	27710	Mid	LTE Band 30	10	25.0	23.84	-0.01	0	Ant B	1121M	QPSK	1	0	16 mm	bottom	1:1	0.592	1.306	0.773	A113
2310.00	27710	Mid	LTE Band 30	10	24.0	22.92	-0.01	1	Ant B	1121M	QPSK	25	12	16 mm	bottom	1:1	0.470	1.282	0.603	
2310.00	27710	Mid	LTE Band 30	10	24.0	22.85	0.03	1	Ant B	1121M	QPSK	50	0	16 mm	bottom	1:1	0.437	1.303	0.569	
2310.00	27710	Mid	LTE Band 30	10	25.0	23.84	-0.06	0	Ant B	1121M	QPSK	1	0	10 mm	right	1:1	0.261	1.306	0.341	
2310.00	27710	Mid	LTE Band 30	10	24.0	22.92	0.01	1	Ant B	1121M	QPSK	25	12	10 mm	right	1:1	0.220	1.282	0.282	
2310.00	27710	Mid	LTE Band 30	10	20.5	18.90	-0.03	0	Ant B	1121M	QPSK	1	25	10 mm	back	1:1	0.293	1.445	0.423	
2310.00	27710	Mid	LTE Band 30	10	20.5	18.99	0.02	0	Ant B	1121M	QPSK	25	12	10 mm	back	1:1	0.294	1.416	0.416	
2310.00	27710	Mid	LTE Band 30	10	20.5	18.90	0.00	0	Ant B	1121M	QPSK	1	25	10 mm	bottom	1:1	0.486	1.445	0.702	
2310.00	27710	Mid	LTE Band 30	10	20.5	18.99	-0.06	0	Ant B	1121M	QPSK	25	12	10 mm	bottom	1:1	0.489	1.416	0.692	
ANSI / IEEE C95.1 1992 - SAFETY LIMIT Spatial Peak Uncontrolled Exposure/General Population									Body 1.6 W/kg (mW/g) averaged over 1 gram											

FCC ID: A3LSMF916U	 <small>Proud to be part of Samsung</small>	SAR EVALUATION REPORT		Approved by: Quality Manager
Document S/N: 1M2005200087-01-R2.A3L	Test Dates: 06/28/20-08/24/20	DUT Type: Portable Handset	Page 167 of 267	



**Table 11-91
LTE Band 7 UMPC Body SAR**

MEASUREMENT RESULTS																				
FREQUENCY		Mode	Bandwidth [MHz]	Maximum Allowed Power [dBm]	Conducted Power [dBm]	Power Drift [dB]	MPR [dB]	Antenna Config.	Device Serial Number	Modulation	RB Size	RB Offset	Spacing	Side	Duty Cycle	SAR (1g)	Scaling Factor	Reported SAR (1g)	Plot #	
MHz	Ch.															(W/kg)		(W/kg)		
2510.00	20850	Low	LTE Band 7	20	22.0	21.92	0.08	0	Ant B	0909M	QPSK	1	0	12 mm	back	1:1	0.911	1.019	0.928	
2535.00	21100	Mid	LTE Band 7	20	22.0	21.78	0.00	0	Ant B	0909M	QPSK	1	0	12 mm	back	1:1	1.040	1.052	1.094	
2560.00	21350	High	LTE Band 7	20	22.0	21.59	0.02	0	Ant B	0909M	QPSK	1	0	12 mm	back	1:1	1.070	1.099	1.176	
2510.00	20850	Low	LTE Band 7	20	22.0	22.00	0.00	0	Ant B	0909M	QPSK	50	25	12 mm	back	1:1	0.952	1.000	0.952	
2535.00	21100	Mid	LTE Band 7	20	22.0	21.88	-0.16	0	Ant B	0909M	QPSK	50	0	12 mm	back	1:1	1.060	1.028	1.090	
2560.00	21350	High	LTE Band 7	20	22.0	21.67	0.02	0	Ant B	0909M	QPSK	50	25	12 mm	back	1:1	1.100	1.079	1.187	A114
2510.00	20850	Low	LTE Band 7	20	22.0	21.90	0.00	0	Ant B	0909M	QPSK	100	0	12 mm	back	1:1	0.994	1.023	1.017	
2510.00	20850	Low	LTE Band 7	20	22.0	21.92	-0.03	0	Ant B	0909M	QPSK	1	0	10 mm	front	1:1	0.691	1.019	0.704	
2535.00	21100	Mid	LTE Band 7	20	22.0	21.78	-0.07	0	Ant B	0909M	QPSK	1	0	10 mm	front	1:1	0.735	1.052	0.773	
2560.00	21350	High	LTE Band 7	20	22.0	21.59	-0.08	0	Ant B	0909M	QPSK	1	0	10 mm	front	1:1	0.770	1.099	0.846	
2510.00	20850	Low	LTE Band 7	20	22.0	22.00	-0.05	0	Ant B	0909M	QPSK	50	25	10 mm	front	1:1	0.743	1.000	0.743	
2535.00	21100	Mid	LTE Band 7	20	22.0	21.88	-0.01	0	Ant B	0909M	QPSK	50	0	10 mm	front	1:1	0.774	1.028	0.796	
2560.00	21350	High	LTE Band 7	20	22.0	21.67	-0.02	0	Ant B	0909M	QPSK	50	25	10 mm	front	1:1	0.786	1.079	0.848	
2510.00	20850	Low	LTE Band 7	20	22.0	21.90	-0.01	0	Ant B	0909M	QPSK	100	0	10 mm	front	1:1	0.724	1.023	0.741	
2510.00	20850	Low	LTE Band 7	20	22.0	21.92	0.04	0	Ant B	0909M	QPSK	1	0	16 mm	bottom	1:1	0.815	1.019	0.830	
2535.00	21100	Mid	LTE Band 7	20	22.0	21.78	-0.04	0	Ant B	0909M	QPSK	1	0	16 mm	bottom	1:1	0.863	1.052	0.908	
2560.00	21350	High	LTE Band 7	20	22.0	21.59	0.02	0	Ant B	0909M	QPSK	1	0	16 mm	bottom	1:1	0.879	1.099	0.966	
2510.00	20850	Low	LTE Band 7	20	22.0	22.00	0.01	0	Ant B	0909M	QPSK	50	25	16 mm	bottom	1:1	0.847	1.000	0.847	
2535.00	21100	Mid	LTE Band 7	20	22.0	21.88	0.04	0	Ant B	0909M	QPSK	50	0	16 mm	bottom	1:1	0.888	1.028	0.913	
2560.00	21350	High	LTE Band 7	20	22.0	21.67	0.01	0	Ant B	0909M	QPSK	50	25	16 mm	bottom	1:1	0.917	1.079	0.989	
2510.00	20850	Low	LTE Band 7	20	22.0	21.90	-0.02	0	Ant B	0909M	QPSK	100	0	16 mm	bottom	1:1	0.840	1.023	0.859	
2510.00	20850	Low	LTE Band 7	20	22.0	21.92	-0.19	0	Ant B	0909M	QPSK	1	0	10 mm	right	1:1	0.086	1.019	0.088	
2510.00	20850	Low	LTE Band 7	20	22.0	22.00	-0.04	0	Ant B	0909M	QPSK	50	25	10 mm	right	1:1	0.087	1.000	0.087	
2560.00	21350	High	LTE Band 7	20	19.5	18.67	-0.01	0	Ant B	0909M	QPSK	1	0	10 mm	back	1:1	0.647	1.211	0.784	
2560.00	21350	High	LTE Band 7	20	19.5	18.80	-0.01	0	Ant B	0909M	QPSK	50	25	10 mm	back	1:1	0.676	1.175	0.794	
2510.00	20850	Low	LTE Band 7	20	19.5	18.41	-0.10	0	Ant B	0909M	QPSK	1	99	10 mm	bottom	1:1	0.721	1.285	0.926	
2535.00	21100	Mid	LTE Band 7	20	19.5	18.65	-0.09	0	Ant B	0909M	QPSK	1	99	10 mm	bottom	1:1	0.770	1.216	0.936	
2560.00	21350	High	LTE Band 7	20	19.5	18.67	-0.10	0	Ant B	0909M	QPSK	1	0	10 mm	bottom	1:1	0.799	1.211	0.968	
2510.00	20850	Low	LTE Band 7	20	19.5	18.50	-0.04	0	Ant B	0909M	QPSK	50	25	10 mm	bottom	1:1	0.721	1.259	0.908	
2535.00	21100	Mid	LTE Band 7	20	19.5	18.74	-0.07	0	Ant B	0909M	QPSK	50	25	10 mm	bottom	1:1	0.802	1.191	0.955	
2560.00	21350	High	LTE Band 7	20	19.5	18.80	-0.10	0	Ant B	0909M	QPSK	50	25	10 mm	bottom	1:1	0.822	1.175	0.966	
2560.00	21350	High	LTE Band 7	20	19.5	18.66	-0.05	0	Ant B	0909M	QPSK	100	0	10 mm	bottom	1:1	0.806	1.213	0.978	
2510.00	20850	Low	LTE Band 7	20	22.0	21.90	-0.07	0	Ant B	0909M	QPSK	100	0	12 mm	back	1:1	0.937	1.023	0.959	
2560.00	21350	High	LTE Band 7	20	22.0	21.67	0.01	0	Ant B	0909M	QPSK	50	25	12 mm	back	1:1	1.000	1.079	1.079	
ANSI / IEEE C95.1 1992 - SAFETY LIMIT Spatial Peak Uncontrolled Exposure/General Population											Body 1.6 W/kg (mW/g) averaged over 1 gram									

Note: Blue entry represents variability measurement

**Table 11-92
LTE Band 48 UMPC Body SAR**

MEASUREMENT RESULTS																				
FREQUENCY		Mode	Bandwidth [MHz]	Maximum Allowed Power [dBm]	Conducted Power [dBm]	Power Drift [dB]	MPR [dB]	Antenna Config.	Device Serial Number	Modulation	RB Size	RB Offset	Spacing	Side	Duty Cycle	SAR (1g)	Scaling Factor	Reported SAR (1g)	Plot #	
MHz	Ch.															(W/kg)		(W/kg)		
3690.00	56640	High	LTE Band 48	20	20.5	20.34	-0.02	0	Ant F	0075M	QPSK	1	50	10 mm	back	1:1.58	0.350	1.038	0.363	
3690.00	56640	High	LTE Band 48	20	20.5	20.49	0.04	0	Ant F	0075M	QPSK	50	0	10 mm	back	1:1.58	0.352	1.002	0.353	
3690.00	56640	High	LTE Band 48	20	20.5	20.34	-0.06	0	Ant F	0075M	QPSK	1	50	10 mm	front	1:1.58	0.215	1.038	0.223	
3690.00	56640	High	LTE Band 48	20	20.5	20.49	0.07	0	Ant F	0075M	QPSK	50	0	10 mm	front	1:1.58	0.218	1.002	0.218	
3690.00	56640	High	LTE Band 48	20	20.5	20.34	0.08	0	Ant F	0075M	QPSK	1	50	10 mm	top	1:1.58	0.364	1.038	0.378	
3690.00	56640	High	LTE Band 48	20	20.5	20.49	0.01	0	Ant F	0075M	QPSK	50	0	10 mm	top	1:1.58	0.374	1.002	0.375	A115
ANSI / IEEE C95.1 1992 - SAFETY LIMIT Spatial Peak Uncontrolled Exposure/General Population											Body 1.6 W/kg (mW/g) averaged over 1 gram									



FCC ID: A3LSMF916U	 <small>Proud to be part of Samsung</small>	SAR EVALUATION REPORT		Approved by: Quality Manager
Document S/N: 1M2005200087-01-R2.A3L	Test Dates: 06/28/20-08/24/20	DUT Type: Portable Handset	Page 168 of 267	

**Table 11-94
NR Band n71 UMPC Body SAR**

MEASUREMENT RESULTS																				
FREQUENCY		Mode	Bandwidth [MHz]	Maximum Allowed Power [dBm]	Conducted Power [dBm]	Power Drift [dB]	MPR [dB]	Antenna Config.	Device Serial Number	Modulation	RB Size	RB Offset	Spacing	Side	Duty Cycle	SAR (1g) (W/kg)	Scaling Factor	Reported SAR (1g) (W/kg)	Plot #	
MHz	Ch.																			
680.50	136100	Mid	NR Band n71	20	25.5	25.42	0.00	0	Ant A	1126M	DFT-S-OFDM QPSK	1	53	10 mm	back	1:1	0.436	1.019	0.444	A117
680.50	136100	Mid	NR Band n71	20	25.5	25.44	0.04	0	Ant A	1126M	DFT-S-OFDM QPSK	50	28	10 mm	back	1:1	0.436	1.014	0.442	
680.50	136100	Mid	NR Band n71	20	24.0	24.00	-0.03	1.5	Ant A	1126M	CP-OFDM QPSK	1	1	10 mm	back	1:1	0.259	1.000	0.259	
680.50	136100	Mid	NR Band n71	20	25.5	25.42	-0.03	0	Ant A	1126M	DFT-S-OFDM QPSK	1	53	10 mm	front	1:1	0.290	1.019	0.296	
680.50	136100	Mid	NR Band n71	20	25.5	25.44	-0.06	0	Ant A	1126M	DFT-S-OFDM QPSK	50	28	10 mm	front	1:1	0.292	1.014	0.296	
680.50	136100	Mid	NR Band n71	20	25.5	25.42	0.02	0	Ant A	1126M	DFT-S-OFDM QPSK	1	53	10 mm	bottom	1:1	0.252	1.019	0.257	
680.50	136100	Mid	NR Band n71	20	25.5	25.44	-0.04	0	Ant A	1126M	DFT-S-OFDM QPSK	50	28	10 mm	bottom	1:1	0.243	1.014	0.246	
680.50	136100	Mid	NR Band n71	20	25.5	25.42	0.05	0	Ant A	1126M	DFT-S-OFDM QPSK	1	53	10 mm	right	1:1	0.381	1.019	0.388	
680.50	136100	Mid	NR Band n71	20	25.5	25.44	-0.03	0	Ant A	1126M	DFT-S-OFDM QPSK	50	28	10 mm	right	1:1	0.336	1.014	0.341	
ANSI / IEEE C95.1 1992 - SAFETY LIMIT Spatial Peak Uncontrolled Exposure/General Population										Body 1.6 W/kg (mW/g) averaged over 1 gram										

**Table 11-95
NR Band n5 (Cell) UMPC Body SAR**

MEASUREMENT RESULTS																				
FREQUENCY		Mode	Bandwidth [MHz]	Maximum Allowed Power [dBm]	Conducted Power [dBm]	Power Drift [dB]	MPR [dB]	Antenna Config.	Device Serial Number	Modulation	RB Size	RB Offset	Spacing	Side	Duty Cycle	SAR (1g) (W/kg)	Scaling Factor	Reported SAR (1g) (W/kg)	Plot #	
MHz	Ch.																			
836.50	167300	Mid	NR Band n5 (Cell)	20	25.5	25.03	-0.02	0	Ant A	0887M	DFT-S-OFDM QPSK	1	53	10 mm	back	1:1	0.582	1.114	0.648	A118
836.50	167300	Mid	NR Band n5 (Cell)	20	25.5	25.01	-0.03	0	Ant A	0887M	DFT-S-OFDM QPSK	50	28	10 mm	back	1:1	0.558	1.119	0.624	
836.50	167300	Mid	NR Band n5 (Cell)	20	24.0	23.52	-0.07	1.5	Ant A	0887M	CP-OFDM QPSK	1	1	10 mm	back	1:1	0.333	1.117	0.372	
836.50	167300	Mid	NR Band n5 (Cell)	20	25.5	25.03	0.06	0	Ant A	0887M	DFT-S-OFDM QPSK	1	53	10 mm	front	1:1	0.436	1.114	0.486	
836.50	167300	Mid	NR Band n5 (Cell)	20	25.5	25.01	0.01	0	Ant A	0887M	DFT-S-OFDM QPSK	50	28	10 mm	front	1:1	0.433	1.119	0.485	
836.50	167300	Mid	NR Band n5 (Cell)	20	25.5	25.03	0.08	0	Ant A	0887M	DFT-S-OFDM QPSK	1	53	10 mm	bottom	1:1	0.305	1.114	0.340	
836.50	167300	Mid	NR Band n5 (Cell)	20	25.5	25.01	0.02	0	Ant A	0887M	DFT-S-OFDM QPSK	50	28	10 mm	bottom	1:1	0.305	1.119	0.341	
836.50	167300	Mid	NR Band n5 (Cell)	20	25.5	25.03	0.01	0	Ant A	0887M	DFT-S-OFDM QPSK	1	53	10 mm	right	1:1	0.309	1.114	0.344	
836.50	167300	Mid	NR Band n5 (Cell)	20	25.5	25.01	-0.04	0	Ant A	0887M	DFT-S-OFDM QPSK	50	28	10 mm	right	1:1	0.302	1.119	0.338	
ANSI / IEEE C95.1 1992 - SAFETY LIMIT Spatial Peak Uncontrolled Exposure/General Population										Body 1.6 W/kg (mW/g) averaged over 1 gram										



FCC ID: A3LSMF916U		SAR EVALUATION REPORT		Approved by: Quality Manager
Document S/N: 1M2005200087-01-R2.A3L	Test Dates: 06/28/20-08/24/20	DUT Type: Portable Handset	Page 170 of 267	

**Table 11-96
NR Band n66 (AWS) UMPC Body SAR**

MEASUREMENT RESULTS																				
FREQUENCY		Mode	Bandwidth [MHz]	Maximum Allowed Power [dBm]	Conducted Power [dBm]	Power Drift [dB]	MPR [dB]	Antenna Config.	Device Serial Number	Modulation	RB Size	RB Offset	Spacing	Side	Duty Cycle	SAR (1g) (W/kg)	Scaling Factor	Reported SAR (1g) (W/kg)	Plot #	
MHz	Ch.																			
1770.00	354000	High	NR Band n66 (AWS)	20	24.5	23.84	-0.05	0	Ant B	0898M	DFT-S-OFDM QPSK	1	104	12 mm	back	1:1	0.679	1.164	0.790	
1720.00	344000	Low	NR Band n66 (AWS)	20	24.5	23.35	0.03	0	Ant B	0898M	DFT-S-OFDM QPSK	50	28	12 mm	back	1:1	0.692	1.303	0.902	
1745.00	349000	Mid	NR Band n66 (AWS)	20	24.5	23.46	0.08	0	Ant B	0898M	DFT-S-OFDM QPSK	50	28	12 mm	back	1:1	0.798	1.271	1.014	A119
1770.00	354000	High	NR Band n66 (AWS)	20	24.5	23.73	0.03	0	Ant B	0898M	DFT-S-OFDM QPSK	50	28	12 mm	back	1:1	0.760	1.194	0.907	
1770.00	354000	High	NR Band n66 (AWS)	20	23.5	22.72	0.02	1	Ant B	0898M	DFT-S-OFDM QPSK	100	0	12 mm	back	1:1	0.657	1.197	0.786	
1770.00	354000	High	NR Band n66 (AWS)	20	23.0	22.27	0.13	1.5	Ant B	0898M	CP-OFDM QPSK	1	1	12 mm	back	1:1	0.504	1.183	0.596	
1770.00	354000	High	NR Band n66 (AWS)	20	24.5	23.84	-0.05	0	Ant B	0898M	DFT-S-OFDM QPSK	1	104	10 mm	front	1:1	0.599	1.164	0.697	
1770.00	354000	High	NR Band n66 (AWS)	20	24.5	23.73	-0.04	0	Ant B	0898M	DFT-S-OFDM QPSK	50	28	10 mm	front	1:1	0.584	1.194	0.697	
1720.00	344000	Low	NR Band n66 (AWS)	20	24.5	23.36	-0.02	0	Ant B	0898M	DFT-S-OFDM QPSK	1	104	16 mm	bottom	1:1	0.579	1.300	0.753	
1745.00	349000	Mid	NR Band n66 (AWS)	20	24.5	23.58	0.00	0	Ant B	0898M	DFT-S-OFDM QPSK	1	104	16 mm	bottom	1:1	0.637	1.236	0.787	
1770.00	354000	High	NR Band n66 (AWS)	20	24.5	23.84	-0.03	0	Ant B	0898M	DFT-S-OFDM QPSK	1	104	16 mm	bottom	1:1	0.688	1.164	0.801	
1720.00	344000	Low	NR Band n66 (AWS)	20	24.5	23.35	-0.07	0	Ant B	0898M	DFT-S-OFDM QPSK	50	28	16 mm	bottom	1:1	0.628	1.303	0.818	
1745.00	349000	Mid	NR Band n66 (AWS)	20	24.5	23.46	-0.12	0	Ant B	0898M	DFT-S-OFDM QPSK	50	28	16 mm	bottom	1:1	0.657	1.271	0.835	
1770.00	354000	High	NR Band n66 (AWS)	20	24.5	23.73	0.04	0	Ant B	0898M	DFT-S-OFDM QPSK	50	28	16 mm	bottom	1:1	0.674	1.194	0.805	
1770.00	354000	High	NR Band n66 (AWS)	20	23.5	22.72	0.03	1	Ant B	0898M	DFT-S-OFDM QPSK	100	0	16 mm	bottom	1:1	0.554	1.197	0.663	
1770.00	354000	High	NR Band n66 (AWS)	20	24.5	23.84	-0.15	0	Ant B	0898M	DFT-S-OFDM QPSK	1	104	10 mm	right	1:1	0.388	1.164	0.452	
1770.00	354000	High	NR Band n66 (AWS)	20	24.5	23.73	-0.02	0	Ant B	0898M	DFT-S-OFDM QPSK	50	28	10 mm	right	1:1	0.363	1.194	0.433	
1770.00	354000	High	NR Band n66 (AWS)	20	19.5	19.49	0.04	0	Ant B	0898M	DFT-S-OFDM QPSK	1	104	10 mm	back	1:1	0.421	1.002	0.422	
1770.00	354000	High	NR Band n66 (AWS)	20	19.5	19.45	0.01	0	Ant B	0898M	DFT-S-OFDM QPSK	50	0	10 mm	back	1:1	0.420	1.012	0.425	
1770.00	354000	High	NR Band n66 (AWS)	20	19.5	19.49	0.02	0	Ant B	0898M	DFT-S-OFDM QPSK	1	104	10 mm	bottom	1:1	0.663	1.002	0.664	
1770.00	354000	High	NR Band n66 (AWS)	20	19.5	19.45	-0.03	0	Ant B	0898M	DFT-S-OFDM QPSK	50	0	10 mm	bottom	1:1	0.649	1.012	0.657	
ANSI / IEEE C95.1 1992 - SAFETY LIMIT											Body									
Spatial Peak											1.6 W/kg (mW/g)									
Uncontrolled Exposure/General Population											averaged over 1 gram									

**Table 11-97
NR Band n25 (PCS) UMPC Body SAR**

MEASUREMENT RESULTS																				
FREQUENCY		Mode	Bandwidth [MHz]	Maximum Allowed Power [dBm]	Conducted Power [dBm]	Power Drift [dB]	MPR [dB]	Antenna Config.	Device Serial Number	Modulation	RB Size	RB Offset	Spacing	Side	Duty Cycle	SAR (1g) (W/kg)	Scaling Factor	Reported SAR (1g) (W/kg)	Plot #	
MHz	Ch.																			
1882.50	376500	Mid	NR Band n25 (PCS)	20	24.5	23.86	-0.01	0	Ant B	1130M	DFT-S-OFDM QPSK	1	53	12 mm	back	1:1	0.612	1.159	0.709	
1882.50	376500	Mid	NR Band n25 (PCS)	20	24.5	23.76	-0.03	0	Ant B	1130M	DFT-S-OFDM QPSK	50	28	12 mm	back	1:1	0.611	1.186	0.725	
1882.50	376500	Mid	NR Band n25 (PCS)	20	24.5	23.86	0.03	0	Ant B	1130M	DFT-S-OFDM QPSK	1	53	10 mm	front	1:1	0.498	1.159	0.577	
1882.50	376500	Mid	NR Band n25 (PCS)	20	24.5	23.76	0.00	0	Ant B	1130M	DFT-S-OFDM QPSK	50	28	10 mm	front	1:1	0.469	1.186	0.556	
1860.00	372000	Low	NR Band n25 (PCS)	20	24.5	23.80	-0.06	0	Ant B	1130M	DFT-S-OFDM QPSK	1	53	16 mm	bottom	1:1	0.836	1.175	0.982	A120
1882.50	376500	Mid	NR Band n25 (PCS)	20	24.5	23.86	-0.02	0	Ant B	1130M	DFT-S-OFDM QPSK	1	53	16 mm	bottom	1:1	0.757	1.159	0.877	
1905.00	381000	High	NR Band n25 (PCS)	20	24.5	23.74	-0.04	0	Ant B	1130M	DFT-S-OFDM QPSK	1	53	16 mm	bottom	1:1	0.757	1.191	0.902	
1860.00	372000	Low	NR Band n25 (PCS)	20	24.5	23.75	-0.03	0	Ant B	1130M	DFT-S-OFDM QPSK	50	28	16 mm	bottom	1:1	0.768	1.189	0.913	
1882.50	376500	Mid	NR Band n25 (PCS)	20	24.5	23.76	-0.01	0	Ant B	1130M	DFT-S-OFDM QPSK	50	28	16 mm	bottom	1:1	0.745	1.186	0.884	
1905.00	381000	High	NR Band n25 (PCS)	20	24.5	23.57	-0.07	0	Ant B	1130M	DFT-S-OFDM QPSK	50	28	16 mm	bottom	1:1	0.722	1.239	0.895	
1860.00	372000	Low	NR Band n25 (PCS)	20	23.5	22.81	-0.05	1	Ant B	1130M	DFT-S-OFDM QPSK	100	0	16 mm	bottom	1:1	0.626	1.172	0.734	
1860.00	372000	Low	NR Band n25 (PCS)	20	23.0	22.44	-0.02	1.5	Ant B	1130M	CP-OFDM QPSK	1	1	16 mm	bottom	1:1	0.489	1.138	0.556	
1882.50	376500	Mid	NR Band n25 (PCS)	20	24.5	23.86	0.06	0	Ant B	1130M	DFT-S-OFDM QPSK	1	53	10 mm	right	1:1	0.578	1.159	0.670	
1882.50	376500	Mid	NR Band n25 (PCS)	20	24.5	23.76	0.07	0	Ant B	1130M	DFT-S-OFDM QPSK	50	28	10 mm	right	1:1	0.584	1.186	0.693	
1882.50	376500	Mid	NR Band n25 (PCS)	20	19.5	18.94	-0.03	0	Ant B	1130M	DFT-S-OFDM QPSK	1	1	10 mm	back	1:1	0.266	1.138	0.303	
1882.50	376500	Mid	NR Band n25 (PCS)	20	19.5	19.02	-0.03	0	Ant B	1130M	DFT-S-OFDM QPSK	50	0	10 mm	back	1:1	0.261	1.117	0.292	
1882.50	376500	Mid	NR Band n25 (PCS)	20	19.5	18.94	-0.03	0	Ant B	1130M	DFT-S-OFDM QPSK	1	1	10 mm	bottom	1:1	0.581	1.138	0.661	
1882.50	376500	Mid	NR Band n25 (PCS)	20	19.5	19.02	-0.06	0	Ant B	1130M	DFT-S-OFDM QPSK	50	0	10 mm	bottom	1:1	0.552	1.117	0.617	
ANSI / IEEE C95.1 1992 - SAFETY LIMIT											Body									
Spatial Peak											1.6 W/kg (mW/g)									
Uncontrolled Exposure/General Population											averaged over 1 gram									



FCC ID: A3LSMF916U		SAR EVALUATION REPORT		Approved by: Quality Manager
Document S/N: 1M2005200087-01-R2-A3L	Test Dates: 06/28/20-08/24/20	DUT Type: Portable Handset	Page 171 of 267	

**Table 11-98
NR Band n41 UMPC Body SAR**

MEASUREMENT RESULTS																				
FREQUENCY		Mode	Bandwidth [MHz]	Maximum Allowed Power [dBm]	Conducted Power [dBm]	Power Drift [dB]	MPR [dB]	Antenna Config.	Device Serial Number	Modulation	RB Size	RB Offset	Spacing	Side	Duty Cycle	SAR (1g)	Scaling Factor	Reported SAR (1g)	Plot #	
MHz	Ch.															(W/kg)		(W/kg)		
2592.99	518598	Md	NR Band n41	100	25.0	24.16	0.06	0	Ant F	1296M	DFT-S-OFDM QPSK	1	1	10 mm	back	1:4	0.106	1.213	0.129	
2592.99	518598	Md	NR Band n41	100	25.0	23.87	0.16	0	Ant F	1296M	DFT-S-OFDM QPSK	135	69	10 mm	back	1:4	0.086	1.297	0.112	
2592.99	518598	Md	NR Band n41	100	25.0	24.16	0.10	0	Ant F	1296M	DFT-S-OFDM QPSK	1	1	10 mm	front	1:4	0.066	1.213	0.080	
2592.99	518598	Md	NR Band n41	100	25.0	23.87	-0.05	0	Ant F	1296M	DFT-S-OFDM QPSK	135	69	10 mm	front	1:4	0.052	1.297	0.067	
2592.99	518598	Md	NR Band n41	100	25.0	24.16	-0.02	0	Ant F	1296M	DFT-S-OFDM QPSK	1	1	10 mm	top	1:4	0.190	1.213	0.230	A121
2592.99	518598	Md	NR Band n41	100	25.0	23.87	-0.03	0	Ant F	1296M	DFT-S-OFDM QPSK	135	69	10 mm	top	1:4	0.139	1.297	0.180	
2592.99	518598	Md	NR Band n41	100	23.5	22.79	0.03	1.5	Ant F	1296M	CP-OFDM QPSK	1	1	10 mm	top	1:4	0.128	1.178	0.151	
ANSI / IEEE C95.1 1992 - SAFETY LIMIT Spatial Peak Uncontrolled Exposure/General Population											Body 1.6 W/kg (mW/g) averaged over 1 gram									

**Table 11-99
WLAN UMPC Body SAR**

MEASUREMENT RESULTS																			
FREQUENCY		Mode	Service	Bandwidth [MHz]	Maximum Allowed Power [dBm]	Conducted Power [dBm]	Power Drift [dB]	Spacing	Antenna Config.	Device Serial Number	Data Rate (Mbps)	Side	Duty Cycle (%)	Peak SAR of Area Scan	SAR (1g)	Scaling Factor (Power)	Scaling Factor (Duty Cycle)	Reported SAR (1g)	Plot #
MHz	Ch.													(W/kg)	(W/kg)			(W/kg)	
2437	6	802.11b	DSSS	22	19.0	18.99	-0.02	10 mm	1	0815M	1	back	99.8	0.389	0.261	1.002	1.002	0.262	
2437	6	802.11b	DSSS	22	19.0	18.99	0.00	10 mm	1	0815M	1	front	99.8	0.386	0.264	1.002	1.002	0.265	
2412	1	802.11b	DSSS	22	19.0	18.87	-0.03	10 mm	1	0815M	1	top	99.8	0.685	0.451	1.030	1.002	0.465	
2437	6	802.11b	DSSS	22	19.0	18.99	0.06	10 mm	1	0815M	1	top	99.8	1.000	0.627	1.002	1.002	0.630	A122
2462	11	802.11b	DSSS	22	19.0	18.78	-0.02	10 mm	1	0815M	1	top	99.8	0.879	0.579	1.052	1.002	0.610	
2462	11	802.11b	DSSS	22	19.0	18.94	0.02	10 mm	2	0815M	1	back	99.9	0.290	0.190	1.014	1.001	0.193	
2462	11	802.11b	DSSS	22	19.0	18.94	-0.07	10 mm	2	0815M	1	front	99.9	0.173	0.118	1.014	1.001	0.120	
2462	11	802.11b	DSSS	22	19.0	18.94	0.03	10 mm	2	0815M	1	top	99.9	0.210	0.143	1.014	1.001	0.145	
2462	11	802.11b	DSSS	22	19.0	18.94	-0.01	10 mm	2	0815M	1	left	99.9	0.336	0.216	1.014	1.001	0.219	
5300	60	802.11a	OFDM	20	18.0	17.99	-0.04	10 mm	1	0876M	6	back	99.2	0.432	0.207	1.002	1.008	0.209	
5300	60	802.11a	OFDM	20	18.0	17.99	-0.04	10 mm	1	0876M	6	front	99.2	0.116	0.039	1.002	1.008	0.039	
5300	60	802.11a	OFDM	20	18.0	17.99	-0.04	10 mm	1	0876M	6	top	99.2	0.403	0.163	1.002	1.008	0.165	
5300	60	802.11a	OFDM	20	18.0	17.95	-0.04	10 mm	2	0876M	6	back	99.4	0.637	0.290	1.012	1.006	0.295	
5300	60	802.11a	OFDM	20	18.0	17.95	0.04	10 mm	2	0876M	6	front	99.4	0.167	0.066	1.012	1.006	0.067	
5300	60	802.11a	OFDM	20	18.0	17.95	-0.14	10 mm	2	0876M	6	top	99.4	0.236	0.099	1.012	1.006	0.101	
5300	60	802.11a	OFDM	20	18.0	17.95	-0.03	10 mm	2	0876M	6	left	99.4	0.344	0.160	1.012	1.006	0.163	
5620	124	802.11a	OFDM	20	18.0	17.99	0.03	10 mm	1	0876M	6	back	99.2	0.388	0.171	1.002	1.008	0.173	
5620	124	802.11a	OFDM	20	18.0	17.99	0.04	10 mm	1	0876M	6	front	99.2	0.183	0.076	1.002	1.008	0.077	
5620	124	802.11a	OFDM	20	18.0	17.99	-0.06	10 mm	1	0876M	6	top	99.2	0.443	0.185	1.002	1.008	0.187	
5720	144	802.11a	OFDM	20	18.0	17.72	0.02	10 mm	2	0876M	6	back	99.4	0.329	0.147	1.067	1.006	0.158	
5720	144	802.11a	OFDM	20	18.0	17.72	0.13	10 mm	2	0876M	6	front	99.4	0.326	0.130	1.067	1.006	0.140	
5720	144	802.11a	OFDM	20	18.0	17.72	-0.06	10 mm	2	0876M	6	top	99.4	0.286	0.104	1.067	1.006	0.112	
5720	144	802.11a	OFDM	20	18.0	17.72	0.12	10 mm	2	0876M	6	left	99.4	0.120	0.051	1.067	1.006	0.055	
5785	157	802.11a	OFDM	20	18.0	17.93	0.03	10 mm	1	0876M	6	back	99.2	0.408	0.159	1.016	1.008	0.163	
5785	157	802.11a	OFDM	20	18.0	17.93	0.02	10 mm	1	0876M	6	front	99.2	0.284	0.120	1.016	1.008	0.123	
5785	157	802.11a	OFDM	20	18.0	17.93	-0.04	10 mm	1	0876M	6	top	99.2	0.763	0.313	1.016	1.008	0.321	A123
5785	157	802.11a	OFDM	20	18.0	17.98	-0.08	10 mm	2	0876M	6	back	99.4	0.351	0.144	1.005	1.006	0.146	
5785	157	802.11a	OFDM	20	18.0	17.98	0.07	10 mm	2	0876M	6	front	99.4	0.327	0.139	1.005	1.006	0.141	
5785	157	802.11a	OFDM	20	18.0	17.98	-0.04	10 mm	2	0876M	6	top	99.4	0.282	0.099	1.005	1.006	0.100	
5785	157	802.11a	OFDM	20	18.0	17.98	0.16	10 mm	2	0876M	6	left	99.4	0.135	0.051	1.005	1.006	0.052	
ANSI / IEEE C95.1 1992 - SAFETY LIMIT Spatial Peak Uncontrolled Exposure/General Population											Body 1.6 W/kg (mW/g) averaged over 1 gram								

FCC ID: A3LSMF916U	 PCTEST <small>Prøvet til det beste av Samsung</small>	SAR EVALUATION REPORT		Approved by: Quality Manager
Document S/N: 1M2005200087-01-R2.A3L	Test Dates: 06/28/20-08/24/20	DUT Type: Portable Handset	Page 172 of 267	

**Table 11-100
WLAN MIMO UMPC Body SAR**

MEASUREMENT RESULTS																				
FREQUENCY MHz	Ch.	Mode	Service	Bandwidth [MHz]	Maximum Allowed Power (Ant 1) [dBm]	Conducted Power (Ant 1) [dBm]	Maximum Allowed Power (Ant 2) [dBm]	Conducted Power (Ant 2) [dBm]	Power Drift [dB]	Spacing	Antenna Config.	Device Serial Number	Data Rate (Mbps)	Side	Duty Cycle (%)	SAR (1g)	Scaling Factor (Power)	Scaling Factor (Duty Cycle)	Reported SAR	Plot #
																(W/kg)			(W/kg)	
2437	6	802.11b	DSSS	22	19.0	18.99	19.0	18.92	-0.02	10 mm	MIMO	0815M	1	back	99.9	0.353	1.019	1.001	0.360	
2437	6	802.11b	DSSS	22	19.0	18.99	19.0	18.92	0.04	10 mm	MIMO	0815M	1	front	99.9	0.368	1.019	1.001	0.375	
2437	6	802.11b	DSSS	22	19.0	18.99	19.0	18.92	-0.12	10 mm	MIMO	0815M	1	top	99.9	0.549	1.019	1.001	0.560	
2437	6	802.11b	DSSS	22	19.0	18.99	19.0	18.92	-0.03	10 mm	MIMO	0815M	1	left	99.9	0.524	1.019	1.001	0.534	
5260	52	802.11n	OFDM	20	18.0	17.96	18.0	17.95	-0.06	10 mm	MIMO	0876M	13	back	98.6	0.287	1.012	1.014	0.295	
5260	52	802.11n	OFDM	20	18.0	17.96	18.0	17.95	0.06	10 mm	MIMO	0876M	13	front	98.6	0.093	1.012	1.014	0.095	
5260	52	802.11n	OFDM	20	18.0	17.96	18.0	17.95	0.13	10 mm	MIMO	0876M	13	top	98.6	0.294	1.012	1.014	0.302	
5260	52	802.11n	OFDM	20	18.0	17.96	18.0	17.95	0.02	10 mm	MIMO	0876M	13	left	98.6	0.202	1.012	1.014	0.207	
5620	124	802.11n	OFDM	20	18.0	17.91	18.0	17.99	-0.03	10 mm	MIMO	0876M	13	back	98.6	0.211	1.021	1.014	0.218	
5620	124	802.11n	OFDM	20	18.0	17.91	18.0	17.99	0.06	10 mm	MIMO	0876M	13	front	98.6	0.198	1.021	1.014	0.205	
5620	124	802.11n	OFDM	20	18.0	17.91	18.0	17.99	0.06	10 mm	MIMO	0876M	13	top	98.6	0.213	1.021	1.014	0.221	
5620	124	802.11n	OFDM	20	18.0	17.91	18.0	17.99	0.11	10 mm	MIMO	0876M	13	left	98.6	0.156	1.021	1.014	0.162	
5785	157	802.11n	OFDM	20	18.0	17.78	18.0	17.81	0.08	10 mm	MIMO	0876M	13	back	98.6	0.234	1.052	1.014	0.250	
5785	157	802.11n	OFDM	20	18.0	17.78	18.0	17.81	0.08	10 mm	MIMO	0876M	13	front	98.6	0.152	1.052	1.014	0.162	
5785	157	802.11n	OFDM	20	18.0	17.78	18.0	17.81	-0.08	10 mm	MIMO	0876M	13	top	98.6	0.279	1.052	1.014	0.298	
5785	157	802.11n	OFDM	20	18.0	17.78	18.0	17.81	0.07	10 mm	MIMO	0876M	13	left	98.6	0.100	1.052	1.014	0.107	
ANSI / IEEE C95.1 1992 - SAFETY LIMIT										Body										
Spatial Peak										1.6 W/kg (mW/g)										
Uncontrolled Exposure/General Population										averaged over 1 gram										

Note: For 2450 MHz WLAN, to achieve the 22.0 dBm maximum allowed MIMO power shown in the documentation, each antenna transmits at a maximum allowed power of 19.0 dBm. For 5GHz WLAN, to achieve the 21.0 dBm maximum allowed MIMO power shown in the documentation, each antenna transmits at a maximum allowed power of 18.0 dBm.

**Table 11-101
5GHz MIMO UMPC Body SAR with 2.4 GHz WLAN and/or 2.4 GHz Bluetooth**

MEASUREMENT RESULTS																				
FREQUENCY MHz	Ch.	Mode	Service	Bandwidth [MHz]	Maximum Allowed Power (Ant 1) [dBm]	Conducted Power (Ant 1) [dBm]	Maximum Allowed Power (Ant 2) [dBm]	Conducted Power (Ant 2) [dBm]	Power Drift [dB]	Spacing	Antenna Config.	Device Serial Number	Data Rate (Mbps)	Side	Duty Cycle (%)	SAR (1g)	Scaling Factor (Power)	Scaling Factor (Duty Cycle)	Reported SAR	Plot #
																(W/kg)			(W/kg)	
5290	58	802.11ac	OFDM	80	14.0	13.60	14.0	13.85	0.02	10 mm	MIMO	0876M	58.5	back	90.9	0.109	1.096	1.101	0.132	
5290	58	802.11ac	OFDM	80	14.0	13.60	14.0	13.85	0.05	10 mm	MIMO	0876M	58.5	front	90.9	0.034	1.096	1.101	0.041	
5290	58	802.11ac	OFDM	80	14.0	13.60	14.0	13.85	-0.09	10 mm	MIMO	0876M	58.5	top	90.9	0.110	1.096	1.101	0.133	
5290	58	802.11ac	OFDM	80	14.0	13.60	14.0	13.85	-0.03	10 mm	MIMO	0876M	58.5	left	90.9	0.059	1.096	1.101	0.071	
5690	138	802.11ac	OFDM	80	14.0	13.59	14.0	13.68	0.09	10 mm	MIMO	0876M	58.5	back	90.9	0.064	1.099	1.101	0.077	
5690	138	802.11ac	OFDM	80	14.0	13.59	14.0	13.68	0.13	10 mm	MIMO	0876M	58.5	front	90.9	0.046	1.099	1.101	0.056	
5690	138	802.11ac	OFDM	80	14.0	13.59	14.0	13.68	-0.11	10 mm	MIMO	0876M	58.5	top	90.9	0.072	1.099	1.101	0.087	
5690	138	802.11ac	OFDM	80	14.0	13.59	14.0	13.68	-0.16	10 mm	MIMO	0876M	58.5	left	90.9	0.032	1.099	1.101	0.039	
5775	155	802.11ac	OFDM	80	14.0	13.87	14.0	13.80	0.19	10 mm	MIMO	0876M	58.5	back	90.9	0.067	1.047	1.101	0.077	
5775	155	802.11ac	OFDM	80	14.0	13.87	14.0	13.80	0.03	10 mm	MIMO	0876M	58.5	front	90.9	0.052	1.047	1.101	0.060	
5775	155	802.11ac	OFDM	80	14.0	13.87	14.0	13.80	-0.04	10 mm	MIMO	0876M	58.5	top	90.9	0.077	1.047	1.101	0.089	
5775	155	802.11ac	OFDM	80	14.0	13.87	14.0	13.80	0.11	10 mm	MIMO	0876M	58.5	left	90.9	0.029	1.047	1.101	0.033	
ANSI / IEEE C95.1 1992 - SAFETY LIMIT										Body										
Spatial Peak										1.6 W/kg (mW/g)										
Uncontrolled Exposure/General Population										averaged over 1 gram										

Note: 5GHz WLAN MIMO was additionally evaluated at the maximum allowed output power during operations with Simultaneous 2.4 GHz WLAN and 5 GHz WLAN or 2.4 GHz Bluetooth and 5 GHz WLAN. 2.4 GHz WIFI/2.4 GHz Bluetooth were not transmitting during the above evaluations.



FCC ID: A3LSMF916U		SAR EVALUATION REPORT		Approved by: Quality Manager
Document S/N: 1M2005200087-01-R2-A3L	Test Dates: 06/28/20-08/24/20	DUT Type: Portable Handset		Page 173 of 267

Table 11-102
2.4 GHz WLAN Antenna 2 UMPC Body SAR for Conditions mmWave Active

MEASUREMENT RESULTS																		
FREQUENCY		Mode	Service	Bandwidth [MHz]	Maximum Allowed Power [dBm]	Conducted Power [dBm]	Power Drift [dB]	Spacing	Antenna Config.	Device Serial Number	Data Rate (Mbps)	Side	Duty Cycle (%)	SAR (1g)	Scaling Factor (Power)	Scaling Factor (Duty Cycle)	Reported SAR (1g)	Plot #
MHz	Ch.													(W/kg)			(W/kg)	
2462	11	802.11b	DSSS	22	13.0	12.88	0.00	10 mm	2	0815M	1	back	99.9	0.017	1.028	1.001	0.017	
2462	11	802.11b	DSSS	22	13.0	12.88	0.11	10 mm	2	0815M	1	front	99.9	0.009	1.028	1.001	0.009	
2462	11	802.11b	DSSS	22	13.0	12.88	0.06	10 mm	2	0815M	1	top	99.9	0.020	1.028	1.001	0.021	
2462	11	802.11b	DSSS	22	13.0	12.88	0.14	10 mm	2	0815M	1	left	99.9	0.030	1.028	1.001	0.031	
ANSI / IEEE C95.1 1992 - SAFETY LIMIT								Body										
Spatial Peak								1.6 W/kg (mW/g)										
Uncontrolled Exposure/General Population								averaged over 1 gram										



Table 11-103
5 GHz WLAN MIMO UMPC Body SAR for Conditions mmWave Active

MEASUREMENT RESULTS																				
FREQUENCY		Mode	Service	Bandwidth [MHz]	Maximum Allowed Power (Ant 1) [dBm]	Conducted Power (Ant 1) [dBm]	Maximum Allowed Power (Ant 2) [dBm]	Conducted Power (Ant 2) [dBm]	Power Drift [dB]	Spacing	Antenna Config.	Device Serial Number	Data Rate (Mbps)	Side	Duty Cycle (%)	SAR (1g)	Scaling Factor (Power)	Scaling Factor (Duty Cycle)	Reported SAR (1g)	Plot #
MHz	Ch.															(W/kg)			(W/kg)	
5290	58	802.11ac	OFDM	80	11.0	10.37	11.0	10.67	0.13	10 mm	MIMO	0876M	58.5	back	90.9	0.013	1.156	1.101	0.017	
5290	58	802.11ac	OFDM	80	11.0	10.37	11.0	10.67	0.14	10 mm	MIMO	0876M	58.5	front	90.9	0.002	1.156	1.101	0.003	
5290	58	802.11ac	OFDM	80	11.0	10.37	11.0	10.67	0.12	10 mm	MIMO	0876M	58.5	top	90.9	0.019	1.156	1.101	0.024	
5290	58	802.11ac	OFDM	80	11.0	10.37	11.0	10.67	0.05	10 mm	MIMO	0876M	58.5	left	90.9	0.012	1.156	1.101	0.015	
5530	106	802.11ac	OFDM	80	11.0	10.56	11.0	10.75	0.04	10 mm	MIMO	0876M	58.5	back	90.9	0.009	1.107	1.101	0.011	
5530	106	802.11ac	OFDM	80	11.0	10.56	11.0	10.75	0.05	10 mm	MIMO	0876M	58.5	front	90.9	0.012	1.107	1.101	0.015	
5530	106	802.11ac	OFDM	80	11.0	10.56	11.0	10.75	0.11	10 mm	MIMO	0876M	58.5	top	90.9	0.013	1.107	1.101	0.016	
5530	106	802.11ac	OFDM	80	11.0	10.56	11.0	10.75	-0.13	10 mm	MIMO	0876M	58.5	left	90.9	0.005	1.107	1.101	0.006	
5775	155	802.11ac	OFDM	80	11.0	10.82	11.0	10.76	0.04	10 mm	MIMO	0876M	58.5	back	90.9	0.012	1.057	1.101	0.014	
5775	155	802.11ac	OFDM	80	11.0	10.82	11.0	10.76	0.04	10 mm	MIMO	0876M	58.5	front	90.9	0.007	1.057	1.101	0.008	
5775	155	802.11ac	OFDM	80	11.0	10.82	11.0	10.76	0.17	10 mm	MIMO	0876M	58.5	top	90.9	0.009	1.057	1.101	0.010	
5775	155	802.11ac	OFDM	80	11.0	10.82	11.0	10.76	0.09	10 mm	MIMO	0876M	58.5	left	90.9	0.001	1.057	1.101	0.001	
ANSI / IEEE C95.1 1992 - SAFETY LIMIT								Body												
Spatial Peak								1.6 W/kg (mW/g)												
Uncontrolled Exposure/General Population								averaged over 1 gram												

Note: To achieve the 14.0 dBm maximum allowed MIMO power shown in the documentation, each antenna transmits at a maximum allowed power of 11.0 dBm.

Table 11-104
DSS UMPC Body SAR

MEASUREMENT RESULTS																	
FREQUENCY		Mode	Service	Maximum Allowed Power [dBm]	Conducted Power [dBm]	Power Drift [dB]	Spacing	Antenna Config.	Device Serial Number	Data Rate (Mbps)	Side	Duty Cycle (%)	SAR (1g)	Scaling Factor (Cond Power)	Scaling Factor (Duty Cycle)	Reported SAR (1g)	Plot #
MHz	Ch.												(W/kg)			(W/kg)	
2441	39	Bluetooth	FHSS	20.0	19.53	0.02	10 mm	1	0815M	1	back	77.9	0.138	1.115	1.284	0.198	
2441	39	Bluetooth	FHSS	20.0	19.53	0.05	10 mm	1	0815M	1	front	77.9	0.140	1.115	1.284	0.200	
2441	39	Bluetooth	FHSS	20.0	19.53	-0.02	10 mm	1	0815M	1	top	77.9	0.393	1.115	1.284	0.563	A124
2441	39	Bluetooth	FHSS	20.0	19.23	-0.07	10 mm	2	0815M	1	back	77.3	0.179	1.193	1.294	0.274	
2441	39	Bluetooth	FHSS	20.0	19.23	-0.03	10 mm	2	0815M	1	front	77.3	0.151	1.193	1.294	0.231	
2441	39	Bluetooth	FHSS	20.0	19.23	-0.03	10 mm	2	0815M	1	top	77.3	0.121	1.193	1.294	0.185	
2441	39	Bluetooth	FHSS	20.0	19.23	0.01	10 mm	2	0815M	1	left	77.3	0.227	1.193	1.294	0.348	
ANSI / IEEE C95.1 1992 - SAFETY LIMIT								Body									
Spatial Peak								1.6 W/kg (mW/g)									
Uncontrolled Exposure/General Population								averaged over 1 gram									

FCC ID: A3LSMF916U		SAR EVALUATION REPORT		Approved by: Quality Manager
Document S/N: 1M2005200087-01-R2.A3L	Test Dates: 06/28/20-08/24/20	DUT Type: Portable Handset	Page 174 of 267	

11.6 Standalone UMPC Extremity SAR

**Table 11-105
CDMA BC10 (§90S) UMPC Extremity SAR**

MEASUREMENT RESULTS																
FREQUENCY		Mode	Service	Maximum Allowed Power [dBm]	Conducted Power [dBm]	Power Drift [dB]	Spacing	Antenna Config.	Tune State	Device Serial Number	Duty Cycle	Side	SAR (10g)	Scaling Factor	Reported SAR (10g)	Plot #
MHz	Ch.												(W/kg)		(W/kg)	
820.10	564	CDMA BC10 (§90S)	EVDO Rev. 0	26.0	25.15	-0.16	0 mm	Ant A	11	0744M	1:1	back	1.180	1.216	1.435	A125
820.10	564	CDMA BC10 (§90S)	EVDO Rev. 0	26.0	25.15	0.00	0 mm	Ant A	11	0744M	1:1	front	0.961	1.216	1.169	
820.10	564	CDMA BC10 (§90S)	EVDO Rev. 0	26.0	25.15	0.00	0 mm	Ant A	11	0744M	1:1	bottom	0.631	1.216	0.767	
820.10	564	CDMA BC10 (§90S)	EVDO Rev. 0	26.0	25.15	-0.12	0 mm	Ant A	11	0744M	1:1	right	1.130	1.216	1.374	
ANSI / IEEE C95.1 1992 - SAFETY LIMIT Spatial Peak Uncontrolled Exposure/General Population							Extremity 4.0 W/kg (mW/g) averaged over 10 grams									

**Table 11-106
CDMA BC0 (§22H) UMPC Extremity SAR**

MEASUREMENT RESULTS																
FREQUENCY		Mode	Service	Maximum Allowed Power [dBm]	Conducted Power [dBm]	Power Drift [dB]	Spacing	Antenna Config.	Tune State	Device Serial Number	Duty Cycle	Side	SAR (10g)	Scaling Factor	Reported SAR (10g)	Plot #
MHz	Ch.												(W/kg)		(W/kg)	
824.70	1013	CDMA BC0 (§22H)	EVDO Rev. 0	26.0	25.19	-0.14	0 mm	Ant A	0	0744M	1:1	back	1.180	1.205	1.422	
836.52	384	CDMA BC0 (§22H)	EVDO Rev. 0	26.0	25.16	0.03	0 mm	Ant A	0	0744M	1:1	back	1.330	1.213	1.613	A126
848.31	777	CDMA BC0 (§22H)	EVDO Rev. 0	26.0	25.08	-0.03	0 mm	Ant A	0	0744M	1:1	back	1.300	1.236	1.607	
836.52	384	CDMA BC0 (§22H)	EVDO Rev. 0	26.0	25.16	-0.07	0 mm	Ant A	0	0744M	1:1	front	1.080	1.213	1.310	
836.52	384	CDMA BC0 (§22H)	EVDO Rev. 0	26.0	25.16	-0.15	0 mm	Ant A	0	0744M	1:1	bottom	0.553	1.213	0.671	
836.52	384	CDMA BC0 (§22H)	EVDO Rev. 0	26.0	25.16	-0.03	0 mm	Ant A	0	0744M	1:1	right	1.290	1.213	1.565	
836.52	384	CDMA BC0 (§22H)	EVDO Rev. 0	24.5	23.51	-0.01	0 mm	Ant B	N/A	0744M	1:1	back	1.110	1.256	1.394	
836.52	384	CDMA BC0 (§22H)	EVDO Rev. 0	24.5	23.51	0.05	0 mm	Ant B	N/A	0744M	1:1	front	0.717	1.256	0.901	
836.52	384	CDMA BC0 (§22H)	EVDO Rev. 0	24.5	23.51	-0.08	0 mm	Ant B	N/A	0744M	1:1	bottom	0.547	1.256	0.687	
836.52	384	CDMA BC0 (§22H)	EVDO Rev. 0	24.5	23.51	-0.02	0 mm	Ant B	N/A	0744M	1:1	right	0.122	1.256	0.153	
ANSI / IEEE C95.1 1992 - SAFETY LIMIT Spatial Peak Uncontrolled Exposure/General Population							Extremity 4.0 W/kg (mW/g) averaged over 10 grams									





FCC ID: A3LSMF916U		SAR EVALUATION REPORT		Approved by: Quality Manager
Document S/N: 1M2005200087-01-R2.A3L	Test Dates: 06/28/20-08/24/20	DUT Type: Portable Handset		Page 175 of 267

Table 11-107
PCS CDMA UMPC Extremity SAR

MEASUREMENT RESULTS															
FREQUENCY		Mode	Service	Maximum Allowed Power [dBm]	Conducted Power [dBm]	Power Drift [dB]	Spacing	Antenna Config.	Device Serial Number	Duty Cycle	Side	SAR (10g)	Scaling Factor	Reported SAR (10g)	Plot #
MHz	Ch.											(W/kg)		(W/kg)	
1880.00	600	PCS CDMA	EVDO Rev. 0	24.0	23.16	-0.02	12 mm	Ant B	1102M	1:1	back	0.337	1.213	0.409	
1880.00	600	PCS CDMA	EVDO Rev. 0	24.0	23.16	0.11	9 mm	Ant B	1102M	1:1	front	0.374	1.213	0.454	
1880.00	600	PCS CDMA	EVDO Rev. 0	24.0	23.16	-0.03	16 mm	Ant B	1102M	1:1	bottom	0.405	1.213	0.491	
1851.25	25	PCS CDMA	EVDO Rev. 0	24.0	23.14	0.09	0 mm	Ant B	1102M	1:1	right	2.060	1.219	2.511	
1880.00	600	PCS CDMA	EVDO Rev. 0	24.0	23.16	0.07	0 mm	Ant B	1102M	1:1	right	2.130	1.213	2.584	
1908.75	1175	PCS CDMA	EVDO Rev. 0	24.0	23.23	-0.07	0 mm	Ant B	1102M	1:1	right	2.490	1.194	2.973	A127
1880.00	600	PCS CDMA	EVDO Rev. 0	20.0	18.58	-0.11	0 mm	Ant B	1102M	1:1	back	1.200	1.387	1.664	
1880.00	600	PCS CDMA	EVDO Rev. 0	20.0	18.58	-0.10	0 mm	Ant B	1102M	1:1	front	0.728	1.387	1.010	
1851.25	25	PCS CDMA	EVDO Rev. 0	20.0	19.02	-0.03	0 mm	Ant B	1102M	1:1	bottom	2.410	1.253	3.020	
1880.00	600	PCS CDMA	EVDO Rev. 0	20.0	18.58	-0.02	0 mm	Ant B	1102M	1:1	bottom	2.270	1.387	3.148	
1908.75	1175	PCS CDMA	EVDO Rev. 0	20.0	18.95	-0.02	0 mm	Ant B	1102M	1:1	bottom	2.180	1.274	2.777	
ANSI / IEEE C95.1 1992 - SAFETY LIMIT Spatial Peak Uncontrolled Exposure/General Population							Extremity 4.0 W/kg (mW/g) averaged over 10 grams								

Table 11-108
GSM 850 UMPC Extremity SAR

MEASUREMENT RESULTS																
FREQUENCY		Mode	Service	Maximum Allowed Power [dBm]	Conducted Power [dBm]	Power Drift [dB]	Spacing	Antenna Config.	Device Serial Number	# of Time Slots	Duty Cycle	Side	SAR (10g)	Scaling Factor	Reported SAR (10g)	Plot #
MHz	Ch.												(W/kg)		(W/kg)	
824.20	128	GSM 850	GPRS	30.5	28.76	-0.01	0 mm	Ant A	0897M	3	1:2.76	back	1.100	1.493	1.642	
836.60	190	GSM 850	GPRS	30.5	28.88	-0.06	0 mm	Ant A	0897M	3	1:2.76	back	1.390	1.452	2.018	A128
848.80	251	GSM 850	GPRS	30.5	29.08	-0.02	0 mm	Ant A	0897M	3	1:2.76	back	0.879	1.387	1.219	
836.60	190	GSM 850	GPRS	30.5	28.88	-0.03	0 mm	Ant A	0897M	3	1:2.76	front	1.030	1.452	1.496	
836.60	190	GSM 850	GPRS	30.5	28.88	-0.11	0 mm	Ant A	0897M	3	1:2.76	bottom	0.715	1.452	1.038	
836.60	190	GSM 850	GPRS	30.5	28.88	-0.10	0 mm	Ant A	0897M	3	1:2.76	right	0.954	1.452	1.385	
ANSI / IEEE C95.1 1992 - SAFETY LIMIT Spatial Peak Uncontrolled Exposure/General Population							Extremity 4.0 W/kg (mW/g) averaged over 10 grams									

FCC ID: A3LSMF916U	 PCTEST <small>Provided to be part of Samsung</small>	SAR EVALUATION REPORT		Approved by: Quality Manager
Document S/N: 1M2005200087-01-R2.A3L	Test Dates: 06/28/20-08/24/20	DUT Type: Portable Handset	Page 176 of 267	

**Table 11-109
GSM 1900 UMPC Extremity SAR**

MEASUREMENT RESULTS																
FREQUENCY		Mode	Service	Maximum Allowed Power [dBm]	Conducted Power [dBm]	Power Drift [dB]	Spacing	Antenna Config.	Device Serial Number	# of Time Slots	Duty Cycle	Side	SAR (10g)	Scaling Factor	Reported SAR (10g)	Plot #
MHz	Ch.												(W/kg)		(W/kg)	
1880.00	661	GSM 1900	GPRS	27.5	26.72	-0.07	12 mm	Ant B	1102M	3	1:2.76	back	0.187	1.197	0.224	
1880.00	661	GSM 1900	GPRS	27.5	26.72	-0.04	9 mm	Ant B	1102M	3	1:2.76	front	0.183	1.197	0.219	
1880.00	661	GSM 1900	GPRS	27.5	26.72	0.01	16 mm	Ant B	1102M	3	1:2.76	bottom	0.219	1.197	0.262	
1880.00	661	GSM 1900	GPRS	27.5	26.72	0.03	0 mm	Ant B	1102M	3	1:2.76	right	0.973	1.197	1.165	
1880.00	661	GSM 1900	GPRS	23.0	21.82	-0.13	0 mm	Ant B	1102M	4	1:2.076	back	0.852	1.312	1.118	
1880.00	661	GSM 1900	GPRS	23.0	21.82	-0.01	0 mm	Ant B	1102M	4	1:2.076	front	0.534	1.312	0.701	
1850.20	512	GSM 1900	GPRS	23.0	21.84	-0.10	0 mm	Ant B	1102M	4	1:2.076	bottom	1.740	1.306	2.272	A129
1880.00	661	GSM 1900	GPRS	23.0	21.82	-0.02	0 mm	Ant B	1102M	4	1:2.076	bottom	1.520	1.312	1.994	
1909.80	810	GSM 1900	GPRS	23.0	21.69	-0.04	0 mm	Ant B	1102M	4	1:2.076	bottom	1.650	1.352	2.231	
ANSI / IEEE C95.1 1992 - SAFETY LIMIT Spatial Peak Uncontrolled Exposure/General Population								Extremity 4.0 W/kg (mW/g) averaged over 10 grams								

**Table 11-110
UMTS 850 UMPC Extremity SAR**

MEASUREMENT RESULTS																
FREQUENCY		Mode	Service	Maximum Allowed Power [dBm]	Conducted Power [dBm]	Power Drift [dB]	Spacing	Antenna Config.	Tune State	Device Serial Number	Duty Cycle	Side	SAR (10g)	Scaling Factor	Reported SAR (10g)	Plot #
MHz	Ch.												(W/kg)		(W/kg)	
826.40	4132	UMTS 850	RMC	25.8	24.31	-0.04	0 mm	Ant A	0	0744M	1:1	back	1.410	1.409	1.987	
836.60	4183	UMTS 850	RMC	25.8	24.32	-0.05	0 mm	Ant A	0	0744M	1:1	back	1.510	1.406	2.123	
846.60	4233	UMTS 850	RMC	25.8	24.25	-0.04	0 mm	Ant A	0	0744M	1:1	back	1.670	1.429	2.386	A130
836.60	4183	UMTS 850	RMC	25.8	24.32	0.00	0 mm	Ant A	0	0744M	1:1	front	1.120	1.406	1.575	
836.60	4183	UMTS 850	RMC	25.8	24.32	-0.05	0 mm	Ant A	0	0744M	1:1	bottom	0.799	1.406	1.123	
836.60	4183	UMTS 850	RMC	25.8	24.32	-0.10	0 mm	Ant A	0	0744M	1:1	right	1.420	1.406	1.997	
ANSI / IEEE C95.1 1992 - SAFETY LIMIT Spatial Peak Uncontrolled Exposure/General Population								Extremity 4.0 W/kg (mW/g) averaged over 10 grams								



FCC ID: A3LSMF916U		SAR EVALUATION REPORT		Approved by: Quality Manager
Document S/N: 1M2005200087-01-R2.A3L	Test Dates: 06/28/20-08/24/20	DUT Type: Portable Handset		Page 177 of 267

Table 11-111
UMTS 1750 UMPC Extremity SAR

MEASUREMENT RESULTS															
FREQUENCY		Mode	Service	Maximum Allowed Power [dBm]	Conducted Power [dBm]	Power Drift [dB]	Spacing	Antenna Config.	Device Serial Number	Duty Cycle	Side	SAR (10g)	Scaling Factor	Reported SAR (10g)	Plot #
MHz	Ch.											(W/kg)		(W/kg)	
1732.40	1412	UMTS 1750	RMC	25.5	24.24	-0.02	12 mm	Ant B	1134M	1:1	back	0.469	1.337	0.627	
1732.40	1412	UMTS 1750	RMC	25.5	24.24	0.09	9 mm	Ant B	1134M	1:1	front	0.438	1.337	0.586	
1732.40	1412	UMTS 1750	RMC	25.5	24.24	0.00	16 mm	Ant B	1134M	1:1	bottom	0.399	1.337	0.533	
1712.40	1312	UMTS 1750	RMC	25.5	24.11	0.01	0 mm	Ant B	1134M	1:1	right	1.700	1.377	2.341	
1732.40	1412	UMTS 1750	RMC	25.5	24.24	0.02	0 mm	Ant B	1134M	1:1	right	1.850	1.337	2.473	
1752.60	1513	UMTS 1750	RMC	25.5	23.53	0.02	0 mm	Ant B	1134M	1:1	right	1.510	1.574	2.377	
1732.40	1412	UMTS 1750	RMC	20.0	18.93	0.05	0 mm	Ant B	1134M	1:1	back	1.420	1.279	1.816	
1732.40	1412	UMTS 1750	RMC	20.0	18.93	-0.08	0 mm	Ant B	1134M	1:1	front	0.996	1.279	1.274	
1712.40	1312	UMTS 1750	RMC	20.0	18.75	0.00	0 mm	Ant B	1134M	1:1	bottom	2.320	1.334	3.095	
1732.40	1412	UMTS 1750	RMC	20.0	18.93	0.00	0 mm	Ant B	1134M	1:1	bottom	2.460	1.279	3.146	A131
1752.60	1513	UMTS 1750	RMC	20.0	18.90	-0.02	0 mm	Ant B	1134M	1:1	bottom	2.360	1.288	3.040	
ANSI / IEEE C95.1 1992 - SAFETY LIMIT Spatial Peak Uncontrolled Exposure/General Population							Extremity 4.0 W/kg (mW/g) averaged over 10 grams								

Table 11-112
UMTS 1900 UMPC Extremity SAR

MEASUREMENT RESULTS															
FREQUENCY		Mode	Service	Maximum Allowed Power [dBm]	Conducted Power [dBm]	Power Drift [dB]	Spacing	Antenna Config.	Device Serial Number	Duty Cycle	Side	SAR (10g)	Scaling Factor	Reported SAR (10g)	Plot #
MHz	Ch.											(W/kg)		(W/kg)	
1880.00	9400	UMTS 1900	RMC	24.5	23.81	-0.03	12 mm	Ant B	0018M	1:1	back	0.410	1.172	0.481	
1880.00	9400	UMTS 1900	RMC	24.5	23.81	0.04	9 mm	Ant B	0018M	1:1	front	0.426	1.172	0.499	
1880.00	9400	UMTS 1900	RMC	24.5	23.81	-0.08	16 mm	Ant B	0018M	1:1	bottom	0.452	1.172	0.530	
1852.40	9262	UMTS 1900	RMC	24.5	23.60	0.02	0 mm	Ant B	0018M	1:1	right	2.550	1.230	3.137	
1880.00	9400	UMTS 1900	RMC	24.5	23.81	0.02	0 mm	Ant B	0018M	1:1	right	2.100	1.172	2.461	
1907.60	9538	UMTS 1900	RMC	24.5	23.82	0.07	0 mm	Ant B	0018M	1:1	right	2.620	1.169	3.063	A132
1880.00	9400	UMTS 1900	RMC	20.0	18.63	-0.12	0 mm	Ant B	0018M	1:1	back	0.919	1.371	1.260	
1880.00	9400	UMTS 1900	RMC	20.0	18.63	-0.01	0 mm	Ant B	0018M	1:1	front	0.699	1.371	0.958	
1852.40	9262	UMTS 1900	RMC	20.0	19.01	0.11	0 mm	Ant B	0018M	1:1	bottom	2.390	1.256	3.002	
1880.00	9400	UMTS 1900	RMC	20.0	18.63	0.14	0 mm	Ant B	0018M	1:1	bottom	2.010	1.371	2.756	
1907.60	9538	UMTS 1900	RMC	20.0	18.94	0.14	0 mm	Ant B	0018M	1:1	bottom	2.280	1.276	2.909	
1907.60	9538	UMTS 1900	RMC	24.5	23.82	0.03	0 mm	Ant B	0018M	1:1	right	2.530	1.169	2.958	
ANSI / IEEE C95.1 1992 - SAFETY LIMIT Spatial Peak Uncontrolled Exposure/General Population							Extremity 4.0 W/kg (mW/g) averaged over 10 grams								

Note: Blue entry represents variability measurement



FCC ID: A3LSMF916U	 PCTEST <small>Prove it to be part of Samsung</small>	SAR EVALUATION REPORT		Approved by: Quality Manager
Document S/N: 1M2005200087-01-R2.A3L	Test Dates: 06/28/20-08/24/20	DUT Type: Portable Handset	Page 178 of 267	

Table 11-113
LTE Band 71 UMPC Extremity SAR

MEASUREMENT RESULTS																					
FREQUENCY		Mode	Bandwidth [MHz]	Tune State	Maximum Allowed Power [dBm]	Conducted Power [dBm]	Power Drift [dB]	MPR [dB]	Antenna Config.	Serial Number	Modulation	RB Size	RB Offset	Spacing	Side	Duty Cycle	SAR (10g)	Scaling Factor	Reported SAR (10g)	Plot #	
MHz	Ch.																(W/kg)		(W/kg)		
680.50	133297	Mid	LTE Band 71	20	9	25.8	24.67	0.00	0	Ant A	0069M	QPSK	1	0	0 mm	back	1:1	1.180	1.297	1.530	A133
680.50	133297	Mid	LTE Band 71	20	9	24.8	23.77	-0.05	1	Ant A	0069M	QPSK	50	50	0 mm	back	1:1	0.883	1.268	1.120	
680.50	133297	Mid	LTE Band 71	20	9	25.8	24.67	-0.03	0	Ant A	0069M	QPSK	1	0	0 mm	front	1:1	0.704	1.297	0.913	
680.50	133297	Mid	LTE Band 71	20	9	24.8	23.77	-0.03	1	Ant A	0069M	QPSK	50	50	0 mm	front	1:1	0.518	1.268	0.657	
680.50	133297	Mid	LTE Band 71	20	9	25.8	24.67	-0.12	0	Ant A	0069M	QPSK	1	0	0 mm	bottom	1:1	0.728	1.297	0.944	
680.50	133297	Mid	LTE Band 71	20	9	24.8	23.77	-0.11	1	Ant A	0069M	QPSK	50	50	0 mm	bottom	1:1	0.520	1.268	0.659	
680.50	133297	Mid	LTE Band 71	20	9	25.8	24.67	-0.03	0	Ant A	0069M	QPSK	1	0	0 mm	right	1:1	0.998	1.297	1.294	
680.50	133297	Mid	LTE Band 71	20	9	24.8	23.77	0.00	1	Ant A	0069M	QPSK	50	50	0 mm	right	1:1	0.819	1.268	1.038	
ANSI / IEEE C95.1 1992 - SAFETY LIMIT Spatial Peak Uncontrolled Exposure/General Population										Extremity 4.0 W/kg (mW/g) averaged over 10 grams											



Table 11-114
LTE Band 12 UMPC Extremity SAR

MEASUREMENT RESULTS																					
FREQUENCY		Mode	Bandwidth [MHz]	Tune State	Maximum Allowed Power [dBm]	Conducted Power [dBm]	Power Drift [dB]	MPR [dB]	Antenna Config.	Serial Number	Modulation	RB Size	RB Offset	Spacing	Side	Duty Cycle	SAR (10g)	Scaling Factor	Reported SAR (10g)	Plot #	
MHz	Ch.																(W/kg)		(W/kg)		
707.50	23095	Mid	LTE Band 12	10	9	25.8	25.10	-0.10	0	Ant A	0069M	QPSK	1	49	0 mm	back	1:1	0.850	1.175	0.999	
707.50	23095	Mid	LTE Band 12	10	9	24.8	24.06	-0.12	1	Ant A	0069M	QPSK	25	25	0 mm	back	1:1	0.733	1.186	0.869	
707.50	23095	Mid	LTE Band 12	10	9	25.8	25.10	0.01	0	Ant A	0069M	QPSK	1	49	0 mm	front	1:1	0.711	1.175	0.835	
707.50	23095	Mid	LTE Band 12	10	9	24.8	24.06	-0.01	1	Ant A	0069M	QPSK	25	25	0 mm	front	1:1	0.603	1.186	0.715	
707.50	23095	Mid	LTE Band 12	10	9	25.8	25.10	-0.02	0	Ant A	0069M	QPSK	1	49	0 mm	bottom	1:1	0.606	1.175	0.712	
707.50	23095	Mid	LTE Band 12	10	9	24.8	24.06	-0.16	1	Ant A	0069M	QPSK	25	25	0 mm	bottom	1:1	0.521	1.186	0.618	
707.50	23095	Mid	LTE Band 12	10	9	25.8	25.10	-0.09	0	Ant A	0069M	QPSK	1	49	0 mm	right	1:1	1.120	1.175	1.316	A134
707.50	23095	Mid	LTE Band 12	10	9	24.8	24.06	-0.05	1	Ant A	0069M	QPSK	25	25	0 mm	right	1:1	0.936	1.186	1.110	
ANSI / IEEE C95.1 1992 - SAFETY LIMIT Spatial Peak Uncontrolled Exposure/General Population										Extremity 4.0 W/kg (mW/g) averaged over 10 grams											

Table 11-115
LTE Band 13 UMPC Extremity SAR

MEASUREMENT RESULTS																					
FREQUENCY		Mode	Bandwidth [MHz]	Tune State	Maximum Allowed Power [dBm]	Conducted Power [dBm]	Power Drift [dB]	MPR [dB]	Antenna Config.	Serial Number	Modulation	RB Size	RB Offset	Spacing	Side	Duty Cycle	SAR (10g)	Scaling Factor	Reported SAR (10g)	Plot #	
MHz	Ch.																(W/kg)		(W/kg)		
782.00	23230	Mid	LTE Band 13	10	10	25.8	24.15	0.10	0	Ant A	0069M	QPSK	1	49	0 mm	back	1:1	1.150	1.462	1.681	
782.00	23230	Mid	LTE Band 13	10	10	24.8	23.35	0.05	1	Ant A	0069M	QPSK	25	0	0 mm	back	1:1	1.020	1.396	1.424	
782.00	23230	Mid	LTE Band 13	10	10	25.8	24.15	-0.03	0	Ant A	0069M	QPSK	1	49	0 mm	front	1:1	1.030	1.462	1.506	
782.00	23230	Mid	LTE Band 13	10	10	24.8	23.35	0.01	1	Ant A	0069M	QPSK	25	0	0 mm	front	1:1	0.822	1.396	1.148	
782.00	23230	Mid	LTE Band 13	10	10	25.8	24.15	0.07	0	Ant A	0069M	QPSK	1	49	0 mm	bottom	1:1	0.764	1.462	1.117	
782.00	23230	Mid	LTE Band 13	10	10	24.8	23.35	0.04	1	Ant A	0069M	QPSK	25	0	0 mm	bottom	1:1	0.639	1.396	0.892	
782.00	23230	Mid	LTE Band 13	10	10	25.8	24.15	-0.02	0	Ant A	0069M	QPSK	1	49	0 mm	right	1:1	1.270	1.462	1.857	A135
782.00	23230	Mid	LTE Band 13	10	10	24.8	23.35	-0.06	1	Ant A	0069M	QPSK	25	0	0 mm	right	1:1	1.020	1.396	1.424	
782.00	23230	Mid	LTE Band 13	10	N/A	23.8	22.33	-0.02	0	Ant B	0069M	QPSK	1	0	0 mm	back	1:1	0.986	1.403	1.383	
782.00	23230	Mid	LTE Band 13	10	N/A	22.8	21.48	-0.03	1	Ant B	0069M	QPSK	25	0	0 mm	back	1:1	0.850	1.355	1.152	
782.00	23230	Mid	LTE Band 13	10	N/A	23.8	22.33	-0.06	0	Ant B	0069M	QPSK	1	0	0 mm	front	1:1	0.336	1.403	0.471	
782.00	23230	Mid	LTE Band 13	10	N/A	22.8	21.48	-0.06	1	Ant B	0069M	QPSK	25	0	0 mm	front	1:1	0.292	1.355	0.396	
782.00	23230	Mid	LTE Band 13	10	N/A	23.8	22.33	0.00	0	Ant B	0069M	QPSK	1	0	0 mm	bottom	1:1	0.644	1.403	0.904	
782.00	23230	Mid	LTE Band 13	10	N/A	22.8	21.48	-0.09	1	Ant B	0069M	QPSK	25	0	0 mm	bottom	1:1	0.560	1.355	0.759	
782.00	23230	Mid	LTE Band 13	10	N/A	23.8	22.33	0.10	0	Ant B	0069M	QPSK	1	0	0 mm	right	1:1	0.044	1.403	0.062	
782.00	23230	Mid	LTE Band 13	10	N/A	22.8	21.48	0.10	1	Ant B	0069M	QPSK	25	0	0 mm	right	1:1	0.038	1.355	0.051	
ANSI / IEEE C95.1 1992 - SAFETY LIMIT Spatial Peak Uncontrolled Exposure/General Population										Extremity 4.0 W/kg (mW/g) averaged over 10 grams											

Table 11-116



FCC ID: A3LSMF916U	 PCTEST Proud to be part of Samsung	SAR EVALUATION REPORT		Approved by: Quality Manager
Document S/N: 1M2005200087-01-R2.A3L	Test Dates: 06/28/20-08/24/20	DUT Type: Portable Handset	Page 179 of 267	

LTE Band 14 UMPC Extremity SAR

MEASUREMENT RESULTS																					
FREQUENCY		Mode	Bandwidth [MHz]	Tune State	Maximum Allowed Power [dBm]	Conducted Power [dBm]	Power Drift [dB]	MPR [dB]	Antenna Config.	Serial Number	Modulation	RB Size	RB Offset	Spacing	Side	Duty Cycle	SAR (10g) (W/kg)	Scaling Factor	Reported SAR (10g) (W/kg)	Plot #	
MHz	Ch.																				
793.00	23330	Mid	LTE Band 14	10	9	25.8	24.11	0.01	0	Ant A	0069M	QPSK	1	0	0 mm	back	1:1	1.470	1.476	2.170	A136
793.00	23330	Mid	LTE Band 14	10	9	24.8	23.14	-0.05	1	Ant A	0069M	QPSK	25	12	0 mm	back	1:1	1.220	1.466	1.789	
793.00	23330	Mid	LTE Band 14	10	9	24.8	23.04	-0.11	1	Ant A	0069M	QPSK	50	0	0 mm	back	1:1	1.060	1.500	1.590	
793.00	23330	Mid	LTE Band 14	10	9	25.8	24.11	-0.02	0	Ant A	0069M	QPSK	1	0	0 mm	front	1:1	1.100	1.476	1.624	
793.00	23330	Mid	LTE Band 14	10	9	24.8	23.14	0.01	1	Ant A	0069M	QPSK	25	12	0 mm	front	1:1	0.894	1.466	1.311	
793.00	23330	Mid	LTE Band 14	10	9	25.8	24.11	0.01	0	Ant A	0069M	QPSK	1	0	0 mm	bottom	1:1	0.701	1.476	1.035	
793.00	23330	Mid	LTE Band 14	10	9	24.8	23.14	0.02	1	Ant A	0069M	QPSK	25	12	0 mm	bottom	1:1	0.546	1.466	0.800	
793.00	23330	Mid	LTE Band 14	10	9	25.8	24.11	0.03	0	Ant A	0069M	QPSK	1	0	0 mm	right	1:1	1.270	1.476	1.875	
793.00	23330	Mid	LTE Band 14	10	9	24.8	23.14	0.12	1	Ant A	0069M	QPSK	25	12	0 mm	right	1:1	1.020	1.466	1.495	
793.00	23330	Mid	LTE Band 14	10	N/A	23.8	22.42	-0.11	0	Ant B	0069M	QPSK	1	0	0 mm	back	1:1	1.050	1.374	1.443	
793.00	23330	Mid	LTE Band 14	10	N/A	22.8	21.36	-0.05	1	Ant B	0069M	QPSK	25	12	0 mm	back	1:1	0.871	1.393	1.213	
793.00	23330	Mid	LTE Band 14	10	N/A	23.8	22.42	-0.02	0	Ant B	0069M	QPSK	1	0	0 mm	front	1:1	0.511	1.374	0.702	
793.00	23330	Mid	LTE Band 14	10	N/A	22.8	21.36	-0.03	1	Ant B	0069M	QPSK	25	12	0 mm	front	1:1	0.439	1.393	0.612	
793.00	23330	Mid	LTE Band 14	10	N/A	23.8	22.42	0.01	0	Ant B	0069M	QPSK	1	0	0 mm	bottom	1:1	0.804	1.374	1.105	
793.00	23330	Mid	LTE Band 14	10	N/A	22.8	21.36	-0.03	1	Ant B	0069M	QPSK	25	12	0 mm	bottom	1:1	0.635	1.393	0.885	
793.00	23330	Mid	LTE Band 14	10	N/A	23.8	22.42	0.06	0	Ant B	0069M	QPSK	1	0	0 mm	right	1:1	0.063	1.374	0.087	
793.00	23330	Mid	LTE Band 14	10	N/A	22.8	21.36	0.06	1	Ant B	0069M	QPSK	25	12	0 mm	right	1:1	0.055	1.393	0.077	
ANSI / IEEE C95.1 1992 - SAFETY LIMIT Spatial Peak Uncontrolled Exposure/General Population										Extremity 4.0 W/kg (mW/g) averaged over 10 grams											

Table 11-117
LTE Band 26 (Cell) UMPC Extremity SAR

MEASUREMENT RESULTS																					
FREQUENCY		Mode	Bandwidth [MHz]	Tune State	Maximum Allowed Power [dBm]	Conducted Power [dBm]	Power Drift [dB]	MPR [dB]	Antenna Config.	Serial Number	Modulation	RB Size	RB Offset	Spacing	Side	Duty Cycle	SAR (10g) (W/kg)	Scaling Factor	Reported SAR (10g) (W/kg)	Plot #	
MHz	Ch.																				
831.50	26865	Mid	LTE Band 26 (Cell)	15	0	25.8	24.74	-0.02	0	Ant A	0069M	QPSK	1	36	0 mm	back	1:1	1.620	1.276	2.067	A137
831.50	26865	Mid	LTE Band 26 (Cell)	15	0	24.8	23.84	0.01	1	Ant A	0069M	QPSK	36	37	0 mm	back	1:1	1.340	1.247	1.671	
831.50	26865	Mid	LTE Band 26 (Cell)	15	0	24.8	23.72	0.01	1	Ant A	0069M	QPSK	75	0	0 mm	back	1:1	1.360	1.282	1.744	
831.50	26865	Mid	LTE Band 26 (Cell)	15	0	25.8	24.74	0.06	0	Ant A	0069M	QPSK	1	36	0 mm	front	1:1	1.230	1.276	1.569	
831.50	26865	Mid	LTE Band 26 (Cell)	15	0	24.8	23.84	0.02	1	Ant A	0069M	QPSK	36	37	0 mm	front	1:1	0.992	1.247	1.237	
831.50	26865	Mid	LTE Band 26 (Cell)	15	0	25.8	24.74	-0.04	0	Ant A	0069M	QPSK	1	36	0 mm	bottom	1:1	0.800	1.276	1.021	
831.50	26865	Mid	LTE Band 26 (Cell)	15	0	24.8	23.84	-0.08	1	Ant A	0069M	QPSK	36	37	0 mm	bottom	1:1	0.621	1.247	0.774	
831.50	26865	Mid	LTE Band 26 (Cell)	15	0	25.8	24.74	-0.08	0	Ant A	0069M	QPSK	1	36	0 mm	right	1:1	1.250	1.276	1.595	
831.50	26865	Mid	LTE Band 26 (Cell)	15	0	24.8	23.84	-0.03	1	Ant A	0069M	QPSK	36	37	0 mm	right	1:1	1.040	1.247	1.297	
ANSI / IEEE C95.1 1992 - SAFETY LIMIT Spatial Peak Uncontrolled Exposure/General Population										Extremity 4.0 W/kg (mW/g) averaged over 10 grams											

FCC ID: A3LSMF916U	 <small>Proud to be part of Samsung</small>	SAR EVALUATION REPORT		Approved by: Quality Manager
Document S/N: 1M2005200087-01-R2-A3L	Test Dates: 06/28/20-08/24/20	DUT Type: Portable Handset	Page 180 of 267	

**Table 11-118
LTE Band 5 (Cell) UMPC Extremity SAR**

MEASUREMENT RESULTS																							
1 CC Uplink 2 CC Uplink	Component Carrier	FREQUENCY		Mode	Bandwidth [MHz]	Tune State	Maximum Allowed Power [dBm]	Conducted Power [dBm]	Power Drift [dB]	MPR [dB]	Antenna Config.	Serial Number	Modulation	RB Size	RB Offset	Spacing	Side	Duty Cycle	SAR (10g)	Scaling Factor	Reported SAR	Plot #	
		MHz	Ch.																(W/kg)		(W/kg)		
1 CC Uplink	N/A	836.50	20525	Mid	LTE Band 5 (Cell)	10	0	25.8	24.85	-0.04	0	Ant A	0905M	QPSK	1	0	0 mm	back	1:1	1.830	1.245	2.278	A138
1 CC Uplink	N/A	836.50	20525	Mid	LTE Band 5 (Cell)	10	0	24.8	23.98	-0.07	1	Ant A	0905M	QPSK	25	12	0 mm	back	1:1	1.470	1.208	1.776	
1 CC Uplink	N/A	836.50	20525	Mid	LTE Band 5 (Cell)	10	0	24.8	23.78	-0.06	1	Ant A	0905M	QPSK	50	0	0 mm	back	1:1	1.450	1.265	1.834	
2 CC Uplink	PCC	836.50	20525	Mid	LTE Band 5 (Cell)	10	0	25.8	24.26	-0.04	0	Ant A	0905M	QPSK	1	0	0 mm	back	1:1	1.660	1.426	2.367	
	SCC	829.30	20453																				
1 CC Uplink	N/A	836.50	20525	Mid	LTE Band 5 (Cell)	10	0	25.8	24.85	0.00	0	Ant A	0905M	QPSK	1	0	0 mm	front	1:1	1.270	1.245	1.581	
1 CC Uplink	N/A	836.50	20525	Mid	LTE Band 5 (Cell)	10	0	24.8	23.98	0.01	1	Ant A	0905M	QPSK	25	12	0 mm	front	1:1	1.020	1.208	1.232	
1 CC Uplink	N/A	836.50	20525	Mid	LTE Band 5 (Cell)	10	0	25.8	24.85	-0.02	0	Ant A	0905M	QPSK	1	0	0 mm	bottom	1:1	0.695	1.245	0.865	
1 CC Uplink	N/A	836.50	20525	Mid	LTE Band 5 (Cell)	10	0	24.8	23.98	-0.11	1	Ant A	0905M	QPSK	25	12	0 mm	bottom	1:1	0.570	1.208	0.889	
1 CC Uplink	N/A	836.50	20525	Mid	LTE Band 5 (Cell)	10	0	25.8	24.85	-0.04	0	Ant A	0905M	QPSK	1	0	0 mm	right	1:1	1.400	1.245	1.743	
1 CC Uplink	N/A	836.50	20525	Mid	LTE Band 5 (Cell)	10	0	24.8	23.98	0.04	1	Ant A	0905M	QPSK	25	12	0 mm	right	1:1	1.180	1.208	1.425	
ANSI / IEEE C95.1 1992 - SAFETY LIMIT Spatial Peak Uncontrolled Exposure/General Population										Extremity 4.0 W/kg (mW/g) averaged over 10 grams													

**Table 11-119
LTE Band 66 (AWS) UMPC Extremity SAR**

MEASUREMENT RESULTS																						
1 CC Uplink 2 CC Uplink	Component Carrier	FREQUENCY		Mode	Bandwidth [MHz]	Maximum Allowed Power [dBm]	Conducted Power [dBm]	Power Drift [dB]	MPR [dB]	Antenna Config.	Serial Number	Modulation	RB Size	RB Offset	Spacing	Side	Duty Cycle	SAR (10g)	Scaling Factor	Reported SAR	Plot #	
		MHz	Ch.															(W/kg)		(W/kg)		
1 CC Uplink	N/A	1770.00	132572	High	LTE Band 66 (AWS)	20	25.0	24.30	-0.02	0	Ant B	1133M	QPSK	1	99	12 mm	back	1:1	0.342	1.175	0.402	
1 CC Uplink	N/A	1770.00	132572	High	LTE Band 66 (AWS)	20	24.0	23.32	-0.05	1	Ant B	1133M	QPSK	50	25	12 mm	back	1:1	0.277	1.169	0.324	
1 CC Uplink	N/A	1770.00	132572	High	LTE Band 66 (AWS)	20	25.0	24.30	0.04	0	Ant B	1133M	QPSK	1	99	9 mm	front	1:1	0.476	1.175	0.559	
1 CC Uplink	N/A	1770.00	132572	High	LTE Band 66 (AWS)	20	24.0	23.32	0.02	1	Ant B	1133M	QPSK	50	25	9 mm	front	1:1	0.382	1.169	0.447	
1 CC Uplink	N/A	1770.00	132572	High	LTE Band 66 (AWS)	20	25.0	24.30	-0.02	0	Ant B	1133M	QPSK	1	99	16 mm	bottom	1:1	0.328	1.175	0.385	
1 CC Uplink	N/A	1770.00	132572	High	LTE Band 66 (AWS)	20	24.0	23.32	-0.02	1	Ant B	1133M	QPSK	50	25	16 mm	bottom	1:1	0.268	1.169	0.313	
1 CC Uplink	N/A	1770.00	132572	High	LTE Band 66 (AWS)	20	25.0	24.30	-0.10	0	Ant B	1133M	QPSK	1	99	0 mm	right	1:1	1.390	1.175	1.633	
1 CC Uplink	N/A	1770.00	132572	High	LTE Band 66 (AWS)	20	24.0	23.32	-0.01	1	Ant B	1133M	QPSK	50	25	0 mm	right	1:1	1.160	1.169	1.356	
1 CC Uplink	N/A	1770.00	132572	High	LTE Band 66 (AWS)	20	20.0	19.53	-0.01	0	Ant B	1133M	QPSK	1	99	0 mm	back	1:1	1.690	1.114	1.883	
1 CC Uplink	N/A	1770.00	132572	High	LTE Band 66 (AWS)	20	20.0	19.54	-0.02	0	Ant B	1133M	QPSK	50	25	0 mm	back	1:1	1.740	1.112	1.935	
1 CC Uplink	N/A	1770.00	132572	High	LTE Band 66 (AWS)	20	20.0	19.53	-0.05	0	Ant B	1133M	QPSK	1	99	0 mm	front	1:1	0.930	1.114	1.036	
1 CC Uplink	N/A	1770.00	132572	High	LTE Band 66 (AWS)	20	20.0	19.54	-0.07	0	Ant B	1133M	QPSK	50	25	0 mm	front	1:1	0.951	1.112	1.058	
1 CC Uplink	N/A	1720.00	132072	Low	LTE Band 66 (AWS)	20	20.0	18.92	-0.05	0	Ant B	1133M	QPSK	1	50	0 mm	bottom	1:1	2.320	1.282	2.974	
1 CC Uplink	N/A	1745.00	132322	Mid	LTE Band 66 (AWS)	20	20.0	19.26	-0.04	0	Ant B	1133M	QPSK	1	50	0 mm	bottom	1:1	2.480	1.186	2.941	
1 CC Uplink	N/A	1770.00	132572	High	LTE Band 66 (AWS)	20	20.0	19.53	-0.04	0	Ant B	1133M	QPSK	1	99	0 mm	bottom	1:1	2.690	1.114	2.997	
1 CC Uplink	N/A	1720.00	132072	Low	LTE Band 66 (AWS)	20	20.0	19.28	-0.06	0	Ant B	1133M	QPSK	50	25	0 mm	bottom	1:1	2.460	1.180	2.903	
1 CC Uplink	N/A	1745.00	132322	Mid	LTE Band 66 (AWS)	20	20.0	19.47	-0.06	0	Ant B	1133M	QPSK	50	25	0 mm	bottom	1:1	2.650	1.130	2.995	
1 CC Uplink	N/A	1770.00	132572	High	LTE Band 66 (AWS)	20	20.0	19.50	-0.07	0	Ant B	1133M	QPSK	50	0	0 mm	bottom	1:1	2.800	1.122	3.142	
1 CC Uplink	N/A	1770.00	132572	High	LTE Band 66 (AWS)	20	20.0	19.54	-0.06	0	Ant B	1133M	QPSK	50	25	0 mm	bottom	1:1	2.830	1.112	3.147	
1 CC Uplink	N/A	1775.00	132622	High	LTE Band 66 (AWS)	10	20.0	19.51	-0.03	0	Ant B	1133M	QPSK	25	0	0 mm	bottom	1:1	2.810	1.119	3.144	
1 CC Uplink	N/A	1770.00	132572	High	LTE Band 66 (AWS)	20	20.0	19.47	-0.05	0	Ant B	1133M	QPSK	100	0	0 mm	bottom	1:1	2.380	1.130	2.689	
2 CC Uplink 66C	PCC	1770.00	132572	High	LTE Band 66 (AWS)	20	20.0	19.92	-0.03	0	Ant B	1133M	QPSK	50	0	0 mm	bottom	1:1	2.940	1.019	2.996	A139
	SCC	1750.20	132374																			
2 CC Uplink 66B	PCC	1775.00	132622	High	LTE Band 66 (AWS)	10	20.0	19.72	-0.04	0	Ant B	1133M	QPSK	25	0	0 mm	bottom	1:1	2.810	1.067	2.998	
	SCC	1765.10	132523																			
ANSI / IEEE C95.1 1992 - SAFETY LIMIT Spatial Peak Uncontrolled Exposure/General Population										Extremity 4.0 W/kg (mW/g) averaged over 10 grams												



FCC ID: A3LSMF916U		SAR EVALUATION REPORT		Approved by: Quality Manager
Document S/N: 1M2005200087-01-R2.A3L	Test Dates: 06/28/20-08/24/20	DUT Type: Portable Handset	Page 181 of 267	

Table 11-120
LTE Band 25 (PCS) UMPC Extremity SAR

MEASUREMENT RESULTS																				
FREQUENCY			Mode	Bandwidth [MHz]	Maximum Allowed Power [dBm]	Conducted Power [dBm]	Power Drift [dB]	MPR [dB]	Antenna Config.	Serial Number	Modulation	RB Size	RB Offset	Spacing	Side	Duty Cycle	SAR (10g) (W/kg)	Scaling Factor	Reported SAR (10g) (W/kg)	Plot #
MHz	Ch.																			
1860.00	26140	Low	LTE Band 25 (PCS)	20	25.5	24.47	-0.04	0	Ant B	1138M	QPSK	1	0	12 mm	back	1:1	0.367	1.268	0.465	
1860.00	26140	Low	LTE Band 25 (PCS)	20	24.5	23.68	-0.07	1	Ant B	1138M	QPSK	50	0	12 mm	back	1:1	0.284	1.208	0.343	
1860.00	26140	Low	LTE Band 25 (PCS)	20	25.5	24.47	-0.02	0	Ant B	1138M	QPSK	1	0	9 mm	front	1:1	0.389	1.268	0.493	
1860.00	26140	Low	LTE Band 25 (PCS)	20	24.5	23.68	0.02	1	Ant B	1138M	QPSK	50	0	9 mm	front	1:1	0.301	1.208	0.364	
1860.00	26140	Low	LTE Band 25 (PCS)	20	25.5	24.47	-0.09	0	Ant B	1138M	QPSK	1	0	16 mm	bottom	1:1	0.334	1.268	0.424	
1860.00	26140	Low	LTE Band 25 (PCS)	20	24.5	23.68	0.01	1	Ant B	1138M	QPSK	50	0	16 mm	bottom	1:1	0.267	1.208	0.323	
1860.00	26140	Low	LTE Band 25 (PCS)	20	25.5	24.47	-0.03	0	Ant B	1138M	QPSK	1	0	0 mm	right	1:1	1.130	1.268	1.433	
1860.00	26140	Low	LTE Band 25 (PCS)	20	24.5	23.68	-0.01	1	Ant B	1138M	QPSK	50	0	0 mm	right	1:1	0.867	1.208	1.047	
1860.00	26140	Low	LTE Band 25 (PCS)	20	20.0	19.22	0.10	0	Ant B	1138M	QPSK	1	0	0 mm	back	1:1	1.160	1.197	1.389	
1860.00	26140	Low	LTE Band 25 (PCS)	20	20.0	19.21	0.06	0	Ant B	1138M	QPSK	50	0	0 mm	back	1:1	1.180	1.199	1.415	
1860.00	26140	Low	LTE Band 25 (PCS)	20	20.0	19.22	-0.09	0	Ant B	1138M	QPSK	1	0	0 mm	front	1:1	0.678	1.197	0.812	
1860.00	26140	Low	LTE Band 25 (PCS)	20	20.0	19.21	-0.08	0	Ant B	1138M	QPSK	50	0	0 mm	front	1:1	0.680	1.199	0.815	
1860.00	26140	Low	LTE Band 25 (PCS)	20	20.0	19.22	-0.02	0	Ant B	1138M	QPSK	1	0	0 mm	bottom	1:1	1.980	1.197	2.370	
1882.50	26365	Mid	LTE Band 25 (PCS)	20	20.0	18.76	-0.03	0	Ant B	1138M	QPSK	1	0	0 mm	bottom	1:1	1.850	1.330	2.461	
1905.00	26590	High	LTE Band 25 (PCS)	20	20.0	18.99	-0.08	0	Ant B	1138M	QPSK	1	99	0 mm	bottom	1:1	2.150	1.262	2.713	
1860.00	26140	Low	LTE Band 25 (PCS)	20	20.0	19.21	-0.02	0	Ant B	1138M	QPSK	50	0	0 mm	bottom	1:1	2.020	1.199	2.422	
1882.50	26365	Mid	LTE Band 25 (PCS)	20	20.0	18.88	-0.09	0	Ant B	1138M	QPSK	50	0	0 mm	bottom	1:1	1.850	1.294	2.394	
1905.00	26590	High	LTE Band 25 (PCS)	20	20.0	18.99	-0.03	0	Ant B	1138M	QPSK	50	50	0 mm	bottom	1:1	2.330	1.262	2.940	A140
1860.00	26140	Low	LTE Band 25 (PCS)	20	20.0	19.07	-0.02	0	Ant B	1138M	QPSK	100	0	0 mm	bottom	1:1	1.960	1.239	2.428	
ANSI / IEEE C95.1 1992 - SAFETY LIMIT Spatial Peak Uncontrolled Exposure/General Population										Extremity 4.0 W/kg (mW/g) averaged over 10 grams										

Table 11-121
LTE Band 30 UMPC Extremity SAR

MEASUREMENT RESULTS																				
FREQUENCY			Mode	Bandwidth [MHz]	Maximum Allowed Power [dBm]	Conducted Power [dBm]	Power Drift [dB]	MPR [dB]	Antenna Config.	Serial Number	Modulation	RB Size	RB Offset	Spacing	Side	Duty Cycle	SAR (10g) (W/kg)	Scaling Factor	Reported SAR (10g) (W/kg)	Plot #
MHz	Ch.																			
2310.00	27710	Mid	LTE Band 30	10	25.0	23.84	0.03	0	Ant B	1121M	QPSK	1	0	12 mm	back	1:1	0.257	1.306	0.336	
2310.00	27710	Mid	LTE Band 30	10	24.0	22.92	0.00	0	Ant B	1121M	QPSK	25	12	12 mm	back	1:1	0.203	1.282	0.260	
2310.00	27710	Mid	LTE Band 30	10	25.0	23.84	-0.02	0	Ant B	1121M	QPSK	1	0	9 mm	front	1:1	0.281	1.306	0.367	
2310.00	27710	Mid	LTE Band 30	10	24.0	22.92	0.00	0	Ant B	1121M	QPSK	25	12	9 mm	front	1:1	0.219	1.282	0.281	
2310.00	27710	Mid	LTE Band 30	10	25.0	23.84	-0.01	0	Ant B	1121M	QPSK	1	0	16 mm	bottom	1:1	0.319	1.306	0.417	
2310.00	27710	Mid	LTE Band 30	10	24.0	22.92	-0.01	0	Ant B	1121M	QPSK	25	12	16 mm	bottom	1:1	0.253	1.282	0.324	
2310.00	27710	Mid	LTE Band 30	10	25.0	23.84	-0.08	0	Ant B	1121M	QPSK	1	0	0 mm	right	1:1	0.544	1.306	0.710	
2310.00	27710	Mid	LTE Band 30	10	24.0	22.92	-0.12	0	Ant B	1121M	QPSK	25	12	0 mm	right	1:1	0.446	1.282	0.572	
2310.00	27710	Mid	LTE Band 30	10	20.5	18.90	0.04	0	Ant B	1121M	QPSK	1	25	0 mm	back	1:1	0.578	1.445	0.835	
2310.00	27710	Mid	LTE Band 30	10	20.5	18.99	-0.03	0	Ant B	1121M	QPSK	25	12	0 mm	back	1:1	0.593	1.416	0.840	
2310.00	27710	Mid	LTE Band 30	10	20.5	18.90	0.00	0	Ant B	1121M	QPSK	1	25	0 mm	front	1:1	0.519	1.445	0.750	
2310.00	27710	Mid	LTE Band 30	10	20.5	18.99	0.04	0	Ant B	1121M	QPSK	25	12	0 mm	front	1:1	0.527	1.416	0.746	
2310.00	27710	Mid	LTE Band 30	10	20.5	18.90	-0.07	0	Ant B	1121M	QPSK	1	25	0 mm	bottom	1:1	1.990	1.445	2.876	
2310.00	27710	Mid	LTE Band 30	10	20.5	18.99	-0.08	0	Ant B	1121M	QPSK	25	12	0 mm	bottom	1:1	2.030	1.416	2.874	A141
2310.00	27710	Mid	LTE Band 30	10	20.5	18.87	-0.12	0	Ant B	1121M	QPSK	50	0	0 mm	bottom	1:1	1.990	1.455	2.895	
ANSI / IEEE C95.1 1992 - SAFETY LIMIT Spatial Peak Uncontrolled Exposure/General Population										Extremity 4.0 W/kg (mW/g) averaged over 10 grams										



FCC ID: A3LSMF916U		SAR EVALUATION REPORT		Approved by: Quality Manager
Document S/N: 1M2005200087-01-R2-A3L	Test Dates: 06/28/20-08/24/20	DUT Type: Portable Handset	Page 182 of 267	

Table 11-122
LTE Band 7 UMPC Extremity SAR

MEASUREMENT RESULTS																				
FREQUENCY		Mode	Bandwidth [MHz]	Maximum Allowed Power [dBm]	Conducted Power [dBm]	Power Drift [dB]	MPR [dB]	Antenna Config.	Serial Number	Modulation	RB Size	RB Offset	Spacing	Side	Duty Cycle	SAR (10g) (W/kg)	Scaling Factor	Reported SAR (10g) (W/kg)	Plot #	
MHz	Ch.																			
2510.00	20850	Low	LTE Band 7	20	22.0	21.92	0.08	0	Ant B	0909M	QPSK	1	0	12 mm	back	1:1	0.441	1.019	0.449	
2510.00	20850	Low	LTE Band 7	20	22.0	22.00	0.00	0	Ant B	0909M	QPSK	50	25	12 mm	back	1:1	0.460	1.000	0.460	
2510.00	20850	Low	LTE Band 7	20	22.0	21.92	-0.01	0	Ant B	0909M	QPSK	1	0	9 mm	front	1:1	0.405	1.019	0.413	
2510.00	20850	Low	LTE Band 7	20	22.0	22.00	-0.02	0	Ant B	0909M	QPSK	50	25	9 mm	front	1:1	0.431	1.000	0.431	
2510.00	20850	Low	LTE Band 7	20	22.0	21.92	0.04	0	Ant B	0909M	QPSK	1	0	16 mm	bottom	1:1	0.414	1.019	0.422	
2510.00	20850	Low	LTE Band 7	20	22.0	22.00	0.01	0	Ant B	0909M	QPSK	50	25	16 mm	bottom	1:1	0.429	1.000	0.429	
2510.00	20850	Low	LTE Band 7	20	22.0	21.92	-0.05	0	Ant B	0909M	QPSK	1	0	0 mm	right	1:1	0.325	1.019	0.331	
2510.00	20850	Low	LTE Band 7	20	22.0	22.00	-0.03	0	Ant B	0909M	QPSK	50	25	0 mm	right	1:1	0.359	1.000	0.359	
2560.00	21350	High	LTE Band 7	20	19.5	18.67	-0.03	0	Ant B	0909M	QPSK	1	0	0 mm	back	1:1	1.330	1.211	1.611	
2560.00	21350	High	LTE Band 7	20	19.5	18.80	-0.02	0	Ant B	0909M	QPSK	50	25	0 mm	back	1:1	1.370	1.175	1.610	
2560.00	21350	High	LTE Band 7	20	19.5	18.67	-0.04	0	Ant B	0909M	QPSK	1	0	0 mm	front	1:1	1.190	1.211	1.441	
2560.00	21350	High	LTE Band 7	20	19.5	18.80	-0.04	0	Ant B	0909M	QPSK	50	25	0 mm	front	1:1	1.230	1.175	1.445	
2510.00	20850	Low	LTE Band 7	20	19.5	18.41	-0.02	0	Ant B	0909M	QPSK	1	99	0 mm	bottom	1:1	1.990	1.285	2.557	
2535.00	21100	Mid	LTE Band 7	20	19.5	18.65	-0.15	0	Ant B	0909M	QPSK	1	99	0 mm	bottom	1:1	2.130	1.216	2.590	
2560.00	21350	High	LTE Band 7	20	19.5	18.67	-0.02	0	Ant B	0909M	QPSK	1	0	0 mm	bottom	1:1	1.890	1.211	2.289	
2510.00	20850	Low	LTE Band 7	20	19.5	18.50	-0.02	0	Ant B	0909M	QPSK	50	25	0 mm	bottom	1:1	2.120	1.259	2.669	
2535.00	21100	Mid	LTE Band 7	20	19.5	18.74	-0.04	0	Ant B	0909M	QPSK	50	25	0 mm	bottom	1:1	2.280	1.191	2.715	A142
2560.00	21350	High	LTE Band 7	20	19.5	18.80	-0.02	0	Ant B	0909M	QPSK	50	25	0 mm	bottom	1:1	1.980	1.175	2.327	
2560.00	21350	High	LTE Band 7	20	19.5	18.66	-0.03	0	Ant B	0909M	QPSK	100	0	0 mm	bottom	1:1	2.240	1.213	2.717	
ANSI / IEEE C95.1 1992 - SAFETY LIMIT Spatial Peak Uncontrolled Exposure/General Population										Extremity 4.0 W/kg (mW/g) averaged over 10 grams										

Table 11-123
LTE Band 48 UMPC Extremity SAR

MEASUREMENT RESULTS																						
1 CC Uplink / 2 CC Uplink	Component Carrier	FREQUENCY		Mode	Bandwidth [MHz]	Maximum Allowed Power [dBm]	Conducted Power [dBm]	Power Drift [dB]	MPR [dB]	Antenna Config.	Serial Number	Modulation	RB Size	RB Offset	Spacing	Side	Duty Cycle	SAR (10g) (W/kg)	Scaling Factor	Reported SAR (10g) (W/kg)	Plot #	
		MHz	Ch.																			
1 CC Uplink	N/A	3690.00	56640	High	LTE Band 48	20	20.5	20.34	-0.06	0	Ant F	0075M	QPSK	1	50	0 mm	back	1:1.58	0.652	1.038	0.677	
1 CC Uplink	N/A	3690.00	56640	High	LTE Band 48	20	20.5	20.49	-0.09	0	Ant F	0075M	QPSK	50	0	0 mm	back	1:1.58	0.635	1.002	0.636	
1 CC Uplink	N/A	3690.00	56640	High	LTE Band 48	20	20.5	20.34	-0.02	0	Ant F	0075M	QPSK	1	50	0 mm	front	1:1.58	0.590	1.038	0.612	
1 CC Uplink	N/A	3690.00	56640	High	LTE Band 48	20	20.5	20.49	-0.18	0	Ant F	0075M	QPSK	50	0	0 mm	front	1:1.58	0.590	1.002	0.591	
1 CC Uplink	N/A	3560.00	55340	Low	LTE Band 48	20	20.5	20.01	0.13	0	Ant F	0075M	QPSK	1	50	0 mm	top	1:1.58	1.360	1.119	1.522	
1 CC Uplink	N/A	3603.30	55773	Low-Mid	LTE Band 48	20	20.5	19.85	0.10	0	Ant F	0075M	QPSK	1	50	0 mm	top	1:1.58	1.380	1.161	1.602	
1 CC Uplink	N/A	3646.70	56207	Mid-High	LTE Band 48	20	20.5	20.20	0.02	0	Ant F	0075M	QPSK	1	50	0 mm	top	1:1.58	1.570	1.072	1.683	
1 CC Uplink	N/A	3690.00	56640	High	LTE Band 48	20	20.5	20.34	0.08	0	Ant F	0075M	QPSK	1	50	0 mm	top	1:1.58	1.790	1.038	1.858	
1 CC Uplink	N/A	3560.00	55340	Low	LTE Band 48	20	20.5	20.00	0.08	0	Ant F	0075M	QPSK	50	25	0 mm	top	1:1.58	1.400	1.122	1.571	
1 CC Uplink	N/A	3603.30	55773	Low-Mid	LTE Band 48	20	20.5	19.98	0.06	0	Ant F	0075M	QPSK	50	0	0 mm	top	1:1.58	1.440	1.127	1.623	
1 CC Uplink	N/A	3646.70	56207	Mid-High	LTE Band 48	20	20.5	20.21	0.03	0	Ant F	0075M	QPSK	50	25	0 mm	top	1:1.58	1.610	1.069	1.721	
1 CC Uplink	N/A	3690.00	56640	High	LTE Band 48	20	20.5	20.49	0.03	0	Ant F	0075M	QPSK	50	0	0 mm	top	1:1.58	1.810	1.002	1.814	
1 CC Uplink	N/A	3690.00	56640	High	LTE Band 48	20	20.5	20.33	0.05	0	Ant F	0075M	QPSK	100	0	0 mm	top	1:1.58	1.840	1.040	1.914	
2 CC Uplink	PCC	3690.00	56640	High	LTE Band 48	20	20.5	20.50	0.05	0	Ant F	0075M	QPSK	100	0	0 mm	top	1:1.58	1.860	1.000	1.860	A143
	SCC	3670.20	56442																			
ANSI / IEEE C95.1 1992 - SAFETY LIMIT Spatial Peak Uncontrolled Exposure/General Population										Extremity 4.0 W/kg (mW/g) averaged over 10 grams												





FCC ID: A3LSMF916U		SAR EVALUATION REPORT		Approved by: Quality Manager
Document S/N: 1M2005200087-01-R2-A3L	Test Dates: 06/28/20-08/24/20	DUT Type: Portable Handset		Page 183 of 267

Table 11-124
LTE Band 41 UMPC Extremity SAR

MEASUREMENT RESULTS																				
FREQUENCY		Mode	Bandwidth [MHz]	Maximum Allowed Power [dBm]	Conducted Power [dBm]	Power Drift [dB]	MPR [dB]	Antenna Config.	Serial Number	Modulation	RB Size	RB Offset	Spacing	Side	Duty Cycle	SAR (10g) (W/kg)	Scaling Factor	Reported SAR (10g) (W/kg)	Plot #	
MHz	Ch.																			
2680.00	41490	High	LTE Band 41	20	23.5	22.89	-0.04	0	Ant B	0901M	QPSK	1	50	12 mm	back	1:1.58	0.455	1.151	0.524	
2680.00	41490	High	LTE Band 41	20	23.5	23.05	-0.03	0	Ant B	0901M	QPSK	50	50	12 mm	back	1:1.58	0.449	1.109	0.498	
2680.00	41490	High	LTE Band 41	20	23.5	22.89	0.02	0	Ant B	0901M	QPSK	1	50	9 mm	front	1:1.58	0.423	1.151	0.487	
2680.00	41490	High	LTE Band 41	20	23.5	23.05	0.03	0	Ant B	0901M	QPSK	50	50	9 mm	front	1:1.58	0.423	1.109	0.469	
2680.00	41490	High	LTE Band 41	20	23.5	22.89	-0.17	0	Ant B	0901M	QPSK	1	50	16 mm	bottom	1:1.58	0.443	1.151	0.510	
2680.00	41490	High	LTE Band 41	20	23.5	23.05	-0.19	0	Ant B	0901M	QPSK	50	50	16 mm	bottom	1:1.58	0.444	1.109	0.492	
2680.00	41490	High	LTE Band 41	20	23.5	22.89	-0.11	0	Ant B	0901M	QPSK	1	50	0 mm	right	1:1.58	0.448	1.151	0.516	
2680.00	41490	High	LTE Band 41	20	23.5	23.05	-0.15	0	Ant B	0901M	QPSK	50	50	0 mm	right	1:1.58	0.453	1.109	0.502	
2506.00	39750	Low	LTE Band 41	20	20.0	18.70	0.09	0	Ant B	0901M	QPSK	1	0	0 mm	back	1:1.58	1.460	1.349	1.970	
2549.50	40185	Low-Mid	LTE Band 41	20	20.0	18.75	0.01	0	Ant B	0901M	QPSK	1	0	0 mm	back	1:1.58	1.690	1.334	2.254	
2593.00	40620	Mid	LTE Band 41	20	20.0	18.93	0.03	0	Ant B	0901M	QPSK	1	50	0 mm	back	1:1.58	1.930	1.279	2.468	
2636.50	41055	Mid-High	LTE Band 41	20	20.0	19.08	0.02	0	Ant B	0901M	QPSK	1	50	0 mm	back	1:1.58	1.990	1.236	2.460	
2680.00	41490	High	LTE Band 41	20	20.0	19.39	0.01	0	Ant B	0901M	QPSK	1	50	0 mm	back	1:1.58	2.040	1.151	2.348	
2506.00	39750	Low	LTE Band 41	20	20.0	18.87	0.07	0	Ant B	0901M	QPSK	50	0	0 mm	back	1:1.58	1.550	1.297	2.010	
2549.50	40185	Low-Mid	LTE Band 41	20	20.0	18.99	0.07	0	Ant B	0901M	QPSK	50	25	0 mm	back	1:1.58	1.830	1.262	2.309	
2593.00	40620	Mid	LTE Band 41	20	20.0	19.12	0.03	0	Ant B	0901M	QPSK	50	25	0 mm	back	1:1.58	2.030	1.225	2.487	
2636.50	41055	Mid-High	LTE Band 41	20	20.0	19.27	-0.04	0	Ant B	0901M	QPSK	50	25	0 mm	back	1:1.58	2.130	1.183	2.520	A144
2680.00	41490	High	LTE Band 41	20	20.0	19.47	0.01	0	Ant B	0901M	QPSK	50	25	0 mm	back	1:1.58	2.130	1.130	2.407	
2680.00	41490	High	LTE Band 41	20	20.0	19.38	0.07	0	Ant B	0901M	QPSK	100	0	0 mm	back	1:1.58	2.020	1.153	2.329	
2680.00	41490	High	LTE Band 41	20	20.0	19.39	0.10	0	Ant B	0901M	QPSK	1	50	0 mm	front	1:1.58	1.030	1.151	1.186	
2680.00	41490	High	LTE Band 41	20	20.0	19.47	0.10	0	Ant B	0901M	QPSK	50	25	0 mm	front	1:1.58	1.110	1.130	1.254	
2506.00	39750	Low	LTE Band 41	20	20.0	18.70	-0.02	0	Ant B	0901M	QPSK	1	0	0 mm	bottom	1:1.58	1.540	1.349	2.077	
2549.50	40185	Low-Mid	LTE Band 41	20	20.0	18.75	-0.17	0	Ant B	0901M	QPSK	1	0	0 mm	bottom	1:1.58	1.580	1.334	2.108	
2593.00	40620	Mid	LTE Band 41	20	20.0	18.93	-0.18	0	Ant B	0901M	QPSK	1	50	0 mm	bottom	1:1.58	1.650	1.279	2.110	
2636.50	41055	Mid-High	LTE Band 41	20	20.0	19.08	-0.02	0	Ant B	0901M	QPSK	1	50	0 mm	bottom	1:1.58	1.720	1.236	2.126	
2680.00	41490	High	LTE Band 41	20	20.0	19.39	-0.14	0	Ant B	0901M	QPSK	1	50	0 mm	bottom	1:1.58	1.670	1.151	1.922	
2506.00	39750	Low	LTE Band 41	20	20.0	18.87	-0.02	0	Ant B	0901M	QPSK	50	0	0 mm	bottom	1:1.58	1.580	1.297	2.049	
2549.50	40185	Low-Mid	LTE Band 41	20	20.0	18.99	-0.02	0	Ant B	0901M	QPSK	50	25	0 mm	bottom	1:1.58	1.660	1.262	2.095	
2593.00	40620	Mid	LTE Band 41	20	20.0	19.12	-0.02	0	Ant B	0901M	QPSK	50	25	0 mm	bottom	1:1.58	1.720	1.225	2.107	
2636.50	41055	Mid-High	LTE Band 41	20	20.0	19.27	-0.11	0	Ant B	0901M	QPSK	50	25	0 mm	bottom	1:1.58	1.730	1.183	2.047	
2680.00	41490	High	LTE Band 41	20	20.0	19.47	-0.14	0	Ant B	0901M	QPSK	50	25	0 mm	bottom	1:1.58	1.720	1.130	1.944	
2680.00	41490	High	LTE Band 41	20	20.0	19.38	-0.19	0	Ant B	0901M	QPSK	100	0	0 mm	bottom	1:1.58	1.800	1.153	2.075	
ANSI / IEEE C95.1 1992 - SAFETY LIMIT										Extremity										
Spatial Peak										4.0 W/kg (mW/g)										
Uncontrolled Exposure/General Population										averaged over 10 grams										

FCC ID: A3LSMF916U		SAR EVALUATION REPORT		Approved by: Quality Manager
Document S/N: 1M2005200087-01-R2.A3L	Test Dates: 06/28/20-08/24/20	DUT Type: Portable Handset	Page 184 of 267	

**Table 11-125
NR Band n71 UMPC Extremity SAR**

MEASUREMENT RESULTS																				
FREQUENCY		Mode	Bandwidth [MHz]	Maximum Allowed Power [dBm]	Conducted Power [dBm]	Power Drift [dB]	MPR [dB]	Antenna Config.	Serial Number	Modulation	RB Size	RB Offset	Spacing	Side	Duty Cycle	SAR (10g)	Scaling Factor	Reported SAR (10g)	Plot #	
MHz	Ch.															(W/kg)		(W/kg)		
680.50	136100	Mid	NR Band n71	20	25.5	25.42	-0.06	0	Ant A	1126M	DFT-S-OFDM QPSK	1	53	0 mm	back	1:1	1.210	1.019	1.233	A145
680.50	136100	Mid	NR Band n71	20	25.5	25.44	-0.13	0	Ant A	1126M	DFT-S-OFDM QPSK	50	28	0 mm	back	1:1	1.070	1.014	1.085	
680.50	136100	Mid	NR Band n71	20	24.0	24.00	-0.16	1.5	Ant A	1126M	CP-OFDM QPSK	1	1	0 mm	back	1:1	0.561	1.000	0.561	
680.50	136100	Mid	NR Band n71	20	25.5	25.42	-0.01	0	Ant A	1126M	DFT-S-OFDM QPSK	1	53	0 mm	front	1:1	0.905	1.019	0.922	
680.50	136100	Mid	NR Band n71	20	25.5	25.44	0.06	0	Ant A	1126M	DFT-S-OFDM QPSK	50	28	0 mm	front	1:1	0.905	1.014	0.918	
680.50	136100	Mid	NR Band n71	20	25.5	25.42	-0.03	0	Ant A	1126M	DFT-S-OFDM QPSK	1	53	0 mm	bottom	1:1	0.824	1.019	0.840	
680.50	136100	Mid	NR Band n71	20	25.5	25.44	-0.03	0	Ant A	1126M	DFT-S-OFDM QPSK	50	28	0 mm	bottom	1:1	0.838	1.014	0.850	
680.50	136100	Mid	NR Band n71	20	25.5	25.42	-0.15	0	Ant A	1126M	DFT-S-OFDM QPSK	1	53	0 mm	right	1:1	0.737	1.019	0.751	
680.50	136100	Mid	NR Band n71	20	25.5	25.44	-0.14	0	Ant A	1126M	DFT-S-OFDM QPSK	50	28	0 mm	right	1:1	0.688	1.014	0.698	
ANSI / IEEE C95.1 1992 - SAFETY LIMIT Spatial Peak Uncontrolled Exposure/General Population										Extremity 4.0 W/kg (mW/g) averaged over 10 grams										

**Table 11-126
NR Band n5 (Cell) UMPC Extremity SAR**

MEASUREMENT RESULTS																				
FREQUENCY		Mode	Bandwidth [MHz]	Maximum Allowed Power [dBm]	Conducted Power [dBm]	Power Drift [dB]	MPR [dB]	Antenna Config.	Serial Number	Modulation	RB Size	RB Offset	Spacing	Side	Duty Cycle	SAR (10g)	Scaling Factor	Reported SAR (10g)	Plot #	
MHz	Ch.															(W/kg)		(W/kg)		
836.50	167300	Mid	NR Band n5 (Cell)	20	25.5	25.03	0.00	0	Ant A	0887M	DFT-S-OFDM QPSK	1	53	0 mm	back	1:1	1.660	1.114	1.849	
836.50	167300	Mid	NR Band n5 (Cell)	20	25.5	25.01	-0.01	0	Ant A	0887M	DFT-S-OFDM QPSK	50	28	0 mm	back	1:1	1.690	1.119	1.891	A146
836.50	167300	Mid	NR Band n5 (Cell)	20	24.0	23.52	-0.06	1.5	Ant A	0887M	CP-OFDM QPSK	1	1	0 mm	back	1:1	1.140	1.117	1.273	
836.50	167300	Mid	NR Band n5 (Cell)	20	25.5	25.03	0.00	0	Ant A	0887M	DFT-S-OFDM QPSK	1	53	0 mm	front	1:1	1.220	1.114	1.359	
836.50	167300	Mid	NR Band n5 (Cell)	20	25.5	25.01	-0.03	0	Ant A	0887M	DFT-S-OFDM QPSK	50	28	0 mm	front	1:1	1.210	1.119	1.354	
836.50	167300	Mid	NR Band n5 (Cell)	20	25.5	25.03	0.09	0	Ant A	0887M	DFT-S-OFDM QPSK	1	53	0 mm	bottom	1:1	0.724	1.114	0.807	
836.50	167300	Mid	NR Band n5 (Cell)	20	25.5	25.01	0.00	0	Ant A	0887M	DFT-S-OFDM QPSK	50	28	0 mm	bottom	1:1	0.730	1.119	0.817	
836.50	167300	Mid	NR Band n5 (Cell)	20	25.5	25.03	-0.05	0	Ant A	0887M	DFT-S-OFDM QPSK	1	53	0 mm	right	1:1	0.884	1.114	0.985	
836.50	167300	Mid	NR Band n5 (Cell)	20	25.5	25.01	0.02	0	Ant A	0887M	DFT-S-OFDM QPSK	50	28	0 mm	right	1:1	0.855	1.119	0.957	
ANSI / IEEE C95.1 1992 - SAFETY LIMIT Spatial Peak Uncontrolled Exposure/General Population										Extremity 4.0 W/kg (mW/g) averaged over 10 grams										



FCC ID: A3LSMF916U	 PCTEST <small>Proud to be part of Samsung</small>	SAR EVALUATION REPORT		Approved by: Quality Manager
Document S/N: 1M2005200087-01-R2.A3L	Test Dates: 06/28/20-08/24/20	DUT Type: Portable Handset	Page 185 of 267	

Table 11-127
NR Band n66 (AWS) UMPC Extremity SAR

MEASUREMENT RESULTS																				
FREQUENCY		Mode	Bandwidth [MHz]	Maximum Allowed Power [dBm]	Conducted Power [dBm]	Power Drift [dB]	MPR [dB]	Antenna Config.	Serial Number	Modulation	RB Size	RB Offset	Spacing	Side	Duty Cycle	SAR (10g)	Scaling Factor	Reported SAR (10g)	Plot #	
MHz	Ch.															(W/kg)		(W/kg)		
1770.00	354000	High	NR Band n66 (AWS)	20	24.5	23.84	-0.06	0	Ant B	0898M	DFT-S-OFDM QPSK	1	104	12 mm	back	1:1	0.368	1.164	0.428	
1770.00	354000	High	NR Band n66 (AWS)	20	24.5	23.73	0.03	0	Ant B	0898M	DFT-S-OFDM QPSK	50	28	12 mm	back	1:1	0.409	1.194	0.488	
1770.00	354000	High	NR Band n66 (AWS)	20	24.5	23.84	-0.08	0	Ant B	0898M	DFT-S-OFDM QPSK	1	104	9 mm	front	1:1	0.413	1.164	0.481	
1770.00	354000	High	NR Band n66 (AWS)	20	24.5	23.73	-0.03	0	Ant B	0898M	DFT-S-OFDM QPSK	50	28	9 mm	front	1:1	0.402	1.194	0.480	
1770.00	354000	High	NR Band n66 (AWS)	20	24.5	23.84	-0.03	0	Ant B	0898M	DFT-S-OFDM QPSK	1	104	16 mm	bottom	1:1	0.384	1.164	0.447	
1770.00	354000	High	NR Band n66 (AWS)	20	24.5	23.73	0.04	0	Ant B	0898M	DFT-S-OFDM QPSK	50	28	16 mm	bottom	1:1	0.374	1.194	0.447	
1770.00	354000	High	NR Band n66 (AWS)	20	24.5	23.84	0.00	0	Ant B	0898M	DFT-S-OFDM QPSK	1	104	0 mm	right	1:1	1.310	1.164	1.525	
1770.00	354000	High	NR Band n66 (AWS)	20	24.5	23.73	-0.04	0	Ant B	0898M	DFT-S-OFDM QPSK	50	28	0 mm	right	1:1	1.250	1.194	1.493	
1770.00	354000	High	NR Band n66 (AWS)	20	19.5	19.49	0.03	0	Ant B	0898M	DFT-S-OFDM QPSK	1	104	0 mm	back	1:1	1.550	1.002	1.553	
1770.00	354000	High	NR Band n66 (AWS)	20	19.5	19.45	-0.01	0	Ant B	0898M	DFT-S-OFDM QPSK	50	0	0 mm	back	1:1	1.570	1.012	1.589	
1770.00	354000	High	NR Band n66 (AWS)	20	19.5	19.49	-0.14	0	Ant B	0898M	DFT-S-OFDM QPSK	1	104	0 mm	front	1:1	1.050	1.002	1.052	
1770.00	354000	High	NR Band n66 (AWS)	20	19.5	19.45	-0.15	0	Ant B	0898M	DFT-S-OFDM QPSK	50	0	0 mm	front	1:1	1.060	1.012	1.073	
1720.00	344000	Low	NR Band n66 (AWS)	20	19.5	19.21	-0.17	0	Ant B	0898M	DFT-S-OFDM QPSK	1	104	0 mm	bottom	1:1	2.730	1.069	2.918	
1745.00	349000	Mid	NR Band n66 (AWS)	20	19.5	19.36	-0.04	0	Ant B	0898M	DFT-S-OFDM QPSK	1	1	0 mm	bottom	1:1	2.830	1.033	2.923	
1770.00	354000	High	NR Band n66 (AWS)	20	19.5	19.49	-0.04	0	Ant B	0898M	DFT-S-OFDM QPSK	1	104	0 mm	bottom	1:1	2.930	1.002	2.936	
1720.00	344000	Low	NR Band n66 (AWS)	20	19.5	19.20	-0.15	0	Ant B	0898M	DFT-S-OFDM QPSK	50	0	0 mm	bottom	1:1	2.840	1.072	3.044	
1745.00	349000	Mid	NR Band n66 (AWS)	20	19.5	19.43	-0.11	0	Ant B	0898M	DFT-S-OFDM QPSK	50	0	0 mm	bottom	1:1	2.800	1.016	2.845	
1770.00	354000	High	NR Band n66 (AWS)	20	19.5	19.45	-0.04	0	Ant B	0898M	DFT-S-OFDM QPSK	50	0	0 mm	bottom	1:1	2.910	1.012	2.945	
1770.00	354000	High	NR Band n66 (AWS)	20	19.5	19.41	-0.03	0	Ant B	0898M	DFT-S-OFDM QPSK	100	0	0 mm	bottom	1:1	3.000	1.021	3.063	A147
1770.00	354000	High	NR Band n66 (AWS)	20	19.5	19.50	-0.02	0	Ant B	0898M	CP-OFDM QPSK	1	1	0 mm	bottom	1:1	2.860	1.000	2.860	
1770.00	354000	High	NR Band n66 (AWS)	20	19.5	19.41	-0.17	0	Ant B	0898M	DFT-S-OFDM QPSK	100	0	0 mm	bottom	1:1	2.970	1.021	3.032	
ANSI / IEEE C95.1 1992 - SAFETY LIMIT Spatial Peak Uncontrolled Exposure/General Population										Extremity 4.0 W/kg (mW/g) averaged over 10 grams										

Note: Blue entry represents variability measurement





FCC ID: A3LSMF916U	 PCTEST <small>Proud to be part of Samsung</small>	SAR EVALUATION REPORT		Approved by: Quality Manager
Document S/N: 1M2005200087-01-R2.A3L	Test Dates: 06/28/20-08/24/20	DUT Type: Portable Handset	Page 186 of 267	

Table 11-128
NR Band n25 (PCS) UMPC Extremity SAR

MEASUREMENT RESULTS																				
FREQUENCY		Mode	Bandwidth [MHz]	Maximum Allowed Power [dBm]	Conducted Power [dBm]	Power Drift [dB]	MPR [dB]	Antenna Config.	Serial Number	Modulation	RB Size	RB Offset	Spacing	Side	Duty Cycle	SAR (10g) (W/kg)	Scaling Factor	Reported SAR (10g) (W/kg)	Plot #	
MHz	Ch.																			
1882.50	376500	Mid	NR Band n25 (PCS)	20	24.5	23.86	-0.01	0	Ant B	1130M	DFT-S-OFDM QPSK	1	53	12 mm	back	1:1	0.345	1.159	0.400	
1882.50	376500	Mid	NR Band n25 (PCS)	20	24.5	23.76	-0.03	0	Ant B	1130M	DFT-S-OFDM QPSK	50	28	12 mm	back	1:1	0.343	1.186	0.407	
1882.50	376500	Mid	NR Band n25 (PCS)	20	24.5	23.86	-0.01	0	Ant B	1130M	DFT-S-OFDM QPSK	1	53	9 mm	front	1:1	0.345	1.159	0.400	
1882.50	376500	Mid	NR Band n25 (PCS)	20	24.5	23.76	-0.04	0	Ant B	1130M	DFT-S-OFDM QPSK	50	28	9 mm	front	1:1	0.325	1.186	0.385	
1882.50	376500	Mid	NR Band n25 (PCS)	20	24.5	23.86	-0.02	0	Ant B	1130M	DFT-S-OFDM QPSK	1	53	16 mm	bottom	1:1	0.434	1.159	0.503	
1882.50	376500	Mid	NR Band n25 (PCS)	20	24.5	23.76	-0.01	0	Ant B	1130M	DFT-S-OFDM QPSK	50	28	16 mm	bottom	1:1	0.425	1.186	0.504	
1860.00	372000	Low	NR Band n25 (PCS)	20	24.5	23.80	0.04	0	Ant B	1130M	DFT-S-OFDM QPSK	1	53	0 mm	right	1:1	2.340	1.175	2.750	A148
1882.50	376500	Mid	NR Band n25 (PCS)	20	24.5	23.86	-0.08	0	Ant B	1130M	DFT-S-OFDM QPSK	1	53	0 mm	right	1:1	2.050	1.159	2.376	
1905.00	381000	High	NR Band n25 (PCS)	20	24.5	23.74	-0.08	0	Ant B	1130M	DFT-S-OFDM QPSK	1	53	0 mm	right	1:1	2.080	1.191	2.477	
1860.00	372000	Low	NR Band n25 (PCS)	20	24.5	23.75	-0.10	0	Ant B	1130M	DFT-S-OFDM QPSK	50	28	0 mm	right	1:1	1.900	1.189	2.259	
1882.50	376500	Mid	NR Band n25 (PCS)	20	24.5	23.76	-0.09	0	Ant B	1130M	DFT-S-OFDM QPSK	50	28	0 mm	right	1:1	2.120	1.186	2.514	
1905.00	381000	High	NR Band n25 (PCS)	20	24.5	23.57	-0.11	0	Ant B	1130M	DFT-S-OFDM QPSK	50	28	0 mm	right	1:1	1.890	1.239	2.342	
1860.00	372000	Low	NR Band n25 (PCS)	20	23.5	22.81	-0.12	1	Ant B	1130M	DFT-S-OFDM QPSK	100	0	0 mm	right	1:1	1.880	1.172	2.203	
1860.00	372000	Low	NR Band n25 (PCS)	20	23.0	22.44	0.04	1.5	Ant B	1130M	CP-OFDM QPSK	1	1	0 mm	right	1:1	1.560	1.138	1.775	
1882.50	376500	Mid	NR Band n25 (PCS)	20	19.5	18.94	0.02	0	Ant B	1130M	DFT-S-OFDM QPSK	1	1	0 mm	back	1:1	0.751	1.138	0.855	
1882.50	376500	Mid	NR Band n25 (PCS)	20	19.5	19.02	-0.07	0	Ant B	1130M	DFT-S-OFDM QPSK	50	0	0 mm	back	1:1	0.753	1.117	0.841	
1882.50	376500	Mid	NR Band n25 (PCS)	20	19.5	18.94	-0.05	0	Ant B	1130M	DFT-S-OFDM QPSK	1	1	0 mm	front	1:1	0.587	1.138	0.668	
1882.50	376500	Mid	NR Band n25 (PCS)	20	19.5	19.02	0.00	0	Ant B	1130M	DFT-S-OFDM QPSK	50	0	0 mm	front	1:1	0.574	1.117	0.641	
1860.00	372000	Low	NR Band n25 (PCS)	20	19.5	18.70	-0.05	0	Ant B	1130M	DFT-S-OFDM QPSK	1	1	0 mm	bottom	1:1	2.010	1.202	2.416	
1882.50	376500	Mid	NR Band n25 (PCS)	20	19.5	18.94	-0.03	0	Ant B	1130M	DFT-S-OFDM QPSK	1	1	0 mm	bottom	1:1	1.800	1.138	2.048	
1905.00	381000	High	NR Band n25 (PCS)	20	19.5	18.68	-0.03	0	Ant B	1130M	DFT-S-OFDM QPSK	1	53	0 mm	bottom	1:1	1.700	1.208	2.054	
1882.50	376500	Mid	NR Band n25 (PCS)	20	19.5	19.02	-0.10	0	Ant B	1130M	DFT-S-OFDM QPSK	50	0	0 mm	bottom	1:1	1.750	1.117	1.955	
1882.50	376500	Mid	NR Band n25 (PCS)	20	19.5	18.92	-0.03	0	Ant B	1130M	DFT-S-OFDM QPSK	100	0	0 mm	bottom	1:1	1.690	1.143	1.932	
ANSI / IEEE C95.1 1992 - SAFETY LIMIT Spatial Peak Uncontrolled Exposure/General Population										Extremity 4.0 W/kg (mW/g) averaged over 10 grams										



Table 11-129
NR Band n41 UMPC Extremity SAR

MEASUREMENT RESULTS																				
FREQUENCY		Mode	Bandwidth [MHz]	Maximum Allowed Power [dBm]	Conducted Power [dBm]	Power Drift [dB]	MPR [dB]	Antenna Config.	Serial Number	Modulation	RB Size	RB Offset	Spacing	Side	Duty Cycle	SAR (10g) (W/kg)	Scaling Factor	Reported SAR (10g) (W/kg)	Plot #	
MHz	Ch.																			
2592.99	518598	Mid	NR Band n41	100	25.0	24.16	0.07	0	Ant F	1296M	DFT-S-OFDM QPSK	1	1	0 mm	back	1:4	0.423	1.213	0.513	
2592.99	518598	Mid	NR Band n41	100	25.0	23.87	0.08	0	Ant F	1296M	DFT-S-OFDM QPSK	135	69	0 mm	back	1:4	0.402	1.297	0.521	
2592.99	518598	Mid	NR Band n41	100	25.0	24.16	-0.05	0	Ant F	1296M	DFT-S-OFDM QPSK	1	1	0 mm	front	1:4	0.327	1.213	0.397	
2592.99	518598	Mid	NR Band n41	100	25.0	23.87	-0.05	0	Ant F	1296M	DFT-S-OFDM QPSK	135	69	0 mm	front	1:4	0.358	1.297	0.464	
2592.99	518598	Mid	NR Band n41	100	25.0	24.16	-0.06	0	Ant F	1296M	DFT-S-OFDM QPSK	1	1	0 mm	top	1:4	1.020	1.213	1.237	A149
2592.99	518598	Mid	NR Band n41	100	25.0	23.87	-0.03	0	Ant F	1296M	DFT-S-OFDM QPSK	135	69	0 mm	top	1:4	0.976	1.297	1.266	
2592.99	518598	Mid	NR Band n41	100	23.5	22.79	0.00	1.5	Ant F	1296M	CP-OFDM QPSK	1	1	0 mm	top	1:4	0.711	1.178	0.838	
ANSI / IEEE C95.1 1992 - SAFETY LIMIT Spatial Peak Uncontrolled Exposure/General Population										Extremity 4.0 W/kg (mW/g) averaged over 10 grams										

FCC ID: A3LSMF916U	 <small>Proud to be part of Samsung</small>	SAR EVALUATION REPORT		Approved by: Quality Manager
Document S/N: 1M2005200087-01-R2.A3L	Test Dates: 06/28/20-08/24/20	DUT Type: Portable Handset	Page 187 of 267	

**Table 11-130
WLAN UMPC Extremity SAR**

MEASUREMENT RESULTS																		
FREQUENCY		Mode	Service	Bandwidth [MHz]	Maximum Allowed Power [dBm]	Conducted Power [dBm]	Power Drift [dB]	Spacing	Antenna Config.	Device Serial Number	Data Rate (Mbps)	Side	Duty Cycle (%)	SAR (10g)	Scaling Factor (Power)	Scaling Factor (Duty Cycle)	Reported SAR (10g)	Plot #
MHz	Ch.													(W/kg)			(W/kg)	
2437	6	802.11b	DSSS	22	19.0	18.99	-0.07	0 mm	1	0815M	1	back	99.8	1.080	1.002	1.002	1.084	
2437	6	802.11b	DSSS	22	19.0	18.99	-0.04	0 mm	1	0815M	1	front	99.8	1.120	1.002	1.002	1.124	
2437	6	802.11b	DSSS	22	19.0	18.99	0.15	0 mm	1	0815M	1	top	99.8	1.330	1.002	1.002	1.335	
2462	11	802.11b	DSSS	22	19.0	18.94	-0.05	0 mm	2	0815M	1	back	99.9	0.623	1.014	1.001	0.632	
2462	11	802.11b	DSSS	22	19.0	18.94	0.16	0 mm	2	0815M	1	front	99.9	0.505	1.014	1.001	0.513	
2462	11	802.11b	DSSS	22	19.0	18.94	0.01	0 mm	2	0815M	1	top	99.9	0.410	1.014	1.001	0.416	
2462	11	802.11b	DSSS	22	19.0	18.94	0.01	0 mm	2	0815M	1	left	99.9	1.020	1.014	1.001	1.035	
5300	60	802.11a	OFDM	20	18.0	17.99	0.15	0 mm	1	0876M	6	back	99.2	0.884	1.002	1.008	0.893	
5300	60	802.11a	OFDM	20	18.0	17.99	-0.10	0 mm	1	0876M	6	front	99.2	0.187	1.002	1.008	0.189	
5300	60	802.11a	OFDM	20	18.0	17.99	-0.06	0 mm	1	0876M	6	top	99.2	1.430	1.002	1.008	1.444	
5300	60	802.11a	OFDM	20	18.0	17.95	-0.02	0 mm	2	0876M	6	back	99.4	1.070	1.012	1.006	1.089	
5300	60	802.11a	OFDM	20	18.0	17.95	0.04	0 mm	2	0876M	6	front	99.4	0.276	1.012	1.006	0.281	
5300	60	802.11a	OFDM	20	18.0	17.95	0.06	0 mm	2	0876M	6	top	99.4	0.404	1.012	1.006	0.411	
5300	60	802.11a	OFDM	20	18.0	17.95	-0.03	0 mm	2	0876M	6	left	99.4	0.485	1.012	1.006	0.494	
5620	124	802.11a	OFDM	20	18.0	17.99	0.04	0 mm	1	0876M	6	back	99.2	1.200	1.002	1.008	1.212	
5620	124	802.11a	OFDM	20	18.0	17.99	-0.05	0 mm	1	0876M	6	front	99.2	0.418	1.002	1.008	0.422	
5620	124	802.11a	OFDM	20	18.0	17.99	-0.15	0 mm	1	0876M	6	top	99.2	1.280	1.002	1.008	1.293	
5720	144	802.11a	OFDM	20	18.0	17.72	0.10	0 mm	2	0876M	6	back	99.4	0.756	1.067	1.006	0.811	
5720	144	802.11a	OFDM	20	18.0	17.72	0.03	0 mm	2	0876M	6	front	99.4	0.417	1.067	1.006	0.448	
5720	144	802.11a	OFDM	20	18.0	17.72	0.04	0 mm	2	0876M	6	top	99.4	0.260	1.067	1.006	0.279	
5720	144	802.11a	OFDM	20	18.0	17.72	0.03	0 mm	2	0876M	6	left	99.4	0.214	1.067	1.006	0.230	
5785	157	802.11a	OFDM	20	18.0	17.93	0.02	0 mm	1	0876M	6	back	99.2	1.270	1.016	1.008	1.301	
5785	157	802.11a	OFDM	20	18.0	17.93	-0.03	0 mm	1	0876M	6	front	99.2	0.476	1.016	1.008	0.487	
5785	157	802.11a	OFDM	20	18.0	17.93	-0.03	0 mm	1	0876M	6	top	99.2	1.380	1.016	1.008	1.413	
5785	157	802.11a	OFDM	20	18.0	17.98	-0.03	0 mm	2	0876M	6	back	99.4	0.910	1.005	1.006	0.920	
5785	157	802.11a	OFDM	20	18.0	17.98	0.02	0 mm	2	0876M	6	front	99.4	0.437	1.005	1.006	0.442	
5785	157	802.11a	OFDM	20	18.0	17.98	-0.06	0 mm	2	0876M	6	top	99.4	0.313	1.005	1.006	0.316	
5785	157	802.11a	OFDM	20	18.0	17.98	0.04	0 mm	2	0876M	6	left	99.4	0.207	1.005	1.006	0.209	
ANSI / IEEE C95.1 1992 - SAFETY LIMIT Spatial Peak Uncontrolled Exposure/General Population								Extremity 4.0 W/kg (mW/g) averaged over 10 grams										

FCC ID: A3LSMF916U	 PCTEST <small>Prove it to be part of Samsung</small>	SAR EVALUATION REPORT		Approved by: Quality Manager
Document S/N: 1M2005200087-01-R2.A3L	Test Dates: 06/28/20-08/24/20	DUT Type: Portable Handset	Page 188 of 267	

**Table 11-131
WLAN MIMO UMPC Extremity SAR**

MEASUREMENT RESULTS																				
FREQUENCY		Mode	Service	Bandwidth [MHz]	Maximum Allowed Power (Ant 1) [dBm]	Conducted Power (Ant 1) [dBm]	Maximum Allowed Power (Ant 2) [dBm]	Conducted Power (Ant 2) [dBm]	Power Drift [dB]	Spacing	Antenna Config.	Device Serial Number	Data Rate (Mbps)	Side	Duty Cycle (%)	SAR (10g)	Scaling Factor (Power)	Scaling Factor (Duty Cycle)	Reported SAR (10g)	Plot #
MHz	Ch.															(W/kg)			(W/kg)	
2437	6	802.11b	DSSS	22	19.0	18.99	19.0	18.92	-0.05	0 mm	MIMO	0815M	1	back	99.9	0.765	1.019	1.001	0.780	
2437	6	802.11b	DSSS	22	19.0	18.99	19.0	18.92	0.08	0 mm	MIMO	0815M	1	front	99.9	0.853	1.019	1.001	0.870	
2437	6	802.11b	DSSS	22	19.0	18.99	19.0	18.92	-0.12	0 mm	MIMO	0815M	1	top	99.9	1.170	1.019	1.001	1.193	
2412	1	802.11b	DSSS	22	19.0	18.87	19.0	18.76	-0.11	0 mm	MIMO	0815M	1	left	99.9	1.890	1.057	1.001	2.000	A150
2437	6	802.11b	DSSS	22	19.0	18.99	19.0	18.92	0.03	0 mm	MIMO	0815M	1	left	99.9	1.580	1.019	1.001	1.612	
2462	11	802.11b	DSSS	22	19.0	18.78	19.0	18.94	0.07	0 mm	MIMO	0815M	1	left	99.9	1.310	1.052	1.001	1.379	
5260	52	802.11n	OFDM	20	18.0	17.96	18.0	17.95	-0.13	0 mm	MIMO	0876M	13	back	98.6	0.402	1.012	1.014	0.413	
5260	52	802.11n	OFDM	20	18.0	17.96	18.0	17.95	0.04	0 mm	MIMO	0876M	13	front	98.6	0.398	1.012	1.014	0.408	
5260	52	802.11n	OFDM	20	18.0	17.96	18.0	17.95	0.15	0 mm	MIMO	0876M	13	top	98.6	1.340	1.012	1.014	1.375	
5260	52	802.11n	OFDM	20	18.0	17.96	18.0	17.95	0.08	0 mm	MIMO	0876M	13	left	98.6	0.630	1.012	1.014	0.646	
5620	124	802.11n	OFDM	20	18.0	17.91	18.0	17.99	0.05	0 mm	MIMO	0876M	13	back	98.6	0.538	1.021	1.014	0.557	
5620	124	802.11n	OFDM	20	18.0	17.91	18.0	17.99	0.09	0 mm	MIMO	0876M	13	front	98.6	0.440	1.021	1.014	0.456	
5500	100	802.11n	OFDM	20	18.0	17.99	18.0	17.87	0.13	0 mm	MIMO	0876M	13	top	98.6	1.580	1.030	1.014	1.650	
5620	124	802.11n	OFDM	20	18.0	17.91	18.0	17.99	0.15	0 mm	MIMO	0876M	13	top	98.6	1.590	1.021	1.014	1.646	
5720	144	802.11n	OFDM	20	18.0	17.94	18.0	17.65	0.15	0 mm	MIMO	0876M	13	top	98.6	1.550	1.084	1.014	1.704	
5620	124	802.11n	OFDM	20	18.0	17.91	18.0	17.99	0.03	0 mm	MIMO	0876M	13	left	98.6	0.602	1.021	1.014	0.623	
5785	157	802.11n	OFDM	20	18.0	17.78	18.0	17.81	0.03	0 mm	MIMO	0876M	13	back	98.6	1.700	1.052	1.014	1.813	
5785	157	802.11n	OFDM	20	18.0	17.78	18.0	17.81	0.03	0 mm	MIMO	0876M	13	front	98.6	0.579	1.052	1.014	0.618	
5745	149	802.11n	OFDM	20	18.0	17.99	18.0	17.34	0.03	0 mm	MIMO	0876M	13	top	98.6	1.660	1.164	1.014	1.959	
5785	157	802.11n	OFDM	20	18.0	17.78	18.0	17.81	-0.17	0 mm	MIMO	0876M	13	top	98.6	1.940	1.052	1.014	2.069	A151
5825	165	802.11n	OFDM	20	18.0	17.83	18.0	17.58	-0.08	0 mm	MIMO	0876M	13	top	98.6	1.690	1.102	1.014	1.888	
5785	157	802.11n	OFDM	20	18.0	17.78	18.0	17.81	0.10	0 mm	MIMO	0876M	13	left	98.6	0.428	1.052	1.014	0.457	
ANSI / IEEE C95.1 1992 - SAFETY LIMIT										Extremity										
Spatial Peak										4.0 W/kg (mW/g)										
Uncontrolled Exposure/General Population										averaged over 10 grams										

Note: For 2450 MHz WLAN, to achieve the 22.0 dBm maximum allowed MIMO power shown in the documentation, each antenna transmits at a maximum allowed power of 19.0 dBm. For 5GHz WLAN, to achieve the 21.0 dBm maximum allowed MIMO power shown in the documentation, each antenna transmits at a maximum allowed power of 18.0 dBm.

**Table 11-132
2.4 GHz MIMO UMPC Extremity SAR with 5 GHz WLAN**

MEASUREMENT RESULTS																				
FREQUENCY		Mode	Service	Bandwidth [MHz]	Maximum Allowed Power (Ant 1) [dBm]	Conducted Power (Ant 1) [dBm]	Maximum Allowed Power (Ant 2) [dBm]	Conducted Power (Ant 2) [dBm]	Power Drift [dB]	Spacing	Antenna Config.	Device Serial Number	Data Rate (Mbps)	Side	Duty Cycle (%)	SAR (10g)	Scaling Factor (Power)	Scaling Factor (Duty Cycle)	Reported SAR (10g)	Plot #
MHz	Ch.															(W/kg)			(W/kg)	
2437	6	802.11n	OFDM	20	17.0	16.93	17.0	16.91	0.11	0 mm	MIMO	0815M	13	back	98.7	0.731	1.021	1.013	0.756	
2437	6	802.11n	OFDM	20	17.0	16.93	17.0	16.91	0.08	0 mm	MIMO	0815M	13	front	98.7	0.500	1.021	1.013	0.517	
2437	6	802.11n	OFDM	20	17.0	16.93	17.0	16.91	-0.04	0 mm	MIMO	0815M	13	top	98.7	0.628	1.021	1.013	0.650	
2437	6	802.11n	OFDM	20	17.0	16.93	17.0	16.91	0.09	0 mm	MIMO	0815M	13	left	98.7	0.991	1.021	1.013	1.025	
ANSI / IEEE C95.1 1992 - SAFETY LIMIT										Extremity										
Spatial Peak										4.0 W/kg (mW/g)										
Uncontrolled Exposure/General Population										averaged over 10 grams										

Note: 2450 MHz WLAN MIMO was additionally evaluated at the maximum allowed output power during operations with Simultaneous 2.4 GHz and 5 GHz WLAN. 5 GHz WIFI was not transmitting during the above evaluations.



FCC ID: A3LSMF916U		SAR EVALUATION REPORT		Approved by: Quality Manager
Document S/N: 1M2005200087-01-R2.A3L	Test Dates: 06/28/20-08/24/20	DUT Type: Portable Handset	Page 189 of 267	

Table 11-133
5 GHz UMPC Extremity SAR with 2.4 GHz WLAN and/or 2.4 GHz Bluetooth

MEASUREMENT RESULTS																				
FREQUENCY		Mode	Service	Bandwidth [MHz]	Maximum Allowed Power (Ant 1) [dBm]	Conducted Power (Ant 1) [dBm]	Maximum Allowed Power (Ant 2) [dBm]	Conducted Power (Ant 2) [dBm]	Power Drift [dB]	Spacing	Antenna Config.	Device Serial Number	Data Rate (Mbps)	Side	Duty Cycle (%)	SAR (10g)	Scaling Factor (Power)	Scaling Factor (Duty Cycle)	Reported SAR (10g)	Plot #
MHz	Ch.															(W/kg)			(W/kg)	
5290	58	802.11ac	OFDM	80	14.0	13.60	14.0	13.85	-0.05	0 mm	MIMO	0876M	58.5	back	90.9	0.413	1.096	1.101	0.498	
5290	58	802.11ac	OFDM	80	14.0	13.60	14.0	13.85	0.03	0 mm	MIMO	0876M	58.5	front	90.9	0.090	1.096	1.101	0.109	
5290	58	802.11ac	OFDM	80	14.0	13.60	14.0	13.85	-0.07	0 mm	MIMO	0876M	58.5	top	90.9	0.572	1.096	1.101	0.690	
5290	58	802.11ac	OFDM	80	14.0	13.60	14.0	13.85	0.03	0 mm	MIMO	0876M	58.5	left	90.9	0.206	1.096	1.101	0.249	
5690	138	802.11ac	OFDM	80	14.0	13.59	14.0	13.68	0.16	0 mm	MIMO	0876M	58.5	back	90.9	0.469	1.099	1.101	0.567	
5690	138	802.11ac	OFDM	80	14.0	13.59	14.0	13.68	-0.13	0 mm	MIMO	0876M	58.5	front	90.9	0.155	1.099	1.101	0.188	
5690	138	802.11ac	OFDM	80	14.0	13.59	14.0	13.68	-0.17	0 mm	MIMO	0876M	58.5	top	90.9	0.614	1.099	1.101	0.743	
5690	138	802.11ac	OFDM	80	14.0	13.59	14.0	13.68	0.06	0 mm	MIMO	0876M	58.5	left	90.9	0.130	1.099	1.101	0.157	
5775	155	802.11ac	OFDM	80	14.0	13.87	14.0	13.80	0.03	0 mm	MIMO	0876M	58.5	back	90.9	0.514	1.047	1.101	0.593	
5775	155	802.11ac	OFDM	80	14.0	13.87	14.0	13.80	0.01	0 mm	MIMO	0876M	58.5	front	90.9	0.194	1.047	1.101	0.224	
5775	155	802.11ac	OFDM	80	14.0	13.87	14.0	13.80	-0.03	0 mm	MIMO	0876M	58.5	top	90.9	0.673	1.047	1.101	0.776	
5775	155	802.11ac	OFDM	80	14.0	13.87	14.0	13.80	0.08	0 mm	MIMO	0876M	58.5	left	90.9	0.136	1.047	1.101	0.157	
ANSI / IEEE C95.1 1992 - SAFETY LIMIT Spatial Peak Uncontrolled Exposure/General Population										Extremity 4.0 W/kg (mW/g) averaged over 10 grams										

Note: 5 GHz WLAN MIMO was additionally evaluated at the maximum allowed output power during operations with Simultaneous 2.4 GHz WLAN and 5 GHz WLAN or 2.4 GHz Bluetooth and 5 GHz WLAN. 2.4 GHz WIFI/2.4 GHz Bluetooth were not transmitting during the above evaluations.

Table 11-134
2.4 GHz WLAN Antenna 2 UMPC Extremity SAR for Conditions mmWave Active

MEASUREMENT RESULTS																			
FREQUENCY		Mode	Service	Bandwidth [MHz]	Maximum Allowed Power [dBm]	Conducted Power [dBm]	Power Drift [dB]	Spacing	Antenna Config.	Device Serial Number	Data Rate (Mbps)	Side	Duty Cycle (%)	SAR (10g)	Scaling Factor (Power)	Scaling Factor (Duty Cycle)	Reported SAR (10g)	Plot #	
MHz	Ch.													(W/kg)			(W/kg)		
2462	11	802.11b	DSSS	22	13.0	12.88	0.06	0 mm	2	0815M	1	back	99.9	0.048	1.028	1.001	0.049		
2462	11	802.11b	DSSS	22	13.0	12.88	0.17	0 mm	2	0815M	1	front	99.9	0.068	1.028	1.001	0.070		
2462	11	802.11b	DSSS	22	13.0	12.88	-0.09	0 mm	2	0815M	1	top	99.9	0.071	1.028	1.001	0.073		
2462	11	802.11b	DSSS	22	13.0	12.88	-0.03	0 mm	2	0815M	1	left	99.9	0.175	1.028	1.001	0.180		
ANSI / IEEE C95.1 1992 - SAFETY LIMIT Spatial Peak Uncontrolled Exposure/General Population										Phablet 4.0 W/kg (mW/g) averaged over 10 grams									



FCC ID: A3LSMF916U	 PCTEST <small>Provided to be part of Samsung</small>	SAR EVALUATION REPORT		Approved by: Quality Manager
Document S/N: 1M2005200087-01-R2.A3L	Test Dates: 06/28/20-08/24/20	DUT Type: Portable Handset		Page 190 of 267

Table 11-135
5 GHz WLAN UMPC Body SAR for Conditions mmWave Active

MEASUREMENT RESULTS																				
FREQUENCY		Mode	Service	Bandwidth [MHz]	Maximum Allowed Power (Ant 1) [dBm]	Conducted Power (Ant 1) [dBm]	Maximum Allowed Power (Ant 2) [dBm]	Conducted Power (Ant 2) [dBm]	Power Drift [dB]	Spacing	Antenna Config.	Device Serial Number	Data Rate (Mbps)	Side	Duty Cycle (%)	SAR (10g)	Scaling Factor (Power)	Scaling Factor (Duty Cycle)	Reported SAR (10g)	Plot #
MHz	Ch.															(W/kg)			(W/kg)	
5290	58	802.11ac	OFDM	80	11.0	10.37	11.0	10.67	0.14	0 mm	MIMO	0876M	58.5	back	90.9	0.082	1.156	1.101	0.104	
5290	58	802.11ac	OFDM	80	11.0	10.37	11.0	10.67	0.06	0 mm	MIMO	0876M	58.5	front	90.9	0.027	1.156	1.101	0.034	
5290	58	802.11ac	OFDM	80	11.0	10.37	11.0	10.67	0.04	0 mm	MIMO	0876M	58.5	top	90.9	0.119	1.156	1.101	0.151	
5290	58	802.11ac	OFDM	80	11.0	10.37	11.0	10.67	0.04	0 mm	MIMO	0876M	58.5	left	90.9	0.075	1.156	1.101	0.095	
5530	106	802.11ac	OFDM	80	11.0	10.56	11.0	10.75	0.11	0 mm	MIMO	0876M	58.5	back	90.9	0.091	1.107	1.101	0.111	
5530	106	802.11ac	OFDM	80	11.0	10.56	11.0	10.75	-0.05	0 mm	MIMO	0876M	58.5	front	90.9	0.052	1.107	1.101	0.063	
5530	106	802.11ac	OFDM	80	11.0	10.56	11.0	10.75	0.05	0 mm	MIMO	0876M	58.5	top	90.9	0.102	1.107	1.101	0.124	
5530	106	802.11ac	OFDM	80	11.0	10.56	11.0	10.75	0.05	0 mm	MIMO	0876M	58.5	left	90.9	0.066	1.107	1.101	0.080	
5775	155	802.11ac	OFDM	80	11.0	10.82	11.0	10.76	0.10	0 mm	MIMO	0876M	58.5	back	90.9	0.072	1.057	1.101	0.084	
5775	155	802.11ac	OFDM	80	11.0	10.82	11.0	10.76	-0.04	0 mm	MIMO	0876M	58.5	front	90.9	0.123	1.057	1.101	0.143	
5775	155	802.11ac	OFDM	80	11.0	10.82	11.0	10.76	-0.04	0 mm	MIMO	0876M	58.5	top	90.9	0.500	1.057	1.101	0.582	
5775	155	802.11ac	OFDM	80	11.0	10.82	11.0	10.76	0.02	0 mm	MIMO	0876M	58.5	left	90.9	0.104	1.057	1.101	0.121	
ANSI / IEEE C95.1 1992 - SAFETY LIMIT Spatial Peak Uncontrolled Exposure/General Population										Phablet 4.0 W/kg (mW/g) averaged over 10 grams										

Note: To achieve the 14.0 dBm maximum allowed MIMO power shown in the documentation, each antenna transmits at a maximum allowed power of 11.0 dBm.



Table 11-136
DSS UMPC Extremity SAR

MEASUREMENT RESULTS																		
FREQUENCY		Mode	Service	Maximum Allowed Power [dBm]	Conducted Power [dBm]	Power Drift [dB]	Spacing	Antenna Config.	Device Serial Number	Data Rate (Mbps)	Side	Duty Cycle (%)	SAR (10g)	Scaling Factor (Cond Power)	Scaling Factor (Duty Cycle)	Reported SAR (10g)	Plot #	
MHz	Ch.												(W/kg)			(W/kg)		
2441	39	Bluetooth	FHSS	20.0	19.53	-0.05	0 mm	1	1356M	1	back	77.9	0.336	1.115	1.284	0.481		
2441	39	Bluetooth	FHSS	20.0	19.53	-0.05	0 mm	1	1356M	1	front	77.9	0.446	1.115	1.284	0.639		
2441	39	Bluetooth	FHSS	20.0	19.53	0.04	0 mm	1	1356M	1	top	77.9	0.619	1.115	1.284	0.886	A152	
2441	39	Bluetooth	FHSS	20.0	19.23	-0.02	0 mm	2	1356M	1	back	77.3	0.220	1.193	1.294	0.337		
2441	39	Bluetooth	FHSS	20.0	19.23	-0.03	0 mm	2	1356M	1	front	77.3	0.420	1.193	1.294	0.643		
2441	39	Bluetooth	FHSS	20.0	19.23	-0.15	0 mm	2	1356M	1	top	77.3	0.398	1.193	1.294	0.610		
2441	39	Bluetooth	FHSS	20.0	19.23	0.14	0 mm	2	1356M	1	left	77.3	0.095	1.193	1.294	0.146		
ANSI / IEEE C95.1 1992 - SAFETY LIMIT Spatial Peak Uncontrolled Exposure/General Population										Extremity 4.0 W/kg (mW/g) averaged over 10 grams								

11.7 SAR Test Notes

General Notes:

- The test data reported are the worst-case SAR values according to test procedures specified in IEEE 1528-2013, and FCC KDB Publication 447498 D01v06.
- Batteries are fully charged at the beginning of the SAR measurements.
- Liquid tissue depth was at least 15.0 cm for all frequencies.
- The manufacturer has confirmed that the device(s) tested have the same physical, mechanical and thermal characteristics and are within operational tolerances expected for production units.
- SAR results were scaled to the maximum allowed power to demonstrate compliance per FCC KDB Publication 447498 D01v06.

FCC ID: A3LSMF916U	 <small> Proud to be part of Samsung </small>	SAR EVALUATION REPORT		Approved by: Quality Manager
Document S/N: 1M2005200087-01-R2.A3L	Test Dates: 06/28/20-08/24/20	DUT Type: Portable Handset	Page 191 of 267	



6. Device was tested using a fixed spacing for body-worn accessory testing. A separation distance of 15 mm was considered because the manufacturer has determined that there will be body-worn accessories available in the marketplace for users to support this separation distance.
7. Per FCC KDB Publication 648474 D04v01r03, body-worn SAR was evaluated without a headset connected to the device. Since the standalone reported body-worn SAR was ≤ 1.2 W/kg, no additional body-worn SAR evaluations using a headset cable were required.
8. Per FCC KDB 865664 D01v01r04, variability SAR tests were performed when the measured SAR results for a frequency band were greater than or equal to 0.8 W/kg. Repeated SAR measurements are highlighted in the tables above for clarity. Please see Section 13 for variability analysis.
9. During SAR Testing for the Wireless Router conditions per FCC KDB Publication 941225 D06v02r01, the actual Portable Hotspot operation (with actual simultaneous transmission of a transmitter with WIFI) was not activated (See Section 6.7 for more details).
10. Per FCC KDB Publication 648474 D04v01r03, this device is considered a "phablet" when it is in closed configuration since the diagonal dimension is > 160 mm and < 200 mm. Therefore, phablet SAR tests are required when wireless router mode does not apply or if wireless router 1g SAR > 1.2 W/kg. Additional SAR tests for phablet SAR were evaluated per KDB 616217 Section 6 (See Section 6.9 for more information)
11. This device supports dynamic antenna tuning for some bands. Per FCC Guidance, SAR was measured according to the normally required SAR measurement configurations with tuner active. The auto-tune state determined by the device was verified before and after each SAR measurement and is listed in tables above. Please see Section 14 for supplemental data.
12. Unless otherwise noted, when 10g SAR measurement is considered, a factor of 2.5 is applied to the thresholds below.
13. Per FCC KDB Publication 941225 D07v01r02, this device is considered a "UMPC mini-tablet" when it is in open configuration. UMPC body 1g SAR tests are required on all surfaces and edges ≤ 25 mm from a transmitting antenna. Therefore, to address hand exposure, UMPC extremity 10g SAR tests are required at a test separation distance of 0 mm for all measured 1g SAR (at 10 mm) configurations.
14. This device uses Qualcomm Smart Transmit for 2G/3G/4G/5G operations to control and manage transmitting power in real time to ensure RF Exposure compliance. Per FCC Guidance, compliance for was assessed at the minimum of the time averaged power and the maximum output power for each band/mode/exposure condition (DSI).

GSM Test Notes:

1. Body-Worn accessory testing is typically associated with voice operations. Therefore, GSM voice was evaluated for body-worn SAR.
2. Justification for reduced test configurations per KDB Publication 941225 D01v03r01 and October 2013 TCB Workshop Notes: The source-based frame-averaged output power was evaluated for all GPRS/EDGE slot configurations. The configuration with the highest target frame averaged output power was evaluated for hotspot SAR. When the maximum frame-averaged powers are equivalent across two or more slots (within 0.25 dB), the configuration with the most number of time slots was tested.
3. Per FCC KDB Publication 447498 D01v06, if the reported (scaled) SAR measured at the middle channel or highest output power channel for each test configuration is ≤ 0.8 W/kg for 1g evaluations then testing at the other channels is not required for such test configuration(s). When the maximum output power variation across the required test channels is $> \frac{1}{2}$ dB, instead of the middle channel, the highest output power channel was used.

CDMA Notes:

1. Head SAR for CDMA2000 mode was tested under RC3/SO55 per FCC KDB Publication 941225 D01v03r01.
2. Body-Worn SAR was tested with 1x RTT with TDSO / SO32 FCH Only. EVDO Rev0 and RevA and TDSO / SO32 FCH+SCH SAR tests were not required per the 3G SAR Test Reduction Procedure in FCC KDB Publication 941225 D01v03r01.

FCC ID: A3LSMF916U	 PCTEST <small>Should be the part of Samsung</small>	SAR EVALUATION REPORT		Approved by: Quality Manager
Document S/N: 1M2005200087-01-R2.A3L	Test Dates: 06/28/20-08/24/20	DUT Type: Portable Handset	Page 192 of 267	



3. CDMA Wireless Router SAR is measured using Subtype 0/1 Physical Layer configurations for Rev. 0 according to KDB 941225 D01v03r01 procedures for data devices. Wireless Router SAR tests for Subtype 2 of Rev.A and 1x RTT configurations were not required per the 3G SAR Test Reduction Policy in KDB Publication 941225 D01v03r01.
4. Head SAR was additionally evaluated using EVDO Rev. A to determine compliance for VoIP operations.
5. Per FCC KDB Publication 447498 D01v06, if the reported (scaled) SAR measured at the middle channel or highest output power channel for each test configuration is ≤ 0.8 W/kg for 1g evaluations then testing at the other channels is not required for such test configuration(s). When the maximum output power variation across the required test channels is $> \frac{1}{2}$ dB, instead of the middle channel, the highest output power channel was used.
6. CDMA 1X Advanced technology was not required for SAR since the maximum allowed output powers for 1X Advanced was not more than 0.25 dB higher than the maximum powers for 1X.

UMTS Notes:

1. UMTS mode was tested under RMC 12.2 kbps with HSPA Inactive per KDB Publication 941225 D01v03r01. AMR and HSPA SAR was not required per the 3G Test Reduction Procedure in KDB Publication 941225 D01v03r01.
2. Per FCC KDB Publication 447498 D01v06, if the reported (scaled) SAR measured at the middle channel or highest output power channel for each test configuration is ≤ 0.8 W/kg for 1g evaluations then testing at the other channels is not required for such test configuration(s). When the maximum output power variation across the required test channels is $> \frac{1}{2}$ dB, instead of the middle channel, the highest output power channel was used.

LTE Notes:

1. LTE test configurations are determined according to SAR Evaluation Considerations for LTE Devices in FCC KDB Publication 941225 D05v02r04. The general test procedures used for testing can be found in Section 8.6.4.
2. MPR is permanently implemented for this device by the manufacturer. The specific manufacturer target MPR is indicated alongside the SAR results. MPR is enabled for this device, according to 3GPP TS36.101 Section 6.2.3 – 6.2.5 under Table 6.2.3-1.
3. A-MPR was disabled for all SAR tests by setting NS=01 and MCC=001 on the base station simulator. SAR tests were performed with the same number of RB and RB offsets transmitting on all TTI frames (maximum TTI).
4. Per FCC KDB Publication 447498 D01v06, when the reported LTE Band 41 or LTE Band 48 SAR measured at the highest output power channel in a given a test configuration was > 0.6 W/kg for 1g evaluations, testing at the other channels was required for such test configurations.
5. TDD LTE was tested per the guidance provided in FCC KDB Publication 941225 D05v02r04. Testing was performed using UL-DL configuration 0 with 6 UL subframes and 2 S subframes using extended cyclic prefix only and special subframe configuration 6. SAR tests were performed at maximum output power and worst-case transmission duty factor in extended cyclic prefix. Per 3GPP 36.211 Section 4, the duty factor for special subframe configuration 6 using extended cyclic prefix is 0.633.
6. Per KDB Publication 941225 D05Av01r02, SAR for downlink only LTE CA operations was not needed since the maximum average output power in LTE CA mode was not >0.25 dB higher than the maximum output power when downlink carrier aggregation was inactive.
7. This device supports Power Class 2 and Power Class 3 operations for LTE Band 41. The highest available duty cycle for Power Class 2 operations is 43.3 % using UL-DL configuration 1. Per FCC Guidance, all SAR tests were performed using Power Class 3. SAR with power class 2 at the available duty factor was additionally performed for the power class 3 configuration with the highest SAR configuration for each exposure conditions. Please see Section 14 for linearity results.
8. For LTE Band 5, LTE Band 66, LTE Band 48, and LTE Band 41, per FCC guidance, SAR was first measured with only a single carrier active in the uplink (carrier aggregation not active). For each exposure condition, the uplink CA scenario with two component carriers was additionally tested for the configuration with the highest SAR when carrier aggregation was not active. The SCC was configured with the closest

FCC ID: A3LSMF916U	 PCTEST <small>Proud to be part of Samsung</small>	SAR EVALUATION REPORT		Approved by: Quality Manager
Document S/N: 1M2005200087-01-R2.A3L	Test Dates: 06/28/20-08/24/20	DUT Type: Portable Handset	Page 193 of 267	

available contiguous channel. The two component carriers were configured so the resource blocks are physically allocated side by side to achieve the maximum output power.



9. This device supports LTE Band 41 ULCA active with Power Class 2. The highest SAR test configuration for each exposure condition in Power Class 3 with ULCA active was repeated with Power Class 2 with ULCA active.

NR Notes:

1. NR implementation of n71, n5, n66, n2, n25, and n41 is limited to EN-DC operations only, with LTE Bands 2/5/7/12/13/14/25/30/41/48/66 acting as anchor bands. Per FCC guidance, SAR tests for NR Bands and LTE Anchors Bands were performed separately due to limitations in SAR probe calibration factors.
2. Due to test setup limitations, SAR testing for NR was performed using test mode software to establish the connection.
3. Simultaneous transmission analysis for EN-DC operations is addressed in the Part 2 Test Report (Serial Number can be found in the bibliography).
4. This device additionally supports some EN-DC conditions where additional LTE carriers are added on the downlink only.
5. Per FCC Guidance, the device was configured with the tuner state selected by the device in LTE mode with auto-tune active at the same frequency as the NR test results. Additional tuner states were evaluated per April 2019 TCBC Workshop Guidance. Please see Section 14 for supplemental data.
6. Per FCC Guidance, NR modulations and RB Sizes/Offsets were selected for testing such that configurations with the highest output power were evaluated for SAR tests.
7. For final implementation, NR Band n41 slot configuration is synchronized using maximum duty cycle of 25%. SAR testing was performed using FTM mode with a 25% duty cycle applied to match final duty cycle.

WLAN Notes:



1. For held-to-ear, hotspot, phablet, and UMPC mini-tablet operations, the initial test position procedures were applied. When reported SAR for the initial test position is ≤ 0.4 W/kg for 1g evaluations, no additional testing for the remaining test positions was required. Otherwise, SAR is evaluated at the subsequent highest peak SAR positions until the reported SAR result is ≤ 0.8 W/kg or all test positions are measured.
2. Justification for test configurations for WLAN per KDB Publication 248227 D01v02r02 for 2.4 GHz WIFI single transmission chain operations, the highest measured maximum output power channel for DSSS was selected for SAR measurement. SAR for OFDM modes (2.4 GHz 802.11g/n/ax) was not required due to the maximum allowed powers and the highest reported DSSS SAR. See Section 8.7.5 for more information.
3. Justification for test configurations for WLAN per KDB Publication 248227 D01v02r02 for 5 GHz WIFI single transmission chain operations, the initial test configuration was selected according to the transmission mode with the highest maximum allowed powers. Other transmission modes were not investigated since the highest reported SAR for initial test configuration adjusted by the ratio of maximum output powers is less than 1.2 W/kg for 1g evaluations. See Section 8.7.6 for more information.
4. Per KDB Publication 248227 D01v02r02, SAR for MIMO was evaluated by following the simultaneous SAR provisions from KDB Publication 447498 D01v06 by either evaluating the sum of the 1g SAR values of each antenna transmitting independently or making a SAR measurement with both antennas transmitting simultaneously. Please see Section 12 for complete analysis.
5. When the maximum reported 1g averaged SAR is ≤ 0.8 W/kg, SAR testing on additional channels was not required. Otherwise, SAR for the next highest output power channel was required until the reported SAR result was ≤ 1.20 W/kg for 1g evaluations or all test channels were measured.
6. The device was configured to transmit continuously at the required data rate, channel bandwidth and signal modulation, using the highest transmission duty factor supported by the test mode tools. The reported SAR was scaled to the 100% transmission duty factor to determine compliance. Procedures used to measure the duty factor are identical to that in the associated EMC test reports.

FCC ID: A3LSMF916U	 PCTEST <small> Proud to be part of Samsung</small>	SAR EVALUATION REPORT		Approved by: Quality Manager
Document S/N: 1M2005200087-01-R2.A3L	Test Dates: 06/28/20-08/24/20	DUT Type: Portable Handset	Page 194 of 267	

7. When 10g SAR measurement is considered, a factor of 2.5 is applied to the thresholds above.

Bluetooth Notes

1. Bluetooth SAR was measured with the device connected to a call box with hopping disabled with DH5 operation and Tx Tests test mode type. Per October 2016 TCB Workshop Notes, the reported SAR was scaled to the 100% transmission duty factor to determine compliance. See Section 9.7 for the time domain plot and calculation for the duty factor of the device.
2. Head and Hotspot Bluetooth SAR were evaluated for BT BR tethering applications.

FCC ID: A3LSMF916U	 PCTEST <small>Proud to be part of Samsung</small>	SAR EVALUATION REPORT		Approved by: Quality Manager
Document S/N: 1M2005200087-01-R2.A3L	Test Dates: 06/28/20-08/24/20	DUT Type: Portable Handset		Page 195 of 267

12 FCC MULTI-TX AND ANTENNA SAR CONSIDERATIONS

12.1 Introduction

The following procedures adopted from FCC KDB Publication 447498 D01v06 are applicable to devices with built-in unlicensed transmitters such as 802.11 and Bluetooth devices which may simultaneously transmit with the licensed transmitter.

12.2 Simultaneous Transmission Procedures



This device contains transmitters that may operate simultaneously. Therefore, simultaneous transmission analysis is required. Per FCC KDB Publication 447498 D01v06 4.3.2 and IEEE 1528-2013 Section 6.3.4.1.2, simultaneous transmission SAR test exclusion may be applied when the sum of the 1g SAR for all the simultaneous transmitting antennas in a specific physical test configuration is ≤ 1.6 W/kg. The different test positions in an exposure condition may be considered collectively to determine SAR test exclusion according to the sum of 1g or 10g SAR.

Per FCC KDB Publication 941225 D06v02r01, the devices edges with antennas more than 2.5 cm from edge are not required to be evaluated for SAR (“-”).

(*) For test positions that were not required to be evaluated for WLAN SAR per FCC KDB publication 248227, the worst case WLAN SAR result for the applicable exposure conditions was used for simultaneous transmission analysis.

For SAR summation, the highest reported SAR across all test distances was used as the most conservative evaluation for simultaneous transmission analysis for each device edge.



Qualcomm Smart Transmit algorithm in WWAN adds directly the time-averaged RF exposure from 4G and time-averaged RF exposure from 5G NR. Smart Transmit algorithm controls the total RF exposure from both 4G and 5G NR to not exceed FCC limit. Therefore, simultaneous transmission compliance between 4G+5G operations is demonstrated in the Qualcomm Part 2 Report during algorithm validation.

FCC ID: A3LSMF916U	 PCTEST <small>Proud to be part of Samsung</small>	SAR EVALUATION REPORT		Approved by: Quality Manager
Document S/N: 1M2005200087-01-R2.A3L	Test Dates: 06/28/20-08/24/20	DUT Type: Portable Handset	Page 196 of 267	

12.3 Head SAR Simultaneous Transmission Analysis

Table 12-1
Simultaneous Transmission Scenario with 2.4 GHz WLAN (Held to Ear)

Configuration	Mode	2G/3G/4G/5G SAR (W/kg)	2.4 GHz WLAN Ant 1 SAR (W/kg)	2.4 GHz WLAN Ant 2 SAR (W/kg)	Σ SAR (W/kg)
		1	2	3	1+2+3
Head SAR	CDMA BC10 (§90S)	0.248	0.352	0.238	0.838
	CDMA BC0 (§22H)	0.276	0.352	0.238	0.866
	PCS CDMA	0.073	0.352	0.238	0.663
	GSM 850	0.172	0.352	0.238	0.762
	GSM 1900	0.028	0.352	0.238	0.618
	UMTS 850	0.291	0.352	0.238	0.881
	UMTS 1750	0.071	0.352	0.238	0.661
	UMTS 1900	0.083	0.352	0.238	0.673
	LTE Band 71	0.139	0.352	0.238	0.729
	LTE Band 12	0.108	0.352	0.238	0.698
	LTE Band 13	0.284	0.352	0.238	0.874
	LTE Band 14	0.267	0.352	0.238	0.857
	LTE Band 26 (Cell)	0.278	0.352	0.238	0.868
	LTE Band 5 (Cell)	0.292	0.352	0.238	0.882
	LTE Band 66 (AWS)	0.061	0.352	0.238	0.651
	LTE Band 25 (PCS)	0.056	0.352	0.238	0.646
	LTE Band 30	0.056	0.352	0.238	0.646
	LTE Band 7	0.236	0.352	0.238	0.826
	LTE Band 48	0.161	0.352	0.238	0.751
	LTE Band 41	0.070	0.352	0.238	0.660
NR Band n71	0.158	0.352	0.238	0.748	
NR Band n5 (Cell)	0.229	0.352	0.238	0.819	
NR Band n66 (AWS)	0.050	0.352	0.238	0.640	
NR Band n25 (PCS)	0.052	0.352	0.238	0.642	
NR Band n41	0.081	0.352	0.238	0.671	

FCC ID: A3LSMF916U	 PCTEST <small>Prove it to be part of Samsung</small>	SAR EVALUATION REPORT		Approved by: Quality Manager
Document S/N: 1M2005200087-01-R2.A3L	Test Dates: 06/28/20-08/24/20	DUT Type: Portable Handset		Page 197 of 267

**Table 12-2
Simultaneous Transmission Scenario with 5 GHz WLAN (Held to Ear)**

Configuration	Mode	2G/3G/4G/5G SAR (W/kg)	5 GHz WLAN Ant 1 SAR (W/kg)	5 GHz WLAN Ant 2 SAR (W/kg)	Σ SAR (W/kg)
		1	2	3	
Head SAR	CDMA BC10 (§90S)	0.248	0.118	0.061	0.427
	CDMA BC0 (§22H)	0.276	0.118	0.061	0.455
	PCS CDMA	0.073	0.118	0.061	0.252
	GSM 850	0.172	0.118	0.061	0.351
	GSM 1900	0.028	0.118	0.061	0.207
	UMTS 850	0.291	0.118	0.061	0.470
	UMTS 1750	0.071	0.118	0.061	0.250
	UMTS 1900	0.083	0.118	0.061	0.262
	LTE Band 71	0.139	0.118	0.061	0.318
	LTE Band 12	0.108	0.118	0.061	0.287
	LTE Band 13	0.284	0.118	0.061	0.463
	LTE Band 14	0.267	0.118	0.061	0.446
	LTE Band 26 (Cell)	0.278	0.118	0.061	0.457
	LTE Band 5 (Cell)	0.292	0.118	0.061	0.471
	LTE Band 66 (AWS)	0.061	0.118	0.061	0.240
	LTE Band 25 (PCS)	0.056	0.118	0.061	0.235
	LTE Band 30	0.056	0.118	0.061	0.235
	LTE Band 7	0.236	0.118	0.061	0.415
	LTE Band 48	0.161	0.118	0.061	0.340
	LTE Band 41	0.070	0.118	0.061	0.249
NR Band n71	0.158	0.118	0.061	0.337	
NR Band n5 (Cell)	0.229	0.118	0.061	0.408	
NR Band n66 (AWS)	0.050	0.118	0.061	0.229	
NR Band n25 (PCS)	0.052	0.118	0.061	0.231	
NR Band n41	0.081	0.118	0.061	0.260	



FCC ID: A3LSMF916U	 PCTEST <small>Proud to be part of Samsung</small>	SAR EVALUATION REPORT		Approved by: Quality Manager
Document S/N: 1M2005200087-01-R2.A3L	Test Dates: 06/28/20-08/24/20	DUT Type: Portable Handset		Page 198 of 267

Table 12-3

Simultaneous Transmission Scenario with 2.4 GHz WLAN MIMO and 5 GHz WLAN MIMO (Held to Ear)

Configuration	Mode	2G/3G/4G/5G SAR (W/kg)	2.4 GHz WLAN Ant 1 SAR (W/kg)	2.4 GHz WLAN Ant 2 SAR (W/kg)	5 GHz WLAN Ant 1 SAR (W/kg)	5 GHz WLAN Ant 2 SAR (W/kg)	Σ SAR (W/kg)
		1	2	3	4	5	1+2+3+4+5
Head SAR	CDMA BC10 (\$90S)	0.248	0.352	0.238	0.118	0.061	1.017
	CDMA BC0 (\$22H)	0.276	0.352	0.238	0.118	0.061	1.045
	PCS CDMA	0.073	0.352	0.238	0.118	0.061	0.842
	GSM 850	0.172	0.352	0.238	0.118	0.061	0.941
	GSM 1900	0.028	0.352	0.238	0.118	0.061	0.797
	UMTS 850	0.291	0.352	0.238	0.118	0.061	1.060
	UMTS 1750	0.071	0.352	0.238	0.118	0.061	0.840
	UMTS 1900	0.083	0.352	0.238	0.118	0.061	0.852
	LTE Band 71	0.139	0.352	0.238	0.118	0.061	0.908
	LTE Band 12	0.108	0.352	0.238	0.118	0.061	0.877
	LTE Band 13	0.284	0.352	0.238	0.118	0.061	1.053
	LTE Band 14	0.267	0.352	0.238	0.118	0.061	1.036
	LTE Band 26 (Cell)	0.278	0.352	0.238	0.118	0.061	1.047
	LTE Band 5 (Cell)	0.292	0.352	0.238	0.118	0.061	1.061
	LTE Band 66 (AWS)	0.061	0.352	0.238	0.118	0.061	0.830
	LTE Band 25 (PCS)	0.056	0.352	0.238	0.118	0.061	0.825
	LTE Band 30	0.056	0.352	0.238	0.118	0.061	0.825
	LTE Band 7	0.236	0.352	0.238	0.118	0.061	1.005
	LTE Band 48	0.161	0.352	0.238	0.118	0.061	0.930
	LTE Band 41	0.070	0.352	0.238	0.118	0.061	0.839
NR Band n71	0.158	0.352	0.238	0.118	0.061	0.927	
NR Band n5 (Cell)	0.229	0.352	0.238	0.118	0.061	0.998	
NR Band n66 (AWS)	0.050	0.352	0.238	0.118	0.061	0.819	
NR Band n25 (PCS)	0.052	0.352	0.238	0.118	0.061	0.821	
NR Band n41	0.081	0.352	0.238	0.118	0.061	0.850	



FCC ID: A3LSMF916U	 PCTEST <small>Proud to be part of Samsung</small>	SAR EVALUATION REPORT		Approved by: Quality Manager
Document S/N: 1M2005200087-01-R2.A3L	Test Dates: 06/28/20-08/24/20	DUT Type: Portable Handset	Page 199 of 267	

Table 12-4
Simultaneous Transmission Scenario with Bluetooth (Held to Ear)

Configuration	Mode	2G/3G/4G/5G SAR (W/kg)	Bluetooth Ant 1 SAR (W/kg)	Bluetooth Ant 2 SAR (W/kg)	Σ SAR (W/kg)	
		1	2	3	1+2	1+3
Head SAR	CDMA BC10 (\$90S)	0.248	0.322	0.100	0.570	0.348
	CDMA BC0 (\$22H)	0.276	0.322	0.100	0.598	0.376
	PCS CDMA	0.073	0.322	0.100	0.395	0.173
	GSM 850	0.172	0.322	0.100	0.494	0.272
	GSM 1900	0.028	0.322	0.100	0.350	0.128
	UMTS 850	0.291	0.322	0.100	0.613	0.391
	UMTS 1750	0.071	0.322	0.100	0.393	0.171
	UMTS 1900	0.083	0.322	0.100	0.405	0.183
	LTE Band 71	0.139	0.322	0.100	0.461	0.239
	LTE Band 12	0.108	0.322	0.100	0.430	0.208
	LTE Band 13	0.284	0.322	0.100	0.606	0.384
	LTE Band 14	0.267	0.322	0.100	0.589	0.367
	LTE Band 26 (Cell)	0.278	0.322	0.100	0.600	0.378
	LTE Band 5 (Cell)	0.292	0.322	0.100	0.614	0.392
	LTE Band 66 (AWS)	0.061	0.322	0.100	0.383	0.161
	LTE Band 25 (PCS)	0.056	0.322	0.100	0.378	0.156
	LTE Band 30	0.056	0.322	0.100	0.378	0.156
	LTE Band 7	0.236	0.322	0.100	0.558	0.336
	LTE Band 48	0.161	0.322	0.100	0.483	0.261
	LTE Band 41	0.070	0.322	0.100	0.392	0.170
NR Band n71	0.158	0.322	0.100	0.480	0.258	
NR Band n5 (Cell)	0.229	0.322	0.100	0.551	0.329	
NR Band n66 (AWS)	0.050	0.322	0.100	0.372	0.150	
NR Band n25 (PCS)	0.052	0.322	0.100	0.374	0.152	
NR Band n41	0.081	0.322	0.100	0.403	0.181	



FCC ID: A3LSMF916U	 PCTEST <small>Prove it to be part of Samsung</small>	SAR EVALUATION REPORT		Approved by: Quality Manager
Document S/N: 1M2005200087-01-R2.A3L	Test Dates: 06/28/20-08/24/20	DUT Type: Portable Handset		Page 200 of 267

Table 12-5

Simultaneous Transmission Scenario with Bluetooth Antenna 1 and 5 GHz WLAN MIMO (Held to Ear)

Configuration	Mode	2G/3G/4G/5G SAR (W/kg)	Bluetooth Ant 1 SAR (W/kg)	5 GHz WLAN Ant 1 SAR (W/kg)	5 GHz WLAN Ant 2 SAR (W/kg)	Σ SAR (W/kg)
		1	2	3	4	1+2+3+4
Head SAR	CDMA BC10 (§90S)	0.248	0.322	0.118	0.061	0.749
	CDMA BC0 (§22H)	0.276	0.322	0.118	0.061	0.777
	PCS CDMA	0.073	0.322	0.118	0.061	0.574
	GSM 850	0.172	0.322	0.118	0.061	0.673
	GSM 1900	0.028	0.322	0.118	0.061	0.529
	UMTS 850	0.291	0.322	0.118	0.061	0.792
	UMTS 1750	0.071	0.322	0.118	0.061	0.572
	UMTS 1900	0.083	0.322	0.118	0.061	0.584
	LTE Band 71	0.139	0.322	0.118	0.061	0.640
	LTE Band 12	0.108	0.322	0.118	0.061	0.609
	LTE Band 13	0.284	0.322	0.118	0.061	0.785
	LTE Band 14	0.267	0.322	0.118	0.061	0.768
	LTE Band 26 (Cell)	0.278	0.322	0.118	0.061	0.779
	LTE Band 5 (Cell)	0.292	0.322	0.118	0.061	0.793
	LTE Band 66 (AWS)	0.061	0.322	0.118	0.061	0.562
	LTE Band 25 (PCS)	0.056	0.322	0.118	0.061	0.557
	LTE Band 30	0.056	0.322	0.118	0.061	0.557
	LTE Band 7	0.236	0.322	0.118	0.061	0.737
	LTE Band 48	0.161	0.322	0.118	0.061	0.662
	LTE Band 41	0.070	0.322	0.118	0.061	0.571
NR Band n71	0.158	0.322	0.118	0.061	0.659	
NR Band n5 (Cell)	0.229	0.322	0.118	0.061	0.730	
NR Band n66 (AWS)	0.050	0.322	0.118	0.061	0.551	
NR Band n25 (PCS)	0.052	0.322	0.118	0.061	0.553	
NR Band n41	0.081	0.322	0.118	0.061	0.582	



FCC ID: A3LSMF916U	 PCTEST <small>Proud to be part of Samsung</small>	SAR EVALUATION REPORT		Approved by: Quality Manager
Document S/N: 1M2005200087-01-R2.A3L	Test Dates: 06/28/20-08/24/20	DUT Type: Portable Handset	Page 201 of 267	

Table 12-6

Simultaneous Transmission Scenario with Bluetooth Antenna 2 and 5 GHz WLAN MIMO (Held to Ear)

Configuration	Mode	2G/3G/4G/5G SAR (W/kg)	Bluetooth Ant 2 SAR (W/kg)	5 GHz WLAN Ant 1 SAR (W/kg)	5 GHz WLAN Ant 2 SAR (W/kg)	Σ SAR (W/kg)
		1	2	3	4	1+2+3+4
Head SAR	CDMA BC10 (§90S)	0.248	0.100	0.118	0.061	0.527
	CDMA BC0 (§22H)	0.276	0.100	0.118	0.061	0.555
	PCS CDMA	0.073	0.100	0.118	0.061	0.352
	GSM 850	0.172	0.100	0.118	0.061	0.451
	GSM 1900	0.028	0.100	0.118	0.061	0.307
	UMTS 850	0.291	0.100	0.118	0.061	0.570
	UMTS 1750	0.071	0.100	0.118	0.061	0.350
	UMTS 1900	0.083	0.100	0.118	0.061	0.362
	LTE Band 71	0.139	0.100	0.118	0.061	0.418
	LTE Band 12	0.108	0.100	0.118	0.061	0.387
	LTE Band 13	0.284	0.100	0.118	0.061	0.563
	LTE Band 14	0.267	0.100	0.118	0.061	0.546
	LTE Band 26 (Cell)	0.278	0.100	0.118	0.061	0.557
	LTE Band 5 (Cell)	0.292	0.100	0.118	0.061	0.571
	LTE Band 66 (AWS)	0.061	0.100	0.118	0.061	0.340
	LTE Band 25 (PCS)	0.056	0.100	0.118	0.061	0.335
	LTE Band 30	0.056	0.100	0.118	0.061	0.335
	LTE Band 7	0.236	0.100	0.118	0.061	0.515
	LTE Band 48	0.161	0.100	0.118	0.061	0.440
	LTE Band 41	0.070	0.100	0.118	0.061	0.349
NR Band n71	0.158	0.100	0.118	0.061	0.437	
NR Band n5 (Cell)	0.229	0.100	0.118	0.061	0.508	
NR Band n66 (AWS)	0.050	0.100	0.118	0.061	0.329	
NR Band n25 (PCS)	0.052	0.100	0.118	0.061	0.331	
NR Band n41	0.081	0.100	0.118	0.061	0.360	





FCC ID: A3LSMF916U	 PCTEST <small>Proud to be part of Samsung</small>	SAR EVALUATION REPORT		Approved by: Quality Manager
Document S/N: 1M2005200087-01-R2.A3L	Test Dates: 06/28/20-08/24/20	DUT Type: Portable Handset	Page 202 of 267	

Table 12-7
Simultaneous Transmission Scenario with Bluetooth Antenna 1, 2.4 GHz WLAN Antenna 2, and 5 GHz WLAN MIMO (Held to Ear)

Configuration	Mode	2G/3G/4G/5G SAR (W/kg)	Bluetooth Ant 1 SAR (W/kg)	2.4 GHz WLAN Ant 2 SAR (W/kg)	5 GHz WLAN Ant 1 SAR (W/kg)	5 GHz WLAN Ant 2 SAR (W/kg)	Σ SAR (W/kg)
		1	2	3	4	5	
Head SAR	CDMA BC10 (\$90S)	0.248	0.322	0.238	0.118	0.061	0.987
	CDMA BC0 (\$22H)	0.276	0.322	0.238	0.118	0.061	1.015
	PCS CDMA	0.073	0.322	0.238	0.118	0.061	0.812
	GSM 850	0.172	0.322	0.238	0.118	0.061	0.911
	GSM 1900	0.028	0.322	0.238	0.118	0.061	0.767
	UMTS 850	0.291	0.322	0.238	0.118	0.061	1.030
	UMTS 1750	0.071	0.322	0.238	0.118	0.061	0.810
	UMTS 1900	0.083	0.322	0.238	0.118	0.061	0.822
	LTE Band 71	0.139	0.322	0.238	0.118	0.061	0.878
	LTE Band 12	0.108	0.322	0.238	0.118	0.061	0.847
	LTE Band 13	0.284	0.322	0.238	0.118	0.061	1.023
	LTE Band 14	0.267	0.322	0.238	0.118	0.061	1.006
	LTE Band 26 (Cell)	0.278	0.322	0.238	0.118	0.061	1.017
	LTE Band 5 (Cell)	0.292	0.322	0.238	0.118	0.061	1.031
	LTE Band 66 (AWS)	0.061	0.322	0.238	0.118	0.061	0.800
	LTE Band 25 (PCS)	0.056	0.322	0.238	0.118	0.061	0.795
	LTE Band 30	0.056	0.322	0.238	0.118	0.061	0.795
	LTE Band 7	0.236	0.322	0.238	0.118	0.061	0.975
	LTE Band 48	0.161	0.322	0.238	0.118	0.061	0.900
	LTE Band 41	0.070	0.322	0.238	0.118	0.061	0.809
	NR Band n71	0.158	0.322	0.238	0.118	0.061	0.897
NR Band n5 (Cell)	0.229	0.322	0.238	0.118	0.061	0.968	
NR Band n66 (AWS)	0.050	0.322	0.238	0.118	0.061	0.789	
NR Band n25 (PCS)	0.052	0.322	0.238	0.118	0.061	0.791	
NR Band n41	0.081	0.322	0.238	0.118	0.061	0.820	

FCC ID: A3LSMF916U	 PCTEST <small>Proud to be part of Samsung</small>	SAR EVALUATION REPORT		Approved by: Quality Manager
Document S/N: 1M2005200087-01-R2.A3L	Test Dates: 06/28/20-08/24/20	DUT Type: Portable Handset		Page 203 of 267

12.4 Body-Worn Simultaneous Transmission Analysis

Table 12-8
Simultaneous Transmission Scenario with 2.4 GHz WLAN (Body-Worn at 1.5 cm)

Configuration	Mode	2G/3G/4G/5G SAR (W/kg)	2.4 GHz WLAN Ant 1 SAR (W/kg)	2.4 GHz WLAN Ant 2 SAR (W/kg)	Σ SAR (W/kg)
		1	2	3	
Body - Worn SAR	CDMA BC10 (\$90S)	0.336	0.028	0.015	0.379
	CDMA BC0 (\$22H)	0.401	0.028	0.015	0.444
	PCS CDMA	0.406	0.028	0.015	0.449
	GSM 850	0.201	0.028	0.015	0.244
	GSM 1900	0.232	0.028	0.015	0.275
	UMTS 850	0.262	0.028	0.015	0.305
	UMTS 1750	0.993	0.028	0.015	1.036
	UMTS 1900	0.599	0.028	0.015	0.642
	LTE Band 71	0.241	0.028	0.015	0.284
	LTE Band 12	0.139	0.028	0.015	0.182
	LTE Band 13	0.342	0.028	0.015	0.385
	LTE Band 14	0.303	0.028	0.015	0.346
	LTE Band 26 (Cell)	0.316	0.028	0.015	0.359
	LTE Band 5 (Cell)	0.305	0.028	0.015	0.348
	LTE Band 66 (AWS)	1.135	0.028	0.015	1.178
	LTE Band 25 (PCS)	0.469	0.028	0.015	0.512
	LTE Band 30	0.627	0.028	0.015	0.670
	LTE Band 7	0.520	0.028	0.015	0.563
	LTE Band 48	0.248	0.028	0.015	0.291
	LTE Band 41	0.471	0.028	0.015	0.514
NR Band n71	0.209	0.028	0.015	0.252	
NR Band n5 (Cell)	0.320	0.028	0.015	0.363	
NR Band n66 (AWS)	0.747	0.028	0.015	0.790	
NR Band n25 (PCS)	0.488	0.028	0.015	0.531	
NR Band n41	0.034	0.028	0.015	0.077	



FCC ID: A3LSMF916U	 PCTEST <small>Proud to be part of Samsung</small>	SAR EVALUATION REPORT		Approved by: Quality Manager
Document S/N: 1M2005200087-01-R2.A3L	Test Dates: 06/28/20-08/24/20	DUT Type: Portable Handset		Page 204 of 267

Table 12-9
Simultaneous Transmission Scenario with 5 GHz WLAN (Body-Worn at 1.5 cm)

Configuration	Mode	2G/3G/4G/5G SAR (W/kg)	5 GHz WLAN Ant 1 SAR (W/kg)	5 GHz WLAN Ant 2 SAR (W/kg)	Σ SAR (W/kg)
		1	2	3	1+2+3
Body - Worn SAR	CDMA BC10 (§90S)	0.336	0.016	0.010	0.362
	CDMA BC0 (§22H)	0.401	0.016	0.010	0.427
	PCS CDMA	0.406	0.016	0.010	0.432
	GSM 850	0.201	0.016	0.010	0.227
	GSM 1900	0.232	0.016	0.010	0.258
	UMTS 850	0.262	0.016	0.010	0.288
	UMTS 1750	0.993	0.016	0.010	1.019
	UMTS 1900	0.599	0.016	0.010	0.625
	LTE Band 71	0.241	0.016	0.010	0.267
	LTE Band 12	0.139	0.016	0.010	0.165
	LTE Band 13	0.342	0.016	0.010	0.368
	LTE Band 14	0.303	0.016	0.010	0.329
	LTE Band 26 (Cell)	0.316	0.016	0.010	0.342
	LTE Band 5 (Cell)	0.305	0.016	0.010	0.331
	LTE Band 66 (AWS)	1.135	0.016	0.010	1.161
	LTE Band 25 (PCS)	0.469	0.016	0.010	0.495
	LTE Band 30	0.627	0.016	0.010	0.653
	LTE Band 7	0.520	0.016	0.010	0.546
	LTE Band 48	0.248	0.016	0.010	0.274
	LTE Band 41	0.471	0.016	0.010	0.497
NR Band n71	0.209	0.016	0.010	0.235	
NR Band n5 (Cell)	0.320	0.016	0.010	0.346	
NR Band n66 (AWS)	0.747	0.016	0.010	0.773	
NR Band n25 (PCS)	0.488	0.016	0.010	0.514	
NR Band n41	0.034	0.016	0.010	0.060	



FCC ID: A3LSMF916U	 <small>Proud to be part of Samsung</small>	SAR EVALUATION REPORT		Approved by: Quality Manager
Document S/N: 1M2005200087-01-R2.A3L	Test Dates: 06/28/20-08/24/20	DUT Type: Portable Handset		Page 205 of 267

Table 12-10
Simultaneous Transmission Scenario with 2.4 GHz WLAN MIMO and 5 GHz WLAN MIMO (Body-Worn at 1.5 cm)

Configuration	Mode	2G/3G/4G/5G SAR (W/kg)	2.4 GHz WLAN Ant 1 SAR (W/kg)	2.4 GHz WLAN Ant 2 SAR (W/kg)	5 GHz WLAN Ant 1 SAR (W/kg)	5 GHz WLAN Ant 2 SAR (W/kg)	Σ SAR (W/kg)
		1	2	3	4	5	1+2+3+4+5
Body - Worn SAR	CDMA BC10 (\$90S)	0.336	0.028	0.015	0.016	0.010	0.405
	CDMA BC0 (\$22H)	0.401	0.028	0.015	0.016	0.010	0.470
	PCS CDMA	0.406	0.028	0.015	0.016	0.010	0.475
	GSM 850	0.201	0.028	0.015	0.016	0.010	0.270
	GSM 1900	0.232	0.028	0.015	0.016	0.010	0.301
	UMTS 850	0.262	0.028	0.015	0.016	0.010	0.331
	UMTS 1750	0.993	0.028	0.015	0.016	0.010	1.062
	UMTS 1900	0.599	0.028	0.015	0.016	0.010	0.668
	LTE Band 71	0.241	0.028	0.015	0.016	0.010	0.310
	LTE Band 12	0.139	0.028	0.015	0.016	0.010	0.208
	LTE Band 13	0.342	0.028	0.015	0.016	0.010	0.411
	LTE Band 14	0.303	0.028	0.015	0.016	0.010	0.372
	LTE Band 26 (Cell)	0.316	0.028	0.015	0.016	0.010	0.385
	LTE Band 5 (Cell)	0.305	0.028	0.015	0.016	0.010	0.374
	LTE Band 66 (AWS)	1.135	0.028	0.015	0.016	0.010	1.204
	LTE Band 25 (PCS)	0.469	0.028	0.015	0.016	0.010	0.538
	LTE Band 30	0.627	0.028	0.015	0.016	0.010	0.696
	LTE Band 7	0.520	0.028	0.015	0.016	0.010	0.589
	LTE Band 48	0.248	0.028	0.015	0.016	0.010	0.317
	LTE Band 41	0.471	0.028	0.015	0.016	0.010	0.540
	NR Band n71	0.209	0.028	0.015	0.016	0.010	0.278
NR Band n5 (Cell)	0.320	0.028	0.015	0.016	0.010	0.389	
NR Band n66 (AWS)	0.747	0.028	0.015	0.016	0.010	0.816	
NR Band n25 (PCS)	0.488	0.028	0.015	0.016	0.010	0.557	
NR Band n41	0.034	0.028	0.015	0.016	0.010	0.103	



FCC ID: A3LSMF916U	 PCTEST <small>Proud to be part of Samsung</small>	SAR EVALUATION REPORT		Approved by: Quality Manager
Document S/N: 1M2005200087-01-R2.A3L	Test Dates: 06/28/20-08/24/20	DUT Type: Portable Handset		Page 206 of 267

Table 12-11
Simultaneous Transmission Scenario with Bluetooth (Body-Worn at 1.5 cm)

Configuration	Mode	2G/3G/4G/5G SAR (W/kg)	BluetoothAnt 1 SAR (W/kg)	BluetoothAnt 2 SAR (W/kg)	Σ SAR (W/kg)	
		1	2	3	1+2	1+3
Body - Worn SAR	CDMA BC10 (\$90S)	0.336	0.013	0.015	0.349	0.351
	CDMA BC0 (\$22H)	0.401	0.013	0.015	0.414	0.416
	PCS CDMA	0.406	0.013	0.015	0.419	0.421
	GSM 850	0.201	0.013	0.015	0.214	0.216
	GSM 1900	0.232	0.013	0.015	0.245	0.247
	UMTS 850	0.262	0.013	0.015	0.275	0.277
	UMTS 1750	0.993	0.013	0.015	1.006	1.008
	UMTS 1900	0.599	0.013	0.015	0.612	0.614
	LTE Band 71	0.241	0.013	0.015	0.254	0.256
	LTE Band 12	0.139	0.013	0.015	0.152	0.154
	LTE Band 13	0.342	0.013	0.015	0.355	0.357
	LTE Band 14	0.303	0.013	0.015	0.316	0.318
	LTE Band 26 (Cell)	0.316	0.013	0.015	0.329	0.331
	LTE Band 5 (Cell)	0.305	0.013	0.015	0.318	0.320
	LTE Band 66 (AWS)	1.135	0.013	0.015	1.148	1.150
	LTE Band 25 (PCS)	0.469	0.013	0.015	0.482	0.484
	LTE Band 30	0.627	0.013	0.015	0.640	0.642
	LTE Band 7	0.520	0.013	0.015	0.533	0.535
	LTE Band 48	0.248	0.013	0.015	0.261	0.263
	LTE Band 41	0.471	0.013	0.015	0.484	0.486
NR Band n71	0.209	0.013	0.015	0.222	0.224	
NR Band n5 (Cell)	0.320	0.013	0.015	0.333	0.335	
NR Band n66 (AWS)	0.747	0.013	0.015	0.760	0.762	
NR Band n25 (PCS)	0.488	0.013	0.015	0.501	0.503	
NR Band n41	0.034	0.013	0.015	0.047	0.049	



FCC ID: A3LSMF916U	 <small>Prove it to be part of Samsung</small>	SAR EVALUATION REPORT		Approved by: Quality Manager
Document S/N: 1M2005200087-01-R2.A3L	Test Dates: 06/28/20-08/24/20	DUT Type: Portable Handset		Page 207 of 267

Table 12-12
Simultaneous Transmission Scenario with Bluetooth Antenna 1 and 5 GHz WLAN MIMO (Body-Worn at 1.5 cm)

Configuration	Mode	2G/3G/4G/5G SAR (W/kg)	BluetoothAnt 1 SAR (W/kg)	5 GHz WLAN Ant 1 SAR (W/kg)	5 GHz WLAN Ant 2 SAR (W/kg)	Σ SAR (W/kg)
		1	2	3	4	
Body - Worn SAR	CDMA BC10 (§90S)	0.336	0.013	0.016	0.010	0.375
	CDMA BC0 (§22H)	0.401	0.013	0.016	0.010	0.440
	PCS CDMA	0.406	0.013	0.016	0.010	0.445
	GSM 850	0.201	0.013	0.016	0.010	0.240
	GSM 1900	0.232	0.013	0.016	0.010	0.271
	UMTS 850	0.262	0.013	0.016	0.010	0.301
	UMTS 1750	0.993	0.013	0.016	0.010	1.032
	UMTS 1900	0.599	0.013	0.016	0.010	0.638
	LTE Band 71	0.241	0.013	0.016	0.010	0.280
	LTE Band 12	0.139	0.013	0.016	0.010	0.178
	LTE Band 13	0.342	0.013	0.016	0.010	0.381
	LTE Band 14	0.303	0.013	0.016	0.010	0.342
	LTE Band 26 (Cell)	0.316	0.013	0.016	0.010	0.355
	LTE Band 5 (Cell)	0.305	0.013	0.016	0.010	0.344
	LTE Band 66 (AWS)	1.135	0.013	0.016	0.010	1.174
	LTE Band 25 (PCS)	0.469	0.013	0.016	0.010	0.508
	LTE Band 30	0.627	0.013	0.016	0.010	0.666
	LTE Band 7	0.520	0.013	0.016	0.010	0.559
	LTE Band 48	0.248	0.013	0.016	0.010	0.287
	LTE Band 41	0.471	0.013	0.016	0.010	0.510
NR Band n71	0.209	0.013	0.016	0.010	0.248	
NR Band n5 (Cell)	0.320	0.013	0.016	0.010	0.359	
NR Band n66 (AWS)	0.747	0.013	0.016	0.010	0.786	
NR Band n25 (PCS)	0.488	0.013	0.016	0.010	0.527	
NR Band n41	0.034	0.013	0.016	0.010	0.073	



FCC ID: A3LSMF916U	 <small>Proud to be part of Samsung</small>	SAR EVALUATION REPORT		Approved by: Quality Manager
Document S/N: 1M2005200087-01-R2.A3L	Test Dates: 06/28/20-08/24/20	DUT Type: Portable Handset	Page 208 of 267	

Table 12-13
Simultaneous Transmission Scenario with Bluetooth Antenna 2 and 5 GHz WLAN MIMO (Body-Worn at 1.5 cm)

Configuration	Mode	2G/3G/4G/5G SAR (W/kg)	BluetoothAnt 2 SAR (W/kg)	5 GHz WLAN Ant 1 SAR (W/kg)	5 GHz WLAN Ant 2 SAR (W/kg)	Σ SAR (W/kg)
		1	2	3	4	
Body - Worn SAR	CDMA BC10 (§90S)	0.336	0.015	0.016	0.010	0.377
	CDMA BC0 (§22H)	0.401	0.015	0.016	0.010	0.442
	PCS CDMA	0.406	0.015	0.016	0.010	0.447
	GSM 850	0.201	0.015	0.016	0.010	0.242
	GSM 1900	0.232	0.015	0.016	0.010	0.273
	UMTS 850	0.262	0.015	0.016	0.010	0.303
	UMTS 1750	0.993	0.015	0.016	0.010	1.034
	UMTS 1900	0.599	0.015	0.016	0.010	0.640
	LTE Band 71	0.241	0.015	0.016	0.010	0.282
	LTE Band 12	0.139	0.015	0.016	0.010	0.180
	LTE Band 13	0.342	0.015	0.016	0.010	0.383
	LTE Band 14	0.303	0.015	0.016	0.010	0.344
	LTE Band 26 (Cell)	0.316	0.015	0.016	0.010	0.357
	LTE Band 5 (Cell)	0.305	0.015	0.016	0.010	0.346
	LTE Band 66 (AWS)	1.135	0.015	0.016	0.010	1.176
	LTE Band 25 (PCS)	0.469	0.015	0.016	0.010	0.510
	LTE Band 30	0.627	0.015	0.016	0.010	0.668
	LTE Band 7	0.520	0.015	0.016	0.010	0.561
	LTE Band 48	0.248	0.015	0.016	0.010	0.289
	LTE Band 41	0.471	0.015	0.016	0.010	0.512
	NR Band n71	0.209	0.015	0.016	0.010	0.250
NR Band n5 (Cell)	0.320	0.015	0.016	0.010	0.361	
NR Band n66 (AWS)	0.747	0.015	0.016	0.010	0.788	
NR Band n25 (PCS)	0.488	0.015	0.016	0.010	0.529	
NR Band n41	0.034	0.015	0.016	0.010	0.075	





FCC ID: A3LSMF916U	 <small>Proud to be part of Samsung</small>	SAR EVALUATION REPORT		Approved by: Quality Manager
Document S/N: 1M2005200087-01-R2.A3L	Test Dates: 06/28/20-08/24/20	DUT Type: Portable Handset	Page 209 of 267	

Table 12-14
Simultaneous Transmission Scenario with Bluetooth Antenna 1, 2.4 GHz WLAN Antenna 2, and 5 GHz WLAN MIMO (Body-Worn at 1.5 cm)

Configuration	Mode	2G/3G/4G/5G SAR (W/kg)	BluetoothAnt 1 SAR (W/kg)	2.4 GHz WLAN Ant 2 SAR (W/kg)	5 GHz WLAN Ant 1 SAR (W/kg)	5 GHz WLAN Ant 2 SAR (W/kg)	Σ SAR (W/kg)
		1	2	3	4	5	
Body - Worn SAR	CDMA BC10 (\$90S)	0.336	0.013	0.015	0.016	0.010	0.390
	CDMA BC0 (\$22H)	0.401	0.013	0.015	0.016	0.010	0.455
	PCS CDMA	0.406	0.013	0.015	0.016	0.010	0.460
	GSM 850	0.201	0.013	0.015	0.016	0.010	0.255
	GSM 1900	0.232	0.013	0.015	0.016	0.010	0.286
	UMTS 850	0.262	0.013	0.015	0.016	0.010	0.316
	UMTS 1750	0.993	0.013	0.015	0.016	0.010	1.047
	UMTS 1900	0.599	0.013	0.015	0.016	0.010	0.653
	LTE Band 71	0.241	0.013	0.015	0.016	0.010	0.295
	LTE Band 12	0.139	0.013	0.015	0.016	0.010	0.193
	LTE Band 13	0.342	0.013	0.015	0.016	0.010	0.396
	LTE Band 14	0.303	0.013	0.015	0.016	0.010	0.357
	LTE Band 26 (Cell)	0.316	0.013	0.015	0.016	0.010	0.370
	LTE Band 5 (Cell)	0.305	0.013	0.015	0.016	0.010	0.359
	LTE Band 66 (AWS)	1.135	0.013	0.015	0.016	0.010	1.189
	LTE Band 25 (PCS)	0.469	0.013	0.015	0.016	0.010	0.523
	LTE Band 30	0.627	0.013	0.015	0.016	0.010	0.681
	LTE Band 7	0.520	0.013	0.015	0.016	0.010	0.574
	LTE Band 48	0.248	0.013	0.015	0.016	0.010	0.302
	LTE Band 41	0.471	0.013	0.015	0.016	0.010	0.525
	NR Band n71	0.209	0.013	0.015	0.016	0.010	0.263
NR Band n5 (Cell)	0.320	0.013	0.015	0.016	0.010	0.374	
NR Band n66 (AWS)	0.747	0.013	0.015	0.016	0.010	0.801	
NR Band n25 (PCS)	0.488	0.013	0.015	0.016	0.010	0.542	
NR Band n41	0.034	0.013	0.015	0.016	0.010	0.088	

FCC ID: A3LSMF916U	 <small>Proud to be part of Samsung</small>	SAR EVALUATION REPORT		Approved by: Quality Manager
Document S/N: 1M2005200087-01-R2.A3L	Test Dates: 06/28/20-08/24/20	DUT Type: Portable Handset		Page 210 of 267



12.5 Hotspot SAR Simultaneous Transmission Analysis

Per FCC KDB Publication 941225 D06v02r01, the devices edges with antennas more than 2.5 cm from edge are not required to be evaluated for SAR (“-“).

(*) For test positions that were not required to be evaluated for WLAN SAR per FCC KDB publication 248227, the worst case WLAN SAR result for the applicable exposure conditions was used for simultaneous transmission analysis.

Table 12-15
Simultaneous Transmission Scenario with 2.4 GHz WLAN (Hotspot at 1.0 cm)

Configuration	Mode	2G/3G/4G/5G SAR (W/kg)	2.4 GHz WLAN Ant 1 SAR (W/kg)	2.4 GHz WLAN Ant 2 SAR (W/kg)	Σ SAR (W/kg)
		1	2	3	
Hotspot SAR	CDMA BC10 (\$90S)	0.694	0.635	0.149	1.478
	CDMA BC0 (\$22H)	0.832	0.635	0.149	See Table Below
	PCS CDMA	0.890	0.635	0.149	See Table Below
	GPRS 850	0.912	0.635	0.149	See Table Below
	GPRS 1900	0.690	0.635	0.149	1.474
	UMTS 850	0.575	0.635	0.149	1.359
	UMTS 1750	1.005	0.635	0.149	See Table Below
	UMTS 1900	0.890	0.635	0.149	See Table Below
	LTE Band 71	0.501	0.635	0.149	1.285
	LTE Band 12	0.389	0.635	0.149	1.173
	LTE Band 13	0.782	0.635	0.149	1.566
	LTE Band 14	0.679	0.635	0.149	1.463
	LTE Band 26 (Cell)	0.612	0.635	0.149	1.396
	LTE Band 5 (Cell)	0.772	0.635	0.149	1.556
	LTE Band 66 (AWS)	0.798	0.635	0.149	1.582
	LTE Band 25 (PCS)	0.811	0.635	0.149	See Table Below
	LTE Band 30	1.062	0.635	0.149	See Table Below
	LTE Band 7	1.059	0.635	0.149	See Table Below
	LTE Band 48	0.493	0.635	0.149	1.277
	LTE Band 41	0.950	0.635	0.149	See Table Below
NR Band n71	0.485	0.635	0.149	1.269	
NR Band n5 (Cell)	0.661	0.635	0.149	1.445	
NR Band n66 (AWS)	0.937	0.635	0.149	See Table Below	
NR Band n25 (PCS)	0.772	0.635	0.149	1.556	
NR Band n41	0.181	0.635	0.149	0.965	

FCC ID: A3LSMF916U	 PCTEST Proud to be part of Samsung	SAR EVALUATION REPORT		Approved by: Quality Manager
Document S/N: 1M2005200087-01-R2.A3L	Test Dates: 06/28/20-08/24/20	DUT Type: Portable Handset		Page 211 of 267

Simult Tx	Configuration	EVDO BC0 (\$22H) SAR (W/kg)	2.4 GHz WLAN Ant 1 SAR (W/kg)	2.4 GHz WLAN Ant 2 SAR (W/kg)	Σ SAR (W/kg)	Simult Tx	Configuration	PCS EVDO SAR (W/kg)	2.4 GHz WLAN Ant 1 SAR (W/kg)	2.4 GHz WLAN Ant 2 SAR (W/kg)	Σ SAR (W/kg)	Simult Tx	Configuration	GPRS 850 SAR (W/kg)	2.4 GHz WLAN Ant 1 SAR (W/kg)	2.4 GHz WLAN Ant 2 SAR (W/kg)	Σ SAR (W/kg)
		1	2	3	1+2+3			1	2	3	1+2+3			1	2	3	1+2+3
Hotspot SAR	Back	0.832	0.045	0.027	0.904	Hotspot SAR	Back	0.390	0.045	0.027	0.462	Hotspot SAR	Back	0.912	0.045	0.027	0.984
	Front	0.178	0.307	0.131	0.616		Front	0.090	0.307	0.131	0.528		Front	0.158	0.307	0.131	0.596
	Top	-	0.635	0.082	0.717		Top	-	0.635	0.082	0.717		Top	-	0.635	0.082	0.717
	Bottom	0.372	-	-	0.372		Bottom	0.890	-	-	0.890		Bottom	0.330	-	-	0.330
	Right	0.474	-	0.149	0.623		Right	0.222	-	0.149	0.371		Right	0.533	-	0.149	0.682
Left	0.072	0.094	0.005	0.171	Left	0.058	0.094	0.005	0.157	Left	0.094	0.094	0.005	0.193			
Simult Tx	Configuration	UMTS 1750 SAR (W/kg)	2.4 GHz WLAN Ant 1 SAR (W/kg)	2.4 GHz WLAN Ant 2 SAR (W/kg)	Σ SAR (W/kg)	Simult Tx	Configuration	UMTS 1900 SAR (W/kg)	2.4 GHz WLAN Ant 1 SAR (W/kg)	2.4 GHz WLAN Ant 2 SAR (W/kg)	Σ SAR (W/kg)	Simult Tx	Configuration	LTE Band 25 (PCS) SAR (W/kg)	2.4 GHz WLAN Ant 1 SAR (W/kg)	2.4 GHz WLAN Ant 2 SAR (W/kg)	Σ SAR (W/kg)
		1	2	3	1+2+3			1	2	3	1+2+3			1	2	3	1+2+3
Hotspot SAR	Back	0.647	0.045	0.027	0.719	Hotspot SAR	Back	0.415	0.045	0.027	0.487	Hotspot SAR	Back	0.311	0.045	0.027	0.383
	Front	0.125	0.307	0.131	0.563		Front	0.093	0.307	0.131	0.531		Front	0.071	0.307	0.131	0.509
	Top	-	0.635	0.082	0.717		Top	-	0.635	0.082	0.717		Top	-	0.635	0.082	0.717
	Bottom	1.005	-	-	1.005		Bottom	0.890	-	-	0.890		Bottom	0.811	-	-	0.811
	Right	0.130	-	0.149	0.279		Right	0.208	-	0.149	0.357		Right	0.284	-	0.149	0.433
Left	0.078	0.094	0.005	0.177	Left	0.080	0.094	0.005	0.179	Left	0.036	0.094	0.005	0.135			
Simult Tx	Configuration	LTE Band 30 SAR (W/kg)	2.4 GHz WLAN Ant 1 SAR (W/kg)	2.4 GHz WLAN Ant 2 SAR (W/kg)	Σ SAR (W/kg)	Simult Tx	Configuration	LTE Band 7 SAR (W/kg)	2.4 GHz WLAN Ant 1 SAR (W/kg)	2.4 GHz WLAN Ant 2 SAR (W/kg)	Σ SAR (W/kg)	Simult Tx	Configuration	LTE Band 41 SAR (W/kg)	2.4 GHz WLAN Ant 1 SAR (W/kg)	2.4 GHz WLAN Ant 2 SAR (W/kg)	Σ SAR (W/kg)
		1	2	3	1+2+3			1	2	3	1+2+3			1	2	3	1+2+3
Hotspot SAR	Back	0.429	0.045	0.027	0.501	Hotspot SAR	Back	0.335	0.045	0.027	0.407	Hotspot SAR	Back	0.460	0.045	0.027	0.532
	Front	0.120	0.307	0.131	0.558		Front	0.222	0.307	0.131	0.660		Front	0.116	0.307	0.131	0.554
	Top	-	0.635	0.082	0.717		Top	-	0.635	0.082	0.717		Top	-	0.635	0.082	0.717
	Bottom	1.062	-	-	1.062		Bottom	1.059	-	-	1.059		Bottom	0.950	-	-	0.950
	Right	0.166	-	0.149	0.315		Right	0.056	-	0.149	0.205		Right	0.062	-	0.149	0.211
Left	0.064	0.094	0.005	0.163	Left	0.040	0.094	0.005	0.139	Left	0.051	0.094	0.005	0.150			
Simult Tx	Configuration	NR Band n66 (AWS) SAR (W/kg)	2.4 GHz WLAN Ant 1 SAR (W/kg)	2.4 GHz WLAN Ant 2 SAR (W/kg)	Σ SAR (W/kg)	Simult Tx	Configuration	NR Band n66 (AWS) SAR (W/kg)	2.4 GHz WLAN Ant 1 SAR (W/kg)	2.4 GHz WLAN Ant 2 SAR (W/kg)	Σ SAR (W/kg)	Simult Tx	Configuration	NR Band n66 (AWS) SAR (W/kg)	2.4 GHz WLAN Ant 1 SAR (W/kg)	2.4 GHz WLAN Ant 2 SAR (W/kg)	Σ SAR (W/kg)
		1	2	3	1+2+3			1	2	3	1+2+3			1	2	3	1+2+3
Hotspot SAR	Back	0.552	0.045	0.027	0.624	Hotspot SAR	Back	0.552	0.045	0.027	0.624	Hotspot SAR	Back	0.552	0.045	0.027	0.624
	Front	0.088	0.307	0.131	0.526		Front	0.088	0.307	0.131	0.526		Front	0.088	0.307	0.131	0.526
	Top	-	0.635	0.082	0.717		Top	-	0.635	0.082	0.717		Top	-	0.635	0.082	0.717
	Bottom	0.937	-	-	0.937		Bottom	0.937	-	-	0.937		Bottom	0.937	-	-	0.937
	Right	0.185	-	0.149	0.334		Right	0.185	-	0.149	0.334		Right	0.185	-	0.149	0.334
Left	0.059	0.094	0.005	0.158	Left	0.059	0.094	0.005	0.158	Left	0.059	0.094	0.005	0.158			



FCC ID: A3LSMF916U	 PCTEST <small>Prove it to be part of Samsung</small>	SAR EVALUATION REPORT		Approved by: Quality Manager
Document S/N: 1M2005200087-01-R2.A3L	Test Dates: 06/28/20-08/24/20	DUT Type: Portable Handset	Page 212 of 267	

Table 12-16
Simultaneous Transmission Scenario with 5 GHz WLAN (Hotspot at 1.0 cm)

Configuration	Mode	2G/3G/4G/5G SAR (W/kg)	5 GHz WLAN Ant 1 SAR (W/kg)	5 GHz WLAN Ant 2 SAR (W/kg)	Σ SAR (W/kg)
		1	2	3	1+2+3
Hotspot SAR	CDMA BC10 (§90S)	0.694	0.275	0.105	1.074
	CDMA BC0 (§22H)	0.832	0.275	0.105	1.212
	PCS CDMA	0.890	0.275	0.105	1.270
	GPRS 850	0.912	0.275	0.105	1.292
	GPRS 1900	0.690	0.275	0.105	1.070
	UMTS 850	0.575	0.275	0.105	0.955
	UMTS 1750	1.005	0.275	0.105	1.385
	UMTS 1900	0.890	0.275	0.105	1.270
	LTE Band 71	0.501	0.275	0.105	0.881
	LTE Band 12	0.389	0.275	0.105	0.769
	LTE Band 13	0.782	0.275	0.105	1.162
	LTE Band 14	0.679	0.275	0.105	1.059
	LTE Band 26 (Cell)	0.612	0.275	0.105	0.992
	LTE Band 5 (Cell)	0.772	0.275	0.105	1.152
	LTE Band 66 (AWS)	0.798	0.275	0.105	1.178
	LTE Band 25 (PCS)	0.811	0.275	0.105	1.191
	LTE Band 30	1.062	0.275	0.105	1.442
	LTE Band 7	1.059	0.275	0.105	1.439
	LTE Band 48	0.493	0.275	0.105	0.873
	LTE Band 41	0.950	0.275	0.105	1.330
NR Band n71	0.485	0.275	0.105	0.865	
NR Band n5 (Cell)	0.661	0.275	0.105	1.041	
NR Band n66 (AWS)	0.937	0.275	0.105	1.317	
NR Band n25 (PCS)	0.772	0.275	0.105	1.152	
NR Band n41	0.181	0.275	0.105	0.561	





FCC ID: A3LSMF916U	 <small>Proud to be part of Samsung</small>	SAR EVALUATION REPORT		Approved by: Quality Manager
Document S/N: 1M2005200087-01-R2.A3L	Test Dates: 06/28/20-08/24/20	DUT Type: Portable Handset		Page 213 of 267

Table 12-17
Simultaneous Transmission Scenario with 2.4 GHz WLAN MIMO and 5 GHz WLAN MIMO (Hotspot at 1.0 cm)

Simult Tx	Configuration	EVDO BC10 (\$90S) SAR (W/kg)	2.4 GHz WLAN Ant 1 SAR (W/kg)	2.4 GHz WLAN Ant 2 SAR (W/kg)	5 GHz WLAN Ant 1 SAR (W/kg)	5 GHz WLAN Ant 2 SAR (W/kg)	Σ SAR (W/kg)	Simult Tx	Configuration	EVDO BC0 (\$22H) SAR (W/kg)	2.4 GHz WLAN Ant 1 SAR (W/kg)	2.4 GHz WLAN Ant 2 SAR (W/kg)	5 GHz WLAN Ant 1 SAR (W/kg)	5 GHz WLAN Ant 2 SAR (W/kg)	Σ SAR (W/kg)
		1	2	3	4	5	1+2+3+4+5			1	2	3	4	5	1+2+3+4+5
Hotspot SAR	Back	0.694	0.045	0.027	0.019	0.011	0.796	Hotspot SAR	Back	0.832	0.045	0.027	0.019	0.011	0.934
	Front	0.186	0.307	0.131	0.275	0.105	1.004		Front	0.178	0.307	0.131	0.275	0.105	0.996
	Top	-	0.635	0.082	0.266	0.090	1.073		Top	-	0.635	0.082	0.266	0.090	1.073
	Bottom	0.338	-	-	-	-	0.338		Bottom	0.372	-	-	-	-	0.372
	Right	0.439	-	0.149	-	0.105*	0.693		Right	0.474	-	0.149	-	0.105*	0.728
	Left	-	0.094	0.005	0.047	0.015	0.161		Left	0.072	0.094	0.005	0.047	0.015	0.233
Hotspot SAR	Back	0.390	0.045	0.027	0.019	0.011	0.492	Hotspot SAR	Back	0.912	0.045	0.027	0.019	0.011	1.014
	Front	0.090	0.307	0.131	0.275	0.105	0.908		Front	0.158	0.307	0.131	0.275	0.105	0.976
	Top	-	0.635	0.082	0.266	0.090	1.073		Top	-	0.635	0.082	0.266	0.090	1.073
	Bottom	0.890	-	-	-	-	0.890		Bottom	0.330	-	-	-	-	0.330
	Right	0.222	-	0.149	-	0.105*	0.476		Right	0.533	-	0.149	-	0.105*	0.787
	Left	0.058	0.094	0.005	0.047	0.015	0.219		Left	0.094	0.094	0.005	0.047	0.015	0.255
Hotspot SAR	Back	0.262	0.045	0.027	0.019	0.011	0.364	Hotspot SAR	Back	0.575	0.045	0.027	0.019	0.011	0.677
	Front	0.070	0.307	0.131	0.275	0.105	0.888		Front	0.187	0.307	0.131	0.275	0.105	1.005
	Top	-	0.635	0.082	0.266	0.090	1.073		Top	-	0.635	0.082	0.266	0.090	1.073
	Bottom	0.690	-	-	-	-	0.690		Bottom	0.319	-	-	-	-	0.319
	Right	0.220	-	0.149	-	0.105*	0.474		Right	0.484	-	0.149	-	0.105*	0.738
	Left	0.046	0.094	0.005	0.047	0.015	0.207		Left	-	0.094	0.005	0.047	0.015	0.161
Hotspot SAR	Back	0.647	0.045	0.027	0.019	0.011	0.749	Hotspot SAR	Back	0.415	0.045	0.027	0.019	0.011	0.517
	Front	0.125	0.307	0.131	0.275	0.105	0.943		Front	0.093	0.307	0.131	0.275	0.105	0.911
	Top	-	0.635	0.082	0.266	0.090	1.073		Top	-	0.635	0.082	0.266	0.090	1.073
	Bottom	1.005	-	-	-	-	1.005		Bottom	0.890	-	-	-	-	0.890
	Right	0.130	-	0.149	-	0.105*	0.384		Right	0.208	-	0.149	-	0.105*	0.462
	Left	0.078	0.094	0.005	0.047	0.015	0.239		Left	0.080	0.094	0.005	0.047	0.015	0.241
Hotspot SAR	Back	0.450	0.045	0.027	0.019	0.011	0.552	Hotspot SAR	Back	0.278	0.045	0.027	0.019	0.011	0.380
	Front	0.187	0.307	0.131	0.275	0.105	1.005		Front	0.118	0.307	0.131	0.275	0.105	0.936
	Top	-	0.635	0.082	0.266	0.090	1.073		Top	-	0.635	0.082	0.266	0.090	1.073
	Bottom	0.291	-	-	-	-	0.291		Bottom	0.187	-	-	-	-	0.187
	Right	0.501	-	0.149	-	0.105*	0.755		Right	0.389	-	0.149	-	0.105*	0.643
	Left	-	0.094	0.005	0.047	0.015	0.161		Left	-	0.094	0.005	0.047	0.015	0.161
Hotspot SAR	Back	0.782	0.045	0.027	0.019	0.011	0.884	Hotspot SAR	Back	0.679	0.045	0.027	0.019	0.011	0.781
	Front	0.269	0.307	0.131	0.275	0.105	1.087		Front	0.280	0.307	0.131	0.275	0.105	1.098
	Top	-	0.635	0.082	0.266	0.090	1.073		Top	-	0.635	0.082	0.266	0.090	1.073
	Bottom	0.325	-	-	-	-	0.325		Bottom	0.350	-	-	-	-	0.350
	Right	0.637	-	0.149	-	0.105*	0.891		Right	0.614	-	0.149	-	0.105*	0.888
	Left	0.086	0.094	0.005	0.047	0.015	0.247		Left	0.059	0.094	0.005	0.047	0.015	0.220

FCC ID: A3LSMF916U	 <small>Proud to be part of Samsung</small>	SAR EVALUATION REPORT		Approved by: Quality Manager
Document S/N: 1M2005200087-01-R2.A3L	Test Dates: 06/28/20-08/24/20	DUT Type: Portable Handset	Page 214 of 267	

Simult Tx	Configuration	LTE Band 26 (Cell) SAR (W/kg)	2.4 GHz WLAN Ant 1 SAR (W/kg)	2.4 GHz WLAN Ant 2 SAR (W/kg)	5 GHz WLAN Ant 1 SAR (W/kg)	5 GHz WLAN Ant 2 SAR (W/kg)	Σ SAR (W/kg)	Simult Tx	Configuration	LTE Band 5 (Cell) SAR (W/kg)	2.4 GHz WLAN Ant 1 SAR (W/kg)	2.4 GHz WLAN Ant 2 SAR (W/kg)	5 GHz WLAN Ant 1 SAR (W/kg)	5 GHz WLAN Ant 2 SAR (W/kg)	Σ SAR (W/kg)
		1	2	3	4	5	1+2+3+4+5			1	2	3	4	5	1+2+3+4+5
Hotspot SAR	Back	0.612	0.045	0.027	0.019	0.011	0.714	Hotspot SAR	Back	0.772	0.045	0.027	0.019	0.011	0.874
	Front	0.158	0.307	0.131	0.275	0.105	0.976		Front	0.159	0.307	0.131	0.275	0.105	0.977
	Top	-	0.635	0.082	0.266	0.090	1.073		Top	-	0.635	0.082	0.266	0.090	1.073
	Bottom	0.330	-	-	-	-	0.330		Bottom	0.331	-	-	-	-	0.331
	Right	0.410	-	0.149	-	0.105*	0.664		Right	0.449	-	0.149	-	0.105*	0.703
	Left	-	0.094	0.005	0.047	0.015	0.161		Left	-	0.094	0.005	0.047	0.015	0.161
Hotspot SAR	Back	0.514	0.045	0.027	0.019	0.011	0.616	Hotspot SAR	Back	0.311	0.045	0.027	0.019	0.011	0.413
	Front	0.091	0.307	0.131	0.275	0.105	0.909		Front	0.071	0.307	0.131	0.275	0.105	0.889
	Top	-	0.635	0.082	0.266	0.090	1.073		Top	-	0.635	0.082	0.266	0.090	1.073
	Bottom	0.798	-	-	-	-	0.798		Bottom	0.811	-	-	-	-	0.811
	Right	0.137	-	0.149	-	0.105*	0.391		Right	0.284	-	0.149	-	0.105*	0.538
	Left	0.046	0.094	0.005	0.047	0.015	0.207		Left	0.036	0.094	0.005	0.047	0.015	0.197
Hotspot SAR	Back	0.429	0.045	0.027	0.019	0.011	0.531	Hotspot SAR	Back	0.335	0.045	0.027	0.019	0.011	0.437
	Front	0.120	0.307	0.131	0.275	0.105	0.938		Front	0.222	0.307	0.131	0.275	0.105	1.040
	Top	-	0.635	0.082	0.266	0.090	1.073		Top	-	0.635	0.082	0.266	0.090	1.073
	Bottom	1.062	-	-	-	-	1.062		Bottom	1.059	-	-	-	-	1.059
	Right	0.166	-	0.149	-	0.105*	0.420		Right	0.056	-	0.149	-	0.105*	0.310
	Left	0.064	0.094	0.005	0.047	0.015	0.225		Left	0.040	0.094	0.005	0.047	0.015	0.201
Hotspot SAR	Back	0.361	0.045	0.027	0.019	0.011	0.463	Hotspot SAR	Back	0.460	0.045	0.027	0.019	0.011	0.562
	Front	0.073	0.307	0.131	0.275	0.105	0.891		Front	0.116	0.307	0.131	0.275	0.105	0.934
	Top	0.493	0.635	0.082	0.266	0.090	1.566		Top	-	0.635	0.082	0.266	0.090	1.073
	Bottom	-	-	-	-	-	-		Bottom	0.950	-	-	-	-	0.950
	Right	-	-	0.149	-	0.105*	0.254		Right	0.062	-	0.149	-	0.105*	0.318
	Left	0.051	0.094	0.005	0.047	0.015	0.212		Left	0.051	0.094	0.005	0.047	0.015	0.212
Hotspot SAR	Back	0.372	0.045	0.027	0.019	0.011	0.474	Hotspot SAR	Back	0.661	0.045	0.027	0.019	0.011	0.763
	Front	0.141	0.307	0.131	0.275	0.105	0.959		Front	0.137	0.307	0.131	0.275	0.105	0.955
	Top	-	0.635	0.082	0.266	0.090	1.073		Top	-	0.635	0.082	0.266	0.090	1.073
	Bottom	0.210	-	-	-	-	0.210		Bottom	0.267	-	-	-	-	0.267
	Right	0.485	-	0.149	-	0.105*	0.739		Right	0.365	-	0.149	-	0.105*	0.619
	Left	-	0.094	0.005	0.047	0.015	0.161		Left	-	0.094	0.005	0.047	0.015	0.161
Hotspot SAR	Back	0.552	0.045	0.027	0.019	0.011	0.654	Hotspot SAR	Back	0.341	0.045	0.027	0.019	0.011	0.443
	Front	0.088	0.307	0.131	0.275	0.105	0.906		Front	0.061	0.307	0.131	0.275	0.105	0.879
	Top	-	0.635	0.082	0.266	0.090	1.073		Top	-	0.635	0.082	0.266	0.090	1.073
	Bottom	0.937	-	-	-	-	0.937		Bottom	0.772	-	-	-	-	0.772
	Right	0.185	-	0.149	-	0.105*	0.439		Right	0.165	-	0.149	-	0.105*	0.419
	Left	0.059	0.094	0.005	0.047	0.015	0.220		Left	0.045	0.094	0.005	0.047	0.015	0.206

Simult Tx	Configuration	NR Band n41 SAR (W/kg)	2.4 GHz WLAN Ant 1 SAR (W/kg)	2.4 GHz WLAN Ant 2 SAR (W/kg)	5 GHz WLAN Ant 1 SAR (W/kg)	5 GHz WLAN Ant 2 SAR (W/kg)	Σ SAR (W/kg)
		1	2	3	4	5	1+2+3+4+5
Hotspot SAR	Back	0.105	0.045	0.027	0.019	0.011	0.207
	Front	0.029	0.307	0.131	0.275	0.105	0.847
	Top	0.181	0.635	0.082	0.266	0.090	1.254
	Bottom	-	-	-	-	-	-
	Right	-	-	0.149	-	0.105*	0.254
	Left	0.030	0.094	0.005	0.047	0.015	0.191



FCC ID: A3LSMF916U	 PCTEST <small> Proud to be part of Samsung </small>	SAR EVALUATION REPORT		Approved by: Quality Manager
Document S/N: 1M2005200087-01-R2.A3L	Test Dates: 06/28/20-08/24/20	DUT Type: Portable Handset	Page 215 of 267	

Table 12-18
Simultaneous Transmission Scenario with Bluetooth (Hotspot at 1.0 cm)

Configuration	Mode	2G/3G/4G/5G SAR (W/kg)	Bluetooth Ant 1 SAR (W/kg)	Bluetooth Ant 2 SAR (W/kg)	Σ SAR (W/kg)	
		1	2	3	1+2	1+3
Hotspot SAR	CDMA BC10 (\$90S)	0.694	0.299	0.103	0.993	0.797
	CDMA BC0 (\$22H)	0.832	0.299	0.103	1.131	0.935
	PCS CDMA	0.890	0.299	0.103	1.189	0.993
	GPRS 850	0.912	0.299	0.103	1.211	1.015
	GPRS 1900	0.690	0.299	0.103	0.989	0.793
	UMTS 850	0.575	0.299	0.103	0.874	0.678
	UMTS 1750	1.005	0.299	0.103	1.304	1.108
	UMTS 1900	0.890	0.299	0.103	1.189	0.993
	LTE Band 71	0.501	0.299	0.103	0.800	0.604
	LTE Band 12	0.389	0.299	0.103	0.688	0.492
	LTE Band 13	0.782	0.299	0.103	1.081	0.885
	LTE Band 14	0.679	0.299	0.103	0.978	0.782
	LTE Band 26 (Cell)	0.612	0.299	0.103	0.911	0.715
	LTE Band 5 (Cell)	0.772	0.299	0.103	1.071	0.875
	LTE Band 66 (AWS)	0.798	0.299	0.103	1.097	0.901
	LTE Band 25 (PCS)	0.811	0.299	0.103	1.110	0.914
	LTE Band 30	1.062	0.299	0.103	1.361	1.165
	LTE Band 7	1.059	0.299	0.103	1.358	1.162
	LTE Band 48	0.493	0.299	0.103	0.792	0.596
	LTE Band 41	0.950	0.299	0.103	1.249	1.053
NR Band n71	0.485	0.299	0.103	0.784	0.588	
NR Band n5 (Cell)	0.661	0.299	0.103	0.960	0.764	
NR Band n66 (AWS)	0.937	0.299	0.103	1.236	1.040	
NR Band n25 (PCS)	0.772	0.299	0.103	1.071	0.875	
NR Band n41	0.181	0.299	0.103	0.480	0.284	



FCC ID: A3LSMF916U	 <small>Prove it to be part of Samsung</small>	SAR EVALUATION REPORT		Approved by: Quality Manager
Document S/N: 1M2005200087-01-R2.A3L	Test Dates: 06/28/20-08/24/20	DUT Type: Portable Handset		Page 216 of 267

Table 12-19

Simultaneous Transmission Scenario with Bluetooth Antenna 1 and 5 GHz WLAN MIMO (Hotspot at 1.0 cm)

Configuration	Mode	2G/3G/4G/5G SAR (W/kg)	Bluetooth Ant 1 SAR (W/kg)	5 GHz WLAN Ant 1 SAR (W/kg)	5 GHz WLAN Ant 2 SAR (W/kg)	Σ SAR (W/kg)
		1	2	3	4	1+2+3+4
Hotspot SAR	CDMA BC10 (\$90S)	0.694	0.299	0.275	0.105	1.373
	CDMA BC0 (\$22H)	0.832	0.299	0.275	0.105	1.511
	PCS CDMA	0.890	0.299	0.275	0.105	1.569
	GPRS 850	0.912	0.299	0.275	0.105	1.591
	GPRS 1900	0.690	0.299	0.275	0.105	1.369
	UMTS 850	0.575	0.299	0.275	0.105	1.254
	UMTS 1750	1.005	0.299	0.275	0.105	See Table Below
	UMTS 1900	0.890	0.299	0.275	0.105	1.569
	LTE Band 71	0.501	0.299	0.275	0.105	1.180
	LTE Band 12	0.389	0.299	0.275	0.105	1.068
	LTE Band 13	0.782	0.299	0.275	0.105	1.461
	LTE Band 14	0.679	0.299	0.275	0.105	1.358
	LTE Band 26 (Cell)	0.612	0.299	0.275	0.105	1.291
	LTE Band 5 (Cell)	0.772	0.299	0.275	0.105	1.451
	LTE Band 66 (AWS)	0.798	0.299	0.275	0.105	1.477
	LTE Band 25 (PCS)	0.811	0.299	0.275	0.105	1.490
	LTE Band 30	1.062	0.299	0.275	0.105	See Table Below
	LTE Band 7	1.059	0.299	0.275	0.105	See Table Below
	LTE Band 48	0.493	0.299	0.275	0.105	1.172
	LTE Band 41	0.950	0.299	0.275	0.105	See Table Below
NR Band n71	0.485	0.299	0.275	0.105	1.164	
NR Band n5 (Cell)	0.661	0.299	0.275	0.105	1.340	
NR Band n66 (AWS)	0.937	0.299	0.275	0.105	See Table Below	
NR Band n25 (PCS)	0.772	0.299	0.275	0.105	1.451	
NR Band n41	0.181	0.299	0.275	0.105	0.860	

Simult Tx	Configuration	UMTS 1750 SAR (W/kg)	Bluetooth Ant 1 SAR (W/kg)	5 GHz WLAN Ant 1 SAR (W/kg)	5 GHz WLAN Ant 2 SAR (W/kg)	Σ SAR (W/kg)	Simult Tx	Configuration	LTE Band 30 SAR (W/kg)	Bluetooth Ant 1 SAR (W/kg)	5 GHz WLAN Ant 1 SAR (W/kg)	5 GHz WLAN Ant 2 SAR (W/kg)	Σ SAR (W/kg)
		1	2	3	4	1+2+3+4			1	2	3	4	1+2+3+4
Hotspot SAR	Back	0.647	0.024	0.019	0.011	0.701	Hotspot SAR	Back	0.429	0.024	0.019	0.011	0.483
	Front	0.125	0.142	0.275	0.105	0.647		Front	0.120	0.142	0.275	0.105	0.642
	Top	-	0.299	0.266	0.090	0.655		Top	-	0.299	0.266	0.090	0.655
	Bottom	1.005	-	-	-	1.005		Bottom	1.062	-	-	-	1.062
	Right	0.130	-	-	0.105*	0.235		Right	0.166	-	-	0.105*	0.271
Left	0.078	0.050	0.047	0.015	0.190	Left	0.064	0.050	0.047	0.015	0.176		
Hotspot SAR	Back	0.335	0.024	0.019	0.011	0.389	Hotspot SAR	Back	0.480	0.024	0.019	0.011	0.514
	Front	0.222	0.142	0.275	0.105	0.744		Front	0.116	0.142	0.275	0.105	0.638
	Top	-	0.299	0.266	0.090	0.655		Top	-	0.299	0.266	0.090	0.655
	Bottom	1.059	-	-	-	1.059		Bottom	0.950	-	-	-	0.950
	Right	0.056	-	-	0.105*	0.161		Right	0.062	-	-	0.105*	0.167
Left	0.040	0.050	0.047	0.015	0.152	Left	0.051	0.050	0.047	0.015	0.163		

Simult Tx	Configuration	NR Band n66 (AWS) SAR (W/kg)	Bluetooth Ant 1 SAR (W/kg)	5 GHz WLAN Ant 1 SAR (W/kg)	5 GHz WLAN Ant 2 SAR (W/kg)	Σ SAR (W/kg)
		1	2	3	4	1+2+3+4
Hotspot SAR	Back	0.552	0.024	0.019	0.011	0.606
	Front	0.088	0.142	0.275	0.105	0.610
	Top	-	0.299	0.266	0.090	0.655
	Bottom	0.937	-	-	-	0.937
	Right	0.185	-	-	0.105*	0.290
Left	0.059	0.050	0.047	0.015	0.171	



FCC ID: A3LSMF916U	 PCTEST <small>Prove to be part of Samsung</small>	SAR EVALUATION REPORT		Approved by: Quality Manager
Document S/N: 1M2005200087-01-R2.A3L	Test Dates: 06/28/20-08/24/20	DUT Type: Portable Handset		Page 217 of 267

Table 12-20
Simultaneous Transmission Scenario with Bluetooth Antenna 2 and 5 GHz WLAN MIMO (Hotspot at 1.0 cm)

Configuration	Mode	2G/3G/4G/5G SAR (W/kg)	Bluetooth Ant 2 SAR (W/kg)	5 GHz WLAN Ant 1 SAR (W/kg)	5 GHz WLAN Ant 2 SAR (W/kg)	Σ SAR (W/kg)
		1	2	3	4	1+2+3+4
Hotspot SAR	CDMA BC10 (§90S)	0.694	0.103	0.275	0.105	1.177
	CDMA BC0 (§22H)	0.832	0.103	0.275	0.105	1.315
	PCS CDMA	0.890	0.103	0.275	0.105	1.373
	GPRS 850	0.912	0.103	0.275	0.105	1.395
	GPRS 1900	0.690	0.103	0.275	0.105	1.173
	UMTS 850	0.575	0.103	0.275	0.105	1.058
	UMTS 1750	1.005	0.103	0.275	0.105	1.488
	UMTS 1900	0.890	0.103	0.275	0.105	1.373
	LTE Band 71	0.501	0.103	0.275	0.105	0.984
	LTE Band 12	0.389	0.103	0.275	0.105	0.872
	LTE Band 13	0.782	0.103	0.275	0.105	1.265
	LTE Band 14	0.679	0.103	0.275	0.105	1.162
	LTE Band 26 (Cell)	0.612	0.103	0.275	0.105	1.095
	LTE Band 5 (Cell)	0.772	0.103	0.275	0.105	1.255
	LTE Band 66 (AWS)	0.798	0.103	0.275	0.105	1.281
	LTE Band 25 (PCS)	0.811	0.103	0.275	0.105	1.294
	LTE Band 30	1.062	0.103	0.275	0.105	1.545
	LTE Band 7	1.059	0.103	0.275	0.105	1.542
	LTE Band 48	0.493	0.103	0.275	0.105	0.976
	LTE Band 41	0.950	0.103	0.275	0.105	1.433
	NR Band n71	0.485	0.103	0.275	0.105	0.968
NR Band n5 (Cell)	0.661	0.103	0.275	0.105	1.144	
NR Band n66 (AWS)	0.937	0.103	0.275	0.105	1.420	
NR Band n25 (PCS)	0.772	0.103	0.275	0.105	1.255	
NR Band n41	0.181	0.103	0.275	0.105	0.664	





FCC ID: A3LSMF916U	 <small>Proud to be part of Samsung</small>	SAR EVALUATION REPORT		Approved by: Quality Manager
Document S/N: 1M2005200087-01-R2.A3L	Test Dates: 06/28/20-08/24/20	DUT Type: Portable Handset	Page 218 of 267	

Table 12-21



Simultaneous Transmission Scenario with Bluetooth Antenna 1, 2.4 GHz WLAN Antenna 2, and 5 GHz WLAN MIMO (Hotspot at 1.0 cm)

Configuration	Mode	2G/3G/4G/5G SAR (W/kg)	Bluetooth Ant 1 SAR (W/kg)	2.4 GHz WLAN Ant 2 SAR (W/kg)	5 GHz WLAN Ant 1 SAR (W/kg)	5 GHz WLAN Ant 2 SAR (W/kg)	Σ SAR (W/kg)
		1	2	3	4	5	1+2+3+4+5
Hotspot SAR	CDMA BC10 (\$90S)	0.694	0.299	0.149	0.275	0.105	1.522
	CDMA BC0 (\$22H)	0.832	0.299	0.149	0.275	0.105	See Table Below
	PCS CDMA	0.890	0.299	0.149	0.275	0.105	See Table Below
	GPRS 850	0.912	0.299	0.149	0.275	0.105	See Table Below
	GPRS 1900	0.690	0.299	0.149	0.275	0.105	1.518
	UMTS 850	0.575	0.299	0.149	0.275	0.105	1.403
	UMTS 1750	1.005	0.299	0.149	0.275	0.105	See Table Below
	UMTS 1900	0.890	0.299	0.149	0.275	0.105	See Table Below
	LTE Band 71	0.501	0.299	0.149	0.275	0.105	1.329
	LTE Band 12	0.389	0.299	0.149	0.275	0.105	1.217
	LTE Band 13	0.782	0.299	0.149	0.275	0.105	See Table Below
	LTE Band 14	0.679	0.299	0.149	0.275	0.105	1.507
	LTE Band 26 (Cell)	0.612	0.299	0.149	0.275	0.105	1.440
	LTE Band 5 (Cell)	0.772	0.299	0.149	0.275	0.105	See Table Below
	LTE Band 66 (AWS)	0.798	0.299	0.149	0.275	0.105	See Table Below
	LTE Band 25 (PCS)	0.811	0.299	0.149	0.275	0.105	See Table Below
	LTE Band 30	1.062	0.299	0.149	0.275	0.105	See Table Below
	LTE Band 7	1.059	0.299	0.149	0.275	0.105	See Table Below
	LTE Band 48	0.493	0.299	0.149	0.275	0.105	1.321
	LTE Band 41	0.950	0.299	0.149	0.275	0.105	See Table Below
	NR Band n71	0.485	0.299	0.149	0.275	0.105	1.313
NR Band n5 (Cell)	0.661	0.299	0.149	0.275	0.105	1.489	
NR Band n66 (AWS)	0.937	0.299	0.149	0.275	0.105	See Table Below	
NR Band n25 (PCS)	0.772	0.299	0.149	0.275	0.105	See Table Below	
NR Band n41	0.181	0.299	0.149	0.275	0.105	1.009	

Simult Tx	Configuration	EVDO BC0 (\$22H) SAR (W/kg)	Bluetooth Ant 1 SAR (W/kg)	2.4 GHz WLAN Ant 2 SAR (W/kg)	5 GHz WLAN Ant 1 SAR (W/kg)	5 GHz WLAN Ant 2 SAR (W/kg)	Σ SAR (W/kg)	Simult Tx	Configuration	PCS EVDO SAR (W/kg)	Bluetooth Ant 1 SAR (W/kg)	2.4 GHz WLAN Ant 2 SAR (W/kg)	5 GHz WLAN Ant 1 SAR (W/kg)	5 GHz WLAN Ant 2 SAR (W/kg)	Σ SAR (W/kg)
		1	2	3	4	5	1+2+3+4+5			1	2	3	4	5	1+2+3+4+5
Hotspot SAR	Back	0.832	0.024	0.027	0.019	0.011	0.913	Hotspot SAR	Back	0.390	0.024	0.027	0.019	0.011	0.471
	Front	0.178	0.142	0.131	0.275	0.105	0.831		Front	0.090	0.142	0.131	0.275	0.105	0.743
	Top	-	0.299	0.082	0.266	0.090	0.737		Top	-	0.299	0.082	0.266	0.090	0.737
	Bottom	0.372	-	-	-	-	0.372		Bottom	0.890	-	-	-	-	0.890
	Right	0.474	-	0.149	-	0.105*	0.728		Right	0.222	-	0.149	-	0.105*	0.476
	Left	0.072	0.050	0.005	0.047	0.015	0.189		Left	0.058	0.050	0.005	0.047	0.015	0.175
Hotspot SAR	Back	0.912	0.024	0.027	0.019	0.011	0.993	Hotspot SAR	Back	0.647	0.024	0.027	0.019	0.011	0.728
	Front	0.158	0.142	0.131	0.275	0.105	0.811		Front	0.125	0.142	0.131	0.275	0.105	0.778
	Top	-	0.299	0.082	0.266	0.090	0.737		Top	-	0.299	0.082	0.266	0.090	0.737
	Bottom	0.330	-	-	-	-	0.330		Bottom	1.005	-	-	-	-	1.005
	Right	0.533	-	0.149	-	0.105*	0.787		Right	0.130	-	0.149	-	0.105*	0.384
	Left	0.094	0.050	0.005	0.047	0.015	0.211		Left	0.078	0.050	0.005	0.047	0.015	0.195
Hotspot SAR	Back	0.415	0.024	0.027	0.019	0.011	0.496	Hotspot SAR	Back	0.782	0.024	0.027	0.019	0.011	0.863
	Front	0.093	0.142	0.131	0.275	0.105	0.746		Front	0.269	0.142	0.131	0.275	0.105	0.922
	Top	-	0.299	0.082	0.266	0.090	0.737		Top	-	0.299	0.082	0.266	0.090	0.737
	Bottom	0.890	-	-	-	-	0.890		Bottom	0.325	-	-	-	-	0.325
	Right	0.208	-	0.149	-	0.105*	0.462		Right	0.637	-	0.149	-	0.105*	0.891
	Left	0.080	0.050	0.005	0.047	0.015	0.197		Left	0.086	0.050	0.005	0.047	0.015	0.203

FCC ID: A3LSMF916U	 PCTEST <small>Prove to be part of Samsung</small>	SAR EVALUATION REPORT		Approved by: Quality Manager
Document S/N: 1M2005200087-01-R2.A3L	Test Dates: 06/28/20-08/24/20	DUT Type: Portable Handset	Page 219 of 267	

Simult Tx	Configuration	LTE Band 5 (Cell) SAR (W/kg)	Bluetooth Ant 1 SAR (W/kg)	2.4 GHz WLAN Ant 2 SAR (W/kg)	5 GHz WLAN Ant 1 SAR (W/kg)	5 GHz WLAN Ant 2 SAR (W/kg)	Σ SAR (W/kg)	Simult Tx	Configuration	LTE Band 66 (AWS) SAR (W/kg)	Bluetooth Ant 1 SAR (W/kg)	2.4 GHz WLAN Ant 2 SAR (W/kg)	5 GHz WLAN Ant 1 SAR (W/kg)	5 GHz WLAN Ant 2 SAR (W/kg)	Σ SAR (W/kg)	
		1	2	3	4	5	1+2+3+4+5			1	2	3	4	5	1+2+3+4+5	
Hotspot SAR	Back	0.772	0.024	0.027	0.019	0.011	0.853	Hotspot SAR	Back	0.514	0.024	0.027	0.019	0.011	0.595	
	Front	0.159	0.142	0.131	0.275	0.105	0.812		Front	0.091	0.142	0.131	0.275	0.105	0.744	
	Top	-	0.299	0.082	0.266	0.090	0.737		Top	-	0.299	0.082	0.266	0.090	0.737	
	Bottom	0.331	-	-	-	-	0.331		Bottom	0.798	-	-	-	-	-	0.798
	Right	0.449	-	0.149	-	0.105*	0.703		Right	0.137	-	0.149	-	0.105*	0.391	
	Left	-	0.050	0.005	0.047	0.015	0.117		Left	0.046	0.050	0.005	0.047	0.015	0.163	
Hotspot SAR	Back	0.311	0.024	0.027	0.019	0.011	0.392	Hotspot SAR	Back	0.429	0.024	0.027	0.019	0.011	0.510	
	Front	0.071	0.142	0.131	0.275	0.105	0.724		Front	0.120	0.142	0.131	0.275	0.105	0.773	
	Top	-	0.299	0.082	0.266	0.090	0.737		Top	-	0.299	0.082	0.266	0.090	0.737	
	Bottom	0.811	-	-	-	-	0.811		Bottom	1.062	-	-	-	-	-	1.062
	Right	0.284	-	0.149	-	0.105*	0.538		Right	0.166	-	0.149	-	0.105*	0.420	
	Left	0.036	0.050	0.005	0.047	0.015	0.153		Left	0.064	0.050	0.005	0.047	0.015	0.181	
Hotspot SAR	Back	0.335	0.024	0.027	0.019	0.011	0.416	Hotspot SAR	Back	0.460	0.024	0.027	0.019	0.011	0.541	
	Front	0.222	0.142	0.131	0.275	0.105	0.875		Front	0.116	0.142	0.131	0.275	0.105	0.789	
	Top	-	0.299	0.082	0.266	0.090	0.737		Top	-	0.299	0.082	0.266	0.090	0.737	
	Bottom	1.059	-	-	-	-	1.059		Bottom	0.950	-	-	-	-	-	0.950
	Right	0.056	-	0.149	-	0.105*	0.310		Right	0.062	-	0.149	-	0.105*	0.316	
	Left	0.040	0.050	0.005	0.047	0.015	0.157		Left	0.051	0.050	0.005	0.047	0.015	0.168	
Hotspot SAR	Back	0.552	0.024	0.027	0.019	0.011	0.633	Hotspot SAR	Back	0.341	0.024	0.027	0.019	0.011	0.422	
	Front	0.088	0.142	0.131	0.275	0.105	0.741		Front	0.061	0.142	0.131	0.275	0.105	0.714	
	Top	-	0.299	0.082	0.266	0.090	0.737		Top	-	0.299	0.082	0.266	0.090	0.737	
	Bottom	0.937	-	-	-	-	0.937		Bottom	0.772	-	-	-	-	-	0.772
	Right	0.185	-	0.149	-	0.105*	0.439		Right	0.165	-	0.149	-	0.105*	0.419	
	Left	0.059	0.050	0.005	0.047	0.015	0.176		Left	0.045	0.050	0.005	0.047	0.015	0.162	

FCC ID: A3L5MF916U	 PCTEST Proud to be part of Samsung	SAR EVALUATION REPORT		Approved by: Quality Manager
Document S/N: 1M2005200087-01-R2.A3L	Test Dates: 06/28/20-08/24/20	DUT Type: Portable Handset	Page 220 of 267	

12.6 Phablet Simultaneous Transmission Analysis

Per FCC KDB Publication 941225 D06v02r01, the devices edges with antennas more than 2.5 cm from edge are not required to be evaluated for SAR (“-“).



(*) For test positions that were not required to be evaluated for WLAN SAR per FCC KDB publication 248227, the worst case WLAN SAR result for the applicable exposure conditions was used for simultaneous transmission analysis.

For SAR summation, the highest reported SAR across all test distances was used as the most conservative evaluation for simultaneous transmission analysis for each device edge.

Per FCC KDB Publication 648474 D04 Handset SAR, Phablet SAR tests were not required if wireless router 1g SAR (scaled to the maximum output power, including tolerance) < 1.2 W/kg. Therefore no further analysis beyond the tables included in this section was required to determine that possible simultaneous transmission scenarios would not exceed the SAR limit.

Table 12-22
Simultaneous Transmission Scenario with 5 GHz WLAN (Phablet)

Simult Tx	Configuration	PCS EVDO SAR (W/kg)	5 GHz WLAN MIMO SAR (W/kg)	Σ SAR (W/kg)	Simult Tx	Configuration	GPRS 1900 SAR (W/kg)	5 GHz WLAN MIMO SAR (W/kg)	Σ SAR (W/kg)	Simult Tx	Configuration	UMTS 1750 SAR (W/kg)	5 GHz WLAN MIMO SAR (W/kg)	Σ SAR (W/kg)
		1	2	1+2			1	2	1+2			1	2	1+2
Phablet SAR	Back	1.789	0.042	1.831	Phablet SAR	Back	0.824	0.042	0.866	Phablet SAR	Back	2.601	0.042	2.643
	Front	0.727	2.616	3.343		Front	0.348	2.616	2.964		Front	0.777	2.616	3.393
	Top	-	1.698	1.698		Top	-	1.698	1.698		Top	-	1.698	1.698
	Bottom	2.719	-	2.719		Bottom	1.763	-	1.763		Bottom	2.841	-	2.841
	Right	2.436	0.444	2.880		Right	1.269	0.444	1.713		Right	1.511	0.444	1.955
	Left	0.380	0.091	0.471		Left	0.176	0.091	0.267		Left	0.341	0.091	0.432
Phablet SAR	Back	1.823	0.042	1.865	Phablet SAR	Back	1.857	0.042	1.899	Phablet SAR	Back	1.168	0.042	1.210
	Front	0.670	2.616	3.286		Front	0.673	2.616	3.289		Front	0.606	2.616	3.222
	Top	-	1.698	1.698		Top	-	1.698	1.698		Top	-	1.698	1.698
	Bottom	2.632	-	2.632		Bottom	2.325	-	2.325		Bottom	2.156	-	2.156
	Right	2.396	0.444	2.840		Right	1.293	0.444	1.737		Right	2.624	0.444	3.068
	Left	0.338	0.091	0.429		Left	0.320	0.091	0.411		Left	0.271	0.091	0.362
Phablet SAR	Back	1.662	0.042	1.704	Phablet SAR	Back	1.599	0.042	1.641	Phablet SAR	Back	2.433	0.042	2.475
	Front	0.628	2.616	3.244		Front	1.240	2.616	3.856		Front	0.195	2.616	2.811
	Top	-	1.698	1.698		Top	-	1.698	1.698		Top	-	1.698	1.698
	Bottom	3.143	-	3.143		Bottom	2.707	-	2.707		Bottom	2.867	-	2.867
	Right	1.217	0.444	1.661		Right	0.394	0.444	0.838		Right	0.467	0.444	0.911
	Left	0.411	0.091	0.502		Left	0.294	0.091	0.385		Left	0.236	0.091	0.327
Phablet SAR	Back	2.075	0.042	2.117	Phablet SAR	Back	1.377	0.042	1.419	Phablet SAR	Back	1.377	0.042	1.419
	Front	0.454	2.616	3.070		Front	0.520	2.616	3.136		Front	0.520	2.616	3.136
	Top	-	1.698	1.698		Top	-	1.698	1.698		Top	-	1.698	1.698
	Bottom	2.776	-	2.776		Bottom	2.100	-	2.100		Bottom	2.100	-	2.100
	Right	1.337	0.444	1.781		Right	1.878	0.444	2.322		Right	1.878	0.444	2.322
	Left	0.307	0.091	0.398		Left	0.364	0.091	0.455		Left	0.364	0.091	0.455

FCC ID: A3LSMF916U	 PCTEST Proud to be part of Samsung	SAR EVALUATION REPORT		Approved by: Quality Manager
Document S/N: 1M2005200087-01-R2.A3L	Test Dates: 06/28/20-08/24/20	DUT Type: Portable Handset	Page 221 of 267 REV 21.4 M 09/11/2019	

12.7 UMPC Body Simultaneous Transmission Analysis

Per FCC KDB Publication 941225 D06v02r01, the devices edges with antennas more than 2.5 cm from edge are not required to be evaluated for SAR (“-”).

(*) For test positions that were not required to be evaluated for WLAN SAR per FCC KDB publication 248227, the worst case WLAN SAR result for the applicable exposure conditions was used for simultaneous transmission analysis.

For SAR summation, the highest reported SAR across all test distances was used as the most conservative evaluation for simultaneous transmission analysis for each device edge.

Table 12-23
Simultaneous Transmission Scenario with 2.4 GHz WLAN (UMPC Body)

Configuration	Mode	2G/3G/4G/5G SAR (W/kg)	2.4 GHz WLAN MIMO SAR (W/kg)	Σ SAR (W/kg)
		1	2	
UMPC Body SAR	CDMA BC10 (§90S)	0.713	0.560	1.273
	CDMA BC0 (§22H)	0.826	0.560	1.386
	PCS CDMA	0.987	0.560	1.547
	GPRS 850	0.820	0.560	1.380
	GPRS 1900	0.598	0.560	1.158
	UMTS 850	1.007	0.560	1.567
	UMTS 1750	1.159	0.560	See Table Below
	UMTS 1900	1.146	0.560	See Table Below
	LTE Band 71	0.655	0.560	1.215
	LTE Band 12	0.456	0.560	1.016
	LTE Band 13	0.750	0.560	1.310
	LTE Band 14	0.779	0.560	1.339
	LTE Band 26 (Cell)	0.790	0.560	1.350
	LTE Band 5 (Cell)	0.928	0.560	1.488
	LTE Band 66 (AWS)	0.877	0.560	1.437
	LTE Band 25 (PCS)	1.070	0.560	See Table Below
	LTE Band 30	0.773	0.560	1.333
	LTE Band 7	1.187	0.560	See Table Below
	LTE Band 48	0.378	0.560	0.938
	LTE Band 41	1.259	0.560	See Table Below
NR Band n71	0.444	0.560	1.004	
NR Band n5 (Cell)	0.648	0.560	1.208	
NR Band n66 (AWS)	1.014	0.560	1.574	
NR Band n25 (PCS)	0.982	0.560	1.542	
NR Band n41	0.230	0.560	0.790	

Simult Tx	Configuration	UMTS 1750 SAR (W/kg)	2.4 GHz WLAN MIMO SAR (W/kg)	Σ SAR (W/kg)	Simult Tx	Configuration	UMTS 1900 SAR (W/kg)	2.4 GHz WLAN MIMO SAR (W/kg)	Σ SAR (W/kg)	Simult Tx	Configuration	LTE Band 25 (PCS) SAR (W/kg)	2.4 GHz WLAN MIMO SAR (W/kg)	Σ SAR (W/kg)
		1	2	1+2			1	2	1+2			1	2	1+2
UMPC Body SAR	Back	1.159	0.360	1.519	UMPC Body SAR	Back	1.037	0.360	1.397	UMPC Body SAR	Back	1.070	0.360	1.430
	Front	0.975	0.375	1.350		Front	0.683	0.375	1.058		Front	0.747	0.375	1.122
	Top	-	0.560	0.560		Top	-	0.560	0.560		Top	-	0.560	0.560
	Bottom	0.952	-	0.952		Bottom	1.146	-	1.146		Bottom	0.751	-	0.751
	Right	0.529	-	0.529		Right	0.772	-	0.772		Right	1.019	-	1.019
Left	-	0.534	0.534	Left	-	0.534	0.534	Left	-	0.534	0.534			

Simult Tx	Configuration	LTE Band 7 SAR (W/kg)	2.4 GHz WLAN MIMO SAR (W/kg)	Σ SAR (W/kg)	Simult Tx	Configuration	LTE Band 41 SAR (W/kg)	2.4 GHz WLAN MIMO SAR (W/kg)	Σ SAR (W/kg)
		1	2	1+2			1	2	1+2
UMPC Body SAR	Back	1.187	0.360	1.547	UMPC Body SAR	Back	1.130	0.360	1.490
	Front	0.848	0.375	1.223		Front	0.975	0.375	1.350
	Top	-	0.560	0.560		Top	-	0.560	0.560
	Bottom	0.989	-	0.989		Bottom	1.259	-	1.259
	Right	0.088	-	0.088		Right	0.144	-	0.144
Left	-	0.534	0.534	Left	-	0.534	0.534		



FCC ID: A3LSMF916U	 PCTEST <small>Proud to be part of Samsung</small>	SAR EVALUATION REPORT		Approved by: Quality Manager
Document S/N: 1M2005200087-01-R2.A3L	Test Dates: 06/28/20-08/24/20	DUT Type: Portable Handset	Page 222 of 267	

Table 12-24
Simultaneous Transmission Scenario with 5GHz WLAN (UMPC Body)

Configuration	Mode	2G/3G/4G/5G SAR (W/kg)	5 GHz WLAN MIMO SAR (W/kg)	Σ SAR (W/kg)
		1	2	
UMPC Body SAR	CDMA BC10 (§90S)	0.713	0.302	1.015
	CDMA BC0 (§22H)	0.826	0.302	1.128
	PCS CDMA	0.987	0.302	1.289
	GPRS 850	0.820	0.302	1.122
	GPRS 1900	0.598	0.302	0.900
	UMTS 850	1.007	0.302	1.309
	UMTS 1750	1.159	0.302	1.461
	UMTS 1900	1.146	0.302	1.448
	LTE Band 71	0.655	0.302	0.957
	LTE Band 12	0.456	0.302	0.758
	LTE Band 13	0.750	0.302	1.052
	LTE Band 14	0.779	0.302	1.081
	LTE Band 26 (Cell)	0.790	0.302	1.092
	LTE Band 5 (Cell)	0.928	0.302	1.230
	LTE Band 66 (AWS)	0.877	0.302	1.179
	LTE Band 25 (PCS)	1.070	0.302	1.372
	LTE Band 30	0.773	0.302	1.075
	LTE Band 7	1.187	0.302	1.489
	LTE Band 48	0.378	0.302	0.680
	LTE Band 41	1.259	0.302	1.561
NR Band n71	0.444	0.302	0.746	
NR Band n5 (Cell)	0.648	0.302	0.950	
NR Band n66 (AWS)	1.014	0.302	1.316	
NR Band n25 (PCS)	0.982	0.302	1.284	
NR Band n41	0.230	0.302	0.532	



FCC ID: A3LSMF916U	 <small>Proud to be part of Samsung</small>	SAR EVALUATION REPORT		Approved by: Quality Manager
Document S/N: 1M2005200087-01-R2.A3L	Test Dates: 06/28/20-08/24/20	DUT Type: Portable Handset	Page 223 of 267	

Table 12-25



Simultaneous Transmission Scenario with 2.4 GHz WLAN MIMO and 5 GHz WLAN MIMO (UMPC Body)

Configuration	Mode	2G/3G/4G/5G SAR (W/kg)	2.4 GHz WLAN MIMO SAR (W/kg)	5 GHz WLAN MIMO at 16 dBm SAR (W/kg)	Σ SAR (W/kg)
		1	2	3	
UMPC Body SAR	CDMA BC10 (\$90S)	0.713	0.560	0.133	1.406
	CDMA BC0 (\$22H)	0.826	0.560	0.133	1.519
	PCS CDMA	0.987	0.560	0.133	See Table Below
	GPRS 850	0.820	0.560	0.133	1.513
	GPRS 1900	0.598	0.560	0.133	1.291
	UMTS 850	1.007	0.560	0.133	See Table Below
	UMTS 1750	1.159	0.560	0.133	See Table Below
	UMTS 1900	1.146	0.560	0.133	See Table Below
	LTE Band 71	0.655	0.560	0.133	1.348
	LTE Band 12	0.456	0.560	0.133	1.149
	LTE Band 13	0.750	0.560	0.133	1.443
	LTE Band 14	0.779	0.560	0.133	1.472
	LTE Band 26 (Cell)	0.790	0.560	0.133	1.483
	LTE Band 5 (Cell)	0.928	0.560	0.133	See Table Below
	LTE Band 66 (AWS)	0.877	0.560	0.133	1.570
	LTE Band 25 (PCS)	1.070	0.560	0.133	See Table Below
	LTE Band 30	0.773	0.560	0.133	1.466
	LTE Band 7	1.187	0.560	0.133	See Table Below
	LTE Band 48	0.378	0.560	0.133	1.071
	LTE Band 41	1.259	0.560	0.133	See Table Below
NR Band n71	0.444	0.560	0.133	1.137	
NR Band n5 (Cell)	0.648	0.560	0.133	1.341	
NR Band n66 (AWS)	1.014	0.560	0.133	See Table Below	
NR Band n25 (PCS)	0.982	0.560	0.133	See Table Below	
NR Band n41	0.230	0.560	0.133	0.923	

Simult Tx	Configuration	PCS EVDO SAR (W/kg)	2.4 GHz WLAN MIMO SAR (W/kg)	5 GHz WLAN MIMO at 16 dBm SAR (W/kg)	Σ SAR (W/kg)	Simult Tx	Configuration	UMTS 850 SAR (W/kg)	2.4 GHz WLAN MIMO SAR (W/kg)	5 GHz WLAN MIMO at 16 dBm SAR (W/kg)	Σ SAR (W/kg)
		1	2	3	1+2+3			1	2	3	1+2+3
UMPC Body SAR	Back	0.728	0.360	0.132	1.220	UMPC Body SAR	Back	1.007	0.360	0.132	1.499
	Front	0.730	0.375	0.060	1.165		Front	0.643	0.375	0.060	1.078
	Top	-	0.560	0.133	0.693		Top	-	0.560	0.133	0.693
	Bottom	0.987	-	-	0.987		Bottom	0.420	-	-	0.420
	Right	0.659	-	-	0.659		Right	0.488	-	-	0.488
	Left	-	0.534	0.071	0.605		Left	-	0.534	0.071	0.605

Simult Tx	Configuration	UMTS 1750 SAR (W/kg)	2.4 GHz WLAN MIMO SAR (W/kg)	5 GHz WLAN MIMO at 16 dBm SAR (W/kg)	Σ SAR (W/kg)	SPLSR			Simult Tx	Configuration	UMTS 1900 SAR (W/kg)	2.4 GHz WLAN MIMO SAR (W/kg)	5 GHz WLAN MIMO at 16 dBm SAR (W/kg)	Σ SAR (W/kg)
		1	2	3	1+2+3	1+2	1+3	2+3			1	2	3	1+2+3
UMPC Body SAR	Back	1.159	0.360	0.132	See Note 1	0.01	0.01	0.01	UMPC Body SAR	Back	1.037	0.360	0.132	1.529
	Front	0.975	0.375	0.060	1.410	N/A	N/A	N/A		Front	0.683	0.375	0.060	1.118
	Top	-	0.560	0.133	0.693	N/A	N/A	N/A		Top	-	0.560	0.133	0.693
	Bottom	0.952	-	-	0.952	N/A	N/A	N/A		Bottom	1.146	-	-	1.146
	Right	0.529	-	-	0.529	N/A	N/A	N/A		Right	0.772	-	-	0.772
	Left	-	0.534	0.071	0.605	N/A	N/A	N/A		Left	-	0.534	0.071	0.605

Simult Tx	Configuration	LTE Band 5 (Cell) SAR (W/kg)	2.4 GHz WLAN MIMO SAR (W/kg)	5 GHz WLAN MIMO at 16 dBm SAR (W/kg)	Σ SAR (W/kg)	Simult Tx	Configuration	LTE Band 25 (PCS) SAR (W/kg)	2.4 GHz WLAN MIMO SAR (W/kg)	5 GHz WLAN MIMO at 16 dBm SAR (W/kg)	Σ SAR (W/kg)
		1	2	3	1+2+3			1	2	3	1+2+3
UMPC Body SAR	Back	0.928	0.360	0.132	1.420	UMPC Body SAR	Back	1.070	0.360	0.132	1.562
	Front	0.579	0.375	0.060	1.014		Front	0.747	0.375	0.060	1.182
	Top	-	0.560	0.133	0.693		Top	-	0.560	0.133	0.693
	Bottom	0.402	-	-	0.402		Bottom	0.751	-	-	0.751
	Right	0.420	-	-	0.420		Right	1.019	-	-	1.019
	Left	-	0.534	0.071	0.605		Left	-	0.534	0.071	0.605

FCC ID: A3LSMF916U	 PCTEST <small>Proud to be part of Samsung</small>	SAR EVALUATION REPORT		Approved by: Quality Manager
Document S/N: 1M2005200087-01-R2.A3L	Test Dates: 06/28/20-08/24/20	DUT Type: Portable Handset		Page 224 of 267

Simult Tx	Configuration	LTE Band 7 SAR (W/kg)	2.4 GHz WLAN MIMO SAR (W/kg)	5 GHz WLAN MIMO at 16 dBm SAR (W/kg)	Σ SAR (W/kg)	SPLSR			Simult Tx	Configuration	LTE Band 41 SAR (W/kg)	2.4 GHz WLAN MIMO SAR (W/kg)	5 GHz WLAN MIMO at 16 dBm SAR (W/kg)	Σ SAR (W/kg)	SPLSR		
		1	2	3		1+2+3	1+2	1+3			2+3	1	2		3	1+2+3	1+2
UMPC Body SAR	Back	1.187	0.360	0.132	See Note 1	0.01	0.01	0.01	UMPC Body SAR	Back	1.130	0.360	0.132	See Note 1	0.01	0.01	0.01
	Front	0.848	0.375	0.060	1.283	N/A	N/A	N/A		Front	0.975	0.375	0.060	1.410	N/A	N/A	N/A
	Top	-	0.560	0.133	0.693	N/A	N/A	N/A		Top	-	0.560	0.133	0.693	N/A	N/A	N/A
	Bottom	0.989	-	-	0.989	N/A	N/A	N/A		Bottom	1.259	-	-	1.259	N/A	N/A	N/A
	Right	0.088	-	-	0.088	N/A	N/A	N/A		Right	0.144	-	-	0.144	N/A	N/A	N/A
	Left	-	0.534	0.071	0.605	N/A	N/A	N/A		Left	-	0.534	0.071	0.605	N/A	N/A	N/A
Simult Tx	Configuration	NR Band n66 (AWS) SAR (W/kg)	2.4 GHz WLAN MIMO SAR (W/kg)	5 GHz WLAN MIMO at 16 dBm SAR (W/kg)	Σ SAR (W/kg)	Simult Tx	Configuration	NR Band n25 (PCS) SAR (W/kg)	2.4 GHz WLAN MIMO SAR (W/kg)	5 GHz WLAN MIMO at 16 dBm SAR (W/kg)	Σ SAR (W/kg)						
		1	2	3				1+2+3	1	2		3	1+2+3				
UMPC Body SAR	Back	1.014	0.360	0.132	1.506	UMPC Body SAR	Back	0.725	0.360	0.132	1.217						
	Front	0.697	0.375	0.060	1.132		Front	0.577	0.375	0.060	1.012						
	Top	-	0.560	0.133	0.693		Top	-	0.560	0.133	0.693						
	Bottom	0.835	-	-	0.835		Bottom	0.982	-	-	0.982						
	Right	0.452	-	-	0.452		Right	0.693	-	-	0.693						
	Left	-	0.534	0.071	0.605		Left	-	0.534	0.071	0.605						



FCC ID: A3LSMF916U	 PCTEST <small>Prove it to be part of Samsung</small>	SAR EVALUATION REPORT		Approved by: Quality Manager
Document S/N: 1M2005200087-01-R2.A3L	Test Dates: 06/28/20-08/24/20	DUT Type: Portable Handset		Page 225 of 267

Table 12-26
Simultaneous Transmission Scenario with Bluetooth (UMPC Body)

Configuration	Mode	2G/3G/4G/5G SAR (W/kg)	Bluetooth Ant 1 SAR (W/kg)	Bluetooth Ant 2 SAR (W/kg)	Σ SAR (W/kg)	
		1	2	3	1+2	1+3
UMPC Body SAR	CDMA BC10 (\$90S)	0.713	0.563	0.348	1.276	1.061
	CDMA BC0 (\$22H)	0.826	0.563	0.348	1.389	1.174
	PCS CDMA	0.987	0.563	0.348	1.550	1.335
	GPRS 850	0.820	0.563	0.348	1.383	1.168
	GPRS 1900	0.598	0.563	0.348	1.161	0.946
	UMTS 850	1.007	0.563	0.348	1.570	1.355
	UMTS 1750	1.159	0.563	0.348	See Table Below	1.507
	UMTS 1900	1.146	0.563	0.348	See Table Below	1.494
	LTE Band 71	0.655	0.563	0.348	1.218	1.003
	LTE Band 12	0.456	0.563	0.348	1.019	0.804
	LTE Band 13	0.750	0.563	0.348	1.313	1.098
	LTE Band 14	0.779	0.563	0.348	1.342	1.127
	LTE Band 26 (Cell)	0.790	0.563	0.348	1.353	1.138
	LTE Band 5 (Cell)	0.928	0.563	0.348	1.491	1.276
	LTE Band 66 (AWS)	0.877	0.563	0.348	1.440	1.225
	LTE Band 25 (PCS)	1.070	0.563	0.348	See Table Below	1.418
	LTE Band 30	0.773	0.563	0.348	1.336	1.121
	LTE Band 7	1.187	0.563	0.348	See Table Below	1.535
	LTE Band 48	0.378	0.563	0.348	0.941	0.726
	LTE Band 41	1.259	0.563	0.348	See Table Below	See Table Below
NR Band n71	0.444	0.563	0.348	1.007	0.792	
NR Band n5 (Cell)	0.648	0.563	0.348	1.211	0.996	
NR Band n66 (AWS)	1.014	0.563	0.348	1.577	1.362	
NR Band n25 (PCS)	0.982	0.563	0.348	1.545	1.330	
NR Band n41	0.230	0.563	0.348	0.793	0.578	

Simult Tx	Configuration	UMTS 1750 SAR (W/kg)	Bluetooth Ant 1 SAR (W/kg)	Bluetooth Ant 2 SAR (W/kg)	Σ SAR (W/kg)		Simult Tx	Configuration	UMTS 1900 SAR (W/kg)	Bluetooth Ant 1 SAR (W/kg)	Bluetooth Ant 2 SAR (W/kg)	Σ SAR (W/kg)	
		1	2	3	1+2	1+3			1	2	3	1+2	1+3
UMPC Body SAR	Back	1.159	0.198	0.274	1.357	1.433	UMPC Body SAR	Back	1.037	0.198	0.274	1.235	1.311
	Front	0.975	0.200	0.231	1.175	1.206		Front	0.683	0.200	0.231	0.883	0.914
	Top	-	0.563	0.185	0.563	0.185		Top	-	0.563	0.185	0.563	0.185
	Bottom	0.952	-	-	0.952	0.952		Bottom	1.146	-	-	1.146	1.146
	Right	0.529	-	-	0.529	0.529		Right	0.772	-	-	0.772	0.772
Left	-	-	0.348	-	0.348	Left	-	-	0.348	-	0.348	-	

Simult Tx	Configuration	LTE Band 25 (PCS) SAR (W/kg)	Bluetooth Ant 1 SAR (W/kg)	Bluetooth Ant 2 SAR (W/kg)	Σ SAR (W/kg)		Simult Tx	Configuration	LTE Band 7 SAR (W/kg)	Bluetooth Ant 1 SAR (W/kg)	Bluetooth Ant 2 SAR (W/kg)	Σ SAR (W/kg)	
		1	2	3	1+2	1+3			1	2	3	1+2	1+3
UMPC Body SAR	Back	1.070	0.198	0.274	1.268	1.344	UMPC Body SAR	Back	1.187	0.198	0.274	1.385	1.461
	Front	0.747	0.200	0.231	0.947	0.978		Front	0.848	0.200	0.231	1.048	1.079
	Top	-	0.563	0.185	0.563	0.185		Top	-	0.563	0.185	0.563	0.185
	Bottom	0.751	-	-	0.751	0.751		Bottom	0.989	-	-	0.989	0.989
	Right	1.019	-	-	1.019	1.019		Right	0.088	-	-	0.088	0.088
Left	-	-	0.348	-	0.348	Left	-	-	0.348	-	0.348	-	

Simult Tx	Configuration	LTE Band 41 SAR (W/kg)	Bluetooth Ant 1 SAR (W/kg)	Bluetooth Ant 2 SAR (W/kg)	Σ SAR (W/kg)	
		1	2	3	1+2	1+3
UMPC Body SAR	Back	1.130	0.198	0.274	1.328	1.404
	Front	0.975	0.200	0.231	1.175	1.206
	Top	-	0.563	0.185	0.563	0.185
	Bottom	1.259	-	-	1.259	1.259
	Right	0.144	-	-	0.144	0.144
Left	-	-	0.348	-	0.348	





FCC ID: A3LSMF916U	 <small>Proud to be part of Samsung</small>	SAR EVALUATION REPORT		Approved by: Quality Manager
Document S/N: 1M2005200087-01-R2.A3L	Test Dates: 06/28/20-08/24/20	DUT Type: Portable Handset	Page 226 of 267	

Table 12-27

Simultaneous Transmission Scenario with Bluetooth Antenna 1 and 5 GHz WLAN MIMO (UMPC Body)

Configuration	Mode	2G/3G/4G/5G SAR (W/kg)	Bluetooth Ant 1 SAR (W/kg)	5 GHz WLAN MIMO at 16 dBm SAR (W/kg)	Σ SAR (W/kg)
		1	2	3	
UMPC Body SAR	CDMA BC10 (\$90S)	0.713	0.563	0.133	1.409
	CDMA BC0 (\$22H)	0.826	0.563	0.133	1.522
	PCS CDMA	0.987	0.563	0.133	See Table Below
	GPRS 850	0.820	0.563	0.133	1.516
	GPRS 1900	0.598	0.563	0.133	1.294
	UMTS 850	1.007	0.563	0.133	See Table Below
	UMTS 1750	1.159	0.563	0.133	See Table Below
	UMTS 1900	1.146	0.563	0.133	See Table Below
	LTE Band 71	0.655	0.563	0.133	1.351
	LTE Band 12	0.456	0.563	0.133	1.152
	LTE Band 13	0.750	0.563	0.133	1.446
	LTE Band 14	0.779	0.563	0.133	1.475
	LTE Band 26 (Cell)	0.790	0.563	0.133	1.486
	LTE Band 5 (Cell)	0.928	0.563	0.133	See Table Below
	LTE Band 66 (AWS)	0.877	0.563	0.133	1.573
	LTE Band 25 (PCS)	1.070	0.563	0.133	See Table Below
	LTE Band 30	0.773	0.563	0.133	1.469
	LTE Band 7	1.187	0.563	0.133	See Table Below
	LTE Band 48	0.378	0.563	0.133	1.074
	LTE Band 41	1.259	0.563	0.133	See Table Below
	NR Band n71	0.444	0.563	0.133	1.140
NR Band n5 (Cell)	0.648	0.563	0.133	1.344	
NR Band n66 (AWS)	1.014	0.563	0.133	See Table Below	
NR Band n25 (PCS)	0.982	0.563	0.133	See Table Below	
NR Band n41	0.230	0.563	0.133	0.926	

Simult Tx	Configuration	PCS EVDO SAR (W/kg)	Bluetooth Ant 1 SAR (W/kg)	5 GHz WLAN MIMO at 16 dBm SAR (W/kg)	Σ SAR (W/kg)	Simult Tx	Configuration	UMTS 850 SAR (W/kg)	Bluetooth Ant 1 SAR (W/kg)	5 GHz WLAN MIMO at 16 dBm SAR (W/kg)	Σ SAR (W/kg)	Simult Tx	Configuration	UMTS 1750 SAR (W/kg)	Bluetooth Ant 1 SAR (W/kg)	5 GHz WLAN MIMO at 16 dBm SAR (W/kg)	Σ SAR (W/kg)
		1	2	3	1+2+3			1	2	3	1+2+3			1	2	3	1+2+3
UMPC Body SAR	Back	0.728	0.198	0.132	1.058	UMPC Body SAR	Back	1.007	0.198	0.132	1.337	UMPC Body SAR	Back	1.159	0.198	0.132	1.489
	Front	0.730	0.200	0.060	0.990		Front	0.643	0.200	0.060	0.903		Front	0.975	0.200	0.060	1.235
	Top	-	0.563	0.133	0.696		Top	-	0.563	0.133	0.696		Top	-	0.563	0.133	0.696
	Bottom	0.987	-	-	0.987		Bottom	0.420	-	-	0.420		Bottom	0.952	-	-	0.952
	Right	0.659	-	-	0.659		Right	0.488	-	-	0.488		Right	0.529	-	-	0.529
	Left	-	-	0.071	0.071		Left	-	-	0.071	0.071		Left	-	-	0.071	0.071
UMPC Body SAR	Back	1.037	0.198	0.132	1.367	UMPC Body SAR	Back	0.928	0.198	0.132	1.258	UMPC Body SAR	Back	1.070	0.198	0.132	1.400
	Front	0.683	0.200	0.060	0.943		Front	0.579	0.200	0.060	0.839		Front	0.747	0.200	0.060	1.007
	Top	-	0.563	0.133	0.696		Top	-	0.563	0.133	0.696		Top	-	0.563	0.133	0.696
	Bottom	1.146	-	-	1.146		Bottom	0.402	-	-	0.402		Bottom	0.751	-	-	0.751
	Right	0.772	-	-	0.772		Right	0.420	-	-	0.420		Right	1.019	-	-	1.019
	Left	-	-	0.071	0.071		Left	-	-	0.071	0.071		Left	-	-	0.071	0.071

FCC ID: A3LSMF916U	 PCTEST <small>Prove it to be part of the solution</small>	SAR EVALUATION REPORT		Approved by: Quality Manager
Document S/N: 1M2005200087-01-R2.A3L	Test Dates: 06/28/20-08/24/20	DUT Type: Portable Handset	Page 227 of 267	

Simult Tx	Configuration	NR Band n66 (AWS) SAR (W/kg)	Bluetooth Ant 1 SAR (W/kg)	5 GHz WLAN MIMO at 16 dBm SAR (W/kg)	Σ SAR (W/kg)	Simult Tx	Configuration	LTE Band 7 SAR (W/kg)	Bluetooth Ant 1 SAR (W/kg)	5 GHz WLAN MIMO at 16 dBm SAR (W/kg)	Σ SAR (W/kg)	Simult Tx	Configuration	LTE Band 41 SAR (W/kg)	Bluetooth Ant 1 SAR (W/kg)	5 GHz WLAN MIMO at 16 dBm SAR (W/kg)	Σ SAR (W/kg)	
		1	2	3	1+2+3			1	2	3	1+2+3			1	2	3	1+2+3	
UMPC Body SAR	Back	1.014	0.198	0.132	1.344	UMPC Body SAR	Back	1.187	0.198	0.132	1.517	UMPC Body SAR	Back	1.130	0.198	0.132	1.460	
	Front	0.697	0.200	0.060	0.957		Front	0.848	0.200	0.060	1.108		Front	0.975	0.200	0.060	1.235	
	Top	-	0.563	0.133	0.696		Top	-	0.563	0.133	0.696		Top	-	0.563	0.133	0.696	
	Bottom	0.835	-	-	0.835		Bottom	0.989	-	-	0.989		Bottom	1.259	-	-	1.259	
	Right	0.452	-	-	0.452		Right	0.088	-	-	0.088		Right	0.144	-	-	0.144	
	Left	-	-	0.071	0.071		Left	-	-	0.071	0.071		Left	-	-	0.071	0.071	
						Simult Tx	Configuration	NR Band n25 (PCS) SAR (W/kg)	Bluetooth Ant 1 SAR (W/kg)	5 GHz WLAN MIMO at 16 dBm SAR (W/kg)	Σ SAR (W/kg)							
								1	2	3	1+2+3							
						UMPC Body SAR	Back	0.725	0.198	0.132	1.055							
					Front		0.577	0.200	0.060	0.837								
					Top		-	0.563	0.133	0.696								
					Bottom		0.982	-	-	0.982								
					Right		0.693	-	-	0.693								
					Left		-	-	0.071	0.071								



FCC ID: A3LSMF916U	 PCTEST <small>Prove it to be part of Samsung</small>	SAR EVALUATION REPORT		Approved by: Quality Manager
Document S/N: 1M2005200087-01-R2.A3L	Test Dates: 06/28/20-08/24/20	DUT Type: Portable Handset		Page 228 of 267

Table 12-28

Simultaneous Transmission Scenario with Bluetooth Antenna 2 and 5 GHz WLAN MIMO (UMPC Body)

Configuration	Mode	2G/3G/4G/5G SAR (W/kg)	Bluetooth Ant 2 SAR (W/kg)	5 GHz WLAN MIMO at 16 dBm SAR (W/kg)	Σ SAR (W/kg)
		1	2	3	
UMPC Body SAR	CDMA BC10 (\$90S)	0.713	0.348	0.133	1.194
	CDMA BC0 (\$22H)	0.826	0.348	0.133	1.307
	PCS CDMA	0.987	0.348	0.133	1.468
	GPRS 850	0.820	0.348	0.133	1.301
	GPRS 1900	0.598	0.348	0.133	1.079
	UMTS 850	1.007	0.348	0.133	1.488
	UMTS 1750	1.159	0.348	0.133	See Table Below
	UMTS 1900	1.146	0.348	0.133	See Table Below
	LTE Band 71	0.655	0.348	0.133	1.136
	LTE Band 12	0.456	0.348	0.133	0.937
	LTE Band 13	0.750	0.348	0.133	1.231
	LTE Band 14	0.779	0.348	0.133	1.260
	LTE Band 26 (Cell)	0.790	0.348	0.133	1.271
	LTE Band 5 (Cell)	0.928	0.348	0.133	1.409
	LTE Band 66 (AWS)	0.877	0.348	0.133	1.358
	LTE Band 25 (PCS)	1.070	0.348	0.133	1.551
	LTE Band 30	0.773	0.348	0.133	1.254
	LTE Band 7	1.187	0.348	0.133	See Table Below
	LTE Band 48	0.378	0.348	0.133	0.859
	LTE Band 41	1.259	0.348	0.133	See Table Below
	NR Band n71	0.444	0.348	0.133	0.925
NR Band n5 (Cell)	0.648	0.348	0.133	1.129	
NR Band n66 (AWS)	1.014	0.348	0.133	1.495	
NR Band n25 (PCS)	0.982	0.348	0.133	1.463	
NR Band n41	0.230	0.348	0.133	0.711	

Simult Tx	Configuration	UMTS 1750 SAR (W/kg)	Bluetooth Ant 2 SAR (W/kg)	5 GHz WLAN MIMO at 16 dBm SAR (W/kg)	Σ SAR (W/kg)	Simult Tx	Configuration	UMTS 1900 SAR (W/kg)	Bluetooth Ant 2 SAR (W/kg)	5 GHz WLAN MIMO at 16 dBm SAR (W/kg)	Σ SAR (W/kg)	Simult Tx	Configuration	LTE Band 7 SAR (W/kg)	Bluetooth Ant 2 SAR (W/kg)	5 GHz WLAN MIMO at 16 dBm SAR (W/kg)	Σ SAR (W/kg)					
		1	2	3	1+2+3			1	2	3	1+2+3			1	2	3	1+2+3					
UMPC Body SAR	Back	1.159	0.274	0.132	1.565	UMPC Body SAR	Back	1.037	0.274	0.132	1.443	UMPC Body SAR	Back	1.187	0.274	0.132	1.593					
	Front	0.975	0.231	0.060	1.266		Front	0.683	0.231	0.060	0.974		Front	0.848	0.231	0.060	1.139					
	Top	-	0.185	0.133	0.318		Top	-	0.185	0.133	0.318		Top	-	0.185	0.133	0.318					
	Bottom	0.952	-	-	0.952		Bottom	1.146	-	-	1.146		Bottom	0.989	-	-	0.989					
	Right	0.529	-	-	0.529		Right	0.772	-	-	0.772		Right	0.088	-	-	0.088					
Left	-	0.348	0.071	0.419	Left	-	0.348	0.071	0.419	Left	-	0.348	0.071	0.419								
UMPC Body SAR	Configuration	LTE Band 41 SAR (W/kg)	Bluetooth Ant 2 SAR (W/kg)	5 GHz WLAN MIMO at 16 dBm SAR (W/kg)	Σ SAR (W/kg)	UMPC Body SAR	Configuration	LTE Band 41 SAR (W/kg)	Bluetooth Ant 2 SAR (W/kg)	5 GHz WLAN MIMO at 16 dBm SAR (W/kg)	Σ SAR (W/kg)	UMPC Body SAR	Configuration	LTE Band 41 SAR (W/kg)	Bluetooth Ant 2 SAR (W/kg)	5 GHz WLAN MIMO at 16 dBm SAR (W/kg)	Σ SAR (W/kg)					
																		1	2	3	1+2+3	
																		Back	1.130	0.274	0.132	1.536
																		Front	0.975	0.231	0.060	1.266
																		Top	-	0.185	0.133	0.318
																		Bottom	1.259	-	-	1.259
Right	0.144	-	-	0.144																		
Left	-	0.348	0.071	0.419																		





FCC ID: A3LSMF916U	 PCTEST <small>Proud to be part of Samsung</small>	SAR EVALUATION REPORT		Approved by: Quality Manager
Document S/N: 1M2005200087-01-R2.A3L	Test Dates: 06/28/20-08/24/20	DUT Type: Portable Handset		Page 229 of 267

Table 12-29
Simultaneous Transmission Scenario with Bluetooth Antenna 1, 2.4 GHz WLAN Antenna 2, and 5 GHz WLAN MIMO (UMPC Body)

Simult Tx	Configuration	EVDO BC10 (\$80S) SAR (W/kg)	Bluetooth Ant 1 SAR (W/kg)	2.4 GHz WLAN Ant 2 SAR (W/kg)	5 GHz WLAN MIMO at 16 dBm SAR (W/kg)	Σ SAR (W/kg)	Simult Tx	Configuration	EVDO BC0 (\$22H) SAR (W/kg)	Bluetooth Ant 1 SAR (W/kg)	2.4 GHz WLAN Ant 2 SAR (W/kg)	5 GHz WLAN MIMO at 16 dBm SAR (W/kg)	Σ SAR (W/kg)	
		1	2	3	4	1+2+3+4			1	2	3	4	1+2+3+4	
UMPC Body SAR	Back	0.713	0.198	0.193	0.132	1.236	UMPC Body SAR	Back	0.826	0.198	0.193	0.132	1.349	
	Front	0.528	0.200	0.120	0.060	0.908		Front	0.523	0.200	0.120	0.060	0.903	
	Top	-	0.563	0.145	0.133	0.841		Top	-	0.563	0.145	0.133	0.841	
	Bottom	0.349	-	-	-	0.349		Bottom	0.422	-	-	-	0.422	
	Right	0.330	-	-	-	0.330		Right	0.405	-	-	-	0.405	
Left	-	-	0.219	0.071	0.290	Left	-	-	0.219	0.071	0.290			
Simult Tx	Configuration	PCS EVDO SAR (W/kg)	Bluetooth Ant 1 SAR (W/kg)	2.4 GHz WLAN Ant 2 SAR (W/kg)	5 GHz WLAN MIMO at 16 dBm SAR (W/kg)	Σ SAR (W/kg)	Simult Tx	Configuration	GPRS 850 SAR (W/kg)	Bluetooth Ant 1 SAR (W/kg)	2.4 GHz WLAN Ant 2 SAR (W/kg)	5 GHz WLAN MIMO at 16 dBm SAR (W/kg)	Σ SAR (W/kg)	
		1	2	3	4	1+2+3+4			1	2	3	4	1+2+3+4	
	UMPC Body SAR	Back	0.728	0.198	0.193	0.132	1.251	UMPC Body SAR	Back	0.820	0.198	0.193	0.132	1.343
		Front	0.730	0.200	0.120	0.060	1.110		Front	0.716	0.200	0.120	0.060	1.096
		Top	-	0.563	0.145	0.133	0.841		Top	-	0.563	0.145	0.133	0.841
Bottom		0.987	-	-	-	0.987	Bottom		0.492	-	-	-	0.492	
Right		0.659	-	-	-	0.659	Right		0.555	-	-	-	0.555	
Left	-	-	0.219	0.071	0.290	Left	-	-	0.219	0.071	0.290			
Simult Tx	Configuration	GPRS 1900 SAR (W/kg)	Bluetooth Ant 1 SAR (W/kg)	2.4 GHz WLAN Ant 2 SAR (W/kg)	5 GHz WLAN MIMO at 16 dBm SAR (W/kg)	Σ SAR (W/kg)	Simult Tx	Configuration	UMTS 850 SAR (W/kg)	Bluetooth Ant 1 SAR (W/kg)	2.4 GHz WLAN Ant 2 SAR (W/kg)	5 GHz WLAN MIMO at 16 dBm SAR (W/kg)	Σ SAR (W/kg)	
		1	2	3	4	1+2+3+4			1	2	3	4	1+2+3+4	
	UMPC Body SAR	Back	0.401	0.198	0.193	0.132	0.924	UMPC Body SAR	Back	1.007	0.198	0.193	0.132	1.530
		Front	0.377	0.200	0.120	0.060	0.757		Front	0.643	0.200	0.120	0.060	1.023
		Top	-	0.563	0.145	0.133	0.841		Top	-	0.563	0.145	0.133	0.841
Bottom		0.598	-	-	-	0.598	Bottom		0.420	-	-	-	0.420	
Right		0.339	-	-	-	0.339	Right		0.488	-	-	-	0.488	
Left	-	-	0.219	0.071	0.290	Left	-	-	0.219	0.071	0.290			
Simult Tx	Configuration	UMTS 1750 SAR (W/kg)	Bluetooth Ant 1 SAR (W/kg)	2.4 GHz WLAN Ant 2 SAR (W/kg)	5 GHz WLAN MIMO at 16 dBm SAR (W/kg)	Σ SAR (W/kg)	SPLSR							
		1	2	3	4	1+2+3+4	1+2	1+3	1+4	2+3	2+4	3+4		
	UMPC Body SAR	Back	1.159	0.198	0.193	0.132	See Note 1	0.01	0.01	0.01	0.01	0.01	0.00	
		Front	0.975	0.200	0.120	0.060	1.355	N/A	N/A	N/A	N/A	N/A	N/A	
		Top	-	0.563	0.145	0.133	0.841	N/A	N/A	N/A	N/A	N/A	N/A	
Bottom		0.952	-	-	-	0.952	N/A	N/A	N/A	N/A	N/A	N/A		
Right		0.529	-	-	-	0.529	N/A	N/A	N/A	N/A	N/A	N/A		
Left	-	-	0.219	0.071	0.290	N/A	N/A	N/A	N/A	N/A	N/A			
Simult Tx	Configuration	UMTS 1900 SAR (W/kg)	Bluetooth Ant 1 SAR (W/kg)	2.4 GHz WLAN Ant 2 SAR (W/kg)	5 GHz WLAN MIMO at 16 dBm SAR (W/kg)	Σ SAR (W/kg)	Simult Tx	Configuration	LTE Band 71 SAR (W/kg)	Bluetooth Ant 1 SAR (W/kg)	2.4 GHz WLAN Ant 2 SAR (W/kg)	5 GHz WLAN MIMO at 16 dBm SAR (W/kg)	Σ SAR (W/kg)	
		1	2	3	4	1+2+3+4			1	2	3	4	1+2+3+4	
	UMPC Body SAR	Back	1.037	0.198	0.193	0.132	1.560	UMPC Body SAR	Back	0.655	0.198	0.193	0.132	1.178
		Front	0.683	0.200	0.120	0.060	1.063		Front	0.372	0.200	0.120	0.060	0.752
		Top	-	0.563	0.145	0.133	0.841		Top	-	0.563	0.145	0.133	0.841
Bottom		1.146	-	-	-	1.146	Bottom		0.319	-	-	-	0.319	
Right		0.772	-	-	-	0.772	Right		0.447	-	-	-	0.447	
Left	-	-	0.219	0.071	0.290	Left	-	-	0.219	0.071	0.290			
Simult Tx	Configuration	LTE Band 12 SAR (W/kg)	Bluetooth Ant 1 SAR (W/kg)	2.4 GHz WLAN Ant 2 SAR (W/kg)	5 GHz WLAN MIMO at 16 dBm SAR (W/kg)	Σ SAR (W/kg)	Simult Tx	Configuration	LTE Band 13 SAR (W/kg)	Bluetooth Ant 1 SAR (W/kg)	2.4 GHz WLAN Ant 2 SAR (W/kg)	5 GHz WLAN MIMO at 16 dBm SAR (W/kg)	Σ SAR (W/kg)	
		1	2	3	4	1+2+3+4			1	2	3	4	1+2+3+4	
	UMPC Body SAR	Back	0.456	0.198	0.193	0.132	0.979	UMPC Body SAR	Back	0.750	0.198	0.193	0.132	1.273
		Front	0.364	0.200	0.120	0.060	0.744		Front	0.608	0.200	0.120	0.060	0.988
		Top	-	0.563	0.145	0.133	0.841		Top	-	0.563	0.145	0.133	0.841
Bottom		0.301	-	-	-	0.301	Bottom		0.373	-	-	-	0.373	
Right		0.349	-	-	-	0.349	Right		0.458	-	-	-	0.458	
Left	-	-	0.219	0.071	0.290	Left	-	-	0.219	0.071	0.290			
Simult Tx	Configuration	LTE Band 14 SAR (W/kg)	Bluetooth Ant 1 SAR (W/kg)	2.4 GHz WLAN Ant 2 SAR (W/kg)	5 GHz WLAN MIMO at 16 dBm SAR (W/kg)	Σ SAR (W/kg)	Simult Tx	Configuration	LTE Band 26 (Cell) SAR (W/kg)	Bluetooth Ant 1 SAR (W/kg)	2.4 GHz WLAN Ant 2 SAR (W/kg)	5 GHz WLAN MIMO at 16 dBm SAR (W/kg)	Σ SAR (W/kg)	
		1	2	3	4	1+2+3+4			1	2	3	4	1+2+3+4	
	UMPC Body SAR	Back	0.779	0.198	0.193	0.132	1.302	UMPC Body SAR	Back	0.790	0.198	0.193	0.132	1.313
		Front	0.595	0.200	0.120	0.060	0.975		Front	0.581	0.200	0.120	0.060	0.961
		Top	-	0.563	0.145	0.133	0.841		Top	-	0.563	0.145	0.133	0.841
Bottom		0.425	-	-	-	0.425	Bottom		0.382	-	-	-	0.382	
Right		0.502	-	-	-	0.502	Right		0.399	-	-	-	0.399	
Left	-	-	0.219	0.071	0.290	Left	-	-	0.219	0.071	0.290			

FCC ID: A3LSMF916U	 PCTEST <small>Proud to be part of Samsung</small>	SAR EVALUATION REPORT		Approved by: Quality Manager
Document S/N: 1M2005200087-01-R2-A3L	Test Dates: 06/28/20-08/24/20	DUT Type: Portable Handset	Page 230 of 267	

Simult Tx	Configuration	LTE Band 5 (Cell) SAR (W/kg)	Bluetooth Ant 1 SAR (W/kg)	2.4 GHz WLAN Ant 2 SAR (W/kg)	5 GHz WLAN MIMO at 16 dBm SAR (W/kg)	Σ SAR (W/kg)	Simult Tx	Configuration	LTE Band 66 (AWS) SAR (W/kg)	Bluetooth Ant 1 SAR (W/kg)	2.4 GHz WLAN Ant 2 SAR (W/kg)	5 GHz WLAN MIMO at 16 dBm SAR (W/kg)	Σ SAR (W/kg)
		1	2	3	4	1+2+3+4			1	2	3	4	1+2+3+4
UMPC Body SAR	Back	0.928	0.198	0.193	0.132	1.451	UMPC Body SAR	Back	0.724	0.198	0.193	0.132	1.247
	Front	0.579	0.200	0.120	0.060	0.959		Front	0.877	0.200	0.120	0.060	1.257
	Top	-	0.563	0.145	0.133	0.841		Top	-	0.563	0.145	0.133	0.841
	Bottom	0.402	-	-	-	0.402		Bottom	0.682	-	-	-	0.682
	Right	0.420	-	-	-	0.420		Right	0.428	-	-	-	0.428
Left	-	-	0.219	0.071	0.290	Left	-	-	0.219	0.071	0.290		

Simult Tx	Configuration	LTE Band 7 SAR (W/kg)	Bluetooth Ant 1 SAR (W/kg)	2.4 GHz WLAN Ant 2 SAR (W/kg)	5 GHz WLAN MIMO at 16 dBm SAR (W/kg)	Σ SAR (W/kg)	SPLSR					
		1	2	3	4	1+2+3+4	1+2	1+3	1+4	2+3	2+4	3+4
UMPC Body SAR	Back	1.187	0.198	0.193	0.132	See Note 1	0.01	0.01	0.01	0.01	0.01	0.00
	Front	0.848	0.200	0.120	0.060	1.228	N/A	N/A	N/A	N/A	N/A	N/A
	Top	-	0.563	0.145	0.133	0.841	N/A	N/A	N/A	N/A	N/A	N/A
	Bottom	0.989	-	-	-	0.989	N/A	N/A	N/A	N/A	N/A	N/A
	Right	0.088	-	-	-	0.088	N/A	N/A	N/A	N/A	N/A	N/A
Left	-	-	0.219	0.071	0.290	0.290	N/A	N/A	N/A	N/A	N/A	



Simult Tx	Configuration	LTE Band 41 SAR (W/kg)	Bluetooth Ant 1 SAR (W/kg)	2.4 GHz WLAN Ant 2 SAR (W/kg)	5 GHz WLAN MIMO at 16 dBm SAR (W/kg)	Σ SAR (W/kg)	SPLSR					
		1	2	3	4	1+2+3+4	1+2	1+3	1+4	2+3	2+4	3+4
UMPC Body SAR	Back	1.130	0.198	0.193	0.132	See Note 1	0.01	0.01	0.01	0.01	0.01	0.00
	Front	0.975	0.200	0.120	0.060	1.355	N/A	N/A	N/A	N/A	N/A	N/A
	Top	-	0.563	0.145	0.133	0.841	N/A	N/A	N/A	N/A	N/A	N/A
	Bottom	1.259	-	-	-	1.259	N/A	N/A	N/A	N/A	N/A	N/A
	Right	0.144	-	-	-	0.144	N/A	N/A	N/A	N/A	N/A	N/A
Left	-	-	0.219	0.071	0.290	0.290	N/A	N/A	N/A	N/A	N/A	

Simult Tx	Configuration	LTE Band 48 SAR (W/kg)	Bluetooth Ant 1 SAR (W/kg)	2.4 GHz WLAN Ant 2 SAR (W/kg)	5 GHz WLAN MIMO at 16 dBm SAR (W/kg)	Σ SAR (W/kg)	Simult Tx	Configuration	NR Band n71 SAR (W/kg)	Bluetooth Ant 1 SAR (W/kg)	2.4 GHz WLAN Ant 2 SAR (W/kg)	5 GHz WLAN MIMO at 16 dBm SAR (W/kg)	Σ SAR (W/kg)
		1	2	3	4	1+2+3+4			1	2	3	4	1+2+3+4
UMPC Body SAR	Back	0.363	0.198	0.193	0.132	0.886	UMPC Body SAR	Back	0.444	0.198	0.193	0.132	0.967
	Front	0.223	0.200	0.120	0.060	0.603		Front	0.296	0.200	0.120	0.060	0.676
	Top	0.378	0.563	0.145	0.133	1.219		Top	-	0.563	0.145	0.133	0.841
	Bottom	-	-	-	-	-		Bottom	0.257	-	-	-	0.257
	Right	-	-	-	-	-		Right	0.388	-	-	-	0.388
Left	-	-	0.219	0.071	0.290	Left	-	-	0.219	0.071	0.290		

Simult Tx	Configuration	NR Band n5 (Cell) SAR (W/kg)	Bluetooth Ant 1 SAR (W/kg)	2.4 GHz WLAN Ant 2 SAR (W/kg)	5 GHz WLAN MIMO at 16 dBm SAR (W/kg)	Σ SAR (W/kg)	Simult Tx	Configuration	NR Band n66 (AWS) SAR (W/kg)	Bluetooth Ant 1 SAR (W/kg)	2.4 GHz WLAN Ant 2 SAR (W/kg)	5 GHz WLAN MIMO at 16 dBm SAR (W/kg)	Σ SAR (W/kg)
		1	2	3	4	1+2+3+4			1	2	3	4	1+2+3+4
UMPC Body SAR	Back	0.648	0.198	0.193	0.132	1.171	UMPC Body SAR	Back	1.014	0.198	0.193	0.132	1.537
	Front	0.486	0.200	0.120	0.060	0.866		Front	0.697	0.200	0.120	0.060	1.077
	Top	-	0.563	0.145	0.133	0.841		Top	-	0.563	0.145	0.133	0.841
	Bottom	0.341	-	-	-	0.341		Bottom	0.835	-	-	-	0.835
	Right	0.344	-	-	-	0.344		Right	0.452	-	-	-	0.452
Left	-	-	0.219	0.071	0.290	Left	-	-	0.219	0.071	0.290		

Notes:

- No evaluation was performed to determine the aggregate 1g SAR for these configurations as the SPLS ratio between the antenna pairs was not greater than 0.04 per FCC KDB 447498 D01v06. See Section 12.9 for detailed SPLS ratio analysis.

FCC ID: A3LSMF916U	 PCTEST Proud to be part of Samsung	SAR EVALUATION REPORT		Approved by: Quality Manager
Document S/N: 1M2005200087-01-R2.A3L	Test Dates: 06/28/20-08/24/20	DUT Type: Portable Handset	Page 231 of 267	

12.8 UMPC Extremity Simultaneous Transmission Analysis

Per FCC KDB Publication 941225 D06v02r01, the devices edges with antennas more than 2.5 cm from edge are not required to be evaluated for SAR (“-“).



(*) For test positions that were not required to be evaluated for WLAN SAR per FCC KDB publication 248227, the worst case WLAN SAR result for the applicable exposure conditions was used for simultaneous transmission analysis.

For SAR summation, the highest reported SAR across all test distances was used as the most conservative evaluation for simultaneous transmission analysis for each device edge.



Table 12-30
Simultaneous Transmission Scenario with 2.4 GHz WLAN (UMPC Extremity)

Configuration	Mode	2G/3G/4G/5G SAR (W/kg)	2.4 GHz WLAN MIMO SAR (W/kg)	Σ SAR (W/kg)
		1	2	
UMPC Extremity SAR	CDMA BC10 (\$90S)	1.435	2.000	3.435
	CDMA BC0 (\$22H)	1.613	2.000	3.613
	PCS CDMA	3.148	2.000	See Table Below
	GPRS 850	2.018	2.000	See Table Below
	GPRS 1900	2.272	2.000	See Table Below
	UMTS 850	2.386	2.000	See Table Below
	UMTS 1750	3.146	2.000	See Table Below
	UMTS 1900	3.137	2.000	See Table Below
	LTE Band 71	1.530	2.000	3.530
	LTE Band 12	1.316	2.000	3.316
	LTE Band 13	1.857	2.000	3.857
	LTE Band 14	2.170	2.000	See Table Below
	LTE Band 26 (Cell)	2.067	2.000	See Table Below
	LTE Band 5 (Cell)	2.367	2.000	See Table Below
	LTE Band 66 (AWS)	3.147	2.000	See Table Below
	LTE Band 25 (PCS)	2.940	2.000	See Table Below
	LTE Band 30	2.895	2.000	See Table Below
	LTE Band 7	2.717	2.000	See Table Below
	LTE Band 48	1.914	2.000	3.914
	LTE Band 41	2.520	2.000	See Table Below
NR Band n71	1.233	2.000	3.233	
NR Band n5 (Cell)	1.891	2.000	3.891	
NR Band n66 (AWS)	3.063	2.000	See Table Below	
NR Band n25 (PCS)	2.750	2.000	See Table Below	
NR Band n41	1.266	2.000	3.266	

Simult Tx	Configuration	PCS EVDO SAR (W/kg)	2.4 GHz WLAN MIMO SAR (W/kg)	Σ SAR (W/kg)	Simult Tx	Configuration	GPRS 850 SAR (W/kg)	2.4 GHz WLAN MIMO SAR (W/kg)	Σ SAR (W/kg)	Simult Tx	Configuration	GPRS 1900 SAR (W/kg)	2.4 GHz WLAN MIMO SAR (W/kg)	Σ SAR (W/kg)
		1	2	1+2			1	2	1+2			1	2	1+2
UMPC Extremity SAR	Back	1.664	0.780	2.444	UMPC Extremity SAR	Back	2.018	0.780	2.798	UMPC Extremity SAR	Back	1.118	0.780	1.898
	Front	1.010	0.870	1.880		Front	1.496	0.870	2.366		Front	0.701	0.870	1.571
	Top	-	1.193	1.193		Top	-	1.193	1.193		Top	-	1.193	1.193
	Bottom	3.148	-	3.148		Bottom	1.038	-	1.038		Bottom	2.272	-	2.272
	Right	2.973	-	2.973		Right	1.385	-	1.385		Right	1.165	-	1.165
Left	-	2.000	2.000	Left	-	2.000	2.000	Left	-	2.000	2.000			
UMPC Extremity SAR	Back	2.386	0.780	3.166	UMPC Extremity SAR	Back	1.816	0.780	2.596	UMPC Extremity SAR	Back	1.260	0.780	2.040
	Front	1.575	0.870	2.445		Front	1.274	0.870	2.144		Front	0.958	0.870	1.828
	Top	-	1.193	1.193		Top	-	1.193	1.193		Top	-	1.193	1.193
	Bottom	1.123	-	1.123		Bottom	3.146	-	3.146		Bottom	3.002	-	3.002
	Right	1.997	-	1.997		Right	2.473	-	2.473		Right	3.137	-	3.137
Left	-	2.000	2.000	Left	-	2.000	2.000	Left	-	2.000	2.000			

FCC ID: A3LSMF916U	 PCTEST <small>Proud to be part of Samsung</small>	SAR EVALUATION REPORT		Approved by: Quality Manager
Document S/N: 1M2005200087-01-R2.A3L	Test Dates: 06/28/20-08/24/20	DUT Type: Portable Handset		Page 232 of 267

Simult Tx	Configuration	LTE Band 14 SAR (W/kg)	2.4 GHz WLAN MIMO SAR (W/kg)	Σ SAR (W/kg)	Simult Tx	Configuration	LTE Band 26 (Cell) SAR (W/kg)	2.4 GHz WLAN MIMO SAR (W/kg)	Σ SAR (W/kg)	Simult Tx	Configuration	LTE Band 5 (Cell) SAR (W/kg)	2.4 GHz WLAN MIMO SAR (W/kg)	Σ SAR (W/kg)
		1	2	1+2			1	2	1+2			1	2	1+2
UMPC Extremity SAR	Back	2.170	0.780	2.950	UMPC Extremity SAR	Back	2.067	0.780	2.847	UMPC Extremity SAR	Back	2.367	0.780	3.147
	Front	1.624	0.870	2.494		Front	1.569	0.870	2.439		Front	1.581	0.870	2.451
	Top	-	1.193	1.193		Top	-	1.193	1.193		Top	-	1.193	1.193
	Bottom	1.105	-	1.105		Bottom	1.021	-	1.021		Bottom	0.865	-	0.865
	Right	1.875	-	1.875		Right	1.595	-	1.595		Right	1.743	-	1.743
Left	-	2.000	2.000	Left	-	2.000	2.000	Left	-	2.000	2.000			
Simult Tx	Configuration	LTE Band 66 (AWS) SAR (W/kg)	2.4 GHz WLAN MIMO SAR (W/kg)	Σ SAR (W/kg)	Simult Tx	Configuration	LTE Band 25 (PCS) SAR (W/kg)	2.4 GHz WLAN MIMO SAR (W/kg)	Σ SAR (W/kg)	Simult Tx	Configuration	LTE Band 30 SAR (W/kg)	2.4 GHz WLAN MIMO SAR (W/kg)	Σ SAR (W/kg)
		1	2	1+2			1	2	1+2			1	2	1+2
UMPC Extremity SAR	Back	1.935	0.780	2.715	UMPC Extremity SAR	Back	1.415	0.780	2.195	UMPC Extremity SAR	Back	0.840	0.780	1.620
	Front	1.058	0.870	1.928		Front	0.815	0.870	1.685		Front	0.750	0.870	1.620
	Top	-	1.193	1.193		Top	-	1.193	1.193		Top	-	1.193	1.193
	Bottom	3.147	-	3.147		Bottom	2.940	-	2.940		Bottom	2.895	-	2.895
	Right	1.633	-	1.633		Right	1.433	-	1.433		Right	0.710	-	0.710
Left	-	2.000	2.000	Left	-	2.000	2.000	Left	-	2.000	2.000			
Simult Tx	Configuration	LTE Band 7 SAR (W/kg)	2.4 GHz WLAN MIMO SAR (W/kg)	Σ SAR (W/kg)	Simult Tx	Configuration	LTE Band 41 SAR (W/kg)	2.4 GHz WLAN MIMO SAR (W/kg)	Σ SAR (W/kg)	Simult Tx	Configuration	NR Band n66 (AWS) SAR (W/kg)	2.4 GHz WLAN MIMO SAR (W/kg)	Σ SAR (W/kg)
		1	2	1+2			1	2	1+2			1	2	1+2
UMPC Extremity SAR	Back	1.611	0.780	2.391	UMPC Extremity SAR	Back	2.520	0.780	3.300	UMPC Extremity SAR	Back	1.589	0.780	2.369
	Front	1.445	0.870	2.315		Front	1.254	0.870	2.124		Front	1.073	0.870	1.943
	Top	-	1.193	1.193		Top	-	1.193	1.193		Top	-	1.193	1.193
	Bottom	2.717	-	2.717		Bottom	2.126	-	2.126		Bottom	3.063	-	3.063
	Right	0.359	-	0.359		Right	0.516	-	0.516		Right	1.525	-	1.525
Left	-	2.000	2.000	Left	-	2.000	2.000	Left	-	2.000	2.000			
Simult Tx	Configuration	NR Band n25 (PCS) SAR (W/kg)	2.4 GHz WLAN MIMO SAR (W/kg)	Σ SAR (W/kg)	Simult Tx	Configuration	NR Band n25 (PCS) SAR (W/kg)	2.4 GHz WLAN MIMO SAR (W/kg)	Σ SAR (W/kg)	Simult Tx	Configuration	NR Band n25 (PCS) SAR (W/kg)	2.4 GHz WLAN MIMO SAR (W/kg)	Σ SAR (W/kg)
		1	2	1+2			1	2	1+2			1	2	1+2
UMPC Extremity SAR	Back	0.855	0.780	1.635	UMPC Extremity SAR	Back	0.855	0.780	1.635	UMPC Extremity SAR	Back	0.855	0.780	1.635
	Front	0.668	0.870	1.538		Front	0.668	0.870	1.538		Front	0.668	0.870	1.538
	Top	-	1.193	1.193		Top	-	1.193	1.193		Top	-	1.193	1.193
	Bottom	2.416	-	2.416		Bottom	2.416	-	2.416		Bottom	2.416	-	2.416
	Right	2.750	-	2.750		Right	2.750	-	2.750		Right	2.750	-	2.750
Left	-	2.000	2.000	Left	-	2.000	2.000	Left	-	2.000	2.000			

FCC ID: A3LSMF916U	 PCTEST <small>Provided to be part of Samsung</small>	SAR EVALUATION REPORT		Approved by: Quality Manager
Document S/N: 1M2005200087-01-R2.A3L	Test Dates: 06/28/20-08/24/20	DUT Type: Portable Handset		Page 233 of 267



**Table 12-31
Simultaneous Transmission Scenario with 5 GHz WLAN (UMPC Extremity)**

Configuration	Mode	2G/3G/4G/5G SAR (W/kg)	5 GHz WLAN MIMO SAR (W/kg)	Σ SAR (W/kg)
		1	2	
UMPC Extremity SAR	CDMA BC10 (\$90S)	1.435	2.069	3.504
	CDMA BC0 (\$22H)	1.613	2.069	3.682
	PCS CDMA	3.148	2.069	See Table Below
	GPRS 850	2.018	2.069	See Table Below
	GPRS 1900	2.272	2.069	See Table Below
	UMTS 850	2.386	2.069	See Table Below
	UMTS 1750	3.146	2.069	See Table Below
	UMTS 1900	3.137	2.069	See Table Below
	LTE Band 71	1.530	2.069	3.599
	LTE Band 12	1.316	2.069	3.385
	LTE Band 13	1.857	2.069	3.926
	LTE Band 14	2.170	2.069	See Table Below
	LTE Band 26 (Cell)	2.067	2.069	See Table Below
	LTE Band 5 (Cell)	2.367	2.069	See Table Below
	LTE Band 66 (AWS)	3.147	2.069	See Table Below
	LTE Band 25 (PCS)	2.940	2.069	See Table Below
	LTE Band 30	2.895	2.069	See Table Below
	LTE Band 7	2.717	2.069	See Table Below
	LTE Band 48	1.914	2.069	3.983
	LTE Band 41	2.520	2.069	See Table Below
NR Band n71	1.233	2.069	3.302	
NR Band n5 (Cell)	1.891	2.069	3.960	
NR Band n66 (AWS)	3.063	2.069	See Table Below	
NR Band n25 (PCS)	2.750	2.069	See Table Below	
NR Band n41	1.266	2.069	3.335	

Simult Tx	Configuration	PCS EVDO SAR (W/kg)	5 GHz WLAN MIMO SAR (W/kg)	Σ SAR (W/kg)	Simult Tx	Configuration	GPRS 850 SAR (W/kg)	5 GHz WLAN MIMO SAR (W/kg)	Σ SAR (W/kg)	Simult Tx	Configuration	GPRS 1900 SAR (W/kg)	5 GHz WLAN MIMO SAR (W/kg)	Σ SAR (W/kg)
		1	2				1+2	1				2	1+2	
UMPC Extremity SAR	Back	1.664	1.813	3.477	UMPC Extremity SAR	Back	2.018	1.813	3.831	UMPC Extremity SAR	Back	1.118	1.813	2.931
	Front	1.010	0.618	1.628		Front	1.496	0.618	2.114		Front	0.701	0.618	1.319
	Top	-	2.069	2.069		Top	-	2.069	2.069		Top	-	2.069	2.069
	Bottom	3.148	-	3.148		Bottom	1.038	-	1.038		Bottom	2.272	-	2.272
	Right	2.973	-	2.973		Right	1.385	-	1.385		Right	1.165	-	1.165
Left	-	0.646	0.646	Left	-	0.646	0.646	Left	-	0.646	0.646			

Simult Tx	Configuration	UMTS 850 SAR (W/kg)	5 GHz WLAN MIMO SAR (W/kg)	Σ SAR (W/kg)	SPLSR	Simult Tx	Configuration	UMTS 1750 SAR (W/kg)	5 GHz WLAN MIMO SAR (W/kg)	Σ SAR (W/kg)	Simult Tx	Configuration	UMTS 1900 SAR (W/kg)	5 GHz WLAN MIMO SAR (W/kg)	Σ SAR (W/kg)
		1	2					1+2	1				2	1+2	
UMPC Extremity SAR	Back	2.386	1.813	See Note 1	0.05	UMPC Extremity SAR	Back	1.816	1.813	3.629	UMPC Extremity SAR	Back	1.260	1.813	3.073
	Front	1.575	0.618	2.193	N/A		Front	1.274	0.618	1.892		Front	0.958	0.618	1.576
	Top	-	2.069	2.069	N/A		Top	-	2.069	2.069		Top	-	2.069	2.069
	Bottom	1.123	-	1.123	N/A		Bottom	3.146	-	3.146		Bottom	3.002	-	3.002
	Right	1.997	-	1.997	N/A		Right	2.473	-	2.473		Right	3.137	-	3.137
Left	-	0.646	0.646	N/A	Left	-	0.646	0.646	Left	-	0.646	0.646			

Simult Tx	Configuration	LTE Band 14 SAR (W/kg)	5 GHz WLAN MIMO SAR (W/kg)	Σ SAR (W/kg)	Simult Tx	Configuration	LTE Band 26 (Cell) SAR (W/kg)	5 GHz WLAN MIMO SAR (W/kg)	Σ SAR (W/kg)	Simult Tx	Configuration	LTE Band 5 (Cell) SAR (W/kg)	5 GHz WLAN MIMO SAR (W/kg)	Σ SAR (W/kg)	SPLSR
		1	2				1+2	1				2	1+2		
UMPC Extremity SAR	Back	2.170	1.813	3.983	UMPC Extremity SAR	Back	2.067	1.813	3.880	UMPC Extremity SAR	Back	2.367	1.813	See Note 1	0.05
	Front	1.624	0.618	2.242		Front	1.569	0.618	2.187		Front	1.581	0.618	2.199	N/A
	Top	-	2.069	2.069		Top	-	2.069	2.069		Top	-	2.069	2.069	N/A
	Bottom	1.105	-	1.105		Bottom	1.021	-	1.021		Bottom	0.865	-	0.865	N/A
	Right	1.875	-	1.875		Right	1.595	-	1.595		Right	1.743	-	1.743	N/A
Left	-	0.646	0.646	Left	-	0.646	0.646	Left	-	0.646	0.646	N/A			

FCC ID: A3LSMF916U	 PCTEST <small>Proud to be part of Samsung</small>	SAR EVALUATION REPORT		Approved by: Quality Manager
Document S/N: 1M2005200087-01-R2.A3L	Test Dates: 06/28/20-08/24/20	DUT Type: Portable Handset	Page 234 of 267	

Simult Tx	Configuration	LTE Band 66 (AWS) SAR (W/kg)	5 GHz WLAN MIMO SAR (W/kg)	Σ SAR (W/kg)	Simult Tx	Configuration	LTE Band 25 (PCS) SAR (W/kg)	5 GHz WLAN MIMO SAR (W/kg)	Σ SAR (W/kg)	Simult Tx	Configuration	LTE Band 30 SAR (W/kg)	5 GHz WLAN MIMO SAR (W/kg)	Σ SAR (W/kg)
		1	2	1+2			1	2	1+2			1	2	1+2
UMPC Extremity SAR	Back	1.935	1.813	3.748	UMPC Extremity SAR	Back	1.415	1.813	3.228	UMPC Extremity SAR	Back	0.840	1.813	2.653
	Front	1.058	0.618	1.676		Front	0.815	0.618	1.433		Front	0.750	0.618	1.368
	Top	-	2.069	2.069		Top	-	2.069	2.069		Top	-	2.069	2.069
	Bottom	3.147	-	3.147		Bottom	2.940	-	2.940		Bottom	2.895	-	2.895
	Right	1.633	-	1.633		Right	1.433	-	1.433		Right	0.710	-	0.710
Left	-	0.646	0.646	Left	-	0.646	0.646	Left	-	0.646	0.646			

Simult Tx	Configuration	LTE Band 7 SAR (W/kg)	5 GHz WLAN MIMO SAR (W/kg)	Σ SAR (W/kg)	Simult Tx	Configuration	LTE Band 41 SAR (W/kg)	5 GHz WLAN MIMO SAR (W/kg)	Σ SAR (W/kg)	SPLSR	Simult Tx	Configuration	NR Band n66 (AWS) SAR (W/kg)	5 GHz WLAN MIMO SAR (W/kg)	Σ SAR (W/kg)
		1	2	1+2			1	2	1+2	1+2			1	2	1+2
UMPC Extremity SAR	Back	1.611	1.813	3.424	UMPC Extremity SAR	Back	2.520	1.813	See Note 1	0.06	UMPC Extremity SAR	Back	1.589	1.813	3.402
	Front	1.445	0.618	2.063		Front	1.254	0.618	1.872	N/A		Front	1.073	0.618	1.691
	Top	-	2.069	2.069		Top	-	2.069	2.069	N/A		Top	-	2.069	2.069
	Bottom	2.717	-	2.717		Bottom	2.126	-	2.126	N/A		Bottom	3.063	-	3.063
	Right	0.359	-	0.359		Right	0.516	-	0.516	N/A		Right	1.525	-	1.525
Left	-	0.646	0.646	Left	-	0.646	0.646	N/A	Left	-	0.646	0.646			

Simult Tx	Configuration	NR Band n25 (PCS) SAR (W/kg)	5 GHz WLAN MIMO SAR (W/kg)	Σ SAR (W/kg)
		1	2	1+2
UMPC Extremity SAR	Back	0.855	1.813	2.668
	Front	0.668	0.618	1.286
	Top	-	2.069	2.069
	Bottom	2.416	-	2.416
	Right	2.750	-	2.750
Left	-	0.646	0.646	





FCC ID: A3LSMF916U	 PCTEST <small>Result to be part of the release</small>	SAR EVALUATION REPORT		Approved by: Quality Manager
Document S/N: 1M2005200087-01-R2.A3L	Test Dates: 06/28/20-08/24/20	DUT Type: Portable Handset		Page 235 of 267



Table 12-32
Simultaneous Transmission Scenario with 2.4 GHz WLAN MIMO and 5 GHz WLAN MIMO (UMPC Extremity)

Configuration	Mode	2G/3G/4G/5G SAR (W/kg)	2.4 GHz WLAN MIMO at 19 dBm SAR (W/kg)	5 GHz WLAN MIMO at 16 dBm SAR (W/kg)	Σ SAR (W/kg)
		1	2	3	1+2+3
UMPC Extremity SAR	CDMA BC10 (\$90S)	1.435	1.025	0.776	3.236
	CDMA BC0 (\$22H)	1.613	1.025	0.776	3.414
	PCS CDMA	3.148	1.025	0.776	See Table Below
	GPRS 850	2.018	1.025	0.776	3.819
	GPRS 1900	2.272	1.025	0.776	See Table Below
	UMTS 850	2.386	1.025	0.776	See Table Below
	UMTS 1750	3.146	1.025	0.776	See Table Below
	UMTS 1900	3.137	1.025	0.776	See Table Below
	LTE Band 71	1.530	1.025	0.776	3.331
	LTE Band 12	1.316	1.025	0.776	3.117
	LTE Band 13	1.857	1.025	0.776	3.658
	LTE Band 14	2.170	1.025	0.776	3.971
	LTE Band 26 (Cell)	2.067	1.025	0.776	3.868
	LTE Band 5 (Cell)	2.367	1.025	0.776	See Table Below
	LTE Band 66 (AWS)	3.147	1.025	0.776	See Table Below
	LTE Band 25 (PCS)	2.940	1.025	0.776	See Table Below
	LTE Band 30	2.895	1.025	0.776	See Table Below
	LTE Band 7	2.717	1.025	0.776	See Table Below
	LTE Band 48	1.914	1.025	0.776	3.715
	LTE Band 41	2.520	1.025	0.776	See Table Below
NR Band n71	1.233	1.025	0.776	3.034	
NR Band n5 (Cell)	1.891	1.025	0.776	3.692	
NR Band n66 (AWS)	3.063	1.025	0.776	See Table Below	
NR Band n25 (PCS)	2.750	1.025	0.776	See Table Below	
NR Band n41	1.266	1.025	0.776	3.067	

Simult Tx	Configuration	PCS EVDO SAR (W/kg)	2.4 GHz WLAN MIMO at 19 dBm SAR (W/kg)	5 GHz WLAN MIMO at 16 dBm SAR (W/kg)	Σ SAR (W/kg)	Simult Tx	Configuration	GPRS 1900 SAR (W/kg)	2.4 GHz WLAN MIMO at 19 dBm SAR (W/kg)	5 GHz WLAN MIMO at 16 dBm SAR (W/kg)	Σ SAR (W/kg)
		1	2	3	1+2+3			1	2	3	1+2+3
UMPC Extremity SAR	Back	1.664	0.756	0.593	3.013	UMPC Extremity SAR	Back	1.118	0.756	0.593	2.467
	Front	1.010	0.517	0.224	1.751		Front	0.701	0.517	0.224	1.442
	Top	-	0.650	0.776	1.426		Top	-	0.650	0.776	1.426
	Bottom	3.148	-	-	3.148		Bottom	2.272	-	-	2.272
	Right	2.973	-	-	2.973		Right	1.165	-	-	1.165
Left	-	1.025	0.249	1.274	Left	-	1.025	0.249	1.274		
UMPC Extremity SAR	Back	1.575	0.517	0.224	2.316	UMPC Extremity SAR	Back	1.816	0.756	0.593	3.165
	Front	1.575	0.517	0.224	2.316		Front	1.274	0.517	0.224	2.015
	Top	-	0.650	0.776	1.426		Top	-	0.650	0.776	1.426
	Bottom	1.123	-	-	1.123		Bottom	3.146	-	-	3.146
	Right	1.997	-	-	1.997		Right	2.473	-	-	2.473
Left	-	1.025	0.249	1.274	Left	-	1.025	0.249	1.274		
UMPC Extremity SAR	Back	1.260	0.756	0.593	2.609	UMPC Extremity SAR	Back	2.367	0.756	0.593	3.716
	Front	0.958	0.517	0.224	1.699		Front	1.581	0.517	0.224	2.322
	Top	-	0.650	0.776	1.426		Top	-	0.650	0.776	1.426
	Bottom	3.002	-	-	3.002		Bottom	0.865	-	-	0.865
	Right	3.137	-	-	3.137		Right	1.743	-	-	1.743
Left	-	1.025	0.249	1.274	Left	-	1.025	0.249	1.274		

FCC ID: A3LSMF916U	 PCTEST <small>Proud to be part of Samsung</small>	SAR EVALUATION REPORT		Approved by: Quality Manager
Document S/N: 1M2005200087-01-R2.A3L	Test Dates: 06/28/20-08/24/20	DUT Type: Portable Handset	Page 236 of 267	

Simult Tx	Configuration	LTE Band 66 (AWS) SAR (W/kg)	2.4 GHz WLAN MIMO at 19 dBm SAR (W/kg)	5 GHz WLAN MIMO at 16 dBm SAR (W/kg)	Σ SAR (W/kg)	Simult Tx	Configuration	LTE Band 25 (PCS) SAR (W/kg)	2.4 GHz WLAN MIMO at 19 dBm SAR (W/kg)	5 GHz WLAN MIMO at 16 dBm SAR (W/kg)	Σ SAR (W/kg)
		1	2	3	1+2+3			1	2	3	1+2+3
UMPC Extremity SAR	Back	1.935	0.756	0.593	3.284	UMPC Extremity SAR	Back	1.415	0.756	0.593	2.764
	Front	1.058	0.517	0.224	1.799		Front	0.815	0.517	0.224	1.556
	Top	-	0.650	0.776	1.426		Top	-	0.650	0.776	1.426
	Bottom	3.147	-	-	3.147		Bottom	2.940	-	-	2.940
	Right	1.633	-	-	1.633		Right	1.433	-	-	1.433
Left	-	1.025	0.249	1.274	Left	-	1.025	0.249	1.274		
Simult Tx	Configuration	LTE Band 30 SAR (W/kg)	2.4 GHz WLAN MIMO at 19 dBm SAR (W/kg)	5 GHz WLAN MIMO at 16 dBm SAR (W/kg)	Σ SAR (W/kg)	Simult Tx	Configuration	LTE Band 7 SAR (W/kg)	2.4 GHz WLAN MIMO at 19 dBm SAR (W/kg)	5 GHz WLAN MIMO at 16 dBm SAR (W/kg)	Σ SAR (W/kg)
		1	2	3	1+2+3			1	2	3	1+2+3
UMPC Extremity SAR	Back	0.840	0.756	0.593	2.189	UMPC Extremity SAR	Back	1.611	0.756	0.593	2.960
	Front	0.750	0.517	0.224	1.491		Front	1.445	0.517	0.224	2.186
	Top	-	0.650	0.776	1.426		Top	-	0.650	0.776	1.426
	Bottom	2.895	-	-	2.895		Bottom	2.717	-	-	2.717
	Right	0.710	-	-	0.710		Right	0.359	-	-	0.359
Left	-	1.025	0.249	1.274	Left	-	1.025	0.249	1.274		
Simult Tx	Configuration	LTE Band 41 SAR (W/kg)	2.4 GHz WLAN MIMO at 19 dBm SAR (W/kg)	5 GHz WLAN MIMO at 16 dBm SAR (W/kg)	Σ SAR (W/kg)	Simult Tx	Configuration	NR Band n66 (AWS) SAR (W/kg)	2.4 GHz WLAN MIMO at 19 dBm SAR (W/kg)	5 GHz WLAN MIMO at 16 dBm SAR (W/kg)	Σ SAR (W/kg)
		1	2	3	1+2+3			1	2	3	1+2+3
UMPC Extremity SAR	Back	2.520	0.756	0.593	3.869	UMPC Extremity SAR	Back	1.589	0.756	0.593	2.938
	Front	1.254	0.517	0.224	1.995		Front	1.073	0.517	0.224	1.814
	Top	-	0.650	0.776	1.426		Top	-	0.650	0.776	1.426
	Bottom	2.126	-	-	2.126		Bottom	3.063	-	-	3.063
	Right	0.516	-	-	0.516		Right	1.525	-	-	1.525
Left	-	1.025	0.249	1.274	Left	-	1.025	0.249	1.274		
Simult Tx	Configuration	NR Band n25 (PCS) SAR (W/kg)	2.4 GHz WLAN MIMO at 19 dBm SAR (W/kg)	5 GHz WLAN MIMO at 16 dBm SAR (W/kg)	Σ SAR (W/kg)	Simult Tx	Configuration	NR Band n25 (PCS) SAR (W/kg)	2.4 GHz WLAN MIMO at 19 dBm SAR (W/kg)	5 GHz WLAN MIMO at 16 dBm SAR (W/kg)	Σ SAR (W/kg)
		1	2	3	1+2+3			1	2	3	1+2+3
UMPC Extremity SAR	Back	0.855	0.756	0.593	2.204	UMPC Extremity SAR	Back	0.855	0.756	0.593	2.204
	Front	0.668	0.517	0.224	1.409		Front	0.668	0.517	0.224	1.409
	Top	-	0.650	0.776	1.426		Top	-	0.650	0.776	1.426
	Bottom	2.416	-	-	2.416		Bottom	2.416	-	-	2.416
	Right	2.750	-	-	2.750		Right	2.750	-	-	2.750
Left	-	1.025	0.249	1.274	Left	-	1.025	0.249	1.274		

FCC ID: A3LSMF916U	 PCTEST <small>Prove it to be part of Samsung</small>	SAR EVALUATION REPORT		Approved by: Quality Manager
Document S/N: 1M2005200087-01-R2.A3L	Test Dates: 06/28/20-08/24/20	DUT Type: Portable Handset	Page 237 of 267	

**Table 12-33
Simultaneous Transmission Scenario with Bluetooth (UMPC Extremity)**

Configuration	Mode	2G/3G/4G/5G SAR (W/kg)	Bluetooth Ant 1 SAR (W/kg)	Bluetooth Ant 2 SAR (W/kg)	Σ SAR (W/kg)	
		1		1	1+2	1+3
UMPC Extremity SAR	CDMA BC10 (§90S)	1.435	0.886	0.643	2.321	2.078
	CDMA BC0 (§22H)	1.613	0.886	0.643	2.499	2.256
	PCS CDMA	3.148	0.886	0.643	See Table Below	3.791
	GPRS 850	2.018	0.886	0.643	2.904	2.661
	GPRS 1900	2.272	0.886	0.643	3.158	2.915
	UMTS 850	2.386	0.886	0.643	3.272	3.029
	UMTS 1750	3.146	0.886	0.643	See Table Below	3.789
	UMTS 1900	3.137	0.886	0.643	See Table Below	3.780
	LTE Band 71	1.530	0.886	0.643	2.416	2.173
	LTE Band 12	1.316	0.886	0.643	2.202	1.959
	LTE Band 13	1.857	0.886	0.643	2.743	2.500
	LTE Band 14	2.170	0.886	0.643	3.056	2.813
	LTE Band 26 (Cell)	2.067	0.886	0.643	2.953	2.710
	LTE Band 5 (Cell)	2.367	0.886	0.643	3.253	3.010
	LTE Band 66 (AWS)	3.147	0.886	0.643	See Table Below	3.790
	LTE Band 25 (PCS)	2.940	0.886	0.643	3.826	3.583
	LTE Band 30	2.895	0.886	0.643	3.781	3.538
	LTE Band 7	2.717	0.886	0.643	3.603	3.360
	LTE Band 48	1.914	0.886	0.643	2.800	2.557
	LTE Band 41	2.520	0.886	0.643	3.406	3.163
NR Band n71	1.233	0.886	0.643	2.119	1.876	
NR Band n5 (Cell)	1.891	0.886	0.643	2.777	2.534	
NR Band n66 (AWS)	3.063	0.886	0.643	3.949	3.706	
NR Band n25 (PCS)	2.750	0.886	0.643	3.636	3.393	
NR Band n41	1.266	0.886	0.643	2.152	1.909	

Simult Tx	Configuration	PCS EVDO SAR (W/kg)	Bluetooth Ant 1 SAR (W/kg)	Σ SAR (W/kg)	Simult Tx	Configuration	UMTS 1750 SAR (W/kg)	Bluetooth Ant 1 SAR (W/kg)	Σ SAR (W/kg)	Simult Tx	Configuration	UMTS 1900 SAR (W/kg)	Bluetooth Ant 1 SAR (W/kg)	Σ SAR (W/kg)
		1	2	1+2			1	2	1+2			1	2	1+2
UMPC Extremity SAR	Back	1.664	0.481	2.145	UMPC Extremity SAR	Back	1.816	0.481	2.297	UMPC Extremity SAR	Back	1.260	0.481	1.741
	Front	1.010	0.639	1.649		Front	1.274	0.639	1.913		Front	0.958	0.639	1.597
	Top	-	0.886	0.886		Top	-	0.886	0.886		Top	-	0.886	0.886
	Bottom	3.148	-	3.148		Bottom	3.146	-	3.146		Bottom	3.002	-	3.002
	Right	2.973	-	2.973		Right	2.473	-	2.473		Right	3.137	-	3.137
Left	-	-	-	Left	-	-	-	Left	-	-	-			

Simult Tx	Configuration	LTE Band 66 (AWS) SAR (W/kg)	Bluetooth Ant 1 SAR (W/kg)	Σ SAR (W/kg)
		1	2	1+2
UMPC Extremity SAR	Back	1.935	0.481	2.416
	Front	1.058	0.639	1.697
	Top	-	0.886	0.886
	Bottom	3.147	-	3.147
	Right	1.633	-	1.633
Left	-	-	-	



FCC ID: A3LSMF916U	 <small>Proud to be part of Samsung</small>	SAR EVALUATION REPORT		Approved by: Quality Manager
Document S/N: 1M2005200087-01-R2.A3L	Test Dates: 06/28/20-08/24/20	DUT Type: Portable Handset	Page 238 of 267	



Table 12-34

Simultaneous Transmission Scenario with Bluetooth Antenna 1 and 5 GHz WLAN MIMO (UMPC Extremity)

Configuration	Mode	2G/3G/4G/5G SAR (W/kg)	Bluetooth Ant 1 SAR (W/kg)	5 GHz WLAN MIMO at 16 dBm SAR (W/kg)	Σ SAR (W/kg)
		1		1	1+2+3
UMPC Extremity SAR	CDMA BC10 (\$90S)	1.435	0.886	0.776	3.097
	CDMA BC0 (\$22H)	1.613	0.886	0.776	3.275
	PCS CDMA	3.148	0.886	0.776	See Table Below
	GPRS 850	2.018	0.886	0.776	3.680
	GPRS 1900	2.272	0.886	0.776	3.934
	UMTS 850	2.386	0.886	0.776	See Table Below
	UMTS 1750	3.146	0.886	0.776	See Table Below
	UMTS 1900	3.137	0.886	0.776	See Table Below
	LTE Band 71	1.530	0.886	0.776	3.192
	LTE Band 12	1.316	0.886	0.776	2.978
	LTE Band 13	1.857	0.886	0.776	3.519
	LTE Band 14	2.170	0.886	0.776	3.832
	LTE Band 26 (Cell)	2.067	0.886	0.776	3.729
	LTE Band 5 (Cell)	2.367	0.886	0.776	See Table Below
	LTE Band 66 (AWS)	3.147	0.886	0.776	See Table Below
	LTE Band 25 (PCS)	2.940	0.886	0.776	See Table Below
	LTE Band 30	2.895	0.886	0.776	See Table Below
	LTE Band 7	2.717	0.886	0.776	See Table Below
	LTE Band 48	1.914	0.886	0.776	3.576
	LTE Band 41	2.520	0.886	0.776	See Table Below
NR Band n71	1.233	0.886	0.776	2.895	
NR Band n5 (Cell)	1.891	0.886	0.776	3.553	
NR Band n66 (AWS)	3.063	0.886	0.776	See Table Below	
NR Band n25 (PCS)	2.750	0.886	0.776	See Table Below	
NR Band n41	1.266	0.886	0.776	2.928	

Simult Tx	Configuration	PCS EVDO SAR (W/kg)	Bluetooth Ant 1 SAR (W/kg)	5 GHz WLAN MIMO at 16 dBm SAR (W/kg)	Σ SAR (W/kg)	Simult Tx	Configuration	UMTS 850 SAR (W/kg)	Bluetooth Ant 1 SAR (W/kg)	5 GHz WLAN MIMO at 16 dBm SAR (W/kg)	Σ SAR (W/kg)
		1	2	3	1+2+3			1	2	3	1+2+3
UMPC Extremity SAR	Back	1.664	0.481	0.593	2.738	UMPC Extremity SAR	Back	2.386	0.481	0.593	3.460
	Front	1.010	0.639	0.224	1.873		Front	1.575	0.639	0.224	2.438
	Top	-	0.886	0.776	1.662		Top	-	0.886	0.776	1.662
	Bottom	3.148	-	-	3.148		Bottom	1.123	-	-	1.123
	Right	2.973	-	-	2.973		Right	1.997	-	-	1.997
Left	-	-	0.249	0.249	Left	-	-	0.249	0.249		

Simult Tx	Configuration	UMTS 1750 SAR (W/kg)	Bluetooth Ant 1 SAR (W/kg)	5 GHz WLAN MIMO at 16 dBm SAR (W/kg)	Σ SAR (W/kg)	Simult Tx	Configuration	UMTS 1900 SAR (W/kg)	Bluetooth Ant 1 SAR (W/kg)	5 GHz WLAN MIMO at 16 dBm SAR (W/kg)	Σ SAR (W/kg)
		1	2	3	1+2+3			1	2	3	1+2+3
UMPC Extremity SAR	Back	1.816	0.481	0.593	2.890	UMPC Extremity SAR	Back	1.260	0.481	0.593	2.334
	Front	1.274	0.639	0.224	2.137		Front	0.958	0.639	0.224	1.821
	Top	-	0.886	0.776	1.662		Top	-	0.886	0.776	1.662
	Bottom	3.146	-	-	3.146		Bottom	3.002	-	-	3.002
	Right	2.473	-	-	2.473		Right	3.137	-	-	3.137
Left	-	-	0.249	0.249	Left	-	-	0.249	0.249		

FCC ID: A3LSMF916U	 PCTEST <small>Proud to be part of Samsung</small>	SAR EVALUATION REPORT		Approved by: Quality Manager
Document S/N: 1M2005200087-01-R2.A3L	Test Dates: 06/28/20-08/24/20	DUT Type: Portable Handset		Page 239 of 267

Simult Tx	Configuration	LTE Band 5 (Cell) SAR (W/kg)	Bluetooth Ant 1 SAR (W/kg)	5 GHz WLAN MIMO at 16 dBm SAR (W/kg)	Σ SAR (W/kg)	Simult Tx	Configuration	LTE Band 66 (AWS) SAR (W/kg)	Bluetooth Ant 1 SAR (W/kg)	5 GHz WLAN MIMO at 16 dBm SAR (W/kg)	Σ SAR (W/kg)
		1	2	3	1+2+3			1	2	3	1+2+3
UMPC Extremity SAR	Back	2.367	0.481	0.593	3.441	UMPC Extremity SAR	Back	1.935	0.481	0.593	3.009
	Front	1.581	0.639	0.224	2.444		Front	1.058	0.639	0.224	1.921
	Top	-	0.886	-	1.662		Top	-	0.886	-	1.662
	Bottom	0.865	-	-	0.865		Bottom	3.147	-	-	3.147
	Right	1.743	-	-	1.743		Right	1.633	-	-	1.633
Left	-	-	0.249	0.249	Left	-	-	0.249	0.249		
Simult Tx	Configuration	LTE Band 25 (PCS) SAR (W/kg)	Bluetooth Ant 1 SAR (W/kg)	5 GHz WLAN MIMO at 16 dBm SAR (W/kg)	Σ SAR (W/kg)	Simult Tx	Configuration	LTE Band 30 SAR (W/kg)	Bluetooth Ant 1 SAR (W/kg)	5 GHz WLAN MIMO at 16 dBm SAR (W/kg)	Σ SAR (W/kg)
		1	2	3	1+2+3			1	2	3	1+2+3
UMPC Extremity SAR	Back	1.415	0.481	0.593	2.489	UMPC Extremity SAR	Back	0.840	0.481	0.593	1.914
	Front	0.815	0.639	0.224	1.678		Front	0.750	0.639	0.224	1.613
	Top	-	0.886	0.776	1.662		Top	-	0.886	0.776	1.662
	Bottom	2.940	-	-	2.940		Bottom	2.895	-	-	2.895
	Right	1.433	-	-	1.433		Right	0.710	-	-	0.710
Left	-	-	0.249	0.249	Left	-	-	0.249	0.249		
Simult Tx	Configuration	LTE Band 7 SAR (W/kg)	Bluetooth Ant 1 SAR (W/kg)	5 GHz WLAN MIMO at 16 dBm SAR (W/kg)	Σ SAR (W/kg)	Simult Tx	Configuration	LTE Band 41 SAR (W/kg)	Bluetooth Ant 1 SAR (W/kg)	5 GHz WLAN MIMO at 16 dBm SAR (W/kg)	Σ SAR (W/kg)
		1	2	3	1+2+3			1	2	3	1+2+3
UMPC Extremity SAR	Back	1.611	0.481	0.593	2.685	UMPC Extremity SAR	Back	2.520	0.481	0.593	3.594
	Front	1.445	0.639	0.224	2.308		Front	1.254	0.639	0.224	2.117
	Top	-	0.886	0.776	1.662		Top	-	0.886	0.776	1.662
	Bottom	2.717	-	-	2.717		Bottom	2.126	-	-	2.126
	Right	0.359	-	-	0.359		Right	0.516	-	-	0.516
Left	-	-	0.249	0.249	Left	-	-	0.249	0.249		
Simult Tx	Configuration	NR Band n66 (AWS) SAR (W/kg)	Bluetooth Ant 1 SAR (W/kg)	5 GHz WLAN MIMO at 16 dBm SAR (W/kg)	Σ SAR (W/kg)	Simult Tx	Configuration	NR Band n25 (PCS) SAR (W/kg)	Bluetooth Ant 1 SAR (W/kg)	5 GHz WLAN MIMO at 16 dBm SAR (W/kg)	Σ SAR (W/kg)
		1	2	3	1+2+3			1	2	3	1+2+3
UMPC Extremity SAR	Back	1.589	0.481	0.593	2.663	UMPC Extremity SAR	Back	0.855	0.481	0.593	1.929
	Front	1.073	0.639	0.224	1.936		Front	0.668	0.639	0.224	1.531
	Top	-	0.886	0.776	1.662		Top	-	0.886	0.776	1.662
	Bottom	3.063	-	-	3.063		Bottom	2.416	-	-	2.416
	Right	1.525	-	-	1.525		Right	2.750	-	-	2.750
Left	-	-	0.249	0.249	Left	-	-	0.249	0.249		



FCC ID: A3LSMF916U	 PCTEST <small>Prove it to be part of Samsung</small>	SAR EVALUATION REPORT		Approved by: Quality Manager
Document S/N: 1M2005200087-01-R2.A3L	Test Dates: 06/28/20-08/24/20	DUT Type: Portable Handset		Page 240 of 267

Table 12-35



Simultaneous Transmission Scenario with Bluetooth Antenna 2 and 5 GHz WLAN MIMO (UMPC Extremity)

Configuration	Mode	2G/3G/4G/5G SAR (W/kg)	Bluetooth Ant 2 SAR (W/kg)	5 GHz WLAN MIMO at 16 dBm SAR (W/kg)	Σ SAR (W/kg)
		1	2	3	1+2+3
UMPC Extremity SAR	CDMA BC10 (\$90S)	1.435	0.643	0.776	2.854
	CDMA BC0 (\$22H)	1.613	0.643	0.776	3.032
	PCS CDMA	3.148	0.643	0.776	See Table Below
	GPRS 850	2.018	0.643	0.776	3.437
	GPRS 1900	2.272	0.643	0.776	3.691
	UMTS 850	2.386	0.643	0.776	3.805
	UMTS 1750	3.146	0.643	0.776	See Table Below
	UMTS 1900	3.137	0.643	0.776	See Table Below
	LTE Band 71	1.530	0.643	0.776	2.949
	LTE Band 12	1.316	0.643	0.776	2.735
	LTE Band 13	1.857	0.643	0.776	3.276
	LTE Band 14	2.170	0.643	0.776	3.589
	LTE Band 26 (Cell)	2.067	0.643	0.776	3.486
	LTE Band 5 (Cell)	2.367	0.643	0.776	3.786
	LTE Band 66 (AWS)	3.147	0.643	0.776	See Table Below
	LTE Band 25 (PCS)	2.940	0.643	0.776	See Table Below
	LTE Band 30	2.895	0.643	0.776	See Table Below
	LTE Band 7	2.717	0.643	0.776	See Table Below
	LTE Band 48	1.914	0.643	0.776	3.333
	LTE Band 41	2.520	0.643	0.776	3.939
NR Band n71	1.233	0.643	0.776	2.652	
NR Band n5 (Cell)	1.891	0.643	0.776	3.310	
NR Band n66 (AWS)	3.063	0.643	0.776	See Table Below	
NR Band n25 (PCS)	2.750	0.643	0.776	See Table Below	
NR Band n41	1.266	0.643	0.776	2.685	

Simult Tx	Configuration	PCS EVDO SAR (W/kg)	Bluetooth Ant 2 SAR (W/kg)	5 GHz WLAN MIMO at 16 dBm SAR (W/kg)	Σ SAR (W/kg)	Simult Tx	Configuration	UMTS 1750 SAR (W/kg)	Bluetooth Ant 2 SAR (W/kg)	5 GHz WLAN MIMO at 16 dBm SAR (W/kg)	Σ SAR (W/kg)
		1	2	3	1+2+3			1	2	3	1+2+3
UMPC Extremity SAR	Back	1.664	0.337	0.593	2.594	UMPC Extremity SAR	Back	1.816	0.337	0.593	2.746
	Front	1.010	0.643	0.224	1.877		Front	1.274	0.643	0.224	2.141
	Top	-	0.610	0.776	1.386		Top	-	0.610	0.776	1.386
	Bottom	3.148	-	-	3.148		Bottom	3.146	-	-	3.146
	Right	2.973	-	-	2.973		Right	2.473	-	-	2.473
	Left	-	0.146	0.249	0.395		Left	-	0.146	0.249	0.395

Simult Tx	Configuration	UMTS 1900 SAR (W/kg)	Bluetooth Ant 2 SAR (W/kg)	5 GHz WLAN MIMO at 16 dBm SAR (W/kg)	Σ SAR (W/kg)	Simult Tx	Configuration	LTE Band 66 (AWS) SAR (W/kg)	Bluetooth Ant 2 SAR (W/kg)	5 GHz WLAN MIMO at 16 dBm SAR (W/kg)	Σ SAR (W/kg)
		1	2	3	1+2+3			1	2	3	1+2+3
UMPC Extremity SAR	Back	1.260	0.337	0.593	2.190	UMPC Extremity SAR	Back	1.935	0.337	0.593	2.865
	Front	0.958	0.643	0.224	1.825		Front	1.058	0.643	0.224	1.925
	Top	-	0.610	0.776	1.386		Top	-	0.610	0.776	1.386
	Bottom	3.002	-	-	3.002		Bottom	3.147	-	-	3.147
	Right	3.137	-	-	3.137		Right	1.633	-	-	1.633
	Left	-	0.146	0.249	0.395		Left	-	0.146	0.249	0.395

Simult Tx	Configuration	LTE Band 25 (PCS) SAR (W/kg)	Bluetooth Ant 2 SAR (W/kg)	5 GHz WLAN MIMO at 16 dBm SAR (W/kg)	Σ SAR (W/kg)	Simult Tx	Configuration	LTE Band 30 SAR (W/kg)	Bluetooth Ant 2 SAR (W/kg)	5 GHz WLAN MIMO at 16 dBm SAR (W/kg)	Σ SAR (W/kg)
		1	2	3	1+2+3			1	2	3	1+2+3
UMPC Extremity SAR	Back	1.415	0.337	0.593	2.345	UMPC Extremity SAR	Back	0.840	0.337	0.593	1.770
	Front	0.815	0.643	0.224	1.682		Front	0.750	0.643	0.224	1.617
	Top	-	0.610	0.776	1.386		Top	-	0.610	0.776	1.386
	Bottom	2.940	-	-	2.940		Bottom	2.895	-	-	2.895
	Right	1.433	-	-	1.433		Right	0.710	-	-	0.710
	Left	-	0.146	0.249	0.395		Left	-	0.146	0.249	0.395

FCC ID: A3LSMF916U	 PCTEST <small>Prove it to be part of the solution.</small>	SAR EVALUATION REPORT		Approved by: Quality Manager
Document S/N: 1M2005200087-01-R2.A3L	Test Dates: 06/28/20-08/24/20	DUT Type: Portable Handset		Page 241 of 267

Simult Tx	Configuration	LTE Band 7 SAR (W/kg)	Bluetooth Ant 2 SAR (W/kg)	5 GHz WLAN MIMO at 16 dBm SAR (W/kg)	Σ SAR (W/kg)	Simult Tx	Configuration	NR Band n66 (AWS) SAR (W/kg)	Bluetooth Ant 2 SAR (W/kg)	5 GHz WLAN MIMO at 16 dBm SAR (W/kg)	Σ SAR (W/kg)
		1	2	3	1+2+3			1	2	3	1+2+3
UMPC Extremity SAR	Back	1.611	0.337	0.593	2.541	UMPC Extremity SAR	Back	1.589	0.337	0.593	2.519
	Front	1.445	0.643	0.224	2.312		Front	1.073	0.643	0.224	1.940
	Top	-	0.610	0.776	1.386		Top	-	0.610	0.776	1.386
	Bottom	2.717	-	-	2.717		Bottom	3.063	-	-	3.063
	Right	0.359	-	-	0.359		Right	1.525	-	-	1.525
	Left	-	0.146	0.249	0.395		Left	-	0.146	0.249	0.395
Simult Tx	Configuration	NR Band n25 (PCS) SAR (W/kg)	Bluetooth Ant 2 SAR (W/kg)	5 GHz WLAN MIMO at 16 dBm SAR (W/kg)	Σ SAR (W/kg)	Simult Tx	Configuration	NR Band n25 (PCS) SAR (W/kg)	Bluetooth Ant 2 SAR (W/kg)	5 GHz WLAN MIMO at 16 dBm SAR (W/kg)	Σ SAR (W/kg)
		1	2	3	1+2+3			1	2	3	1+2+3
UMPC Extremity SAR	Back	0.855	0.337	0.593	1.785	UMPC Extremity SAR	Back	0.855	0.337	0.593	1.785
	Front	0.668	0.643	0.224	1.535		Front	0.668	0.643	0.224	1.535
	Top	-	0.610	0.776	1.386		Top	-	0.610	0.776	1.386
	Bottom	2.416	-	-	2.416		Bottom	2.416	-	-	2.416
	Right	2.750	-	-	2.750		Right	2.750	-	-	2.750
	Left	-	0.146	0.249	0.395		Left	-	0.146	0.249	0.395



FCC ID: A3LSMF916U	 PCTEST <small>Prove it to be part of Samsung</small>	SAR EVALUATION REPORT		Approved by: Quality Manager
Document S/N: 1M2005200087-01-R2.A3L	Test Dates: 06/28/20-08/24/20	DUT Type: Portable Handset	Page 242 of 267	

Table 12-36
Simultaneous Transmission Scenario with Bluetooth Antenna 1, 2.4 GHz WLAN Antenna 2, and 5 GHz
WLAN MIMO (UMPC Extremity)

Simult Tx	Configuration	EVDO BC10 (\$90S) SAR (W/kg)	Bluetooth Ant 1 SAR (W/kg)	2.4 GHz WLAN Ant 2 SAR (W/kg)	5 GHz WLAN MIMO at 16 dBm SAR (W/kg)	Σ SAR (W/kg)	Simult Tx	Configuration	EVDO BC0 (\$22H) SAR (W/kg)	Bluetooth Ant 1 SAR (W/kg)	2.4 GHz WLAN Ant 2 SAR (W/kg)	5 GHz WLAN MIMO at 16 dBm SAR (W/kg)	Σ SAR (W/kg)
		1	2	3	4	1+2+3+4			1	2	3	4	1+2+3+4
UMPC Extremity SAR	Back	1.435	0.481	0.632	0.593	3.141	UMPC Extremity SAR	Back	1.613	0.481	0.632	0.593	3.319
	Front	1.169	0.639	0.513	0.224	2.545		Front	1.310	0.639	0.513	0.224	2.686
	Top	-	0.886	0.416	0.776	2.078		Top	-	0.886	0.416	0.776	2.078
	Bottom	0.767	-	-	-	0.767		Bottom	0.687	-	-	-	0.687
	Right	1.374	-	-	-	1.374		Right	1.565	-	-	-	1.565
Left	-	-	1.035	0.249	1.284	Left	-	-	1.035	0.249	1.284		

Simult Tx	Configuration	PCS EVDO SAR (W/kg)	Bluetooth Ant 1 SAR (W/kg)	2.4 GHz WLAN Ant 2 SAR (W/kg)	5 GHz WLAN MIMO at 16 dBm SAR (W/kg)	Σ SAR (W/kg)	Simult Tx	Configuration	GPRS 850 SAR (W/kg)	Bluetooth Ant 1 SAR (W/kg)	2.4 GHz WLAN Ant 2 SAR (W/kg)	5 GHz WLAN MIMO at 16 dBm SAR (W/kg)	Σ SAR (W/kg)
		1	2	3	4	1+2+3+4			1	2	3	4	1+2+3+4
UMPC Extremity SAR	Back	1.664	0.481	0.632	0.593	3.370	UMPC Extremity SAR	Back	2.018	0.481	0.632	0.593	3.724
	Front	1.010	0.639	0.513	0.224	2.386		Front	1.496	0.639	0.513	0.224	2.872
	Top	-	0.886	0.416	0.776	2.078		Top	-	0.886	0.416	0.776	2.078
	Bottom	3.148	-	-	-	3.148		Bottom	1.038	-	-	-	1.038
	Right	2.973	-	-	-	2.973		Right	1.385	-	-	-	1.385
Left	-	-	1.035	0.249	1.284	Left	-	-	1.035	0.249	1.284		



Simult Tx	Configuration	GPRS 1900 SAR (W/kg)	Bluetooth Ant 1 SAR (W/kg)	2.4 GHz WLAN Ant 2 SAR (W/kg)	5 GHz WLAN MIMO at 16 dBm SAR (W/kg)	Σ SAR (W/kg)
		1	2	3	4	1+2+3+4
UMPC Extremity SAR	Back	1.118	0.481	0.632	0.593	2.824
	Front	0.701	0.639	0.513	0.224	2.077
	Top	-	0.886	0.416	0.776	2.078
	Bottom	2.272	-	-	-	2.272
	Right	1.165	-	-	-	1.165
Left	-	-	1.035	0.249	1.284	

Simult Tx	Configuration	UMTS 850 SAR (W/kg)	Bluetooth Ant 1 SAR (W/kg)	2.4 GHz WLAN Ant 2 SAR (W/kg)	5 GHz WLAN MIMO at 16 dBm SAR (W/kg)	Σ SAR (W/kg)	SPLSR					
		1	2	3	4	1+2+3+4	1+2	1+3	1+4	2+3	2+4	3+4
UMPC Extremity SAR	Back	2.386	0.481	0.632	0.593	See Note 1	0.03	0.03	0.03	0.02	0.05	0.03
	Front	1.575	0.639	0.513	0.224	2.951	N/A	N/A	N/A	N/A	N/A	N/A
	Top	-	0.886	0.416	0.776	2.078	N/A	N/A	N/A	N/A	N/A	N/A
	Bottom	1.123	-	-	-	1.123	N/A	N/A	N/A	N/A	N/A	N/A
	Right	1.997	-	-	-	1.997	N/A	N/A	N/A	N/A	N/A	N/A
Left	-	-	1.035	0.249	1.284	N/A	N/A	N/A	N/A	N/A	N/A	

Simult Tx	Configuration	UMTS 1750 SAR (W/kg)	Bluetooth Ant 1 SAR (W/kg)	2.4 GHz WLAN Ant 2 SAR (W/kg)	5 GHz WLAN MIMO at 16 dBm SAR (W/kg)	Σ SAR (W/kg)	Simult Tx	Configuration	UMTS 1900 SAR (W/kg)	Bluetooth Ant 1 SAR (W/kg)	2.4 GHz WLAN Ant 2 SAR (W/kg)	5 GHz WLAN MIMO at 16 dBm SAR (W/kg)	Σ SAR (W/kg)
		1	2	3	4	1+2+3+4			1	2	3	4	1+2+3+4
UMPC Extremity SAR	Back	1.816	0.481	0.632	0.593	3.522	UMPC Extremity SAR	Back	1.260	0.481	0.632	0.593	2.966
	Front	1.274	0.639	0.513	0.224	2.650		Front	0.958	0.639	0.513	0.224	2.334
	Top	-	0.886	0.416	0.776	2.078		Top	-	0.886	0.416	0.776	2.078
	Bottom	3.146	-	-	-	3.146		Bottom	3.002	-	-	-	3.002
	Right	2.473	-	-	-	2.473		Right	3.137	-	-	-	3.137
Left	-	-	1.035	0.249	1.284	Left	-	-	1.035	0.249	1.284		

Simult Tx	Configuration	LTE Band 71 SAR (W/kg)	Bluetooth Ant 1 SAR (W/kg)	2.4 GHz WLAN Ant 2 SAR (W/kg)	5 GHz WLAN MIMO at 16 dBm SAR (W/kg)	Σ SAR (W/kg)	Simult Tx	Configuration	LTE Band 12 SAR (W/kg)	Bluetooth Ant 1 SAR (W/kg)	2.4 GHz WLAN Ant 2 SAR (W/kg)	5 GHz WLAN MIMO at 16 dBm SAR (W/kg)	Σ SAR (W/kg)
		1	2	3	4	1+2+3+4			1	2	3	4	1+2+3+4
UMPC Extremity SAR	Back	1.530	0.481	0.632	0.593	3.236	UMPC Extremity SAR	Back	0.999	0.481	0.632	0.593	2.705
	Front	0.913	0.639	0.513	0.224	2.289		Front	0.835	0.639	0.513	0.224	2.211
	Top	-	0.886	0.416	0.776	2.078		Top	-	0.886	0.416	0.776	2.078
	Bottom	0.944	-	-	-	0.944		Bottom	0.712	-	-	-	0.712
	Right	1.294	-	-	-	1.294		Right	1.316	-	-	-	1.316
Left	-	-	1.035	0.249	1.284	Left	-	-	1.035	0.249	1.284		

Simult Tx	Configuration	LTE Band 13 SAR (W/kg)	Bluetooth Ant 1 SAR (W/kg)	2.4 GHz WLAN Ant 2 SAR (W/kg)	5 GHz WLAN MIMO at 16 dBm SAR (W/kg)	Σ SAR (W/kg)	Simult Tx	Configuration	LTE Band 14 SAR (W/kg)	Bluetooth Ant 1 SAR (W/kg)	2.4 GHz WLAN Ant 2 SAR (W/kg)	5 GHz WLAN MIMO at 16 dBm SAR (W/kg)	Σ SAR (W/kg)
		1	2	3	4	1+2+3+4			1	2	3	4	1+2+3+4
UMPC Extremity SAR	Back	1.681	0.481	0.632	0.593	3.387	UMPC Extremity SAR	Back	2.170	0.481	0.632	0.593	3.876
	Front	1.506	0.639	0.513	0.224	2.882		Front	1.624	0.639	0.513	0.224	3.000
	Top	-	0.886	0.416	0.776	2.078		Top	-	0.886	0.416	0.776	2.078
	Bottom	1.117	-	-	-	1.117		Bottom	1.105	-	-	-	1.105
	Right	1.857	-	-	-	1.857		Right	1.875	-	-	-	1.875
Left	-	-	1.035	0.249	1.284	Left	-	-	1.035	0.249	1.284		

FCC ID: A3LSMF916U	 <small>Proud to be part of Samsung</small>	SAR EVALUATION REPORT		Approved by: Quality Manager
Document S/N: 1M2005200087-01-R2.A3L	Test Dates: 06/28/20-08/24/20	DUT Type: Portable Handset		Page 243 of 267

Simult Tx	Configuration	LTE Band 26 (Cell) SAR (W/kg)	Bluetooth Ant 1 SAR (W/kg)	2.4 GHz WLAN Ant 2 SAR (W/kg)	5 GHz WLAN MIMO at 16 dBm SAR (W/kg)	Σ SAR (W/kg)
		1	2	3	4	1+2+3+4
UMPC Extremity SAR	Back	2.067	0.481	0.632	0.593	3.773
	Front	1.569	0.639	0.513	0.224	2.945
	Top	-	0.886	0.416	0.776	2.078
	Bottom	1.021	-	-	-	1.021
	Right	1.595	-	-	-	1.595
Left	-	-	1.035	0.249	1.284	

Simult Tx	Configuration	LTE Band 5 (Cell) SAR (W/kg)	Bluetooth Ant 1 SAR (W/kg)	2.4 GHz WLAN Ant 2 SAR (W/kg)	5 GHz WLAN MIMO at 16 dBm SAR (W/kg)	Σ SAR (W/kg)	SPLSR					
		1	2	3	4	1+2+3+4	1+2	1+3	1+4	2+3	2+4	3+4
UMPC Extremity SAR	Back	2.367	0.481	0.632	0.593	See Note 1	0.03	0.03	0.03	0.02	0.05	0.03
	Front	1.581	0.639	0.513	0.224	2.957	N/A	N/A	N/A	N/A	N/A	N/A
	Top	-	0.886	0.416	0.776	2.078	N/A	N/A	N/A	N/A	N/A	N/A
	Bottom	0.865	-	-	-	0.865	N/A	N/A	N/A	N/A	N/A	N/A
	Right	1.743	-	-	-	1.743	N/A	N/A	N/A	N/A	N/A	N/A
	Left	-	-	1.035	0.249	1.284	N/A	N/A	N/A	N/A	N/A	N/A



Simult Tx	Configuration	LTE Band 66 (AWS) SAR (W/kg)	Bluetooth Ant 1 SAR (W/kg)	2.4 GHz WLAN Ant 2 SAR (W/kg)	5 GHz WLAN MIMO at 16 dBm SAR (W/kg)	Σ SAR (W/kg)	Simult Tx	Configuration	LTE Band 25 (PCS) SAR (W/kg)	Bluetooth Ant 1 SAR (W/kg)	2.4 GHz WLAN Ant 2 SAR (W/kg)	5 GHz WLAN MIMO at 16 dBm SAR (W/kg)	Σ SAR (W/kg)
		1	2	3	4	1+2+3+4			1	2	3	4	1+2+3+4
UMPC Extremity SAR	Back	1.935	0.481	0.632	0.593	3.641	UMPC Extremity SAR	Back	1.415	0.481	0.632	0.593	3.121
	Front	1.058	0.639	0.513	0.224	2.434		Front	0.815	0.639	0.513	0.224	2.191
	Top	-	0.886	0.416	0.776	2.078		Top	-	0.886	0.416	0.776	2.078
	Bottom	3.147	-	-	-	3.147		Bottom	2.940	-	-	-	2.940
	Right	1.633	-	-	-	1.633		Right	1.433	-	-	-	1.433
	Left	-	-	1.035	0.249	1.284		Left	-	-	1.035	0.249	1.284

Simult Tx	Configuration	LTE Band 30 SAR (W/kg)	Bluetooth Ant 1 SAR (W/kg)	2.4 GHz WLAN Ant 2 SAR (W/kg)	5 GHz WLAN MIMO at 16 dBm SAR (W/kg)	Σ SAR (W/kg)	Simult Tx	Configuration	LTE Band 7 SAR (W/kg)	Bluetooth Ant 1 SAR (W/kg)	2.4 GHz WLAN Ant 2 SAR (W/kg)	5 GHz WLAN MIMO at 16 dBm SAR (W/kg)	Σ SAR (W/kg)
		1	2	3	4	1+2+3+4			1	2	3	4	1+2+3+4
UMPC Extremity SAR	Back	0.840	0.481	0.632	0.593	2.546	UMPC Extremity SAR	Back	1.611	0.481	0.632	0.593	3.317
	Front	0.750	0.639	0.513	0.224	2.126		Front	1.445	0.639	0.513	0.224	2.821
	Top	-	0.886	0.416	0.776	2.078		Top	-	0.886	0.416	0.776	2.078
	Bottom	2.895	-	-	-	2.895		Bottom	2.717	-	-	-	2.717
	Right	0.710	-	-	-	0.710		Right	0.359	-	-	-	0.359
	Left	-	-	1.035	0.249	1.284		Left	-	-	1.035	0.249	1.284

Simult Tx	Configuration	LTE Band 49 SAR (W/kg)	Bluetooth Ant 1 SAR (W/kg)	2.4 GHz WLAN Ant 2 SAR (W/kg)	5 GHz WLAN MIMO at 16 dBm SAR (W/kg)	Σ SAR (W/kg)
		1	2	3	4	1+2+3+4
UMPC Extremity SAR	Back	0.677	0.481	0.632	0.593	2.383
	Front	0.612	0.639	0.513	0.224	1.988
	Top	1.914	0.886	0.416	0.776	3.992
	Bottom	-	-	-	-	-
	Right	-	-	-	-	-
Left	-	-	1.035	0.249	1.284	

Simult Tx	Configuration	LTE Band 41 SAR (W/kg)	Bluetooth Ant 1 SAR (W/kg)	2.4 GHz WLAN Ant 2 SAR (W/kg)	5 GHz WLAN MIMO at 16 dBm SAR (W/kg)	Σ SAR (W/kg)	SPLSR					
		1	2	3	4	1+2+3+4	1+2	1+3	1+4	2+3	2+4	3+4
UMPC Extremity SAR	Back	2.520	0.481	0.632	0.593	See Note 1	0.04	0.03	0.03	0.02	0.05	0.03
	Front	1.254	0.639	0.513	0.224	2.630	N/A	N/A	N/A	N/A	N/A	N/A
	Top	-	0.886	0.416	0.776	2.078	N/A	N/A	N/A	N/A	N/A	N/A
	Bottom	2.126	-	-	-	2.126	N/A	N/A	N/A	N/A	N/A	N/A
	Right	0.516	-	-	-	0.516	N/A	N/A	N/A	N/A	N/A	N/A
	Left	-	-	1.035	0.249	1.284	N/A	N/A	N/A	N/A	N/A	N/A

Simult Tx	Configuration	NR Band n71 SAR (W/kg)	Bluetooth Ant 1 SAR (W/kg)	2.4 GHz WLAN Ant 2 SAR (W/kg)	5 GHz WLAN MIMO at 16 dBm SAR (W/kg)	Σ SAR (W/kg)	Simult Tx	Configuration	NR Band n5 (Cell) SAR (W/kg)	Bluetooth Ant 1 SAR (W/kg)	2.4 GHz WLAN Ant 2 SAR (W/kg)	5 GHz WLAN MIMO at 16 dBm SAR (W/kg)	Σ SAR (W/kg)
		1	2	3	4	1+2+3+4			1	2	3	4	1+2+3+4
UMPC Extremity SAR	Back	1.233	0.481	0.632	0.593	2.939	UMPC Extremity SAR	Back	1.891	0.481	0.632	0.593	3.597
	Front	0.922	0.639	0.513	0.224	2.298		Front	1.359	0.639	0.513	0.224	2.735
	Top	-	0.886	0.416	0.776	2.078		Top	-	0.886	0.416	0.776	2.078
	Bottom	0.850	-	-	-	0.850		Bottom	0.817	-	-	-	0.817
	Right	0.751	-	-	-	0.751		Right	0.985	-	-	-	0.985
	Left	-	-	1.035	0.249	1.284		Left	-	-	1.035	0.249	1.284



FCC ID: A3LSMF916U	 PCTEST <small>Prove it to be part of it</small>	SAR EVALUATION REPORT		Approved by: Quality Manager
Document S/N: 1M2005200087-01-R2.A3L	Test Dates: 06/28/20-08/24/20	DUT Type: Portable Handset		Page 244 of 267

Simult Tx	Configuration	NR Band n66 (AWS) SAR (W/kg)	Bluetooth Ant 1 SAR (W/kg)	2.4 GHz WLAN Ant 2 SAR (W/kg)	5 GHz WLAN MIMO at 16 dBm SAR (W/kg)	Σ SAR (W/kg)	Simult Tx	Configuration	NR Band n25 (PCS) SAR (W/kg)	Bluetooth Ant 1 SAR (W/kg)	2.4 GHz WLAN Ant 2 SAR (W/kg)	5 GHz WLAN MIMO at 16 dBm SAR (W/kg)	Σ SAR (W/kg)
		1	2	3	4	1+2+3+4			1	2	3	4	1+2+3+4
UMPC Extremity SAR	Back	1.589	0.481	0.632	0.593	3.295	UMPC Extremity SAR	Back	0.855	0.481	0.632	0.593	2.561
	Front	1.073	0.639	0.513	0.224	2.449		Front	0.668	0.639	0.513	0.224	2.044
	Top	-	0.886	0.416	0.776	2.078		Top	-	0.886	0.416	0.776	2.078
	Bottom	3.063	-	-	-	3.063		Bottom	2.416	-	-	-	2.416
	Right	1.525	-	-	-	1.525		Right	2.750	-	-	-	2.750
	Left	-	-	1.035	0.249	1.284		Left	-	-	1.035	0.249	1.284

Simult Tx	Configuration	NR Band n41 SAR (W/kg)	Bluetooth Ant 1 SAR (W/kg)	2.4 GHz WLAN Ant 2 SAR (W/kg)	5 GHz WLAN MIMO at 16 dBm SAR (W/kg)	Σ SAR (W/kg)
		1	2	3	4	1+2+3+4
UMPC Extremity SAR	Back	0.521	0.481	0.632	0.593	2.227
	Front	0.464	0.639	0.513	0.224	1.840
	Top	1.266	0.886	0.416	0.776	3.344
	Bottom	-	-	-	-	-
	Right	-	-	-	-	-
	Left	-	-	1.035	0.249	1.284

Notes:

1. No evaluation was performed to determine the aggregate 10g SAR for these configurations as the SPLS ratio between the antenna pairs was not greater than 0.10 per FCC KDB 447498 D01v06. See Section 12.9 for detailed SPLS ratio analysis.

FCC ID: A3LSMF916U	 PCTEST <small>Prove it to be part of Samsung</small>	SAR EVALUATION REPORT		Approved by: Quality Manager
Document S/N: 1M2005200087-01-R2.A3L	Test Dates: 06/28/20-08/24/20	DUT Type: Portable Handset		Page 245 of 267

12.1 SPLSR Evaluation and Analysis

Per FCC KDB Publication 447498 D01v06, when the sum of the standalone transmitters is more than 1.6 W/kg for 1g and 4 W/kg for 10g, the SAR sum to peak locations can be analyzed to determine SAR distribution overlaps. When the SAR peak to location ratio (shown below) for each pair of antennas is ≤ 0.04 for 1g and ≤ 0.10 for 10g, simultaneous SAR evaluation is not required. The distance between the transmitters was calculated using the following formula.

$$\text{Distance}_{\text{Tx1} - \text{Tx2}} = R_i = \sqrt{(x_1 - x_2)^2 + (y_1 - y_2)^2} \text{ (Mini-Tablet)}$$

$$\text{SPLSR Ratio} = \frac{(SAR_1 + SAR_2)^{1.5}}{R_i}$$



12.1.1 Back Side UMPC Body SPLSR Evaluation and Analysis

Table 12-37
Peak SAR Locations for Back Side UMPC Body

Mode/Band	x (mm)	y (mm)
2.4 GHz WLAN Ant 2	28.60	67.60
2.4 GHz WLAN MIMO	30.20	55.20
5 GHz WLAN MIMO at 16 dBm	-15.00	79.00
2.4 GHz Bluetooth Ant 1	14.60	80.40
UMTS 1750	-55.00	-87.00
LTE Band 7	-57.40	-82.80
LTE Band 41	-56.20	-79.20



Table 12-38
Back Side UMPC Body SAR to Peak Location Separation Ratio Calculations

Antenna Pair		Standalone SAR (W/kg)		Standalone SAR Sum (W/kg)	Peak SAR Separation Distance (mm)	SPLSR Ratio	Plot Number
Ant "a"	Ant "b"	a	b	a+b	D _{a-b}	(a+b) ^{1.5} /D _{a-b}	
UMTS 1750	2.4 GHz WLAN MIMO	1.159	0.360	1.519	165.77	0.01	1
UMTS 1750	5 GHz WLAN MIMO at 16 dBm	1.159	0.132	1.291	170.75	0.01	
2.4 GHz WLAN MIMO	5 GHz WLAN MIMO at 16 dBm	0.360	0.132	0.492	51.08	0.01	
LTE Band 7	2.4 GHz WLAN MIMO	1.187	0.360	1.547	163.46	0.01	2
LTE Band 7	5 GHz WLAN MIMO at 16 dBm	1.187	0.132	1.319	167.26	0.01	
2.4 GHz WLAN MIMO	5 GHz WLAN MIMO at 16 dBm	0.360	0.132	0.492	51.08	0.01	3
LTE Band 41	2.4 GHz WLAN MIMO	1.130	0.360	1.49	159.78	0.01	
LTE Band 41	5 GHz WLAN MIMO at 16 dBm	1.130	0.132	1.262	163.48	0.01	
2.4 GHz WLAN MIMO	5 GHz WLAN MIMO at 16 dBm	0.360	0.132	0.492	51.08	0.01	4
UMTS 1750	2.4 GHz Bluetooth Ant 1	1.159	0.198	1.357	181.29	0.01	
UMTS 1750	2.4 GHz WLAN Ant 2	1.159	0.193	1.352	175.76	0.01	
UMTS 1750	5 GHz WLAN MIMO at 16 dBm	1.159	0.132	1.291	170.75	0.01	5
2.4 GHz Bluetooth Ant 1	2.4 GHz WLAN Ant 2	0.198	0.193	0.391	18.97	0.01	
2.4 GHz Bluetooth Ant 1	5 GHz WLAN MIMO at 16 dBm	0.198	0.132	0.33	29.63	0.01	
2.4 GHz WLAN Ant 2	5 GHz WLAN MIMO at 16 dBm	0.193	0.132	0.325	45.07	0.00	6
LTE Band 7	2.4 GHz Bluetooth Ant 1	1.187	0.198	1.385	178.38	0.01	
LTE Band 7	2.4 GHz WLAN Ant 2	1.187	0.193	1.38	173.25	0.01	
LTE Band 7	5 GHz WLAN MIMO at 16 dBm	1.187	0.132	1.319	167.26	0.01	6
2.4 GHz Bluetooth Ant 1	2.4 GHz WLAN Ant 2	0.198	0.193	0.391	18.97	0.01	
2.4 GHz Bluetooth Ant 1	5 GHz WLAN MIMO at 16 dBm	0.198	0.132	0.33	29.63	0.01	
2.4 GHz WLAN Ant 2	5 GHz WLAN MIMO at 16 dBm	0.193	0.132	0.325	45.07	0.00	6
LTE Band 41	2.4 GHz Bluetooth Ant 1	1.130	0.198	1.328	174.60	0.01	
LTE Band 41	2.4 GHz WLAN Ant 2	1.130	0.193	1.323	169.53	0.01	
LTE Band 41	5 GHz WLAN MIMO at 16 dBm	1.130	0.132	1.262	163.48	0.01	6
2.4 GHz Bluetooth Ant 1	2.4 GHz WLAN Ant 2	0.198	0.193	0.391	18.97	0.01	
2.4 GHz Bluetooth Ant 1	5 GHz WLAN MIMO at 16 dBm	0.198	0.132	0.33	29.63	0.01	
2.4 GHz WLAN Ant 2	5 GHz WLAN MIMO at 16 dBm	0.193	0.132	0.325	45.07	0.00	6

FCC ID: A3LSMF916U	 PCTEST Proud to be part of Samsung	SAR EVALUATION REPORT		Approved by: Quality Manager
Document S/N: 1M2005200087-01-R2-A3L	Test Dates: 06/28/20-08/24/20	DUT Type: Portable Handset		Page 246 of 267

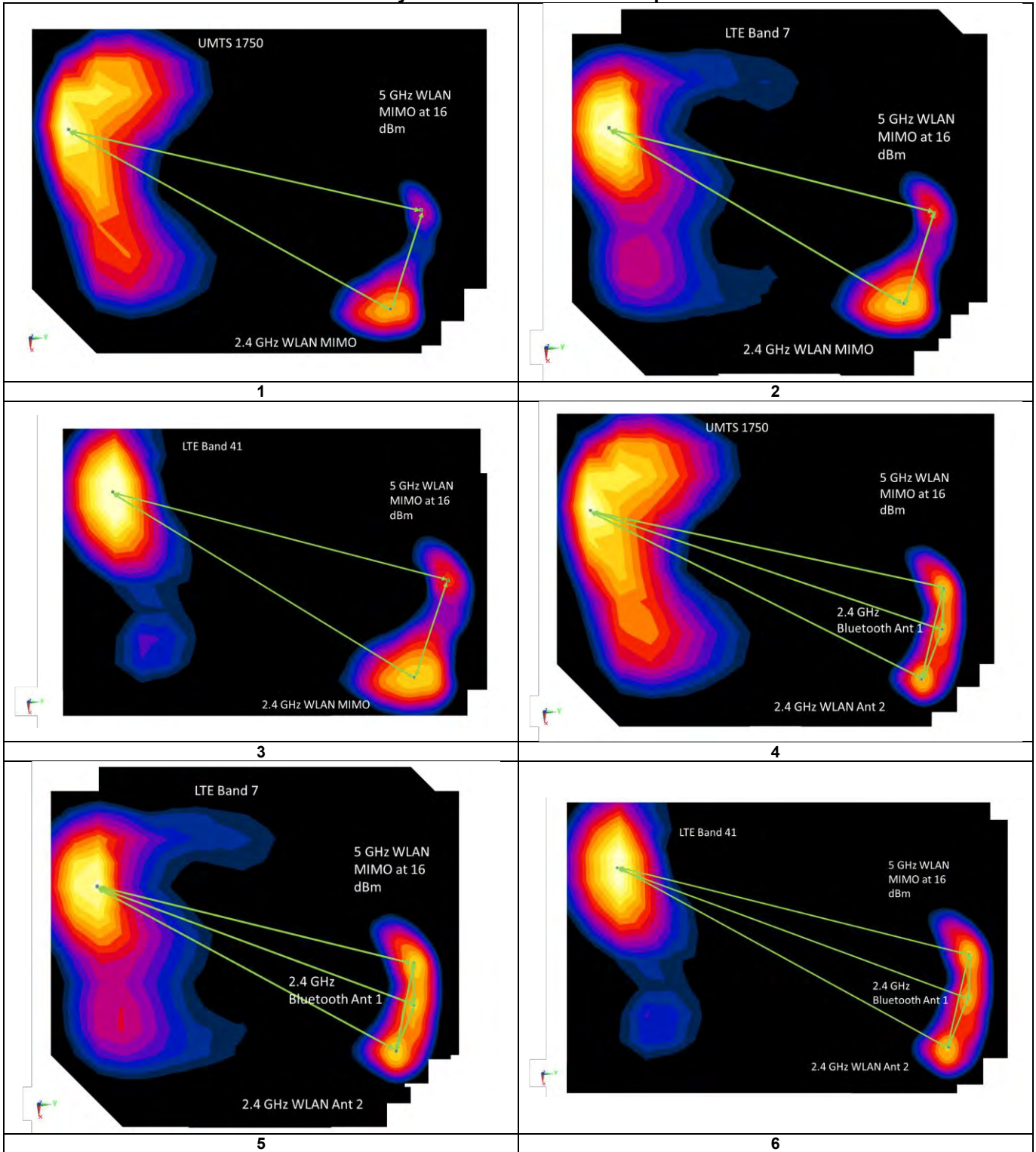
**Table 12-39
Back Side UMPC Body SAR to Peak Location Separation Ratio Plots**



FCC ID: A3LSMF916U	 <small>Proud to be part of Samsung</small>	SAR EVALUATION REPORT		Approved by: Quality Manager
Document S/N: 1M2005200087-01-R2.A3L	Test Dates: 06/28/20-08/24/20	DUT Type: Portable Handset		Page 247 of 267



12.1.2 Back Side UMPC Extremity SPLSR Evaluation and Analysis

Table 12-40
Peak SAR Locations for Back Side UMPC Extremity

Mode/Band	x (mm)	y (mm)
2.4 GHz WLAN Ant 2	26.20	83.80
5 GHz WLAN MIMO	-16.00	77.00
5 GHz WLAN MIMO at 16 dBm	-16.00	80.00
2.4 GHz Bluetooth Ant 1	-20.20	58.80
UMTS 850	-78.50	-77.80
LTE Band 5 (Cell)	-83.50	-77.00
LTE Band 41	-58.60	-80.40



Table 12-41
Back Side UMPC Extremity SAR to Peak Location Separation Ratio Calculations

Antenna Pair		Standalone SAR (W/kg)		Standalone SAR Sum (W/kg)	Peak SAR Separation Distance (mm)	SPLS Ratio	Plot Number
Ant "a"	Ant "b"	a	b	a+b	D_{a-b}	$(a+b)^{1.5}/D_{a-b}$	
UMTS 850	5 GHz WLAN MIMO	2.386	1.813	4.199	166.94	0.05	1
LTE Band 5 (Cell)	5 GHz WLAN MIMO	2.367	1.813	4.18	168.14	0.05	2
LTE Band 41	5 GHz WLAN MIMO	2.520	1.813	4.333	163.06	0.06	3
UMTS 850	2.4 GHz Bluetooth Ant 1	2.386	0.481	2.867	148.52	0.03	4
UMTS 850	2.4 GHz WLAN Ant 2	2.386	0.632	3.018	192.55	0.03	
UMTS 850	5 GHz WLAN MIMO at 16 dBm	2.386	0.593	2.979	169.73	0.03	
2.4 GHz Bluetooth Ant 1	2.4 GHz WLAN Ant 2	0.481	0.632	1.113	52.71	0.02	
2.4 GHz Bluetooth Ant 1	5 GHz WLAN MIMO at 16 dBm	0.481	0.593	1.074	21.61	0.05	
2.4 GHz WLAN Ant 2	5 GHz WLAN MIMO at 16 dBm	0.632	0.593	1.225	42.37	0.03	
LTE Band 5 (Cell)	2.4 GHz Bluetooth Ant 1	2.367	0.481	2.848	149.83	0.03	5
LTE Band 5 (Cell)	2.4 GHz WLAN Ant 2	2.367	0.632	2.999	194.66	0.03	
LTE Band 5 (Cell)	5 GHz WLAN MIMO at 16 dBm	2.367	0.593	2.96	170.90	0.03	
2.4 GHz Bluetooth Ant 1	2.4 GHz WLAN Ant 2	0.481	0.632	1.113	52.71	0.02	
2.4 GHz Bluetooth Ant 1	5 GHz WLAN MIMO at 16 dBm	0.481	0.593	1.074	21.61	0.05	
2.4 GHz WLAN Ant 2	5 GHz WLAN MIMO at 16 dBm	0.632	0.593	1.225	42.37	0.03	
LTE Band 41	2.4 GHz Bluetooth Ant 1	2.520	0.481	3.001	144.40	0.04	6
LTE Band 41	2.4 GHz WLAN Ant 2	2.520	0.632	3.152	184.80	0.03	
LTE Band 41	5 GHz WLAN MIMO at 16 dBm	2.520	0.593	3.113	165.96	0.03	
2.4 GHz Bluetooth Ant 1	2.4 GHz WLAN Ant 2	0.481	0.632	1.113	52.71	0.02	
2.4 GHz Bluetooth Ant 1	5 GHz WLAN MIMO at 16 dBm	0.481	0.593	1.074	21.61	0.05	
2.4 GHz WLAN Ant 2	5 GHz WLAN MIMO at 16 dBm	0.632	0.593	1.225	42.37	0.03	

FCC ID: A3LSMF916U	 PCTEST <small>Proud to be part of Samsung</small>	SAR EVALUATION REPORT		Approved by: Quality Manager
Document S/N: 1M2005200087-01-R2.A3L	Test Dates: 06/28/20-08/24/20	DUT Type: Portable Handset		Page 248 of 267

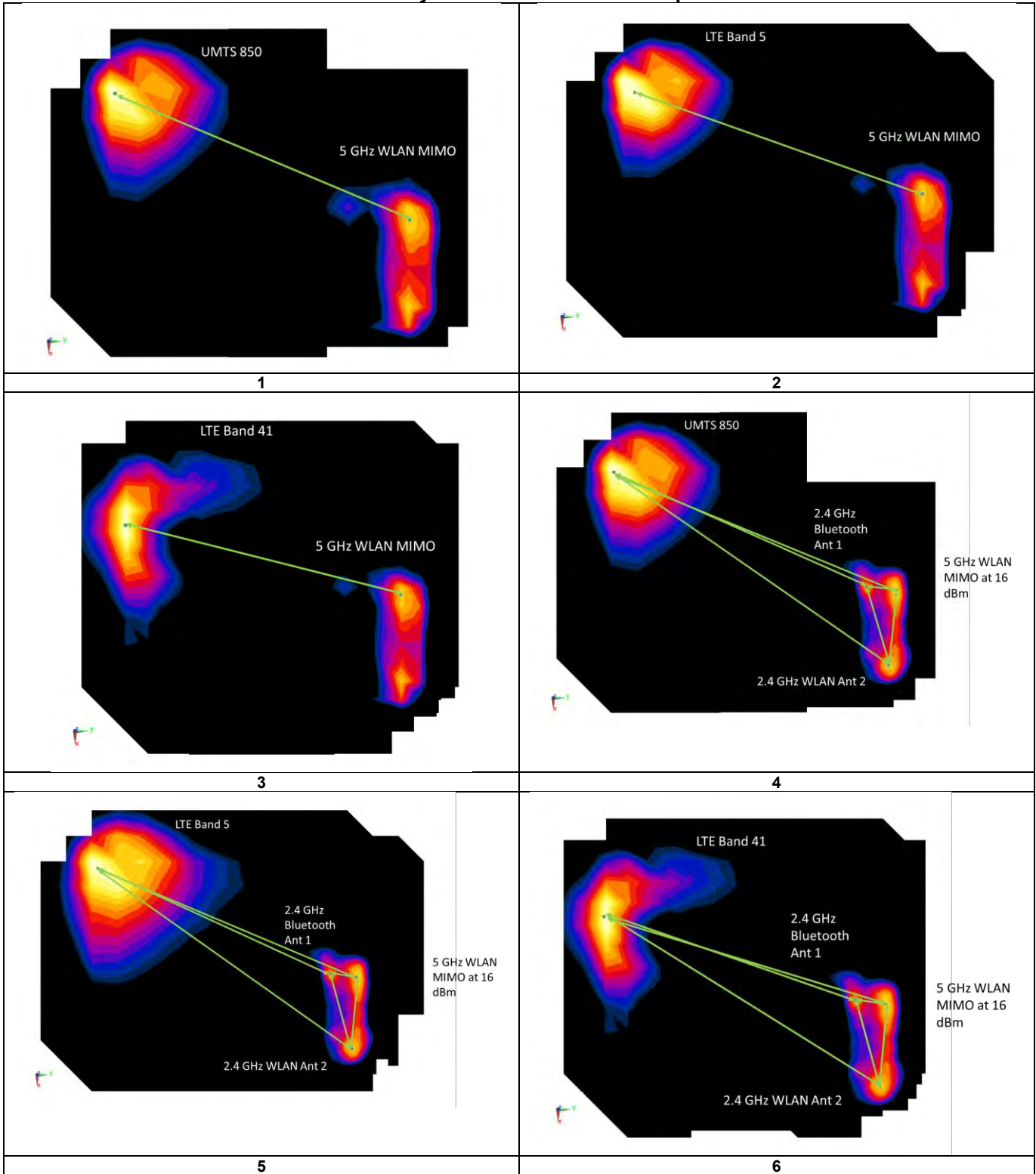

**Table 12-42
Back Side UMPC Extremity SAR to Peak Location Separation Ratio Plots**



FCC ID: A3LSMF916U	 PCTEST <small>Prove it to be part of Samsung</small>	SAR EVALUATION REPORT		Approved by: Quality Manager
Document S/N: 1M2005200087-01-R2.A3L	Test Dates: 06/28/20-08/24/20	DUT Type: Portable Handset		Page 249 of 267

12.2 Simultaneous Transmission Conclusion

The above numerical summed SAR results and SPLSR analysis are sufficient to determine that simultaneous transmission cases will not exceed the SAR limit and therefore no measured volumetric simultaneous SAR summation is required per FCC KDB Publication 447498 D01v06 and IEEE 1528- 2013 Section 6.3.4.1.

FCC ID: A3LSMF916U	 SAR EVALUATION REPORT 		Approved by: Quality Manager
Document S/N: 1M2005200087-01-R2.A3L	Test Dates: 06/28/20-08/24/20	DUT Type: Portable Handset	Page 250 of 267

13 SAR MEASUREMENT VARIABILITY

13.1 Measurement Variability

Per FCC KDB Publication 865664 D01v01r04, SAR measurement variability was assessed for each frequency band, which was determined by the SAR probe calibration point and tissue-equivalent medium used for the device measurements. When both head and body tissue-equivalent media were required for SAR measurements in a frequency band, the variability measurement procedures were applied to the tissue medium with the highest measured SAR, using the highest measured SAR configuration for that tissue-equivalent medium. These additional measurements were repeated after the completion of all measurements requiring the same head or body tissue-equivalent medium in a frequency band. The test device was returned to ambient conditions (normal room temperature) with the battery fully charged before it was re-mounted on the device holder for the repeated measurement(s) to minimize any unexpected variations in the repeated results.

SAR Measurement Variability was assessed using the following procedures for each frequency band:

- 1) When the original highest measured SAR is ≥ 0.80 W/kg, the measurement was repeated once.
- 2) A second repeated measurement was performed only if the ratio of largest to smallest SAR for the original and first repeated measurements was > 1.20 or when the original or repeated measurement was ≥ 1.45 W/kg (~ 10% from the 1g SAR limit).
- 3) A third repeated measurement was performed only if the original, first or second repeated measurement was ≥ 1.5 W/kg and the ratio of largest to smallest SAR for the original, first and second repeated measurements is > 1.20 .
- 4) Repeated measurements are not required when the original highest measured SAR is < 0.80 W/kg
- 5) When 10g SAR measurement is considered, a factor of 2.5 is applied to the thresholds above.

**Table 13-1
1g Body/UMPC SAR Measurement Variability Results**

BODY VARIABILITY RESULTS														
Band	FREQUENCY		Mode	DUT Configuration	Service	Side	Spacing	Measured SAR (1g)	1st Repeated SAR (1g)	Ratio	2nd Repeated SAR (1g)	Ratio	3rd Repeated SAR (1g)	Ratio
	MHz	Ch.						(W/kg)	(W/kg)		(W/kg)		(W/kg)	
1750	1770.00	354000	NR Band n66 (AWS), 20 MHz Bandwidth	Closed -Hotspot	DFT-S-OFDM QPSK, 50 RB, 0 RB Offset	bottom	10 mm	0.883	0.810	1.09	N/A	N/A	N/A	N/A
1900	1852.40	9262	UMTS 1900	Open - UMPC Body	RMC	bottom	16 mm	0.932	0.921	1.01	N/A	N/A	N/A	N/A
2450	2510.00	20850	LTE Band 7, 20 MHz Bandwidth	Open - UMPC Body	QPSK, 100 RB, 0 RB Offset	back	12 mm	0.994	0.937	1.06	N/A	N/A	N/A	N/A
2600	2560.00	20850	LTE Band 7, 20 MHz Bandwidth	Open - UMPC Body	QPSK, 50 RB, 25 RB Offset	back	12 mm	1.100	1.000	1.10	N/A	N/A	N/A	N/A
ANSI / IEEE C95.1 1992 - SAFETY LIMIT Spatial Peak Uncontrolled Exposure/General Population							Body 1.6 W/kg (mW/g) averaged over 1 gram							





FCC ID: A3LSMF916U	 PCTEST <small>Prove it to be part of Samsung</small>	SAR EVALUATION REPORT		Approved by: Quality Manager
Document S/N: 1M2005200087-01-R2.A3L	Test Dates: 06/28/20-08/24/20	DUT Type: Portable Handset	Page 251 of 267	

Table 13-2
10g Phablet/UMPC SAR Measurement Variability Results

PHABLET VARIABILITY RESULTS															
Band	FREQUENCY		Mode	DUT Configuration	Service	Data Rate (Mbps)	Side	Spacing	Measured SAR (10g)	1st Repeated SAR (10g)	Ratio	2nd Repeated SAR (10g)	Ratio	3rd Repeated SAR (10g)	Ratio
	MHz	Ch.							(W/kg)	(W/kg)		(W/kg)		(W/kg)	
1900	1907.60	9538	UMTS 1900	Open - UMPC Extremity	RMC	N/A	right	0 mm	2.620	2.530	1.04	N/A	N/A	N/A	N/A
1750	1770.00	354000	NR Band n66 (AWS), 20 MHz Bandwidth	Open - UMPC Extremity	DFT-S-OFDM QPSK, 100 RB, 0 RB Offset	N/A	bottom	0 mm	3.000	2.970	1.01	N/A	N/A	N/A	N/A
2300	2310.00	27710	LTE Band 30, 10 MHz Bandwidth	Closed - Phablet	QPSK, 25 RB, 12 RB Offset	N/A	bottom	0 mm	2.210	2.200	1.00	N/A	N/A	N/A	N/A
2450	2510.00	20850	LTE Band 7, 20 MHz Bandwidth	Closed - Phablet	QPSK, 50 RB, 25 RB Offset	N/A	bottom	0 mm	2.150	2.150	1.00	N/A	N/A	N/A	N/A
2600	PCC: 2680.00 SCC: 2660.20	PCC: 41490 SCC: 41292	LTE Band 41, 20 MHz Bandwidth, PC3, ULCA	Closed - Phablet	PCC/SCC: QPSK, 100 RB, 0 RB Offset	N/A	bottom	0 mm	2.590	2.560	1.01	N/A	N/A	N/A	N/A
5600	5620.00	124	802.11n, 20 MHz Bandwidth	Closed - Phablet	OFDM, MIMO	13	front	0 mm	2.230	2.120	1.05	N/A	N/A	N/A	N/A
5750	5720.00	144	802.11n, 20 MHz Bandwidth	Closed - Phablet	OFDM, MIMO	13	front	0 mm	2.380	2.350	1.01	N/A	N/A	N/A	N/A
ANSI / IEEE C95.1 1992 - SAFETY LIMIT Spatial Peak Uncontrolled Exposure/General Population								Phablet 4.0 W/kg (mW/g) averaged over 10 grams							

13.2 Measurement Uncertainty

The measured SAR was <1.5 W/kg for 1g and <3.75 W/kg for 10g for all frequency bands. Therefore, per KDB Publication 865664 D01v01r04, the extended measurement uncertainty analysis per IEEE 1528-2013 was not required.

FCC ID: A3LSMF916U	 <small>Proud to be part of Samsung</small>	SAR EVALUATION REPORT		Approved by: Quality Manager
Document S/N: 1M2005200087-01-R2.A3L	Test Dates: 06/28/20-08/24/20	DUT Type: Portable Handset	Page 252 of 267	

14 ADDITIONAL TESTING PER FCC GUIDANCE

14.1 Tuner Testing

Per April 2019 TCB Workshop Notes, the following test procedures were followed to demonstrate that the SAR results in Section 11 represented the appropriate SAR test conditions. For bands with dynamic tuning implemented, SAR was measured according to the required FCC SAR test procedures with the dynamic tuner active to allow the device to automatically tune to the antenna state for the respective RF exposure test configurations. Additional single point SAR time-sweep measurements were evaluated for other tuner states to determine that the other tuner configurations would result in equivalent or lower SAR values. The additional tuner hardware has no influence on the antenna characteristics, other than impedance matching.

To evaluate all the tuner states, the 152 tuner states were divided among the aggregate band, mode and exposure combinations. Single point time-sweep measurements were performed at the peak SAR location determined by the zoom scan of the configuration with the highest reported SAR for each combination. The tuner state was able to be established remotely so that the device was not moved for the entire series of single point SAR for the tuner states in each combination. The SAR probe remained stationary at the same position throughout the entire series of single point measurements for each combination. When the single point SAR or 1g SAR was > 1.2 W/kg for a particular band/mode/exposure condition, point SAR measurements were made for all 152 states.

The operational description contains more information about the design and implementation of the dynamic antenna tuning.



FCC ID: A3LSMF916U	 PCTEST <small>Praxis to be part of Samsung</small>	SAR EVALUATION REPORT		Approved by: Quality Manager
Document S/N: 1M2005200087-01-R2.A3L	Test Dates: 06/28/20-08/24/20	DUT Type: Portable Handset	Page 253 of 267	

Table 14-1
UMTS/CDMA Supplemental Head SAR Data

Supplemental Head SAR Data					
CDMA BC10		CDMA BC0		UMTS B5	
EVDO		EVDO		RMC	
Test Position	Left Cheek	Test Position	Right Cheek	Test Position	Right Cheek
Frequency (MHz)	820.1	Frequency (MHz)	836.52	Frequency (MHz)	836.6
Channel	564	Channel	384	Channel	4183
Measured 1g SAR (W/kg)	0.205	Measured 1g SAR (W/kg)	0.228	Measured 1g SAR (W/kg)	0.207
Average Value of Time Sweep (W/kg)		Average Value of Time Sweep (W/kg)		Average Value of Time Sweep (W/kg)	
Auto-tune (State 1)	0.238	Auto-tune (State 1)	0.298	Auto-tune (State 1)	0.274
Default (State 144)	0.240	Default (State 144)	0.308	Default (State 0)	0.280
State 1	0.227	State 1	0.291	State 1	0.267
State 15	0.113	State 3	0.263	State 6	0.096
State 17	0.032	State 15	0.110	State 11	0.259
State 24	0.118	State 21	0.262	State 14	0.198
State 26	0.036	State 23	0.204	State 18	0.251
State 31	0.170	State 34	0.040	State 29	0.222
State 45	0.206	State 40	0.202	State 36	0.280
State 55	0.228	State 47	0.271	State 43	0.047
State 72	0.178	State 61	0.051	State 56	0.256
State 76	0.118	State 92	0.225	State 74	0.180
State 89	0.021	State 118	0.241	State 123	0.055
State 117	0.208	State 129	0.173	State 131	0.113
State 140	0.084	State 140	0.085	State 137	0.193
State 144	0.240	State 146	0.277	State 145	0.243

Table 14-2
LTE Supplemental Head SAR Data

Supplemental Head SAR Data					
LTE B71		LTE B12		LTE B13	
QPSK, 20MHz Bandwidth, 1 RB, 0 RB Offset		QPSK, 10 MHz Bandwidth, 1 RB, 49 RB Offset		QPSK, 10 MHz Bandwidth, 1 RB, 49 RB Offset	
Test Position	Right Cheek	Test Position	Right Cheek	Test Position	Right Cheek
Frequency (MHz)	680.5	Frequency (MHz)	707.5	Frequency (MHz)	782.0
Channel	133297	Channel	23095	Channel	23230
Measured 1g SAR (W/kg)	0.107	Measured 1g SAR (W/kg)	0.092	Measured 1g SAR (W/kg)	0.194
Average Value of Time Sweep (W/kg)		Average Value of Time Sweep (W/kg)		Average Value of Time Sweep (W/kg)	
Auto-tune (State 9)	0.136	Auto-tune (State 27)	0.120	Auto-tune (State 10)	0.248
Default (State 29)	0.119	Default (State 145)	0.119	Default (State 9)	0.184
State 2	0.057	State 5	0.052	State 8	0.007
State 9	0.122	State 27	0.112	State 10	0.241
State 13	0.077	State 30	0.122	State 20	0.148
State 16	0.011	State 37	0.091	State 26	0.008
State 25	0.011	State 39	0.071	State 35	0.008
State 33	0.044	State 60	0.048	State 42	0.030
State 38	0.060	State 72	0.081	State 44	0.006
State 46	0.115	State 87	0.039	State 50	0.082
State 57	0.085	State 91	0.056	State 64	0.155
State 73	0.042	State 93	0.085	State 80	0.002
State 114	0.004	State 112	0.032	State 101	0.110
State 125	0.003	State 121	0.081	State 116	0.002
State 134	0.002	State 142	0.017	State 126	0.178
State 147	0.125	State 151	0.115	State 149	0.174



FCC ID: A3LSMF916U	 PCTEST <small> Proud to be part of Samsung</small>	SAR EVALUATION REPORT		Approved by: Quality Manager
Document S/N: 1M2005200087-01-R2.A3L	Test Dates: 06/28/20-08/24/20	DUT Type: Portable Handset		Page 254 of 267

Table 14-3
LTE Supplemental Head SAR Data Continued

Supplemental Head SAR Data					
LTE B14		LTE B26		LTE B5	
QPSK, 10 MHz Bandwidth, 1 RB, 0 RB Offset		QPSK, 15 MHz Bandwidth, 1 RB, 36 RB Offset		QPSK, 10 MHz Bandwidth, 1 RB, 0 RB Offset	
Test Position	Right Cheek	Test Position	Right Cheek	Test Position	Right Cheek
Frequency (MHz)	793.0	Frequency (MHz)	831.5	Frequency (MHz)	836.5
Channel	23330	Channel	26865	Channel	20525
Measured 1g SAR (W/kg)	0.181	Measured 1g SAR (W/kg)	0.218	Measured 1g SAR (W/kg)	0.232
Average Value of Time Sweep (W/kg)		Average Value of Time Sweep (W/kg)		Average Value of Time Sweep (W/kg)	
Auto-tune (State 9)	0.230	Auto-tune (State 36)	0.281	Auto-tune (State 0)	0.304
Default (State 9)	0.228	Default (State 144)	0.300	Default (State 144)	0.298
State 7	0.024	State 3	0.259	State 0	0.301
State 9	0.228	State 36	0.298	State 4	0.242
State 12	0.203	State 70	0.034	State 22	0.268
State 80	0.004	State 78	0.050	State 31	0.215
State 94	0.112	State 89	0.018	State 41	0.188
State 96	0.041	State 102	0.165	State 43	0.064
State 106	0.025	State 104	0.100	State 49	0.260
State 113	0.046	State 107	0.015	State 68	0.167
State 125	0.013	State 114	0.044	State 107	0.018
State 132	0.036	State 120	0.180	State 115	0.031
State 134	0.011	State 124	0.025	State 127	0.244
State 137	0.168	State 128	0.205	State 136	0.226
State 142	0.022	State 142	0.022	State 143	0.016
State 147	0.226	State 148	0.209	State 149	0.283

Table 14-4
UMTS/CDMA Supplemental Body SAR Data

Supplemental Body SAR Data					
CDMA BC10		CDMA BC0		UMTS B5	
EVDO		EVDO		RMC	
Test Position	Back (UMPC)	Test Position	Back (Closed)	Test Position	Back (UMPC)
Spacing	10 mm	Spacing	10 mm	Spacing	10 mm
Frequency (MHz)	820.1	Frequency (MHz)	836.52	Frequency (MHz)	846.6
Channel	564	Channel	384	Channel	4233
Measured 1g SAR (W/kg)	0.586	Measured 1g SAR (W/kg)	0.686	Measured 1g SAR (W/kg)	0.705
Average Value of Time Sweep (W/kg)		Average Value of Time Sweep (W/kg)		Average Value of Time Sweep (W/kg)	
Auto-tune (State 11)	0.863	Auto-tune (State 0)	1.062	Auto-tune (State 0)	1.132
Default (State 144)	0.049	Default (State 144)	1.072	Default (State 118)	0.868
State 4	0.594	State 0	1.072	State 0	1.125
State 6	0.255	State 9	0.951	State 7	0.185
State 11	0.863	State 24	0.376	State 19	1.072
State 12	0.83	State 48	0.915	State 45	1.076
State 49	0.77	State 58	0.845	State 55	1.049
State 69	0.31	State 71	0.085	State 70	0.171
State 82	0.725	State 82	0.877	State 76	0.483
State 86	0.449	State 89	0.071	State 78	0.175
State 97	0.143	State 94	0.574	State 81	1.05
State 103	0.563	State 100	0.8	State 98	0.091
State 116	0.045	State 113	0.291	State 106	0.132
State 118	0.697	State 119	0.796	State 132	0.215
State 135	0.782	State 128	0.766	State 138	0.665
State 150	0.58	State 144	1.072	State 151	1.001





FCC ID: A3LSMF916U	 PCTEST <small>Proud to be part of Samsung</small>	SAR EVALUATION REPORT		Approved by: Quality Manager
Document S/N: 1M2005200087-01-R2-A3L	Test Dates: 06/28/20-08/24/20	DUT Type: Portable Handset		Page 255 of 267

Table 14-5
LTE Supplemental Body SAR Data

Supplemental Body SAR Data					
LTE B71		LTE B12		LTE B13	
QPSK, 20 MHz Bandwidth, 1 RB, 0 RB Offset		QPSK, 10 MHz Bandwidth, 1 RB, 49 RB Offset		QPSK, 10 MHz Bandwidth, 1 RB, 49 RB Offset	
Test Position	Back (UMPC)	Test Position	Back (UMPC)	Test Position	Back (Closed)
Spacing	10 mm	Spacing	10 mm	Spacing	10 mm
Frequency (MHz)	680.5	Frequency (MHz)	707.5	Frequency (MHz)	782.0
Channel	133297	Channel	23095	Channel	23230
Measured 1g SAR (W/kg)	0.505	Measured 1g SAR (W/kg)	0.388	Measured 1g SAR (W/kg)	0.535
Average Value of Time Sweep (W/kg)		Average Value of Time Sweep (W/kg)		Average Value of Time Sweep (W/kg)	
Auto-tune (State 9)	0.858	Auto-tune (State 9)	0.702	Auto-tune (State 10)	0.795
Default (State 29)	0.751	Default (State 145)	0.684	Default (State 9)	0.659
State 9	0.812	State 9	0.730	State 10	0.780
State 10	0.709	State 28	0.726	State 32	0.318
State 51	0.176	State 52	0.071	State 54	0.652
State 53	0.056	State 59	0.294	State 62	0.039
State 74	0.241	State 69	0.174	State 65	0.538
State 77	0.106	State 75	0.223	State 67	0.414
State 86	0.256	State 96	0.081	State 79	0.035
State 97	0.061	State 99	0.72	State 83	0.421
State 102	0.564	State 104	0.245	State 84	0.335
State 105	0.188	State 117	0.636	State 103	0.278
State 111	0.176	State 124	0.043	State 109	0.393
State 122	0.24	State 130	0.245	State 120	0.314
State 133	0.057	State 139	0.328	State 141	0.082
State 148	0.426	State 150	0.476	State 146	0.654

Table 14-6
LTE Supplemental Body SAR Data Continued

Supplemental Body SAR Data					
LTE B14		LTE B26		LTE B5	
QPSK, 10 MHz Bandwidth, 1RB, 0 RB Offset		QPSK, 15 MHz Bandwidth, 1 RB, 36 RB Offset		QPSK, 10 MHz Bandwidth, 1 RB, 0 RB Offset	
Test Position	Back (UMPC)	Test Position	Back (UMPC)	Test Position	Back (UMPC)
Spacing	10 mm	Spacing	10 mm	Spacing	10 mm
Frequency (MHz)	793.0	Frequency (MHz)	831.5	Frequency (MHz)	836.5
Channel	23330	Channel	26865	Channel	20525
Measured 1g SAR (W/kg)	0.528	Measured 1g SAR (W/kg)	0.619	Measured 1g SAR (W/kg)	0.718
Average Value of Time Sweep (W/kg)		Average Value of Time Sweep (W/kg)		Average Value of Time Sweep (W/kg)	
Auto-tune (State 9)	0.900	Auto-tune (State 0)	1.066	Auto-tune (State 0)	1.070
Default (State 9)	0.942	Default (State 108)	0.845	Default (State 108)	0.886
State 9	0.942	State 0	1.074	State 0	1.150
State 71	0.078	State 28	0.808	State 12	1.126
State 79	0.054	State 65	0.812	State 17	0.231
State 81	0.893	State 73	0.639	State 27	0.756
State 85	0.45	State 83	0.902	State 63	0.807
State 90	0.865	State 88	0.187	State 66	0.87
State 93	0.481	State 92	0.855	State 80	0.099
State 99	0.894	State 98	0.12	State 85	0.888
State 108	0.731	State 105	0.208	State 88	0.226
State 122	0.294	State 109	0.595	State 90	1.003
State 127	0.615	State 121	0.724	State 95	0.676
State 133	0.073	State 131	0.521	State 110	0.582
State 141	0.146	State 143	0.073	State 135	0.964
State 145	0.914	State 148	0.778	State 150	0.737

FCC ID: A3LSMF916U	 PCTEST <small> Proud to be part of Samsung</small>	SAR EVALUATION REPORT		Approved by: Quality Manager
Document S/N: 1M2005200087-01-R2-A3L	Test Dates: 06/28/20-08/24/20	DUT Type: Portable Handset		Page 256 of 267

14.2 LTE Band 41 Power Class 2 and Power Class 3 Linearity

This device supports Power Class 2 and Power Class 3 operations for LTE Band 41. The highest available duty cycle for Power Class 2 operations is 43.3 % using UL-DL configuration 1. Per May 2017 TCB Workshop Notes based on the device behavior, all SAR tests were performed using Power Class 3. SAR with Power Class 2 at the highest power and available duty factor was additionally performed for the Power Class 3 configuration with the highest SAR for each exposure condition. The linearity between the Power Class 2 and Power Class 3 SAR results and the respective frame averaged powers was calculated to determine that the results were linear. When ULCA is active, the linearity between the Power Class 2 with ULCA active and Power Class 3 with ULCA active SAR results and the respective frame averaged powers was calculated to determine that the results were linear. Per May 2017 TCB Workshop, no additional SAR measurements were required since the linearity between power classes was < 10% and all reported SAR values were < 1.4 W/kg for 1g and < 3.5 W/kg for 10g.

Table 14-7
LTE Band 41 Head Linearity Data

	LTE Band 41 PC3	LTE Band 41 PC2
Maximum Allowed Output Power (dBm)	25.0	28.0
Measured Output Power (dBm)	24.14	27.10
Measured SAR (W/kg)	0.045	0.057
Measured Power (mW)	259.42	512.86
Duty Cycle	63.3%	43.3%
Frame Averaged Output Power (mW)	164.21	222.07
% deviation from expected linearity		-5.80%

Figure 14-1
LTE Band 41 Head Linearity

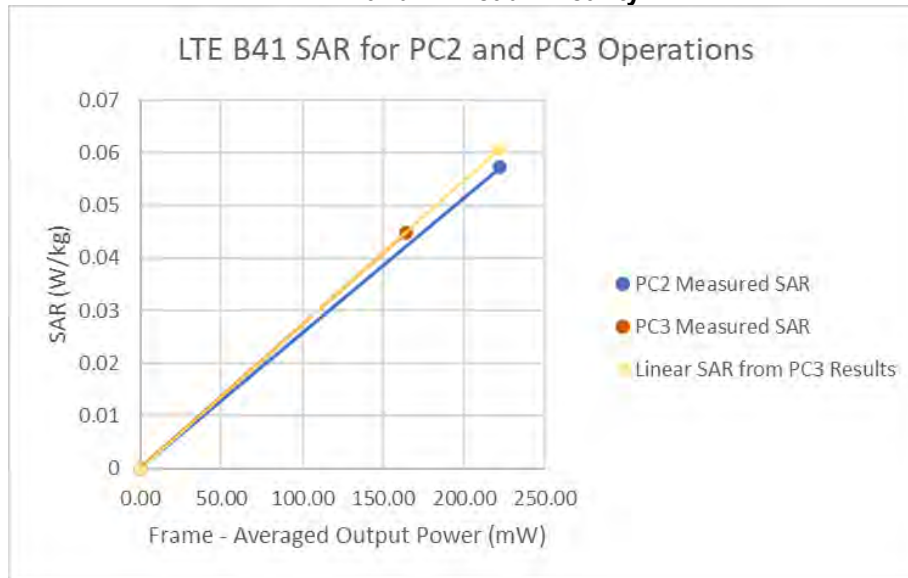



FCC ID: A3LSMF916U	 PCTEST Proud to be part of Samsung	SAR EVALUATION REPORT		Approved by: Quality Manager
Document S/N: 1M2005200087-01-R2.A3L	Test Dates: 06/28/20-08/24/20	DUT Type: Portable Handset		Page 257 of 267

Table 14-8
LTE Band 41 ULCA Head Linearity Data

	LTE Band 41 PC3	LTE Band 41 PC2
Maximum Allowed Output Power (dBm)	25.0	28.0
Measured Output Power (dBm)	24.16	27.81
Measured SAR (W/kg)	0.043	0.064
Measured Power (mW)	260.62	603.95
Duty Cycle	63.3%	43.3%
Frame Averaged Output Power (mW)	164.97	261.51
% deviation from expected linearity		-6.84%

Figure 14-2
LTE Band 41 ULCA Head Linearity



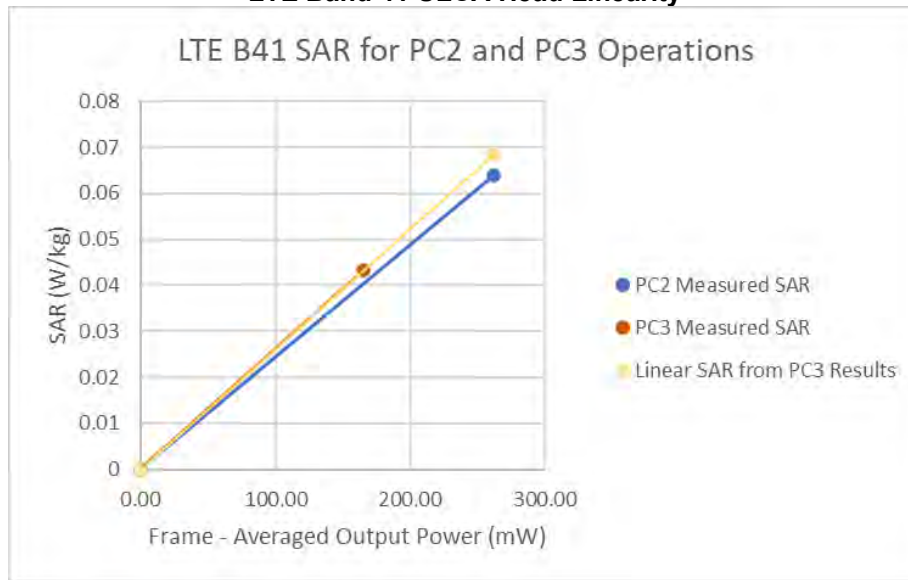

FCC ID: A3LSMF916U	 <small>Proud to be part of Samsung</small>	SAR EVALUATION REPORT		Approved by: Quality Manager
Document S/N: 1M2005200087-01-R2.A3L	Test Dates: 06/28/20-08/24/20	DUT Type: Portable Handset		Page 258 of 267

Table 14-9
LTE Band 41 1g Body Linearity Data

	LTE Band 41 PC3	LTE Band 41 PC2
Maximum Allowed Output Power (dBm)	20.0	21.6
Measured Output Power (dBm)	18.80	20.49
Measured SAR (W/kg)	0.955	0.912
Measured Power (mW)	75.86	111.94
Duty Cycle	63.3%	43.3%
Frame Averaged Output Power (mW)	48.02	48.47
% deviation from expected linearity		-5.40%

Figure 14-3
LTE Band 41 1g Body Linearity



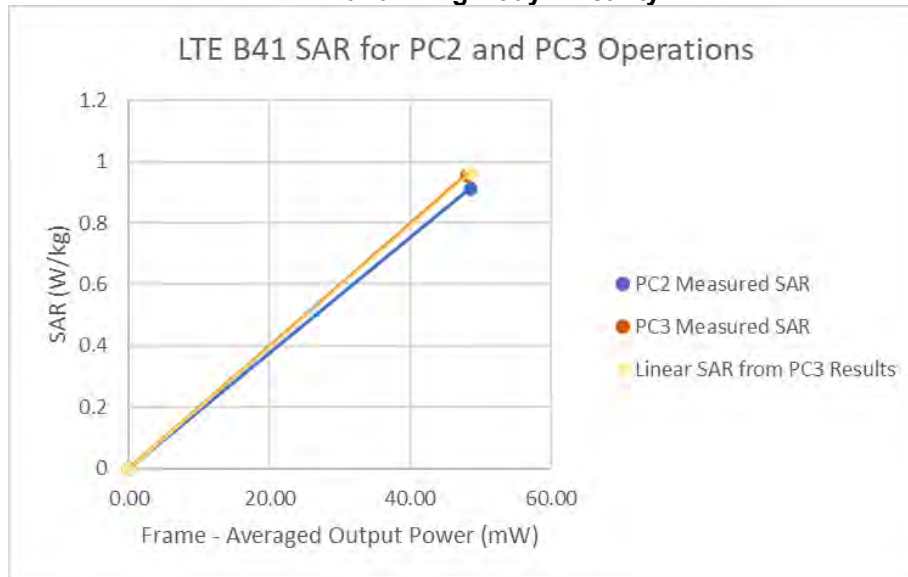

FCC ID: A3LSMF916U	 <small>Proud to be part of Samsung</small>	SAR EVALUATION REPORT		Approved by: Quality Manager
Document S/N: 1M2005200087-01-R2.A3L	Test Dates: 06/28/20-08/24/20	DUT Type: Portable Handset		Page 259 of 267

Table 14-10
LTE Band 41 ULCA 1g Body Linearity Data

	LTE Band 41 PC3	LTE Band 41 PC2
Maximum Allowed Output Power (dBm)	20.0	21.6
Measured Output Power (dBm)	19.30	21.07
Measured SAR (W/kg)	1.020	1.060
Measured Power (mW)	85.11	127.94
Duty Cycle	63.3%	43.3%
Frame Averaged Output Power (mW)	53.88	55.40
% deviation from expected linearity		1.07%

Figure 14-4
LTE Band 41 ULCA 1g Body Linearity



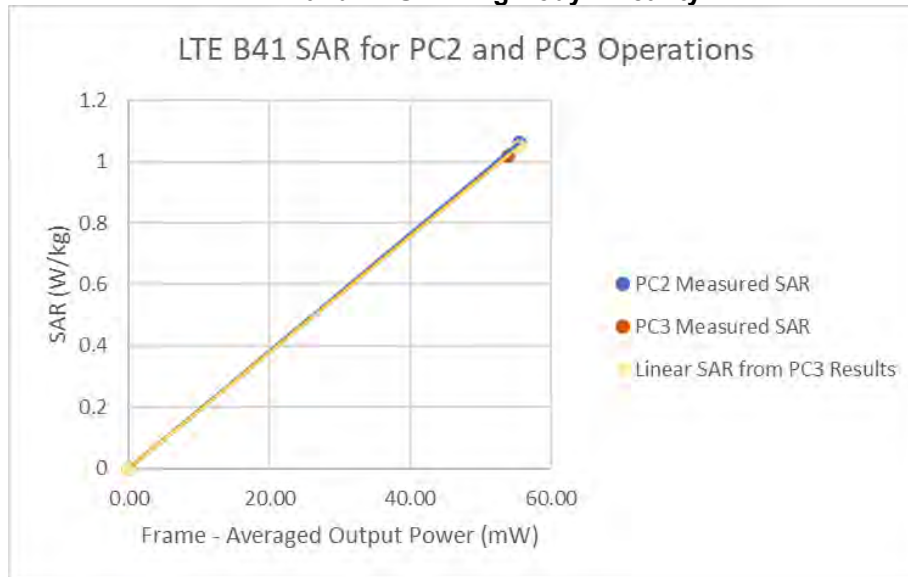

FCC ID: A3LSMF916U	 <small>Result to be part of Samsung</small>	SAR EVALUATION REPORT		Approved by: Quality Manager
Document S/N: 1M2005200087-01-R2.A3L	Test Dates: 06/28/20-08/24/20	DUT Type: Portable Handset		Page 260 of 267

Table 14-11
LTE Band 41 10g Body Linearity Data

	LTE Band 41 PC3	LTE Band 41 PC2
Maximum Allowed Output Power (dBm)	20	21.6
Measured Output Power (dBm)	19.38	20.88
Measured SAR (W/kg)	2.370	2.260
Measured Power (mW)	86.70	122.46
Duty Cycle	63.3%	43.3%
Frame Averaged Output Power (mW)	54.88	53.03
% deviation from expected linearity		-1.31%

Figure 14-5
LTE Band 41 10g Body Linearity



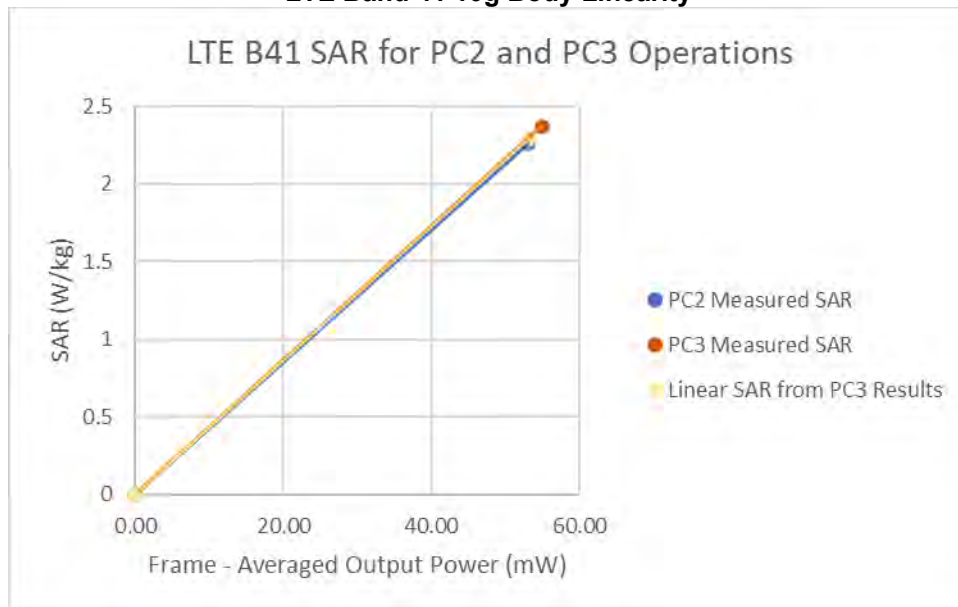



FCC ID: A3LSMF916U	 <small>Proud to be part of Samsung</small>	SAR EVALUATION REPORT		Approved by: Quality Manager
Document S/N: 1M2005200087-01-R2.A3L	Test Dates: 06/28/20-08/24/20	DUT Type: Portable Handset		Page 261 of 267

Table 14-12
LTE Band 41 ULCA 10g Body Linearity Data

	LTE Band 41 PC3	LTE Band 41 PC2
Maximum Allowed Output Power (dBm)	20.0	21.6
Measured Output Power (dBm)	19.56	21.15
Measured SAR (W/kg)	2.590	2.510
Measured Power (mW)	90.36	130.32
Duty Cycle	63.3%	43.3%
Frame Averaged Output Power (mW)	57.20	56.43
% deviation from expected linearity		-1.76%

Figure 14-6
LTE Band 41 ULCA 10g Body Linearity

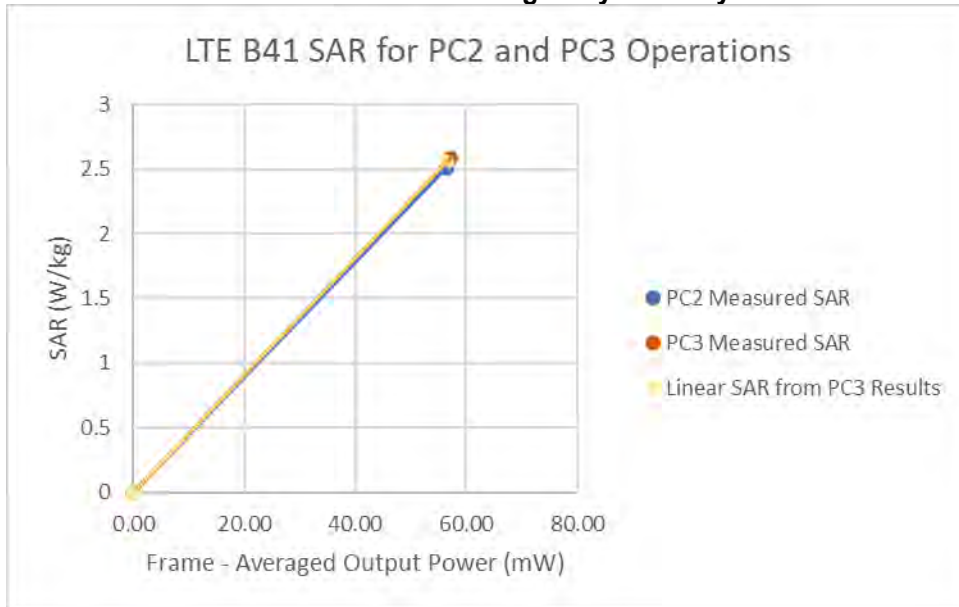



FCC ID: A3LSMF916U	 <small>Proud to be part of Samsung</small>	SAR EVALUATION REPORT		Approved by: Quality Manager
Document S/N: 1M2005200087-01-R2.A3L	Test Dates: 06/28/20-08/24/20	DUT Type: Portable Handset		Page 262 of 267

15 EQUIPMENT LIST



Manufacturer	Model	Description	Cal Date	Cal Interval	Cal Due	Serial Number
Agilent	8753ES	Network Analyzer	3/5/2020	Annual	3/5/2021	MY40001472
Agilent	85033E	3.5mm Standard Calibration Kit	6/6/2020	Annual	6/6/2021	MYS3402352
Agilent	E5515C	8960 Series 10 Wireless Communications Test Set	2/10/2020	Annual	2/10/2021	GB4230325
Agilent	E4438C	ESG Vector Signal Generator	9/30/2019	Annual	9/30/2020	US41460739
Agilent	E4432B	ESG-D Series Signal Generator	7/14/2019	Annual	7/14/2020	US40053896
Agilent	N5182A	MXG Vector Signal Generator	5/13/2020	Annual	5/13/2021	MY47420603
Agilent	8753ES	Network Analyzer	3/5/2020	Annual	3/5/2021	MY40001472
Agilent	8753ES	S-Parameter Network Analyzer	8/26/2019	Annual	8/26/2020	MY40005670
Agilent	8753ES	S-Parameter Vector Network Analyzer	9/19/2019	Annual	9/19/2020	MY40003841
Agilent	E5515C	Wireless Communications Test Set	9/25/2019	Annual	9/25/2020	GB43304278
Agilent	E5515C	Wireless Communications Test Set	1/14/2020	Triennial	1/14/2023	GB43304447
Agilent	N4010A	Wireless Connectivity Test Set	N/A	N/A	N/A	GB44450273
Agilent	N4010A	Wireless Connectivity Test Set	N/A	N/A	N/A	GB46170464
Amplifier Research	150A0DC	Amplifier	CBT	N/A	CBT	350132
Amplifier Research	1551G6	Amplifier	CBT	N/A	CBT	343971
Amplifier Research	1551G6	Amplifier	CBT	N/A	CBT	433978
Anritsu	ML2495A	Power Meter	12/17/2019	Annual	12/17/2020	941001
Anritsu	ML2496A	Power Meter	3/23/2020	Annual	3/23/2021	1351001
Anritsu	MA2411B	Pulse Power Sensor	12/4/2019	Annual	12/4/2020	1126066
Anritsu	MT8821C	Radio Communication Analyzer	11/22/2019	Annual	11/22/2020	6262044715
Anritsu	MT8821C	Radio Communication Analyzer	7/6/2020	Annual	7/6/2021	6262155000
Anritsu	MT8821C	Radio Communication Analyzer	7/3/2020	Annual	7/3/2021	6262155047
Anritsu	MT8821C	Radio Communication Analyzer	5/21/2020	Annual	5/21/2021	6201144419
Anritsu	MA24106A	USB Power Sensor	8/27/2019	Annual	8/27/2020	1827533
Anritsu	MA24106A	USB Power Sensor	6/3/2020	Annual	6/3/2021	2018527
Anritsu	MT8862A	Wireless Connectivity Test Set	8/8/2019	Annual	8/8/2020	6261782395
COMTECH	AR85729-5	Solid State Amplifier	CBT	N/A	CBT	M155400-009
COMTECH	AR85729-5/7598	Solid State Amplifier	CBT	N/A	CBT	M155400-1002
Control Company	4352	Long Stem Thermometer	5/16/2020	Biennial	5/16/2022	200294567
Control Company	4040	Therm./Clock/Humidity Monitor	6/29/2019	Biennial	6/29/2021	192291463
Control Company	4040	Therm./Clock/Humidity Monitor	6/29/2019	Biennial	6/29/2021	192291470
Control Company	4352	Ultra Long Stem Thermometer	11/29/2018	Biennial	11/29/2020	181766816
Control Company	4352	Ultra Long Stem Thermometer	11/29/2018	Biennial	11/29/2020	181766817
Keysight	7210	Dual Directional Coupler	CBT	N/A	CBT	M15518025
Keysight Technologies	N9020A	MXA Signal Analyzer	12/19/2019	Annual	12/19/2020	MY48010233
KEYSIGHT	E4438C	VECTOR SIGNAL GENERATOR	6/22/2020	Annual	6/22/2021	MY45092078
Keysight Technologies	N6705B	DC Power Analyzer	4/27/2019	Biennial	4/27/2021	MYS3004059
Keysight Technologies	AT/N6705B	DC Power Supply	N/A	N/A	N/A	MYS3001315
Keysight Technologies	85033E	Standard Mechanical Calibration Kit (DC to 9GHz, 3.5mm)	7/2/2019	Annual	7/2/2020	MYS3401181
MCL	BW-N6W5+	5dB Attenuator	CBT	N/A	CBT	1139
Mini-Circuits	SLF-240+	Low Pass Filter	CBT	N/A	CBT	8897560902
Mini-Circuits	VLF-600+	Low Pass Filter	CBT	N/A </tr		

Note: 1. Each equipment item was used solely within its respective calibration period.
 2. CBT (Calibrated Before Testing). Prior to testing, the measurement paths containing a cable, amplifier, attenuator, coupler or filter were connected to a calibrated source (i.e. a signal generator) to determine the losses of the measurement path. The power meter offset was then adjusted to compensate for the measurement system losses. This level offset is stored within the power meter before measurements are made. This calibration verification procedure applies to the system verification and output power measurements. The calibrated reading is then taken directly from the power meter after compensation of the losses for all final power measurements.

FCC ID: A3LSMF916U		 SAR EVALUATION REPORT		 Approved by: Quality Manager	
Document S/N:	Test Dates:	DUT Type:	Page 263 of 267		
1M2005200087-01-R2.A3L	06/28/20-08/24/20	Portable Handset			

16 MEASUREMENT UNCERTAINTIES

a	c	d	e= f(d,k)	f	g	h = c x f/e	i = c x g/e	k
Uncertainty Component	Tol. (± %)	Prob. Dist.	Div.	c _i 1gm	c _i 10 gms	1gm u _i (± %)	10gms u _i (± %)	v _i
Measurement System								
Probe Calibration	6.55	N	1	1.0	1.0	6.6	6.6	∞
Axial Isotropy	0.25	N	1	0.7	0.7	0.2	0.2	∞
Hemishperical Isotropy	1.3	N	1	0.7	0.7	0.9	0.9	∞
Boundary Effect	2.0	R	1.73	1.0	1.0	1.2	1.2	∞
Linearity	0.3	N	1	1.0	1.0	0.3	0.3	∞
System Detection Limits	0.25	R	1.73	1.0	1.0	0.1	0.1	∞
Readout Electronics	0.3	N	1	1.0	1.0	0.3	0.3	∞
Response Time	0.8	R	1.73	1.0	1.0	0.5	0.5	∞
Integration Time	2.6	R	1.73	1.0	1.0	1.5	1.5	∞
RF Ambient Conditions - Noise	3.0	R	1.73	1.0	1.0	1.7	1.7	∞
RF Ambient Conditions - Reflections	3.0	R	1.73	1.0	1.0	1.7	1.7	∞
Probe Positioner Mechanical Tolerance	0.4	R	1.73	1.0	1.0	0.2	0.2	∞
Probe Positioning w/ respect to Phantom	6.7	R	1.73	1.0	1.0	3.9	3.9	∞
Extrapolation, Interpolation & Integration algorithms for Max. SAR Evaluation	4.0	R	1.73	1.0	1.0	2.3	2.3	∞
Test Sample Related								
Test Sample Positioning	2.7	N	1	1.0	1.0	2.7	2.7	35
Device Holder Uncertainty	1.67	N	1	1.0	1.0	1.7	1.7	5
Output Power Variation - SAR drift measurement	5.0	R	1.73	1.0	1.0	2.9	2.9	∞
SAR Scaling	0.0	R	1.73	1.0	1.0	0.0	0.0	∞
Phantom & Tissue Parameters								
Phantom Uncertainty (Shape & Thickness tolerances)	7.6	R	1.73	1.0	1.0	4.4	4.4	∞
Liquid Conductivity - measurement uncertainty	4.2	N	1	0.78	0.71	3.3	3.0	10
Liquid Permittivity - measurement uncertainty	4.1	N	1	0.23	0.26	1.0	1.1	10
Liquid Conductivity - Temperature Uncertainty	3.4	R	1.73	0.78	0.71	1.5	1.4	∞
Liquid Permittivity - Temperature Uncertainty	0.6	R	1.73	0.23	0.26	0.1	0.1	∞
Liquid Conductivity - deviation from target values	5.0	R	1.73	0.64	0.43	1.8	1.2	∞
Liquid Permittivity - deviation from target values	5.0	R	1.73	0.60	0.49	1.7	1.4	∞
Combined Standard Uncertainty (k=1)	RSS					11.5	11.3	60
Expanded Uncertainty (95% CONFIDENCE LEVEL)	k=2					23.0	22.6	



FCC ID: A3LSMF916U	 PCTEST <small>Proud to be part of Samsung</small>	SAR EVALUATION REPORT		Approved by: Quality Manager
Document S/N: 1M2005200087-01-R2.A3L	Test Dates: 06/28/20-08/24/20	DUT Type: Portable Handset		Page 264 of 267

17 CONCLUSION

17.1 Measurement Conclusion



The SAR evaluation indicates that the EUT complies with the RF radiation exposure limits of the FCC and Innovation, Science, and Economic Development Canada, with respect to all parameters subject to this test. These measurements were taken to simulate the RF effects of RF exposure under worst-case conditions. Precise laboratory measures were taken to assure repeatability of the tests. The results and statements relate only to the item(s) tested.

Please note that the absorption and distribution of electromagnetic energy in the body are very complex phenomena that depend on the mass, shape, and size of the body, the orientation of the body with respect to the field vectors, and the electrical properties of both the body and the environment. Other variables that may play a substantial role in possible biological effects are those that characterize the environment (e.g. ambient temperature, air velocity, relative humidity, and body insulation) and those that characterize the individual (e.g. age, gender, activity level, debilitation, or disease). Because various factors may interact with one another to vary the specific biological outcome of an exposure to electromagnetic fields, any protection guide should consider maximal amplification of biological effects as a result of field-body interactions, environmental conditions, and physiological variables. [3]



FCC ID: A3LSMF916U	 PCTEST <small>Prove it to be part of Samsung</small>	SAR EVALUATION REPORT		Approved by: Quality Manager
Document S/N: 1M2005200087-01-R2.A3L	Test Dates: 06/28/20-08/24/20	DUT Type: Portable Handset	Page 265 of 267	

18 REFERENCES

- [1] Federal Communications Commission, ET Docket 93-62, Guidelines for Evaluating the Environmental Effects of Radiofrequency Radiation, Aug. 1996.
- [2] ANSI/IEEE C95.1-2005, American National Standard safety levels with respect to human exposure to radio frequency electromagnetic fields, 3kHz to 300GHz, New York: IEEE, 2006.
- [3] ANSI/IEEE C95.1-1992, American National Standard safety levels with respect to human exposure to radio frequency electromagnetic fields, 3kHz to 300GHz, New York: IEEE, Sept. 1992.
- [4] ANSI/IEEE C95.3-2002, IEEE Recommended Practice for the Measurement of Potentially Hazardous Electromagnetic Fields - RF and Microwave, New York: IEEE, December 2002.
- [5] IEEE Standards Coordinating Committee 39 –Standards Coordinating Committee 34 – IEEE Std. 1528-2013, IEEE Recommended Practice for Determining the Peak Spatial-Average Specific Absorption Rate (SAR) in the Human Head from Wireless Communications Devices: Measurement Techniques.
- [6] NCRP, National Council on Radiation Protection and Measurements, Biological Effects and Exposure Criteria for RadioFrequency Electromagnetic Fields, NCRP Report No. 86, 1986. Reprinted Feb. 1995.
- [7] T. Schmid, O. Egger, N. Kuster, Automated E-field scanning system for dosimetric assessments, IEEE Transaction on Microwave Theory and Techniques, vol. 44, Jan. 1996, pp. 105-113.
- [8] K. Pokovic, T. Schmid, N. Kuster, Robust setup for precise calibration of E-field probes in tissue simulating liquids at mobile communications frequencies, ICECOM97, Oct. 1997, pp. 1 -124.
- [9] K. Pokovic, T. Schmid, and N. Kuster, E-field Probe with improved isotropy in brain simulating liquids, Proceedings of the ELMAR, Zadar, Croatia, June 23-25, 1996, pp. 172-175.
- [10] Schmid & Partner Engineering AG, Application Note: Data Storage and Evaluation, June 1998, p2.
- [11] V. Hombach, K. Meier, M. Burkhardt, E. Kuhn, N. Kuster, The Dependence of EM Energy Absorption upon Human Modeling at 900 MHz, IEEE Transaction on Microwave Theory and Techniques, vol. 44 no. 10, Oct. 1996, pp. 1865-1873.
- [12] N. Kuster and Q. Balzano, Energy absorption mechanism by biological bodies in the near field of dipole antennas above 300MHz, IEEE Transaction on Vehicular Technology, vol. 41, no. 1, Feb. 1992, pp. 17-23.
- [13] G. Hartsgrove, A. Kraszewski, A. Surowiec, Simulated Biological Materials for Electromagnetic Radiation Absorption Studies, University of Ottawa, Bioelectromagnetics, Canada: 1987, pp. 29-36.
- [14] Q. Balzano, O. Garay, T. Manning Jr., Electromagnetic Energy Exposure of Simulated Users of Portable Cellular Telephones, IEEE Transactions on Vehicular Technology, vol. 44, no.3, Aug. 1995.
- [15] W. Gander, Computermathematick, Birkhaeuser, Basel, 1992.
- [16] W.H. Press, S.A. Teukolsky, W.T. Vetterling, and B.P. Flannery, Numerical Recipes in C, The Art of Scientific Computing, Second edition, Cambridge University Press, 1992.
- [17] N. Kuster, R. Kastle, T. Schmid, Dosimetric evaluation of mobile communications equipment with known precision, IEEE Transaction on Communications, vol. E80-B, no. 5, May 1997, pp. 645-652.

FCC ID: A3LSMF916U	 PCTEST <small>Proud to be part of Samsung</small>	SAR EVALUATION REPORT		Approved by: Quality Manager
Document S/N: 1M2005200087-01-R2.A3L	Test Dates: 06/28/20-08/24/20	DUT Type: Portable Handset	Page 266 of 267	

- [18] CENELEC CLC/SC111B, European Prestandard (prENV 50166-2), Human Exposure to Electromagnetic Fields High-frequency: 10kHz-300GHz, Jan. 1995.
- [19] Prof. Dr. Niels Kuster, ETH, Eidgenössische Technische Hochschule Zürich, Dosimetric Evaluation of the Cellular Phone.
- [20] IEC 62209-1, Measurement procedure for the assessment of specific absorption rate of human exposure to radio frequency fields from hand-held and body-mounted wireless communication devices - Part 1: Devices used next to the ear (Frequency range of 300 MHz to 6 GHz), July 2016.
- [21] Innovation, Science, Economic Development Canada RSS-102 Radio Frequency Exposure Compliance of Radiocommunication Apparatus (All Frequency Bands) Issue 5, March 2015.
- [22] Health Canada Safety Code 6 Limits of Human Exposure to Radio Frequency Electromagnetic Fields in the Frequency Range from 3 kHz – 300 GHz, 2015
- [23] FCC SAR Test Procedures for 2G-3G Devices, Mobile Hotspot and UMPC Devices KDB Publications 941225, D01-D07
- [24] SAR Measurement Guidance for IEEE 802.11 Transmitters, KDB Publication 248227 D01
- [25] FCC SAR Considerations for Handsets with Multiple Transmitters and Antennas, KDB Publications 648474 D03-D04
- [26] FCC SAR Evaluation Considerations for Laptop, Notebook, Netbook and Tablet Computers, FCC KDB Publication 616217 D04
- [27] FCC SAR Measurement and Reporting Requirements for 100MHz – 6 GHz, KDB Publications 865664 D01-D02
- [28] FCC General RF Exposure Guidance and SAR Procedures for Dongles, KDB Publication 447498, D01-D02
- [29] Anexo à Resolução No. 533, de 10 de Setembro de 2009.
- [30] IEC 62209-2, Human exposure to radio frequency fields from hand-held and body-mounted wireless communication devices - Human models, instrumentation, and procedures - Part 2: Procedure to determine the specific absorption rate (SAR) for wireless communication devices used in close proximity to the human body (frequency range of 30 MHz to 6 GHz), Mar. 2010.

FCC ID: A3LSMF916U	 PCTEST <small>PROUD TO BE PART OF SAMSUNG</small>	SAR EVALUATION REPORT		Approved by: Quality Manager
Document S/N: 1M2005200087-01-R2.A3L	Test Dates: 06/28/20-08/24/20	DUT Type: Portable Handset	Page 267 of 267	

APPENDIX A: SAR TEST DATA

PCTEST

DUT: A3LSMF916U; Type: Portable Handset; Serial: 1136M

Communication System: UID 0, Cellular CDMA; Frequency: 820.1 MHz; Duty Cycle: 1:1
Medium: 835 Head; Medium parameters used (interpolated):
 $f = 820.1$ MHz; $\sigma = 0.897$ S/m; $\epsilon_r = 42.804$; $\rho = 1000$ kg/m³
Phantom section: Left Section

Test Date: 07/06/2020; Ambient Temp: 24.9°C; Tissue Temp: 22.5°C

Probe: EX3DV4 - SN7406; ConvF(9.61, 9.61, 9.61) @ 820.1 MHz; Calibrated: 6/23/2020
Sensor-Surface: 1.4mm (Mechanical Surface Detection)
Electronics: DAE4 Sn1583; Calibrated: 5/14/2020
Phantom: Twin-SAM V8.0; Type: QD 000 P41 Ax; Serial: 1966
Measurement SW: DASY52, Version 52.10 (4);SEMCAD X Version 14.6.14 (7483)

Mode: Cell. EVDO Rev. A, BC 10, Left Head, Cheek, Mid.ch

Area Scan (8x13x1): Measurement grid: dx=15mm, dy=15mm

Zoom Scan (5x5x7)/Cube 0: Measurement grid: dx=8mm, dy=8mm, dz=5mm

Reference Value = 15.49 V/m; Power Drift = 0.02 dB

Peak SAR (extrapolated) = 0.254 W/kg

SAR(1 g) = 0.205 W/kg

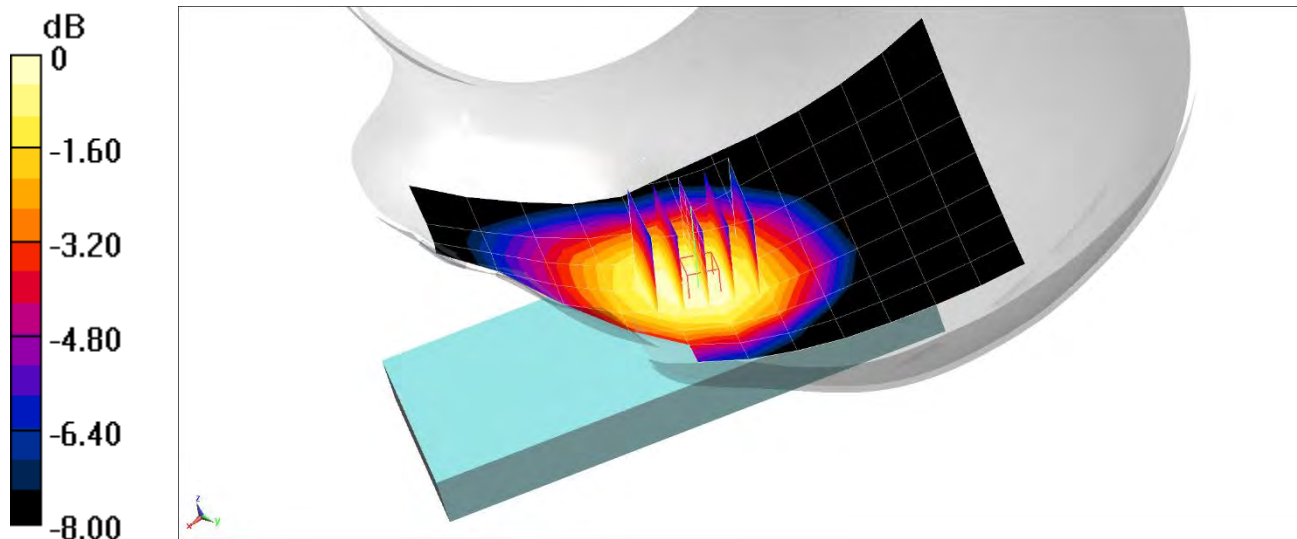

0 dB = 0.235 W/kg = -6.29 dBW/kg

PCTEST

DUT: A3LSMF916U; Type: Portable Handset; Serial: 1136M

Communication System: UID 0, CDMA; Frequency: 836.52 MHz; Duty Cycle: 1:1
Medium: 835 Head; Medium parameters used (interpolated):
 $f = 836.52$ MHz; $\sigma = 0.904$ S/m; $\epsilon_r = 42.754$; $\rho = 1000$ kg/m³
Phantom section: Right Section

Test Date: 07/06/2020; Ambient Temp: 24.9°C; Tissue Temp: 22.5°C

Probe: EX3DV4 - SN7406; ConvF(9.61, 9.61, 9.61) @ 836.52 MHz; Calibrated: 6/23/2020
Sensor-Surface: 1.4mm (Mechanical Surface Detection)
Electronics: DAE4 Sn1583; Calibrated: 5/14/2020
Phantom: Twin-SAM V8.0; Type: QD 000 P41 Ax; Serial: 1966
Measurement SW: DASY52, Version 52.10 (4);SEMCAD X Version 14.6.14 (7483)

Mode: Cell. EVDO Rev. A, BC 0, Antenna A, Right Head, Cheek, Mid.ch

Area Scan (9x13x1): Measurement grid: dx=15mm, dy=15mm

Zoom Scan (5x5x7)/Cube 0: Measurement grid: dx=8mm, dy=8mm, dz=5mm

Reference Value = 16.24 V/m; Power Drift = 0.02 dB

Peak SAR (extrapolated) = 0.291 W/kg

SAR(1 g) = 0.228 W/kg

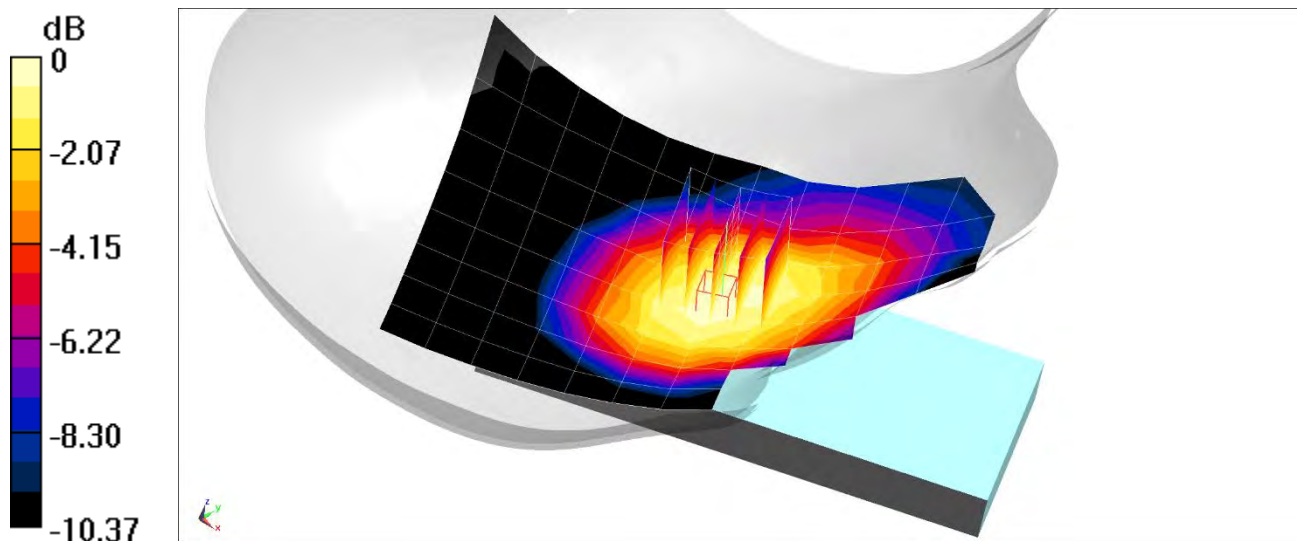

0 dB = 0.269 W/kg = -5.70 dBW/kg

PCTEST

DUT: A3LSMF916U; Type: Portable Handset; Serial: 1134M

Communication System: UID 0, PCS CDMA; Frequency: 1880 MHz; Duty Cycle: 1:1
Medium: 1900 Head; Medium parameters used:
 $f = 1880 \text{ MHz}$; $\sigma = 1.359 \text{ S/m}$; $\epsilon_r = 40.11$; $\rho = 1000 \text{ kg/m}^3$
Phantom section: Left Section

Test Date: 07/03/2020; Ambient Temp: 23.4°C; Tissue Temp: 21.3°C

Probe: EX3DV4 - SN7410; ConvF(8.11, 8.11, 8.11) @ 1880 MHz; Calibrated: 7/16/2019
Sensor-Surface: 1.4mm (Mechanical Surface Detection)
Electronics: DAE4 Sn1322; Calibrated: 7/11/2019
Phantom: Twin-SAM V8.0; Type: QD 000 P41 Ax; Serial: 1966
Measurement SW: DASY52, Version 52.10 (4);SEMCAD X Version 14.6.14 (7483)

Mode: PCS CDMA, Left Head, Cheek, Mid.ch

Area Scan (9x15x1): Measurement grid: dx=15mm, dy=15mm

Zoom Scan (5x5x7)/Cube 0: Measurement grid: dx=8mm, dy=8mm, dz=5mm

Reference Value = 6.666 V/m; Power Drift = 0.12 dB

Peak SAR (extrapolated) = 0.0900 W/kg

SAR(1 g) = 0.056 W/kg

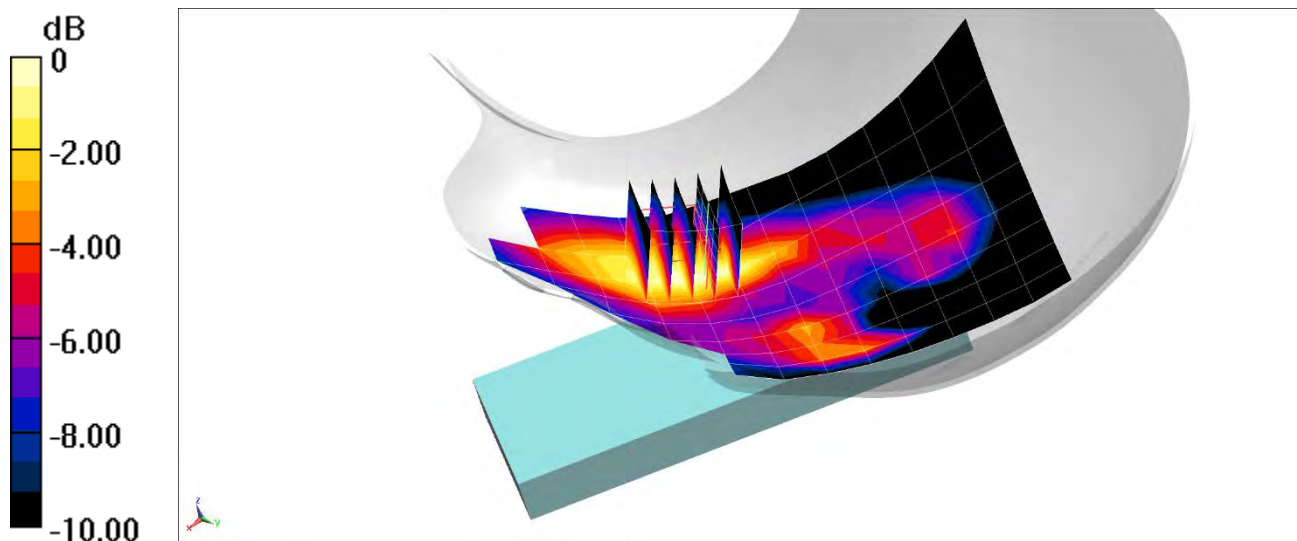

0 dB = 0.0768 W/kg = -11.15 dBW/kg

PCTEST

DUT: A3LSMF916U; Type: Portable Handset; Serial: 1136M

Communication System: UID 0, GSM; Frequency: 836.6 MHz; Duty Cycle: 1:8.3
Medium: 835 Head; Medium parameters used (interpolated):
 $f = 836.6$ MHz; $\sigma = 0.908$ S/m; $\epsilon_r = 41.726$; $\rho = 1000$ kg/m³
Phantom section: Right Section

Test Date: 06/29/2020; Ambient Temp: 23.1°C; Tissue Temp: 21.9°C

Probe: EX3DV4 - SN7410; ConvF(9.88, 9.88, 9.88) @ 836.6 MHz; Calibrated: 7/16/2019
Sensor-Surface: 1.4mm (Mechanical Surface Detection)
Electronics: DAE4 Sn1322; Calibrated: 7/11/2019
Phantom: Twin-SAM V8.0; Type: QD 000 P41 Ax; Serial: 1966
Measurement SW: DASY52, Version 52.10 (4);SEMCAD X Version 14.6.14 (7483)

Mode: GSM 850, Antenna A, Right Head, Cheek, Mid.ch

Area Scan (9x15x1): Measurement grid: dx=15mm, dy=15mm

Zoom Scan (5x5x7)/Cube 0: Measurement grid: dx=8mm, dy=8mm, dz=5mm

Reference Value = 13.30 V/m; Power Drift = -0.02 dB

Peak SAR (extrapolated) = 0.195 W/kg

SAR(1 g) = 0.155 W/kg

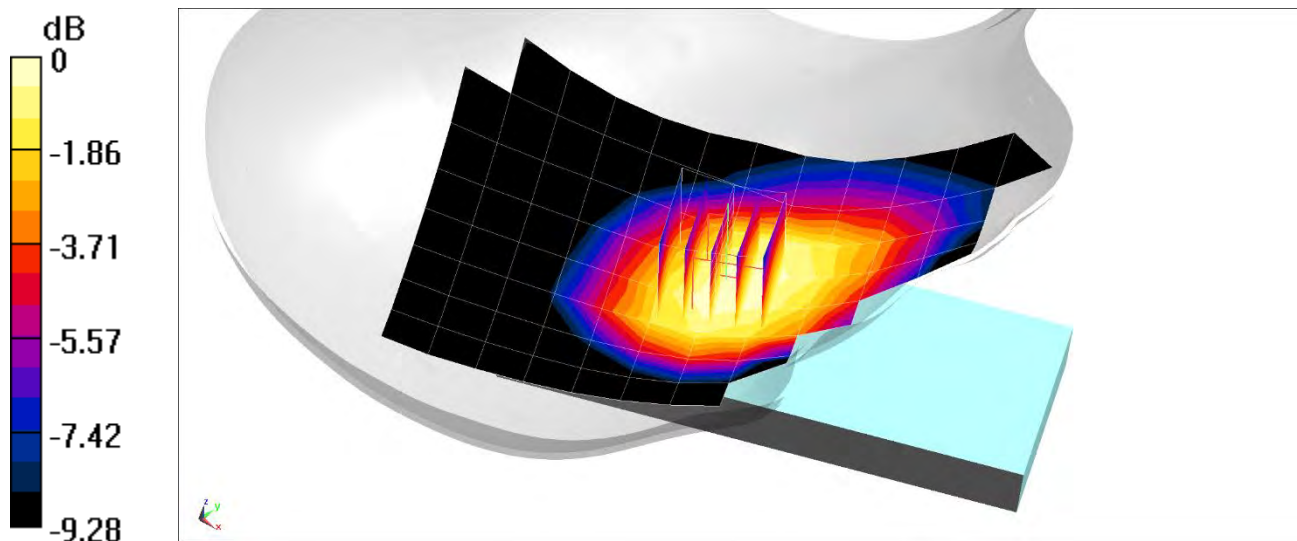

0 dB = 0.182 W/kg = -7.40 dBW/kg

PCTEST

DUT: A3LSMF916U; Type: Portable Handset; Serial: 1134M

Communication System: UID 0, GSM; Frequency: 1880 MHz; Duty Cycle: 1:8.3
Medium: 1900 Head; Medium parameters used:
 $f = 1880 \text{ MHz}$; $\sigma = 1.359 \text{ S/m}$; $\epsilon_r = 40.11$; $\rho = 1000 \text{ kg/m}^3$
Phantom section: Left Section

Test Date: 07/03/2020; Ambient Temp: 23.4°C; Tissue Temp: 21.3°C

Probe: EX3DV4 - SN7410; ConvF(8.11, 8.11, 8.11) @ 1880 MHz; Calibrated: 7/16/2019
Sensor-Surface: 1.4mm (Mechanical Surface Detection)
Electronics: DAE4 Sn1322; Calibrated: 7/11/2019
Phantom: Twin-SAM V8.0; Type: QD 000 P41 Ax; Serial: 1966
Measurement SW: DASY52, Version 52.10 (4);SEMCAD X Version 14.6.14 (7483)

Mode: GSM 1900, Left Head, Cheek, Mid.ch

Area Scan (9x13x1): Measurement grid: dx=15mm, dy=15mm

Zoom Scan (5x5x7)/Cube 0: Measurement grid: dx=8mm, dy=8mm, dz=5mm

Reference Value = 3.911 V/m; Power Drift = 0.04 dB

Peak SAR (extrapolated) = 0.0310 W/kg

SAR(1 g) = 0.019 W/kg

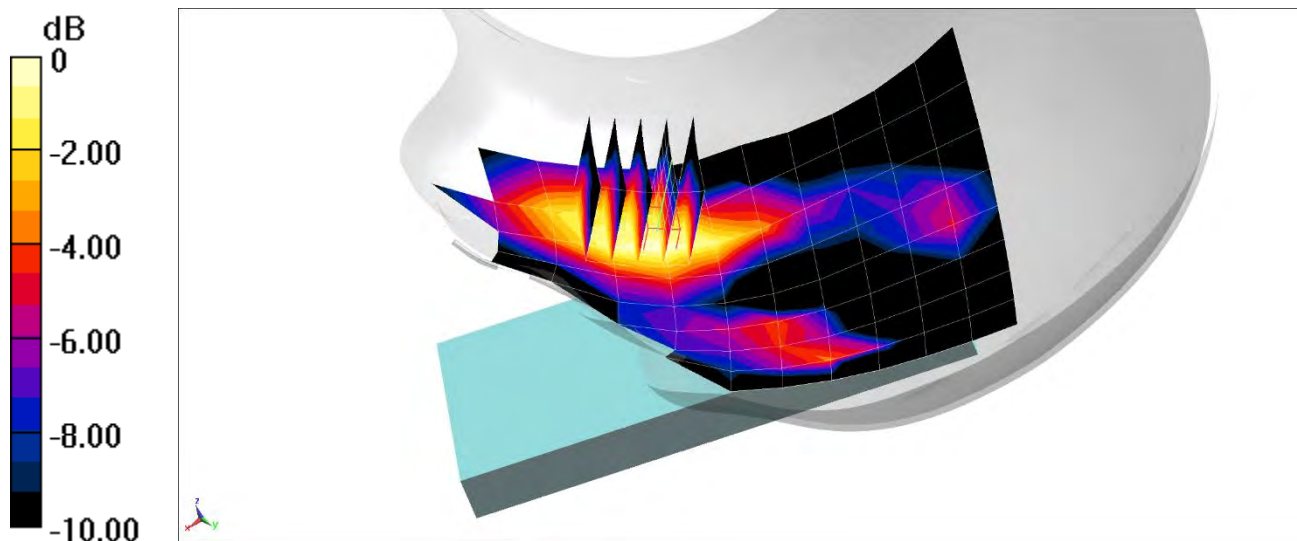

0 dB = 0.0260 W/kg = -15.85 dBW/kg

PCTEST

DUT: A3LSMF916U; Type: Portable Handset; Serial: 1136M

Communication System: UID 0, UMTS; Frequency: 836.6 MHz; Duty Cycle: 1:1
Medium: 835 Head; Medium parameters used (interpolated):
 $f = 836.6$ MHz; $\sigma = 0.904$ S/m; $\epsilon_r = 42.754$; $\rho = 1000$ kg/m³
Phantom section: Right Section

Test Date: 07/06/2020; Ambient Temp: 24.9°C; Tissue Temp: 22.5°C

Probe: EX3DV4 - SN7406; ConvF(9.61, 9.61, 9.61) @ 836.6 MHz; Calibrated: 6/23/2020
Sensor-Surface: 1.4mm (Mechanical Surface Detection)
Electronics: DAE4 Sn1583; Calibrated: 5/14/2020
Phantom: Twin-SAM V8.0; Type: QD 000 P41 Ax; Serial: 1966
Measurement SW: DASY52, Version 52.10 (4);SEMCAD X Version 14.6.14 (7483)

Mode: UMTS 850, Right Head, Cheek, Mid.ch

Area Scan (9x13x1): Measurement grid: dx=15mm, dy=15mm

Zoom Scan (5x5x7)/Cube 0: Measurement grid: dx=8mm, dy=8mm, dz=5mm

Reference Value = 14.95 V/m; Power Drift = 0.00 dB

Peak SAR (extrapolated) = 0.266 W/kg

SAR(1 g) = 0.207 W/kg

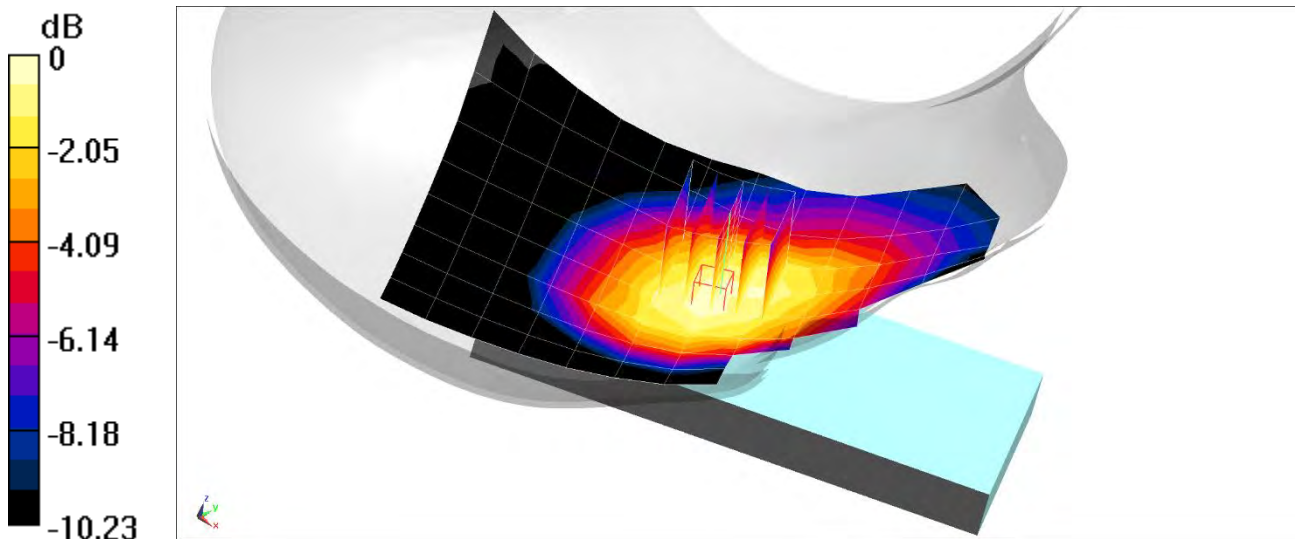

0 dB = 0.246 W/kg = -6.09 dBW/kg

PCTEST

DUT: A3LSMF916U; Type: Portable Handset; Serial: 1134M

Communication System: UID 0, UMTS; Frequency: 1732.4 MHz; Duty Cycle: 1:1
Medium: 1750 Head; Medium parameters used (interpolated):
 $f = 1732.4$ MHz; $\sigma = 1.303$ S/m; $\epsilon_r = 40.814$; $\rho = 1000$ kg/m³
Phantom section: Right Section

Test Date: 07/02/2020; Ambient Temp: 23.1°C; Tissue Temp: 22.7°C

Probe: EX3DV4 - SN3589; ConvF(7.55, 7.55, 7.55) @ 1732.4 MHz; Calibrated: 1/21/2020
Sensor-Surface: 1.4mm (Mechanical Surface Detection)
Electronics: DAE4 Sn1558; Calibrated: 1/13/2020
Phantom: Twin-SAM V5.0 (30); Type: QD 000 P40 CD; Serial: 1647
Measurement SW: DASY52, Version 52.10 (4);SEMCAD X Version 14.6.14 (7483)

Mode: UMTS 1750, Right Head, Cheek, Mid.ch

Area Scan (9x15x1): Measurement grid: dx=15mm, dy=15mm

Zoom Scan (5x5x7)/Cube 0: Measurement grid: dx=8mm, dy=8mm, dz=5mm

Reference Value = 6.813 V/m; Power Drift = 0.03 dB

Peak SAR (extrapolated) = 0.0800 W/kg

SAR(1 g) = 0.053 W/kg

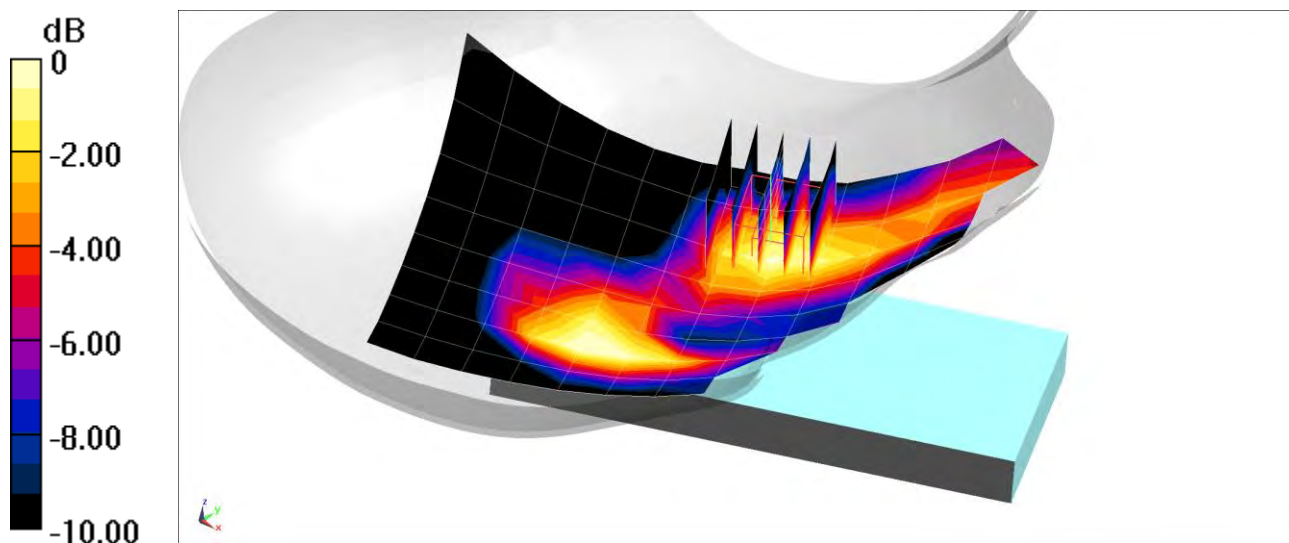

0 dB = 0.0703 W/kg = -11.53 dBW/kg

PCTEST

DUT: A3LSMF916U; Type: Portable Handset; Serial: 1134M

Communication System: UID 0, UMTS; Frequency: 1880 MHz; Duty Cycle: 1:1
Medium: 1900 Head; Medium parameters used:
 $f = 1880 \text{ MHz}$; $\sigma = 1.359 \text{ S/m}$; $\epsilon_r = 40.11$; $\rho = 1000 \text{ kg/m}^3$
Phantom section: Left Section

Test Date: 07/03/2020; Ambient Temp: 23.4°C; Tissue Temp: 21.3°C

Probe: EX3DV4 - SN7410; ConvF(8.11, 8.11, 8.11) @ 1880 MHz; Calibrated: 7/16/2019
Sensor-Surface: 1.4mm (Mechanical Surface Detection)
Electronics: DAE4 Sn1322; Calibrated: 7/11/2019
Phantom: Twin-SAM V8.0 ; Type: QD 000 P41 Ax; Serial: 1966
Measurement SW: DASY52, Version 52.10 (4);SEMCAD X Version 14.6.14 (7483)

Mode: UMTS 1900, Left Head, Cheek, Mid.ch

Area Scan (8x13x1): Measurement grid: dx=15mm, dy=15mm

Zoom Scan (5x5x7)/Cube 0: Measurement grid: dx=8mm, dy=8mm, dz=5mm

Reference Value = 7.468 V/m; Power Drift = 0.07 dB

Peak SAR (extrapolated) = 0.111 W/kg

SAR(1 g) = 0.071 W/kg

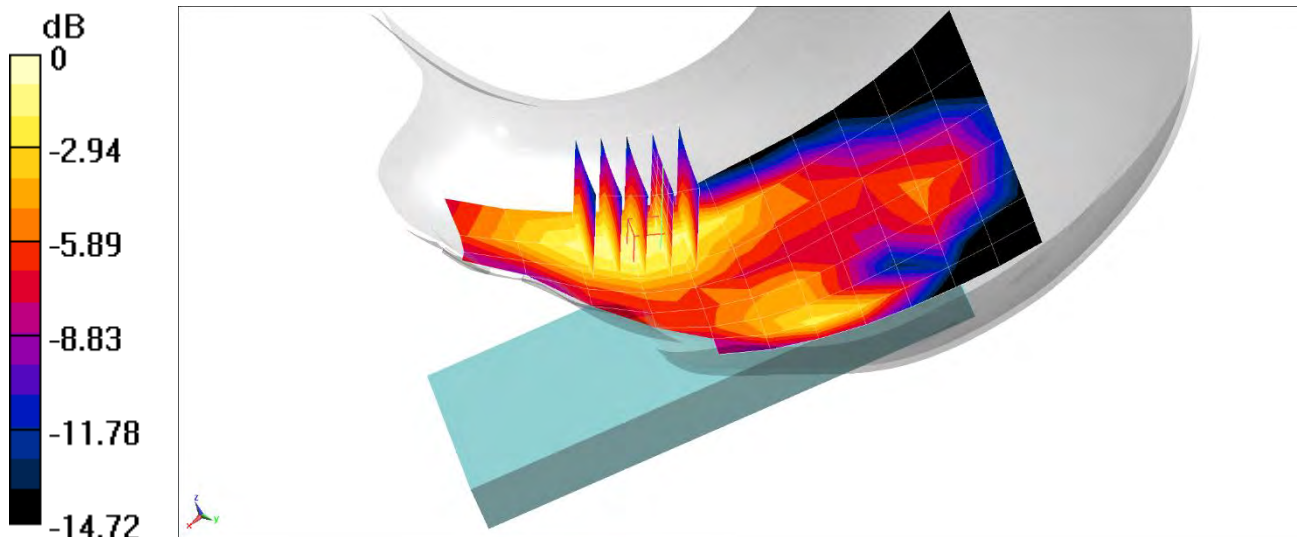

0 dB = 0.0958 W/kg = -10.19 dBW/kg

PCTEST

DUT: A3LSMF916U; Type: Portable Handset; Serial: 0069M

Communication System: UID 0, LTE Band 71; Frequency: 680.5 MHz; Duty Cycle: 1:1
Medium: 750 Head; Medium parameters used (interpolated):
 $f = 680.5$ MHz; $\sigma = 0.851$ S/m; $\epsilon_r = 43.278$; $\rho = 1000$ kg/m³
Phantom section: Right Section

Test Date: 07/23/2020; Ambient Temp: 22.9°C; Tissue Temp: 22.7°C

Probe: EX3DV4 - SN3589; ConvF(8.7, 8.7, 8.7) @ 680.5 MHz; Calibrated: 1/21/2020
Sensor-Surface: 1.4mm (Mechanical Surface Detection)
Electronics: DAE4 Sn1558; Calibrated: 1/13/2020
Phantom: Twin-SAM V5.0 (30); Type: QD 000 P40 CD; Serial: 1647
Measurement SW: DASY52, Version 52.10 (4);SEMCAD X Version 14.6.14 (7483)

**Mode: LTE Band 71, Right Head, Cheek, Mid.ch,
20 MHz Bandwidth, QPSK, 1 RB, 0 RB Offset**

Area Scan (9x15x1): Measurement grid: dx=15mm, dy=15mm

Zoom Scan (5x5x7)/Cube 0: Measurement grid: dx=8mm, dy=8mm, dz=5mm

Reference Value = 11.73 V/m; Power Drift = -0.05 dB

Peak SAR (extrapolated) = 0.135 W/kg

SAR(1 g) = 0.107 W/kg

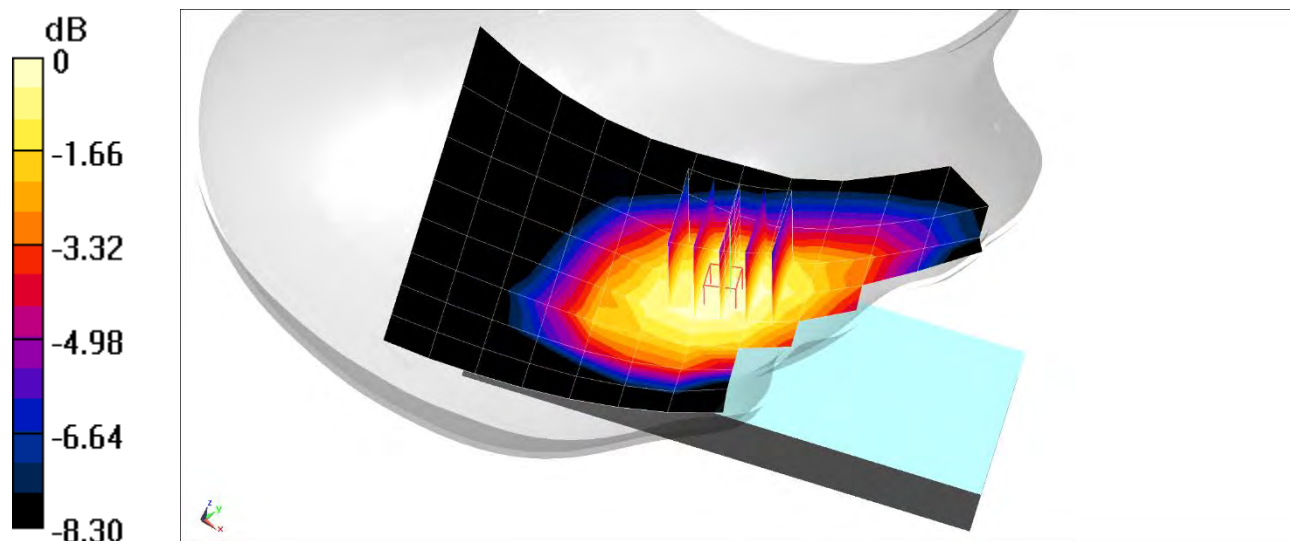

0 dB = 0.125 W/kg = -9.03 dBW/kg

PCTEST

DUT: A3LSMF916U; Type: Portable Handset; Serial: 0069M

Communication System: UID 0, LTE Band 12; Frequency: 707.5 MHz; Duty Cycle: 1:1
Medium: 750 Head; Medium parameters used (interpolated):
 $f = 707.5$ MHz; $\sigma = 0.859$ S/m; $\epsilon_r = 43.188$; $\rho = 1000$ kg/m³
Phantom section: Right Section

Test Date: 07/23/2020; Ambient Temp: 22.9°C; Tissue Temp: 22.7°C

Probe: EX3DV4 - SN3589; ConvF(8.7, 8.7, 8.7) @ 707.5 MHz; Calibrated: 1/21/2020
Sensor-Surface: 1.4mm (Mechanical Surface Detection)
Electronics: DAE4 Sn1558; Calibrated: 1/13/2020
Phantom: Twin-SAM V5.0 (30); Type: QD 000 P40 CD; Serial: 1647
Measurement SW: DASY52, Version 52.10 (4);SEMCAD X Version 14.6.14 (7483)

**Mode: LTE Band 12, Right Head, Cheek, Mid.ch,
10 MHz Bandwidth, QPSK, 1 RB, 49 RB Offset**

Area Scan (9x15x1): Measurement grid: dx=15mm, dy=15mm

Zoom Scan (5x5x7)/Cube 0: Measurement grid: dx=8mm, dy=8mm, dz=5mm

Reference Value = 10.85 V/m; Power Drift = 0.04 dB

Peak SAR (extrapolated) = 0.117 W/kg

SAR(1 g) = 0.092 W/kg

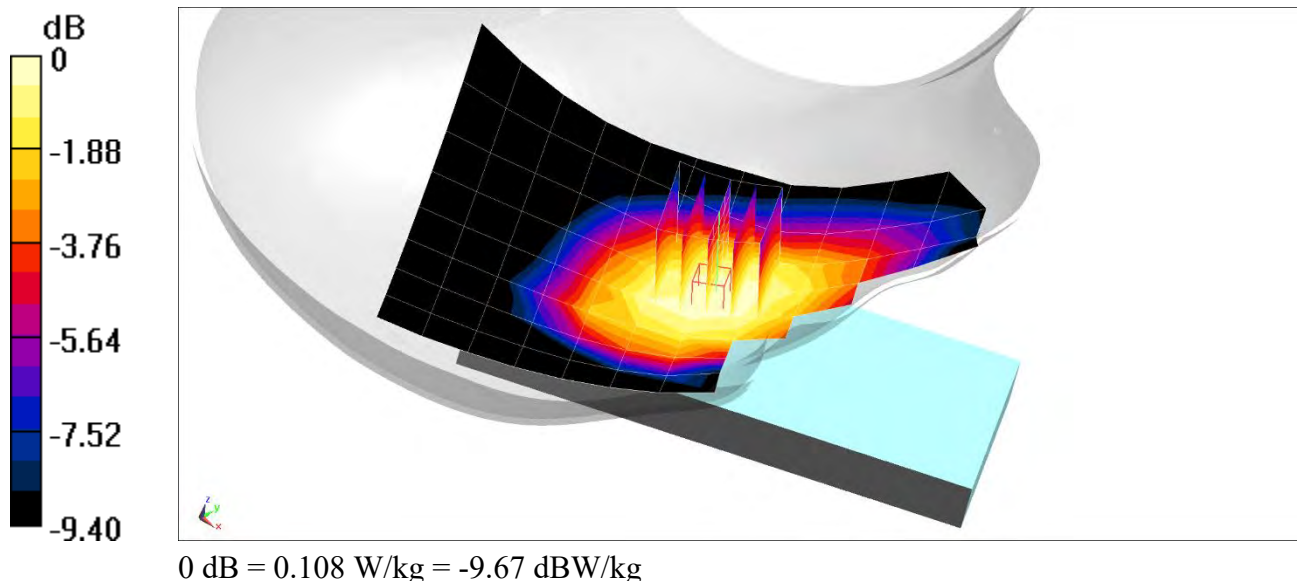

PCTEST

DUT: A3LSMF916U; Type: Portable Handset; Serial: 0069M

Communication System: UID 0, LTE Band 13; Frequency: 782 MHz; Duty Cycle: 1:1
Medium: 750 Head; Medium parameters used (interpolated):
 $f = 782 \text{ MHz}$; $\sigma = 0.884 \text{ S/m}$; $\epsilon_r = 43.007$; $\rho = 1000 \text{ kg/m}^3$
Phantom section: Right Section

Test Date: 07/23/2020; Ambient Temp: 22.9°C; Tissue Temp: 22.7°C

Probe: EX3DV4 - SN3589; ConvF(8.7, 8.7, 8.7) @ 782 MHz; Calibrated: 1/21/2020
Sensor-Surface: 1.4mm (Mechanical Surface Detection)
Electronics: DAE4 Sn1558; Calibrated: 1/13/2020
Phantom: Twin-SAM V5.0 (30); Type: QD 000 P40 CD; Serial: 1647
Measurement SW: DASY52, Version 52.10 (4);SEMCAD X Version 14.6.14 (7483)

**Mode: LTE Band 13, Antenna A, Right Head, Cheek, Mid.ch,
10 MHz Bandwidth, QPSK, 1 RB, 49 RB Offset**

Area Scan (9x15x1): Measurement grid: dx=15mm, dy=15mm

Zoom Scan (5x5x7)/Cube 0: Measurement grid: dx=8mm, dy=8mm, dz=5mm

Reference Value = 15.44 V/m; Power Drift = 0.06 dB

Peak SAR (extrapolated) = 0.245 W/kg

SAR(1 g) = 0.194 W/kg

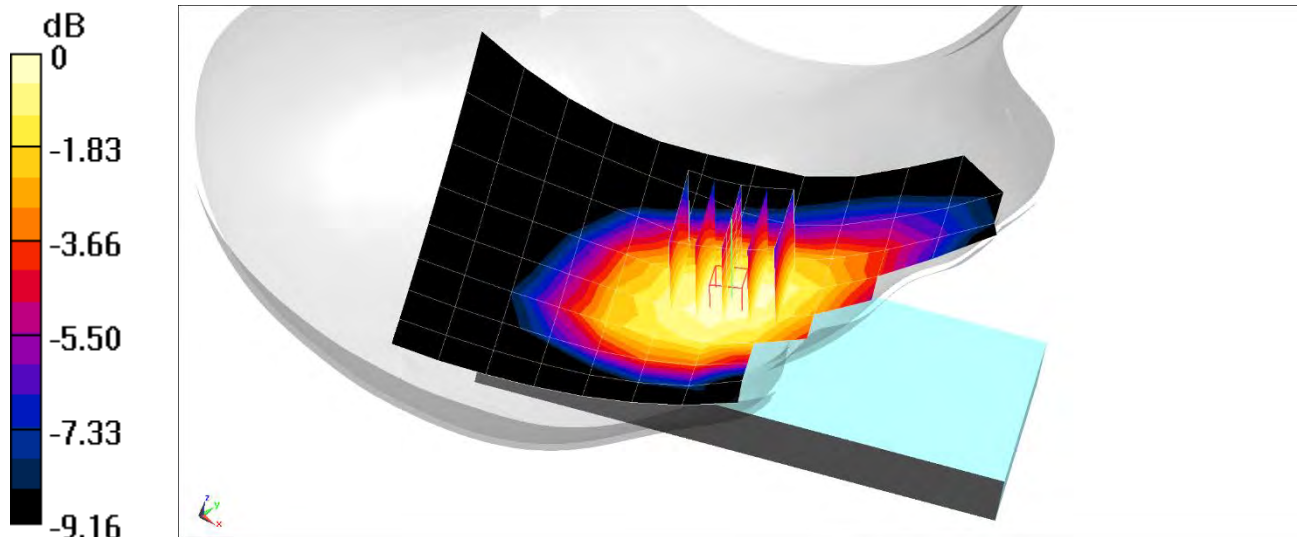

0 dB = 0.226 W/kg = -6.46 dBW/kg

PCTEST

DUT: A3LSMF916U; Type: Portable Handset; Serial: 0069M

Communication System: UID 0, LTE Band 14; Frequency: 793 MHz; Duty Cycle: 1:1
Medium: 750 Head; Medium parameters used (interpolated):
 $f = 793 \text{ MHz}$; $\sigma = 0.888 \text{ S/m}$; $\epsilon_r = 42.973$; $\rho = 1000 \text{ kg/m}^3$
Phantom section: Right Section

Test Date: 07/23/2020; Ambient Temp: 22.9°C; Tissue Temp: 22.7°C

Probe: EX3DV4 - SN3589; ConvF(8.7, 8.7, 8.7) @ 793 MHz; Calibrated: 1/21/2020
Sensor-Surface: 1.4mm (Mechanical Surface Detection)
Electronics: DAE4 Sn1558; Calibrated: 1/13/2020
Phantom: Twin-SAM V5.0 (30); Type: QD 000 P40 CD; Serial: 1647
Measurement SW: DASY52, Version 52.10 (4);SEMCAD X Version 14.6.14 (7483)

**Mode: LTE Band 14, Antenna A, Right Head, Cheek, Mid.ch,
10 MHz Bandwidth, QPSK, 1 RB, 0 RB Offset**

Area Scan (9x15x1): Measurement grid: dx=15mm, dy=15mm

Zoom Scan (5x5x7)/Cube 0: Measurement grid: dx=8mm, dy=8mm, dz=5mm

Reference Value = 14.92 V/m; Power Drift = 0.01 dB

Peak SAR (extrapolated) = 0.226 W/kg

SAR(1 g) = 0.181 W/kg

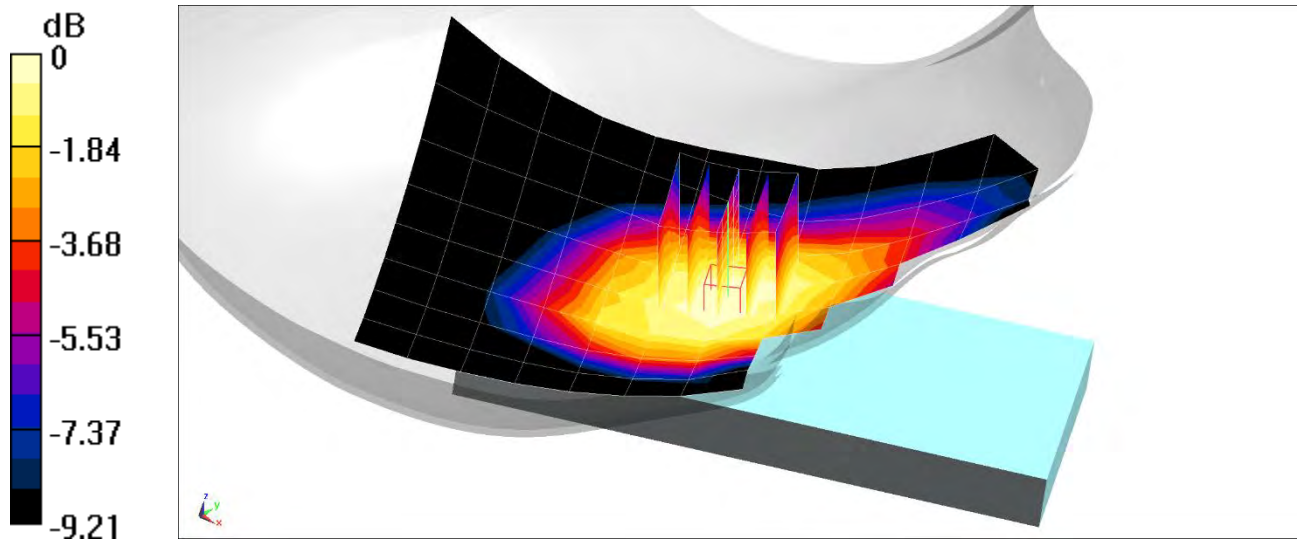

0 dB = 0.209 W/kg = -6.80 dBW/kg

PCTEST

DUT: A3LSMF916U; Type: Portable Handset; Serial: 1114M

Communication System: UID 0, LTE Band 26; Frequency: 831.5 MHz; Duty Cycle: 1:1
Medium: 835 Head; Medium parameters used (interpolated):
 $f = 831.5$ MHz; $\sigma = 0.902$ S/m; $\epsilon_r = 42.769$; $\rho = 1000$ kg/m³
Phantom section: Right Section

Test Date: 07/06/2020; Ambient Temp: 24.9°C; Tissue Temp: 22.5°C

Probe: EX3DV4 - SN7406; ConvF(9.61, 9.61, 9.61) @ 831.5 MHz; Calibrated: 6/23/2020
Sensor-Surface: 1.4mm (Mechanical Surface Detection)
Electronics: DAE4 Sn1583; Calibrated: 5/14/2020
Phantom: Twin-SAM V8.0; Type: QD 000 P41 Ax; Serial: 1966
Measurement SW: DASY52, Version 52.10 (4);SEMCAD X Version 14.6.14 (7483)

**Mode: LTE Band 26 (Cell.), Right Head, Cheek, Mid.ch,
15 MHz Bandwidth, QPSK, 1 RB, 36 RB Offset**

Area Scan (9x13x1): Measurement grid: dx=15mm, dy=15mm

Zoom Scan (5x5x7)/Cube 0: Measurement grid: dx=8mm, dy=8mm, dz=5mm

Reference Value = 16.59 V/m; Power Drift = -0.06 dB

Peak SAR (extrapolated) = 0.287 W/kg

SAR(1 g) = 0.218 W/kg

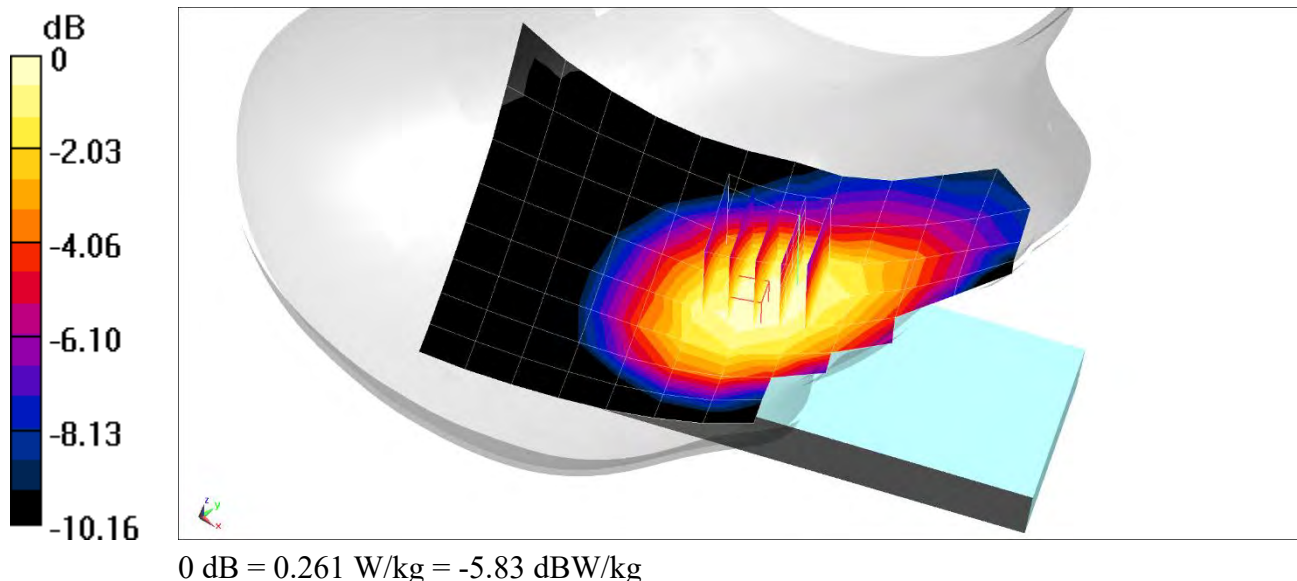

PCTEST

DUT: A3LSMF916U; Type: Portable Handset; Serial: 1105M

Communication System: UID 0, LTE Band 5 (Cell.); Frequency: 836.5 MHz; Duty Cycle: 1:1
Medium: 835 Head; Medium parameters used (interpolated):
 $f = 836.5 \text{ MHz}$; $\sigma = 0.904 \text{ S/m}$; $\epsilon_r = 42.754$; $\rho = 1000 \text{ kg/m}^3$
Phantom section: Right Section

Test Date: 07/06/2020; Ambient Temp: 24.9°C; Tissue Temp: 22.5°C

Probe: EX3DV4 - SN7406; ConvF(9.61, 9.61, 9.61) @ 836.5 MHz; Calibrated: 6/23/2020
Sensor-Surface: 1.4mm (Mechanical Surface Detection)
Electronics: DAE4 Sn1583; Calibrated: 5/14/2020
Phantom: Twin-SAM V8.0; Type: QD 000 P41 Ax; Serial: 1966
Measurement SW: DASY52, Version 52.10 (4);SEMCAD X Version 14.6.14 (7483)

**Mode: LTE Band 5 (Cell.), Right Head, Cheek, Mid.ch,
10 MHz Bandwidth, QPSK, 1 RB, 0 RB Offset**

Area Scan (9x13x1): Measurement grid: dx=15mm, dy=15mm

Zoom Scan (5x5x7)/Cube 0: Measurement grid: dx=8mm, dy=8mm, dz=5mm

Reference Value = 16.87 V/m; Power Drift = -0.19 dB

Peak SAR (extrapolated) = 0.302 W/kg

SAR(1 g) = 0.232 W/kg

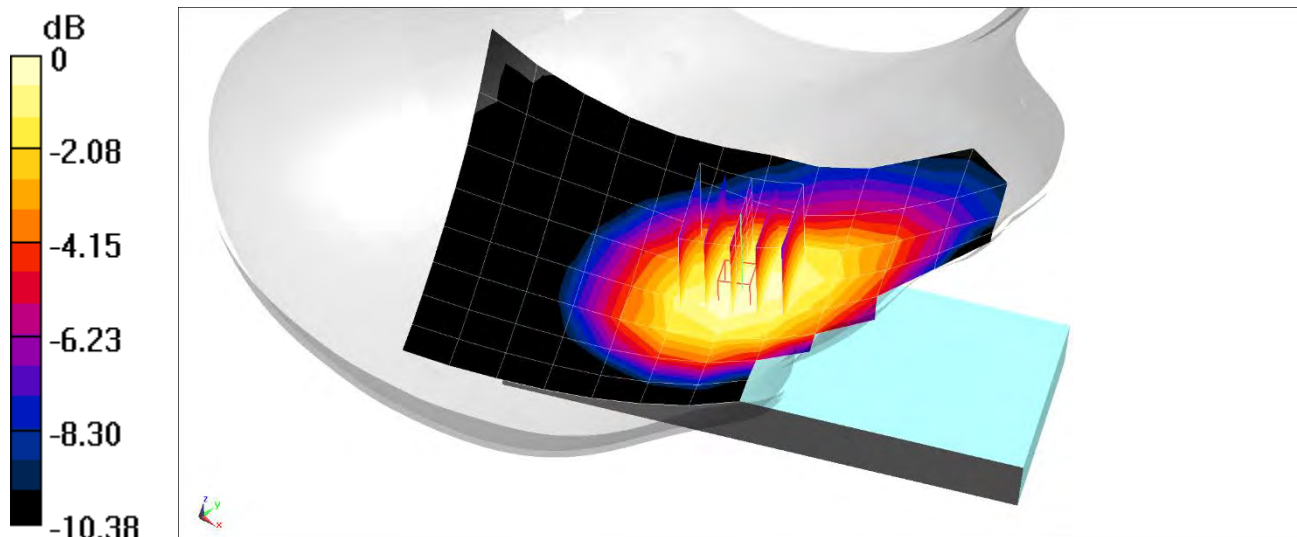

0 dB = 0.278 W/kg = -5.56 dBW/kg