

TEST REPORT

HAC RF Emission Test for certification of SM-F741U

APPLICANT

Samsung Electronics. Co., Ltd.

REPORT NO.

HCT-SR-2404-FC002

DATE OF ISSUE

Apr. 26, 2024

Tested by
Ji Hoon, Kim

(signature) 김지훈

Technical Manager
Yun Jeang, Heo

(signature) Yun Jeang Heo

HCT CO., LTD.
BongJai Huh
BongJai Huh / CEO



HCT CO.,LTD.

2-6, 73, 74, Seoicheon-ro 578beon-gil, Majang-myeon, Icheon-si, Gyeonggi-do, 17383 KOREA
Tel. +82 31 645 6300 Fax. +82 31 645 6401

TEST REPORT

HAC RF Emission
Test for
certification

REPORT NO.
HCT-SR-2404-FC002

DATE OF ISSUE
Apr. 26, 2024

FCC ID
A3LSMF741U

Applicant **SAMSUNG Electronics Co., Ltd**
129, Samsung-ro, Yeongtong-gu, Suwon-Si, Gyeonggi-do, 16677, Korea

Product Name Mobile Phone
Model Name SM-F741U
Additional Model Name SM-F741U1

Date of Test Apr. 15, 2024

Location of Test Permanent Testing Lab On Site Testing Lab
(Address: 74, Seoicheon-ro 578beon-gil, Majang-myeon, Icheon-si, Gyeonggi-do, 17383 KOREA)

FCC Rule Part(s) **FCC 47 CFR §20.19 , ANSI C63.19-2019**

C63.19-2019 HAC Result: **PASS**

REVISION HISTORY

The revision history for this test report is shown in table.

Revision No.	Date of Issue	Description
0	Apr. 26, 2024	Initial Release

Notice

Content

The results shown in this test report only apply to the sample(s), as received, provided by the applicant, unless otherwise stated.

The test results have only been applied with the test methods required by the standard(s).

The laboratory is not accredited for the test results marked *.

Information provided by the applicant is marked **.

Test results provided by external providers are marked ***.

When confirmation of authenticity of this test report is required, please contact www.hct.co.kr

The test results in this test report are not associated with the ((KS Q) ISO/IEC 17025) accreditation by KOLAS (Korea Laboratory Accreditation Scheme) / A2LA (American Association for Laboratory Accreditation) that are under the ILAC (International Laboratory Accreditation Cooperation) Mutual Recognition Agreement (MRA).

CONTENTS

1. Test Regulations.....	5
2. Test Location	6
3. DEVICE UNDER TEST DESCRIPTION.....	8
4. HAC Measurement Set-Up.....	10
5. System Specifications.....	11
6. WD emission requirements.....	13
7. System Validation.....	14
8. Modulation Interference Factor (MIF)	16
9. Analysis of RF Air interface Technologies	18
10. HAC RF Emission Test Procedure (RF Audio Interference Level, RFAIL)	23
11. Measurement Uncertainties.....	26
12. HAC Test Data Summary	27
13. HAC Test Equipment Chamber List.....	29
14. HAC Test Equipment List.....	30
15. CONCLUSION.....	31
Appendix A. TEST SETUP PHOTO.....	32
Appendix B. HAC RF Emission Test Plots.....	33
Appendix C. System Validation Plot.....	50
Appendix D. Probe Calibration Data.....	55
Appendix E. Dipole Calibration Data.....	77
Appendix F. UID Specifications.....	100

1. Test Regulations

The tests were performed according to the following regulations:

Test Standard	FCC 47 CFR §20.19, ANSI C63.19-2019
Test Method	<ul style="list-style-type: none">• FCC CFR47 Part 20.19• ANSI C63.19 2019-version• FCC KDB 285076 D01 HAC Guidance v06r04• FCC KDB 285076 D03 HAC FAQ v01r06• TCB workshop updates

2. Test Location

2.1 Test Laboratory

Company Name	HCT Co., Ltd.
Address	74, Seoicheon-ro 578beon-gil, Majang-myeon, Icheon-si, Gyeonggi-do, 17383 KOREA
Telephone	031-645-6300
Fax.	031-645-6401

2.2 Test Facilities

Our laboratories are accredited and approved by the following approval agencies according to ISO/IEC 17025.

Korea	National Radio Research Agency (Designation No. KR0032)
	KOLAS (Testing No. KT197)

2.3 General Information of the EUT

Model Name	SM-F741U
Additional Model Name	SM-F741U1
Equipment Type	Mobile Phone
FCC ID	A3LSMF741U
Application Type	Certification
Applicant	SAMSUNG Electronics Co., Ltd.

2.4 Test Methodology

The Tests document in this report were performed in accordance with ANSI C63.19-2019 method of Measurement of Compatibility between Wireless Communication Devices and Hearing Aids, FCC published KDB 285076 D01 HAC Guidance v06r04, FCC Published KDB285076 D03 HAC FAQ v01r06 and TCB Workshop updates.

3. DEVICE UNDER TEST DESCRIPTION

3.1 DUT specification

Device Wireless specification overview		
Band & Mode	Operating Mode	Tx Frequency
GSM850	Voice / Data	824.2 MHz ~ 848.8 MHz
GSM1900	Voice / Data	1 850.2 MHz ~ 1 909.8 MHz
UMTS Band 2	Voice / Data	1 852.4 MHz ~ 1 907.6 MHz
UMTS Band 4	Voice / Data	1 712.4 MHz ~ 1 752.6 MHz
UMTS Band 5	Voice / Data	826.4 MHz ~ 846.6 MHz
LTE FDD Band 2 (PCS)	Voice / Data	1 850.7 MHz ~ 1 909.3 MHz
LTE FDD Band 4 (AWS)	Voice / Data	1 710.7 MHz ~ 1 754.3 MHz
LTE FDD Band 5 (Cell)	Voice / Data	824.7 MHz ~ 848.3 MHz
LTE FDD Band 7	Voice / Data	2 502.5 MHz ~ 2 567.5 MHz
LTE FDD Band 12	Voice / Data	699.7 MHz ~ 715.3 MHz
LTE FDD Band 13	Voice / Data	779.5 MHz ~ 784.5 MHz
LTE FDD Band 14	Voice / Data	790.5 MHz ~ 795.5 MHz
LTE FDD Band 25	Voice / Data	1 850.7 MHz ~ 1 914.3 MHz
LTE FDD Band 26	Voice / Data	814.7 MHz ~ 848.3 MHz
LTE FDD Band 30	Voice / Data	2 307.5 MHz ~ 2 312.5 MHz
LTE TDD Band 38	Voice / Data	2 572.5 MHz ~ 2 617.5 MHz
LTE TDD Band 41	Voice / Data	2 498.5 MHz ~ 2 687.5 MHz
LTE TDD Band 48	Voice / Data	3 552.5 MHz ~ 3 697.5 MHz
LTE FDD Band 66 (AWS)	Voice / Data	1 710.7 MHz ~ 1 779.3 MHz
LTE FDD Band 71	Voice / Data	665.5 MHz ~ 695.5 MHz
NR FDD Band n2 (PCS)	Voice / Data	1 852.5 MHz ~ 1 907.5 MHz
NR FDD Band n5	Voice / Data	826.5 MHz ~ 846.5 MHz
NR FDD Band n7	Voice / Data	2 502.5 MHz ~ 2 567.5 MHz
NR FDD Band n12	Voice / Data	701.5 MHz ~ 713.5 MHz
NR FDD Band n25 (PCS)	Voice / Data	1 852.5 MHz ~ 1 912.5 MHz
NR FDD Band n26	Voice / Data	816.5 MHz ~ 846.5 MHz
NR FDD Band n30	Voice / Data	2 307.5 MHz ~ 2 312.5 MHz
NR TDD Band n38	Voice / Data	2 575 MHz ~ 2 615 MHz
NR TDD Band n41	Voice / Data	2 501.01 MHz ~ 2 685 MHz
NR TDD Band n48	Voice / Data	3 555 MHz ~ 3 695.01 MHz
NR FDD Band n66	Voice / Data	1 712.5 MHz ~ 1 777.5 MHz
NR FDD Band n70	Voice / Data	1 697.5 MHz ~ 1 707.5 MHz
NR FDD Band n71	Voice / Data	665.5 MHz ~ 695.5 MHz
NR TDD Band n77	Voice / Data	3 705 MHz ~ 3 975 MHz
NR TDD Band n77 DoD	Voice / Data	3 445.01 MHz ~ 3 544.98 MHz
NR TDD Band n78	Voice / Data	3 705 MHz ~ 3 795 MHz
NR TDD Band n78 DoD	Voice / Data	3 455.01 MHz ~ 3 544.98 MHz
NR Band n258	Data	24 250 MHz ~ 24 450 MHz; 24 750 MHz ~ 25 250 MHz
NR Band n260	Data	37 000 MHz ~ 40 000 MHz
NR Band n261	Data	27 500 MHz ~ 28 350 MHz
U-NII-1	Voice / Data	5 180 MHz ~ 5 240 MHz
U-NII-2A	Voice / Data	5 260 MHz ~ 5 320 MHz
U-NII-2C	Voice / Data	5 500 MHz ~ 5 720 MHz
U-NII-3	Voice / Data	5 745 MHz ~ 5 825 MHz
U-NII-4	Voice / Data	5 845 MHz ~ 5 885 MHz
U-NII-5	Voice / Data	5 925 MHz ~ 6 425 MHz
U-NII-6	Voice / Data	6 425 MHz ~ 6 525 MHz
U-NII-7	Voice / Data	6 525 MHz ~ 6 865 MHz
U-NII-8	Voice / Data	6 865 MHz ~ 7 115 MHz
2.4 GHz WLAN	Voice / Data	2 412 MHz ~ 2 462 MHz
Bluetooth / LE 5.3	Data	2 402 MHz ~ 2 480 MHz
NFC	Data	13.56 MHz
WPC	Data	110 kHz ~ 148 kHz

3.2 Device Under Test

Normal operation	Held to head	
Back Cover	The Back Cover is not removable	
Test sample information	S/N	Notes
	XCT0421M	RF Emission Test

4. HAC Measurement Set-Up

These measurements are performed using the DASY8 automated dosimetric assessment system. It is made by Schmid & Partner Engineering AG (SPEAG) in Zurich, Switzerland. It consists of high precision robotics system (Staubli), robot controller, Pentium IV computer, near-field probe, probe alignment sensor. The robot is a six-axis industrial robot performing precise movements.

A cell controller system contains the power supply, robot controller, teach pendant (Joystick), and remote control, is used to drive the robot motors. The PC consists of the HP Pentium IV 3.0 GHz computer with Windows XP system and HAC Measurement Software DASY5, A/D interface card, monitor, mouse, and keyboard. The Staubli Robot is connected to the cell controller to allow software manipulation of the robot. A data acquisition electronic (DAE) circuit performs the signal amplification, signal multiplexing, AD-conversion, offset measurements, mechanical surface detection, collision detection, etc. is connected to the Electro-optical coupler (EOC). The EOC performs the conversion from the optical into digital electric signal of the DAE and transfers data to the PC plug-in card.

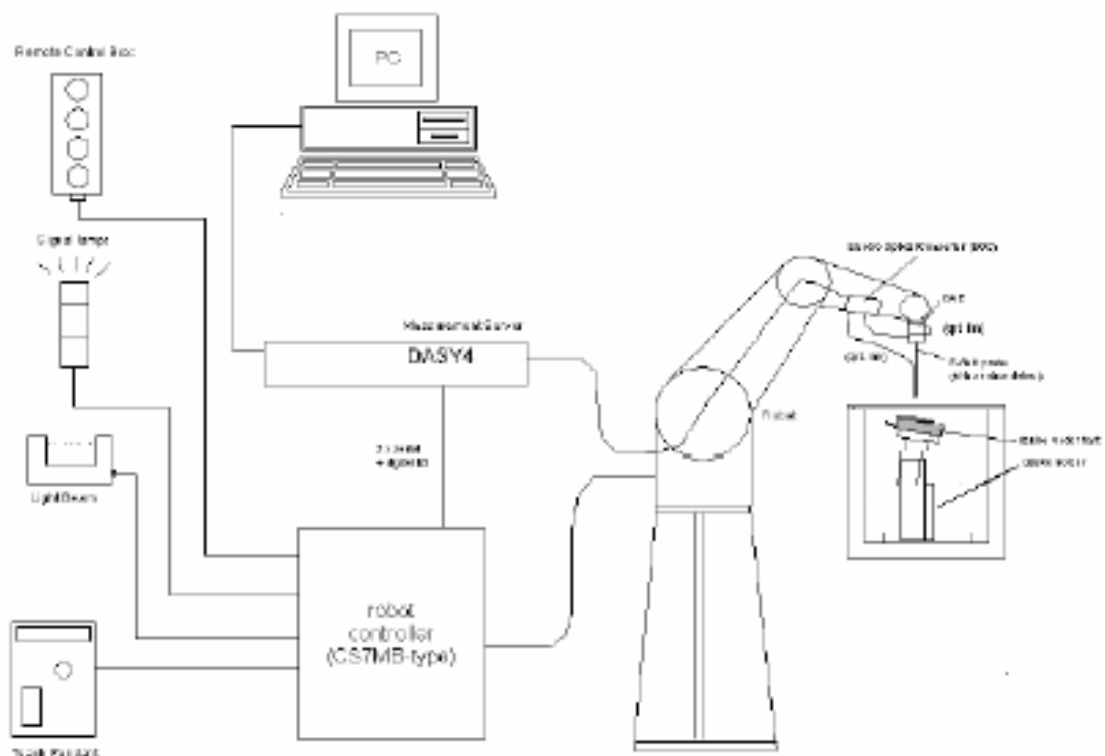

Figure 1. HAC Test Measurement Set-up

The DAE4 consists of a highly sensitive electrometer-grade preamplifier with auto-zeroing, a channel and gain-switching multiplexer, a fast 16 bit AD-converter and a command decoder and control logic unit. Transmission to the PC-card is accomplished through an optical downlink for data and status information and an optical uplink for commands and clock lines.

The mechanical probe mounting device includes two different sensor systems for frontal and sidewise probe contacts. They are also used for mechanical surface detection and probe collision detection.

The robot uses its own controller with a built in VME-bus computer.

5. System Specifications

E-field measurements are performed using the DASY8 automated dosimetric assessment system. The DASY8 is made by Schmid & Partner Engineering AG (SPEAG) in Zurich, Switzerland.

The DASY8 HAC Extension consists of the following parts:

5.1 E-Field Probe Description

EF3DV3 Isotropic E-Field Probe

Construction:	One dipole parallel, two dipoles normal to probe axis Interleaved sensors Built-in shielding against static charges PEEK enclosure material
Calibration:	In air from 30 MHz to 5.8 GHz(absolute accuracy $\pm 5.1\%$, $k=2$) ISO/IEC 17025 <u>calibration service</u> available.
Frequency:	30 MHz – >6 GHz; Linearity: ± 0.2 dB (100 MHz – 3 GHz)
Directivity:	± 0.2 dB in air (rotation around probe axis) ± 0.4 dB in air (rotation normal to probe axis)
Dynamic Range:	2 V/m to > 1000 V/m; Linearity: ± 0.2 dB
Dimensions:	Overall length: 337 mm (Tip: 20 mm) Tip diameter: 3.9 mm (Body: 12 mm) Distance from probe tip to dipole centers: 1.5 mm Sensor displacement to probe's calibration point: <0.7 mm
Application:	General near-field measurements up to 6 GHz HAC measurements up to 6 GHz Field component measurements Fast automatic scanning in phantoms

5.2 Phantom & Device Holder



Figure 2. HAC Phantom & Device Holder

The Test Arch phantom should be positioned horizontally on a stable surface. Reference markings on the Phantom allow the complete setup of all predefined phantom positions and measurement grids by manually teaching three points in the robot.

The specially designed Test Arch allows high precision positioning of both the device and any of the validation dipoles.

5.3 Robotic System Specifications

System information :

The RF Extension enables measurements of the electric (E-) field generated by wireless communication devices around their audio acoustic output. It is composed of an isotropic E-field probe (i.e., EF3DVx) mounted to the precision TX2 robot allowing to scan the field over a user-defined area. The probes are miniaturized, sensitive, isotopic, linear, and stable. The spatial precision of the probe position during scanning is better than 0.2 mm. A Test Arch enables easy and repeatable positioning of the device to be tested. The E-field averaged over the measurement area is provided as requested by the ANSI-C63.19-2019.

Software information :

The Jupyter Notebook web-based GUIs guide the user through the compliance workflow. The main features are: Optimized scanning according to ANSI-C63.19-2019, Integrated system performance check module, Generation of test reports

6. WD emission requirements

The WD's conducted power must be at or below either the stated RFAIPL (Table 6.1) or the stated peak power level (Table 6.2), or the average near-field emissions over the measurement area must be at or below the stated RFAIL (Table 6.3), or the stated peak field strength (Table 6.4).

The WD may demonstrate compliance by meeting any of these four requirements, but it must do so in each of its operating bands at its established worst-case normal speech-mode operating condition.

Table 6.1 -Wireless device RF audio interference power level

Frequency range (MHz)	RF_{AIPL} (dBm)
<960	29
960–2000	26
>2000	25

Table 6.2 -Wireless device RF Peak power level

Frequency range (MHz)	RF_{Peak Power} (dBm)
< 960	35
960–2000	32
>2000	31

Table 6.3 -Wireless device RF audio interference level

Frequency range (MHz)	RF_{AIL} [dB(V/m)]
≤960	39
960–2000	36
>2000	35

Table 6.4 -Wireless device RF Peak near-field level

Frequency range (MHz)	RF_{peak} [dB(V/m)]
≤960	45
960–2000	42
>2000	41

7. System Validation

The test setup was validated when first configured and verified periodically thereafter to ensure proper function. The procedure provided in this section is a validation procedure using dipole antennas for which the field levels were computed by numeric modeling.

Procedure:

Place a dipole antenna meeting the requirements given in ANSI C63.19 in the normally occupied by the WD. The dipole antenna serves as a known source for an electrical and magnetic output. Position the E-field probe so that the following occurs:

- The probes and their cables are parallel to the coaxial feed of the dipole antenna
- The probe cables and the coaxial feed of the dipole antenna approach the measurement area from opposite directions
- The center point of the probe element(s) is 15 mm from the closest surface of the dipole elements.

Scan the length of the dipole with the E-field probe and record the two maximum values found near the dipole ends. Average the two readings and compare the reading to the expected value in the calibration certificate or the expected value in this standard.

Setup diagram

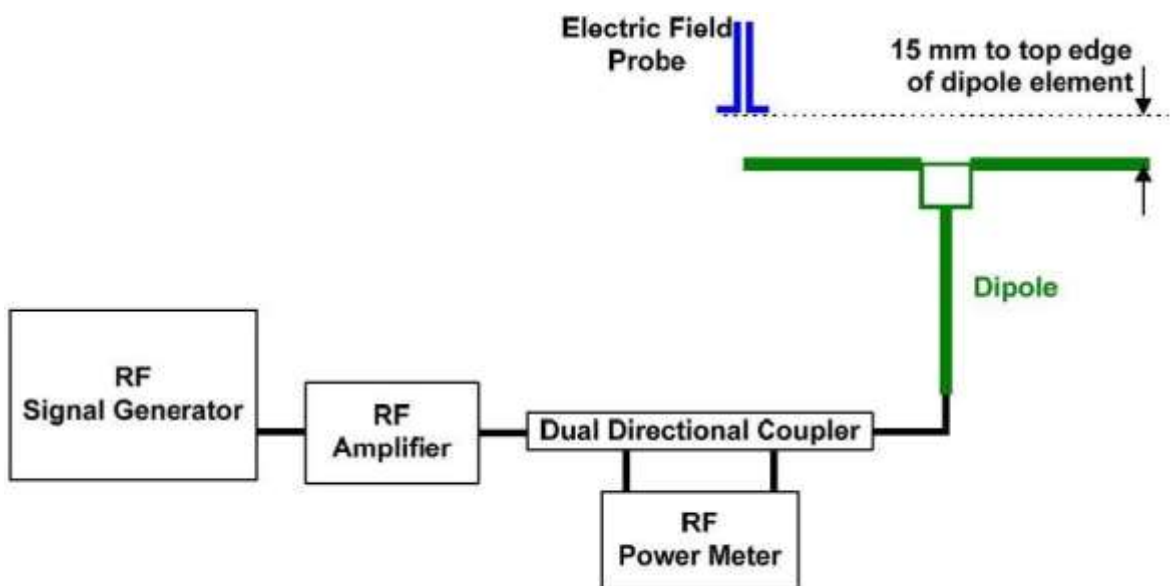

7.1 SYSTEM Validation Result

Mode	Date	Dipole Type_Seria_ Freq.	Input Power	MAX. Measured from		Average max. above arm	Target Value SPEAG	Dev.	Dipole Calib. Due Date
				Above high end	Above low end				
			[dBm]	[V/m]	[V/m]	[V/m]	[V/m]	[%]	
CW	04/15/2024	CD835V3_SN:1024_(835 MHz)	20	105.20	101.65	103.43	109.9	-5.89	02/22/2025
CW	04/15/2024	CD1880V3_SN:1019_(1880 MHz)	20	88.15	86.21	87.18	84.3	+3.42	02/22/2025
CW	04/15/2024	CD2600V3_SN:1019_(2600 MHz)	20	85.30	83.76	84.53	84.5	+0.04	09/22/2025
CW	04/15/2024	CD3500V3_SN:1012_(3500 MHz)	20	82.98	81.24	82.11	82.0	+0.13	11/17/2025

Notes:

- 1) Delta (%) = 100 * (Measured value minus Target value) divided by Target value.
ANSI-C63.19 requires values to be within 18% of their targets. 12% is deviation and 13% is measurement uncertainty.
- 2) The maximum E-field was evaluated and compared to the target values provided by SPEAG in the calibration certificate of specific dipoles.
- 3) Please refer to the attachment for detailed measurement data and plot.

8. Modulation Interference Factor (MIF)

The HAC Standard ANSI C63.19 defines a new scaling using the Modulation Interference Factor (MIF) which replaces the need for the Articulation Weighting Factor (AWF) during the evaluation and is applicable to any modulation scheme.

The Modulation Interference factor (MIF, in dB) is added to the measured average E-field (in dBV/m) and converts it to the RF Audio Interference level (in dBV/m). This level considers the audible amplitude modulation components in the RF E-field. CW fields without amplitude modulation are assumed to not interfere with the hearing aid electronics. Modulations without time slots and low fluctuations at low frequencies have low MIF values, TDMA modulations with narrow transmission and repetition rates of few 100 Hz have high MIF values and give similar classifications as ANSI C63.19.

Definitions

E-field probes have a bandwidth <10 kHz and can therefore not evaluate the RF envelope in the full audio band. DASY8 is therefore using the "indirect" measurement method according to ANSI C63.19 which is the primary method. These near field probes read the averaged E-field measurement. Especially for the new high peak-to-average (PAR) signal types, the probes shall be linearized by probe modulation response (PMR) calibration in order to not overestimate the field reading.

The evaluation method or the MIF is defined in ANSI C63.19 section D.7. An RMS demodulated RF signal is fed to a spectral filter (similar to an A weighting filter) and forwarded to a temporal filter acting as a quasi-peak detector. The averaged output of these filtering is called to a 1 kHz 80% AM signal as reference. MIF measurement requires additional instrumentation and is not well suited for evaluation by the end user with reasonable uncertainty. It may alternatively be determined through analysis and simulation, because it is constraint and characteristic for a communication signal. DASY8 uses well defined signals for PMR calibration. The MIF of these signals has been determined by simulation and is automatically applied.

MIF values were not tested by a probe or as specified in the standards but are based on analysis provided by SPEAG for all the air interfaces (CDMA, GSM, WCDMA, LTE, NR, and Wi-Fi). The data included in this report are for the worst case operating modes. The UIDs used are listed below:

SPEAG test files

UID	Communication System Name	MIF (dB)
10021-DAC	GSM-FDD (TDMA, GMSK)	3.63
10460-AAB	UMTS-FDD (WCDMA,AMR)	-25.43
10170-CAF	LTE-FDD (SC-FDMA, 1 RB, 20 MHz, 16QAM)	-9.76
10182-CAF	LTE-FDD (SC-FDMA, 1 RB, 15 MHz, 16QAM)	-9.76
10176-CAH	LTE-FDD (SC-FDMA, 1 RB, 10 MHz, 16QAM)	-9.76
10235-CAH	LTE-TDD (SC-FDMA, 1 RB, 10 MHz, 16QAM)	-1.44
10173-CAH	LTE-TDD (SC-FDMA, 1 RB, 20 MHz, 16QAM)	-1.44
10061-CAB	IEEE 802.11b WiFi 2.4 GHz (DSSS, 11 Mbps)	-2.02
10077-CAB	IEEE 802.11g WiFi 2.4 GHz (DSSS/OFDM, 54 Mbps)	0.12
10069-CAD	IEEE 802.11a/h WiFi 5 GHz (OFDM, 54 Mbps)	-3.15
10591-AAC	IEEE 802.11n (HT Mixed, 20MHz, MCS0, 90pc dc)	-5.59
10607-AAC	IEEE 802.11ac WiFi (20MHz, MCS0, 90pc dc)	-5.60
10616-AAC	IEEE 802.11ac WiFi (40MHz, MCS0, 90pc dc)	-5.57
10626-AAC	IEEE 802.11ac WiFi (80MHz, MCS0, 90pc dc)	-5.64
10636-AAD	IEEE 802.11ac WiFi (160MHz, MCS0, 90pc duty cycle)	-5.56
10671-AAC	IEEE 802.11ax WiFi (20MHz, MCS0, 90pc dc)	-5.58
10695-AAC	IEEE 802.11ax WiFi (40MHz, MCS0, 90pc dc)	-6.01
10719-AAC	IEEE 802.11ax WiFi (80MHz, MCS0, 90pc dc)	-6.04
10743-AAC	IEEE 802.11ax (160MHz, MCS0, 90pc duty cycle)	-6.60
10929-AAC	5G NR (DFT-s-OFDM, 1 RB, 10 MHz, QPSK, 15 kHz)	-15.06
10930-AAC	5G NR (DFT-s-OFDM, 1 RB, 15 MHz, QPSK, 15 kHz)	-15.06
10931-AAC	5G NR (DFT-s-OFDM, 1 RB, 20 MHz, QPSK, 15 kHz)	-15.06
10934-AAC	5G NR (DFT-s-OFDM, 1 RB, 40 MHz, QPSK, 15 kHz)	-15.07
10973-AAD	5G NR (DFT-s-OFDM, 1 RB, 100 MHz, QPSK, 30 kHz) 5G NR (DFT-s-OFDM, 1 RB, 40 MHz, QPSK, 30 kHz)	-1.64

A PMR calibrated probe is linearized for the selected waveform over the full dynamic range within the uncertainty specified in its calibration certificate. E-field probes have a bandwidth <10 kHz and can therefore not evaluate the RF envelope in the full audio band. DASY8 is therefore using the "Windirect" measurement method according to ANSI C63.19 which is the primary method. These near field probes read the averaged E-field measurement. Especially for the new high peak-to-average (PAR) signal types, the probes shall be linearized by PMR calibration in order to not overestimate the field reading.

The MIF measurement uncertainty is estimated as follows, for modulation frequencies from slotted waveforms with fundamental frequency and at least 2 harmonics within 10 kHz:

- 0.2 dB for MIF -7 to +5 dB,
- 0.5 dB for MIF -13 to +11 dB
- 1 dB for MIF > -20 dB

9. Analysis of RF Air interface Technologies

An analysis was performed, following the guidance of 4.2 and 4.5 of the ANSI standard, of the RF air interface technologies being evaluated. The factors that will affect the RF interference Potential were evaluated, and the worst case operating modes were identified and used in the evaluation. A WD's interference potential is a function both of the WD's average near-field field strength and of the signal's audio-frequency amplitude modulation characteristics. Per 4.2, The WD's conducted power must be at or below either the stated RFAIPL (Table 6.1) or the stated peak power level (Table 6.2), or the average near-field emissions over the measurement area must be at or below the stated RFAIL (Table 5.3), or the stated peak field strength (Table 6.4).

Only transmit modes that occur during conversational speech with the WD held in a talking position at the ear should be considered. The transmit modes to be tested shall be clearly identified in the test report.

a) Measure peak conducted power; compare to the associated qualification level.

b) Measure RF audio interference power level (RFAIPL) (see 4.4); compare to the associated qualification level.

- Indirect measurement, where the waveform-specific modulation interference factor (MIF), as specified in D.7, is measured separately and added to the measured average conducted power, in dBm. The MIF is independent of overall signal level (within the constraints of the transmission protocol) and may be measured using either a conducted input or an air interface.

Table 6.1 -Wireless device RF audio interference power level

Frequency range (MHz)	RFAIPL (dBm)
<960	29
960–2000	26
>2000	25

c) Measure peak E-field strength, averaged over the designated scan area (see 4.5.3.2.4); compare to the associated qualification level.

d) Measure RF audio interference level (RFAIL), averaged over the designated scan area (see 4.5.3); compare to the associated qualification level.

9.1 Air Interfaces and Operating Mode

Air-Interface	Band (MHz)	Type	Evaluation	Simultaneous Transmissions	Name of Voice service
GSM	850	VO	RFAIL	Yes: BT, WLAN	CMRS Voice
	1900				
	GPRS/EDGE	VD	N/A	Yes: BT, WLAN	Google Meet
WCDMA	850	VO	RFAIPL	Yes: BT, WLAN	CMRS Voice
	1700				
	1900				
	HSPA	VD	N/A	Yes: BT, WLAN	Google Meet
LTE (FDD)	680 (B71)	VD	RFAIPL	Yes: NR, BT, WLAN	VoLTE, Google Meet
	700 (B12/13/14)				
	850 (B5/26)				
	1700 (B4/66)				
	1900 (B2/25)				
	2300 (B30)				
	2500 (B7)				
LTE (TDD)	2600 (B41/B38)	VD	RFAIL	Yes: NR, BT, WLAN	VoLTE, Google Meet
	3600 (B48)		RFAIPL		
NR(FDD)	680(B71)	VD	RFAIPL	Yes: LTE, BT, WLAN	VoNR,Google Meet
	700(B12)				
	850(B5/26)				
	1700(B66,B70)				
	1900(B2/25)				
	2300(B30)				
	2500 (B7)				
NR -TDD	2600(B41)	VD	RFAIL	Yes: LTE, BT, WLAN	VoNR,Google Meet
	3800(B77, B78)		RFAIL		
	25000 (n258)		No ¹		
	28000 (n261)		No ¹		
	39000 (n260)		No ¹		
WLAN	2450	VD	RFAIPL	Yes: WWAN, BT and WLAN 5GHz, 6GHz	VoWiFi, Google Meet
	5200 (U-NII-1)		RFAIPL	Yes: WWAN and WLAN 2.4GHz, BT	
	5300 (U-NII-2A)		RFAIPL		
	5500 (U-NII-2C)		RFAIPL		
	5800 (U-NII-3)		RFAIPL		
	5900 (U-NII-4)		RFAIPL		
	6200(UNII 5)		RFAIPL ²		
	6500(UNII 6)		No ¹		
	6700(UNII 7)		No ¹		
	7000(UNII 8)		No ¹		
BT	2450	DT	RFAIPL		Yes: WWAN and Wifi 5GHz
Type Transport VO = CMRS Voice Service DT = Digital Transport VD = CMRS IP Voice Service and Digital Transport			Note: 1. N251, n260,n261, Wifi 6GHz are currently outside the scope of ANSI C63.19 and FCC HAC regulations. 2.UNII band 5 was evaluated for operations which are entirely below 6 GHz.		

9.2 Individual Mode Evaluations For RF Audio interference Power Level (RFAIPL)

Max. Average Power + MIF calculations for Low Power Exemptions

Air Interface	Maximum [dBm]	Worst case MIF [dBm]	RFAIPL [dBm]	RFAIPL Limit [dBm]	RFAIPL
GSM850 ANT A	31.0	3.63	34.63	≥29 dBm	Measurement
GSM1900 ANT A	29.0	3.63	32.63	≥26 dBm	Measurement
WCDMA 850 ANT A	24.0	-25.43	-1.43	≥29 dBm	Pass
WCDMA 1700 ANT A	23.0	-25.43	-2.43	≥26 dBm	Pass
WCDMA 1900 ANT A	22.5	-25.43	-2.93	≥26 dBm	Pass
LTE Band 2 ANT A	23.3	-9.76	13.54	≥26 dBm	Pass
LTE Band 2 ANT I	25.0	-9.76	15.24	≥26 dBm	Pass
LTE Band 4 ANT A	23.3	-9.76	13.54	≥26 dBm	Pass
LTE Band 4 ANT I	25.5	-9.76	15.74	≥26 dBm	Pass
LTE Band 5 ANT A	24.5	-9.76	14.74	≥29 dBm	Pass
LTE Band 7 ANT B	22.3	-9.76	12.54	≥25 dBm	Pass
LTE Band 7 ANT I	25.0	-9.76	15.24	≥25 dBm	Pass
LTE Band 12 ANT A	24.5	-9.76	14.74	≥29 dBm	Pass
LTE Band 13 ANT A	24.3	-9.76	14.54	≥29 dBm	Pass
LTE Band 14 ANT A	24.0	-9.76	14.24	≥29 dBm	Pass
LTE Band 25 ANT A	23.3	-9.76	13.54	≥26 dBm	Pass
LTE Band 25 ANT I	25.0	-9.76	15.24	≥26 dBm	Pass
LTE Band 26 ANT A	24.5	-9.76	14.74	≥29 dBm	Pass
LTE Band 30 ANT B	21.5	-9.76	11.74	≥25 dBm	Pass
LTE Band 30 ANT I	24.0	-9.76	14.24	≥25 dBm	Pass
LTE Band 38 ANT B	22.0	-1.44	20.56	≥25 dBm	Pass
LTE Band 38 ANT I	25.0	-1.44	23.56	≥25 dBm	Pass
LTE Band 41 (PC2) ANT B	25.0	-1.44	23.56	≥25 dBm	Pass
LTE Band 41 (PC3) ANT B	22.0	-1.44	20.56	≥25 dBm	Pass
LTE Band 41 (PC2) ANT I	26.5	-1.44	25.06	≥25 dBm	Measurement
LTE Band 41 (PC3) ANT I	25.0	-1.44	23.56	≥25 dBm	Pass
LTE Band 48 ANT F	24.0	-1.44	22.56	≥25 dBm	Pass
LTE Band 66 ANT A	23.8	-9.76	14.04	≥26 dBm	Pass
LTE Band 66 ANT I	25.5	-9.76	15.74	≥26 dBm	Pass
LTE Band 71 ANT A	25.0	-9.76	15.24	≥29 dBm	Pass
NR Band 2 ANT A	23.0	-15.06	7.94	≥26 dBm	Pass
NR Band 2 ANT I	25.0	-15.06	9.94	≥26 dBm	Pass
NR Band 5 ANT A	24.5	-15.06	9.44	≥29 dBm	Pass
NR Band 7 ANT B	22.0	-15.06	6.94	≥25 dBm	Pass
NR Band 7 ANT I	24.5	-15.06	9.44	≥25 dBm	Pass
NR Band 12 ANT A	24.5	-15.06	9.44	≥29 dBm	Pass
NR Band 25 ANT A	23.0	-15.06	7.94	≥26 dBm	Pass
NR Band 25 ANT I	25.0	-15.06	9.94	≥26 dBm	Pass
NR Band 26 ANT A	24.5	-15.06	9.44	≥29 dBm	Pass
NR Band 30 ANT B	22.0	-15.06	6.94	≥25 dBm	Pass
NR Band 30 ANT I	24.0	-15.06	8.94	≥25 dBm	Pass
NR Band 38 ANT B	22.0	-1.64	20.36	≥25 dBm	Pass
NR Band 38 ANT I	24.5	-1.64	22.86	≥25 dBm	Pass
NR Band 41 (PC2) ANT I	28.0	-1.64	26.36	≥25 dBm	Measurement
NR Band 48 ANT F	24.5	-1.64	22.86	≥25 dBm	Pass
NR Band 66 ANT A	23.5	-15.06	8.44	≥26 dBm	Pass

Air Interface	Maximum [dBm]	Worst case MIF [dBm]	RFAIPL [dBm]	RFAIPL Limit [dBm]	RFAIPL
NR Band 66 ANT I	25.7	-15.06	10.64	≥26 dBm	Pass
NR Band 70 ANT A	23.5	-15.06	8.44	≥26 dBm	Pass
NR Band 70 ANT I	25.5	-15.06	10.44	≥26 dBm	Pass
NR Band 71 ANT A	25.0	-15.06	9.94	≥29 dBm	Pass
NR Band 77(PC2) ANT F	27.0	-1.64	25.36	≥25 dBm	Measurement
NR Band 78(PC2) ANT F	27.0	-1.64	25.36	≥25 dBm	Measurement ³
802.11b(2.4GHz)	22.0	-2.02	19.98	≥25 dBm	Pass
802.11g(2.4GHz)	21.0	0.12	21.12	≥25 dBm	Pass
802.11n (2.4GHz)	21.0	-5.59	15.41	≥25 dBm	Pass
802.11ac (2.4GHz)	20.0	-5.57	14.43	≥25 dBm	Pass
802.11ax (2.4GHz)	20.0	-6.60	13.4	≥25 dBm	Pass
802.11a(5GHz) 20 MHz	19.0	-3.15	15.85	≥25 dBm	Pass
802.11n(5GHz) 20 MHz	19.0	-3.15	15.85	≥25 dBm	Pass
802.11n(5GHz) 40 MHz	18.0	-3.15	14.85	≥25 dBm	Pass
802.11ac(5GHz) 20 MHz	19.0	-5.57	13.43	≥25 dBm	Pass
802.11ac(5GHz) 40 MHz	18.0	-5.57	12.43	≥25 dBm	Pass
802.11ac(5GHz) 80 MHz	17.0	-5.57	11.43	≥25 dBm	Pass
802.11ax(5GHz) 20 MHz	19.0	-6.60	12.4	≥25 dBm	Pass
802.11ax(5GHz) 40 MHz	18.0	-6.60	11.4	≥25 dBm	Pass
802.11ax(5GHz) 80 MHz	17.0	-6.60	10.4	≥25 dBm	Pass
802.11ax(5GHz) 160 MHz	16.0	-6.60	9.4	≥25 dBm	Pass
Bluetooth	19.0	1.02	20.02	≥25 dBm	Pass

Note(s):

1. Max tune-up limit.
2. LTE Band 41, LTE Band 48 Support intra-band contiguous uplink carrier aggregation with same target power of standalone mode. Testing for uplink carrier aggregation is not required because it uses same Tx Band, modulations and same target power with standalone mode.
3. NR Band 78(Frequency Range : 3450-3550 MHz, 3700-3800 MHz) is covered by NR Band 77 (Frequency Range : 3450-3550 MHz, 3700-3980 MHz). Due to overlapping frequency range.
4. Bluetooth was evaluated in maximum power with BDR mode.

9.3 Measure RF audio interference power level Conclusions

Per ANSI C63.19-2019, RF Emissions testing for this device is required only for GSM Voice Mode as well as LTE TDD (B41) and NR TDD(B41, B77,B78) data mode voice. All other applicable RFAIL tests are exempt from testing in accordance with C63.19 Section 4.7 Table 4.1 - Wireless device RF Audio interference power level.

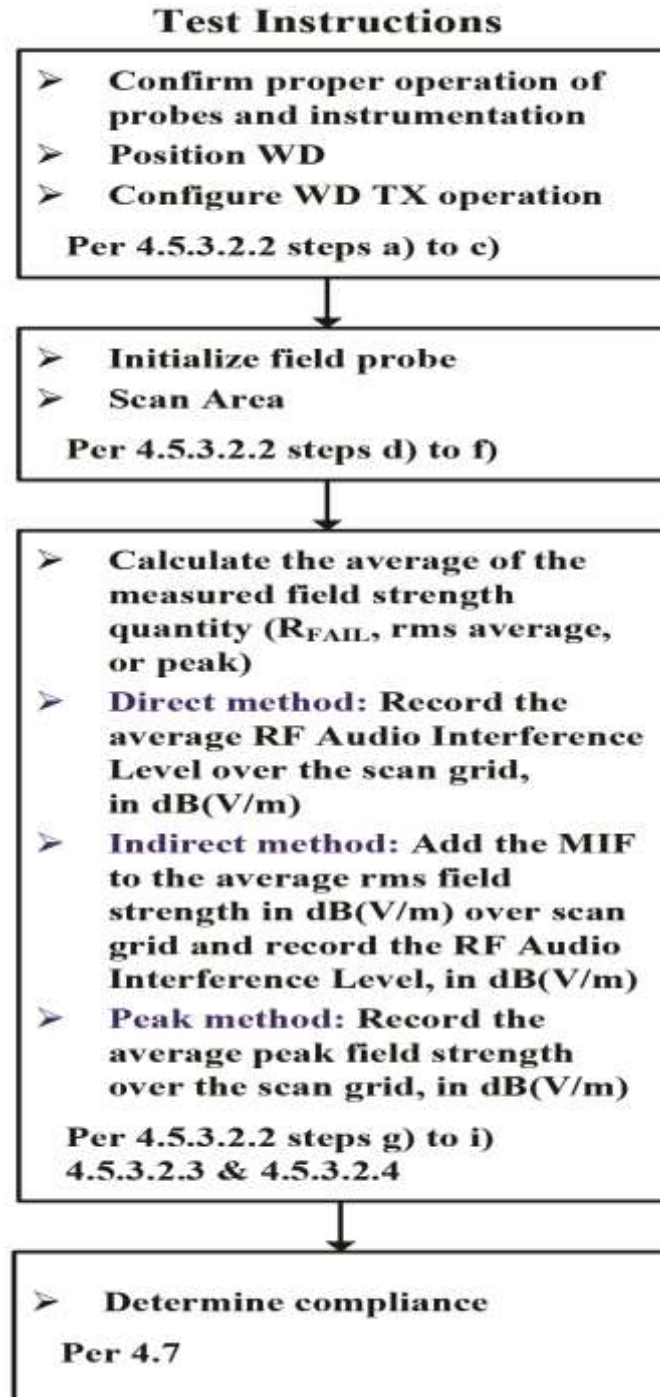
10. HAC RF Emission Test Procedure (RF Audio Interference Level, R_{FAIL})

The evaluation was performed with the following procedure:

- a) Confirm proper operation of the field probe, probe measurement system, spectral and temporal weighting filters, and the positioning system.
- b) Position the WD in its intended test position. A gauge block, depicted in A.1.2, can simplify this positioning.
- c) Set the WD to transmit a fixed and repeatable combination of signal power and modulation characteristic that is representative of the worst case (highest interference potential) encountered in normal use. Transiently occurring start-up, changeover, or termination conditions, or other operation likely to occur less than 1% of the time during normal operation, may be excluded from consideration.
- d) The measurement area shall be centered on the acoustic output or the T-Coil mode measurement reference point, as appropriate. Locate the field probe at the initial test position in the 50 mm by 50 mm measurement area, which is contained in the measurement plane, described in 4.5.2 and illustrated in Figure A.1. If the field alignment method is used, align the probe for maximum field reception.
- e) Record the reading at the output of the measurement system.
- f) Scan the entire 50 mm by 50 mm measurement area in equally spaced step sizes and record the reading at each measurement point. The step size shall meet the specification for step size in 4.5.3.
- g) Calculate the average of the measurements taken in Step f).
- h) Convert the average value found in Step g) to RF audio interference level, in volts per meter, by taking the square root of the reading and then dividing it by the measurement system transfer function, as established in 4.5.3.2.1 pre-test procedure. Convert the result to dB(V/m) by taking the base-10 logarithm and multiplying it by 20. Expressed as a formula:
RF audio interference level in db(V/M)= $20 \times \log(R_{ave}^{1/2} / TF)$
Where, R ave is the average reading
- i) Compare this RF audio interference level to the limits in 4.7 and record the result.

The Picture below illustrates the references and reference plane that shall be used in the WD emissions measurement.

The measurement area is 50.0 mm by 50.0 mm.

The measurement area is centered on the audio frequency output transducer of the WD (speaker or T-Coil signal). The measurement area is in a reference plane, which is defined as the planar area tangent to the highest point in the area of the phone that normally rests against the user's ear. It is parallel to the centerline of the receiver area of the phone and is defined by the points of the receiver-end of the WD handset, which, in normal handset use, rest against the ear. The measurement plane is parallel to, and 15.0 mm in front of, the reference plane.

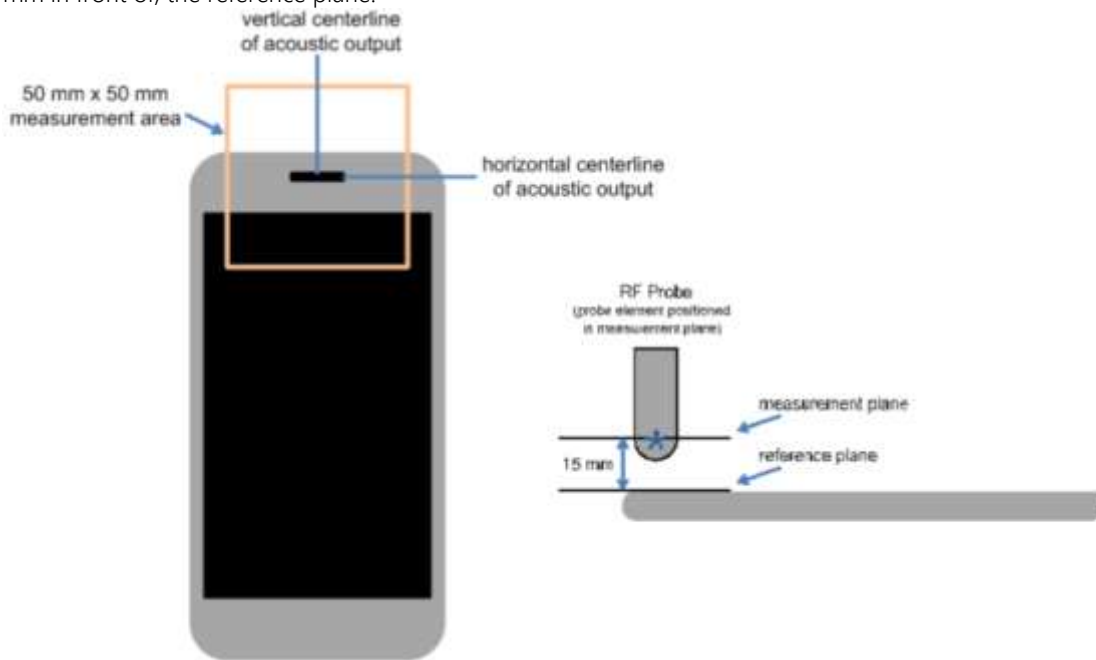

WD reference and plane for RF emission measurements

11. Measurement Uncertainties

Error Description	Uncertainty value [±%]	Probe Dist.	Div.	(Ci) E	Std. Unc. E [±%]
Measurement System					
Probe Calibration	5.10	N	1	1	5.10
Axial Isotropy	4.70	R	√3	1	2.71
Sensor Displacement	7.20	R	√3	1	4.16
Boundary Effects	2.40	R	√3	1	1.39
Phantom Boundary Effect	7.20	R	√3	1	4.16
Linearity	4.70	R	√3	1	2.71
Scaling with PMR calibration	10.00	R	√3	1	5.77
System Detection Limit	1.00	R	√3	1	0.58
Readout Electronics	0.30	N	1	1	0.30
Response Time	0.80	R	√3	1	0.46
Integration Time	2.60	R	√3	1	1.50
RF Ambient Conditions	3.00	R	√3	1	1.73
RF Reflections	12.00	R	√3	1	6.93
Probe Positioner	1.20	R	√3	1	0.69
Probe Positioning	3.00	R	√3	1	1.73
Extrap. and Interpolation	1.00	R	√3	1	0.58
Test Sample Related					
Device Positioning Vertical	4.70	R	√3	1	2.71
Device Positioning Lateral	1.00	R	√3	1	0.58
Device Holder and Phantom	2.40	R	√3	1	1.39
Power Drift	5.00	R	√3	1	2.89
Phantom and Setup Related					
Phantom Thickness	2.40	R	√3	1	1.39
Combined Std. Uncertainty	(k=1)				13.72
Expanded Std. Uncertainty on Power	(Coverage Factor for 95%, k =2)				27.44
Expanded Std. Uncertainty on Field	(Coverage Factor for 95%)				13.72

12. HAC Test Data Summary

E-Field Measurement Result (GSM850/ GSM1900)

Mode	Channel	Results*	Results* Plus 0.2dB uncertainty	R _{FAIL} Limit	FCC Margin	R _{FAIL} Pass/Fail	Plot No.
		[dB(V/m)]	[dB(V/m)]	[dB(V/m)]	[dB]		
GSM 850 ANT A	128	33.68	33.88	39	5.32	Pass	1
	190	33.39	33.59	39	5.61	Pass	2
	251	32.59	32.79	39	6.41	Pass	3
GSM 1900 ANT A	512	21.22	21.42	36	14.78	Pass	4
	661	19.45	19.65	36	16.55	Pass	5
	810	19.59	19.79	36	16.41	Pass	6

Note(s): *: Measured Audio Interference level in Db (V/m): indirect method (max rms field strength Plus MIF)

E-Field Measurement Result (LTE TDD)

Mode	Channel	Mod.	BW	RB Size	RB offset	Results*	Results* Plus 0.2dB uncertainty	R _{FAIL} Limit	FCC Margin	R _{FAIL} Pass/Fail	Plot No.
						[dB(V/m)]	[dB(V/m)]	[dB(V/m)]	[dB]		
LTE TDD Band 41 (PC2) ANT I	39750	16QAM	20	1	0	19.25	19.45	35	15.75	Pass	7
	40185	16QAM	20	1	0	22.29	22.49	35	12.71	Pass	8
	40620	16QAM	20	1	0	22.26	22.46	35	12.74	Pass	9
	41055	16QAM	20	1	0	21.60	21.8	35	13.40	Pass	10
	41490	16QAM	20	1	0	20.55	20.75	35	14.45	Pass	11
NR Band n41 PC2 ANT I	518598	DFT-s QPSK	100	1	1	23.74	23.94	35	11.26	Pass	12

Note(s): *: Measured Audio Interference level in Db (V/m): indirect method (max rms field strength Plus MIF)

E-Field Measurement Result (NR TDD)

Mode	Ch.	Mod.	BW	RB Size	RB offset	Results*	Results* Plus 0.2dB uncertainty	RFAIL Limit	FCC Margin	RFAIL Pass/Fail	Plot No.
						[dB(V/m)]	[dB(V/m)]	[dB(V/m)]	[dB]		
NR Band n77 PC2 ANT F	650000	DFT-s QPSK	100	1	1	27.88	28.08	35	7.12	Pass	13
	656000	DFT-s QPSK	100	1	1	27.78	27.98	35	7.22	Pass	14
	662000	DFT-s QPSK	100	1	1	28.09	28.29	35	6.91	Pass	15
NR Band n77 DoD PC2 ANT F	633334	DFT-s QPSK	100	1	1	27.69	27.89	35	7.31	Pass	16

Note(s): *: Measured Audio Interference level in Db (V/m): indirect method (max rms field strength Plus MIF)

13. HAC Test Equipment Chamber List

The test sites and measurement facilities used to collect data are located at

SAR 12 Room(HAC)

14. HAC Test Equipment List

Manufacturer	Type / Model	S/N	Calib. Date	Calib.Interval	Calib.Due
SPEAG	HAC Phantom	-	N/A	N/A	N/A
HP	SAR System Control PC	-	N/A	N/A	N/A
Staubli	TX2-60 Lspe	F/21/0029002/A/001	N/A	N/A	N/A
Staubli	CS9spe-TX2-60	F/21/0029002/C/001	N/A	N/A	N/A
Staubli	Teach Pendant (Joystick)	D21144507C	N/A	N/A	N/A
Staubli	Light Alignment Sensor	2007	N/A	N/A	N/A
SPEAG	DAE4	1254	06/02/2023	Annual	06/02/2024
SPEAG	E-Field Probe EF3DV3*	4034	01/16/2024	Annual	01/16/2025
SPEAG	Dipole CD835V3	1024	02/22/2023	Annual	02/22/2025
SPEAG	Dipole CD1880V3	1019	02/22/2023	Annual	02/22/2025
SPEAG	Dipole CD2600V3	1019	09/22/2023	Annual	09/22/2025
SPEAG	Dipole CD3500V3	1012	11/17/2023	Annual	11/17/2025
HP	Power Meter E4419B	MY40511243	02/15/2024	Annual	02/15/2025
Agilent	Power Sensor 8481A	SG1091286	09/21/2023	Annual	09/21/2024
Agilent	Power Sensor 8481A	MY41090675	09/21/2023	Annual	09/21/2024
Agilent	Power Meter N1911A	MY45101406	05/26/2023	Annual	05/26/2024
Agilent	Power Sensor N1921A	MY55220026	07/28/2023	Annual	07/28/2024
Agilent	Signal Generator N5182A	MY47070230	03/19/2024	Annual	03/19/2025
Agilent	11636B/Power Divider	58698	01/15/2024	Annual	01/15/2025
TESTO	608-H1/Thermometer	83239085	10/24/2023	Annual	10/24/2024
EMPOWER	RF Power Amplifier / 2135DEFAAXLXX	1084	05/26/2023	Annual	05/26/2024
Agilent	Directional Bridge 86205A	3140A04581	04/25/2023	Annual	04/25/2024
MICRO LAB	LP Filter / LA-60N	32011	09/21/2023	Annual	09/21/2024
MICRO LAB	LP Filter / LA-30N	-	09/21/2023	Annual	09/21/2024
MICRO LAB	LP Filter / LA-15N	10453	09/21/2023	Annual	09/21/2024
HP	Attenuator (3dB) 333340A	02427	08/22/2023	Annual	08/22/2024
WEINSCHL	Attenuator (20dB) Y6979	464269	08/22/2023	Annual	08/22/2024
WEINSCHL	Attenuator (10dB) 3M-10	z6226	10/23/2023	Annual	10/23/2024
HP	Attenuator (20dB) 8493C	09271	08/22/2023	Annual	08/22/2024
R & S	Radio Communication Tester	167918	03/20/2024	Annual	03/20/2025
Agilent	MXA Signal Analyzer N9020A	MY50510407	06/07/2023	Annual	06/07/2024
R & S	BLUETOOTH TESTER CBT	100272	01/16/2024	Annual	01/16/2025
Anritsu	Radio Communication Tester MT8821C	6262044720	11/28/2023	Annual	11/28/2024
Anritsu	Radio Communication Tester MT8000A	6262036812	11/28/2023	Annual	11/28/2024
Keysight	UXM 5G Wireless Test Set	MY58460166	08/01/2023	Annual	08/01/2024

*: According to SPEAG's Technical Report, "MIF Verification", Doc # TR-FB-12.09.04-1, issued date: 9/4/2012. E-field probes are calibrated with specified uncertainty according to ISO 17025 as described in their calibration certificate. The MIF according to the definition in ANSI C63.19 is specific for a modulation and can therefore be used as a constant value if the probe has been PMR calibrated.

15. CONCLUSION

The HAC measurement indicates that the EUT complies with the HAC limits of the ANSI-C63.19-2019. These measurements are taken to simulate the RF effects exposure under worst-case conditions. Precise Laboratory measures were taken to assure repeatability of the tests.

Appendix A. TEST SETUP PHOTO

Please refer to test Setup Photo file no. as follows;

Rev. No.	File No.
0	HCT-SR-2404-FC002-P

Appendix B. HAC RF Emission Test Plots

Plot No.1

Date : 2024-04-15

GSM850 128ch ANT A
Hardware Setup

Probe Name	Probe Calibration Date	DAE Name	DAE Calibration Date
EF3DV3 - SN4034	January 16, 2024	DAE4 Sn1254	June 02, 2023

Communication Systems

Band Name	Communication Systems Name	Channel	Frequency [MHz]
GSM 850	GSM-FDD (TDMA, GMSK)	128	824.2

Grid Settings

Extent X [mm]	Extent Y [mm]	Step X [mm]	Step Y [mm]	Distance [mm]
50.0	50.0	5.0	5.0	15.0

Results

E _{max} [dB(V/m)]	E _{avg50x50 max} [dB(V/m)]	MIF [dB]	RFail [dB(V/m)]
32.45	30.05	3.63	33.68

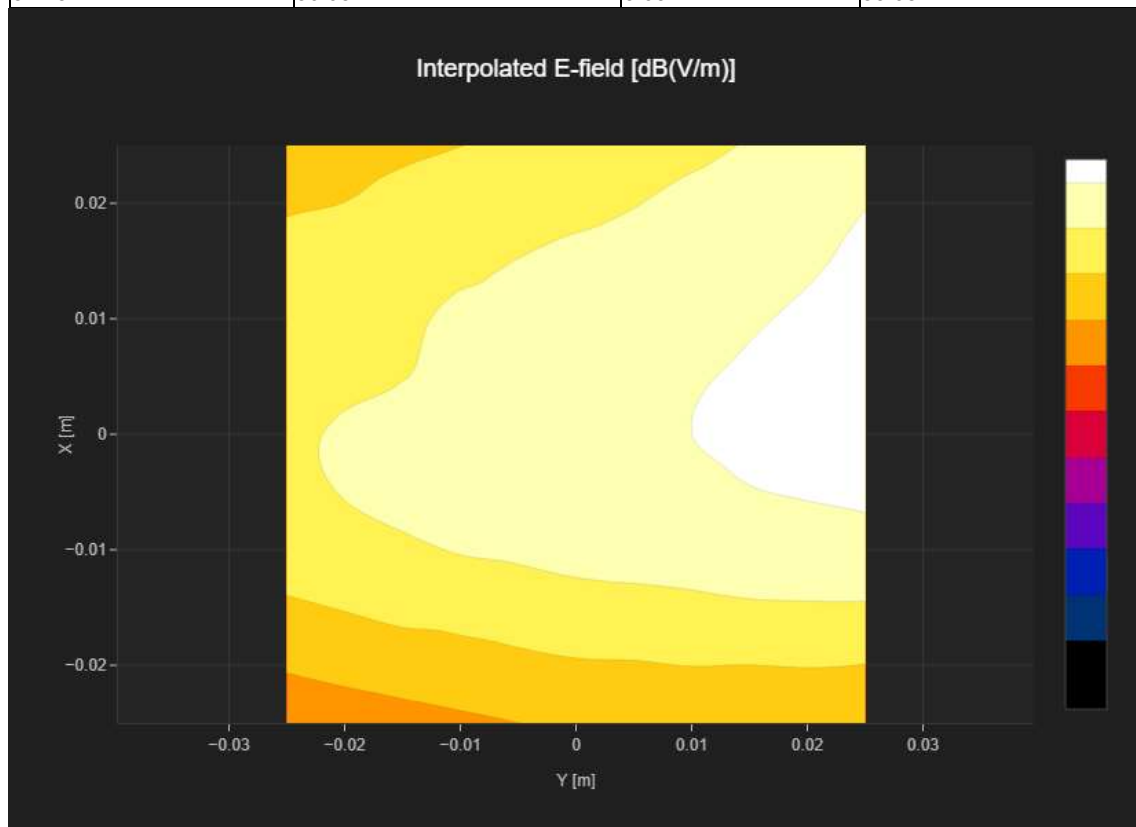

Plot No.2

Date : 2024-04-15

GSM850 190ch ANT A
Hardware Setup

Probe Name	Probe Calibration Date	DAE Name	DAE Calibration Date
EF3DV3 - SN4034	January 16, 2024	DAE4 Sn1254	June 02, 2023

Communication Systems

Band Name	Communication Systems Name	Channel	Frequency [MHz]
GSM 850	GSM-FDD (TDMA, GMSK)	190	836.6

Grid Settings

Extent X [mm]	Extent Y [mm]	Step X [mm]	Step Y [mm]	Distance [mm]
50.0	50.0	5.0	5.0	15.0

Results

E _{max} [dB(V/m)]	E _{avg50x50 max} [dB(V/m)]	MIF [dB]	RFail [dB(V/m)]
32.38	29.76	3.63	33.39

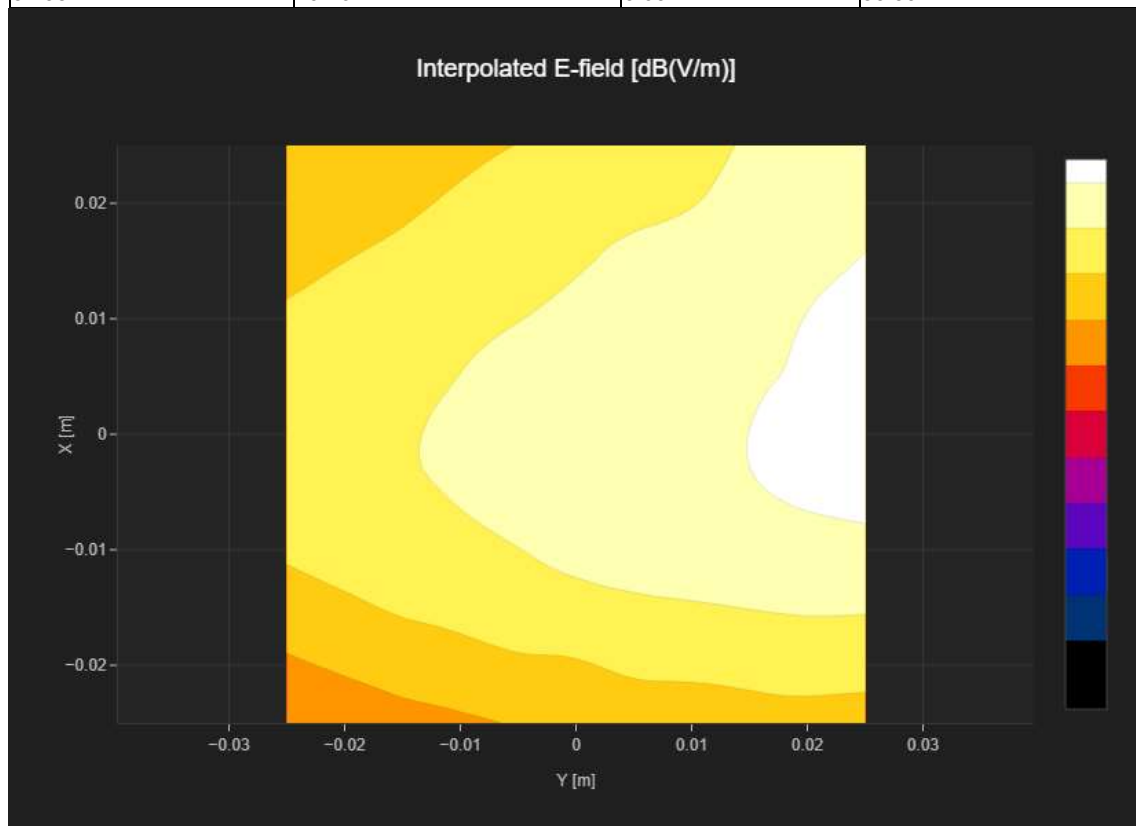

Plot No.3

Date : 2024-04-15

GSM850 251ch ANT A
Hardware Setup

Probe Name	Probe Calibration Date	DAE Name	DAE Calibration Date
EF3DV3 - SN4034	January 16, 2024	DAE4 Sn1254	June 02, 2023

Communication Systems

Band Name	Communication Systems Name	Channel	Frequency [MHz]
GSM 850	GSM-FDD (TDMA, GMSK)	251	848.8

Grid Settings

Extent X [mm]	Extent Y [mm]	Step X [mm]	Step Y [mm]	Distance [mm]
50.0	50.0	5.0	5.0	15.0

Results

E _{max} [dB(V/m)]	E _{avg50x50 max} [dB(V/m)]	MIF [dB]	RFail [dB(V/m)]
31.34	28.96	3.63	32.59

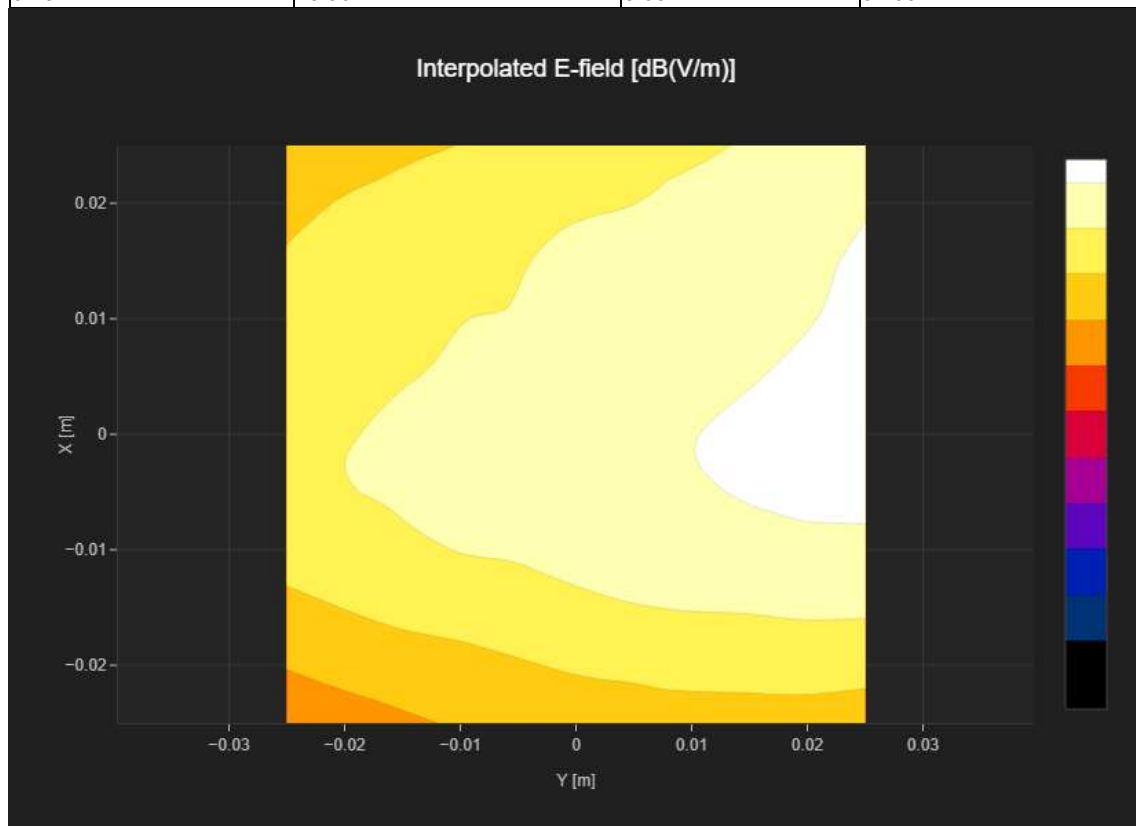

Plot No.4

Date : 2024-04-15

GSM1900 512ch ANT A
Hardware Setup

Probe Name	Probe Calibration Date	DAE Name	DAE Calibration Date
EF3DV3 - SN4034	January 16, 2024	DAE4 Sn1254	June 02, 2023

Communication Systems

Band Name	Communication Systems Name	Channel	Frequency [MHz]
PCS 1900	GSM-FDD (TDMA, GMSK)	512	1850.2

Grid Settings

Extent X [mm]	Extent Y [mm]	Step X [mm]	Step Y [mm]	Distance [mm]
50.0	50.0	5.0	5.0	15.0

Results

E _{max} [dB(V/m)]	E _{avg50x50 max} [dB(V/m)]	MIF [dB]	RFail [dB(V/m)]
21.65	17.59	3.63	21.22

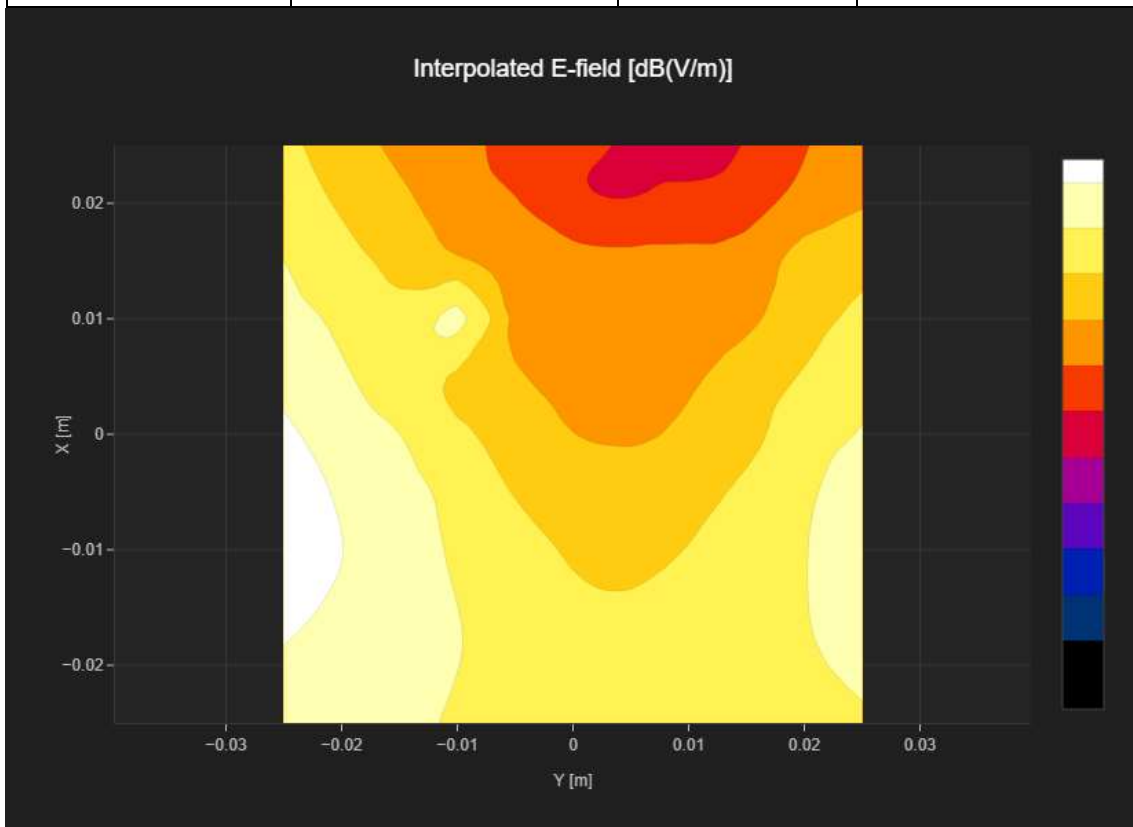

Plot No.5

Date : 2024-04-15

GSM1900 661ch ANT A
Hardware Setup

Probe Name	Probe Calibration Date	DAE Name	DAE Calibration Date
EF3DV3 - SN4034	January 16, 2024	DAE4 Sn1254	June 02, 2023

Communication Systems

Band Name	Communication Systems Name	Channel	Frequency [MHz]
PCS 1900	GSM-FDD (TDMA, GMSK)	661	1880.0

Grid Settings

Extent X [mm]	Extent Y [mm]	Step X [mm]	Step Y [mm]	Distance [mm]
50.0	50.0	5.0	5.0	15.0

Results

E _{max} [dB(V/m)]	E _{avg50x50 max} [dB(V/m)]	MIF [dB]	RFail [dB(V/m)]
19.38	15.82	3.63	19.45

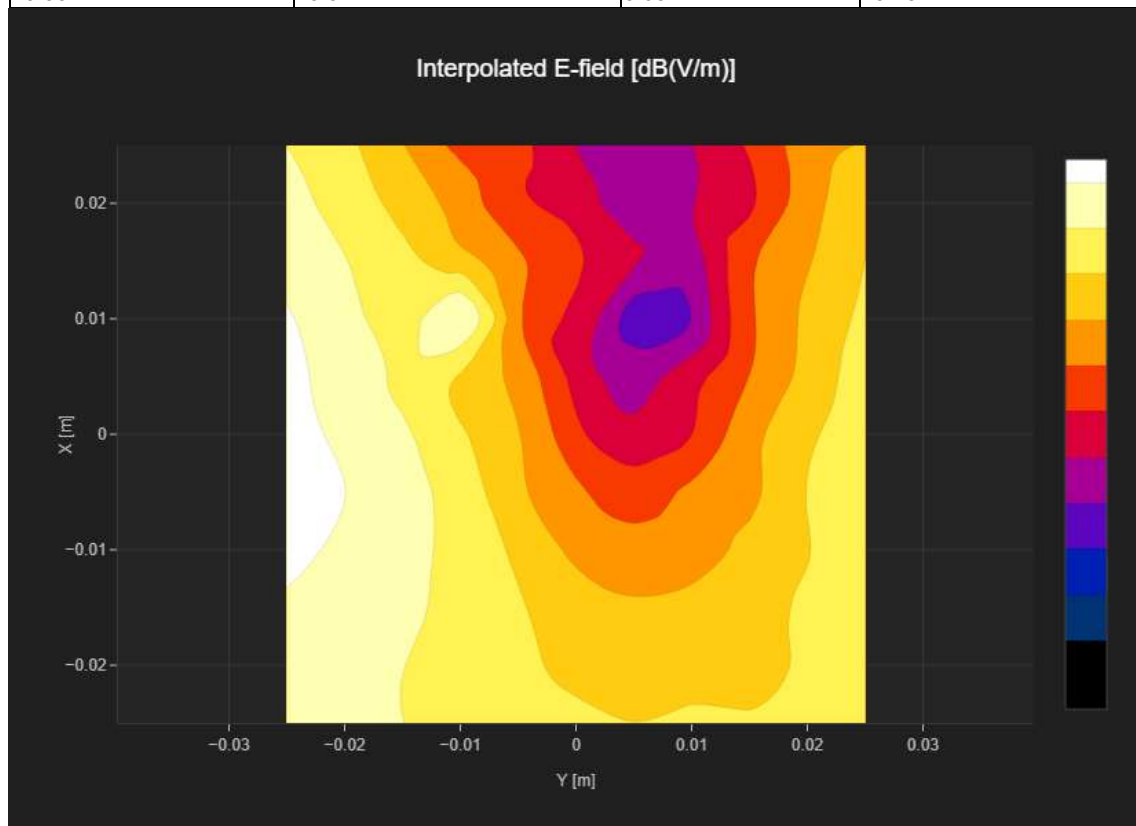

Plot No.6

Date : 2024-04-15

GSM1900 810ch ANT A
Hardware Setup

Probe Name	Probe Calibration Date	DAE Name	DAE Calibration Date
EF3DV3 - SN4034	January 16, 2024	DAE4 Sn1254	June 02, 2023

Communication Systems

Band Name	Communication Systems Name	Channel	Frequency [MHz]
PCS 1900	GSM-FDD (TDMA, GMSK)	810	1909.8

Grid Settings

Extent X [mm]	Extent Y [mm]	Step X [mm]	Step Y [mm]	Distance [mm]
50.0	50.0	5.0	5.0	15.0

Results

E _{max} [dB(V/m)]	E _{avg50x50 max} [dB(V/m)]	MIF [dB]	RFail [dB(V/m)]
19.17	15.96	3.63	19.59

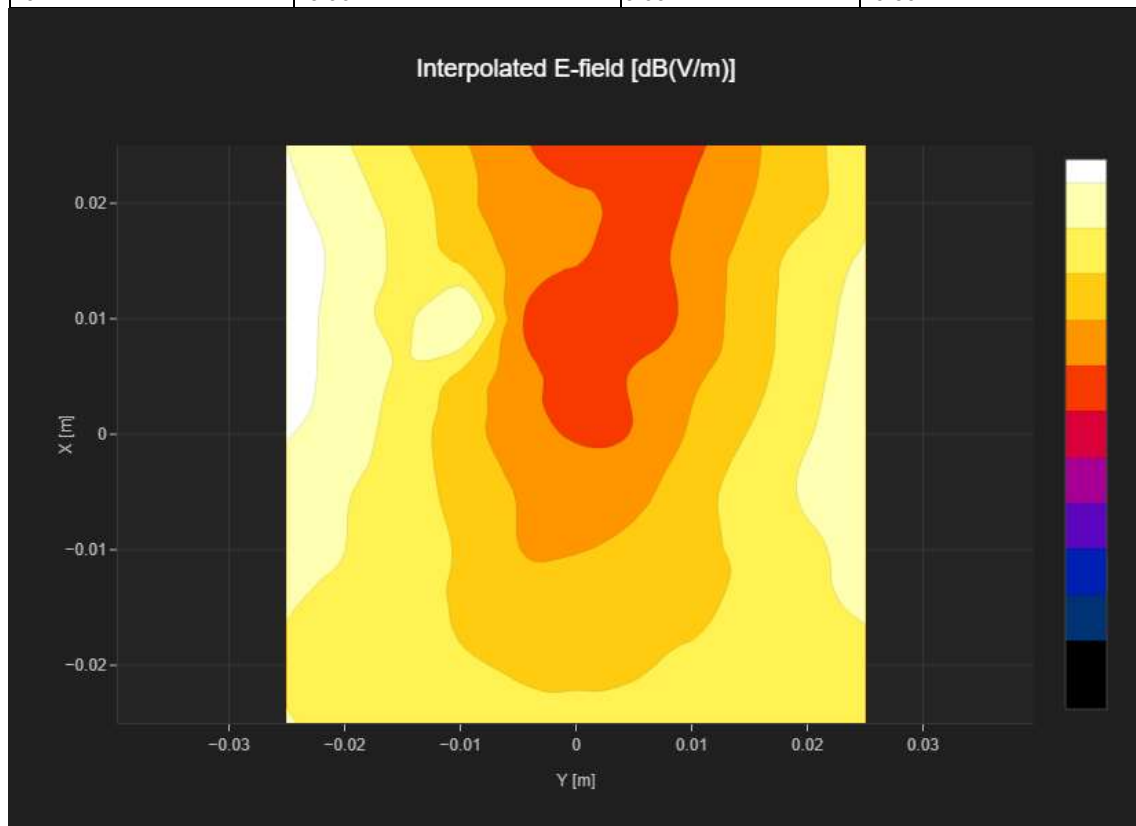

Plot No.7

Date : 2024-04-15

LTE TDD Band 41(PC2) 16QAM 20MHz 1RB 0offset 39750ch ANT I
Hardware Setup

Probe Name	Probe Calibration Date	DAE Name	DAE Calibration Date
EF3DV3 - SN4034	January 16, 2024	DAE4 Sn1254	June 02, 2023

Communication Systems

Band Name	Communication Systems Name	Channel	Frequency [MHz]
Band 41, E-UTRA/TDD	LTE-TDD (SC-FDMA, 1 RB, 20 MHz, 16-QAM)	39750	2506.0

Grid Settings

Extent X [mm]	Extent Y [mm]	Step X [mm]	Step Y [mm]	Distance [mm]
50.0	50.0	5.0	5.0	15.0

Results

E _{max} [dB(V/m)]	E _{avg50x50 max} [dB(V/m)]	MIF [dB]	RFail [dB(V/m)]
28.19	20.69	-1.44	19.25

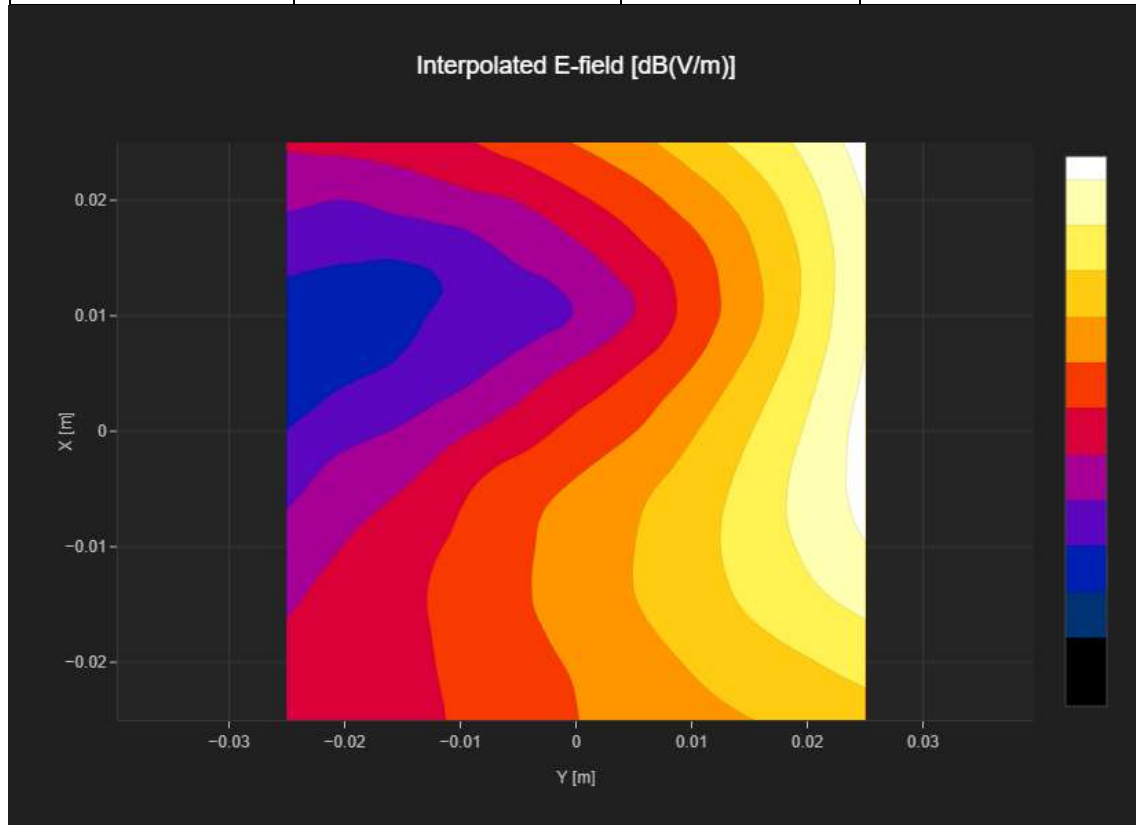

Plot No.8

Date : 2024-04-15

LTE TDD Band 41(PC2) 16QAM 20MHz 1RB 0offset 40185ch ANT I
 Hardware Setup

Probe Name	Probe Calibration Date	DAE Name	DAE Calibration Date
EF3DV3 - SN4034	January 16, 2024	DAE4 Sn1254	June 02, 2023

Communication Systems

Band Name	Communication Systems Name	Channel	Frequency [MHz]
Band 41, E-UTRA/TDD	LTE-TDD (SC-FDMA, 1 RB, 20 MHz, 16-QAM)	40185	2549.5

Grid Settings

Extent X [mm]	Extent Y [mm]	Step X [mm]	Step Y [mm]	Distance [mm]
50.0	50.0	5.0	5.0	15.0

Results

E _{max} [dB(V/m)]	E _{avg50x50 max} [dB(V/m)]	MIF [dB]	RFail [dB(V/m)]
29.2	23.73	-1.44	22.29

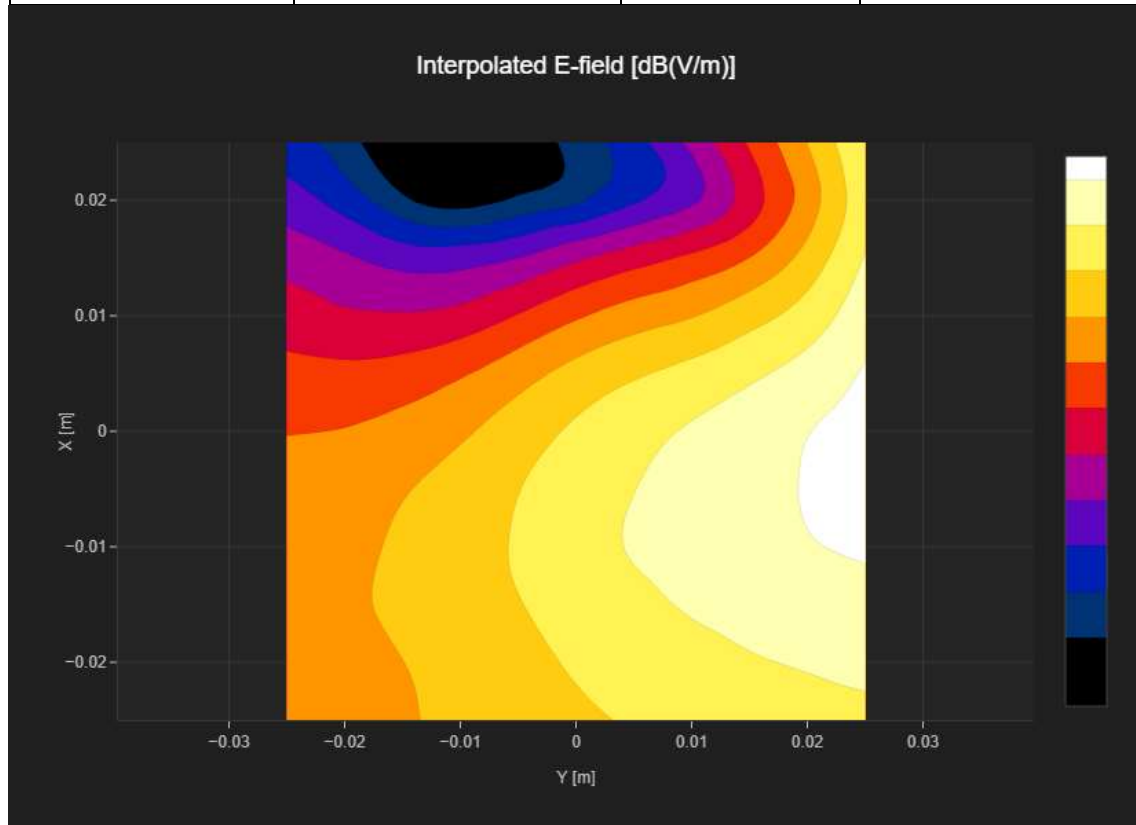

Plot No.9

Date : 2024-04-15

LTE TDD Band 41(PC2) 16QAM 20MHz 1RB 0offset 40620ch ANT I
 Hardware Setup

Probe Name	Probe Calibration Date	DAE Name	DAE Calibration Date
EF3DV3 - SN4034	January 16, 2024	DAE4 Sn1254	June 02, 2023

Communication Systems

Band Name	Communication Systems Name	Channel	Frequency [MHz]
Band 41, E-UTRA/TDD	LTE-TDD (SC-FDMA, 1 RB, 20 MHz, 16-QAM)	40620	2593.0

Grid Settings

Extent X [mm]	Extent Y [mm]	Step X [mm]	Step Y [mm]	Distance [mm]
50.0	50.0	5.0	5.0	15.0

Results

E _{max} [dB(V/m)]	E _{avg50x50 max} [dB(V/m)]	MIF [dB]	RFail [dB(V/m)]
29.77	23.7	-1.44	22.26

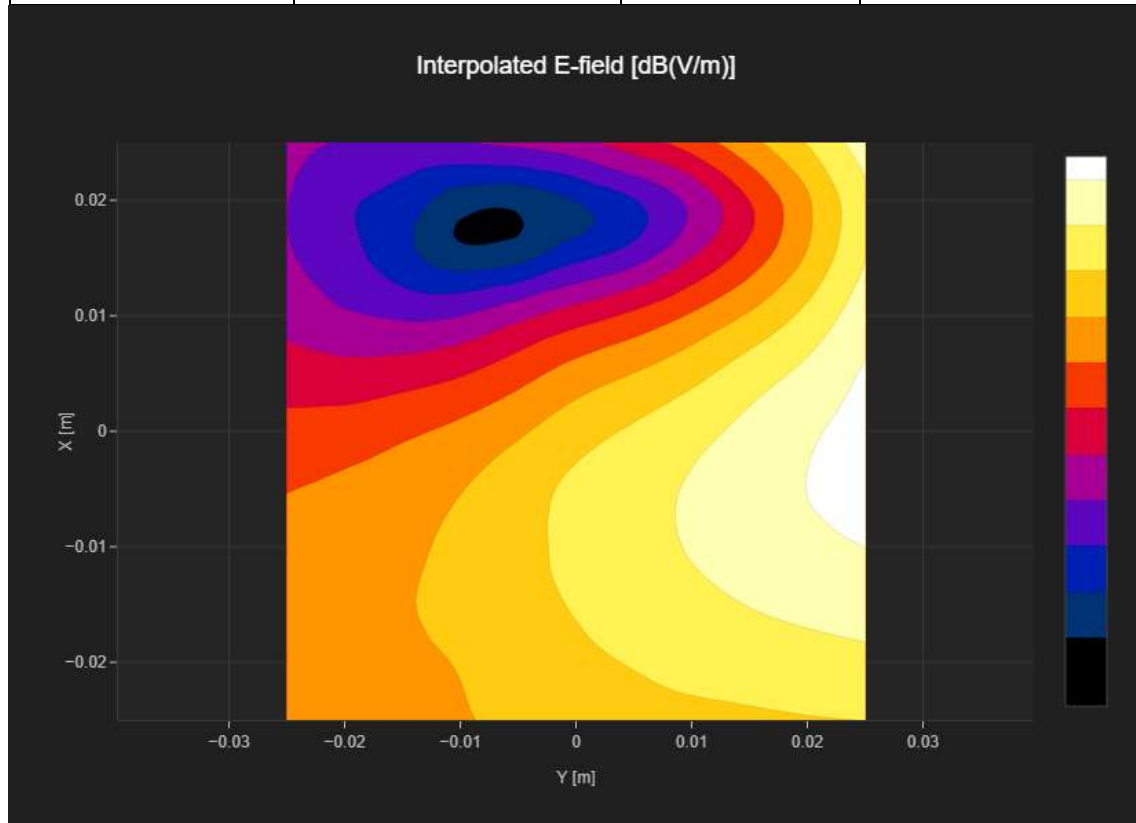

Plot No.10

Date : 2024-04-15

LTE TDD Band 41(PC2) 16QAM 20MHz 1RB 0offset 41055ch ANT I
Hardware Setup

Probe Name	Probe Calibration Date	DAE Name	DAE Calibration Date
EF3DV3 - SN4034	January 16, 2024	DAE4 Sn1254	June 02, 2023

Communication Systems

Band Name	Communication Systems Name	Channel	Frequency [MHz]
Band 41, E-UTRA/TDD	LTE-TDD (SC-FDMA, 1 RB, 20 MHz, 16-QAM)	41055	2636.5

Grid Settings

Extent X [mm]	Extent Y [mm]	Step X [mm]	Step Y [mm]	Distance [mm]
50.0	50.0	5.0	5.0	15.0

Results

E _{max} [dB(V/m)]	E _{avg50x50 max} [dB(V/m)]	MIF [dB]	RFail [dB(V/m)]
28.74	23.04	-1.44	21.6

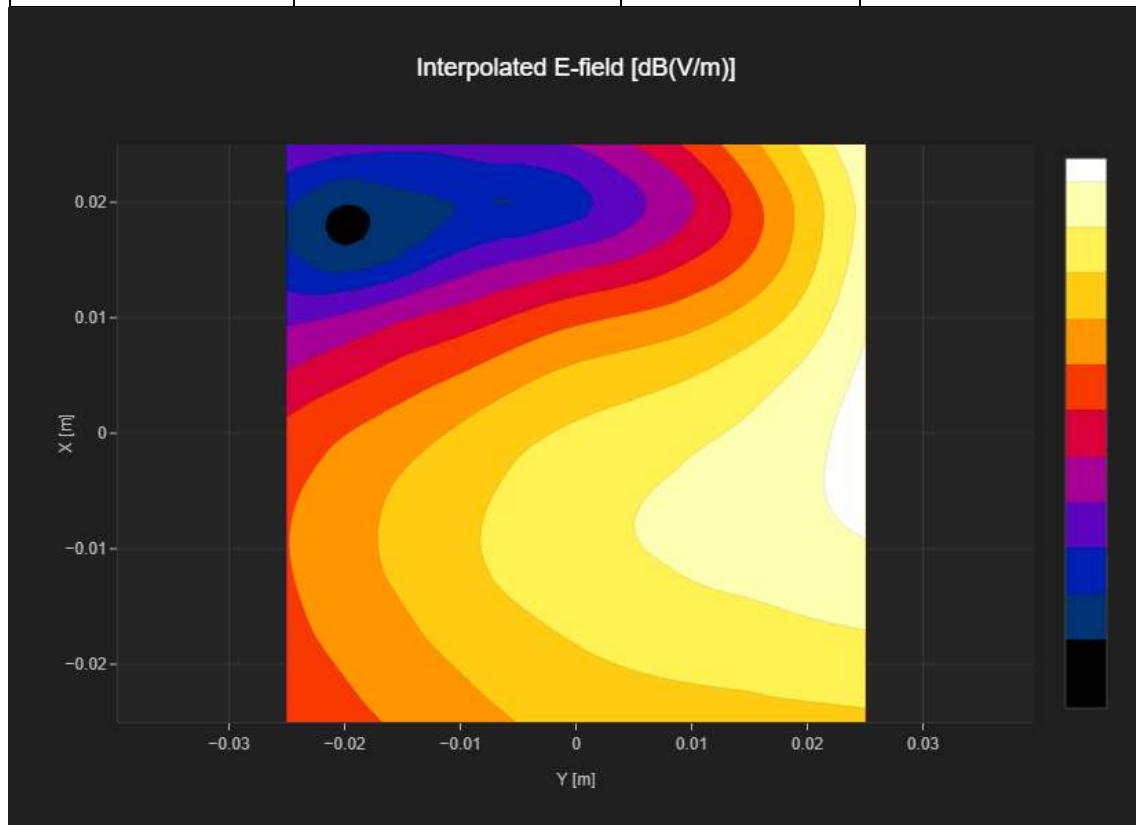

Plot No.11

Date : 2024-04-15

LTE TDD Band 41(PC2) 16QAM 20MHz 1RB 0offset 41490ch ANT I
Hardware Setup

Probe Name	Probe Calibration Date	DAE Name	DAE Calibration Date
EF3DV3 - SN4034	January 16, 2024	DAE4 Sn1254	June 02, 2023

Communication Systems

Band Name	Communication Systems Name	Channel	Frequency [MHz]
Band 41, E-UTRA/TDD	LTE-TDD (SC-FDMA, 1 RB, 20 MHz, 16-QAM)	41490	2680.0

Grid Settings

Extent X [mm]	Extent Y [mm]	Step X [mm]	Step Y [mm]	Distance [mm]
50.0	50.0	5.0	5.0	15.0

Results

E _{max} [dB(V/m)]	E _{avg50x50 max} [dB(V/m)]	MIF [dB]	RFail [dB(V/m)]
28.84	21.99	-1.44	20.55

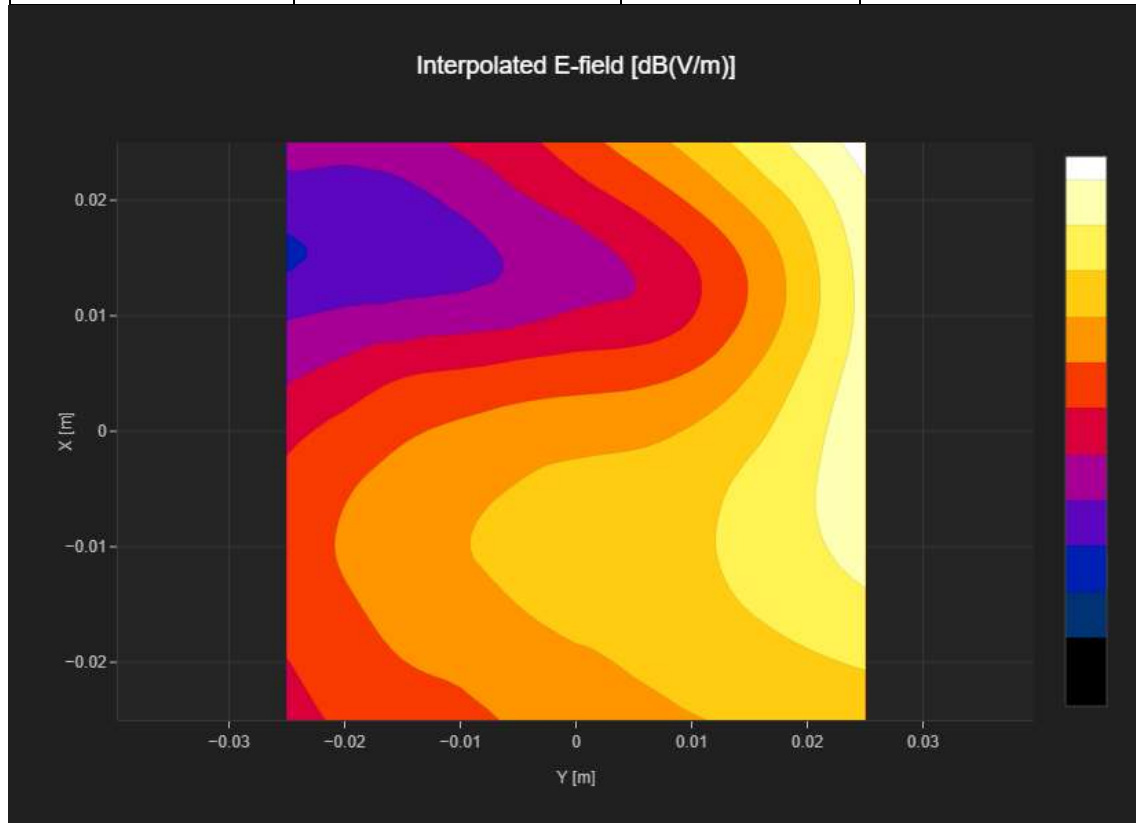

Plot No.12

Date : 2024-04-15

NR Band n41(PC2) DFT-s 100MHz 1RB 1offset 518598ch ANT I
Hardware Setup

Probe Name	Probe Calibration Date	DAE Name	DAE Calibration Date
EF3DV3 - SN4034	January 16, 2024	DAE4 Sn1254	June 02, 2023

Communication Systems

Band Name	Communication Systems Name	Channel	Frequency [MHz]
Band n41	5G NR (DFT-s-OFDM, 1 RB, 100 MHz, QPSK, 30 kHz)	518598	2592.99

Grid Settings

Extent X [mm]	Extent Y [mm]	Step X [mm]	Step Y [mm]	Distance [mm]
50.0	50.0	5.0	5.0	15.0

Results

E _{max} [dB(V/m)]	E _{avg50x50 max} [dB(V/m)]	MIF [dB]	RFail [dB(V/m)]
31.2	25.38	-1.64	23.74

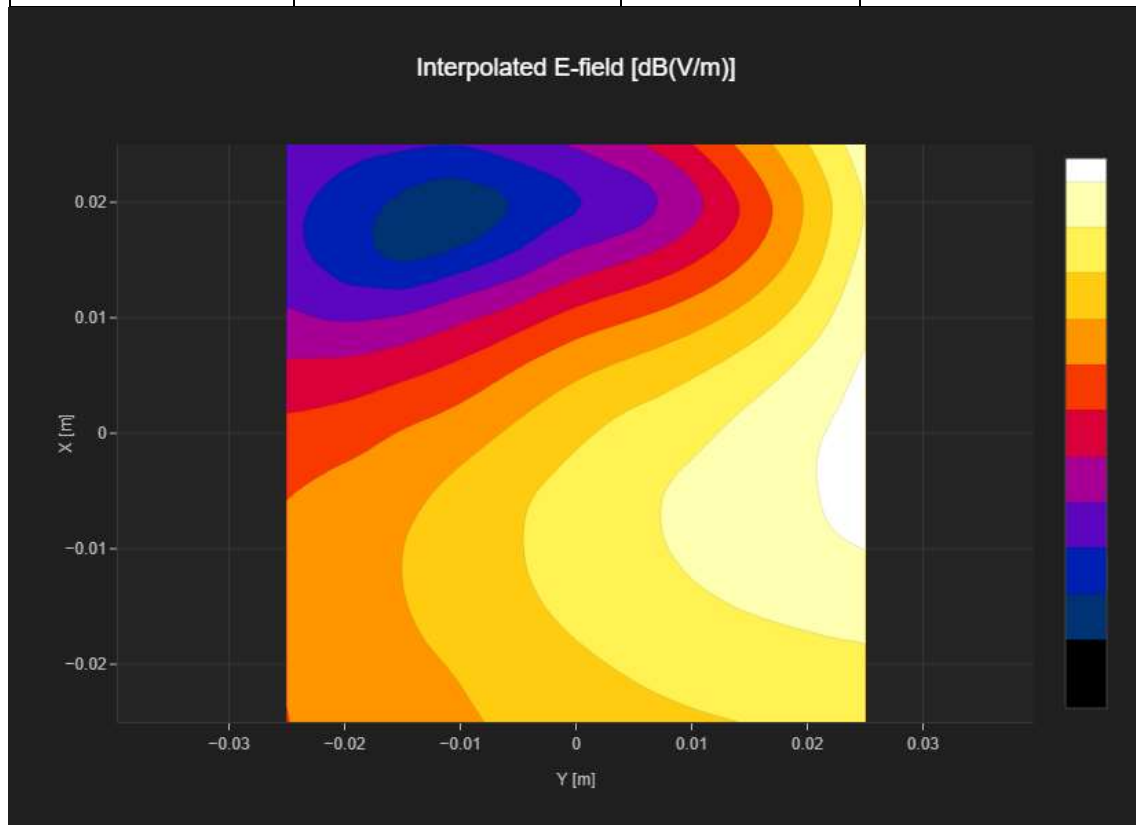

No.13

Date : 2024-04-15

NR Band n77(PC2) DFT-s 100MHz 1RB 1offset 650000ch ANT F
 Hardware Setup

Probe Name	Probe Calibration Date	DAE Name	DAE Calibration Date
EF3DV3 - SN4034	January 16, 2024	DAE4 Sn1254	June 02, 2023

Communication Systems

Band Name	Communication Systems Name	Channel	Frequency [MHz]
Band n77	5G NR (DFT-s-OFDM, 1 RB, 100 MHz, QPSK, 30 kHz)	650000	3750.0

Grid Settings

Extent X [mm]	Extent Y [mm]	Step X [mm]	Step Y [mm]	Distance [mm]
50.0	50.0	5.0	5.0	15.0

Results

E _{max} [dB(V/m)]	E _{avg50x50 max} [dB(V/m)]	MIF [dB]	RFail [dB(V/m)]
33.4	29.52	-1.64	27.88

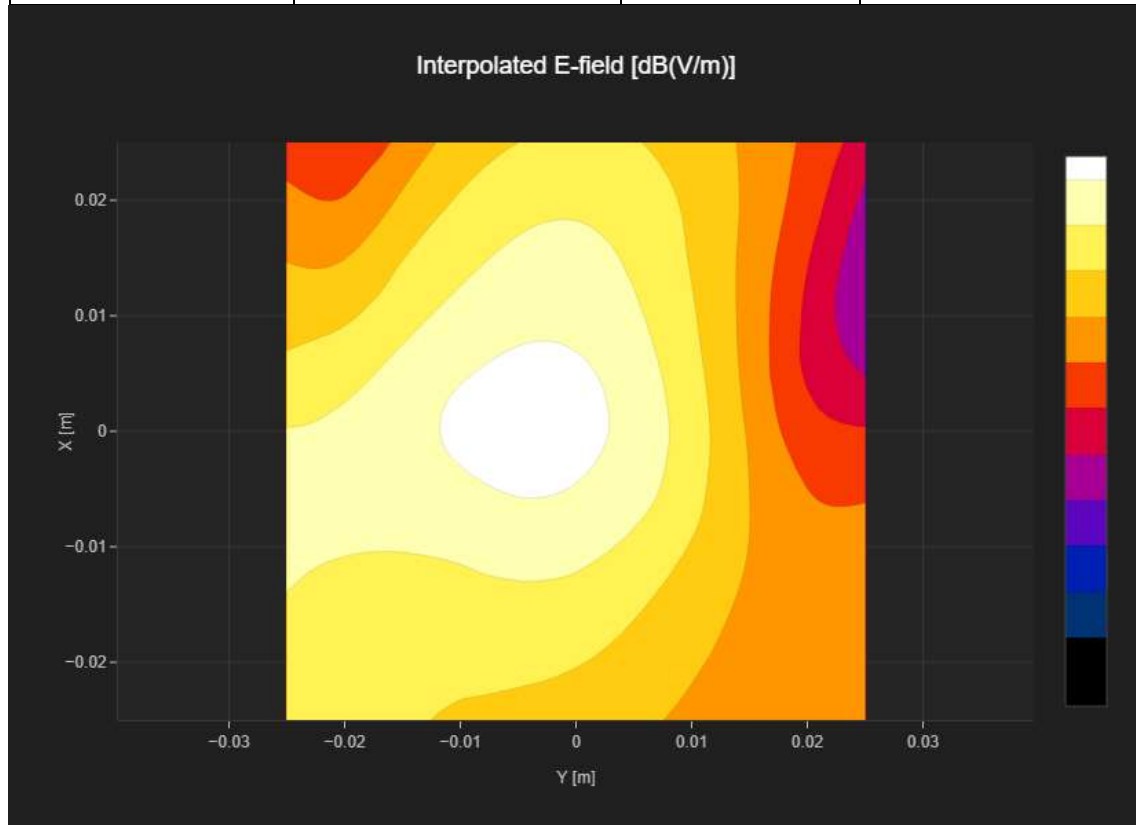

No.14

Date : 2024-04-15

NR Band n77(PC2) DFT-s 100MHz 1RB 1offset 656000ch ANT F
Hardware Setup

Probe Name	Probe Calibration Date	DAE Name	DAE Calibration Date
EF3DV3 - SN4034	January 16, 2024	DAE4 Sn1254	June 02, 2023

Communication Systems

Band Name	Communication Systems Name	Channel	Frequency [MHz]
Band n77	5G NR (DFT-s-OFDM, 1 RB, 100 MHz, QPSK, 30 kHz)	656000	3840.0

Grid Settings

Extent X [mm]	Extent Y [mm]	Step X [mm]	Step Y [mm]	Distance [mm]
50.0	50.0	5.0	5.0	15.0

Results

E _{max} [dB(V/m)]	E _{avg50x50 max} [dB(V/m)]	MIF [dB]	RFail [dB(V/m)]
33.71	29.42	-1.64	27.78

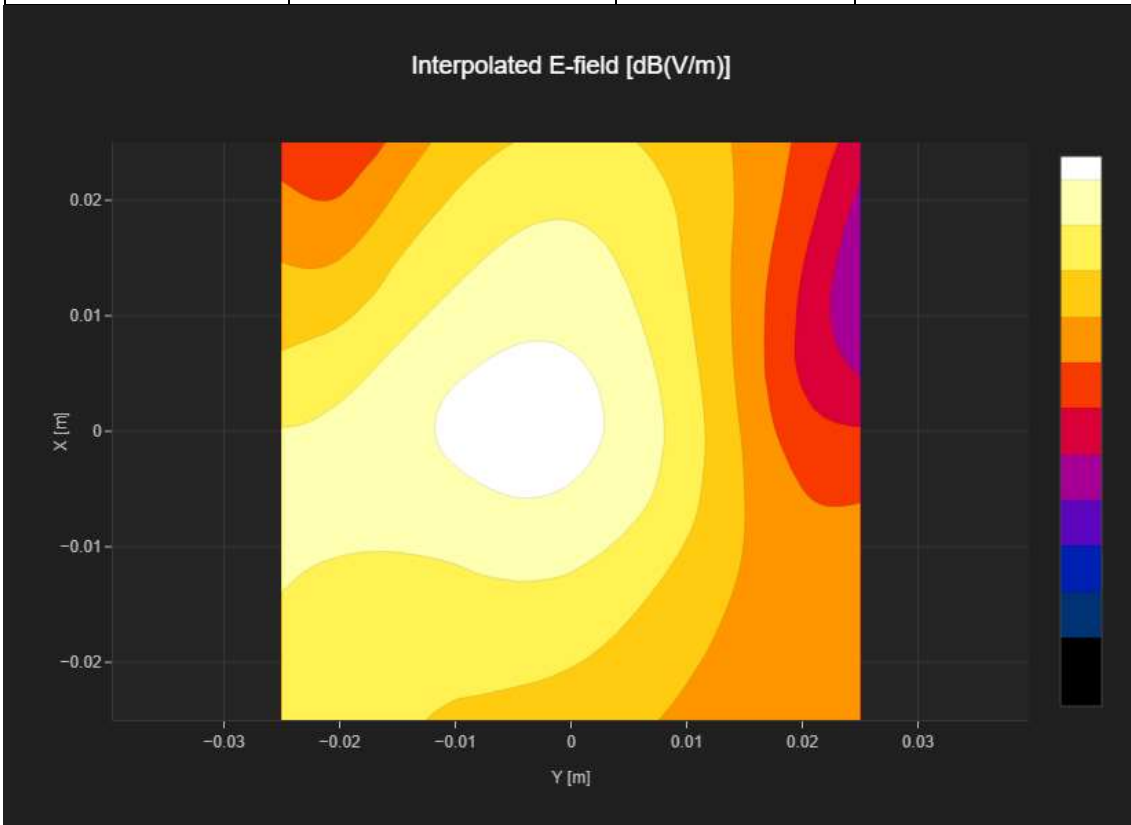

No.15

Date : 2024-04-15

NR Band n77(PC2) DFT-s 100MHz 1RB 1offset 662000ch ANT F
Hardware Setup

Probe Name	Probe Calibration Date	DAE Name	DAE Calibration Date
EF3DV3 - SN4034	January 16, 2024	DAE4 Sn1254	June 02, 2023

Communication Systems

Band Name	Communication Systems Name	Channel	Frequency [MHz]
Band n77	5G NR (DFT-s-OFDM, 1 RB, 100 MHz, QPSK, 30 kHz)	662000	3930.0

Grid Settings

Extent X [mm]	Extent Y [mm]	Step X [mm]	Step Y [mm]	Distance [mm]
50.0	50.0	5.0	5.0	15.0

Results

E _{max} [dB(V/m)]	E _{avg50x50 max} [dB(V/m)]	MIF [dB]	RFail [dB(V/m)]
34.71	29.73	-1.64	28.09

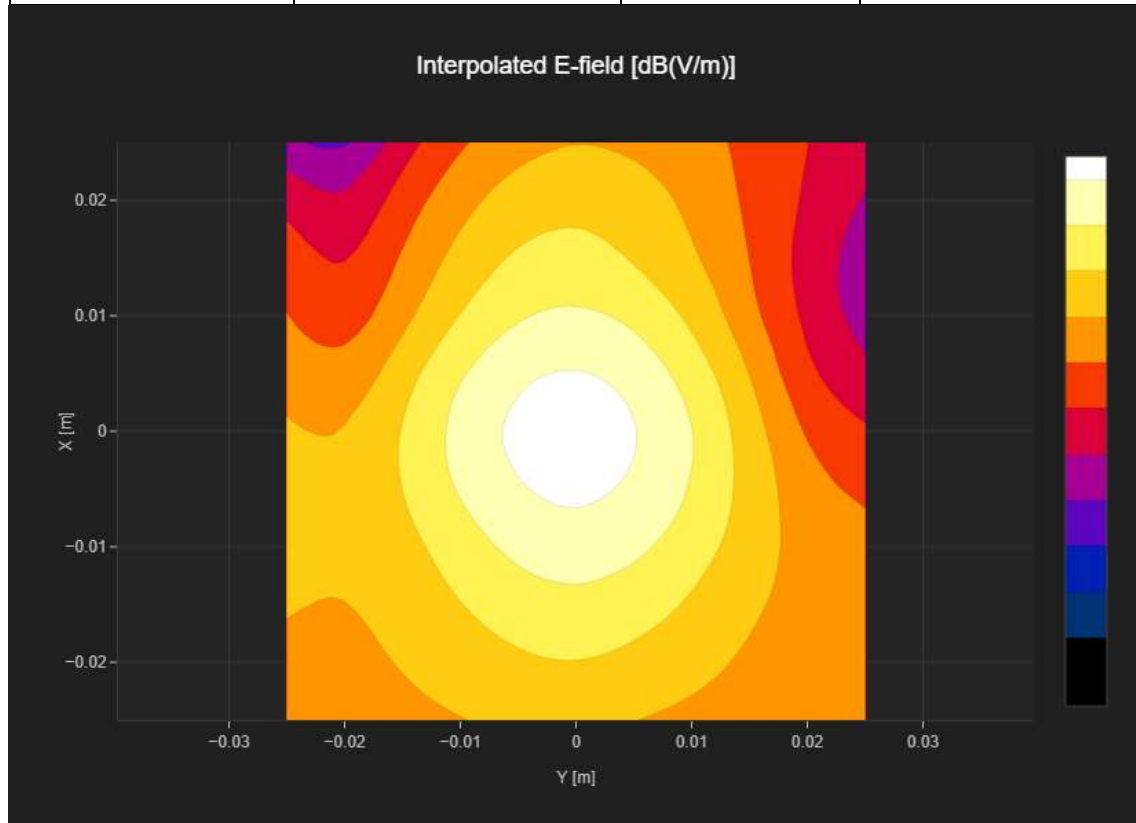

No.16

Date : 2024-04-15

NR Band n77(PC2) DFT-s 100MHz 1RB 1offset 633334ch ANT F
 Hardware Setup

Probe Name	Probe Calibration Date	DAE Name	DAE Calibration Date
EF3DV3 - SN4034	January 16, 2024	DAE4 Sn1254	June 02, 2023

Communication Systems

Band Name	Communication Systems Name	Channel	Frequency [MHz]
Band n77	5G NR (DFT-s-OFDM, 1 RB, 100 MHz, QPSK, 30 kHz)	633334	3500.01

Grid Settings

Extent X [mm]	Extent Y [mm]	Step X [mm]	Step Y [mm]	Distance [mm]
50.0	50.0	5.0	5.0	15.0

Results

E _{max} [dB(V/m)]	E _{avg50x50 max} [dB(V/m)]	MIF [dB]	RFail [dB(V/m)]
33.4	29.33	-1.64	27.69

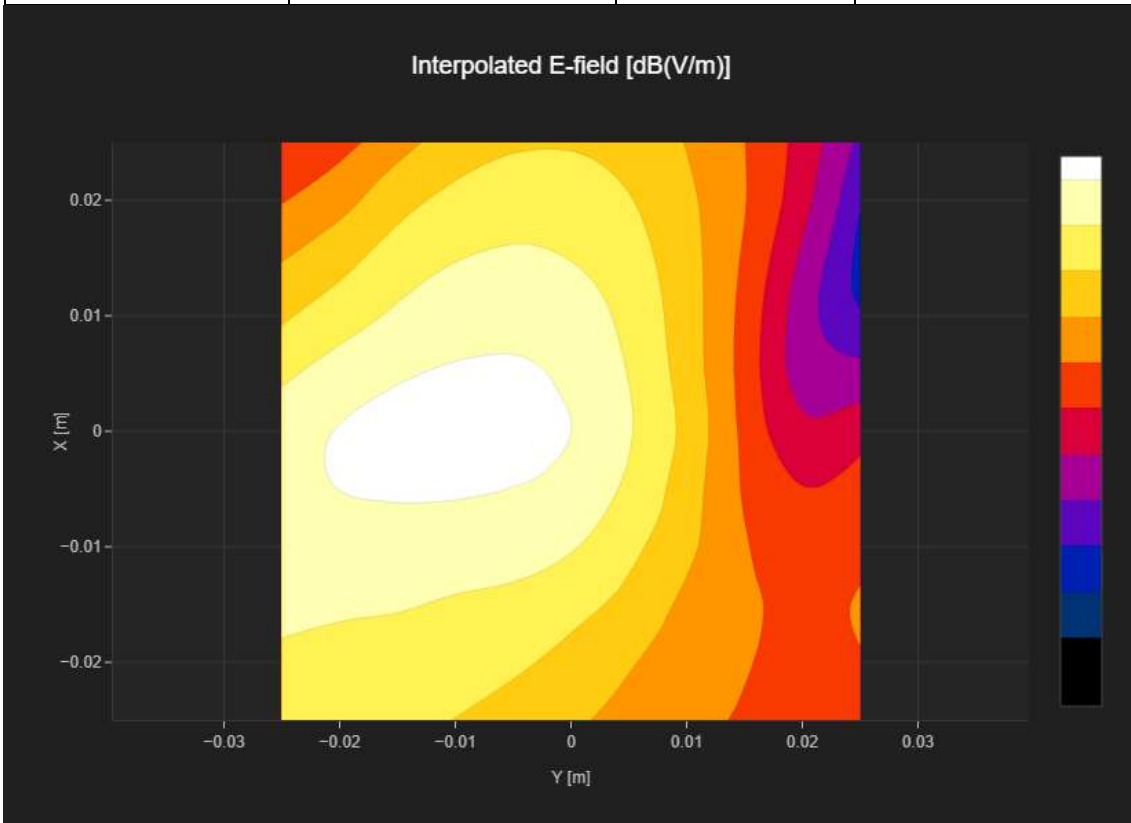

Appendix C. System Validation Plot

835MHz Verification

Date : 2024-04-15

Hardware Setup

Probe Name	Probe Calibration Date	DAE Name	DAE Calibration Date
EF3DV3 - SN4034	January 16, 2024	DAE4 Sn1254	June 02, 2023

Communication Systems

Band Name	Communication Systems Name	Channel	Frequency [MHz]
CD835	CW	50	835.0

Grid Settings

Extent X [mm]	Extent Y [mm]	Step X [mm]	Step Y [mm]	Distance [mm]
20.0	180.0	5.0	5.0	15.0

Results

Dipole Type	Dipole Serial Number	E _{max} [V/m]	Drift [dB]
CD835	1024	103	0.14

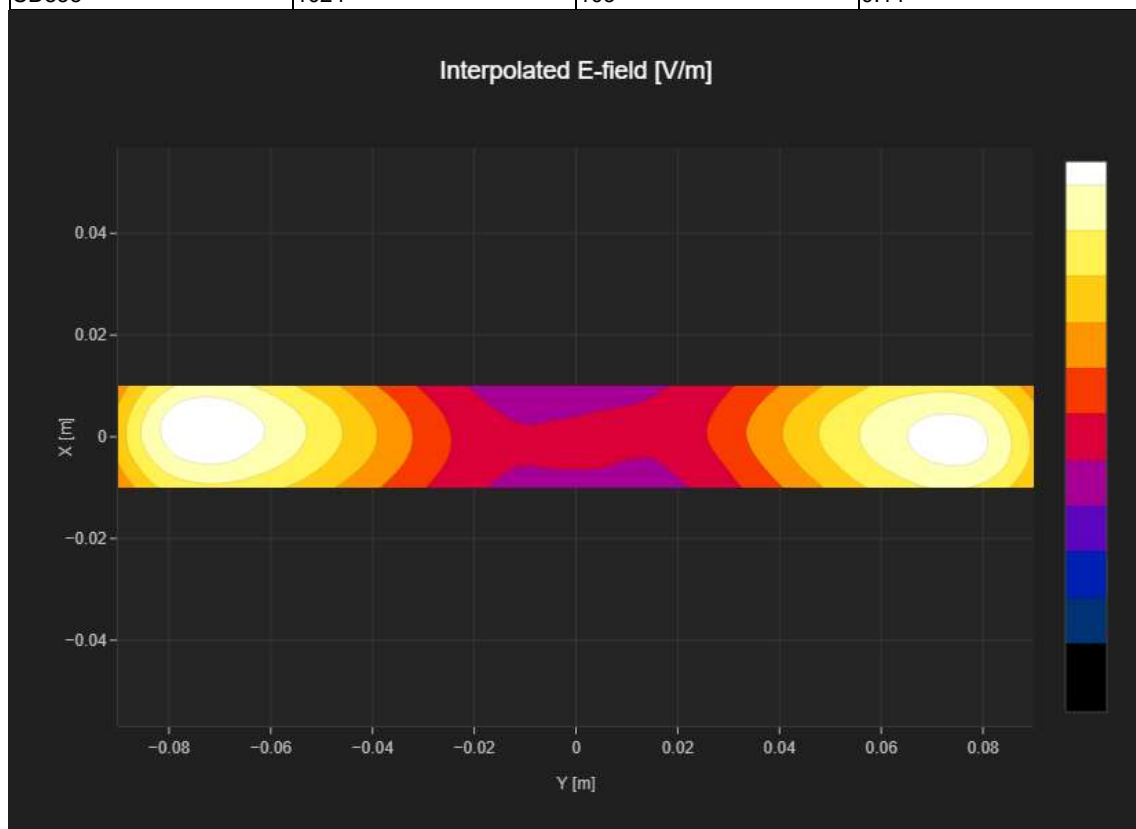

1880MHz Verification

Date : 2024-04-15

Hardware Setup

Probe Name	Probe Calibration Date	DAE Name	DAE Calibration Date
EF3DV3 - SN4034	January 16, 2024	DAE4 Sn1254	June 02, 2023

Communication Systems

Band Name	Communication Systems Name	Channel	Frequency [MHz]
CD835	CW	50	1880.0

Grid Settings

Extent X [mm]	Extent Y [mm]	Step X [mm]	Step Y [mm]	Distance [mm]
20.0	90.0	5.0	5.0	15.0

Results

Dipole Type	Dipole Serial Number	E _{max} [V/m]	Drift [dB]
CD1880	1019	87.2	0.03

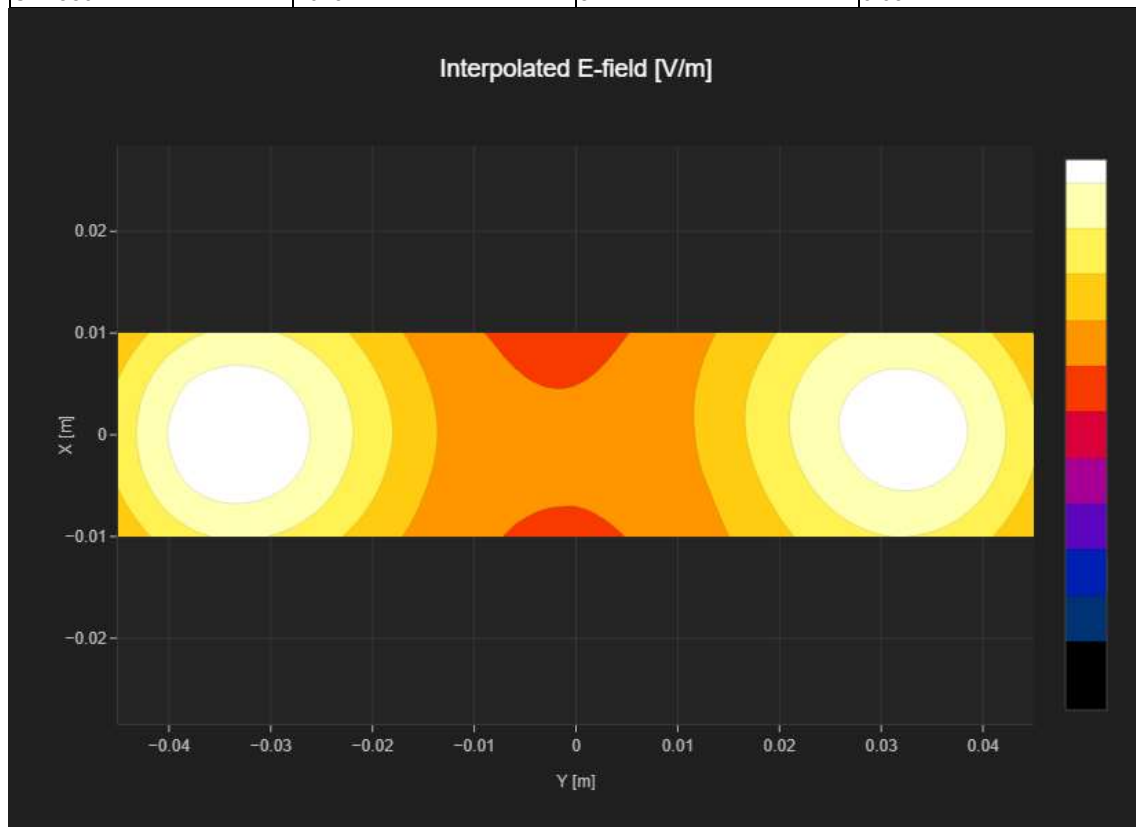

2600MHz Verification

Date : 2024-04-15

Hardware Setup

Probe Name	Probe Calibration Date	DAE Name	DAE Calibration Date
EF3DV3 - SN4034	January 16, 2024	DAE4 Sn1254	June 02, 2023

Communication Systems

Band Name	Communication Systems Name	Channel	Frequency [MHz]
CD835	CW	50	2600.0

Grid Settings

Extent X [mm]	Extent Y [mm]	Step X [mm]	Step Y [mm]	Distance [mm]
20.0	90.0	5.0	5.0	15.0

Results

Dipole Type	Dipole Serial Number	E _{max} [V/m]	Drift [dB]
CD2600	1019	84.5	-0.09

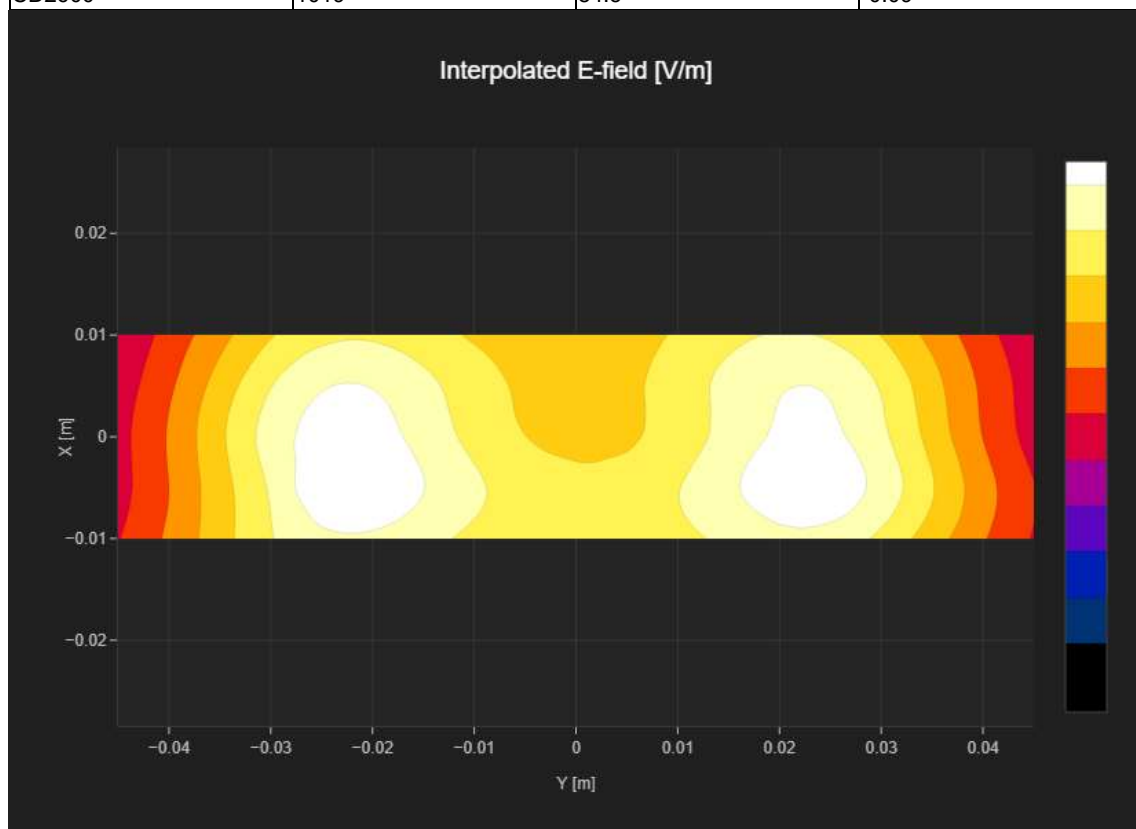

3500MHz Verification

Date : 2024-04-15

Hardware Setup

Probe Name	Probe Calibration Date	DAE Name	DAE Calibration Date
EF3DV3 - SN4034	January 16, 2024	DAE4 Sn1254	June 02, 2023

Communication Systems

Band Name	Communication Systems Name	Channel	Frequency [MHz]
CD835	CW	50	3500.0

Grid Settings

Extent X [mm]	Extent Y [mm]	Step X [mm]	Step Y [mm]	Distance [mm]
20.0	60.0	5.0	5.0	15.0

Results

Dipole Type	Dipole Serial Number	E _{max} [V/m]	Drift [dB]
CD3500	1012	82.1	-0.08

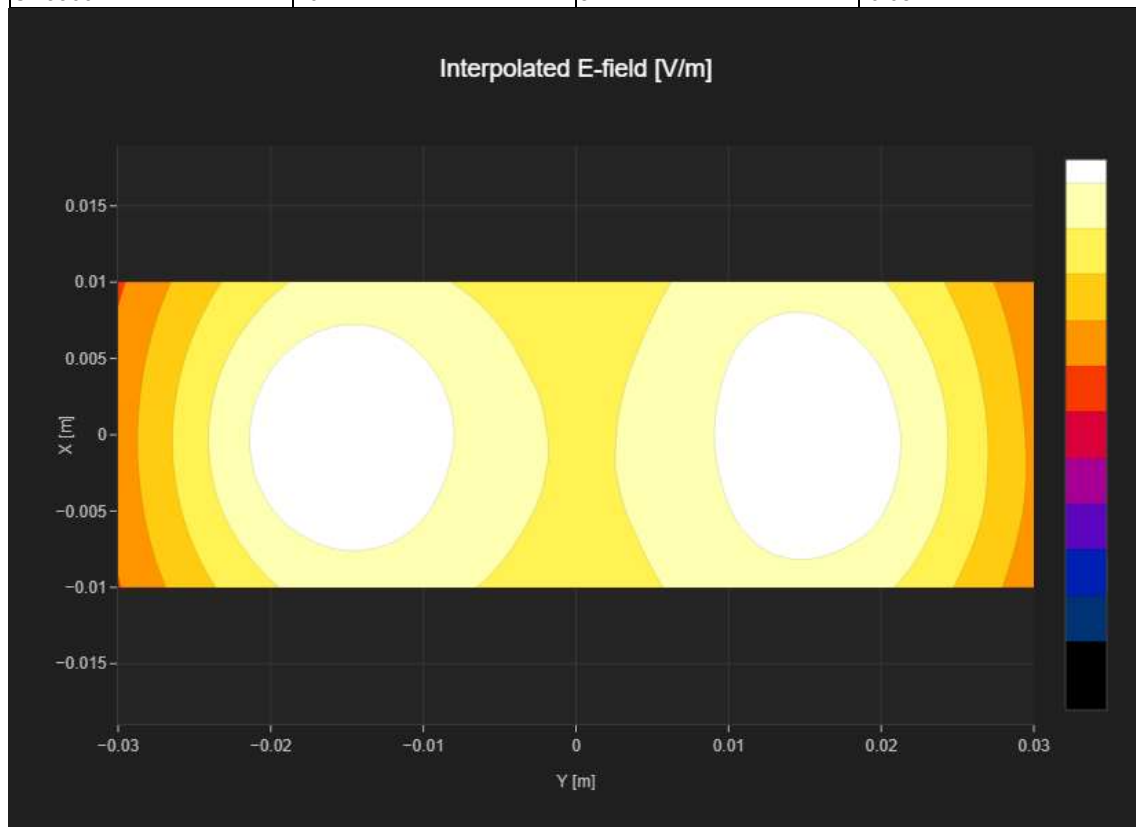

Appendix D. Probe Calibration Data

**Calibration Laboratory of
Schmid & Partner
Engineering AG**
Zeughausstrasse 43, 8004 Zurich, Switzerland



S Schweizerischer Kalibrierdienst
C Service suisse d'étalonnage
S Servizio svizzero di taratura
S Swiss Calibration Service

Accredited by the Swiss Accreditation Service (SAS)
The Swiss Accreditation Service is one of the signatories to the EA
Multilateral Agreement for the recognition of calibration certificates

Accreditation No.: **SCS 0108**

Client **HCT**
Gyeonggi-do, Republic of Korea

Certificate No. **EF-4034_Jan24**

CALIBRATION CERTIFICATE		검	안	나	자	확	인	자
Object	EF3DV3 - SN:4034							
Calibration procedure(s)	QA CAL-02.v9, QA CAL-25.v8 Calibration procedure for E-field probes optimized for close near field evaluations in air							
Calibration date	January 16, 2024							
<p>This calibration certificate documents the traceability to national standards, which realize the physical units of measurements (SI). The measurements and the uncertainties with confidence probability are given on the following pages and are part of the certificate. All calibrations have been conducted in the closed laboratory facility: environment temperature (22 ± 3) °C and humidity < 70%. Calibration Equipment used (M&TE critical for calibration)</p>								

Primary Standards	ID	Cal Date (Certificate No.)	Scheduled Calibration
Power meter NRP2	SN: 104778	30-Mar-23 (No. 217-03804/03805)	Mar-24
Power sensor NRP-Z91	SN: 103244	30-Mar-23 (No. 217-03804)	Mar-24
Power sensor NRP-Z91	SN: 103245	30-Mar-23 (No. 217-03805)	Mar-24
Reference 20 dB Attenuator	SN: CC2552 (20x)	30-Mar-23 (No. 217-03809)	Mar-24
DAE4	SN: 789	18-Oct-23 (No. DAE4-789_Oct23)	Oct-24
Reference Probe ER3DV6	SN: 2328	02-Oct-23 (No. ER3-2328_Oct23)	Oct-24

Secondary Standards	ID	Check Date (in house)	Scheduled Check
Power meter E4419B	SN: GB41293874	06-Apr-16 (in house check Jun-22)	In house check: Jun-24
Power sensor E4412A	SN: MY41498087	06-Apr-16 (in house check Jun-22)	In house check: Jun-24
Power sensor E4412A	SN: 000110210	06-Apr-16 (in house check Jun-22)	In house check: Jun-24
RF generator HP B648C	SN: US3642U01700	04-Aug-99 (in house check Jun-22)	In house check: Jun-24
Network Analyzer E8358A	SN: US41080477	31-Mar-14 (in house check Oct-22)	In house check: Oct-24

	Name	Function	Signature
Calibrated by	Jeffrey Katzman	Laboratory Technician	
Approved by	Sven Kühn	Technical Manager	
Issued: January 16, 2024			
This calibration certificate shall not be reproduced except in full without written approval of the laboratory.			

**Calibration Laboratory of
Schmid & Partner
Engineering AG**
Zeughausstrasse 43, 8004 Zurich, Switzerland



S Schweizerischer Kalibrierdienst
C Service suisse d'étalonnage
S Servizio svizzero di taratura
S Swiss Calibration Service

Accredited by the Swiss Accreditation Service (SAS)
The Swiss Accreditation Service is one of the signatories to the EA
Multilateral Agreement for the recognition of calibration certificates

Accreditation No.: **SCS 0108**

Glossary

NORM _{x,y,z}	sensitivity in free space
DCP	diode compression point
CF	crest factor (1/duty_cycle) of the RF signal
A, B, C, D	modulation dependent linearization parameters
En	incident E-field orientation normal to probe axis
Ep	incident E-field orientation parallel to probe axis
Polarization φ	φ rotation around probe axis
Polarization θ	θ rotation around an axis that is in the plane normal to probe axis (at measurement center), i.e., $\theta = 0$ is normal to probe axis
Connector Angle	information used in DASY system to align probe sensor X to the robot coordinate system

Calibration is Performed According to the Following Standards:

- a) IEEE Std 1309-2005, "IEEE Standard for calibration of electromagnetic field sensors and probes, excluding antennas, from 9 kHz to 40 GHz", December 2005
- b) CTIA Test Plan for Hearing Aid Compatibility, Rev 3.1.1, May 2017

Methods Applied and Interpretation of Parameters:

- **NORM_{x,y,z}**: Assessed for E-field polarization $\theta = 0$ for XY sensors and $\theta = 90$ for Z sensor ($f \leq 900$ MHz in TEM-cell; $f > 1800$ MHz in R22 waveguide).
- **NORM(f)_{x,y,z}** = **NORM_{x,y,z}** * **frequency_response** (see Frequency Response Chart).
- **DCP_{x,y,z}**: DCP are numerical linearization parameters assessed based on the data of power sweep with CW signal. DCP does not depend on frequency nor media.
- **PAR**: PAR is the Peak to Average Ratio that is not calibrated but determined based on the signal characteristics
- **A_{x,y,z}; B_{x,y,z}; C_{x,y,z}; D_{x,y,z}; VR_{x,y,z}**: A, B, C, D are numerical linearization parameters assessed based on the data of power sweep for specific modulation signal. The parameters do not depend on frequency nor media. VR is the maximum calibration range expressed in RMS voltage across the diode.
- **Spherical isotropy (3D deviation from isotropy)**: in a locally homogeneous field realized using an open waveguide setup
- **Sensor Offset**: The sensor offset corresponds to the offset of virtual measurement center from the probe tip (on probe axis). No tolerance required.
- **Connector Angle**: The angle is assessed using the information gained by determining the **NORM_x** (no uncertainty required).

EF3DV3 - SN:4034

January 16, 2024

Parameters of Probe: EF3DV3 - SN:4034
Basic Calibration Parameters

	Sensor X	Sensor Y	Sensor Z	Unc (k = 2)
Norm ($\mu\text{V}/(\text{V}/\text{m})^2$)	0.93	0.78	1.24	$\pm 10.1\%$
DCP (mV) ^B	96.8	99.3	98.8	$\pm 4.7\%$

Calibration Results for Frequency Response (30 MHz – 5.8 GHz)

Frequency MHz	Target E-field (En) V/m	Measured E-field (En) V/m	Deviation E-field (En)	Target E-field (Ep) V/m	Measured E-field (Ep) V/m	Deviation E-field (Ep)	Unc (k = 2)
30	77.1	77.0	-0.1%	77.1	77.3	0.2%	$\pm 5.1\%$
100	77.0	77.9	1.3%	76.9	77.6	0.9%	$\pm 5.1\%$
450	77.3	78.2	1.2%	77.2	77.9	0.9%	$\pm 5.1\%$
600	77.2	77.6	0.5%	77.2	77.3	0.1%	$\pm 5.1\%$
750	77.2	77.5	0.4%	77.2	77.2	0.0%	$\pm 5.1\%$
1800	143.0	139.9	-2.1%	143.1	140.2	-2.0%	$\pm 5.1\%$
2000	134.8	129.4	-4.1%	134.8	129.5	-3.9%	$\pm 5.1\%$
2200	127.5	124.5	-2.4%	127.5	125.8	-1.3%	$\pm 5.1\%$
2500	125.4	120.2	-4.2%	125.4	121.3	-3.2%	$\pm 5.1\%$
3000	79.4	76.2	-4.0%	79.5	77.5	-2.5%	$\pm 5.1\%$
3500	256.0	255.4	-0.2%	256.1	252.4	-1.5%	$\pm 5.1\%$
3700	249.6	244.9	-1.9%	249.7	243.1	-2.6%	$\pm 5.1\%$
5200	50.7	50.8	0.2%	50.8	51.1	0.6%	$\pm 5.1\%$
5500	49.6	48.8	-1.6%	49.6	49.1	-1.0%	$\pm 5.1\%$
5800	48.8	47.9	-2.0%	48.9	47.5	-2.7%	$\pm 5.1\%$

The reported uncertainty of measurement is stated as the standard uncertainty of measurement multiplied by the coverage factor $k=2$, which for a normal distribution corresponds to a coverage probability of approximately 95%.

^A Linearization parameter uncertainty for maximum specified field strength.

^B Uncertainty is determined using the max. deviation from linear response applying rectangular distribution and is expressed for the square of the field value.

EF3DV3 - SN:4034

January 16, 2024

Parameters of Probe: EF3DV3 - SN:4034
Calibration Results for Modulation Response

UID	Communication System Name		A dB	B dB $\sqrt{\mu V}$	C	D dB	VR mV	Max dev.	Max Unc ^E k = 2
0	CW	X	0.00	0.00	1.00	0.00	144.1	±2.5%	±4.7%
		Y	0.00	0.00	1.00		172.3		
		Z	0.00	0.00	1.00		174.7		
10352	Pulse Waveform (200Hz, 10%)	X	5.39	73.76	14.21	10.00	60.0	±2.3%	±9.6%
		Y	5.99	75.18	15.07		60.0		
		Z	4.70	71.96	13.51		60.0		
10353	Pulse Waveform (200Hz, 20%)	X	7.70	79.51	15.11	6.99	80.0	±0.9%	±9.6%
		Y	11.30	83.83	16.83		80.0		
		Z	4.20	73.40	13.00		80.0		
10354	Pulse Waveform (200Hz, 40%)	X	20.00	89.56	16.71	3.98	95.0	±0.7%	±9.6%
		Y	20.00	91.21	17.77		95.0		
		Z	20.00	88.70	16.26		95.0		
10355	Pulse Waveform (200Hz, 60%)	X	20.00	91.75	16.59	2.22	120.0	±0.8%	±9.6%
		Y	20.00	95.54	18.66		120.0		
		Z	20.00	89.96	15.72		120.0		
10387	QPSK Waveform, 1 MHz	X	1.91	68.54	16.43	1.00	150.0	±1.7%	±9.6%
		Y	2.00	70.02	17.16		150.0		
		Z	1.93	69.53	16.76		150.0		
10388	QPSK Waveform, 10 MHz	X	2.61	70.65	17.22	0.00	150.0	±1.0%	±9.6%
		Y	2.66	71.38	17.75		150.0		
		Z	2.47	70.22	17.12		150.0		
10396	64-QAM Waveform, 100 kHz	X	3.17	73.09	20.34	3.01	150.0	±0.7%	±9.6%
		Y	2.99	72.48	20.20		150.0		
		Z	2.68	70.61	19.05		150.0		
10399	64-QAM Waveform, 40 MHz	X	3.67	67.87	16.36	0.00	150.0	±1.1%	±9.6%
		Y	3.58	67.63	16.35		150.0		
		Z	3.53	67.43	16.18		150.0		
10414	WLAN CCDF, 64-QAM, 40 MHz	X	4.82	65.43	15.60	0.00	150.0	±2.4%	±9.6%
		Y	4.82	65.68	15.79		150.0		
		Z	4.78	65.62	15.71		150.0		

Note: For details on UID parameters see Appendix

The reported uncertainty of measurement is stated as the standard uncertainty of measurement multiplied by the coverage factor $k=2$, which for a normal distribution corresponds to a coverage probability of approximately 95%.

^B Linearization parameter uncertainty for maximum specified field strength.

^E Uncertainty is determined using the max. deviation from linear response applying rectangular distribution and is expressed for the square of the field value.

EF3DV3 - SN:4034

January 16, 2024

Parameters of Probe: EF3DV3 - SN:4034

Sensor Frequency Model Parameters

	Sensor X	Sensor Y	Sensor Z
Frequency Corr. (LF)	0.18	0.13	6.31
Frequency Corr. (HF)	2.82	2.82	2.82

Sensor Model Parameters

	C1 fF	C2 fF	α V ⁻¹	T1 ms V ⁻²	T2 ms V ⁻¹	T3 ms	T4 V ⁻²	T5 V ⁻¹	T6
x	51.9	342.64	36.77	8.12	0.30	5.01	1.07	0.18	1.01
y	46.1	303.16	36.58	8.77	0.45	4.99	0.94	0.16	1.00
z	45.7	300.46	36.50	7.61	0.43	4.99	0.70	0.18	1.00

Other Probe Parameters

Sensor Arrangement	Rectangular
Connector Angle	6.5°
Mechanical Surface Detection Mode	enabled
Optical Surface Detection Mode	disabled
Probe Overall Length	337 mm
Probe Body Diameter	12 mm
Tip Length	25 mm
Tip Diameter	4 mm
Probe Tip to Sensor X Calibration Point	1.5 mm
Probe Tip to Sensor Y Calibration Point	1.5 mm
Probe Tip to Sensor Z Calibration Point	1.5 mm

EF3DV3 - SN:4034

January 16, 2024

Receiving Pattern (ϕ), $\theta = 0^\circ$

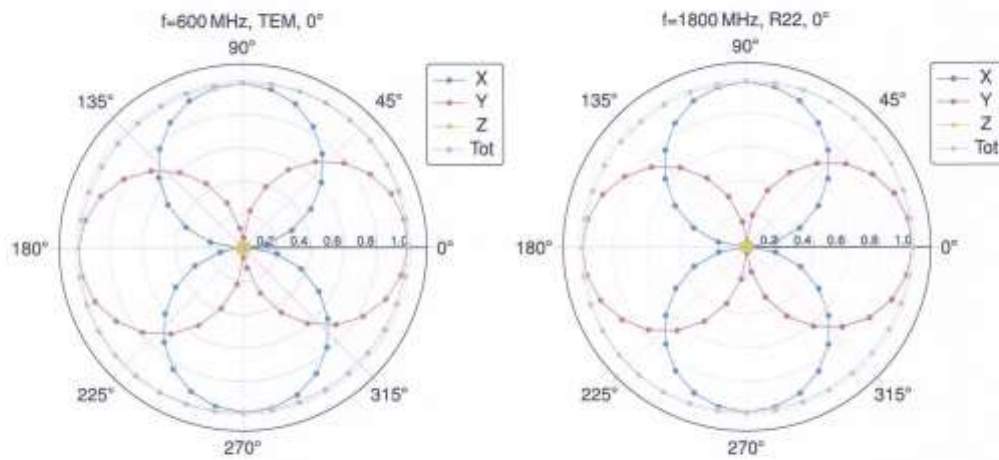

Receiving Pattern (ϕ), $\theta = 90^\circ$

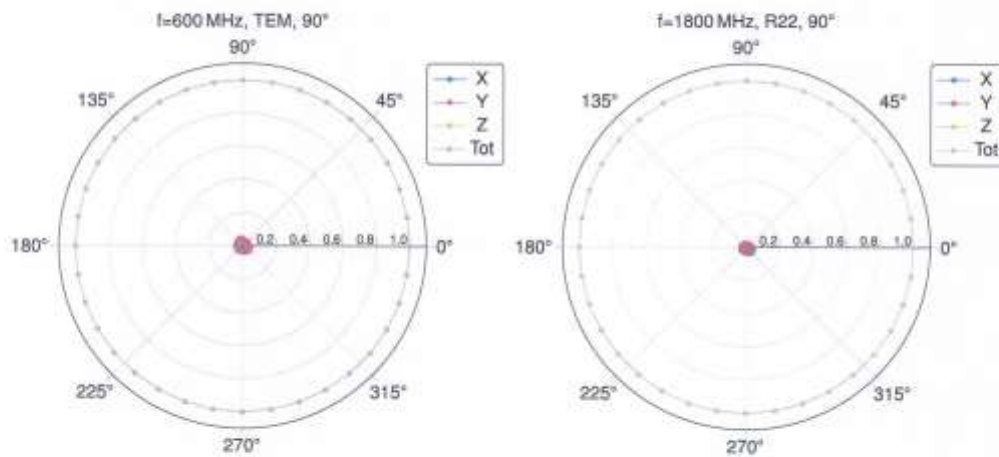

EF3DV3 - SN:4034

January 16, 2024

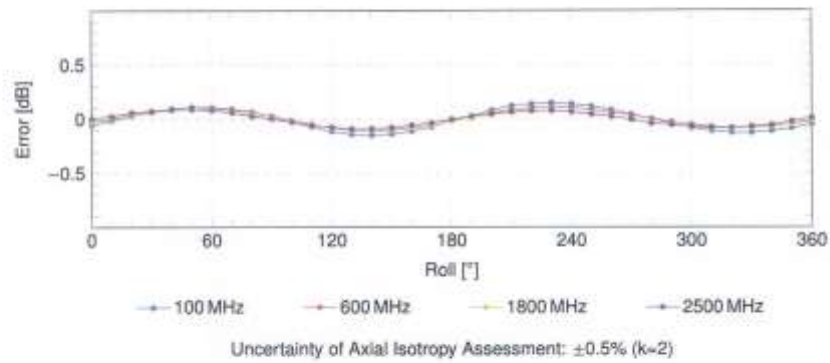
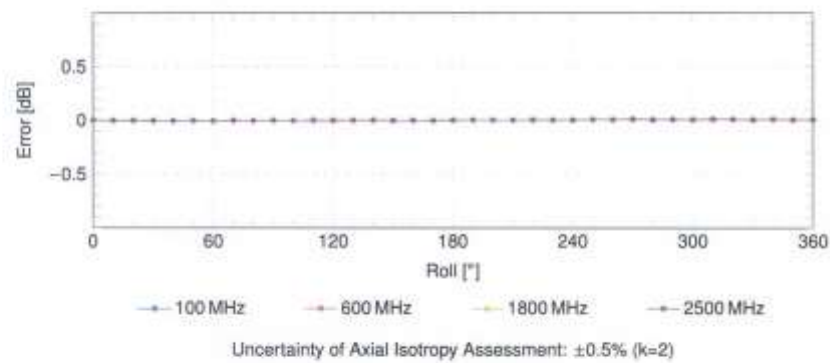
Receiving Pattern (ϕ), $\theta = 0^\circ$ **Receiving Pattern (ϕ), $\theta = 90^\circ$** 

EF3DV3 - SN:4034

January 16, 2024

Dynamic Range f(E-field)

(TEM cell, $f_{\text{eval}} = 900\text{MHz}$)

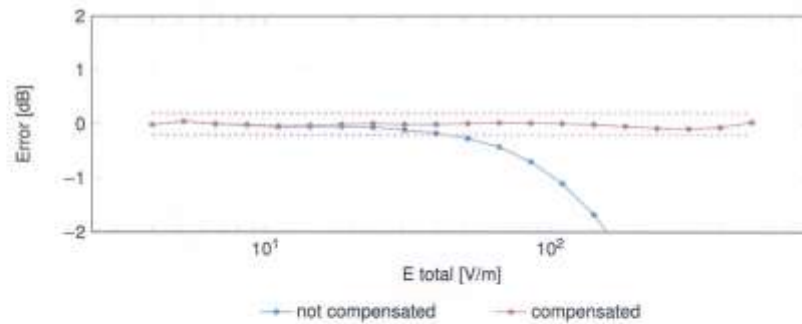
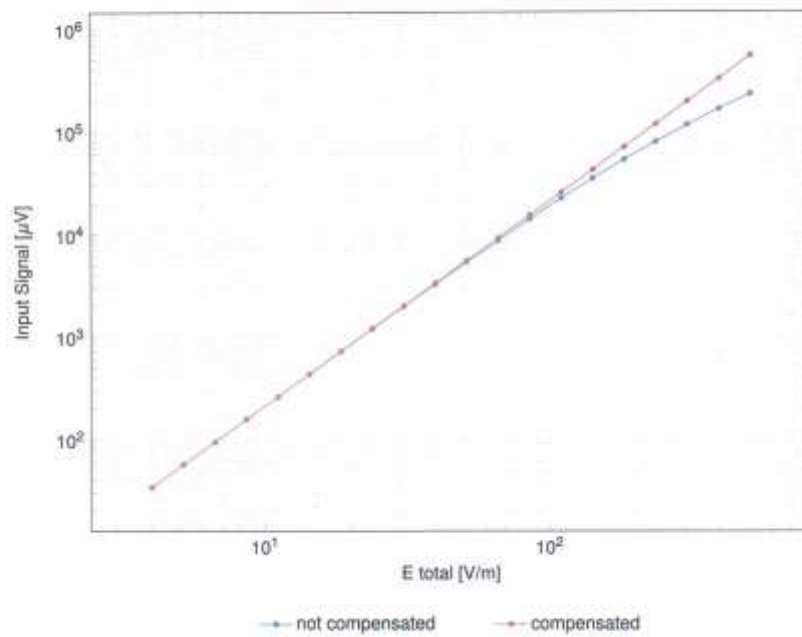

Uncertainty of Linearity Assessment: $\pm 0.6\%$ (k=2)

EF3DV3 - SN:4034

January 16, 2024

Deviation from Isotropy in Air

Error (ϕ, θ), $f = 900\text{MHz}$

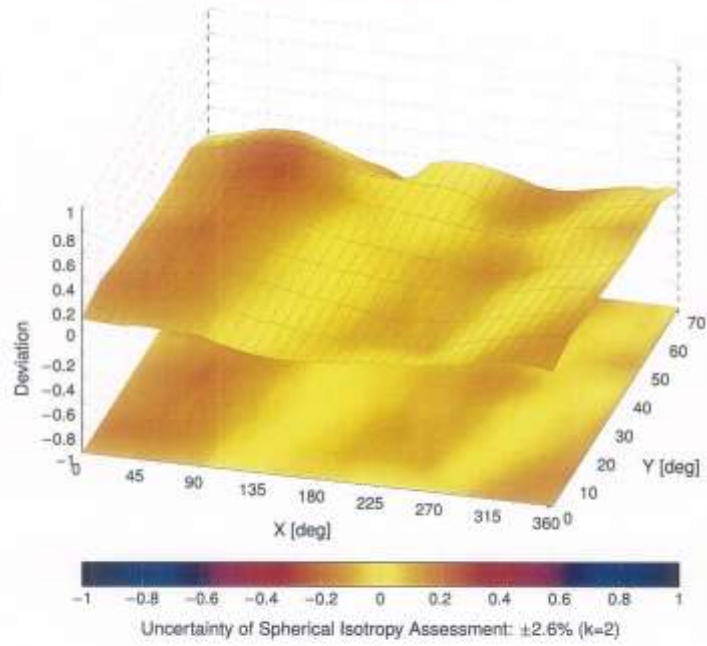

EF3DV3 - SN:4034

January 16, 2024

Appendix: Modulation Calibration Parameters

UID	Rev	Communication System Name	Group	PAR (dB)	Unc ^F k = 2
0		CW	CW	0.00	±4.7
10010	CAB	SAR Validation (Square, 100 ms, 10 ms)	Test	10.00	±9.6
10011	CAC	UMTS-FDD (WCDMA)	WCDMA	2.91	±9.6
10012	CAB	IEEE 802.11b WiFi 2.4 GHz (DSSS, 1 Mbps)	WLAN	1.87	±9.6
10013	CAB	IEEE 802.11g WiFi 2.4 GHz (DSSS-OFDM, 6 Mbps)	WLAN	9.46	±9.6
10021	DAC	GSM-FDD (TDMA, GMSK)	GSM	9.39	±9.6
10023	DAC	GPRS-FDD (TDMA, GMSK, TN 0)	GSM	9.57	±9.6
10024	DAC	GPRS-FDD (TDMA, GMSK, TN 0-1)	GSM	6.56	±9.6
10025	DAC	EDGE-FDD (TDMA, 8PSK, TN 0)	GSM	12.62	±9.6
10026	DAC	EDGE-FDD (TDMA, 8PSK, TN 0-1)	GSM	9.55	±9.6
10027	DAC	GPRS-FDD (TDMA, GMSK, TN 0-1-2)	GSM	4.80	±9.6
10028	DAC	GPRS-FDD (TDMA, GMSK, TN 0-1-2-3)	GSM	3.55	±9.6
10029	DAC	EDGE-FDD (TDMA, 8PSK, TN 0-1-2)	GSM	7.78	±9.6
10030	CAA	IEEE 802.15.1 Bluetooth (GFSK, DH1)	Bluetooth	5.30	±9.6
10031	CAA	IEEE 802.15.1 Bluetooth (GFSK, DH3)	Bluetooth	1.87	±9.6
10032	CAA	IEEE 802.15.1 Bluetooth (GFSK, DH5)	Bluetooth	1.16	±9.6
10033	CAA	IEEE 802.15.1 Bluetooth (PI4-DQPSK, DH1)	Bluetooth	7.74	±9.6
10034	CAA	IEEE 802.15.1 Bluetooth (PI4-DQPSK, DH3)	Bluetooth	4.53	±9.6
10035	CAA	IEEE 802.15.1 Bluetooth (PI4-DQPSK, DH5)	Bluetooth	3.83	±9.6
10036	CAA	IEEE 802.15.1 Bluetooth (8-PSK, DH1)	Bluetooth	8.01	±9.6
10037	CAA	IEEE 802.15.1 Bluetooth (8-PSK, DH3)	Bluetooth	4.77	±9.6
10038	CAA	IEEE 802.15.1 Bluetooth (8-PSK, DH5)	Bluetooth	4.10	±9.6
10039	CAB	CDMA2000 (1xRTT, RC1)	CDMA2000	4.57	±9.6
10042	CAB	IS-54 / IS-136 FDD (TDMA/FDM, PI4-DQPSK, HalfRate)	AMPS	7.78	±9.6
10044	CAA	IS-91/EIA/TIA-553 FDD (FDMA, FM)	AMPS	0.00	±9.6
10048	CAA	DECT (TDD, TDMA/FDM, GFSK, Full Slot, 24)	DECT	13.80	±9.6
10049	CAA	DECT (TDD, TDMA/FDM, GFSK, Double Slot, 12)	DECT	10.79	±9.6
10056	CAA	UMTS-TDD (TD-SCDMA, 1.28 Mbps)	TD-SCDMA	11.01	±9.6
10058	DAC	EDGE-FDD (TDMA, 8PSK, TN 0-1-2-3)	GSM	6.52	±9.6
10059	CAB	IEEE 802.11b WiFi 2.4 GHz (DSSS, 2 Mbps)	WLAN	2.12	±9.6
10060	CAB	IEEE 802.11b WiFi 2.4 GHz (DSSS, 5.5 Mbps)	WLAN	2.83	±9.6
10061	CAB	IEEE 802.11b WiFi 2.4 GHz (DSSS, 11 Mbps)	WLAN	3.60	±9.6
10062	CAD	IEEE 802.11a/h WiFi 5 GHz (OFDM, 6 Mbps)	WLAN	8.68	±9.6
10063	CAD	IEEE 802.11a/h WiFi 5 GHz (OFDM, 9 Mbps)	WLAN	8.63	±9.6
10064	CAD	IEEE 802.11a/h WiFi 5 GHz (OFDM, 12 Mbps)	WLAN	9.08	±9.6
10065	CAD	IEEE 802.11a/h WiFi 5 GHz (OFDM, 18 Mbps)	WLAN	9.00	±9.6
10066	CAD	IEEE 802.11a/h WiFi 5 GHz (OFDM, 24 Mbps)	WLAN	9.38	±9.6
10067	CAD	IEEE 802.11a/h WiFi 5 GHz (OFDM, 36 Mbps)	WLAN	10.12	±9.6
10068	CAD	IEEE 802.11a/h WiFi 5 GHz (OFDM, 48 Mbps)	WLAN	10.24	±9.6
10069	CAD	IEEE 802.11a/h WiFi 5 GHz (OFDM, 54 Mbps)	WLAN	10.56	±9.6
10071	CAB	IEEE 802.11g WiFi 2.4 GHz (DSSS/OFDM, 9 Mbps)	WLAN	9.83	±9.6
10072	CAB	IEEE 802.11g WiFi 2.4 GHz (DSSS/OFDM, 12 Mbps)	WLAN	9.82	±9.6
10073	CAB	IEEE 802.11g WiFi 2.4 GHz (DSSS/OFDM, 18 Mbps)	WLAN	9.94	±9.6
10074	CAB	IEEE 802.11g WiFi 2.4 GHz (DSSS/OFDM, 24 Mbps)	WLAN	10.30	±9.6
10075	CAB	IEEE 802.11g WiFi 2.4 GHz (DSSS/OFDM, 36 Mbps)	WLAN	10.77	±9.6
10076	CAB	IEEE 802.11g WiFi 2.4 GHz (DSSS/OFDM, 48 Mbps)	WLAN	10.94	±9.6
10077	CAB	IEEE 802.11g WiFi 2.4 GHz (DSSS/OFDM, 54 Mbps)	WLAN	11.00	±9.6
10081	CAB	CDMA2000 (1xRTT, RC3)	CDMA2000	3.97	±9.6
10082	CAB	IS-54 / IS-136 FDD (TDMA/FDM, PI4-DQPSK, FullRate)	AMPS	4.77	±9.6
10090	DAC	GPRS-FDD (TDMA, GMSK, TN 0-4)	GSM	6.56	±9.6
10097	CAC	UMTS-FDD (HSDPA)	WCDMA	3.98	±9.6
10098	CAC	UMTS-FDD (HSUPA, Subtest 2)	WCDMA	3.98	±9.6
10099	DAC	EDGE-FDD (TDMA, 8PSK, TN 0-4)	GSM	9.55	±9.6
10100	CAF	LTE-FDD (SC-FDMA, 100% RB, 20 MHz, QPSK)	LTE-FDD	5.67	±9.6
10101	CAF	LTE-FDD (SC-FDMA, 100% RB, 20 MHz, 16-QAM)	LTE-FDD	6.42	±9.6
10102	CAF	LTE-FDD (SC-FDMA, 100% RB, 20 MHz, 64-QAM)	LTE-FDD	6.50	±9.6
10103	CAH	LTE-TDD (SC-FDMA, 100% RB, 20 MHz, QPSK)	LTE-TDD	9.29	±9.6
10104	CAH	LTE-TDD (SC-FDMA, 100% RB, 20 MHz, 16-QAM)	LTE-TDD	9.97	±9.6
10105	CAH	LTE-TDD (SC-FDMA, 100% RB, 20 MHz, 64-QAM)	LTE-TDD	10.01	±9.6
10108	CAH	LTE-FDD (SC-FDMA, 100% RB, 10 MHz, QPSK)	LTE-FDD	5.80	±9.6
10109	CAH	LTE-FDD (SC-FDMA, 100% RB, 10 MHz, 16-QAM)	LTE-FDD	6.43	±9.6
10110	CAH	LTE-FDD (SC-FDMA, 100% RB, 5 MHz, QPSK)	LTE-FDD	5.75	±9.6
10111	CAH	LTE-FDD (SC-FDMA, 100% RB, 5 MHz, 16-QAM)	LTE-FDD	6.44	±9.6

Certificate No: EF-4034_Jan24

Page 10 of 21

EF3DV3 - SN:4034

January 16, 2024

UID	Rev	Communication System Name	Group	PAR (dB)	Unc ^F k = 2
10112	CAH	LTE-FDD (SC-FDMA, 100% RB, 10 MHz, 64-QAM)	LTE-FDD	6.59	±0.6
10113	CAH	LTE-FDD (SC-FDMA, 100% RB, 5 MHz, 64-QAM)	LTE-FDD	6.62	±0.6
10114	CAD	IEEE 802.11n (HT Greenfield, 13.5 Mbps, BPSK)	WLAN	8.10	±0.6
10115	CAD	IEEE 802.11n (HT Greenfield, 81 Mbps, 16-QAM)	WLAN	8.46	±0.6
10116	CAD	IEEE 802.11n (HT Greenfield, 135 Mbps, 64-QAM)	WLAN	8.15	±0.6
10117	CAD	IEEE 802.11n (HT Mixed, 13.5 Mbps, BPSK)	WLAN	8.07	±0.6
10118	CAD	IEEE 802.11n (HT Mixed, 81 Mbps, 16-QAM)	WLAN	8.59	±0.6
10119	CAD	IEEE 802.11n (HT Mixed, 135 Mbps, 64-QAM)	WLAN	8.13	±0.6
10140	CAF	LTE-FDD (SC-FDMA, 100% RB, 15 MHz, 16-QAM)	LTE-FDD	6.49	±0.6
10141	CAF	LTE-FDD (SC-FDMA, 100% RB, 15 MHz, 64-QAM)	LTE-FDD	6.53	±0.6
10142	CAF	LTE-FDD (SC-FDMA, 100% RB, 3 MHz, QPSK)	LTE-FDD	5.73	±0.6
10143	CAF	LTE-FDD (SC-FDMA, 100% RB, 3 MHz, 16-QAM)	LTE-FDD	6.35	±0.6
10144	CAF	LTE-FDD (SC-FDMA, 100% RB, 3 MHz, 64-QAM)	LTE-FDD	6.65	±0.6
10145	CAG	LTE-FDD (SC-FDMA, 100% RB, 1.4 MHz, QPSK)	LTE-FDD	5.76	±0.6
10146	CAG	LTE-FDD (SC-FDMA, 100% RB, 1.4 MHz, 16-QAM)	LTE-FDD	6.41	±0.6
10147	CAG	LTE-FDD (SC-FDMA, 100% RB, 1.4 MHz, 64-QAM)	LTE-FDD	6.72	±0.6
10149	CAF	LTE-FDD (SC-FDMA, 50% RB, 20 MHz, 16-QAM)	LTE-FDD	6.42	±0.6
10150	CAF	LTE-FDD (SC-FDMA, 50% RB, 20 MHz, 64-QAM)	LTE-FDD	6.60	±0.6
10151	CAH	LTE-TDD (SC-FDMA, 50% RB, 20 MHz, QPSK)	LTE-TDD	9.28	±0.6
10152	CAH	LTE-TDD (SC-FDMA, 50% RB, 20 MHz, 16-QAM)	LTE-TDD	9.92	±0.6
10153	CAH	LTE-TDD (SC-FDMA, 50% RB, 20 MHz, 64-QAM)	LTE-TDD	10.05	±0.6
10154	CAH	LTE-FDD (SC-FDMA, 50% RB, 10 MHz, QPSK)	LTE-FDD	5.75	±0.6
10155	CAH	LTE-FDD (SC-FDMA, 50% RB, 10 MHz, 16-QAM)	LTE-FDD	6.43	±0.6
10156	CAH	LTE-FDD (SC-FDMA, 50% RB, 5 MHz, QPSK)	LTE-FDD	5.79	±0.6
10157	CAH	LTE-FDD (SC-FDMA, 50% RB, 5 MHz, 16-QAM)	LTE-FDD	6.49	±0.6
10158	CAH	LTE-FDD (SC-FDMA, 50% RB, 10 MHz, 64-QAM)	LTE-FDD	6.62	±0.6
10159	CAH	LTE-FDD (SC-FDMA, 50% RB, 5 MHz, 64-QAM)	LTE-FDD	6.56	±0.6
10160	CAF	LTE-FDD (SC-FDMA, 50% RB, 15 MHz, QPSK)	LTE-FDD	5.82	±0.6
10161	CAF	LTE-FDD (SC-FDMA, 50% RB, 15 MHz, 16-QAM)	LTE-FDD	6.43	±0.6
10162	CAF	LTE-FDD (SC-FDMA, 50% RB, 15 MHz, 64-QAM)	LTE-FDD	6.58	±0.6
10166	CAG	LTE-FDD (SC-FDMA, 50% RB, 1.4 MHz, QPSK)	LTE-FDD	5.46	±0.6
10167	CAG	LTE-FDD (SC-FDMA, 50% RB, 1.4 MHz, 16-QAM)	LTE-FDD	6.21	±0.6
10168	CAG	LTE-FDD (SC-FDMA, 50% RB, 1.4 MHz, 64-QAM)	LTE-FDD	6.79	±0.6
10169	CAF	LTE-FDD (SC-FDMA, 1 RB, 20 MHz, QPSK)	LTE-FDD	5.73	±0.6
10170	CAF	LTE-FDD (SC-FDMA, 1 RB, 20 MHz, 16-QAM)	LTE-FDD	6.52	±0.6
10171	AAF	LTE-FDD (SC-FDMA, 1 RB, 20 MHz, 64-QAM)	LTE-FDD	6.49	±0.6
10172	CAH	LTE-TDD (SC-FDMA, 1 RB, 20 MHz, QPSK)	LTE-TDD	9.21	±0.6
10173	CAH	LTE-TDD (SC-FDMA, 1 RB, 20 MHz, 16-QAM)	LTE-TDD	9.48	±0.6
10174	CAH	LTE-TDD (SC-FDMA, 1 RB, 20 MHz, 64-QAM)	LTE-TDD	10.25	±0.6
10175	CAH	LTE-FDD (SC-FDMA, 1 RB, 10 MHz, QPSK)	LTE-FDD	5.72	±0.6
10176	CAH	LTE-FDD (SC-FDMA, 1 RB, 10 MHz, 16-QAM)	LTE-FDD	6.52	±0.6
10177	CAJ	LTE-FDD (SC-FDMA, 1 RB, 5 MHz, QPSK)	LTE-FDD	5.73	±0.6
10178	CAH	LTE-FDD (SC-FDMA, 1 RB, 5 MHz, 16-QAM)	LTE-FDD	6.52	±0.6
10179	CAH	LTE-FDD (SC-FDMA, 1 RB, 10 MHz, 64-QAM)	LTE-FDD	6.50	±0.6
10180	CAH	LTE-FDD (SC-FDMA, 1 RB, 5 MHz, 64-QAM)	LTE-FDD	6.50	±0.6
10181	CAF	LTE-FDD (SC-FDMA, 1 RB, 15 MHz, QPSK)	LTE-FDD	5.72	±0.6
10182	CAF	LTE-FDD (SC-FDMA, 1 RB, 15 MHz, 16-QAM)	LTE-FDD	6.52	±0.6
10183	AAE	LTE-FDD (SC-FDMA, 1 RB, 15 MHz, 64-QAM)	LTE-FDD	6.50	±0.6
10184	CAF	LTE-FDD (SC-FDMA, 1 RB, 3 MHz, QPSK)	LTE-FDD	5.73	±0.6
10185	CAF	LTE-FDD (SC-FDMA, 1 RB, 3 MHz, 16-QAM)	LTE-FDD	6.51	±0.6
10186	AAF	LTE-FDD (SC-FDMA, 1 RB, 3 MHz, 64-QAM)	LTE-FDD	6.50	±0.6
10187	CAG	LTE-FDD (SC-FDMA, 1 RB, 1.4 MHz, QPSK)	LTE-FDD	5.73	±0.6
10188	CAG	LTE-FDD (SC-FDMA, 1 RB, 1.4 MHz, 16-QAM)	LTE-FDD	6.52	±0.6
10189	AAG	LTE-FDD (SC-FDMA, 1 RB, 1.4 MHz, 64-QAM)	LTE-FDD	6.50	±0.6
10193	CAD	IEEE 802.11n (HT Greenfield, 6.5 Mbps, BPSK)	WLAN	8.09	±0.6
10194	CAD	IEEE 802.11n (HT Greenfield, 39 Mbps, 16-QAM)	WLAN	8.12	±0.6
10195	CAD	IEEE 802.11n (HT Greenfield, 65 Mbps, 64-QAM)	WLAN	8.21	±0.6
10196	CAD	IEEE 802.11n (HT Mixed, 6.5 Mbps, BPSK)	WLAN	8.10	±0.6
10197	CAD	IEEE 802.11n (HT Mixed, 39 Mbps, 16-QAM)	WLAN	8.13	±0.6
10198	CAD	IEEE 802.11n (HT Mixed, 65 Mbps, 64-QAM)	WLAN	8.27	±0.6
10219	CAD	IEEE 802.11n (HT Mixed, 7.2 Mbps, BPSK)	WLAN	8.03	±0.6
10220	CAD	IEEE 802.11n (HT Mixed, 43.3 Mbps, 16-QAM)	WLAN	8.13	±0.6
10221	CAD	IEEE 802.11n (HT Mixed, 72.2 Mbps, 64-QAM)	WLAN	8.27	±0.6
10222	CAD	IEEE 802.11n (HT Mixed, 15 Mbps, BPSK)	WLAN	8.06	±0.6
10223	CAD	IEEE 802.11n (HT Mixed, 90 Mbps, 16-QAM)	WLAN	8.46	±0.6
10224	CAD	IEEE 802.11n (HT Mixed, 150 Mbps, 64-QAM)	WLAN	8.06	±0.6

EF3DV3 - SN:4034

January 16, 2024

UID	Rev	Communication System Name	Group	PAR (dB)	Unc ^k k = 2
10226	CAC	UMTS-FDD (HSPA+)	WCDMA	9.97	±9.6
10226	CAC	LTE-TDD (SC-FDMA, 1 RB, 1.4 MHz, 16-QAM)	LTE-TDD	9.49	±9.6
10227	CAC	LTE-TDD (SC-FDMA, 1 RB, 1.4 MHz, 64-QAM)	LTE-TDD	10.26	±9.6
10228	CAC	LTE-TDD (SC-FDMA, 1 RB, 1.4 MHz, QPSK)	LTE-TDD	9.22	±9.6
10229	CAE	LTE-TDD (SC-FDMA, 1 RB, 3 MHz, 16-QAM)	LTE-TDD	9.48	±9.6
10230	CAE	LTE-TDD (SC-FDMA, 1 RB, 3 MHz, 64-QAM)	LTE-TDD	10.25	±9.6
10231	CAE	LTE-TDD (SC-FDMA, 1 RB, 3 MHz, QPSK)	LTE-TDD	9.19	±9.6
10232	CAH	LTE-TDD (SC-FDMA, 1 RB, 5 MHz, 16-QAM)	LTE-TDD	9.48	±9.6
10233	CAH	LTE-TDD (SC-FDMA, 1 RB, 5 MHz, 64-QAM)	LTE-TDD	10.25	±9.6
10234	CAH	LTE-TDD (SC-FDMA, 1 RB, 5 MHz, QPSK)	LTE-TDD	9.21	±9.6
10235	CAH	LTE-TDD (SC-FDMA, 1 RB, 10 MHz, 16-QAM)	LTE-TDD	9.48	±9.6
10236	CAH	LTE-TDD (SC-FDMA, 1 RB, 10 MHz, 64-QAM)	LTE-TDD	10.25	±9.6
10237	CAH	LTE-TDD (SC-FDMA, 1 RB, 10 MHz, QPSK)	LTE-TDD	9.21	±9.6
10238	CAG	LTE-TDD (SC-FDMA, 1 RB, 15 MHz, 16-QAM)	LTE-TDD	9.48	±9.6
10239	CAG	LTE-TDD (SC-FDMA, 1 RB, 15 MHz, 64-QAM)	LTE-TDD	10.25	±9.6
10240	CAG	LTE-TDD (SC-FDMA, 1 RB, 15 MHz, QPSK)	LTE-TDD	9.21	±9.6
10241	CAC	LTE-TDD (SC-FDMA, 50% RB, 1.4 MHz, 16-QAM)	LTE-TDD	9.82	±9.6
10242	CAC	LTE-TDD (SC-FDMA, 50% RB, 1.4 MHz, 64-QAM)	LTE-TDD	9.86	±9.6
10243	CAC	LTE-TDD (SC-FDMA, 50% RB, 1.4 MHz, QPSK)	LTE-TDD	9.46	±9.6
10244	CAE	LTE-TDD (SC-FDMA, 50% RB, 3 MHz, 16-QAM)	LTE-TDD	10.06	±9.6
10245	CAE	LTE-TDD (SC-FDMA, 50% RB, 3 MHz, 64-QAM)	LTE-TDD	10.06	±9.6
10246	CAE	LTE-TDD (SC-FDMA, 50% RB, 3 MHz, QPSK)	LTE-TDD	9.30	±9.6
10247	CAH	LTE-TDD (SC-FDMA, 50% RB, 5 MHz, 16-QAM)	LTE-TDD	9.91	±9.6
10248	CAH	LTE-TDD (SC-FDMA, 50% RB, 5 MHz, 64-QAM)	LTE-TDD	10.09	±9.6
10249	CAH	LTE-TDD (SC-FDMA, 50% RB, 5 MHz, QPSK)	LTE-TDD	9.29	±9.6
10250	CAH	LTE-TDD (SC-FDMA, 50% RB, 10 MHz, 16-QAM)	LTE-TDD	9.61	±9.6
10251	CAH	LTE-TDD (SC-FDMA, 50% RB, 10 MHz, 64-QAM)	LTE-TDD	10.17	±9.6
10252	CAH	LTE-TDD (SC-FDMA, 50% RB, 10 MHz, QPSK)	LTE-TDD	9.24	±9.6
10253	CAG	LTE-TDD (SC-FDMA, 50% RB, 15 MHz, 16-QAM)	LTE-TDD	9.90	±9.6
10254	CAG	LTE-TDD (SC-FDMA, 50% RB, 15 MHz, 64-QAM)	LTE-TDD	10.14	±9.6
10255	CAG	LTE-TDD (SC-FDMA, 50% RB, 15 MHz, QPSK)	LTE-TDD	9.20	±9.6
10256	CAC	LTE-TDD (SC-FDMA, 100% RB, 1.4 MHz, 16-QAM)	LTE-TDD	9.96	±9.6
10257	CAC	LTE-TDD (SC-FDMA, 100% RB, 1.4 MHz, 64-QAM)	LTE-TDD	10.08	±9.6
10258	CAC	LTE-TDD (SC-FDMA, 100% RB, 1.4 MHz, QPSK)	LTE-TDD	9.34	±9.6
10259	CAE	LTE-TDD (SC-FDMA, 100% RB, 3 MHz, 16-QAM)	LTE-TDD	9.98	±9.6
10260	CAE	LTE-TDD (SC-FDMA, 100% RB, 3 MHz, 64-QAM)	LTE-TDD	9.97	±9.6
10261	CAE	LTE-TDD (SC-FDMA, 100% RB, 3 MHz, QPSK)	LTE-TDD	9.24	±9.6
10262	CAH	LTE-TDD (SC-FDMA, 100% RB, 5 MHz, 16-QAM)	LTE-TDD	9.83	±9.6
10263	CAH	LTE-TDD (SC-FDMA, 100% RB, 5 MHz, 64-QAM)	LTE-TDD	10.16	±9.6
10264	CAH	LTE-TDD (SC-FDMA, 100% RB, 5 MHz, QPSK)	LTE-TDD	9.23	±9.6
10265	CAH	LTE-TDD (SC-FDMA, 100% RB, 10 MHz, 16-QAM)	LTE-TDD	9.92	±9.6
10266	CAH	LTE-TDD (SC-FDMA, 100% RB, 10 MHz, 64-QAM)	LTE-TDD	10.07	±9.6
10267	CAH	LTE-TDD (SC-FDMA, 100% RB, 10 MHz, QPSK)	LTE-TDD	9.30	±9.6
10268	CAG	LTE-TDD (SC-FDMA, 100% RB, 15 MHz, 16-QAM)	LTE-TDD	10.06	±9.6
10269	CAG	LTE-TDD (SC-FDMA, 100% RB, 15 MHz, 64-QAM)	LTE-TDD	10.13	±9.6
10270	CAG	LTE-TDD (SC-FDMA, 100% RB, 15 MHz, QPSK)	LTE-TDD	9.58	±9.6
10274	CAC	UMTS-FDD (HSUPA, Subtest 5, 3GPP RelB.10)	WCDMA	4.87	±9.6
10275	CAC	UMTS-FDD (HSUPA, Subtest 5, 3GPP RelB.4)	WCDMA	3.96	±9.6
10277	CAA	PHS (QPSK)	PHS	11.81	±9.6
10278	CAA	PHS (QPSK, BW 884 MHz, Roll-off 0.5)	PHS	11.81	±9.6
10279	CAA	PHS (QPSK, BW 884 MHz, Roll-off 0.38)	PHS	12.18	±9.6
10290	AAB	CDMA2000, RC1, SC55, Full Rate	CDMA2000	3.91	±9.6
10291	AAB	CDMA2000, RC3, SC55, Full Rate	CDMA2000	3.46	±9.6
10292	AAB	CDMA2000, RC3, SC32, Full Rate	CDMA2000	3.39	±9.6
10293	AAB	CDMA2000, RC3, SC3, Full Rate	CDMA2000	3.50	±9.6
10295	AAB	CDMA2000, RC1, SC3, 1/8th Rate 25 fr.	CDMA2000	12.49	±9.6
10297	AAE	LTE-FDD (SC-FDMA, 50% RB, 20 MHz, QPSK)	LTE-FDD	5.81	±9.6
10298	AAE	LTE-FDD (SC-FDMA, 50% RB, 3 MHz, QPSK)	LTE-FDD	5.72	±9.6
10299	AAE	LTE-FDD (SC-FDMA, 50% RB, 3 MHz, 16-QAM)	LTE-FDD	6.39	±9.6
10300	AAE	LTE-FDD (SC-FDMA, 50% RB, 3 MHz, 64-QAM)	LTE-FDD	6.60	±9.6
10301	AAA	IEEE 802.16e WIMAX (29-18, 5 ms, 10 MHz, QPSK, PUSC)	WIMAX	12.03	±9.6
10302	AAA	IEEE 802.16e WIMAX (29-18, 5 ms, 10 MHz, QPSK, PUSC, 3 CTRL symbols)	WIMAX	12.57	±9.6
10303	AAA	IEEE 802.16e WIMAX (31-15, 5 ms, 10 MHz, 64QAM, PUSC)	WIMAX	12.52	±9.6
10304	AAA	IEEE 802.16e WIMAX (29-18, 5 ms, 10 MHz, 64QAM, PUSC)	WIMAX	11.86	±9.6
10305	AAA	IEEE 802.16e WIMAX (31-15, 10 ms, 10 MHz, 64QAM, PUSC, 15 symbols)	WIMAX	15.24	±9.6
10306	AAA	IEEE 802.16e WIMAX (29-18, 10 ms, 10 MHz, 64QAM, PUSC, 18 symbols)	WIMAX	14.67	±9.6

Certificate No: EF-4034_Jan24

Page 12 of 21

EF3DV3 - SN:4034

January 16, 2024

UID	Rev	Communication System Name	Group	PAR (dB)	Unc ^k k = 2
10307	AAA	IEEE 802.16e WIMAX (20-18, 10ms, 10MHz, QPSK, PUSC, 16 symbols)	WIMAX	14.49	±9.6
10308	AAA	IEEE 802.16e WIMAX (20-18, 10ms, 10MHz, 16QAM, PUSC)	WIMAX	14.46	±9.6
10309	AAA	IEEE 802.16e WIMAX (20-18, 10ms, 10MHz, 16QAM, AMC 2x3, 18 symbols)	WIMAX	14.58	±9.6
10310	AAA	IEEE 802.16e WIMAX (20-18, 10ms, 10MHz, QPSK, AMC 2x3, 18 symbols)	WIMAX	14.57	±9.6
10311	AAE	LTE-FDD (SC-FDMA, 100% RB, 15MHz, QPSK)	LTE-FDD	6.06	±9.6
10313	AAA	IDEN 1:3	IDEN	10.51	±9.6
10314	AAA	IDEN 1:6	IDEN	13.48	±9.6
10315	AAB	IEEE 802.11b WiFi 2.4GHz (DSSS, 1 Mbps, 96pc duty cycle)	WLAN	1.71	±9.6
10316	AAB	IEEE 802.11g WiFi 2.4GHz (ERP-OFDM, 6 Mbps, 96pc duty cycle)	WLAN	8.36	±9.6
10317	AAE	IEEE 802.11a WiFi 5GHz (OFDM, 6 Mbps, 96pc duty cycle)	WLAN	8.36	±9.6
10352	AAA	Pulse Waveform (200Hz, 10%)	Generic	10.00	±9.6
10353	AAA	Pulse Waveform (200Hz, 20%)	Generic	6.99	±9.6
10354	AAA	Pulse Waveform (200Hz, 40%)	Generic	3.98	±9.6
10355	AAA	Pulse Waveform (200Hz, 60%)	Generic	2.22	±9.6
10356	AAA	Pulse Waveform (200Hz, 80%)	Generic	0.97	±9.6
10367	AAA	QPSK Waveform, 1 MHz	Generic	5.10	±9.6
10388	AAA	QPSK Waveform, 10 MHz	Generic	5.22	±9.6
10398	AAA	64-QAM Waveform, 100 kHz	Generic	6.27	±9.6
10399	AAA	64-QAM Waveform, 40 MHz	Generic	6.27	±9.6
10400	AAE	IEEE 802.11ac WiFi (20 MHz, 64-QAM, 99pc duty cycle)	WLAN	8.37	±9.6
10401	AAE	IEEE 802.11ac WiFi (40 MHz, 64-QAM, 99pc duty cycle)	WLAN	8.60	±9.6
10402	AAE	IEEE 802.11ac WiFi (80 MHz, 64-QAM, 99pc duty cycle)	WLAN	8.53	±9.6
10403	AAB	CDMA2000 (1xEV-DO, Rev. 0)	CDMA2000	3.76	±9.6
10404	AAB	CDMA2000 (1xEV-DO, Rev. A)	CDMA2000	3.77	±9.6
10406	AAB	CDMA2000, RC3, SC92, SC90, Full Rate	CDMA2000	5.22	±9.6
10410	AAH	LTE-TDD (SC-FDMA, 1 RB, 10 MHz, QPSK, UL Subframe=2,3,4,7,8,9, Subframe Conf=4)	LTE-TDD	7.82	±9.6
10414	AAA	WLAN CCDF, 64-QAM, 40 MHz	Generic	8.54	±9.6
10415	AAA	IEEE 802.11b WiFi 2.4GHz (DSSS, 1 Mbps, 96pc duty cycle)	WLAN	1.94	±9.6
10416	AAA	IEEE 802.11g WiFi 2.4GHz (ERP-OFDM, 6 Mbps, 96pc duty cycle)	WLAN	8.23	±9.6
10417	AAC	IEEE 802.11ah WiFi 5GHz (OFDM, 6 Mbps, 99pc duty cycle)	WLAN	8.23	±9.6
10418	AAA	IEEE 802.11g WiFi 2.4GHz (DSSS-OFDM, 6 Mbps, 99pc duty cycle, Long preamble)	WLAN	8.14	±9.6
10419	AAA	IEEE 802.11g WiFi 2.4GHz (DSSS-OFDM, 6 Mbps, 99pc duty cycle, Short preamble)	WLAN	8.19	±9.6
10422	AAC	IEEE 802.11n (HT Greenfield, 7.2 Mbps, BPSK)	WLAN	8.32	±9.6
10423	AAC	IEEE 802.11n (HT Greenfield, 43.3 Mbps, 16-QAM)	WLAN	8.47	±9.6
10424	AAC	IEEE 802.11n (HT Greenfield, 72.2 Mbps, 64-QAM)	WLAN	8.40	±9.6
10425	AAC	IEEE 802.11n (HT Greenfield, 15 Mbps, BPSK)	WLAN	8.41	±9.6
10426	AAC	IEEE 802.11n (HT Greenfield, 90 Mbps, 16-QAM)	WLAN	8.45	±9.6
10427	AAC	IEEE 802.11n (HT Greenfield, 150 Mbps, 64-QAM)	WLAN	8.41	±9.6
10430	AAE	LTE-FDD (OFDMA, 5 MHz, E-TM 3.1)	LTE-FDD	8.28	±9.6
10431	AAE	LTE-FDD (OFDMA, 10 MHz, E-TM 3.1)	LTE-FDD	8.38	±9.6
10432	AAD	LTE-FDD (OFDMA, 15 MHz, E-TM 3.1)	LTE-FDD	8.34	±9.6
10433	AAD	LTE-FDD (OFDMA, 20 MHz, E-TM 3.1)	LTE-FDD	8.34	±9.6
10434	AAB	W-CDMA (BS Test Model 1, 64 DPCH)	WCDMA	8.60	±9.6
10435	AAG	LTE-TDD (SC-FDMA, 1 RB, 20 MHz, QPSK, UL Subframe=2,3,4,7,8,9)	LTE-TDD	7.82	±9.6
10447	AAE	LTE-FDD (OFDMA, 5 MHz, E-TM 3.1, Clipping 44%)	LTE-FDD	7.56	±9.6
10448	AAE	LTE-FDD (OFDMA, 10 MHz, E-TM 3.1, Clipping 44%)	LTE-FDD	7.53	±9.6
10449	AAD	LTE-FDD (OFDMA, 15 MHz, E-TM 3.1, Clipping 44%)	LTE-FDD	7.51	±9.6
10450	AAD	LTE-FDD (OFDMA, 20 MHz, E-TM 3.1, Clipping 44%)	LTE-FDD	7.48	±9.6
10451	AAB	W-CDMA (BS Test Model 1, 64 DPCH, Clipping 44%)	WCDMA	7.59	±9.6
10453	AAE	Validation (Square, 10ms, 1 ms)	Test	10.00	±9.6
10456	AAC	IEEE 802.11ac WiFi (160 MHz, 64-QAM, 99pc duty cycle)	WLAN	8.63	±9.6
10457	AAB	UMTS-FDD (DC-HSPA)	WCDMA	6.62	±9.6
10458	AAA	CDMA2000 (1xEV-DO, Rev. B, 2 carriers)	CDMA2000	6.55	±9.6
10459	AAA	CDMA2000 (1xEV-DO, Rev. B, 3 carriers)	CDMA2000	8.25	±9.6
10460	AAB	UMTS-FDD (WCDMA, AMR)	WCDMA	2.39	±9.6
10461	AAC	LTE-TDD (SC-FDMA, 1 RB, 1.4 MHz, QPSK, UL Subframe=2,3,4,7,8,9)	LTE-TDD	7.82	±9.6
10462	AAC	LTE-TDD (SC-FDMA, 1 RB, 1.4 MHz, 16-QAM, UL Subframe=2,3,4,7,8,9)	LTE-TDD	8.30	±9.6
10463	AAC	LTE-TDD (SC-FDMA, 1 RB, 1.4 MHz, 64-QAM, UL Subframe=2,3,4,7,8,9)	LTE-TDD	8.56	±9.6
10464	AAD	LTE-TDD (SC-FDMA, 1 RB, 3MHz, QPSK, UL Subframe=2,3,4,7,8,9)	LTE-TDD	7.82	±9.6
10465	AAD	LTE-TDD (SC-FDMA, 1 RB, 3MHz, 16-QAM, UL Subframe=2,3,4,7,8,9)	LTE-TDD	8.32	±9.6
10466	AAD	LTE-TDD (SC-FDMA, 1 RB, 3MHz, 64-QAM, UL Subframe=2,3,4,7,8,9)	LTE-TDD	8.57	±9.6
10467	AAG	LTE-TDD (SC-FDMA, 1 RB, 5MHz, QPSK, UL Subframe=2,3,4,7,8,9)	LTE-TDD	7.82	±9.6
10468	AAG	LTE-TDD (SC-FDMA, 1 RB, 5MHz, 16-QAM, UL Subframe=2,3,4,7,8,9)	LTE-TDD	8.32	±9.6
10469	AAG	LTE-TDD (SC-FDMA, 1 RB, 5MHz, 64-QAM, UL Subframe=2,3,4,7,8,9)	LTE-TDD	8.56	±9.6
10470	AAG	LTE-TDD (SC-FDMA, 1 RB, 10 MHz, QPSK, UL Subframe=2,3,4,7,8,9)	LTE-TDD	7.82	±9.6
10471	AAG	LTE-TDD (SC-FDMA, 1 RB, 10 MHz, 16-QAM, UL Subframe=2,3,4,7,8,9)	LTE-TDD	8.32	±9.6

Certificate No: EF-4034_Jan24

Page 13 of 21

EF3DV3 - SN:4034

January 16, 2024

UID	Rev	Communication System Name	Group	PAR (dB)	Unc ² k = 2
10472	AAG	LTE-TDD (SC-FDMA, 1 RB, 10 MHz, 64-QAM, UL Subframe=2,3,4,7,8,9)	LTE-TDD	8.57	±9.6
10473	AAF	LTE-TDD (SC-FDMA, 1 RB, 15 MHz, QPSK, UL Subframe=2,3,4,7,8,9)	LTE-TDD	7.82	±9.6
10474	AAF	LTE-TDD (SC-FDMA, 1 RB, 15 MHz, 16-QAM, UL Subframe=2,3,4,7,8,9)	LTE-TDD	8.32	±9.6
10475	AAF	LTE-TDD (SC-FDMA, 1 RB, 15 MHz, 64-QAM, UL Subframe=2,3,4,7,8,9)	LTE-TDD	8.57	±9.6
10477	AAG	LTE-TDD (SC-FDMA, 1 RB, 20 MHz, 16-QAM, UL Subframe=2,3,4,7,8,9)	LTE-TDD	8.32	±9.6
10478	AAG	LTE-TDD (SC-FDMA, 1 RB, 20 MHz, 64-QAM, UL Subframe=2,3,4,7,8,9)	LTE-TDD	8.57	±9.6
10479	AAC	LTE-TDD (SC-FDMA, 50% RB, 1.4 MHz, QPSK, UL Subframe=2,3,4,7,8,9)	LTE-TDD	7.74	±9.6
10480	AAC	LTE-TDD (SC-FDMA, 50% RB, 1.4 MHz, 16-QAM, UL Subframe=2,3,4,7,8,9)	LTE-TDD	8.18	±9.6
10481	AAC	LTE-TDD (SC-FDMA, 50% RB, 1.4 MHz, 64-QAM, UL Subframe=2,3,4,7,8,9)	LTE-TDD	8.45	±9.6
10482	AAD	LTE-TDD (SC-FDMA, 50% RB, 3 MHz, QPSK, UL Subframe=2,3,4,7,8,9)	LTE-TDD	7.71	±9.6
10483	AAD	LTE-TDD (SC-FDMA, 50% RB, 3 MHz, 16-QAM, UL Subframe=2,3,4,7,8,9)	LTE-TDD	8.39	±9.6
10484	AAD	LTE-TDD (SC-FDMA, 50% RB, 3 MHz, 64-QAM, UL Subframe=2,3,4,7,8,9)	LTE-TDD	8.47	±9.6
10485	AAG	LTE-TDD (SC-FDMA, 50% RB, 5 MHz, QPSK, UL Subframe=2,3,4,7,8,9)	LTE-TDD	7.59	±9.6
10486	AAG	LTE-TDD (SC-FDMA, 50% RB, 5 MHz, 16-QAM, UL Subframe=2,3,4,7,8,9)	LTE-TDD	8.28	±9.6
10487	AAG	LTE-TDD (SC-FDMA, 50% RB, 5 MHz, 64-QAM, UL Subframe=2,3,4,7,8,9)	LTE-TDD	8.60	±9.6
10488	AAG	LTE-TDD (SC-FDMA, 50% RB, 10 MHz, QPSK, UL Subframe=2,3,4,7,8,9)	LTE-TDD	7.70	±9.6
10489	AAG	LTE-TDD (SC-FDMA, 50% RB, 10 MHz, 16-QAM, UL Subframe=2,3,4,7,8,9)	LTE-TDD	8.31	±9.6
10490	AAG	LTE-TDD (SC-FDMA, 50% RB, 10 MHz, 64-QAM, UL Subframe=2,3,4,7,8,9)	LTE-TDD	8.54	±9.6
10491	AAF	LTE-TDD (SC-FDMA, 50% RB, 15 MHz, QPSK, UL Subframe=2,3,4,7,8,9)	LTE-TDD	7.74	±9.6
10492	AAF	LTE-TDD (SC-FDMA, 50% RB, 15 MHz, 16-QAM, UL Subframe=2,3,4,7,8,9)	LTE-TDD	8.41	±9.6
10493	AAF	LTE-TDD (SC-FDMA, 50% RB, 15 MHz, 64-QAM, UL Subframe=2,3,4,7,8,9)	LTE-TDD	8.55	±9.6
10494	AAG	LTE-TDD (SC-FDMA, 50% RB, 20 MHz, QPSK, UL Subframe=2,3,4,7,8,9)	LTE-TDD	7.74	±9.6
10495	AAG	LTE-TDD (SC-FDMA, 50% RB, 20 MHz, 16-QAM, UL Subframe=2,3,4,7,8,9)	LTE-TDD	8.37	±9.6
10496	AAG	LTE-TDD (SC-FDMA, 50% RB, 20 MHz, 64-QAM, UL Subframe=2,3,4,7,8,9)	LTE-TDD	8.54	±9.6
10497	AAC	LTE-TDD (SC-FDMA, 100% RB, 1.4 MHz, QPSK, UL Subframe=2,3,4,7,8,9)	LTE-TDD	7.67	±9.6
10498	AAC	LTE-TDD (SC-FDMA, 100% RB, 1.4 MHz, 16-QAM, UL Subframe=2,3,4,7,8,9)	LTE-TDD	8.40	±9.6
10499	AAC	LTE-TDD (SC-FDMA, 100% RB, 1.4 MHz, 64-QAM, UL Subframe=2,3,4,7,8,9)	LTE-TDD	8.68	±9.6
10500	AAD	LTE-TDD (SC-FDMA, 100% RB, 3 MHz, QPSK, UL Subframe=2,3,4,7,8,9)	LTE-TDD	7.67	±9.6
10501	AAD	LTE-TDD (SC-FDMA, 100% RB, 3 MHz, 16-QAM, UL Subframe=2,3,4,7,8,9)	LTE-TDD	8.44	±9.6
10502	AAD	LTE-TDD (SC-FDMA, 100% RB, 3 MHz, 64-QAM, UL Subframe=2,3,4,7,8,9)	LTE-TDD	8.52	±9.6
10503	AAG	LTE-TDD (SC-FDMA, 100% RB, 5 MHz, QPSK, UL Subframe=2,3,4,7,8,9)	LTE-TDD	7.72	±9.6
10504	AAG	LTE-TDD (SC-FDMA, 100% RB, 5 MHz, 16-QAM, UL Subframe=2,3,4,7,8,9)	LTE-TDD	8.31	±9.6
10505	AAG	LTE-TDD (SC-FDMA, 100% RB, 5 MHz, 64-QAM, UL Subframe=2,3,4,7,8,9)	LTE-TDD	8.54	±9.6
10506	AAG	LTE-TDD (SC-FDMA, 100% RB, 10 MHz, QPSK, UL Subframe=2,3,4,7,8,9)	LTE-TDD	7.74	±9.6
10507	AAG	LTE-TDD (SC-FDMA, 100% RB, 10 MHz, 16-QAM, UL Subframe=2,3,4,7,8,9)	LTE-TDD	8.36	±9.6
10508	AAG	LTE-TDD (SC-FDMA, 100% RB, 10 MHz, 64-QAM, UL Subframe=2,3,4,7,8,9)	LTE-TDD	8.55	±9.6
10509	AAF	LTE-TDD (SC-FDMA, 100% RB, 15 MHz, QPSK, UL Subframe=2,3,4,7,8,9)	LTE-TDD	7.99	±9.6
10510	AAF	LTE-TDD (SC-FDMA, 100% RB, 15 MHz, 16-QAM, UL Subframe=2,3,4,7,8,9)	LTE-TDD	8.49	±9.6
10511	AAF	LTE-TDD (SC-FDMA, 100% RB, 15 MHz, 64-QAM, UL Subframe=2,3,4,7,8,9)	LTE-TDD	8.51	±9.6
10512	AAG	LTE-TDD (SC-FDMA, 100% RB, 20 MHz, QPSK, UL Subframe=2,3,4,7,8,9)	LTE-TDD	7.74	±9.6
10513	AAG	LTE-TDD (SC-FDMA, 100% RB, 20 MHz, 16-QAM, UL Subframe=2,3,4,7,8,9)	LTE-TDD	8.42	±9.6
10514	AAG	LTE-TDD (SC-FDMA, 100% RB, 20 MHz, 64-QAM, UL Subframe=2,3,4,7,8,9)	LTE-TDD	8.45	±9.6
10515	AAA	IEEE 802.11b WiFi 2.4 GHz (DSSS, 2 Mbps, 99pc duty cycle)	WLAN	1.58	±9.6
10516	AAA	IEEE 802.11b WiFi 2.4 GHz (DSSS, 5.5 Mbps, 99pc duty cycle)	WLAN	1.57	±9.6
10517	AAA	IEEE 802.11b WiFi 2.4 GHz (DSSS, 11 Mbps, 99pc duty cycle)	WLAN	1.58	±9.6
10518	AAC	IEEE 802.11a/h WiFi 5 GHz (OFDM, 9 Mbps, 99pc duty cycle)	WLAN	8.23	±9.6
10519	AAC	IEEE 802.11a/h WiFi 5 GHz (OFDM, 12 Mbps, 99pc duty cycle)	WLAN	8.39	±9.6
10520	AAC	IEEE 802.11a/h WiFi 5 GHz (OFDM, 18 Mbps, 99pc duty cycle)	WLAN	8.12	±9.6
10521	AAC	IEEE 802.11a/h WiFi 5 GHz (OFDM, 24 Mbps, 99pc duty cycle)	WLAN	7.97	±9.6
10522	AAC	IEEE 802.11a/h WiFi 5 GHz (OFDM, 36 Mbps, 99pc duty cycle)	WLAN	8.45	±9.6
10523	AAC	IEEE 802.11a/h WiFi 5 GHz (OFDM, 48 Mbps, 99pc duty cycle)	WLAN	8.08	±9.6
10524	AAC	IEEE 802.11a/h WiFi 5 GHz (OFDM, 54 Mbps, 99pc duty cycle)	WLAN	8.27	±9.6
10525	AAC	IEEE 802.11ac WiFi (20 MHz, MCS0, 99pc duty cycle)	WLAN	8.36	±9.6
10526	AAC	IEEE 802.11ac WiFi (20 MHz, MCS1, 99pc duty cycle)	WLAN	8.42	±9.6
10527	AAC	IEEE 802.11ac WiFi (20 MHz, MCS2, 99pc duty cycle)	WLAN	8.21	±9.6
10528	AAC	IEEE 802.11ac WiFi (20 MHz, MCS3, 99pc duty cycle)	WLAN	8.36	±9.6
10529	AAC	IEEE 802.11ac WiFi (20 MHz, MCS4, 99pc duty cycle)	WLAN	8.36	±9.6
10531	AAC	IEEE 802.11ac WiFi (20 MHz, MCS6, 99pc duty cycle)	WLAN	8.43	±9.6
10532	AAC	IEEE 802.11ac WiFi (20 MHz, MCS7, 99pc duty cycle)	WLAN	8.29	±9.6
10533	AAC	IEEE 802.11ac WiFi (20 MHz, MCS8, 99pc duty cycle)	WLAN	8.38	±9.6
10534	AAC	IEEE 802.11ac WiFi (40 MHz, MCS0, 99pc duty cycle)	WLAN	8.45	±9.6
10535	AAC	IEEE 802.11ac WiFi (40 MHz, MCS1, 99pc duty cycle)	WLAN	8.45	±9.6
10536	AAC	IEEE 802.11ac WiFi (40 MHz, MCS2, 99pc duty cycle)	WLAN	8.32	±9.6
10537	AAC	IEEE 802.11ac WiFi (40 MHz, MCS3, 99pc duty cycle)	WLAN	8.44	±9.6
10538	AAC	IEEE 802.11ac WiFi (40 MHz, MCS4, 99pc duty cycle)	WLAN	8.54	±9.6
10540	AAC	IEEE 802.11ac WiFi (40 MHz, MCS6, 99pc duty cycle)	WLAN	8.39	±9.6

Certificate No: EF-4034_Jan24

Page 14 of 21

EF3DV3 - SN:4034

January 16, 2024

UID	Rev	Communication System Name	Group	PAR (dB)	Unc ^k k = 2
10541	AAC	IEEE 802.11ac WiFi (40 MHz, MCS7, 99pc duty cycle)	WLAN	8.46	±9.6
10542	AAC	IEEE 802.11ac WiFi (40 MHz, MCS8, 99pc duty cycle)	WLAN	8.65	±9.6
10543	AAC	IEEE 802.11ac WiFi (40 MHz, MCS9, 99pc duty cycle)	WLAN	8.65	±9.6
10544	AAC	IEEE 802.11ac WiFi (80 MHz, MCS0, 99pc duty cycle)	WLAN	8.47	±9.6
10545	AAC	IEEE 802.11ac WiFi (80 MHz, MCS1, 99pc duty cycle)	WLAN	8.55	±9.6
10546	AAC	IEEE 802.11ac WiFi (80 MHz, MCS2, 99pc duty cycle)	WLAN	8.35	±9.6
10547	AAC	IEEE 802.11ac WiFi (80 MHz, MCS3, 99pc duty cycle)	WLAN	8.49	±9.6
10548	AAC	IEEE 802.11ac WiFi (80 MHz, MCS4, 99pc duty cycle)	WLAN	8.37	±9.6
10550	AAC	IEEE 802.11ac WiFi (80 MHz, MCS6, 99pc duty cycle)	WLAN	8.38	±9.6
10551	AAC	IEEE 802.11ac WiFi (80 MHz, MCS7, 99pc duty cycle)	WLAN	8.50	±9.6
10552	AAC	IEEE 802.11ac WiFi (80 MHz, MCS8, 99pc duty cycle)	WLAN	8.42	±9.6
10553	AAC	IEEE 802.11ac WiFi (80 MHz, MCS9, 99pc duty cycle)	WLAN	8.45	±9.6
10554	AAD	IEEE 802.11ac WiFi (160 MHz, MCS0, 99pc duty cycle)	WLAN	8.48	±9.6
10555	AAD	IEEE 802.11ac WiFi (160 MHz, MCS1, 99pc duty cycle)	WLAN	8.47	±9.6
10556	AAD	IEEE 802.11ac WiFi (160 MHz, MCS2, 99pc duty cycle)	WLAN	8.50	±9.6
10557	AAD	IEEE 802.11ac WiFi (160 MHz, MCS3, 99pc duty cycle)	WLAN	8.52	±9.6
10558	AAD	IEEE 802.11ac WiFi (160 MHz, MCS4, 99pc duty cycle)	WLAN	8.61	±9.6
10560	AAD	IEEE 802.11ac WiFi (160 MHz, MCS6, 99pc duty cycle)	WLAN	8.73	±9.6
10561	AAD	IEEE 802.11ac WiFi (160 MHz, MCS7, 99pc duty cycle)	WLAN	8.56	±9.6
10562	AAD	IEEE 802.11ac WiFi (160 MHz, MCS8, 99pc duty cycle)	WLAN	8.69	±9.6
10563	AAD	IEEE 802.11ac WiFi (160 MHz, MCS9, 99pc duty cycle)	WLAN	8.77	±9.6
10564	AAA	IEEE 802.11g WiFi 2.4 GHz (DSSS-OFDM, 9 Mbps, 99pc duty cycle)	WLAN	8.25	±9.6
10565	AAA	IEEE 802.11g WiFi 2.4 GHz (DSSS-OFDM, 12 Mbps, 99pc duty cycle)	WLAN	8.45	±9.6
10566	AAA	IEEE 802.11g WiFi 2.4 GHz (DSSS-OFDM, 18 Mbps, 99pc duty cycle)	WLAN	8.13	±9.6
10567	AAA	IEEE 802.11g WiFi 2.4 GHz (DSSS-OFDM, 24 Mbps, 99pc duty cycle)	WLAN	8.00	±9.6
10568	AAA	IEEE 802.11g WiFi 2.4 GHz (DSSS-OFDM, 36 Mbps, 99pc duty cycle)	WLAN	8.37	±9.6
10569	AAA	IEEE 802.11g WiFi 2.4 GHz (DSSS-OFDM, 48 Mbps, 99pc duty cycle)	WLAN	8.10	±9.6
10570	AAA	IEEE 802.11g WiFi 2.4 GHz (DSSS-OFDM, 54 Mbps, 99pc duty cycle)	WLAN	8.30	±9.6
10571	AAA	IEEE 802.11b WiFi 2.4 GHz (DSSS, 1 Mbps, 90pc duty cycle)	WLAN	1.99	±9.6
10572	AAA	IEEE 802.11b WiFi 2.4 GHz (DSSS, 2 Mbps, 90pc duty cycle)	WLAN	1.99	±9.6
10573	AAA	IEEE 802.11b WiFi 2.4 GHz (DSSS, 5.5 Mbps, 90pc duty cycle)	WLAN	1.98	±9.6
10574	AAA	IEEE 802.11b WiFi 2.4 GHz (DSSS, 11 Mbps, 90pc duty cycle)	WLAN	1.98	±9.6
10575	AAA	IEEE 802.11g WiFi 2.4 GHz (DSSS-OFDM, 6 Mbps, 90pc duty cycle)	WLAN	8.59	±9.6
10576	AAA	IEEE 802.11g WiFi 2.4 GHz (DSSS-OFDM, 9 Mbps, 90pc duty cycle)	WLAN	8.60	±9.6
10577	AAA	IEEE 802.11g WiFi 2.4 GHz (DSSS-OFDM, 12 Mbps, 90pc duty cycle)	WLAN	8.70	±9.6
10578	AAA	IEEE 802.11g WiFi 2.4 GHz (DSSS-OFDM, 18 Mbps, 90pc duty cycle)	WLAN	8.49	±9.6
10579	AAA	IEEE 802.11g WiFi 2.4 GHz (DSSS-OFDM, 24 Mbps, 90pc duty cycle)	WLAN	8.36	±9.6
10580	AAA	IEEE 802.11g WiFi 2.4 GHz (DSSS-OFDM, 36 Mbps, 90pc duty cycle)	WLAN	8.75	±9.6
10581	AAA	IEEE 802.11g WiFi 2.4 GHz (DSSS-OFDM, 48 Mbps, 90pc duty cycle)	WLAN	8.35	±9.6
10582	AAA	IEEE 802.11g WiFi 2.4 GHz (DSSS-OFDM, 54 Mbps, 90pc duty cycle)	WLAN	8.67	±9.6
10583	AAC	IEEE 802.11a/h WiFi 5 GHz (OFDM, 6 Mbps, 90pc duty cycle)	WLAN	8.59	±9.6
10584	AAC	IEEE 802.11a/h WiFi 5 GHz (OFDM, 9 Mbps, 90pc duty cycle)	WLAN	8.60	±9.6
10585	AAC	IEEE 802.11a/h WiFi 5 GHz (OFDM, 12 Mbps, 90pc duty cycle)	WLAN	8.70	±9.6
10586	AAC	IEEE 802.11a/h WiFi 5 GHz (OFDM, 18 Mbps, 90pc duty cycle)	WLAN	8.49	±9.6
10587	AAC	IEEE 802.11a/h WiFi 5 GHz (OFDM, 24 Mbps, 90pc duty cycle)	WLAN	8.36	±9.6
10588	AAC	IEEE 802.11a/h WiFi 5 GHz (OFDM, 36 Mbps, 90pc duty cycle)	WLAN	8.76	±9.6
10589	AAC	IEEE 802.11a/h WiFi 5 GHz (OFDM, 48 Mbps, 90pc duty cycle)	WLAN	8.35	±9.6
10590	AAC	IEEE 802.11a/h WiFi 5 GHz (OFDM, 54 Mbps, 90pc duty cycle)	WLAN	8.67	±9.6
10591	AAC	IEEE 802.11n (HT Mixed, 20 MHz, MCS0, 90pc duty cycle)	WLAN	8.63	±9.6
10592	AAC	IEEE 802.11n (HT Mixed, 20 MHz, MCS1, 90pc duty cycle)	WLAN	8.79	±9.6
10593	AAC	IEEE 802.11n (HT Mixed, 20 MHz, MCS2, 90pc duty cycle)	WLAN	8.64	±9.6
10594	AAC	IEEE 802.11n (HT Mixed, 20 MHz, MCS3, 90pc duty cycle)	WLAN	8.74	±9.6
10595	AAC	IEEE 802.11n (HT Mixed, 20 MHz, MCS4, 90pc duty cycle)	WLAN	8.74	±9.6
10596	AAC	IEEE 802.11n (HT Mixed, 20 MHz, MCS5, 90pc duty cycle)	WLAN	8.71	±9.6
10597	AAC	IEEE 802.11n (HT Mixed, 20 MHz, MCS6, 90pc duty cycle)	WLAN	8.72	±9.6
10598	AAC	IEEE 802.11n (HT Mixed, 20 MHz, MCS7, 90pc duty cycle)	WLAN	8.50	±9.6
10599	AAC	IEEE 802.11n (HT Mixed, 40 MHz, MCS0, 90pc duty cycle)	WLAN	8.79	±9.6
10600	AAC	IEEE 802.11n (HT Mixed, 40 MHz, MCS1, 90pc duty cycle)	WLAN	8.88	±9.6
10601	AAC	IEEE 802.11n (HT Mixed, 40 MHz, MCS2, 90pc duty cycle)	WLAN	8.82	±9.6
10602	AAC	IEEE 802.11n (HT Mixed, 40 MHz, MCS3, 90pc duty cycle)	WLAN	8.94	±9.6
10603	AAC	IEEE 802.11n (HT Mixed, 40 MHz, MCS4, 90pc duty cycle)	WLAN	8.93	±9.6
10604	AAC	IEEE 802.11n (HT Mixed, 40 MHz, MCS5, 90pc duty cycle)	WLAN	8.76	±9.6
10605	AAC	IEEE 802.11n (HT Mixed, 40 MHz, MCS6, 90pc duty cycle)	WLAN	8.97	±9.6
10606	AAC	IEEE 802.11n (HT Mixed, 40 MHz, MCS7, 90pc duty cycle)	WLAN	8.82	±9.6
10607	AAC	IEEE 802.11ac WiFi (20 MHz, MCS0, 90pc duty cycle)	WLAN	8.64	±9.6
10608	AAC	IEEE 802.11ac WiFi (20 MHz, MCS1, 90pc duty cycle)	WLAN	8.77	±9.6

Certificate No: EF-4034_Jan24

Page 15 of 21

EF3DV3 - SN:4034

January 16, 2024

UID	Rev	Communication System Name	Group	PAR (dB)	Unc ^E k = 2
10609	AAC	IEEE 802.11ac WiFi (20 MHz, MCS2, 90pc duty cycle)	WLAN	8.57	±9.6
10610	AAC	IEEE 802.11ac WiFi (20 MHz, MCS3, 90pc duty cycle)	WLAN	8.78	±9.6
10611	AAC	IEEE 802.11ac WiFi (20 MHz, MCS4, 90pc duty cycle)	WLAN	8.70	±9.6
10612	AAC	IEEE 802.11ac WiFi (20 MHz, MCS5, 90pc duty cycle)	WLAN	8.77	±9.6
10613	AAC	IEEE 802.11ac WiFi (20 MHz, MCS6, 90pc duty cycle)	WLAN	8.94	±9.6
10614	AAC	IEEE 802.11ac WiFi (20 MHz, MCS7, 90pc duty cycle)	WLAN	8.59	±9.6
10615	AAC	IEEE 802.11ac WiFi (20 MHz, MCS8, 90pc duty cycle)	WLAN	8.82	±9.6
10616	AAC	IEEE 802.11ac WiFi (40 MHz, MCS0, 90pc duty cycle)	WLAN	8.82	±9.6
10617	AAC	IEEE 802.11ac WiFi (40 MHz, MCS1, 90pc duty cycle)	WLAN	8.81	±9.6
10618	AAC	IEEE 802.11ac WiFi (40 MHz, MCS2, 90pc duty cycle)	WLAN	8.58	±9.6
10619	AAC	IEEE 802.11ac WiFi (40 MHz, MCS3, 90pc duty cycle)	WLAN	8.86	±9.6
10620	AAC	IEEE 802.11ac WiFi (40 MHz, MCS4, 90pc duty cycle)	WLAN	8.87	±9.6
10621	AAC	IEEE 802.11ac WiFi (40 MHz, MCS5, 90pc duty cycle)	WLAN	8.77	±9.6
10622	AAC	IEEE 802.11ac WiFi (40 MHz, MCS6, 90pc duty cycle)	WLAN	8.88	±9.6
10623	AAC	IEEE 802.11ac WiFi (40 MHz, MCS7, 90pc duty cycle)	WLAN	8.82	±9.6
10624	AAC	IEEE 802.11ac WiFi (40 MHz, MCS8, 90pc duty cycle)	WLAN	8.96	±9.6
10625	AAC	IEEE 802.11ac WiFi (40 MHz, MCS9, 90pc duty cycle)	WLAN	8.96	±9.6
10626	AAC	IEEE 802.11ac WiFi (80 MHz, MCS0, 90pc duty cycle)	WLAN	8.83	±9.6
10627	AAC	IEEE 802.11ac WiFi (80 MHz, MCS1, 90pc duty cycle)	WLAN	8.88	±9.6
10628	AAC	IEEE 802.11ac WiFi (80 MHz, MCS2, 90pc duty cycle)	WLAN	8.71	±9.6
10629	AAC	IEEE 802.11ac WiFi (80 MHz, MCS3, 90pc duty cycle)	WLAN	8.85	±9.6
10630	AAC	IEEE 802.11ac WiFi (80 MHz, MCS4, 90pc duty cycle)	WLAN	8.72	±9.6
10631	AAC	IEEE 802.11ac WiFi (80 MHz, MCS5, 90pc duty cycle)	WLAN	8.81	±9.6
10632	AAC	IEEE 802.11ac WiFi (80 MHz, MCS6, 90pc duty cycle)	WLAN	8.74	±9.6
10633	AAC	IEEE 802.11ac WiFi (80 MHz, MCS7, 90pc duty cycle)	WLAN	8.83	±9.6
10634	AAC	IEEE 802.11ac WiFi (80 MHz, MCS8, 90pc duty cycle)	WLAN	8.80	±9.6
10635	AAC	IEEE 802.11ac WiFi (80 MHz, MCS9, 90pc duty cycle)	WLAN	8.81	±9.6
10636	AAD	IEEE 802.11ac WiFi (160 MHz, MCS0, 90pc duty cycle)	WLAN	8.83	±9.6
10637	AAD	IEEE 802.11ac WiFi (160 MHz, MCS1, 90pc duty cycle)	WLAN	8.79	±9.6
10638	AAD	IEEE 802.11ac WiFi (160 MHz, MCS2, 90pc duty cycle)	WLAN	8.86	±9.6
10639	AAD	IEEE 802.11ac WiFi (160 MHz, MCS3, 90pc duty cycle)	WLAN	8.85	±9.6
10640	AAD	IEEE 802.11ac WiFi (160 MHz, MCS4, 90pc duty cycle)	WLAN	8.98	±9.6
10641	AAD	IEEE 802.11ac WiFi (160 MHz, MCS5, 90pc duty cycle)	WLAN	9.06	±9.6
10642	AAD	IEEE 802.11ac WiFi (160 MHz, MCS6, 90pc duty cycle)	WLAN	9.06	±9.6
10643	AAD	IEEE 802.11ac WiFi (160 MHz, MCS7, 90pc duty cycle)	WLAN	8.89	±9.6
10644	AAD	IEEE 802.11ac WiFi (160 MHz, MCS8, 90pc duty cycle)	WLAN	9.05	±9.6
10645	AAD	IEEE 802.11ac WiFi (160 MHz, MCS9, 90pc duty cycle)	WLAN	9.11	±9.6
10646	AAH	LTE-TDD (SC-FDMA, 1 RB, 5 MHz, QPSK, UL Subframe=2,7)	LTE-TDD	11.96	±9.6
10647	AAG	LTE-TDD (SC-FDMA, 1 RB, 20 MHz, QPSK, UL Subframe=2,7)	LTE-TDD	11.96	±9.6
10648	AAA	CDMA2000 (1x Advanced)	CDMA2000	3.45	±9.6
10652	AAF	LTE-TDD (OFDMA, 5 MHz, E-TM 3.1, Clipping 44%)	LTE-TDD	6.91	±9.6
10653	AAF	LTE-TDD (OFDMA, 10 MHz, E-TM 3.1, Clipping 44%)	LTE-TDD	7.42	±9.6
10654	AAE	LTE-TDD (OFDMA, 15 MHz, E-TM 3.1, Clipping 44%)	LTE-TDD	8.96	±9.6
10655	AAF	LTE-TDD (OFDMA, 20 MHz, E-TM 3.1, Clipping 44%)	LTE-TDD	7.21	±9.6
10658	AAB	Pulse Waveform (200Hz, 10%)	Test	10.00	±9.6
10659	AAB	Pulse Waveform (200Hz, 20%)	Test	8.99	±9.6
10660	AAB	Pulse Waveform (200Hz, 40%)	Test	3.98	±9.6
10661	AAB	Pulse Waveform (200Hz, 60%)	Test	2.22	±9.6
10662	AAB	Pulse Waveform (200Hz, 80%)	Test	0.97	±9.6
10670	AAA	Bluetooth Low Energy	Bluetooth	2.19	±9.6
10671	AAC	IEEE 802.11ax (20 MHz, MCS0, 90pc duty cycle)	WLAN	8.09	±9.6
10672	AAC	IEEE 802.11ax (20 MHz, MCS1, 90pc duty cycle)	WLAN	8.57	±9.6
10673	AAC	IEEE 802.11ax (20 MHz, MCS2, 90pc duty cycle)	WLAN	8.78	±9.6
10674	AAC	IEEE 802.11ax (20 MHz, MCS3, 90pc duty cycle)	WLAN	8.74	±9.6
10675	AAC	IEEE 802.11ax (20 MHz, MCS4, 90pc duty cycle)	WLAN	8.90	±9.6
10676	AAC	IEEE 802.11ax (20 MHz, MCS5, 90pc duty cycle)	WLAN	8.77	±9.6
10677	AAC	IEEE 802.11ax (20 MHz, MCS6, 90pc duty cycle)	WLAN	8.73	±9.6
10678	AAC	IEEE 802.11ax (20 MHz, MCS7, 90pc duty cycle)	WLAN	8.78	±9.6
10679	AAC	IEEE 802.11ax (20 MHz, MCS8, 90pc duty cycle)	WLAN	8.89	±9.6
10680	AAC	IEEE 802.11ax (20 MHz, MCS9, 90pc duty cycle)	WLAN	8.80	±9.6
10681	AAC	IEEE 802.11ax (20 MHz, MCS10, 90pc duty cycle)	WLAN	8.62	±9.6
10682	AAC	IEEE 802.11ax (20 MHz, MCS11, 90pc duty cycle)	WLAN	8.83	±9.6
10683	AAC	IEEE 802.11ax (20 MHz, MCS0, 99pc duty cycle)	WLAN	8.42	±9.6
10684	AAC	IEEE 802.11ax (20 MHz, MCS1, 99pc duty cycle)	WLAN	8.26	±9.6
10685	AAC	IEEE 802.11ax (20 MHz, MCS2, 99pc duty cycle)	WLAN	8.33	±9.6
10686	AAC	IEEE 802.11ax (20 MHz, MCS3, 99pc duty cycle)	WLAN	8.28	±9.6

Certificate No: EF-4034_Jan24

Page 16 of 21

EF3DV3 - SN:4034

January 16, 2024

UID	Rev	Communication System Name	Group	PAR (dB)	Unc ^k k = 2
10687	AAC	IEEE 802.11ax (20 MHz, MCS4, 99pc duty cycle)	WLAN	8.45	±0.6
10688	AAC	IEEE 802.11ax (20 MHz, MCS5, 99pc duty cycle)	WLAN	8.29	±0.6
10689	AAC	IEEE 802.11ax (20 MHz, MCS6, 99pc duty cycle)	WLAN	8.55	±0.6
10690	AAC	IEEE 802.11ax (20 MHz, MCS7, 99pc duty cycle)	WLAN	8.29	±0.6
10691	AAC	IEEE 802.11ax (20 MHz, MCS8, 99pc duty cycle)	WLAN	8.25	±0.6
10692	AAC	IEEE 802.11ax (20 MHz, MCS9, 99pc duty cycle)	WLAN	8.29	±0.6
10693	AAC	IEEE 802.11ax (20 MHz, MCS10, 99pc duty cycle)	WLAN	8.25	±0.6
10694	AAC	IEEE 802.11ax (20 MHz, MCS11, 99pc duty cycle)	WLAN	8.57	±0.6
10695	AAC	IEEE 802.11ax (40 MHz, MCS0, 90pc duty cycle)	WLAN	8.78	±0.6
10696	AAC	IEEE 802.11ax (40 MHz, MCS1, 90pc duty cycle)	WLAN	8.91	±0.6
10697	AAC	IEEE 802.11ax (40 MHz, MCS2, 90pc duty cycle)	WLAN	8.61	±0.6
10698	AAC	IEEE 802.11ax (40 MHz, MCS3, 90pc duty cycle)	WLAN	8.89	±0.6
10699	AAC	IEEE 802.11ax (40 MHz, MCS4, 90pc duty cycle)	WLAN	8.82	±0.6
10700	AAC	IEEE 802.11ax (40 MHz, MCS5, 90pc duty cycle)	WLAN	8.73	±0.6
10701	AAC	IEEE 802.11ax (40 MHz, MCS6, 90pc duty cycle)	WLAN	8.86	±0.6
10702	AAC	IEEE 802.11ax (40 MHz, MCS7, 90pc duty cycle)	WLAN	8.70	±0.6
10703	AAC	IEEE 802.11ax (40 MHz, MCS8, 90pc duty cycle)	WLAN	8.82	±0.6
10704	AAC	IEEE 802.11ax (40 MHz, MCS9, 90pc duty cycle)	WLAN	8.56	±0.6
10705	AAC	IEEE 802.11ax (40 MHz, MCS10, 90pc duty cycle)	WLAN	8.69	±0.6
10706	AAC	IEEE 802.11ax (40 MHz, MCS11, 90pc duty cycle)	WLAN	8.66	±0.6
10707	AAC	IEEE 802.11ax (40 MHz, MCS0, 99pc duty cycle)	WLAN	8.32	±0.6
10708	AAC	IEEE 802.11ax (40 MHz, MCS1, 99pc duty cycle)	WLAN	8.55	±0.6
10709	AAC	IEEE 802.11ax (40 MHz, MCS2, 99pc duty cycle)	WLAN	8.33	±0.6
10710	AAC	IEEE 802.11ax (40 MHz, MCS3, 99pc duty cycle)	WLAN	8.29	±0.6
10711	AAC	IEEE 802.11ax (40 MHz, MCS4, 99pc duty cycle)	WLAN	8.39	±0.6
10712	AAC	IEEE 802.11ax (40 MHz, MCS5, 99pc duty cycle)	WLAN	8.67	±0.6
10713	AAC	IEEE 802.11ax (40 MHz, MCS6, 99pc duty cycle)	WLAN	8.33	±0.6
10714	AAC	IEEE 802.11ax (40 MHz, MCS7, 99pc duty cycle)	WLAN	8.25	±0.6
10715	AAC	IEEE 802.11ax (40 MHz, MCS8, 99pc duty cycle)	WLAN	8.45	±0.6
10716	AAC	IEEE 802.11ax (40 MHz, MCS9, 99pc duty cycle)	WLAN	8.30	±0.6
10717	AAC	IEEE 802.11ax (40 MHz, MCS10, 99pc duty cycle)	WLAN	8.48	±0.6
10718	AAC	IEEE 802.11ax (40 MHz, MCS11, 99pc duty cycle)	WLAN	8.24	±0.6
10719	AAC	IEEE 802.11ax (80 MHz, MCS0, 90pc duty cycle)	WLAN	8.81	±0.6
10720	AAC	IEEE 802.11ax (80 MHz, MCS1, 90pc duty cycle)	WLAN	8.87	±0.6
10721	AAC	IEEE 802.11ax (80 MHz, MCS2, 90pc duty cycle)	WLAN	8.76	±0.6
10722	AAC	IEEE 802.11ax (80 MHz, MCS3, 90pc duty cycle)	WLAN	8.58	±0.6
10723	AAC	IEEE 802.11ax (80 MHz, MCS4, 90pc duty cycle)	WLAN	8.70	±0.6
10724	AAC	IEEE 802.11ax (80 MHz, MCS5, 90pc duty cycle)	WLAN	8.90	±0.6
10725	AAC	IEEE 802.11ax (80 MHz, MCS6, 90pc duty cycle)	WLAN	8.74	±0.6
10726	AAC	IEEE 802.11ax (80 MHz, MCS7, 90pc duty cycle)	WLAN	8.72	±0.6
10727	AAC	IEEE 802.11ax (80 MHz, MCS8, 90pc duty cycle)	WLAN	8.86	±0.6
10728	AAC	IEEE 802.11ax (80 MHz, MCS9, 90pc duty cycle)	WLAN	8.65	±0.6
10729	AAC	IEEE 802.11ax (80 MHz, MCS10, 90pc duty cycle)	WLAN	8.64	±0.6
10730	AAC	IEEE 802.11ax (80 MHz, MCS11, 90pc duty cycle)	WLAN	8.67	±0.6
10731	AAC	IEEE 802.11ax (80 MHz, MCS0, 99pc duty cycle)	WLAN	8.42	±0.6
10732	AAC	IEEE 802.11ax (80 MHz, MCS1, 99pc duty cycle)	WLAN	8.46	±0.6
10733	AAC	IEEE 802.11ax (80 MHz, MCS2, 99pc duty cycle)	WLAN	8.40	±0.6
10734	AAC	IEEE 802.11ax (80 MHz, MCS3, 99pc duty cycle)	WLAN	8.25	±0.6
10735	AAC	IEEE 802.11ax (80 MHz, MCS4, 99pc duty cycle)	WLAN	8.33	±0.6
10736	AAC	IEEE 802.11ax (80 MHz, MCS5, 99pc duty cycle)	WLAN	8.27	±0.6
10737	AAC	IEEE 802.11ax (80 MHz, MCS6, 99pc duty cycle)	WLAN	8.36	±0.6
10738	AAC	IEEE 802.11ax (80 MHz, MCS7, 99pc duty cycle)	WLAN	8.42	±0.6
10739	AAC	IEEE 802.11ax (80 MHz, MCS8, 99pc duty cycle)	WLAN	8.29	±0.6
10740	AAC	IEEE 802.11ax (80 MHz, MCS9, 99pc duty cycle)	WLAN	8.48	±0.6
10741	AAC	IEEE 802.11ax (80 MHz, MCS10, 99pc duty cycle)	WLAN	8.40	±0.6
10742	AAC	IEEE 802.11ax (80 MHz, MCS11, 99pc duty cycle)	WLAN	8.43	±0.6
10743	AAC	IEEE 802.11ax (160 MHz, MCS0, 90pc duty cycle)	WLAN	8.94	±0.6
10744	AAC	IEEE 802.11ax (160 MHz, MCS1, 90pc duty cycle)	WLAN	9.16	±0.6
10745	AAC	IEEE 802.11ax (160 MHz, MCS2, 90pc duty cycle)	WLAN	8.93	±0.6
10746	AAC	IEEE 802.11ax (160 MHz, MCS3, 90pc duty cycle)	WLAN	9.11	±0.6
10747	AAC	IEEE 802.11ax (160 MHz, MCS4, 90pc duty cycle)	WLAN	9.04	±0.6
10748	AAC	IEEE 802.11ax (160 MHz, MCS5, 90pc duty cycle)	WLAN	8.93	±0.6
10749	AAC	IEEE 802.11ax (160 MHz, MCS6, 90pc duty cycle)	WLAN	8.90	±0.6
10750	AAC	IEEE 802.11ax (160 MHz, MCS7, 90pc duty cycle)	WLAN	8.79	±0.6
10751	AAC	IEEE 802.11ax (160 MHz, MCS8, 90pc duty cycle)	WLAN	8.82	±0.6
10752	AAC	IEEE 802.11ax (160 MHz, MCS9, 90pc duty cycle)	WLAN	8.81	±0.6

Certificate No: EF-4034_Jan24

Page 17 of 21

EF3DV3 - SN:4034

January 16, 2024

UID	Rev	Communication System Name	Group	PAR (dB)	Unc ^k k = 2
10753	AAC	IEEE 802.11ax (160 MHz, MCS10, 99pc duty cycle)	WLAN	9.00	±9.6
10754	AAC	IEEE 802.11ax (160 MHz, MCS11, 99pc duty cycle)	WLAN	8.94	±9.6
10755	AAC	IEEE 802.11ax (160 MHz, MCS9, 99pc duty cycle)	WLAN	8.84	±9.6
10756	AAC	IEEE 802.11ax (160 MHz, MCS1, 99pc duty cycle)	WLAN	8.77	±9.6
10757	AAC	IEEE 802.11ax (160 MHz, MCS2, 99pc duty cycle)	WLAN	8.77	±9.6
10758	AAC	IEEE 802.11ax (160 MHz, MCS3, 99pc duty cycle)	WLAN	8.69	±9.6
10759	AAC	IEEE 802.11ax (160 MHz, MCS4, 99pc duty cycle)	WLAN	8.58	±9.6
10760	AAC	IEEE 802.11ax (160 MHz, MCS5, 99pc duty cycle)	WLAN	8.49	±9.6
10761	AAC	IEEE 802.11ax (160 MHz, MCS8, 99pc duty cycle)	WLAN	8.58	±9.6
10762	AAC	IEEE 802.11ax (160 MHz, MCS7, 99pc duty cycle)	WLAN	8.48	±9.6
10763	AAC	IEEE 802.11ax (160 MHz, MCS8, 99pc duty cycle)	WLAN	8.53	±9.6
10764	AAC	IEEE 802.11ax (160 MHz, MCS9, 99pc duty cycle)	WLAN	8.54	±9.6
10765	AAC	IEEE 802.11ax (160 MHz, MCS10, 99pc duty cycle)	WLAN	8.54	±9.6
10766	AAC	IEEE 802.11ax (160 MHz, MCS11, 99pc duty cycle)	WLAN	8.51	±9.6
10767	AAE	5G NR (CP-OFDM, 1 RB, 5 MHz, QPSK, 15 kHz)	5G NR FR1 TDD	7.99	±9.6
10768	AAD	5G NR (CP-OFDM, 1 RB, 10 MHz, QPSK, 15 kHz)	5G NR FR1 TDD	8.01	±9.6
10769	AAD	5G NR (CP-OFDM, 1 RB, 15 MHz, QPSK, 15 kHz)	5G NR FR1 TDD	8.01	±9.6
10770	AAD	5G NR (CP-OFDM, 1 RB, 20 MHz, QPSK, 15 kHz)	5G NR FR1 TDD	8.02	±9.6
10771	AAD	5G NR (CP-OFDM, 1 RB, 25 MHz, QPSK, 15 kHz)	5G NR FR1 TDD	8.02	±9.6
10772	AAD	5G NR (CP-OFDM, 1 RB, 30 MHz, QPSK, 15 kHz)	5G NR FR1 TDD	8.23	±9.6
10773	AAD	5G NR (CP-OFDM, 1 RB, 40 MHz, QPSK, 15 kHz)	5G NR FR1 TDD	8.03	±9.6
10774	AAD	5G NR (CP-OFDM, 1 RB, 50 MHz, QPSK, 15 kHz)	5G NR FR1 TDD	8.02	±9.6
10775	AAD	5G NR (CP-OFDM, 50% RB, 5 MHz, QPSK, 15 kHz)	5G NR FR1 TDD	8.31	±9.6
10776	AAD	5G NR (CP-OFDM, 50% RB, 10 MHz, QPSK, 15 kHz)	5G NR FR1 TDD	8.30	±9.6
10777	AAC	5G NR (CP-OFDM, 50% RB, 15 MHz, QPSK, 15 kHz)	5G NR FR1 TDD	8.30	±9.6
10778	AAD	5G NR (CP-OFDM, 50% RB, 20 MHz, QPSK, 15 kHz)	5G NR FR1 TDD	8.34	±9.6
10779	AAC	5G NR (CP-OFDM, 50% RB, 25 MHz, QPSK, 15 kHz)	5G NR FR1 TDD	8.42	±9.6
10780	AAD	5G NR (CP-OFDM, 50% RB, 30 MHz, QPSK, 15 kHz)	5G NR FR1 TDD	8.38	±9.6
10781	AAD	5G NR (CP-OFDM, 50% RB, 40 MHz, QPSK, 15 kHz)	5G NR FR1 TDD	8.38	±9.6
10782	AAD	5G NR (CP-OFDM, 50% RB, 50 MHz, QPSK, 15 kHz)	5G NR FR1 TDD	8.43	±9.6
10783	AAE	5G NR (CP-OFDM, 100% RB, 5 MHz, QPSK, 15 kHz)	5G NR FR1 TDD	8.31	±9.6
10784	AAD	5G NR (CP-OFDM, 100% RB, 10 MHz, QPSK, 15 kHz)	5G NR FR1 TDD	8.29	±9.6
10785	AAD	5G NR (CP-OFDM, 100% RB, 15 MHz, QPSK, 15 kHz)	5G NR FR1 TDD	8.40	±9.6
10786	AAD	5G NR (CP-OFDM, 100% RB, 20 MHz, QPSK, 15 kHz)	5G NR FR1 TDD	8.35	±9.6
10787	AAD	5G NR (CP-OFDM, 100% RB, 25 MHz, QPSK, 15 kHz)	5G NR FR1 TDD	8.44	±9.6
10788	AAD	5G NR (CP-OFDM, 100% RB, 30 MHz, QPSK, 15 kHz)	5G NR FR1 TDD	8.39	±9.6
10789	AAD	5G NR (CP-OFDM, 100% RB, 40 MHz, QPSK, 15 kHz)	5G NR FR1 TDD	8.37	±9.6
10790	AAD	5G NR (CP-OFDM, 100% RB, 50 MHz, QPSK, 15 kHz)	5G NR FR1 TDD	8.39	±9.6
10791	AAE	5G NR (CP-OFDM, 1 RB, 5 MHz, QPSK, 30 kHz)	5G NR FR1 TDD	7.83	±9.6
10792	AAD	5G NR (CP-OFDM, 1 RB, 10 MHz, QPSK, 30 kHz)	5G NR FR1 TDD	7.92	±9.6
10793	AAD	5G NR (CP-OFDM, 1 RB, 15 MHz, QPSK, 30 kHz)	5G NR FR1 TDD	7.95	±9.6
10794	AAD	5G NR (CP-OFDM, 1 RB, 20 MHz, QPSK, 30 kHz)	5G NR FR1 TDD	7.82	±9.6
10795	AAD	5G NR (CP-OFDM, 1 RB, 25 MHz, QPSK, 30 kHz)	5G NR FR1 TDD	7.84	±9.6
10796	AAD	5G NR (CP-OFDM, 1 RB, 30 MHz, QPSK, 30 kHz)	5G NR FR1 TDD	7.82	±9.6
10797	AAD	5G NR (CP-OFDM, 1 RB, 40 MHz, QPSK, 30 kHz)	5G NR FR1 TDD	8.01	±9.6
10798	AAD	5G NR (CP-OFDM, 1 RB, 50 MHz, QPSK, 30 kHz)	5G NR FR1 TDD	7.89	±9.6
10799	AAD	5G NR (CP-OFDM, 1 RB, 60 MHz, QPSK, 30 kHz)	5G NR FR1 TDD	7.93	±9.6
10801	AAD	5G NR (CP-OFDM, 1 RB, 80 MHz, QPSK, 30 kHz)	5G NR FR1 TDD	7.89	±9.6
10802	AAD	5G NR (CP-OFDM, 1 RB, 90 MHz, QPSK, 30 kHz)	5G NR FR1 TDD	7.87	±9.6
10803	AAD	5G NR (CP-OFDM, 1 RB, 100 MHz, QPSK, 30 kHz)	5G NR FR1 TDD	7.93	±9.6
10805	AAD	5G NR (CP-OFDM, 50% RB, 10 MHz, QPSK, 30 kHz)	5G NR FR1 TDD	8.34	±9.6
10806	AAD	5G NR (CP-OFDM, 50% RB, 15 MHz, QPSK, 30 kHz)	5G NR FR1 TDD	8.37	±9.6
10809	AAD	5G NR (CP-OFDM, 50% RB, 30 MHz, QPSK, 30 kHz)	5G NR FR1 TDD	8.34	±9.6
10810	AAD	5G NR (CP-OFDM, 50% RB, 40 MHz, QPSK, 30 kHz)	5G NR FR1 TDD	8.34	±9.6
10812	AAD	5G NR (CP-OFDM, 50% RB, 60 MHz, QPSK, 30 kHz)	5G NR FR1 TDD	8.35	±9.6
10817	AAE	5G NR (CP-OFDM, 100% RB, 5 MHz, QPSK, 30 kHz)	5G NR FR1 TDD	8.35	±9.6
10818	AAD	5G NR (CP-OFDM, 100% RB, 10 MHz, QPSK, 30 kHz)	5G NR FR1 TDD	8.34	±9.6
10819	AAD	5G NR (CP-OFDM, 100% RB, 15 MHz, QPSK, 30 kHz)	5G NR FR1 TDD	8.33	±9.6
10820	AAD	5G NR (CP-OFDM, 100% RB, 20 MHz, QPSK, 30 kHz)	5G NR FR1 TDD	8.30	±9.6
10821	AAD	5G NR (CP-OFDM, 100% RB, 25 MHz, QPSK, 30 kHz)	5G NR FR1 TDD	8.41	±9.6
10822	AAD	5G NR (CP-OFDM, 100% RB, 30 MHz, QPSK, 30 kHz)	5G NR FR1 TDD	8.41	±9.6
10823	AAD	5G NR (CP-OFDM, 100% RB, 40 MHz, QPSK, 30 kHz)	5G NR FR1 TDD	8.36	±9.6
10824	AAD	5G NR (CP-OFDM, 100% RB, 50 MHz, QPSK, 30 kHz)	5G NR FR1 TDD	8.39	±9.6
10825	AAD	5G NR (CP-OFDM, 100% RB, 60 MHz, QPSK, 30 kHz)	5G NR FR1 TDD	8.41	±9.6
10827	AAD	5G NR (CP-OFDM, 100% RB, 80 MHz, QPSK, 30 kHz)	5G NR FR1 TDD	8.42	±9.6
10828	AAD	5G NR (CP-OFDM, 100% RB, 90 MHz, QPSK, 30 kHz)	5G NR FR1 TDD	8.43	±9.6

EF3DV3 - SN:4034

January 16, 2024

UID	Rev	Communication System Name	Group	PAR (dB)	Unc ^k k = 2
10829	AAD	5G NR (CP-OFDM, 100% RB, 100 MHz, QPSK, 30 kHz)	5G NR FR1 TDD	8.40	±9.6
10830	AAD	5G NR (CP-OFDM, 1 RB, 10 MHz, QPSK, 60 kHz)	5G NR FR1 TDD	7.63	±9.6
10831	AAD	5G NR (CP-OFDM, 1 RB, 15 MHz, QPSK, 60 kHz)	5G NR FR1 TDD	7.73	±9.6
10832	AAD	5G NR (CP-OFDM, 1 RB, 20 MHz, QPSK, 60 kHz)	5G NR FR1 TDD	7.74	±9.6
10833	AAD	5G NR (CP-OFDM, 1 RB, 25 MHz, QPSK, 60 kHz)	5G NR FR1 TDD	7.70	±9.6
10834	AAD	5G NR (CP-OFDM, 1 RB, 30 MHz, QPSK, 60 kHz)	5G NR FR1 TDD	7.75	±9.6
10835	AAD	5G NR (CP-OFDM, 1 RB, 40 MHz, QPSK, 60 kHz)	5G NR FR1 TDD	7.70	±9.6
10836	AAD	5G NR (CP-OFDM, 1 RB, 50 MHz, QPSK, 60 kHz)	5G NR FR1 TDD	7.66	±9.6
10837	AAD	5G NR (CP-OFDM, 1 RB, 60 MHz, QPSK, 60 kHz)	5G NR FR1 TDD	7.68	±9.6
10839	AAD	5G NR (CP-OFDM, 1 RB, 80 MHz, QPSK, 60 kHz)	5G NR FR1 TDD	7.70	±9.6
10840	AAD	5G NR (CP-OFDM, 1 RB, 90 MHz, QPSK, 60 kHz)	5G NR FR1 TDD	7.67	±9.6
10841	AAD	5G NR (CP-OFDM, 1 RB, 100 MHz, QPSK, 60 kHz)	5G NR FR1 TDD	7.71	±9.6
10843	AAD	5G NR (CP-OFDM, 50% RB, 15 MHz, QPSK, 60 kHz)	5G NR FR1 TDD	8.49	±9.6
10844	AAD	5G NR (CP-OFDM, 50% RB, 20 MHz, QPSK, 60 kHz)	5G NR FR1 TDD	8.34	±9.6
10846	AAD	5G NR (CP-OFDM, 50% RB, 30 MHz, QPSK, 60 kHz)	5G NR FR1 TDD	8.41	±9.6
10854	AAD	5G NR (CP-OFDM, 100% RB, 10 MHz, QPSK, 60 kHz)	5G NR FR1 TDD	8.34	±9.6
10855	AAD	5G NR (CP-OFDM, 100% RB, 15 MHz, QPSK, 60 kHz)	5G NR FR1 TDD	8.36	±9.6
10856	AAD	5G NR (CP-OFDM, 100% RB, 20 MHz, QPSK, 60 kHz)	5G NR FR1 TDD	8.37	±9.6
10857	AAD	5G NR (CP-OFDM, 100% RB, 25 MHz, QPSK, 60 kHz)	5G NR FR1 TDD	8.35	±9.6
10858	AAD	5G NR (CP-OFDM, 100% RB, 30 MHz, QPSK, 60 kHz)	5G NR FR1 TDD	8.36	±9.6
10859	AAD	5G NR (CP-OFDM, 100% RB, 40 MHz, QPSK, 60 kHz)	5G NR FR1 TDD	8.34	±9.6
10860	AAD	5G NR (CP-OFDM, 100% RB, 50 MHz, QPSK, 60 kHz)	5G NR FR1 TDD	8.41	±9.6
10861	AAD	5G NR (CP-OFDM, 100% RB, 60 MHz, QPSK, 60 kHz)	5G NR FR1 TDD	8.40	±9.6
10863	AAD	5G NR (CP-OFDM, 100% RB, 80 MHz, QPSK, 60 kHz)	5G NR FR1 TDD	8.41	±9.6
10864	AAD	5G NR (CP-OFDM, 100% RB, 90 MHz, QPSK, 60 kHz)	5G NR FR1 TDD	8.37	±9.6
10865	AAD	5G NR (CP-OFDM, 100% RB, 100 MHz, QPSK, 60 kHz)	5G NR FR1 TDD	8.41	±9.6
10866	AAD	5G NR (DFT-s-OFDM, 1 RB, 100 MHz, QPSK, 30 kHz)	5G NR FR1 TDD	5.68	±9.6
10868	AAD	5G NR (DFT-s-OFDM, 100% RB, 100 MHz, QPSK, 30 kHz)	5G NR FR1 TDD	5.69	±9.6
10869	AAE	5G NR (DFT-s-OFDM, 1 RB, 100 MHz, QPSK, 120 kHz)	5G NR FR2 TDD	5.75	±9.6
10870	AAE	5G NR (DFT-s-OFDM, 100% RB, 100 MHz, QPSK, 120 kHz)	5G NR FR2 TDD	5.66	±9.6
10871	AAE	5G NR (DFT-s-OFDM, 1 RB, 100 MHz, 16QAM, 120 kHz)	5G NR FR2 TDD	5.75	±9.6
10872	AAE	5G NR (DFT-s-OFDM, 100% RB, 100 MHz, 16QAM, 120 kHz)	5G NR FR2 TDD	6.52	±9.6
10873	AAE	5G NR (DFT-s-OFDM, 1 RB, 100 MHz, 64QAM, 120 kHz)	5G NR FR2 TDD	6.61	±9.6
10874	AAE	5G NR (DFT-s-OFDM, 100% RB, 100 MHz, 64QAM, 120 kHz)	5G NR FR2 TDD	6.65	±9.6
10875	AAE	5G NR (CP-OFDM, 1 RB, 100 MHz, QPSK, 120 kHz)	5G NR FR2 TDD	7.78	±9.6
10876	AAE	5G NR (CP-OFDM, 100% RB, 100 MHz, QPSK, 120 kHz)	5G NR FR2 TDD	8.39	±9.6
10877	AAE	5G NR (CP-OFDM, 1 RB, 100 MHz, 16QAM, 120 kHz)	5G NR FR2 TDD	7.95	±9.6
10878	AAE	5G NR (CP-OFDM, 100% RB, 100 MHz, 16QAM, 120 kHz)	5G NR FR2 TDD	8.41	±9.6
10879	AAE	5G NR (CP-OFDM, 1 RB, 100 MHz, 64QAM, 120 kHz)	5G NR FR2 TDD	8.12	±9.6
10880	AAE	5G NR (CP-OFDM, 100% RB, 100 MHz, 64QAM, 120 kHz)	5G NR FR2 TDD	8.38	±9.6
10881	AAE	5G NR (DFT-s-OFDM, 1 RB, 50 MHz, QPSK, 120 kHz)	5G NR FR2 TDD	5.75	±9.6
10882	AAE	5G NR (DFT-s-OFDM, 100% RB, 50 MHz, QPSK, 120 kHz)	5G NR FR2 TDD	5.96	±9.6
10883	AAE	5G NR (DFT-s-OFDM, 1 RB, 50 MHz, 16QAM, 120 kHz)	5G NR FR2 TDD	6.57	±9.6
10884	AAE	5G NR (DFT-s-OFDM, 100% RB, 50 MHz, 16QAM, 120 kHz)	5G NR FR2 TDD	6.53	±9.6
10885	AAE	5G NR (DFT-s-OFDM, 1 RB, 50 MHz, 64QAM, 120 kHz)	5G NR FR2 TDD	6.61	±9.6
10886	AAE	5G NR (DFT-s-OFDM, 100% RB, 50 MHz, 64QAM, 120 kHz)	5G NR FR2 TDD	6.65	±9.6
10887	AAE	5G NR (CP-OFDM, 1 RB, 50 MHz, QPSK, 120 kHz)	5G NR FR2 TDD	7.78	±9.6
10888	AAE	5G NR (CP-OFDM, 100% RB, 50 MHz, QPSK, 120 kHz)	5G NR FR2 TDD	8.35	±9.6
10889	AAE	5G NR (CP-OFDM, 1 RB, 50 MHz, 16QAM, 120 kHz)	5G NR FR2 TDD	8.02	±9.6
10890	AAE	5G NR (CP-OFDM, 100% RB, 50 MHz, 16QAM, 120 kHz)	5G NR FR2 TDD	8.40	±9.6
10891	AAE	5G NR (CP-OFDM, 1 RB, 50 MHz, 64QAM, 120 kHz)	5G NR FR2 TDD	8.13	±9.6
10892	AAE	5G NR (CP-OFDM, 100% RB, 50 MHz, 64QAM, 120 kHz)	5G NR FR2 TDD	8.41	±9.6
10897	AAC	5G NR (DFT-s-OFDM, 1 RB, 5 MHz, QPSK, 30 kHz)	5G NR FR1 TDD	5.66	±9.6
10898	AAB	5G NR (DFT-s-OFDM, 1 RB, 10 MHz, QPSK, 30 kHz)	5G NR FR1 TDD	5.67	±9.6
10899	AAB	5G NR (DFT-s-OFDM, 1 RB, 15 MHz, QPSK, 30 kHz)	5G NR FR1 TDD	5.67	±9.6
10900	AAB	5G NR (DFT-s-OFDM, 1 RB, 20 MHz, QPSK, 30 kHz)	5G NR FR1 TDD	5.68	±9.6
10901	AAB	5G NR (DFT-s-OFDM, 1 RB, 25 MHz, QPSK, 30 kHz)	5G NR FR1 TDD	5.68	±9.6
10902	AAB	5G NR (DFT-s-OFDM, 1 RB, 30 MHz, QPSK, 30 kHz)	5G NR FR1 TDD	5.68	±9.6
10903	AAB	5G NR (DFT-s-OFDM, 1 RB, 40 MHz, QPSK, 30 kHz)	5G NR FR1 TDD	5.68	±9.6
10904	AAB	5G NR (DFT-s-OFDM, 1 RB, 50 MHz, QPSK, 30 kHz)	5G NR FR1 TDD	5.68	±9.6
10905	AAB	5G NR (DFT-s-OFDM, 1 RB, 60 MHz, QPSK, 30 kHz)	5G NR FR1 TDD	5.68	±9.6
10906	AAB	5G NR (DFT-s-OFDM, 1 RB, 80 MHz, QPSK, 30 kHz)	5G NR FR1 TDD	5.68	±9.6
10907	AAC	5G NR (DFT-s-OFDM, 50% RB, 5 MHz, QPSK, 30 kHz)	5G NR FR1 TDD	5.76	±9.6
10908	AAB	5G NR (DFT-s-OFDM, 50% RB, 10 MHz, QPSK, 30 kHz)	5G NR FR1 TDD	5.93	±9.6
10909	AAB	5G NR (DFT-s-OFDM, 50% RB, 15 MHz, QPSK, 30 kHz)	5G NR FR1 TDD	5.96	±9.6
10910	AAB	5G NR (DFT-s-OFDM, 50% RB, 20 MHz, QPSK, 30 kHz)	5G NR FR1 TDD	5.83	±9.6

Certificate No: EF-4034_Jan24

Page 19 of 21

EF3DV3 - SN:4034

January 16, 2024

UID	Rev	Communication System Name	Group	PAR (dB)	Unc ^E k = 2
10911	AAB	5G NR (DFT-s-OFDM, 50% RB, 25 MHz, QPSK, 30 kHz)	5G NR FR1 TDD	5.93	±9.6
10912	AAB	5G NR (DFT-s-OFDM, 50% RB, 30 MHz, QPSK, 30 kHz)	5G NR FR1 TDD	5.84	±9.6
10913	AAB	5G NR (DFT-s-OFDM, 50% RB, 40 MHz, QPSK, 30 kHz)	5G NR FR1 TDD	5.84	±9.6
10914	AAB	5G NR (DFT-s-OFDM, 50% RB, 50 MHz, QPSK, 30 kHz)	5G NR FR1 TDD	5.85	±9.6
10915	AAB	5G NR (DFT-s-OFDM, 50% RB, 60 MHz, QPSK, 30 kHz)	5G NR FR1 TDD	5.83	±9.6
10916	AAB	5G NR (DFT-s-OFDM, 50% RB, 80 MHz, QPSK, 30 kHz)	5G NR FR1 TDD	5.87	±9.6
10917	AAB	5G NR (DFT-s-OFDM, 50% RB, 100 MHz, QPSK, 30 kHz)	5G NR FR1 TDD	5.94	±9.6
10918	AAC	5G NR (DFT-s-OFDM, 100% RB, 5 MHz, QPSK, 30 kHz)	5G NR FR1 TDD	5.86	±9.6
10919	AAB	5G NR (DFT-s-OFDM, 100% RB, 10 MHz, QPSK, 30 kHz)	5G NR FR1 TDD	5.86	±9.6
10920	AAB	5G NR (DFT-s-OFDM, 100% RB, 15 MHz, QPSK, 30 kHz)	5G NR FR1 TDD	5.87	±9.6
10921	AAB	5G NR (DFT-s-OFDM, 100% RB, 20 MHz, QPSK, 30 kHz)	5G NR FR1 TDD	5.84	±9.6
10922	AAB	5G NR (DFT-s-OFDM, 100% RB, 25 MHz, QPSK, 30 kHz)	5G NR FR1 TDD	5.82	±9.6
10923	AAB	5G NR (DFT-s-OFDM, 100% RB, 30 MHz, QPSK, 30 kHz)	5G NR FR1 TDD	5.84	±9.6
10924	AAB	5G NR (DFT-s-OFDM, 100% RB, 40 MHz, QPSK, 30 kHz)	5G NR FR1 TDD	5.84	±9.6
10925	AAB	5G NR (DFT-s-OFDM, 100% RB, 50 MHz, QPSK, 30 kHz)	5G NR FR1 TDD	5.95	±9.6
10926	AAB	5G NR (DFT-s-OFDM, 100% RB, 60 MHz, QPSK, 30 kHz)	5G NR FR1 TDD	5.84	±9.6
10927	AAB	5G NR (DFT-s-OFDM, 100% RB, 80 MHz, QPSK, 30 kHz)	5G NR FR1 TDD	5.94	±9.6
10928	AAC	5G NR (DFT-s-OFDM, 1 RB, 5 MHz, QPSK, 15 kHz)	5G NR FR1 FDD	5.52	±9.6
10929	AAC	5G NR (DFT-s-OFDM, 1 RB, 10 MHz, QPSK, 15 kHz)	5G NR FR1 FDD	5.52	±9.6
10930	AAC	5G NR (DFT-s-OFDM, 1 RB, 15 MHz, QPSK, 15 kHz)	5G NR FR1 FDD	5.52	±9.6
10931	AAC	5G NR (DFT-s-OFDM, 1 RB, 20 MHz, QPSK, 15 kHz)	5G NR FR1 FDD	5.51	±9.6
10932	AAC	5G NR (DFT-s-OFDM, 1 RB, 25 MHz, QPSK, 15 kHz)	5G NR FR1 FDD	5.51	±9.6
10933	AAC	5G NR (DFT-s-OFDM, 1 RB, 30 MHz, QPSK, 15 kHz)	5G NR FR1 FDD	5.51	±9.6
10934	AAC	5G NR (DFT-s-OFDM, 1 RB, 40 MHz, QPSK, 15 kHz)	5G NR FR1 FDD	5.51	±9.6
10935	AAD	5G NR (DFT-s-OFDM, 1 RB, 50 MHz, QPSK, 15 kHz)	5G NR FR1 FDD	5.51	±9.6
10936	AAC	5G NR (DFT-s-OFDM, 50% RB, 5 MHz, QPSK, 15 kHz)	5G NR FR1 FDD	5.90	±9.6
10937	AAC	5G NR (DFT-s-OFDM, 50% RB, 10 MHz, QPSK, 15 kHz)	5G NR FR1 FDD	5.77	±9.6
10938	AAC	5G NR (DFT-s-OFDM, 50% RB, 15 MHz, QPSK, 15 kHz)	5G NR FR1 FDD	5.90	±9.6
10939	AAC	5G NR (DFT-s-OFDM, 50% RB, 20 MHz, QPSK, 15 kHz)	5G NR FR1 FDD	5.82	±9.6
10940	AAC	5G NR (DFT-s-OFDM, 50% RB, 25 MHz, QPSK, 15 kHz)	5G NR FR1 FDD	5.89	±9.6
10941	AAC	5G NR (DFT-s-OFDM, 50% RB, 30 MHz, QPSK, 15 kHz)	5G NR FR1 FDD	5.83	±9.6
10942	AAC	5G NR (DFT-s-OFDM, 50% RB, 40 MHz, QPSK, 15 kHz)	5G NR FR1 FDD	5.85	±9.6
10943	AAD	5G NR (DFT-s-OFDM, 50% RB, 50 MHz, QPSK, 15 kHz)	5G NR FR1 FDD	5.95	±9.6
10944	AAC	5G NR (DFT-s-OFDM, 100% RB, 5 MHz, QPSK, 15 kHz)	5G NR FR1 FDD	5.81	±9.6
10945	AAC	5G NR (DFT-s-OFDM, 100% RB, 10 MHz, QPSK, 15 kHz)	5G NR FR1 FDD	5.85	±9.6
10946	AAC	5G NR (DFT-s-OFDM, 100% RB, 15 MHz, QPSK, 15 kHz)	5G NR FR1 FDD	5.83	±9.6
10947	AAC	5G NR (DFT-s-OFDM, 100% RB, 20 MHz, QPSK, 15 kHz)	5G NR FR1 FDD	5.87	±9.6
10948	AAC	5G NR (DFT-s-OFDM, 100% RB, 25 MHz, QPSK, 15 kHz)	5G NR FR1 FDD	5.94	±9.6
10949	AAC	5G NR (DFT-s-OFDM, 100% RB, 30 MHz, QPSK, 15 kHz)	5G NR FR1 FDD	5.87	±9.6
10950	AAC	5G NR (DFT-s-OFDM, 100% RB, 40 MHz, QPSK, 15 kHz)	5G NR FR1 FDD	5.94	±9.6
10951	AAD	5G NR (DFT-s-OFDM, 100% RB, 50 MHz, QPSK, 15 kHz)	5G NR FR1 FDD	5.92	±9.6
10952	AAA	5G NR DL (CP-OFDM, TM 3.1, 5 MHz, 64-QAM, 15 kHz)	5G NR FR1 FDD	8.25	±9.6
10953	AAA	5G NR DL (CP-OFDM, TM 3.1, 10 MHz, 64-QAM, 15 kHz)	5G NR FR1 FDD	8.15	±9.6
10954	AAA	5G NR DL (CP-OFDM, TM 3.1, 15 MHz, 64-QAM, 15 kHz)	5G NR FR1 FDD	8.23	±9.6
10955	AAA	5G NR DL (CP-OFDM, TM 3.1, 20 MHz, 64-QAM, 15 kHz)	5G NR FR1 FDD	8.42	±9.6
10956	AAA	5G NR DL (CP-OFDM, TM 3.1, 5 MHz, 64-QAM, 30 kHz)	5G NR FR1 FDD	8.14	±9.6
10957	AAA	5G NR DL (CP-OFDM, TM 3.1, 10 MHz, 64-QAM, 30 kHz)	5G NR FR1 FDD	8.31	±9.6
10958	AAA	5G NR DL (CP-OFDM, TM 3.1, 15 MHz, 64-QAM, 30 kHz)	5G NR FR1 FDD	8.61	±9.6
10959	AAA	5G NR DL (CP-OFDM, TM 3.1, 20 MHz, 64-QAM, 30 kHz)	5G NR FR1 FDD	8.33	±9.6
10960	AAC	5G NR DL (CP-OFDM, TM 3.1, 5 MHz, 64-QAM, 15 kHz)	5G NR FR1 TDD	9.32	±9.6
10961	AAB	5G NR DL (CP-OFDM, TM 3.1, 10 MHz, 64-QAM, 15 kHz)	5G NR FR1 TDD	9.36	±9.6
10962	AAB	5G NR DL (CP-OFDM, TM 3.1, 15 MHz, 64-QAM, 15 kHz)	5G NR FR1 TDD	9.40	±9.6
10963	AAB	5G NR DL (CP-OFDM, TM 3.1, 20 MHz, 64-QAM, 15 kHz)	5G NR FR1 TDD	9.55	±9.6
10964	AAC	5G NR DL (CP-OFDM, TM 3.1, 5 MHz, 64-QAM, 30 kHz)	5G NR FR1 TDD	9.29	±9.6
10965	AAB	5G NR DL (CP-OFDM, TM 3.1, 10 MHz, 64-QAM, 30 kHz)	5G NR FR1 TDD	9.37	±9.6
10966	AAB	5G NR DL (CP-OFDM, TM 3.1, 15 MHz, 64-QAM, 30 kHz)	5G NR FR1 TDD	9.55	±9.6
10967	AAB	5G NR DL (CP-OFDM, TM 3.1, 20 MHz, 64-QAM, 30 kHz)	5G NR FR1 TDD	9.42	±9.6
10968	AAB	5G NR DL (CP-OFDM, TM 3.1, 100 MHz, 64-QAM, 30 kHz)	5G NR FR1 TDD	8.49	±9.6
10972	AAB	5G NR (CP-OFDM, 1 RB, 20 MHz, QPSK, 15 kHz)	5G NR FR1 TDD	11.58	±9.6
10973	AAB	5G NR (DFT-s-OFDM, 1 RB, 100 MHz, QPSK, 30 kHz)	5G NR FR1 TDD	9.06	±9.6
10974	AAB	5G NR (CP-OFDM, 100% RB, 100 MHz, 256-QAM, 30 kHz)	5G NR FR1 TDD	10.28	±9.6
10978	AAA	ULLA BDR	ULLA	1.16	±9.6
10979	AAA	ULLA HDR4	ULLA	8.58	±9.6
10980	AAA	ULLA HDR8	ULLA	10.32	±9.6
10981	AAA	ULLA HDRp4	ULLA	3.19	±9.6
10982	AAA	ULLA HDRp8	ULLA	3.43	±9.6

Certificate No: EF-4034_Jan24

Page 20 of 21

EF3DV3 - SN:4034

January 16, 2024

UID	Rev	Communication System Name	Group	PAR (dB)	Unc ^E k = 2
10983	AAA	5G NR DL (CP-OFDM, TM 3.1, 40 MHz, 64-QAM, 15 kHz)	5G NR FR1 TDD	9.31	±9.6
10984	AAA	5G NR DL (CP-OFDM, TM 3.1, 50 MHz, 64-QAM, 15 kHz)	5G NR FR1 TDD	9.42	±9.6
10985	AAA	5G NR DL (CP-OFDM, TM 3.1, 40 MHz, 64-QAM, 30 kHz)	5G NR FR1 TDD	9.54	±9.6
10986	AAA	5G NR DL (CP-OFDM, TM 3.1, 50 MHz, 64-QAM, 30 kHz)	5G NR FR1 TDD	9.50	±9.6
10987	AAA	5G NR DL (CP-OFDM, TM 3.1, 60 MHz, 64-QAM, 30 kHz)	5G NR FR1 TDD	9.93	±9.6
10988	AAA	5G NR DL (CP-OFDM, TM 3.1, 70 MHz, 64-QAM, 30 kHz)	5G NR FR1 TDD	9.38	±9.6
10989	AAA	5G NR DL (CP-OFDM, TM 3.1, 80 MHz, 64-QAM, 30 kHz)	5G NR FR1 TDD	9.33	±9.6
10990	AAA	5G NR DL (CP-OFDM, TM 3.1, 90 MHz, 64-QAM, 30 kHz)	5G NR FR1 TDD	9.52	±9.6
11003	AAA	5G NR DL (CP-OFDM, TM 3.1, 30 MHz, 64-QAM, 15 kHz)	5G NR FR1 TDD	10.24	±9.6
11004	AAA	5G NR DL (CP-OFDM, TM 3.1, 30 MHz, 64-QAM, 30 kHz)	5G NR FR1 TDD	10.73	±9.6
11005	AAA	5G NR DL (CP-OFDM, TM 3.1, 25 MHz, 64-QAM, 15 kHz)	5G NR FR1 FDD	8.70	±9.6
11006	AAA	5G NR DL (CP-OFDM, TM 3.1, 30 MHz, 64-QAM, 15 kHz)	5G NR FR1 FDD	8.55	±9.6
11007	AAA	5G NR DL (CP-OFDM, TM 3.1, 40 MHz, 64-QAM, 15 kHz)	5G NR FR1 FDD	8.48	±9.6
11008	AAA	5G NR DL (CP-OFDM, TM 3.1, 50 MHz, 64-QAM, 15 kHz)	5G NR FR1 FDD	8.51	±9.6
11009	AAA	5G NR DL (CP-OFDM, TM 3.1, 25 MHz, 64-QAM, 30 kHz)	5G NR FR1 FDD	8.76	±9.6
11010	AAA	5G NR DL (CP-OFDM, TM 3.1, 30 MHz, 64-QAM, 30 kHz)	5G NR FR1 FDD	8.95	±9.6
11011	AAA	5G NR DL (CP-OFDM, TM 3.1, 40 MHz, 64-QAM, 30 kHz)	5G NR FR1 FDD	8.96	±9.6
11012	AAA	5G NR DL (CP-OFDM, TM 3.1, 50 MHz, 64-QAM, 30 kHz)	5G NR FR1 FDD	8.68	±9.6
11013	AAA	IEEE 802.11be (320 MHz, MCS1, 99pc duty cycle)	WLAN	8.47	±9.6
11014	AAA	IEEE 802.11be (320 MHz, MCS2, 99pc duty cycle)	WLAN	8.45	±9.6
11015	AAA	IEEE 802.11be (320 MHz, MCS3, 99pc duty cycle)	WLAN	8.44	±9.6
11016	AAA	IEEE 802.11be (320 MHz, MCS4, 99pc duty cycle)	WLAN	8.44	±9.6
11017	AAA	IEEE 802.11be (320 MHz, MCS5, 99pc duty cycle)	WLAN	8.41	±9.6
11018	AAA	IEEE 802.11be (320 MHz, MCS6, 99pc duty cycle)	WLAN	8.40	±9.6
11019	AAA	IEEE 802.11be (320 MHz, MCS7, 99pc duty cycle)	WLAN	8.29	±9.6
11020	AAA	IEEE 802.11be (320 MHz, MCS8, 99pc duty cycle)	WLAN	8.27	±9.6
11021	AAA	IEEE 802.11be (320 MHz, MCS9, 99pc duty cycle)	WLAN	8.46	±9.6
11022	AAA	IEEE 802.11be (320 MHz, MCS10, 99pc duty cycle)	WLAN	8.36	±9.6
11023	AAA	IEEE 802.11be (320 MHz, MCS11, 99pc duty cycle)	WLAN	8.09	±9.6
11024	AAA	IEEE 802.11be (320 MHz, MCS12, 99pc duty cycle)	WLAN	8.42	±9.6
11025	AAA	IEEE 802.11be (320 MHz, MCS13, 99pc duty cycle)	WLAN	8.37	±9.6
11026	AAA	IEEE 802.11be (320 MHz, MCS0, 99pc duty cycle)	WLAN	8.39	±9.6

^E Uncertainty is determined using the max. deviation from linear response applying rectangular distribution and is expressed for the square of the field value.

Appendix E. Dipole Calibration Data

**Calibration Laboratory of
Schmid & Partner
Engineering AG**
Zeughausstrasse 43, 8004 Zurich, Switzerland



S Schweizerischer Kalibrierdienst
C Service suisse d'étalonnage
S Servizio svizzero di taratura
S Swiss Calibration Service

Accredited by the Swiss Accreditation Service (SAS)
The Swiss Accreditation Service is one of the signatories to the EA
Multilateral Agreement for the recognition of calibration certificates

Accreditation No.: **SCS 0108**

Client **HCT**

Certificate No: **CD835V3-1024_Feb23**

CALIBRATION CERTIFICATE

Object: **CD835V3 - SN: 1024**

Calibration procedure(s): **QA CAL-20.v7
Calibration Procedure for Validation Sources in air**

Calibration date: **February 22, 2023**

This calibration certificate documents the traceability to national standards, which realize the physical units of measurements (SI).
The measurements and the uncertainties with confidence probability are given on the following pages and are part of the certificate.

All calibrations have been conducted in the closed laboratory facility: environment temperature (22 ± 3)°C and humidity < 70%.

Calibration Equipment used (M&TE critical for calibration)

Primary Standards	ID #	Cal Date (Certificate No.)	Scheduled Calibration
Power meter NRP	SN: 104778	04-Apr-22 (No. 217-03525/03524)	Apr-23
Power sensor NRP-Z91	SN: 103244	04-Apr-22 (No. 217-03524)	Apr-23
Power sensor NRP-Z91	SN: 103245	04-Apr-22 (No. 217-03525)	Apr-23
Reference 20 dB Attenuator	SN: BH9394 (20k)	04-Apr-22 (No. 217-03527)	Apr-23
Type-N mismatch combination	SN: 310982 / 06327	04-Apr-22 (No. 217-03528)	Apr-23
Probe EF3DV3	SN: 4013	30-Dec-22 (No. EF3-4013_Dec22)	Dec-23
DAE4	SN: 781	03-Jan-23 (No. DAE4-781_Jan23)	Jan-24

Secondary Standards	ID #	Check Date (in house)	Scheduled Check
Power meter Agilent 4419B	SN: GB42420191	09-Oct-09 (in house check Oct-20)	In house check: Oct-23
Power sensor HP E4412A	SN: US38485102	05-Jan-10 (in house check Oct-20)	In house check: Oct-23
Power sensor HP 8482A	SN: US37285597	09-Oct-09 (in house check Oct-20)	In house check: Oct-23
RF generator R&S SMT-06	SN: 837633/005	10-Jan-19 (in house check Oct-20)	In house check: Oct-23
Network Analyzer Agilent E8358A	SN: US41080477	31-Mar-14 (in house check Oct-22)	In house check: Oct-24

Calibrated by:	Name	Function	Signature
	Aldona Georgiadou	Laboratory Technician	
Approved by:	Niels Kuster	Quality Manager	

issued: February 22, 2023

This calibration certificate shall not be reproduced except in full without written approval of the laboratory.

결 재	담당자 DL/박성호 2023.02.03	확인자 DL/최영선 2023.02.03
--------	-----------------------------	-----------------------------

**Calibration Laboratory of
Schmid & Partner
Engineering AG**
Zeughausstrasse 43, 8004 Zurich, Switzerland



S Schweizerischer Kalibrierdienst
C Service suisse d'étalonnage
S Servizio svizzero di taratura
S Swiss Calibration Service

Accredited by the Swiss Accreditation Service (SAS)
The Swiss Accreditation Service is one of the signatories to the EA
Multilateral Agreement for the recognition of calibration certificates

Accreditation No.: **SCS 0108**

References

- [1] ANSI-C63.19-2019 (ANSI-C63.19-2011)
American National Standard, Methods of Measurement of Compatibility between Wireless Communications Devices and Hearing Aids.

Methods Applied and Interpretation of Parameters:

- **Coordinate System:** y-axis is in the direction of the dipole arms. z-axis is from the basis of the antenna (mounted on the table) towards its feed point between the two dipole arms. x-axis is normal to the other axes. In coincidence with the standards [1], the measurement planes (probe sensor center) are selected to be at a distance of 15 mm above the top metal edge of the dipole arms.
- **Measurement Conditions:** Further details are available from the hardcopies at the end of the certificate. All figures stated in the certificate are valid at the frequency indicated. The forward power to the dipole connector is set with a calibrated power meter connected and monitored with an auxiliary power meter connected to a directional coupler. While the dipole under test is connected, the forward power is adjusted to the same level.
- **Antenna Positioning:** The dipole is mounted on a HAC Test Arch phantom using the matching dipole positioner with the arms horizontal and the feeding cable coming from the floor. The measurements are performed in a shielded room with absorbers around the setup to reduce the reflections. It is verified before the mounting of the dipole under the Test Arch phantom, that its arms are perfectly in a line. It is installed on the HAC dipole positioner with its arms parallel below the dielectric reference wire and able to move elastically in vertical direction without changing its relative position to the top center of the Test Arch phantom. The vertical distance to the probe is adjusted after dipole mounting with a DASYS Surface Check job. Before the measurement, the distance between phantom surface and probe tip is verified. The proper measurement distance is selected by choosing the matching section of the HAC Test Arch phantom with the proper device reference point (upper surface of the dipole) and the matching grid reference point (tip of the probe) considering the probe sensor offset. The vertical distance to the probe is essential for the accuracy.
- **Feed Point Impedance and Return Loss:** These parameters are measured using a Vector Network Analyzer. The impedance is specified at the SMA connector of the dipole. The influence of reflections was eliminated by applying the averaging function while moving the dipole in the air, at least 70cm away from any obstacles.
- **E-field distribution:** E field is measured in the x-y-plane with an isotropic E-field probe with 100 mW forward power to the antenna feed point. In accordance with [1], the scan area is 20mm wide, its length exceeds the dipole arm length (180 or 90mm). The sensor center is 15 mm (in z) above the metal top of the dipole arms. Two 3D maxima are available near the end of the dipole arms. Assuming the dipole arms are perfectly in one line, the average of these two maxima (in subgrid 2 and subgrid 8) is determined to compensate for any non-parallelity to the measurement plane as well as the sensor displacement. The E-field value stated as calibration value represents the maximum of the interpolated 3D-E-field, in the plane above the dipole surface.

The reported uncertainty of measurement is stated as the standard uncertainty of measurement multiplied by the coverage factor $k=2$, which for a normal distribution corresponds to a coverage probability of approximately 95%.

Measurement Conditions

DASY system configuration, as far as not given on page 1.

DASY Version	DASY5	V52.10.4
Phantom	HAC Test Arch	
Distance Dipole Top - Probe Center	15 mm	
Scan resolution	dx, dy = 5 mm	
Frequency	835 MHz \pm 1 MHz	
Input power drift	< 0.05 dB	

Maximum Field values at 835 MHz

E-field 15 mm above dipole surface	condition	Interpolated maximum
Maximum measured above high end	100 mW input power	112.3 V/m = 41.01 dBV/m
Maximum measured above low end	100 mW input power	107.4 V/m = 40.62 dBV/m
Averaged maximum above arm	100 mW input power	109.9 V/m \pm 12.8 % (k=2)

Appendix (Additional assessments outside the scope of SCS 0108)

Antenna Parameters

Frequency	Return Loss	Impedance
800 MHz	17.8 dB	40.7 Ω - 7.1 j Ω
835 MHz	23.4 dB	54.8 Ω + 5.3 j Ω
880 MHz	17.4 dB	61.2 Ω - 10.1 j Ω
900 MHz	17.4 dB	54.6 Ω - 13.5 j Ω
945 MHz	22.4 dB	50.4 Ω + 7.6 j Ω

3.2 Antenna Design and Handling

The calibration dipole has a symmetric geometry with a built-in two stub matching network, which leads to the enhanced bandwidth.

The dipole is built of standard semirigid coaxial cable. The internal matching line is open ended. The antenna is therefore open for DC signals.

Do not apply force to dipole arms, as they are liable to bend. The soldered connections near the feedpoint may be damaged. After excessive mechanical stress or overheating, check the impedance characteristics to ensure that the internal matching network is not affected.

After long term use with 40W radiated power, only a slight warming of the dipole near the feedpoint can be measured.

Impedance Measurement Plot

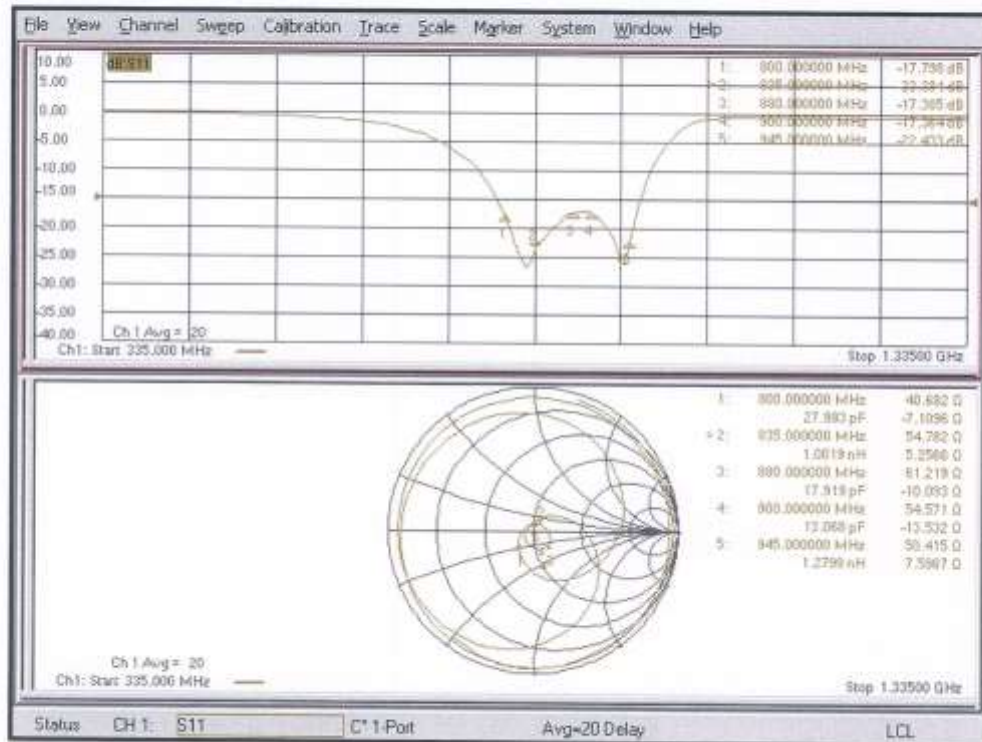

DASY5 E-field Result

Date: 22.02.2023

Test Laboratory: SPEAG Lab2

DUT: HAC-Dipole 835 MHz; Type: CD835V3; Serial: CD835V3 - SN: 1024

Communication System: UID 0 - CW ; Frequency: 835 MHz
 Medium parameters used: $\sigma = 0$ S/m, $\epsilon_r = 1$; $\rho = 0$ kg/m³
 Phantom section: RF Section
 Measurement Standard: DASY5 (IEEE/IEC/ANSI C63.19-2011)

DASY52 Configuration:

- Probe: EF3DV3 - SN4013; ConvF(1, 1, 1) @ 835 MHz; Calibrated: 30.12.2022
- Sensor-Surface: (Fix Surface)
- Electronics: DAE4 Sn781; Calibrated: 03.01.2023
- Phantom: HAC Test Arch with AMCC; Type: 5D HAC P01 BA; Serial: 1070
- DASY52 52.10.4(1535); SEMCAD X 14.6.14(7501)

Dipole E-Field measurement @ 835MHz/E-Scan - 835MHz d=15mm/Hearing Aid Compatibility Test (41x361x1):

Interpolated grid: dx=0.5000 mm, dy=0.5000 mm
 Device Reference Point: 0, 0, -6,3 mm
 Reference Value = 136.2 V/m; Power Drift = 0.00 dB
 Applied MIF = 0.00 dB
 RF audio interference level = 41.01 dBV/m
Emission category: M3

MIF scaled E-field

Grid 1 M3	Grid 2 M3	Grid 3 M3
40.6 dBV/m	40.62 dBV/m	40.27 dBV/m
Grid 4 M4	Grid 5 M4	Grid 6 M4
36.05 dBV/m	36.07 dBV/m	35.77 dBV/m
Grid 7 M3	Grid 8 M3	Grid 9 M3
40.92 dBV/m	41.01 dBV/m	40.71 dBV/m

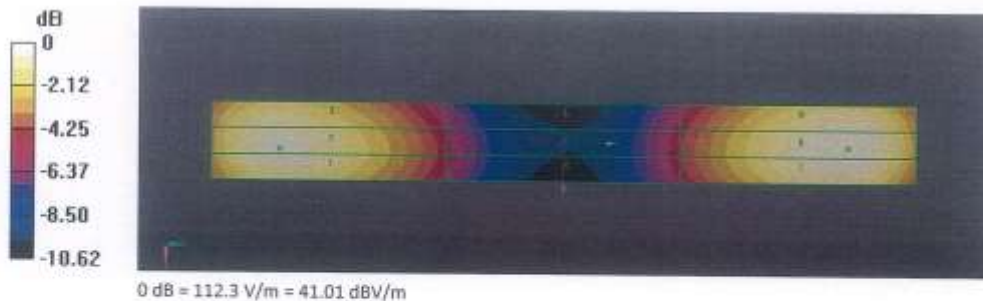

DIPOLE CALIBRATION EXTENSION

Per KDB 865664 D01, Dipole calibration intervals of up to three years may be considered for reference dipoles when it is demonstrated that the HAC target, impedance and return loss of a dipole have remained stable according to the following requirements:

1. The measured HAC does not deviate more than 10% from the target on the calibration certificate.
2. The return-loss does not deviate more than 20% from the previous measurement and meets the required 20dB minimum return-loss requirement.
3. The measurement of real or imaginary parts of impedance does not deviate more than 5Ω from the previous measurement.

The following dipole was checked to pass the above 3 requirements to have 2-year calibration period from the calibration date:

Calibration Date	Extension Date	Certificate SAR Target E-Field V/m@20.0dBm	Measured SAR Target E-Field V/m@20.0dBm	Deviation(%)	Certificate Impedance (Ohm)	Measured Impedance (Ohm)	Deviation(%)	Certificate ReturnLoss (dB)	Measured ReturnLoss (dB)	Deviation(%)	PASS/FAIL
02/22/2023	02/22/2024	109.9	109.2	-0.64	54.8	47.1	7.7	-23.4	-22.4	-4.27	PASS

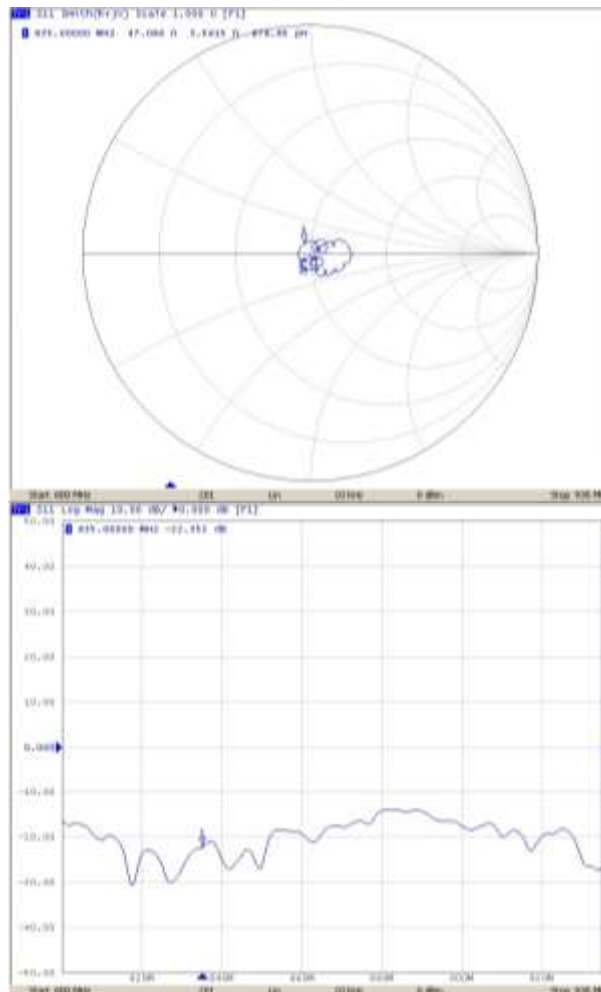

**Calibration Laboratory of
Schmid & Partner
Engineering AG**
Zeughausstrasse 43, 8004 Zurich, Switzerland



S Schweizerischer Kalibrierdienst
C Service suisse d'étalonnage
S Servizio svizzero di taratura
S Swiss Calibration Service

Accredited by the Swiss Accreditation Service (SAS)
The Swiss Accreditation Service is one of the signatories to the EA
Multilateral Agreement for the recognition of calibration certificates

Accreditation No.: **SCS 0108**

Client **HCT**

Certificate No: **CD1880V3-1019_Feb23**

CALIBRATION CERTIFICATE

Object: **CD1880V3 - SN: 1019**

Calibration procedure(s): **QA CAL-20.v7
Calibration Procedure for Validation Sources in air**

Calibration date: **February 22, 2023**

This calibration certificate documents the traceability to national standards, which realize the physical units of measurements (SI).
The measurements and the uncertainties with confidence probability are given on the following pages and are part of the certificate.

All calibrations have been conducted in the closed laboratory facility: environment temperature (22 ± 3)°C and humidity < 70%.

Calibration Equipment used (M&TE critical for calibration)

Primary Standards	ID #	Cal Date (Certificate No.)	Scheduled Calibration
Power meter NRP	SN: 104778	04-Apr-22 (No. 217-03525/03524)	Apr-23
Power sensor NRP-Z91	SN: 103244	04-Apr-22 (No. 217-03524)	Apr-23
Power sensor NRP-Z91	SN: 103245	04-Apr-22 (No. 217-03525)	Apr-23
Reference 20 dB Attenuator	SN: BH9394 (20k)	04-Apr-22 (No. 217-03527)	Apr-23
Type-N mismatch combination	SN: 310982 / 06327	04-Apr-22 (No. 217-03528)	Apr-23
Probe EF3DV3	SN: 4013	30-Dec-22 (No. EF3-4013_Dec22)	Dec-23
DAE4	SN: 781	03-Jan-23 (No. DAE4-781_Jan23)	Jan-24

Secondary Standards	ID #	Check Date (in house)	Scheduled Check
Power meter Agilent 4419B	SN: GB42420191	09-Oct-09 (in house check Oct-20)	In house check: Oct-23
Power sensor HP E4412A	SN: US38485102	05-Jan-10 (in house check Oct-20)	In house check: Oct-23
Power sensor HP 8482A	SN: US37295597	09-Oct-09 (in house check Oct-20)	In house check: Oct-23
RF generator R&S SMT-06	SN: 837633/005	10-Jan-19 (in house check Oct-20)	In house check: Oct-23
Network Analyzer Agilent E8358A	SN: US41080477	31-Mar-14 (in house check Oct-22)	In house check: Oct-24

Calibrated by:	Name	Function	Signature
	Aldona Georgiadou	Laboratory Technician	
Approved by:	Niels Kuster	Quality Manager	

Issued: February 22, 2023

This calibration certificate shall not be reproduced except in full without written approval of the laboratory.

결 재	담당자	확인자
	 DL Park 2023.03.03	 KS Kim 2023.03.03

**Calibration Laboratory of
Schmid & Partner
Engineering AG**
Zeughausstrasse 43, 8004 Zurich, Switzerland



S Schweizerischer Kalibrierdienst
C Service suisse d'étalonnage
S Servizio svizzero di taratura
S Swiss Calibration Service

Accredited by the Swiss Accreditation Service (SAS)
The Swiss Accreditation Service is one of the signatories to the EA
Multilateral Agreement for the recognition of calibration certificates

Accreditation No.: **SCS 0108**

References

- [1] ANSI-C63.19-2019 (ANSI-C63.19-2011)
American National Standard, Methods of Measurement of Compatibility between Wireless Communications Devices and Hearing Aids.

Methods Applied and Interpretation of Parameters:

- **Coordinate System:** y-axis is in the direction of the dipole arms. z-axis is from the basis of the antenna (mounted on the table) towards its feed point between the two dipole arms. x-axis is normal to the other axes. In coincidence with the standards [1], the measurement planes (probe sensor center) are selected to be at a distance of 15 mm above the top metal edge of the dipole arms.
- **Measurement Conditions:** Further details are available from the hardcopies at the end of the certificate. All figures stated in the certificate are valid at the frequency indicated. The forward power to the dipole connector is set with a calibrated power meter connected and monitored with an auxiliary power meter connected to a directional coupler. While the dipole under test is connected, the forward power is adjusted to the same level.
- **Antenna Positioning:** The dipole is mounted on a HAC Test Arch phantom using the matching dipole positioner with the arms horizontal and the feeding cable coming from the floor. The measurements are performed in a shielded room with absorbers around the setup to reduce the reflections. It is verified before the mounting of the dipole under the Test Arch phantom, that its arms are perfectly in a line. It is installed on the HAC dipole positioner with its arms parallel below the dielectric reference wire and able to move elastically in vertical direction without changing its relative position to the top center of the Test Arch phantom. The vertical distance to the probe is adjusted after dipole mounting with a DASY5 Surface Check job. Before the measurement, the distance between phantom surface and probe tip is verified. The proper measurement distance is selected by choosing the matching section of the HAC Test Arch phantom with the proper device reference point (upper surface of the dipole) and the matching grid reference point (tip of the probe) considering the probe sensor offset. The vertical distance to the probe is essential for the accuracy.
- **Feed Point Impedance and Return Loss:** These parameters are measured using a Vector Network Analyzer. The impedance is specified at the SMA connector of the dipole. The influence of reflections was eliminated by applying the averaging function while moving the dipole in the air, at least 70cm away from any obstacles.
- **E-field distribution:** E field is measured in the x-y-plane with an isotropic E-field probe with 100 mW forward power to the antenna feed point. In accordance with [1], the scan area is 20mm wide, its length exceeds the dipole arm length (180 or 90mm). The sensor center is 15 mm (in z) above the metal top of the dipole arms. Two 3D maxima are available near the end of the dipole arms. Assuming the dipole arms are perfectly in one line, the average of these two maxima (in subgrid 2 and subgrid 8) is determined to compensate for any non-parallelity to the measurement plane as well as the sensor displacement. The E-field value stated as calibration value represents the maximum of the interpolated 3D-E-field, in the plane above the dipole surface.

The reported uncertainty of measurement is stated as the standard uncertainty of measurement multiplied by the coverage factor $k=2$, which for a normal distribution corresponds to a coverage probability of approximately 95%.

Measurement Conditions

DASY system configuration, as far as not given on page 1.

DASY Version	DASY5	V52.10.4
Phantom	HAC Test Arch	
Distance Dipole Top - Probe Center	15 mm	
Scan resolution	dx, dy = 5 mm	
Frequency	1880 MHz \pm 1 MHz	
Input power drift	< 0.05 dB	

Maximum Field values at 1880 MHz

E-field 15 mm above dipole surface	condition	Interpolated maximum
Maximum measured above high end	100 mW input power	85.5 V/m = 38.64 dBV/m
Maximum measured above low end	100 mW input power	83.1 V/m = 38.39 dBV/m
Averaged maximum above arm	100 mW input power	84.3 V/m \pm 12.8 % (k=2)

Appendix (Additional assessments outside the scope of SCS 0108)

Antenna Parameters

Nominal Frequencies

Frequency	Return Loss	Impedance
1730 MHz	32.1 dB	52.3 Ω + 1.0 j Ω
1880 MHz	18.9 dB	56.5 Ω + 10.3 j Ω
1900 MHz	19.0 dB	59.3 Ω + 8.0 j Ω
1950 MHz	22.7 dB	57.9 Ω - 0.6 j Ω
2000 MHz	27.5 dB	50.7 Ω + 4.2 j Ω

3.2 Antenna Design and Handling

The calibration dipole has a symmetric geometry with a built-in two stub matching network, which leads to the enhanced bandwidth.

The dipole is built of standard semirigid coaxial cable. The internal matching line is open ended. The antenna is therefore open for DC signals.

Do not apply force to dipole arms, as they are liable to bend. The soldered connections near the feedpoint may be damaged. After excessive mechanical stress or overheating, check the impedance characteristics to ensure that the internal matching network is not affected.

After long term use with 40W radiated power, only a slight warming of the dipole near the feedpoint can be measured.

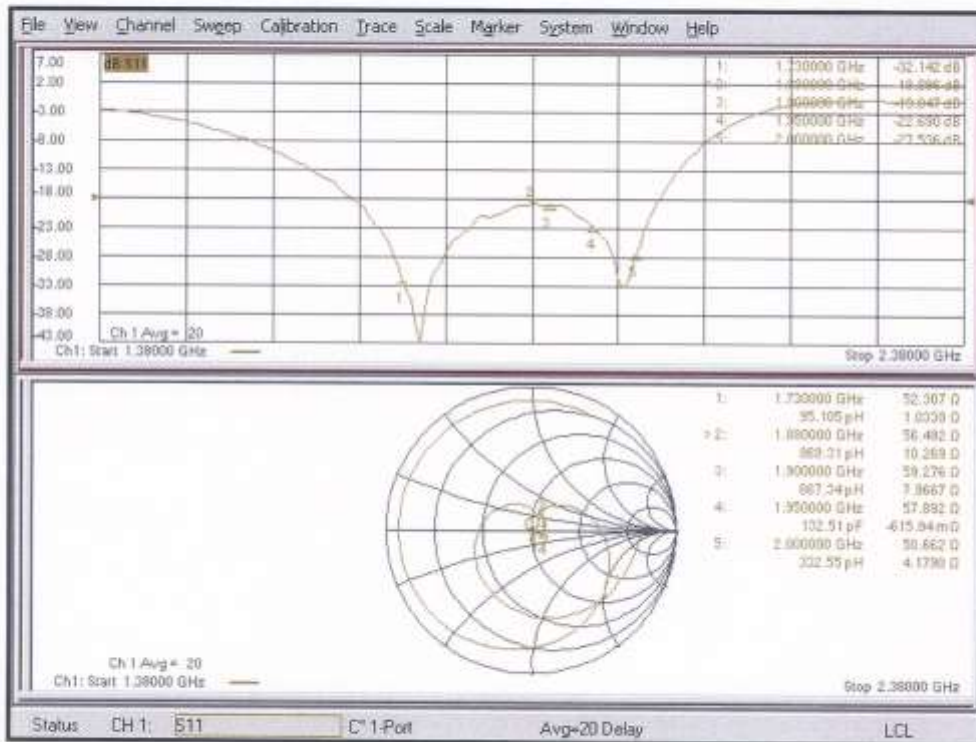
Impedance Measurement Plot

DASY5 E-field Result

Date: 22.02.2023

Test Laboratory: SPEAG Lab2

DUT: HAC Dipole 1880 MHz; Type: CD1880V3; Serial: CD1880V3 - SN: 1019

Communication System: UID 0 - CW ; Frequency: 1880 MHz
 Medium parameters used: $\sigma = 0$ S/m, $\epsilon_r = 1$; $\rho = 0$ kg/m³
 Phantom section: RF Section
 Measurement Standard: DASY5 (IEEE/IEC/ANSI C63.19-2011)

DASY52 Configuration:

- Probe: EF3DV3 - SN4013; ConvF[1, 1, 1] @ 1880 MHz Calibrated: 30.12.2022
- Sensor-Surface: (Fix Surface)
- Electronics: DAE4 Sn781; Calibrated: 03.01.2023
- Phantom: HAC Test Arch with AMCC; Type: SD HAC P01 BA; Serial: 1070
- DASY52 52.10.4(1535); SEMCAD X 14.6.14(7501)

Dipole E-Field measurement @ 1880MHz/E-Scan - 1880MHz d=15mm/Hearing Aid Compatibility Test (41x181x1):

Interpolated grid: dx=0.5000 mm, dy=0.5000 mm
 Device Reference Point: 0, 0, -6.3 mm
 Reference Value = 149.9 V/m; Power Drift = 0.02 dB
 Applied MIF = 0.00 dB
 RF audio interference level = 38.64 dBV/m
Emission category: M2

MIF scaled E-field

Grid 1 M2 38.32 dBV/m	Grid 2 M2 38.39 dBV/m	Grid 3 M2 38.1 dBV/m
Grid 4 M2 35.88 dBV/m	Grid 5 M2 35.91 dBV/m	Grid 6 M2 35.82 dBV/m
Grid 7 M2 38.57 dBV/m	Grid 8 M2 38.64 dBV/m	Grid 9 M2 38.34 dBV/m

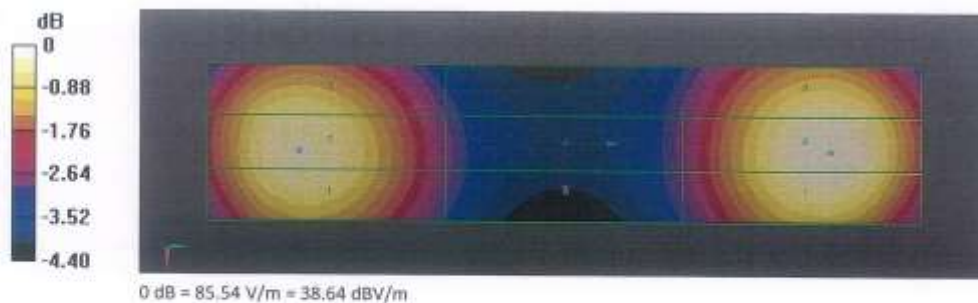

DIPOLE CALIBRATION EXTENSION

Per KDB 865664 D01, Dipole calibration intervals of up to three years may be considered for reference dipoles when it is demonstrated that the HAC target, impedance and return loss of a dipole have remained stable according to the following requirements:

1. The measured HAC does not deviate more than 10% from the target on the calibration certificate.
2. The return-loss does not deviate more than 20% from the previous measurement and meets the required 20dB minimum return-loss requirement.
3. The measurement of real or imaginary parts of impedance does not deviate more than 5Ω from the previous measurement.

The following dipole was checked to pass the above 3 requirements to have 2-year calibration period from the calibration date:

Calibration Date	Extention Date	Certificate SAR Target E-Field V/m@20.0dBm	Measuered SAR Target E-Field V/m@20.0dBm	Deviation(%)	Certificate Impedance (Ohm)	Measured Impedance (Ohm)	Deviation(%)	Certificate ReturnLoss (dB)	Measured ReturnLoss (dB)	Deviation(%)	PASS/FAIL
02/22/2023	02/22/2024	84.3	85.8	1.78	56.5	54.1	2.4	-18.9	-18.8	-0.53	PASS

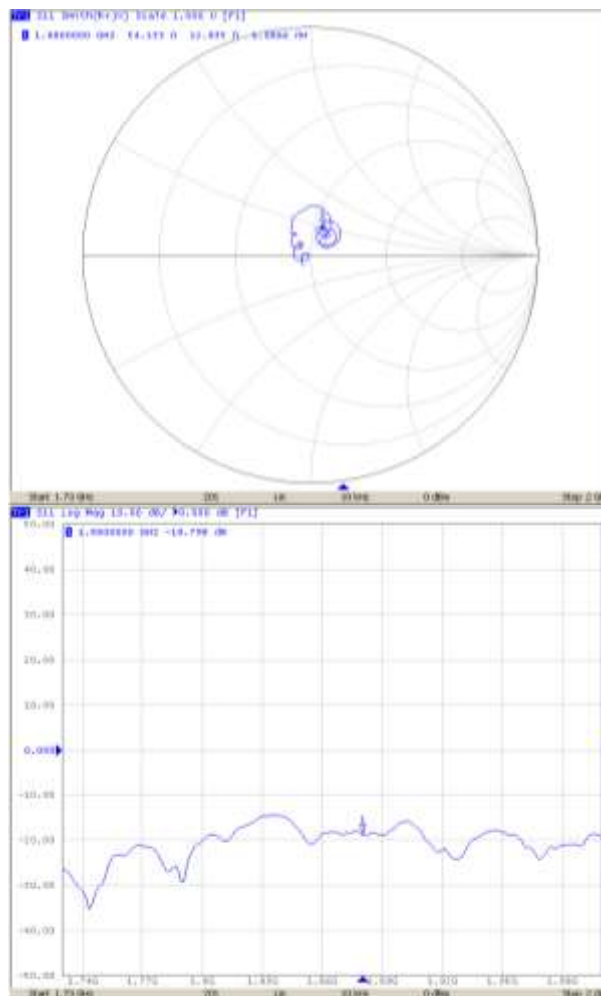

**Calibration Laboratory of
Schmid & Partner
Engineering AG**
Zeughausstrasse 43, 8004 Zurich, Switzerland



S Schweizerischer Kalibrierdienst
C Service suisse d'étalonnage
S Servizio svizzero di taratura
S Swiss Calibration Service

Accredited by the Swiss Accreditation Service (SAS)
The Swiss Accreditation Service is one of the signatories to the EA
Multilateral Agreement for the recognition of calibration certificates

Accreditation No.: **SCS 0108**

Client **HCT**
Gyeonggi-do, Republic of Korea

Certificate No. **CD2600V3-1019_Sep23**

CALIBRATION CERTIFICATE

Object: **CD2600V3 - SN: 1019**

Calibration procedure(s): **QA CAL-20.v7
Calibration Procedure for Validation Sources in air**

Calibration date: **September 22, 2023**

This calibration certificate documents the traceability to national standards, which realize the physical units of measurements (SI).
The measurements and the uncertainties with confidence probability are given on the following pages and are part of the certificate.

All calibrations have been conducted in the closed laboratory facility; environment temperature (22 ± 3)°C and humidity < 70%.

Calibration Equipment used (M&TE critical for calibration)

Primary Standards	ID #	Cal Date (Certificate No.)	Scheduled Calibration
Power meter NRP2	SN: 104778	30-Mar-23 (No. 217-03804/03805)	Mar-24
Power sensor NRP-Z91	SN: 103244	30-Mar-23 (No. 217-03804)	Mar-24
Power sensor NRP-Z91	SN: 103245	30-Mar-23 (No. 217-03805)	Mar-24
Reference 20 dB Attenuator	SN: BH8394 (20k)	30-Mar-23 (No. 217-03809)	Mar-24
Type-N mismatch combination	SN: 310882 / 08327	30-Mar-23 (No. 217-03810)	Mar-24
Probe EF3DV3	SN: 4013	30-Dec-22 (No. EF3-4013_Dec22)	Dec-23
DAE4	SN: 781	03-Jan-23 (No. DAE4-781_Jan23)	Jan-24

Secondary Standards	ID #	Check Date (In house)	Scheduled Check
Power meter Agilent 4419B	SN: GB42420191	09-Oct-09 (in house check Oct-20)	In house check: Oct-23
Power sensor HP E4412A	SN: US38465102	05-Jan-10 (in house check Oct-20)	In house check: Oct-23
Power sensor HP 8482A	SN: US37295597	09-Oct-09 (in house check Oct-20)	In house check: Oct-23
RF generator R&S SMT-06	SN: 837633/005	10-Jan-19 (in house check Oct-20)	In house check: Oct-23
Network Analyzer Agilent E8358A	SN: US41080477	31-Mar-14 (in house check Oct-22)	In house check: Oct-24

Calibrated by: **Claudio Leubler** (Name), **Laboratory Technician** (Function), *[Signature]* (Signature)

Approved by: **Sven Külin** (Name), **Technical Manager** (Function), *[Signature]* (Signature)

Issued: September 24, 2023

This calibration certificate shall not be reproduced except in full without written approval of the laboratory.

검	단	과	화	인	과
기	장	장	장	장	장
2023	10.11	2023	10.11	2023	10.11

**Calibration Laboratory of
Schmid & Partner
Engineering AG**
Zeughausstrasse 43, 8004 Zurich, Switzerland



S Schweizerischer Kalibrierdienst
C Service suisse d'étalonnage
S Servizio svizzero di taratura
Swiss Calibration Service

Accreditation No.: **SCS 0108**

Accredited by the Swiss Accreditation Service (SAS)
The Swiss Accreditation Service is one of the signatories to the EA
Multilateral Agreement for the recognition of calibration certificates

References

- [1] ANSI-C63.19-2019 (ANSI-C63.19-2011)
American National Standard, Methods of Measurement of Compatibility between Wireless Communications Devices and Hearing Aids.

Methods Applied and Interpretation of Parameters:

- **Coordinate System:** y-axis is in the direction of the dipole arms. z-axis is from the basis of the antenna (mounted on the table) towards its feed point between the two dipole arms. x-axis is normal to the other axes. In coincidence with the standards [1], the measurement planes (probe sensor center) are selected to be at a distance of 15 mm above the top metal edge of the dipole arms.
- **Measurement Conditions:** Further details are available from the hardcopies at the end of the certificate. All figures stated in the certificate are valid at the frequency indicated. The forward power to the dipole connector is set with a calibrated power meter connected and monitored with an auxiliary power meter connected to a directional coupler. While the dipole under test is connected, the forward power is adjusted to the same level.
- **Antenna Positioning:** The dipole is mounted on a HAC Test Arch phantom using the matching dipole positioner with the arms horizontal and the feeding cable coming from the floor. The measurements are performed in a shielded room with absorbers around the setup to reduce the reflections. It is verified before the mounting of the dipole under the Test Arch phantom, that its arms are perfectly in a line. It is installed on the HAC dipole positioner with its arms parallel below the dielectric reference wire and able to move elastically in vertical direction without changing its relative position to the top center of the Test Arch phantom. The vertical distance to the probe is adjusted after dipole mounting with a DASY5 Surface Check job. Before the measurement, the distance between phantom surface and probe tip is verified. The proper measurement distance is selected by choosing the matching section of the HAC Test Arch phantom with the proper device reference point (upper surface of the dipole) and the matching grid reference point (tip of the probe) considering the probe sensor offset. The vertical distance to the probe is essential for the accuracy.
- **Feed Point Impedance and Return Loss:** These parameters are measured using a Vector Network Analyzer. The impedance with the SMA connector of the dipole. The influence of reflections was eliminated by applying the averaging function while moving the dipole in the air, at least 70cm away from any obstacles.
- **E-field distribution:** E field is measured in the x-y-plane with an isotropic E-field probe with 100 mW forward power to the antenna feed point. In accordance with [1], the scan area is 20mm wide, its length exceeds the dipole arm length (180 or 90mm). The sensor center is 15 mm (in z) above the metal top of the dipole arms. Two 3D maxima are available near the end of the dipole arms. Assuming the dipole arms are perfectly in one line, the average of these two maxima (in subgrid 2 and subgrid 8) is determined to compensate for any non-parallelity to the measurement plane as well as the sensor displacement. The E-field value stated as calibration value represents the maximum of the interpolated 3D-E-field, in the plane above the dipole surface.

The reported uncertainty of measurement is stated as the standard uncertainty of measurement multiplied by the coverage factor $k=2$, which for a normal distribution corresponds to a coverage probability of approximately 95%.

Measurement Conditions

DASY system configuration, as far as not given on page 1.

DASY Version	DASY5	V52.10.4
Phantom	HAC Test Arch	
Distance Dipole Top - Probe Center	15 mm	
Scan resolution	dx, dy = 5 mm	
Frequency	2600 MHz ± 1 MHz	
Input power drift	< 0.05 dB	

Maximum Field values at 2600 MHz

E-field 15 mm above dipole surface	condition	Interpolated maximum
Maximum measured above high end	100 mW input power	85.0 V/m = 38.59 dBV/m
Maximum measured above low end	100 mW input power	84.1 V/m = 38.49 dBV/m
Averaged maximum above arm	100 mW input power	84.5 V/m ± 12.8 % (k=2)

Appendix (Additional assessments outside the scope of SCS 0108)

Antenna Parameters

Frequency	Return Loss	Impedance
2450 MHz	19.6 dB	43.7 Ω - 7.6 jΩ
2550 MHz	33.7 dB	48.4 Ω + 1.2 jΩ
2600 MHz	35.1 dB	51.3 Ω + 1.2 jΩ
2650 MHz	28.4 dB	54.0 Ω - 0.3 jΩ
2750 MHz	18.1 dB	51.0 Ω - 12.7 jΩ

3.2 Antenna Design and Handling

The calibration dipole has a symmetric geometry with a built-in two stub matching network, which leads to the enhanced bandwidth.

The dipole is built of standard semirigid coaxial cable. The internal matching line is open ended. The antenna is therefore open for DC signals.

Do not apply force to dipole arms, as they are liable to bend. The soldered connections near the feedpoint may be damaged. After excessive mechanical stress or overheating, check the impedance characteristics to ensure that the internal matching network is not affected.

After long term use with 40W radiated power, only a slight warming of the dipole near the feedpoint can be measured.

Impedance Measurement Plot

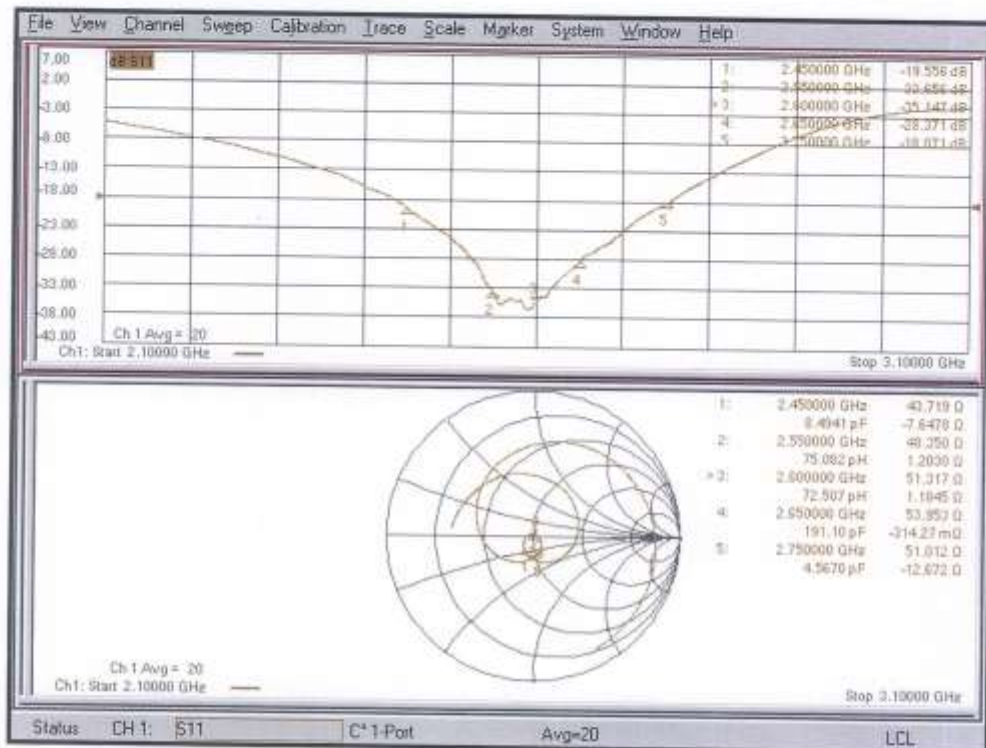

DASY5 E-field Result

Date: 22.09.2023

Test Laboratory: SPEAG Lab2

DUT: HAC Dipole 2600 MHz; Type: CD2600V3; Serial: CD2600V3 - SN: 1019

Communication System: UID 0 - CW ; Frequency: 2600 MHz
 Medium parameters used: $\sigma = 0 \text{ S/m}$, $\epsilon_r = 1$; $\rho = 0 \text{ kg/m}^3$
 Phantom section: RF Section
 Measurement Standard: DASY5 (IEEE/IEC/ANSI C63.19-2011)

DASY52 Configuration:

- Probe: EF3DV3 - SN4013; ConvF(1, 1, 1) @ 2600 MHz; Calibrated: 30.12.2022
- Sensor-Surface: (Fix Surface)
- Electronics: DAE4 Sn781; Calibrated: 03.01.2023
- Phantom: HAC Test Arch with AMCC; Type: SO HAC P01 BA; Serial: 1070
- DASY52 52.10.4(1535); SEMCAD X 14.6.14(7501)

Dipole E-Field measurement @ 2600MHz/E-Scan - 2600MHz d=15mm/Hearing Aid Compatibility Test (41x181x1):
 Interpolated grid: dx=0.5000 mm, dy=0.5000 mm
 Device Reference Point: 0, 0, -6.3 mm
 Reference Value = 67.52 V/m; Power Drift = 0.00 dB
 Applied MIF = 0.00 dB
 RF audio interference level = 38.59 dBV/m
Emission category: M2

MIF scaled E-field

Grid 1 M2 38.56 dBV/m	Grid 2 M2 38.59 dBV/m	Grid 3 M2 38.24 dBV/m
Grid 4 M2 37.9 dBV/m	Grid 5 M2 37.91 dBV/m	Grid 6 M2 37.62 dBV/m
Grid 7 M2 38.42 dBV/m	Grid 8 M2 38.49 dBV/m	Grid 9 M2 38.21 dBV/m

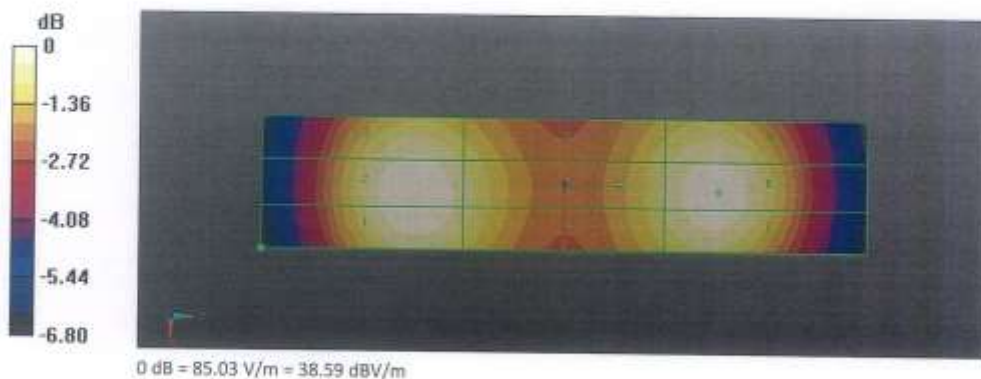

**Calibration Laboratory of
Schmid & Partner
Engineering AG**
Zeughausstrasse 43, 8004 Zurich, Switzerland



S Schweizerischer Kalibrierdienst
C Service suisse d'étalonnage
S Servizio svizzero di taratura
Swiss Calibration Service

Accreditation No.: **SCS 0108**

Accredited by the Swiss Accreditation Service (SAS)
The Swiss Accreditation Service is one of the signatories to the EA
Multilateral Agreement for the recognition of calibration certificates

Client **HCT**
Gyeonggi-do, Republic of Korea

Certificate No. **CD3500V3-1012_Nov23**

CALIBRATION CERTIFICATE

Object: **CD3500V3 - SN: 1012**

Calibration procedure(s): **QA CAL-20.v7
Calibration Procedure for Validation Sources in air**

Calibration date: **November 17, 2023**

This calibration certificate documents the traceability to national standards, which realize the physical units of measurements (SI).
The measurements and the uncertainties with confidence probability are given on the following pages and are part of the certificate.

All calibrations have been conducted in the closed laboratory facility: environment temperature (22 ± 3)°C and humidity < 70%.

Calibration Equipment used (M&TE critical for calibration)

Primary Standards	ID #	Cal Date (Certificate No.)	Scheduled Calibration
Power meter NRP2	SN: 104778	30-Mar-23 (No. 217-03804/03805)	Mar-24
Power sensor NRP-Z91	SN: 103244	30-Mar-23 (No. 217-03804)	Mar-24
Power sensor NRP-Z91	SN: 103245	30-Mar-23 (No. 217-03805)	Mar-24
Reference 20 dB Attenuator	SN: BH9394 (20k)	30-Mar-23 (No. 217-03809)	Mar-24
Type-N mismatch combination	SN: 310982 / 05327	30-Mar-23 (No. 217-03810)	Mar-24
Probe EF3DV3	SN: 4013	30-Dec-22 (No. EFS-4013_Dec22)	Dec-23
DAE4	SN: 781	03-Jan-23 (No. DAE4-781_Jan23)	Jan-24

Secondary Standards	ID #	Check Date (in house)	Scheduled Check
Power meter Agilent 4419B	SN: GB42420191	09-Oct-09 (in house check Oct-20)	In house check: Dec-23
Power sensor HP E4412A	SN: US38485102	05-Jan-10 (in house check Oct-20)	In house check: Dec-23
Power sensor HP 8482A	SN: US37295597	09-Oct-09 (in house check Oct-20)	In house check: Dec-23
RF generator R&S SMT-06	SN: 837633/005	10-Jan-19 (in house check Oct-20)	In house check: Dec-23
Network Analyzer Agilent E8358A	SN: US41080477	31-Mar-14 (in house check Oct-22)	In house check: Oct-24

Calibrated by:	Name: Claudio Leubler Function: Laboratory Technician	Signature:
Approved by:	Name: Sven Kühn Function: Technical Manager	Signature:

Issued: November 22, 2023

This calibration certificate shall not be reproduced except in full without written approval of the laboratory.

검	인	인	인
자	자	자	자
일	일	일	일
년	년	년	년
월	월	월	월
일	일	일	일

**Calibration Laboratory of
Schmid & Partner
Engineering AG**
Zeughausstrasse 43, 8004 Zurich, Switzerland



S Schweizerischer Kalibrierdienst
C Service suisse d'étalonnage
S Servizio svizzero di taratura
S Swiss Calibration Service

Accreditation No.: **SCS 0108**

Accredited by the Swiss Accreditation Service (SAS)
The Swiss Accreditation Service is one of the signatories to the EA
Multilateral Agreement for the recognition of calibration certificates

References

- [1] ANSI-C63.19-2019 (ANSI-C63.19-2011)
American National Standard, Methods of Measurement of Compatibility between Wireless Communications Devices and Hearing Aids.

Methods Applied and Interpretation of Parameters:

- **Coordinate System:** y-axis is in the direction of the dipole arms. z-axis is from the basis of the antenna (mounted on the table) towards its feed point between the two dipole arms. x-axis is normal to the other axes. In coincidence with the standards [1], the measurement planes (probe sensor center) are selected to be at a distance of 15 mm above the top metal edge of the dipole arms.
- **Measurement Conditions:** Further details are available from the hardcopies at the end of the certificate. All figures stated in the certificate are valid at the frequency indicated. The forward power to the dipole connector is set with a calibrated power meter connected and monitored with an auxiliary power meter connected to a directional coupler. While the dipole under test is connected, the forward power is adjusted to the same level.
- **Antenna Positioning:** The dipole is mounted on a HAC Test Arch phantom using the matching dipole positioner with the arms horizontal and the feeding cable coming from the floor. The measurements are performed in a shielded room with absorbers around the setup to reduce the reflections. It is verified before the mounting of the dipole under the Test Arch phantom, that its arms are perfectly in a line. It is installed on the HAC dipole positioner with its arms parallel below the dielectric reference wire and able to move elastically in vertical direction without changing its relative position to the top center of the Test Arch phantom. The vertical distance to the probe is adjusted after dipole mounting with a DASY5 Surface Check job. Before the measurement, the distance between phantom surface and probe tip is verified. The proper measurement distance is selected by choosing the matching section of the HAC Test Arch phantom with the proper device reference point (upper surface of the dipole) and the matching grid reference point (tip of the probe) considering the probe sensor offset. The vertical distance to the probe is essential for the accuracy.
- **Feed Point Impedance and Return Loss:** These parameters are measured using a Vector Network Analyzer. The impedance is specified at the SMA connector of the dipole. The influence of reflections was eliminated by applying the averaging function while moving the dipole in the air, at least 70cm away from any obstacles.
- **E-field distribution:** E field is measured in the x-y-plane with an isotropic E-field probe with 100 mW forward power to the antenna feed point. In accordance with [1], the scan area is 20mm wide, its length exceeds the dipole arm length (180 or 90mm). The sensor center is 15 mm (in z) above the metal top of the dipole arms. Two 3D maxima are available near the end of the dipole arms. Assuming the dipole arms are perfectly in one line, the average of these two maxima (in subgrid 2 and subgrid 8) is determined to compensate for any non-parallelity to the measurement plane as well as the sensor displacement. The E-field value stated as calibration value represents the maximum of the interpolated 3D-E-field, in the plane above the dipole surface.

The reported uncertainty of measurement is stated as the standard uncertainty of measurement multiplied by the coverage factor $k=2$, which for a normal distribution corresponds to a coverage probability of approximately 95%.

Measurement Conditions

DASY system configuration, as far as not given on page 1.

DASY Version	DASY5	V52.10.4
Phantom	HAC Test Arch	
Distance Dipole Top - Probe Center	15 mm	
Scan resolution	dx, dy = 5 mm	
Frequency	3500 MHz \pm 1 MHz	
Input power drift	< 0.05 dB	

Maximum Field values at 3500 MHz

E-field 15 mm above dipole surface	condition	Interpolated maximum
Maximum measured above high end	100 mW input power	83.2 V/m = 38.41 dBV/m
Maximum measured above low end	100 mW input power	80.8 V/m = 38.15 dBV/m
Averaged maximum above arm	100 mW input power	82.0 V/m \pm 12.8 % (k=2)

Appendix (Additional assessments outside the scope of SCS 0108)

Antenna Parameters

Frequency	Return Loss	Impedance
3300 MHz	18.5 dB	63.3 Ω - 1.7 j Ω
3400 MHz	24.8 dB	53.1 Ω - 5.0 j Ω
3500 MHz	27.7 dB	50.8 Ω - 4.1 j Ω
3600 MHz	26.6 dB	47.0 Ω - 3.4 j Ω
3700 MHz	23.1 dB	43.6 Ω + 1.6 j Ω

3.2 Antenna Design and Handling

The calibration dipole has a symmetric geometry with a built-in two stub matching network, which leads to the enhanced bandwidth.

The dipole is built of standard semirigid coaxial cable. The internal matching line is open ended. The antenna is therefore open for DC signals.

Do not apply force to dipole arms, as they are liable to bend. The soldered connections near the feedpoint may be damaged. After excessive mechanical stress or overheating, check the impedance characteristics to ensure that the internal matching network is not affected.

After long term use with 40W radiated power, only a slight warming of the dipole near the feedpoint can be measured.

Impedance Measurement Plot

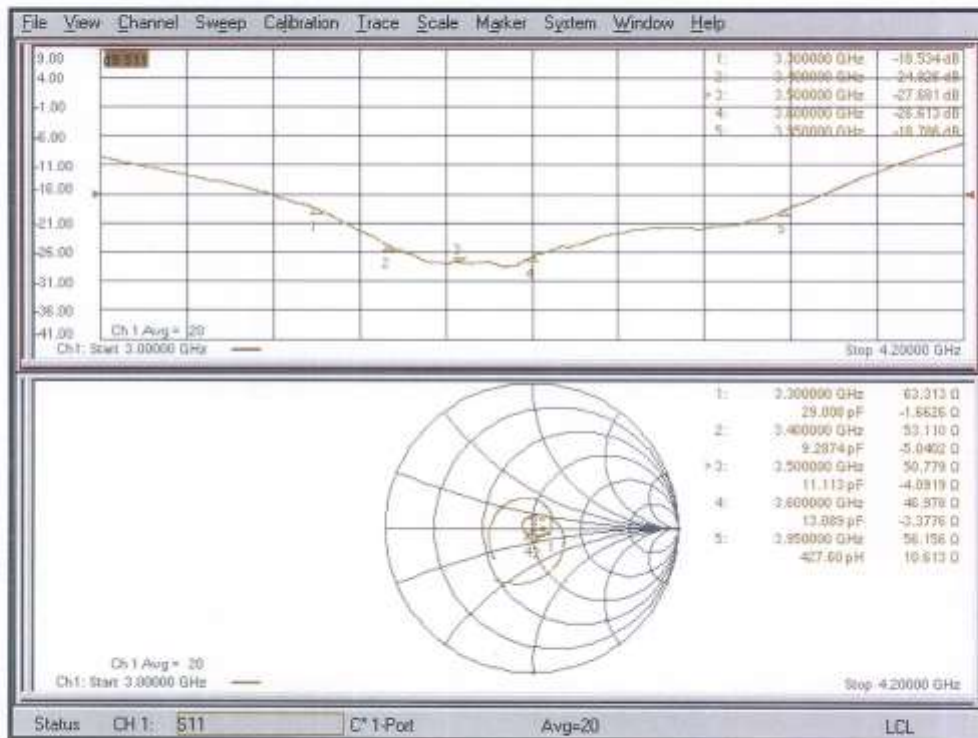

DASY5 E-field Result

Date: 17.11.2023

Test Laboratory: SPEAG Lab2

DUT: HAC Dipole 3500 MHz; Type: CD3500V3; Serial: CD3500V3 - SN: 1012

Communication System: UID 0 - CW ; Frequency: 3500 MHz
 Medium parameters used: $\sigma = 0 \text{ S/m}$, $\epsilon_r = 1$; $\rho = 0 \text{ kg/m}^3$
 Phantom section: RF Section
 Measurement Standard: DASY5 (IEEE/IEC/ANSI C63.19-2011)

DASY52 Configuration:

- Probe: EF3DV3 - SN4013; ConvF(1, 1, 1) @ 3500 MHz; Calibrated: 30.12.2022
- Sensor-Surface: (Fix Surface)
- Electronics: DAE4 Sn781; Calibrated: 03.01.2023
- Phantom: HAC Test Arch with AMCC; Type: SD HAC P01 BA; Serial: 1070
- DASY52 52.10.4(1535); SEMCAD X 14.6.14(7501)

Dipole E-Field measurement @ 3500MHz/E-Scan - 3500MHz d=15mm/Hearing Aid Compatibility Test (41x181x1):

Interpolated grid: dx=0.5000 mm, dy=0.5000 mm
 Device Reference Point: 0, 0, -6.3 mm
 Reference Value = 35.74 V/m; Power Drift = -0.01 dB
 Applied MIF = 0.00 dB
 RF audio interference level = 38.41 dBV/m
Emission category: M2

MIF scaled E-field

Grid 1 M2 38.36 dBV/m	Grid 2 M2 38.41 dBV/m	Grid 3 M2 38.17 dBV/m
Grid 4 M2 38.36 dBV/m	Grid 5 M2 38.41 dBV/m	Grid 6 M2 38.17 dBV/m
Grid 7 M2 38.11 dBV/m	Grid 8 M2 38.15 dBV/m	Grid 9 M2 37.86 dBV/m

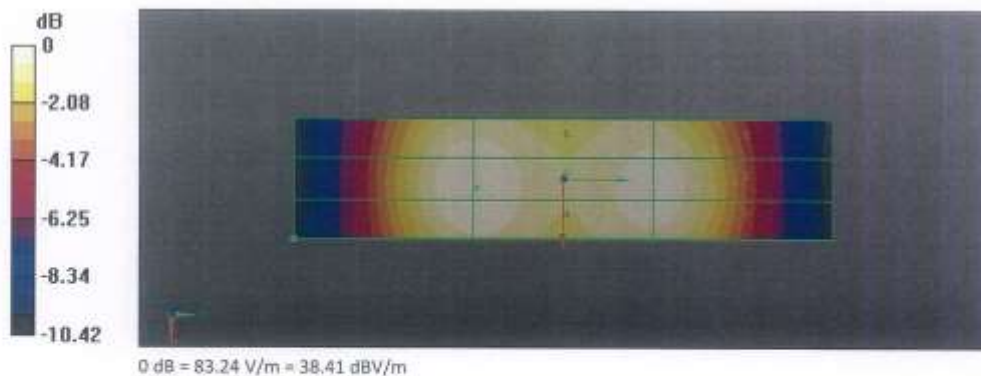

Appendix F. UID Specifications

**Calibration Laboratory of
Schmid & Partner
Engineering AG**
Zeughausstrasse 43, 8004 Zurich, Switzerland

Name:	GSM-FDD (TDMA, GMSK)
Group:	GSM
UID:	10021-DAC
PAR: ¹	9.39 dB
MIF: ²	3.63 dB
Standard Reference:	ETSI TS 100 909 V8.9.0 (2005-01) FCC OET KDB 941225, D03 and D04 Periodic pulsed modulation
Category:	GMSK
Modulation:	
Frequency Band:	GSM 450 (450.4 - 457.6 MHz) GSM 480 (478.8 - 486.0 MHz) GSM 710 (698.0 - 716.0 MHz) GSM 750 (747.0 - 763.0 MHz) GSM 850 (824.0 - 849.0 MHz) P-GSM 900 (890.0 - 915.0 MHz) E-GSM 900 (880.0 - 915.0 MHz) R-GSM 900 (876.0 - 915.0 MHz) DCS 1800 (1710.0 - 1785.0 MHz) PCS 1900 (1850.0 - 1910.0 MHz) ER-GSM 900 (873.0 - 915.0 MHz) Validation band (0.0 - 6000.0 MHz)
Detailed Specification:	Active Slot: TN0 Data: PN9 continuous Frame: composed out of 8 Slots Multiframe: 26th (IDLE) Frame set blank Slottype & -timing: Normal burst for GMSK
Bandwidth:	0.2 MHz
Integration Time:	120.0 ms

**Calibration Laboratory of
Schmid & Partner
Engineering AG**
Zeughausstrasse 43, 8004 Zurich, Switzerland

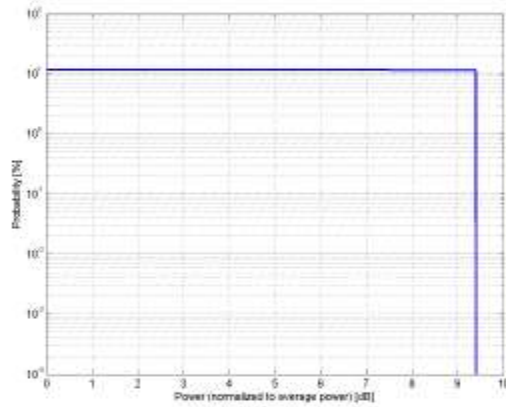

Complementary Cumulative Distribution Function (CCDF)

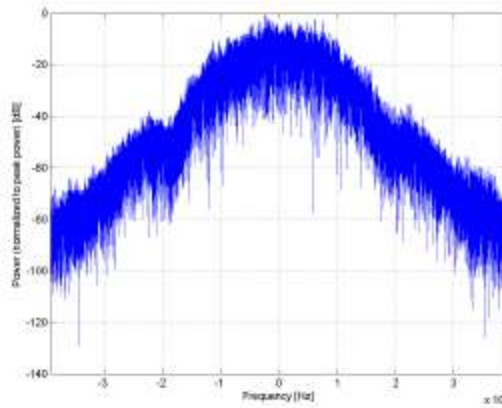

Frequency Domain

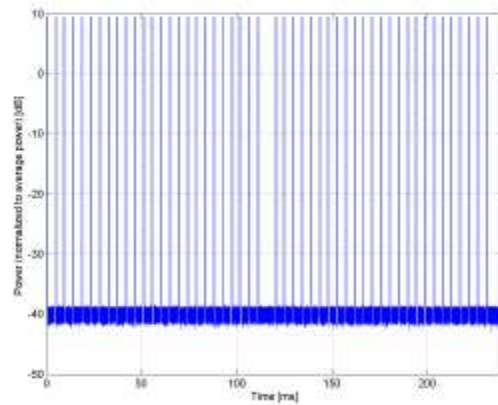

Time Domain

**Calibration Laboratory of
Schmid & Partner
Engineering AG**
Zeughausstrasse 43, 8004 Zurich, Switzerland

Name:	UMTS-FDD (WCDMA, AMR)
Group:	WCDMA
UID:	10460-AAB
PAR: ¹	2.39 dB
MIF: ²	-25.43 dB
Standard Reference:	FCC OET KDB 941225 D01 SAR test for 3G devices v03
Category:	Random amplitude modulation
Modulation:	QPSK
Frequency Band:	Band 1 (1920.0 - 1980.0 MHz) Band 2 (1850.0 - 1910.0 MHz) Band 3 (1710.0 - 1785.0 MHz) Band 4 (1710.0 - 1755.0 MHz) Band 5 (824.0 - 849.0 MHz) Band 6 (830.0 - 840.0 MHz) Band 7 (2500.0 - 2570.0 MHz) Band 8 (880.0 - 915.0 MHz) Band 9 (1749.9 - 1784.9 MHz) Band 10 (1710.0 - 1770.0 MHz) Band 11 (1427.9 - 1452.9 MHz) Band 12 (698.0 - 716.0 MHz) Band 13 (777.0 - 787.0 MHz) Band 14 (788.0 - 798.0 MHz) Band 19 (830.0 - 845.0 MHz) Band 20 (832.0 - 862.0 MHz) Band 21 (1447.9 - 1462.9 MHz) Band 22 (3410.0 - 3490.0 MHz) Band 25 (1850.0 - 1915.0 MHz) Band 26 (814.0 - 849.0 MHz) Validation band (0.0 - 6000.0 MHz)
Detailed Specification:	Dedicated Channel Type: 12.2 kbps AMR 3.4 kbps SRB
Bandwidth:	5.0 MHz
Integration Time:	100.0 ms

**Calibration Laboratory of
Schmid & Partner
Engineering AG**
Zeughausstrasse 43, 8004 Zurich, Switzerland

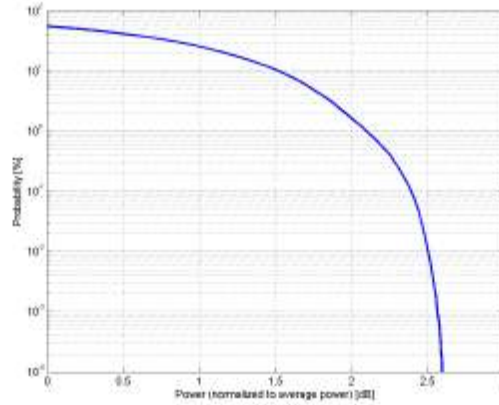

Complementary Cumulative Distribution Function (CCDF)

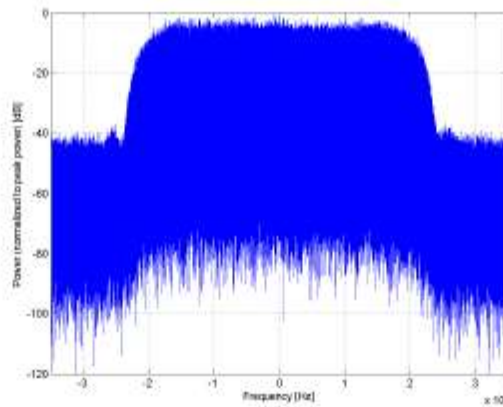

Frequency Domain

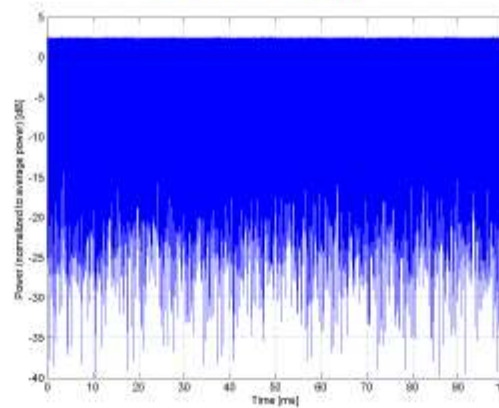

Time Domain

**Calibration Laboratory of
Schmid & Partner
Engineering AG**
Zeughausstrasse 43, 8004 Zurich, Switzerland

Name:	LTE-FDD (SC-FDMA, 1 RB, 20 MHz, 16-QAM)
Group:	LTE-FDD
UID:	10170-CAF
PAR: ¹	6.52 dB
MIF: ²	-9.76 dB
Standard Reference:	3GPP / ETSI TS 136.101 V8.4.0 3GPP / ETSI TS 136.213 V8.4.0 FCC OET KDB 941225 D05 SAR for LTE Devices v01
Category:	Random amplitude modulation
Modulation:	16-QAM
Frequency Band:	Band 1 (1920.0 - 1980.0 MHz) Band 2 (1850.0 - 1910.0 MHz) Band 3 (1710.0 - 1785.0 MHz) Band 4 (1710.0 - 1755.0 MHz) Band 7 (2500.0 - 2570.0 MHz) Band 9 (1749.9 - 1784.9 MHz) Band 10 (1710.0 - 1770.0 MHz) Band 20 (832.0 - 862.0 MHz) Band 22 (3410.0 - 3490.0 MHz) Band 23 (2000.0 - 2020.0 MHz) Band 25 (1850.0 - 1915.0 MHz) Band 28 (703.0 - 748.0 MHz) Band 65 (1920.0 - 2010.0 MHz) Band 66 (1710.0 - 1780.0 MHz) Band 70 (1895.0 - 1710.0 MHz) Band 71 (683.0 - 698.0 MHz) Band 74 (1427.0 - 1470.0 MHz) Validation band (0.0 - 6000.0 MHz)
Detailed Specification:	Modulation Scheme: SC-FDMA Number of PUSCHs: 1 Settings for Subframe #0 to #9: Modulation Scheme: 16QAM Data Type: UL-SCH Number RB: 1 Transport Block Size: 256 TBS Index: 14 MCS Index: 15 Data Type: PUS
Bandwidth:	20.0 MHz
Integration Time:	10.0 ms

¹ PAR (0.1%) in accordance with FCC KDB 971168, Section 6.0 "Measurement of the Peak-to-Average Power Ratio (PAR)"
² Modulation Interference Factor (MIF) value valid only in conjunction with advanced probe response linearization calibration for the same communication system (same UID and version).

**Calibration Laboratory of
Schmid & Partner
Engineering AG**
Zeughausstrasse 43, 8004 Zurich, Switzerland

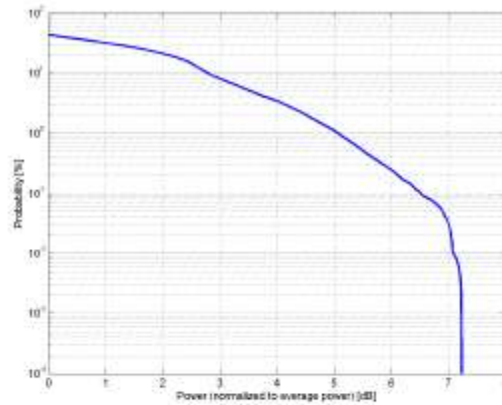

Complementary Cumulative Distribution Function (CCDF)

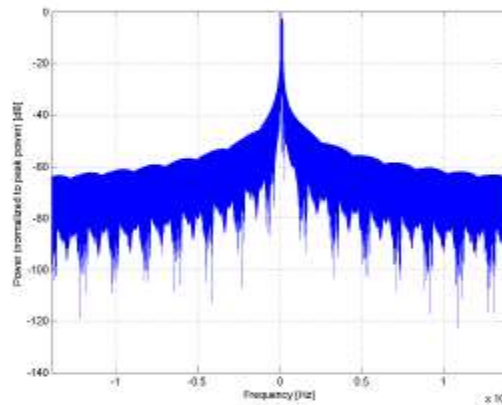

Frequency Domain

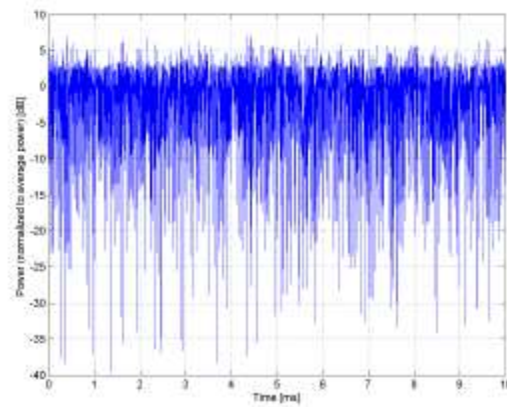

Time Domain

**Calibration Laboratory of
 Schmid & Partner
 Engineering AG**
 Zeughausstrasse 43, 8004 Zurich, Switzerland

Name:	LTE-FDD (SC-FDMA, 1 RB, 15 MHz, 16-QAM)
Group:	LTE-FDD
UID:	10182-CAF
PAR:¹	6.52 dB
MIF:²	-9.76 dB
Standard Reference:	3GPP / ETSI TS 136.101 V8.4.0 3GPP / ETSI TS 136.213 V8.4.0 FCC OET KDB 941225 D05 SAR for LTE Devices v01
Category:	Random amplitude modulation
Modulation:	16-QAM
Frequency Band:	Band 1 (1920.0 - 1980.0 MHz) Band 2 (1850.0 - 1910.0 MHz) Band 3 (1710.0 - 1785.0 MHz) Band 4 (1710.0 - 1755.0 MHz) Band 7 (2500.0 - 2570.0 MHz) Band 9 (1749.9 - 1784.9 MHz) Band 10 (1710.0 - 1770.0 MHz) Band 18 (815.0 - 830.0 MHz) Band 19 (830.0 - 845.0 MHz) Band 20 (832.0 - 862.0 MHz) Band 21 (1447.9 - 1462.9 MHz) Band 22 (3410.0 - 3490.0 MHz) Band 23 (2000.0 - 2020.0 MHz) Band 25 (1850.0 - 1915.0 MHz) Band 26 (814.0 - 849.0 MHz) Band 28 (703.0 - 748.0 MHz) Band 65 (1920.0 - 2010.0 MHz) Band 66 (1710.0 - 1780.0 MHz) Band 68 (698.0 - 728.0 MHz) Band 70 (1695.0 - 1710.0 MHz) Band 71 (683.0 - 698.0 MHz) Band 74 (1427.0 - 1470.0 MHz) Validation band (0.0 - 6000.0 MHz)
Detailed Specification:	Modulation Scheme: SC-FDMA Number of PUSCHs: 1 Settings for Subframe #0 to #9: Modulation Scheme: 16QAM Data Type: UL-SCH Number RB: 1 Transport Block Size: 256 TBS Index: 14 MCS Index: 15 Data Type: PN9
Bandwidth:	15.0 MHz
Integration Time:	10.0 ms

¹ PAR (0.1%) in accordance with FCC KDB 971168, Section 6.0 "Measurement of the Peak-to-Average Power Ratio (PAR)"
² Modulation Interference Factor (MIF) value valid only in conjunction with advanced probe response linearization calibration for the same communication system (same UID and version).

**Calibration Laboratory of
Schmid & Partner
Engineering AG**
Zeughausstrasse 43, 8004 Zurich, Switzerland

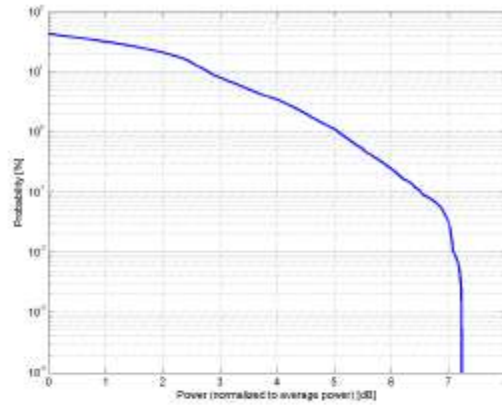

Complementary Cumulative Distribution Function (CCDF)

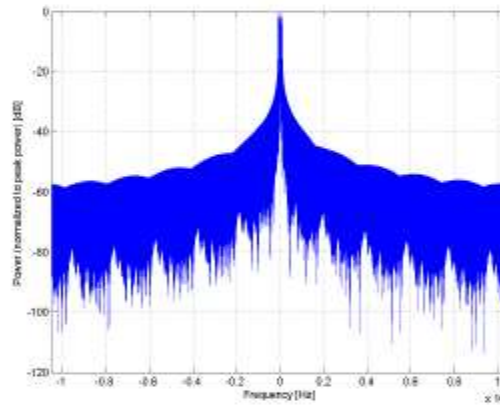

Frequency Domain

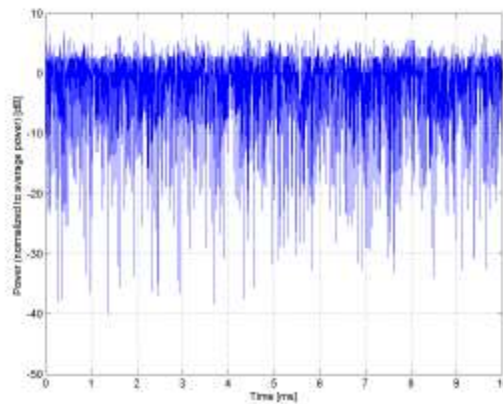

Time Domain

**Calibration Laboratory of
 Schmid & Partner
 Engineering AG**
 Zeughausstrasse 43, 8004 Zurich, Switzerland

Name:	LTE-FDD (SC-FDMA, 1 RB, 10 MHz, 16-QAM)
Group:	LTE-FDD
UID:	10176-CAH
PAR:¹	6.52 dB
MIF:²	-9.76 dB
Standard Reference:	3GPP / ETSI TS 136.101 V8.4.0 3GPP / ETSI TS 136.213 V8.4.0 FCC OET KDB 941225 D05 SAR for LTE Devices v01
Category:	Random amplitude modulation
Modulation:	16-QAM
Frequency Band:	Band 1 (1920.0 - 1980.0 MHz) Band 2 (1850.0 - 1910.0 MHz) Band 3 (1710.0 - 1785.0 MHz) Band 4 (1710.0 - 1755.0 MHz) Band 5 (824.0 - 849.0 MHz) Band 6 (830.0 - 840.0 MHz) Band 7 (2500.0 - 2570.0 MHz) Band 8 (880.0 - 915.0 MHz) Band 9 (1749.9 - 1784.9 MHz) Band 10 (1710.0 - 1770.0 MHz) Band 11 (1427.9 - 1447.9 MHz) Band 12 (899.0 - 718.0 MHz) Band 13 (777.0 - 787.0 MHz) Band 14 (788.0 - 798.0 MHz) Band 17 (704.0 - 718.0 MHz) Band 18 (815.0 - 830.0 MHz) Band 19 (830.0 - 845.0 MHz) Band 20 (832.0 - 862.0 MHz) Band 21 (1447.9 - 1482.9 MHz) Band 22 (3410.0 - 3490.0 MHz) Band 23 (2000.0 - 2020.0 MHz) Band 24 (1626.5 - 1860.5 MHz) Band 25 (1850.0 - 1915.0 MHz) Band 26 (814.0 - 849.0 MHz) Band 27 (807.0 - 824.0 MHz) Band 28 (703.0 - 748.0 MHz) Band 30 (2305.0 - 2315.0 MHz) Band 65 (1920.0 - 2010.0 MHz) Band 66 (1710.0 - 1790.0 MHz) Band 68 (898.0 - 728.0 MHz) Band 70 (1895.0 - 1710.0 MHz) Band 71 (863.0 - 698.0 MHz) Band 74 (1427.0 - 1470.0 MHz) Band 85 (898.0 - 716.0 MHz) Validation band (0.0 - 6000.0 MHz)
Detailed Specification:	Modulation Scheme: SC-FDMA Number of PUSCHs: 1 Settings for Subframe #0 to #9: Modulation Scheme: QPSK Data Type: UL-SCH Number RB: 1 Transport Block Size: 256 TBS Index: 14 MCS Index: 15 Data Type: PUS
Bandwidth:	10.0 MHz
Integration Time:	10.0 ms

¹ PAR (0.1%) in accordance with FCC KDB 971168, Section 6.0 "Measurement of the Peak-to-Average Power Ratio (PAR)"
² Modulation Interference Factor (MIF) value valid only in conjunction with advanced probe response linearization calibration for the same communication system (same UID and version).

**Calibration Laboratory of
Schmid & Partner
Engineering AG**
Zeughausstrasse 43, 8004 Zurich, Switzerland

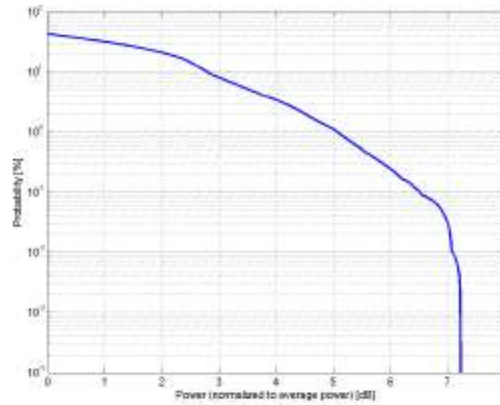

Complementary Cumulative Distribution Function (CCDF)

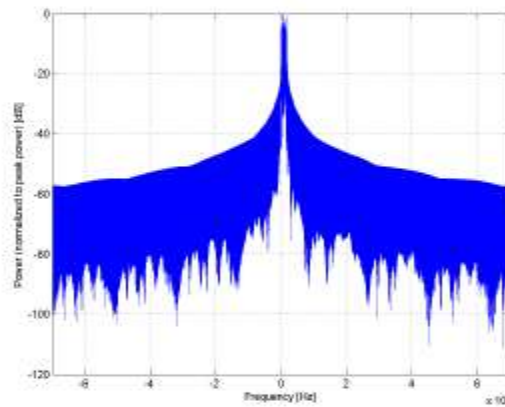

Frequency Domain

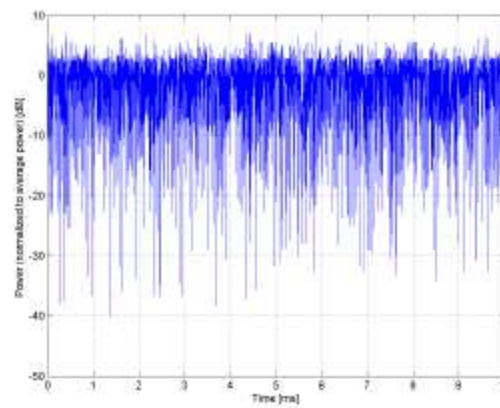

Time Domain

**Calibration Laboratory of
Schmid & Partner
Engineering AG**
Zeughausstrasse 43, 8004 Zurich, Switzerland

Name:	LTE-TDD (SC-FDMA, 1 RB, 10 MHz, 16-QAM)
Group:	LTE-TDD
UID:	10235-CAH
PAR:¹	9.48 dB
MIF:²	-1.44 dB
Standard Reference:	3GPP / ETSI TS 136.101 V8.4.0 3GPP / ETSI TS 136.213 V8.4.0 FCC OET KDB 941225 D05 SAR for LTE Devices v01
Category:	Random amplitude modulation
Modulation:	16-QAM
Frequency Band:	Band 33 (1900.0 - 1920.0 MHz) Band 34 (2010.0 - 2025.0 MHz) Band 35 (1850.0 - 1910.0 MHz) Band 36 (1930.0 - 1990.0 MHz) Band 37 (1910.0 - 1930.0 MHz) Band 38 (2570.0 - 2620.0 MHz) Band 39 (1880.0 - 1920.0 MHz) Band 40 (2300.0 - 2400.0 MHz) Band 41 (2496.0 - 2690.0 MHz) Band 42 (3400.0 - 3800.0 MHz) Band 43 (3600.0 - 3800.0 MHz) Band 44 (703.0 - 803.0 MHz) Band 45 (1447.0 - 1467.0 MHz) Band 46 (5150.0 - 5925.0 MHz) Band 47 (5855.0 - 5925.0 MHz) Band 48 (3550.0 - 3700.0 MHz) Band 49 (3550.0 - 3700.0 MHz) Band 50 (1432.0 - 1517.0 MHz) Band 52 (3300.0 - 3400.0 MHz) Band 53 (2483.5 - 2495.0 MHz) Validation band (0.0 - 6000.0 MHz)
Detailed Specification:	Modulation Scheme: SC-FDMA Uplink-downlink configuration: 1 Special Subframe configuration: 4 Number of Frames: 1 Settings for UL Subframe 2,3,7,8: Number of PUSCHs: 1 Modulation Scheme: 16QAM Allocated RB: 1 Start Number of RB: 25 Data Type: PNGfx
Bandwidth:	10.0 MHz
Integration Time:	10.0 ms

¹ PAR (0.1%) in accordance with FCC KDB 971168, Section 6.0 "Measurement of the Peak-to-Average Power Ratio (PAPR)"
² Modulation Interference Factor (MIF) value valid only in conjunction with advanced probe response linearization calibration for the same communication system (same UID and version).

**Calibration Laboratory of
Schmid & Partner
Engineering AG**
Zeughausstrasse 43, 8004 Zurich, Switzerland

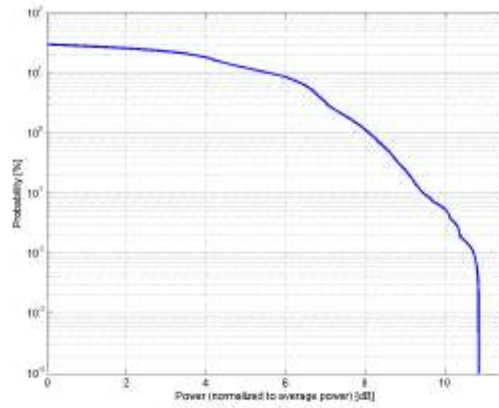

Complementary Cumulative Distribution Function (CCDF)

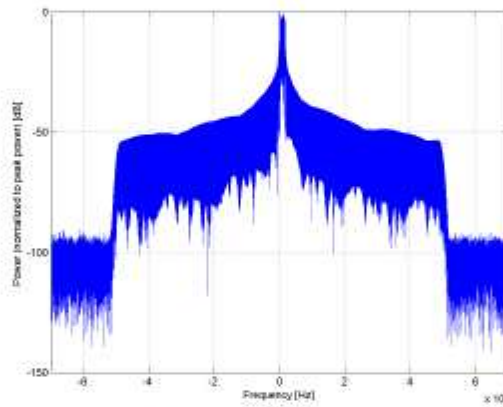

Frequency Domain

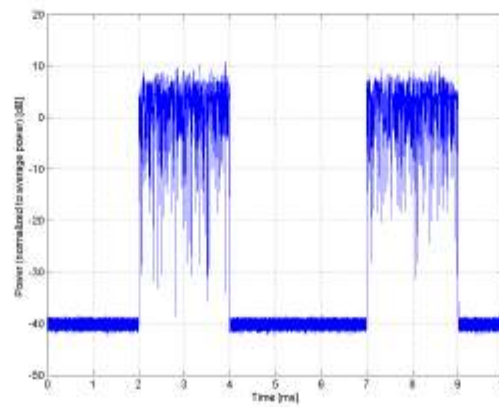

Time Domain

**Calibration Laboratory of
Schmid & Partner
Engineering AG**
Zeughausstrasse 43, 8004 Zurich, Switzerland

Name:	LTE-TDD (SC-FDMA, 1 RB, 20 MHz, 16-QAM)
Group:	LTE-TDD
UID:	10173-CAH
PAR:¹	9.48 dB
MIF:²	-1.44 dB
Standard Reference:	3GPP / ETSI TS 136.101 V8.4.0 3GPP / ETSI TS 136.213 V8.4.0 FCC OET KDB 941225 D05 SAR for LTE Devices v02
Category:	Random amplitude modulation
Modulation:	16-QAM
Frequency Band:	Band 33 (1900.0 - 1920.0 MHz) Band 35 (1850.0 - 1910.0 MHz) Band 36 (1930.0 - 1990.0 MHz) Band 37 (1910.0 - 1930.0 MHz) Band 38 (2570.0 - 2620.0 MHz) Band 39 (1880.0 - 1920.0 MHz) Band 40 (2300.0 - 2400.0 MHz) Band 41 (2496.0 - 2690.0 MHz) Band 42 (3400.0 - 3600.0 MHz) Band 43 (3600.0 - 3800.0 MHz) Band 44 (703.0 - 803.0 MHz) Band 45 (1447.0 - 1467.0 MHz) Band 46 (5150.0 - 5925.0 MHz) Band 47 (5855.0 - 5925.0 MHz) Band 48 (3550.0 - 3700.0 MHz) Band 49 (3550.0 - 3700.0 MHz) Band 50 (1432.0 - 1517.0 MHz) Band 52 (3300.0 - 3400.0 MHz) Validation band (0.0 - 6000.0 MHz)
Detailed Specification:	Modulation Scheme: SC-FDMA Uplink-downlink configuration: 1 Special Subframe configuration: 4 Number of Frames: 1 Settings for UL Subframe 2,3,7,8: Number of PUSCHs: 1 Modulation Scheme: 16QAM Allocated RB: 1 Start Number of RB: 50 Data Type: PNG6e
Bandwidth:	20.0 MHz
Integration Time:	8.0 ms

¹ PAR (0.1%) in accordance with FCC KDB 971168, Section 6.0 "Measurement of the Peak-to-Average Power Ratio (PAR)"
² Modulation Interference Factor (MIF) value valid only in conjunction with advanced probe response linearization calibration for the same communication system (same UID and version).

**Calibration Laboratory of
Schmid & Partner
Engineering AG**
Zeughausstrasse 43, 8004 Zurich, Switzerland

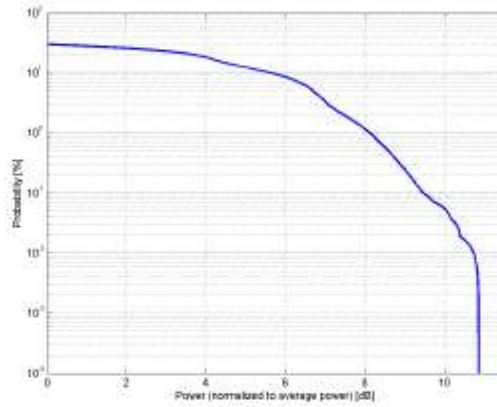

Complementary Cumulative Distribution Function (CCDF)

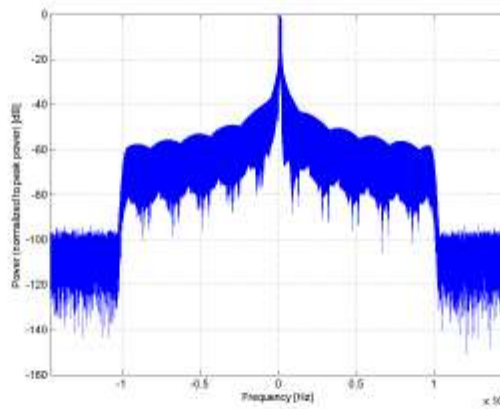

Frequency Domain

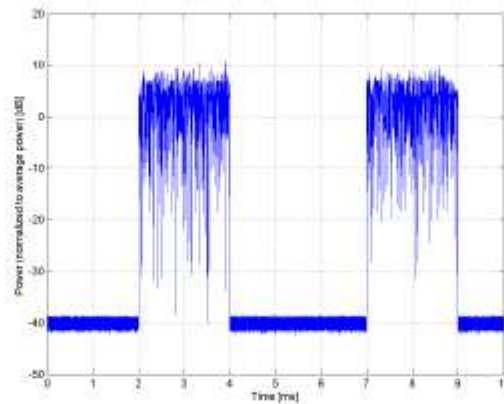

Time Domain

**Calibration Laboratory of
Schmid & Partner
Engineering AG**
Zeughausstrasse 43, 8004 Zurich, Switzerland

Name:	IEEE 802.11b WiFi 2.4 GHz (DSSS, 11 Mbps)
Group:	WLAN
UID:	10061-CAB
PAR: ¹	3.60 dB
MIF: ²	-2.02 dB
Standard Reference:	IEEE 802.11b-1999 , Part 11, FCC SAR meas for 802 11 a b g v01r02 (248227 D01)
Category:	Random amplitude modulation
Modulation:	DQPSK
Frequency Band:	WLAN 2.4GHz (2412.0-2484.0 MHz, 20230)
Detailed Specification:	Data Rate: 11 Mbps Spreading, Coding: CCK PPDU format: Long Preamble & Heading PSDU Length: 1024
Bandwidth:	PSDU Data: PN9 20.0 MHz
Integration Time:	1.5 ms

¹ PAR (0.1%) in accordance with FCC KDB 971168, Section 6.0 "Measurement of the Peak-to-Average Power Ratio (PAR)"
² Modulation Interference Factor (MIF) value valid only in conjunction with advanced probe response linearization calibration for the same communication system (same UID and version).

**Calibration Laboratory of
Schmid & Partner
Engineering AG**
Zeughausstrasse 43, 8004 Zurich, Switzerland

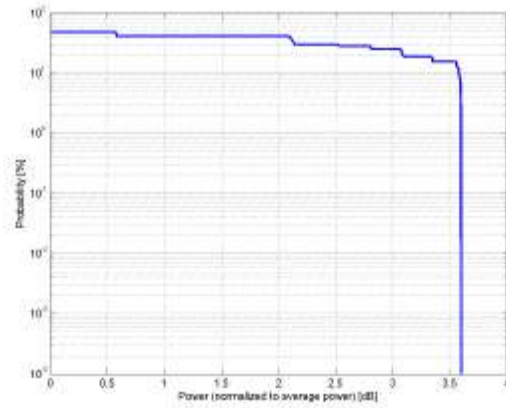

Complementary Cumulative Distribution Function (CCDF)

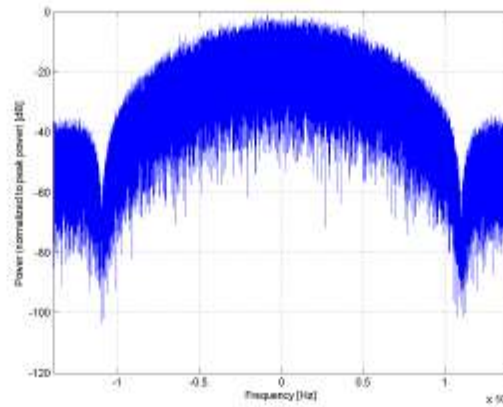

Frequency Domain

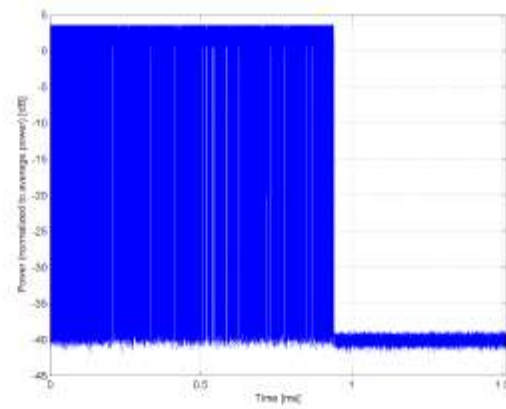

Time Domain

**Calibration Laboratory of
Schmid & Partner
Engineering AG**
Zeughausstrasse 43, 8004 Zurich, Switzerland

Name:	IEEE 802.11g WiFi 2.4 GHz (DSSS/OFDM, 54 Mbps)
Group:	WLAN
UID:	10077-CAB
PAR: ¹	11.00 dB
MIF: ²	0.12 dB
Standard Reference:	IEEE 802.11g-2003 , Part 11 FCC SAR meas for 802 11 a b g v01r02 (248227 D01)
Category:	Random amplitude modulation
Modulation:	64-QAM
Frequency Band:	WLAN 2.4GHz (2412.0-2484.0 MHz, 20230)
Detailed Specification:	Data Rate: 54 Mbps Coding Rate: 3/4 Coded bits per subcarrier: 6 Coded bits per OFDM symbol: 288 Data bits per OFDM symbol: 216 PSDU Length: 1000 Bytes PSDU Data: PN9
Bandwidth:	20.0 MHz
Integration Time:	0.9 ms

¹ PAR (0.1%) in accordance with FCC KDB 971168, Section 6.0 "Measurement of the Peak-to-Average Power Ratio (PAPR)"
² Modulation Interference Factor (MIF) value valid only in conjunction with advanced probe response linearization calibration for the same communication system (same UID and version).

**Calibration Laboratory of
Schmid & Partner
Engineering AG**
Zeughausstrasse 43, 8004 Zurich, Switzerland

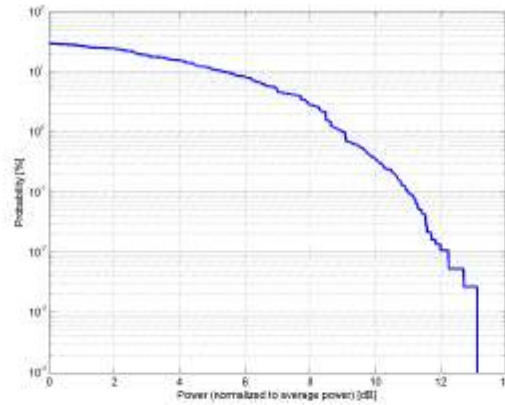

Complementary Cumulative Distribution Function (CCDF)

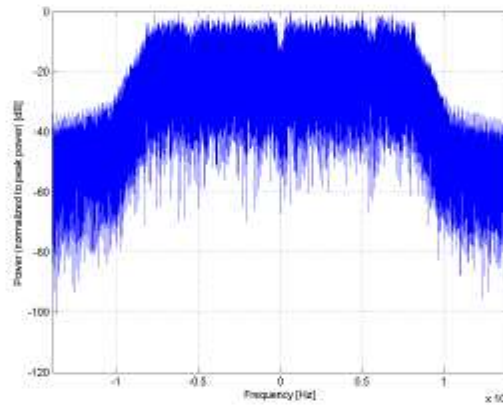

Frequency Domain

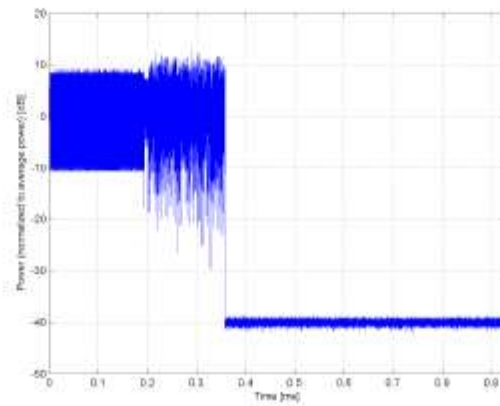

Time Domain

**Calibration Laboratory of
Schmid & Partner
Engineering AG**
Zeughausstrasse 43, 8004 Zurich, Switzerland

Name:	IEEE 802.11a/h WIFI 5 GHz (OFDM, 54 Mbps)
Group:	WLAN
UID:	10069-CAD
PAR: ¹	10.56 dB
MIF: ²	-3.15 dB
Standard Reference:	IEEE 802.11a-1999 (R2003) , Part 11 IEEE 802.11h-2003 , Part 11 FCC SAR meas for 802.11 a b g v01r02 (248227 D01)
Category:	Random amplitude modulation
Modulation:	64-QAM
Frequency Band:	WLAN 5GHz (4915.0 - 5825.0 MHz) U-NII-1, U-NII-2A (5170 - 5330 MHz) U-NII-2C Standalone (5490 - 5710 MHz) U-NII-2C <:5.85 GHz (5490 - 5850 MHz) U-NII-3 Standalone (5735 - 5835 MHz) U-NII-2C, U-NII-3 (5650 - 5835 MHz) U-NII-4 (5.825 - 5.925 MHz) Validation band (0.0 - 6000.0 MHz)
Detailed Specification:	Data Rate: 54 Mbps Coding Rate: 3/4 Coded bits per subcarrier: 6 Coded bits per OFDM symbol: 288 Data bits per OFDM symbol: 216 PSDU Length: 1000 Bytes PSDU Data: PNG
Bandwidth:	20.0 MHz
Integration Time:	0.3ms

¹ PAR (0.1%) in accordance with FCC KDB 971168, Section 6.0 "Measurement of the Peak-to-Average Power Ratio (PAPR)"
² Modulation Interference Factor (MIF) value valid only in conjunction with advanced probe response linearization calibration for the same communication system (same UID and version).

**Calibration Laboratory of
Schmid & Partner
Engineering AG**
Zeughausstrasse 43, 8004 Zurich, Switzerland

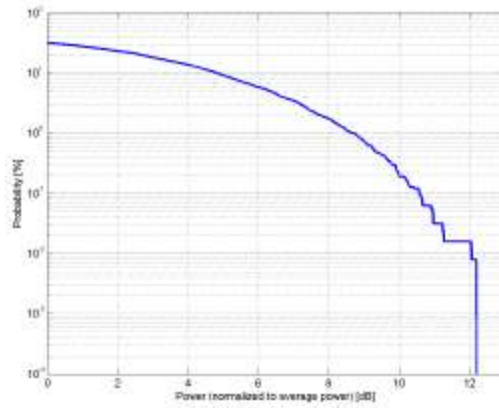

Complementary Cumulative Distribution Function (CCDF)

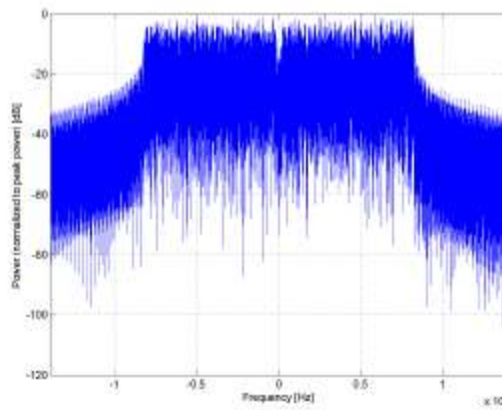

Frequency Domain

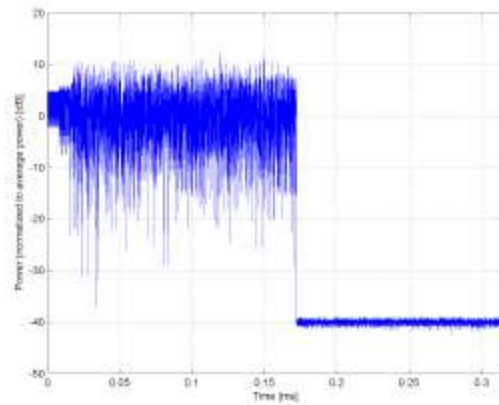

Time Domain

**Calibration Laboratory of
Schmid & Partner
Engineering AG**
Zeughausstrasse 43, 8004 Zurich, Switzerland

Name:	IEEE 802.11n (HT Mixed, 20MHz, MCS0, 90pc duty cycle)
Group:	WLAN
UID:	10591-AAC
PAR: ¹	0.63 dB
MIF: ²	-5.59 dB
Standard Reference:	IEEE 802.11-2012 FCC OET KDB 248227 D01 802.11 Wi-Fi SAR v02r01
Category:	Random amplitude modulation
Modulation:	BPSK
Frequency Band:	WLAN 2.4GHz (2412.0 - 2484.0 MHz) WLAN 5GHz (4915.0 - 5825.0 MHz) U-NII-1, U-NII-2A (5170 - 5330 MHz) U-NII-2C Standalone (5490 - 5710 MHz) U-NII-2C <5.85 GHz (5490 - 5650 MHz) U-NII-3 Standalone (5735 - 5835 MHz) U-NII-2C, U-NII-3 (5650 - 5835 MHz) U-NII-4 (5.825 - 5.925 MHz) Validation band (0.0 - 6000.0 MHz)
Detailed Specification:	Duty cycle: 90% MPDU length: 4096 bytes MCS: 0 Guard interval: long
Bandwidth:	20.0 MHz
Integration Time:	5.6 ms

¹ PAR (0.1%) in accordance with FCC KDB 971168, Section 6.0 "Measurement of the Peak-to-Average Power Ratio (PAR)"
² Modulation Interference Factor (MIF) value valid only in conjunction with advanced probe response linearization calibration for the same communication system (same UID and version).

**Calibration Laboratory of
Schmid & Partner
Engineering AG**
Zeughausstrasse 43, 8004 Zurich, Switzerland

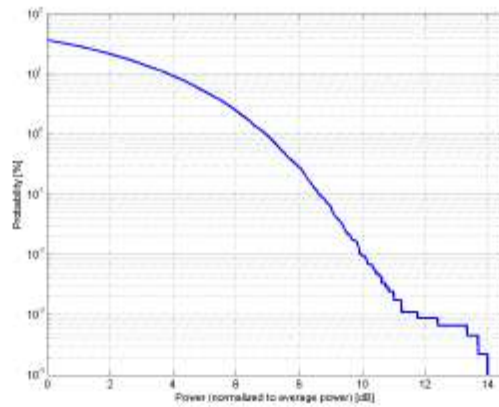

Complementary Cumulative Distribution Function (CCDF)

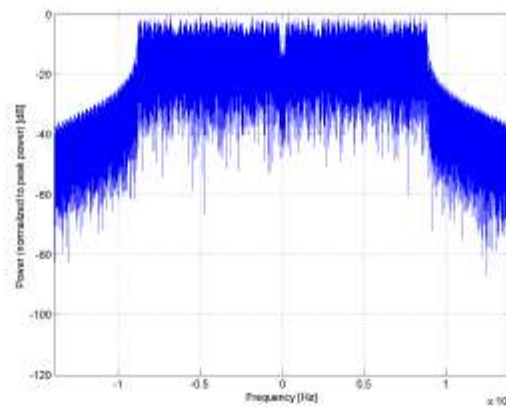

Frequency Domain

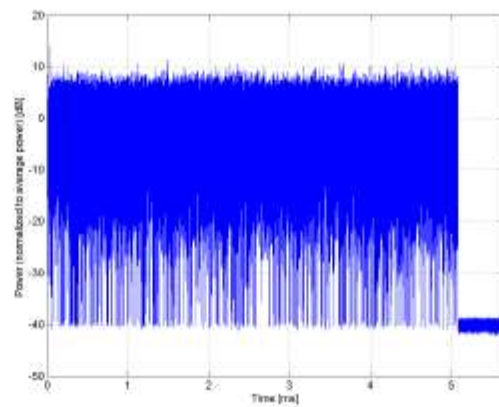

Time Domain

**Calibration Laboratory of
Schmid & Partner
Engineering AG**
Zeughausstrasse 43, 8004 Zurich, Switzerland

Name:	IEEE 802.11ac WIFI (20MHz, MCS0, 90pc duty cycle)
Group:	WLAN
UID:	10607-AAC
PAR: ¹	8.64 dB
MIF: ²	-5.60 dB
Standard Reference:	IEEE 802.11-2013 FCC OET KDB 248227 D01 802.11 Wi-Fi SAR v02r01
Category:	Random amplitude modulation
Modulation:	BPSK
Frequency Band:	WLAN 2.4GHz (2412.0 - 2484.0 MHz) WLAN 5GHz (4916.0 - 5825.0 MHz) U-NII-1, U-NII-2A (5170 - 5330 MHz) U-NII-2C Standalone (5490 - 5710 MHz) U-NII-2C <-5.85 GHz (5490 - 5850 MHz) U-NII-3 Standalone (5735 - 5835 MHz) U-NII-2C, U-NII-3 (5860 - 5835 MHz) U-NII-4 (5.825 - 5.925 MHz) Validation band (0.0 - 6000.0 MHz)
Detailed Specification:	Bandwidth: 20MHz Duty cycle: 90% MCS: 0 Number of spatial streams: 1 MPDU length: 4096
Bandwidth:	20.0 MHz
Integration Time:	5.7 ms

¹ PAR (0.1%) in accordance with FCC KDB 971168, Section 6.0 "Measurement of the Peak-to-Average Power Ratio (PAR)"
² Modulation Interference Factor (MIF) value valid only in conjunction with advanced probe response linearization calibration for the same communication system (same UID and version).

**Calibration Laboratory of
Schmid & Partner
Engineering AG**
Zeughausstrasse 43, 8004 Zurich, Switzerland

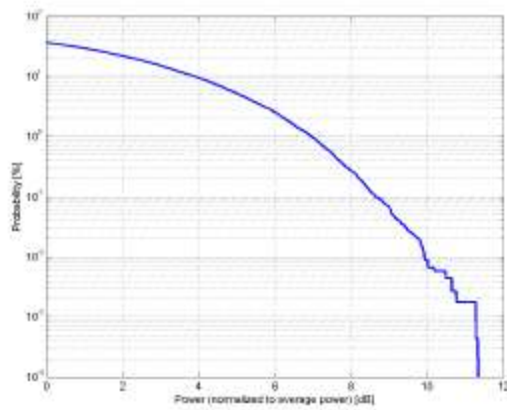

Complementary Cumulative Distribution Function (CCDF)

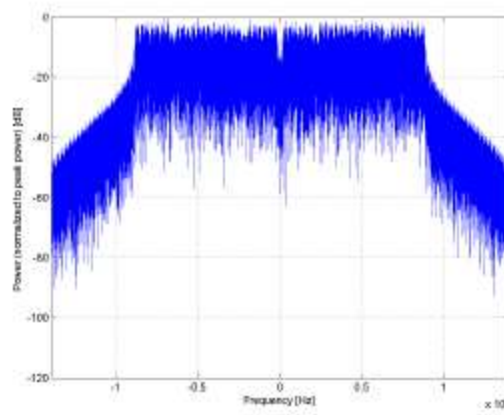

Frequency Domain

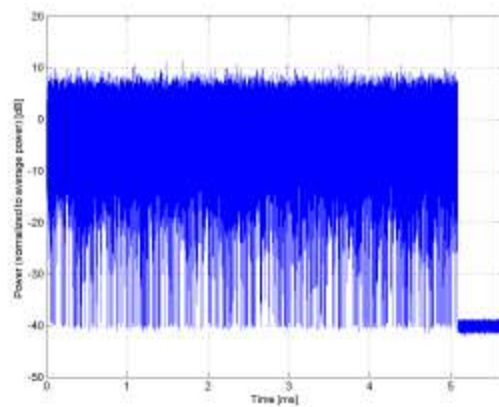

Time Domain

**Calibration Laboratory of
Schmid & Partner
Engineering AG**
Zeughausstrasse 43, 8004 Zurich, Switzerland

Name:	IEEE 802.11ac WIFI (40MHz, MCS0, 90pc duty cycle)
Group:	WLAN
UID:	10616-AAC
PAR: ¹	8.82 dB
MIF: ²	-5.57 dB
Standard Reference:	IEEE 802.11-2013 FCC OET KDB 248227 D01 802.11 Wi-Fi SAR v02r01
Category:	Random amplitude modulation
Modulation:	BPSK
Frequency Band:	WLAN 2.4GHz (2412.0 - 2484.0 MHz) WLAN 5GHz (4915.0 - 5825.0 MHz) U-NII-1, U-NII-2A (5170 - 5330 MHz) U-NII-2C Standalone (5490 - 5710 MHz) U-NII-2C <-5.85 GHz (5490 - 5850 MHz) U-NII-3 Standalone (5735 - 5835 MHz) U-NII-2C, U-NII-3 (5850 - 5835 MHz) U-NII-4 (5.825 - 5.925 MHz) Validation band (0.0 - 6000.0 MHz)
Detailed Specification:	Bandwidth: 40MHz Duty cycle: 90% MCS: 0 Number of spatial streams: 1 MPDU length: 8192
Bandwidth:	40.0 MHz
Integration Time:	5.4 ms

¹ PAR (0.1%) in accordance with FCC KDB 971168, Section 6.0 "Measurement of the Peak-to-Average Power Ratio (PAR)"
² Modulation Interference Factor (MIF) value valid only in conjunction with advanced probe response linearization calibration for the same communication system (same UID and version).

**Calibration Laboratory of
Schmid & Partner
Engineering AG**
Zeughausstrasse 43, 8004 Zurich, Switzerland

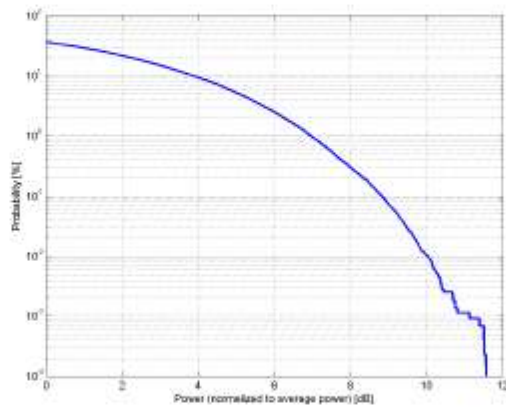

Complementary Cumulative Distribution Function (CCDF)

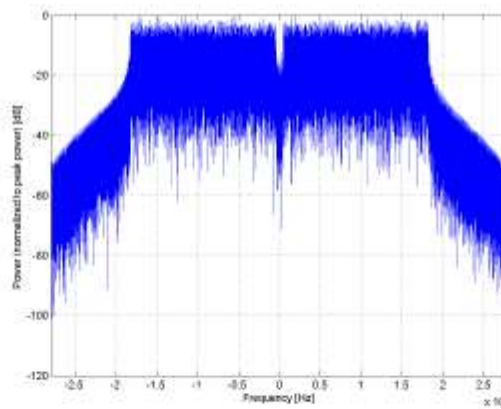

Frequency Domain

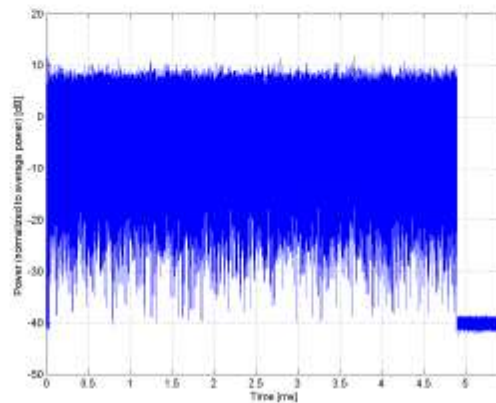

Time Domain

**Calibration Laboratory of
Schmid & Partner
Engineering AG**
Zeughausstrasse 43, 8004 Zurich, Switzerland

Name:	IEEE 802.11ac WiFi (80MHz, MCS0, 90pc duty cycle)
Group:	WLAN
UID:	10626-AAC
PAR: ¹	8.83 dB
MIF: ²	-5.64 dB
Standard Reference:	IEEE 802.11-2013 FCC OET KDB 248227 D01 802.11 Wi-Fi SAR v02r01
Category:	Random amplitude modulation
Modulation:	BPSK
Frequency Band:	WLAN 2.4GHz (2412.0 - 2484.0 MHz) WLAN 5GHz (4915.0 - 5825.0 MHz) U-NII-1, U-NII-2A (5170 - 5330 MHz) U-NII-2C Standalone (5490 - 5710 MHz) U-NII-2C <5.85 GHz (5490 - 5850 MHz) U-NII-3 Standalone (5735 - 5835 MHz) U-NII-2C, U-NII-3 (5650 - 5835 MHz) U-NII-4 (5.825 - 5.925 MHz) Validation band (0.0 - 6000.0 MHz)
Detailed Specification:	Bandwidth: 80MHz Duty cycle: 90% MCS: 0 Number of spatial streams: 1 MPDU length: 8192
Bandwidth:	80.0 MHz
Integration Time:	2.5 ms

¹ PAR (0.1%) in accordance with FCC KDB 971168, Section 6.0 "Measurement of the Peak-to-Average Power Ratio (PAR)"
² Modulation Interference Factor (MIF) value valid only in conjunction with advanced probe response linearization calibration for the same communication system (same UID and version).

**Calibration Laboratory of
Schmid & Partner
Engineering AG**
Zeughausstrasse 43, 8004 Zurich, Switzerland

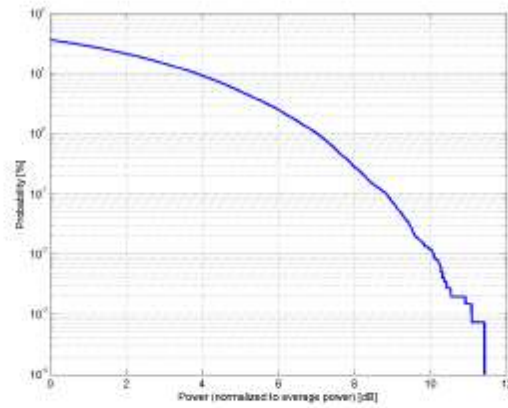

Complementary Cumulative Distribution Function (CCDF)

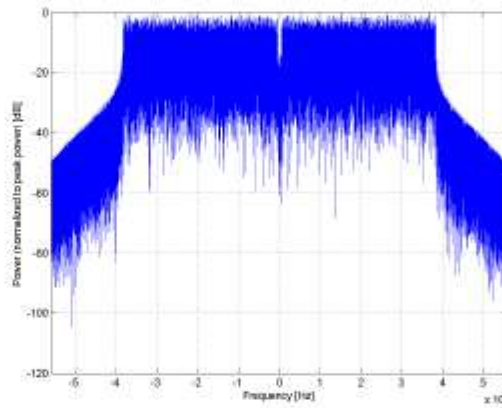

Frequency Domain

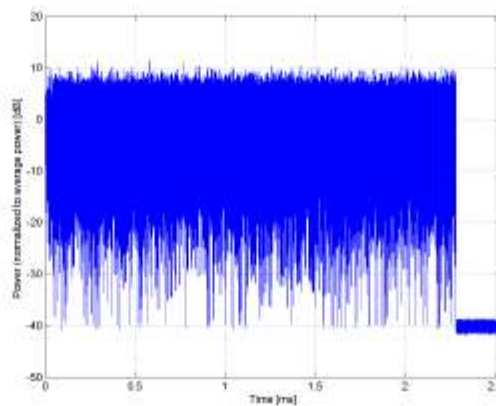

Time Domain

**Calibration Laboratory of
Schmid & Partner
Engineering AG**
Zeughausstrasse 43, 8004 Zurich, Switzerland

Name:	IEEE 802.11ac WiFi (160MHz, MCS0, 90pc duty cycle)
Group:	WLAN
UID:	10636-AAD
PAR: ¹	8.83 dB
MIF: ²	-5.56 dB
Standard Reference:	IEEE 802.11-2013 FCC OET KDB 248227 D01 802.11 Wi-Fi SAR v02r01
Category:	Random amplitude modulation
Modulation:	BPSK
Frequency Band:	WLAN 2.4GHz (2412.0 - 2484.0 MHz) WLAN 5GHz (4915.0 - 5825.0 MHz) U-NII-1, U-NII-2A (5170 - 5330 MHz) U-NII-2C Standalone (5490 - 5710 MHz) U-NII-2C < 5.65 GHz (5490 - 5650 MHz) U-NII-3 Standalone (5735 - 5835 MHz) U-NII-2C, U-NII-3 (5650 - 5835 MHz) U-NII-4 (5.825 - 5.925 MHz) Validation band (0.0 - 6000.0 MHz)
Detailed Specification:	Bandwidth: 160MHz Duty cycle: 90% MCS: 0 Number of spatial streams: 1 MPDU length: 32768
Bandwidth:	160.0 MHz
Integration Time:	5.0 ms

¹ PAR (0.1%) in accordance with FCC KDB 971168, Section 6.0 "Measurement of the Peak-to-Average Power Ratio (PAPR)"
² Modulation Interference Factor (MIF) value valid only in conjunction with advanced probe response linearization calibration for the same communication system (same UID and version).

**Calibration Laboratory of
Schmid & Partner
Engineering AG**
Zeughausstrasse 43, 8004 Zurich, Switzerland

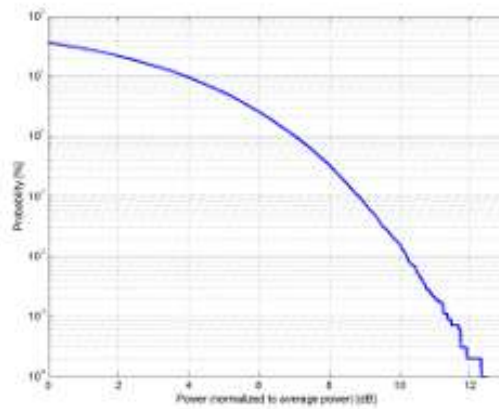

Complementary Cumulative Distribution Function (CCDF)

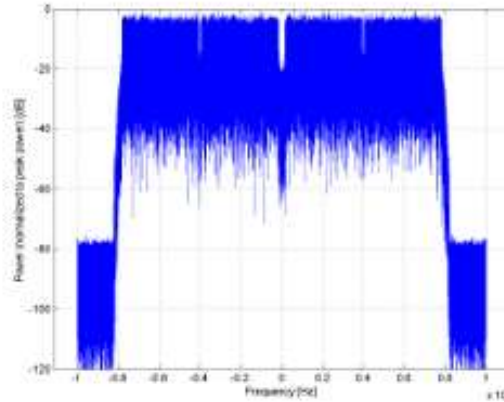

Frequency Domain

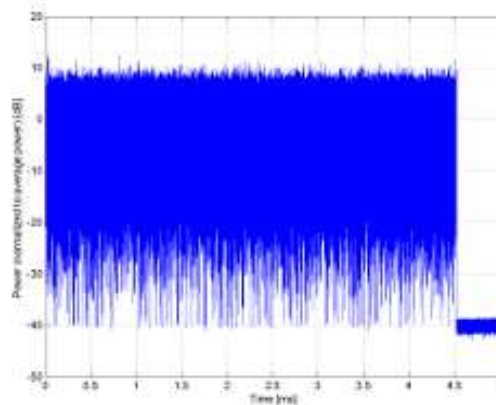

Time Domain

**Calibration Laboratory of
Schmid & Partner
Engineering AG**
Zeughausstrasse 43, 8004 Zurich, Switzerland

Name:	IEEE 802.11ax (20MHz, MCS0, 90pc duty cycle)
Group:	WLAN
UID:	10671-AAC
PAR: ¹	9.09 dB
MIF: ²	-5.58 dB
Standard Reference:	SPEAG
Category:	Random amplitude modulation
Modulation:	BPSK
Frequency Band:	WLAN 2.4GHz (2412.0 - 2484.0 MHz) WLAN 5GHz (4915.0 - 5825.0 MHz) U-NII-1, U-NII-2A (5170 - 5330 MHz) U-NII-2C Standalone (5490 - 5710 MHz) U-NII-2C <5.85 GHz (5490 - 5850 MHz) U-NII-3 Standalone (5735 - 5835 MHz) U-NII-2C, U-NII-3 (5860 - 5835 MHz) U-NII-5 (5925 - 6425 MHz) U-NII-6 (6425 - 6525 MHz) U-NII-7 (6525 - 6875 MHz) U-NII-8 (6875 - 7125 MHz) U-NII-4 (5.825 - 5.925 MHz) Validation band (0.0 - 6000.0 MHz)
Detailed Specification:	Bandwidth: 20MHz Duty Cycle: 90% Number of spatial stream: 1
Bandwidth:	20.0MHz
Integration Time:	5.0ms

¹ PAR (0.1%) in accordance with FCC KDB 971168, Section 6.0 "Measurement of the Peak-to-Average Power Ratio (PAPR)"
² Modulation Interference Factor (MIF) value valid only in conjunction with advanced probe response linearization calibration for the same communication system (same UID and version).

**Calibration Laboratory of
Schmid & Partner
Engineering AG**
Zeughausstrasse 43, 8004 Zurich, Switzerland

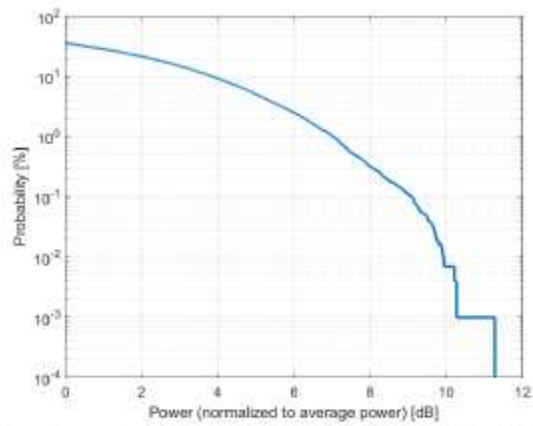

Complementary Cumulative Distribution Function (CCDF)

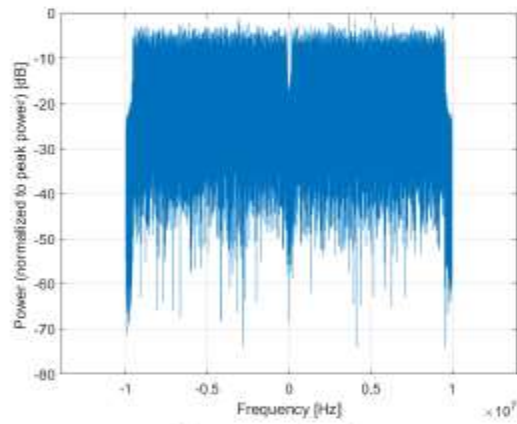

Frequency Domain

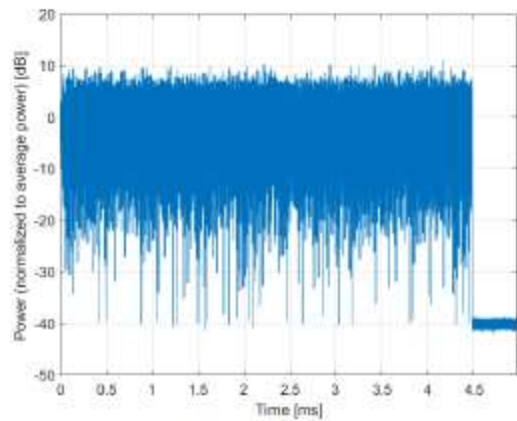

Time Domain

**Calibration Laboratory of
Schmid & Partner
Engineering AG**
Zeughausstrasse 43, 8004 Zurich, Switzerland

Name:	IEEE 802.11ax (40MHz, MCS0, 90pc duty cycle)
Group:	WLAN
UID:	10695-AAC
FAR: ¹	8.78 dB
MIF: ²	-6.01 dB
Standard Reference:	SPEAG
Category:	Random amplitude modulation
Modulation:	BPSK
Frequency Band:	WLAN 2.4GHz (2412.0 - 2484.0 MHz) WLAN 5GHz (4915.0 - 5925.0 MHz) U-NII-1, U-NII-2A (5170 - 5330 MHz) U-NII-2C Standalone (5490 - 5710 MHz) U-NII-2C < 5.65 GHz (5490 - 5650 MHz) U-NII-3 Standalone (5735 - 5835 MHz) U-NII-2C, U-NII-3 (5650 - 5835 MHz) U-NII-5 (5925 - 6425 MHz) U-NII-6 (6425 - 6525 MHz) U-NII-7 (6525 - 6875 MHz) U-NII-8 (6875 - 7125 MHz) U-NII-4 (5.825 - 5.925 MHz) Validation band (0.0 - 6000.0 MHz)
Detailed Specification:	Bandwidth: 40MHz Duty Cycle: 90% Number of spatial stream: 1
Bandwidth:	40.0MHz
Integration Time:	1.4 ms

¹ FAR (0.1%) in accordance with FCC KDB 971168, Section 6.0 "Measurement of the Peak-to-Average Power Ratio (FAPR)"
² Modulation Interference Factor (MIF) value valid only in conjunction with advanced probe response linearization calibration for the same communication system (same UID and version).

**Calibration Laboratory of
Schmid & Partner
Engineering AG**
Zeughausstrasse 43, 8004 Zurich, Switzerland

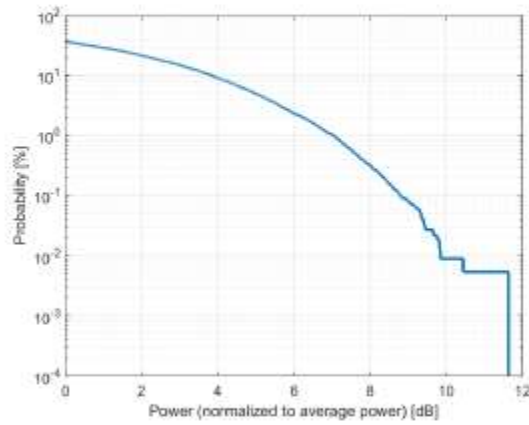

Complementary Cumulative Distribution Function (CCDF)

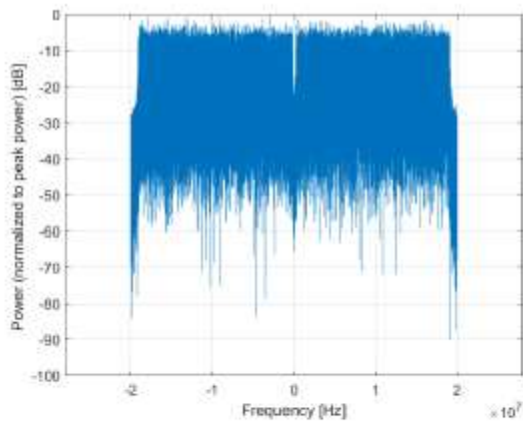

Frequency Domain

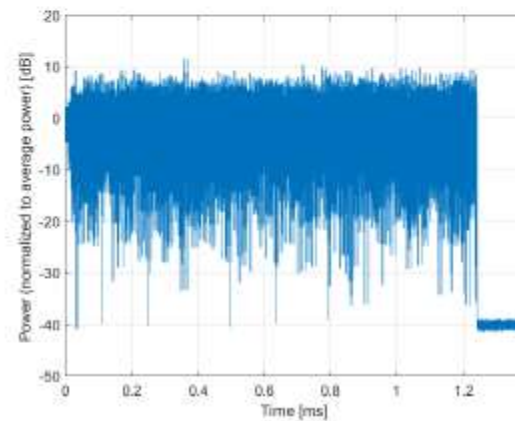

Time Domain

**Calibration Laboratory of
Schmid & Partner
Engineering AG**
Zeughausstrasse 43, 8004 Zurich, Switzerland

Name:	IEEE 802.11ax (80MHz, MCS0, 90pc duty cycle)
Group:	WLAN
UID:	10719-AAC
PAR: ¹	8.61 dB
MIF: ²	-6.04 dB
Standard Reference:	SPEAG
Category:	Random amplitude modulation
Modulation:	BPSK
Frequency Band:	WLAN 2.4GHz (2412.0 - 2484.0 MHz) WLAN 5GHz (4915.0 - 5825.0 MHz) U-NII-1, U-NII-2A (5170 - 5330 MHz) U-NII-2C Standalone (5490 - 5710 MHz) U-NII-2C <5.65 GHz (5490 - 5650 MHz) U-NII-3 Standalone (5735 - 5835 MHz) U-NII-2C, U-NII-3 (5850 - 5835 MHz) U-NII-5 (5925 - 6425 MHz) U-NII-6 (6425 - 6525 MHz) U-NII-7 (6525 - 6875 MHz) U-NII-8 (6875 - 7125 MHz) U-NII-4 (5.825 - 5.925 MHz) Validation band (0.0 - 6000.0 MHz)
Detailed Specification:	Bandwidth: 80MHz Duty Cycle: 90% Number of spatial stream: 1
Bandwidth:	80.0 MHz
Integration Time:	1.5 ms

¹ PAR (0.1%) in accordance with FCC KDB 971168, Section 6.0 "Measurement of the Peak-to-Average Power Ratio (PAR)"
² Modulation Interference Factor (MIF) value valid only in conjunction with advanced probe response linearization calibration for the same communication system (same UID and version).

**Calibration Laboratory of
Schmid & Partner
Engineering AG**
Zeughausstrasse 43, 8004 Zurich, Switzerland

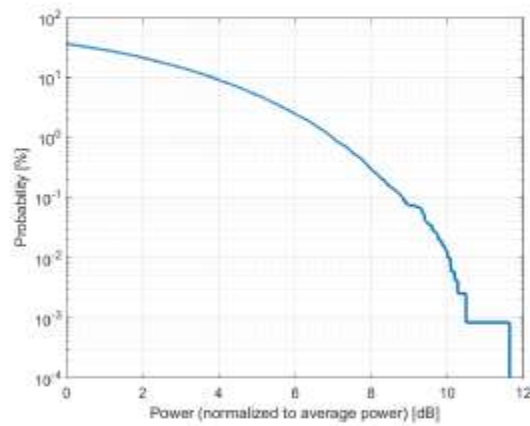

Complementary Cumulative Distribution Function (CCDF)

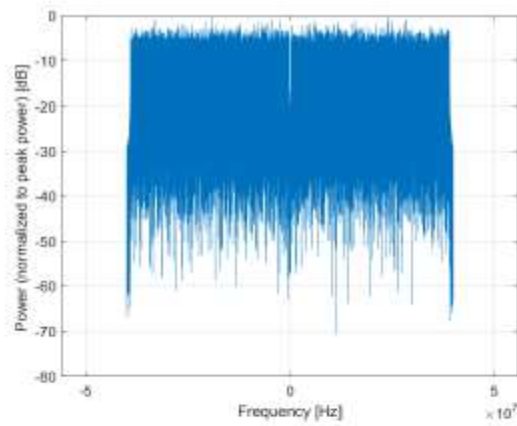

Frequency Domain

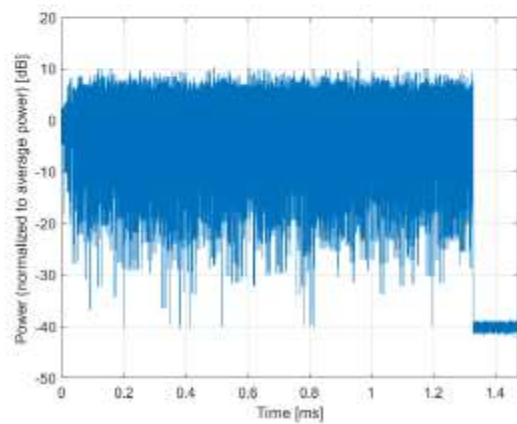

Time Domain

**Calibration Laboratory of
Schmid & Partner
Engineering AG**
Zeughausstrasse 43, 8004 Zurich, Switzerland

Name:	IEEE 802.11ax (160MHz, MCS0, 90pc duty cycle)
Group:	WLAN
UID:	10743-AAC
PAR: ¹	8.94 dB
MIF: ²	-6.60 dB
Standard Reference:	SPEAG
Category:	Random amplitude modulation
Modulation:	BPSK
Frequency Band:	WLAN 2.4GHz (2412.0 - 2484.0 MHz) WLAN 5GHz (4915.0 - 5825.0 MHz) U-NII-1, U-NII-2A (5170 - 5330 MHz) U-NII-2C Standalone (5490 - 5710 MHz) U-NII-2C <5.65 GHz (5490 - 5650 MHz) U-NII-3 Standalone (5735 - 5835 MHz) U-NII-2C, U-NII-3 (5650 - 5835 MHz) U-NII-5 (5925 - 6425 MHz) U-NII-6 (6425 - 6525 MHz) U-NII-7 (6525 - 6875 MHz) U-NII-8 (6875 - 7125 MHz) U-NII-4 (5.825 - 5.925 MHz) Validation band (0.0 - 6000.0 MHz)
Detailed Specification:	Bandwidth: 160MHz Duty Cycle: 90% Number of spatial stream: 1
Bandwidth:	160.0 MHz
Integration Time:	0.9 ms

¹ PAR (0.1%) in accordance with FCC KDB 971168, Section 6.0 "Measurement of the Peak-to-Average Power Ratio (PAPR)"
² Modulation Interference Factor (MIF) value valid only in conjunction with advanced probe response linearization calibration for the same communication system (same UID and version).

**Calibration Laboratory of
Schmid & Partner
Engineering AG**
Zeughausstrasse 43, 8004 Zurich, Switzerland

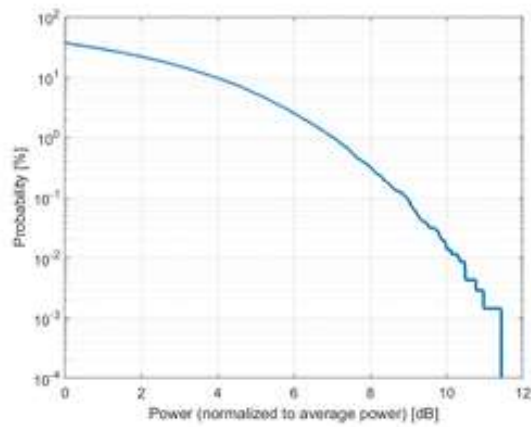

Complementary Cumulative Distribution Function (CCDF)

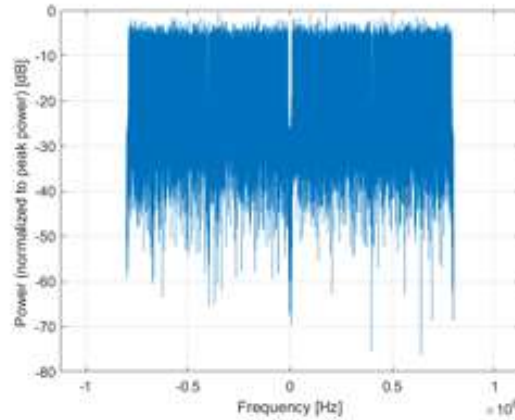

Frequency Domain

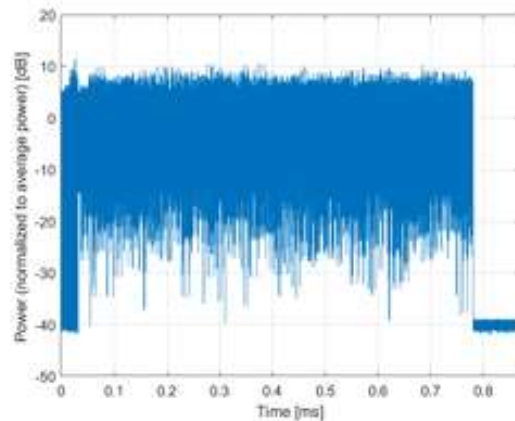

Time Domain

**Calibration Laboratory of
Schmid & Partner
Engineering AG**
Zeughausstrasse 43, 8004 Zurich, Switzerland

Name:	5G NR (DFT-s-OFDM, 1 RB, 10 MHz, QPSK, 15 kHz)
Group:	5G NR FR1 FDD
UID:	10929-AAC
PAR:¹	5.52 dB
MIF:²	-15.06 dB
Standard Reference:	SPEAG
Category:	Random amplitude modulation
Modulation:	QPSK
Frequency Band:	Band n2 (1850 - 1910 MHz) Band n5 (824 - 849 MHz) Band n25 (1850 - 1915 MHz) Band n66 (1710 - 1780 MHz) Band n71 (863 - 898 MHz) Band n1 (1920 - 1980 MHz) Band n3 (1710 - 1785 MHz) Band n7 (2500 - 2570 MHz) Band n8 (880 - 915 MHz) Band n12 (899 - 716 MHz) Band n14 (788 - 798 MHz) Band n18 (815 - 830 MHz) Band n20 (832 - 862 MHz) Band n26 (814 - 849 MHz) Band n28 (703 - 748 MHz) Band n30 (2305 - 2315 MHz) Band n65 (1920 - 2010 MHz) Band n70 (1695 - 1710 MHz) Band n74 (1427 - 1470 MHz) Band n91 (832 - 862 MHz) Band n92 (832 - 862 MHz) Band n93 (880 - 915 MHz) Band n94 (880 - 915 MHz) Band n80 (1710 - 1785 MHz) Band n81 (880 - 915 MHz) Band n82 (832 - 862 MHz) Band n83 (703 - 748 MHz) Band n84 (1920 - 1980 MHz) Band n86 (1710 - 1780 MHz) Band n89 (824 - 849 MHz) Band n95 (2010 - 2025 MHz) Band n24 (1626.5 - 1660.5 MHz) Band n97 (2300 - 2400 MHz) Band n98 (1880 - 1920 MHz) Band n99 (1626.5 - 1660.5 MHz) Validation band (0.0 - 6000.0 MHz)
Detailed Specification:	Multiplexing Scheme: DFT-s-OFDM Modulation Scheme: QPSK Subcarrier Spacing: 15 kHz Number RBs: 1 Data Type: PNG
Bandwidth:	10.0 MHz
Integration Time:	10.0 ms

¹ PAR (0.1%) in accordance with FCC KDB 971168, Section 6.0 "Measurement of the Peak-to-Average Power Ratio (PAR)"
² Modulation Interference Factor (MIF) value valid only in conjunction with advanced probe response linearization calibration for the same communication system (same UID and version).

**Calibration Laboratory of
Schmid & Partner
Engineering AG**
Zeughausstrasse 43, 8004 Zurich, Switzerland

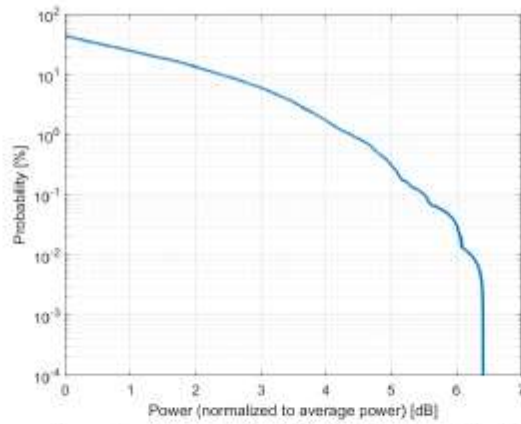

Complementary Cumulative Distribution Function (CCDF)

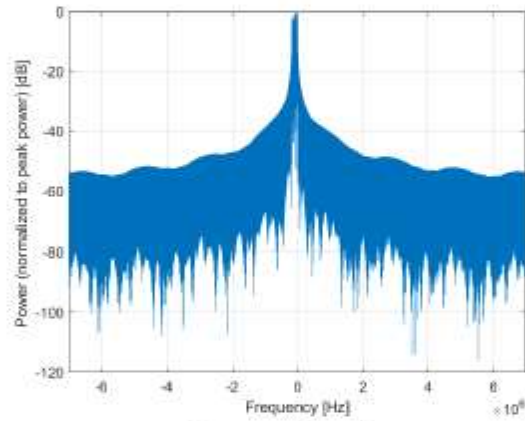

Frequency Domain

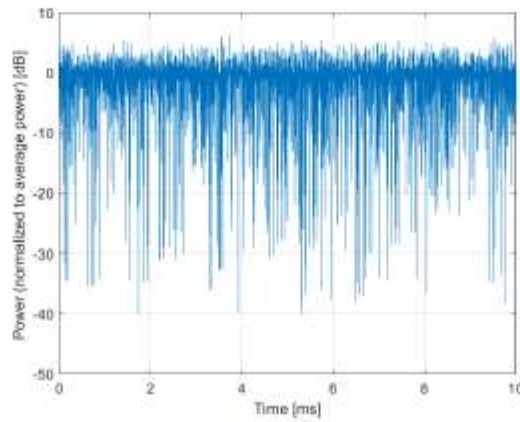

Time Domain

**Calibration Laboratory of
Schmid & Partner
Engineering AG**
Zeughausstrasse 43, 8004 Zurich, Switzerland

Name:	5G NR (DFT-s-OFDM, 1 RB, 15 MHz, QPSK, 15 kHz)
Group:	5G NR FR1 FDD
UID:	10930-AAC
PAR:¹	5.52 dB
MIF:²	-15.06 dB
Standard Reference:	SPEAG
Category:	Random amplitude modulation
Modulation:	QPSK
Frequency Band:	Band n2 (1850 - 1910 MHz) Band n5 (824 - 849 MHz) Band n25 (1850 - 1915 MHz) Band n66 (1710 - 1790 MHz) Band n71 (863 - 698 MHz) Band n1 (1920 - 1980 MHz) Band n3 (1710 - 1785 MHz) Band n7 (2500 - 2570 MHz) Band n8 (880 - 915 MHz) Band n12 (699 - 716 MHz) Band n18 (815 - 830 MHz) Band n20 (832 - 862 MHz) Band n26 (814 - 849 MHz) Band n28 (703 - 748 MHz) Band n65 (1920 - 2010 MHz) Band n70 (1695 - 1710 MHz) Band n74 (1427 - 1470 MHz) Band n92 (832 - 862 MHz) Band n94 (880 - 915 MHz) Band n80 (1710 - 1785 MHz) Band n81 (880 - 915 MHz) Band n82 (832 - 862 MHz) Band n83 (703 - 748 MHz) Band n84 (1920 - 1980 MHz) Band n86 (1710 - 1790 MHz) Band n89 (824 - 849 MHz) Band n95 (2010 - 2025 MHz) Band n97 (2300 - 2400 MHz) Band n98 (1880 - 1920 MHz) Validation band (0.0 - 6000.0 MHz)
Detailed Specification:	Multiplexing Scheme: DFT-s-OFDM Modulation Scheme: QPSK Subcarrier Spacing: 15 kHz Number RBs: 1 Data Type: PN9
Bandwidth:	15.0 MHz
Integration Time:	10.0 ms

¹ PAR (0.1%) in accordance with FCC KDB 971168, Section 6.0 "Measurement of the Peak-to-Average Power Ratio (PAPR)"
² Modulation Interference Factor (MIF) value valid only in conjunction with advanced probe response linearization calibration for the same communication system (same UID and version).

**Calibration Laboratory of
Schmid & Partner
Engineering AG**
Zeughausstrasse 43, 8004 Zurich, Switzerland

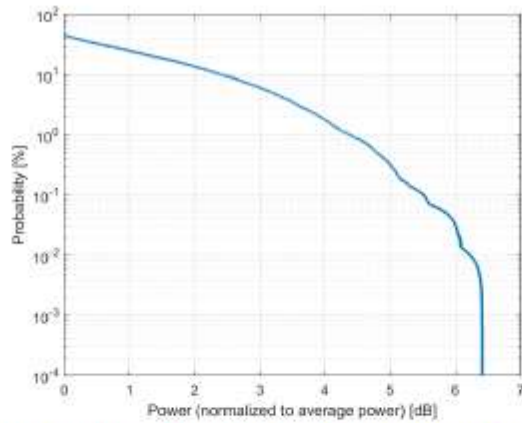

Complementary Cumulative Distribution Function (CCDF)

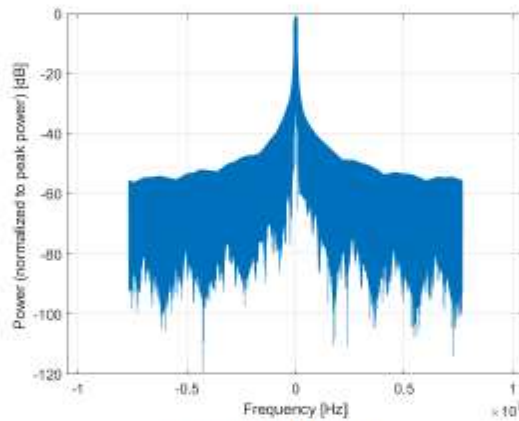

Frequency Domain

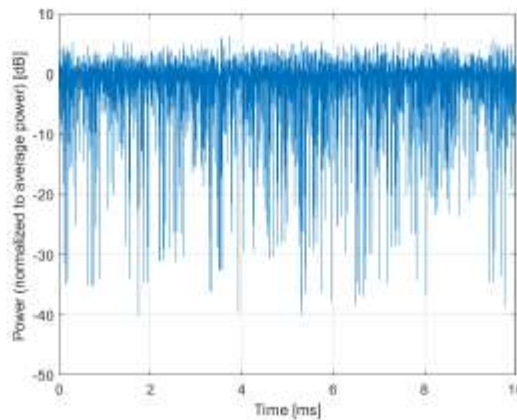

Time Domain

**Calibration Laboratory of
Schmid & Partner
Engineering AG**
Zeughausstrasse 43, 8004 Zurich, Switzerland

Name:	5G NR (DFT-s-OFDM, 1 RB, 20 MHz, QPSK, 15 kHz)
Group:	5G NR FR1 FDD
UID:	10931-AAC
PAR: ¹	5.51 dB
MIF: ²	-15.06 dB
Standard Reference:	SPEAG
Category:	Random amplitude modulation
Modulation:	QPSK
Frequency Band:	Band n2 (1850 - 1910 MHz) Band n5 (824 - 849 MHz) Band n25 (1850 - 1915 MHz) Band n66 (1710 - 1780 MHz) Band n71 (863 - 898 MHz) Band n1 (1920 - 1980 MHz) Band n3 (1710 - 1785 MHz) Band n7 (2500 - 2570 MHz) Band n8 (880 - 915 MHz) Band n20 (832 - 862 MHz) Band n26 (814 - 849 MHz) Band n28 (703 - 748 MHz) Band n65 (1920 - 2010 MHz) Band n74 (1427 - 1470 MHz) Band n92 (832 - 862 MHz) Band n94 (890 - 915 MHz) Band n80 (1710 - 1785 MHz) Band n81 (880 - 915 MHz) Band n82 (832 - 862 MHz) Band n83 (703 - 748 MHz) Band n84 (1920 - 1980 MHz) Band n86 (1710 - 1780 MHz) Band n89 (824 - 849 MHz) Band n97 (2300 - 2400 MHz) Band n98 (1880 - 1920 MHz) Validation band (0.0 - 6000.0 MHz)
Detailed Specification:	Multiplexing Scheme: DFT-s-OFDM Modulation Scheme: QPSK Subcarrier Spacing: 15 kHz Number RBs: 1 Data Type: PNG
Bandwidth:	20.0 MHz
Integration Time:	10.0 ms

¹ PAR (0.1%) in accordance with FCC KDB 971168, Section 6.0 "Measurement of the Peak-to-Average Power Ratio (PAR)"
² Modulation Interference Factor (MIF) value valid only in conjunction with advanced probe response linearization calibration for the same communication system (same UID and version).

**Calibration Laboratory of
Schmid & Partner
Engineering AG**
Zeughausstrasse 43, 8004 Zurich, Switzerland

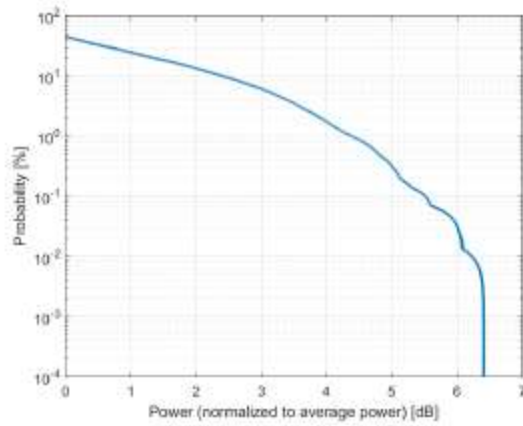

Complementary Cumulative Distribution Function (CCDF)

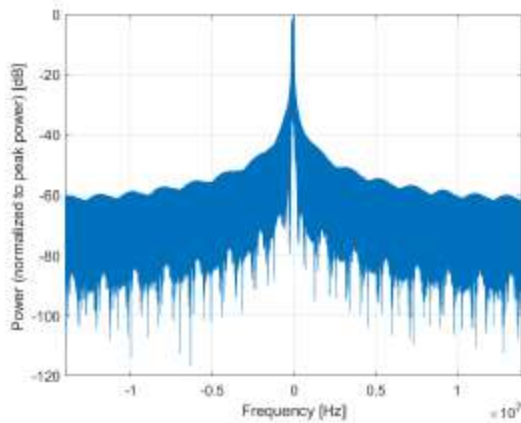

Frequency Domain

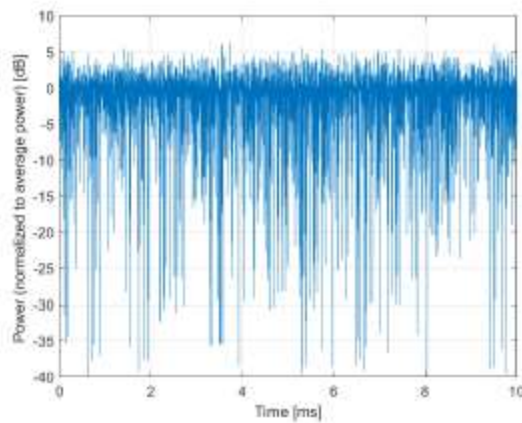

Time Domain

**Calibration Laboratory of
Schmid & Partner
Engineering AG**
Zeughausstrasse 43, 8004 Zurich, Switzerland

Name:	5G NR (DFT-s-OFDM, 1 RB, 40 MHz, QPSK, 15 kHz)
Group:	5G NR FR1 FDD
UID:	10934-AAC
PAR: ¹	5.51 dB
MIF: ²	-15.07 dB
Standard Reference:	SPEAG
Category:	Random amplitude modulation
Modulation:	QPSK
Frequency Band:	Band n25 (1850 - 1915 MHz) Band n66 (1710 - 1780 MHz) Band n1 (1920 - 1980 MHz) Band n3 (1710 - 1785 MHz) Band n7 (2500 - 2570 MHz) Band n96 (1710 - 1780 MHz) Band n97 (2300 - 2400 MHz) Band n98 (1880 - 1920 MHz) Validation band (0.0 - 6000.0 MHz)
Detailed Specification:	Multiplexing Scheme: DFT-s-OFDM Modulation Scheme: QPSK Subcarrier Spacing: 15 kHz Number RBs: 1 Data Type: PN9
Bandwidth:	40.0 MHz
Integration Time:	10.0 ms

¹ PAR (0.1%) in accordance with FCC KDB 971168, Section 6.0 "Measurement of the Peak-to-Average Power Ratio (PAR)"
² Modulation Interference Factor (MIF) value valid only in conjunction with advanced probe response linearization calibration for the same communication system (same UID and version).

**Calibration Laboratory of
Schmid & Partner
Engineering AG**
Zeughausstrasse 43, 8004 Zurich, Switzerland

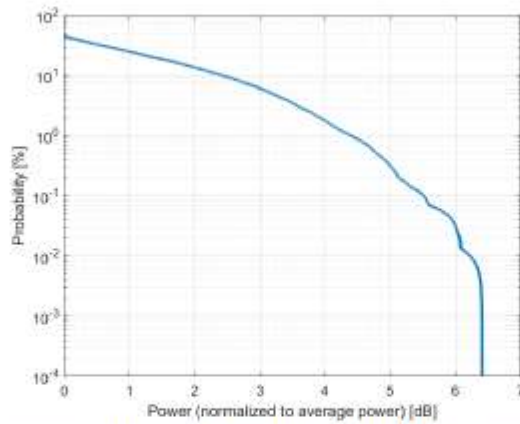

Complementary Cumulative Distribution Function (CCDF)

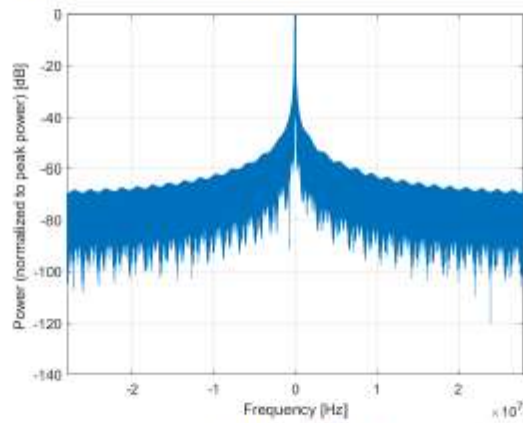

Frequency Domain

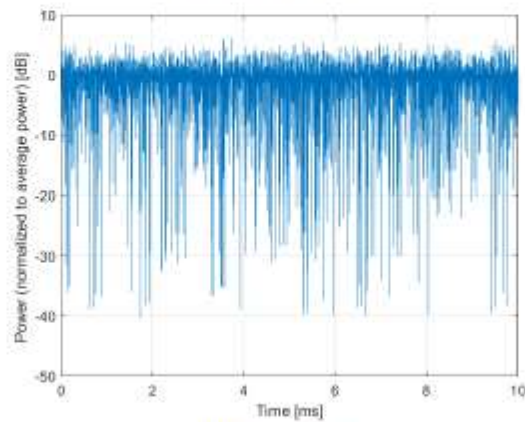

Time Domain

**Calibration Laboratory of
Schmid & Partner
Engineering AG**
Zeughausstrasse 43, 8004 Zurich, Switzerland

Name:	5G NR (DFT-s-OFDM, 1 RB, 100 MHz, QPSK, 30 kHz)
Group:	5G NR FR1 TDD
UID:	10973-AAB
PAR: ¹	9.06 dB
MIF: ²	-1.64 dB
Standard Reference:	SPEAG
Category:	Random amplitude modulation
Modulation:	QPSK
Frequency Band:	Band n41 (2496 - 2690 MHz) Band n48 (3550 - 3700 MHz) Band n77 (3300 - 4200 MHz) Band n78 (3300 - 3800 MHz) Band n79 (4400 - 5000 MHz) Band n90 (2496 - 2690 MHz) Validation band (0.0 - 6000.0 MHz)
Detailed Specification:	Multiplexing Scheme: DFT-s-OFDM Modulation Scheme: QPSK Subcarrier Spacing: 30 kHz Number RBs: 1 Slot Format Index: - Data Type: PUS
Bandwidth:	100.0 MHz
Integration Time:	10.0 ms

¹ PAR (0.1%) in accordance with FCC KDB 971168, Section 6.0 "Measurement of the Peak-to-Average Power Ratio (PAR)"
² Modulation Interference Factor (MIF) value valid only in conjunction with advanced probe response linearization calibration for the same communication system (same UID and version).

**Calibration Laboratory of
Schmid & Partner
Engineering AG**
Zeughausstrasse 43, 8004 Zurich, Switzerland

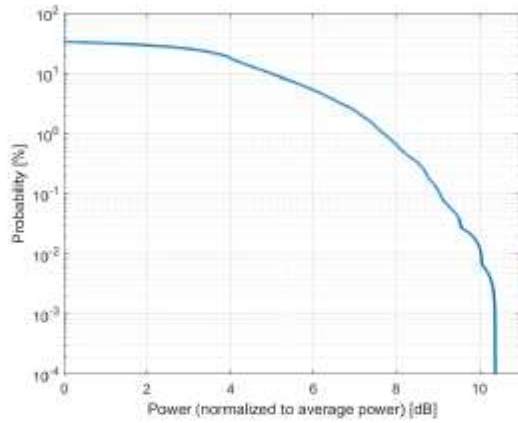

Complementary Cumulative Distribution Function (CCDF)

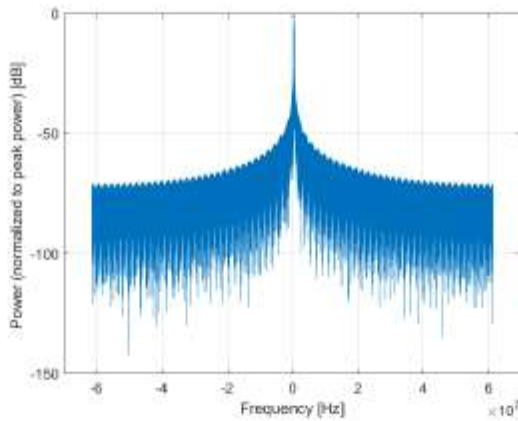

Frequency Domain

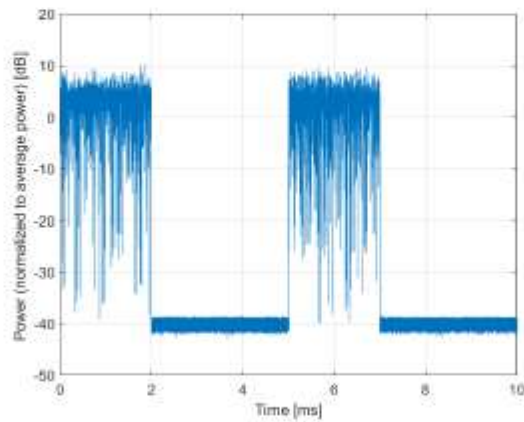

Time Domain