

TEST REPORT

EMC Test for SC-54E

APPLICANT
SAMSUNG Electronics Co., Ltd.

REPORT NO.
HCT-EM-2405-FC002

DATE OF ISSUE
May 24, 2024

Tested by
Wook Yi



Technical Manager
Jeong-Hyun Choi



HCT CO., LTD.
Bongjai Huh
BongJai Huh / CEO



HCT Co., Ltd.

2-6, 73, 74, Seoicheon-ro 578beon-gil, Majang-myeon, Icheon-si, Gyeonggi-do, 17383 KOREA
Tel. +82 31 645 6300 Fax. +82 31 645 6401

**TEST
REPORT**

FCC Certification

REPORT NO.

HCT-EM-2405-FC002

DATE OF ISSUE

May 24, 2024

FCC ID.

A3LSMF741JPN

Applicant

SAMSUNG Electronics Co., Ltd.

129, Samsung-ro, Yeongtong-gu, Suwon-si, Gyeonggi-do,
16677, Korea

Product Name

Mobile Phone

Model Name

SC-54E

Series Model Name

SCG29

Date of Test

05.09.2024 - 05.10.2024

Location of Test

Permanent Testing Lab On Site Testing Lab
(Address: See clause 1.2)

Test Standard Used

FCC CFR 47 PART 15 Subpart B Class B
ANSI C63.4-2014

Test Results

Refer to the present document

Manufacturer

SAMSUNG Electronics Co., Ltd.

REVISION HISTORY

The revision history for this test report is shown in table.

Revision No.	Date of Issue	Description
0	May 24, 2024	Initial Release

Notice

Content

The results shown in this test report only apply to the sample(s), as received, provided by the applicant, unless otherwise stated.

The test results have only been applied with the test methods required by the standard(s).

The laboratory is not accredited for the test results marked *.

Information provided by the applicant is marked **.

Test results provided by external providers are marked ***.

When confirmation of authenticity of this test report is required, please contact www.hct.co.kr

The test results in this test report are not associated with the ((KS Q) ISO/IEC 17025) accreditation by KOLAS (Korea Laboratory Accreditation Scheme) that are under the ILAC (International Laboratory Accreditation Cooperation) Mutual Recognition Agreement (MRA).

CONTENTS

1. TESTING LABORATORY	5
1.1 General Information	5
1.2 Location of the Test Site	5
2. GENERAL INFORMATION	6
2.1 Description of EUT	6
2.2 Power Source	6
2.3 Tested System Details	7
2.4 Cable Description	7
2.5 Noise Suppression Parts on Cable (I/O Cable)	7
2.6 Test Facility	8
2.7 Calibration of Measuring Instrument	8
2.8 Measurement Uncertainty	8
3. DESCRIPTION OF TESTING	9
3.1 Measurement of Conducted Emission	9
3.2 Measurement of Radiated Emission	10
3.3 Configuration of Tested System	12
4. OPERATION OF THE EUT	13
5. MEASURING INSTRUMENT	15
6. EMISSION TEST SUMMARY	17
6.1 Conducted Emission	17
6.2 Radiated Emission Below 1 GHz	18
6.3 Radiated Emission Above 1 GHz	23
7. APPENDIX A. TEST SETUP PHOTO	30

1. TESTING LABORATORY

1.1 General Information

Organization Name	HCT Co., Ltd.
Address	74, Seoicheon-ro 578beon-gil, Majang-myeon, Icheon-si, Gyeonggi-do, 17383. Rep. of Korea
Telephone	+82 31 645 6300
FAX	+82 31 645 6401

1.2 Location of the Test Site

The test site is located at the following address.;

Address	74, Seoicheon-ro 578beon-gil, Majang-myeon, Icheon-si, Gyeonggi-do, 17383. Rep. of Korea
Telephone	031-645-6300
FAX	031-645-6401

2. GENERAL INFORMATION

2.1 Description of EUT

FCC ID	A3LSMF741JPN
Product Name	Mobile Phone
Model Name	SC-54E
Series Model Name	SCG29
Operating Frequency Band	GSM 850/900/1800/1900, WCDMA FDD 1/5, LTE B1/2/3/4/5/7/8/12/13/18/19/20/21/26/28/38/39/40/41/42/66, 5G FR1 n1/3/5/28/40/41/66/77/78/79, BT BDR/EDR/LE, WLAN a/b/g/n/ac/ax, GNSS, NFC, WPT
Testing Frequency Band	GSM 850/1900, WCDMA B5, LTE B2/4/5/12/13/41/66, 5G NR n5/41/66, BT BDR/EDR/LE, WLAN a/b/g/n/ac/ax, GNSS, NFC, WPT
Manufacturer	SAMSUNG Electronics Co., Ltd.

2.2 Power Source

During the test, the following power supply levels are utilized/provided.;

Power supply: AC 120 V, 60 Hz

2.3 Tested System Details

All equipment descriptions used in the tested system (including inserted cards) are:

Device Type	Model Name	Serial Number	Manufacturer
Mobile Phone	SC-54E	-	SAMSUNG Electronics Co., Ltd.
Travel Adapter ^{a)}	EP-TA800	-	DONGYANG E&P
Data Cable	EP-DN980	-	RFTECH
Earphone	EO-IC100	-	CRESYN

a) Input: 100~240 V, 50~60 Hz, 0.7 A / Output: (PDO)5.0 V, 3.0 A or 9.0 V, 2.77 A (PPS)3.3~5.9 V, 3.0 A or 3.3~11.0 V, 2.25 A

2.4 Cable Description

Product Name	Port	Power Cord Shielded (Y/N)	I/O Cable Shielded (Y/N)	Length (m)
EUT	USB Type C (Data Cable)	Y	N/A	(P) 1.0
	USB Type C (Earphone)	N/A	N	(D) 1.3

“(D)” data cable and “(P)” power cable

2.5 Noise Suppression Parts on Cable (I/O Cable)

Product Name	Port	Ferrite Bead (Y/N)	Location	Metal Hood (Y/N)	Location
EUT	Data Cable (USB Type C)	N	N/A	Y	Both End
	Earphone (USB Type C)	N	N/A	Y	EUT End

2.6 Test Facility

The measurement facilities are constructed in conformance with the requirements of ANSI C63.4-2014. The Normalized site attenuations (30 MHz to 1 GHz) and Site validation (1 GHz to 18 GHz) were performed in accordance with the standard in ANSI C63.4-2014 and ANSI C63.4a-2017

Our laboratories are accredited and designated in accordance with the provisions of Radio Waves ACT and International Standard ISO/IEC 17025:2017. (National Radio Research Agency, CABID No. KR0032)

2.7 Calibration of Measuring Instrument

The measuring equipment, which was utilized in performing the tests documented herein, has been calibrated in accordance with the manufacturers recommendations for utilizing calibration equipment, which is traceable to recognized national standards.

Especially, all antenna for measurement is calibrated in accordance with the requirements of C63.5:2017.

2.8 Measurement Uncertainty

The measurement uncertainties shown below were calculated in accordance with the requirements of ANSI C63.4-2014. All measurement uncertainty values are shown with a coverage factor of $k = 2$ to indicate a 95 % level of confidence. The measurement data shown herein meets or exceeds the U_{CISPR} measurement uncertainty values specified in CISPR 16-4-2 and, thus, can be compared directly to specified limits to determine compliance.

Parameter	Test Site	Expanded Uncertainty
Radiated Emission	3 m Semi Anechoic Chamber #1	30 MHz to 1 GHz: 5.8 dB
		1 GHz to 18 GHz: 4.8 dB
		18 GHz to 40 GHz: 5.8 dB

3. DESCRIPTION OF TESTING

3.1 Measurement of Conducted Emission

The test procedure was in accordance with ANSI C63.4-2014, Clause 7.3

a. The EUT was placed 0.4 meters from the conducting wall of the shielded room with EUT being connected to the power mains through a line impedance stabilization network (LISN).

If the EUT is connected to the PC through USB, the AC power-line adapter of the PC is directly connected to a line impedance stabilization network (LISN).

Other support units were connected to the power mains through another LISN. The two LISNs provide 50 Ohm/ 50uH of coupling impedance for the measuring instrument.

b. Both conducted lines are measured in Quasi-Peak and Average mode, including the worst-case data points for each tested configuration.

c. The frequency range from 150 kHz to 30 MHz was searched.

Conducted Emission Limits

Frequency (MHz)	Resolution Bandwidth (kHz)	Class A		Class B	
		Quasi-Peak (dBµV)	Average (dBµV)	Quasi-Peak (dBµV)	Average (dBµV)
0.15 to 0.5	9	79	66	66 to 56*	56 to 46*
0.5 to 5	9	73	60	56	46
5 to 30	9	73	60	60	50

NOTE. Decreases with the logarithm of the frequency.

3.2 Measurement of Radiated Emission

The test procedure was in accordance with ANSI C63.4-2014, Clause 8.3

- a. The EUT was placed on the top of a turn table 0.8 meters above the ground at a semi-anechoic chamber. The table was rotated 360 degrees to determine the position of the highest radiation.
- b. The EUT was set 3 m away from the interference-receiving antenna, which was mounted on the top of a variable-height antenna tower.
- c. The antenna height is varied from 1 m to 4 m above the ground to determine the maximum value of the field strength. Both horizontal and vertical polarizations of the antenna are set to make the measurement.
- d. For each suspected emission, the EUT was arranged to its worst case and then the antenna was tuned to heights from 1 m to 4 m and the turn table was turned from 0 degrees to 360 degrees to find the maximum reading.
- e. The test-receiver system was set to Quasi-Peak detect function and specified bandwidth with maximum hold mode when the test frequency is below 1 GHz.
- f. The test-receiver system was set to Peak and Average detect function and specified bandwidth with maximum hold mode when the test frequency is above 1 GHz.
- g. Place the measurement antenna away from each area of the EUT determined to be a source of emissions at the specified measurement distance, while keeping the measurement antenna aimed at the source of emissions at each frequency of significant emissions, with polarization oriented for maximum response. (1 GHz to 40 GHz)

Radiated Emission Limits

Frequency (MHz)	Class A			Class B		
	Antenna Distance (m)	Field Strength ($\mu\text{V}/\text{m}$)	Quasi-Peak (dB $\mu\text{V}/\text{m}$)	Antenna Distance (m)	Field Strength ($\mu\text{V}/\text{m}$)	Quasi-Peak (dB $\mu\text{V}/\text{m}$)
30 to 88	10	90	39.0	3	100	40.0
88 to 216	10	150	43.5	3	150	43.5
216 to 960	10	210	46.4	3	200	46.0
Above 960	10	300	49.5	3	500	54.0
Frequency (MHz)	Antenna Distance (m)	Class A		Class B		
		Peak (dB $\mu\text{V}/\text{m}$)	Average (dB $\mu\text{V}/\text{m}$)	Peak (dB $\mu\text{V}/\text{m}$)	Average (dB $\mu\text{V}/\text{m}$)	
Above 1 000	3	80	60	74	54	

Frequency Range of Radiated Measurements

An unintentional radiator, including a digital device, the spectrum shall be investigated from the lowest radio frequency signal generated or used in the device, without going below the lowest frequency for which a Radiated Emission limit is specified, up to the frequency shown in the following table

Highest frequency generated or used in the device or on which the device operates or tunes (MHz)	Upper frequency of measurement range (MHz)
Below 1.705	30
1.705 to 108	1 000
108 to 500	2 000
500 to 1 000	5 000
Above 1 000	5th harmonic of the highest frequency or 40 GHz, whichever is lower

3.3 Configuration of Tested System

The EUT was configured in the following manner.

At the request of the manufacturer, the configuration of the tests was arranged.

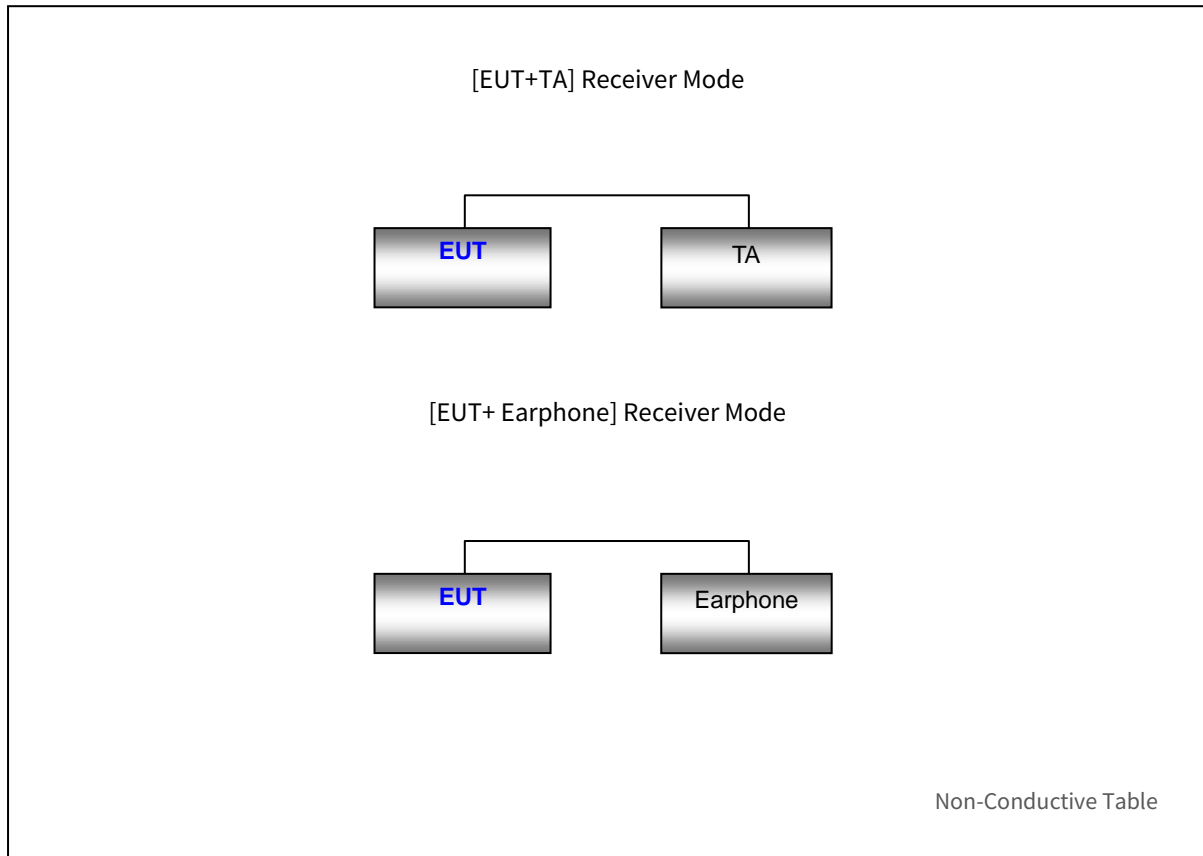

4. OPERATION OF THE EUT

During preliminary tests, the following operating mode was investigated.

Receiver mode(GSM 850 Low/Middle/High ch Idle)

Receiver mode(WCDMA B5 Low/Middle/High ch Idle)

Receiver mode(LTE B5_Low/Middle/High ch)

Receiver mode(LTE B12_Low/Middle/High ch)

Receiver mode(LTE B13_Low/Middle/High ch)

Receiver mode(5G NR n5_Low/Middle/High ch)

NOTE. The worst case is tested.

4.1 Conducted Emission (Not Applicable)

Operating Mode: Not applicable

NOTE. Conducted emission for receiver mode is covered by JBP report.

4.2 Radiated Emission

It was final tested the following operating mode, after connecting all peripheral devices.

Operating Mode:

Radiated Emission below 1 GHz

[EUT+TA] EUT Unfolded	LTE B5+5G NR n5 Low ch Idle *
	LTE B5+5G NR n5 Middle ch Idle
	LTE B5+5G NR n5 High ch Idle
	LTE B12+B13 Low ch Idle *
	LTE B12+B13 Middle ch Idle
	LTE B12+B13 High ch Idle
[EUT+TA] EUT Folded	LTE B5+5G NR n5 Low ch Idle *
[EUT+ Earphone]	LTE B5+5G NR n5 Low ch Idle *

Radiated Emission above 1 GHz

[EUT+TA] EUT Unfolded	LTE B5+5G NR n5 Low ch Idle *
	LTE B12+B13 Low ch Idle
[EUT+TA] EUT Folded	LTE B5+5G NR n5 Low ch Idle *
[EUT+ Earphone]	LTE B5+5G NR n5 Low ch Idle *

NOTE.

1. Three orientations have been investigated and the worst-case orientation (x-axis: The display of EUT placed on the table is facing upwards) is reported.
2. Frequency bands adjacent to each other are tested as one mode.
3. The worst case of operating mode is reported. [*].

5. MEASURING INSTRUMENT

Type	Model Name	Manufacturer	Serial Number	Calibration Cycle	Next Calibration Date
Conducted emission					
<input type="checkbox"/>	EMI Test Receiver	ESR7	Rohde & Schwarz	101910	1 year 05.26.2024
<input type="checkbox"/>	LISN	ENV216	Rohde & Schwarz	102245	1 year 08.02.2024
<input type="checkbox"/>	Software	EMC32	Rohde & Schwarz	-	-
Radiated emission below 1 GHz					
<input checked="" type="checkbox"/>	EMI Test Receiver	ESU40	Rohde & Schwarz	100524	1 year 05.07.2025
<input checked="" type="checkbox"/>	Bi-Log Antenna	VULB9168	Schwarzbeck	255	2 year 03.10.2025
<input checked="" type="checkbox"/>	Antenna master	MA4640-XP-ET	INNCO SYSTEM	-	N/A -
<input checked="" type="checkbox"/>	Antenna master controller	CO3000	INNCO SYSTEM	CO3000/870/ 35990515/L	N/A -
<input checked="" type="checkbox"/>	Turn Table	1060	INNCO SYSTEM	-	N/A -
<input checked="" type="checkbox"/>	Turn Table controller	CO2000	INNCO SYSTEM	CO2000/095/ 7590304/L	N/A -
<input checked="" type="checkbox"/>	Universal radio communication tester	CMU200	Rohde & Schwarz	107488	1 year 09.22.2024
<input checked="" type="checkbox"/>	Mobile communication test set	CMW500	Rohde & Schwarz	103246	1 year 08.28.2024
<input checked="" type="checkbox"/>	Radio communication analyzer	MT8821C	ANRITSU	6262192376	1 year 10.17.2024
<input checked="" type="checkbox"/>	Antenna (for Communication)	HyperLOG7060	Aaronia	66450	- -
<input checked="" type="checkbox"/>	Radio communication analyzer	MT8000A	ANRITSU	6262208294	1 year 10.17.2024
<input checked="" type="checkbox"/>	Antenna (for Communication)	HyperLOG7060	Aaronia	66451	- -
<input checked="" type="checkbox"/>	Software	EMC32	Rohde & Schwarz	-	-

Type	Model Name	Manufacturer	Serial Number	Calibration Cycle	Next Calibration Date
Radiated emission above 1 GHz					
<input checked="" type="checkbox"/>	EMI Test Receiver	ESU40	Rohde & Schwarz	100524	1 year 05.07.2025
<input checked="" type="checkbox"/>	Antenna master	MA4640-XP-ET	INNCO SYSTEM	-	N/A -
<input checked="" type="checkbox"/>	Antenna master controller	CO3000	INNCO SYSTEM	CO3000/870/ 35990515/L	N/A -
<input checked="" type="checkbox"/>	Turn Table	1060	INNCO SYSTEM	-	N/A -
<input checked="" type="checkbox"/>	Turn Table controller	CO2000	INNCO SYSTEM	CO2000/095/ 7590304/L	N/A -
<input checked="" type="checkbox"/>	Low Noise Amplifier	TK-PA18H	TESTEK	170034-L	1 year 11.01.2024
<input checked="" type="checkbox"/>	Low Noise Amplifier	TK-PA1840H	TESTEK	170030-L	1 year 02.20.2025
<input checked="" type="checkbox"/>	Horn Antenna	HF907	Rohde & Schwarz	103160	1 year 10.16.2024
<input checked="" type="checkbox"/>	Horn Antenna	BBHA 9170	Schwarzbeck	BBHA9170 #786	1 year 11.01.2024
<input checked="" type="checkbox"/>	Radio communication analyzer	MT8821C	ANRITSU	6262192376	1 year 10.17.2024
<input checked="" type="checkbox"/>	Mobile communication test set	CMW500	Rohde & Schwarz	103246	1 year 08.28.2024
<input checked="" type="checkbox"/>	Universal radio communication tester	CMU200	Rohde & Schwarz	107488	1 year 09.22.2024
<input checked="" type="checkbox"/>	Antenna (for Communication)	HyperLOG7060	Aaronia	66450	- -
<input checked="" type="checkbox"/>	Radio communication analyzer	MT8000A	ANRITSU	6262208294	1 year 10.17.2024
<input checked="" type="checkbox"/>	Antenna (for Communication)	HyperLOG7060	Aaronia	66451	- -
<input checked="" type="checkbox"/>	Software	EMC32	Rohde & Schwarz	-	- -

6. EMISSION TEST SUMMARY

6.1 Conducted Emission

6.1.1 Operating Condition

The test results of conducted emission at mains ports provide the following information:

Test Standard Used	FCC CFR 47 PART 15 Subpart B Class B ANSI C63.4-2014
Frequency Range	150 kHz to 30 MHz
Detector	Quasi-Peak, CISPR-Average
Bandwidth	9 kHz (6 dB)
Operating Mode	Not applicable
Test Site	EMI Shield Room
Temperature	min. - °C / max. - °C
Relative Humidity	min. - % / max. - %
Test Date	-

A conducted emission is calculated by the following equation.;

Calculation Formula: $A = B + C$ Where

- A: QuasiPeak or CAverage in dB μ V
- B: Receiver reading in dB μ V
- C: Corr. in dB (LISN Factor + Cable Loss)

Margin in dB = Limit - QuasiPeak or CAverage
L1 = Live, N = Neutral

Two graphs measurement for both Live(L1) and Neutral(N) of the LISN are combined into one graph.

6.1.2 Measuring Data

Not applicable

6.2 Radiated Emission Below 1 GHz

6.2.1 Operating Condition

The test results of radiated emission provide the following information:

Used Test Standard	FCC CFR 47 PART 15 Subpart B Class B ANSI C63.4-2014
Frequency Range	30 MHz to 1 000 MHz
Detector	Quasi-Peak
Bandwidth	120 kHz (6 dB)
Antenna Height	1 m to 4 m
Operating Mode	<p>[EUT+TA] EUT Unfolded LTE B5+5G NR n5 Low ch Idle LTE B12+B13 Low ch Idle</p> <p>[EUT+TA] EUT Folded LTE B5+5G NR n5 Low ch Idle</p> <p>[EUT+Earphone] LTE B5+5G NR n5 Low ch Idle</p>
Test Site	3 m Semi Anechoic Chamber #1
Temperature	min. 23.5 °C, max. 26.6 °C
Relative Humidity	min. 35.9 %, max. 44.6 %
Test Date	05.09.2024

A field strength is calculated by the following equation.;

Calculation Formula: $A = B + C$ Where

- A: Quasi Peak in dB μ V/m (Field strength)
- B: Receiver reading in dB μ V
- C: Corr. in dB (Cable loss + Antenna factor)

Margin in dB = Limit - QuasiPeak
Polarity H = Horizontal, Polarity V = Vertical

6.2.2 Measuring Data

[EUT+TA] EUT Unfolded

LTE B5+5G NR n5 Low ch Idle

Full Spectrum

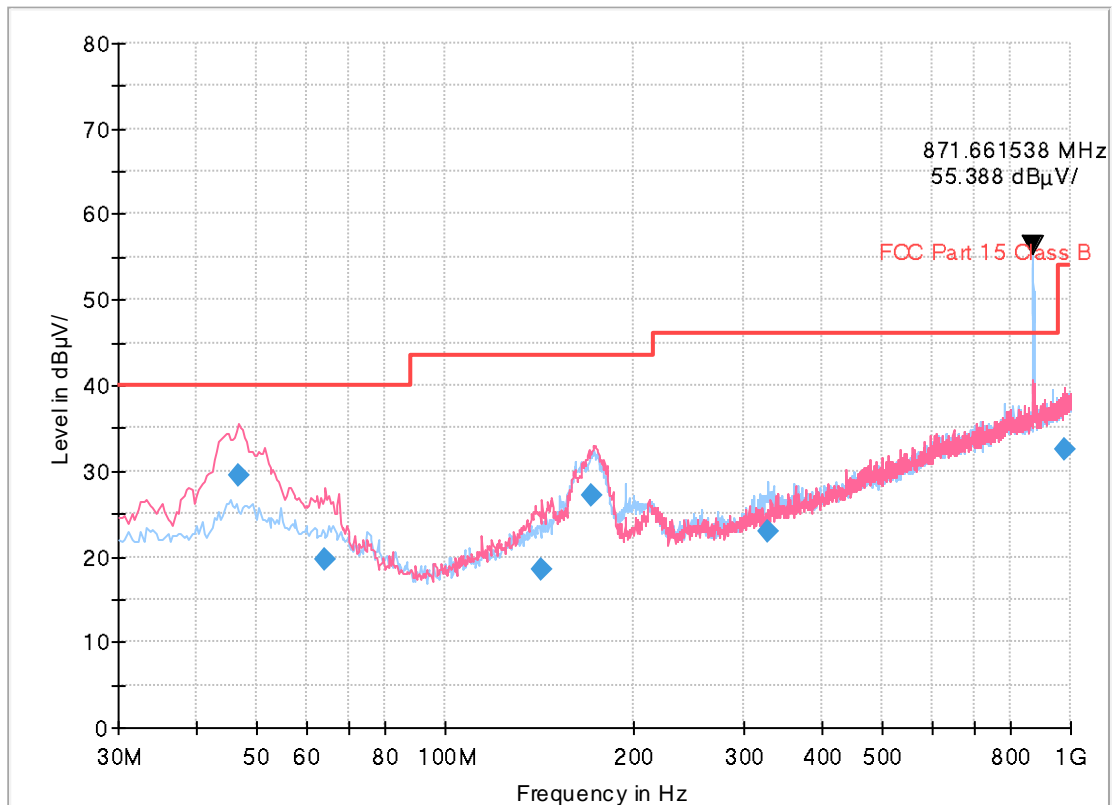

Frequency (MHz)	QuasiPeak (dBµV/m)	Limit (dBµV/m)	Margin (dB)	Height (cm)	Pol	Azimuth (deg)	Corr. (dB)
46.7622	29.55	40.00	10.45	100.0	V	75.0	20.1
64.3033	19.53	40.00	20.47	100.0	V	104.0	19.1
142.6373	18.46	43.50	25.04	109.7	V	156.0	19.5
170.9748	27.15	43.50	16.35	174.7	H	52.0	19.0
328.4426	22.91	46.00	23.09	100.0	H	205.0	21.3
975.3460	32.53	54.00	21.47	201.7	V	284.0	32.4

- NOTE. 1. Carrier Frequency: Rx 871.6615 MHz
 2. These are signals for fundamental frequency from the base station

LTE B12+B13 Low ch Idle

Full Spectrum

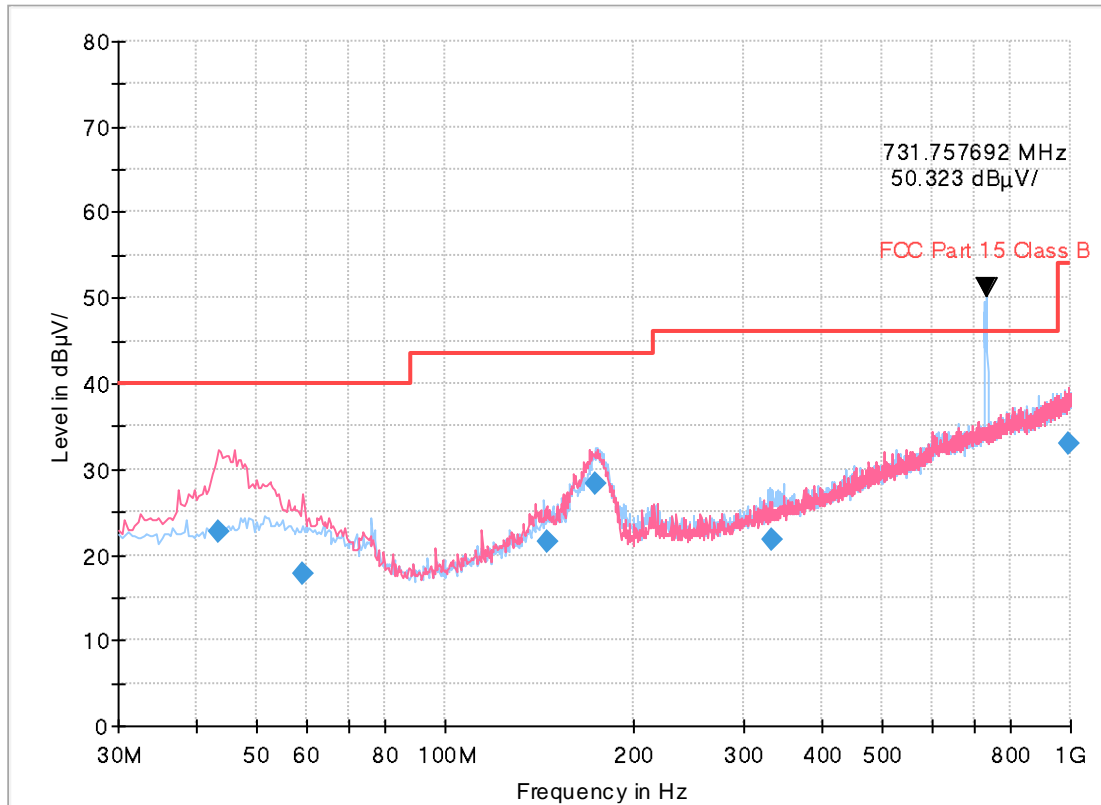

Frequency (MHz)	QuasiPeak (dBµV/m)	Limit (dBµV/m)	Margin (dB)	Height (cm)	Pol	Azimuth (deg)	Corr. (dB)
43.4360	22.74	40.00	17.26	100.0	V	16.0	19.9
59.0785	17.74	40.00	22.26	303.8	V	74.0	19.7
145.2829	21.44	43.50	22.06	107.9	V	97.0	19.6
174.3466	28.32	43.50	15.18	174.9	H	34.0	18.7
332.5600	21.65	46.00	24.35	111.7	H	61.0	21.4
995.5412	32.90	54.00	21.10	100.0	V	7.0	32.6

- NOTE. 1. Carrier Frequency: Rx 731.7576 MHz
 2. These are signals for fundamental frequency from the base station

[EUT+TA] EUT Folded

LTE B5+5G NR n5 Low ch Idle

Full Spectrum

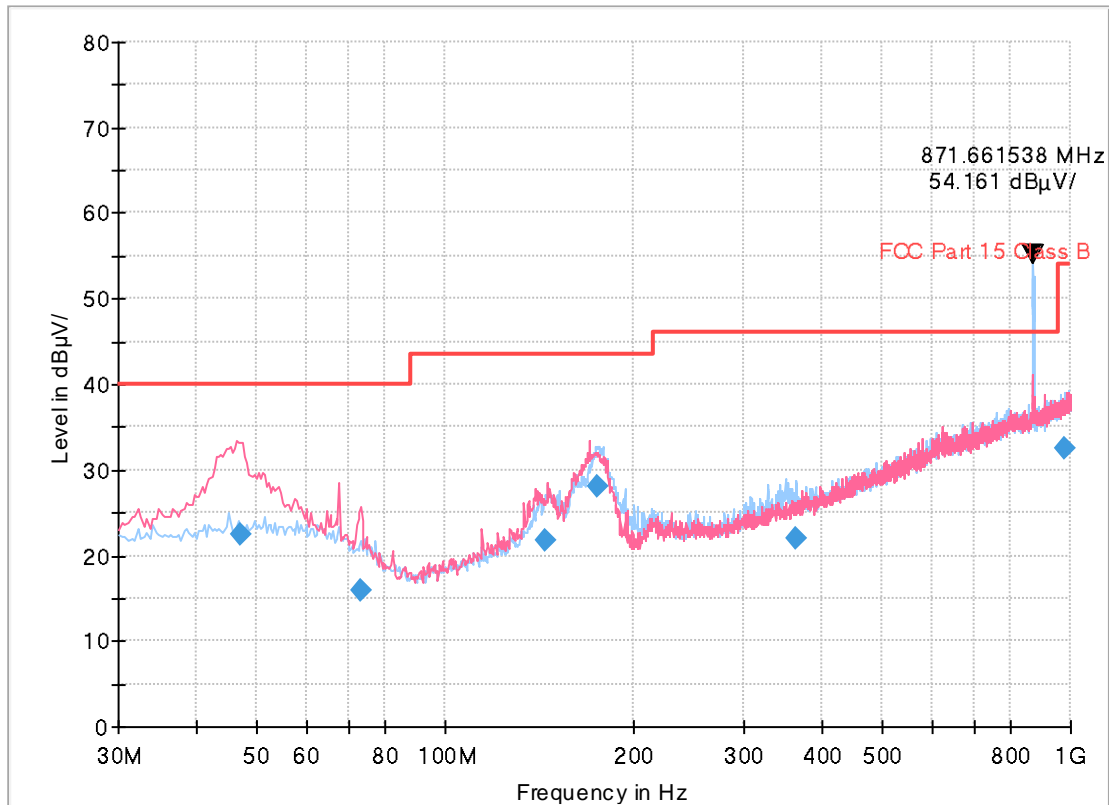

Frequency (MHz)	QuasiPeak (dBµV/m)	Limit (dBµV/m)	Margin (dB)	Height (cm)	Pol	Azimuth (deg)	Corr. (dB)
47.1162	22.43	40.00	17.57	109.9	V	75.0	20.1
73.3124	15.87	40.00	24.13	187.8	V	181.0	17.5
144.5361	21.77	43.50	21.73	201.8	H	216.0	19.5
175.5101	27.97	43.50	15.53	174.9	H	53.0	18.6
362.7499	22.05	46.00	23.95	100.0	H	73.0	22.2
976.5325	32.61	54.00	21.39	321.8	H	250.0	32.4

- NOTE. 1. Carrier Frequency: Rx 871.6615 MHz
 2. These are signals for fundamental frequency from the base station

[EUT+Earphone]

LTE B5+5G NR n5 Low ch Idle

Full Spectrum

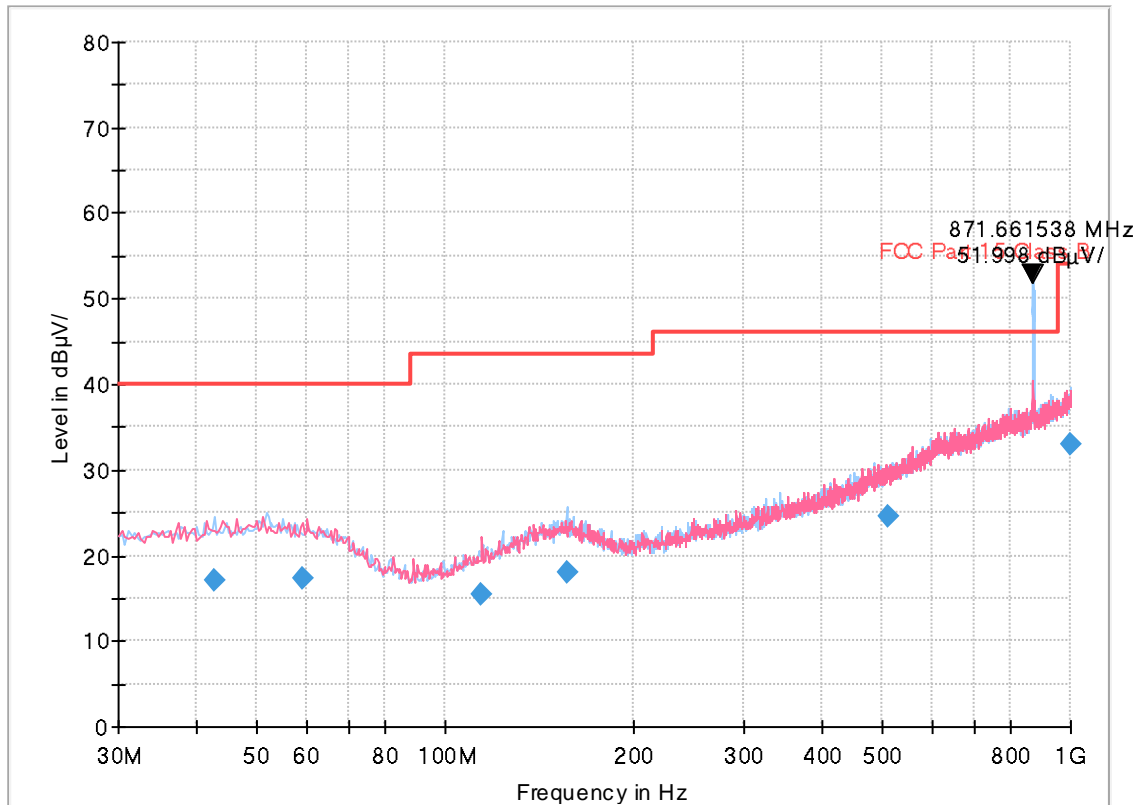

Frequency (MHz)	QuasiPeak (dBµV/m)	Limit (dBµV/m)	Margin (dB)	Height (cm)	Pol	Azimuth (deg)	Corr. (dB)
42.6766	17.03	40.00	22.97	205.8	H	7.0	19.8
59.0797	17.20	40.00	22.80	125.2	V	212.0	19.7
114.3510	15.36	43.50	28.14	221.7	V	242.0	16.8
156.5142	17.91	43.50	25.59	283.7	H	182.0	19.8
510.1974	24.52	46.00	21.48	185.9	H	306.0	25.6
998.5372	32.87	54.00	21.13	303.9	H	16.0	32.7

- NOTE. 1. Carrier Frequency: Rx 871.6615 MHz
 2. These are signals for fundamental frequency from the base station

6.3 Radiated Emission Above 1 GHz

6.3.1 Operating Condition

The test results of radiated emission provide the following information:

Used Test Standard	FCC CFR 47 PART 15 Subpart B Class B ANSI C63.4-2014
Detector	Peak, CISPR-Average
Bandwidth	1 MHz
Highest Frequency	7 125 MHz
Tested Frequency Range	1 GHz to 40 GHz
Antenna Height	1 m to 4 m
Operating Mode	<p>[EUT+TA] EUT Unfolded LTE B5+5G NR n5 Low ch Idle</p> <p>[EUT+TA] EUT Folded LTE B5+5G NR n5 Low ch Idle</p> <p>[EUT+Earphone] LTE B5+5G NR n5 Low ch Idle</p>
Test Site	3 m Semi Anechoic Chamber #1
Temperature	min. 24.1 °C, max. 26.4 °C
Relative Humidity	min. 35.3 %, max. 43.5 %
Test Date	05.10.2024

A field strength is calculated by the following equation.;

Calculation Formula: $A = B + C$

Where

A: Peak or CAverage in dBμV/m (Field strength)

B: Receiver reading in dBμV

C: Corr. in dB (Cable loss + Antenna factor)

Margin in dB = Limit - Peak or CAverage

Polarity H = Horizontal, Polarity V = Vertical

6.3.2 Measuring Data

[EUT+TA / EUT Unfolded] LTE B5+5G NR n5 Low ch Idle

1 GHz to 18 GHz

Full Spectrum

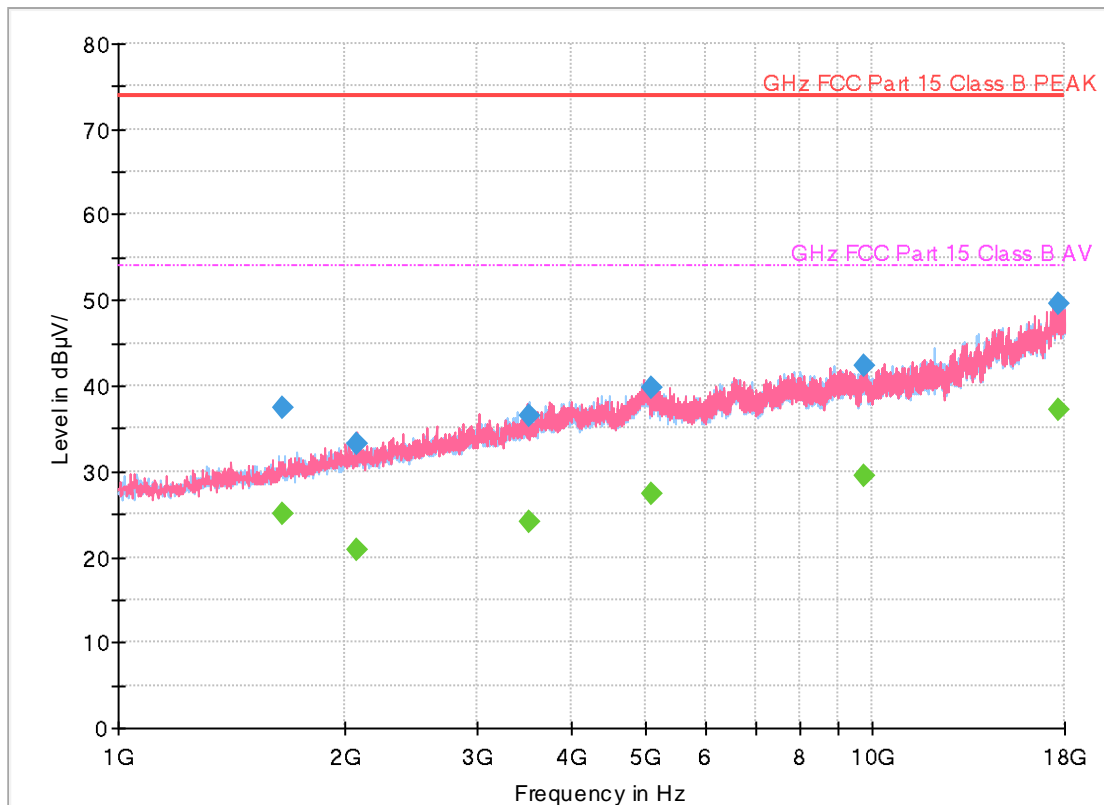

Frequency (MHz)	MaxPeak (dBµV/m)	Limit (dBµV/m)	Margin (dB)	Height (cm)	Pol	Azimuth (deg)	Corr. (dB)
1650.5850	37.36	74.00	36.64	374.8	H	283.0	-28.1
2071.7650	33.27	74.00	40.73	293.8	V	320.0	-25.6
3508.4950	36.41	74.00	37.59	400.0	V	0.0	-19.5
5091.0550	39.87	74.00	34.13	122.9	V	295.0	-14.7
9745.3500	42.35	74.00	31.65	383.9	H	26.0	-8.8
17625.3850	49.58	74.00	24.42	216.8	V	129.0	4.9

Frequency (MHz)	CAverage (dBµV/m)	Limit (dBµV/m)	Margin (dB)	Height (cm)	Pol	Azimuth (deg)	Corr. (dB)
1650.5850	24.92	54.00	29.08	374.8	H	283.0	-28.1
2071.7650	20.74	54.00	33.26	293.8	V	320.0	-25.6
3508.4950	24.08	54.00	29.92	400.0	V	0.0	-19.5
5091.0550	27.30	54.00	26.70	122.9	V	295.0	-14.7
9745.3500	29.57	54.00	24.43	383.9	H	26.0	-8.8
17625.3850	37.27	54.00	16.73	216.8	V	129.0	4.9

18 GHz to 40 GHz

Full Spectrum

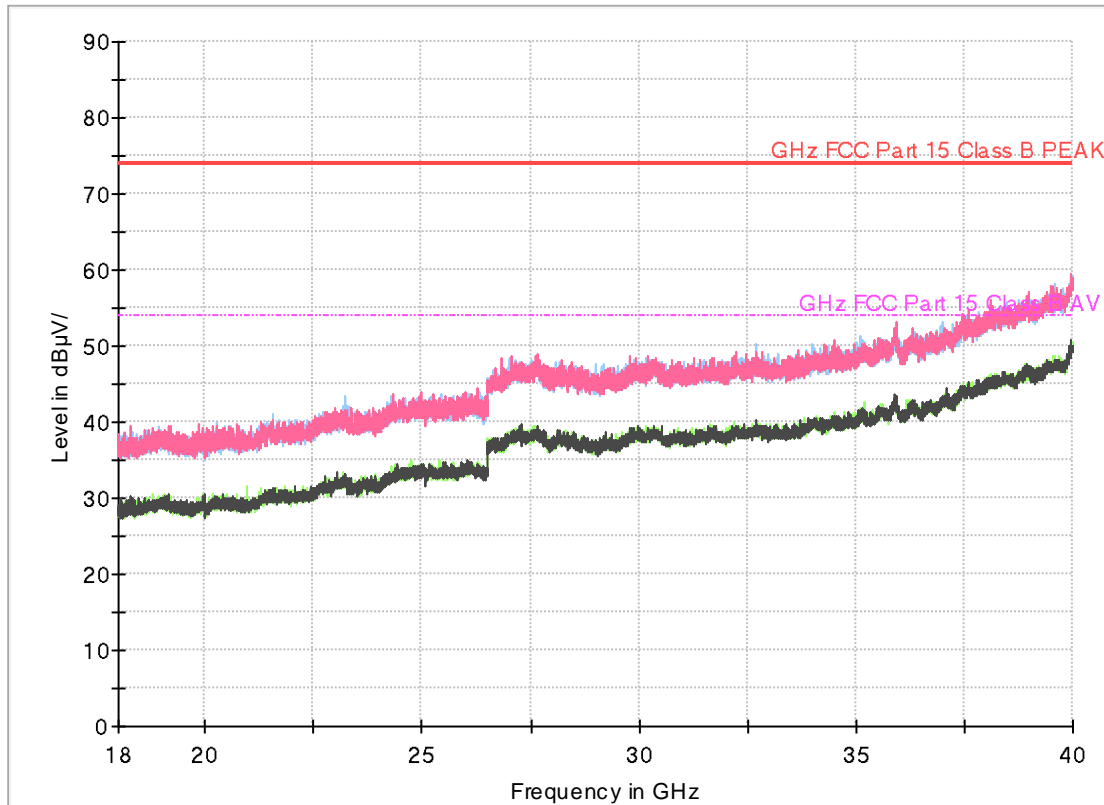

[EUT+TA / EUT Folded] LTE B5+5G NR n5 Low ch Idle

1 GHz to 18 GHz

Full Spectrum

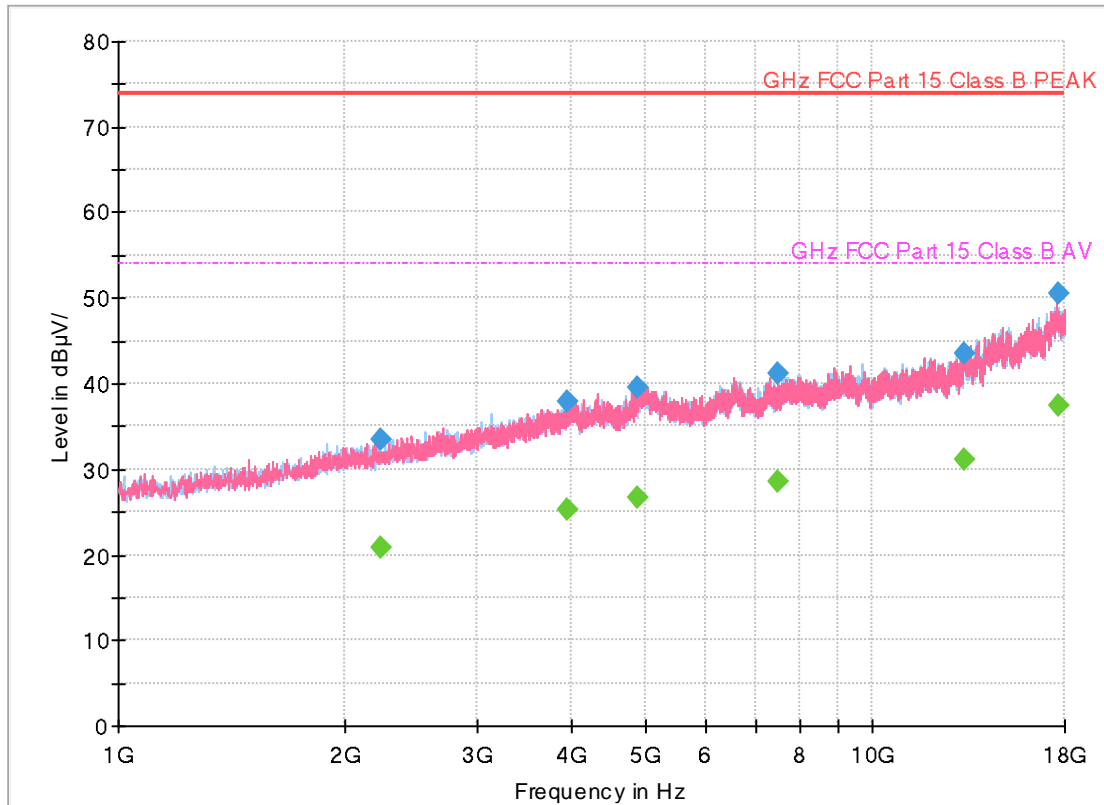

Frequency (MHz)	MaxPeak (dBµV/m)	Limit (dBµV/m)	Margin (dB)	Height (cm)	Pol	Azimuth (deg)	Corr. (dB)
2234.7500	33.49	74.00	40.51	383.8	H	294.0	-24.9
3947.8750	37.80	74.00	36.20	400.0	V	37.0	-17.8
4898.9800	39.53	74.00	34.47	400.0	V	88.0	-15.2
7498.8900	41.06	74.00	32.94	118.9	V	272.0	-10.7
13234.4050	43.61	74.00	30.39	304.9	H	6.0	-4.0
17633.0000	50.55	74.00	23.45	225.2	H	13.0	4.9

Frequency (MHz)	CAverage (dBµV/m)	Limit (dBµV/m)	Margin (dB)	Height (cm)	Pol	Azimuth (deg)	Corr. (dB)
2234.7500	20.90	54.00	33.10	383.8	H	294.0	-24.9
3947.8750	25.29	54.00	28.71	400.0	V	37.0	-17.8
4898.9800	26.73	54.00	27.27	400.0	V	88.0	-15.2
7498.8900	28.43	54.00	25.57	118.9	V	272.0	-10.7
13234.4050	31.18	54.00	22.82	304.9	H	6.0	-4.0
17633.0000	37.45	54.00	16.55	225.2	H	13.0	4.9

18 GHz to 40 GHz

Full Spectrum

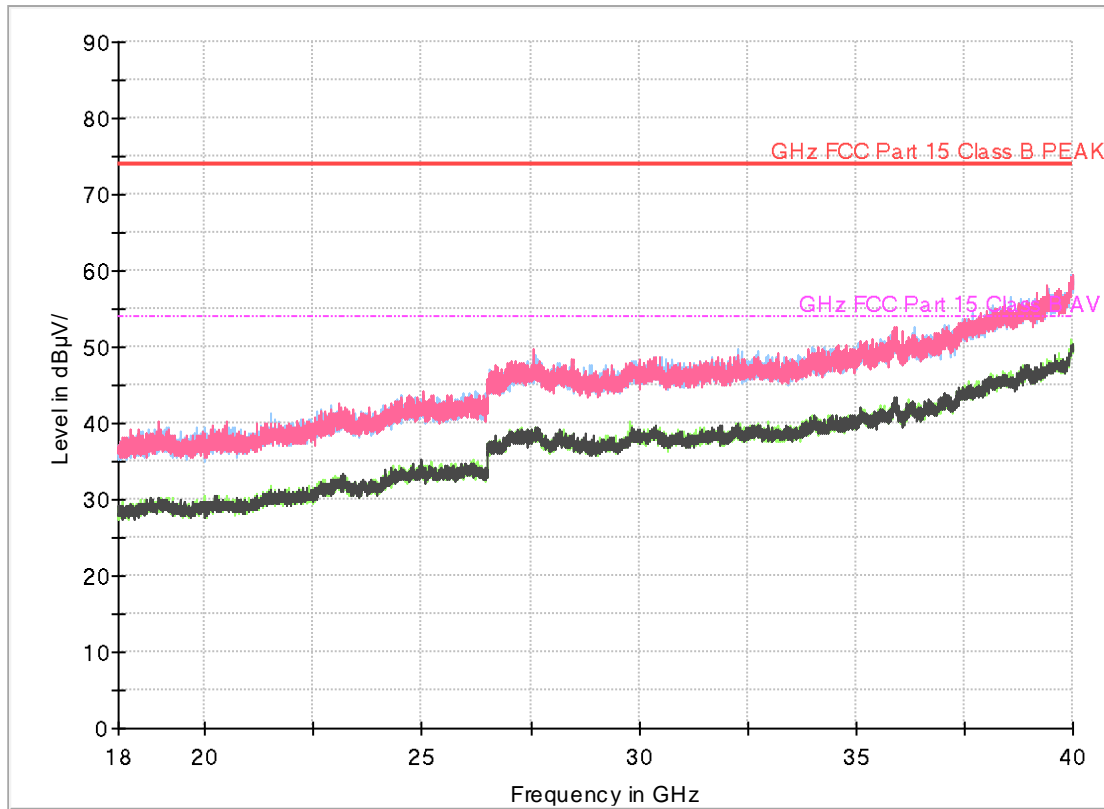

[EUT+Earphone] LTE B5+5G NR n5 Low ch Idle

1 GHz to 18 GHz

Full Spectrum

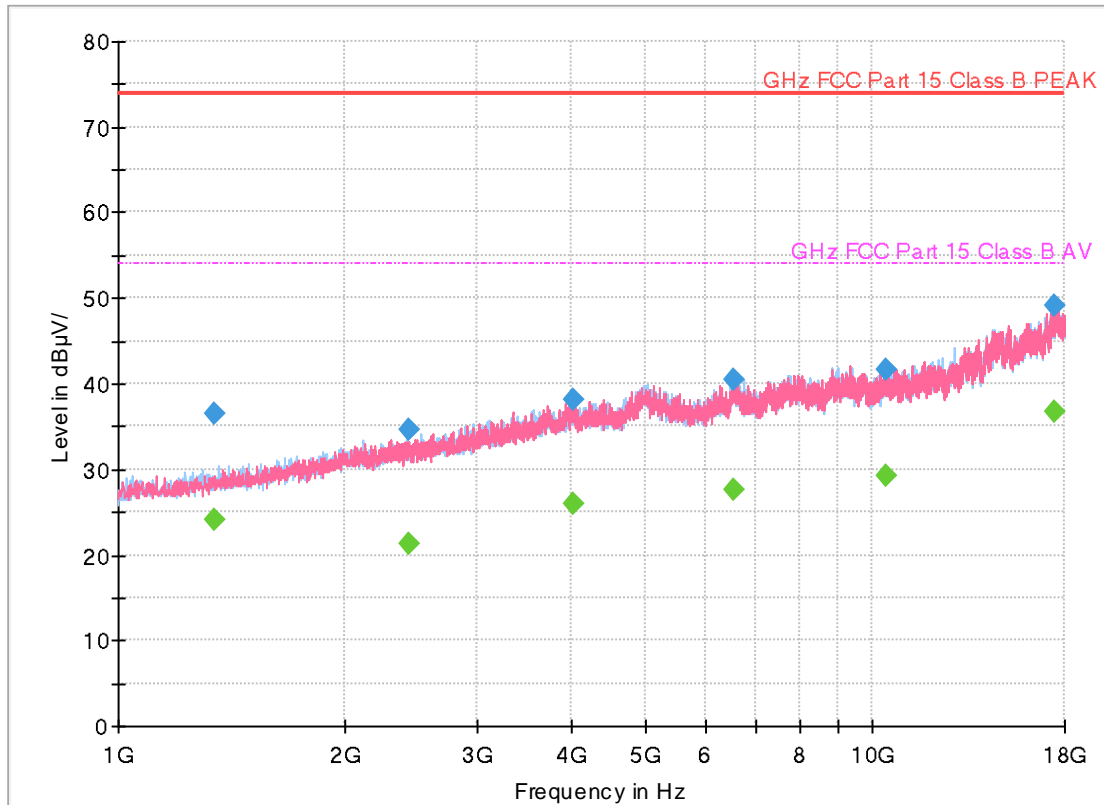

Frequency (MHz)	MaxPeak (dBµV/m)	Limit (dBµV/m)	Margin (dB)	Height (cm)	Pol	Azimuth (deg)	Corr. (dB)
1342.3150	36.58	74.00	37.42	320.9	V	57.0	-29.8
2433.6600	34.61	74.00	39.39	206.8	H	251.0	-24.1
4016.2600	38.11	74.00	35.89	206.9	V	104.0	-17.6
6545.4400	40.53	74.00	33.47	393.9	H	25.0	-12.1
10451.5850	41.75	74.00	32.25	100.0	V	169.0	-7.9
17437.9050	49.05	74.00	24.95	107.9	V	313.0	4.2

Frequency (MHz)	CAverage (dBµV/m)	Limit (dBµV/m)	Margin (dB)	Height (cm)	Pol	Azimuth (deg)	Corr. (dB)
1342.3150	24.02	54.00	29.98	320.9	V	57.0	-29.8
2433.6600	21.35	54.00	32.65	206.8	H	251.0	-24.1
4016.2600	25.92	54.00	28.08	206.9	V	104.0	-17.6
6545.4400	27.68	54.00	26.32	393.9	H	25.0	-12.1
10451.5850	29.34	54.00	24.66	100.0	V	169.0	-7.9
17437.9050	36.63	54.00	17.37	107.9	V	313.0	4.2

18 GHz to 40 GHz

Full Spectrum

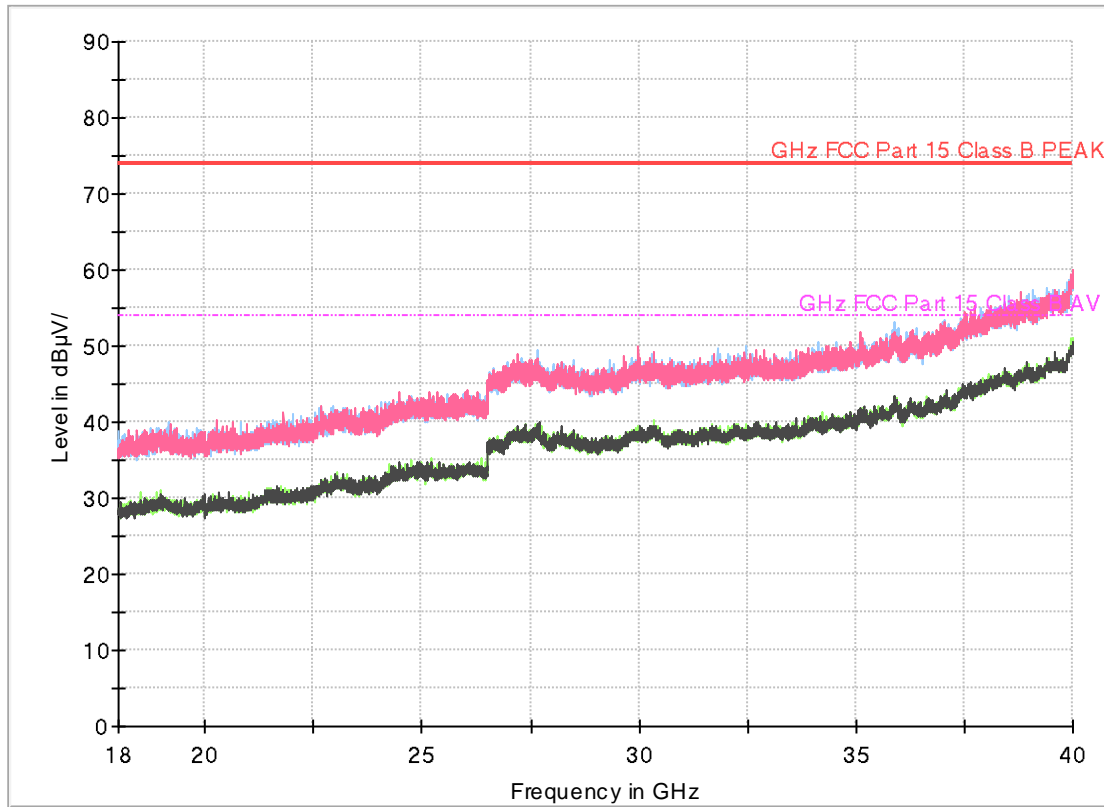

7. APPENDIX A. TEST SETUP PHOTO

Please refer to Appendix. A and test setup photo file no. as follows;

File No.	Date of Issue	Description
HCT-EM-2405-FC002-P	May 24, 2024	Initial Release

End of report