

# TEST REPORT

## PART 2: RF Exposure Compliance Test of SM-F741B

APPLICANT

Samsung Electronics. Co., Ltd.

REPORT NO.

HCT-SR-2405-FC004

DATE OF ISSUE

May. 03, 2024

Tested by  
Jung Hun Park

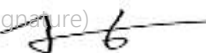
(signature)  

Technical Manager  
Yun Jeang, Heo

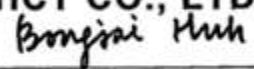

HCT CO., LTD.  
  
BongJai Huh / CEO



HCT CO.,LTD.

2-6, 73, 74, Seoicheon-ro 578beon-gil, Majang-myeon, Icheon-si, Gyeonggi-do, 17383 KOREA  
Tel. +82 31 645 6300 Fax. +82 31 645 6401

# TEST REPORT

PART 2 RF Exposure  
Compliance Test for  
certification

REPORT NO.  
HCT-SR-2405-FC004

DATE OF ISSUE  
May. 03, 2024

FCC ID  
A3LSMF741B

Applicant **SAMSUNG Electronics Co., Ltd**  
**129, Samsung-ro, Yeongtong-gu, Suwon-Si, Gyeonggi-do, 16677, Korea**

Product Name **Mobile Phone**  
Model Name **SM-F741B**  
Additional Model Name

Date of Test **Apr. 11, 2024~ May. 03, 2024.**

Location of Test  **Permanent Testing Lab**  **On Site Testing Lab**  
**(Address: 74, Seoicheon-ro 578beon-gil, Majang-myeon, Icheon-si, Gyeonggi-do, 17383 KOREA)**

FCC Rule Part(s) **CFR §2.1093**

Results **Pass**

## REVISION HISTORY

The revision history for this test report is shown in table.

| Revision No. | Date of Issue | Description     |
|--------------|---------------|-----------------|
| 0            | May. 03, 2024 | Initial Release |

## Notice

---

### Content

---

The results shown in this test report only apply to the sample(s), as received, provided by the applicant, unless otherwise stated.

The test results have only been applied with the test methods required by the standard(s).

The laboratory is not accredited for the test results marked \*.

Information provided by the applicant is marked \*\*.

Test results provided by external providers are marked \*\*\*.

When confirmation of authenticity of this test report is required, please contact [www.hct.co.kr](http://www.hct.co.kr)

The test results in this test report are not associated with the ((KS Q) ISO/IEC 17025) accreditation by KOLAS (Korea Laboratory Accreditation Scheme) / A2LA (American Association for Laboratory Accreditation) that are under the ILAC (International Laboratory Accreditation Cooperation) Mutual Recognition Agreement (MRA).

---

## CONTENTS

|   |    |
|---|----|
| 1. RF Exposure Limits .....   | 5  |
| 2. Test Location.....   | 7  |
| 3. DEVICE UNDER TEST DESCRIPTION .....                              | 8  |
| 4. Tx Varying Transmission Test Cases and Test Proposal .....       | 14 |
| 5. SAR Time Averaging Validation Test Procedures .....              | 18 |
| 6. Test Configurations.....   | 37 |
| 7. Time-varying Tx power measurement for below 6GHz frequency ..... | 41 |
| 8. Equipment List.....  | 71 |
| 9. Conclusion .....   | 72 |
| Appendix A: Test Sequences .....                                    | 73 |
| Appendix B: Test Procedures for sub6 NR + LTE Radio .....           | 76 |

## 1. RF Exposure Limits

### 1.1 RF Exposure Limits for Frequencies < 6 GHz

| HUMAN EXPOSURE   | UNCONTROLLED ENVIRONMENT<br>General Population<br>(W/kg) or (mW/g) | CONTROLLED ENVIRONMENT<br>Occupational<br>(W/kg) or (mW/g) |
|--|--|--|
| SPATIAL PEAK SAR *<br>(Partial Body)                   | 1.6  | 8.0  |
| SPATIAL AVERAGE SAR **<br>(Whole Body)                 | 0.08   | 0.4  |
| SPATIAL PEAK SAR ***<br>(Hands / Feet / Ankle / Wrist) | 4.0  | 20.0   |

#### NOTES:

\* The Spatial Peak value of the SAR averaged over any 1 g of tissue (defined as a tissue volume in the shape of a cube) and over the appropriate averaging time.

\*\* The Spatial Average value of the SAR averaged over the whole-body.

\*\*\* The Spatial Peak value of the SAR averaged over any 10 g of tissue (defined as a tissue volume in the shape of a cube) and over the appropriate averaging time.

**Uncontrolled Environments** are defined as locations where there is the exposure of individuals who have no knowledge or control of their exposure. The general population/uncontrolled exposure limits are applicable to situations in which the general public may be exposed or in which persons who are exposed as a consequence of their employment may not be made fully aware of the potential for exposure or cannot exercise control over their exposure. Members of the general public would come under this category when exposure is not employment-related; for example, in the case of a wireless transmitter that exposes persons in its vicinity.

**Controlled Environments** are defined as locations where there is exposure that may be incurred by persons who are aware of the potential for exposure, (i.e. as a result of employment or occupation). In general, occupational/controlled exposure limits are applicable to situations in which persons are exposed as a consequence of their employment, who have been made fully aware of the potential for exposure and can exercise control over their exposure. This exposure category is also applicable when the exposure is of a transient nature due to incidental passage through a location where the exposure levels may be higher than the general population/uncontrolled limits, but the exposed person is fully aware of the potential for exposure and can exercise control over his or her exposure by leaving the area or by some other appropriate means.

### 1.2 RF Exposure Limits for Frequencies > 6 GHz

Per §1.1310 (d)(3), the MPE limits are applied for frequencies above 6 GHz. Power Density is expressed in units of W/m<sup>2</sup> or mW/cm<sup>2</sup>.

Peak Spatially Averaged Power Density was evaluated over a circular area of 4 cm<sup>2</sup> per interim FCC Guidance for near-field power density evaluations per October 2018 TCB Workshop notes

| Frequency range (MHz)                                   | Power density (mW/cm <sup>2</sup> ) | Averaging time (minutes) |
|---|-------------------------------------|--------------------------|
| (A) Limits for Occupational/Controlled Exposure         |                                     |                          |
| 1,500-100,000   | 5                                   | 6                        |
| (B) Limits for General Population/Uncontrolled Exposure |                                     |                          |
| 1,500-100,000   | 1                                   | 30                       |

### 1.3 Interim Guidance for Time Averaging

Per October 2018 TCB Workshop Notes, the below time-averaging windows can be used for assessing time-averaged exposures for devices that are capable of actively monitoring and adjusting power output over time to comply with exposure limits.

| Interim Guidance | Frequency (GHz) | Maximum Averaging Time (sec) |
|------------------|-----------------|------------------------------|
| SAR              | < 3             | 100                          |
|                  | 3 – 6           | 60                           |
| MPE              | 6 - 10          | 30                           |
|                  | 10 - 16         | 14                           |
|                  | 16 – 24         | 8                            |
|                  | 24 – 42         | 4                            |
|                  | 42 – 95         | 2                            |

## 2. Test Location

### 2.1 Test Laboratory

|              |   |
|--------------|---|
| Company Name | HCT Co., Ltd.   |
| Address      | 74, Seoicheon-ro 578beon-gil, Majang-myeon, Icheon-si, Gyeonggi-do, 17383 KOREA |
| Telephone    | 031-645-6300  |
| Fax.         | 031-645-6401  |

### 2.2 Test Facilities

Our laboratories are accredited and approved by the following approval agencies according to ISO/IEC 17025.

|       |   |
|-------|---|
| Korea | National Radio Research Agency (Designation No. KR0032) |
|       | KOLAS (Testing No. KT197)                               |

### 2.3 General Information of the EUT

|                  |                               |
|------------------|-------------------------------|
| Model Name       | SM-F741B                      |
| Equipment Type   | Mobile Phone                  |
| FCC ID           | A3LSMF741B                    |
| Application Type | Certification                 |
| Applicant        | SAMSUNG Electronics Co., Ltd. |

### 3. DEVICE UNDER TEST DESCRIPTION

#### 3.1 DUT specification

| Device Wireless specification overview |                |                             |
|--|----------------|-----------------------------|
| Band & Mode                            | Operating Mode | Tx Frequency                |
| GSM850                                 | Voice / Data   | 824.2 MHz ~ 848.8 MHz       |
| GSM1900                                | Voice / Data   | 1 850.2 MHz ~ 1 909.8 MHz   |
| UMTS Band 2                            | Voice / Data   | 1 852.4 MHz ~ 1 907.6 MHz   |
| UMTS Band 4                            | Voice / Data   | 1 712.4 MHz ~ 1 752.6 MHz   |
| UMTS Band 5                            | Voice / Data   | 826.4 MHz ~ 846.6 MHz       |
| LTE FDD Band 2 (PCS)                   | Voice / Data   | 1 850.7 MHz ~ 1 909.3 MHz   |
| LTE FDD Band 4 (AWS)                   | Voice / Data   | 1 710.7 MHz ~ 1 754.3 MHz   |
| LTE FDD Band 5 (Cell)                  | Voice / Data   | 824.7 MHz ~ 848.3 MHz       |
| LTE FDD Band 12                        | Voice / Data   | 699.7 MHz ~ 715.3 MHz       |
| LTE FDD Band 13                        | Voice / Data   | 779.5 MHz ~ 784.5 MHz       |
| LTE FDD Band 17                        | Voice / Data   | 706.5 MHz ~ 713.5 MHz       |
| LTE FDD Band 25                        | Voice / Data   | 1 850.7 MHz ~ 1 914.3 MHz   |
| LTE FDD Band 26                        | Voice / Data   | 814.7 MHz ~ 848.3 MHz       |
| LTE TDD Band 41                        | Voice / Data   | 2 498.5 MHz ~ 2 687.5 MHz   |
| LTE FDD Band 66 (AWS)                  | Voice / Data   | 1 710.7 MHz ~ 1 779.3 MHz   |
| NR FDD Band n2 (PCS)                   | Voice / Data   | 1 852.5 MHz ~ 1 907.5 MHz   |
| NR FDD Band n5                         | Voice / Data   | 826.5 MHz ~ 846.5 MHz       |
| NR FDD Band n25 (PCS)                  | Voice / Data   | 1 852.5 MHz ~ 1 912.5 MHz   |
| NR TDD Band n41                        | Voice / Data   | 2 501.01 MHz ~ 2 685 MHz    |
| NR FDD Band n66                        | Voice / Data   | 1 712.5 MHz ~ 1 777.5 MHz   |
| NR TDD Band n77                        | Voice / Data   | 3 705 MHz ~ 3 975 MHz       |
| NR TDD Band n77 DoD                    | Voice / Data   | 3 445.01 MHz ~ 3 544.98 MHz |
| U-NII-1                                | Voice / Data   | 5 180 MHz ~ 5 240 MHz       |
| U-NII-2A                               | Voice / Data   | 5 260 MHz ~ 5 320 MHz       |
| U-NII-2C                               | Voice / Data   | 5 500 MHz ~ 5 720 MHz       |
| U-NII-3                                | Voice / Data   | 5 745 MHz ~ 5 825 MHz       |
| U-NII-4                                | Voice / Data   | 5 845 MHz ~ 5 885 MHz       |
| U-NII-5                                | Voice / Data   | 5 925 MHz ~ 6 425 MHz       |
| U-NII-6                                | Voice / Data   | 6 425 MHz ~ 6 525 MHz       |
| U-NII-7                                | Voice / Data   | 6 525 MHz ~ 6 865 MHz       |
| U-NII-8                                | Voice / Data   | 6 865 MHz ~ 7 115 MHz       |
| 2.4 GHz WLAN                           | Voice / Data   | 2 412 MHz ~ 2 462 MHz       |
| Bluetooth / LE 5.3                     | Data           | 2 402 MHz ~ 2 480 MHz       |
| NFC                                    | Data           | 13.56 MHz                   |
| WPC                                    | Data           | 110 kHz ~ 148 kHz           |

|                       | Mode   | Serial Number      |
|-----------------------|--|--------------------|
| Device Serial Numbers | 2G/3G/4G 5G Sub 6 NR/WLAN/BT   | XCM0312M, XCM0309M |
|                       | The manufacturer has confirmed that the devices tested have the same physical, mechanical and thermal characteristics are within operational tolerances expected for production units. |                    |



**Measurement Plot Summary Table**

| Test Case# | Test Scenario  | Tech      | Band   | Antenna | DSI | Channel | Frequency | Plot No. |
|------------|--|-----------|--------|---------|-----|---------|-----------|----------|
| 1          | Time-varying Tx power transmission                       | LTE       | B25    | I       | 2   | 26590   | 1905      | 1        |
| 2          |  |           | B41    | I       | 2   | 40620   | 2593      | 2        |
| 3          |  | UMTS      | B2     | A       | 3   | 9538    | 1907.6    | 3        |
| 4          |  | GPRS      | 1900   | A       | 3   | 661     | 1880      | 4        |
| 5          |  | Sub6 NR   | n25    | I       | 3   | 376500  | 1882.5    | 5        |
| 6          |  |           | n77    | F       | 2   | 650000  | 3750      | 6        |
| 7          | Change in Call   | Sub6 NR   | n25    | I       | 3   | 376500  | 1882.5    | 7        |
| 8          | Tech/Band Switch   | LTE       | B25    | A       | 3   | 26590   | 1905      | 8        |
|            |  | UMTS      | B2     | A       | 3   | 9538    | 1907.6    |          |
| 9          | Inter Uplink CA Switch                                   | LTE       | B66    | A       | 3   | 132572  | 1770      | 9        |
|            |  |           | B12    | A       | 3   | 23095   | 707.5     |          |
| 10         | DSI Switch   | Sub6 NR   | n25    | I       | 3   | 376500  | 1882.5    | 10       |
|            |  |           | n25    | I       | 0   | 376500  | 1882.5    |          |
| 11         | Antenna Switch   | Sub6 NR   | n25    | I       | 3   | 376500  | 1882.5    | 11       |
|            |  |           | n25    | A       | 3   | 376500  | 1882.5    |          |
| 12         | Time Window  | Sub6 NR   | n77    | F       | 2   | 650000  | 3750      | 12, 13   |
|            |  |           | n41    | I       | 2   | 518598  | 2592.99   |          |
| 13         | SAR1 vs SAR2   | LTE       | B12    | A       | 3   | 23095   | 707.5     | 14       |
|            |  | Sub6 NR   | n25    | I       | 3   | 376500  | 1882.5    |          |
| 14         | Exposure category switch<br>Head to non-head to head     | Sub6 NR   | n77    | F       | 2   | 650000  | 3750      | 15       |
|            |  |           | n77    | F       | 3   | 662000  | 3930      |          |
| 15         | Exposure category switch<br>non-Head to head to non-head | Sub6 NR   | n25    | A       | 3   | 376500  | 1882.5    | 16       |
|            |  |           | n25    | A       | 2   | 376500  | 1882.5    |          |
| 16         | WLAN SAR vs SAR<br>(Dual Band Simultaneous mode)         | WLAN      | 2.4GHz | F       | 2   | 11      | 2462      | 17       |
|            |  | WLAN      | 5GHz   | F       | 2   | 169     | 5845      |          |
| 17         | WWAN+WLAN+BT<br>Continuity Test                          | LTE       | B25    | I       | 2   | 26590   | 1905      | 18       |
|            |  | WLAN      | 5GHz   | F       | 2   | 169     | 5845      |          |
|            |  | Bluetooth | 2.4GHz | F       | 2   | 79      | 2441      |          |

### 3.2 Test Under Dynamic Transmission Condition for RF Exposure Compliance

This feature performs time averaging algorithm in real time to control and manage transmitting power and ensure the time-averaged RF exposure is in compliance with FCC requirements all the time.

The Smart Transmit algorithm maintains the time-averaged transmit power, in turn, time-averaged RF exposure of SAR\_design\_target for sub 6 radio, below the predefined time averaged power limit for each characterized technology and band.

Smart Transmit allows the device to transmit at higher power instantaneously, as high as Pmax, when needed, but enforces power limiting to maintain time-averaged transmit power to Plimit for frequencies < 6 GHz and input.power.limit for frequencies > 6 GHz.

DUT Contains embedded file system(EFS) version 21 configured for second generation(GEN2) for Sub 6.

Note that the device uncertainty for sub 6GHz WWAN/WLAN/BT is 1.0dB for this DUT.

- o WLAN\_BT\_control: ON/OFF switch. ONLY applicable for Smart Transmit EFS version 19 (or higher). The EFS version 19 (or higher) provides the entry to manage Qualcomm WLAN/BT chipsets under Smart Transmit control. When selected 'ON', Smart Transmit will manage time averaged RF exposure from all WWAN/WLAN/BT radios. If selected "OFF", then WLAN and BT are the radios outside of Smart Transmit control.

- o Tx\_power\_at\_SAR\_design\_target (Plimit in dBm) for Tx transmitting frequency < 6 GHz The maximum time-average transmit power, in dBm, at which this radio configuration (i.e., band and technology) reaches the SAR\_design\_target. This SAR\_design\_target is pre determined for the specific device and it shall be less than regulatory SAR limit after accounting for all design related tolerances. The time-averaged SAR is assessed against this SAR\_design\_target in real time to determine the compliance. The Plimit could vary with technology, band, antenna and DSI (device state index), therefore it has the unique value for each technology, band, antenna and DSI.

The reserve margin for WWAN radios can be configured for each sub6 antenna group, and each exposure category as shown below:

For a given exposure category (head vs. non-head) and antenna group, OEM can configure:

- o TOTAL\_MIN\_RES\_RATIO

This entry corresponds to the minimum reserve margin for WWAN radio or WLAN radio when operating in standalone mode per antenna group. Here, TOTAL\_MIN\_RES\_RATIO is 0.5.

- o WWAN\_PRI\_SPLIT\_RATIO, WWAN\_SEC\_SPLIT\_RATIO, WLAN\_SPLIT\_RATIO

In multi-Tx scenarios in the same antenna group, minimum reserve for each active radio (i.e., WWAN primary radio, WWAN secondary radio, WLAN radio) is a product of the corresponding fraction out of sum of active radio split ratios and TOTAL\_MIN\_RES\_RATIO.

In case of WWAN primary and WWAN secondary simultaneous transmission in the same antenna group, the minimum reserve for each radio, respectively, are:

- o  $TOTAL\_MIN\_RES\_RATIO * \{WWAN\_PRI\_SPLIT\_RATIO / (WWAN\_PRI\_SPLIT\_RATIO + WWAN\_SEC\_SPLIT\_RATIO)\}$
- o  $TOTAL\_MIN\_RES\_RATIO * \{WWAN\_SEC\_SPLIT\_RATIO / (WWAN\_PRI\_SPLIT\_RATIO + WWAN\_SEC\_SPLIT\_RATIO)\}$

In case of WWAN primary and WLAN simultaneous transmission in the same antenna group, the minimum reserve for each radio, respectively, are:

- o  $TOTAL\_MIN\_RES\_RATIO * \{WWAN\_PRI\_SPLIT\_RATIO / (WWAN\_PRI\_SPLIT\_RATIO + WLAN\_SPLIT\_RATIO)\}$
- o  $TOTAL\_MIN\_RES\_RATIO * \{WLAN\_SPLIT\_RATIO / (WWAN\_PRI\_SPLIT\_RATIO + WLAN\_SPLIT\_RATIO)\}$

In case of WWAN primary, WWAN secondary and WLAN simultaneous transmission in the same antenna group, the minimum reserve for each radio, respectively, are:

- o  $TOTAL\_MIN\_RES\_RATIO * \{WWAN\_PRI\_SPLIT\_RATIO / (WWAN\_PRI\_SPLIT\_RATIO + WWAN\_SEC\_SPLIT\_RATIO + WLAN\_SPLIT\_RATIO)\}$
- o  $TOTAL\_MIN\_RES\_RATIO * \{WWAN\_SEC\_SPLIT\_RATIO / (WWAN\_PRI\_SPLIT\_RATIO + WWAN\_SEC\_SPLIT\_RATIO + WLAN\_SPLIT\_RATIO)\}$
- o  $TOTAL\_MIN\_RES\_RATIO * \{WLAN\_SPLIT\_RATIO / (WWAN\_PRI\_SPLIT\_RATIO + WWAN\_SEC\_SPLIT\_RATIO + WLAN\_SPLIT\_RATIO)\}$

Here, WWAN\_PRI\_SPLIT\_RATIO, WWAN\_SEC\_SPLIT\_RATIO and WLAN\_SPLIT\_RATIO are in linear units ranging between [0 1].

- o WLAN\_MARGIN\_IN\_MODEM\_APM When WWAN modem is turned off (say, in airplane mode – APM), then the RF exposure budget is split between WLAN and BT radios, where WLAN RF exposure budget is WLAN\_MARGIN\_IN\_MODEM\_APM and BT exposure budget is (1–WLAN\_MARGIN\_IN\_MODEM\_APM).

Here, WLAN\_MARGIN\_IN\_MODEM\_APM is in linear units ranging between [0 1].

- o BT (Bluetooth) Config BT\_STANDALONE: desired BT transmit power = (BT\_STANDALONE \* Plimit) in BT single radio transmission condition, where Plimit is BT Tx\_power\_at\_SAR\_design\_target in mW.

BT\_AND\_1\_RADIO\_SAME\_AG: reduced BT transmit power = (BT\_AND\_1\_RADIO\_SAME\_AG \* Plimit) in a two-radio transmission condition. Here, two radios (BT+WLAN or BT+WWAN) are in the same AG.

BT\_AND\_2+\_RADIO\_SAME\_AG: further reduced BT transmit power = (BT\_AND\_2+\_RADIO\_SAME\_AG \* Plimit) in a three (or more)-radio transmission condition.

Here, all radios, i.e., BT with 2 or more other radios (WWAN primary, WWAN secondary, WLAN), are in the same AG.

BT\_STANDALONE, BT\_AND\_1\_RADIO\_SAME\_AG and BT\_AND\_2+\_RADIO\_SAME\_AG are in linear units ranging between [0 1].

NOTE: NOTE: For BT, Pmax allocated by Smart Transmit  $\leq$  Plimit. In other words, BT allowed maximum power will be at one of the above 3 levels relative to Plimit depending on transmission scenarios as described above.

The equivalent reserve of Reserve\_power\_margin for Preserve calculation in v19 (or higher) EFS if WLAN/BT radios are under Smart Transmit control is (TOTAL\_MIN\_RES\_RATIO+BT\_AND\_2+\_RADIO\_SAME\_AG).

#### ■ input.power.limit (dBm) for Tx transmitting frequency $\geq$ 6 GHz

The maximum time-average power at the input of antenna element port, in dBm, at which each beam meets the PD\_design\_target that is less than the regulatory power density limit after accounting for all design related tolerances.

#### ■ Multi\_Tx\_factor: ONLY applicable for Smart Transmit EFS version 19 (or higher).

The EFS version 19 (or higher) provides the entry to improve performance of sub6 radios in simultaneous transmission scenarios.

With EFS version 19: In single Tx transmission scenarios, Smart Transmit ensures time-averaged RF exposure is  $\leq (SAR\_design\_target * 10(+ sub6 device uncertainty/10)) <$  regulatory RF exposure limit for sub6 radio managed by Smart Transmit. In simultaneous Tx transmission scenarios, Smart Transmit ensures time-averaged RF exposure is  $\leq (SAR\_design\_target * multi\_Tx\_factor * 10(+ sub6 device uncertainty/10)) <$  regulatory RF exposure limit for sub6 radios managed by Smart Transmit. These simultaneous transmission scenarios are listed below:

- 2-or-more radio scenarios within WWAN like EN-DC, LTE ULCA, etc.
- 2-or-more-radio across technologies such as WWAN+WLAN, WWAN+BT, WLAN+BT and WWAN+WLAN+BT transmission scenarios (if WLAN/BT radios are also managed by Smart Transmit).

The multi Tx factor can be determined using<sup>↵</sup>

$$multi\_Tx\_factor \leq \frac{\frac{regulatory\ SAR\ limit^{\dagger}}{SAR\_design\_target \times 10^{\frac{sub6\ device\ uncertainty\ (dB)}{10}}}}{reported\ SAR}$$

† regulatory SAR limit may be reduced to meet some specific requirement, e.g., antenna grouping.<sup>↵</sup>

**NOTE:** If only 2 WLAN radios are transmitting (e.g., 2.4GHz + 5GHz), then multi Tx factor is not applied by Smart Transmit.<sup>↵</sup>

**NOTE:** If WWAN modem is offline (i.e., in airplane mode), then multi Tx factor is not applied by Smart Transmit for WLAN and BT simultaneous transmission.<sup>↵</sup>

■ Hand exposure applicability when device held next to head: Yes/No switch. ONLY applicable for Smart Transmit EFS version 19 (or higher).

If “Yes” is selected in Smart Transmit EFS version 19 (or higher) for the country/region of interest, then Smart Transmit will ensure time-averaged RF exposure compliance in both hand and head tissue regions when device is held next to head in a voice call. Otherwise, if “No” is selected, then Smart Transmit will ensure time-averaged RF exposure compliance only in head tissue region when device is held next to head.

This purpose of the Part 2 report is to demonstrate the DUT complies with FCC RF exposure requirement under Tx varying transmission scenarios, thereby validity of Qualcomm® Smart Transmit feature implementation in this device. It serves to compliment the Part 0 and Part 1 Test Reports to justify compliance per FCC

All Part 2 tests of this device were conducted according to the guidelines of the Qualcomm document 80-W2112-5 Rev. YD

#### ■ Test case reduction for multiple filings

Per the Guidance of the FCC and Qualcomm (Document No: 80-W2112-5 Rev. YD, Sec.4.2,)

For multiple filings with same chipset, the test case reduction proposal for Part 2 testing is:

1. Full set of tests in the first filing, i.e., both power measurement and RF exposure measurement, are required.
2. For all subsequent filings with the same chipset, only power measurement (scenarios (a) – (i)) is required. In the case of scenario (a) time-varying Tx transmission test, only one band (instead of two bands) per technology is sufficient

#### ■ **Regulatory body configuration:**

Based on regulatory requirement for each countries/regions, FCC time window/limits and/or ICNIRP 1998 time window/limits can be selected and/or combined. Additionally, Time-Averaged Exposure mode or Peak Exposure mode can be selected based on MCC for Smart Transmit to operate. In Time-Averaged Exposure mode, the wireless device can instantaneously transmit at high transmit powers and exceed the Plimit for a short duration before limiting the power to maintain the time-averaged transmit power under the Plimit; while in Peak Exposure mode, the maximum instantaneous transmit power is limited to Plimit. Depending on EFS version, regulatory body configuration is different.

#### ■ **force peak for Tx transmitting frequency**

The Smart Transmit feature applies time-averaging windows when the device detects an MCC that matches Time-Averaged Exposure MCCs list. For each of the MCCs under Time-Averaged Exposure MCCs list, the Smart Transmit feature can limit either maximum peak power or maximum time-average power to Plimit per tech/band/antenna/DSI. If force peak is set to '1' for a given tech/band/antenna/DSI in the EFS, then the Smart Transmit feature limits the maximum Tx power to Plimit for the selected tech/band/antenna/DSI. In other words, with force peak set to '1', under static condition (i.e., fixed tech/band/antenna/DSI) and in single active Tx scenario, Smart Transmit can guarantee Tx power level of Plimit at all times.

The EFS Version of A3LF741B is EFS ver.21

This device was tested in part 2 of Tx Varying transmission(Time-Averaged Exposure mode) testing using US MCC (310).and MCC ,'1' was used to test the peak exposure mode.

## 4. Tx Varying Transmission Test Cases and Test Proposal

To validate time averaging feature and demonstrate the compliance in Tx varying transmission conditions, the following transmission scenarios are covered in Part 2 test:

1. During a time-varying Tx power transmission: To prove that the Smart Transmit feature accounts for Tx power variations in time accurately.
2. During a call disconnect and re-establish scenario: To prove that the Smart Transmit feature accounts for history of past Tx power transmissions accurately.
3. During technology/band handover: To prove that the Smart Transmit feature functions correctly during transitions in technology/band.
4. During DSI (Device State Index) change: To prove that the Smart Transmit feature functions correctly during transition from one device state (DSI) to another.
5. During antenna (or beam) switch: To prove that the Smart Transmit feature functions correctly during transitions in antenna (such as AsDiv scenario) or beams (different antenna array configurations).
6. During time window switch: To prove that the Smart Transmit feature correctly handles the transition from one time window to another specified by FCC, and maintains the normalized time-averaged RF exposure to be less than normalized FCC limit of 1.0 at all times.
7. SAR exposure switching between two active radios (radio1 and radio2): To prove that the Smart Transmit feature functions correctly and ensures total RF exposure compliance when exposure varies among SAR\_radio1 only, SAR\_radio1 + SAR\_radio2, and SAR\_radio2 only scenarios.
8. System level compliance continuity: To demonstrate the time averaged RF exposure compliance continuity during technology transition in both single-radio and multi-radio transmission scenarios and under both modes (i.e., ON and airplane) of WWAN modem.

NOTE: Technology in this test refers to WWAN, WLAN and/or Bluetooth

NOTE: For WWAN, theoretically, either sub6 radio or mmW radio can be selected for this system level compliance continuity test as Smart Transmit internal operation is identical. Thus, the test with either WWAN sub6 or mmW radio is sufficient. However, since FCC time average window for WWAN mmW NR is 4 seconds, to be more practical and feasible in actual measurement, sub6 WWAN radio is recommended to be selected for this test.

NOTE: As described in Section 2.3, BT allowed maximum power will be at one of the 3 levels populated in EFS depending on transmission scenarios, and BT's Pmax allocated by Smart Transmit is always  $\leq$  Plimit. Therefore, for 9.b), either WWAN or WLAN can be selected as a terrestrial network for demonstrating the compliance continuity during bidirectional transitions between non-terrestrial networks and terrestrial network. Test with one pair of terrestrial and non-terrestrial radios is sufficient as the continuity among all terrestrial technologies is covered and validated in 9.a).

As described in Part 0 report, the RF exposure is proportional to the Tx power for a SAR- and PD- characterized wireless device. Thus, feature validation in Part 2 can be effectively performed through conducted (for  $f < 6\text{GHz}$ ) and radiated (for  $f \geq 6\text{GHz}$ ) power measurement. Therefore, the compliance demonstration under dynamic transmission conditions and feature validation are done in conducted/radiated power measurement setup for transmission scenario 1 through 8.

■ Test case reduction for multiple filings

Per Qualcomm Document (80-W2112-5 Rev. YD ,Sec 4.2 , For Multiple variants which uses the same chipset. -the same chipset and Smart Transmit algorithm are used in the new model- the number of test cases in Part 2 can be reduced in the case of multiple filings using same chipset (post full part 2 test on the first filing), i.e., the essential test cases in power measurement are required to ensure the Smart Transmit performs as expected in the new design, but the RF exposure measurement can be excluded.

Furthermore, as described in Section 5.2.1of 80-W2112-5 Rev. YD, for scenario (a), two bands per technology are selected for time-varying Tx transmission test to provide high confidence. In this case, one band per technology can be considered as well to reduce test cases further.

The strategy for testing in Tx varying transmission condition is outlined as follows:

Demonstrate the total RF exposure averaged over FCC defined time windows does not exceed FCC's SAR and PD limits, through time-averaged power measurements

Measure conducted Tx power (for  $f < 6\text{GHz}$ ) versus time, and radiated Tx power (EIR P for  $f > 10\text{GHz}$ ) versus time.

Convert it into RF exposure and divide by respective FCC limits to get normalized exposure versus time.

Perform running time-averaging over FCC defined time windows.

Demonstrate that the total normalized time-averaged RF exposure is less than 1 for all transmission scenarios (i.e., transmission scenarios 1, 2, 3, 4, 5, 6, 7, and 8) at all times.

**Mathematical expression:**

– For sub-6 transmissions only:

$$1g\_or\_10gSAR(t) = \frac{conducted\_Tx\_power(t)}{conducted\_Tx\_power\_Plimit} * 1g\_or\_10gSAR\_Plimit \quad (1a)$$

$$\frac{\frac{1}{TSAR} \int_{t-TSAR}^t 1g\_or\_10gSAR(t) dt}{FCC\ SAR\ limit} \leq 1 \quad (1b)$$

– For sub-6+mmW transmission:

$$1g\_or\_10gSAR(t) = \frac{conducted\_Tx\_power(t)}{conducted\_Tx\_power\_Plimit} * 1g\_or\_10gSAR\_Plimit \quad (2a)$$

$$4cm^2PD(t) = \frac{radiated\_Tx\_power(t)}{radiated\_Tx\_power\_input\_power\_limit} * 4cm^2PD\_input\_power\_limit \quad (2b)$$

$$\frac{\frac{1}{TSAR} \int_{t-TSAR}^t 1g\_or\_10gSAR(t) dt}{FCC\ SAR\ limit} + \frac{\frac{1}{TPD} \int_{t-TPD}^t 4cm^2PD(t) dt}{FCC\ 4cm^2\ PD\ limit} \leq 1 \quad (2c)$$

where,  $conducted\_Tx\_power(t)$ ,  $conducted\_Tx\_power\_Plimit$ , and  $1g\_or\_10gSAR\_Plimit$  correspond to the measured instantaneous conducted Tx power, measured conducted Tx power at P<sub>limit</sub>, and measured 1gSAR or 10gSAR values at P<sub>limit</sub> corresponding to sub-6 transmission. Similarly,  $radiated\_Tx\_power(t)$ ,  $radiated\_Tx\_power\_input\_power\_limit$ , and  $4cm^2PD\_input\_power\_limit$  correspond to the measured instantaneous radiated Tx power, radiated Tx power at input.power.limit (i.e., radiated power limit), and 4cm<sup>2</sup>PD value at input.power.limit corresponding to mmW transmission. Both P<sub>limit</sub> and input.power.limit are the parameters pre-defined in Part 0 and loaded via Embedded File System (EFS) onto the EUT. TSAR is the FCC defined time window for sub-6 radio; TPD is the FCC defined time window for mmW radio.

Demonstrate the total RF exposure averaged over FCC defined time windows does not exceed FCC's SAR and PD limits, through time-averaged SAR and PD measurements. Note as mentioned earlier, this measurement is performed for transmission scenario 1 only.



For sub-6 transmissions only, measure instantaneous SAR versus time; for LTE+sub6 NR transmission, request low power (or all-down bits) on LTE so that measured SAR predominantly corresponds to sub6NR.

Convert it into RF exposure and divide by respective FCC limits to obtain normalized exposure versus time. Perform time averaging over FCC defined time window.

Demonstrate that the total normalized time-averaged RF exposure is less than 1 for transmission scenario 1 at all times.

**Mathematical expression:**

- For sub-6 transmission only:

$$1g\_or\_10gSAR(t) = \frac{pointSAR(t)}{pointSAR\_Plimit} * 1g\_or\_10gSAR(t)\_Plimit \quad (3a)$$

$$\frac{\frac{1}{T_{SAR}} \int_{t-T_{SAR}}^t 1g\_or\_10gSAR(t) dt}{FCC\ SAR\ limit} \leq 1 \quad (3b)$$

- For LTE+mmW transmission:

$$1g\_or\_10gSAR(t) = \frac{conducted\_Tx\_power(t)}{conducted\_Tx\_power\_Plimit} * 1g\_or\_10gSAR\_Plimit \quad (4a)$$

$$4cm^2PD(t) = \frac{[pointE(t)]^2}{[pointE\_input.power.limit]^2} * 4cm^2PD\_input.power.limit \quad (4b)$$

$$\frac{\frac{1}{T_{SAR}} \int_{t-T_{SAR}}^t 1g\_or\_10gSAR(t) dt}{FCC\ SAR\ limit} + \frac{\frac{1}{T_{PD}} \int_{t-T_{PD}}^t 4cm^2PD(t) dt}{FCC\ 4cm^2PD\ limit} \leq 1 \quad (4c)$$

where, pointSAR(t), PointSAR\_Plimit and 1g\_or\_10gSAR\_Plimit correspond to the measured instantaneous point SAR, measured point SAR at Plimit, and measured 1gSAR or 10gSAR values at Plimit corresponding to sub-

6transmission. Similarly, pointE(t), pointE\_input.power.limit and 4cm<sup>2</sup>PD\_input.power.limit correspond to the measured instantaneous E-field, E-field at input.power.limit, and 4cm<sup>2</sup>PD value at inputpower.limit corresponding to mmW transmission.

Note: DASy6 measurement system by Schmid & Partner Engineering AG (SPEAG) of Zurich, Switzerland measures relative E-field, and provides ratio of [pointE(t)]<sup>2</sup>/[pointE\_input.power.limit]<sup>2</sup> versus time

## 5. SAR Time Averaging Validation Test Procedures

This chapter provides the test plan and test procedure for validating Qualcomm Smart Transmit feature for sub-6 transmission. The 100 seconds time window for operating  $f < 3\text{GHz}$  is used as an example to detail the test procedures in this chapter. The same test plan and test procedures described in this chapter apply to 60 seconds time window for operating  $f \geq 3\text{GHz}$ .

### 5.1 Test sequence determination for validation

Following the FCC recommendation, two test sequences having time-variation in Tx power are predefined for sub-6 ( $f < 6\text{GHz}$ ) validation:

Test sequence 1: request EUT's Tx power to be at maximum power, measured  $P_{max}^{\dagger}$ , for 80s, then requesting for half of the maximum power, i.e., measured  $P_{max}/2$ , for the rest of the time.

Test sequence 2: request EUT's Tx power to vary with time. This sequence is generated relative to measured  $P_{max}$ , measured  $P_{limit}$  and calculated  $P_{reserve}$  (= measured  $P_{limit}$  in dBm -  $Reserve\_power\_margin$  in dB) of EUT based on measured  $P_{limit}$ .

NOTE: See Section 2.3, for EUT enabled with Smart Transmit EFS version 17 or lower,  $Reserve\_power\_margin$  (dB) is a global parameters and applies to all WWAN technologies.

For EUT enabled with Smart Transmit EFS version 18 (or higher):

$Reserve\_power\_margin$  (dB) =  $Reserve\_power\_margin\_db\_2g\_3g\_wwan$  for 2G and 3G WWAN technology;  
 $Reserve\_power\_margin$  (dB) =  $-10 \cdot \log_{10}(\text{total\_min\_exp\_budget\_linear\_4g\_5g\_wwan})$  for 4G and 5G technology.

The details for generating these two test sequences is described and listed in Appendix A.

NOTE: For test sequence generation, "measured  $P_{limit}$ " and "measured  $P_{max}$ " are used instead of the " $P_{limit}$ " specified in EFS entry and " $P_{max}$ " specified for the device, because Smart Transmit feature operates against the actual power level of the " $P_{limit}$ " that was calibrated for the EUT. The "measured  $P_{limit}$ " accurately reflects what the feature is referencing to, therefore, it should be used during feature validation testing. The RF tune up and device- to-device variation are already considered in Part 0 report prior to determining  $P_{limit}$ .

### 5.2 Test configuration selection criteria for validating Smart Transmit feature

For validating Smart Transmit feature, this section provides a general guidance to select test cases. In practice, an adjustment can be made in test case selection. The justification/clarification may be provided.

#### 5.2.1 Test configuration selection for time-varying Tx power transmission

The Smart Transmit time averaging feature operation is independent of bands, modes, and channels for a given technology. Hence, validation of Smart Transmit in one band/mode/channel per technology is sufficient. Two bands per technology are proposed and selected for this testing to provide high confidence in this validation.

The criteria for the selection are based on the  $P_{limit}$  values determined in Part 0 report. Select two bands\* in each supported technology that correspond to least\*\* and highest\*\*\*  $P_{limit}$  values that are less than  $P_{max}$  for validating Smart Transmit.

\*If one *Plimit* level applies to all the bands within a technology, then only one band needs to be tested. In this case, within the bands having the same *Plimit*, the radio configuration (e.g., # of RBs, channel#) and device position that correspond to the highest *measured* 1gSAR at *Plimit* shown in Part 1 report is selected.

\*\* In case of multiple bands having the same least *Plimit* within the technology, The "least *Plimit*" term also implies that the technology/band with the largest difference between Pmax and *Plimit* ( $Plimit < Pmax$ ) should be considered in the selection.

\*\*\* The band having a higher *Plimit* needs to be properly selected so that the power limiting enforced by Smart Transmit can be validated using the pre-defined test sequences. If the highest *Plimit* in a technology is too high where the power limiting enforcement is not needed when testing with the pre-defined test sequences, then the next highest level is checked. This process is continued within the technology until the second band for validation testing is determined.

### 5.2.2 Test configuration selection for change in call

The criteria to select a test configuration for call-drop measurement is:

Select technology/band with least *Plimit* among all supported technologies/bands, and select the radio configuration (e.g., # of RBs, channel#) in this technology/band that corresponds to the highest *measured* 1gSAR at *Plimit* listed in Part 1 report.

In case of multiple bands having same least *Plimit*, then select the band having the highest *measured* 1gSAR at *Plimit* in Part 1 report.

This test is performed with the EUT's Tx power requested to be at maximum power, the above band selection will result in Tx power enforcement (i.e., EUT forced to have Tx power at *Preserve*) for longest duration in one FCC defined time window. The call change (call drop/reestablish) is performed during the Tx power enforcement duration (i.e., during the time when EUT is forced to have Tx power at *Preserve*). One test is sufficient as the feature operation is independent of technology and band.

### 5.2.3 Test configuration selection for change in technology/band

The selection criteria for this measurement is, for a given antenna, to have EUT switch from a technology/band with lowest *Plimit* within the technology group (in case of multiple bands having the same *Plimit*, then select the band with highest *measured* 1gSAR at *Plimit*) to a technology/band with highest *Plimit* within the technology group, in case of multiple bands having the same *Plimit*, then select the band with lowest *measured* 1gSAR at *Plimit* in Part 1 report, or vice versa.

This test is performed with the EUT's Tx power requested to be at maximum power, the technology/band switch is performed during Tx power enforcement duration (i.e., during the time when EUT is forced to have Tx power at *Preserve*).

### 5.2.4 Test configuration selection for change in antenna

The criteria to select a test configuration for antenna switch measurement is:

Whenever possible and supported by the EUT, first select antenna switch configuration within the same technology/band (i.e., same technology and band combination) and having different *Plimit*, and having both  $Plimit < Pmax$  where possible. Otherwise, select at least one antenna having  $Plimit < Pmax$ .

In case of multiple bands having same difference in *Plimit* among supported antennas, then select the band having the highest *measured* 1gSAR at *Plimit* in Part 1 report.

This test is performed with the EUT's Tx power requested to be at maximum power in selected technology/band, and antenna change is conducted during Tx power enforcement duration (i.e., during the time when EUT is forced to have Tx power at *P<sub>reserve</sub>*).

### 5.2.5 Test configuration selection for change in DSI

The criteria to select a test configuration for DSI change test is  
Select a technology/band having the  $P_{limit} < P_{max}$  within any technology and DSI group, and for the same technology/band having a different  $P_{limit}$  in any other DSI group. Note that the selected DSI transition need to be supported by the device.

NOTE: The antennas corresponding to the selected DSIs should be in the same antenna group if EUT is configured with GEN2\_SUB6 or GEN2\_SUB6\_MMW, and selected DSIs should be under the same exposure category (i.e., both selected DSIs are either under head exposure category or under non-head exposure category) if EUT is enabled with Smart Transmit version 18 or higher.

This test is performed with the EUT's Tx power requested to be at maximum power in selected technology/band, and DSI change is conducted during Tx power enforcement duration (i.e., during the time when EUT is forced to have Tx power at *P<sub>reserve</sub>*).

### 5.2.6 Test configuration selection for change in time window

FCC specifies different time window for time averaging based on operation frequency. The criteria to select a test configuration for validating Smart Transmit feature and demonstrating the compliance during the change in time window is

Select any technology/band that has operation frequency classified in one-time window defined by FCC (such as 100-seconds time window), and its corresponding  $P_{limit}$  is less than  $P_{max}$  if possible.

Select the 2<sup>nd</sup> technology/band that has operation frequency classified in a different time window defined by FCC (such as 60-seconds time window), and its corresponding  $P_{limit}$  is less than  $P_{max}$  if possible.

it is preferred both  $P_{limit}$  values of two selected technologies/band less than corresponding  $P_{max}$ , but if not possible, at least one of technologies/bands has its  $P_{limit}$  less than  $P_{max}$ .

Note The antennas corresponding to the selected radio configurations for this test should be in the same antenna group if EUT is configured with GEN2\_SUB6 or GEN2\_SUB6\_MMW.

### 5.2.7 Test configuration selection for SAR exposure switching

If supported, the test configuration for SAR exposure switching should cover

1. SAR exposure switch when two active radios are in the same time window  
(a. LTE+sub6 NR, b. Inter-band ULCA, c. WLAN DBS)
2. SAR exposure switch when two active radios are in different time windows. One test with two active radios in any two different time windows is sufficient as Smart Transmit operation is the same for RF exposure switch in any combination of two different time windows. For device supporting LTE + mmW NR, this test is covered in SAR vs PD exposure switch validation.

The Smart Transmit time averaging operation is independent of the source of SAR exposure (for example, LTE vs. Sub6 NR) and ensures total time-averaged RF exposure compliance. Hence, validation of Smart Transmit in any one simultaneous SAR transmission scenario (i.e., one combination for LTE + Sub6 NR transmission) is

sufficient, where the SAR exposure varies among SARradio1 only, SARradio1 + SARradio2, and SARradio2 only scenarios.

The criteria to select a test configuration for validating Smart Transmit feature during SAR exposure switching scenarios is

-Select any two < 6GHz technologies/bands that the EUT supports simultaneous transmission (for example, LTE+Sub6NR).

- Among all supported simultaneous transmission configurations, the selection order is select one configuration where both  $P_{limit}$  of radio1 and radio2 is less than their corresponding  $P_{max}$ , preferably, with different  $P_{limits}$ . If this configuration is not available, then, select one configuration that has  $P_{limit}$  less than its  $P_{max}$  for at least one radio. If this cannot be found, then, select one configuration that has  $P_{limit}$  of radio1 and radio2 greater than  $P_{max}$  but with least  $(P_{limit} - P_{max})$  delta.

Test for one simultaneous transmission scenario is sufficient as the feature operation is the same.

### 5.2.8 Test configuration selection for exposure category switch

The criteria to select a test configuration for exposure category switch measurement is:

o If the device's intended exposure mode is configured for time averaged exposure mode operation, then:  
If  $P_{limit} < P_{max}$  for at least one radio out of all supported technology/band/antenna/DSI, then:

1) Out of all head exposure DSIs, select a technology/band/antenna/DSI having the least  $P_{limit}$  ( $< P_{max}$ ), furthermore, having the largest difference between  $P_{max}$  and  $P_{limit}$  ( $P_{limit} < P_{max}$ ) should be considered in the selection. Then, select a second DSI in the non-head exposure category DSI that has the least  $P_{limit}$  among all the non-head DSIs for the same technology/band/antenna. This technology/band/antenna and selected DSIs are used for head to non-head to head exposure switch test. If the  $P_{limit} > P_{max}$  for all supported technology/band/antenna/DSI in head exposure category, then this test is not required.

2) Similarly, out of all non-head exposure DSIs, select a technology/band/antenna/DSI having the least  $P_{limit}$  ( $< P_{max}$ ), furthermore, having the largest difference between  $P_{max}$  and  $P_{limit}$  ( $P_{limit} < P_{max}$ ) should be considered in the selection. Then, select a second DSI in the head exposure category DSI that has the least  $P_{limit}$  among all the head DSIs for the same technology/band/antenna. This technology/band/antenna and selected DSIs are used for nonhead to head to non-head exposure switch test. If the  $P_{limit} > P_{max}$  for all supported technology/band/antenna/DSI in non-head exposure category, then this test is not required.  
If  $P_{limit} > P_{max}$  for all supported technology/band/antenna/DSIs for both head and non-head DSI categories, then:

3) select a supported sub6 simultaneous transmission scenario (like LTE + FR1 NSA or FR1 interband NR-DC, etc.) in head DSI that has  $P_{limit} < P_{max} + 10 \cdot \log(N)$  for all radios of selected technology(s)/band(s)/antenna(s), where N is the number of active radios in selected sub6 simultaneous transmission scenario. Note that the antennas determined for the selected radios of simultaneous transmission scenario should be in the same antenna group if EUT is configured with GEN2\_SUB6 or GEN2\_SUB6\_MMW. Then, select a second DSI in the non-head exposure category that has the lowest  $P_{limit}$  among all the non-head DSIs for all the radios of the selected technology(s)/band(s)/antenna(s) simultaneous transmission scenario. This selected technology(s)/band(s)/antenna(s) and selected DSIs are used for head to non-head to head exposure switch test. If the head DSI has  $P_{limit} > P_{max} + 10 \cdot \log(N)$  for all radios supported in sub6 simultaneous transmission scenarios, then this test is not required.

4) select a supported sub6 simultaneous transmission scenario (like LTE + FR1 NSA, or FR1 interband NR-DC, etc.) in non-head DSI that has  $P_{limit} < P_{max} + 10 \cdot \log(N)$  for all radios of the selected technology(s)/band(s)/antenna(s), where N is the number of active radios in selected sub6 simultaneous transmission scenario.

Note that the antennas determined for the selected radios of simultaneous transmission scenario should be in the same antenna group if EUT is configured with GEN2\_SUB6 or GEN2\_SUB6\_MMW. Then, select a second DSI in the head exposure category that has the lowest  $P_{limit}$  among all the head DSIs for all the radios of the selected technology(s)/band(s)/antenna(s) simultaneous transmission scenario. This selected technology(s)/band(s)/antenna(s) and selected DSIs are used for non-head to head to non-head exposure switch test. If the non-head DSI has  $P_{limit} > P_{max} + 10 \cdot \log(N)$  for all radios supported in sub6 simultaneous transmission scenarios, then this test is not required.

Use the highest measured  $1g\_or\_10g$  SAR at  $P_{limit}$  ( $P_{limit} < P_{max}$ ) shown in Part 1 report for the selected tech/band/antenna/DSI out of all radio configurations and device positions in Equation (3a), (4a), (5a) and (6a) to calculate time-varying SAR. However, in the case of  $P_{limit} > P_{max}$ , the SAR measured in Part 1 report for the corresponding radio configuration selected and tested in Part 2 should be applied in Equation (3a), (4a), (5a) and (6a).

If the device's intended exposure mode is configured for peak exposure mode operation, then:

- 1) Select a supported sub6 simultaneous transmission scenario (like LTE + FR1 NSA, or FR1 interband NR-DC, etc.) in head DSI that has  $P_{limit} < P_{max} + 10 \cdot \log(N)$  for all radios of selected technology(s)/band(s)/antenna(s), where  $N$  is the number of active radios in selected sub6 simultaneous transmission scenario. Note that the antennas determined for the selected radios of simultaneous transmission scenario should be in the same antenna group if EUT is configured with GEN2\_SUB6 or GEN2\_SUB6\_MMW. Then, select a second DSI in the non-head exposure category that has the lowest  $P_{limit}$  among all the non-head DSIs for all the radios of the selected technology(s)/band(s)/antenna(s) simultaneous transmission scenario. This selected technology(s)/band(s)/antenna(s) and selected DSIs are used for head to non-head to head exposure switch test. If the head DSI has  $P_{limit} > P_{max} + 10 \cdot \log(N)$  for all radios supported in sub6 simultaneous transmission scenarios, then this test is not required.
- 2) Select a supported sub6 simultaneous transmission scenario (like LTE + FR1 NSA, or FR1 interband NR-DC, etc.) in non-head DSI that has  $P_{limit} < P_{max} + 10 \cdot \log(N)$  for all radios of the selected technology(s)/band(s)/antenna(s), where  $N$  is the number of active radios in selected sub6 simultaneous transmission scenario. Note that the antennas determined for the selected radios of simultaneous transmission scenario should be in the same antenna group if EUT is configured with GEN2\_SUB6 or GEN2\_SUB6\_MMW. Then,

select a second DSI in the head exposure category that has the lowest  $P_{limit}$  among all the head DSIs for all the radios of the selected technology(s)/band(s)/antenna(s) simultaneous transmission scenario. This selected technology(s)/band(s)/antenna(s) and selected DSIs are used for non-head to head to non-head exposure switch test. If the non-head DSI has  $P_{limit} > P_{max} + 10 \cdot \log(N)$  for all radios supported in sub6 simultaneous transmission scenarios, then this test is not required.

Use the highest measured  $1g\_or\_10g$  SAR at  $P_{limit}$  ( $P_{limit} < P_{max}$ ) shown in Part 1 report for the selected tech/band/antenna/DSI out of all radio configurations and device positions in Equation (3a), (4a), (5a) and (6a) to calculate time-varying SAR. However, in the case of  $P_{limit} > P_{max}$ , the SAR measured in Part 1 report for the corresponding radio configuration selected and tested in Part 2 should be applied in Equation (3a), (4a), (5a) and (6a).

### 5.2.9 Test configuration selection for system level compliance continuity

The purpose of system level compliance test is to demonstrate the compliance continuity in the following scenarios:

1. Across technology switch
2. During transition from single technology to multi-technology
3. In transition when WWAN went from ON to airplane mode
4. Active WLAN radio and/or Bluetooth (BT) radio with WWAN in airplane mode
5. Time window transition when WWAN in airplane mode

Note: Technology in this section refers to WWAN, WLAN or BT. The selection criteria for radios to be tested is to select a radio which has the largest  $P_{max}/P_{limit}$  ratio among all configurations supported (including SISO, MIMO, DBS, SISO+MIMO or DBS+MIMO whichever appropriate) within each technology and within the same antenna group.

### 5.3 Test procedures for conducted power measurements

This section provides general conducted power measurement procedures to perform compliance test under dynamic transmission scenarios described in Section 4. In practice, an adjustment can be made in these procedures. The justification/clarification may be provided.

#### 5.3.1 Time-varying Tx power transmission scenario

This test is performed with the two pre-defined test sequences described in Section 5.1 for all the technologies and bands selected in Section 5.2.1. The purpose of the test is to demonstrate the effectiveness of power limiting enforcement and that the time-averaged SAR (corresponding time-averaged Tx power) does not exceed the FCC limit at all times (see Eq. (1a) and (1b)).

#### Test procedure

1. Measure  $P_{max}$ , measure  $P_{limit}$  and calculate  $Reserve (= \text{measured } P_{limit} \text{ in dBm} - Reserve\_power\_margin \text{ in dB})$  and follow Section 5.1 to generate the test sequences for all the technologies and bands selected in Section 5.2.1. Both test sequence 1 and test sequence 2 are created based on measured  $P_{max}$  and measured  $P_{limit}$  of the EUT. Test condition to measure  $P_{max}$  and  $P_{limit}$  is:
  - Measure  $P_{max}$  with Smart Transmit disabled and callbox set to request maximum power.
  - Measure  $P_{limit}$  with Smart Transmit enabled and  $Reserve\_power\_margin$  set to 0 dB, callbox set to request maximum power.
2. Set  $Reserve\_power\_margin$  to actual (intended) value and reset power on EUT to enable Smart Transmit, establish radio link in desired radio configuration, with callbox requesting the EUT's Tx power to be at pre-defined test sequence 1, measure and record Tx power versus time, and then convert the conducted Tx power into 1gSAR or 10gSAR value (see Eq. (1a)) using measured  $P_{limit}$  from above Step 1. Perform running time average to determine time-averaged power and 1gSAR or 10gSAR versus time as illustrated in Figure 5-1 where using 100-seconds time window as an example.

**NOTE:** In Eq.(1a), instantaneous Tx power is converted into instantaneous 1gSAR or 10gSAR value by applying the measured worst-case 1gSAR or 10gSAR value at  $P_{limit}$  for the corresponding technology/band/antenna/DSI reported in Part 1 report.

**NOTE:** For an easier computation of the running time average, 0 dBm can be added at the beginning of the test sequences the length of the responding time window, for example, add 0dBm for 100-seconds so the running time average can be directly performed starting with the first 100-seconds data using excel spreadsheet. This technique applies to all tests performed in this Part 2 report for easier time-averaged computation using excel spreadsheet.

Figure 5-1 100s running average illustration

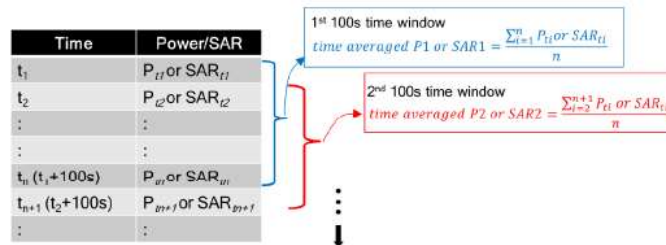

3. Make one plot containing:

- Instantaneous Tx power versus time measured in Step2,
- Requested Tx power used in Step 2 (test sequence1),
- Computed time-averaged power versus time determined in Step2,
- Time-averaged power limit (corresponding to FCC SAR limit of 1.6 W/kg for 1gSAR or 4.0W/kg for 10gSAR) given by

$$Time\ averaged\ power\ limit = meas.P_{limit} + 10 \times \log\left(\frac{FCC\ SAR\ limit}{meas.SAR\_Plimit}\right) \quad (5a)$$

where  $meas. P_{limit}$  and  $meas. SAR\_Plimit$  correspond to measured power at  $P_{limit}$  and measured SAR at  $P_{limit}$ .

4. Make another plot containing:

- Computed time-averaged 1gSAR or 10gSAR versus time determined in Step2
  - FCC  $1gSAR_{limit}$  of 1.6W/kg or FCC  $10gSAR_{limit}$  of 4.0W/kg.
- Repeat Steps 2 ~ 4 for pre-defined test sequence 2 and replace the requested Tx power (test sequence 1) in Step 2 with test sequence2.
  - Repeat Steps 2 ~ 5 for all the selected technologies and bands.

The validation criteria are, at all times, the time-averaged power versus time shown in Step 3 plot shall not exceed the time-averaged power limit (defined in Eq. (5a)), in turn, the time-averaged 1gSAR or 10gSAR versus time shown in Step 4 plot shall not exceed the FCC limit of 1.6 W/kg for 1gSAR or 4.0 W/kg for 10gSAR (i.e., Eq. (1b)).



### 5.3.2 Change in call scenario

This test is to demonstrate that Smart Transmit feature accurately accounts for the past Tx powers during time-averaging when a new call is established.

The call disconnects and re-establishment needs to be performed during power limit enforcement, i.e., when the EUT's Tx power is at *Preserve* level, to demonstrate the continuity of RF exposure management and limiting in call change scenario. In other words, the RF exposure averaged over any FCC defined time window (including the time windows containing the call change) doesn't exceed FCC limit of 1.6 W/kg for 1gSAR or 4.0 W/kg for 10gSAR.

#### Test procedure

1. Measure *P<sub>limit</sub>* for the technology/band selected in Section 5.2.2. Measure *P<sub>limit</sub>* with Smart Transmit enabled and *Reserve\_power\_margin* set to 0 dB, callbox set to request maximum power.
2. Set *Reserve\_power\_margin* to actual (intended) value and reset power on EUT to enable Smart Transmit.
3. Establish radio link with callbox in the selected technology/band.
4. Request EUT's Tx power at 0 dBm for at least one time window specified for the selected technology/band, followed by requesting EUT's Tx power to be at maximum power for about ~60 seconds, and then drop the call for ~10 seconds. Afterwards, re-establish another call in the same radio configuration (i.e., same technology/band/channel) and continue callbox requesting EUT's Tx power to be at maximum power for the remaining time of at least another full duration of the specified time window. Measure and record Tx power versus time. Once the measurement is done, extract instantaneous Tx power versus time, convert the measured conducted Tx power into 1gSAR or 10gSAR value using Eq. (1a), and then perform the running time average to determine time-averaged power and 1gSAR or 10gSAR versus time.

**NOTE:** In Eq.(1a), instantaneous Tx power is converted into instantaneous 1gSAR or 10gSAR value by applying the measured worst-case 1gSAR or 10gSAR value at *P<sub>limit</sub>* for the corresponding technology/band/antenna/DSI reported in Part 1 report.

5. Make one plot containing: (a) instantaneous Tx power versus time, (b) requested power, (c) computed time-averaged power, (d) time-averaged power limit calculated using Eq.(5a).
6. Make another plot containing: (a) computed time-averaged 1gSAR or 10gSAR versus time, and (b) FCC limit of 1.6 W/kg for 1gSAR or 4.0 W/kg for 10gSAR.

The validation criteria are, at all times, the time-averaged power versus time shall not exceed the time-averaged power limit (defined in Eq.(5a)), in turn, the time-averaged 1gSAR or 10gSAR versus time shall not exceed the FCC limit of 1.6 W/kg for 1gSAR or 4.0 W/kg for 10gSAR (i.e., Eq. (1b)).

### 5.3.3. Change in technology and band

This test is to demonstrate the correct power control by Smart Transmit during technology switches and/or band handovers.

Similar to the change in call test in Section 5.2.3, to validate the continuity of RF exposure limiting during the transition, the technology and band handover needs to be performed when EUT's Tx power is at *Preserve* level (i.e., during Tx power enforcement) to make sure that the EUT's Tx power from previous *Preserve* level to the new *Preserve* level (corresponding to new technology/band). Since the *P<sub>limit</sub>* could vary with technology and band, Eq. (1a) can be written as follows to convert the instantaneous Tx power in 1gSAR or 10gSAR exposure for the two given radios, respectively:

$$1g\_or\_10gSAR_1(t) = \frac{conducted\_Tx\_power\_1(t)}{conducted\_Tx\_power\_P_{limit\_1}} * 1g\_or\_10gSAR\_P_{limit\_1} \quad (6a)$$

$$1g\_or\_10gSAR_2(t) = \frac{conducted\_Tx\_power\_2(t)}{conducted\_Tx\_power\_P_{limit\_2}} * 1g\_or\_10gSAR\_P_{limit\_2} \quad (6b)$$

$$\frac{1}{T_{SAR}} \left[ \int_{t-T_{SAR}}^{t_1} \frac{1g\_or\_10gSAR_1(t)}{FCC\ SAR\ limit} dt + \int_{t-T_{SAR}}^t \frac{1g\_or\_10gSAR_2(t)}{FCC\ SAR\ limit} dt \right] \leq 1 \quad (6c)$$

where,  $conducted\_Tx\_power\_1(t)$ ,  $conducted\_Tx\_power\_Plimit\_1$ , and  $1g\_or\_10gSAR\_Plimit\_1$  correspond to the measured instantaneous conducted Tx power, measured conducted Tx power at  $Plimit$ , and measured  $1gSAR$  or  $10gSAR$  value at  $Plimit$  of technology1/band1;  $conducted\_Tx\_power\_2(t)$ ,  $conducted\_Tx\_power\_Plimit\_2(t)$ , and  $1g\_or\_10gSAR\_Plimit\_2$  correspond to the measured instantaneous conducted Tx power, measured conducted Tx power at  $Plimit$ , and measured  $1gSAR$  or  $10gSAR$  value at  $Plimit$  of technology2/band2. Transition from technology1/band1 to the technology2/band2 happens at time-instant  $t$ .

#### Test procedure

1. Measure  $Plimit$  for both the technologies and bands selected in Section 5.2.3. Measure  $Plimit$  with Smart Transmit enabled and  $Reserve\_power\_margin$  set to 0 dB, callbox set to request maximum power.
2. Set  $Reserve\_power\_margin$  to actual (intended) value and reset power on EUT to enable Smart Transmit
3. Establish radio link with callbox in first technology/band selected.
4. Request EUT's Tx power at 0 dBm for at least one time window specified for the selected technology/band, followed by requesting EUT's Tx power to be at maximum power for about ~60 seconds, and then switch to second technology/band selected. Continue with callbox requesting EUT's Tx power to be at maximum power for the remaining time of at least another full duration of the specified time window. Measure and record Tx power versus time for the full duration of the test.
5. Once the measurement is done, extract instantaneous Tx power versus time, and convert the conducted Tx power into  $1gSAR$  or  $10gSAR$  value using Eq. (6a) and (6b) and corresponding measured  $Plimit$  values from Step 1 of this section. Perform the running time average to determine time-averaged power and  $1gSAR$  or  $10gSAR$  versus time.

**NOTE:** In Eq.(6a) & (6b), instantaneous Tx power is converted into instantaneous  $1gSAR$  or  $10gSAR$  value by applying the measured worst-case  $1gSAR$  or  $10gSAR$  value at  $Plimit$  for the corresponding technology/band/antenna/DSI reported in Part 1 report.

6. Make one plot containing: (a) instantaneous Tx power versus time, (b) requested power, (c) computed time-averaged power, (d) time-averaged power limit calculated using Eq.(5a).
7. Make another plot containing: (a) computed time-averaged  $1gSAR$  or  $10gSAR$  versus time, and (b) FCC limit of 1.6 W/kg for  $1gSAR$  or 4.0 W/kg for  $10gSAR$ .

The validation criteria are, at all times, the time-averaged  $1gSAR$  or  $10gSAR$  versus time shall not exceed the FCC limit of 1.6 W/kg for  $1gSAR$  or 4.0 W/kg for  $10gSAR$  (i.e., Eq. (6c)).

### 5.3.4 Change in antenna

This test is to demonstrate the correct power control by Smart Transmit during antenna switches from one antenna to another. The test procedure is identical to Section 5.2.4, by replacing technology/band switch operation with antenna switch. The validation criteria are, at all times, the time-averaged 1gSAR or 10gSAR versus time shall not exceed FCC limit of 1.6 W/kg for 1gSAR or 4.0 W/kg for 10gSAR.

### 5.3.5 Change in DSI

This test is to demonstrate the correct power control by Smart Transmit during DSI switches from one DSI to another. The test procedure is identical to Section 5.2.5, by replacing technology/band switch operation with DSI switch. The validation criteria are, at all times, the time-averaged 1gSAR or 10gSAR versus time shall not exceed FCC limit of 1.6 W/kg for 1gSAR or 4.0 W/kg for 10gSAR.

### 5.3.6 Change in time window

This test is to demonstrate the correct power control by Smart Transmit during the change in averaging time window when a specific band handover occurs. FCC specifies time-averaging windows of 100s for Tx frequency < 3GHz, and 60s for Tx frequency between 3GHz and 6GHz.

To validate the continuity of RF exposure limiting during the transition, the band handover test needs to be performed when EUT handovers from operation band less than 3GHz to greater than 3GHz and vice versa. The equations (3a) and (3b) in Section 4 can be written as follows for transmission scenario having change in time window,

$$1gSAR_1(t) = \frac{\text{conducted\_Tx\_power\_1}(t)}{\text{conducted\_Tx\_power\_Plimit\_1}} * 1g\_or\ 10g\_SAR\_Plimit\_1 \quad (7a)$$

$$1gSAR_2(t) = \frac{\text{conducted\_Tx\_power\_2}(t)}{\text{conducted\_Tx\_power\_Plimit\_2}} * 1g\_or\ 10g\_SAR\_Plimit\_2 \quad (7b)$$

$$\frac{1}{T1SAR} \left[ \int_{t-T1SAR}^{t_1} \frac{1g\_or\ 10g\_SAR_1(t)}{FCC\ SAR\ limit} dt \right] + \frac{1}{T2SAR} \left[ \int_{t-T2SAR}^t \frac{1g\_or\ 10g\_SAR_2(t)}{FCC\ SAR\ limit} dt \right] \leq 1 \quad (7c)$$

where, *conducted\_Tx\_power\_1(t)*, *conducted\_Tx\_power\_Plimit\_1*, and *1g\_or 10g\_SAR\_Plimit\_1* correspond to the instantaneous Tx power, conducted Tx power at *Plimit* and compliance *1g\_or 10g\_SAR* values at *Plimit\_1* of band1 with time-averaging window '*T1SAR*'; *conducted\_Tx\_power\_2(t)*, *conducted\_Tx\_power\_Plimit\_2*, and *1g\_or 10g\_SAR\_Plimit\_2* correspond to the instantaneous Tx power, conducted Tx power at *Plimit* and compliance *1g\_or 10g\_SAR* values at *Plimit\_2* of band2 with time-averaging window '*T2SAR*'. One of the two bands is less than 3GHz, another is greater than 3GHz. Transition from first band with time-averaging window '*T1SAR*' to the second band with time-averaging window '*T2SAR*' happens at time-instant '*t1*'.

### Test procedure

1. Measure  $P_{limit}$  for both the technologies and bands selected in Section 5.2.6. Measure  $P_{limit}$  with Smart Transmit enabled and  $Reserve\_power\_margin$  set to 0 dB, callbox set to request maximum power.
2. Set  $Reserve\_power\_margin$  to actual (intended) value and enable Smart Transmit

### Transition from 100s time window to 60s time window, and vice versa

3. Establish radio link with callbox in the technology/band having 100s time window selected in Section 5.2.6.
4. Request EUT's Tx power to be at 0 dBm for at least 100 seconds, followed by requesting EUT's Tx power to be at maximum power for about ~140 seconds, and then switch to second technology/band (having 60s time window) selected in Section 5.2.6. Continue with callbox requesting EUT's Tx power to be at maximum power for about ~60s in this second technology/band, and then switch back to the first technology/band. Continue with callbox requesting EUT's Tx power to be at maximum power for at least another 100s. Measure and record Tx power versus time for the entire duration of the test.
5. Once the measurement is done, extract instantaneous Tx power versus time, and convert the conducted Tx power into 1gSAR or 10gSAR value (see Eq. (7a) and (7b)) using corresponding technology/band Step 1 result, and then perform 100s running average to determine time-averaged 1gSAR or 10gSAR versus time. Note that in Eq.(7a) & (7b), instantaneous Tx power is converted into instantaneous 1gSAR or 10gSAR value by applying the worst-case 1gSAR or 10gSAR value tested in Part 1 for the selected technologies/bands at  $P_{limit}$ .
6. Make one plot containing: (a) instantaneous Tx power versus time measured in Step4.
7. Make another plot containing: (a) instantaneous 1gSAR versus time determined in Step 5, (b) computed time-averaged 1gSAR versus time determined in Step 5, and (c) corresponding regulatory  $1gSAR_{limit}$  of 1.6W/kg or  $10gSAR_{limit}$  of 4.0W/kg.

### Transition from 60s time window to 100s time window, and vice versa

8. Establish radio link with callbox in the technology/band having 60s time window selected in Section 5.2.6.
9. Request EUT's Tx power to be at 0 dBm for at least 60 seconds, followed by requesting EUT's Tx power to be at maximum power for about ~80 seconds, and then switch to second technology/band (having 100s time window) selected in Section 5.2.6. Continue with callbox requesting EUT's Tx power to be at maximum power for about ~100s in this second technology/band, and then switch back to the first technology/band. Continue with callbox requesting EUT's Tx power to be at maximum power for the remaining time for a total test time of 500 seconds. Measure and record Tx power versus time for the entire duration of the test.
10. Repeat above Step 5~7 to generate the plots

The validation criteria is, at all times, the time-averaged 1gSAR or 10gSAR versus time shall not exceed the regulatory  $1gSAR_{limit}$  of 1.6W/kg or  $10gSAR_{limit}$  of 4.0W/kg.

### 5.3.7 SAR exposure switching

This test is to demonstrate that Smart Transmit feature accurately accounts for switching in exposures among SAR from radio1 only, SAR from both radio1 and radio2, and SAR from radio2 only scenarios, and ensures total time-averaged RF exposure complies with the FCC limit. The detailed test procedure for SAR exposure switching in the case of LTE+Sub6 NR non- standalone mode transmission scenario is provided in Appendix B.2.

#### Test procedure:

1. Measure conducted Tx power corresponding to  $P_{limit}$  for radio1 and radio2 in selected band. Test condition to measure conducted  $P_{limits}$ :
  - Establish device in call with the callbox for radio1 technology/band. Measure conducted Tx power corresponding to radio1  $P_{limit}$  with Smart Transmit enabled and  $Reserve\_power\_margin$  set to 0 dB, callbox set to request maximum power.
  - Repeat above step to measure conducted Tx power corresponding to radio2  $P_{limit}$ . If radio2 is dependent on radio1 (for example, non-standalone mode of Sub6 NR requiring radio1 LTE as anchor), then establish radio1 + radio2 call with callbox, and request all down bits for radio1 LTE. In this scenario, with callbox requesting maximum power from radio2 Sub6 NR, measured conducted Tx power corresponds to radio2  $P_{limit}$  (as radio1 LTE is at all-downbits)
2. Set  $Reserve\_power\_margin$  to actual (intended) value, with EUT setup for radio1 + radio2 call. In this description, it is assumed that radio2 has lower priority than radio1. Establish device in radio1+radio2 call, and request all-down bits or low power on radio1, with callbox requesting EUT's Tx power to be at maximum power in radio2 for at least one time window. After one time window, set callbox to request EUT's Tx power to be at maximum power on radio1, i.e., all-up bits. Continue radio1+radio2 call with both radios at maximum power for at least one time window, and drop (or request all-down bits on) radio2. Continue radio1 at maximum power for at least one time window. Record the conducted Tx power for both radio1 and radio2 for the entire duration of this test.
3. Once the measurement is done, extract instantaneous Tx power versus time for both radio1 and radio2 links. Convert the conducted Tx power for both these radios into 1gSAR or 10gSAR value (see Eq. (6a) and (6b)) using corresponding technology/band  $P_{limit}$  measured in Step 1, and then perform the running time average to determine time-averaged 1gSAR or 10gSAR versus time.
4. Make one plot containing: (a) instantaneous Tx power versus time measured in Step2.
5. Make another plot containing: (a) instantaneous 1gSAR versus time determined in Step 3, (b) computed time-averaged 1gSAR versus time determined in Step 3, and (c) corresponding regulatory  $1gSAR_{limit}$  of 1.6W/kg or  $10gSAR_{limit}$  of 4.0W/kg.

The validation criteria is, at all times, the time-averaged 1gSAR or 10gSAR versus time shall not exceed the regulatory  $1gSAR_{limit}$  of 1.6W/kg or  $10gSAR_{limit}$  of 4.0W/kg.

### 5.3.8 Exposure category switch

This test is performed with the EUT being requested to transmit at maximum power in selected technology/band/antenna/DSI. The change in exposure category is preferably performed during Tx power enforcement (i.e., EUT forced to transmit at a sustainable level). One test is sufficient as this feature operation is independent of technology, band and antenna. Test procedure are:

In case of head to non-head to head exposure switch test, 'first DSI' in below test procedure refers to head DSI and 'second DSI' refers to non-head DSI. Similarly, in case of non-head to head to non-head exposure switch test, 'first DSI' in below test procedure refers to non-head DSI and 'second DSI' refers to head DSI.

1. Measure Plimit for all the technology(s)/band(s)/antenna(s)/DSI(s) selected following the above selection criteria. Measure Plimit with Smart Transmit Peak exposure mode enabled and callbox set to request maximum power.
2. Set EUT to intended Smart Transmit exposure mode.
3. Establish radio link with first DSI and with callbox in the selected technology(s)/band(s)/antenna(s).
4. Request EUT to transmit at 0 dBm for at least 100 seconds, followed by requesting EUT to transmit at maximum Tx power for the active radio(s) for half of the regulatory time window, and then switch to the second DSI for ~10s, and switch back to the first DSI for at least one time window. Throughout this test, when switching between DSIs (i.e., switching between exposure categories), continue with callbox requesting EUT to transmit at maximum Tx power for the active radio(s). Measure and record Tx power versus time for the entire duration of the test.
5. Once the measurement is done, extract instantaneous Tx power versus time, and convert the conducted Tx power into 1g\_or\_10gSAR value (see Eq. (7a) and (7b)) using the corresponding Plimit measured in Step 1 and 1g\_or\_10gSAR value measured in 80-W2112-4 Part 1 report, and then perform 100s running average to determine time-averaged 1g\_or\_10gSAR versus time as illustrated in Figure 5-1. Note that in Eq.(7a) & (7b), instantaneous Tx power is converted into instantaneous 1g\_or\_10gSAR value by applying the worstcase 1gSAR value for the selected technologies/bands at Plimit as reported in 80-W2112-4 Part 1 report.
6. Make one plot containing: (a) computed time-averaged normalized 1g\_or\_10gSAR of the selected technology(s)/band(s)/antenna(s) versus time determined in Step 5 for exposure under first DSI, (b) total time-averaged normalized exposure for exposure under first DSI if simultaneous transmission scenario was tested, and (c) normalized regulatory limit of 1.0.
7. Make another plot containing: (a) computed time-averaged 1g\_or\_10gSAR of the selected technology(s)/band(s)/antenna(s) versus time determined in Step 5 for exposure under second DSI, (b) total time-averaged normalized exposure for exposure under second DSI if simultaneous transmission scenario was tested, and (c) normalized regulatory limit of 1.0.

The validation criteria is, at all times, the time-averaged normalized exposure versus time shall not exceed the normalized limit of 1.0 for both first & second DSIs (i.e., both head exposure category and non-head exposure category)

### 5.3.9 Tests for WLAN/BT radios if under time averaged RF exposure control

If WLAN/BT radios are enabled to be under time-averaged RF exposure control, then the tests described in this Appendix need to be verified for time average RF exposure compliance. Qualcomm Smart Transmit EFS version 19 (or higher) supports Qualcomm WLAN/BT radios inside Smart Transmit. If Qualcomm WLAN/BT radios are configured in the EFS version 19 (or higher) to be managed under Smart Transmit control, then time-averaged RF exposure compliance for WLAN and BT radios needs to be verified. In this regard, with EFS version 19, Smart Transmit does not allow instantaneous Tx power of BT radio to exceed P<sub>limit</sub> at any time instance, therefore, BT is NOT needed to be included in all single Tx scenarios tested in Part 2 tests in this document.

On the other hand, with WLAN configured for time-averaging, the transmission scenarios described in Section 5.2 should be tested and included in Part 2 tests, i.e.,

1. Section 5.2 transmission scenario #1: Time-varying Tx power tests described in Section 5.2.1 and 5.3.1 using test sequences described in Appendix A.1. The Smart Transmit time averaging operation is independent of bands, modes, and channels for a given technology. Hence, validation of Smart Transmit in one band/mode/channel per technology is sufficient. Two bands per technology (in this case, WLAN) are proposed and selected for this testing to provide high confidence in this validation.
2. Section 5.2 transmission scenario #2/3/4/5/6: Include WLAN radios in test configuration selection for tests in Section 5.2.2, 5.2.3, 5.2.4, 5.2.5 and 5.2.6. If WLAN radio(s) is selected based on the selection criteria described in Section 5.2, then the corresponding test should be performed with selected WLAN radio following the test procedures described in Section 5.3, otherwise, no additional test is required for WLAN radio for those transmission scenarios.
3. Section 5.2 transmission scenario #7: Similar to the SAR exposure switch test described in Section 5.2.7 for WWAN, an additional SAR switch test for WLAN radios is required to demonstrate the total exposure is compliant in simultaneous WLAN transmission scenarios. Note that this test is in addition to SAR switch test performed for WWAN radios.

### 5.3.10 Switch in SAR exposure between WLAN transmitters

This test is to demonstrate that Smart Transmit feature accurately accounts for switching in exposures among SAR for single WLAN radio, simultaneous WLAN radio & back to single WLAN radio, and ensures total time-averaged RF exposure compliance with FCC limit. This test is similar to SAR exposure switch tests for WWAN radios.

In test setup, the isolation between WLAN radio1 and WLAN radio2 should be 20dB or higher for this test. Test configuration selection criteria: Among all supported simultaneous transmission configurations, the selection order is

1. Select SISO configurations where both P<sub>limit</sub> of radio1 and radio2 is less than their corresponding P<sub>max</sub>. If this configuration is not available, then,
2. Select one SISO configuration that has P<sub>limit</sub> less than its P<sub>max</sub> for at least one radio. If this cannot be found, then,

3. Select MIMO configurations where both MIMO Plimit of radio1 and MIMO Plimit of radio2 is less than their corresponding Pmax. If this configuration is not available, then,
4. Select one MIMO configuration that has MIMO Plimit less than its Pmax for at least one radio. If this cannot be found, then,
5. Select MIMO configurations with least MIMO Plimit for both radio1 and radio2. The test for SAR exposure switch for WLAN radios is not required if  $\text{MIMO Plimit} > \text{Pmax} + 3\text{dB}$  for both radio configurations.

NOTE: The antennas corresponding to the selected radio configurations for this test should be in the same antenna group if EUT is configured with GEN2\_SUB6 or GEN2\_SUB6\_MMW.

Test procedure:

1. Measure Plimit for WLAN radio1 and WLAN radio2 in selected band. Test condition to measure conducted Plimit is:  
Establish a WLAN call in desired radio1 configuration. Measure conducted Tx power corresponding to WLAN radio1 Plimit with Smart Transmit Peak exposure mode enabled and callbox set to request maximum duty cycle.

Repeat above step to measure Plimit corresponding to WLAN radio2 configuration.

2. Set EUT to the intended Smart Transmit exposure mode. First, establish WLAN connection with the callbox in radio2 configuration at low duty cycle for one time window. After one time window, request radio2 configuration to transmit at maximum duty cycle for more than one time-window duration to test predominantly radio2 SAR exposure scenario. After at least one time-window, add radio1 configuration to the existing radio2 configuration call, and request both radio1 and radio2 to transmit at maximum duty cycle to test radio1 and radio2 SAR exposure scenario. After at least one more time-window, drop (or request low duty cycle) radio2 configuration to test predominantly radio1 SAR exposure scenario. Continue the test for at least one more time-window. Record the conducted Tx powers for both radio1 and radio2 configurations for the entire duration of this test.
3. Once the measurement is done, extract instantaneous Tx power versus time for both radio1 and radio2 configurations. Similar to technology/band switch test in Section 5.3.3, convert the conducted Tx power for both these radios into 1g\_or\_10gSAR value (see Eq. (7a) and (7b)) using corresponding technology/band Plimit measured in Step 1, and then perform 30s running average to determine time-averaged 1g\_or\_10gSAR versus time as illustrated in Figure 5-1. Note that here all WLAN bands are averaged over the same time window (i.e., 30s for FCC, 360s for ICNIRP) inside Smart Transmit.
4. Make one plot containing: (a) computed normalized time-averaged 1g\_or\_10gSAR for radio1 configuration versus time determined in Step 3, (b) computed normalized time-averaged 1g\_or\_10gSAR for radio2 configuration versus time determined in Step 3, (c) computed total normalized time-averaged 1g\_or\_10gSAR versus time (sum of Steps (4.a) and (4.b)) determined in Step 3, and (d) corresponding normalized regulatory 1g\_or\_10gSARlimit limit of 1.0.

The validation criteria is, at all times, the time-averaged 1g\_or\_10gSAR versus time shall not exceed the regulatory 1g\_or\_10gSARlimit limit.



### 5.3.11 System level compliance continuity

Below is the test flow outline of the system level compliance test. The test contains 6 sections and 5 transitions: Start with WWAN radio transmission (Section A), transition to WLAN transmission (Section B), transition to simultaneous transmission of WWAN + WLAN + BT (Section C), then drop off WWAN radio and set WWAN to airplane mode, at the same time transition to WLAN+BT transmission simultaneously (Section D), transition to BT only transmission (Section E), and finally transition to WLAN only transmission (Section F).

Figure5 – System level compliance continuity

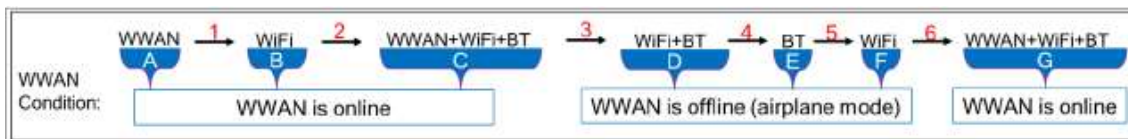

Test configuration selection criteria:

If the device supports simultaneous transmission of WWAN, WLAN and BT, then the selection criteria for system level compliance continuity test is:

- For a given DSI and antenna group, select band/antenna configurations for WWAN, WLAN and BT technologies that have the largest ( $P_{max} - P_{limit}$ ) delta. In case of multiple bands/antennas having the same difference between  $P_{max}$  and  $P_{limit}$  within a given technology, then select any one band/antenna out of them.

NOTE: The antennas corresponding to the selected technologies/bands for the system level compliance continuity test case should be in the same antenna group if EUT is configured with GEN2\_SUB6 or GEN2\_SUB6\_MMW

NOTE: For this test, WLAN radio configuration is selected different from 2.4GHz band so as to not interfere with BT measurements. Therefore, select least  $P_{limit}$  configuration for WLAN outside the 2.4GHz band.

Test procedure:

1. Measure conducted Tx power corresponding to  $P_{limit}$  for all three (WWAN, WLAN & BT) technologies in the selected radio configurations. Test condition to measure conducted  $P_{limit}$  for each technology is:

Establish device in call with the callbox for the first technology in desired band. Measure conducted Tx power corresponding to the first technology  $P_{limit}$  with Smart Transmit Peak exposure mode enabled and callbox set to request maximum power (or maximum duty cycle in case of WLAN/BT).

Repeat above step to measure conducted Tx power corresponding to the remaining two technologies'  $P_{limit}$ . In the case of BT, measured conducted Tx power is compensated by tested duty cycle and BT\_STANDALONE EFS parameter, i.e., measured  $P_{limit} = \text{conducted power measured in BT standalone condition} / \text{BT\_STANDALONE} / \text{BT\_duty\_cycle}$ .

2. Set EUT to the intended Smart Transmit exposure mode.
3. As depicted in Figure 5, first
  - i. Section A: Establish WWAN connection with the callbox in selected WWAN radio configuration. Request EUT to transmit at 0 dBm for at least one WWAN time window (100s or 60s), followed by requesting EUT to transmit at maximum Tx power for {one WWAN

- time window (TWWAN = 100s if  $f < 3\text{GHz}$  or 60s if  $3\text{GHz} < f < 6\text{GHz}$  for FCC, 360s for ICNIRP) + the maximum high power duration allowed in one TWWAN}
- ii. Section B: After TA\_WWAN, drop WWAN connection and establish WLAN connection with the callbox in selected WLAN radio configuration and request EUT to transmit at maximum duty cycle (and maximum power) for {one WLAN time-window duration (TWLAN = 30s for all WLAN frequency bands for FCC, 360s for ICNIRP) + the maximum high power duration allowed in one TWLAN}
  - iii. Section C: After TB\_WLAN, add the selected WWAN and BT radios to have the simultaneous transmission of WWAN + WLAN + BT. Request WWAN radio to transmit at maximum power and request WLAN & BT radios to transmit at maximum duty cycle (and maximum power) for at least one  $\max\{\text{TA\_WWAN}, \text{TB\_WLAN}, \text{TBT}\}$ , where, TBT = 100s for FCC.
  - iv. Section D: Drop WWAN connection and set WWAN modem into airplane mode. Continue requesting WLAN & BT radios to transmit at maximum duty cycle (and maximum power) for at least two times the max
  - v. Section E: Drop WLAN connection. Continue requesting BT radio to transmit at maximum duty cycle (and maximum power). Continue the test for at least one TBT.
  - vi. Section F: In the case of FCC time windows, after at least one TBT, drop BT connection and establish back WLAN connection in selected radio configuration. Continue requesting WLAN radio to transmit at maximum duty cycle (and maximum power).
  - vii. Section G: Disable airplane mode and add WWAN and BT connections after Section F in the case of FCC time windows (Disable airplane mode and add WWAN and WLAN connections after Section E in the case of ICNIRP time windows) to have the simultaneous transmission of WWAN + WLAN + BT. Request WWAN radio to transmit at maximum power and request WLAN & BT radios to transmit at maximum duty cycle (and maximum power) for at least one  $\max\{\text{TA\_WWAN}, \text{TB\_WLAN}, \text{TBT}\}$ , where, TBT = 100s for FCC.
4. Once the measurement is done, extract instantaneous Tx power versus time for all WWAN, WLAN and BT radios in selected configurations. Similar to technology/band switch test in Section 5.3.3, convert the conducted Tx power for both these radios into 1g\_or\_10gSAR value (see Eq. (7a) and (7b)) using corresponding technology/band P<sub>limit</sub> measured in Step 1, and then perform running average over corresponding time-windows (i.e., 100s/60s for WWAN radio, 30s for WLAN radio and 100s for BT radio in case of FCC time-windows)
  5. Make one plot containing: (a) computed normalized time-averaged 1g\_or\_10gSAR for WWAN radio configuration versus time determined in Step 4, (b) computed normalized time-averaged 1g\_or\_10gSAR for WLAN radio configuration versus time determined in Step 4, (c) computed normalized time-averaged 1g\_or\_10gSAR for BT radio configuration versus time determined in Step 4, (d) computed total normalized time-averaged 1g\_or\_10gSAR versus time (sum of Steps (5.a), (5.b) and (5.c)) determined in Step 5, and (e) corresponding normalized regulatory 1g\_or\_10gSAR limit of 1.0.

The validation criteria is, at all times, the time-averaged 1g\_or\_10gSAR versus time shall not exceed the regulatory 1g\_or\_10gSARlimit limit.

If multi\_Tx\_factor is set to > 1.0 with EFS version 19 (or higher), then in single Tx transmission scenarios, Smart Transmit ensures time-averaged RF exposure is  $\leq (\text{SAR\_design\_target} * 10(+ \text{sub6 device uncertainty}/10)) < \text{regulatory RF exposure limit for sub6 radio managed by Smart Transmit}$ . In simultaneous Tx transmission scenarios, Smart Transmit ensures time-averaged RF exposure is  $\leq (\text{SAR\_design\_target} * \text{multi\_Tx\_factor} * 10(+ \text{sub6 device uncertainty}/10)) < \text{regulatory RF exposure limit for sub6 radios managed by Smart Transmit}$ . These simultaneous transmission scenarios are listed below:

- 2-or-more radio scenarios within WWAN like EN-DC, etc
- 2-or-more-radio across technologies such as WWAN+WLAN, WWAN+BT, WLAN+BT and WWAN+WLAN+BT transmission scenarios (if WLAN/BT radios are also managed by Smart Transmit).

#### 5.4 Test procedure for time-varying SAR measurements

This section provides general time-varying SAR measurement procedures to perform compliance test under dynamic transmission scenarios described in Section 4. In practice, an adjustment can be made in these procedures. The justification/clarification may be provided.

To perform the validation through SAR measurement for transmission scenario 1 described in Section 4, the “path loss” between callbox antenna and EUT needs to be calibrated to ensure that the EUT Tx power reacts to the requested power from callbox in a radiated call. It should be noted that when signaling in closed loop mode, protocol-level power control is in play, resulting in EUT not solely following callbox TPC (Tx power control) commands. In other words, EUT response has many dependencies (RSSI, quality of signal, path loss variation, fading, etc.) other than just TPC commands. These dependencies have less impact in conducted setup (as it is a controlled environment and the path loss can be very well calibrated) but have significant impact on radiated testing in an uncontrolled environment, such as SAR test setup. Therefore, the deviation in EUT Tx power from callbox requested power is expected, however the time- averaged SAR should not exceed FCC SAR requirement at all times as Smart Transmit controls Tx power at EUT.

#### The following steps are for time averaging feature validation through SAR measurement:

1. “Path Loss” calibration: Place the EUT against the phantom in the worst-case position determined based on Section 5.2.1. For each band selected, prior to SAR measurement, perform “path loss” calibration between callbox antenna and EUT. Since the SAR test environment is not controlled and well calibrated for OTA (Over the Air) test, extreme care needs to be taken to avoid the influence from reflections. The test setup is described in Section 7.1.
2. Time averaging feature validation:
  - i. For a given radio configuration (technology/band) selected in Section 5.2.1, enable Smart Transmit and set *Reserve\_power\_margin* to 0 dB, with callbox to request maximum power, perform area scan, conduct pointSAR measurement at peak location of the area scan. This point SAR value, *pointSAR\_Plimit*, corresponds to point SAR at the measured *Plimit* (i.e., measured *Plimit* from the EUT in Step 1 of Section 5.3.1).
  - ii. Set *Reserve\_power\_margin* to actual (intended) value and reset power on EUT to enable Smart Transmit. Note, if *Reserve\_power\_margin* cannot be set wirelessly, care must be taken to re-position the EUT in the exact same position relative to the SAM phantom as in above Step 2.i. Establish radio link in desired radio configuration, with callbox requesting the EUT’s Tx power at power levels described by test sequence 1 generated in Step 1 of Section 5.3.1, conduct point SAR measurement versus time at peak location of the area scan determined in Step 2.i of this section. Once the measurement is done, extract instantaneous point SAR vs time data, *point SAR(t)*, and convert it into instantaneous 1gSAR or 10gSAR vs. time using Eq. (3a), re-written below:

$$1g\_or\_10gSAR(t) = \frac{pointSAR(t)}{pointSAR\_P_{limit}} * 1g\_or\_10gSAR\_P_{limit}$$

where,  $pointSAR\_P_{limit}$  is the value determined in Step 2.i, and  $pointSAR(t)$  is the instantaneous point SAR measured in Step 2.ii, 1g-

or 10gSAR,  $P_{limit}$  is the measured 1gSAR or 10gSAR value listed in Part 1 report.

iii. Perform 100s running average to determine time-averaged 1gSAR or 10gSAR versus time.

iv. Make one plot containing: (a) time-averaged 1gSAR or 10gSAR versus time determined in Step 2.iii of this section, (b) FCC limit of 1.6 W/kg for 1gSAR or 4.0 W/kg for 10gSAR.

v Repeat 2.ii ~ 2.iv for test sequence 2 generated in Step 1 of Section 5.3.1.

vi. Repeat 2.i ~ 2.v for all the technologies and bands selected in Section 5.2.1.

The time-averaging validation criteria for SAR measurement is that, at all times, the time-averaged 1gSAR or 10gSAR versus time shall not exceed FCC limit of 1.6 W/kg for 1gSAR or 4.0 W/kg for 10gSAR (i.e., Eq. (3b)).

## 6. Test Configurations

### 6.1 WWAN,WLAN,BT (sub-6)transmission

The  $P_{limit}$  values, corresponding to 1.0 W/kg (1gSAR) and 2.5 W/kg (10gSAR) of  $SAR_{design\_target}$ , for technologies and bands supported by EUT are derived in Part 0 report and summarized in Table 6-1. Note all  $P_{limit}$  power levels entered in Table 6-1 correspond to average power levels after accounting for duty cycle in the case of TDD modulation schemes.

Table 6-1:  $P_{limit}$  for supported technologies and bands ( $P_{limit}$  in setting)

| Plim values in green indicate Plimit < Pmax                        |        |         | Plim values in grey indicate Plimit > Pmax |         |               |                      |         | Maximum Tune-up Output Power (Frame Averaged Power) [dBm] |
|--|--------|---------|--|---------|---------------|----------------------|---------|---|
| Plimit corresponding to 1 W/kg (1g) 2.5W/kg(10g) SAR_Design_target |        |         | Body-worn                                  | Phablet | Head (RCV ON) | Hotspot (Hotspot on) | Earjack |   |
| SAR Exposure Position  |        |         | 1g   | 10g     | 1g            | 1g                   | 1g/10g  |   |
| Averaging volume   |        |         | 10 mm                                      | 0mm     | 0 mm          | 10/5 mm              | 10/0 mm |   |
| seperation Distance  |        |         | DSI=0                                      | DSI=1   | DSI=2         | DSI=3                | DSI=4   |   |
| Mode   | Band   | Antenna |  |         |               |                      |         |   |
| GSM/GPRS/EDGE  | 850    | ANT A   | 27.5                                       |         | 31.5          | 19.3                 | 30.1    | 22.8  |
| GSM/GPRS/EDGE  | 1900   | ANT A   | 17.3                                       |         | 34.8          | 15.3                 | 22.6    | 20.3  |
| UMTS   | 2      | ANT A   | 20.0                                       |         | 20.9          | 15.5                 | 20.0    | 22.0  |
| UMTS   | 4      | ANT A   | 20.0                                       |         | 21.4          | 17.5                 | 20.0    | 22.0  |
| UMTS   | 5      | ANT A   | 25.8                                       |         | 22.4          | 21.5                 | 29.4    | 23.0  |
| LTE FDD  | 25(2)  | ANT A   | 20.3                                       |         | 30.9          | 15.3                 | 20.3    | 22.3  |
| LTE FDD  | 25(2)  | ANT I   | 20.5                                       |         | 15.0          | 15.5                 | 20.5    | 24.5  |
| LTE FDD  | 66(4)  | ANT A   | 19.8                                       |         | 33.8          | 16.8                 | 19.8    | 22.8  |
| LTE FDD  | 66(4)  | ANT I   | 20.5                                       |         | 16.5          | 16.5                 | 20.5    | 24.5  |
| LTE FDD  | 12(17) | ANT A   | 21.0                                       |         | 32.2          | 21.0                 | 21.0    | 23.5  |
| LTE FDD  | 13     | ANT A   | 21.0                                       |         | 30.2          | 21.0                 | 21.0    | 23.5  |
| LTE FDD  | 26(5)  | ANT A   | 27.9                                       |         | 31.3          | 22.5                 | 29.6    | 23.5  |
| LTE TDD PC3  | 41     | ANT B   | 22.4                                       |         | 37.1          | 15.0                 | 22.4    | 19.0  |
| LTE TDD PC3  | 41     | ANT I   | 20.5                                       |         | 13.8          | 16.5                 | 20.5    | 22.5  |
| LTE TDD PC2  | 41     | ANT B   | 20.7                                       |         | 39.5          | 17.7                 | 20.7    | 20.4  |
| LTE TDD PC2  | 41     | ANT I   | 20.5                                       |         | 13.8          | 16.5                 | 20.5    | 21.9  |
| NR FDD   | 25(2)  | ANT A   | 20.3                                       |         | 33.4          | 15.3                 | 20.3    | 22.0  |
| NR FDD   | 25(2)  | ANT I   | 21.0                                       |         | 15.5          | 16.0                 | 21.0    | 25.0  |
| NR FDD   | 5      | ANT A   | 26.6                                       |         | 30.2          | 22.5                 | 28.7    | 23.5  |
| NR TDD SRS 1 PC3   | 41     | ANT I   | 21.0                                       |         | 14.3          | 17.0                 | 21.0    | 24.5  |
| NR TDD SRS 2   | 41     | ANT B   | 16.0                                       |         | 11.2          | 13.5                 | 16.0    | 19.5  |
| NR TDD SRS 3   | 41     | ANT F   | 18.0                                       |         | 13.2          | 15.5                 | 18.0    | 23.0  |
| NR TDD SRS 4   | 41     | ANT C   | 12.5                                       |         | 7.7           | 10.0                 | 12.5    | 17.5  |
| NR FDD   | 66     | ANT A   | 20.3                                       |         | 34.4          | 17.3                 | 20.3    | 22.5  |
| NR FDD   | 66     | ANT I   | 20.5                                       |         | 17.0          | 17.0                 | 20.5    | 24.7  |
| NR TDD SRS 1 PC3   | 77     | ANT F   | 18.5                                       |         | 14.0          | 15.5                 | 18.5    | 24.5  |
| NR TDD SRS 2   | 77     | ANT I   | 18.5                                       |         | 14.0          | 15.5                 | 18.5    | 24.5  |
| NR TDD SRS 3   | 77     | ANT E   | 18.5                                       |         | 14.0          | 15.5                 | 18.5    | 24.5  |
| NR TDD SRS 4   | 77     | ANT C   | 12.0                                       |         | 7.5           | 9.0                  | 12.0    | 15.0  |
| NR TDD SRS 1 PC3   | 77 DoD | ANT F   | 18.5                                       |         | 14.0          | 15.5                 | 18.5    | 24.5  |
| NR TDD SRS 2   | 77 DoD | ANT I   | 18.5                                       |         | 14.0          | 15.5                 | 18.5    | 24.5  |
| NR TDD SRS 3   | 77 DoD | ANT E   | 18.5                                       |         | 14.0          | 15.5                 | 18.5    | 24.5  |
| NR TDD SRS 4   | 77 DoD | ANT C   | 12.0                                       |         | 7.5           | 9.0                  | 12.0    | 15.0  |
| WLAN   | 2.4    | ANT F   | 20.4                                       |         | 19.3          | 21.6                 | 20.4    | 18.0  |
| WLAN   | 2.4    | ANT H   | 23.9                                       |         | 20.6          | 26.1                 | 23.9    | 18.0  |
| WLAN   | 5      | ANT F   | 18.4                                       |         | 16.9          | 19.7                 | 18.4    | 15.0  |
| WLAN   | 5      | ANT H   | 21.3                                       |         | 20.7          | 20.4                 | 25.3    | 15.0  |
| WLAN   | 6      | ANT F   | 24.4                                       |         | 16.7          | N/A                  | 24.4    | 10.0  |
| WLAN   | 6      | ANT H   | 24.0                                       |         | 20.4          | N/A                  | 24.0    | 10.0  |
| BT   | 2.4    | ANT F   | 19.8                                       |         | 19.8          | 21.0                 | 19.8    | 18.0  |
| BT   | 2.4    | ANT H   | 25.0                                       |         | 19.6          | N/A                  | 25.0    | 17.0  |

\* Maximum tune up target power,  $P_{max}$  is configured in NV settings in EUT to limit maximum transmitting power. This power is converted into peak power in NV settings for TDD schemes. The EUT maximum allowed output power is equal to  $P_{max} + 1\text{dB}$  device uncertainty.

Based on selection criteria described in Section 5.2, the selected technologies/bands for testing time-varying test sequences are highlighted in yellow in Table 6-1.

As per Part 1 report, the Reserve\_power\_margin(dB) for Samsung Mobile Phone (FCC ID: A3LSMF741B) is set to calculate Preserve in EFS, and is used in Part 2 test. The radio configurations used in Part 2 test for selected technologies, bands, DSIs and antennas are listed in Table 6-1. The corresponding worst-case radio configuration 1gSAR or 10gSAR values for selected technology/band/DSI are extracted from Part 1 report and are listed in the last column of Table 6-2.

Based on equations (1a), (2a), (3a) and (4a), it is clear that Part 2 testing outcome is normalized quantity, which implies that it can be applied to any radio configuration within a selected technology/band/DSI. Thus, as long as applying the worst-case SAR obtained from the worst radio configuration in Part 1 testing to calculate time-varying SAR exposure in equations (1a), (2a), (3a) and (4a), the accuracy in compliance demonstration remains the same.

Table 6-2: Radio configurations selected for Part 2 test

| Test Case # | Test Scenario   | Tech      | Band   | Antenna | DSI | Channel | Frequency [MHz] | RB/RB Offset/Bandwidth (MHz) | Mode          | SAR Exposure Scenario   | Part 1 Worst Case Measured SAR at Plimit (W/kg) |
|-------------|---|-----------|--------|---------|-----|---------|-----------------|------------------------------|---------------|-------------------------|---|
| 1           | Time-varying Tx power transmission                    | LTE       | B25    | I       | 2   | 26590   | 1905            | 1/0/20 MHz BW                | QPSK          | Head, Left Touch, 0mm   | 0.407   |
| 2           |   |           | B41    | I       | 2   | 40620   | 2593            | 1/0/20 MHz BW                | QPSK          | Head, Left Touch, 0mm   | 0.747   |
| 3           |   | UMTS      | B2     | A       | 3   | 9538    | 1907.6          | -                            | RMC           | Close Body, Bottom, 5mm | 0.966   |
| 4           |   | GPRS      | 1900   | A       | 3   | 661     | 1880            | -                            | GPRS, 3 Tx    | Close Body, Bottom, 5mm | 0.540   |
| 5           |   | Sub6 NR   | n25    | I       | 3   | 376500  | 1882.5          | 1/1/40 MHz BW                | QPSK          | Close Body, Right, 5mm  | 0.695   |
| 6           |   |           | n77    | F       | 2   | 650000  | 3750            | 1/1/100 MHz BW               | QPSK          | Head, Right Touch, 0mm  | 0.654   |
| 7           | Change in Call  | Sub6 NR   | n25    | I       | 3   | 376500  | 1882.5          | 1/1/40 MHz BW                | QPSK          | Close Body, Right, 5mm  | 0.695   |
| 8           | Tech/Band Switch                                      | LTE       | B25    | A       | 3   | 26590   | 1905            | 1/0/20 MHz BW                | QPSK          | Close Body, Bottom, 5mm | 0.908   |
|             |   | UMTS      | B2     | A       | 3   | 9538    | 1907.6          | -                            | RMC           | Close Body, Bottom, 5mm | 0.966   |
| 9           | Inter Uplink CA Switch                                | LTE       | B66    | A       | 3   | 132572  | 1770            | 1/1/20 MHz BW                | QPSK          | Open Body, Bottom, 10mm | 0.687   |
|             |   |           | B12    | A       | 3   | 23095   | 707.5           | 1/1/10 MHz BW                | QPSK          | Close Body, Rear, 5mm   | 0.433   |
| 10          | DSI Switch  | Sub6 NR   | n25    | I       | 3   | 376500  | 1882.5          | 1/1/40 MHz BW                | QPSK          | Close Body, Right, 5mm  | 0.695   |
|             |   |           | n25    | I       | 0   | 376500  | 1882.5          | 1/1/40 MHz BW                | QPSK          | Open Body, Rear, 10mm   | 0.399   |
| 11          | Antenna Switch  | Sub6 NR   | n25    | I       | 3   | 376500  | 1882.5          | 1/1/40 MHz BW                | QPSK          | Close Body, Right, 5mm  | 0.695   |
|             |   |           | n25    | A       | 3   | 376500  | 1882.5          | 1/1/40 MHz BW                | QPSK          | Close Body, Bottom, 5mm | 0.754   |
| 12          | Time Window   | Sub6 NR   | n77    | F       | 2   | 650000  | 3750            | 1/1/100 MHz BW               | QPSK          | Head, Right Touch, 0mm  | 0.654   |
|             |   |           | n41    | I       | 2   | 518598  | 2592.99         | 1/1/100 MHz BW               | QPSK          | Head, Left Touch, 0mm   | 0.829   |
| 13          | SAR1 vs SAR2  | LTE       | B12    | A       | 3   | 23095   | 707.5           | 1/1/10 MHz BW                | QPSK          | Close Body, Rear, 5mm   | 0.433   |
|             |   | Sub6 NR   | n25    | I       | 3   | 376500  | 1882.5          | 1/1/40 MHz BW                | QPSK          | Close Body, Right, 5mm  | 0.695   |
| 14          | Exposure category switch Head to non-head to head     | Sub6 NR   | n77    | F       | 2   | 650000  | 3750            | 1/1/100 MHz BW               | QPSK          | Head, Right Touch, 0mm  | 0.654   |
|             |   |           | n77    | F       | 3   | 662000  | 3930            | 1/1/100 MHz BW               | QPSK          | Close Body, Left, 5mm   | 0.891   |
| 15          | Exposure category switch non-Head to head to non-head | Sub6 NR   | n25    | A       | 3   | 376500  | 1882.5          | 1/1/40 MHz BW                | QPSK          | Close Body, Bottom, 5mm | 0.754   |
|             |   |           | n25    | A       | 2   | 376500  | 1882.5          | 1/1/40 MHz BW                | QPSK          | Head, Left Touch, 0mm   | 0.081   |
| 16          | WLAN SAR vs SAR (Dual Band Simultaneous mode)         | WLAN      | 2.4GHz | F       | 2   | 11      | 2462            | -                            | 802.11b 1Mbps | Head, Right Touch, 0mm  | 0.786   |
|             |   | WLAN      | 5GHz   | F       | 2   | 169     | 5845            | -                            | 802.11a 6Mbps | Head, Right Touch, 0mm  | 0.882   |
| 17          | WWAN+WLAN+BT Continuity Test                          | LTE       | B25    | I       | 2   | 26590   | 1905            | 1/0/20 MHz BW                | QPSK          | Head, Left Touch, 0mm   | 0.407   |
|             |   | WLAN      | 5GHz   | F       | 2   | 169     | 5845            | -                            | 802.11a 6Mbps | Head, Right Touch, 0mm  | 0.882   |
|             |   | Bluetooth | 2.4GHz | F       | 2   | 79      | 2441            | -                            | -             | Head, Right Touch, 0mm  | 0.771   |

This device uses different Device State Index (DSI) to configure different time averaged power levels based on certain exposure scenarios.

| Scenario                             | Description  | SAR Test Cases   |
|--------------------------------------|--|--|
| Head<br>(DSI = 2)                    | Device positioned next to head   | Head SAR per KDB Publication 648474 D04  |
| BodyWorn<br>Phablet<br>(DSI = 0,1,4) | Device is held with hand<br>Device being used with a body-worn accessory | Phablet SAR per KDB Publication 648474 D04<br>Body-worn SAR per KDB Publication 648474 D04 |
| Hotspot<br>(DSI = 3)                 | Device transmits in hotspot mode near body                               | Hotspot SAR per KDB Publication 941225 D06   |

Based on the selection criteria described in Section 5.2, the radio configurations for the Tx varying transmission test cases listed in Section 6 are:

1. Technologies and bands for time-varying Tx power transmission: The test case 1~6 listed in Table 6-2 are selected to test with the test sequences defined in Section 5.2.1 in both time- varying conducted power measurement and time-varying SAR measurement. Note that only one GSM band were selected as the second band for these technologies has  $P_{limit}$  greater than  $P_{max}$  requiring no Tx power limitation.
2. Technology and band for change in call test: Following the guidelines in Section 5.2.2 NR 25 band (test case 7 in Table 6-2) is selected for performing the call drop test in conducted power setup.
3. Technologies and bands for change in technology/band test: Following the guidelines in Section 5.2.3, test case 8 in Table 6-2 is selected for handover test from a technology/band/antenna with lowest  $P_{limit}$  within one technology group (LTE B25, DSI=3, Hotspot), to a technology/band in the same DSI with highest  $P_{limit}$  within another technology group (UMTS B2, DSI=3, Hotspot) in conducted power setup.
4. Technologies and bands for change in DSI: Based on selection criteria in Section 5.2.5, for a given technology and band, test case 10 in Table 6-2 is selected for DSI switch test by establishing a call in NR n25 in Hotspot Condition(DSI=3), and then handing over to DSI = 0 with Free space condition scenario in conducted power setup.
5. Technologies and bands for change in antenna: Based on selection criteria in Section 5.2.4, for a given DSI=3 (Hotspot), test case 11 in Table 6-2 is selected for antenna switch NR n25, Ant I to NR n 25, Ant A in conducted power setup.
6. Technologies and bands for change in time-window: Based on selection criteria in Section 5.2.6, for a given DSI=2(Head), test case 12 in Table 6-2 is selected for time window switch between 60s window (NR n77, Ant F) and 100s window (NR n41, Ant I), 100s window (NR n41, Ant I) and 60s window (NR n77, Ant F) in conducted power setup.
7. Technologies and bands for switch in SAR exposure: Based on selection criteria in Section 5.2.7 Scenario 1, test case 9, 13, 16 in Table 6-2 is selected for SAR exposure switching test in one of the supported simultaneous WWAN, WLAN transmission scenario, i.e., LTE + Sub6 NR or PCC + SCC active in the same 100s time window or WLAN radio1 and WLAN radio2 active in the same 30s time window, in conducted power setup.

8. Technologies and bands for switch in exposure category: Based on selection criteria in Section 5.2.8, test case 14, 15 in Table 6-2 is selected for switch in exposure category test by establishing a call in NR n25/77 in DSI=3 (Hotspot), handing over to DSI=2 (Head), and then handing over back to DSI=3 (Hotspot) scenario in conducted power setup.

9. Technologies WWAN + WLAN + BT for switch in System level compliance continuity: Based on selection criteria in Section 5.2.9, test case 17 in Table 6-2 is selected for switch in System level compliance continuity test by Starting with WWAN radio transmission (LTE 25 in DSI=2(Head), transition to WLAN transmission (WLAN ANT F 5GHz), transition to simultaneous transmission of WWAN + WLAN + BT (LTE 25 ANT I + WLAN ANT F 5GHz + BT ANT F), then drop off WWAN radio and set WWAN to airplane mode, at the same time transition to WLAN+BT transmission simultaneously (WLAN ANT 5GHz + BT ANT), transition to BT only transmission (BT ANT), and transition to WLAN only transmission (WLAN ANT F 5GHz), and finally transition to simultaneous transmission of WWAN+WLAN+BT(LTE 25 ANT I+WLAN ANT F 5GHz + BT ANT F) scenario in conducted power setup.



## 7. Time-varying Tx power measurement for below 6GHz frequency

### 7.1 Conducted Measurement Test setup

#### Legacy Test Setup

The Rohde & Schwarz CMW500 callbox is used in this test. The test setup picture and schematic are shown in Figures 7-1a for measurements with a single antenna of EUT (see Appendix C–The test Setup Photo 1), and in Figures 7-1b for measurements involving antenna switch (see Appendix C The test Setup Photo 2).

For single antenna measurement, one port (RF1 COM) of the callbox is connected to the RF port of the EUT using a directional coupler. For antenna & technology switch measurement, two ports (RF1 COM and RF3 COM) of the callbox used for signaling two different technologies are connected to a combiner, which is in turn connected to a directional coupler. The other end of the directional coupler is connected to a splitter to connect to two RF ports of the EUT corresponding to the two antennas of interest. In both the setups, power meter is used to tap the directional coupler for measuring the conducted output power of the EUT. For time averaging validation test (Section 5.3.1), call drop test (Section 5.3.2), and DSI switch test (Section 5.3.4), only RF1 COM port of the callbox is used to communicate with the EUT. For technology/band switch measurement (Section. 5.3.3), both RF1 COM and RF3 COM port of callbox are used to switch from one technology communicating on RF1 COM port to another technology communicating on RF3 COM port. All the path losses from RF port of EUT to the callbox RF COM port and to the power meter are calibrated and automatically entered as offsets in the callbox and the power meter via test scripts on the PC used to control callbox and power meter.

#### LTE+Sub6 NR test setup:

If LTE conducted port and Sub6 NR conducted port are same on this EUT (i.e., they share the same antenna), then low-/high-pass filter is used to separate LTE and Sub6 NR signals for power meter measurement via directional couplers, as shown in below Figures 7-1(c) (see Appendix C- Test setup photo-3)

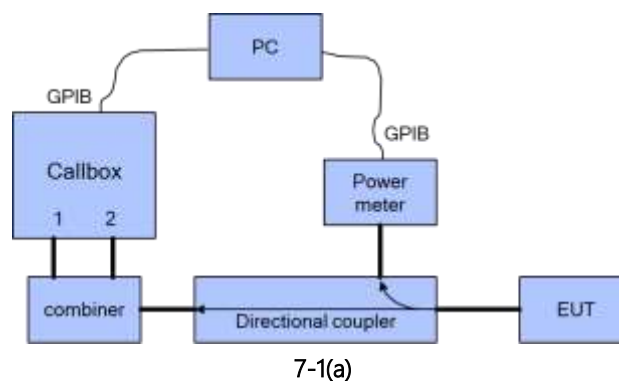

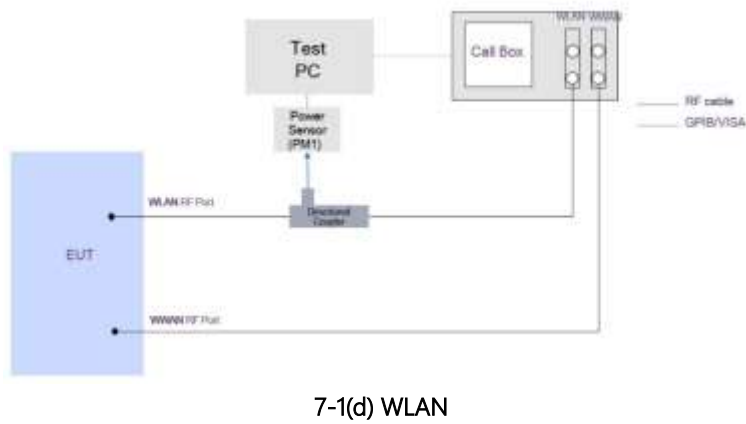
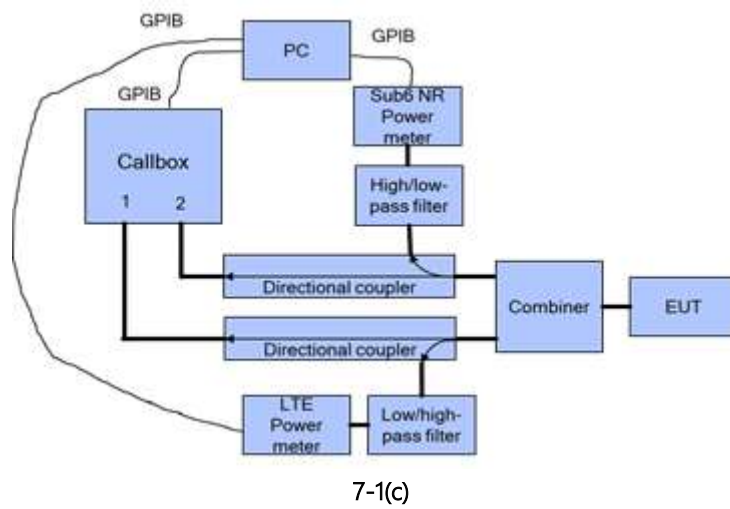
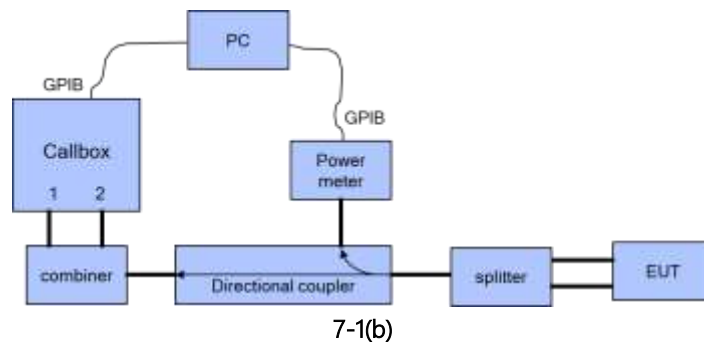

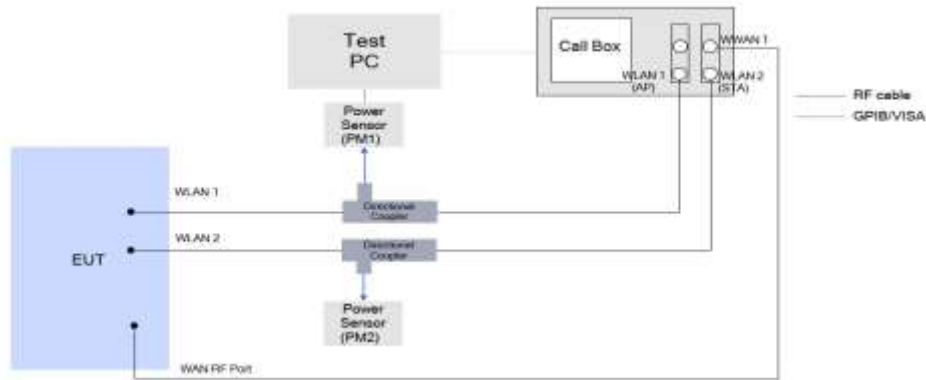

7-1(e) WLAN DBS

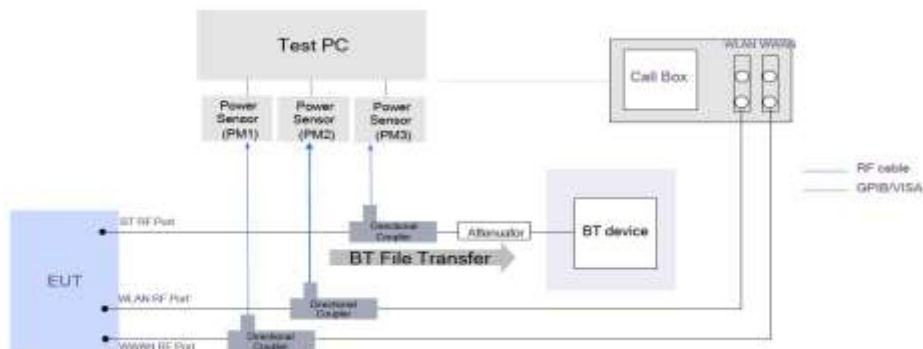

7-1(f) System level compliance

Figure 7-1 Conducted power measurement setup

Both the callbox and power meter are connected to the PC using GPIB cables. Two test scripts are custom made for automation, and the test duration set in the test scripts is 600 seconds. For time-varying Tx power measurement, the PC runs the 1<sup>st</sup> test script to send GPIB commands to control the callbox's requested power versus time, while at the same time to record the conducted power measured at EUT RF port using the power meter. The commands sent to the callbox to request power are:

- 0dBm for 100 seconds
- test sequence 1 or test sequence 2 (defined in Section 5.1 and generated in Section 5.5.1), for 360 seconds
- stay at the last power level of test sequence 1 or test sequence 2 for the remaining time.

Power meter readings are periodically recorded every 100ms. A running average of this measured Tx power over 100 seconds is performed in the post-data processing to determine the 100s-time averaged power. For call drop, technology/band/antenna switch, and DSI switch tests, after the call is established, the callbox is set to request the EUT's Tx power at 0dBm for 100 seconds while simultaneously starting the 2<sup>nd</sup> test script runs at the same time to start recording the Tx power measured at EUT RF port using the power meter. After the initial 100 seconds since starting the Tx power recording, the callbox is set to request maximum power from the EUT for the rest of the test.

Note that the call drop/re-establish, or technology/band/antenna switch or DSI switch is manually performed when the Tx power of EUT is at  $P_{reserve}$  level. See Section 5.3 for detailed test procedure of call drop test, technology/band/antenna switch test and DSI switch test.

## 7.2 Plimit and Pmax measurement Results

The measured  $P_{limit}$  for all the selected radio configurations given in Table 6-2 are listed in below Table 7-1.  $P_{max}$  was also measured for radio configurations selected for testing time-varying Tx power transmission scenarios in order to generate test sequences following the test procedures in Section 5.1.

Table 7-1: Measured Plimit and Pmax of selected radio configuration

| Test Case # | Test Scenario  | Tech      | Band   | Antenna | DSI | Channel | Frequency [MHz] | RB/RB Offset/Bandwidth (MHz) | Mode          | SAR Exposure Scenario   | Plimit Setting[dBm] | Tune Up Target Power Pmax[dBm] | Measured Plimit [dBm] | Measured Pmax [dBm] | Part 1 Worst Case Measured SAR at Plimit (W/kg) |
|-------------|--|-----------|--------|---------|-----|---------|-----------------|------------------------------|---------------|-------------------------|---------------------|--------------------------------|-----------------------|---------------------|---|
| 1           | Time-varying Tx power transmission                     | LTE       | B25    | I       | 2   | 26590   | 1905            | 1/0/20 MHz BW                | QPSK          | Head, Left Touch, 0mm   | 15.00               | 24.50                          | 15.00                 | 24.68               | 0.407   |
| 2           |  |           | B41    | I       | 2   | 40620   | 2593            | 1/0/20 MHz BW                | QPSK          | Head, Left Touch, 0mm   | 13.80               | 22.50                          | 14.18                 | 22.86               | 0.747   |
| 3           |  | UMTS      | B2     | A       | 3   | 9538    | 1907.6          | -                            | RMC           | Close Body, Bottom, 5mm | 15.50               | 22.00                          | 15.99                 | 22.24               | 0.966   |
| 4           |  | GPRS      | 1900   | A       | 3   | 661     | 1880            | -                            | GPRS, 3 Tx    | Close Body, Bottom, 5mm | 15.58               | 19.08                          | 15.22                 | 19.06               | 0.540   |
| 5           |  | Sub6 NR   | n25    | I       | 3   | 376500  | 1882.5          | 1/1/40 MHz BW                | QPSK          | Close Body, Right, 5mm  | 16.00               | 25.00                          | 16.08                 | 25.43               | 0.695   |
| 6           |  |           | n77    | F       | 2   | 650000  | 3750            | 1/1/100 MHz BW               | QPSK          | Head, Right Touch, 0mm  | 14.00               | 24.50                          | 14.03                 | 24.15               | 0.654   |
| 7           | Change in Call   | Sub6 NR   | n25    | I       | 3   | 376500  | 1882.5          | 1/1/40 MHz BW                | QPSK          | Close Body, Right, 5mm  | 16.00               | 25.00                          | 16.08                 | 25.43               | 0.695   |
| 8           | *Tech/Band Switch                                      | LTE       | B25    | A       | 3   | 26590   | 1905            | 1/0/20 MHz BW                | QPSK          | Close Body, Bottom, 5mm | 15.30               | 22.30                          | 15.32                 | 22.31               | 0.908   |
|             |  | UMTS      | B2     | A       | 3   | 9538    | 1907.6          | -                            | RMC           | Close Body, Bottom, 5mm | 15.50               | 22.00                          | 15.99                 | 22.24               | 0.966   |
| 9           | *Inter Uplink CA Switch                                | LTE       | B66    | A       | 3   | 132572  | 1770            | 1/1/20 MHz BW                | QPSK          | Open Body, Bottom, 10mm | 16.80               | 22.80                          | 16.43                 | 22.59               | 0.687   |
|             |  |           | B12    | A       | 3   | 23095   | 707.5           | 1/1/10 MHz BW                | QPSK          | Close Body, Rear, 5mm   | 21.00               | 23.50                          | 20.81                 | 24.14               | 0.433   |
| 10          | *DSI Switch  | Sub6 NR   | n25    | I       | 3   | 376500  | 1882.5          | 1/1/40 MHz BW                | QPSK          | Close Body, Right, 5mm  | 16.00               | 25.00                          | 16.08                 | 25.43               | 0.695   |
|             |  |           | n25    | I       | 0   | 376500  | 1882.5          | 1/1/40 MHz BW                | QPSK          | Open Body, Rear, 10mm   | 21.00               | 25.00                          | 20.97                 | 25.43               | 0.399   |
| 11          | *Antenna Switch  | Sub6 NR   | n25    | I       | 3   | 376500  | 1882.5          | 1/1/40 MHz BW                | QPSK          | Close Body, Right, 5mm  | 16.00               | 25.00                          | 16.08                 | 25.43               | 0.695   |
|             |  |           | n25    | A       | 3   | 376500  | 1882.5          | 1/1/40 MHz BW                | QPSK          | Close Body, Bottom, 5mm | 15.30               | 22.00                          | 15.38                 | 22.54               | 0.754   |
| 12          | *Time Window   | Sub6 NR   | n77    | F       | 2   | 650000  | 3750            | 1/1/100 MHz BW               | QPSK          | Head, Right Touch, 0mm  | 14.00               | 24.50                          | 14.03                 | 24.15               | 0.654   |
|             |  |           | n41    | I       | 2   | 518598  | 2592.99         | 1/1/100 MHz BW               | QPSK          | Head, Left Touch, 0mm   | 14.30               | 24.50                          | 14.34                 | 24.39               | 0.829   |
| 13          | *SAR1 vs SAR2  | LTE       | B12    | A       | 3   | 23095   | 707.5           | 1/1/10 MHz BW                | QPSK          | Close Body, Rear, 5mm   | 21.00               | 23.50                          | 20.81                 | 24.14               | 0.433   |
|             |  | Sub6 NR   | n25    | I       | 3   | 376500  | 1882.5          | 1/1/40 MHz BW                | QPSK          | Close Body, Right, 5mm  | 16.00               | 25.00                          | 16.08                 | 25.43               | 0.695   |
| 14          | *Exposure category switch non-Head to head to non-head | Sub6 NR   | n25    | A       | 3   | 376500  | 1882.5          | 1/1/40 MHz BW                | QPSK          | Close Body, Bottom, 5mm | 15.30               | 22.00                          | 15.38                 | 22.54               | 0.754   |
|             |  |           | n25    | A       | 2   | 376500  | 1882.5          | 1/1/40 MHz BW                | QPSK          | Head, Left Touch, 0mm   | 22.00               | 22.00                          | 22.54                 | 22.54               | 0.081   |
| 15          | *Exposure category switch Head to non-head to head     | Sub6 NR   | n77    | F       | 2   | 650000  | 3750            | 1/1/100 MHz BW               | QPSK          | Head, Right Touch, 0mm  | 14.00               | 24.50                          | 14.03                 | 24.15               | 0.654   |
|             |  |           | n77    | F       | 3   | 662000  | 3930            | 1/1/100 MHz BW               | QPSK          | Close Body, Left, 5mm   | 15.50               | 24.50                          | 15.86                 | 24.15               | 0.891   |
| 16          | *WLAN SAR vs SAR (Dual Band Simultaneous mode)         | WLAN      | 2.4GHz | F       | 2   | 11      | 2462            | -                            | 802.11b 1Mbps | Head, Right Touch, 0mm  | 18.00               | 18.00                          | 17.86                 | 17.86               | 0.786   |
|             |  | WLAN      | 5GHz   | F       | 2   | 169     | 5845            | -                            | 802.11a 6Mbps | Head, Right Touch, 0mm  | 15.00               | 15.00                          | 15.15                 | 15.15               | 0.882   |
| 17          | *WWAN+WLAN+BT Continuity Test                          | LTE       | B25    | I       | 2   | 26590   | 1905            | 1/0/20 MHz BW                | QPSK          | Head, Left Touch, 0mm   | 15.00               | 24.50                          | 15.00                 | 24.68               | 0.407   |
|             |  | WLAN      | 5GHz   | F       | 2   | 169     | 5845            | -                            | 802.11a 6Mbps | Head, Right Touch, 0mm  | 15.00               | 15.00                          | 15.15                 | 15.15               | 0.882   |
|             |  | Bluetooth | 2.4GHz | F       | 2   | 79      | 2441            | -                            | -             | Head, Right Touch, 0mm  | 18.00               | 18.00                          | 18.03                 | 18.03               | 0.771   |

\*Total time-averaged normalized RF Exposure limit

Note:

1. The device uncertainty of  $P_{max}$  is +1dB/-1.5dB as provided by manufacturer.
2. The above  $P_{max}$  /  $P_{limit}$  value for GPRS1900 is Frame Averaged Power for 3Tx Slots
3. Tests including duty-cycle transmit are normalized to frame average.
4. Due to a limitation of the available test equipment, a modified procedure was used for Sub6 NR TDD Cases. The relevant parameters are shown below. On the above table, NR Band n41 & n77 measured  $P_{max}$  and Measured  $P_{limit}$  values represent  $P_{max\_seq}$  and  $P_{limit\_seq}$ . Section B.2 contains more details about the modified procedure used for NR Band n41 & n77 evaluation.
5. Bluetooth  $P_{max}$  &  $P_{limit}$  Power measurement measures Conducted Power by transferring a file to a conduction device.

### 7.3 Time-varying Tx power measurement results

The measurement setup is shown in Figures 7-1(a), 7-1(b) and 7-1(c). The purpose of the time-varying Tx power measurement is to demonstrate the effectiveness of power limiting enforcement and that the time-averaged Tx power when represented in time-averaged 1gSAR or 10gSAR values does not exceed FCC limit as shown in Eq. (1a) and (1b), rewritten below:

$$1g\_or\_10gSAR(t) = \frac{conducted\_Tx\_power(t)}{conducted\_Tx\_power\_P_{limit}} * 1g\_or\_10gSAR\_P_{limit} \quad (1a)$$

$$\frac{\frac{1}{T_{SAR}} \int_{t-T_{SAR}}^t 1g\_or\_10gSAR(t) dt}{FCC\ SAR\ limit} \leq 1 \quad (1b)$$

where,  $conducted\_Tx\_Power(t)$ ,  $conducted\_Tx\_P_{limit}$  and  $1g\_or\_10g\ SAR\_P_{limit}$  correspond to the measured instantaneous conducted Tx power, measured conducted Tx power at  $P_{limit}$  and measured 1gSAR and 10gSAR values at  $P_{limit}$  reported in Part 1 test (listed in Table 7-2 of this report as well).

Following the test procedure in Section 5.3, the conducted Tx power measurement for all selected configurations are reported in this section. In all the conducted Tx power plots, the dotted line represents the requested power by callbox (test sequence 1 or test sequence 2), the blue curve represents the instantaneous conducted Tx power measured using power meter, the green curve represents time-averaged power and red line represents the conducted power limit that corresponds to FCC limit of 1.6 W/kg for 1gSAR or 4.0 W/kg for 10gSAR.

Similarly, in all the 1g or 10gSAR plots (when converted using Eq. (1a)), the green curve represents the 100s time averaged 1gSAR or 10gSAR value calculated based on instantaneous 1gSAR or 10gSAR; and the red line limit represents the FCC limit of 1.6 W/kg for 1gSAR or 4.0 W/kg for 10gSAR.

Time-varying Tx power measurements were conducted on test cases #1 ~ #6 in Table 7-12 by generating test sequence 1 and test sequence 2 given in Appendix A using measured  $P_{limit}$  and measured  $P_{max}$  for each of these test cases. Measurement results for test cases #1 ~ #6 are given in Sections 7.3.1 - 7.3.6.

7.3.1 LTE Band 25 (test case 1 in Table 6-2)

Plot No. 1

Test result for test sequence 1:

Above time-averaged conducted Tx power is converted/calculated into time-averaged 1gSAR using Equation (1a) and plotted below to demonstrate that the time-averaged 1gSAR versus time does not exceed the FCC limit of 1.6 W/kg for 1gSAR

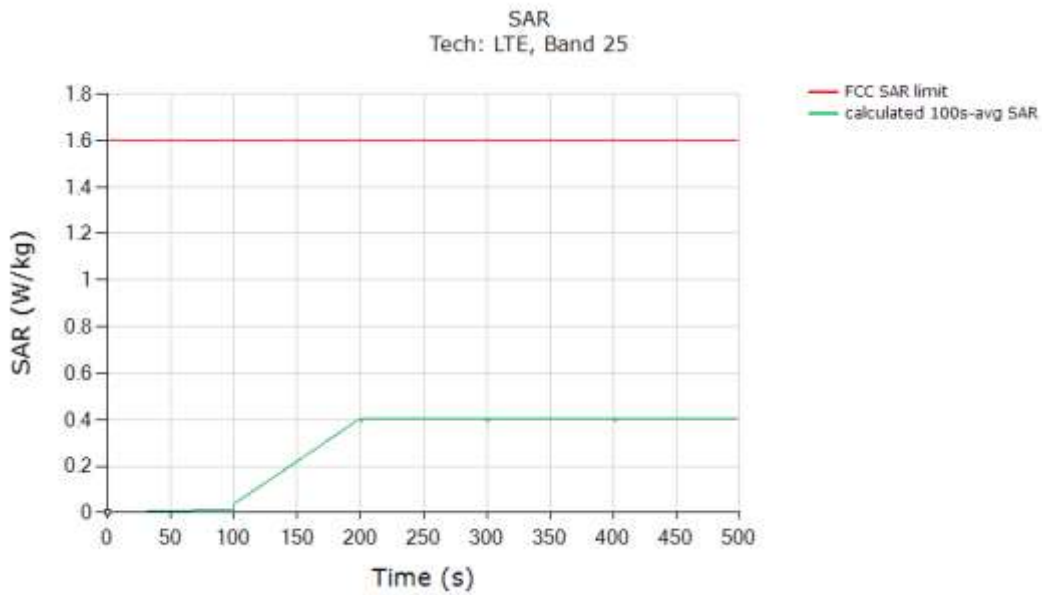

|   |            |
|---|------------|
| FCC 1g SAR Limit [W/kg]   | 1.6 W/kg   |
| Max 100s-time averaged 1gSAR (green curve)  | 0.406 W/kg |
| <i>Validated:</i> Max time averaged SAR (green curve) is within 1dB device uncertainty of measured SAR at <i>Plimit</i> (last column in Table 7-1). |            |

Test result for test sequence 2:

Above time-averaged conducted Tx power is converted/calculated into time-averaged 1gSAR using Equation (1a) and plotted below to demonstrate that the time-averaged 1gSAR versus time does not exceed the FCC limit of 1.6 W/kg for 1gSAR

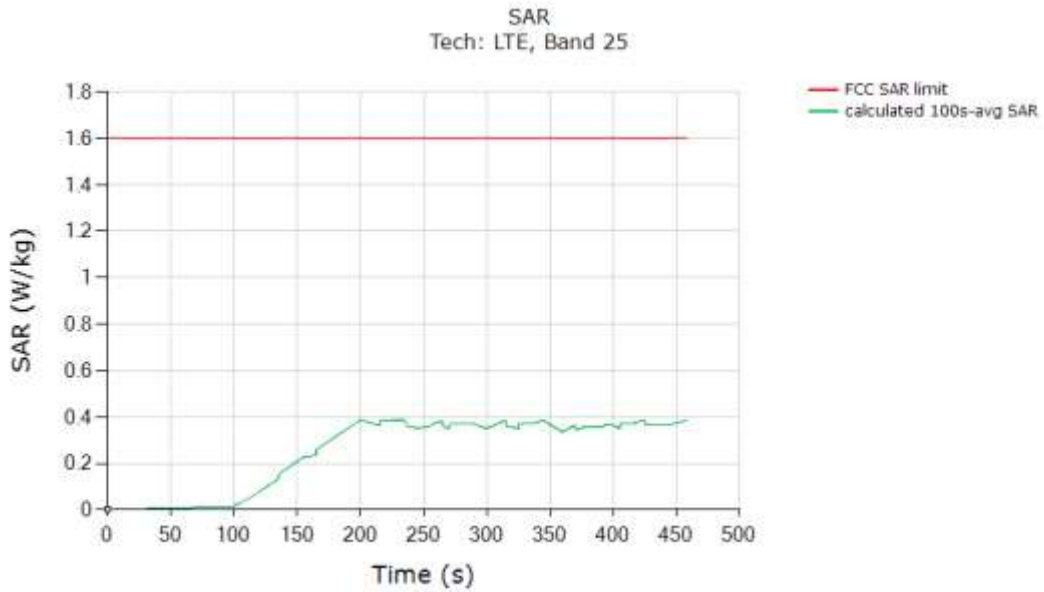

|  |            |
|--|------------|
| FCC 1g SAR Limit [W/kg]  | 1.6 W/kg   |
| Max 100s-time averaged 1gSAR (green curve)   | 0.386 W/kg |
| Validated: Max time averaged SAR (green curve) is within 1dB device uncertainty of measured SAR at <i>Plimit</i> (last column in Table 7-1). |            |

7.3.2 LTE Band 41 (test case 2 in Table 6-2)

Plot No. 2

Test result for test sequence 1:

Above time-averaged conducted Tx power is converted/calculated into time-averaged 1gSAR using Equation (1a) and plotted below to demonstrate that the time-averaged 1gSAR versus time does not exceed the FCC limit of 1.6 W/kg for 1gSAR

:

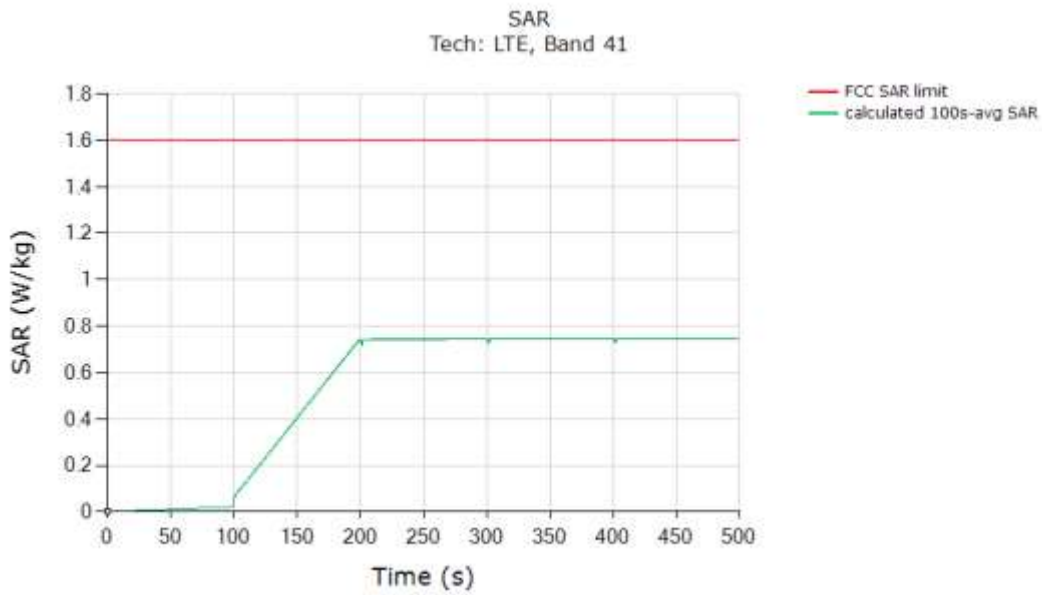

|  |            |
|--|------------|
| FCC 1g SAR Limit [W/kg]  | 1.6 W/kg   |
| Max 100s-time averaged 1gSAR (green curve)   | 0.744 W/kg |
| Validated: Max time averaged SAR (green curve) is within 1dB device uncertainty of measured SAR at <i>Plimit</i> (last column in Table 7-1). |            |



Test result for test sequence 2:

Above time-averaged conducted Tx power is converted/calculated into time-averaged 1.6gSAR using Equation (1a) and plotted below to demonstrate that the time-averaged 1.6gSAR versus time does not exceed the FCC limit of 1.6 W/kg for 1gSAR

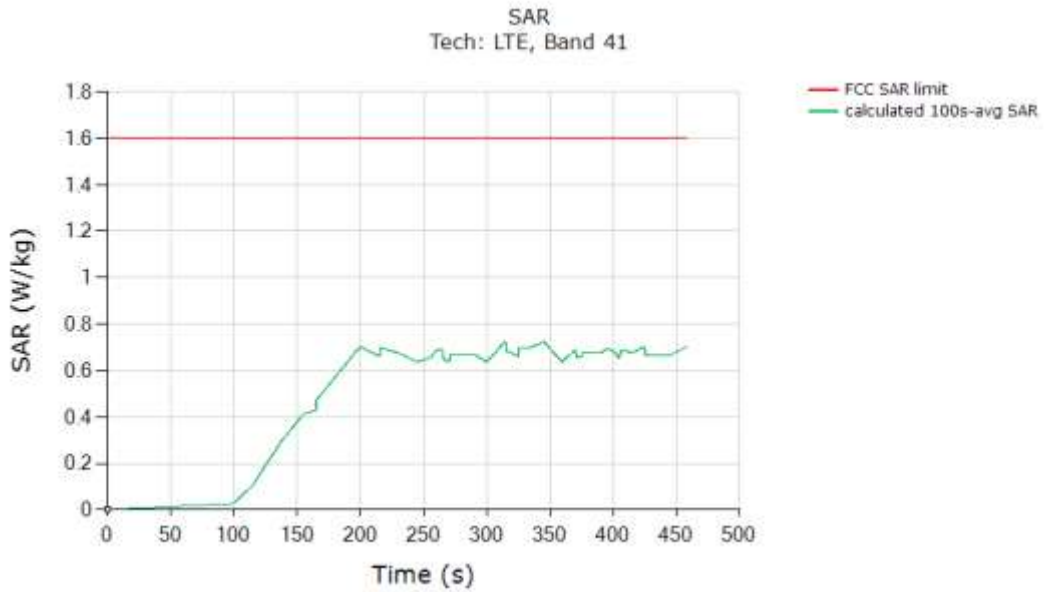

|  |            |
|--|------------|
| FCC 1g SAR Limit [W/kg]  | 1.6 W/kg   |
| Max 100s-time averaged 1gSAR (green curve)   | 0.724 W/kg |
| Validated: Max time averaged SAR (green curve) is within 1dB device uncertainty of measured SAR at <i>Plimit</i> (last column in Table 7-1). |            |

7.3.3 UMTS Band 2 (test case 3 in Table 6-2)

Plot No. 3

Test result for test sequence 1

Above time-averaged conducted Tx power is converted/calculated into time-averaged 1gSAR using Equation (1a) and plotted below to demonstrate that the time-averaged 1gSAR versus time does not exceed the FCC limit of 1.6 W/kg for 1gSAR

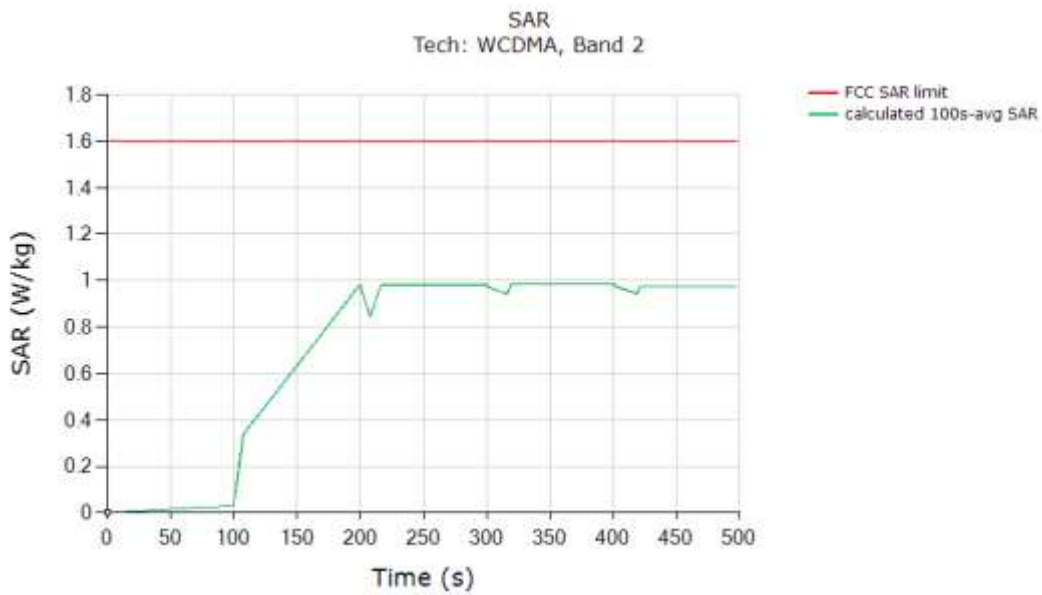

|  |            |
|--|------------|
| FCC 1g SAR Limit [W/kg]  | 1.6 W/kg   |
| Max 100s-time averaged 1gSAR (green curve)   | 0.983 W/kg |
| Validated: Max time averaged SAR (green curve) is within 1dB device uncertainty of measured SAR at <i>Plimit</i> (last column in Table 7-1). |            |

Test result for test sequence 2:

Above time-averaged conducted Tx power is converted/calculated into time-averaged 1gSAR using Equation (1a) and plotted below to demonstrate that the time-averaged 1gSAR versus time does not exceed the FCC limit of 1.6 W/kg for 1gSAR

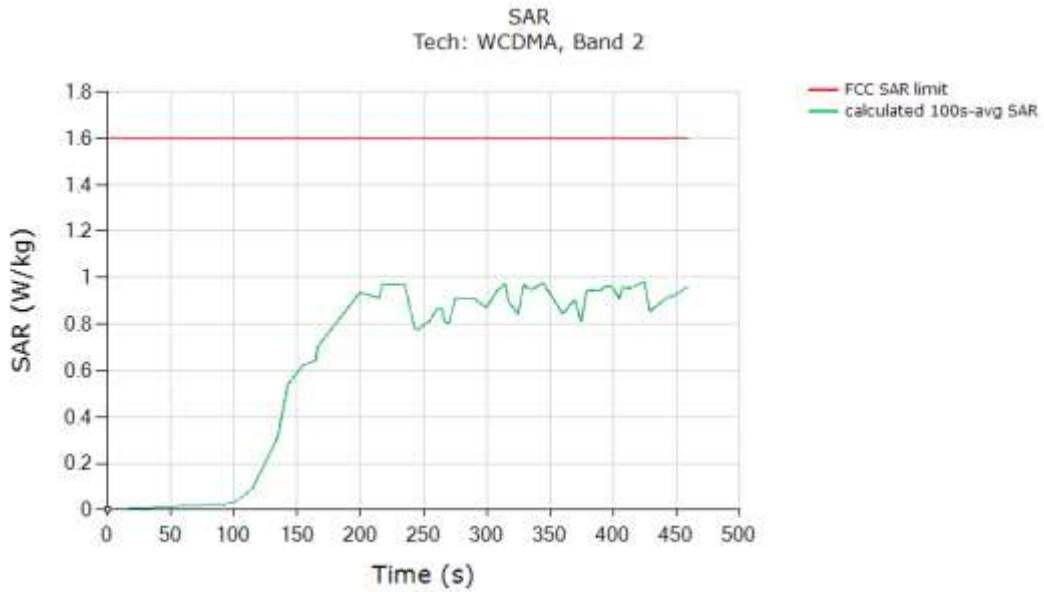

|  |            |
|--|------------|
| FCC 1g SAR Limit [W/kg]  | 1.6 W/kg   |
| Max 100s-time averaged 1gSAR (green curve)   | 0.982 W/kg |
| Validated: Max time averaged SAR (green curve) is within 1dB device uncertainty of measured SAR at <i>Plimit</i> (last column in Table 7-1). |            |

## 7.3.4 GSM/GPRS/EDGE/1900 (test case 4 in Table 6-2)

## Plot No. 4

## Test result for test sequence 1

Above time-averaged conducted Tx power is converted/calculated into time-averaged 1gSAR using Equation (1a) and plotted below to demonstrate that the time-averaged 1gSAR versus time does not exceed the FCC limit of 1.6 W/kg for 1gSAR

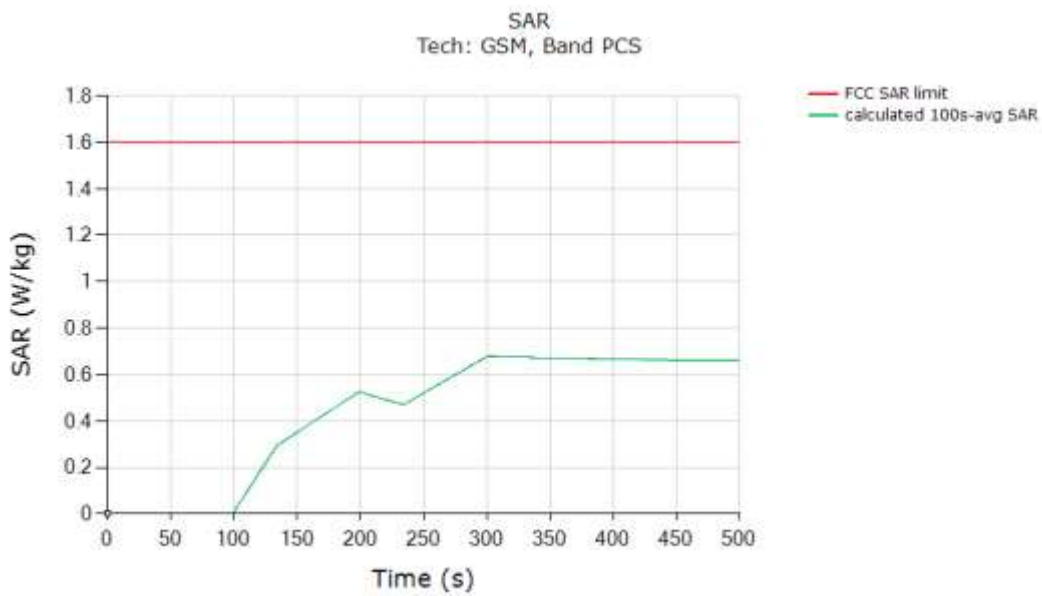

|  |            |
|--|------------|
| FCC 1g SAR Limit [W/kg]  | 1.6 W/kg   |
| Max 100s-time averaged 1gSAR (green curve)   | 0.678 W/kg |
| Validated: Max time averaged SAR (green curve) is within 1dB device uncertainty of measured SAR at <i>Plimit</i> (last column in Table 7-1). |            |

Test result for test sequence 2:

Above time-averaged conducted Tx power is converted/calculated into time-averaged 1gSAR using Equation (1a) and plotted below to demonstrate that the time-averaged 1gSAR versus time does not exceed the FCC limit of 1.6 W/kg for 1gSAR

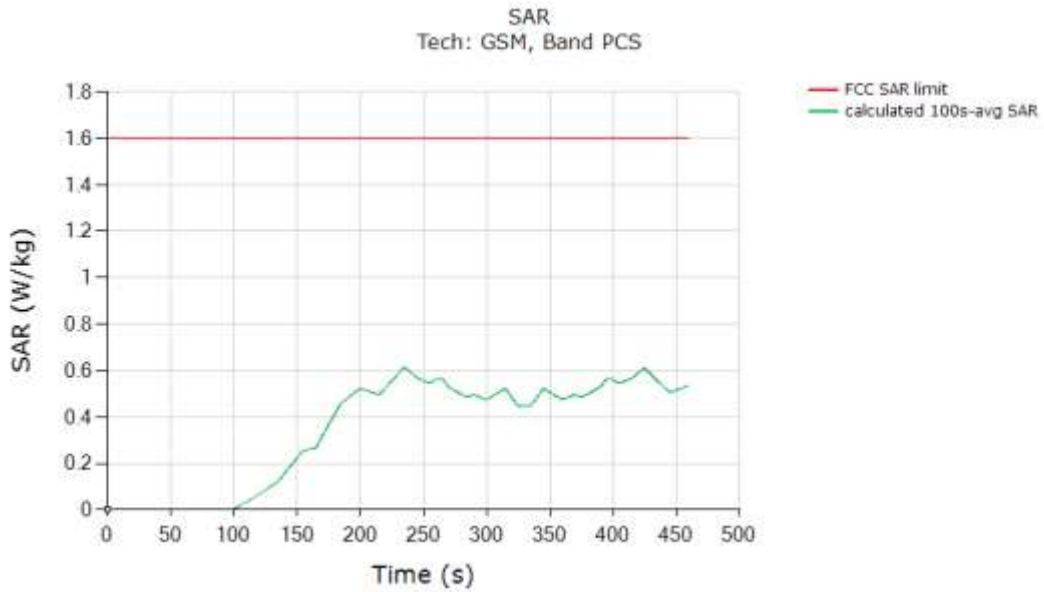

|  |            |
|--|------------|
| FCC 1g SAR Limit [W/kg]  | 1.6 W/kg   |
| Max 100s-time averaged 1gSAR (green curve)   | 0.614 W/kg |
| Validated: Max time averaged SAR (green curve) is within 1dB device uncertainty of measured SAR at <i>Plimit</i> (last column in Table 7-1). |            |

7.3.5 Sub6 NR n25 (test case 5 in Table 6-2)

Plot No. 5

Test result for test sequence 1

Above time-averaged conducted Tx power is converted/calculated into time-averaged 1gSAR using Equation (1a) and plotted below to demonstrate that the time-averaged 1gSAR versus time does not exceed the FCC limit of 1.6 W/kg for 1gSAR:

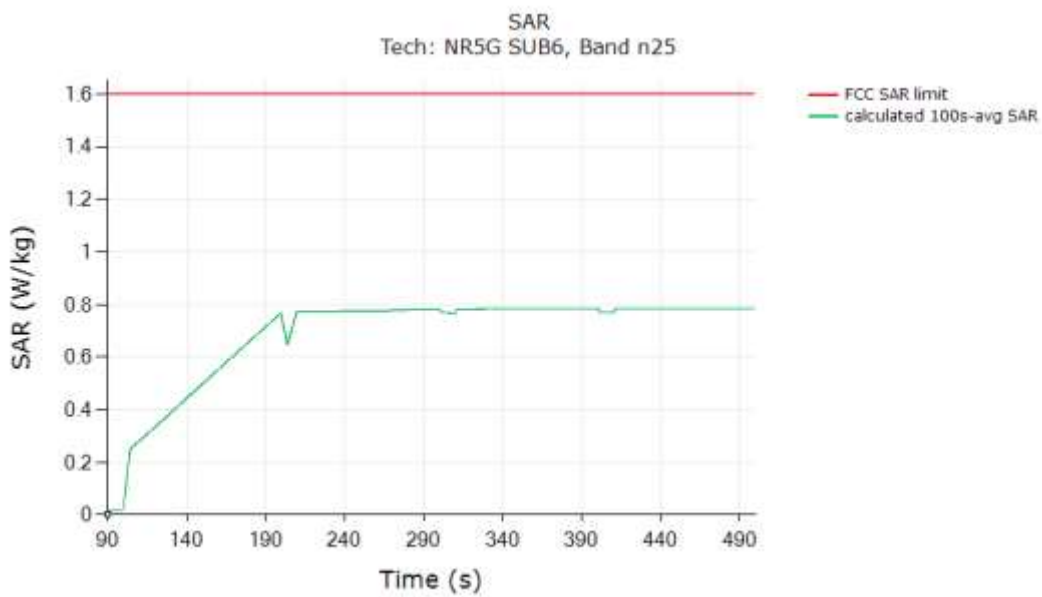

|  |            |
|--|------------|
| FCC 1g SAR Limit [W/kg]  | 1.6 W/kg   |
| Max 100s-time averaged 1g SAR (green curve)  | 0.783 W/kg |
| Validated: Max time averaged SAR (green curve) is within 1dB device uncertainty of measured SAR at <i>Plimit</i> (last column in Table 7-1). |            |

Test result for test sequence 2:

Above time-averaged conducted Tx power is converted/calculated into time-averaged 1gSAR using Equation (1a) and plotted below to demonstrate that the time-averaged 1gSAR versus time does not exceed the FCC limit of 1.6 W/kg for 10gSAR:

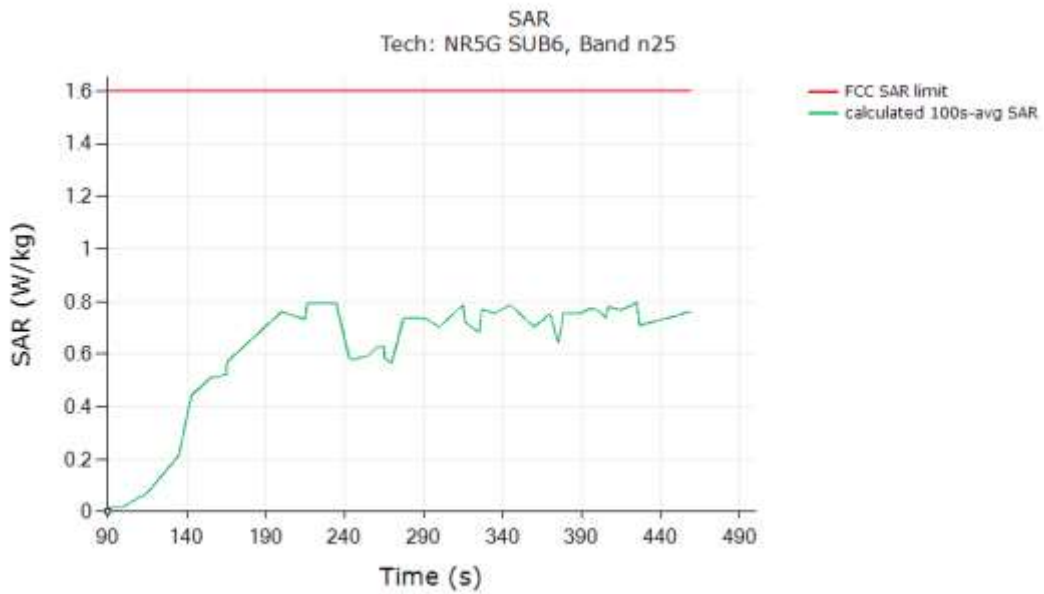

|  |            |
|--|------------|
| FCC 1g SAR Limit [W/kg]  | 1.6 W/kg   |
| Max 100s-time averaged 1gSAR (green curve)   | 0.796 W/kg |
| Validated: Max time averaged SAR (green curve) is within 1dB device uncertainty of measured SAR at <i>Plimit</i> (last column in Table 7-1). |            |

7.3.6 Sub6 NR n77 (test case 6 in Table 6-2)

Plot No. 6

Test result for test sequence 1

Above time-averaged conducted Tx power is converted/calculated into time-averaged 1gSAR using Equation (1a) and plotted below to demonstrate that the time-averaged 1gSAR versus time does not exceed the FCC limit of 1.6 W/kg for 1gSAR:

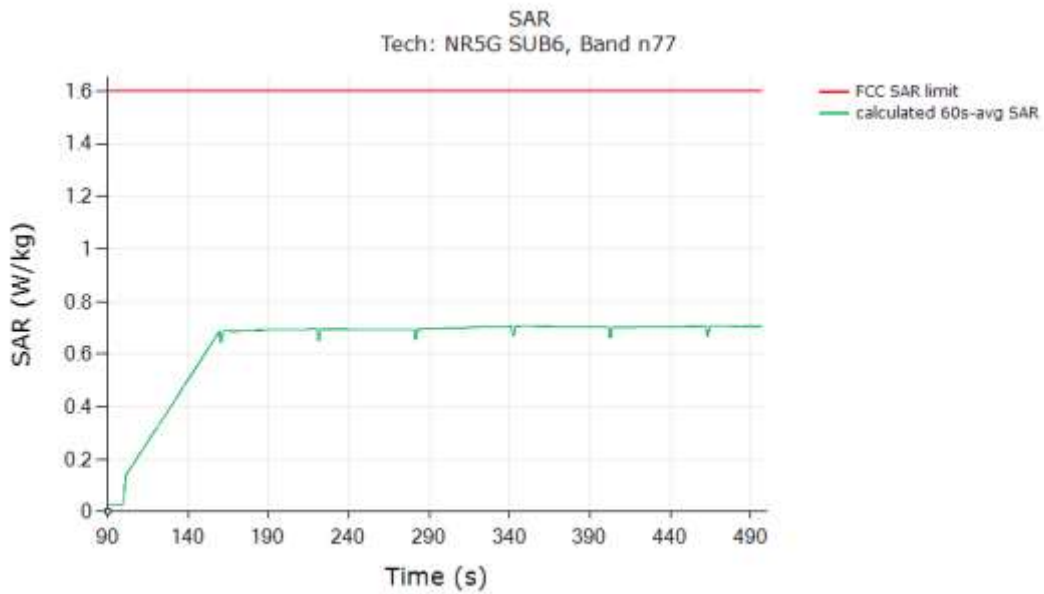

|  |            |
|--|------------|
| FCC 1g SAR Limit [W/kg]  | 1.6 W/kg   |
| Max 60s-time averaged 1g SAR (green curve)   | 0.706 W/kg |
| Validated: Max time averaged SAR (green curve) is within 1dB device uncertainty of measured SAR at <i>Plimit</i> (last column in Table 7-1). |            |



Test result for test sequence 2:

Above time-averaged conducted Tx power is converted/calculated into time-averaged 1gSAR using Equation (1a) and plotted below to demonstrate that the time-averaged 1gSAR versus time does not exceed the FCC limit of 1.6 W/kg for 1gSAR:

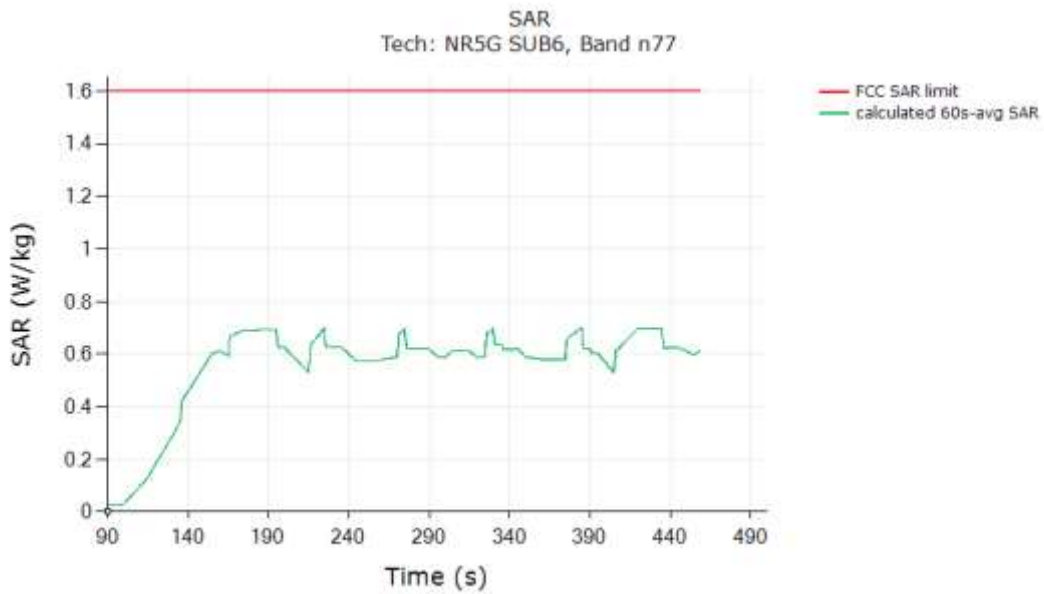

|  |            |
|--|------------|
| FCC 1g SAR Limit [W/kg]  | 1.6 W/kg   |
| Max 60s-time averaged 1gSAR (green curve)  | 0.699 W/kg |
| Validated: Max time averaged SAR (green curve) is within 1dB device uncertainty of measured SAR at <i>Plimit</i> (last column in Table 7-1). |            |

### 7.4 Change in Call Test results (test case 7 in Table 6-2)

This test was measured with NR n25, DSI=3 (Hotspot), and with callbox requesting maximum power. The call drop was manually performed when the EUT is transmitting at *Preserve* level as shown in the plot below. The measurement setup is shown in Figure 7-1(a). The detailed test procedure is described in Section 5.3.2.

Plot No. 7

Call drop test result:

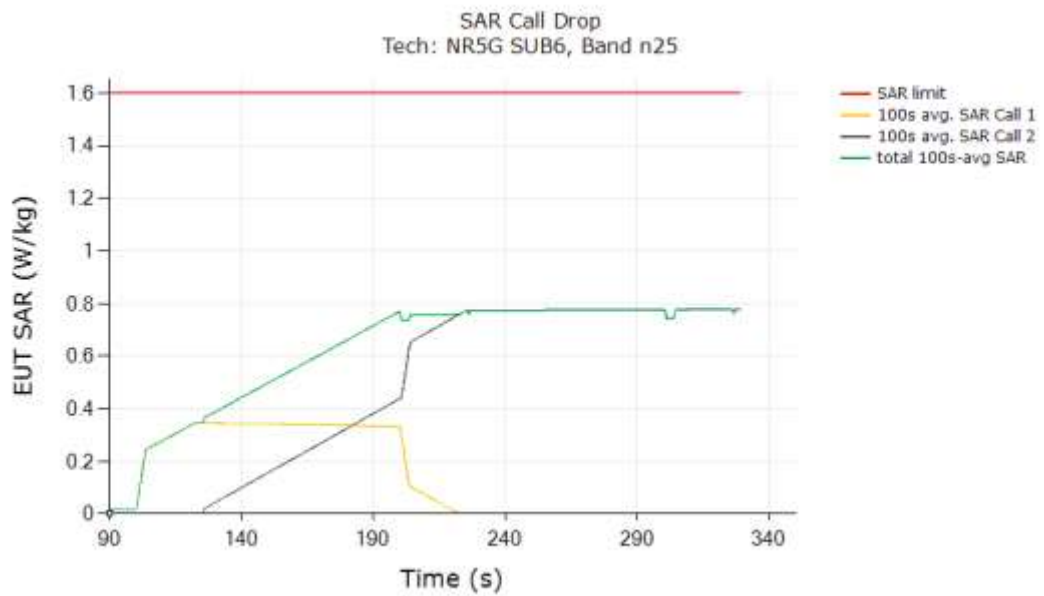

Above time-averaged conducted Tx power is converted/calculated into time-averaged 1gSAR using Equation (1a) and plotted below to demonstrate that the time-averaged 1gSAR versus time does not exceed the FCC limit of 1.6 W/kg for 1gSAR:

|   |            |
|---|------------|
| FCC 1g SAR Limit [W/kg]   | 1.6 W/kg   |
| Max 100s-time averaged 10gSAR (green curve)   | 0.777 W/kg |
| <b>Validated:</b> Max time averaged SAR (green curve) is within 1dB device uncertainty of measured SAR at <i>Plimit</i> (last column in Table 7-1). |            |

The test result validated the continuity of power limiting in call change scenario.

**7.5 Change in technology/band test results (test case 8 in Table 6-2)**

This test was conducted with callbox requesting maximum power, and with technology switch from LTE B25, DSI = 3 (Hotspot) to UMTS B2, DSI =3 (Hotspot). Following procedure detailed in Section 5.3.3, and using the measurement setup shown in Figure 7-1(b).

the technology/band switch was performed when the EUT is transmitting at *Preserve* level as shown in the plot below

**Plot No. 8**

Test result for change in technology/band:

All the time-averaged conducted Tx power measurement results were converted into time-averaged normalized SAR values using Equation (6a), (6b) and (6c), and plotted below to demonstrate that the time-averaged normalized SAR versus time does not exceed the normalized FCC limit of 1.0:

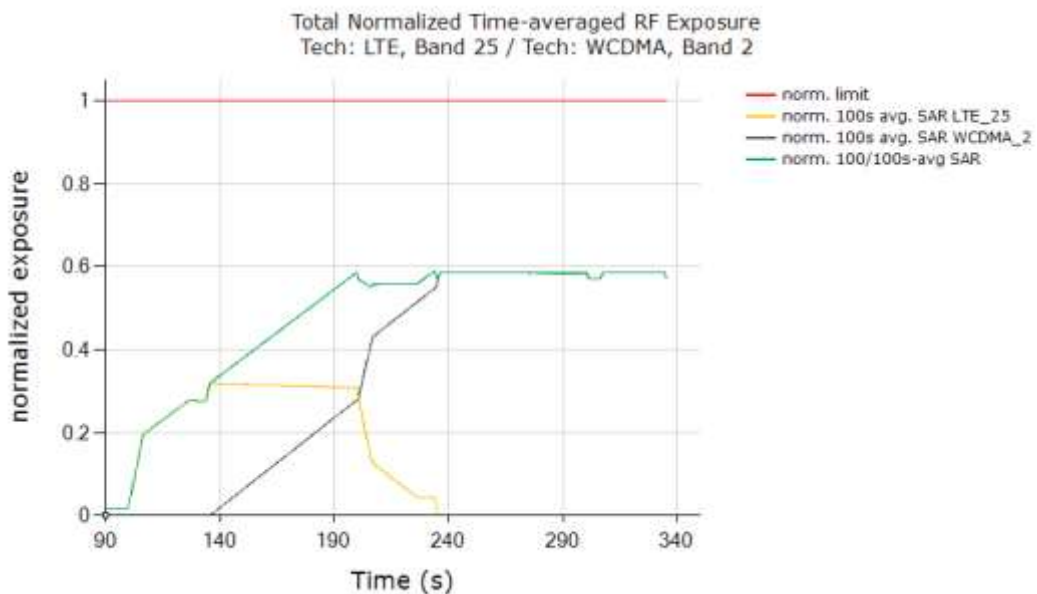

|  |       |
|--|-------|
| FCC normalized SAR limit                           | 1.0   |
| Max 100s-time averaged normalized SAR(green curve) | 0.590 |
| Validated:   |       |

The test result validated the continuity of power limiting in technology/band switch scenario.

### 7.6 Switch in Inter ULCA exposure test results (test case 9 in Table 6-2)

This test was conducted with callbox requesting maximum power, and with the EUT in LTE B66 + LTE B12 call. Here, LTE B66, DSI = 3(Hotspot) (100s window, Plimit = 16.8 dBm, Pmax = 22.8 dBm, measured Plimit = 16.43 dBm), and LTE B12, DSI = 3 (Hotspot) (100s window, Plimit = 21.0 dBm, Pmax = 23.5 dBm, measured Plimit = 20.81 dBm). Following procedure detailed in Section 5.3.7 and Appendix B.2, and using the measurement setup shown in Figure 7-1(c).

The SAR exposure switch measurement is performed with the EUT in various SAR exposure scenarios, i.e., in SAR LTE B12 only scenario (t =10s ~125s), SAR LTE B66+ LTE B12 (t =125s ~ 245s) and SAR LTE B66 only scenario (t >245s).

#### Plot No. 9

All the conducted Tx power measurement results were converted into time-averaged normalized SAR values using Equation (7a), (7b) and (7c), and plotted below to demonstrate that the time-averaged normalized SAR versus time does not exceed the FCC limit of 1 unit. Equation (7a) is used to convert the NR Tx power of device to obtain 100s-averaged normalized SAR in SAR NR n71 as shown in black curve. Similarly, equation (7b) is used to obtain 100s-averaged normalized SAR in SAR NR n66 as shown in orange curve. Equation (7c) is used to obtain total time-averaged normalized SAR as shown in green curve.

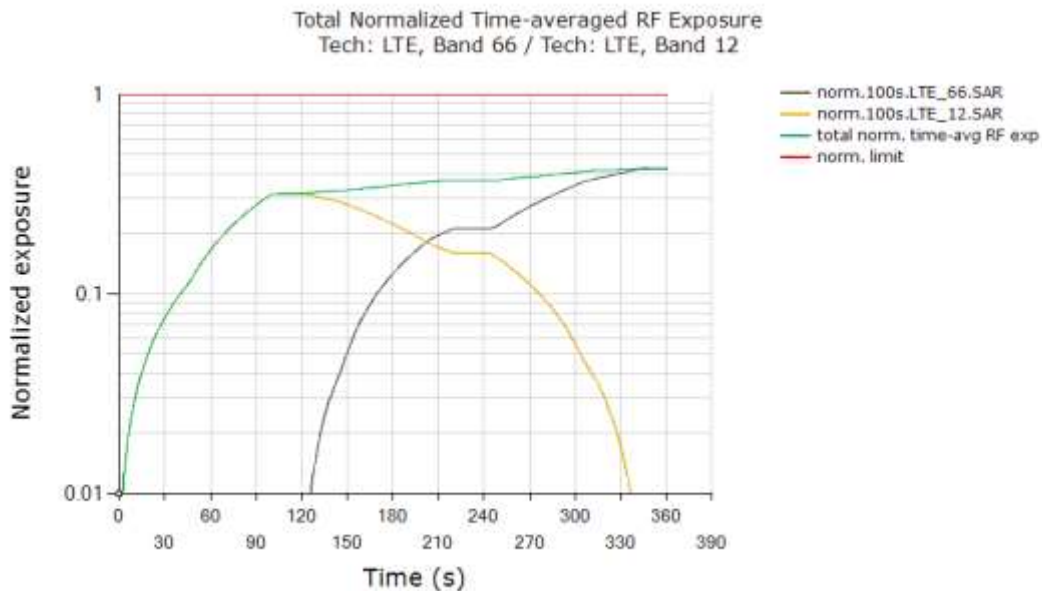

|  |       |
|--|-------|
| FCC normalized SAR limit                           | 1.0   |
| Max 100s-time averaged normalized SAR(green curve) | 0.427 |
| Validated:   |       |

**7.7 Change in DSI test results (test case 10 in Table 6-2)**

This test was conducted with callbox requesting maximum power, and with DSI switch from NR n25 DSI = 3 (Hotspot Mode), Plimit = 16.0 dBm to DSI = 0(BodyWorn), Plimit = 21.0 dBm. Following procedure detailed in Section 5.3.5 using the measurement setup shown in Figure 7-1(a) and (c), the DSI switch was performed when the EUT is transmitting at Preserve level as shown in the plot below.

**Plot No. 10**

Test result for change in DSI:

All the time-averaged conducted Tx power measurement results were converted into time-averaged normalized SAR values using Equation (6a), (6b) and (6c), and plotted below to demonstrate that the time-averaged normalized SAR versus time does not exceed the normalized FCC limit of 1.0:

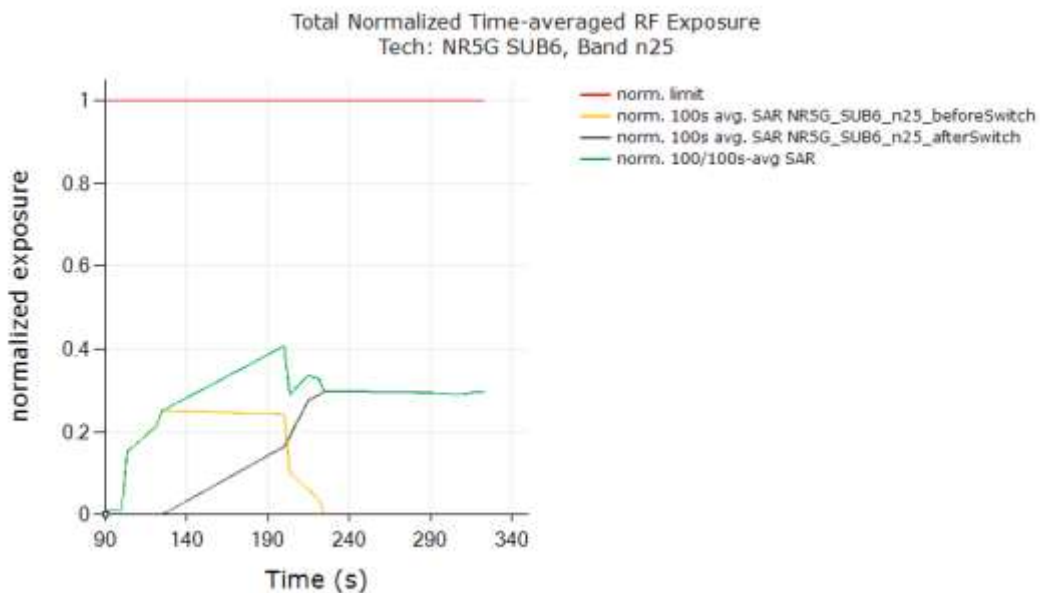

|  |       |
|--|-------|
| FCC normalized SAR limit                           | 1.0   |
| Max 100s-time averaged normalized SAR(green curve) | 0.408 |
| Validated:   |       |

**7.8 Change in Antenna Switch test results (test case 11 in Table 6-2)**

This test was conducted with callbox requesting maximum power, and with Antenna switch from NR n25, DSI = 3 (Hotspot), Plimit = 16.0 dBm Ant. 1 to NR n25 DSI =3 (Hotspot), Plimit = 15.3 dBm Ant. A. Following procedure detailed in Section 5.3.4, and using the measurement setup shown in Table 7-1(b) the Antenna switch was performed when the EUT is transmitting at *Preserve* level as shown in the plot below.

**Plot No. 11**

Test result for change in Antenna Switch:

All the time-averaged conducted Tx power measurement results were converted into time- averaged normalized SAR values using Equation (6a), (6b) and (6c), and plotted below to demonstrate that the time- averaged normalized SAR versus time does not exceed the normalized FCC limit of 1.0:

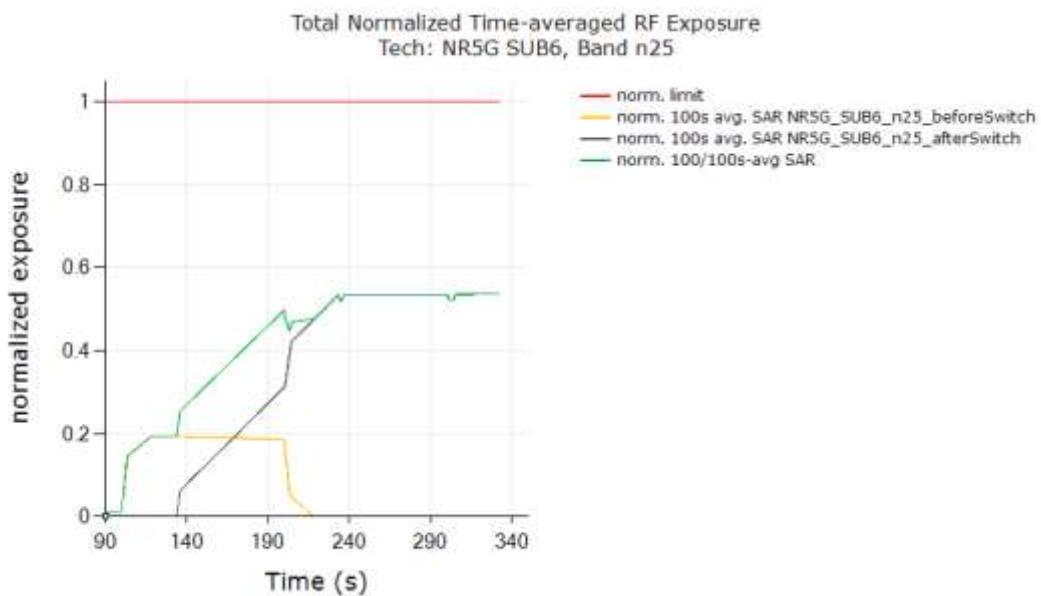

|  |       |
|--|-------|
| FCC normalized SAR limit                           | 1.0   |
| Max 100s-time averaged normalized SAR(green curve) | 0.537 |
| Validated:   |       |

The test result validated the continuity of power limiting in technology/band switch scenario.

### 7.9 Change in Time window switch test results (test case 12 in Table 6-2)

This test was conducted with callbox requesting maximum power, and with antenna switch between NR n77, Ant. F(60s), DSI = 2(Head) and NR n41, Ant. I (100s), DSI = 2(Head). Following procedure detailed in Section 5.3.6, and using the measurement setup shown in Table 7-1(b) the tech/band/antenna switch was performed when the EUT is transmitting at *Preserve* level.

#### 7.9.1 Test case 1 : transition from NR n77 to NR n41 (i.e 60s to 100s) then back to NR n77

##### Plot No.12

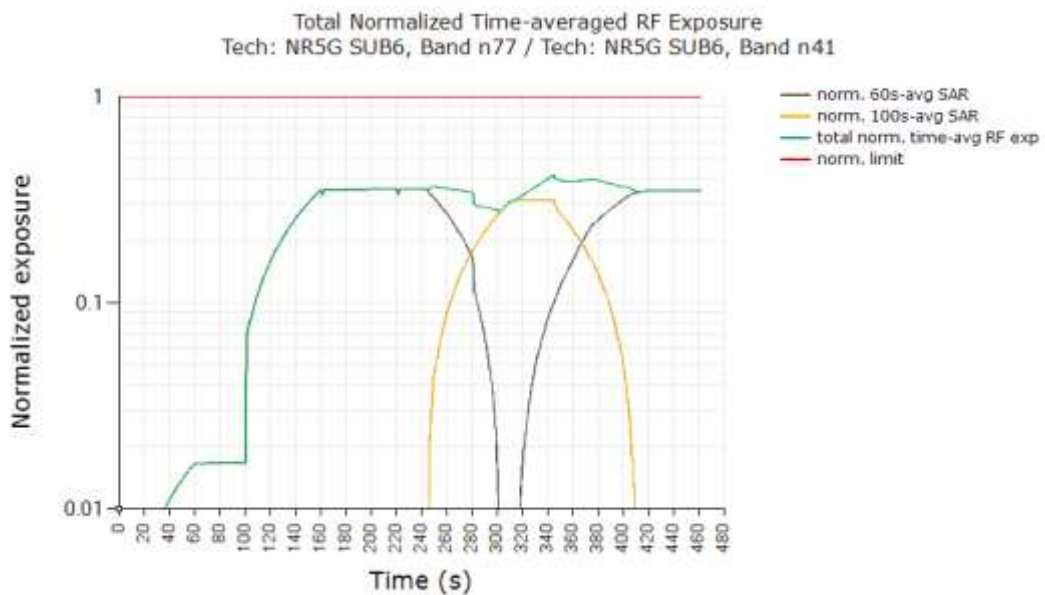

|   |       |
|---|-------|
| FCC normalized total exposure limit                       | 1.0   |
| Max Norm. Total time-avg. SAR (green curve) (green curve) | 0.418 |
| Validated:  |       |

7.9.2 Test case 2 : transition from NR n41 to NR n77 (i.e 100s to 60s) then back to NR n41

Plot No.13

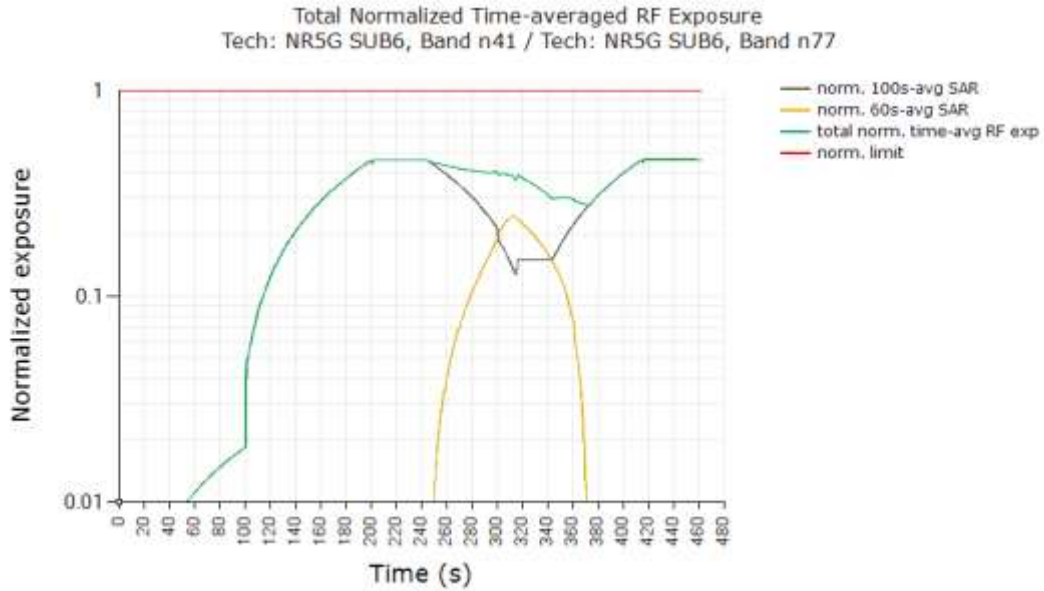

|   |       |
|---|-------|
| FCC normalized total exposure limit                       | 1.0   |
| Max Norm. Total time-avg. SAR (green curve) (green curve) | 0.461 |
| Validated:  |       |



### 7.10 Switch in SAR exposure test results (test case 13 in Table 6-2)

This test was conducted with callbox requesting maximum power, and with the EUT in LTE B12 + Sub6 NR Band n25 call. Here, LTE B12, DSI = 3(Hotspot)(100s window,  $P_{limit} = 21.0$  dBm,  $P_{max} = 23.5$  dBm, measured  $P_{limit} = 20.81$  dBm), and Sub6 NR Band n25, DSI = 3 ( Hotspot)(100s window,  $P_{limit} = 16.0$  dBm, EUT's average  $P_{max} = 25.0$  dBm, measured  $P_{limit} = 16.08$  dBm. Following procedure detailed in Section 5.3.7 and Appendix B.2, and using the measurement setup shown in Table 7-1(c) since LTE and Sub6 NR are sharing the same antenna port. The SAR exposure switch measurement is performed with the EUT in various SAR exposure scenarios, i.e., in SARsub6NR only scenario ( $t = 10s \sim 125s$ ), SARsub6NR + SARLTE scenario ( $t = 125s \sim 245s$ ) and SARLTE only scenario ( $t > 245s$ ).

#### Conducted Plot No.14

All the conducted Tx power measurement results were converted into time-averaged normalized SAR values using Equation (7a), (7b) and (7c), and plotted below to demonstrate that the time-averaged normalized SAR versus time does not exceed the FCC limit of 1 unit. Equation (7a) is used to convert the LTE Tx power of device to obtain 100s-averaged normalized SAR in LTE B12 as shown in black curve. Similarly, equation (7b) is used to obtain 100s-averaged normalized SAR in Sub6 NR n66 as shown in orange curve. Equation (7c) is used to obtain total time-averaged normalized SAR as shown in green curve (i.e., sum of black and orange curves).

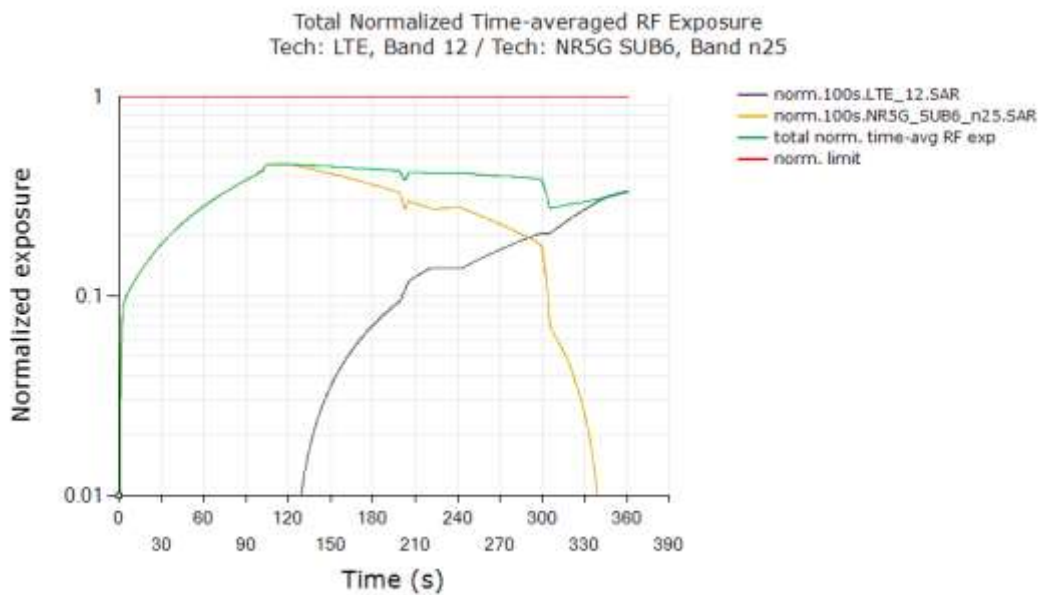

|   |       |
|---|-------|
| FCC normalized total exposure limit                       | 1.0   |
| Max Norm. Total time-avg. SAR (green curve) (green curve) | 0.456 |
| Validated:  |       |

Plot Notes:

Device starts predominantly in Sub6 NR SAR exposure scenario between 5s and 125s, and in LTE SAR + Sub6 NR SAR exposure scenario between 125s and 245s, and in predominantly in LTE SAR exposure scenario after t=245s. Here, Smart Transmit allocates a maximum of 100% of exposure margin (based on 1.5dB reserve margin setting) for Sub6 NR. This corresponds to a normalized 1gSAR exposure value =  $100\% * 0.695 \text{ W/kg measured SAR at Sub6 NR } P_{limit} / 1.6 \text{ W/kg limit} = 0.455 \pm 1\text{dB}$  device related uncertainty (see orange curve between 5s~125s). For predominantly LTE SAR exposure scenario, maximum normalized 10gSAR exposure should correspond to 100% exposure margin =  $0.433 \text{ W/kg measured SAR at LTE } P_{limit} / 1.6 \text{ W/kg limit} = 0.329 \pm 1\text{dB}$  device related uncertainty (see black curve after t =245s).

Additionally, in SAR exposure switch test, at all times the total time-averaged normalized RF exposure (green curve) should not exceed normalized SAR\_design\_target + 1dB device uncertainty. In this test, with a maximum normalized SAR of 0.456 being  $\leq 0.794$  (=  $1/1.6 + 1\text{dB}$  device uncertainty), the above test result validated the continuity of power limiting in SAR exposure switch scenario.

**7.11 Exposure Category Switch (test case 14, 15 in Table 6-2)**

This test was conducted with callbox requesting maximum power, and with switch between NR n25, Ant. A, DSI=3(Hotspot/ Body Exposure) and NR n25, Ant. A, DSI=2(Head Exposure). Following procedure detailed in Sec 5.3.8 and using the measurement setup shown in Table 7-1(a), the exposure category switch was performed when the EUT is transmitting at Preserve level.

**Plot 15**

Maximum power is requested by callbox for the entire duration of the test, time-averaged exposure in non-head DSI gradually increases until t~150s where the device is switched from non-head exposure DSI(first DSI, orange curve) to head exposure DSI(second DSI, black curve) as evident from increase in exposure of black curve and no change in orange curve between t~150s and t~160s. At t~160s, device is switched back from head exposure to non-head exposure as evident from increase in exposure of orange curve and no change in black curve. In this test, the time-averaged normalized RF exposure in head exposure DSI(orange curve) did not exceed normalized limit of 1.0 at all times, and is less than normalized SAR being  $0.635 \leq 0.794 (=1.0/1.6 + 1\text{dB device uncertainty})$ , validating the exposure continuity when switching between non-head exposure and head exposure categories.

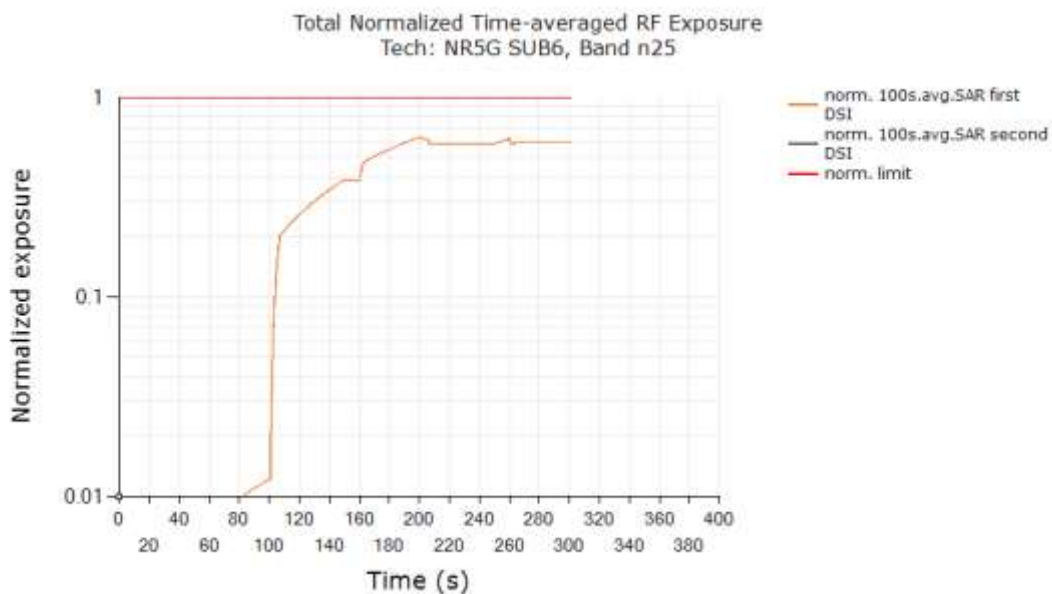

|   |       |
|---|-------|
| FCC normalized total exposure limit                             | 1.0   |
| Max 100s-time averaged normalized SAR (first DSI, orange curve) | 0.635 |
| Validated:  |       |

This test was conducted with callbox requesting maximum power, and with switch between NR n77, Ant. F, DSI=2(Head Exposure) and NR n77, Ant. F, DSI=3(Hotspot/ Body Exposure). Following procedure detailed in Sec 5.3.8 and using the measurement setup shown in Table 7-1(a), the exposure category switch was performed when the EUT is transmitting at Preserve level.

**Plot 16**

Maximum power is requested by callbox for the entire duration of the test, time-averaged exposure in head DSI gradually increases until t~152s where the device is switched from head exposure DSI(first DSI, orange curve) to non-head exposure DSI(second DSI, black curve) as evident from increase in exposure of black curve and no change in orange curve between t~152s and t~162s. At t~162s, device is switched back from non-head exposure to head exposure as evident from increase in exposure of orange curve and no change in black curve. In this test, the time-averaged normalized RF exposure in head exposure DSI(orange curve) did not exceed normalized limit of 1.0 at all times, and is less than normalized SAR 0.463 being  $\leq 0.794 (=1.0/1.6 + 1\text{dB device uncertainty})$ , validating the exposure continuity when switching between head exposure and non-head exposure categories.

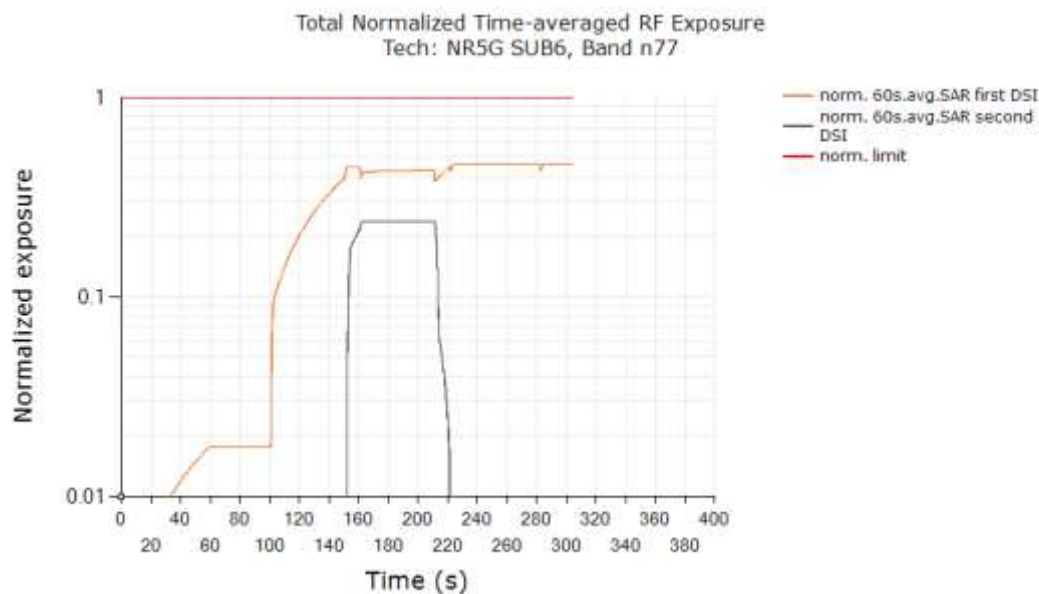

|   |       |
|---|-------|
| FCC normalized total exposure limit                             | 1.0   |
| Max 100s-time averaged normalized SAR (first DSI, orange curve) | 0.463 |
| Validated:  |       |

### 7.12 Switch in SAR exposure test results (test case 16 in Table 6-2)

This test was conducted with callbox set to request maximum duty cycle, and with the EUT in WLAN 2.4GHz + WLAN 5GHz. Here, WLAN 2.4GHz Ant F, DSI = 2(Head) (30s window,  $P_{limit} = 18.0$  dBm,  $P_{max} = 18.0$  dBm, measured  $P_{limit} = 17.86$  dBm), and WLAN 5GHz Ant F, DSI = 2(Head) (30s window,  $P_{limit} = 15.0$  dBm, EUT's average  $P_{max} = 15.0$  dBm, measured  $P_{limit} = 15.15$  dBm). Following procedure detailed in Section 5.3.10, and using the measurement setup shown in Table 7-1(e) The WLAN DBS SAR exposure switch measurement is performed with the EUT in various SAR exposure scenarios.

#### Conducted Plot No.17

All the conducted Tx power measurement results were converted into time-averaged normalized SAR values using Equation (7a), (7b) and (7c), and plotted below to demonstrate that the time-averaged normalized SAR versus time does not exceed the FCC limit of 1 unit. Equation (7a) is used to convert the WLAN Tx power of device to obtain 30s-averaged normalized SAR in WLAN 5 GHz, Ant F as shown in black curve. Similarly, equation (7b) is used to obtain 30s-averaged normalized SAR in WLAN 2.4 GHz, Ant F as shown in orange curve. Equation (7c) is used to obtain total time-averaged normalized SAR as shown in green curve (i.e., sum of black and orange curves).

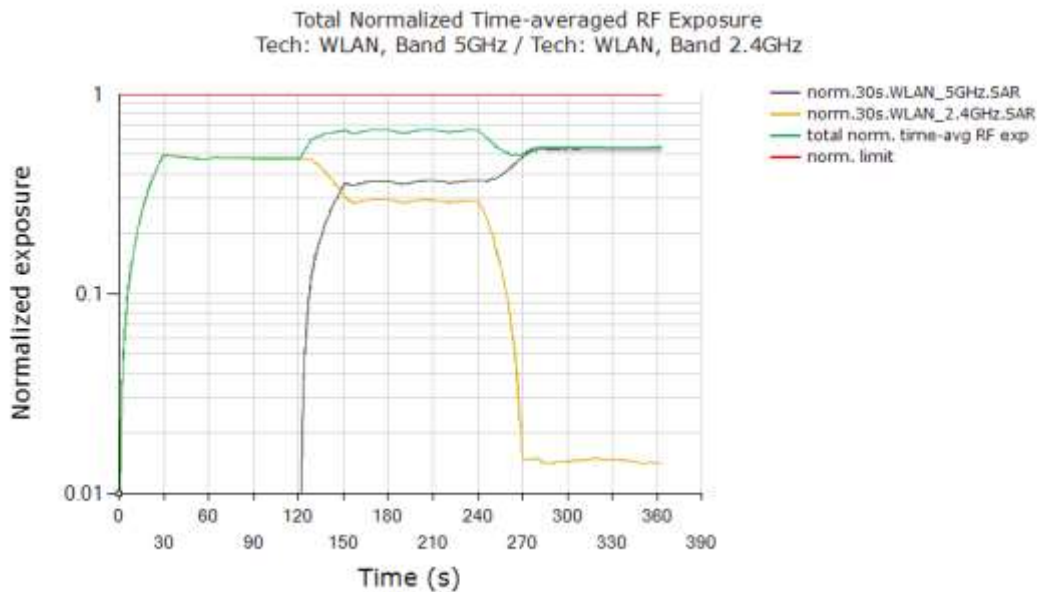

|   |       |
|---|-------|
| FCC normalized total exposure limit                       | 1.0   |
| Max Norm. Total time-avg. SAR (green curve) (green curve) | 0.666 |
| Validated:  |       |

In this test, the total time-averaged normalized RF exposure (green curve) did not exceed normalized limit of 1.0 at all times, the above test result validated the continuity of power limiting in SAR exposure switch scenario.

### 7.13 System level compliance continuity (test case 17 in Table 6-2)

This test was conducted with callbox requesting maximum power for WWAN(LTE 25 in DSI=2 (Head) radio to transmit at maximum power and After drop WWAN connection and establish WLAN(WLAN ANT F 5GHz) connection with the callbox in selected WLAN radio configuration and request EUT to transmit at maximum duty cycle request add the selected WWAN and BT(ANT F) radios to have the simultaneous transmission of WWAN + WLAN + BT. Request WWAN radio to transmit at maximum power and request WLAN & BT radios to transmit at maximum duty cycle Drop WWAN connection and set WWAN modem into airplane mode. Continue requesting WLAN & BT radios to transmit at maximum duty cycle (and maximum power) for at least two times the max Drop WLAN connection. Continue requesting BT radio to transmit at maximum duty cycle (and maximum power). Continue the test for at least one BT. In the case of FCC time windows, drop BT connection and establish back WLAN connection in selected radio configuration. Continue requesting WLAN radio to transmit at maximum duty cycle and finally transition to simultaneous transmission of WWAN+WLAN+BT(LTE 25 AntI+WLAN ANT F 5GHz + BT ANT F) Following procedure detailed in Section 5.3.11, and using the measurement setup shown in Table 7-1(f)

#### Conducted Plot No.18

All the conducted Tx power measurement results were converted into time-averaged normalized SAR values using Equation (7a), (7b) and (7c), and plotted below to demonstrate that the time-averaged normalized SAR versus time does not exceed the FCC limit of 1 unit. Equation (7a), (7b) is used to convert the LTE Tx power of device to obtain 100s-averaged normalized SAR in LTE B7 as shown in black curve. Similarly, equation (7a), (7b) is used to obtain 30s-averaged normalized SAR in WLAN 5GHz as shown in orange curve. And equation (7a), (7b) is used to obtain 100s-averaged normalized SAR in BT as shown in Blue curve. Equation (7c) is used to obtain total time-averaged normalized SAR as shown in green curve (i.e., sum of black and orange and Blue curves).

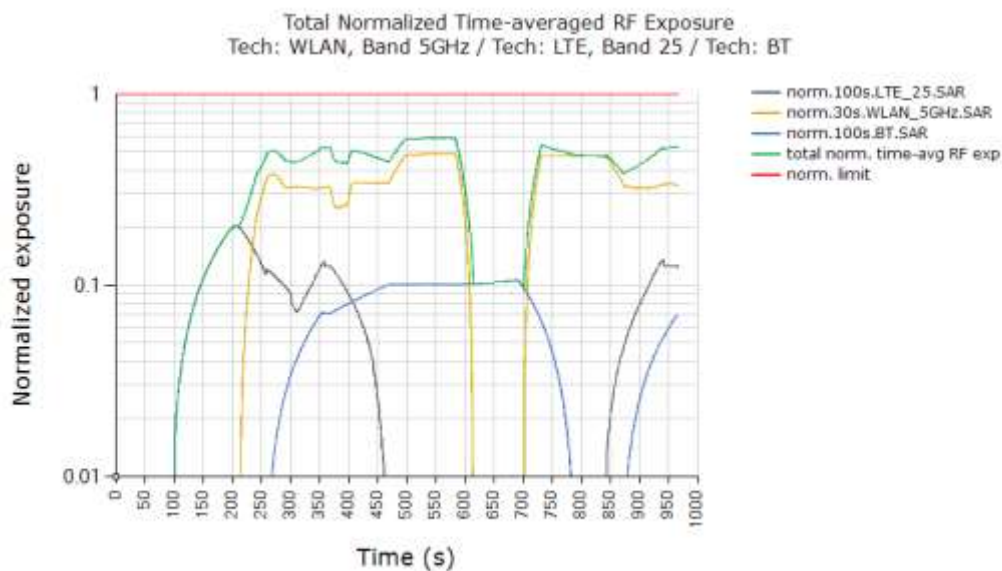

|  |       |
|--|-------|
| FCC normalized total exposure limit                            | 1.0   |
| Max 60s-time averaged normalized SAR (first DSI, orange curve) | 0.590 |
| Validated:   |       |

In this test, the total time-averaged normalized RF exposure (green curve) did not exceed normalized limit of 1.0 at all times, the above test result validated the total RF exposure compliance in system level compliance continuity test scenario

## 8. Equipment List

| Manufacturer              | Type / Model                                | S/N        | Calib. Date | Calib.Interval | Calib.Due  |
|---------------------------|---|------------|-------------|----------------|------------|
| R&S                       | Wireless Communication Test Set/<br>CMW500  | 167918     | 03/20/2024  | Annual         | 03/20/2025 |
| Anritsu                   | Radio communication<br>analyzer/MT8821C     | 6201664725 | 01/17/2024  | Annual         | 01/17/2025 |
| Anritsu                   | Radio communication test<br>station/MT8000A | 6262148305 | 12/21/2023  | Annual         | 12/21/2024 |
| R&S                       | Power Sensor/NRP8S                          | 109996     | 11/24/2023  | Annual         | 11/24/2024 |
| R&S                       | Power Sensor/NRP8S                          | 104636     | 07/03/2023  | Annual         | 07/03/2024 |
| R&S                       | Power Sensor / NRP8S                        | 108076     | 02/28/2024  | Annual         | 02/28/2025 |
| R&S                       | Power Sensor/NRP50S                         | 101351     | 11/24/2023  | Annual         | 11/24/2024 |
| NARDA                     | Directional Coupler / 4226-10               | 03096      | 02/28/2024  | Annual         | 02/28/2025 |
| Narda                     | Directional Coupler/4216-10                 | 01653      | 07/03/2023  | Annual         | 07/03/2024 |
| Narda                     | Directional Coupler/4216-10                 | 01652      | 07/03/2023  | Annual         | 07/03/2024 |
| Narda                     | Directional Coupler/4216-10                 | 2090710    | 07/03/2023  | Annual         | 07/03/2024 |
| Mini-Circuits             | Power Splitter/ZN2PD2-63-S+                 | UU95102009 | 05/26/2023  | Annual         | 05/26/2024 |
| Microlab                  | LP-Filter/LA-30N                            | -          | 09/21/2023  | Annual         | 09/21/2024 |
| Microlab                  | LP-Filter/LA-15N                            | -          | 09/21/2023  | Annual         | 09/21/2024 |
| WEINWRIGHT<br>INSTRUMENTS | High Pass Filter/WHKX12-935                 | 95         | 02/15/2024  | Annual         | 02/15/2025 |
| WEINWRIGHT<br>INSTRUMENTS | High Pass Filter/WHKX12-2805                | 61         | 02/15/2024  | Annual         | 02/15/2025 |
| None                      | Step Attenuator/Variable attenuator         | -          | 03/28/2024  | Annual         | 03/28/2025 |

## 9. Conclusion

Qualcomm Smart Transmit feature employed in Samsung Mobile Phone (FCC A3LSMF741B) has been validated through the conducted/radiated power measurement (as demonstrated in Chapters 8 and 9)

As demonstrated in this report, the power limiting enforcement is effective and the total normalized time-averaged RF exposure does not exceed 1.0 for all the transmission scenarios described in Section 4.

Therefore, the EUT complies with FCC RF exposure requirement.



## Appendix A: Test Sequences

### 1. Test sequence is generated based on below parameters of the EUT:

- a. Measured maximum power ( $P_{max}$ )
- b. Measured Tx\_power\_at\_SAR\_design\_target ( $P_{limit}$ )
- c. Reserve\_power\_margin (dB)

$$P_{reserve} \text{ (dBm)} = \text{measured } P_{limit} \text{ (dBm)} - \text{Reserve\_power\_margin (dB)}$$

For EUT enabled with Smart Transmit EFS version 18, } 2G and 3G WWAN technologies:

$$\text{Reserve\_power\_margin (dB)} = \text{reserve\_power\_margin\_db\_2g\_3g\_wwan } \}$$

4G and 5G WWAN technologies: Reserve\_power\_margin (dB) =

$$-10 * \log_{10}(\text{total\_min\_exp\_budget\_linear\_4g\_5g\_wwan}) \text{ for 4G and 5G technologies}$$

- For EUT enabled with Smart Transmit EFS version 19 (or higher),

If only WWAN technology is managed under Smart Transmit: Reserve\_power\_margin (dB)

$$= -10 * \log_{10}(\text{TOTAL\_MIN\_RES\_RATIO} ) \}$$

If WWAN, WLAN and BT are managed under Smart Transmit: Reserve\_power\_margin (dB)

$$= -10 * \log_{10}(\text{TOTAL\_MIN\_RES\_RATIO} + \text{BT\_AND\_2+_RADIO\_SAME\_AG})$$

- d. FCC SAR\_time\_window (100s for  $f < 3\text{GHz}$ , 60s for  $3\text{GHz} < f \leq 6\text{GHz}$  and 30s for  $6\text{GHz} < f \leq 10\text{GHz}$ )

## 2. Test Sequence 1 Waveform:

Based on the parameters above, the Test Sequence 1 is generated with one transition between high and low Tx powers. Here, high power =  $P_{max}$ ; low power =  $P_{max}/2$ , and the transition occurs after 80 seconds at high power  $P_{max}$ . As long as the power enforcement is taking into effective during one 100s/60s time window, the validation test with this defined test sequence 1 is valid, otherwise, select other radio configuration (band/DSI within the same technology group) having lower  $P_{limit}$  for this test. The Test sequence 1 waveform is shown below:

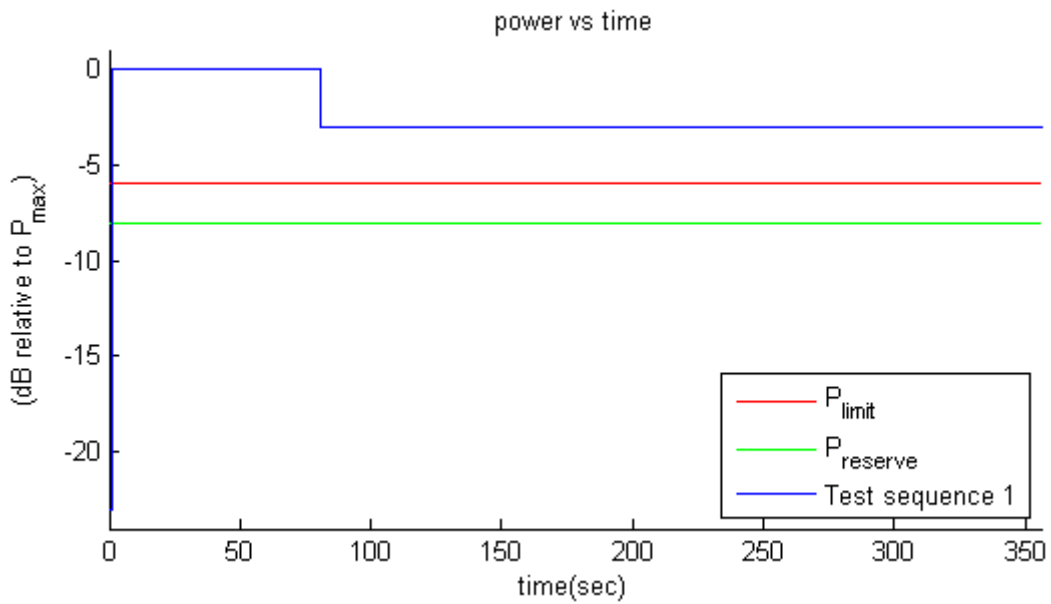

Figure 1 Test sequence 1 waveform

### 3. Test Sequence 2 Waveform:

Based on the parameters in A-1, the Test Sequence 2 is generated as described in Table A-1, which contains two 170 second-long sequences (yellow and green highlighted rows) that are mirrored around the center row of 20s, resulting in a total duration of 360 seconds:

Table -1 Test Sequence 2

| Time duration (seconds) | dB relative to $P_{limit}$ or $P_{reserve}$                                 |
|-------------------------|---|
| 15                      | $P_{reserve} - 2$   |
| 20                      | $P_{limit}$   |
| 20                      | $(P_{limit} + P_{max})/2$ averaged in mW and rounded to nearest 0.1 dB step |
| 10                      | $P_{reserve} - 6$   |
| 20                      | $P_{max}$   |
| 15                      | $P_{limit}$   |
| 15                      | $P_{reserve} - 5$   |
| 20                      | $P_{max}$   |
| 10                      | $P_{reserve} - 3$   |
| 15                      | $P_{limit}$   |
| 10                      | $P_{reserve} - 4$   |
| 20                      | $(P_{limit} + P_{max})/2$ averaged in mW and rounded to nearest 0.1 dB step |
| 10                      | $P_{reserve} - 4$   |
| 15                      | $P_{limit}$   |
| 10                      | $P_{reserve} - 3$   |
| 20                      | $P_{max}$   |
| 15                      | $P_{reserve} - 5$   |
| 15                      | $P_{limit}$   |
| 20                      | $P_{max}$   |
| 10                      | $P_{reserve} - 6$   |
| 20                      | $(P_{limit} + P_{max})/2$ averaged in mW and rounded to nearest 0.1 dB step |
| 20                      | $P_{limit}$   |
| 15                      | $P_{reserve} - 2$   |

The Test Sequence 2 waveform is shown in Figure A-2

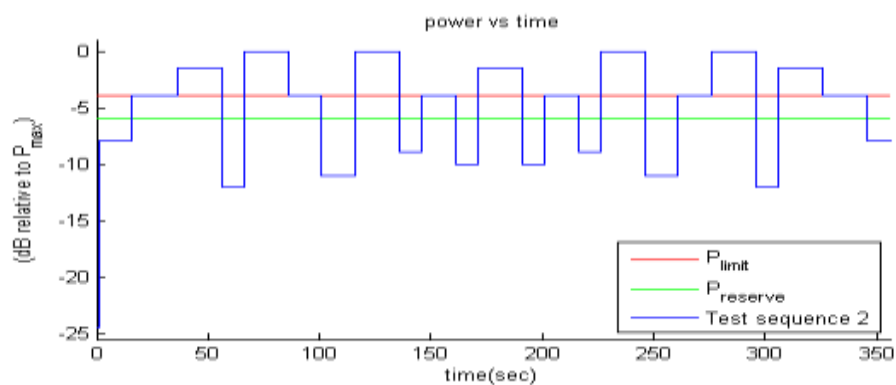

## Appendix B: Test Procedures for sub6 NR + LTE Radio

Appendix B provides the test procedures for validating Qualcomm Smart Transmit feature for LTE + Sub6 NR non-standalone (NSA) mode transmission scenario, where sub-6GHz LTE link acts as an anchor.

### B.1 Time-varying Tx power test for sub6 NR in NSA mode

Follows Section 5.2.1 to select test configurations for time-varying test. This test is performed with two pre-defined test sequences (described in Section 5.1) applied to Sub6 NR (with LTE on all-down bits or low power for the entire test after establishing the LTE+Sub6 NR call with the callbox). Follow the test procedures described in Section 5.3.1 to demonstrate the effectiveness of power limiting enforcement and that the time averaged Tx power of Sub6 NR when converted into 1gSAR values does not exceed the regulatory limit at all times (see Eq. (1a) and (1b)). Sub6 NR response to test sequence1 and test sequence2 will be similar to other technologies (say, LTE), and are shown in Sections 8.3.7 and 8.3.8.

### B.2 Switch in SAR exposure between LTE vs. Sub6 NR during transmission

This test is to demonstrate that Smart Transmit feature accurately accounts for switching in exposures among SAR for LTE radio only, SAR from both LTE radio and sub6 NR, and SAR from sub6 NR only scenarios, and ensures total time-averaged RF exposure compliance with FCC limit.

#### Test procedure:

1. Measure conducted Tx power corresponding to  $P_{limit}$  for LTE and sub6 NR in selected band. Test condition to measure conducted  $P_{limit}$  is:
  - Establish device in call with the callbox for LTE in desired band. Measure conducted Tx power corresponding to LTE  $P_{limit}$  with Smart Transmit enabled and *Reserve\_power\_margin* set to 0 dB, callbox set to request maximum power.
  - Repeat above step to measure conducted Tx power corresponding to Sub6 NR  $P_{limit}$ . If testing LTE+Sub6 NR in non-standalone mode, then establish LTE+Sub6 NR call with callbox and request all down bits for radio1 LTE. In this scenario, with callbox requesting maximum power from Sub6 NR, measured conducted Tx power corresponds to radio2  $P_{limit}$  (as radio1 LTE is at all-down bits)
2. Set *Reserve\_power\_margin* to actual (intended) value with EUT setup for LTE + Sub6 NR call. First, establish LTE connection in all-up bits with the callbox, and then Sub6 NR connection is added with callbox requesting UE to transmit at maximum power in Sub6 NR. As soon as the Sub6 NR connection is established, request all-down bits on LTE link (otherwise, Sub6 NR will not have sufficient RF exposure margin to sustain the call with LTE in all-up bits). Continue LTE (all-down bits)+Sub6 NR transmission for more than one time-window duration to test predominantly Sub6 NR SAR exposure scenario (as SAR exposure is negligible from all-down bits in LTE). After at least one time-window, request LTE to go all-up bits to test LTE SAR and Sub6 NR SAR exposure scenario. After at least one more time-window, drop (or request all-down bits) Sub6 NR transmission to test predominantly LTE SAR exposure scenario. Continue the test for at least one more time-window. Record the conducted Tx powers for both LTE and Sub6 NR for the entire duration of this test.

3. Once the measurement is done, extract instantaneous Tx power versus time for both LTE and Sub6 NR links. Similar to technology/band switch test in Section 5.3.3, convert the conducted Tx power for both these radios into 1gSAR value (see Eq. (6a) and (6b)) using corresponding technology/band  $P_{limit}$  measured in Step 1, and then perform 100s running average to determine time-averaged 1gSAR versus time as illustrated in Figure 3-1. Note that here it is assumed both radios have Tx frequencies < 3GHz, otherwise, 60s running average should be performed for radios having Tx frequency between 3GHz and 6GHz.

4. Make one plot containing: (a) instantaneous Tx power versus time measured in Step 2.

5. Make another plot containing: (a) instantaneous 1gSAR versus time determined in Step 3, (b) computed time-averaged 1gSAR versus time determined in Step 3, and (c) corresponding regulatory  $1gSAR_{limit}$  of 1.6W/kg.

The validation criteria is, at all times, the time-averaged 1gSAR versus time shall not exceed the regulatory  $1gSAR_{limit}$  of 1.6W/kg.

#### **Test procedure for Conducted Test Sequences:**

*For Sub6 NR TDD test cases, a modified procedure was used due to a limitation of the available test equipment.*

1. Measure Pmax, measure Plimit and calculate Preserve (= measured Plimit in dBm = Reserve\_power\_margin in dB) and follow Section 5.1 to generate the test sequences for all the technologies and bands selected in Section 5.2.1. Both test sequence 1 and test sequence 2 are created based on generated Pmax\_sequences of the DUT as described below. Test condition to measure Pmax and Plimit is:

- 1) Measure Pmax\_online\_avg\_dBm with Smart Transmit disabled and callbox set to request maximum power.
- 2) Measure Plimit\_online\_avg\_dBm with Smart Transmit enabled and Reserve\_power\_margin set to 0 dB, callbox set to request maximum power.
- 3) Measure Plimit\_ftm\_dbm in FTM Mode at 25% Duty Cycle.
- 4) Calculate the DutyCycle\_dB = Plimit\_ftm\_dbm – Plimit\_online\_avg\_dBm + 6 dB
- 5) Calculate Pmax\_seq = Pmax\_online\_avg\_dBm + DutyCycle\_dB
- 6) Calculate Plimit\_seq = Plimit\_online\_avg\_dBm + DutyCycle\_dB

2. Follow remaining steps in Section 5.3.1 to complete time-varying Tx test cases

For the SAR test cases, the procedure in Section 5.4 applies however the initial area scan as described in section 5.4 step 2) i) is performed with the device in FTM mode.