

# TEST REPORT

FCC NFC Test for SM-F741B  
Certification

**APPLICANT**  
SAMSUNG Electronics Co., Ltd.

**REPORT NO.**  
HCT-RF-2405-FC026

**DATE OF ISSUE**  
May 3, 2024

**Tested by**  
Kyung Jun Woo



**Technical Manager**  
Jong Seok Lee



**HCT CO., LTD.**  
*Bongjai Huh*  
BongJai Huh / CEO



**HCT CO.,LTD.**

2-6, 73, 74, Seoicheon-ro 578beon-gil, Majang-myeon, Icheon-si, Gyeonggi-do, 17383 KOREA  
Tel. +82 31 645 6300 Fax. +82 31 645 6401

**TEST  
REPORT**

REPORT NO.  
HCT-RF-2405-FC026

DATE OF ISSUE  
May 03, 2024

Applicant	<b>SAMSUNG Electronics Co., Ltd.</b> 129, Samsung-ro, Yeongtong-gu, Suwon-si, Gyeonggi-do, 16677, Rep. of Korea
Product Name	Mobile Phone
Model Name	SM-F741B
FCC ID	A3LSMF741B
RF Output Field Strength	18.56 dB $\mu$ V/m @30 m
FCC Classification	Low Power Communication Device Transmitter (DXX)
Date of Test	February 23, 2024 ~ April 26, 2024
Test Results	PASS
Test Standard Used	FCC Part 15.225 Subpart C
Location of Test	<input checked="" type="checkbox"/> Permanent Testing Lab <input type="checkbox"/> On Site Testing Lab (Address: 74, Seoicheon-ro 578beon-gil, Majang-myeon, Icheon-si, Gyeonggi-do, Republic of Korea)

## REVISION HISTORY

The revision history for this test report is shown in table.

Revision No.	Date of Issue	Description
0	May 03, 2024	Initial Release

## Notice

---

### Content

---

According to the Evaluation report, all of the data contained herein is reused from the reference FCC ID : A3LSMF741U report.

#### Engineering Statement:

The measurements shown in this report were made in accordance with the procedures indicated, and the emissions from this equipment were found to be within the limits applicable. I assume full responsibility for the accuracy and completeness of these measurements, and for the qualifications of all persons taking them. It is further stated that upon the basis of the measurements made, the equipment tested is capable of operation in accordance with the requirements of the FCC Rules under normal use and maintenance.

The results shown in this test report only apply to the sample(s), as received, provided by the applicant, unless otherwise stated.

The test results have only been applied with the test methods required by the standard(s).

The laboratory is not accredited for the test results marked \*.

Information provided by the applicant is marked \*\*.

Test results provided by external providers are marked \*\*\*.

When confirmation of authenticity of this test report is required, please contact [www.hct.co.kr](http://www.hct.co.kr)

The test results in this test report are not associated with the ((KS Q) ISO/IEC 17025) accreditation by KOLAS (Korea Laboratory Accreditation Scheme) / A2LA (American Association for Laboratory Accreditation) that are under the ILAC (International Laboratory Accreditation Cooperation) Mutual Recognition Agreement (MRA).

---

## CONTENTS

1. EUT DESCRIPTION	5
2. TEST METHODOLOGY	6
EUT CONFIGURATION	6
EUT EXERCISE	6
GENERAL TEST PROCEDURES	6
DESCRIPTION OF TEST MODES	6
3. INSTRUMENT CALIBRATION	7
4. FACILITIES AND ACCREDITATIONS	7
FACILITIES	7
EQUIPMENT	7
5. ANTENNA REQUIREMENTS	8
6. MEASUREMENT UNCERTAINTY	8
7. DESCRIPTION OF TESTS	9
8. TEST SUMMARY	18
9. TEST RESULT	19
9.1. Operation within the band 13.110 MHz – 14.010 MHz	19
9.2. Radiated Emission 9 kHz – 30 MHz	21
9.3. Radiated Emission 30 MHz – 1000 MHz	22
9.4. 20 dB Bandwidth	23
9.5. Frequency Stability	24
9.6. POWERLINE CONDUCTED EMISSIONS	28
10. LIST OF TEST EQUIPMENT	32
11. ANNEX A_ TEST SETUP PHOTO	34

## 1. EUT DESCRIPTION

<b>Model</b>	SM-F741B
<b>Additional Model</b>	-
<b>EUT Type</b>	Mobile Phone
<b>Power Supply</b>	DC 3.88 V
<b>Frequency of Operation</b>	13.56 MHz
<b>Transmit Power</b>	18.56 dB $\mu$ V/m @30 m
<b>Modulation Type</b>	ASK
<b>Serial number</b>	Radiated : R3CX20KJSLK

## 2. TEST METHODOLOGY

The measurement procedure described in the American National Standard of Procedures for Compliance Testing of Unlicensed Wireless Devices (ANSI C63.10-2013) is used in the measurement of the test device.

### EUT CONFIGURATION

The EUT configuration for testing is installed on RF field strength measurement to meet the Commissions requirement and operating in a manner that intends to maximize its emission characteristics in a continuous normal application.

### EUT EXERCISE

The EUT was operated in the engineering mode to fix the Tx frequency that was for the purpose of the measurements. According to its specifications, the EUT must comply with the requirements of the Section 15.207, 15.209 and 15.225 under the FCC Rules Part 15 Subpart C.

### GENERAL TEST PROCEDURES

#### Conducted Emissions

The EUT is placed on the turntable, which is 0.8 m above ground plane. According to the requirements in Section 6.2 of ANSI C63.10. (Version :2013) Conducted emissions from the EUT measured in the frequency range between 0.15 MHz and 30MHz using CISPR Quasi-peak and average detector modes.

#### Radiated Emissions

The EUT is placed on a turn table, which is 0.8 m above ground plane. The turntable shall rotate 360 degrees to determine the position of maximum emission level. EUT is set 3 m away from the receiving antenna, which varied from 1 m to 4 m to find out the highest emission. And also, each emission was to be maximized by changing the polarization of receiving antenna both horizontal and vertical. In order to find out the max. emission, the relative positions of this hand-held transmitter (EUT) was rotated through three orthogonal axes according to the requirements in Section 6.6.5 of ANSI C63.10. (Version: 2013).

### DESCRIPTION OF TEST MODES

The EUT has been tested under operating condition. Test program used to control the EUT for staying in continuous transmitting and receiving mode is programmed.

### 3. INSTRUMENT CALIBRATION

The measuring equipment, which was utilized in performing the tests documented herein, has been calibrated in accordance with the manufacturer's recommendations for utilizing calibration equipment, which is traceable to recognized national standards.

Especially, all antenna for measurement is calibrated in accordance with the requirements of C63.5 (Version : 2017).

### 4. FACILITIES AND ACCREDITATIONS

#### FACILITIES

The SAC(Semi-Anechoic Chamber) and conducted measurement facility used to collect the radiated data are located at the 74, Seoicheon-ro 578beon-gil, Majang-myeon, Icheon-si, Gyeonggi-do, 17383, Rep. of KOREA.

The site is constructed in conformance with the requirements of ANSI C63.4. (Version :2014) and CISPR Publication 22.

Detailed description of test facility was submitted to the Commission and accepted dated March 11, 2024 (Registration Number: KR0032).

#### EQUIPMENT

Radiated emissions are measured with one or more of the following types of Linearly polarized antennas: tuned dipole, bi-conical, log periodic, bi-log, and/or ridged waveguide, horn. Spectrum analyzers with pre-selectors and quasi-peak detectors are used to perform radiated measurements.

Conducted emissions are measured with Line Impedance Stabilization Networks and EMI Test Receivers. Calibrated wideband preamplifiers, coaxial cables, and coaxial attenuators are also used for making measurements.

All receiving equipment conforms to CISPR Publication 16-1, "Radio Interference Measuring Apparatus and Measurement Methods."

## 5. ANTENNA REQUIREMENTS

According to FCC 47 CFR § 15.203:

“An intentional radiator antenna shall be designed to ensure that no antenna other than that furnished by the responsible party can be used with the device. The use of a permanently attached antenna or of an antenna that uses a unique coupling to the intentional radiator shall be considered sufficient to comply with the provisions of this section.”

- (1) The antennas of this E.U.T are permanently attached.
- (2) The E.U.T Complies with the requirement of § 15.203

## 6. MEASUREMENT UNCERTAINTY

The measurement uncertainties shown below were calculated in accordance with the requirements of ANSI C63.10-2013.

All measurement uncertainty values are shown with a coverage factor of  $k=2$  to indicate a 95 % level of confidence.

The measurement data shown herein meets or exceeds the  $U_{\text{CISPR}}$  measurement uncertainty values specified in CISPR 16-4-2 and, thus, can be compared directly to specified limits to determine compliance.

Parameter	Expanded Uncertainty (dB)
Conducted Disturbance (150 kHz ~ 30 MHz)	1.98 ( Confidence level about 95 %, $k=2$ )
Radiated Disturbance (9 kHz ~ 30 MHz)	4.36 ( Confidence level about 95 %, $k=2$ )
Radiated Disturbance (30 MHz ~ 1 GHz)	5.70 ( Confidence level about 95 %, $k=2$ )
Radiated Disturbance (1 GHz ~ 18 GHz)	5.52 ( Confidence level about 95 %, $k=2$ )
Radiated Disturbance (18 GHz ~ 40 GHz)	5.66 ( Confidence level about 95 %, $k=2$ )
Radiated Disturbance (Above 40 GHz)	5.58 ( Confidence level about 95 %, $k=2$ )



## 7. DESCRIPTION OF TESTS

### 7.1. Radiated Test

#### Limit (Operation within the band 13.110 MHz – 14.010 MHz)

Frequency (MHz)	Field Strength ( $\mu\text{V/m}$ )	Measurement Distance (m)
13.553 – 13.567	15,848	30
13.410 $\leq f \leq$ 13.553 13.567 $\leq f \leq$ 13.710	334	30
13.110 $\leq f \leq$ 13.410 13.710 $\leq f \leq$ 14.010	106	30

Note:

1. 15,848  $\mu\text{V/m}$  = 84.0 dB $\mu\text{V/m}$
2. 334  $\mu\text{V/m}$  = 50.47 dB $\mu\text{V/m}$
3. 106 $\mu\text{V/m}$  = 40.51 dB $\mu\text{V/m}$

#### Limit(Radiated Spurious Emissions)

Frequency (MHz)	Field Strength ( $\mu\text{V/m}$ )	Measurement Distance (m)
0.009 – 0.490	2400/F(kHz)	300
0.490 – 1.705	24000/F(kHz)	30
1.705 – 30	30	30
30-88	*100	3
88-216	*150	3
216-960	*200	3
Above 960	500	3

\*: Except as provided in 15.209(g), fundamental emissions from intentional radiators operating under this Section shall not be located in the frequency bands 54-72MHz, 76-88MHz, 174-216MHz or 470-806MHz. However, operation within these frequency bands is permitted under other sections of this Part, e.g. 15.231 and 15.241.

## Test Configuration

Below 30 MHz

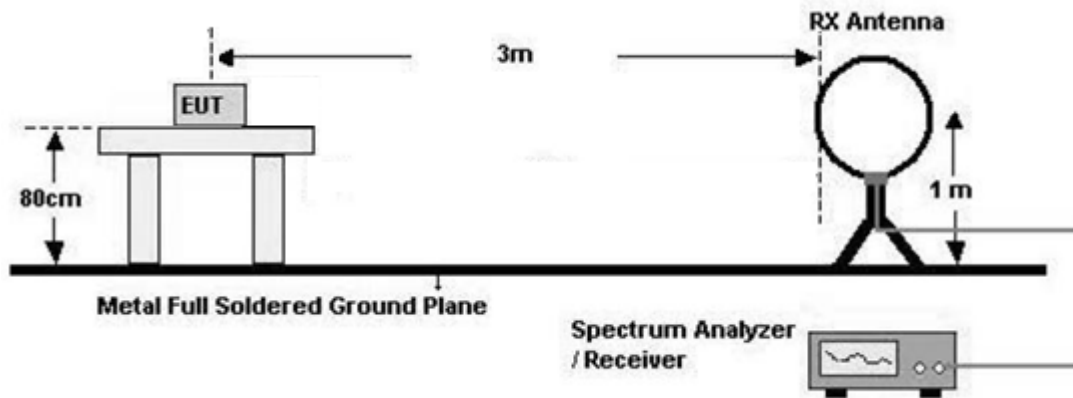

30 MHz - 1 GHz

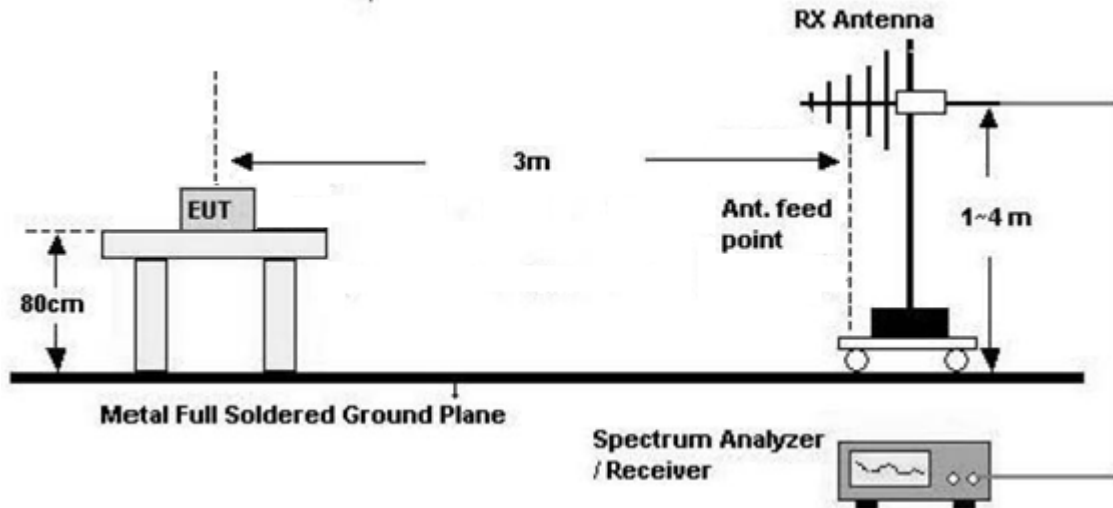

## Test Procedure of in-band

1. The EUT was placed on a non-conductive table located on semi-anechoic chamber.
2. The loop antenna was placed at a location 3 m from the EUT
3. The EUT is placed on a turntable, which is 0.8m above ground plane.
4. We have done x, y, z planes in EUT and horizontal and vertical polarization and Parallel to the ground plane in detecting antenna.
5. The turntable shall be rotated for 360 degrees to determine the position of maximum emission level.

6. Distance Correction Factor =  $40\log(3\text{ m}/30\text{ m}) = -40\text{ dB}$

Measurement Distance : 3 m (Below 30 MHz)

7. Spectrum Setting

1) Frequency Range = 9 kHz ~ 150 kHz

- Detector = Peak
- Trace = Max hold
- RBW = 300 Hz
- VBW  $\geq 3 \times$  RBW

2) Frequency Range = 150 kHz ~ 30 MHz

- Detector = Peak
- Trace = Max hold
- RBW = 10 kHz
- VBW  $\geq 3 \times$  RBW

8. Total = Measured Value + Antenna Factor(A.F) + Cable Loss(C.L) + Distance Factor(D.F)

**Test Procedure of Radiated spurious emissions(Below 30 MHz)**

1. The EUT was placed on a non-conductive table located on semi-anechoic chamber.
2. The loop antenna was placed at a location 3 m from the EUT
3. The EUT is placed on a turntable, which is 0.8m above ground plane.
4. We have done x, y, z planes in EUT and horizontal and vertical polarization and Parallel to the ground plane in detecting antenna.
5. The turntable shall be rotated for 360 degrees to determine the position of maximum emission level.
6. Distance Correction Factor(0.009 MHz – 0.490 MHz) =  $40\log(3\text{ m}/300\text{ m}) = -80\text{ dB}$

Measurement Distance : 3 m

7. Distance Correction Factor(0.490 MHz – 30 MHz) =  $40\log(3\text{ m}/30\text{ m}) = -40\text{ dB}$

Measurement Distance : 3 m

8. Spectrum Setting

1) Frequency Range = 9 kHz ~ 150 kHz

- Detector = Peak
- Trace = Max hold
- RBW = 300 Hz
- VBW  $\geq 3 \times$  RBW

2) Frequency Range = 150 kHz ~ 30 MHz

- Detector = Peak
- Trace = Max hold
- RBW = 10 kHz

- VBW  $\geq$  3 x RBW

9. Total(Measurement Type : Peak)

= Measured Value + Antenna Factor(A.F) + Cable Loss(C.L) + Distance Factor(D.F)

10. Measurement value only up to 6 maximum emissions noted, or would be lesser if no specific emissions from the EUT are recorded (ie: margin > 20 dB from the applicable limit) and considered that's already beyond the background noise floor.

### **KDB 414788 OFS and Chamber Correlation Justification**

Base on FCC 15.31 (f) (2): measurements may be performed at a distance closer than that specified in the regulations; however, an attempt should be made to avoid making measurements in the near field.

OFS and chamber correlation testing had been performed and chamber measured test result is the worst case test result.

### **Test Procedure of Radiated spurious emissions(Above 30 MHz)**

1. The EUT was placed on a non-conductive table located on semi-anechoic chamber.
2. The EUT is placed on a turntable, which is 0.8m above ground plane.
3. The Hybrid antenna was placed at a location 3 m from the EUT, which is varied from 1m to 4m to find out the highest emissions.
4. We have done x, y, z planes in EUT and horizontal and vertical polarization in detecting antenna.
5. The turntable shall be rotated for 360 degrees to determine the position of maximum emission level.

6. Spectrum Setting

- Frequency Range = 30 MHz ~ 1 GHz
- Detector = Peak
- Trace = Max hold
- RBW = 100 kHz
- VBW  $\geq$  3 x RBW

7.Total = Measured Value

- We apply to the offset in the range 30 MHz - 1 GHz.
- The offset = Antenna Factor(A.F) + Cable Loss(C.L)

8. Measurement value only up to 6 maximum emissions noted, or would be lesser if no specific emissions from the EUT are recorded (ie: margin > 20 dB from the applicable limit) and considered that's already beyond the background noise floor.

## 7.2. 20 dB Bandwidth

### Test Configuration

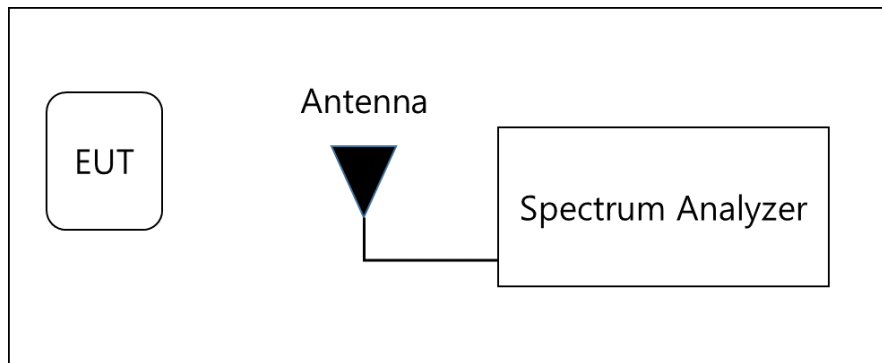

### Test Procedure

The 20 dB bandwidth was measured by using a spectrum analyzer.

(Procedure 6.9.2 in ANSI 63.10-2013)

- 1) RBW = 1 %~5 % of the OBW
- 2) VBW = approximately three times RBW
- 3) Span = between two times and five times the OBW
- 4) Detector = Peak
- 5) Trace mode = Max hold
- 6) Allow the trace to stabilize

Note :

We tested Occupied Bandwidth using the automatic bandwidth measurement capability of a spectrum analyzer.

### 7.3. Frequency Stability

#### Limit

The frequency tolerance of the carrier signal shall be maintained within  $\pm 0.01\%$  of the operating frequency.

#### Test Configuration

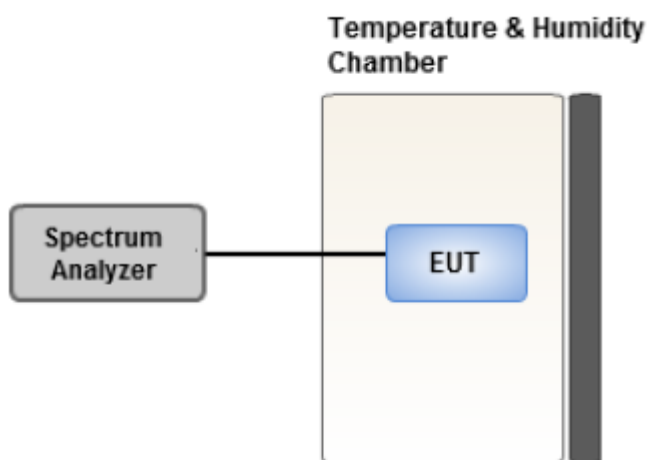

#### Test Procedure.

For battery operated equipment, the equipment tests shall be performed using a new battery.

- 1) Turn the EUT OFF and place it inside the environmental temperature chamber.  
For devices that have oscillator heaters, energize only the heater circuit.
- 2) Set the temperature control on the chamber to the highest specified in the regulatory requirements  
for the type of device and allow the oscillator heater and the chamber temperature to stabilize.
- 3) While maintaining a constant temperature inside the environmental chamber, turn the EUT ON and record the operating frequency at startup, and at 2 minutes, 5 minutes, and 10 minutes after the EUT is energized. Four measurements in total are made.
- 4) The frequency tolerance of the carrier signal shall be maintained within  $\pm 0.01\%$  of the operating frequency.

#### Note:

- 1) Temperature:  
The temperature is varied from  $-20\text{ }^{\circ}\text{C}$  to  $+50\text{ }^{\circ}\text{C}$  using an environmental chamber.
- 2) Primary Supply Voltage :  
The primary supply voltage is varied from 85 % to 115 % of the nominal value for non hand-

carried battery and AC powered equipment.

For hand-carried, battery-powered equipment, primary supply voltage is reduced to the battery operating end point which shall be specified by the manufacturer.

#### 7.4. AC Power line Conducted Emissions

##### Limit

For an intentional radiator that is designed to be connected to the public utility (AC) power line, the radio frequency voltage that is conducted back onto the AC power line on any frequency or frequencies, within the band 150 kHz to 30 MHz, shall not exceed the limits in the following table, as measured using a 50 μH/50 ohms line impedance stabilization network (LISN).

Frequency Range (MHz)	Limits (dBμV)	
	Quasi-peak	Average
0.15 to 0.50	66 to 56 <sup>(a)</sup>	56 to 46 <sup>(a)</sup>
0.50 to 5	56	46
5 to 30	60	50

<sup>(a)</sup>Decreases with the logarithm of the frequency.

Compliance with this provision shall be based on the measurement of the radio frequency voltage between each power line (LINE and NEUTRAL) and ground at the power terminals.

##### Test Configuration

See test photographs attached in Annex A for the actual connections between EUT and support equipment.

##### Test Procedure

1. The EUT is placed on a wooden table 80 cm above the reference ground plane.
2. The EUT is connected via LISN to a test power supply.
3. The measurement results are obtained as described below:
4. Detector : Quasi Peak and Average Detector.
5. The EUT is the device operating below 30 MHz.
  - For unterminated the Antenna, the AC line conducted tests are performed with the antenna connected
  - For terminated the Antenna, the AC line conducted tests are performed with a dummy load connected to the EUT antenna output terminal.

##### Sample Calculation

Quasi-peak(Final Result) = Measured Value + Correction Factor



## 7.5. Worst case configuration and mode

### Radiated test

1. All modes of operation were investigated and the worst case configuration results are reported.
  - Mode : Stand alone, Stand alone + external accessories
  - Worst case : Stand alone
2. EUT Axis : Y
3. All type and bitrate were investigated and the worst case results are reported.
  - Worst case : Type A, 106 kbps
4. All mode of without tag and with tag were investigated and the worst case configuration results are reported.
  - Mode: Without Tag, With Tag
  - Worst case : Without Tag
5. The EUT was tested in three modes(Open, Half-open, Closed), the worst case configuration results are reported.
  - Mode: Open, Half-open, Closed
  - Worst case : Closed Mode
6. All position of loop antenna were investigated and the worst case configuration results are reported.
  - Position : Horizontal, Vertical, Parallel to the ground plane
  - Worst case : Horizontal

### AC Power line Conducted Emissions

1. All modes of operation were investigated and the worst case configuration results are reported.
  - Mode : Stand alone + Earphone + Travel Adapter, Stand alone + Travel Adapter
  - Worst case : Stand alone + Travel Adapter
2. All modes(For unterminated the Antenna, terminated the Antenna) of operation were investigated and the worst case configuration results are reported.
  - Worst case : Unterminated the Antenna

### 20 dB Bandwidth & Frequency Stability

1. All type and bitrate were investigated and the worst case results are reported.
  - Worst case : Type A, 106 kbps

## 8. TEST SUMMARY

Regulation	Requirement	Result
Part 15.225 (a)	Radiated Electric Field Emissions (13.553 MHz to 13.567 MHz)	Pass
Part 15.225 (b)	Radiated Electric Field Emissions ( $13.410 \leq f \leq 13.553$ , $13.567 \leq f \leq 13.710$ )	Pass
Part 15.225 (c)	Radiated Electric Field Emissions ( $13.110 \leq f \leq 13.410$ , $13.710 \leq f \leq 14.010$ )	Pass
Part 15.209	Radiated Electric Field Emissions (9 kHz to 30 MHz)	Pass
Part 15.209	Radiated Electric Field Emissions (30 MHz to 1 GHz)	Pass
Part 15.225 (e)	Frequency Stability	Pass
Part 15.207	AC power conducted emissions (150 kHz to 30 MHz)	Pass
Part 15.215 (c)	20 dB Bandwidth	Pass

## 9. TEST RESULT

### 9.1. Operation within the band 13.110 MHz – 14.010 MHz

Measured Frequency Range :							
13.553 MHz-13.567 MHz							
Frequency (MHz)	Measured Value (dB $\mu$ V/m) @3 m	Ant. Factor +Cable Loss (dB/m)	Distance Correction (dB)	Ant. POL (H/V)	Total (dB $\mu$ V/m) @30 m	Limit (dB $\mu$ V/m) @30 m	Margin (dB)
13.5602	37.97	20.59	-40.00	H	18.56	84.00	65.44
13.5596	32.69	20.59	-40.00	V	13.28	84.00	70.72

Measured Frequency Range :							
13.410 MHz-13.553 MHz and 13.567 MHz-13.710 MHz							
Frequency (MHz)	Measured Value (dB $\mu$ V/m) @3 m	Ant. Factor +Cable Loss (dB/m)	Distance Correction (dB)	Ant. POL (H/V)	Total (dB $\mu$ V/m) @30 m	Limit (dB $\mu$ V/m) @30 m	Margin (dB)
13.5530	32.26	20.59	-40.00	H	12.85	50.47	37.62
13.5671	32.66	20.59	-40.00	H	13.25	50.47	37.22

Measured Frequency Range :							
13.110 MHz – 13.410 MHz and 13.710 MHz-14.010 MHz							
Frequency (MHz)	Measured Value (dB $\mu$ V/m) @3 m	Ant. Factor +Cable Loss (dB/m)	Distance Correction (dB)	Ant. POL (H/V)	Total (dB $\mu$ V/m) @30 m	Limit (dB $\mu$ V/m) @30 m	Margin (dB)
13.3474	23.58	20.59	-40.00	H	4.17	40.51	36.34
13.7712	23.11	20.59	-40.00	H	3.70	40.51	36.81

▣ Test Plot

**Note:**

Plot of worst case are only reported.

13.553 MHz ~ 13.567 MHz

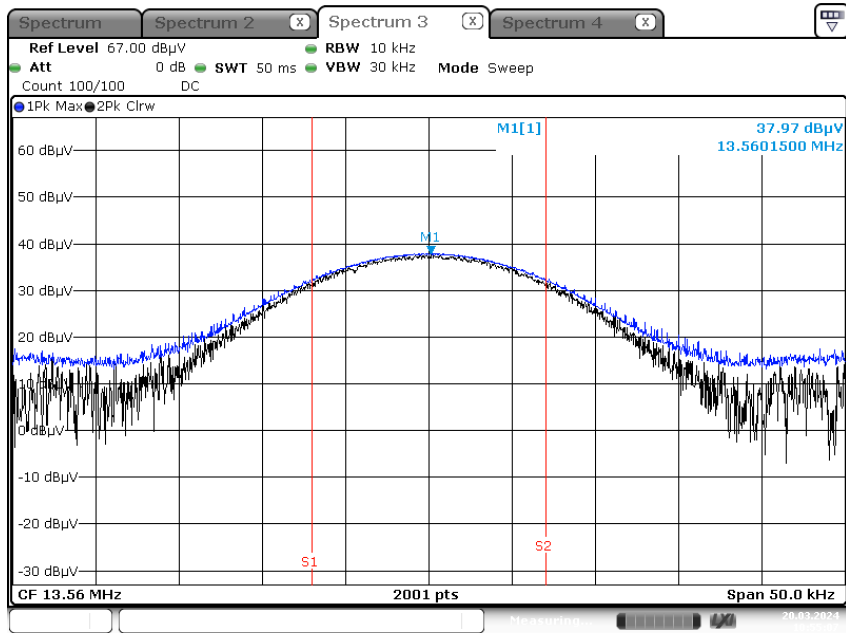

Date: 20.FEB.2024 10:55:07

Worst Case (13.110 MHz – 13.410 MHz)

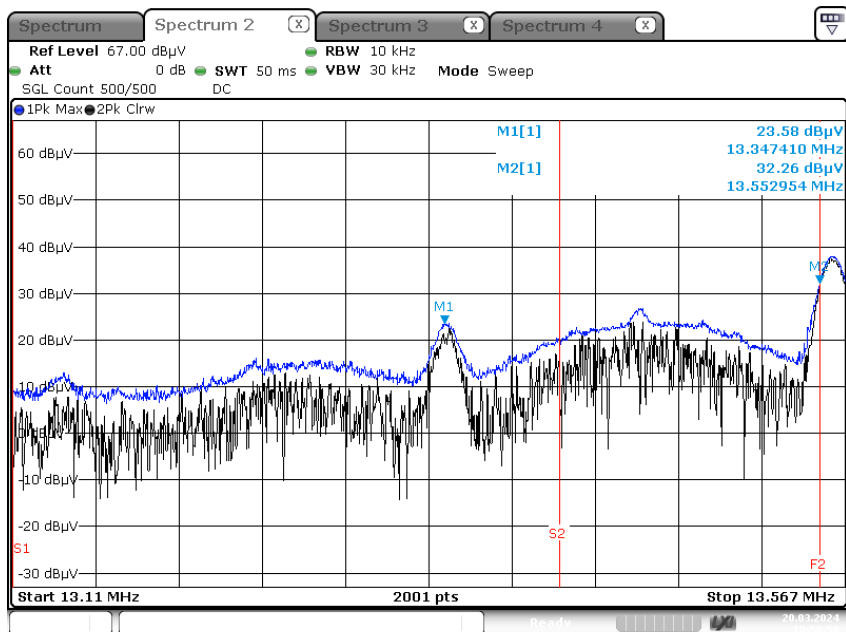

Date: 20.FEB.2024 10:58:58

**9.2. Radiated Emission 9 kHz – 30 MHz**

Measured Frequency Range : 9 kHz - 490 kHz							
Frequency (kHz)	Measured Value (dB $\mu$ V/m) @3 m	Ant. Factor +Cable Loss (dB/m)	Distance Correction (dB)	Ant. POL (H/V)	Total (dB $\mu$ V/m) @300 m	Limit (dB $\mu$ V/m) @300 m	Margin (dB)
0.01932	36.15	19.62	-80.00	H	-24.23	41.88	66.11
0.16487	29.60	20.14	-80.00	H	-30.26	23.26	53.52
Measured Frequency Range : 490 kHz - 30 MHz							
Frequency (MHz)	Measured Value (dB $\mu$ V/m) @3 m	Ant. Factor +Cable Loss (dB/m)	Distance Correction (dB)	Ant. POL (H/V)	Total (dB $\mu$ V/m) @30 m	Limit (dB $\mu$ V/m) @30 m	Margin (dB)
0.50245	22.92	20.05	-40.00	H	2.97	33.58	30.61
4.09600	11.86	20.49	-40.00	H	-7.65	29.54	37.19
14.06990	11.33	20.60	-40.00	H	-8.07	29.54	37.61

### 9.3. Radiated Emission 30 MHz – 1000 MHz

Measured Frequency Range : 30 MHz - 1000 MHz					
Frequency (MHz)	Measured Value (dBμV/m)@ 3 m	Ant. Pol (H/V)	Total (dBμV/m)	Limit (dBμV/m)	Margin (dB)
33.0500	27.90	H	27.90	40.00	12.10
37.4900	27.02	H	27.02	40.00	12.98
#74.0900	26.79	H	26.79	40.00	13.21
#128.8100	28.72	H	28.72	43.52	14.80
148.4010	34.04	H	34.04	43.52	9.48
#280.0200	29.00	H	29.00	46.02	17.02

**Note:**

1. # is the result for restricted band.

**Test Plot**

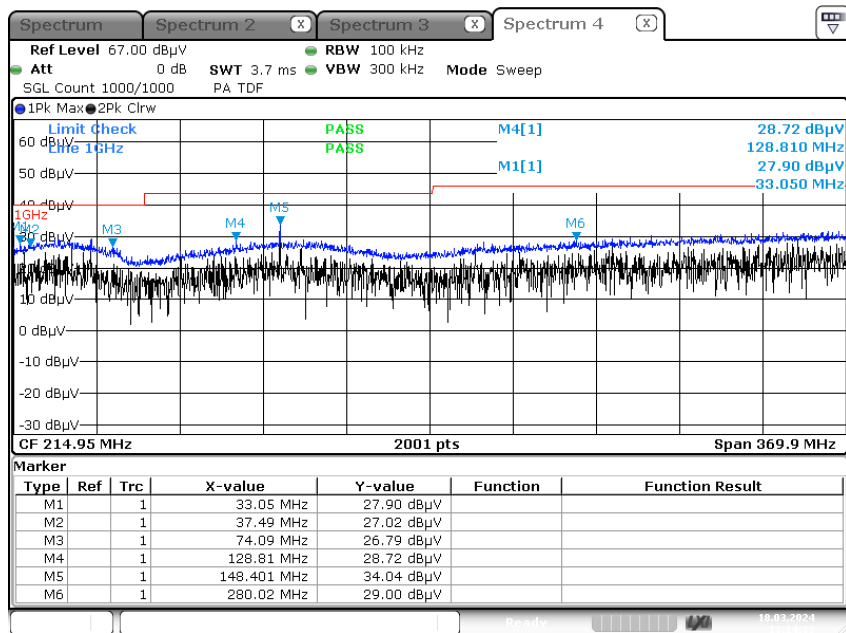

Date: 18.MAR.2024 11:14:13

**Note:**

Plot of worst case was only reported

### 9.4. 20 dB Bandwidth

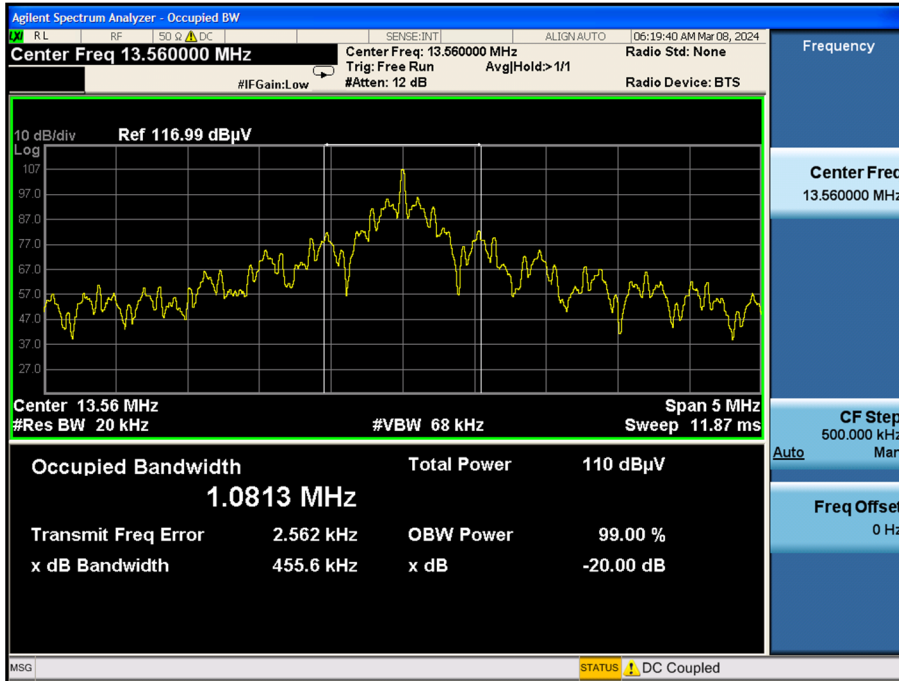

### 9.5. Frequency Stability

#### Startup

OPERATING FREQUENCY: 13.56 MHz  
 REFERENCE VOLTAGE: 3.88 VDC  
 DEVIATION LIMIT: ±0.01 % = ±1356 Hz

Voltage	Power	Temp.	Frequency	Frequency Dev.	Frequency
(%)	(VDC)	(°C)	(MHz)	(Hz)	Dev (%)
100%	3.88	-20	13.560032	32	0.0002381
100%		-10	13.560052	52	0.0003801
100%		0	13.560094	94	0.0006931
100%		+10	13.560030	30	0.0002198
100%		+20(Ref.)	13.560029	29	0.0002105
100%		+30	13.560064	64	0.0004719
100%		+40	13.560059	59	0.0004338
100%		+50	13.560099	99	0.0007274
LOW		3.7	+20	13.560096	96
HIGH	4.45	+20	13.560029	29	0.0002114



**2 minutes**

OPERATING FREQUENCY: 13.56 MHz  
 REFERENCE VOLTAGE: 3.88 VDC  
 DEVIATION LIMIT: ±0.01 % = ±1356 Hz

Voltage	Power	Temp.	Frequency	Frequency Dev.	Frequency
(%)	(VDC)	(°C)	(MHz)	(Hz)	Dev (%)
100%	3.88	-20	13.560060	60	0.0004420
100%		-10	13.560011	11	0.0000837
100%		0	13.560030	30	0.0002233
100%		+10	13.560012	12	0.0000873
100%		+20(Ref.)	13.560010	10	0.0000752
100%		+30	13.560084	84	0.0006204
100%		+40	13.560088	88	0.0006522
100%		+50	13.560053	53	0.0003918
LOW		3.7	+20	13.560013	13
HIGH	4.45	+20	13.560016	16	0.0001155

**5 minutes**

PERATING FREQUENCY: 13.56 MHz  
 REFERENCE VOLTAGE: 3.88 VDC  
 DEVIATION LIMIT: ±0.01 % = ±1356 Hz

Voltage	Power	Temp.	Frequency	Frequency Dev.	Frequency
(%)	(VDC)	(°C)	(MHz)	(Hz)	Dev (%)
100%	3.88	-20	13.560030	30	0.0002210
100%		-10	13.560049	49	0.0003645
100%		0	13.560088	88	0.0006474
100%		+10	13.560092	92	0.0006794
100%		+20(Ref.)	13.560041	41	0.0003008
100%		+30	13.560042	42	0.0003061
100%		+40	13.560014	14	0.0001027
100%		+50	13.560027	27	0.0001982
LOW		3.7	+20	13.560019	19
HIGH	4.45	+20	13.560085	85	0.0006270

**10 minutes**

OPERATING FREQUENCY: 13.56 MHz  
 REFERENCE VOLTAGE: 3.88 VDC  
 DEVIATION LIMIT: ±0.01 % = ±1356 Hz

Voltage	Power	Temp.	Frequency	Frequency Dev.	Frequency
(%)	(VDC)	(°C)	(MHz)	(Hz)	Dev (%)
100%	3.88	-20	13.560004	4	0.0000301
100%		-10	13.560054	54	0.0003978
100%		0	13.560077	77	0.0005656
100%		+10	13.560013	13	0.0000956
100%		+20(Ref.)	13.560025	25	0.0001823
100%		+30	13.560048	48	0.0003506
100%		+40	13.560056	56	0.0004127
100%		+50	13.560090	90	0.0006600
LOW		3.7	+20	13.560033	33
HIGH	4.45	+20	13.560055	55	0.0004061

## 9.6. POWERLINE CONDUCTED EMISSIONS

### Conducted Emissions

Test

1 / 2

## Test Report

### Common Information

EUT : SM-F741U  
 Operating Conditions : NFC Term Mode  
 Comment :

Full Spectrum

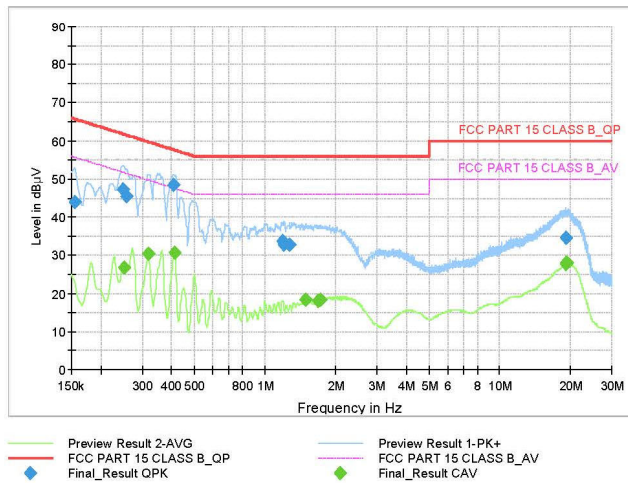

### Final Result QPK

Frequency (MHz)	QuasiPeak (dBµV)	Limit (dBµV)	Margin (dB)	Bandwidth (kHz)	Line	Corr. (dB)
0.1545	44.08	65.75	21.67	9.000	N	9.6
0.2490	47.27	61.79	14.52	9.000	N	9.6
0.2580	45.30	61.50	16.19	9.000	N	9.6
0.4088	48.60	57.67	9.08	9.000	N	9.7
1.1863	33.68	56.00	22.32	9.000	N	9.7
1.2065	32.89	56.00	23.11	9.000	N	9.7
1.2695	32.88	56.00	23.12	9.000	N	9.7
19.1255	34.55	60.00	25.45	9.000	L1	10.4
19.1728	34.73	60.00	25.27	9.000	L1	10.4

2024-04-16

오후 2:03:39

Test

2 / 2

**Final Result\_CAV**

Frequency (MHz)	CAverage (dB $\mu$ V)	Limit (dB $\mu$ V)	Margin (dB)	Bandwidth (kHz)	Line	Corr. (dB)
0.2513	26.76	51.72	24.96	9.000	N	9.6
0.3188	30.47	49.74	19.27	9.000	N	9.6
0.4110	30.80	47.63	16.82	9.000	L1	9.6
1.4968	18.38	46.00	27.62	9.000	L1	9.7
1.6790	17.95	46.00	28.05	9.000	L1	9.7
1.7218	18.37	46.00	27.63	9.000	L1	9.7
19.0558	27.69	50.00	22.31	9.000	L1	10.4
19.1863	27.95	50.00	22.05	9.000	L1	10.4
19.4405	28.14	50.00	21.86	9.000	L1	10.4

2024-04-16

오후 2:03:39

Test

1 / 2

## Test Report

### Common Information

EUT : SM-F741U  
 Operating Conditions : NFC Unterm Mode  
 Comment :

Full Spectrum

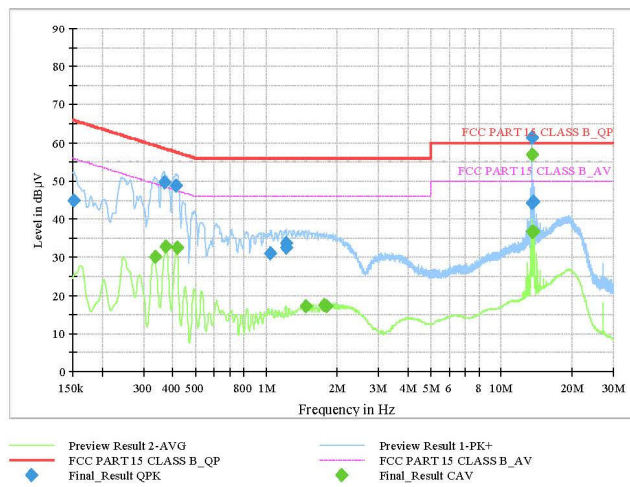

### Final Result QPK

Frequency (MHz)	QuasiPeak (dBµV)	Limit (dBµV)	Margin (dB)	Bandwidth (kHz)	Line	Corr. (dB)
0.1523	44.88	65.88	21.00	9.000	L1	9.6
0.3683	49.52	58.54	9.02	9.000	N	9.6
0.4133	48.81	57.58	8.78	9.000	N	9.7
1.0423	30.94	56.00	25.06	9.000	N	9.7
1.2110	33.73	56.00	22.27	9.000	N	9.7
1.2155	32.44	56.00	23.56	9.000	N	9.7
13.4533	44.27	60.00	15.73	9.000	L1	10.1
13.5590	61.52	60.00	-1.52	9.000	L1	10.1
13.6648	44.54	60.00	15.46	9.000	L1	10.1

2024-04-16

오후 2:09:24

Test

2 / 2

**Final Result\_CAV**

Frequency (MHz)	CAverage (dB $\mu$ V)	Limit (dB $\mu$ V)	Margin (dB)	Bandwidth (kHz)	Line	Corr. (dB)
0.3368	30.10	49.28	19.19	9.000	N	9.6
0.3750	32.66	48.39	15.73	9.000	L1	9.6
0.4155	32.44	47.54	15.09	9.000	L1	9.6
1.4698	17.13	46.00	28.87	9.000	L1	9.7
1.7600	17.50	46.00	28.50	9.000	L1	9.7
1.8028	17.24	46.00	28.76	9.000	L1	9.7
13.4533	36.72	50.00	13.28	9.000	L1	10.1
13.5590	56.88	50.00	-6.88	9.000	L1	10.1
13.6648	36.77	50.00	13.23	9.000	L1	10.1

2024-04-16

오후 2:09:24

## 10. LIST OF TEST EQUIPMENT

### Conducted Test

Equipment	Model	Manufacturer	Serial No.	Due to Calibration	Calibration Interval
LISN	ENV216	Rohde & Schwarz	102245	08/02/2024	Annual
EMI Test Receiver	ESR	Rohde & Schwarz	101910	05/26/2024	Annual
Temperature Chamber	SU-642	ESPEC	93008124	02/19/2025	Annual
DC Power Supply	E3632A	Agilent	KR75305528	01/02/2025	Annual
Attenuator(10 dB)(DC-26.5 GHz)	8493C-010	Agilent	08285	06/02/2024	Annual
Software	EMC32	Rohde & Schwarz	N/A	N/A	N/A

### Note:

1. Equipment listed above that calibrated during the testing period was set for test after the calibration.
2. Equipment listed above that has a calibration due date during the testing period, the testing is completed before equipment expiration date.



**Radiated Test**

Equipment	Model	Manufacturer	Serial No.	Due to Calibration	Calibration Interval
Controller(Antenna mast)	CO3000	Innco system	CO3000-4p	N/A	N/A
Antenna Position Tower	MA4640/800-XP-EP	Innco system	S3AM	08/03/2025	Biennial
Controller	EM2090	Emco	060520	N/A	N/A
Turn Table	N/A	Ets	N/A	N/A	N/A
Loop Antenna	FMZB 1513	Rohde & Schwarz	1513-333	03/07/2026	Biennial
Hybrid Antenna	VULB 9168	Schwarzbeck	9168-0895	08/16/2024	Biennial
Horn Antenna	BBHA 9120D	Schwarzbeck	9120D-1191	11/07/2025	Biennial
Spectrum Analyzer	FSP (9 kHz ~ 40 GHz)	Rohde & Schwarz	100843	10/30/2024	Annual
Spectrum Analyzer	FSV40 (9 kHz ~ 40 GHz)	Rohde & Schwarz	100900	12/06/2024	Annual
Signal Analyzer	N9030A	Keysight	MY55410508	09/04/2024	Annual
Power Amplifier	310N	SONOMA INSTRUMENT	186169	02/14/2025	Annual
Power Amplifier	CBL18265035	CERNEX	22966	11/17/2024	Annual
Power Amplifier	CBL26405040	CERNEX	25956	02/26/2025	Annual

**Note:**

1. Equipment listed above that calibrated during the testing period was set for test after the calibration.
2. Equipment listed above that has a calibration due date during the testing period, the testing is completed before equipment expiration date.
3. Especially, all antenna for measurement is calibrated in accordance with the requirements of C63.5(Version : 2017).

## 11. ANNEX A\_ TEST SETUP PHOTO

Please refer to test setup photo file no. as follows;

No.	Description
1	HCT-RF-2405-FC026-P