



## H.2 LTE Downlink Only Carrier Aggregation Test Selection and Setup

SAR test exclusion for LTE downlink Carrier Aggregation is determined by power measurements according to the number component carriers (CCs) supported by the product implementation. For those configurations required by April 2018 TCBC Workshop Notes, conducted power measurements with LTE Carrier Aggregation (CA) (downlink only) active are made in accordance to KDB Publication 941225 D05Av01r02. The RRC connection is only handled by one cell, the primary component carrier (PCC) for downlink and uplink communications. After making a data connection to the PCC, the UE device adds secondary component carrier(s) (SCC) on the downlink only. All uplink communications and acknowledgements remain identical to specifications when downlink carrier aggregation is inactive on the PCC. Additional conducted output powers are measured with the downlink carrier aggregation active for the configuration with highest measured maximum conducted power with downlink carrier aggregation inactive measured among the channel bandwidth, modulation, and RB combinations in each frequency band.



Per FCC KDB Publication 941225 D05Av01r02, no SAR measurements are required for carrier aggregation configurations when the maximum average output power with downlink only carrier aggregation active is not more than 0.25 dB higher than the average output power with downlink only carrier aggregation inactive. All bands required for SAR testing per FCC KDB procedures were considered. Based on the measured maximum powers below, no additional SAR tests were required for DLCA SAR configurations.

General PCC and SCC configuration selection procedure

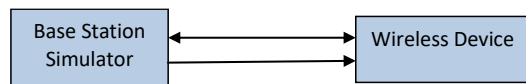
- PCC uplink channel, channel bandwidth, modulation and RB configurations were selected based on section C)3)b)ii) of KDB 941225 D05 V01r02. All LTE bandwidth conducted powers needed for PCC uplink configuration selection can be found in Section 9.3 and appendix F. The downlink PCC channel was paired with the selected PCC uplink channel according to normal configurations without carrier aggregation.
- To maximize aggregated bandwidth, highest channel bandwidth available for that CA combination was selected for SCC. For inter-band CA, the SCC downlink channels were selected near the middle of their transmission bands. For contiguous intra-band CA, the downlink channel spacing between the component carriers was set to multiple of 300 kHz less than the nominal channel spacing defined in section 5.4.1A of 3GPP TS 36.521. For non-contiguous intra-band CA, the downlink channel spacing between the component carriers was set to be larger than the nominal channel spacing and provided maximum separation between the component carriers.
- All selected PCC and SCC(s) remained fully within the uplink/downlink transmission band of the respective component carrier.



**Figure H-1**  
**DL CA Power Measurement Setup**

FCC ID: A3LSMF711JPN	 <b>PCTEST</b> <small>Proud to be part of element</small>	SAR EVALUATION REPORT		Reviewed by: Quality Manager
Test Dates: 06/28/2021-07/31/2021	DUT Type: Portable Handset			APPENDIX H: Page 2 of 5

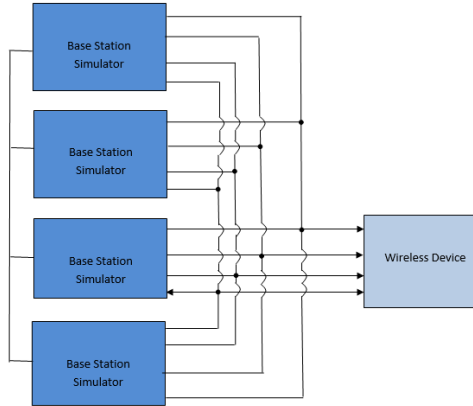



**Figure H-2**  
DL CA with DL 4x4 MIMO Power Measurement Setup

### H.3 Downlink Carrier Aggregation RF Conducted Powers

#### H.3.1 LTE Band 41 as PCC

**Table H-3**  
Maximum Output Powers

Combination	PCC									SCC 1				Power	
	PCC Band	PCC BW [MHz]	PCC (UL) Ch.	PCC (UL) Freq. [MHz]	Mod.	PCC UL# RB	PCC UL RB Offset	PCC (DL) Channel	PCC (DL) Freq. [MHz]	SCC Band	SCC BW [MHz]	SCC (DL) Channel	SCC (DL) Freq. [MHz]	LTE Tx. Power with DL CA Enabled [dBm]	LTE Single Carrier Tx Power [dBm]
CA_41C (1)	LTE B41	20	41490	2680	QPSK	1	50	41490	2680	LTE B41	20	41292	2660.2	24.84	24.86

FCC ID: A3LSMF711JPN	 <b>PCTEST</b> Proud to be part of element	<b>SAR EVALUATION REPORT</b>		<b>Reviewed by:</b> Quality Manager
<b>Test Dates:</b> 06/28/2021-07/31/2021	<b>DUT Type:</b> Portable Handset			<b>APPENDIX H:</b> Page 3 of 5

## H.4 DL CA with DL 4x4 MIMO RF Conduction Powers

This device supports downlink 4x4 MIMO operations for some LTE bands. Uplink transmission is limited to a single output stream. When carrier aggregation was applicable, the general test selection and setup procedures described in Section H.2 were applied.

Per May 2017 TCB Workshop Notes, SAR for 4x4 DL MIMO was not needed since the maximum average output power in 4x4 DL MIMO mode was not more than 0.25 dB higher than the maximum output power with 4x4 DL MIMO inactive. Additionally, SAR for 4x4 MIMO Downlink Carrier Aggregation was not needed since the maximum average output power in 4x4 MIMO Downlink Carrier Aggregation mode was not more than 0.25 dB higher than the maximum output power with 4x4 MIMO Downlink and downlink carrier aggregation inactive.

### H.4.1 LTE 4x4 MIMO DL Standalone Powers



Table H-4  
Maximum Output Powers

LTE Band	Bandwidth [MHz]	Channel	Frequency [MHz]	Modulation	RB Size	RB Offset	4x4 DL MIMO Tx. Power [dBm]	Single Antenna Tx. Power [dBm]	Target Power [dBm]
41	20	41490	2680	QPSK	1	50	24.75	24.86	24.0

### H.4.2 LTE Band 41 as PCC

Table H-5  
Maximum Output Powers

Combination	PCC										SCC 1					Power	
	PCC Band	PCC BW [MHz]	PCC (UL) Ch.	PCC (UL) Freq. [MHz]	Mod.	PCC UL# RB	PCC UL RB Offset	PCC (DL) Ch.	PCC (DL) Freq. [MHz]	DL Ant. Config.	SCC Band	SCC BW [MHz]	SCC (DL) Ch.	SCC (DL) Freq. [MHz]	DL Ant. Config.	LTE Tx.Power with DL CA Enabled (dBm)	LTE Single Carrier Tx Power (dBm)
CA_[41C] (1)	LTE B41	20	41490	2680	QPSK	1	50	41490	2680	4x4	LTE B41	20	41292	2660.2	4x4	24.80	24.86

FCC ID: A3LSMF711JPN	 PCTEST Proud to be part of element	SAR EVALUATION REPORT		Reviewed by: Quality Manager
Test Dates: 06/28/2021-07/31/2021	DUT Type: Portable Handset			APPENDIX H: Page 4 of 5

## H.5 Downlink Carrier Aggregation with CA\_41C Uplink Carrier Aggregation enabled

This device supports uplink carrier aggregation (ULCA) with additional Carrier Aggregation configurations active in the downlink. Power measurements were performed with ULCA active and additional CA configurations active in the downlink for the configuration per Fall 2017 TCB Workshop Notes.



Per FCC Guidance, additional SAR measurements for these configurations were not required since their maximum output power was not more than 0.25 dB higher than the maximum output power for with only ULCA active.

### H.5.1 DL Carrier Aggregation with DL 4x4 MIMO RF Conducted Powers

Note: 4x4 DL MIMO is only operating in the downlink. Uplink transmission is limited to a single output stream for each component carrier of ULCA.

**Table H-6  
Maximum Output Powers**

Combination	PCC										SCC 1										Power	
	PCC Band	PCC BW [MHz]	PCC (UL) Ch.	PCC (UL) Freq. [MHz]	Mod.	PCC UL# RB	PCC UL RB Offset	PCC (DL) Ch.	PCC (DL) Freq. [MHz]	DL Ant. Config.	SCC Band	SCC BW [MHz]	SCC (UL) Ch.	SCC (UL) Freq. [MHz]	Mod.	SCC UL# RB	SCC UL RB Offset	SCC (DL) Ch.	SCC (DL) Freq. [MHz]	DL Ant. Config.	ULCA Tx.Power with add'l CA config.active	ULCA Tx Power (dBm)
CA_41C	LTE B41	20	41490	2680	QPSK	1	0	41490	2680	4x4	LTE B41	20	41292	2660.2	QPSK	1	99	41292	2660.2	4x4	24.69	24.69

FCC ID: A3LSMF711JPN	 PCTEST Proud to be part of element	SAR EVALUATION REPORT		Reviewed by: Quality Manager
Test Dates: 06/28/2021-07/31/2021	DUT Type: Portable Handset			APPENDIX H: Page 5 of 5