

APPENDIX J: PROBE AND DIPOLE CALIBRATION CERTIFICATES



Accreditation No.: **SCS 0108**

Accredited by the Swiss Accreditation Service (SAS)
The Swiss Accreditation Service is one of the signatories to the EA
Multilateral Agreement for the recognition of calibration certificates

Client **PC Test**

Certificate No: **D5GHzV2-1057_Jan21**

CALIBRATION CERTIFICATE

Object **D5GHzV2 - SN:1057**

Calibration procedure(s) **QA CAL-22.v5
Calibration Procedure for SAR Validation Sources between 3-10 GHz**

Calibration date: **January 20, 2021**

*BNV
01-27-2021*

This calibration certificate documents the traceability to national standards, which realize the physical units of measurements (SI).
The measurements and the uncertainties with confidence probability are given on the following pages and are part of the certificate.

All calibrations have been conducted in the closed laboratory facility: environment temperature (22 ± 3)°C and humidity < 70%.

Calibration Equipment used (M&TE critical for calibration)

Primary Standards	ID #	Cal Date (Certificate No.)	Scheduled Calibration
Power meter NRP	SN: 104778	01-Apr-20 (No. 217-03100/03101)	Apr-21
Power sensor NRP-Z91	SN: 103244	01-Apr-20 (No. 217-03100)	Apr-21
Power sensor NRP-Z91	SN: 103245	01-Apr-20 (No. 217-03101)	Apr-21
Reference 20 dB Attenuator	SN: BH9394 (20k)	31-Mar-20 (No. 217-03106)	Apr-21
Type-N mismatch combination	SN: 310982 / 06327	31-Mar-20 (No. 217-03104)	Apr-21
Reference Probe EX3DV4	SN: 3503	30-Dec-20 (No. EX3-3503_Dec20)	Dec-21
DAE4	SN: 601	02-Nov-20 (No. DAE4-601_Nov20)	Nov-21
Secondary Standards	ID #	Check Date (in house)	Scheduled Check
Power meter E4419B	SN: GB39512475	30-Oct-14 (in house check Oct-20)	In house check: Oct-22
Power sensor HP 8481A	SN: US37292783	07-Oct-15 (in house check Oct-20)	In house check: Oct-22
Power sensor HP 8481A	SN: MY41092317	07-Oct-15 (in house check Oct-20)	In house check: Oct-22
RF generator R&S SMT-06	SN: 100972	15-Jun-15 (in house check Oct-20)	In house check: Oct-22
Network Analyzer Agilent E8358A	SN: US41080477	31-Mar-14 (in house check Oct-20)	In house check: Oct-21

	Name	Function	Signature
Calibrated by:	Jeton Kastrati	Laboratory Technician	<i>[Signature]</i>
Approved by:	Katja Pokovic	Technical Manager	<i>[Signature]</i>

Issued: January 20, 2021

This calibration certificate shall not be reproduced except in full without written approval of the laboratory.



Accredited by the Swiss Accreditation Service (SAS)
The Swiss Accreditation Service is one of the signatories to the EA
Multilateral Agreement for the recognition of calibration certificates

Accreditation No.: **SCS 0108**

Glossary:

TSL	tissue simulating liquid
ConvF	sensitivity in TSL / NORM x,y,z
N/A	not applicable or not measured

Calibration is Performed According to the Following Standards:

- IEEE Std 1528-2013, "IEEE Recommended Practice for Determining the Peak Spatial-Averaged Specific Absorption Rate (SAR) in the Human Head from Wireless Communications Devices: Measurement Techniques", June 2013
- IEC 62209-1, "Measurement procedure for the assessment of Specific Absorption Rate (SAR) from hand-held and body-mounted devices used next to the ear (frequency range of 300 MHz to 6 GHz)", July 2016
- IEC 62209-2, "Procedure to determine the Specific Absorption Rate (SAR) for wireless communication devices used in close proximity to the human body (frequency range of 30 MHz to 6 GHz)", March 2010
- KDB 865664, "SAR Measurement Requirements for 100 MHz to 6 GHz"

Additional Documentation:

- DASY4/5 System Handbook

Methods Applied and Interpretation of Parameters:

- Measurement Conditions:** Further details are available from the Validation Report at the end of the certificate. All figures stated in the certificate are valid at the frequency indicated.
- Antenna Parameters with TSL:** The dipole is mounted with the spacer to position its feed point exactly below the center marking of the flat phantom section, with the arms oriented parallel to the body axis.
- Feed Point Impedance and Return Loss:** These parameters are measured with the dipole positioned under the liquid filled phantom. The impedance stated is transformed from the measurement at the SMA connector to the feed point. The Return Loss ensures low reflected power. No uncertainty required.
- Electrical Delay:** One-way delay between the SMA connector and the antenna feed point. No uncertainty required.
- SAR measured:** SAR measured at the stated antenna input power.
- SAR normalized:** SAR as measured, normalized to an input power of 1 W at the antenna connector.
- SAR for nominal TSL parameters:** The measured TSL parameters are used to calculate the nominal SAR result.

The reported uncertainty of measurement is stated as the standard uncertainty of measurement multiplied by the coverage factor $k=2$, which for a normal distribution corresponds to a coverage probability of approximately 95%.

Measurement Conditions

DASY system configuration, as far as not given on page 1.

DASY Version	DASY5	V52.10.4
Extrapolation	Advanced Extrapolation	
Phantom	Modular Flat Phantom V5.0	
Distance Dipole Center - TSL	10 mm	with Spacer
Zoom Scan Resolution	dx, dy = 10.0 mm, dz = 10.0 mm	Graded Ratio = 1.4 (Z direction)
Frequency	5250 MHz ± 1 MHz 5600 MHz ± 1 MHz 5750 MHz ± 1 MHz	

Head TSL parameters at 5250 MHz

The following parameters and calculations were applied.

	Temperature	Permittivity	Conductivity
Nominal Head TSL parameters	22.0 °C	35.9	4.71 mho/m
Measured Head TSL parameters	(22.0 ± 0.2) °C	35.0 ± 6 %	4.51 mho/m ± 6 %
Head TSL temperature change during test	< 0.5 °C	----	----

SAR result with Head TSL at 5250 MHz

SAR averaged over 1 cm³ (1 g) of Head TSL	Condition	
SAR measured	100 mW input power	8.03 W/kg
SAR for nominal Head TSL parameters	normalized to 1W	79.7 W/kg ± 19.9 % (k=2)

SAR averaged over 10 cm³ (10 g) of Head TSL	condition	
SAR measured	100 mW input power	2.29 W/kg
SAR for nominal Head TSL parameters	normalized to 1W	22.7 W/kg ± 19.5 % (k=2)

Head TSL parameters at 5600 MHz

The following parameters and calculations were applied.

	Temperature	Permittivity	Conductivity
Nominal Head TSL parameters	22.0 °C	35.5	5.07 mho/m
Measured Head TSL parameters	(22.0 ± 0.2) °C	34.5 ± 6 %	4.86 mho/m ± 6 %
Head TSL temperature change during test	< 0.5 °C	----	----

SAR result with Head TSL at 5600 MHz

SAR averaged over 1 cm ³ (1 g) of Head TSL	Condition	
SAR measured	100 mW input power	8.45 W/kg
SAR for nominal Head TSL parameters	normalized to 1W	83.8 W/kg ± 19.9 % (k=2)

SAR averaged over 10 cm ³ (10 g) of Head TSL	condition	
SAR measured	100 mW input power	2.38 W/kg
SAR for nominal Head TSL parameters	normalized to 1W	23.6 W/kg ± 19.5 % (k=2)

Head TSL parameters at 5750 MHz

The following parameters and calculations were applied.

	Temperature	Permittivity	Conductivity
Nominal Head TSL parameters	22.0 °C	35.4	5.22 mho/m
Measured Head TSL parameters	(22.0 ± 0.2) °C	34.3 ± 6 %	5.02 mho/m ± 6 %
Head TSL temperature change during test	< 0.5 °C	----	----

SAR result with Head TSL at 5750 MHz

SAR averaged over 1 cm ³ (1 g) of Head TSL	Condition	
SAR measured	100 mW input power	8.08 W/kg
SAR for nominal Head TSL parameters	normalized to 1W	80.1 W/kg ± 19.9 % (k=2)

SAR averaged over 10 cm ³ (10 g) of Head TSL	condition	
SAR measured	100 mW input power	2.27 W/kg
SAR for nominal Head TSL parameters	normalized to 1W	22.5 W/kg ± 19.5 % (k=2)

Body TSL parameters at 5250 MHz

The following parameters and calculations were applied.

	Temperature	Permittivity	Conductivity
Nominal Body TSL parameters	22.0 °C	48.9	5.36 mho/m
Measured Body TSL parameters	(22.0 ± 0.2) °C	49.3 ± 6 %	5.51 mho/m ± 6 %
Body TSL temperature change during test	< 0.5 °C	----	----

SAR result with Body TSL at 5250 MHz

SAR averaged over 1 cm ³ (1 g) of Body TSL	Condition	
SAR measured	100 mW input power	7.42 W/kg
SAR for nominal Body TSL parameters	normalized to 1W	74.3 W/kg ± 19.9 % (k=2)

SAR averaged over 10 cm ³ (10 g) of Body TSL	condition	
SAR measured	100 mW input power	2.06 W/kg
SAR for nominal Body TSL parameters	normalized to 1W	20.7 W/kg ± 19.5 % (k=2)

Body TSL parameters at 5600 MHz

The following parameters and calculations were applied.

	Temperature	Permittivity	Conductivity
Nominal Body TSL parameters	22.0 °C	48.5	5.77 mho/m
Measured Body TSL parameters	(22.0 ± 0.2) °C	48.7 ± 6 %	5.99 mho/m ± 6 %
Body TSL temperature change during test	< 0.5 °C	----	----

SAR result with Body TSL at 5600 MHz

SAR averaged over 1 cm ³ (1 g) of Body TSL	Condition	
SAR measured	100 mW input power	7.73 W/kg
SAR for nominal Body TSL parameters	normalized to 1W	77.4 W/kg ± 19.9 % (k=2)

SAR averaged over 10 cm ³ (10 g) of Body TSL	condition	
SAR measured	100 mW input power	2.13 W/kg
SAR for nominal Body TSL parameters	normalized to 1W	21.4 W/kg ± 19.5 % (k=2)

Body TSL parameters at 5750 MHz

The following parameters and calculations were applied.

	Temperature	Permittivity	Conductivity
Nominal Body TSL parameters	22.0 °C	48.3	5.94 mho/m
Measured Body TSL parameters	(22.0 ± 0.2) °C	48.4 ± 6 %	6.20 mho/m ± 6 %
Body TSL temperature change during test	< 0.5 °C	----	----

SAR result with Body TSL at 5750 MHz

SAR averaged over 1 cm ³ (1 g) of Body TSL	Condition	
SAR measured	100 mW input power	7.26 W/kg
SAR for nominal Body TSL parameters	normalized to 1W	72.8 W/kg ± 19.9 % (k=2)

SAR averaged over 10 cm ³ (10 g) of Body TSL	condition	
SAR measured	100 mW input power	2.00 W/kg
SAR for nominal Body TSL parameters	normalized to 1W	20.0 W/kg ± 19.5 % (k=2)

Appendix (Additional assessments outside the scope of SCS 0108)

Antenna Parameters with Head TSL at 5250 MHz

Impedance, transformed to feed point	48.2 Ω - 5.5 j Ω
Return Loss	- 24.6 dB

Antenna Parameters with Head TSL at 5600 MHz

Impedance, transformed to feed point	53.7 Ω - 3.8 j Ω
Return Loss	- 25.8 dB

Antenna Parameters with Head TSL at 5750 MHz

Impedance, transformed to feed point	51.7 Ω - 1.3 j Ω
Return Loss	- 33.7 dB

Antenna Parameters with Body TSL at 5250 MHz

Impedance, transformed to feed point	49.0 Ω - 4.4 j Ω
Return Loss	- 26.8 dB

Antenna Parameters with Body TSL at 5600 MHz

Impedance, transformed to feed point	55.0 Ω - 1.9 j Ω
Return Loss	- 25.8 dB

Antenna Parameters with Body TSL at 5750 MHz

Impedance, transformed to feed point	53.0 Ω - 0.7 j Ω
Return Loss	- 30.6 dB

General Antenna Parameters and Design

Electrical Delay (one direction)	1.201 ns
----------------------------------	----------

After long term use with 100W radiated power, only a slight warming of the dipole near the feedpoint can be measured.

The dipole is made of standard semirigid coaxial cable. The center conductor of the feeding line is directly connected to the second arm of the dipole. The antenna is therefore short-circuited for DC-signals. On some of the dipoles, small end caps are added to the dipole arms in order to improve matching when loaded according to the position as explained in the "Measurement Conditions" paragraph. The SAR data are not affected by this change. The overall dipole length is still according to the Standard.

No excessive force must be applied to the dipole arms, because they might bend or the soldered connections near the feedpoint may be damaged.

Additional EUT Data

Manufactured by	SPEAG
-----------------	-------

DASY5 Validation Report for Head TSL

Date: 18.01.2021

Test Laboratory: SPEAG, Zurich, Switzerland

DUT: Dipole D5GHzV2; Type: D5GHzV2; Serial: D5GHzV2 - SN:1057

Communication System: UID 0 - CW; Frequency: 5250 MHz, Frequency: 5600 MHz, Frequency: 5750 MHz

Medium parameters used: $f = 5250$ MHz; $\sigma = 4.51$ S/m; $\epsilon_r = 35.0$; $\rho = 1000$ kg/m³,

Medium parameters used: $f = 5600$ MHz; $\sigma = 4.86$ S/m; $\epsilon_r = 34.5$; $\rho = 1000$ kg/m³,

Medium parameters used: $f = 5750$ MHz; $\sigma = 5.02$ S/m; $\epsilon_r = 34.3$; $\rho = 1000$ kg/m³

Phantom section: Flat Section

Measurement Standard: DASY5 (IEEE/IEC/ANSI C63.19-2011)

DASY52 Configuration:

- Probe: EX3DV4 - SN3503; ConvF(5.5, 5.5, 5.5) @ 5250 MHz, ConvF(5.1, 5.1, 5.1) @ 5600 MHz, ConvF(5.08, 5.08, 5.08) @ 5750 MHz; Calibrated: 30.12.2020
- Sensor-Surface: 1.4mm (Mechanical Surface Detection)
- Electronics: DAE4 Sn601; Calibrated: 02.11.2020
- Phantom: Flat Phantom 5.0 (front); Type: QD 000 P50 AA; Serial: 1001
- DASY52 52.10.4(1527); SEMCAD X 14.6.14(7483)

Dipole Calibration for Head Tissue/Pin=100mW, dist=10mm, f=5250 MHz/Zoom Scan, dist=1.4mm (8x8x7)/Cube 0: Measurement grid: dx=4mm, dy=4mm, dz=1.4mm

Reference Value = 77.96 V/m; Power Drift = 0.06 dB

Peak SAR (extrapolated) = 27.1 W/kg

SAR(1 g) = 8.03 W/kg; SAR(10 g) = 2.29 W/kg

Smallest distance from peaks to all points 3 dB below = 7.2 mm

Ratio of SAR at M2 to SAR at M1 = 70.5%

Maximum value of SAR (measured) = 17.9 W/kg

Dipole Calibration for Head Tissue/Pin=100mW, dist=10mm, f=5600 MHz/Zoom Scan, dist=1.4mm (8x8x7)/Cube 0: Measurement grid: dx=4mm, dy=4mm, dz=1.4mm

Reference Value = 78.21 V/m; Power Drift = 0.05 dB

Peak SAR (extrapolated) = 31.2 W/kg

SAR(1 g) = 8.45 W/kg; SAR(10 g) = 2.38 W/kg

Smallest distance from peaks to all points 3 dB below = 7.2 mm

Ratio of SAR at M2 to SAR at M1 = 67.6%

Maximum value of SAR (measured) = 19.8 W/kg

Dipole Calibration for Head Tissue/Pin=100mW, dist=10mm, f=5750 MHz/Zoom Scan, dist=1.4mm (8x8x7)/Cube 0: Measurement grid: dx=4mm, dy=4mm, dz=1.4mm

Reference Value = 75.52 V/m; Power Drift = 0.06 dB

Peak SAR (extrapolated) = 31.6 W/kg

SAR(1 g) = 8.08 W/kg; SAR(10 g) = 2.27 W/kg

Smallest distance from peaks to all points 3 dB below = 7.2 mm

Ratio of SAR at M2 to SAR at M1 = 65.7%

Maximum value of SAR (measured) = 19.2 W/kg

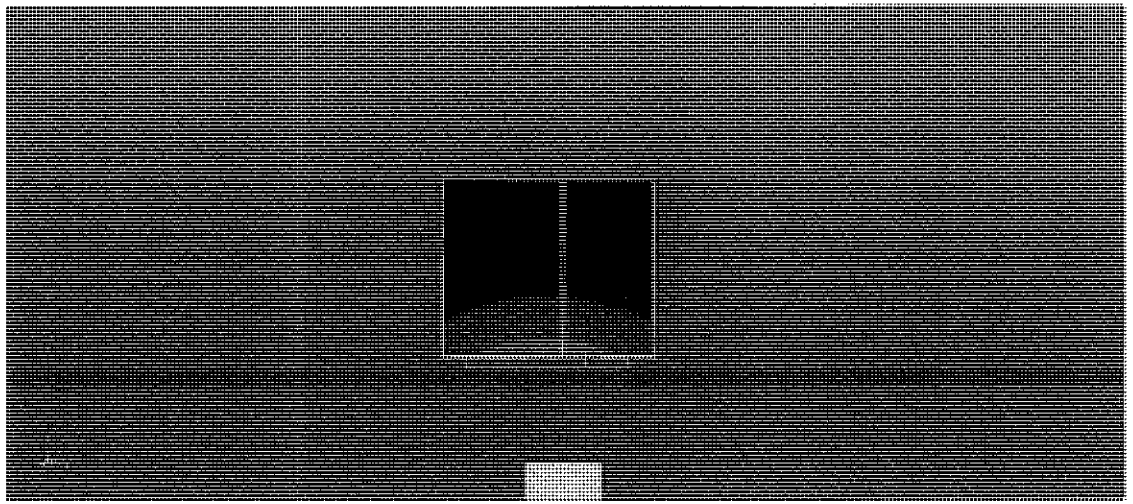
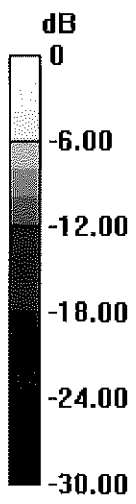

0 dB = 19.8 W/kg = 12.97 dBW/kg

DASY5 Validation Report for Body TSL

Date: 20.01.2021

Test Laboratory: SPEAG, Zurich, Switzerland

DUT: Dipole D5GHzV2; Type: D5GHzV2; Serial: D5GHzV2 - SN:1057

Communication System: UID 0 - CW; Frequency: 5250 MHz, Frequency: 5600 MHz, Frequency: 5750 MHz

Medium parameters used: $f = 5250$ MHz; $\sigma = 5.51$ S/m; $\epsilon_r = 49.3$; $\rho = 1000$ kg/m³,

Medium parameters used: $f = 5600$ MHz; $\sigma = 5.99$ S/m; $\epsilon_r = 48.7$; $\rho = 1000$ kg/m³,

Medium parameters used: $f = 5750$ MHz; $\sigma = 6.20$ S/m; $\epsilon_r = 48.4$; $\rho = 1000$ kg/m³

Phantom section: Flat Section

Measurement Standard: DASY5 (IEEE/IEC/ANSI C63.19-2011)

DASY52 Configuration:

- Probe: EX3DV4 - SN3503; ConvF(5.26, 5.26, 5.26) @ 5250 MHz, ConvF(4.79, 4.79, 4.79) @ 5600 MHz, ConvF(4.66, 4.66, 4.66) @ 5750 MHz; Calibrated: 30.12.2020
- Sensor-Surface: 1.4mm (Mechanical Surface Detection)
- Electronics: DAE4 Sn601; Calibrated: 02.11.2020
- Phantom: Flat Phantom 5.0 (back); Type: QD 000 P50 AA; Serial: 1002
- DASY52 52.10.4(1527); SEMCAD X 14.6.14(7483)

Dipole Calibration for Body Tissue/Pin=100mW, dist=10mm, f=5250 MHz/Zoom Scan, dist=1.4mm (8x8x7)/Cube 0: Measurement grid: dx=4mm, dy=4mm, dz=1.4mm

Reference Value = 66.66 V/m; Power Drift = -0.06 dB

Peak SAR (extrapolated) = 28.1 W/kg

SAR(1 g) = 7.42 W/kg; SAR(10 g) = 2.06 W/kg

Smallest distance from peaks to all points 3 dB below = 7.2 mm

Ratio of SAR at M2 to SAR at M1 = 67.2%

Maximum value of SAR (measured) = 17.2 W/kg

Dipole Calibration for Body Tissue/Pin=100mW, dist=10mm, f=5600 MHz/Zoom Scan, dist=1.4mm (8x8x7)/Cube 0: Measurement grid: dx=4mm, dy=4mm, dz=1.4mm

Reference Value = 66.43 V/m; Power Drift = -0.07 dB

Peak SAR (extrapolated) = 32.5 W/kg

SAR(1 g) = 7.73 W/kg; SAR(10 g) = 2.13 W/kg

Smallest distance from peaks to all points 3 dB below = 6.9 mm

Ratio of SAR at M2 to SAR at M1 = 63.8%

Maximum value of SAR (measured) = 18.6 W/kg

Dipole Calibration for Body Tissue/Pin=100mW, dist=10mm, f=5750 MHz/Zoom Scan, dist=1.4mm (8x8x7)/Cube 0: Measurement grid: dx=4mm, dy=4mm, dz=1.4mm

Reference Value = 64.47 V/m; Power Drift = -0.09 dB

Peak SAR (extrapolated) = 32.1 W/kg

SAR(1 g) = 7.26 W/kg; SAR(10 g) = 2.00 W/kg

Smallest distance from peaks to all points 3 dB below = 6.9 mm

Ratio of SAR at M2 to SAR at M1 = 62.4%

Maximum value of SAR (measured) = 17.9 W/kg

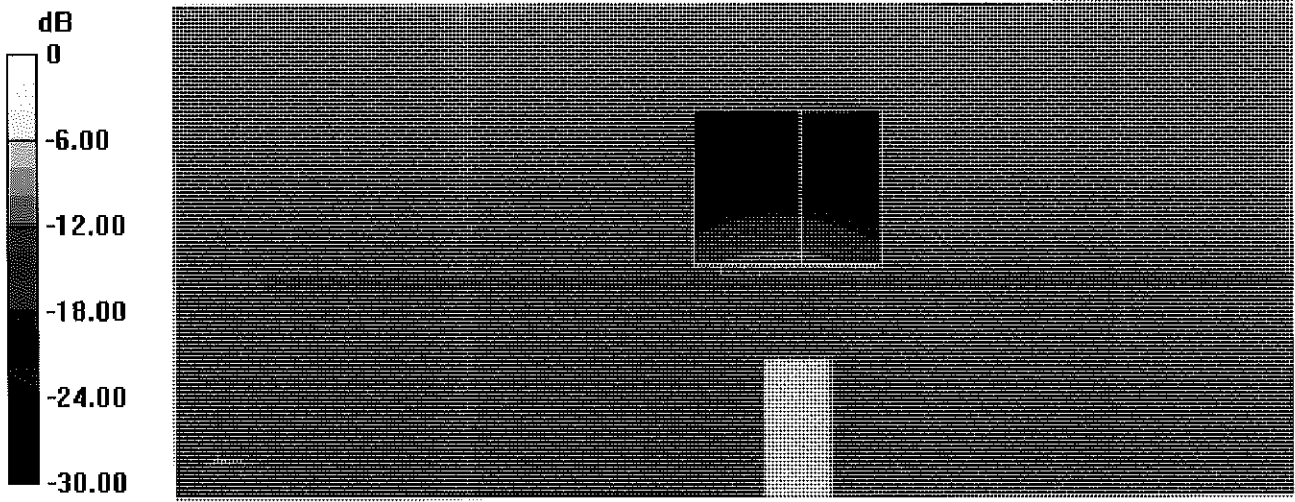

0 dB = 18.6 W/kg = 12.71 dBW/kg



Accreditation No.: **SCS 0108**

Accredited by the Swiss Accreditation Service (SAS)
The Swiss Accreditation Service is one of the signatories to the EA
Multilateral Agreement for the recognition of calibration certificates

Client **PC Test**

Certificate No: **D5GHzV2-1191_Sep20**

CALIBRATION CERTIFICATE

Object **D5GHzV2 - SN:1191**

Calibration procedure(s) **QA CAL-22.v5
Calibration Procedure for SAR Validation Sources between 3-10 GHz** *BNV 10-19-20*

Calibration date: **September 10, 2020**

This calibration certificate documents the traceability to national standards, which realize the physical units of measurements (SI).
The measurements and the uncertainties with confidence probability are given on the following pages and are part of the certificate.

All calibrations have been conducted in the closed laboratory facility: environment temperature (22 ± 3)°C and humidity < 70%.

Calibration Equipment used (M&TE critical for calibration)

Primary Standards	ID #	Cal Date (Certificate No.)	Scheduled Calibration
Power meter NRP	SN: 104778	01-Apr-20 (No. 217-03100/03101)	Apr-21
Power sensor NRP-Z91	SN: 103244	01-Apr-20 (No. 217-03100)	Apr-21
Power sensor NRP-Z91	SN: 103245	01-Apr-20 (No. 217-03101)	Apr-21
Reference 20 dB Attenuator	SN: BH9394 (20k)	31-Mar-20 (No. 217-03106)	Apr-21
Type-N mismatch combination	SN: 310982 / 06327	31-Mar-20 (No. 217-03104)	Apr-21
Reference Probe EX3DV4	SN: 3503	31-Dec-19 (No. EX3-3503_Dec19)	Dec-20
DAE4	SN: 601	27-Dec-19 (No. DAE4-601_Dec19)	Dec-20

Secondary Standards	ID #	Check Date (in house)	Scheduled Check
Power meter E4419B	SN: GB39512475	30-Oct-14 (in house check Feb-19)	In house check: Oct-20
Power sensor HP 8481A	SN: US37292783	07-Oct-15 (in house check Oct-18)	In house check: Oct-20
Power sensor HP 8481A	SN: MY41092317	07-Oct-15 (in house check Oct-18)	In house check: Oct-20
RF generator R&S SMT-06	SN: 100972	15-Jun-15 (in house check Oct-18)	In house check: Oct-20
Network Analyzer Agilent E8358A	SN: US41080477	31-Mar-14 (in house check Oct-19)	In house check: Oct-20

Calibrated by: **Claudio Leubler** (Name) **Laboratory Technician** (Function)

Signature

Approved by: **Katja Pokovic** (Name) **Technical Manager** (Function)

Issued: September 10, 2020

This calibration certificate shall not be reproduced except in full without written approval of the laboratory.



Accredited by the Swiss Accreditation Service (SAS)
The Swiss Accreditation Service is one of the signatories to the EA
Multilateral Agreement for the recognition of calibration certificates

Accreditation No.: **SCS 0108**

Glossary:

TSL	tissue simulating liquid
ConvF	sensitivity in TSL / NORM x,y,z
N/A	not applicable or not measured

Calibration is Performed According to the Following Standards:

- a) IEEE Std 1528-2013, "IEEE Recommended Practice for Determining the Peak Spatial-Averaged Specific Absorption Rate (SAR) in the Human Head from Wireless Communications Devices: Measurement Techniques", June 2013
- b) IEC 62209-1, "Measurement procedure for the assessment of Specific Absorption Rate (SAR) from hand-held and body-mounted devices used next to the ear (frequency range of 300 MHz to 6 GHz)", July 2016
- c) IEC 62209-2, "Procedure to determine the Specific Absorption Rate (SAR) for wireless communication devices used in close proximity to the human body (frequency range of 30 MHz to 6 GHz)", March 2010
- d) KDB 865664, "SAR Measurement Requirements for 100 MHz to 6 GHz"

Additional Documentation:

- e) DASY4/5 System Handbook

Methods Applied and Interpretation of Parameters:

- *Measurement Conditions:* Further details are available from the Validation Report at the end of the certificate. All figures stated in the certificate are valid at the frequency indicated.
- *Antenna Parameters with TSL:* The dipole is mounted with the spacer to position its feed point exactly below the center marking of the flat phantom section, with the arms oriented parallel to the body axis.
- *Feed Point Impedance and Return Loss:* These parameters are measured with the dipole positioned under the liquid filled phantom. The impedance stated is transformed from the measurement at the SMA connector to the feed point. The Return Loss ensures low reflected power. No uncertainty required.
- *Electrical Delay:* One-way delay between the SMA connector and the antenna feed point. No uncertainty required.
- *SAR measured:* SAR measured at the stated antenna input power.
- *SAR normalized:* SAR as measured, normalized to an input power of 1 W at the antenna connector.
- *SAR for nominal TSL parameters:* The measured TSL parameters are used to calculate the nominal SAR result.

The reported uncertainty of measurement is stated as the standard uncertainty of measurement multiplied by the coverage factor $k=2$, which for a normal distribution corresponds to a coverage probability of approximately 95%.

Measurement Conditions

DASY system configuration, as far as not given on page 1.

DASY Version	DASY5	V52.10.4
Extrapolation	Advanced Extrapolation	
Phantom	Modular Flat Phantom V5.0	
Distance Dipole Center - TSL	10 mm	with Spacer
Zoom Scan Resolution	dx, dy = 10.0 mm, dz = 10.0 mm	Graded Ratio = 1.4 (Z direction)
Frequency	5200 MHz ± 1 MHz 5250 MHz ± 1 MHz 5600 MHz ± 1 MHz 5750 MHz ± 1 MHz 5800 MHz ± 1 MHz	

Head TSL parameters at 5200 MHz

The following parameters and calculations were applied.

	Temperature	Permittivity	Conductivity
Nominal Head TSL parameters	22.0 °C	36.0	4.66 mho/m
Measured Head TSL parameters	(22.0 ± 0.2) °C	34.6 ± 6 %	4.47 mho/m ± 6 %
Head TSL temperature change during test	< 0.5 °C	----	----

SAR result with Head TSL at 5200 MHz

SAR averaged over 1 cm³ (1 g) of Head TSL	Condition	
SAR measured	100 mW input power	7.98 W/kg
SAR for nominal Head TSL parameters	normalized to 1W	79.1 W/kg ± 19.9 % (k=2)

SAR averaged over 10 cm³ (10 g) of Head TSL	condition	
SAR measured	100 mW input power	2.29 W/kg
SAR for nominal Head TSL parameters	normalized to 1W	22.6 W/kg ± 19.5 % (k=2)

Head TSL parameters at 5250 MHz

The following parameters and calculations were applied.

	Temperature	Permittivity	Conductivity
Nominal Head TSL parameters	22.0 °C	35.9	4.71 mho/m
Measured Head TSL parameters	(22.0 ± 0.2) °C	34.5 ± 6 %	4.52 mho/m ± 6 %
Head TSL temperature change during test	< 0.5 °C	----	----

SAR result with Head TSL at 5250 MHz

SAR averaged over 1 cm³ (1 g) of Head TSL	Condition	
SAR measured	100 mW input power	8.06 W/kg
SAR for nominal Head TSL parameters	normalized to 1W	79.8 W/kg ± 19.9 % (k=2)

SAR averaged over 10 cm³ (10 g) of Head TSL	condition	
SAR measured	100 mW input power	2.31 W/kg
SAR for nominal Head TSL parameters	normalized to 1W	22.8 W/kg ± 19.5 % (k=2)

Head TSL parameters at 5600 MHz

The following parameters and calculations were applied.

	Temperature	Permittivity	Conductivity
Nominal Head TSL parameters	22.0 °C	35.5	5.07 mho/m
Measured Head TSL parameters	(22.0 ± 0.2) °C	34.0 ± 6 %	4.87 mho/m ± 6 %
Head TSL temperature change during test	< 0.5 °C	----	----

SAR result with Head TSL at 5600 MHz

SAR averaged over 1 cm ³ (1 g) of Head TSL	Condition	
SAR measured	100 mW input power	8.27 W/kg
SAR for nominal Head TSL parameters	normalized to 1W	81.8 W/kg ± 19.9 % (k=2)

SAR averaged over 10 cm ³ (10 g) of Head TSL	condition	
SAR measured	100 mW input power	2.36 W/kg
SAR for nominal Head TSL parameters	normalized to 1W	23.3 W/kg ± 19.5 % (k=2)

Head TSL parameters at 5750 MHz

The following parameters and calculations were applied.

	Temperature	Permittivity	Conductivity
Nominal Head TSL parameters	22.0 °C	35.4	5.22 mho/m
Measured Head TSL parameters	(22.0 ± 0.2) °C	33.8 ± 6 %	5.01 mho/m ± 6 %
Head TSL temperature change during test	< 0.5 °C	----	----

SAR result with Head TSL at 5750 MHz

SAR averaged over 1 cm ³ (1 g) of Head TSL	Condition	
SAR measured	100 mW input power	8.02 W/kg
SAR for nominal Head TSL parameters	normalized to 1W	79.3 W/kg ± 19.9 % (k=2)

SAR averaged over 10 cm ³ (10 g) of Head TSL	condition	
SAR measured	100 mW input power	2.28 W/kg
SAR for nominal Head TSL parameters	normalized to 1W	22.5 W/kg ± 19.5 % (k=2)

Head TSL parameters at 5800 MHz

The following parameters and calculations were applied.

	Temperature	Permittivity	Conductivity
Nominal Head TSL parameters	22.0 °C	35.3	5.27 mho/m
Measured Head TSL parameters	(22.0 ± 0.2) °C	33.7 ± 6 %	5.06 mho/m ± 6 %
Head TSL temperature change during test	< 0.5 °C	----	----

SAR result with Head TSL at 5800 MHz

SAR averaged over 1 cm ³ (1 g) of Head TSL	Condition	
SAR measured	100 mW input power	8.16 W/kg
SAR for nominal Head TSL parameters	normalized to 1W	80.6 W/kg ± 19.9 % (k=2)

SAR averaged over 10 cm ³ (10 g) of Head TSL	condition	
SAR measured	100 mW input power	2.30 W/kg
SAR for nominal Head TSL parameters	normalized to 1W	22.6 W/kg ± 19.5 % (k=2)

Body TSL parameters at 5200 MHz

The following parameters and calculations were applied.

	Temperature	Permittivity	Conductivity
Nominal Body TSL parameters	22.0 °C	49.0	5.30 mho/m
Measured Body TSL parameters	(22.0 ± 0.2) °C	47.5 ± 6 %	5.43 mho/m ± 6 %
Body TSL temperature change during test	< 0.5 °C	----	----

SAR result with Body TSL at 5200 MHz

SAR averaged over 1 cm ³ (1 g) of Body TSL	Condition	
SAR measured	100 mW input power	7.42 W/kg
SAR for nominal Body TSL parameters	normalized to 1W	73.8 W/kg ± 19.9 % (k=2)

SAR averaged over 10 cm ³ (10 g) of Body TSL	condition	
SAR measured	100 mW input power	2.09 W/kg
SAR for nominal Body TSL parameters	normalized to 1W	20.8 W/kg ± 19.5 % (k=2)

Body TSL parameters at 5250 MHz

The following parameters and calculations were applied.

	Temperature	Permittivity	Conductivity
Nominal Body TSL parameters	22.0 °C	48.9	5.36 mho/m
Measured Body TSL parameters	(22.0 ± 0.2) °C	47.4 ± 6 %	5.50 mho/m ± 6 %
Body TSL temperature change during test	< 0.5 °C	----	----

SAR result with Body TSL at 5250 MHz

SAR averaged over 1 cm ³ (1 g) of Body TSL	Condition	
SAR measured	100 mW input power	7.50 W/kg
SAR for nominal Body TSL parameters	normalized to 1W	74.6 W/kg ± 19.9 % (k=2)

SAR averaged over 10 cm ³ (10 g) of Body TSL	condition	
SAR measured	100 mW input power	2.11 W/kg
SAR for nominal Body TSL parameters	normalized to 1W	21.0 W/kg ± 19.5 % (k=2)

Body TSL parameters at 5600 MHz

The following parameters and calculations were applied.

	Temperature	Permittivity	Conductivity
Nominal Body TSL parameters	22.0 °C	48.5	5.77 mho/m
Measured Body TSL parameters	(22.0 ± 0.2) °C	46.8 ± 6 %	5.98 mho/m ± 6 %
Body TSL temperature change during test	< 0.5 °C	----	----

SAR result with Body TSL at 5600 MHz

SAR averaged over 1 cm ³ (1 g) of Body TSL	Condition	
SAR measured	100 mW input power	7.85 W/kg
SAR for nominal Body TSL parameters	normalized to 1W	78.1 W/kg ± 19.9 % (k=2)

SAR averaged over 10 cm ³ (10 g) of Body TSL	condition	
SAR measured	100 mW input power	2.19 W/kg
SAR for nominal Body TSL parameters	normalized to 1W	21.7 W/kg ± 19.5 % (k=2)

Body TSL parameters at 5750 MHz

The following parameters and calculations were applied.

	Temperature	Permittivity	Conductivity
Nominal Body TSL parameters	22.0 °C	48.3	5.94 mho/m
Measured Body TSL parameters	(22.0 ± 0.2) °C	46.5 ± 6 %	6.19 mho/m ± 6 %
Body TSL temperature change during test	< 0.5 °C	----	----

SAR result with Body TSL at 5750 MHz

SAR averaged over 1 cm ³ (1 g) of Body TSL	Condition	
SAR measured	100 mW input power	7.53 W/kg
SAR for nominal Body TSL parameters	normalized to 1W	74.9 W/kg ± 19.9 % (k=2)

SAR averaged over 10 cm ³ (10 g) of Body TSL	condition	
SAR measured	100 mW input power	2.10 W/kg
SAR for nominal Body TSL parameters	normalized to 1W	20.8 W/kg ± 19.5 % (k=2)

Body TSL parameters at 5800 MHz

The following parameters and calculations were applied.

	Temperature	Permittivity	Conductivity
Nominal Body TSL parameters	22.0 °C	48.2	6.00 mho/m
Measured Body TSL parameters	(22.0 ± 0.2) °C	46.4 ± 6 %	6.26 mho/m ± 6 %
Body TSL temperature change during test	< 0.5 °C	----	----

SAR result with Body TSL at 5800 MHz

SAR averaged over 1 cm ³ (1 g) of Body TSL	Condition	
SAR measured	100 mW input power	7.52 W/kg
SAR for nominal Body TSL parameters	normalized to 1W	74.8 W/kg ± 19.9 % (k=2)

SAR averaged over 10 cm ³ (10 g) of Body TSL	condition	
SAR measured	100 mW input power	2.08 W/kg
SAR for nominal Body TSL parameters	normalized to 1W	20.6 W/kg ± 19.5 % (k=2)

Appendix (Additional assessments outside the scope of SCS 0108)

Antenna Parameters with Head TSL at 5200 MHz

Impedance, transformed to feed point	52.0 Ω - 9.7 j Ω
Return Loss	- 20.3 dB

Antenna Parameters with Head TSL at 5250 MHz

Impedance, transformed to feed point	53.4 Ω - 6.0 j Ω
Return Loss	- 23.5 dB

Antenna Parameters with Head TSL at 5600 MHz

Impedance, transformed to feed point	56.9 Ω - 5.1 j Ω
Return Loss	- 21.9 dB

Antenna Parameters with Head TSL at 5750 MHz

Impedance, transformed to feed point	59.2 Ω + 3.1 j Ω
Return Loss	- 21.0 dB

Antenna Parameters with Head TSL at 5800 MHz

Impedance, transformed to feed point	56.2 Ω + 2.0 j Ω
Return Loss	- 24.3 dB

Antenna Parameters with Body TSL at 5200 MHz

Impedance, transformed to feed point	52.7 Ω - 8.3 j Ω
Return Loss	- 21.5 dB

Antenna Parameters with Body TSL at 5250 MHz

Impedance, transformed to feed point	53.1 Ω - 4.4 j Ω
Return Loss	- 25.6 dB

Antenna Parameters with Body TSL at 5600 MHz

Impedance, transformed to feed point	57.8 Ω - 3.2 j Ω
Return Loss	- 22.2 dB

Antenna Parameters with Body TSL at 5750 MHz

Impedance, transformed to feed point	$60.2 \Omega + 3.6 j\Omega$
Return Loss	- 20.2 dB

Antenna Parameters with Body TSL at 5800 MHz

Impedance, transformed to feed point	$56.8 \Omega + 3.6 j\Omega$
Return Loss	- 22.9 dB

General Antenna Parameters and Design

Electrical Delay (one direction)	1.202 ns
----------------------------------	----------

After long term use with 100W radiated power, only a slight warming of the dipole near the feedpoint can be measured.

The dipole is made of standard semirigid coaxial cable. The center conductor of the feeding line is directly connected to the second arm of the dipole. The antenna is therefore short-circuited for DC-signals. On some of the dipoles, small end caps are added to the dipole arms in order to improve matching when loaded according to the position as explained in the "Measurement Conditions" paragraph. The SAR data are not affected by this change. The overall dipole length is still according to the Standard.

No excessive force must be applied to the dipole arms, because they might bend or the soldered connections near the feedpoint may be damaged.

Additional EUT Data

Manufactured by	SPEAG
-----------------	-------

DASY5 Validation Report for Head TSL

Date: 07.09.2020

Test Laboratory: SPEAG, Zurich, Switzerland

DUT: Dipole D5GHzV2; Type: D5GHzV2; Serial: D5GHzV2 - SN:1191

Communication System: UID 0 - CW; Frequency: 5200 MHz, Frequency: 5250 MHz, Frequency: 5600 MHz, Frequency: 5750 MHz, Frequency: 5800 MHz

Medium parameters used: $f = 5200$ MHz; $\sigma = 4.47$ S/m; $\epsilon_r = 34.6$; $\rho = 1000$ kg/m³,

Medium parameters used: $f = 5250$ MHz; $\sigma = 4.52$ S/m; $\epsilon_r = 34.5$; $\rho = 1000$ kg/m³,

Medium parameters used: $f = 5600$ MHz; $\sigma = 4.87$ S/m; $\epsilon_r = 34.0$; $\rho = 1000$ kg/m³,

Medium parameters used: $f = 5750$ MHz; $\sigma = 5.01$ S/m; $\epsilon_r = 33.8$; $\rho = 1000$ kg/m³,

Medium parameters used: $f = 5800$ MHz; $\sigma = 5.06$ S/m; $\epsilon_r = 33.7$; $\rho = 1000$ kg/m³

Phantom section: Flat Section

Measurement Standard: DASY5 (IEEE/IEC/ANSI C63.19-2011)

DASY52 Configuration:

- Probe: EX3DV4 - SN3503; ConvF(5.8, 5.8, 5.8) @ 5200 MHz, ConvF(5.5, 5.5, 5.5) @ 5250 MHz, ConvF(5.1, 5.1, 5.1) @ 5600 MHz, ConvF(5.08, 5.08, 5.08) @ 5750 MHz, ConvF(5.01, 5.01, 5.01) @ 5800 MHz; Calibrated: 31.12.2019
- Sensor-Surface: 1.4mm (Mechanical Surface Detection)
- Electronics: DAE4 Sn601; Calibrated: 27.12.2019
- Phantom: Flat Phantom 5.0 (front); Type: QD 000 P50 AA; Serial: 1001
- DASY52 52.10.4(1527); SEMCAD X 14.6.14(7483)

Dipole Calibration for Head Tissue/Pin=100mW, dist=10mm, f=5200 MHz/Zoom Scan, dist=1.4mm (8x8x7)/Cube 0: Measurement grid: dx=4mm, dy=4mm, dz=1.4mm

Reference Value = 76.03 V/m; Power Drift = -0.09 dB

Peak SAR (extrapolated) = 28.8 W/kg

SAR(1 g) = 7.98 W/kg; SAR(10 g) = 2.29 W/kg

Smallest distance from peaks to all points 3 dB below = 7.2 mm

Ratio of SAR at M2 to SAR at M1 = 68.5%

Maximum value of SAR (measured) = 18.4 W/kg

Dipole Calibration for Head Tissue/Pin=100mW, dist=10mm, f=5250 MHz/Zoom Scan, dist=1.4mm (8x8x7)/Cube 0: Measurement grid: dx=4mm, dy=4mm, dz=1.4mm

Reference Value = 76.98 V/m; Power Drift = -0.08 dB

Peak SAR (extrapolated) = 28.1 W/kg

SAR(1 g) = 8.06 W/kg; SAR(10 g) = 2.31 W/kg

Smallest distance from peaks to all points 3 dB below = 7.2 mm

Ratio of SAR at M2 to SAR at M1 = 69.7%

Maximum value of SAR (measured) = 18.4 W/kg

Dipole Calibration for Head Tissue/Pin=100mW, dist=10mm, f=5600 MHz/Zoom Scan, dist=1.4mm (8x8x7)/Cube 0: Measurement grid: dx=4mm, dy=4mm, dz=1.4mm
 Reference Value = 76.97 V/m; Power Drift = -0.08 dB
 Peak SAR (extrapolated) = 31.1 W/kg
SAR(1 g) = 8.27 W/kg; SAR(10 g) = 2.36 W/kg
 Smallest distance from peaks to all points 3 dB below = 7.2 mm
 Ratio of SAR at M2 to SAR at M1 = 67.1%
 Maximum value of SAR (measured) = 19.5 W/kg

Dipole Calibration for Head Tissue/Pin=100mW, dist=10mm, f=5750 MHz/Zoom Scan, dist=1.4mm (8x8x7)/Cube 0: Measurement grid: dx=4mm, dy=4mm, dz=1.4mm
 Reference Value = 74.08 V/m; Power Drift = -0.09 dB
 Peak SAR (extrapolated) = 31.9 W/kg
SAR(1 g) = 8.02 W/kg; SAR(10 g) = 2.28 W/kg
 Smallest distance from peaks to all points 3 dB below = 7.2 mm
 Ratio of SAR at M2 to SAR at M1 = 65%
 Maximum value of SAR (measured) = 19.3 W/kg

Dipole Calibration for Head Tissue/Pin=100mW, dist=10mm, f=5800 MHz/Zoom Scan, dist=1.4mm (8x8x7)/Cube 0: Measurement grid: dx=4mm, dy=4mm, dz=1.4mm
 Reference Value = 75.29 V/m; Power Drift = -0.09 dB
 Peak SAR (extrapolated) = 32.7 W/kg
SAR(1 g) = 8.16 W/kg; SAR(10 g) = 2.30 W/kg
 Smallest distance from peaks to all points 3 dB below = 7.2 mm
 Ratio of SAR at M2 to SAR at M1 = 65.1%
 Maximum value of SAR (measured) = 19.5 W/kg

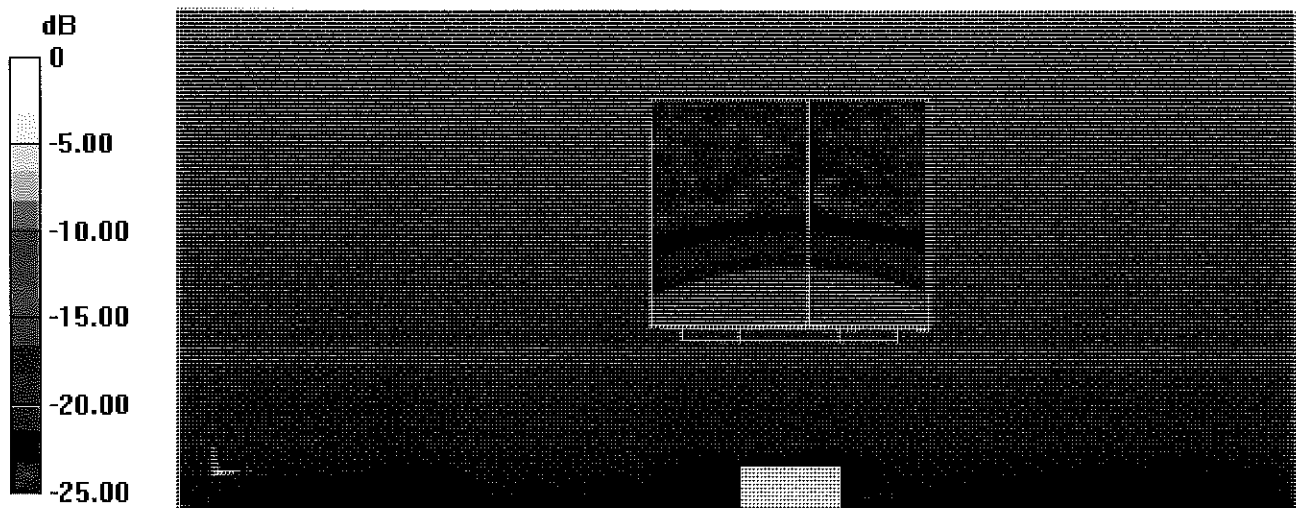

0 dB = 19.5 W/kg = 12.90 dBW/kg

Impedance Measurement Plot for Head TSL (5200, 5600, 5800 MHz)

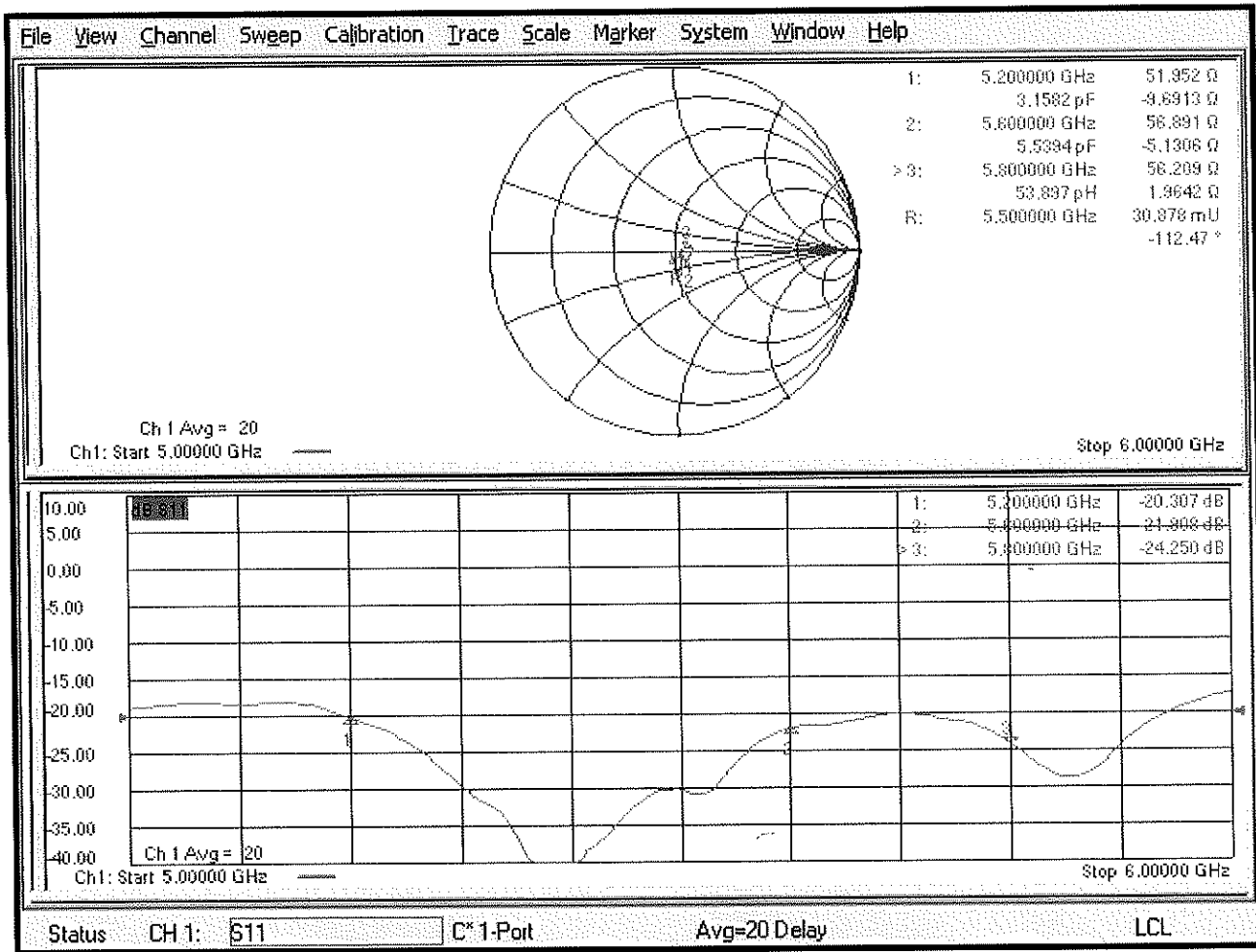

Impedance Measurement Plot for Head TSL (5250, 5750 MHz)

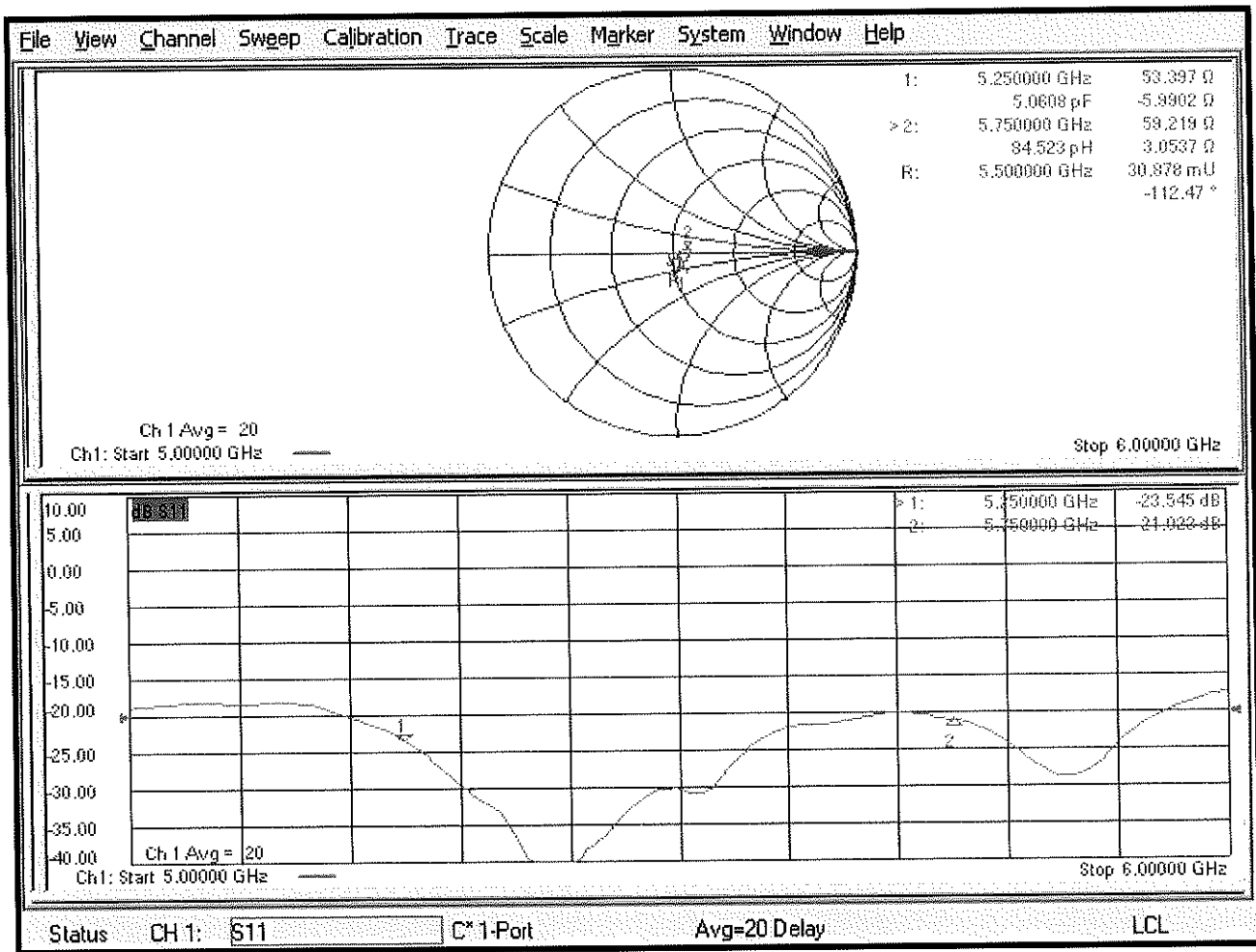

DASY5 Validation Report for Body TSL

Date: 10.09.2020

Test Laboratory: SPEAG, Zurich, Switzerland

DUT: Dipole D5GHzV2; Type: D5GHzV2; Serial: D5GHzV2 - SN:1191

Communication System: UID 0 - CW; Frequency: 5200 MHz, Frequency: 5250 MHz, Frequency: 5600 MHz, Frequency: 5750 MHz, Frequency: 5800 MHz

Medium parameters used: $f = 5200$ MHz; $\sigma = 5.43$ S/m; $\epsilon_r = 47.5$; $\rho = 1000$ kg/m³,

Medium parameters used: $f = 5250$ MHz; $\sigma = 5.50$ S/m; $\epsilon_r = 47.4$; $\rho = 1000$ kg/m³,

Medium parameters used: $f = 5600$ MHz; $\sigma = 5.98$ S/m; $\epsilon_r = 46.8$; $\rho = 1000$ kg/m³,

Medium parameters used: $f = 5750$ MHz; $\sigma = 6.19$ S/m; $\epsilon_r = 46.5$; $\rho = 1000$ kg/m³,

Medium parameters used: $f = 5800$ MHz; $\sigma = 6.26$ S/m; $\epsilon_r = 46.4$; $\rho = 1000$ kg/m³

Phantom section: Flat Section

Measurement Standard: DASY5 (IEEE/IEC/ANSI C63.19-2011)

DASY52 Configuration:

- Probe: EX3DV4 - SN3503; ConvF(5.29, 5.29, 5.29) @ 5200 MHz, ConvF(5.26, 5.26, 5.26) @ 5250 MHz, ConvF(4.79, 4.79, 4.79) @ 5600 MHz, ConvF(4.66, 4.66, 4.66) @ 5750 MHz, ConvF(4.62, 4.62, 4.62) @ 5800 MHz; Calibrated: 31.12.2019
- Sensor-Surface: 1.4mm (Mechanical Surface Detection)
- Electronics: DAE4 Sn601; Calibrated: 27.12.2019
- Phantom: Flat Phantom 5.0 (back); Type: QD 000 P50 AA; Serial: 1002
- DASY52 52.10.4(1527); SEMCAD X 14.6.14(7483)

Dipole Calibration for Body Tissue/Pin=100mW, dist=10mm, f=5200 MHz/Zoom Scan, dist=1.4mm (8x8x7)/Cube 0: Measurement grid: dx=4mm, dy=4mm, dz=1.4mm

Reference Value = 67.72 V/m; Power Drift = -0.06 dB

Peak SAR (extrapolated) = 27.1 W/kg

SAR(1 g) = 7.42 W/kg; SAR(10 g) = 2.09 W/kg

Smallest distance from peaks to all points 3 dB below = 7.2 mm

Ratio of SAR at M2 to SAR at M1 = 68.3%

Maximum value of SAR (measured) = 16.9 W/kg

Dipole Calibration for Body Tissue/Pin=100mW, dist=10mm, f=5250 MHz/Zoom Scan, dist=1.4mm (8x8x7)/Cube 0: Measurement grid: dx=4mm, dy=4mm, dz=1.4mm

Reference Value = 67.69 V/m; Power Drift = -0.05 dB

Peak SAR (extrapolated) = 28.1 W/kg

SAR(1 g) = 7.50 W/kg; SAR(10 g) = 2.11 W/kg

Smallest distance from peaks to all points 3 dB below = 7.2 mm

Ratio of SAR at M2 to SAR at M1 = 67.5%

Maximum value of SAR (measured) = 17.2 W/kg

Dipole Calibration for Body Tissue/Pin=100mW, dist=10mm, f=5600 MHz/Zoom Scan, dist=1.4mm (8x8x7)/Cube 0: Measurement grid: dx=4mm, dy=4mm, dz=1.4mm
 Reference Value = 67.38 V/m; Power Drift = -0.05 dB
 Peak SAR (extrapolated) = 32.5 W/kg
SAR(1 g) = 7.85 W/kg; SAR(10 g) = 2.19 W/kg
 Smallest distance from peaks to all points 3 dB below = 7.2 mm
 Ratio of SAR at M2 to SAR at M1 = 64.2%
 Maximum value of SAR (measured) = 18.5 W/kg

Dipole Calibration for Body Tissue/Pin=100mW, dist=10mm, f=5750 MHz/Zoom Scan, dist=1.4mm (8x8x7)/Cube 0: Measurement grid: dx=4mm, dy=4mm, dz=1.4mm
 Reference Value = 64.99 V/m; Power Drift = -0.06 dB
 Peak SAR (extrapolated) = 32.7 W/kg
SAR(1 g) = 7.53 W/kg; SAR(10 g) = 2.10 W/kg
 Smallest distance from peaks to all points 3 dB below = 7.4 mm
 Ratio of SAR at M2 to SAR at M1 = 62.8%
 Maximum value of SAR (measured) = 18.2 W/kg

Dipole Calibration for Body Tissue/Pin=100mW, dist=10mm, f=5800 MHz/Zoom Scan, dist=1.4mm (8x8x7)/Cube 0: Measurement grid: dx=4mm, dy=4mm, dz=1.4mm
 Reference Value = 65.89 V/m; Power Drift = -0.07 dB
 Peak SAR (extrapolated) = 32.1 W/kg
SAR(1 g) = 7.52 W/kg; SAR(10 g) = 2.08 W/kg
 Smallest distance from peaks to all points 3 dB below = 7.2 mm
 Ratio of SAR at M2 to SAR at M1 = 63.4%
 Maximum value of SAR (measured) = 18.2 W/kg

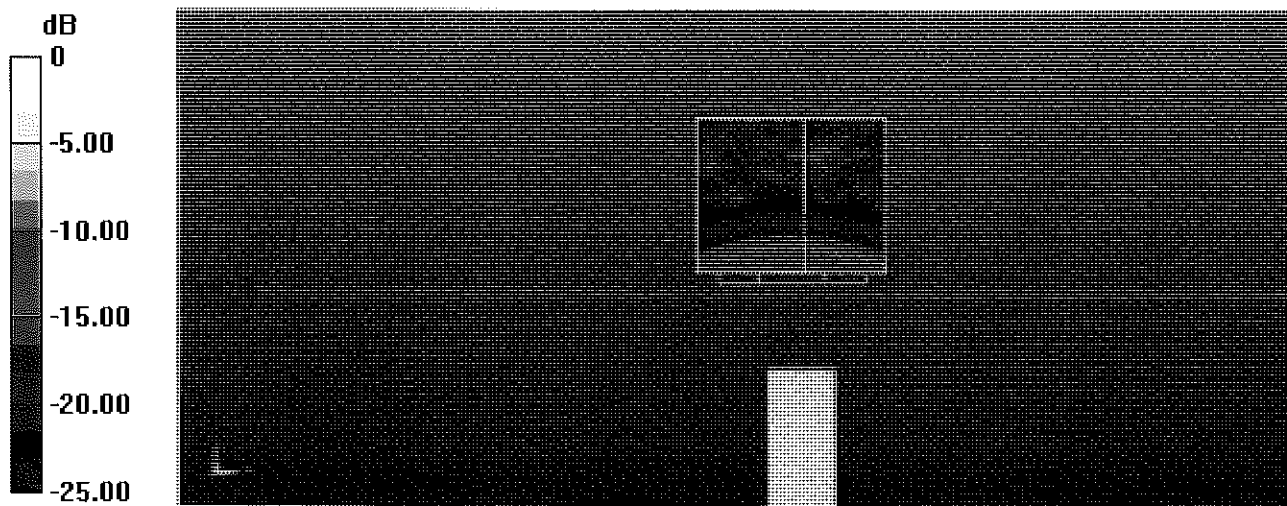

0 dB = 18.5 W/kg = 12.67 dBW/kg

Impedance Measurement Plot for Body TSL (5200, 5600, 5800 MHz)

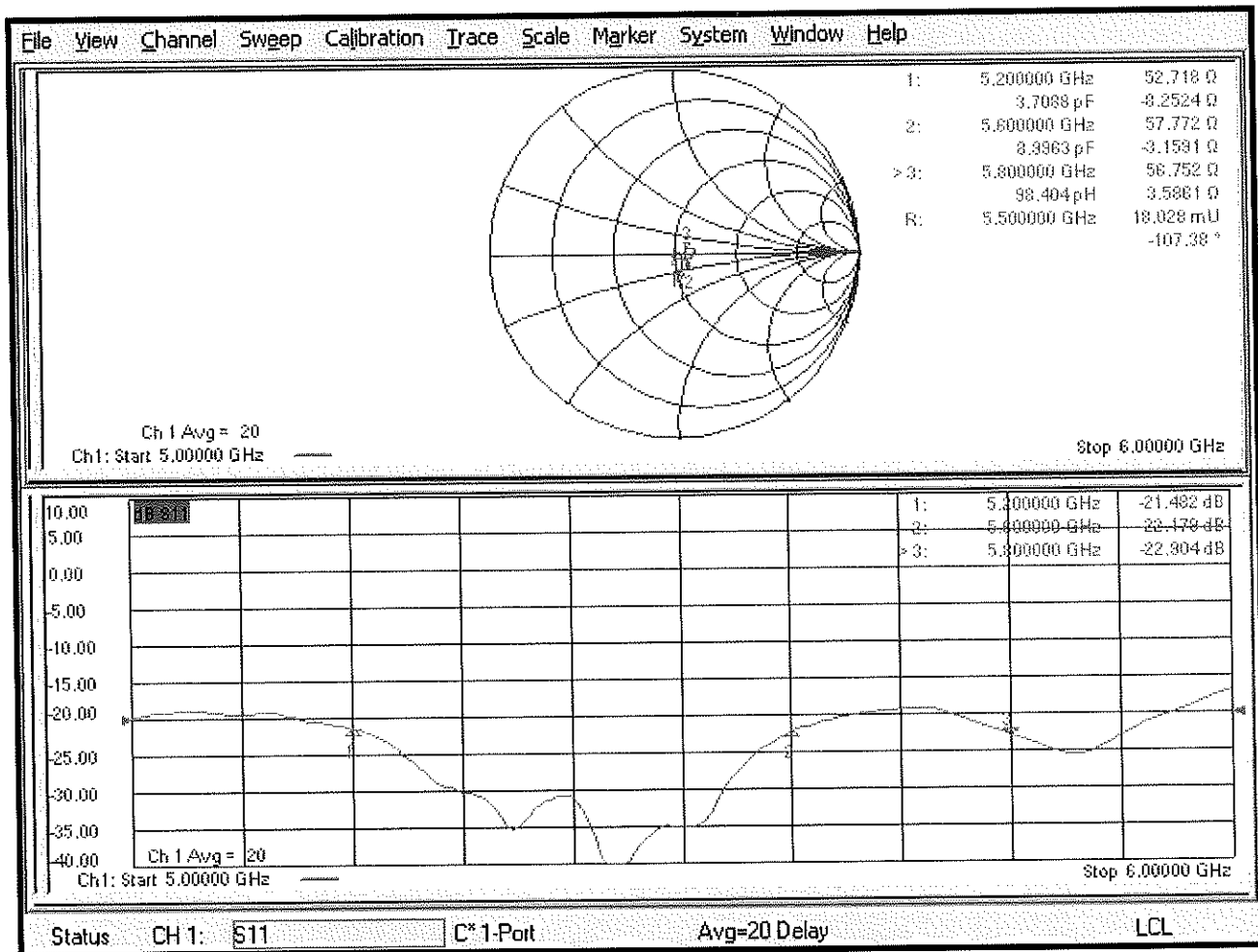

Impedance Measurement Plot for Body TSL (5250, 5750 MHz)

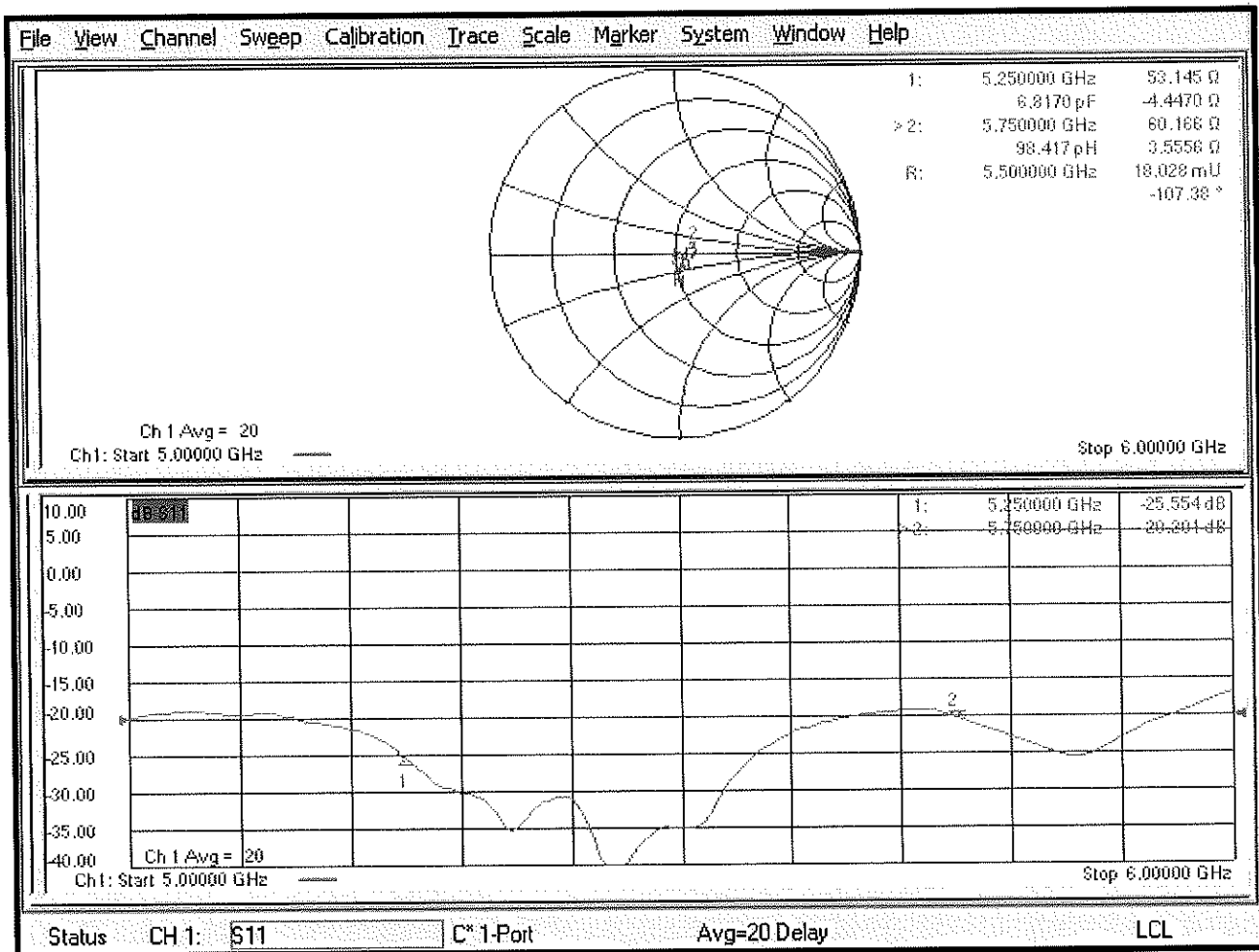

Appendix: Transfer Calibration at Four Validation Locations on SAM Head¹

Evaluation Condition (f=5200 MHz)

Phantom	SAM Head Phantom	For usage with cSAR3DV2-R/L
---------	------------------	-----------------------------

SAR result with SAM Head (Top \cong C0)

SAR averaged over 1 cm³ (1 g) of Head TSL	Condition	
SAR for nominal Head TSL parameters	normalized to 1W	83.7 W/kg \pm 20.3 % (k=2)

SAR averaged over 10 cm³ (10 g) of Head TSL	Condition	
SAR for nominal Head TSL parameters	normalized to 1W	24.1 W/kg \pm 19.9 % (k=2)

SAR result with SAM Head (Mouth \cong F90)

SAR averaged over 1 cm³ (1 g) of Head TSL	Condition	
SAR for nominal Head TSL parameters	normalized to 1W	87.6 W/kg \pm 20.3 % (k=2)

SAR averaged over 10 cm³ (10 g) of Head TSL	condition	
SAR for nominal Head TSL parameters	normalized to 1W	25.3 W/kg \pm 19.9 % (k=2)

SAR result with SAM Head (Neck \cong H0)

SAR averaged over 1 cm³ (1 g) of Head TSL	Condition	
SAR for nominal Head TSL parameters	normalized to 1W	83.6 W/kg \pm 20.3 % (k=2)

SAR averaged over 10 cm³ (10 g) of Head TSL	condition	
SAR for nominal Head TSL parameters	normalized to 1W	23.8 W/kg \pm 19.9 % (k=2)

SAR result with SAM Head (Ear \cong D90)

SAR averaged over 1 cm³ (1 g) of Head TSL	Condition	
SAR for nominal Head TSL parameters	normalized to 1W	53.2 W/kg \pm 20.3 % (k=2)

SAR averaged over 10 cm³ (10 g) of Head TSL	condition	
SAR for nominal Head TSL parameters	normalized to 1W	18.1 W/kg \pm 19.9 % (k=2)

¹ Additional assessments outside the current scope of SCS 0108

Appendix: Transfer Calibration at Four Validation Locations on SAM Head²

Evaluation Condition (f=5800 MHz)

Phantom	SAM Head Phantom	For usage with cSAR3DV2-R/L
---------	------------------	-----------------------------

SAR result with SAM Head (Top \cong C0)

SAR averaged over 1 cm³ (1 g) of Head TSL	Condition	
SAR for nominal Head TSL parameters	normalized to 1W	83.8 W/kg \pm 20.3 % (k=2)

SAR averaged over 10 cm³ (10 g) of Head TSL	condition	
SAR for nominal Head TSL parameters	normalized to 1W	23.5 W/kg \pm 19.9 % (k=2)

SAR result with SAM Head (Mouth \cong F90)

SAR averaged over 1 cm³ (1 g) of Head TSL	Condition	
SAR for nominal Head TSL parameters	normalized to 1W	90.6 W/kg \pm 20.3 % (k=2)

SAR averaged over 10 cm³ (10 g) of Head TSL	condition	
SAR for nominal Head TSL parameters	normalized to 1W	25.5 W/kg \pm 19.9 % (k=2)

SAR result with SAM Head (Neck \cong H0)

SAR averaged over 1 cm³ (1 g) of Head TSL	Condition	
SAR for nominal Head TSL parameters	normalized to 1W	80.9 W/kg \pm 20.3 % (k=2)

SAR averaged over 10 cm³ (10 g) of Head TSL	condition	
SAR for nominal Head TSL parameters	normalized to 1W	22.5 W/kg \pm 19.9 % (k=2)

SAR result with SAM Head (Ear \cong D90)

SAR averaged over 1 cm³ (1 g) of Head TSL	Condition	
SAR for nominal Head TSL parameters	normalized to 1W	57.6 W/kg \pm 20.3 % (k=2)

SAR averaged over 10 cm³ (10 g) of Head TSL	condition	
SAR for nominal Head TSL parameters	normalized to 1W	19.1 W/kg \pm 19.9 % (k=2)

² Additional assessments outside the current scope of SCS 0108



Accredited by the Swiss Accreditation Service (SAS)
The Swiss Accreditation Service is one of the signatories to the EA
Multilateral Agreement for the recognition of calibration certificates

Accreditation No.: **SCS 0108**

Client **PC Test**

Certificate No: **D750V3-1003_Mar20**

CALIBRATION CERTIFICATE

Object **D750V3 - SN:1003**

Calibration procedure(s) **QA CAL-05.v11
Calibration Procedure for SAR Validation Sources between 0.7-3 GHz**

Calibration date: **March 16, 2020**

This calibration certificate documents the traceability to national standards, which realize the physical units of measurements (SI).
The measurements and the uncertainties with confidence probability are given on the following pages and are part of the certificate.

All calibrations have been conducted in the closed laboratory facility: environment temperature $(22 \pm 3)^\circ\text{C}$ and humidity $< 70\%$.

Calibration Equipment used (M&TE critical for calibration)

Primary Standards	ID #	Cal Date (Certificate No.)	Scheduled Calibration
Power meter NRP	SN: 104778	03-Apr-19 (No. 217-02892/02893)	Apr-20
Power sensor NRP-Z91	SN: 103244	03-Apr-19 (No. 217-02892)	Apr-20
Power sensor NRP-Z91	SN: 103245	03-Apr-19 (No. 217-02893)	Apr-20
Reference 20 dB Attenuator	SN: 5058 (20k)	04-Apr-19 (No. 217-02894)	Apr-20
Type-N mismatch combination	SN: 5047.2 / 06327	04-Apr-19 (No. 217-02895)	Apr-20
Reference Probe EX3DV4	SN: 7349	31-Dec-19 (No. EX3-7349_Dec19)	Dec-20
DAE4	SN: 601	27-Dec-19 (No. DAE4-601_Dec19)	Dec-20

Secondary Standards	ID #	Check Date (in house)	Scheduled Check
Power meter E4419B	SN: GB39512475	30-Oct-14 (in house check Feb-19)	In house check: Oct-20
Power sensor HP 8481A	SN: US37292783	07-Oct-15 (in house check Oct-18)	In house check: Oct-20
Power sensor HP 8481A	SN: MY41092317	07-Oct-15 (in house check Oct-18)	In house check: Oct-20
RF generator R&S SMT-06	SN: 100972	15-Jun-15 (in house check Oct-18)	In house check: Oct-20
Network Analyzer Agilent E8358A	SN: US41080477	31-Mar-14 (in house check Oct-19)	In house check: Oct-20

Calibrated by:	Name Jeton Kastrati	Function Laboratory Technician	Signature
Approved by:	Name Katja Pokovic	Technical Manager	

Issued: March 16, 2020

This calibration certificate shall not be reproduced except in full without written approval of the laboratory.

BNV
04/30/2020
BNV
03-20-21



Accredited by the Swiss Accreditation Service (SAS)

The Swiss Accreditation Service is one of the signatories to the EA Multilateral Agreement for the recognition of calibration certificates

Accreditation No.: **SCS 0108**

Glossary:

TSL	tissue simulating liquid
ConvF	sensitivity in TSL / NORM x,y,z
N/A	not applicable or not measured

Calibration is Performed According to the Following Standards:

- IEEE Std 1528-2013, "IEEE Recommended Practice for Determining the Peak Spatial-Averaged Specific Absorption Rate (SAR) in the Human Head from Wireless Communications Devices: Measurement Techniques", June 2013
- IEC 62209-1, "Measurement procedure for the assessment of Specific Absorption Rate (SAR) from hand-held and body-mounted devices used next to the ear (frequency range of 300 MHz to 6 GHz)", July 2016
- IEC 62209-2, "Procedure to determine the Specific Absorption Rate (SAR) for wireless communication devices used in close proximity to the human body (frequency range of 30 MHz to 6 GHz)", March 2010
- KDB 865664, "SAR Measurement Requirements for 100 MHz to 6 GHz"

Additional Documentation:

- DASY4/5 System Handbook

Methods Applied and Interpretation of Parameters:

- Measurement Conditions:** Further details are available from the Validation Report at the end of the certificate. All figures stated in the certificate are valid at the frequency indicated.
- Antenna Parameters with TSL:** The dipole is mounted with the spacer to position its feed point exactly below the center marking of the flat phantom section, with the arms oriented parallel to the body axis.
- Feed Point Impedance and Return Loss:** These parameters are measured with the dipole positioned under the liquid filled phantom. The impedance stated is transformed from the measurement at the SMA connector to the feed point. The Return Loss ensures low reflected power. No uncertainty required.
- Electrical Delay:** One-way delay between the SMA connector and the antenna feed point. No uncertainty required.
- SAR measured:** SAR measured at the stated antenna input power.
- SAR normalized:** SAR as measured, normalized to an input power of 1 W at the antenna connector.
- SAR for nominal TSL parameters:** The measured TSL parameters are used to calculate the nominal SAR result.

The reported uncertainty of measurement is stated as the standard uncertainty of measurement multiplied by the coverage factor $k=2$, which for a normal distribution corresponds to a coverage probability of approximately 95%.

Measurement Conditions

DASY system configuration, as far as not given on page 1.

DASY Version	DASY5	V52.10.4
Extrapolation	Advanced Extrapolation	
Phantom	Modular Flat Phantom	
Distance Dipole Center - TSL	15 mm	with Spacer
Zoom Scan Resolution	dx, dy, dz = 5 mm	
Frequency	750 MHz ± 1 MHz	

Head TSL parameters

The following parameters and calculations were applied.

	Temperature	Permittivity	Conductivity
Nominal Head TSL parameters	22.0 °C	41.9	0.89 mho/m
Measured Head TSL parameters	(22.0 ± 0.2) °C	42.5 ± 6 %	0.88 mho/m ± 6 %
Head TSL temperature change during test	< 0.5 °C	----	----

SAR result with Head TSL

SAR averaged over 1 cm³ (1 g) of Head TSL	Condition	
SAR measured	250 mW input power	2.17 W/kg
SAR for nominal Head TSL parameters	normalized to 1W	8.78 W/kg ± 17.0 % (k=2)

SAR averaged over 10 cm³ (10 g) of Head TSL	condition	
SAR measured	250 mW input power	1.43 W/kg
SAR for nominal Head TSL parameters	normalized to 1W	5.77 W/kg ± 16.5 % (k=2)

Body TSL parameters

The following parameters and calculations were applied.

	Temperature	Permittivity	Conductivity
Nominal Body TSL parameters	22.0 °C	55.5	0.96 mho/m
Measured Body TSL parameters	(22.0 ± 0.2) °C	54.7 ± 6 %	0.96 mho/m ± 6 %
Body TSL temperature change during test	< 0.5 °C	----	----

SAR result with Body TSL

SAR averaged over 1 cm³ (1 g) of Body TSL	Condition	
SAR measured	250 mW input power	2.16 W/kg
SAR for nominal Body TSL parameters	normalized to 1W	8.61 W/kg ± 17.0 % (k=2)

SAR averaged over 10 cm³ (10 g) of Body TSL	condition	
SAR measured	250 mW input power	1.42 W/kg
SAR for nominal Body TSL parameters	normalized to 1W	5.67 W/kg ± 16.5 % (k=2)

Appendix (Additional assessments outside the scope of SCS 0108)

Antenna Parameters with Head TSL

Impedance, transformed to feed point	54.9 Ω - 0.1 j Ω
Return Loss	- 26.7 dB

Antenna Parameters with Body TSL

Impedance, transformed to feed point	51.8 Ω - 2.4 j Ω
Return Loss	- 30.6 dB

General Antenna Parameters and Design

Electrical Delay (one direction)	1.043 ns
----------------------------------	----------

After long term use with 100W radiated power, only a slight warming of the dipole near the feedpoint can be measured.

The dipole is made of standard semirigid coaxial cable. The center conductor of the feeding line is directly connected to the second arm of the dipole. The antenna is therefore short-circuited for DC-signals. On some of the dipoles, small end caps are added to the dipole arms in order to improve matching when loaded according to the position as explained in the "Measurement Conditions" paragraph. The SAR data are not affected by this change. The overall dipole length is still according to the Standard.

No excessive force must be applied to the dipole arms, because they might bend or the soldered connections near the feedpoint may be damaged.

Additional EUT Data

Manufactured by	SPEAG
-----------------	-------

DASY5 Validation Report for Head TSL

Date: 16.03.2020

Test Laboratory: SPEAG, Zurich, Switzerland

DUT: Dipole 750 MHz; Type: D750V3; Serial: D750V3 - SN:1003

Communication System: UID 0 - CW; Frequency: 750 MHz

Medium parameters used: $f = 750 \text{ MHz}$; $\sigma = 0.88 \text{ S/m}$; $\epsilon_r = 42.5$; $\rho = 1000 \text{ kg/m}^3$

Phantom section: Flat Section

Measurement Standard: DASY5 (IEEE/IEC/ANSI C63.19-2011)

DASY52 Configuration:

- Probe: EX3DV4 - SN7349; ConvF(10.07, 10.07, 10.07) @ 750 MHz; Calibrated: 31.12.2019
- Sensor-Surface: 1.4mm (Mechanical Surface Detection)
- Electronics: DAE4 Sn601; Calibrated: 27.12.2019
- Phantom: Flat Phantom 4.9 (front); Type: QD 00L P49 AA; Serial: 1001
- DASY52 52.10.4(1527); SEMCAD X 14.6.14(7483)

Dipole Calibration for Head Tissue/Pin=250 mW, d=15mm/Zoom Scan (7x7x7)/Cube 0:

Measurement grid: $dx=5\text{mm}$, $dy=5\text{mm}$, $dz=5\text{mm}$

Reference Value = 60.72 V/m; Power Drift = -0.04 dB

Peak SAR (extrapolated) = 3.27 W/kg

SAR(1 g) = 2.17 W/kg; SAR(10 g) = 1.43 W/kg

Smallest distance from peaks to all points 3 dB below = 16.5 mm

Ratio of SAR at M2 to SAR at M1 = 66.2%

Maximum value of SAR (measured) = 2.90 W/kg

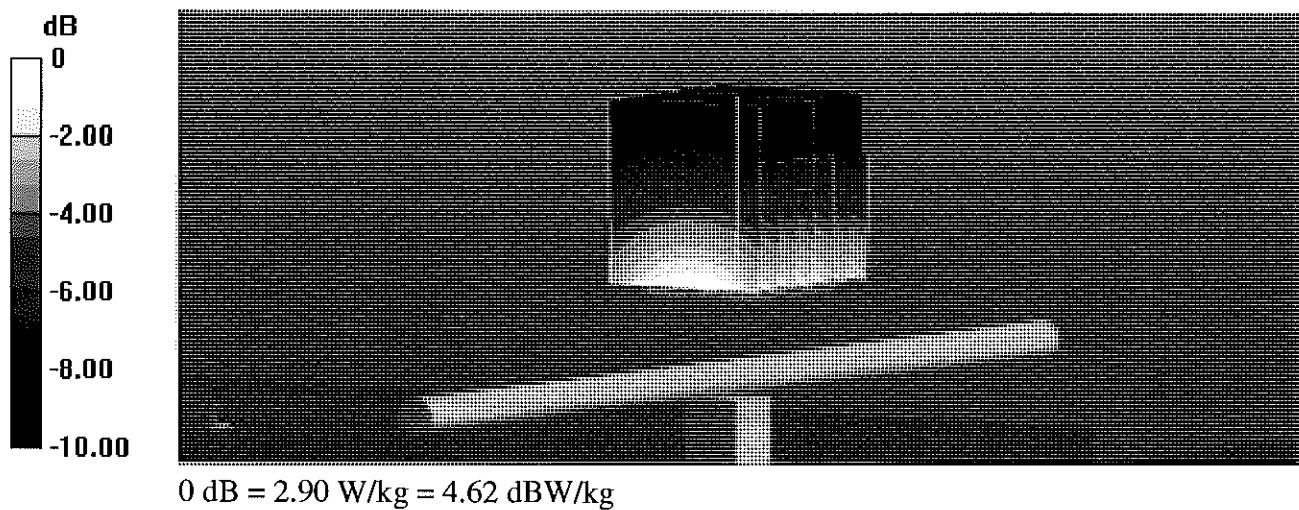

Impedance Measurement Plot for Head TSL

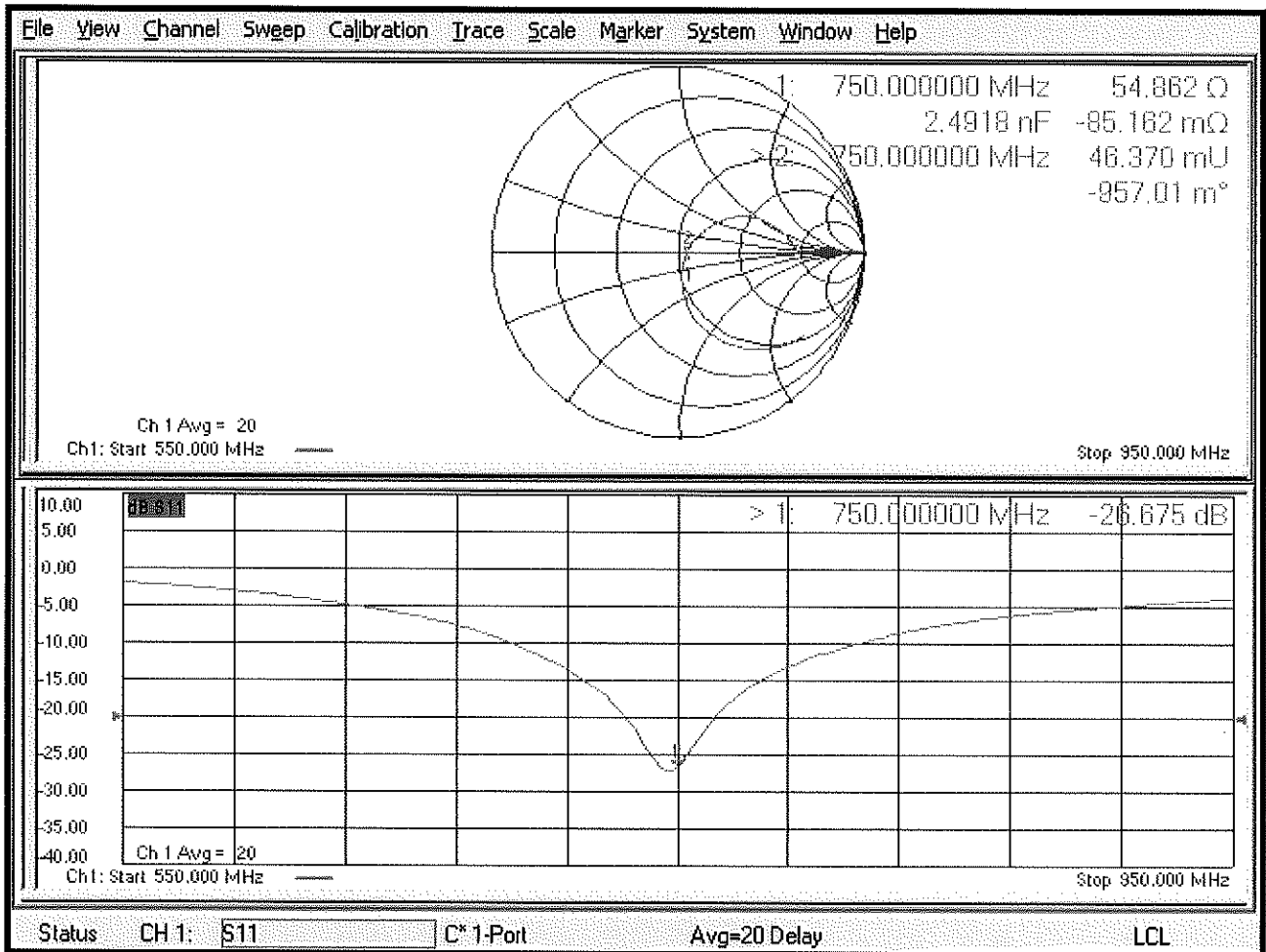

DASY5 Validation Report for Body TSL

Date: 16.03.2020

Test Laboratory: SPEAG, Zurich, Switzerland

DUT: Dipole 750 MHz; Type: D750V3; Serial: D750V3 - SN:1003

Communication System: UID 0 - CW; Frequency: 750 MHz

Medium parameters used: $f = 750$ MHz; $\sigma = 0.96$ S/m; $\epsilon_r = 54.7$; $\rho = 1000$ kg/m³

Phantom section: Flat Section

Measurement Standard: DASY5 (IEEE/IEC/ANSI C63.19-2011)

DASY52 Configuration:

- Probe: EX3DV4 - SN7349; ConvF(10.61, 10.61, 10.61) @ 750 MHz; Calibrated: 31.12.2019
- Sensor-Surface: 1.4mm (Mechanical Surface Detection)
- Electronics: DAE4 Sn601; Calibrated: 27.12.2019
- Phantom: Flat Phantom 4.9 (Back); Type: QD 00R P49 AA; Serial: 1005
- DASY52 52.10.4(1527); SEMCAD X 14.6.14(7483)

Dipole Calibration for Body Tissue/Pin=250 mW, d=15mm/Zoom Scan (7x7x7)/Cube 0:

Measurement grid: dx=5mm, dy=5mm, dz=5mm

Reference Value = 57.60 V/m; Power Drift = -0.06 dB

Peak SAR (extrapolated) = 3.23 W/kg

SAR(1 g) = 2.16 W/kg; SAR(10 g) = 1.42 W/kg

Smallest distance from peaks to all points 3 dB below = 21.2 mm

Ratio of SAR at M2 to SAR at M1 = 66.6%

Maximum value of SAR (measured) = 2.87 W/kg

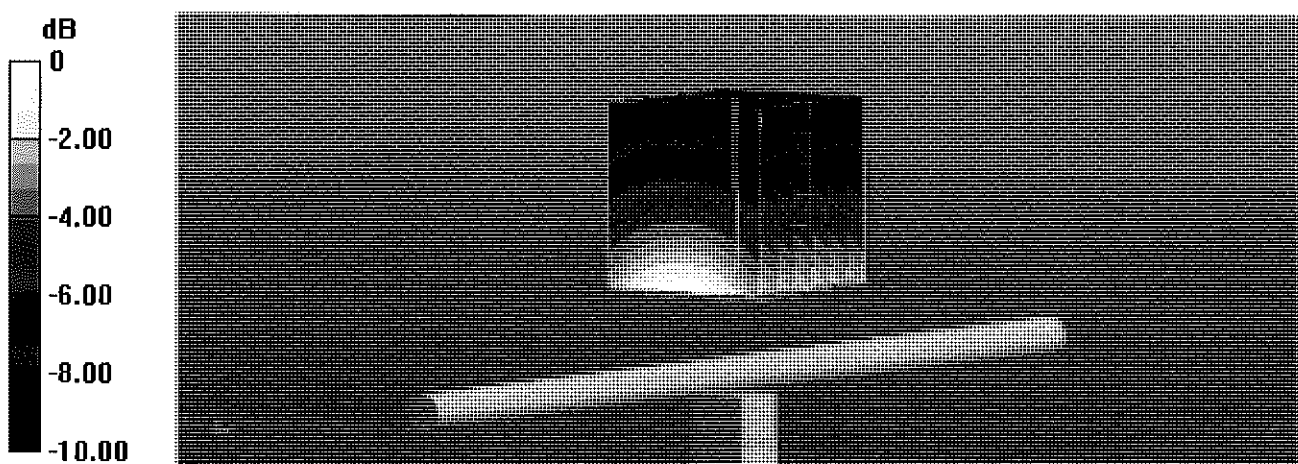

0 dB = 2.87 W/kg = 4.58 dBW/kg

Impedance Measurement Plot for Body TSL

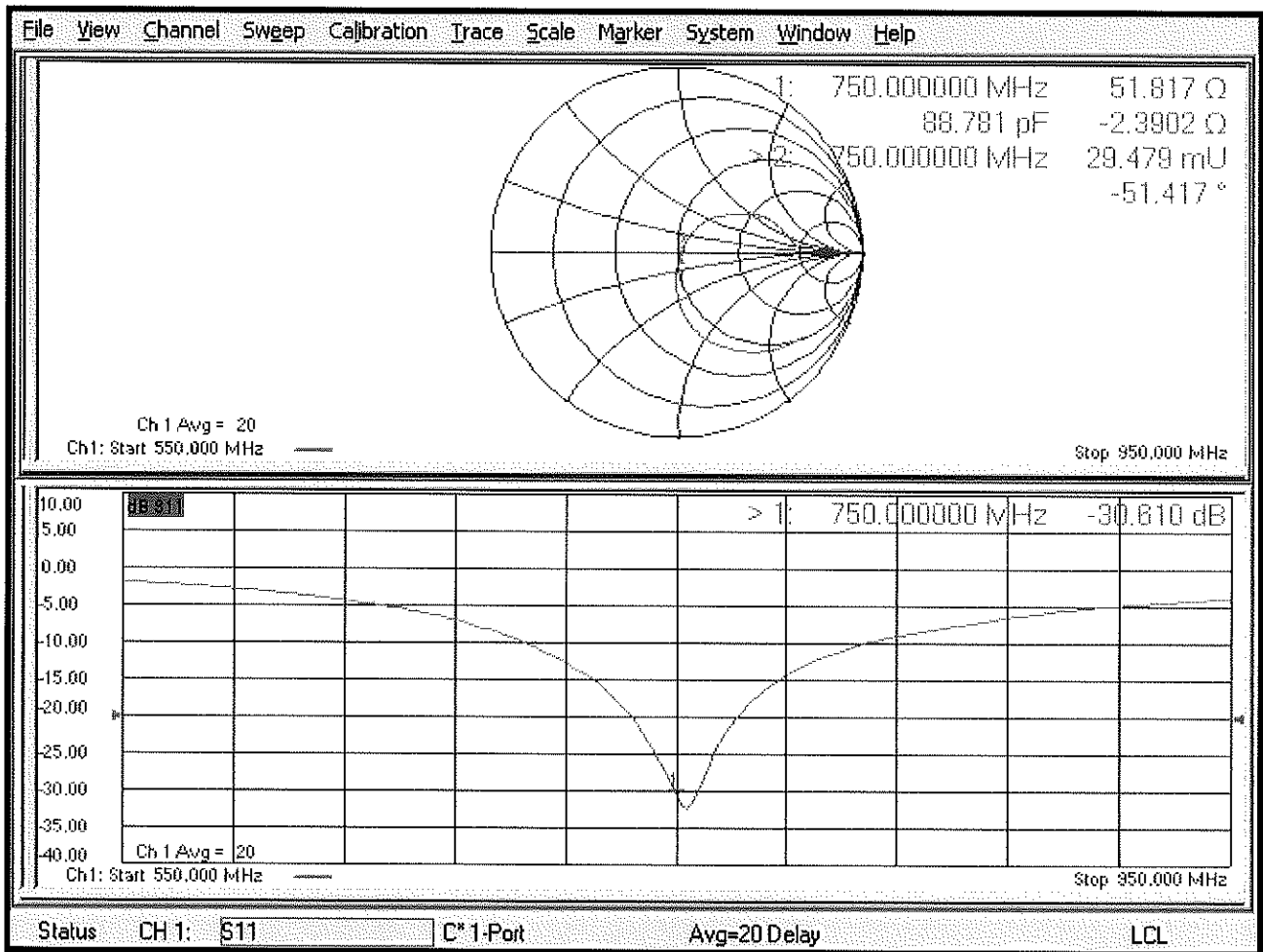

Certification of Calibration

Object: D750V3 – SN: 1003

Calibration procedure(s): Procedure for Calibration Extension for SAR Dipoles.

Extension Calibration date: 03/16/2021

Description: SAR Validation Dipole at 750 MHz.

Calibration Equipment used:

Manufacturer	Model	Description	Cal Date	Cal Interval	Cal Due	Serial Number
Control Company	4040	Therm./Clock/Humidity Monitor	6/29/2019	Biennial	6/29/2021	192291470
Control Company	4353	Long Stem Thermometer	10/28/2020	Biennial	10/28/2022	200670623
Amplifier Research	1551G6	Amplifier	CBT	N/A	CBT	433971
Narda	4772-3	Attenuator (3dB)	CBT	N/A	CBT	9406
Agilent	85033E	3.5mm Standard Calibration Kit	6/6/2020	Annual	6/6/2021	MY53402352
Rohde & Schwarz	ZNLE6	Vector Network Analyzer	9/29/2020	Annual	9/29/2021	101307
Mini-Circuits	BW-N20W5+	DC to 18 GHz Precision Fixed 20 dB Attenuator	CBT	N/A	CBT	N/A
SPEAG	DAK-3.5	Dielectric Assessment Kit	5/12/2020	Annual	5/12/2021	1070
Anritsu	MA2411B	Pulse Power Sensor	8/12/2020	Annual	8/12/2021	1207364
Anritsu	MA2411B	Pulse Power Sensor	9/22/2020	Annual	9/22/2021	1315051
Anritsu	ML2495A	Power Meter	11/3/2020	Annual	11/3/2021	1039008
Anritsu	ML2495A	Power Meter	1/18/2021	Annual	1/18/2022	941001
Agilent	N5182A	MXG Vector Signal Generator	5/13/2020	Annual	5/13/2021	MY47420603
Pasternack	NC-100	Torque Wrench	8/4/2020	Biennial	8/4/2022	N/A
Mini-Circuits	NLP-2950+	Low Pass Filter DC to 2700 MHz	CBT	N/A	CBT	N/A
MiniCircuits	ZHDC-16-63-S+	Bidirectional Coupler	CBT	N/A	CBT	N/A
SPEAG	EX3DV4	SAR Probe	7/20/2020	Annual	7/20/2021	7410
SPEAG	DAE4	Dasy Data Acquisition Electronics	7/15/2020	Annual	7/15/2021	1322

Measurement Uncertainty = $\pm 23\%$ (k=2)

	Name	Function	Signature
Calibrated By:	Hyun Kim	Test Engineer	<i>Hyun Kim</i>
Approved By:	Kaitlin O'Keefe	Senior Technical Manager	<i>KOK</i>

DIPOLE CALIBRATION EXTENSION

Per KDB 865664 D01, calibration intervals of up to three years may be considered for reference dipoles when it is demonstrated that the SAR target, impedance and return loss of a dipole have remained stable according to the following requirements:

1. The measured SAR does not deviate more than 10% from the target on the calibration certificate.
2. The return-loss does not deviate more than 20% from the previous measurement and meets the required 20dB minimum return-loss requirement.
3. The measurement of real or imaginary parts of impedance does not deviate more than 5Ω from the previous measurement.

The following dipole was checked to pass the above 3 requirements to have 2-year calibration period from the calibration date:

Calibration Date	Extension Date	Certificate Electrical Delay (ns)	Certificate SAR Target Head (1g) W/kg @ 23.0 dBm	Measured Head SAR (1g) W/kg @ 23.0 dBm	Deviation 1g (%)	Certificate SAR Target Head (10g) W/kg @ 23.0 dBm	Measured Head SAR (10g) W/kg @ 23.0 dBm	Deviation 10g (%)	Certificate Impedance Head (Ohm) Real	Measured Impedance Head (Ohm) Real	Difference (Ohm) Real	Certificate Impedance Head (Ohm) Imaginary	Measured Impedance Head (Ohm) Imaginary	Difference (Ohm) Imaginary	Certificate Return Loss Head (dB)	Measured Return Loss Head (dB)	Deviation (%)	PASS/FAIL
3/16/2020	3/16/2021	1.043	1.756	1.68	-4.33%	1.15	1.11	-3.81%	54.9	52.8	-2.1	-0.1	-1.4	1.3	-26.7	-30.3	-13.60%	PASS
Calibration Date	Extension Date	Certificate Electrical Delay (ns)	Certificate SAR Target Body (1g) W/kg @ 23.0 dBm	Measured Body SAR (1g) W/kg @ 23.0 dBm	Deviation 1g (%)	Certificate SAR Target Body (10g) W/kg @ 23.0 dBm	Measured Body SAR (10g) W/kg @ 23.0 dBm	Deviation 10g (%)	Certificate Impedance Body (Ohm) Real	Measured Impedance Body (Ohm) Real	Difference (Ohm) Real	Certificate Impedance Body (Ohm) Imaginary	Measured Impedance Body (Ohm) Imaginary	Difference (Ohm) Imaginary	Certificate Return Loss Body (dB)	Measured Return Loss Body (dB)	Deviation (%)	PASS/FAIL
3/16/2020	3/16/2021	1.043	1.722	1.80	4.53%	1.13	1.21	6.70%	51.8	50.1	-1.7	-2.4	-1.4	1.0	-30.6	-29.8	2.60%	PASS

Impedance & Return-Loss Measurement Plot for Head TSL

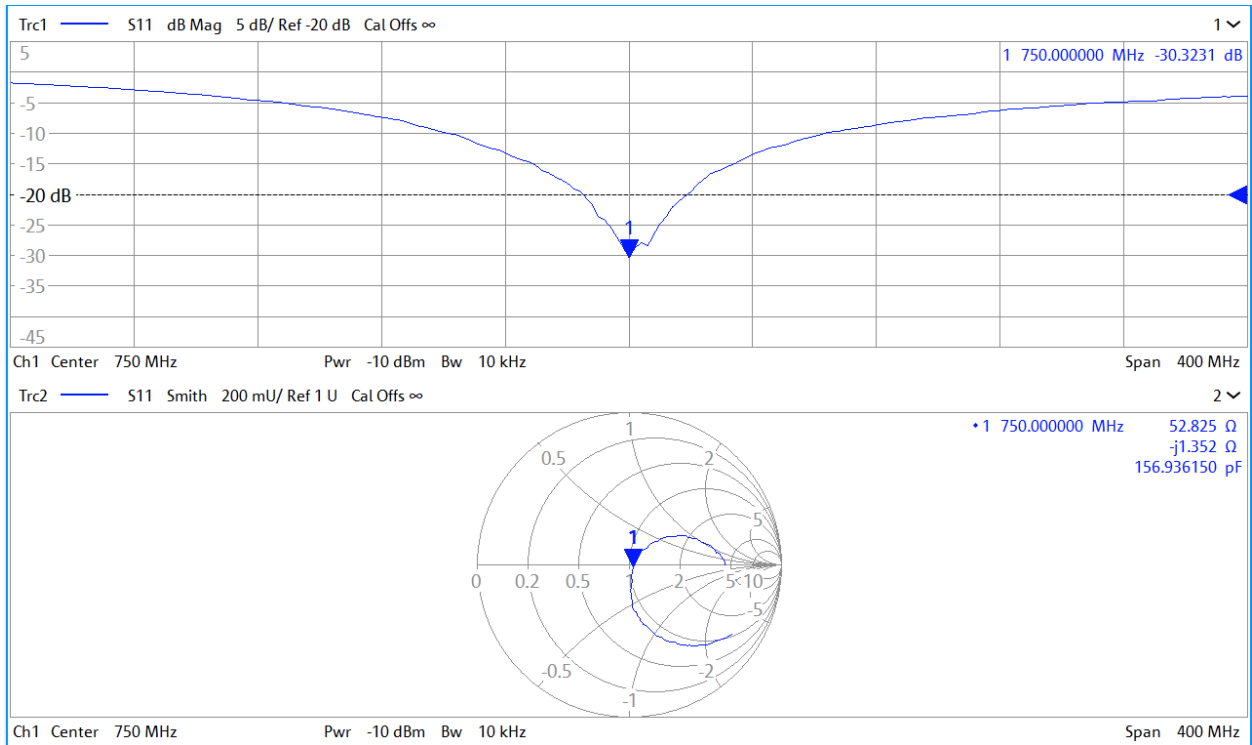

Impedance & Return-Loss Measurement Plot for Body TSL

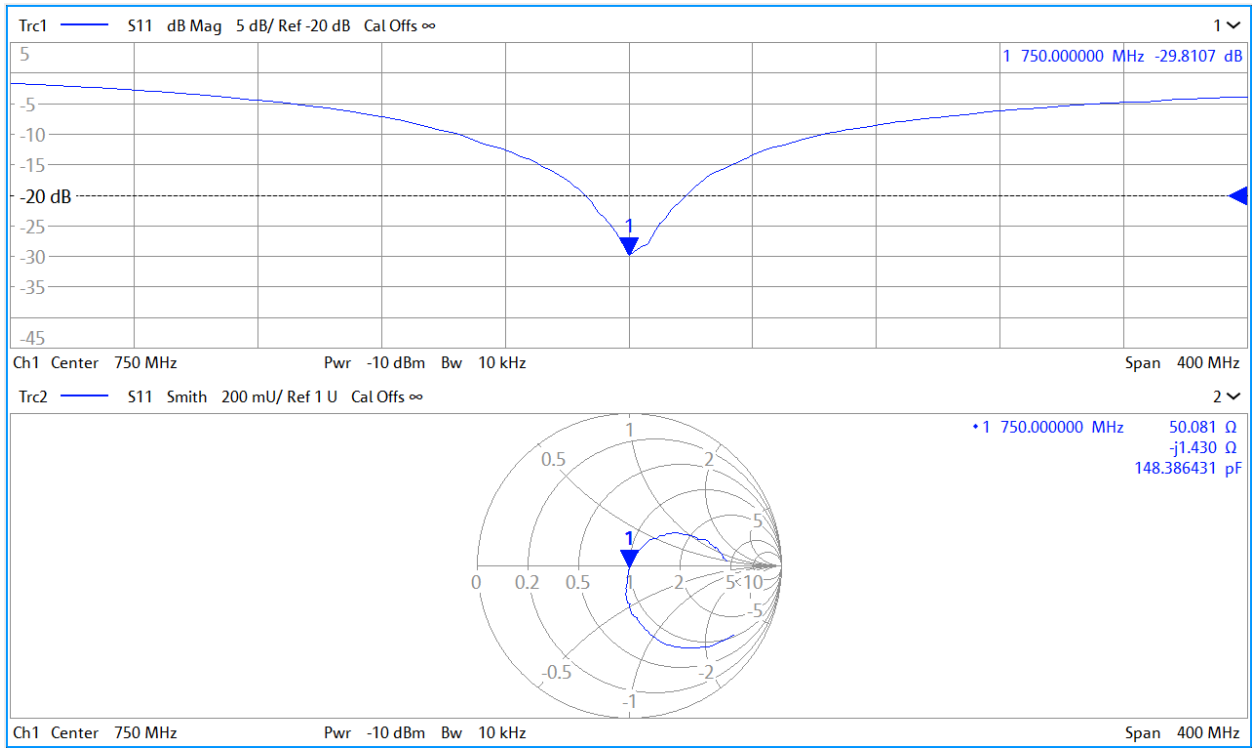



Accredited by the Swiss Accreditation Service (SAS)
The Swiss Accreditation Service is one of the signatories to the EA
Multilateral Agreement for the recognition of calibration certificates

Accreditation No.: **SCS 0108**

Client **PC Test**

Certificate No: **D750V3-1161_Oct18**

CALIBRATION CERTIFICATE

Object **D750V3 - SN:1161**

Calibration procedure(s) **QA CAL-05.v10
Calibration procedure for dipole validation kits above 700 MHz**

Calibration date: **October 19, 2018**

*BN ✓
10-30-2018
BN ✓
10-20-2019
BN ✓
10-23-20*

This calibration certificate documents the traceability to national standards, which realize the physical units of measurements (SI). The measurements and the uncertainties with confidence probability are given on the following pages and are part of the certificate.

All calibrations have been conducted in the closed laboratory facility: environment temperature (22 ± 3)°C and humidity < 70%.

Calibration Equipment used (M&TE critical for calibration)

Primary Standards	ID #	Cal Date (Certificate No.)	Scheduled Calibration
Power meter NRP	SN: 104778	04-Apr-18 (No. 217-02672/02673)	Apr-19
Power sensor NRP-Z91	SN: 103244	04-Apr-18 (No. 217-02672)	Apr-19
Power sensor NRP-Z91	SN: 103245	04-Apr-18 (No. 217-02673)	Apr-19
Reference 20 dB Attenuator	SN: 5058 (20k)	04-Apr-18 (No. 217-02682)	Apr-19
Type-N mismatch combination	SN: 5047.2 / 05327	04-Apr-18 (No. 217-02683)	Apr-19
Reference Probe EX3DV4	SN: 7349	30-Dec-17 (No. EX3-7349_Dec17)	Dec-18
DAE4	SN: 601	04-Oct-18 (No. DAE4-601_Oct18)	Oct-19

Secondary Standards	ID #	Check Date (in house)	Scheduled Check
Power meter EPM-442A	SN: GB37480704	07-Oct-15 (in house check Oct-18)	In house check: Oct-20
Power sensor HP 8481A	SN: US37292783	07-Oct-15 (in house check Oct-18)	In house check: Oct-20
Power sensor HP 8481A	SN: MY41092317	07-Oct-15 (in house check Oct-18)	In house check: Oct-20
RF generator R&S SMT-06	SN: 100972	15-Jun-15 (in house check Oct-18)	In house check: Oct-20
Network Analyzer Agilent E8358A	SN: US41080477	31-Mar-14 (in house check Oct-18)	In house check: Oct-19

Calibrated by: **Manu Seitz** (Laboratory Technician) *[Signature]*
Approved by: **Katja Pokovic** (Technical Manager) *[Signature]*

Issued: October 22, 2018

This calibration certificate shall not be reproduced except in full without written approval of the laboratory.



Accredited by the Swiss Accreditation Service (SAS)

The Swiss Accreditation Service is one of the signatories to the EA
Multilateral Agreement for the recognition of calibration certificates

Accreditation No.: **SCS 0108**

Glossary:

TSL	tissue simulating liquid
ConvF	sensitivity in TSL / NORM x,y,z
N/A	not applicable or not measured

Calibration is Performed According to the Following Standards:

- IEEE Std 1528-2013, "IEEE Recommended Practice for Determining the Peak Spatial-Averaged Specific Absorption Rate (SAR) in the Human Head from Wireless Communications Devices: Measurement Techniques", June 2013
- IEC 62209-1, "Measurement procedure for the assessment of Specific Absorption Rate (SAR) from hand-held and body-mounted devices used next to the ear (frequency range of 300 MHz to 6 GHz)", July 2016
- IEC 62209-2, "Procedure to determine the Specific Absorption Rate (SAR) for wireless communication devices used in close proximity to the human body (frequency range of 30 MHz to 6 GHz)", March 2010
- KDB 865664, "SAR Measurement Requirements for 100 MHz to 6 GHz"

Additional Documentation:

- DASY4/5 System Handbook

Methods Applied and Interpretation of Parameters:

- Measurement Conditions:** Further details are available from the Validation Report at the end of the certificate. All figures stated in the certificate are valid at the frequency indicated.
- Antenna Parameters with TSL:** The dipole is mounted with the spacer to position its feed point exactly below the center marking of the flat phantom section, with the arms oriented parallel to the body axis.
- Feed Point Impedance and Return Loss:** These parameters are measured with the dipole positioned under the liquid filled phantom. The impedance stated is transformed from the measurement at the SMA connector to the feed point. The Return Loss ensures low reflected power. No uncertainty required.
- Electrical Delay:** One-way delay between the SMA connector and the antenna feed point. No uncertainty required.
- SAR measured:** SAR measured at the stated antenna input power.
- SAR normalized:** SAR as measured, normalized to an input power of 1 W at the antenna connector.
- SAR for nominal TSL parameters:** The measured TSL parameters are used to calculate the nominal SAR result.

The reported uncertainty of measurement is stated as the standard uncertainty of measurement multiplied by the coverage factor $k=2$, which for a normal distribution corresponds to a coverage probability of approximately 95%.

Measurement Conditions

DASY system configuration, as far as not given on page 1.

DASY Version	DASY5	V52.10.2
Extrapolation	Advanced Extrapolation	
Phantom	Modular Flat Phantom	
Distance Dipole Center - TSL	15 mm	with Spacer
Zoom Scan Resolution	dx, dy, dz = 5 mm	
Frequency	750 MHz \pm 1 MHz	

Head TSL parameters

The following parameters and calculations were applied.

	Temperature	Permittivity	Conductivity
Nominal Head TSL parameters	22.0 °C	41.9	0.89 mho/m
Measured Head TSL parameters	(22.0 \pm 0.2) °C	40.8 \pm 6 %	0.89 mho/m \pm 6 %
Head TSL temperature change during test	< 0.5 °C	----	----

SAR result with Head TSL

SAR averaged over 1 cm³ (1 g) of Head TSL	Condition	
SAR measured	250 mW input power	2.02 W/kg
SAR for nominal Head TSL parameters	normalized to 1W	8.03 W/kg \pm 17.0 % (k=2)

SAR averaged over 10 cm³ (10 g) of Head TSL	condition	
SAR measured	250 mW input power	1.32 W/kg
SAR for nominal Head TSL parameters	normalized to 1W	5.26 W/kg \pm 16.5 % (k=2)

Body TSL parameters

The following parameters and calculations were applied.

	Temperature	Permittivity	Conductivity
Nominal Body TSL parameters	22.0 °C	55.5	0.96 mho/m
Measured Body TSL parameters	(22.0 \pm 0.2) °C	55.1 \pm 6 %	0.96 mho/m \pm 6 %
Body TSL temperature change during test	< 0.5 °C	----	----

SAR result with Body TSL

SAR averaged over 1 cm³ (1 g) of Body TSL	Condition	
SAR measured	250 mW input power	2.11 W/kg
SAR for nominal Body TSL parameters	normalized to 1W	8.43 W/kg \pm 17.0 % (k=2)

SAR averaged over 10 cm³ (10 g) of Body TSL	condition	
SAR measured	250 mW input power	1.39 W/kg
SAR for nominal Body TSL parameters	normalized to 1W	5.55 W/kg \pm 16.5 % (k=2)

Appendix (Additional assessments outside the scope of SCS 0108)

Antenna Parameters with Head TSL

Impedance, transformed to feed point	55.6 Ω - 1.9 j Ω
Return Loss	- 25.0 dB

Antenna Parameters with Body TSL

Impedance, transformed to feed point	50.6 Ω - 4.2 j Ω
Return Loss	- 27.6 dB

General Antenna Parameters and Design

Electrical Delay (one direction)	1.032 ns
----------------------------------	----------

After long term use with 100W radiated power, only a slight warming of the dipole near the feedpoint can be measured.

The dipole is made of standard semirigid coaxial cable. The center conductor of the feeding line is directly connected to the second arm of the dipole. The antenna is therefore short-circuited for DC-signals. On some of the dipoles, small end caps are added to the dipole arms in order to improve matching when loaded according to the position as explained in the "Measurement Conditions" paragraph. The SAR data are not affected by this change. The overall dipole length is still according to the Standard.

No excessive force must be applied to the dipole arms, because they might bend or the soldered connections near the feedpoint may be damaged.

Additional EUT Data

Manufactured by	SPEAG
Manufactured on	November 19, 2015

DASY5 Validation Report for Head TSL

Date: 19.10.2018

Test Laboratory: SPEAG, Zurich, Switzerland

DUT: Dipole 750 MHz; Type: D750V3; Serial: D750V3 - SN:1161

Communication System: UID 0 - CW; Frequency: 750 MHz

Medium parameters used: $f = 750$ MHz; $\sigma = 0.89$ S/m; $\epsilon_r = 40.8$; $\rho = 1000$ kg/m³

Phantom section: Flat Section

Measurement Standard: DASY5 (IEEE/IEC/ANSI C63.19-2011)

DASY52 Configuration:

- Probe: EX3DV4 - SN7349; ConvF(10.22, 10.22, 10.22) @ 750 MHz; Calibrated: 30.12.2017
- Sensor-Surface: 1.4mm (Mechanical Surface Detection)
- Electronics: DAE4 Sn601; Calibrated: 04.10.2018
- Phantom: Flat Phantom 4.9 (front); Type: QD 00L P49 AA; Serial: 1001
- DASY52 52.10.2(1495); SEMCAD X 14.6.12(7450)

Dipole Calibration for Head Tissue/Pin=250 mW, d=15mm/Zoom Scan (7x7x7)/Cube 0:

Measurement grid: dx=5mm, dy=5mm, dz=5mm

Reference Value = 58.51 V/m; Power Drift = -0.04 dB

Peak SAR (extrapolated) = 3.04 W/kg

SAR(1 g) = 2.02 W/kg; SAR(10 g) = 1.32 W/kg

Maximum value of SAR (measured) = 2.70 W/kg

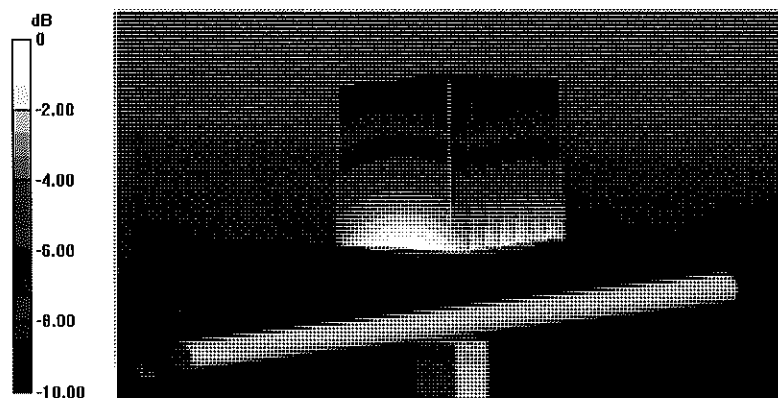

0 dB = 2.70 W/kg = 4.31 dBW/kg

Impedance Measurement Plot for Head TSL

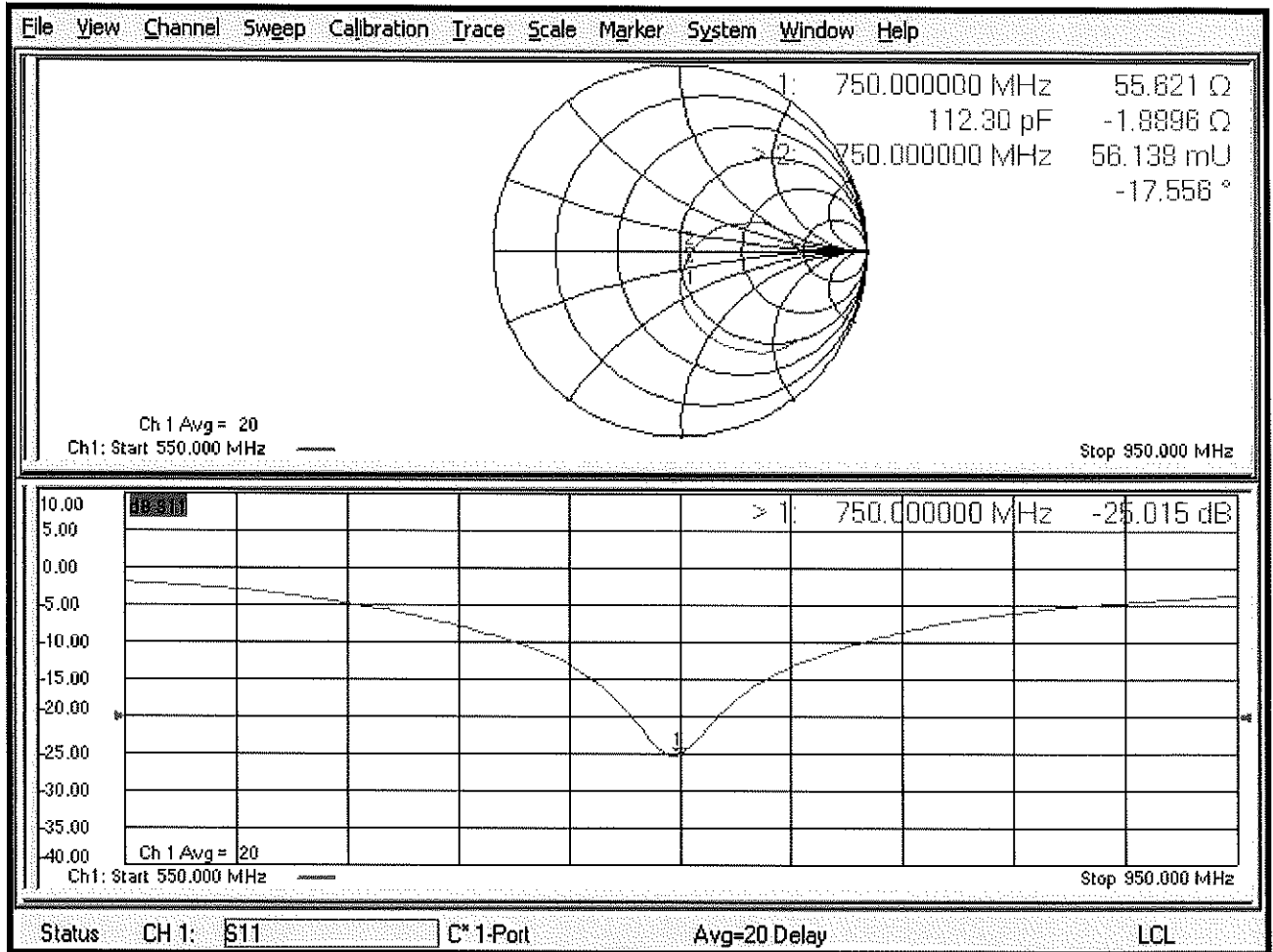

DASY5 Validation Report for Body TSL

Date: 19.10.2018

Test Laboratory: SPEAG, Zurich, Switzerland

DUT: Dipole 750 MHz; Type: D750V3; Serial: D750V3 - SN:1161

Communication System: UID 0 - CW; Frequency: 750 MHz

Medium parameters used: $f = 750$ MHz; $\sigma = 0.96$ S/m; $\epsilon_r = 55.1$; $\rho = 1000$ kg/m³

Phantom section: Flat Section

Measurement Standard: DASY5 (IEEE/IEC/ANSI C63.19-2011)

DASY52 Configuration:

- Probe: EX3DV4 - SN7349; ConvF(10.19, 10.19, 10.19) @ 750 MHz; Calibrated: 30.12.2017
- Sensor-Surface: 1.4mm (Mechanical Surface Detection)
- Electronics: DAE4 Sn601; Calibrated: 04.10.2018
- Phantom: Flat Phantom 4.9 (Back); Type: QD 00R P49 AA; Serial: 1005
- DASY52 52.10.2(1495); SEMCAD X 14.6.12(7450)

Dipole Calibration for Body Tissue/Pin=250 mW, d=15mm/Zoom Scan (7x7x7)/Cube 0:

Measurement grid: dx=5mm, dy=5mm, dz=5mm

Reference Value = 57.57 V/m; Power Drift = -0.02 dB

Peak SAR (extrapolated) = 3.18 W/kg

SAR(1 g) = 2.11 W/kg; SAR(10 g) = 1.39 W/kg

Maximum value of SAR (measured) = 2.83 W/kg

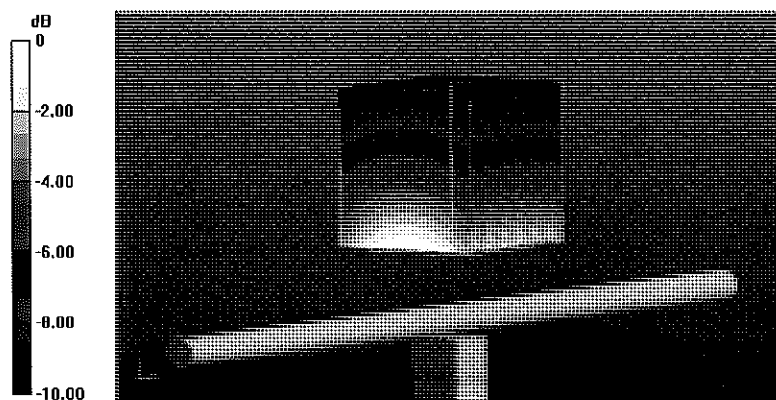

0 dB = 2.83 W/kg = 4.52 dBW/kg

Impedance Measurement Plot for Body TSL

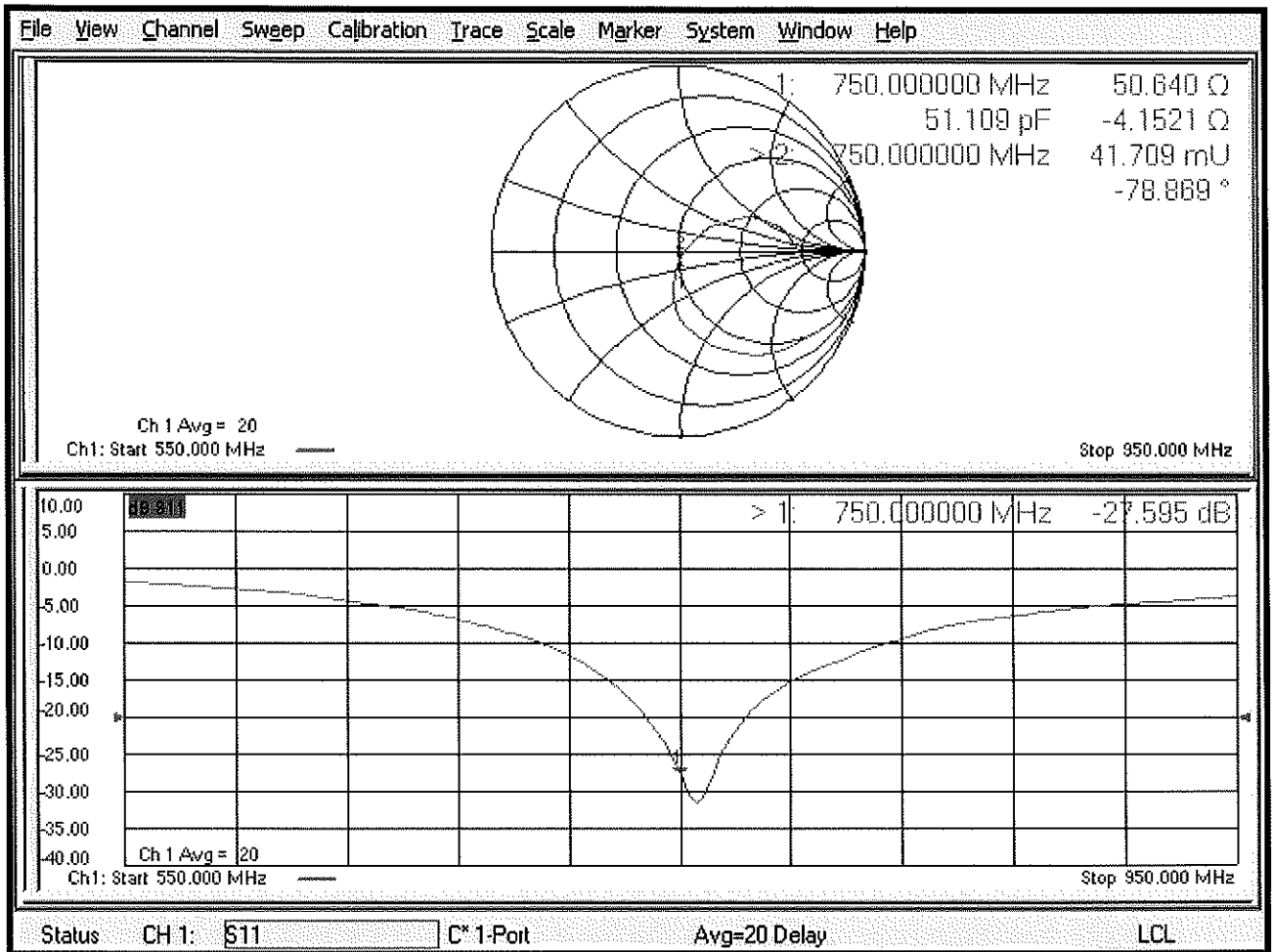

Certification of Calibration

Object D750V3 – SN:1161

Calibration procedure(s) Procedure for Calibration Extension for SAR Dipoles.

Extended Calibration date: October 18, 2019

Description: SAR Validation Dipole at 750 MHz.

Calibration Equipment used:

Manufacturer	Model	Description	Cal Date	Cal Interval	Cal Due	Serial Number
Control Company	4040	Therm./Clock/Humidity Monitor	6/29/2019	Biennial	6/29/2021	192291470
Control Company	4352	Ultra Long Stem Thermometer	8/2/2018	Biennial	8/2/2020	181334684
Amplifier Research	15S1G6	Amplifier	CBT	N/A	CBT	433971
Narda	4772-3	Attenuator (3dB)	CBT	N/A	CBT	9406
Keysight Technologies	85033E	Standard Mechanical Calibration Kit (DC to 9GHz, 3.5mm)	7/2/2019	Annual	7/2/2020	MY53401181
Rohde & Schwarz	ZNLE6	Vector Network Analyzer	10/11/2019	Annual	10/11/2020	101307
Mini-Circuits	BW-N20W5+	DC to 18 GHz Precision Fixed 20 dB Attenuator	CBT	N/A	CBT	N/A
SPEAG	DAKS-3.5	Portable Dielectric Assessment Kit	8/13/2019	Annual	8/13/2020	1041
Anritsu	MA2411B	Pulse Power Sensor	8/14/2019	Annual	8/14/2020	1315051
Anritsu	MA2411B	Pulse Power Sensor	8/8/2019	Annual	8/8/2020	1339008
Anritsu	ML2495A	Power Meter	11/20/2018	Annual	11/20/2019	1039008
Agilent	N5182A	MXG Vector Signal Generator	8/19/2019	Annual	8/19/2020	MY47420837
Seekonk	NC-100	Torque Wrench	5/9/2018	Biennial	5/9/2020	22217
Mini-Circuits	NLP-2950+	Low Pass Filter DC to 2700 MHz	CBT	N/A	CBT	N/A
MiniCircuits	ZHDC-16-63-S+	Bidirectional Coupler	CBT	N/A	CBT	N/A
MiniCircuits	VLF-6000+	Low Pass Filter	CBT	N/A	CBT	N/A
SPEAG	EX3DV4	SAR Probe	4/24/2019	Annual	4/24/2020	7357
SPEAG	EX3DV4	SAR Probe	7/16/2019	Annual	7/16/2020	7410
SPEAG	DAE4	Dasy Data Acquisition Electronics	7/11/2019	Annual	7/11/2020	1322
SPEAG	DAE4	Dasy Data Acquisition Electronics	4/18/2019	Annual	4/18/2020	1407

Note: CBT (Calibrated Before Testing). Prior to testing, the measurement paths containing a cable, amplifier, attenuator, coupler or filter were connected to a calibrated source (i.e. a signal generator) to determine the losses of the measurement path.

Measurement Uncertainty = $\pm 23\%$ (k=2)

	Name	Function	Signature
Calibrated By:	Brodie Halfoster	Team Lead Engineer	<i>BRODIE HALFOSTER</i>
Approved By:	Kaitlin O'Keefe	Senior Technical Manager	<i>KOK</i>

DIPOLE CALIBRATION EXTENSION

Per KDB 865664 D01, calibration intervals of up to three years may be considered for reference dipoles when it is demonstrated that the SAR target, impedance and return loss of a dipole have remained stable according to the following requirements:

1. The measured SAR does not deviate more than 10% from the target on the calibration certificate.
2. The return-loss does not deviate more than 20% from the previous measurement and meets the required 20dB minimum return-loss requirement.
3. The measurement of real or imaginary parts of impedance does not deviate more than 5Ω from the previous measurement.

The following dipole was checked to pass the above 3 requirements to have 2-year calibration period from the calibration date:

Calibration Date	Extension Date	Certificate Electrical Delay (ns)	Certificate SAR Target Head (1g) W/kg @ 23.0 dBm	Measured Head SAR (1g) W/kg @ 23.0 dBm	Deviation 1g (%)	Certificate SAR Target Head (10g) W/kg @ 23.0 dBm	Measured Head SAR (10g) W/kg @ 23.0 dBm	Deviation 10g (%)	Certificate Impedance Head (Ohm) Real	Measured Impedance Head (Ohm) Real	Difference (Ohm) Real	Certificate Impedance Head (Ohm) Imaginary	Measured Impedance Head (Ohm) Imaginary	Difference (Ohm) Imaginary	Certificate Return Loss Head (dB)	Measured Return Loss Head (dB)	Deviation (%)	PASS/FAIL
10/19/2018	10/18/2019	1.032	1.61	1.64	2.12%	1.05	1.08	2.86%	55.6	53.2	2.4	-1.9	-3.4	1.5	-25	-26.8	-7.30%	PASS
Calibration Date	Extension Date	Certificate Electrical Delay (ns)	Certificate SAR Target Body (1g) W/kg @ 23.0 dBm	Measured Body SAR (1g) W/kg @ 23.0 dBm	Deviation 1g (%)	Certificate SAR Target Body (10g) W/kg @ 23.0 dBm	Measured Body SAR (10g) W/kg @ 23.0 dBm	Deviation 10g (%)	Certificate Impedance Body (Ohm) Real	Measured Impedance Body (Ohm) Real	Difference (Ohm) Real	Certificate Impedance Body (Ohm) Imaginary	Measured Impedance Body (Ohm) Imaginary	Difference (Ohm) Imaginary	Certificate Return Loss Body (dB)	Measured Return Loss Body (dB)	Deviation (%)	PASS/FAIL
10/19/2018	10/18/2019	1.032	1.69	1.76	4.39%	1.11	1.17	5.41%	50.6	50	0.6	-4.2	-4	0.2	-27.6	-28.1	-1.80%	PASS

Impedance & Return-Loss Measurement Plot for Head TSL

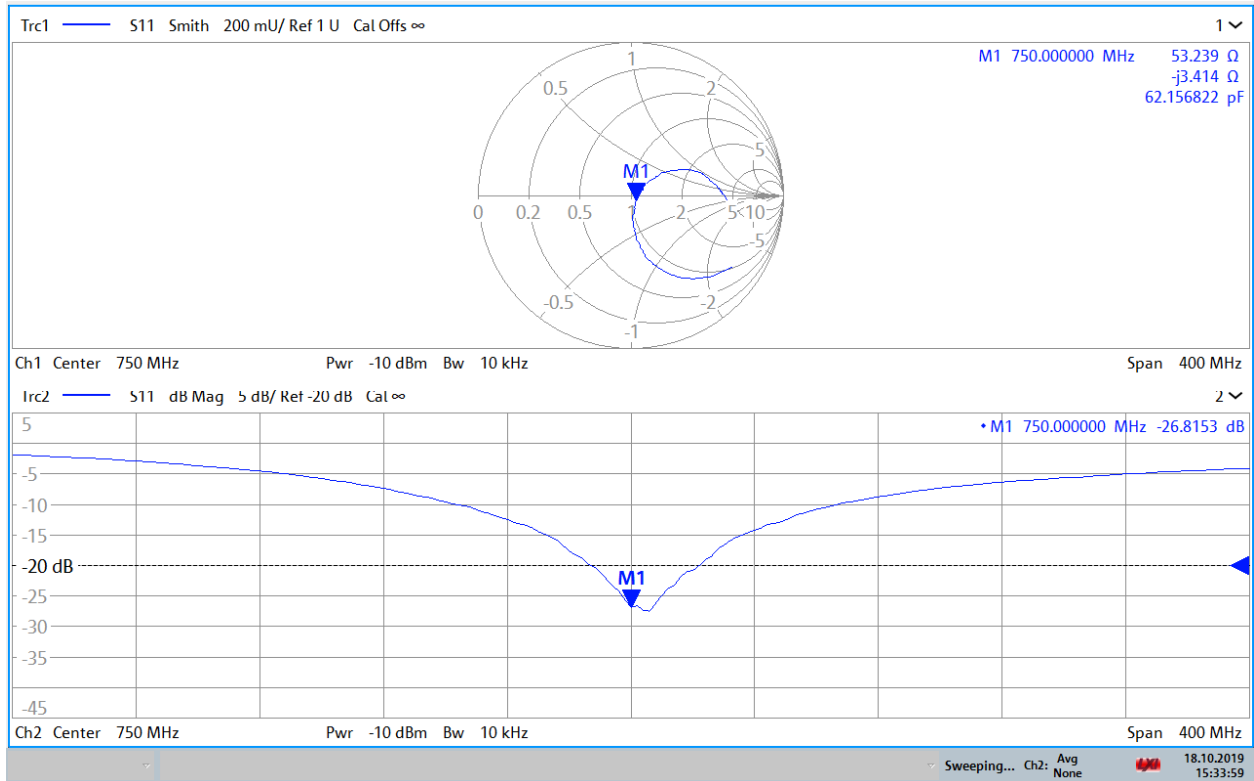

15:34:00 18.10.2019

Impedance & Return-Loss Measurement Plot for Body TSL

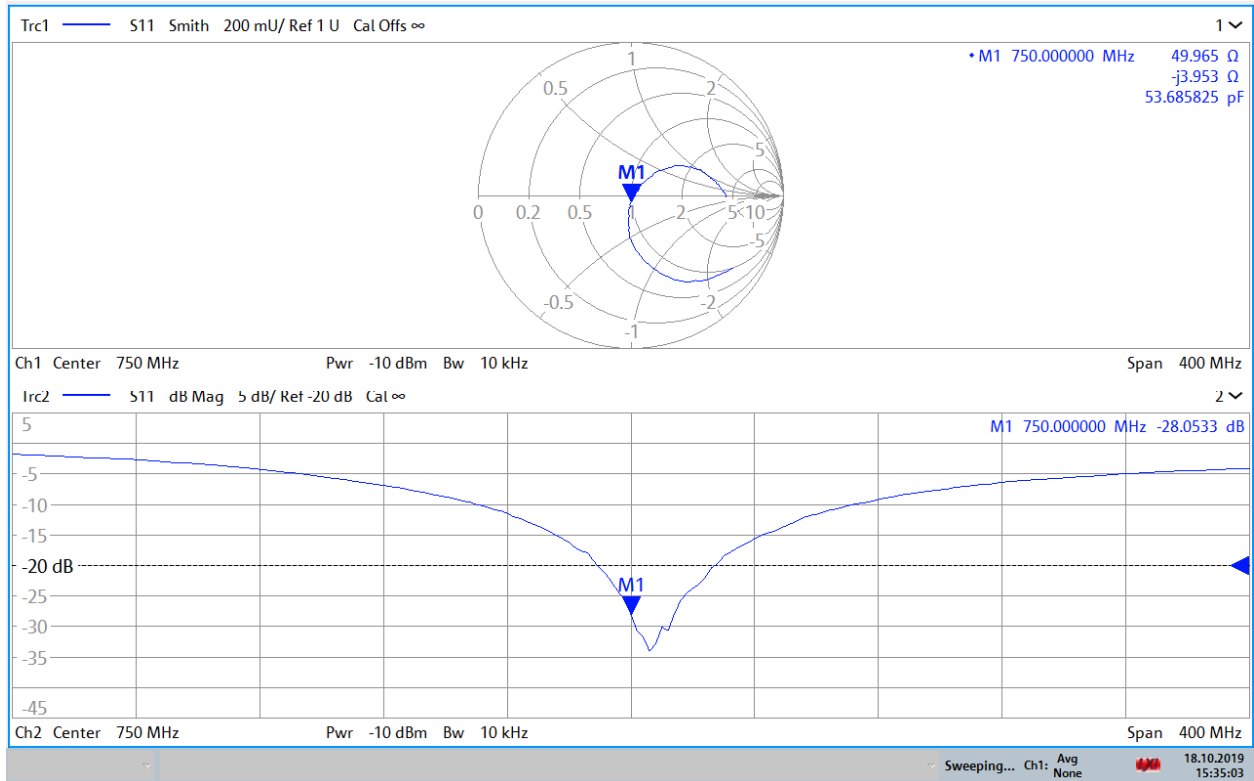

15:35:04 18.10.2019

Certification of Calibration

Object: D750V2 – SN: 1161
 Calibration procedure(s): Procedure for Calibration Extension for SAR Dipoles.
 Extension Calibration date: 10/18/2020
 Description: SAR Validation Dipole at 750 MHz.

Calibration Equipment used:

Manufacturer	Model	Description	Cal Date	Cal Interval	Cal Due	Serial Number
Control Company	4040	Therm./Clock/Humidity Monitor	6/29/2019	Biennial	6/29/2021	192291470
Control Company	4352	Ultra Long Stem Thermometer	11/29/2018	Biennial	11/29/2020	181766816
Amplifier Research	15S1G6	Amplifier	CBT	N/A	CBT	433971
Narda	4772-3	Attenuator (3dB)	CBT	N/A	CBT	9406
Agilent	85033E	3.5mm Standard Calibration Kit	6/6/2020	Annual	6/6/2021	MY53402352
Rohde & Schwarz	ZNLE6	Vector Network Analyzer	9/29/2020	Annual	9/29/2021	101307
Mini-Circuits	BW-N20W5+	DC to 18 GHz Precision Fixed 20 dB Attenuator	CBT	N/A	CBT	N/A
SPEAG	DAK-3.5	Dielectric Assessment Kit	5/12/2020	Annual	5/12/2021	1070
Anritsu	MA2411B	Pulse Power Sensor	8/12/2020	Annual	8/12/2021	1207364
Anritsu	MA2411B	Pulse Power Sensor	9/22/2020	Annual	9/22/2021	1315051
Anritsu	ML2495A	Power Meter	1/15/2020	Annual	1/15/2021	1328004
Anritsu	ML2495A	Power Meter	12/17/2019	Annual	12/17/2020	941001
Agilent	N5182A	MXG Vector Signal Generator	5/13/2020	Annual	5/13/2021	MY47420603
Pasternack	NC-100	Torque Wrench	8/4/2020	Biennial	8/4/2022	N/A
Mini-Circuits	NLP-2950+	Low Pass Filter DC to 2700 MHz	CBT	N/A	CBT	N/A
MiniCircuits	ZHDC-16-63-S+	Bidirectional Coupler	CBT	N/A	CBT	N/A
SPEAG	EX3DV4	SAR Probe	6/23/2020	Annual	6/23/2021	7406
SPEAG	EX3DV4	SAR Probe	8/19/2020	Annual	8/19/2021	7547
SPEAG	DAE4	Dasy Data Acquisition Electronics	8/12/2020	Annual	8/12/2021	1323
SPEAG	DAE4	Dasy Data Acquisition Electronics	5/14/2020	Annual	5/14/2021	1583

Measurement Uncertainty = ±23% (k=2)

	Name	Function	Signature
Calibrated By:	Brodie Halfoster	Test Engineer	<i>BRODIE HALFOSTER</i>
Approved By:	Kaitlin O'Keefe	Senior Technical Manager	<i>KOK</i>

DIPOLE CALIBRATION EXTENSION

Per KDB 865664 D01, calibration intervals of up to three years may be considered for reference dipoles when it is demonstrated that the SAR target, impedance and return loss of a dipole have remained stable according to the following requirements:

1. The measured SAR does not deviate more than 10% from the target on the calibration certificate.
2. The return-loss does not deviate more than 20% from the previous measurement and meets the required 20dB minimum return-loss requirement.
3. The measurement of real or imaginary parts of impedance does not deviate more than 5Ω from the previous measurement.

The following dipole was checked to pass the above 3 requirements to have 3-year calibration period from the calibration date:

Calibration Date	Extension Date	Certificate Electrical Delay (ns)	Certificate SAR Target Head (1g) W/kg @ 23.0 dBm	Measured Head SAR (1g) W/kg @ 23.0 dBm	Deviation 1g (%)	Certificate SAR Target Head (10g) W/kg @ 23.0 dBm	Measured Head SAR (10g) W/kg @ 23.0 dBm	Deviation 10g (%)	Certificate Impedance Head (Ohm) Real	Measured Impedance Head (Ohm) Real	Difference (Ohm) Real	Certificate Impedance Head (Ohm) Imaginary	Measured Impedance Head (Ohm) Imaginary	Difference (Ohm) Imaginary	Certificate Return Loss Head (dB)	Measured Return Loss Head (dB)	Deviation (%)	PASS/FAIL
10/19/2018	10/18/2020	1.032	1.61	1.73	7.72%	1.05	1.12	6.46%	55.6	54.2	1.4	-1.9	-1.4	0.5	-25.0	-27.4	-9.50%	PASS
Calibration Date	Extension Date	Certificate Electrical Delay (ns)	Certificate SAR Target Body (1g) W/kg @ 23.0 dBm	Measured Body SAR (1g) W/kg @ 23.0 dBm	Deviation 1g (%)	Certificate SAR Target Body (10g) W/kg @ 23.0 dBm	Measured Body SAR (10g) W/kg @ 23.0 dBm	Deviation 10g (%)	Certificate Impedance Body (Ohm) Real	Measured Impedance Body (Ohm) Real	Difference (Ohm) Real	Certificate Impedance Body (Ohm) Imaginary	Measured Impedance Body (Ohm) Imaginary	Difference (Ohm) Imaginary	Certificate Return Loss Body (dB)	Measured Return Loss Body (dB)	Deviation (%)	PASS/FAIL
10/19/2018	10/18/2020	1.032	1.69	1.80	6.76%	1.11	1.18	6.31%	50.6	50.8	0.2	-4.2	-4.0	0.2	-27.6	-27.8	-0.90%	PASS

Impedance & Return-Loss Measurement Plot for Head TSL

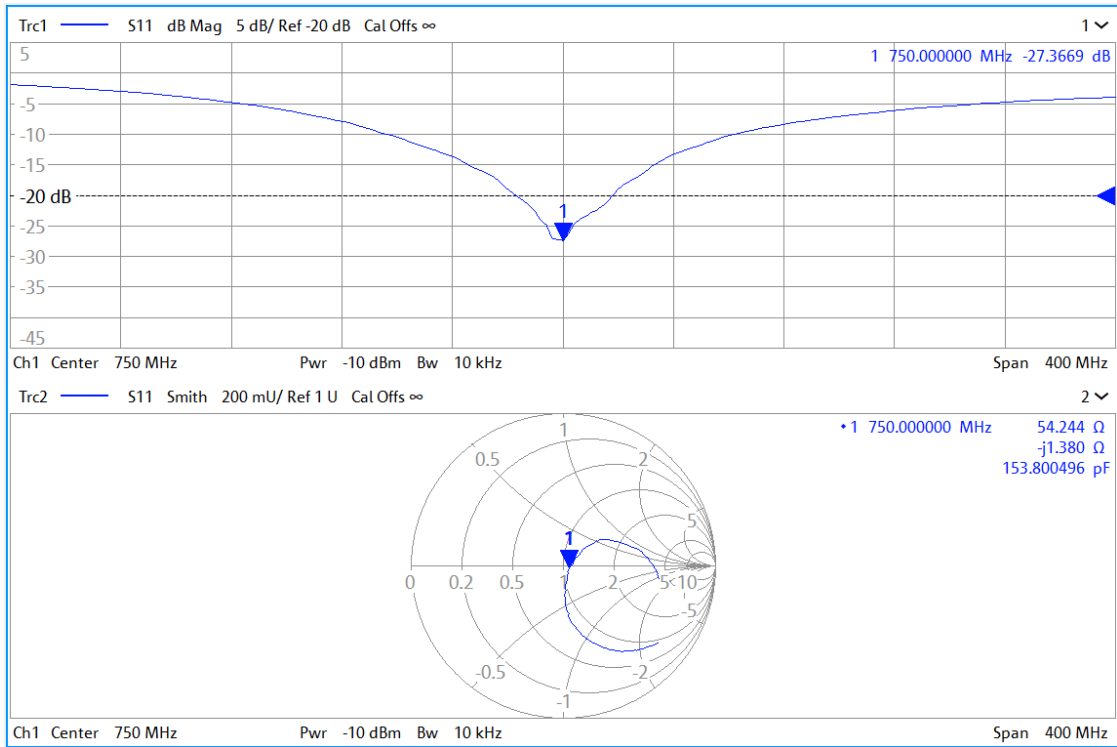

Impedance & Return-Loss Measurement Plot for Body TSL

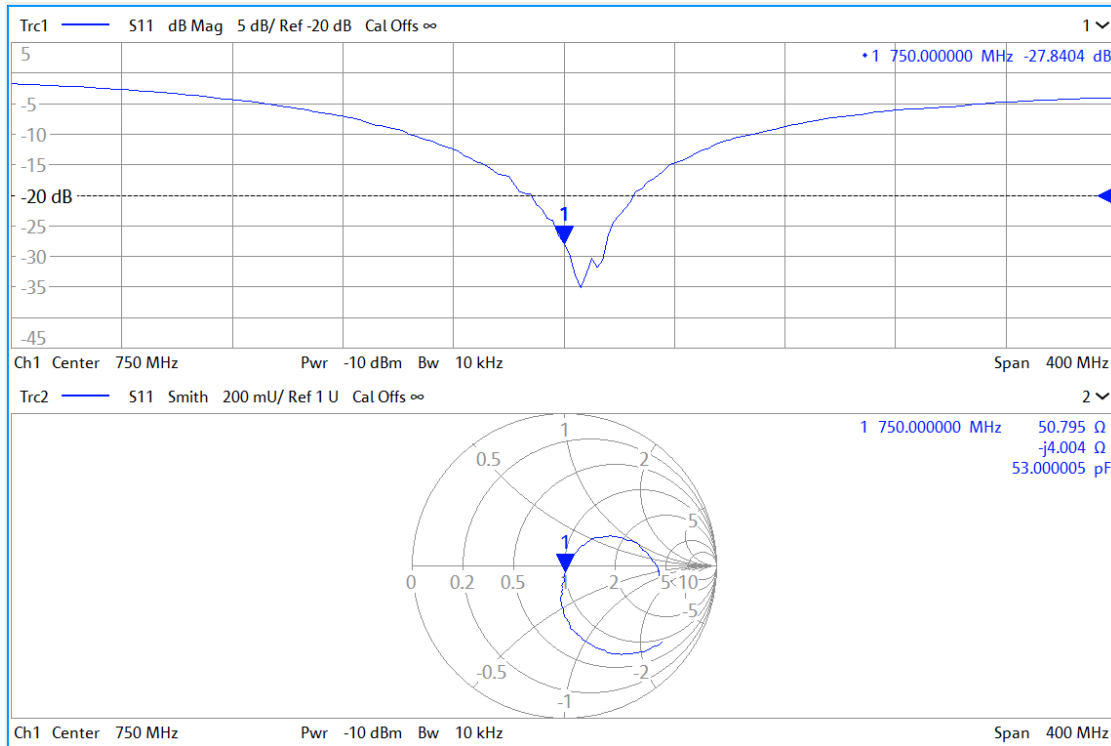



Accredited by the Swiss Accreditation Service (SAS)
The Swiss Accreditation Service is one of the signatories to the EA
Multilateral Agreement for the recognition of calibration certificates

Accreditation No.: **SCS 0108**

Client **PC Test**

Certificate No: **D835V2-4d132_Jan21**

CALIBRATION CERTIFICATE

Object **D835V2 - SN:4d132**

Calibration procedure(s) **QA CAL-05.v11
Calibration Procedure for SAR Validation Sources between 0.7-3 GHz**

Calibration date: **January 21, 2021**

BNV
01-27-2021

This calibration certificate documents the traceability to national standards, which realize the physical units of measurements (SI).
The measurements and the uncertainties with confidence probability are given on the following pages and are part of the certificate.

All calibrations have been conducted in the closed laboratory facility: environment temperature (22 ± 3)°C and humidity < 70%.

Calibration Equipment used (M&TE critical for calibration)

Primary Standards	ID #	Cal Date (Certificate No.)	Scheduled Calibration
Power meter NRP	SN: 104778	01-Apr-20 (No. 217-03100/03101)	Apr-21
Power sensor NRP-Z91	SN: 103244	01-Apr-20 (No. 217-03100)	Apr-21
Power sensor NRP-Z91	SN: 103245	01-Apr-20 (No. 217-03101)	Apr-21
Reference 20 dB Attenuator	SN: BH9394 (20k)	31-Mar-20 (No. 217-03106)	Apr-21
Type-N mismatch combination	SN: 310982 / 06327	31-Mar-20 (No. 217-03104)	Apr-21
Reference Probe EX3DV4	SN: 7349	28-Dec-20 (No. EX3-7349_Dec20)	Dec-21
DAE4	SN: 601	02-Nov-20 (No. DAE4-601_Nov20)	Nov-21

Secondary Standards	ID #	Check Date (in house)	Scheduled Check
Power meter E4419B	SN: GB39512475	30-Oct-14 (in house check Oct-20)	In house check: Oct-22
Power sensor HP 8481A	SN: US37292783	07-Oct-15 (in house check Oct-20)	In house check: Oct-22
Power sensor HP 8481A	SN: MY41092317	07-Oct-15 (in house check Oct-20)	In house check: Oct-22
RF generator R&S SMT-06	SN: 100972	15-Jun-15 (in house check Oct-20)	In house check: Oct-22
Network Analyzer Agilent E8358A	SN: US41080477	31-Mar-14 (in house check Oct-20)	In house check: Oct-21

Calibrated by: **Claudio Leubler** Name: Claudio Leubler Function: Laboratory Technician

Signature *[Signature]*

Approved by: **Katja Pokovic** Name: Katja Pokovic Function: Technical Manager

Signature *[Signature]*

Issued: January 21, 2021

This calibration certificate shall not be reproduced except in full without written approval of the laboratory.



Accredited by the Swiss Accreditation Service (SAS)

The Swiss Accreditation Service is one of the signatories to the EA
Multilateral Agreement for the recognition of calibration certificates

Accreditation No.: **SCS 0108**

Glossary:

TSL	tissue simulating liquid
ConvF	sensitivity in TSL / NORM x,y,z
N/A	not applicable or not measured

Calibration is Performed According to the Following Standards:

- IEEE Std 1528-2013, "IEEE Recommended Practice for Determining the Peak Spatial-Averaged Specific Absorption Rate (SAR) in the Human Head from Wireless Communications Devices: Measurement Techniques", June 2013
- IEC 62209-1, "Measurement procedure for the assessment of Specific Absorption Rate (SAR) from hand-held and body-mounted devices used next to the ear (frequency range of 300 MHz to 6 GHz)", July 2016
- IEC 62209-2, "Procedure to determine the Specific Absorption Rate (SAR) for wireless communication devices used in close proximity to the human body (frequency range of 30 MHz to 6 GHz)", March 2010
- KDB 865664, "SAR Measurement Requirements for 100 MHz to 6 GHz"

Additional Documentation:

- DASY4/5 System Handbook

Methods Applied and Interpretation of Parameters:

- Measurement Conditions:** Further details are available from the Validation Report at the end of the certificate. All figures stated in the certificate are valid at the frequency indicated.
- Antenna Parameters with TSL:** The dipole is mounted with the spacer to position its feed point exactly below the center marking of the flat phantom section, with the arms oriented parallel to the body axis.
- Feed Point Impedance and Return Loss:** These parameters are measured with the dipole positioned under the liquid filled phantom. The impedance stated is transformed from the measurement at the SMA connector to the feed point. The Return Loss ensures low reflected power. No uncertainty required.
- Electrical Delay:** One-way delay between the SMA connector and the antenna feed point. No uncertainty required.
- SAR measured:** SAR measured at the stated antenna input power.
- SAR normalized:** SAR as measured, normalized to an input power of 1 W at the antenna connector.
- SAR for nominal TSL parameters:** The measured TSL parameters are used to calculate the nominal SAR result.

The reported uncertainty of measurement is stated as the standard uncertainty of measurement multiplied by the coverage factor $k=2$, which for a normal distribution corresponds to a coverage probability of approximately 95%.

Measurement Conditions

DASY system configuration, as far as not given on page 1.

DASY Version	DASY5	V52.10.4
Extrapolation	Advanced Extrapolation	
Phantom	Modular Flat Phantom	
Distance Dipole Center - TSL	15 mm	with Spacer
Zoom Scan Resolution	dx, dy, dz = 5 mm	
Frequency	835 MHz \pm 1 MHz	

Head TSL parameters

The following parameters and calculations were applied.

	Temperature	Permittivity	Conductivity
Nominal Head TSL parameters	22.0 °C	41.5	0.90 mho/m
Measured Head TSL parameters	(22.0 \pm 0.2) °C	41.2 \pm 6 %	0.92 mho/m \pm 6 %
Head TSL temperature change during test	< 0.5 °C	----	----

SAR result with Head TSL

SAR averaged over 1 cm³ (1 g) of Head TSL	Condition	
SAR measured	250 mW input power	2.46 W/kg
SAR for nominal Head TSL parameters	normalized to 1W	9.66 W/kg \pm 17.0 % (k=2)

SAR averaged over 10 cm³ (10 g) of Head TSL	condition	
SAR measured	250 mW input power	1.59 W/kg
SAR for nominal Head TSL parameters	normalized to 1W	6.27 W/kg \pm 16.5 % (k=2)

Body TSL parameters

The following parameters and calculations were applied.

	Temperature	Permittivity	Conductivity
Nominal Body TSL parameters	22.0 °C	55.2	0.97 mho/m
Measured Body TSL parameters	(22.0 \pm 0.2) °C	55.3 \pm 6 %	0.98 mho/m \pm 6 %
Body TSL temperature change during test	< 0.5 °C	----	----

SAR result with Body TSL

SAR averaged over 1 cm³ (1 g) of Body TSL	Condition	
SAR measured	250 mW input power	2.47 W/kg
SAR for nominal Body TSL parameters	normalized to 1W	9.81 W/kg \pm 17.0 % (k=2)

SAR averaged over 10 cm³ (10 g) of Body TSL	condition	
SAR measured	250 mW input power	1.62 W/kg
SAR for nominal Body TSL parameters	normalized to 1W	6.44 W/kg \pm 16.5 % (k=2)

Appendix (Additional assessments outside the scope of SCS 0108)

Antenna Parameters with Head TSL

Impedance, transformed to feed point	50.9 Ω - 2.4 j Ω
Return Loss	- 32.0 dB

Antenna Parameters with Body TSL

Impedance, transformed to feed point	47.9 Ω - 4.4 j Ω
Return Loss	- 26.1 dB

General Antenna Parameters and Design

Electrical Delay (one direction)	1.386 ns
----------------------------------	----------

After long term use with 100W radiated power, only a slight warming of the dipole near the feedpoint can be measured.

The dipole is made of standard semirigid coaxial cable. The center conductor of the feeding line is directly connected to the second arm of the dipole. The antenna is therefore short-circuited for DC-signals. On some of the dipoles, small end caps are added to the dipole arms in order to improve matching when loaded according to the position as explained in the "Measurement Conditions" paragraph. The SAR data are not affected by this change. The overall dipole length is still according to the Standard.

No excessive force must be applied to the dipole arms, because they might bend or the soldered connections near the feedpoint may be damaged.

Additional EUT Data

Manufactured by	SPEAG
-----------------	-------

DASY5 Validation Report for Head TSL

Date: 21.01.2021

Test Laboratory: SPEAG, Zurich, Switzerland

DUT: Dipole 835 MHz; Type: D835V2; Serial: D835V2 - SN:4d132

Communication System: UID 0 - CW; Frequency: 835 MHz

Medium parameters used: $f = 835 \text{ MHz}$; $\sigma = 0.92 \text{ S/m}$; $\epsilon_r = 41.2$; $\rho = 1000 \text{ kg/m}^3$

Phantom section: Flat Section

Measurement Standard: DASY5 (IEEE/IEC/ANSI C63.19-2011)

DASY52 Configuration:

- Probe: EX3DV4 - SN7349; ConvF(9.69, 9.69, 9.69) @ 835 MHz; Calibrated: 28.12.2020
- Sensor-Surface: 1.4mm (Mechanical Surface Detection)
- Electronics: DAE4 Sn601; Calibrated: 02.11.2020
- Phantom: Flat Phantom 4.9 (front); Type: QD 00L P49 AA; Serial: 1001
- DASY52 52.10.4(1527); SEMCAD X 14.6.14(7483)

Dipole Calibration for Head Tissue/Pin=250 mW, d=15mm/Zoom Scan (7x7x7)/Cube 0:

Measurement grid: $dx=5\text{mm}$, $dy=5\text{mm}$, $dz=5\text{mm}$

Reference Value = 63.53 V/m; Power Drift = 0.00 dB

Peak SAR (extrapolated) = 3.74 W/kg

SAR(1 g) = 2.46 W/kg; SAR(10 g) = 1.59 W/kg

Smallest distance from peaks to all points 3 dB below = 16 mm

Ratio of SAR at M2 to SAR at M1 = 65.7%

Maximum value of SAR (measured) = 3.30 W/kg

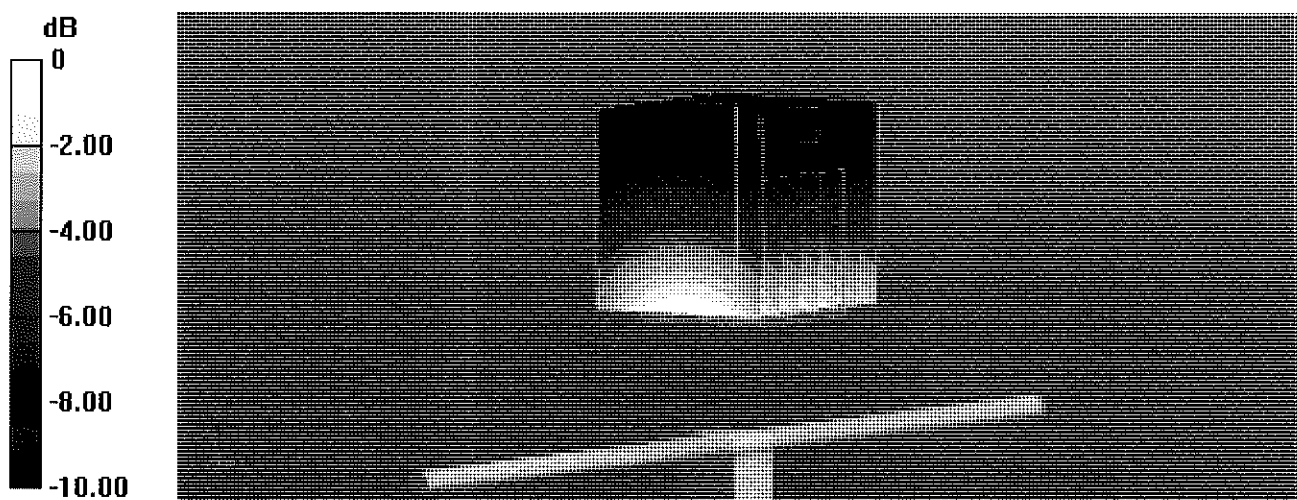

0 dB = 3.30 W/kg = 5.19 dBW/kg

Impedance Measurement Plot for Head TSL

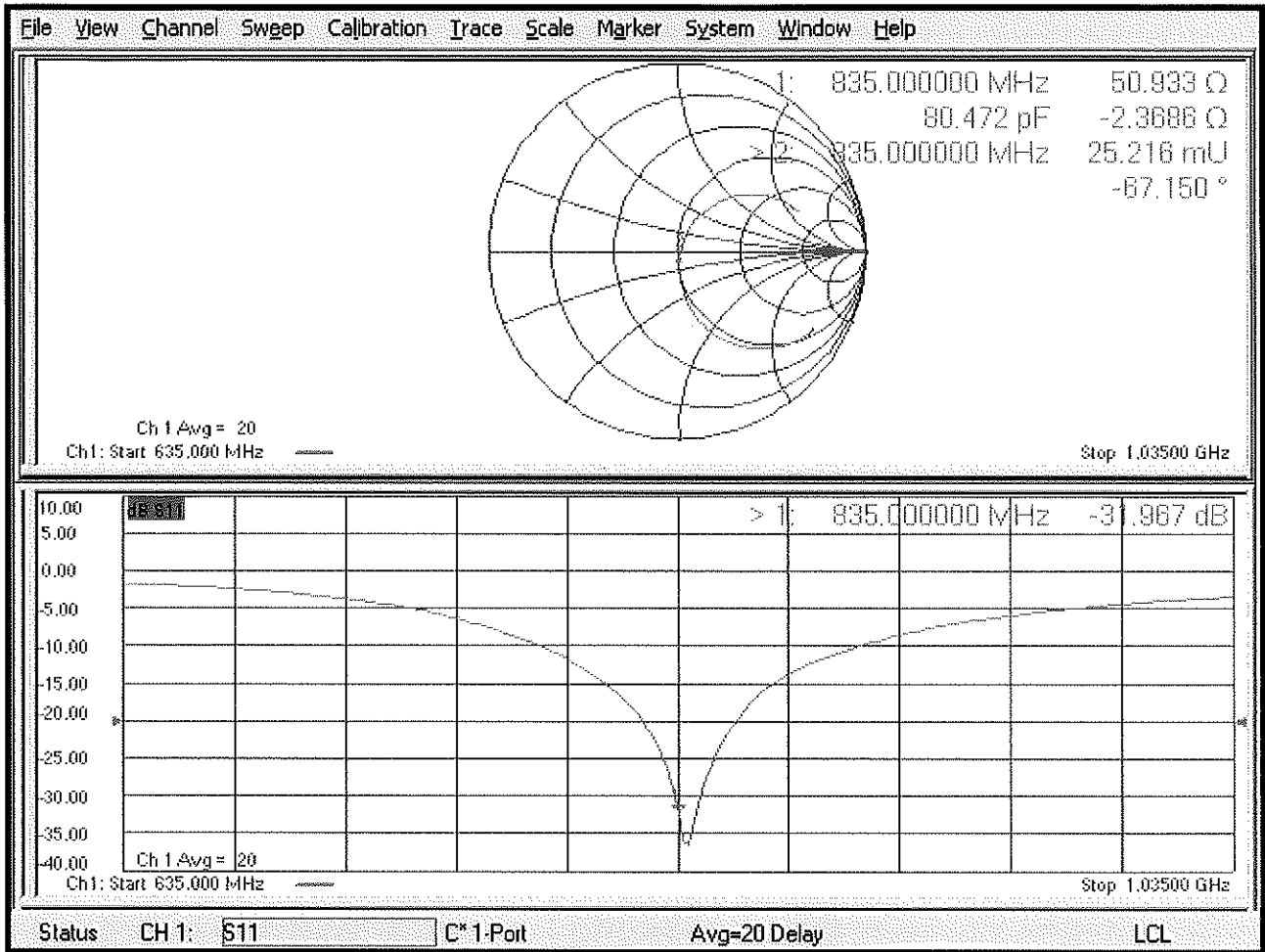

DASY5 Validation Report for Body TSL

Date: 21.01.2021

Test Laboratory: SPEAG, Zurich, Switzerland

DUT: Dipole 835 MHz; Type: D835V2; Serial: D835V2 - SN:4d132

Communication System: UID 0 - CW; Frequency: 835 MHz

Medium parameters used: $f = 835 \text{ MHz}$; $\sigma = 0.98 \text{ S/m}$; $\epsilon_r = 55.3$; $\rho = 1000 \text{ kg/m}^3$

Phantom section: Flat Section

Measurement Standard: DASY5 (IEEE/IEC/ANSI C63.19-2011)

DASY52 Configuration:

- Probe: EX3DV4 - SN7349; ConvF(9.85, 9.85, 9.85) @ 835 MHz; Calibrated: 28.12.2020
- Sensor-Surface: 1.4mm (Mechanical Surface Detection)
- Electronics: DAE4 Sn601; Calibrated: 02.11.2020
- Phantom: Flat Phantom 4.9 (Back); Type: QD 00R P49 AA; Serial: 1005
- DASY52 52.10.4(1527); SEMCAD X 14.6.14(7483)

Dipole Calibration for Body Tissue/Pin=250 mW, $d=15\text{mm}$ /Zoom Scan (7x7x7)/Cube 0:

Measurement grid: $dx=5\text{mm}$, $dy=5\text{mm}$, $dz=5\text{mm}$

Reference Value = 60.51 V/m; Power Drift = -0.02 dB

Peak SAR (extrapolated) = 3.64 W/kg

SAR(1 g) = 2.47 W/kg; SAR(10 g) = 1.62 W/kg

Smallest distance from peaks to all points 3 dB below = 15 mm

Ratio of SAR at M2 to SAR at M1 = 67.9%

Maximum value of SAR (measured) = 3.27 W/kg

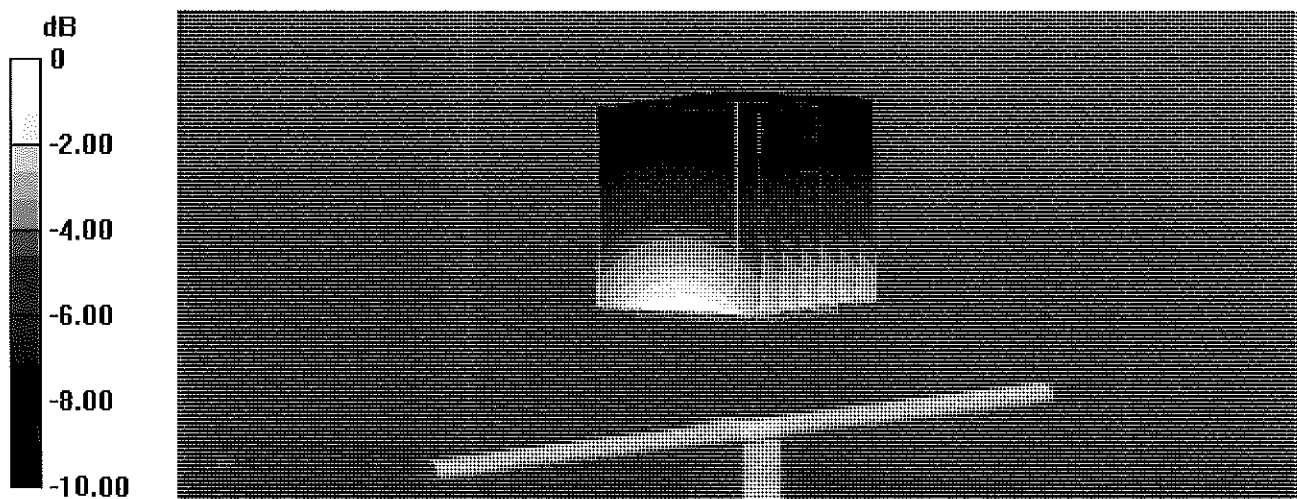

0 dB = 3.27 W/kg = 5.15 dBW/kg

Impedance Measurement Plot for Body TSL

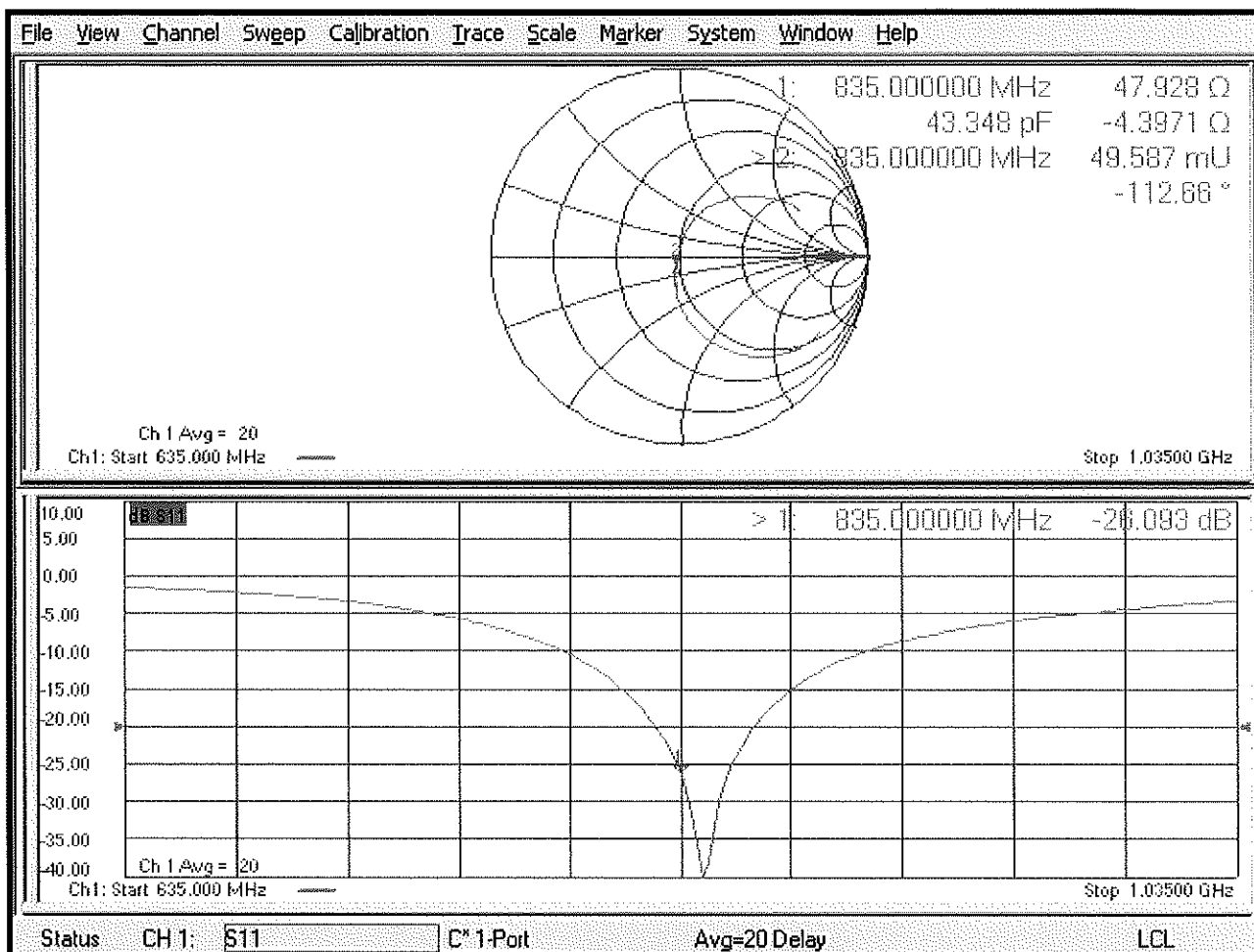

Appendix: Transfer Calibration at Four Validation Locations on SAM Head¹

Evaluation Condition

Phantom	SAM Head Phantom	For usage with cSAR3DV2-R/L
---------	------------------	-----------------------------

SAR result with SAM Head (Top \cong C0)

SAR averaged over 1 cm³ (1 g) of Head TSL	Condition	
SAR for nominal Head TSL parameters	normalized to 1W	9.19 W/kg \pm 17.5 % (k=2)

SAR averaged over 10 cm³ (10 g) of Head TSL	condition	
SAR for nominal Head TSL parameters	normalized to 1W	6.06 W/kg \pm 16.9 % (k=2)

SAR result with SAM Head (Mouth \cong F90)

SAR averaged over 1 cm³ (1 g) of Head TSL	Condition	
SAR for nominal Head TSL parameters	normalized to 1W	9.64 W/kg \pm 17.5 % (k=2)

SAR averaged over 10 cm³ (10 g) of Head TSL	condition	
SAR for nominal Head TSL parameters	normalized to 1W	6.45 W/kg \pm 16.9 % (k=2)

SAR result with SAM Head (Neck \cong H0)

SAR averaged over 1 cm³ (1 g) of Head TSL	Condition	
SAR for nominal Head TSL parameters	normalized to 1W	9.17 W/kg \pm 17.5 % (k=2)

SAR averaged over 10 cm³ (10 g) of Head TSL	condition	
SAR for nominal Head TSL parameters	normalized to 1W	6.17 W/kg \pm 16.9 % (k=2)

SAR result with SAM Head (Ear \cong D90)

SAR averaged over 1 cm³ (1 g) of Head TSL	Condition	
SAR for nominal Head TSL parameters	normalized to 1W	7.88 W/kg \pm 17.5 % (k=2)

SAR averaged over 10 cm³ (10 g) of Head TSL	condition	
SAR for nominal Head TSL parameters	normalized to 1W	5.29 W/kg \pm 16.9 % (k=2)

¹ Additional assessments outside the current scope of SCS 0108



Accredited by the Swiss Accreditation Service (SAS)
The Swiss Accreditation Service is one of the signatories to the EA
Multilateral Agreement for the recognition of calibration certificates

Accreditation No.: **SCS 0108**

Client **PC Test**

Certificate No: **D835V2-4d133_Oct18**

CALIBRATION CERTIFICATE

Object **D835V2 - SN: 4d133**

Calibration procedure(s) **QA CAL-05.v10
Calibration procedure for dipole validation kits above 700 MHz**

Calibration date: **October 19, 2018**

This calibration certificate documents the traceability to national standards, which realize the physical units of measurements (SI).
The measurements and the uncertainties with confidence probability are given on the following pages and are part of the certificate.

All calibrations have been conducted in the closed laboratory facility: environment temperature (22 ± 3)°C and humidity < 70%.

Calibration Equipment used (M&TE critical for calibration)

Primary Standards	ID #	Cal Date (Certificate No.)	Scheduled Calibration
Power meter NRP	SN: 104778	04-Apr-18 (No. 217-02672/02673)	Apr-19
Power sensor NRP-Z91	SN: 103244	04-Apr-18 (No. 217-02672)	Apr-19
Power sensor NRP-Z91	SN: 103245	04-Apr-18 (No. 217-02673)	Apr-19
Reference 20 dB Attenuator	SN: 5058 (20k)	04-Apr-18 (No. 217-02682)	Apr-19
Type-N mismatch combination	SN: 5047.2 / 06327	04-Apr-18 (No. 217-02683)	Apr-19
Reference Probe EX3DV4	SN: 7349	30-Dec-17 (No. EX3-7349_Dec17)	Dec-18
DAE4	SN: 601	04-Oct-18 (No. DAE4-601_Oct18)	Oct-19

Secondary Standards	ID #	Check Date (In house)	Scheduled Check
Power meter EPM-442A	SN: GB37480704	07-Oct-15 (in house check Oct-18)	In house check: Oct-20
Power sensor HP 8481A	SN: US37292783	07-Oct-15 (in house check Oct-18)	In house check: Oct-20
Power sensor HP 8481A	SN: MY41092317	07-Oct-15 (in house check Oct-18)	In house check: Oct-20
RF generator R&S SMT-06	SN: 100972	15-Jun-15 (in house check Oct-18)	In house check: Oct-20
Network Analyzer Agilent E8358A	SN: US41080477	31-Mar-14 (in house check Oct-18)	In house check: Oct-19

Calibrated by: **Manu Seitz** (Laboratory Technician) Signature: *[Signature]*

Approved by: **Kajla Pokovic** (Technical Manager) Signature: *[Signature]*

Issued: October 22, 2018

This calibration certificate shall not be reproduced except in full without written approval of the laboratory.



Accredited by the Swiss Accreditation Service (SAS)

The Swiss Accreditation Service is one of the signatories to the EA Multilateral Agreement for the recognition of calibration certificates

Accreditation No.: **SCS 0108**

Glossary:

TSL	tissue simulating liquid
ConvF	sensitivity in TSL / NORM x,y,z
N/A	not applicable or not measured

Calibration is Performed According to the Following Standards:

- IEEE Std 1528-2013, "IEEE Recommended Practice for Determining the Peak Spatial-Averaged Specific Absorption Rate (SAR) in the Human Head from Wireless Communications Devices: Measurement Techniques", June 2013
- IEC 62209-1, "Measurement procedure for the assessment of Specific Absorption Rate (SAR) from hand-held and body-mounted devices used next to the ear (frequency range of 300 MHz to 6 GHz)", July 2016
- IEC 62209-2, "Procedure to determine the Specific Absorption Rate (SAR) for wireless communication devices used in close proximity to the human body (frequency range of 30 MHz to 6 GHz)", March 2010
- KDB 865664, "SAR Measurement Requirements for 100 MHz to 6 GHz"

Additional Documentation:

- DASY4/5 System Handbook

Methods Applied and Interpretation of Parameters:

- Measurement Conditions:** Further details are available from the Validation Report at the end of the certificate. All figures stated in the certificate are valid at the frequency indicated.
- Antenna Parameters with TSL:** The dipole is mounted with the spacer to position its feed point exactly below the center marking of the flat phantom section, with the arms oriented parallel to the body axis.
- Feed Point Impedance and Return Loss:** These parameters are measured with the dipole positioned under the liquid filled phantom. The impedance stated is transformed from the measurement at the SMA connector to the feed point. The Return Loss ensures low reflected power. No uncertainty required.
- Electrical Delay:** One-way delay between the SMA connector and the antenna feed point. No uncertainty required.
- SAR measured:** SAR measured at the stated antenna input power.
- SAR normalized:** SAR as measured, normalized to an input power of 1 W at the antenna connector.
- SAR for nominal TSL parameters:** The measured TSL parameters are used to calculate the nominal SAR result.

The reported uncertainty of measurement is stated as the standard uncertainty of measurement multiplied by the coverage factor $k=2$, which for a normal distribution corresponds to a coverage probability of approximately 95%.

Measurement Conditions

DASY system configuration, as far as not given on page 1.

DASY Version	DASY5	V52.10.2
Extrapolation	Advanced Extrapolation	
Phantom	Modular Flat Phantom	
Distance Dipole Center - TSL	15 mm	with Spacer
Zoom Scan Resolution	dx, dy, dz = 5 mm	
Frequency	835 MHz \pm 1 MHz	

Head TSL parameters

The following parameters and calculations were applied.

	Temperature	Permittivity	Conductivity
Nominal Head TSL parameters	22.0 °C	41.5	0.90 mho/m
Measured Head TSL parameters	(22.0 \pm 0.2) °C	40.6 \pm 6 %	0.91 mho/m \pm 6 %
Head TSL temperature change during test	< 0.5 °C	----	----

SAR result with Head TSL

SAR averaged over 1 cm³ (1 g) of Head TSL	Condition	
SAR measured	250 mW input power	2.39 W/kg
SAR for nominal Head TSL parameters	normalized to 1W	9.43 W/kg \pm 17.0 % (k=2)

SAR averaged over 10 cm³ (10 g) of Head TSL	condition	
SAR measured	250 mW input power	1.54 W/kg
SAR for nominal Head TSL parameters	normalized to 1W	6.10 W/kg \pm 16.5 % (k=2)

Body TSL parameters

The following parameters and calculations were applied.

	Temperature	Permittivity	Conductivity
Nominal Body TSL parameters	22.0 °C	55.2	0.97 mho/m
Measured Body TSL parameters	(22.0 \pm 0.2) °C	54.9 \pm 6 %	0.98 mho/m \pm 6 %
Body TSL temperature change during test	< 0.5 °C	----	----

SAR result with Body TSL

SAR averaged over 1 cm³ (1 g) of Body TSL	Condition	
SAR measured	250 mW input power	2.46 W/kg
SAR for nominal Body TSL parameters	normalized to 1W	9.75 W/kg \pm 17.0 % (k=2)

SAR averaged over 10 cm³ (10 g) of Body TSL	condition	
SAR measured	250 mW input power	1.61 W/kg
SAR for nominal Body TSL parameters	normalized to 1W	6.40 W/kg \pm 16.5 % (k=2)

Appendix (Additional assessments outside the scope of SCS 0108)

Antenna Parameters with Head TSL

Impedance, transformed to feed point	50.6 Ω - 2.4 j Ω
Return Loss	- 32.2 dB

Antenna Parameters with Body TSL

Impedance, transformed to feed point	45.0 Ω - 6.7 j Ω
Return Loss	- 21.1 dB

General Antenna Parameters and Design

Electrical Delay (one direction)	1.397 ns
----------------------------------	----------

After long term use with 100W radiated power, only a slight warming of the dipole near the feedpoint can be measured.

The dipole is made of standard semirigid coaxial cable. The center conductor of the feeding line is directly connected to the second arm of the dipole. The antenna is therefore short-circuited for DC-signals. On some of the dipoles, small end caps are added to the dipole arms in order to improve matching when loaded according to the position as explained in the "Measurement Conditions" paragraph. The SAR data are not affected by this change. The overall dipole length is still according to the Standard.

No excessive force must be applied to the dipole arms, because they might bend or the soldered connections near the feedpoint may be damaged.

Additional EUT Data

Manufactured by	SPEAG
Manufactured on	July 22, 2011

DASY5 Validation Report for Head TSL

Date: 19.10.2018

Test Laboratory: The name of your organization

DUT: Dipole 835 MHz; Type: D835V2; Serial: D835V2 - SN:4d133

Communication System: UID 0 - CW; Frequency: 835 MHz

Medium parameters used: $f = 835$ MHz; $\sigma = 0.91$ S/m; $\epsilon_r = 40.6$; $\rho = 1000$ kg/m³

Phantom section: Flat Section

Measurement Standard: DASY5 (IEEE/IEC/ANSI C63.19-2011)

DASY52 Configuration:

- Probe: EX3DV4 - SN7349; ConvF(9.9, 9.9, 9.9) @ 835 MHz; Calibrated: 30.12.2017
- Sensor-Surface: 1.4mm (Mechanical Surface Detection)
- Electronics: DAE4 Sn601; Calibrated: 04.10.2018
- Phantom: Flat Phantom 4.9 (front); Type: QD 00L P49 AA; Serial: 1001
- DASY52 52.10.2(1495); SEMCAD X 14.6.12(7450)

Dipole Calibration for Head Tissue/Pin=250 mW, d=15mm/Zoom Scan (7x7x7)/Cube 0:

Measurement grid: dx=5mm, dy=5mm, dz=5mm

Reference Value = 63.02 V/m; Power Drift = -0.02 dB

Peak SAR (extrapolated) = 3.68 W/kg

SAR(1 g) = 2.39 W/kg; SAR(10 g) = 1.54 W/kg

Maximum value of SAR (measured) = 3.24 W/kg

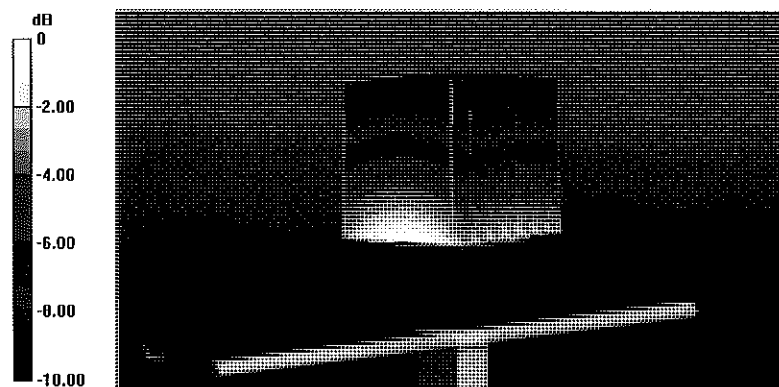

0 dB = 3.24 W/kg = 5.11 dBW/kg

Impedance Measurement Plot for Head TSL

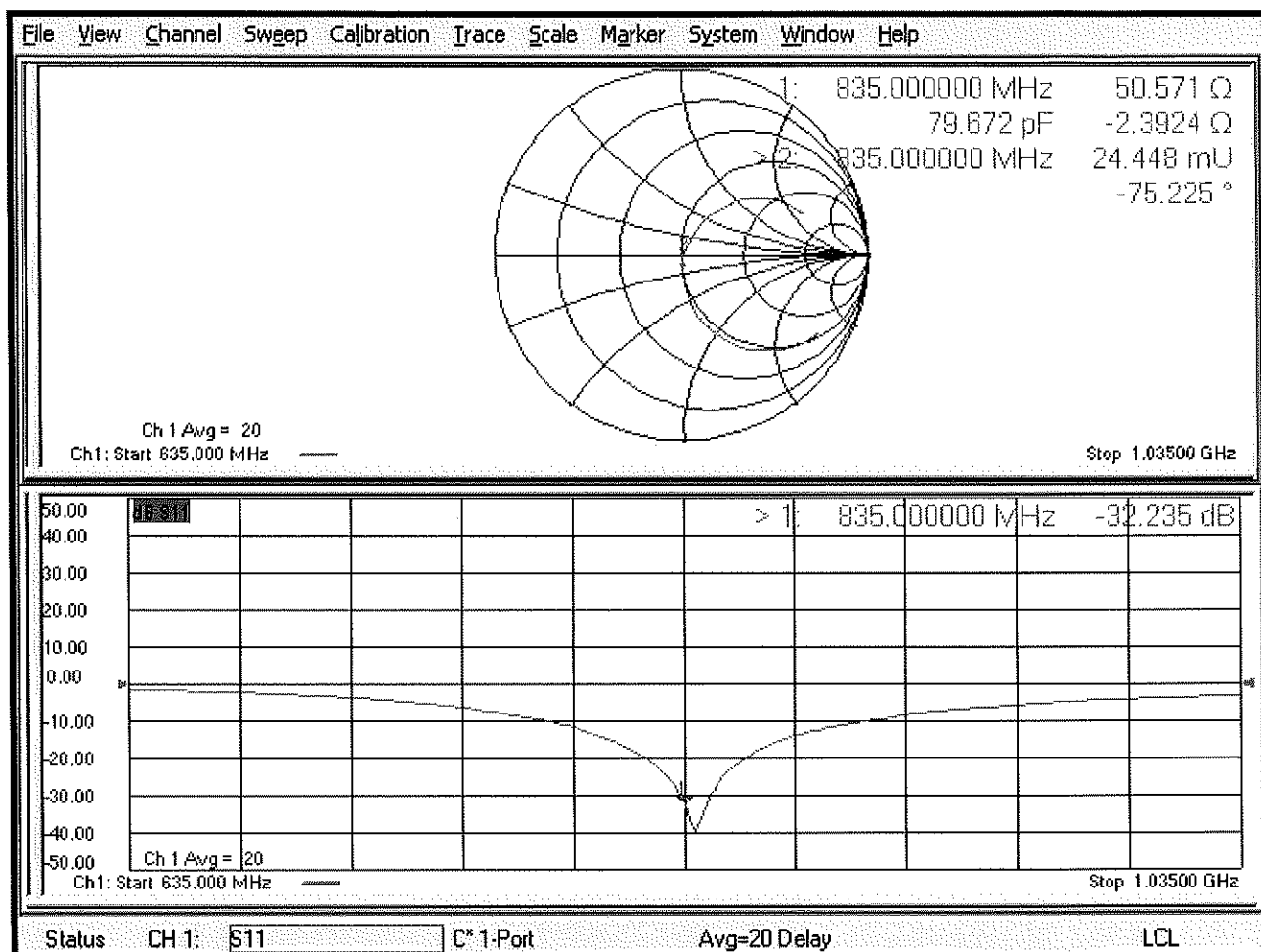

DASY5 Validation Report for Body TSL

Date: 19.10.2018

Test Laboratory: SPEAG, Zurich, Switzerland

DUT: Dipole 835 MHz; Type: D835V2; Serial: D835V2 - SN:4d133

Communication System: UID 0 - CW; Frequency: 835 MHz

Medium parameters used: $f = 835$ MHz; $\sigma = 0.98$ S/m; $\epsilon_r = 54.9$; $\rho = 1000$ kg/m³

Phantom section: Flat Section

Measurement Standard: DASY5 (IEEE/IEC/ANSI C63.19-2011)

DASY52 Configuration:

- Probe: EX3DV4 - SN7349; ConvF(10.05, 10.05, 10.05) @ 835 MHz; Calibrated: 30.12.2017
- Sensor-Surface: 1.4mm (Mechanical Surface Detection)
- Electronics: DAE4 Sn601; Calibrated: 04.10.2018
- Phantom: Flat Phantom 4.9 (Back); Type: QD 00R P49 AA; Serial: 1005
- DASY52 52.10.2(1495); SEMCAD X 14.6.12(7450)

Dipole Calibration for Body Tissue/Pin=250 mW, d=15mm/Zoom Scan (7x7x7)/Cube 0:

Measurement grid: dx=5mm, dy=5mm, dz=5mm

Reference Value = 61.61 V/m; Power Drift = -0.02 dB

Peak SAR (extrapolated) = 3.69 W/kg

SAR(1 g) = 2.46 W/kg; SAR(10 g) = 1.61 W/kg

Maximum value of SAR (measured) = 3.28 W/kg

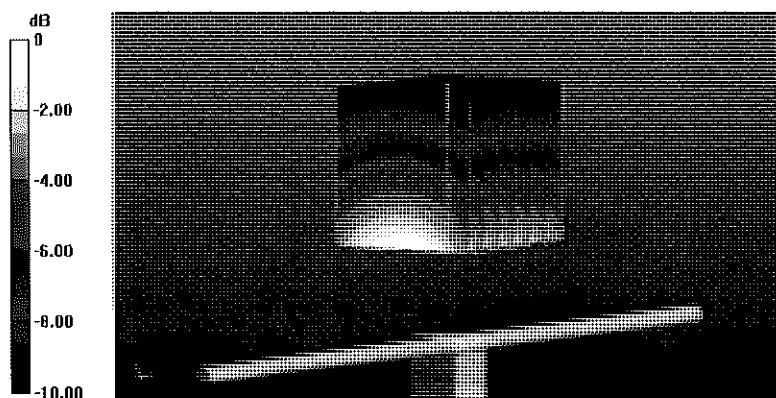

0 dB = 3.28 W/kg = 5.16 dBW/kg

Impedance Measurement Plot for Body TSL

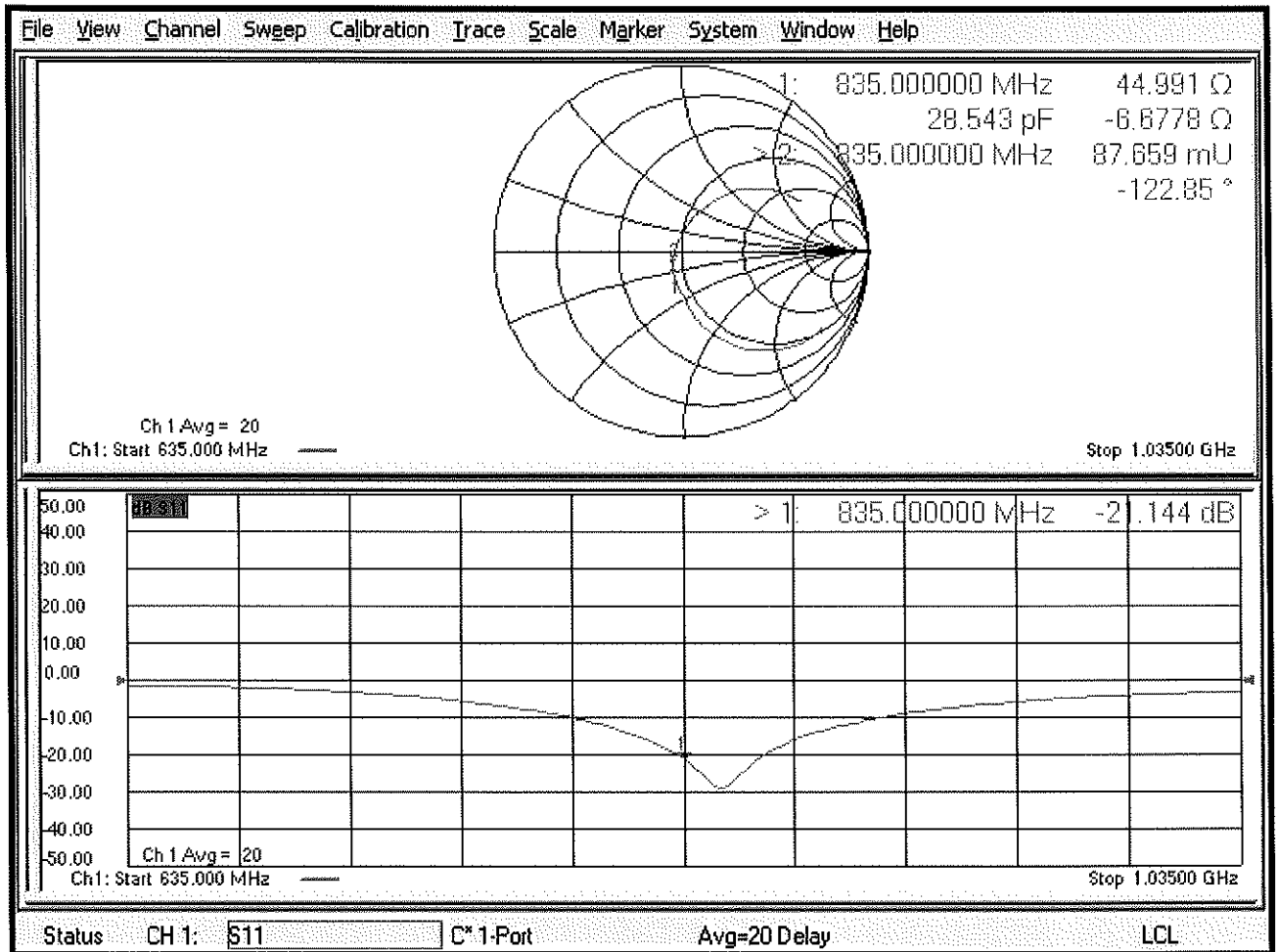

Certification of Calibration

Object D835V2 – SN:4d133

Calibration procedure(s) Procedure for Calibration Extension for SAR Dipoles.

Extended Calibration date: October 18, 2019

Description: SAR Validation Dipole at 835 MHz.

Calibration Equipment used:

Manufacturer	Model	Description	Cal Date	Cal Interval	Cal Due	Serial Number
Control Company	4040	Therm./Clock/Humidity Monitor	6/29/2019	Biennial	6/29/2021	192291470
Control Company	4352	Ultra Long Stem Thermometer	8/2/2018	Biennial	8/2/2020	181334684
Amplifier Research	15S1G6	Amplifier	CBT	N/A	CBT	433971
Narda	4772-3	Attenuator (3dB)	CBT	N/A	CBT	9406
Keysight Technologies	85033E	Standard Mechanical Calibration Kit (DC to 9GHz, 3.5mm)	7/2/2019	Annual	7/2/2020	MY53401181
Rohde & Schwarz	ZNLE6	Vector Network Analyzer	10/11/2019	Annual	10/11/2020	101307
Mini-Circuits	BW-N20W5+	DC to 18 GHz Precision Fixed 20 dB Attenuator	CBT	N/A	CBT	N/A
SPEAG	DAKS-3.5	Portable Dielectric Assessment Kit	8/13/2019	Annual	8/13/2020	1041
Anritsu	MA2411B	Pulse Power Sensor	8/14/2019	Annual	8/14/2020	1315051
Anritsu	MA2411B	Pulse Power Sensor	8/8/2019	Annual	8/8/2020	1339008
Anritsu	ML2495A	Power Meter	11/20/2018	Annual	11/20/2019	1039008
Agilent	N5182A	MXG Vector Signal Generator	8/19/2019	Annual	8/19/2020	MY47420837
Seekonk	NC-100	Torque Wrench	5/9/2018	Biennial	5/9/2020	22217
Mini-Circuits	NLP-2950+	Low Pass Filter DC to 2700 MHz	CBT	N/A	CBT	N/A
MiniCircuits	ZHDC-16-63-S+	Bidirectional Coupler	CBT	N/A	CBT	N/A
MiniCircuits	VLF-6000+	Low Pass Filter	CBT	N/A	CBT	N/A
SPEAG	EX3DV4	SAR Probe	9/19/2019	Annual	9/19/2020	7551
SPEAG	EX3DV4	SAR Probe	4/24/2019	Annual	4/24/2020	7357
SPEAG	DAE4	Dasy Data Acquisition Electronics	9/17/2019	Annual	9/17/2020	1333
SPEAG	DAE4	Dasy Data Acquisition Electronics	4/18/2019	Annual	4/18/2020	1407

Note: CBT (Calibrated Before Testing). Prior to testing, the measurement paths containing a cable, amplifier, attenuator, coupler or filter were connected to a calibrated source (i.e. a signal generator) to determine the losses of the measurement path.

Measurement Uncertainty = $\pm 23\%$ (k=2)

	Name	Function	Signature
Calibrated By:	Brodie Halfoster	Team Lead Engineer	<i>BRODIE HALFOSTER</i>
Approved By:	Kaitlin O'Keefe	Senior Technical Manager	<i>KOK</i>

DIPOLE CALIBRATION EXTENSION

Per KDB 865664 D01, calibration intervals of up to three years may be considered for reference dipoles when it is demonstrated that the SAR target, impedance and return loss of a dipole have remained stable according to the following requirements:

1. The measured SAR does not deviate more than 10% from the target on the calibration certificate.
2. The return-loss does not deviate more than 20% from the previous measurement and meets the required 20dB minimum return-loss requirement.
3. The measurement of real or imaginary parts of impedance does not deviate more than 5Ω from the previous measurement.

The following dipole was checked to pass the above 3 requirements to have 2-year calibration period from the calibration date:

Calibration Date	Extension Date	Certificate Electrical Delay (ns)	Certificate SAR Target Head (1g) W/kg @ 23.0 dBm	Measured Head SAR (1g) W/kg @ 23.0 dBm	Deviation 1g (%)	Certificate SAR Target Head (10g) W/kg @ 23.0 dBm	Measured Head SAR (10g) W/kg @ 23.0 dBm	Deviation 10g (%)	Certificate Impedance Head (Ohm) Real	Measured Impedance Head (Ohm) Real	Difference (Ohm) Real	Certificate Impedance Head (Ohm) Imaginary	Measured Impedance Head (Ohm) Imaginary	Difference (Ohm) Imaginary	Certificate Return Loss Head (dB)	Measured Return Loss Head (dB)	Deviation (%)	PASS/FAIL
10/19/2018	10/18/2019	1.397	1.886	2.03	7.64%	1.22	1.32	8.20%	50.6	49.5	1.1	-2.4	-3.2	0.8	-32.2	-29.8	7.50%	PASS
Calibration Date	Extension Date	Certificate Electrical Delay (ns)	Certificate SAR Target Body (1g) W/kg @ 23.0 dBm	Measured Body SAR (1g) W/kg @ 23.0 dBm	Deviation 1g (%)	Certificate SAR Target Body (10g) W/kg @ 23.0 dBm	Measured Body SAR (10g) W/kg @ 23.0 dBm	Deviation 10g (%)	Certificate Impedance Body (Ohm) Real	Measured Impedance Body (Ohm) Real	Difference (Ohm) Real	Certificate Impedance Body (Ohm) Imaginary	Measured Impedance Body (Ohm) Imaginary	Difference (Ohm) Imaginary	Certificate Return Loss Body (dB)	Measured Return Loss Body (dB)	Deviation (%)	PASS/FAIL
10/19/2018	10/18/2019	1.397	1.96	2.07	6.15%	1.28	1.36	6.25%	45	45.1	0.1	-6.7	-5.1	1.6	-21.1	-22.6	-6.90%	PASS

Impedance & Return-Loss Measurement Plot for Head TSL

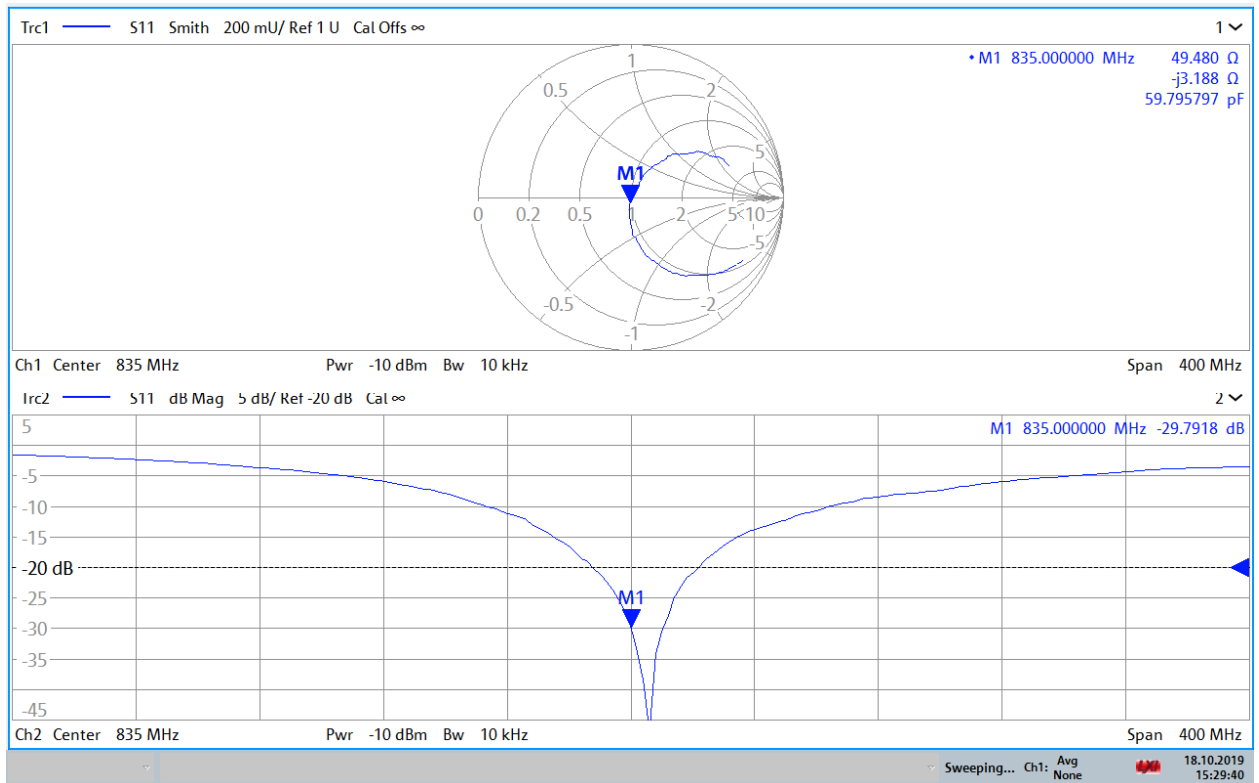

15:29:41 18.10.2019

Impedance & Return-Loss Measurement Plot for Body TSL

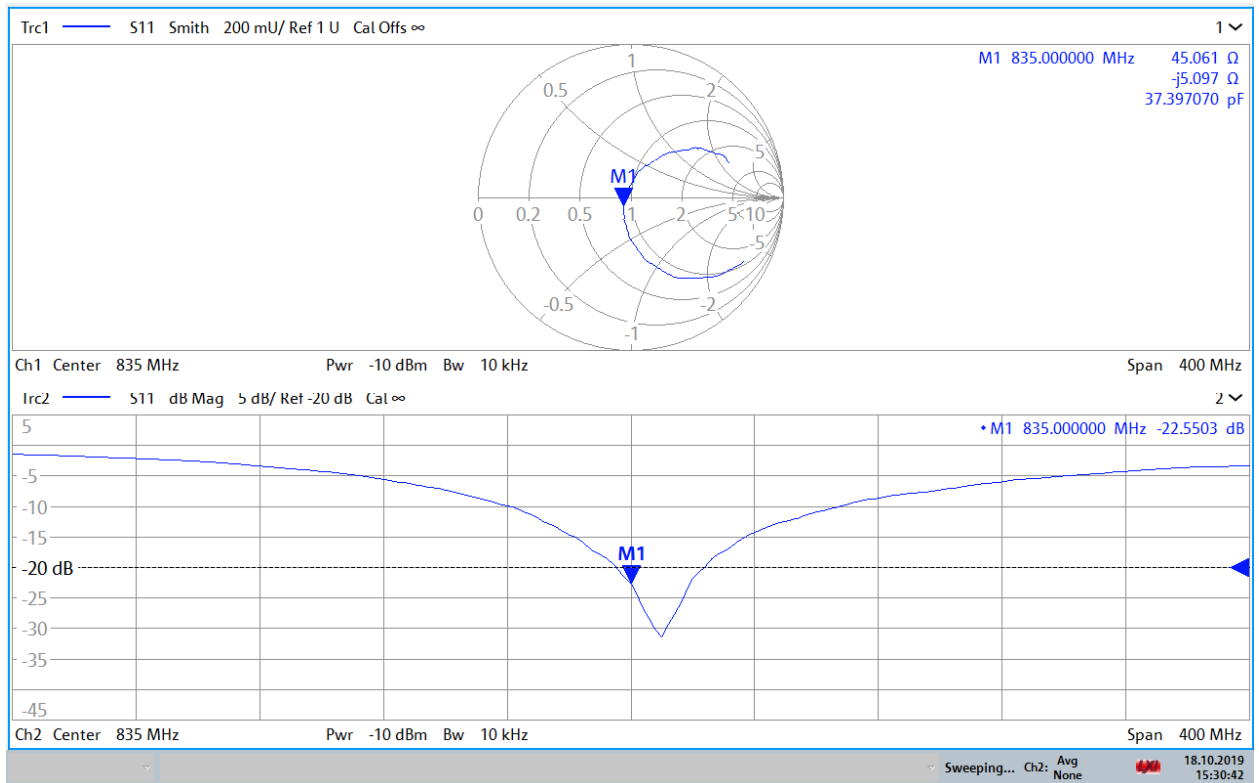

15:30:43 18.10.2019

Certification of Calibration

Object: D835V2 – SN: 4d133
 Calibration procedure(s): Procedure for Calibration Extension for SAR Dipoles.
 Extension Calibration date: 10/18/2020
 Description: SAR Validation Dipole at 835 MHz.

Calibration Equipment used:

Manufacturer	Model	Description	Cal Date	Cal Interval	Cal Due	Serial Number
Control Company	4040	Therm./Clock/Humidity Monitor	6/29/2019	Biennial	6/29/2021	192291470
Control Company	4352	Ultra Long Stem Thermometer	11/29/2018	Biennial	11/29/2020	181766816
Amplifier Research	15S1G6	Amplifier	CBT	N/A	CBT	433971
Narda	4772-3	Attenuator (3dB)	CBT	N/A	CBT	9406
Agilent	85033E	3.5mm Standard Calibration Kit	6/6/2020	Annual	6/6/2021	MY53402352
Rohde & Schwarz	ZNLE6	Vector Network Analyzer	9/29/2020	Annual	9/29/2021	101307
Mini-Circuits	BW-N20W5+	DC to 18 GHz Precision Fixed 20 dB Attenuator	CBT	N/A	CBT	N/A
SPEAG	DAK-3.5	Dielectric Assessment Kit	5/12/2020	Annual	5/12/2021	1070
Anritsu	MA2411B	Pulse Power Sensor	8/12/2020	Annual	8/12/2021	1207364
Anritsu	MA2411B	Pulse Power Sensor	9/22/2020	Annual	9/22/2021	1315051
Anritsu	ML2495A	Power Meter	1/15/2020	Annual	1/15/2021	1328004
Anritsu	ML2495A	Power Meter	12/17/2019	Annual	12/17/2020	941001
Agilent	N5182A	MXG Vector Signal Generator	5/13/2020	Annual	5/13/2021	MY47420603
Pasternack	NC-100	Torque Wrench	8/4/2020	Biennial	8/4/2022	N/A
Mini-Circuits	NLP-2950+	Low Pass Filter DC to 2700 MHz	CBT	N/A	CBT	N/A
MiniCircuits	ZHDC-16-63-S+	Bidirectional Coupler	CBT	N/A	CBT	N/A
MiniCircuits	VLF-6000+	Low Pass Filter	CBT	N/A	CBT	N/A
SPEAG	EX3DV4	SAR Probe	1/21/2020	Annual	1/21/2021	3589
SPEAG	EX3DV4	SAR Probe	12/11/2019	Annual	12/11/2020	7570
SPEAG	DAE4	Dasy Data Acquisition Electronics	3/12/2020	Annual	3/12/2021	1368
SPEAG	DAE4	Dasy Data Acquisition Electronics	6/23/2020	Annual	1/13/2021	1558

Measurement Uncertainty = ±23% (k=2)

	Name	Function	Signature
Calibrated By:	Brodie Halfoster	Test Engineer	<i>BRODIE HALFOSTER</i>
Approved By:	Kaitlin O'Keefe	Senior Technical Manager	<i>KOK</i>

DIPOLE CALIBRATION EXTENSION

Per KDB 865664 D01, calibration intervals of up to three years may be considered for reference dipoles when it is demonstrated that the SAR target, impedance and return loss of a dipole have remained stable according to the following requirements:

1. The measured SAR does not deviate more than 10% from the target on the calibration certificate.
2. The return-loss does not deviate more than 20% from the previous measurement and meets the required 20dB minimum return-loss requirement.
3. The measurement of real or imaginary parts of impedance does not deviate more than 5Ω from the previous measurement.

The following dipole was checked to pass the above 3 requirements to have 3-year calibration period from the calibration date:

Calibration Date	Extension Date	Certificate Electrical Delay (ns)	Certificate SAR Target Head (1g) W/kg @ 23.0 dBm	Measured Head SAR (1g) W/kg @ 23.0 dBm	Deviation 1g (%)	Certificate SAR Target Head (10g) W/kg @ 23.0 dBm	Measured Head SAR (10g) W/kg @ 23.0 dBm	Deviation 10g (%)	Certificate Impedance Head (Ohm) Real	Measured Impedance Head (Ohm) Real	Difference (Ohm) Real	Certificate Impedance Head (Ohm) Imaginary	Measured Impedance Head (Ohm) Imaginary	Difference (Ohm) Imaginary	Certificate Return Loss Head (dB)	Measured Return Loss Head (dB)	Deviation (%)	PASS/FAIL
10/19/2018	10/18/2020	1.397	1.886	2.00	6.04%	1.22	1.28	4.92%	50.6	49.4	1.2	-2.4	-1.5	0.9	-32.2	-35.7	-10.90%	PASS
Calibration Date	Extension Date	Certificate Electrical Delay (ns)	Certificate SAR Target Body (1g) W/kg @ 23.0 dBm	Measured Body SAR (1g) W/kg @ 23.0 dBm	Deviation 1g (%)	Certificate SAR Target Body (10g) W/kg @ 23.0 dBm	Measured Body SAR (10g) W/kg @ 23.0 dBm	Deviation 10g (%)	Certificate Impedance Body (Ohm) Real	Measured Impedance Body (Ohm) Real	Difference (Ohm) Real	Certificate Impedance Body (Ohm) Imaginary	Measured Impedance Body (Ohm) Imaginary	Difference (Ohm) Imaginary	Certificate Return Loss Body (dB)	Measured Return Loss Body (dB)	Deviation (%)	PASS/FAIL
10/19/2018	10/18/2020	1.397	1.95	1.85	-5.13%	1.28	1.22	-4.69%	45.0	45.0	0.0	-6.7	-4.0	2.7	-21.1	-23.4	-10.90%	PASS

Impedance & Return-Loss Measurement Plot for Head TSL

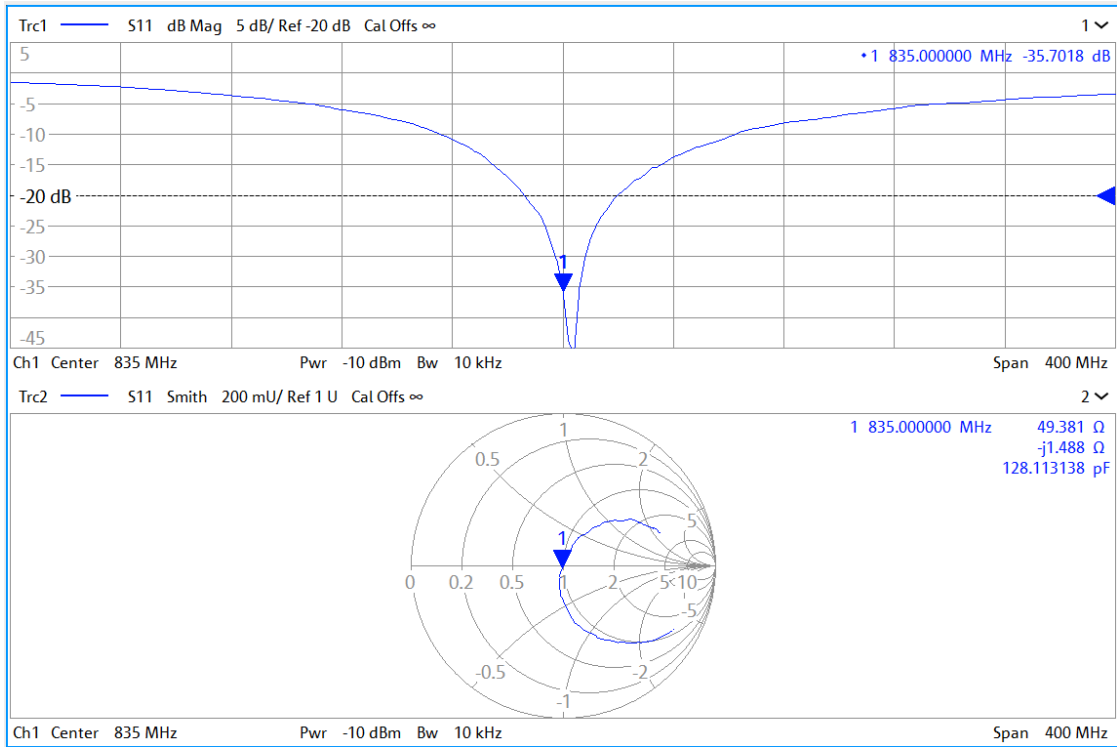

Impedance & Return-Loss Measurement Plot for Body TSL

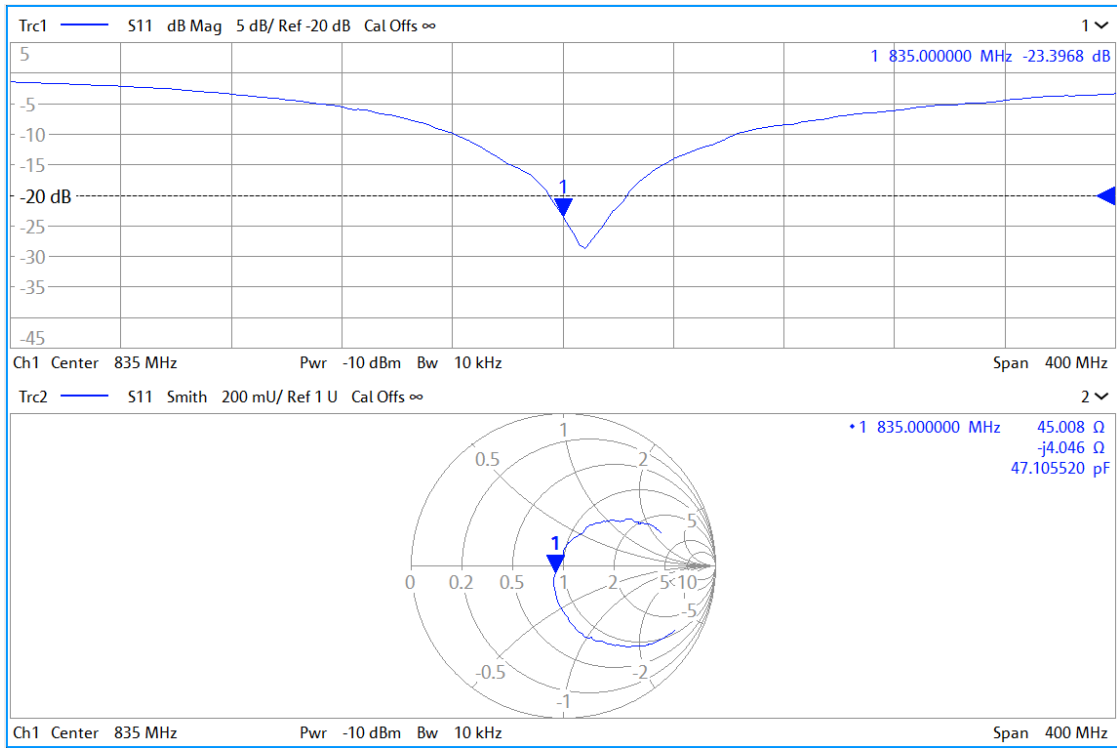



Accredited by the Swiss Accreditation Service (SAS)
The Swiss Accreditation Service is one of the signatories to the EA
Multilateral Agreement for the recognition of calibration certificates

Accreditation No.: **SCS 0108**

Client **PC Test**

Certificate No: **D1750V2-1148_May20**

CALIBRATION CERTIFICATE

Object **D1750V2 - SN:1148**

Calibration procedure(s) **QA CAL-05.v11
Calibration Procedure for SAR Validation Sources between 0.7-3 GHz**

Calibration date: **May 12, 2020**

*BN ✓
6-2-2020
BN ✓
05-13-21*

This calibration certificate documents the traceability to national standards, which realize the physical units of measurements (SI).
The measurements and the uncertainties with confidence probability are given on the following pages and are part of the certificate.

All calibrations have been conducted in the closed laboratory facility: environment temperature (22 ± 3)°C and humidity < 70%.

Calibration Equipment used (M&TE critical for calibration)

Primary Standards	ID #	Cal Date (Certificate No.)	Scheduled Calibration
Power meter NRP	SN: 104778	01-Apr-20 (No. 217-03100/03101)	Apr-21
Power sensor NRP-Z91	SN: 103244	01-Apr-20 (No. 217-03100)	Apr-21
Power sensor NRP-Z91	SN: 103245	01-Apr-20 (No. 217-03101)	Apr-21
Reference 20 dB Attenuator	SN: BH9394 (20k)	31-Mar-20 (No. 217-03106)	Apr-21
Type-N mismatch combination	SN: 310982 / 06327	31-Mar-20 (No. 217-03104)	Apr-21
Reference Probe EX3DV4	SN: 7349	31-Dec-19 (No. EX3-7349_Dec19)	Dec-20
DAE4	SN: 601	27-Dec-19 (No. DAE4-601_Dec19)	Dec-20
Secondary Standards	ID #	Check Date (in house)	Scheduled Check
Power meter E4419B	SN: GB39512475	30-Oct-14 (in house check Feb-19)	In house check: Oct-20
Power sensor HP 8481A	SN: US37292783	07-Oct-15 (in house check Oct-18)	In house check: Oct-20
Power sensor HP 8481A	SN: MY41092317	07-Oct-15 (in house check Oct-18)	In house check: Oct-20
RF generator R&S SMT-06	SN: 100972	15-Jun-15 (in house check Oct-18)	In house check: Oct-20
Network Analyzer Agilent E8358A	SN: US41080477	31-Mar-14 (in house check Oct-19)	In house check: Oct-20

Calibrated by:	Name Jeffrey Katzman	Function Laboratory Technician	Signature
Approved by:	Katja Pokovic	Technical Manager	

Issued: May 13, 2020

This calibration certificate shall not be reproduced except in full without written approval of the laboratory.



Accredited by the Swiss Accreditation Service (SAS)

The Swiss Accreditation Service is one of the signatories to the EA
Multilateral Agreement for the recognition of calibration certificates

Accreditation No.: **SCS 0108**

Glossary:

TSL	tissue simulating liquid
ConvF	sensitivity in TSL / NORM x,y,z
N/A	not applicable or not measured

Calibration is Performed According to the Following Standards:

- IEEE Std 1528-2013, "IEEE Recommended Practice for Determining the Peak Spatial-Averaged Specific Absorption Rate (SAR) in the Human Head from Wireless Communications Devices: Measurement Techniques", June 2013
- IEC 62209-1, "Measurement procedure for the assessment of Specific Absorption Rate (SAR) from hand-held and body-mounted devices used next to the ear (frequency range of 300 MHz to 6 GHz)", July 2016
- IEC 62209-2, "Procedure to determine the Specific Absorption Rate (SAR) for wireless communication devices used in close proximity to the human body (frequency range of 30 MHz to 6 GHz)", March 2010
- KDB 865664, "SAR Measurement Requirements for 100 MHz to 6 GHz"

Additional Documentation:

- DASY4/5 System Handbook

Methods Applied and Interpretation of Parameters:

- Measurement Conditions:** Further details are available from the Validation Report at the end of the certificate. All figures stated in the certificate are valid at the frequency indicated.
- Antenna Parameters with TSL:** The dipole is mounted with the spacer to position its feed point exactly below the center marking of the flat phantom section, with the arms oriented parallel to the body axis.
- Feed Point Impedance and Return Loss:** These parameters are measured with the dipole positioned under the liquid filled phantom. The impedance stated is transformed from the measurement at the SMA connector to the feed point. The Return Loss ensures low reflected power. No uncertainty required.
- Electrical Delay:** One-way delay between the SMA connector and the antenna feed point. No uncertainty required.
- SAR measured:** SAR measured at the stated antenna input power.
- SAR normalized:** SAR as measured, normalized to an input power of 1 W at the antenna connector.
- SAR for nominal TSL parameters:** The measured TSL parameters are used to calculate the nominal SAR result.

The reported uncertainty of measurement is stated as the standard uncertainty of measurement multiplied by the coverage factor $k=2$, which for a normal distribution corresponds to a coverage probability of approximately 95%.

Measurement Conditions

DASY system configuration, as far as not given on page 1.

DASY Version	DASY5	V52.10.4
Extrapolation	Advanced Extrapolation	
Phantom	Modular Flat Phantom	
Distance Dipole Center - TSL	10 mm	with Spacer
Zoom Scan Resolution	dx, dy, dz = 5 mm	
Frequency	1750 MHz \pm 1 MHz	

Head TSL parameters

The following parameters and calculations were applied.

	Temperature	Permittivity	Conductivity
Nominal Head TSL parameters	22.0 °C	40.1	1.37 mho/m
Measured Head TSL parameters	(22.0 \pm 0.2) °C	40.3 \pm 6 %	1.35 mho/m \pm 6 %
Head TSL temperature change during test	< 0.5 °C	----	----

SAR result with Head TSL

SAR averaged over 1 cm³ (1 g) of Head TSL	Condition	
SAR measured	250 mW input power	8.88 W/kg
SAR for nominal Head TSL parameters	normalized to 1W	35.9 W/kg \pm 17.0 % (k=2)

SAR averaged over 10 cm³ (10 g) of Head TSL	condition	
SAR measured	250 mW input power	4.69 W/kg
SAR for nominal Head TSL parameters	normalized to 1W	18.9 W/kg \pm 16.5 % (k=2)

Body TSL parameters

The following parameters and calculations were applied.

	Temperature	Permittivity	Conductivity
Nominal Body TSL parameters	22.0 °C	53.4	1.49 mho/m
Measured Body TSL parameters	(22.0 \pm 0.2) °C	54.1 \pm 6 %	1.47 mho/m \pm 6 %
Body TSL temperature change during test	< 0.5 °C	----	----

SAR result with Body TSL

SAR averaged over 1 cm³ (1 g) of Body TSL	Condition	
SAR measured	250 mW input power	8.98 W/kg
SAR for nominal Body TSL parameters	normalized to 1W	36.3 W/kg \pm 17.0 % (k=2)

SAR averaged over 10 cm³ (10 g) of Body TSL	condition	
SAR measured	250 mW input power	4.80 W/kg
SAR for nominal Body TSL parameters	normalized to 1W	19.3 W/kg \pm 16.5 % (k=2)

Appendix (Additional assessments outside the scope of SCS 0108)

Antenna Parameters with Head TSL

Impedance, transformed to feed point	49.2 Ω - 1.9 j Ω
Return Loss	- 33.6 dB

Antenna Parameters with Body TSL

Impedance, transformed to feed point	45.0 Ω - 1.7 j Ω
Return Loss	- 25.2 dB

General Antenna Parameters and Design

Electrical Delay (one direction)	1.222 ns
----------------------------------	----------

After long term use with 100W radiated power, only a slight warming of the dipole near the feedpoint can be measured.

The dipole is made of standard semirigid coaxial cable. The center conductor of the feeding line is directly connected to the second arm of the dipole. The antenna is therefore short-circuited for DC-signals. On some of the dipoles, small end caps are added to the dipole arms in order to improve matching when loaded according to the position as explained in the "Measurement Conditions" paragraph. The SAR data are not affected by this change. The overall dipole length is still according to the Standard.

No excessive force must be applied to the dipole arms, because they might bend or the soldered connections near the feedpoint may be damaged.

Additional EUT Data

Manufactured by	SPEAG
-----------------	-------

DASY5 Validation Report for Head TSL

Date: 12.05.2020

Test Laboratory: SPEAG, Zurich, Switzerland

DUT: Dipole 1750 MHz; Type: D1750V2; Serial: D1750V2 - SN:1148

Communication System: UID 0 - CW; Frequency: 1750 MHz

Medium parameters used: $f = 1750$ MHz; $\sigma = 1.35$ S/m; $\epsilon_r = 40.3$; $\rho = 1000$ kg/m³

Phantom section: Flat Section

Measurement Standard: DASY5 (IEEE/IEC/ANSI C63.19-2011)

DASY52 Configuration:

- Probe: EX3DV4 - SN7349; ConvF(8.76, 8.76, 8.76) @ 1750 MHz; Calibrated: 31.12.2019
- Sensor-Surface: 1.4mm (Mechanical Surface Detection)
- Electronics: DAE4 Sn601; Calibrated: 27.12.2019
- Phantom: Flat Phantom 5.0 (front); Type: QD 000 P50 AA; Serial: 1001
- DASY52 52.10.4(1527); SEMCAD X 14.6.14(7483)

Dipole Calibration for Head Tissue/Pin=250 mW, d=10mm/Zoom Scan (7x7x7)/Cube 0:

Measurement grid: dx=5mm, dy=5mm, dz=5mm

Reference Value = 105.6 V/m; Power Drift = -0.03 dB

Peak SAR (extrapolated) = 16.4 W/kg

SAR(1 g) = 8.88 W/kg; SAR(10 g) = 4.69 W/kg

Smallest distance from peaks to all points 3 dB below = 10 mm

Ratio of SAR at M2 to SAR at M1 = 54.4%

Maximum value of SAR (measured) = 13.8 W/kg

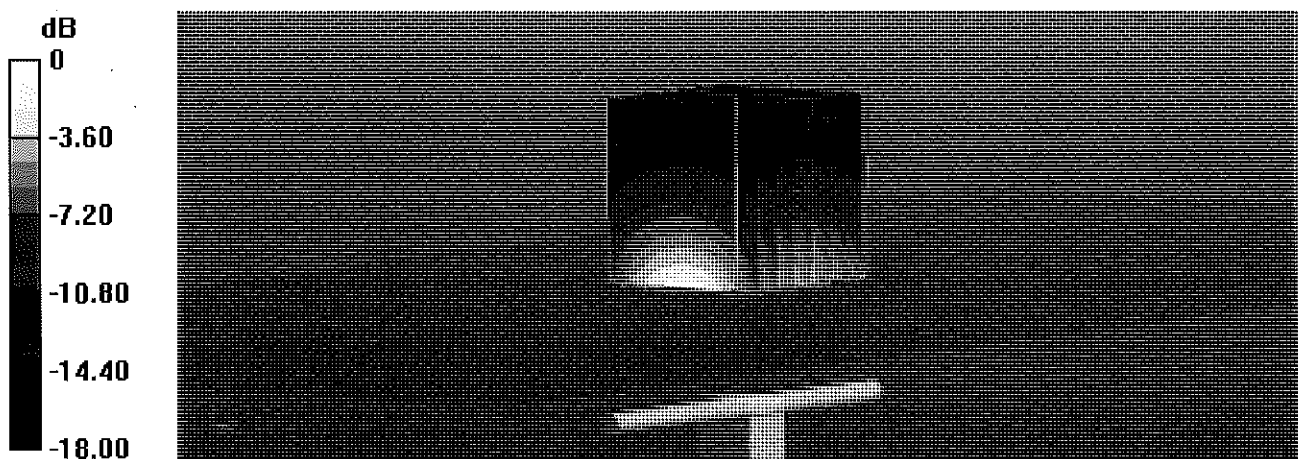

0 dB = 13.8 W/kg = 11.40 dBW/kg

Impedance Measurement Plot for Head TSL

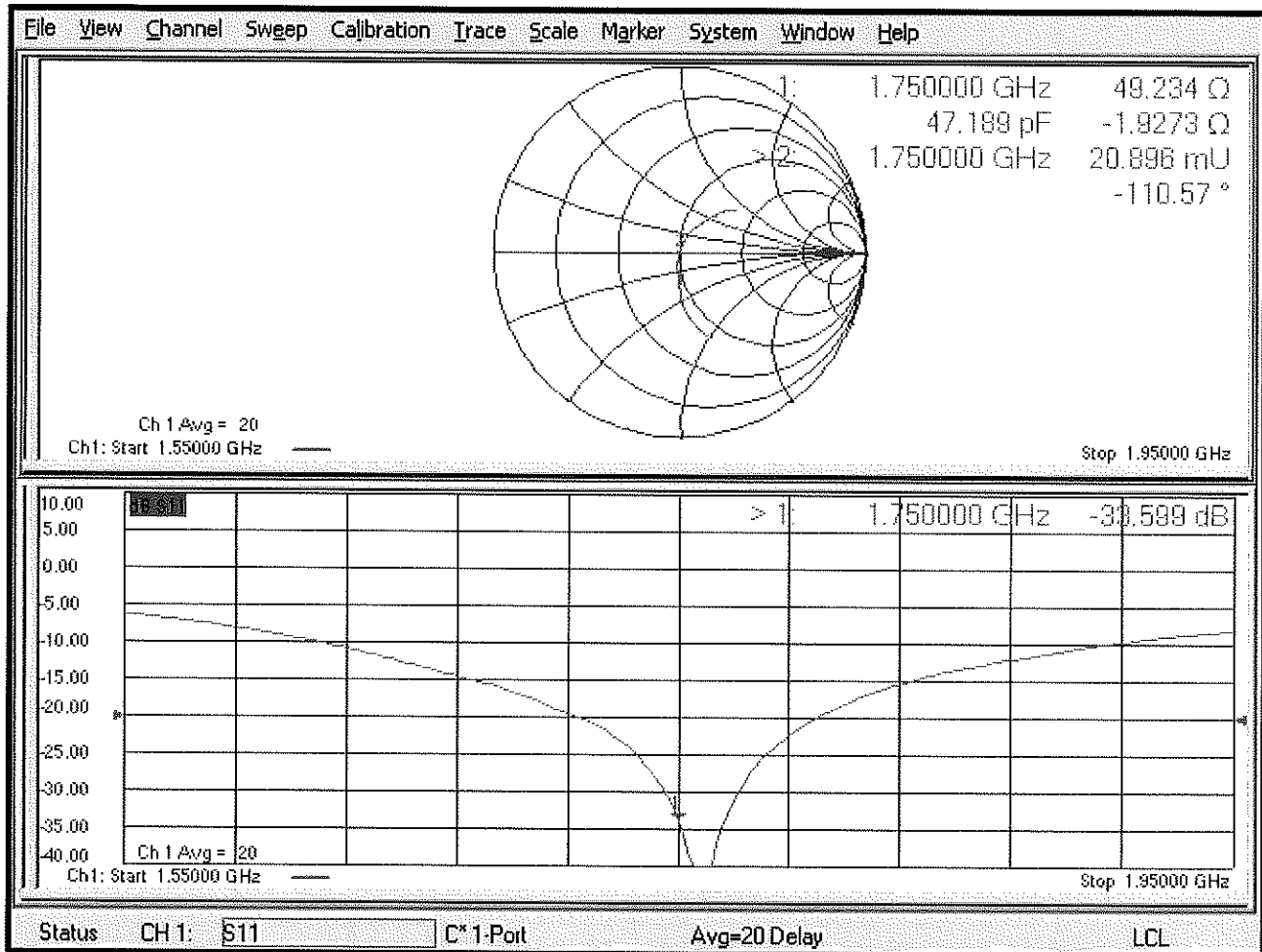

DASY5 Validation Report for Body TSL

Date: 12.05.2020

Test Laboratory: SPEAG, Zurich, Switzerland

DUT: Dipole 1750 MHz; Type: D1750V2; Serial: D1750V2 - SN:1148

Communication System: UID 0 - CW; Frequency: 1750 MHz

Medium parameters used: $f = 1750$ MHz; $\sigma = 1.47$ S/m; $\epsilon_r = 54.1$; $\rho = 1000$ kg/m³

Phantom section: Flat Section

Measurement Standard: DASY5 (IEEE/IEC/ANSI C63.19-2011)

DASY52 Configuration:

- Probe: EX3DV4 - SN7349; ConvF(8.61, 8.61, 8.61) @ 1750 MHz; Calibrated: 31.12.2019
- Sensor-Surface: 1.4mm (Mechanical Surface Detection)
- Electronics: DAE4 Sn601; Calibrated: 27.12.2019
- Phantom: Flat Phantom 5.0 (back); Type: QD 000 P50 AA; Serial: 1002
- DASY52 52.10.4(1527); SEMCAD X 14.6.14(7483)

Dipole Calibration for Body Tissue/Pin=250 mW, d=10mm/Zoom Scan (7x7x7)/Cube 0:

Measurement grid: dx=5mm, dy=5mm, dz=5mm

Reference Value = 99.95 V/m; Power Drift = -0.05 dB

Peak SAR (extrapolated) = 16.1 W/kg

SAR(1 g) = 8.98 W/kg; SAR(10 g) = 4.8 W/kg

Smallest distance from peaks to all points 3 dB below = 10 mm

Ratio of SAR at M2 to SAR at M1 = 57.1%

Maximum value of SAR (measured) = 13.6 W/kg

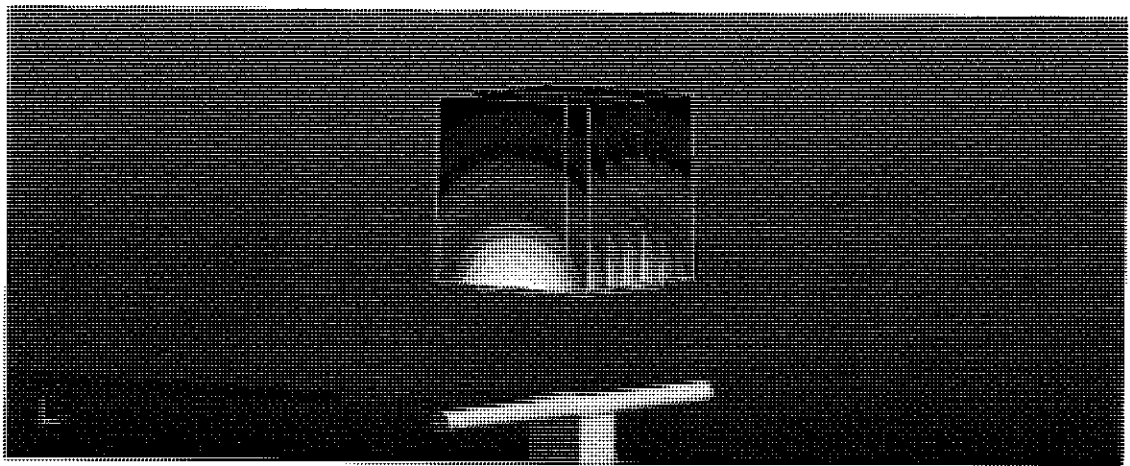
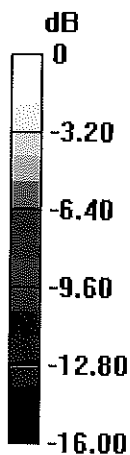

0 dB = 13.6 W/kg = 11.34 dBW/kg

Impedance Measurement Plot for Body TSL

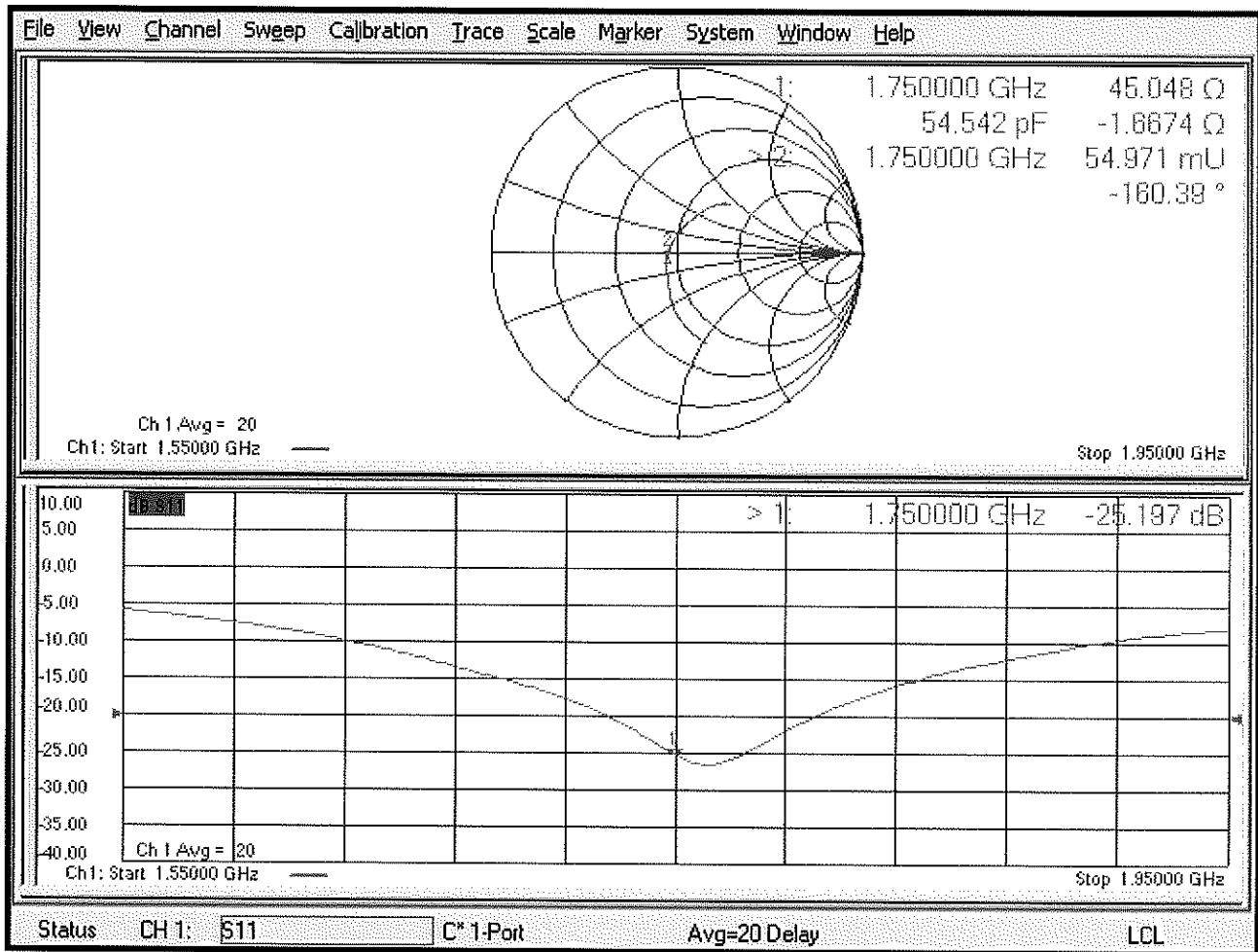

Certification of Calibration

Object: D1750V2 – SN: 1148

Calibration procedure(s): Procedure for Calibration Extension for SAR Dipoles.

Extension Calibration date: 05/12/2021

Description: SAR Validation Dipole at 1750 MHz.

Calibration Equipment used:

Manufacturer	Model	Description	Cal Date	Cal Interval	Cal Due	Serial Number
Control Company	4040	Therm./Clock/Humidity Monitor	6/29/2019	Biennial	6/29/2021	192291470
Control Company	4353	Long Stem Thermometer	10/28/2020	Biennial	10/28/2022	200670623
Amplifier Research	15S1G6	Amplifier	CBT	N/A	CBT	433971
Narda	4772-3	Attenuator (3dB)	CBT	N/A	CBT	9406
Agilent	85033E	3.5mm Standard Calibration Kit	6/6/2020	Annual	6/6/2021	MY53402352
Rohde & Schwarz	ZNLE6	Vector Network Analyzer	9/29/2020	Annual	9/29/2021	101307
Mini-Circuits	BW-N20W5+	DC to 18 GHz Precision Fixed 20 dB Attenuator	CBT	N/A	CBT	N/A
SPEAG	DAK-3.5	Dielectric Assessment Kit	5/12/2020	Annual	5/12/2021	1070
Anritsu	MA2411B	Pulse Power Sensor	8/12/2020	Annual	8/12/2021	1207364
Anritsu	MA2411B	Pulse Power Sensor	9/22/2020	Annual	9/22/2021	1315051
Anritsu	ML2495A	Power Meter	11/3/2020	Annual	11/3/2021	1039008
Anritsu	ML2495A	Power Meter	1/18/2021	Annual	1/18/2022	941001
Agilent	N5182A	MXG Vector Signal Generator	5/13/2020	Annual	5/13/2021	MY47420603
Pasternack	NC-100	Torque Wrench	8/4/2020	Biennial	8/4/2022	N/A
Mini-Circuits	NLP-2950+	Low Pass Filter DC to 2700 MHz	CBT	N/A	CBT	N/A
MiniCircuits	ZHDC-16-63-S+	Bidirectional Coupler	CBT	N/A	CBT	N/A
SPEAG	EX3DV4	SAR Probe	10/20/2020	Annual	10/20/2021	7551
SPEAG	DAE4	Dasy Data Acquisition Electronics	10/16/2020	Annual	10/16/2021	1333

Measurement Uncertainty = $\pm 23\%$ (k=2)

	Name	Function	Signature
Calibrated By:	Hyun Kim	Test Engineer	<i>Hyun Kim</i>
Approved By:	Kaitlin O'Keefe	Senior Technical Manager	<i>KOK</i>

DIPOLE CALIBRATION EXTENSION

Per KDB 865664 D01, calibration intervals of up to three years may be considered for reference dipoles when it is demonstrated that the SAR target, impedance and return loss of a dipole have remained stable according to the following requirements:

1. The measured SAR does not deviate more than 10% from the target on the calibration certificate.
2. The return-loss does not deviate more than 20% from the previous measurement and meets the required 20dB minimum return-loss requirement.
3. The measurement of real or imaginary parts of impedance does not deviate more than 5Ω from the previous measurement.

The following dipole was checked to pass the above 3 requirements to have 2-year calibration period from the calibration date:

Calibration Date	Extension Date	Certificate Electrical Delay (ns)	Certificate SAR Target Head (1g) W/kg @ 20.0 dBm	Measured Head SAR (1g) W/kg @ 20.0 dBm	Deviation 1g (%)	Certificate SAR Target Head (10g) W/kg @ 20.0 dBm	Measured Head SAR (10g) W/kg @ 20.0 dBm	Deviation 10g (%)	Certificate Impedance Head (Ohm) Real	Measured Impedance Head (Ohm) Real	Difference (Ohm) Real	Certificate Impedance Head (Ohm) Imaginary	Measured Impedance Head (Ohm) Imaginary	Difference (Ohm) Imaginary	Certificate Return Loss Head (dB)	Measured Return Loss Head (dB)	Deviation (%)	PASS/FAIL
5/12/2021	5/12/2021	1.222	3.59	3.45	-3.06%	1.89	1.85	-2.12%	49.2	47.8	1.4	-1.9	-1.2	0.7	-33.6	-31.9	5.20%	PASS
Calibration Date	Extension Date	Certificate Electrical Delay (ns)	Certificate SAR Target Body (1g) W/kg @ 20.0 dBm	Measured Body SAR (1g) W/kg @ 20.0 dBm	Deviation 1g (%)	Certificate SAR Target Body (10g) W/kg @ 20.0 dBm	Measured Body SAR (10g) W/kg @ 20.0 dBm	Deviation 10g (%)	Certificate Impedance Body (Ohm) Real	Measured Impedance Body (Ohm) Real	Difference (Ohm) Real	Certificate Impedance Body (Ohm) Imaginary	Measured Impedance Body (Ohm) Imaginary	Difference (Ohm) Imaginary	Certificate Return Loss Body (dB)	Measured Return Loss Body (dB)	Deviation (%)	PASS/FAIL
5/12/2021	5/12/2021	1.222	3.63	3.84	5.79%	1.93	2.02	4.66%	45.0	44.0	1	-1.7	-1.9	0.2	-25.2	-23.9	5.30%	PASS

Impedance & Return-Loss Measurement Plot for Head TSL

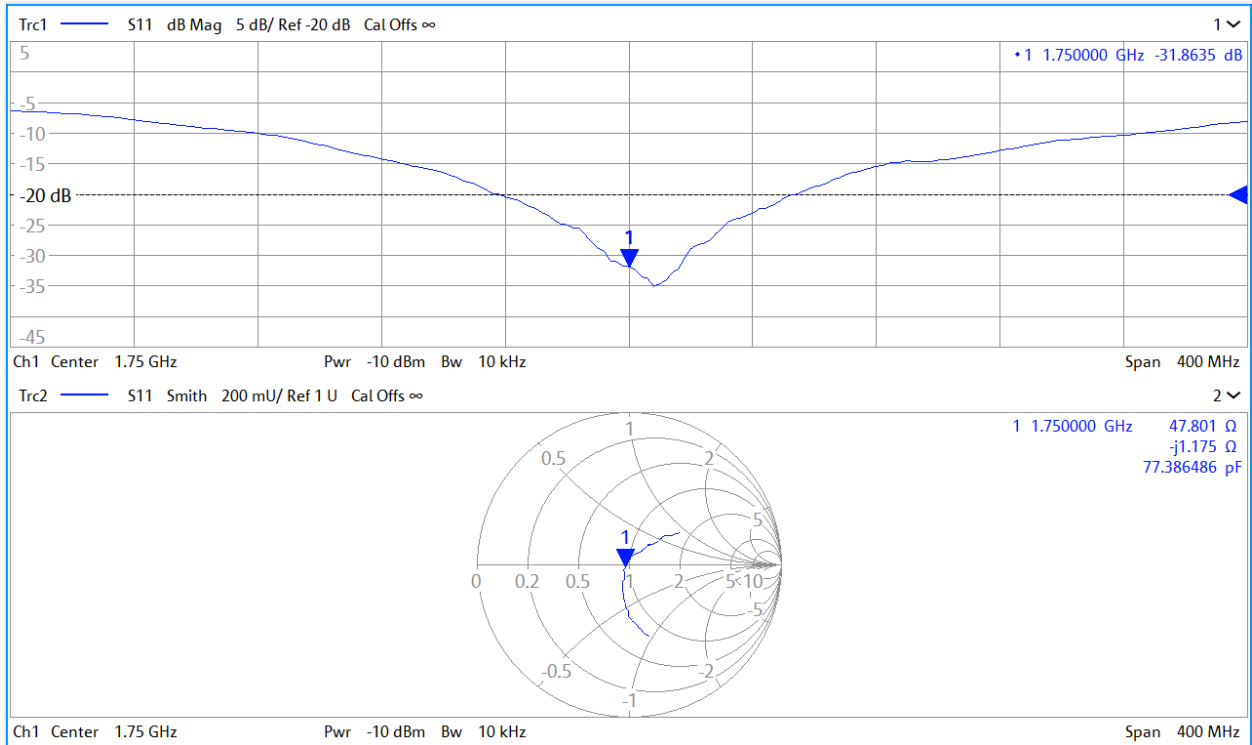

Impedance & Return-Loss Measurement Plot for Body TSL

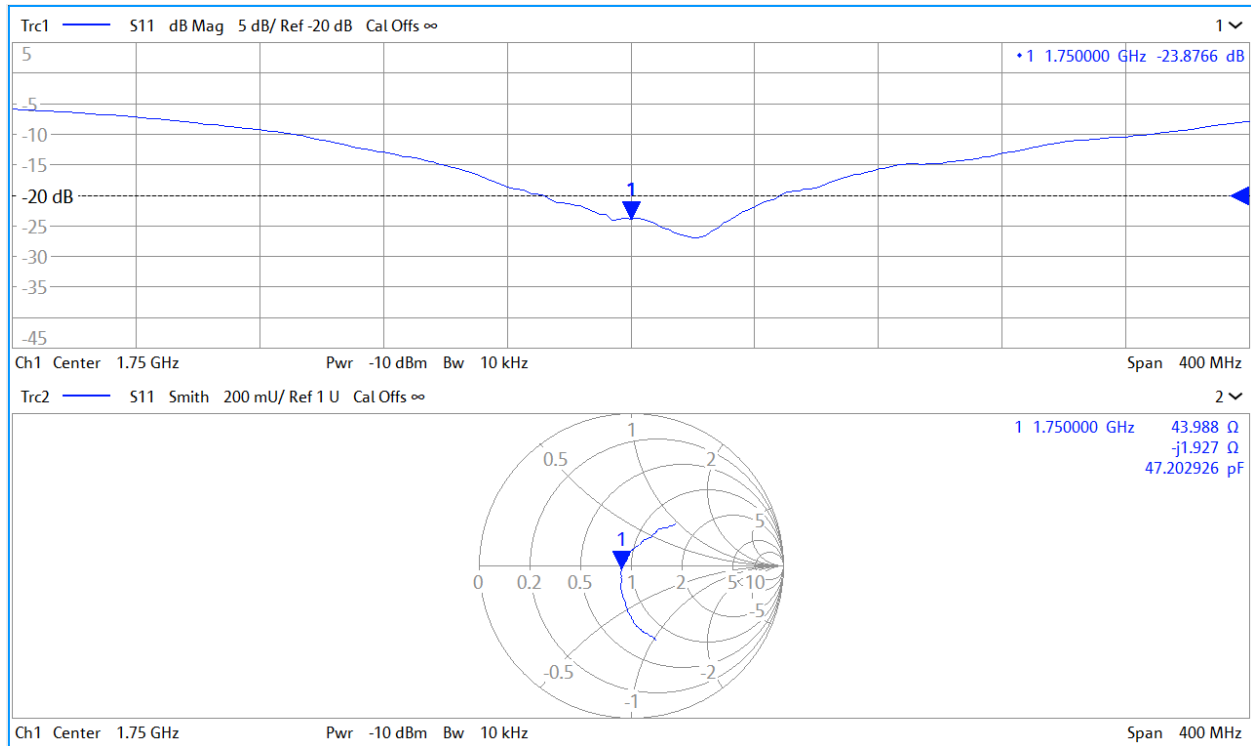



Accredited by the Swiss Accreditation Service (SAS)
The Swiss Accreditation Service is one of the signatories to the EA
Multilateral Agreement for the recognition of calibration certificates

Accreditation No.: **SCS 0108**

Client **PC Test**

Certificate No.: **D1750V2-1150_Oct18**

CALIBRATION CERTIFICATE

Object **D1750V2 - SN:1150**

Calibration procedure(s) **QA CAL-05.v10
Calibration procedure for dipole validation kits above 700 MHz**

Calibration date: **October 22, 2018**

BNV
10/30/2018
BNV
10-20-2019
BNV
10-23-20

This calibration certificate documents the traceability to national standards, which realize the physical units of measurements (SI).
The measurements and the uncertainties with confidence probability are given on the following pages and are part of the certificate.

All calibrations have been conducted in the closed laboratory facility: environment temperature (22 ± 3)°C and humidity < 70%.

Calibration Equipment used (M&TE critical for calibration)

Primary Standards	ID #	Cal Date (Certificate No.)	Scheduled Calibration
Power meter NRP	SN: 104778	04-Apr-18 (No. 217-02672/02673)	Apr-19
Power sensor NRP-Z91	SN: 103244	04-Apr-18 (No. 217-02672)	Apr-19
Power sensor NRP-Z91	SN: 103245	04-Apr-18 (No. 217-02673)	Apr-19
Reference 20 dB Attenuator	SN: 5058 (20k)	04-Apr-18 (No. 217-02682)	Apr-19
Type-N mismatch combination	SN: 5047.2 / 06327	04-Apr-18 (No. 217-02683)	Apr-19
Reference Probe EX3DV4	SN: 7349	30-Dec-17 (No. EX3-7349_Dec17)	Dec-18
DAE4	SN: 601	04-Oct-18 (No. DAE4-601_Oct18)	Oct-19

Secondary Standards	ID #	Check Date (in house)	Scheduled Check
Power meter EPM-442A	SN: GB37480704	07-Oct-15 (in house check Oct-18)	In house check: Oct-20
Power sensor HP 8481A	SN: US37292783	07-Oct-15 (in house check Oct-18)	In house check: Oct-20
Power sensor HP 8481A	SN: MY41092317	07-Oct-15 (in house check Oct-18)	In house check: Oct-20
RF generator R&S SMT-06	SN: 100972	15-Jun-15 (in house check Oct-18)	In house check: Oct-20
Network Analyzer Agilent E8358A	SN: US41080477	31-Mar-14 (in house check Oct-18)	In house check: Oct-19

Calibrated by: **Michael Weber** (Name) / **Laboratory Technician** (Function) / *M. Weber* (Signature)

Approved by: **Katja Pokovic** (Name) / **Technical Manager** (Function) / *K. Pokovic* (Signature)

Issued: October 22, 2018

This calibration certificate shall not be reproduced except in full without written approval of the laboratory.



Accredited by the Swiss Accreditation Service (SAS)
The Swiss Accreditation Service is one of the signatories to the EA
Multilateral Agreement for the recognition of calibration certificates

Accreditation No.: **SCS 0108**

Glossary:

TSL	tissue simulating liquid
ConvF	sensitivity in TSL / NORM x,y,z
N/A	not applicable or not measured

Calibration is Performed According to the Following Standards:

- IEEE Std 1528-2013, "IEEE Recommended Practice for Determining the Peak Spatial-Averaged Specific Absorption Rate (SAR) in the Human Head from Wireless Communications Devices: Measurement Techniques", June 2013
- IEC 62209-1, "Measurement procedure for the assessment of Specific Absorption Rate (SAR) from hand-held and body-mounted devices used next to the ear (frequency range of 300 MHz to 6 GHz)", July 2016
- IEC 62209-2, "Procedure to determine the Specific Absorption Rate (SAR) for wireless communication devices used in close proximity to the human body (frequency range of 30 MHz to 6 GHz)", March 2010
- KDB 865664, "SAR Measurement Requirements for 100 MHz to 6 GHz"

Additional Documentation:

- DASY4/5 System Handbook

Methods Applied and Interpretation of Parameters:

- Measurement Conditions:** Further details are available from the Validation Report at the end of the certificate. All figures stated in the certificate are valid at the frequency indicated.
- Antenna Parameters with TSL:** The dipole is mounted with the spacer to position its feed point exactly below the center marking of the flat phantom section, with the arms oriented parallel to the body axis.
- Feed Point Impedance and Return Loss:** These parameters are measured with the dipole positioned under the liquid filled phantom. The impedance stated is transformed from the measurement at the SMA connector to the feed point. The Return Loss ensures low reflected power. No uncertainty required.
- Electrical Delay:** One-way delay between the SMA connector and the antenna feed point. No uncertainty required.
- SAR measured:** SAR measured at the stated antenna input power.
- SAR normalized:** SAR as measured, normalized to an input power of 1 W at the antenna connector.
- SAR for nominal TSL parameters:** The measured TSL parameters are used to calculate the nominal SAR result.

The reported uncertainty of measurement is stated as the standard uncertainty of measurement multiplied by the coverage factor $k=2$, which for a normal distribution corresponds to a coverage probability of approximately 95%.

Measurement Conditions

DASY system configuration, as far as not given on page 1.

DASY Version	DASY5	V52.10.2
Extrapolation	Advanced Extrapolation	
Phantom	Modular Flat Phantom	
Distance Dipole Center - TSL	10 mm	with Spacer
Zoom Scan Resolution	dx, dy, dz = 5 mm	
Frequency	1750 MHz \pm 1 MHz	

Head TSL parameters

The following parameters and calculations were applied.

	Temperature	Permittivity	Conductivity
Nominal Head TSL parameters	22.0 °C	40.1	1.37 mho/m
Measured Head TSL parameters	(22.0 \pm 0.2) °C	38.8 \pm 6 %	1.33 mho/m \pm 6 %
Head TSL temperature change during test	< 0.5 °C	----	----

SAR result with Head TSL

SAR averaged over 1 cm³ (1 g) of Head TSL	Condition	
SAR measured	250 mW input power	9.02 W/kg
SAR for nominal Head TSL parameters	normalized to 1W	36.5 W/kg \pm 17.0 % (k=2)

SAR averaged over 10 cm³ (10 g) of Head TSL	condition	
SAR measured	250 mW input power	4.76 W/kg
SAR for nominal Head TSL parameters	normalized to 1W	19.2 W/kg \pm 16.5 % (k=2)

Body TSL parameters

The following parameters and calculations were applied.

	Temperature	Permittivity	Conductivity
Nominal Body TSL parameters	22.0 °C	53.4	1.49 mho/m
Measured Body TSL parameters	(22.0 \pm 0.2) °C	53.5 \pm 6 %	1.46 mho/m \pm 6 %
Body TSL temperature change during test	< 0.5 °C	----	----

SAR result with Body TSL

SAR averaged over 1 cm³ (1 g) of Body TSL	Condition	
SAR measured	250 mW input power	9.04 W/kg
SAR for nominal Body TSL parameters	normalized to 1W	36.6 W/kg \pm 17.0 % (k=2)

SAR averaged over 10 cm³ (10 g) of Body TSL	condition	
SAR measured	250 mW input power	4.82 W/kg
SAR for nominal Body TSL parameters	normalized to 1W	19.4 W/kg \pm 16.5 % (k=2)

Appendix (Additional assessments outside the scope of SCS 0108)

Antenna Parameters with Head TSL

Impedance, transformed to feed point	50.9 Ω - 0.4 j Ω
Return Loss	- 40.1 dB

Antenna Parameters with Body TSL

Impedance, transformed to feed point	46.6 Ω - 0.1 j Ω
Return Loss	- 29.2 dB

General Antenna Parameters and Design

Electrical Delay (one direction)	1.217 ns
----------------------------------	----------

After long term use with 100W radiated power, only a slight warming of the dipole near the feedpoint can be measured.

The dipole is made of standard semirigid coaxial cable. The center conductor of the feeding line is directly connected to the second arm of the dipole. The antenna is therefore short-circuited for DC-signals. On some of the dipoles, small end caps are added to the dipole arms in order to improve matching when loaded according to the position as explained in the "Measurement Conditions" paragraph. The SAR data are not affected by this change. The overall dipole length is still according to the Standard.

No excessive force must be applied to the dipole arms, because they might bend or the soldered connections near the feedpoint may be damaged.

Additional EUT Data

Manufactured by	SPEAG
Manufactured on	April 10, 2015

DASY5 Validation Report for Head TSL

Date: 22.10.2018

Test Laboratory: SPEAG, Zurich, Switzerland

DUT: Dipole 1750 MHz; Type: D1750V2; Serial: D1750V2 - SN:1150

Communication System: UID 0 - CW; Frequency: 1750 MHz

Medium parameters used: $f = 1750$ MHz; $\sigma = 1.33$ S/m; $\epsilon_r = 38.8$; $\rho = 1000$ kg/m³

Phantom section: Flat Section

Measurement Standard: DASY5 (IEEE/IEC/ANSI C63.19-2011)

DASY52 Configuration:

- Probe: EX3DV4 - SN7349; ConvF(8.5, 8.5, 8.5) @ 1750 MHz; Calibrated: 30.12.2017
- Sensor-Surface: 1.4mm (Mechanical Surface Detection)
- Electronics: DAE4 Sn601; Calibrated: 04.10.2018
- Phantom: Flat Phantom 5.0 (front); Type: QD 000 P50 AA; Serial: 1001
- DASY52 52.10.2(1495); SEMCAD X 14.6.12(7450)

Dipole Calibration for Head Tissue/Pin=250 mW, d=10mm/Zoom Scan (7x7x7)/Cube 0:

Measurement grid: dx=5mm, dy=5mm, dz=5mm

Reference Value = 108.1 V/m; Power Drift = -0.09 dB

Peak SAR (extrapolated) = 16.7 W/kg

SAR(1 g) = 9.02 W/kg; SAR(10 g) = 4.76 W/kg

Maximum value of SAR (measured) = 14.0 W/kg

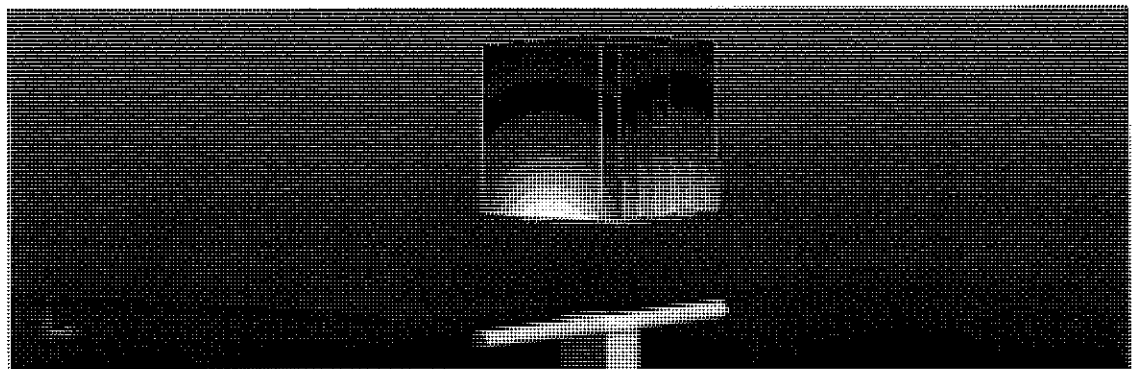
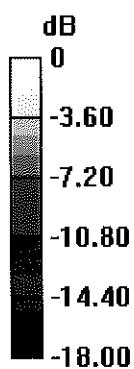

0 dB = 14.0 W/kg = 11.46 dBW/kg

Impedance Measurement Plot for Head TSL

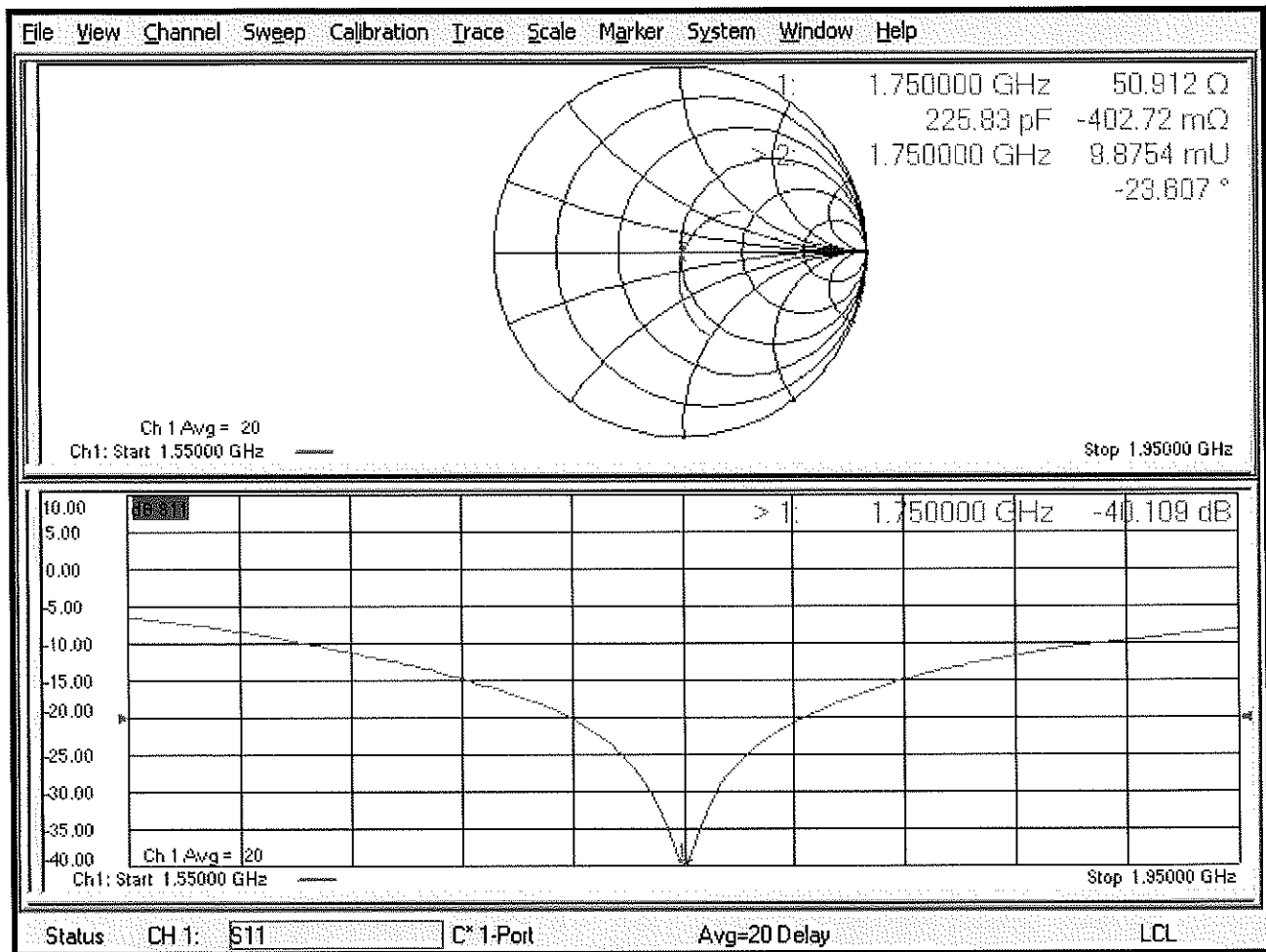

DASY5 Validation Report for Body TSL

Date: 22.10.2018

Test Laboratory: SPEAG, Zurich, Switzerland

DUT: Dipole 1750 MHz; Type: D1750V2; Serial: D1750V2 - SN:1150

Communication System: UID 0 - CW; Frequency: 1750 MHz

Medium parameters used: $f = 1750$ MHz; $\sigma = 1.46$ S/m; $\epsilon_r = 53.5$; $\rho = 1000$ kg/m³

Phantom section: Flat Section

Measurement Standard: DASY5 (IEEE/IEC/ANSI C63.19-2011)

DASY52 Configuration:

- Probe: EX3DV4 - SN7349; ConvF(8.35, 8.35, 8.35) @ 1750 MHz; Calibrated: 30.12.2017
- Sensor-Surface: 1.4mm (Mechanical Surface Detection)
- Electronics: DAE4 Sn601; Calibrated: 04.10.2018
- Phantom: Flat Phantom 5.0 (back); Type: QD 000 P50 AA; Serial: 1002
- DASY52 52.10.2(1495); SEMCAD X 14.6.12(7450)

Dipole Calibration for Body Tissue/Pin=250 mW, d=10mm/Zoom Scan (7x7x7)/Cube 0:

Measurement grid: dx=5mm, dy=5mm, dz=5mm

Reference Value = 102.1 V/m; Power Drift = -0.09 dB

Peak SAR (extrapolated) = 16.0 W/kg

SAR(1 g) = 9.04 W/kg; SAR(10 g) = 4.82 W/kg

Maximum value of SAR (measured) = 13.6 W/kg

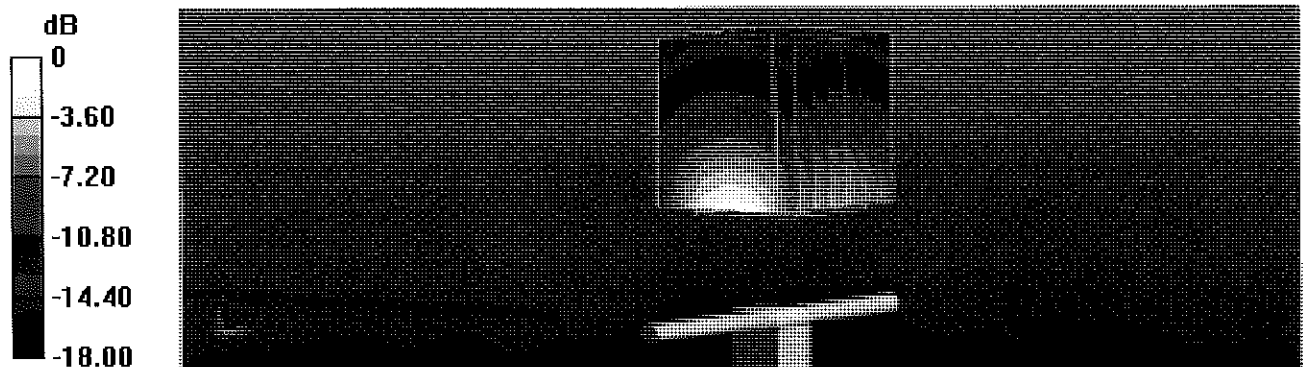

0 dB = 13.6 W/kg = 11.34 dBW/kg

Impedance Measurement Plot for Body TSL

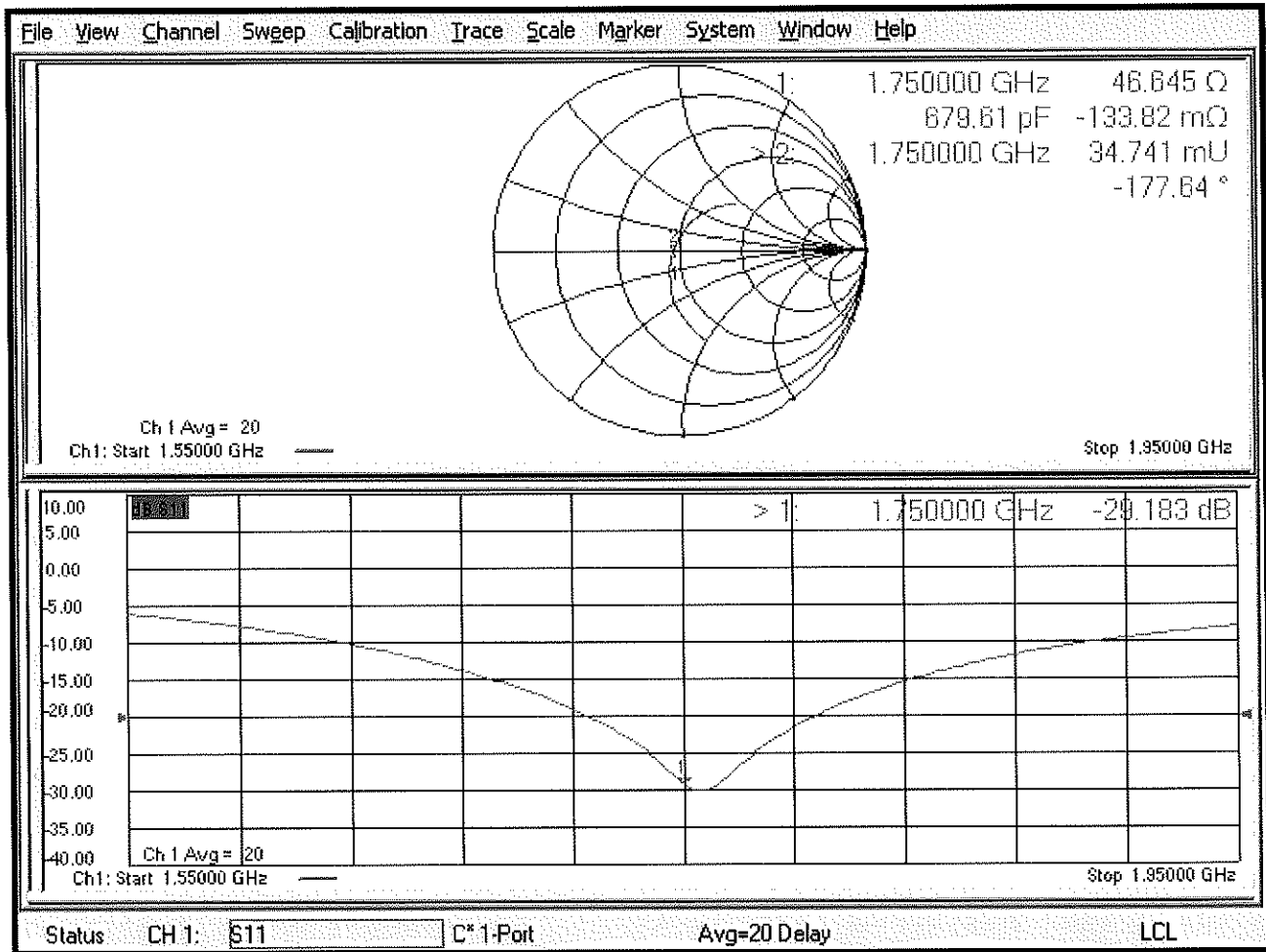

Certification of Calibration

Object D1750V2 – SN:1150
 Calibration procedure(s) Procedure for Calibration Extension for SAR Dipoles.
 Extended Calibration date: October 18, 2019
 Description: SAR Validation Dipole at 1750 MHz.

Calibration Equipment used:

Manufacturer	Model	Description	Cal Date	Cal Interval	Cal Due	Serial Number
Control Company	4040	Therm./Clock/Humidity Monitor	6/29/2019	Biennial	6/29/2021	192291470
Control Company	4352	Ultra Long Stem Thermometer	8/2/2018	Biennial	8/2/2020	181334684
Amplifier Research	15S1G6	Amplifier	CBT	N/A	CBT	433971
Narda	4772-3	Attenuator (3dB)	CBT	N/A	CBT	9406
Keysight Technologies	85033E	Standard Mechanical Calibration Kit (DC to 9GHz, 3.5mm)	7/2/2019	Annual	7/2/2020	MY53401181
Rohde & Schwarz	ZNLE6	Vector Network Analyzer	10/11/2019	Annual	10/11/2020	101307
Mini-Circuits	BW-N20W5+	DC to 18 GHz Precision Fixed 20 dB Attenuator	CBT	N/A	CBT	N/A
SPEAG	DAK5-3.5	Portable Dielectric Assessment Kit	8/13/2019	Annual	8/13/2020	1041
Anritsu	MA2411B	Pulse Power Sensor	8/14/2019	Annual	8/14/2020	1315051
Anritsu	MA2411B	Pulse Power Sensor	8/8/2019	Annual	8/8/2020	1339008
Anritsu	ML2495A	Power Meter	11/20/2018	Annual	11/20/2019	1039008
Agilent	N5182A	MXG Vector Signal Generator	8/19/2019	Annual	8/19/2020	MY47420837
Seekonk	NC-100	Torque Wrench	5/9/2018	Biennial	5/9/2020	22217
Mini-Circuits	NLP-2950+	Low Pass Filter DC to 2700 MHz	CBT	N/A	CBT	N/A
MiniCircuits	ZHDC-16-63-S+	Bidirectional Coupler	CBT	N/A	CBT	N/A
MiniCircuits	VLF-6000+	Low Pass Filter	CBT	N/A	CBT	N/A
SPEAG	EX3DV4	SAR Probe	8/16/2019	Annual	8/16/2020	7308
SPEAG	EX3DV4	SAR Probe	4/24/2019	Annual	4/24/2020	7357
SPEAG	DAE4	Dasy Data Acquisition Electronics	4/18/2019	Annual	4/18/2020	1407
SPEAG	DAE4	Dasy Data Acquisition Electronics	8/14/2019	Annual	8/14/2020	1450

Note: CBT (Calibrated Before Testing). Prior to testing, the measurement paths containing a cable, amplifier, attenuator, coupler or filter were connected to a calibrated source (i.e. a signal generator) to determine the losses of the measurement path.

Measurement Uncertainty = $\pm 23\%$ (k=2)

	Name	Function	Signature
Calibrated By:	Brodie Halfoster	Team Lead Engineer	<i>BRODIE HALBFOSTER</i>
Approved By:	Kaitlin O'Keefe	Senior Technical Manager	<i>KOK</i>

DIPOLE CALIBRATION EXTENSION

Per KDB 865664 D01, calibration intervals of up to three years may be considered for reference dipoles when it is demonstrated that the SAR target, impedance and return loss of a dipole have remained stable according to the following requirements:

1. The measured SAR does not deviate more than 10% from the target on the calibration certificate.
2. The return-loss does not deviate more than 20% from the previous measurement and meets the required 20dB minimum return-loss requirement.
3. The measurement of real or imaginary parts of impedance does not deviate more than 5Ω from the previous measurement.

The following dipole was checked to pass the above 3 requirements to have 2-year calibration period from the calibration date:

Calibration Date	Extension Date	Certificate Electrical Delay (ms)	Certificate SAR Target Head (1g) W/kg @ 20.0 dBm	Measured Head SAR (1g) W/kg @ 20.0 dBm	Deviation 1g (%)	Certificate SAR Target Head (10g) W/kg @ 20.0 dBm	Measured Head SAR (10g) W/kg @ 20.0 dBm	Deviation 10g (%)	Certificate Impedance Head (Ohm) Real	Measured Impedance Head (Ohm) Real	Difference (Ohm) Real	Certificate Impedance Head (Ohm) Imaginary	Measured Impedance Head (Ohm) Imaginary	Difference (Ohm) Imaginary	Certificate Return Loss Head (dB)	Measured Return Loss Head (dB)	Deviation (%)	PASS/FAIL
10/22/2018	10/18/2019	1.217	3.65	3.8	4.11%	1.92	2	4.17%	50.9	49.3	1.6	0.4	-0.7	1.1	-40.1	-40.2	-0.20%	PASS
Calibration Date	Extension Date	Certificate Electrical Delay (ms)	Certificate SAR Target Body (1g) W/kg @ 20.0 dBm	Measured Body SAR (1g) W/kg @ 20.0 dBm	Deviation 1g (%)	Certificate SAR Target Body (10g) W/kg @ 20.0 dBm	Measured Body SAR (10g) W/kg @ 20.0 dBm	Deviation 10g (%)	Certificate Impedance Body (Ohm) Real	Measured Impedance Body (Ohm) Real	Difference (Ohm) Real	Certificate Impedance Body (Ohm) Imaginary	Measured Impedance Body (Ohm) Imaginary	Difference (Ohm) Imaginary	Certificate Return Loss Body (dB)	Measured Return Loss Body (dB)	Deviation (%)	PASS/FAIL
10/22/2018	10/18/2019	1.217	3.66	3.82	4.37%	1.94	2.02	4.12%	46.6	44.7	1.9	-0.1	-0.8	0.7	-29.2	-25	14.40%	PASS

Impedance & Return-Loss Measurement Plot for Head TSL

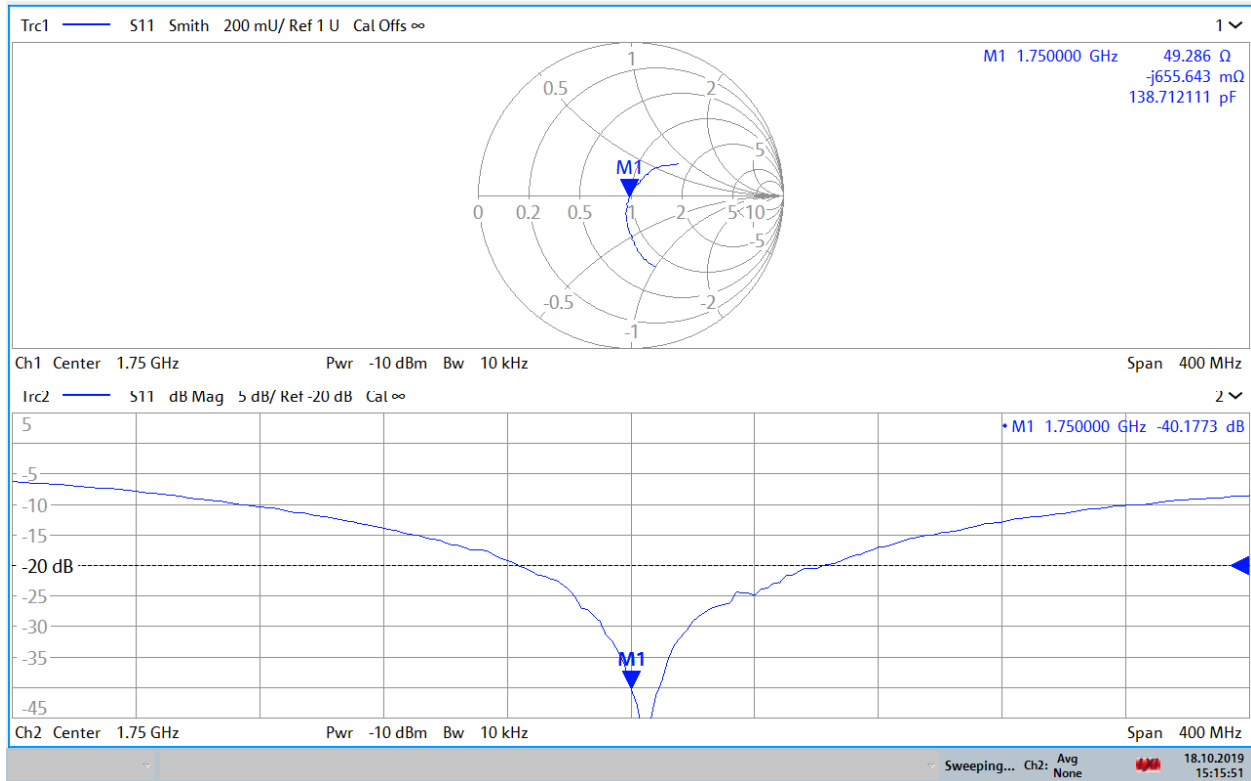

15:15:52 18.10.2019

Impedance & Return-Loss Measurement Plot for Body TSL

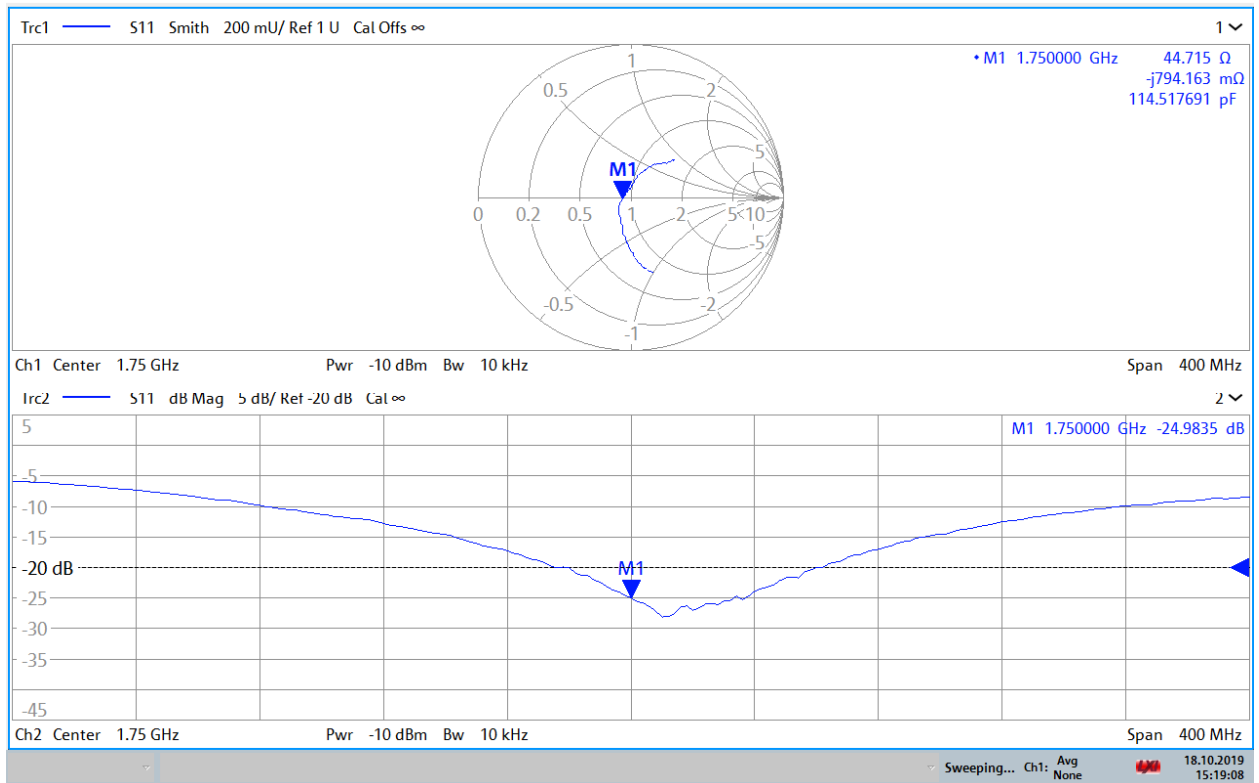

15:19:09 18.10.2019

Certification of Calibration

Object: D1750V2 – SN: 1150

Calibration procedure(s): Procedure for Calibration Extension for SAR Dipoles.

Extension Calibration date: 10/18/2020

Description: SAR Validation Dipole at 1750 MHz.

Calibration Equipment used:

Manufacturer	Model	Description	Cal Date	Cal Interval	Cal Due	Serial Number
Control Company	4040	Therm./Clock/Humidity Monitor	6/29/2019	Biennial	6/29/2021	192291470
Control Company	4352	Ultra Long Stem Thermometer	11/29/2018	Biennial	11/29/2020	181766816
Amplifier Research	15S1G6	Amplifier	CBT	N/A	CBT	433971
Narda	4772-3	Attenuator (3dB)	CBT	N/A	CBT	9406
Agilent	85033E	3.5mm Standard Calibration Kit	6/6/2020	Annual	6/6/2021	MY53402352
Rohde & Schwarz	ZNLE6	Vector Network Analyzer	9/29/2020	Annual	9/29/2021	101307
Mini-Circuits	BW-N20W5+	DC to 18 GHz Precision Fixed 20 dB Attenuator	CBT	N/A	CBT	N/A
SPEAG	DAK-3.5	Dielectric Assessment Kit	5/12/2020	Annual	5/12/2021	1070
Anritsu	MA2411B	Pulse Power Sensor	8/12/2020	Annual	8/12/2021	1207364
Anritsu	MA2411B	Pulse Power Sensor	9/22/2020	Annual	9/22/2021	1315051
Anritsu	ML2495A	Power Meter	1/15/2020	Annual	1/15/2021	1328004
Anritsu	ML2495A	Power Meter	12/17/2019	Annual	12/17/2020	941001
Agilent	N5182A	MXG Vector Signal Generator	5/13/2020	Annual	5/13/2021	MY47420603
Pasternack	NC-100	Torque Wrench	8/4/2020	Biennial	8/4/2022	N/A
Mini-Circuits	NLP-2950+	Low Pass Filter DC to 2700 MHz	CBT	N/A	CBT	N/A
MiniCircuits	ZHDC-16-63-S+	Bidirectional Coupler	CBT	N/A	CBT	N/A
SPEAG	EX3DV4	SAR Probe	7/31/2020	Annual	7/31/2021	7308
SPEAG	EX3DV4	SAR Probe	6/23/2020	Annual	6/23/2021	7406
SPEAG	DAE4	Dasy Data Acquisition Electronics	8/11/2020	Annual	8/11/2021	1450
SPEAG	DAE4	Dasy Data Acquisition Electronics	5/14/2020	Annual	5/14/2021	1583

Measurement Uncertainty = $\pm 23\%$ (k=2)

	Name	Function	Signature
Calibrated By:	Brodie Halfoster	Test Engineer	<i>BRODIE HALFOSTER</i>
Approved By:	Kaitlin O'Keefe	Senior Technical Manager	<i>KOK</i>

DIPOLE CALIBRATION EXTENSION

Per KDB 865664 D01, calibration intervals of up to three years may be considered for reference dipoles when it is demonstrated that the SAR target, impedance and return loss of a dipole have remained stable according to the following requirements:

1. The measured SAR does not deviate more than 10% from the target on the calibration certificate.
2. The return-loss does not deviate more than 20% from the previous measurement and meets the required 20dB minimum return-loss requirement.
3. The measurement of real or imaginary parts of impedance does not deviate more than 5Ω from the previous measurement.

The following dipole was checked to pass the above 3 requirements to have 3-year calibration period from the calibration date:

Calibration Date	Extension Date	Certificate Electrical Delay (ns)	Certificate SAR Target Head (1g) W/kg @ 20.0 dBm	Measured Head SAR (1g) W/kg @ 20.0 dBm	Deviation 1g (%)	Certificate SAR Target Head (10g) W/kg @ 20.0 dBm	Measured Head SAR (10g) W/kg @ 20.0 dBm	Deviation 10g (%)	Certificate Impedance Head (Ohm) Real	Measured Impedance Head (Ohm) Real	Difference (Ohm) Real	Certificate Impedance Head (Ohm) Imaginary	Measured Impedance Head (Ohm) Imaginary	Difference (Ohm) Imaginary	Certificate Return Loss Head (dB)	Measured Return Loss Head (dB)	Deviation (%)	PASS/FAIL
10/22/2018	10/18/2020	1.217	3.65	3.72	1.92%	1.92	1.96	2.08%	50.9	48.7	2.2	0.4	0.6	0.2	-40.1	-37.5	6.50%	PASS
Calibration Date	Extension Date	Certificate Electrical Delay (ns)	Certificate SAR Target Body (1g) W/kg @ 20.0 dBm	Measured Body SAR (1g) W/kg @ 20.0 dBm	Deviation 1g (%)	Certificate SAR Target Body (10g) W/kg @ 20.0 dBm	Measured Body SAR (10g) W/kg @ 20.0 dBm	Deviation 10g (%)	Certificate Impedance Body (Ohm) Real	Measured Impedance Body (Ohm) Real	Difference (Ohm) Real	Certificate Impedance Body (Ohm) Imaginary	Measured Impedance Body (Ohm) Imaginary	Difference (Ohm) Imaginary	Certificate Return Loss Body (dB)	Measured Return Loss Body (dB)	Deviation (%)	PASS/FAIL
10/22/2018	10/18/2020	1.217	3.66	3.79	3.65%	1.94	1.97	1.55%	46.6	45.8	0.8	-0.1	0.4	0.5	-29.2	-27.1	7.10%	PASS

Impedance & Return-Loss Measurement Plot for Head TSL

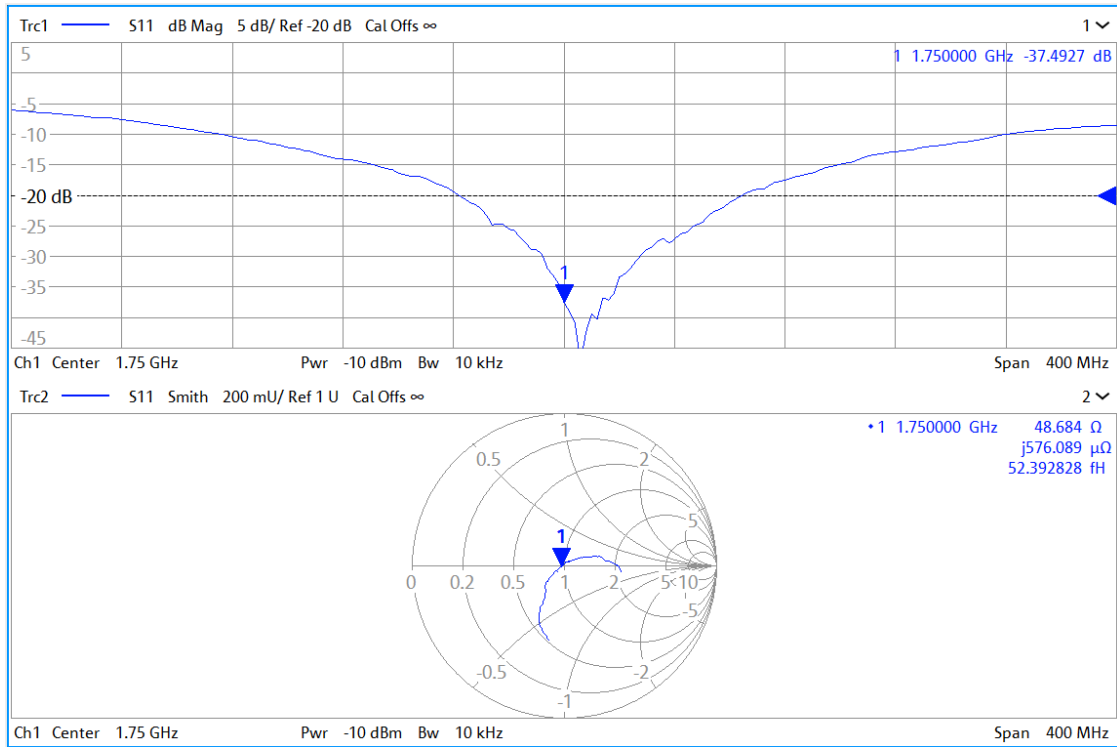

Impedance & Return-Loss Measurement Plot for Body TSL

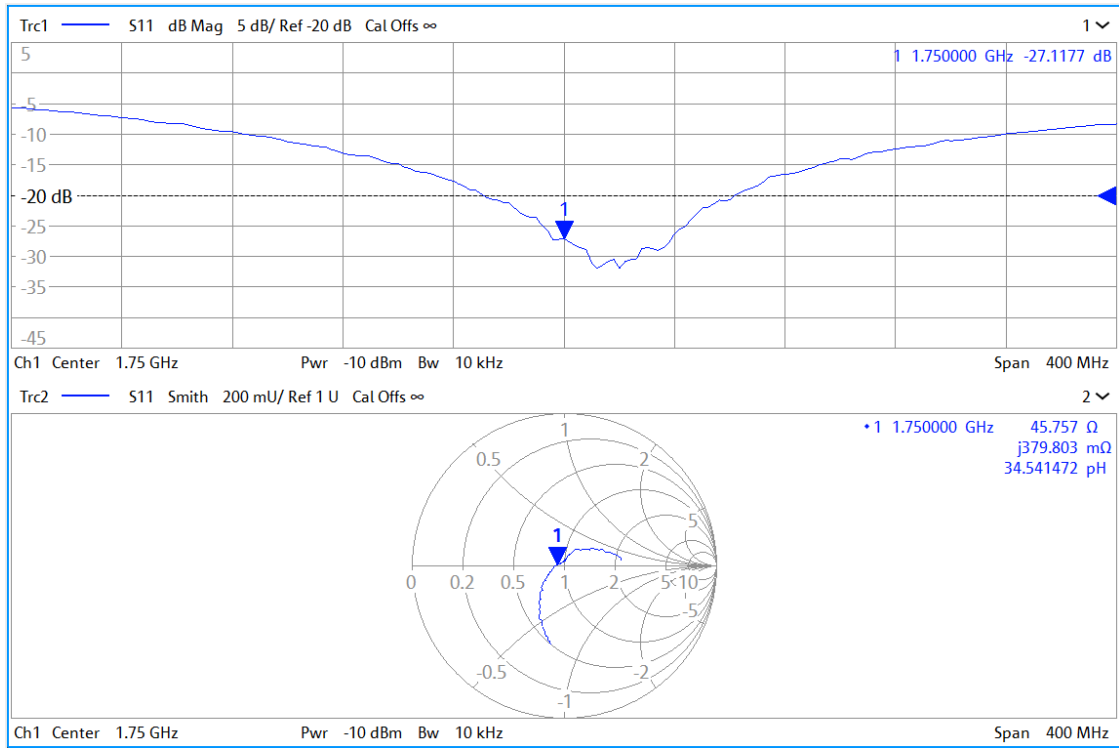



Accredited by the Swiss Accreditation Service (SAS)
The Swiss Accreditation Service is one of the signatories to the EA
Multilateral Agreement for the recognition of calibration certificates

Accreditation No.: **SCS 0108**

Client **PC Test**

Certificate No: **D1900V2-5d080_Oct18**

CALIBRATION CERTIFICATE

Object **D1900V2 - SN:5d080**

Calibration procedure(s) **QA CAL-05 v10
Calibration procedure for dipole validation kits above 700 MHz**

Calibration date: **October 23, 2018**

*BN ✓
10-30-2018
BN ✓
10-20-2019
BN ✓
10-23-20*

This calibration certificate documents the traceability to national standards, which realize the physical units of measurements (SI).
The measurements and the uncertainties with confidence probability are given on the following pages and are part of the certificate.

All calibrations have been conducted in the closed laboratory facility: environment temperature (22 ± 3)°C and humidity < 70%.

Calibration Equipment used (M&TE critical for calibration)

Primary Standards	ID #	Cal Date (Certificate No.)	Scheduled Calibration
Power meter NRP	SN: 104778	04-Apr-18 (No. 217-02672/02673)	Apr-19
Power sensor NRP-Z91	SN: 103244	04-Apr-18 (No. 217-02672)	Apr-19
Power sensor NRP-Z91	SN: 103245	04-Apr-18 (No. 217-02673)	Apr-19
Reference 20 dB Attenuator	SN: 5058 (20k)	04-Apr-18 (No. 217-02682)	Apr-19
Type-N mismatch combination	SN: 5047.2 / 06327	04-Apr-18 (No. 217-02683)	Apr-19
Reference Probe EX3DV4	SN: 7349	30-Dec-17 (No. EX3-7349_Dec17)	Dec-18
DAE4	SN: 601	04-Oct-18 (No. DAE4-601_Oct18)	Oct-19

Secondary Standards	ID #	Check Date (in house)	Scheduled Check
Power meter EPM-442A	SN: GB37480704	07-Oct-15 (in house check Oct-18)	In house check: Oct-20
Power sensor HP 8481A	SN: US37292783	07-Oct-15 (in house check Oct-18)	In house check: Oct-20
Power sensor HP 8481A	SN: MY41092317	07-Oct-15 (in house check Oct-18)	In house check: Oct-20
RF generator R&S SMT-06	SN: 100972	15-Jun-15 (in house check Oct-18)	In house check: Oct-20
Network Analyzer Agilent E8358A	SN: US41080477	31-Mar-14 (in house check Oct-18)	In house check: Oct-19

	Name	Function	Signature
Calibrated by:	Jeton Kastrati	Laboratory Technician	<i>[Signature]</i>
Approved by:	Katja Pokovic	Technical Manager	<i>[Signature]</i>

Issued: October 23, 2018

This calibration certificate shall not be reproduced except in full without written approval of the laboratory.



Accredited by the Swiss Accreditation Service (SAS)

The Swiss Accreditation Service is one of the signatories to the EA Multilateral Agreement for the recognition of calibration certificates

Accreditation No.: **SCS 0108**

Glossary:

TSL	tissue simulating liquid
ConvF	sensitivity in TSL / NORM x,y,z
N/A	not applicable or not measured

Calibration is Performed According to the Following Standards:

- IEEE Std 1528-2013, "IEEE Recommended Practice for Determining the Peak Spatial-Averaged Specific Absorption Rate (SAR) in the Human Head from Wireless Communications Devices: Measurement Techniques", June 2013
- IEC 62209-1, "Measurement procedure for the assessment of Specific Absorption Rate (SAR) from hand-held and body-mounted devices used next to the ear (frequency range of 300 MHz to 6 GHz)", July 2016
- IEC 62209-2, "Procedure to determine the Specific Absorption Rate (SAR) for wireless communication devices used in close proximity to the human body (frequency range of 30 MHz to 6 GHz)", March 2010
- KDB 865664, "SAR Measurement Requirements for 100 MHz to 6 GHz"

Additional Documentation:

- DASY4/5 System Handbook

Methods Applied and Interpretation of Parameters:

- Measurement Conditions:** Further details are available from the Validation Report at the end of the certificate. All figures stated in the certificate are valid at the frequency indicated.
- Antenna Parameters with TSL:** The dipole is mounted with the spacer to position its feed point exactly below the center marking of the flat phantom section, with the arms oriented parallel to the body axis.
- Feed Point Impedance and Return Loss:** These parameters are measured with the dipole positioned under the liquid filled phantom. The impedance stated is transformed from the measurement at the SMA connector to the feed point. The Return Loss ensures low reflected power. No uncertainty required.
- Electrical Delay:** One-way delay between the SMA connector and the antenna feed point. No uncertainty required.
- SAR measured:** SAR measured at the stated antenna input power.
- SAR normalized:** SAR as measured, normalized to an input power of 1 W at the antenna connector.
- SAR for nominal TSL parameters:** The measured TSL parameters are used to calculate the nominal SAR result.

The reported uncertainty of measurement is stated as the standard uncertainty of measurement multiplied by the coverage factor $k=2$, which for a normal distribution corresponds to a coverage probability of approximately 95%.

Measurement Conditions

DASY system configuration, as far as not given on page 1.

DASY Version	DASY5	V52.10.2
Extrapolation	Advanced Extrapolation	
Phantom	Modular Flat Phantom	
Distance Dipole Center - TSL	10 mm	with Spacer
Zoom Scan Resolution	dx, dy, dz = 5 mm	
Frequency	1900 MHz \pm 1 MHz	

Head TSL parameters

The following parameters and calculations were applied.

	Temperature	Permittivity	Conductivity
Nominal Head TSL parameters	22.0 °C	40.0	1.40 mho/m
Measured Head TSL parameters	(22.0 \pm 0.2) °C	40.3 \pm 6 %	1.40 mho/m \pm 6 %
Head TSL temperature change during test	< 0.5 °C	----	----

SAR result with Head TSL

SAR averaged over 1 cm ³ (1 g) of Head TSL	Condition	
SAR measured	250 mW input power	9.93 W/kg
SAR for nominal Head TSL parameters	normalized to 1W	39.8 W/kg \pm 17.0 % (k=2)

SAR averaged over 10 cm ³ (10 g) of Head TSL	condition	
SAR measured	250 mW input power	5.18 W/kg
SAR for nominal Head TSL parameters	normalized to 1W	20.7 W/kg \pm 16.5 % (k=2)

Body TSL parameters

The following parameters and calculations were applied.

	Temperature	Permittivity	Conductivity
Nominal Body TSL parameters	22.0 °C	53.3	1.52 mho/m
Measured Body TSL parameters	(22.0 \pm 0.2) °C	52.9 \pm 6 %	1.47 mho/m \pm 6 %
Body TSL temperature change during test	< 0.5 °C	----	----

SAR result with Body TSL

SAR averaged over 1 cm ³ (1 g) of Body TSL	Condition	
SAR measured	250 mW input power	9.62 W/kg
SAR for nominal Body TSL parameters	normalized to 1W	39.2 W/kg \pm 17.0 % (k=2)

SAR averaged over 10 cm ³ (10 g) of Body TSL	condition	
SAR measured	250 mW input power	5.09 W/kg
SAR for nominal Body TSL parameters	normalized to 1W	20.6 W/kg \pm 16.5 % (k=2)

Appendix (Additional assessments outside the scope of SCS 0108)

Antenna Parameters with Head TSL

Impedance, transformed to feed point	$52.5 \Omega + 7.9 j\Omega$
Return Loss	- 21.8 dB

Antenna Parameters with Body TSL

Impedance, transformed to feed point	$48.1 \Omega + 8.1 j\Omega$
Return Loss	- 21.5 dB

General Antenna Parameters and Design

Electrical Delay (one direction)	1.193 ns
----------------------------------	----------

After long term use with 100W radiated power, only a slight warming of the dipole near the feedpoint can be measured.

The dipole is made of standard semirigid coaxial cable. The center conductor of the feeding line is directly connected to the second arm of the dipole. The antenna is therefore short-circuited for DC-signals. On some of the dipoles, small end caps are added to the dipole arms in order to improve matching when loaded according to the position as explained in the "Measurement Conditions" paragraph. The SAR data are not affected by this change. The overall dipole length is still according to the Standard.

No excessive force must be applied to the dipole arms, because they might bend or the soldered connections near the feedpoint may be damaged.

Additional EUT Data

Manufactured by	SPEAG
Manufactured on	June 28, 2006

DASY5 Validation Report for Head TSL

Date: 23.10.2018

Test Laboratory: SPEAG, Zurich, Switzerland

DUT: Dipole 1900 MHz; Type: D1900V2; Serial: D1900V2 - SN:5d080

Communication System: UID 0 - CW; Frequency: 1900 MHz

Medium parameters used: $f = 1900$ MHz; $\sigma = 1.4$ S/m; $\epsilon_r = 40.3$; $\rho = 1000$ kg/m³

Phantom section: Flat Section

Measurement Standard: DASY5 (IEEE/IEC/ANSI C63.19-2011)

DASY52 Configuration:

- Probe: EX3DV4 - SN7349; ConvF(8.18, 8.18, 8.18) @ 1900 MHz; Calibrated: 30.12.2017
- Sensor-Surface: 1.4mm (Mechanical Surface Detection)
- Electronics: DAE4 Sn601; Calibrated: 04.10.2018
- Phantom: Flat Phantom 5.0 (front); Type: QD 000 P50 AA; Serial: 1001
- DASY52 52.10.2(1495); SEMCAD X 14.6.12(7450)

Dipole Calibration for Head Tissue/Pin=250 mW, d=10mm/Zoom Scan (7x7x7)/Cube 0:

Measurement grid: dx=5mm, dy=5mm, dz=5mm

Reference Value = 110.0 V/m; Power Drift = -0.05 dB

Peak SAR (extrapolated) = 18.7 W/kg

SAR(1 g) = 9.93 W/kg; SAR(10 g) = 5.18 W/kg

Maximum value of SAR (measured) = 15.6 W/kg

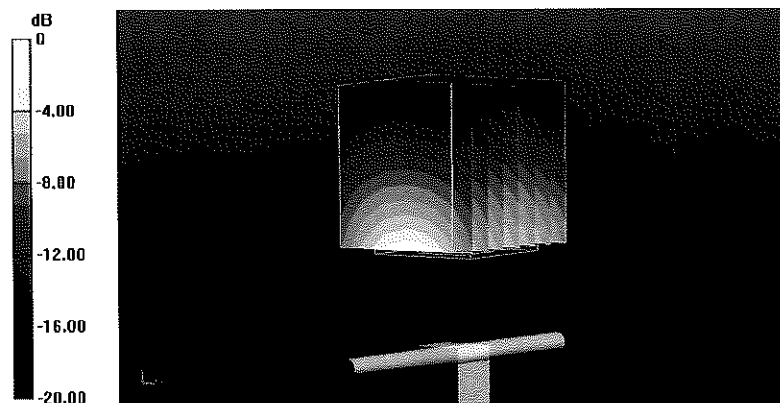

0 dB = 15.6 W/kg = 11.93 dBW/kg

Impedance Measurement Plot for Head TSL

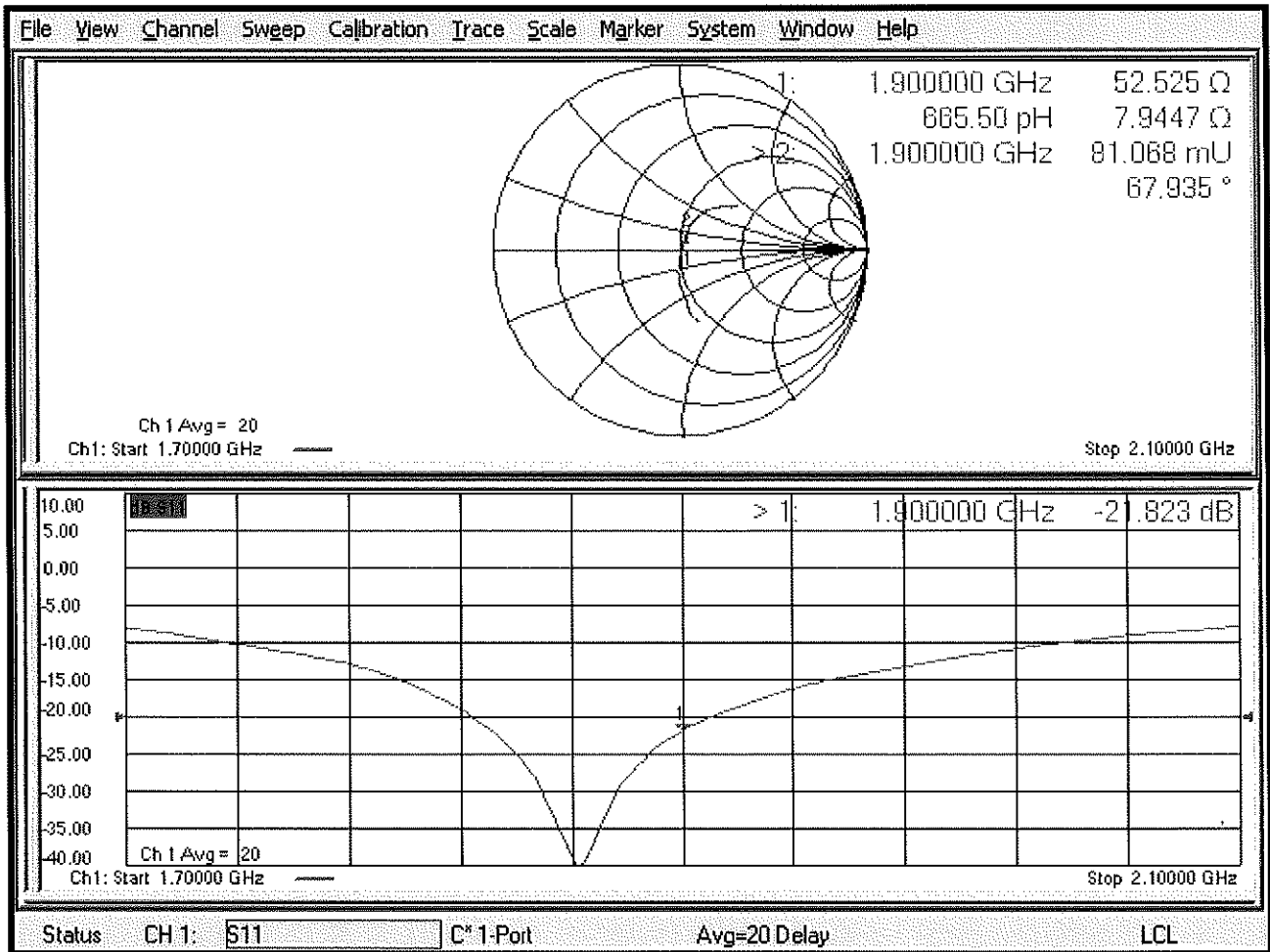

DASY5 Validation Report for Body TSL

Date: 23.10.2018

Test Laboratory: SPEAG, Zurich, Switzerland

DUT: Dipole 1900 MHz; Type: D1900V2; Serial: D1900V2 - SN:5d080

Communication System: UID 0 - CW; Frequency: 1900 MHz

Medium parameters used: $f = 1900$ MHz; $\sigma = 1.47$ S/m; $\epsilon_r = 52.9$; $\rho = 1000$ kg/m³

Phantom section: Flat Section

Measurement Standard: DASY5 (IEEE/IEC/ANSI C63.19-2011)

DASY52 Configuration:

- Probe: EX3DV4 - SN7349; ConvF(8.15, 8.15, 8.15) @ 1900 MHz; Calibrated: 30.12.2017
- Sensor-Surface: 1.4mm (Mechanical Surface Detection)
- Electronics: DAE4 Sn601; Calibrated: 04.10.2018
- Phantom: Flat Phantom 5.0 (back); Type: QD 000 P50 AA; Serial: 1002
- DASY52 52.10.2(1495); SEMCAD X 14.6.12(7450)

Dipole Calibration for Body Tissue/Pin=250 mW, d=10mm/Zoom Scan (7x7x7)/Cube 0:

Measurement grid: dx=5mm, dy=5mm, dz=5mm

Reference Value = 99.86 V/m; Power Drift = 0.00 dB

Peak SAR (extrapolated) = 17.3 W/kg

SAR(1 g) = 9.62 W/kg; SAR(10 g) = 5.09 W/kg

Maximum value of SAR (measured) = 14.1 W/kg

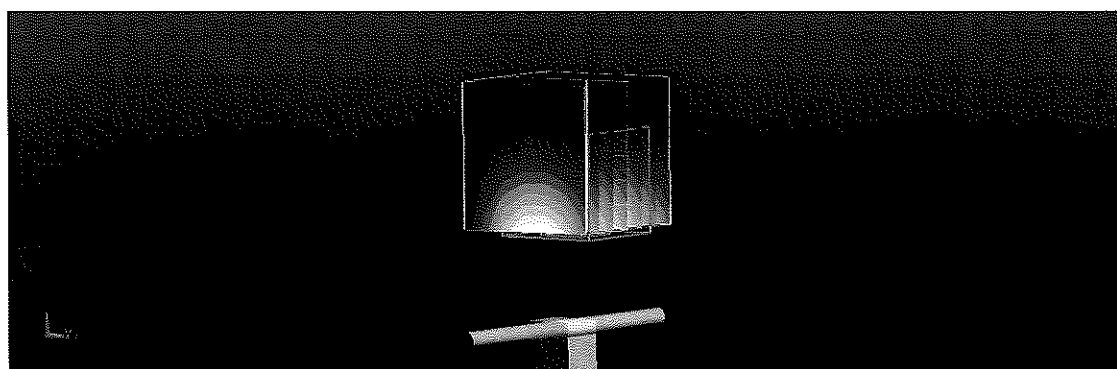
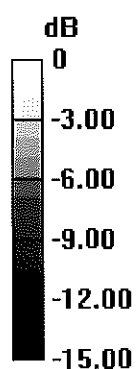

0 dB = 14.1 W/kg = 11.49 dBW/kg

Impedance Measurement Plot for Body TSL

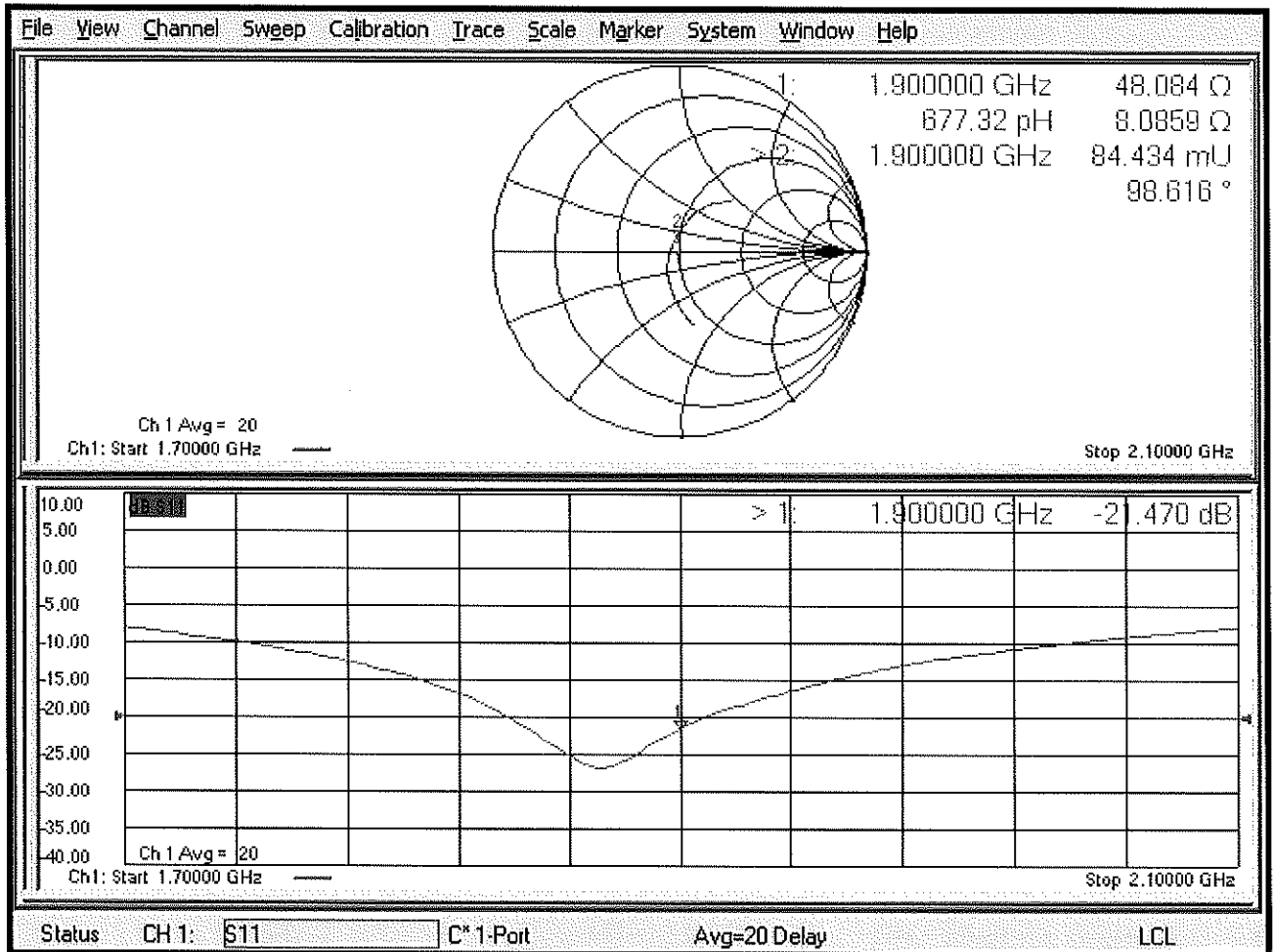

Certification of Calibration

Object: D1900V2 – SN:5d080

Calibration procedure(s): Procedure for Calibration Extension for SAR Dipoles.

Extended Calibration date: October 18, 2019

Description: SAR Validation Dipole at 1900 MHz.

Calibration Equipment used:

Manufacturer	Model	Description	Cal Date	Cal Interval	Cal Due	Serial Number
Control Company	4040	Therm./Clock/Humidity Monitor	6/29/2019	Biennial	6/29/2021	192291470
Control Company	4352	Ultra Long Stem Thermometer	8/2/2018	Biennial	8/2/2020	181334684
Amplifier Research	15S1G6	Amplifier	CBT	N/A	CBT	433971
Narda	4772-3	Attenuator (3dB)	CBT	N/A	CBT	9406
Keysight Technologies	85033E	Standard Mechanical Calibration Kit (DC to 9GHz, 3.5mm)	7/2/2019	Annual	7/2/2020	MY53401181
Rohde & Schwarz	ZNLE6	Vector Network Analyzer	10/11/2019	Annual	10/11/2020	101307
Mini-Circuits	BW-N20W5+	DC to 18 GHz Precision Fixed 20 dB Attenuator	CBT	N/A	CBT	N/A
SPEAG	DAKS-3.5	Portable Dielectric Assessment Kit	8/13/2019	Annual	8/13/2020	1041
Anritsu	MA2411B	Pulse Power Sensor	8/14/2019	Annual	8/14/2020	1315051
Anritsu	MA2411B	Pulse Power Sensor	8/8/2019	Annual	8/8/2020	1339008
Anritsu	ML2495A	Power Meter	11/20/2018	Annual	11/20/2019	1039008
Agilent	N5182A	MXG Vector Signal Generator	8/19/2019	Annual	8/19/2020	MY47420837
Seekonk	NC-100	Torque Wrench	5/9/2018	Biennial	5/9/2020	22217
Mini-Circuits	NLP-2950+	Low Pass Filter DC to 2700 MHz	CBT	N/A	CBT	N/A
MiniCircuits	ZHDC-16-63-S+	Bidirectional Coupler	CBT	N/A	CBT	N/A
MiniCircuits	VLF-6000+	Low Pass Filter	CBT	N/A	CBT	N/A
SPEAG	EX3DV4	SAR Probe	2/19/2019	Annual	2/19/2020	3914
SPEAG	EX3DV4	SAR Probe	5/16/2019	Annual	5/16/2020	7406
SPEAG	DAE4	Dasy Data Acquisition Electronics	5/8/2019	Annual	5/8/2020	859
SPEAG	DAE4	Dasy Data Acquisition Electronics	2/14/2019	Annual	2/14/2020	1272

Note: CBT (Calibrated Before Testing). Prior to testing, the measurement paths containing a cable, amplifier, attenuator, coupler or filter were connected to a calibrated source (i.e. a signal generator) to determine the losses of the measurement path.

Measurement Uncertainty = $\pm 23\%$ (k=2)

	Name	Function	Signature
Calibrated By:	Brodie Halfoster	Team Lead Engineer	<i>BRODIE HALFOSTER</i>
Approved By:	Kaitlin O'Keefe	Senior Technical Manager	<i>KOK</i>

DIPOLE CALIBRATION EXTENSION

Per KDB 865664 D01, calibration intervals of up to three years may be considered for reference dipoles when it is demonstrated that the SAR target, impedance and return loss of a dipole have remained stable according to the following requirements:

1. The measured SAR does not deviate more than 10% from the target on the calibration certificate.
2. The return-loss does not deviate more than 20% from the previous measurement and meets the required 20dB minimum return-loss requirement.
3. The measurement of real or imaginary parts of impedance does not deviate more than 5Ω from the previous measurement.

The following dipole was checked to pass the above 3 requirements to have 2-year calibration period from the calibration date:

Calibration Date	Extension Date	Certificate Electrical Delay (ms)	Certificate SAR Target Head (1g) W/kg @ 20.0 dBm	Measured Head SAR (1g) W/kg @ 20.0 dBm	Deviation 1g (%)	Certificate SAR Target Head (10g) W/kg @ 20.0 dBm	Measured Head SAR (10g) W/kg @ 20.0 dBm	Deviation 10g (%)	Certificate Impedance Head (Ohm) Real	Measured Impedance Head (Ohm) Real	Difference (Ohm) Real	Certificate Impedance Head (Ohm) Imaginary	Measured Impedance Head (Ohm) Imaginary	Difference (Ohm) Imaginary	Certificate Return Loss Head (dB)	Measured Return Loss Head (dB)	Deviation (%)	PASS/FAIL
10/23/2018	10/18/2019	1.193	3.98	4.16	4.52%	2.07	2.13	2.90%	52.5	50.4	2.1	7.9	6.2	1.7	-21.8	-24.2	-10.90%	PASS
Calibration Date	Extension Date	Certificate Electrical Delay (ms)	Certificate SAR Target Body (1g) W/kg @ 20.0 dBm	Measured Body SAR (1g) W/kg @ 20.0 dBm	Deviation 1g (%)	Certificate SAR Target Body (10g) W/kg @ 20.0 dBm	Measured Body SAR (10g) W/kg @ 20.0 dBm	Deviation 10g (%)	Certificate Impedance Body (Ohm) Real	Measured Impedance Body (Ohm) Real	Difference (Ohm) Real	Certificate Impedance Body (Ohm) Imaginary	Measured Impedance Body (Ohm) Imaginary	Difference (Ohm) Imaginary	Certificate Return Loss Body (dB)	Measured Return Loss Body (dB)	Deviation (%)	PASS/FAIL
10/23/2018	10/18/2019	1.193	3.92	4.21	7.40%	2.06	2.16	4.85%	48.1	46.5	1.6	8.1	6.6	1.5	-21.5	-22.2	-3.40%	PASS

Impedance & Return-Loss Measurement Plot for Head TSL

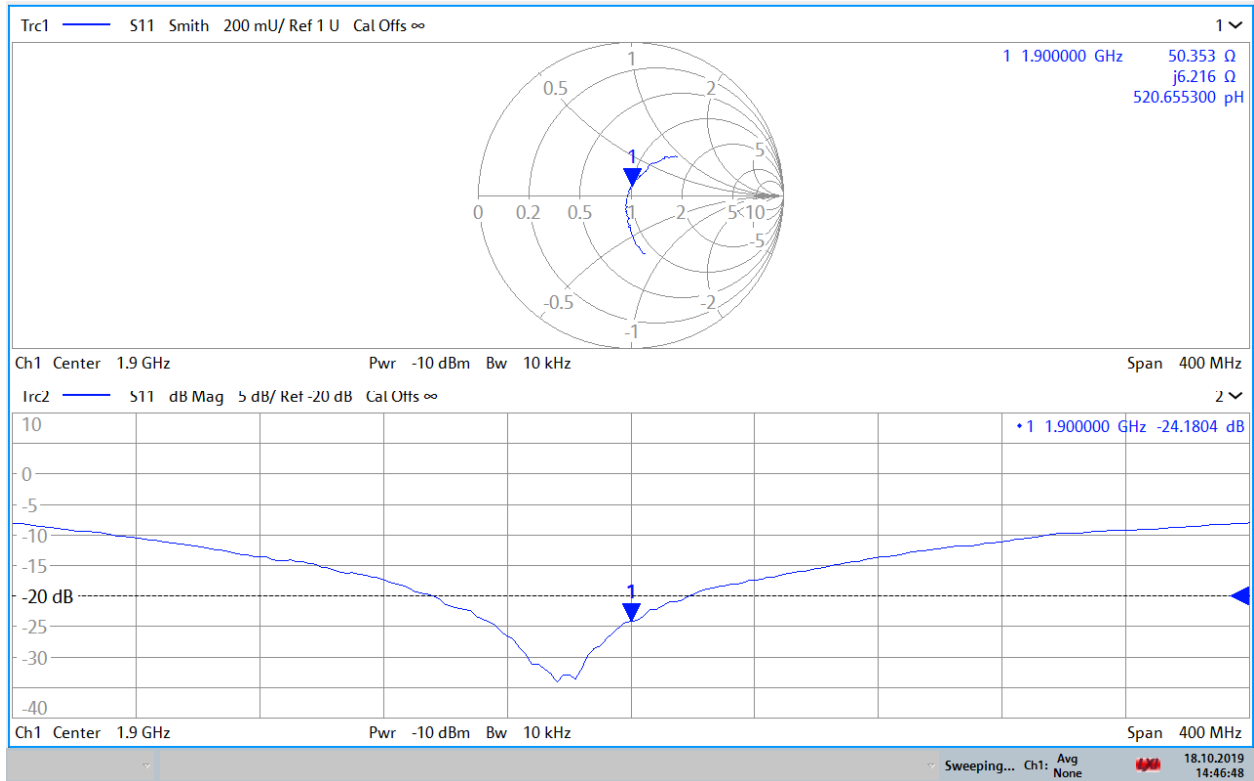

14:46:49 18.10.2019

Impedance & Return-Loss Measurement Plot for Body TSL

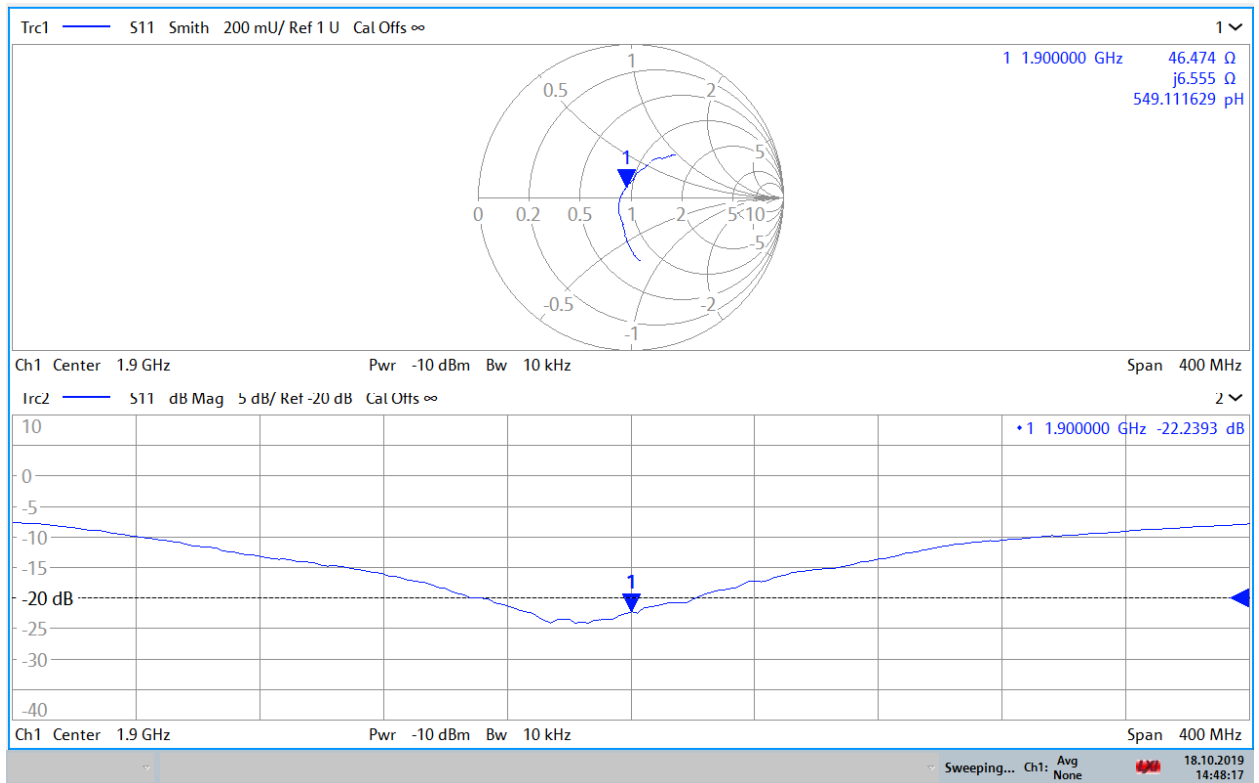

14:48:18 18.10.2019

Certification of Calibration

Object: D1900V2 – SN: 5d080
 Calibration procedure(s): Procedure for Calibration Extension for SAR Dipoles.
 Extension Calibration date: 10/18/2020
 Description: SAR Validation Dipole at 1900 MHz.

Calibration Equipment used:

Manufacturer	Model	Description	Cal Date	Cal Interval	Cal Due	Serial Number
Control Company	4040	Therm./Clock/Humidity Monitor	6/29/2019	Biennial	6/29/2021	192291470
Control Company	4352	Ultra Long Stem Thermometer	11/29/2018	Biennial	11/29/2020	181766816
Amplifier Research	15S1G6	Amplifier	CBT	N/A	CBT	433971
Narda	4772-3	Attenuator (3dB)	CBT	N/A	CBT	9406
Agilent	85033E	3.5mm Standard Calibration Kit	6/6/2020	Annual	6/6/2021	MY53402352
Rohde & Schwarz	ZNLE6	Vector Network Analyzer	9/29/2020	Annual	9/29/2021	101307
Mini-Circuits	BW-N20W5+	DC to 18 GHz Precision Fixed 20 dB Attenuator	CBT	N/A	CBT	N/A
SPEAG	DAK-3.5	Dielectric Assessment Kit	5/12/2020	Annual	5/12/2021	1070
Anritsu	MA2411B	Pulse Power Sensor	8/12/2020	Annual	8/12/2021	1207364
Anritsu	MA2411B	Pulse Power Sensor	9/22/2020	Annual	9/22/2021	1315051
Anritsu	ML2495A	Power Meter	1/15/2020	Annual	1/15/2021	1328004
Anritsu	ML2495A	Power Meter	12/17/2019	Annual	12/17/2020	941001
Agilent	N5182A	MXG Vector Signal Generator	5/13/2020	Annual	5/13/2021	MY47420603
Pasternack	NC-100	Torque Wrench	8/4/2020	Biennial	8/4/2022	N/A
Mini-Circuits	NLP-2950+	Low Pass Filter DC to 2700 MHz	CBT	N/A	CBT	N/A
MiniCircuits	ZHDC-16-63-S+	Bidirectional Coupler	CBT	N/A	CBT	N/A
SPEAG	EX3DV4	SAR Probe	3/18/2020	Annual	3/18/2021	7526
SPEAG	EX3DV4	SAR Probe	12/11/2019	Annual	12/11/2020	7570
SPEAG	DAE4	Dasy Data Acquisition Electronics	12/18/2019	Annual	12/18/2020	859
SPEAG	DAE4	Dasy Data Acquisition Electronics	3/12/2020	Annual	3/12/2021	1368

Measurement Uncertainty = $\pm 23\%$ (k=2)

	Name	Function	Signature
Calibrated By:	Brodie Halfoster	Test Engineer	<i>BRODIE HALFOSTER</i>
Approved By:	Kaitlin O'Keefe	Senior Technical Manager	<i>KOK</i>

DIPOLE CALIBRATION EXTENSION

Per KDB 865664 D01, calibration intervals of up to three years may be considered for reference dipoles when it is demonstrated that the SAR target, impedance and return loss of a dipole have remained stable according to the following requirements:

1. The measured SAR does not deviate more than 10% from the target on the calibration certificate.
2. The return-loss does not deviate more than 20% from the previous measurement and meets the required 20dB minimum return-loss requirement.
3. The measurement of real or imaginary parts of impedance does not deviate more than 5Ω from the previous measurement.

The following dipole was checked to pass the above 3 requirements to have 3-year calibration period from the calibration date:

Calibration Date	Extension Date	Certificate Electrical Delay (ns)	Certificate SAR Target Head (1g) W/kg @ 20.0 dBm	Measured Head SAR (1g) W/kg @ 20.0 dBm	Deviation 1g (%)	Certificate SAR Target Head (10g) W/kg @ 20.0 dBm	Measured Head SAR (10g) W/kg @ 20.0 dBm	Deviation 10g (%)	Certificate Impedance Head (Ohm) Real	Measured Impedance Head (Ohm) Real	Difference (Ohm) Real	Certificate Impedance Head (Ohm) Imaginary	Measured Impedance Head (Ohm) Imaginary	Difference (Ohm) Imaginary	Certificate Return Loss Head (dB)	Measured Return Loss Head (dB)	Deviation (%)	PASS/FAIL
10/23/2018	10/18/2020	1.193	3.98	4.01	0.75%	2.07	2.05	-0.97%	52.5	49.5	4	7.9	6	1.9	-21.8	-24.1	-10.60%	PASS
Calibration Date	Extension Date	Certificate Electrical Delay (ns)	Certificate SAR Target Body (1g) W/kg @ 20.0 dBm	Measured Body SAR (1g) W/kg @ 20.0 dBm	Deviation 1g (%)	Certificate SAR Target Body (10g) W/kg @ 20.0 dBm	Measured Body SAR (10g) W/kg @ 20.0 dBm	Deviation 10g (%)	Certificate Impedance Body (Ohm) Real	Measured Impedance Body (Ohm) Real	Difference (Ohm) Real	Certificate Impedance Body (Ohm) Imaginary	Measured Impedance Body (Ohm) Imaginary	Difference (Ohm) Imaginary	Certificate Return Loss Body (dB)	Measured Return Loss Body (dB)	Deviation (%)	PASS/FAIL
10/23/2018	10/18/2020	1.193	3.92	4.24	8.16%	2.06	2.18	5.83%	48.1	46.1	2	8.1	6.2	2.9	-21.5	-23.3	-8.50%	PASS

Impedance & Return-Loss Measurement Plot for Head TSL

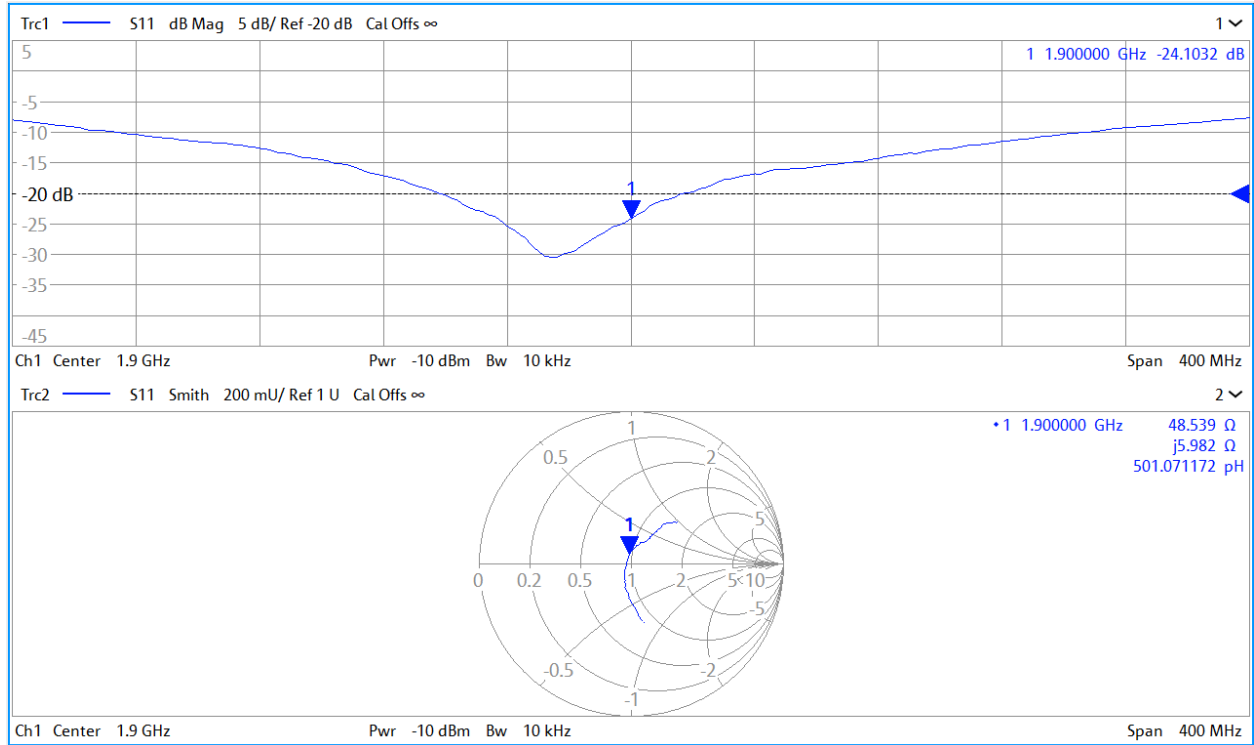

Impedance & Return-Loss Measurement Plot for Body TSL

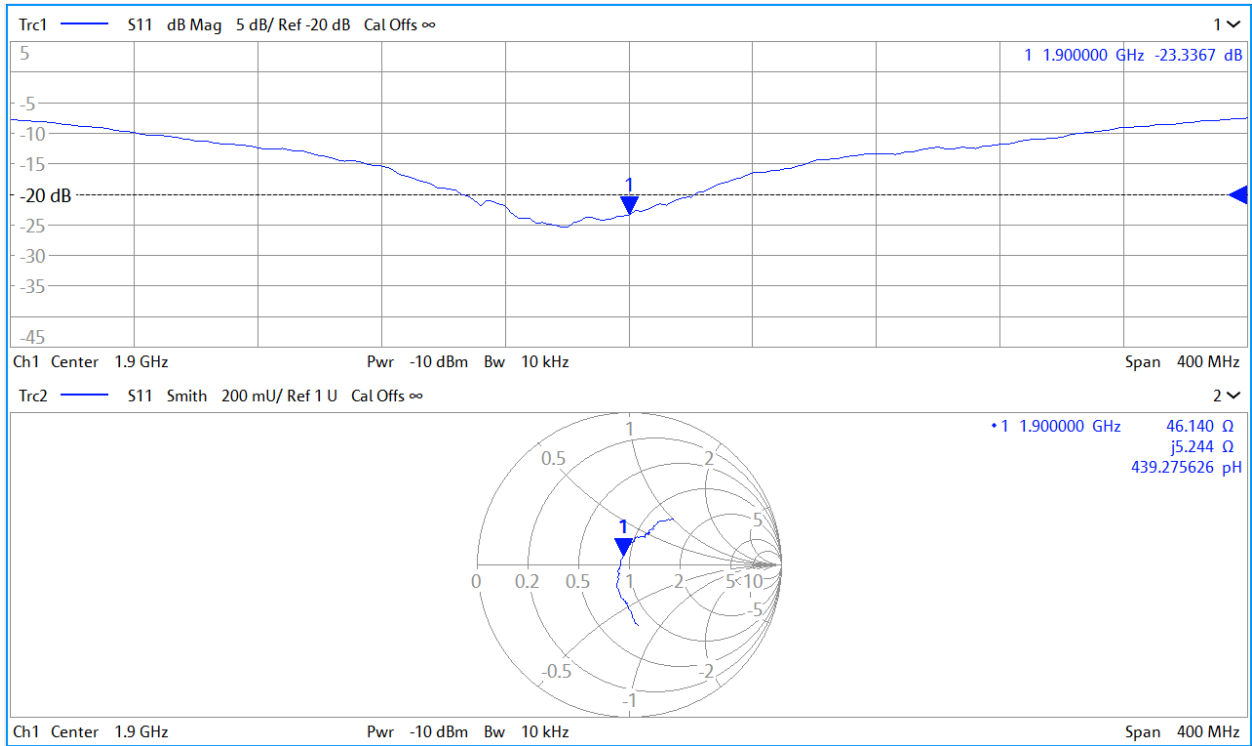



Accredited by the Swiss Accreditation Service (SAS)
The Swiss Accreditation Service is one of the signatories to the EA
Multilateral Agreement for the recognition of calibration certificates

Accreditation No.: **SCS 0108**

Client **PC Test**

Certificate No: **D1900V2-5d148 Feb19**

CALIBRATION CERTIFICATE

Object **D1900V2 - SN:5d148**

Calibration procedure(s) **QA CAL-05.v11
Calibration Procedure for SAR Validation Sources between 0.7-3 GHz**

Calibration date: **February 21, 2019**

*BN ✓
03-01-19
BN ✓
02-26-2020
BN ✓
02-23-21*

This calibration certificate documents the traceability to national standards, which realize the physical units of measurements (SI).
The measurements and the uncertainties with confidence probability are given on the following pages and are part of the certificate.

All calibrations have been conducted in the closed laboratory facility: environment temperature (22 ± 3)°C and humidity < 70%.

Calibration Equipment used (M&TE critical for calibration)

Primary Standards	ID #	Cal Date (Certificate No.)	Scheduled Calibration
Power meter NRP	SN: 104778	04-Apr-18 (No. 217-02672/02673)	Apr-19
Power sensor NRP-Z91	SN: 103244	04-Apr-18 (No. 217-02672)	Apr-19
Power sensor NRP-Z91	SN: 103245	04-Apr-18 (No. 217-02673)	Apr-19
Reference 20 dB Attenuator	SN: 5058 (20k)	04-Apr-18 (No. 217-02682)	Apr-19
Type-N mismatch combination	SN: 5047.2 / 06327	04-Apr-18 (No. 217-02683)	Apr-19
Reference Probe EX3DV4	SN: 7349	31-Dec-18 (No. EX3-7349_Dec18)	Dec-19
DAE4	SN: 601	04-Oct-18 (No. DAE4-601_Oct18)	Oct-19

Secondary Standards	ID #	Check Date (in house)	Scheduled Check
Power meter E4419B	SN: GB39512475	07-Oct-15 (in house check Feb-19)	In house check: Oct-20
Power sensor HP 8481A	SN: US37292783	07-Oct-15 (in house check Oct-18)	In house check: Oct-20
Power sensor HP 8481A	SN: MY41092317	07-Oct-15 (in house check Oct-18)	In house check: Oct-20
RF generator R&S SMT-06	SN: 100972	15-Jun-15 (in house check Oct-18)	In house check: Oct-20
Network Analyzer Agilent E8358A	SN: US41080477	31-Mar-14 (in house check Oct-18)	In house check: Oct-19

Calibrated by: **Manu Seltz** (Name) **Laboratory Technician** (Function)  (Signature)

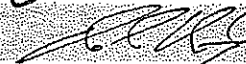
Approved by: **Kalja Pokovic** (Name) **Technical Manager** (Function)  (Signature)

Issued: February 21, 2019

This calibration certificate shall not be reproduced except in full without written approval of the laboratory.



Accredited by the Swiss Accreditation Service (SAS)
The Swiss Accreditation Service is one of the signatories to the EA
Multilateral Agreement for the recognition of calibration certificates

Accreditation No.: **SCS 0108**

Glossary:

TSL	tissue simulating liquid
ConvF	sensitivity in TSL / NORM x,y,z
N/A	not applicable or not measured

Calibration is Performed According to the Following Standards:

- a) IEEE Std 1528-2013, "IEEE Recommended Practice for Determining the Peak Spatial-Averaged Specific Absorption Rate (SAR) in the Human Head from Wireless Communications Devices: Measurement Techniques", June 2013
- b) IEC 62209-1, "Measurement procedure for the assessment of Specific Absorption Rate (SAR) from hand-held and body-mounted devices used next to the ear (frequency range of 300 MHz to 6 GHz)", July 2016
- c) IEC 62209-2, "Procedure to determine the Specific Absorption Rate (SAR) for wireless communication devices used in close proximity to the human body (frequency range of 30 MHz to 6 GHz)", March 2010
- d) KDB 865664, "SAR Measurement Requirements for 100 MHz to 6 GHz"

Additional Documentation:

- e) DASY4/5 System Handbook

Methods Applied and Interpretation of Parameters:

- *Measurement Conditions:* Further details are available from the Validation Report at the end of the certificate. All figures stated in the certificate are valid at the frequency indicated.
- *Antenna Parameters with TSL:* The dipole is mounted with the spacer to position its feed point exactly below the center marking of the flat phantom section, with the arms oriented parallel to the body axis.
- *Feed Point Impedance and Return Loss:* These parameters are measured with the dipole positioned under the liquid filled phantom. The impedance stated is transformed from the measurement at the SMA connector to the feed point. The Return Loss ensures low reflected power. No uncertainty required.
- *Electrical Delay:* One-way delay between the SMA connector and the antenna feed point. No uncertainty required.
- *SAR measured:* SAR measured at the stated antenna input power.
- *SAR normalized:* SAR as measured, normalized to an input power of 1 W at the antenna connector.
- *SAR for nominal TSL parameters:* The measured TSL parameters are used to calculate the nominal SAR result.

The reported uncertainty of measurement is stated as the standard uncertainty of measurement multiplied by the coverage factor $k=2$, which for a normal distribution corresponds to a coverage probability of approximately 95%.

Measurement Conditions

DASY system configuration, as far as not given on page 1.

DASY Version	DASY5	V52.10.2
Extrapolation	Advanced Extrapolation	
Phantom	Modular Flat Phantom	
Distance Dipole Center - TSL	10 mm	with Spacer
Zoom Scan Resolution	dx, dy, dz = 5 mm	
Frequency	1900 MHz \pm 1 MHz	

Head TSL parameters

The following parameters and calculations were applied.

	Temperature	Permittivity	Conductivity
Nominal Head TSL parameters	22.0 °C	40.0	1.40 mho/m
Measured Head TSL parameters	(22.0 \pm 0.2) °C	40.9 \pm 6 %	1.38 mho/m \pm 6 %
Head TSL temperature change during test	< 0.5 °C	----	----

SAR result with Head TSL

SAR averaged over 1 cm ³ (1 g) of Head TSL	Condition	
SAR measured	250 mW input power	9.65 W/kg
SAR for nominal Head TSL parameters	normalized to 1W	39.1 W/kg \pm 17.0 % (k=2)

SAR averaged over 10 cm ³ (10 g) of Head TSL	condition	
SAR measured	250 mW input power	5.05 W/kg
SAR for nominal Head TSL parameters	normalized to 1W	20.4 W/kg \pm 16.5 % (k=2)

Body TSL parameters

The following parameters and calculations were applied.

	Temperature	Permittivity	Conductivity
Nominal Body TSL parameters	22.0 °C	53.3	1.52 mho/m
Measured Body TSL parameters	(22.0 \pm 0.2) °C	53.6 \pm 6 %	1.47 mho/m \pm 6 %
Body TSL temperature change during test	< 0.5 °C	----	----

SAR result with Body TSL

SAR averaged over 1 cm ³ (1 g) of Body TSL	Condition	
SAR measured	250 mW input power	9.56 W/kg
SAR for nominal Body TSL parameters	normalized to 1W	39.1 W/kg \pm 17.0 % (k=2)

SAR averaged over 10 cm ³ (10 g) of Body TSL	condition	
SAR measured	250 mW input power	5.05 W/kg
SAR for nominal Body TSL parameters	normalized to 1W	20.5 W/kg \pm 16.5 % (k=2)

Appendix (Additional assessments outside the scope of SCS 0108)

Antenna Parameters with Head TSL

Impedance, transformed to feed point	51.8 Ω + 6.8 j Ω
Return Loss	- 23.2 dB

Antenna Parameters with Body TSL

Impedance, transformed to feed point	48.4 Ω + 7.8 j Ω
Return Loss	- 21.9 dB

General Antenna Parameters and Design

Electrical Delay (one direction)	1.170 ns
----------------------------------	----------

After long term use with 100W radiated power, only a slight warming of the dipole near the feedpoint can be measured.

The dipole is made of standard semirigid coaxial cable. The center conductor of the feeding line is directly connected to the second arm of the dipole. The antenna is therefore short-circuited for DC-signals. On some of the dipoles, small end caps are added to the dipole arms in order to improve matching when loaded according to the position as explained in the "Measurement Conditions" paragraph. The SAR data are not affected by this change. The overall dipole length is still according to the Standard.

No excessive force must be applied to the dipole arms, because they might bend or the soldered connections near the feedpoint may be damaged.

Additional EUT Data

Manufactured by	SPEAG
-----------------	-------

DASY5 Validation Report for Head TSL

Date: 21.02.2019

Test Laboratory: SPEAG, Zurich, Switzerland

DUT: Dipole 1900 MHz; Type: D1900V2; Serial: D1900V2 - SN:5d148

Communication System: UID 0 - CW; Frequency: 1900 MHz

Medium parameters used: $f = 1900$ MHz; $\sigma = 1.38$ S/m; $\epsilon_r = 40.9$; $\rho = 1000$ kg/m³

Phantom section: Flat Section

Measurement Standard: DASY5 (IEEE/IEC/ANSI C63.19-2011)

DASY52 Configuration:

- Probe: EX3DV4 - SN7349; ConvF(8.26, 8.26, 8.26) @ 1900 MHz; Calibrated: 31.12.2018
- Sensor-Surface: 1.4mm (Mechanical Surface Detection)
- Electronics: DAE4 Sn601; Calibrated: 04.10.2018
- Phantom: Flat Phantom 5.0 (front); Type: QD 000 P50 AA; Serial: 1001
- DASY52 52.10.2(1495); SEMCAD X 14.6.12(7450)

Dipole Calibration for Head Tissue/Pin=250 mW, d=10mm/Zoom Scan (7x7x7)/Cube 0:

Measurement grid: dx=5mm, dy=5mm, dz=5mm

Reference Value = 109.4 V/m; Power Drift = 0.01 dB

Peak SAR (extrapolated) = 17.8 W/kg

SAR(1 g) = 9.65 W/kg; SAR(10 g) = 5.05 W/kg

Maximum value of SAR (measured) = 15.0 W/kg

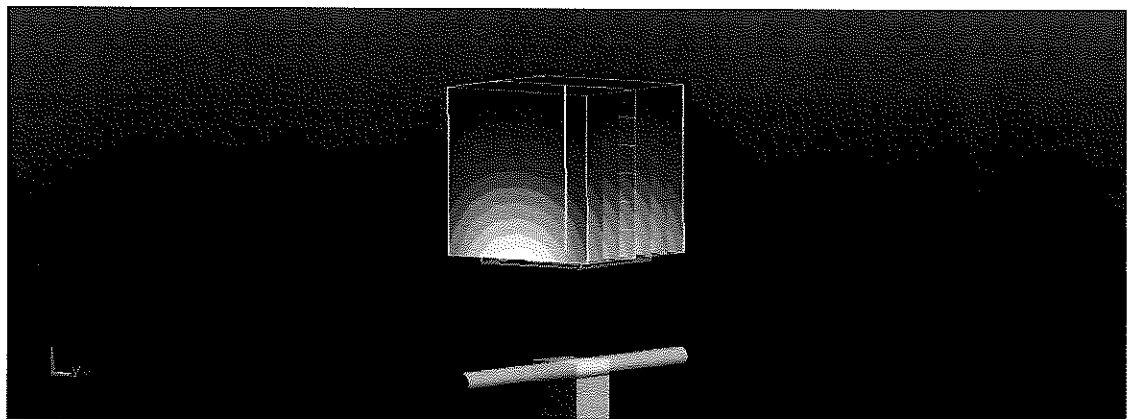
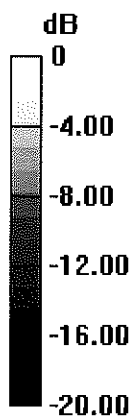

0 dB = 15.0 W/kg = 11.76 dBW/kg

Impedance Measurement Plot for Head TSL

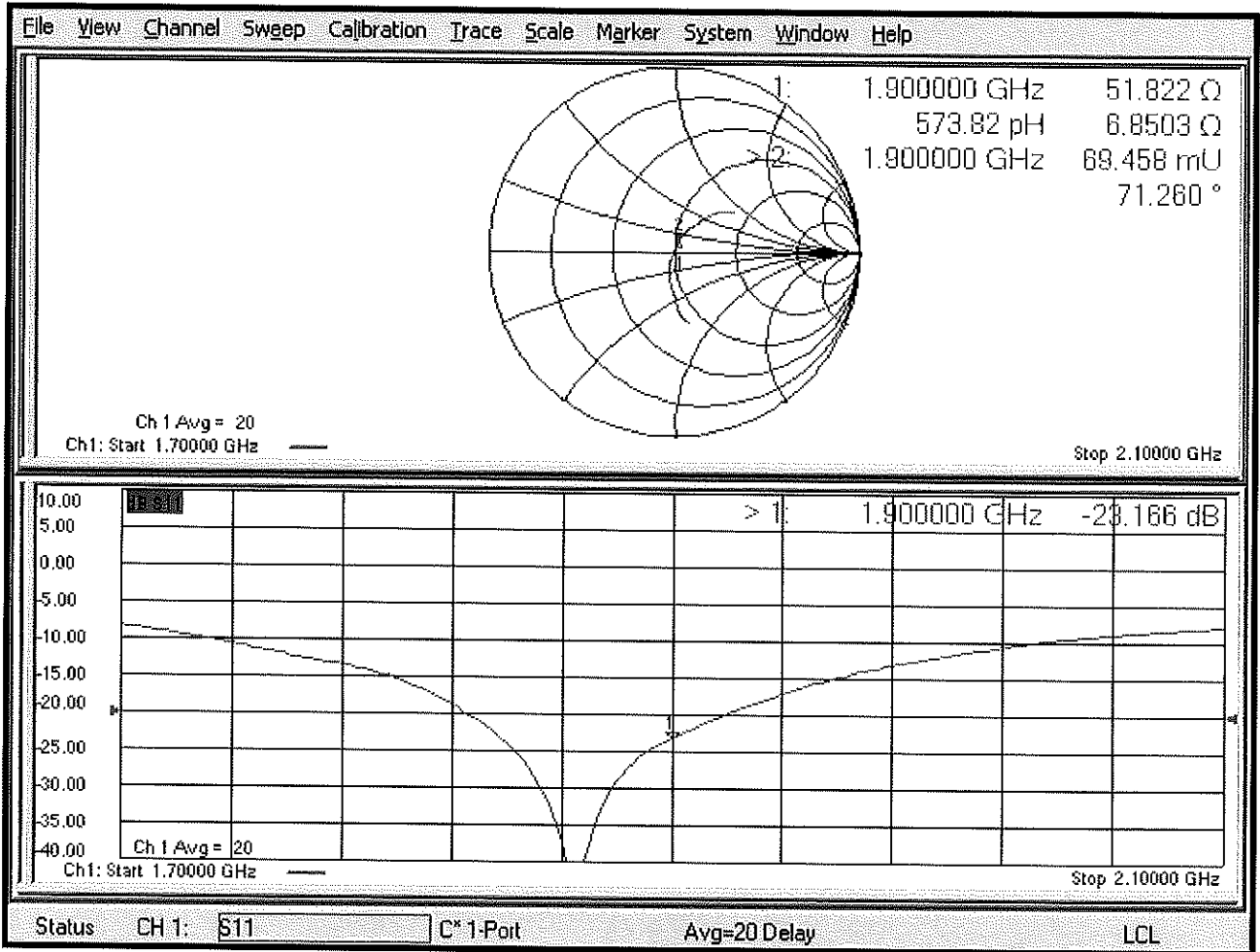

DASY5 Validation Report for Body TSL

Date: 21.02.2019

Test Laboratory: SPEAG, Zurich, Switzerland

DUT: Dipole 1900 MHz; Type: D1900V2; Serial: D1900V2 - SN:5d148

Communication System: UID 0 - CW; Frequency: 1900 MHz

Medium parameters used: $f = 1900$ MHz; $\sigma = 1.47$ S/m; $\epsilon_r = 53.6$; $\rho = 1000$ kg/m³

Phantom section: Flat Section

Measurement Standard: DASY5 (IEEE/IEC/ANSI C63.19-2011)

DASY52 Configuration:

- Probe: EX3DV4 - SN7349; ConvF(8.23, 8.23, 8.23) @ 1900 MHz; Calibrated: 31.12.2018
- Sensor-Surface: 1.4mm (Mechanical Surface Detection)
- Electronics: DAE4 Sn601; Calibrated: 04.10.2018
- Phantom: Flat Phantom 5.0 (back); Type: QD 000 P50 AA; Serial: 1002
- DASY52 52.10.2(1495); SEMCAD X 14.6.12(7450)

Dipole Calibration for Body Tissue/Pin=250 mW, d=10mm/Zoom Scan (7x7x7)/Cube 0:

Measurement grid: dx=5mm, dy=5mm, dz=5mm

Reference Value = 103.7 V/m; Power Drift = -0.03 dB

Peak SAR (extrapolated) = 17.0 W/kg

SAR(1 g) = 9.56 W/kg; SAR(10 g) = 5.05 W/kg

Maximum value of SAR (measured) = 14.4 W/kg

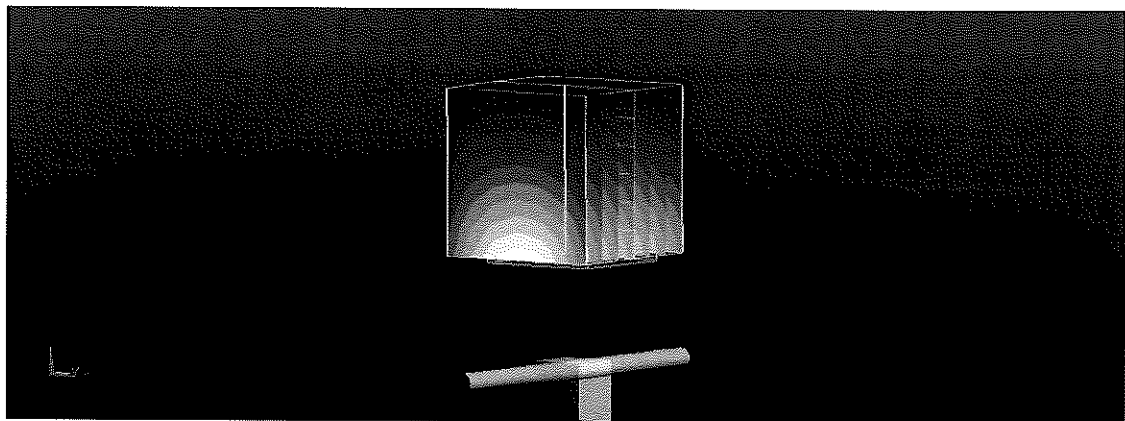
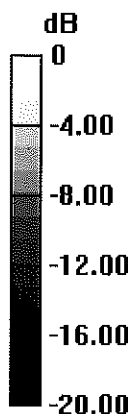

0 dB = 14.4 W/kg = 11.58 dBW/kg

Impedance Measurement Plot for Body TSL

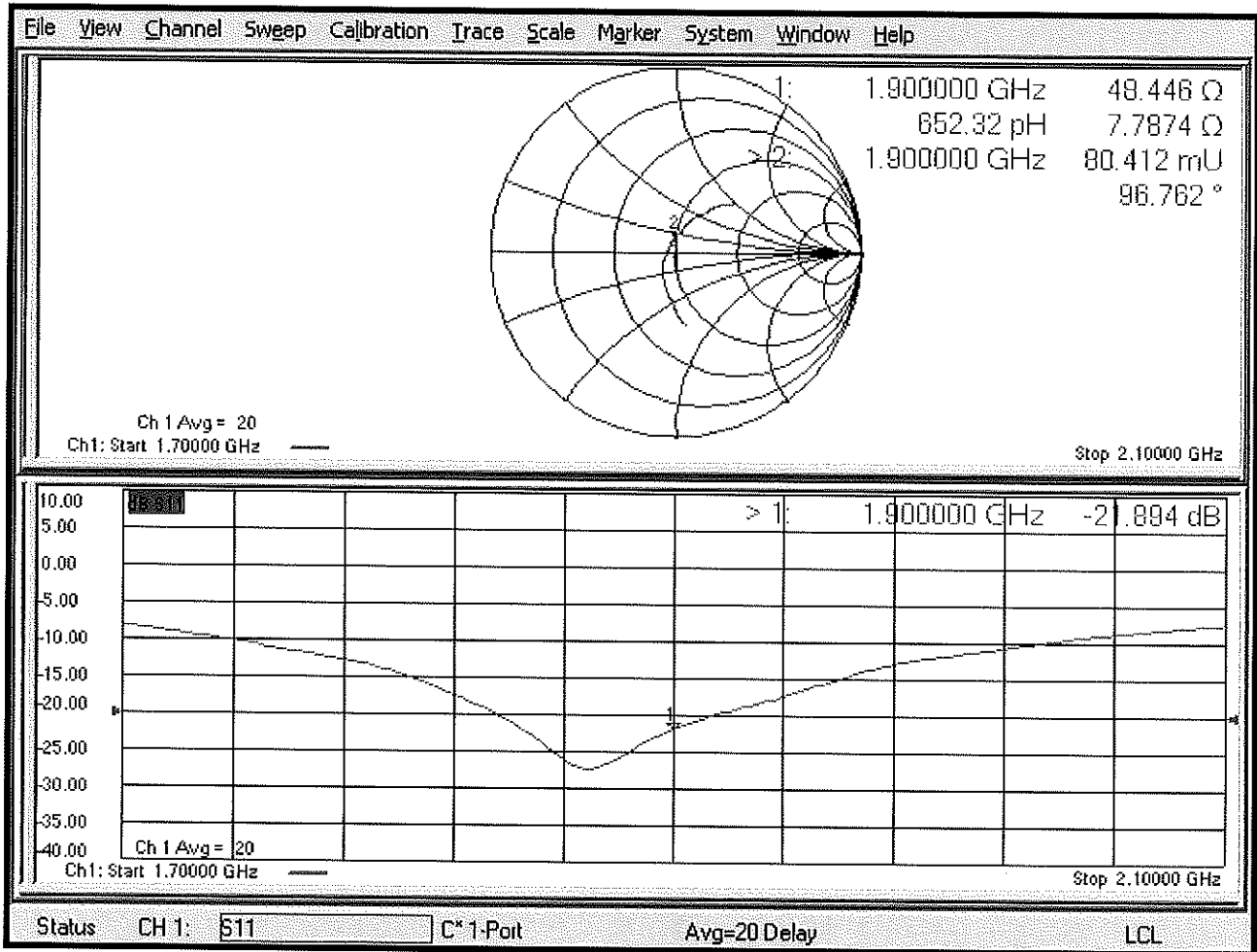

Certification of Calibration

Object D1900V2 – SN: 5d148

Calibration procedure(s) Procedure for Calibration Extension for SAR Dipoles.

Extension Calibration date: 2/21/2020

Description: SAR Validation Dipole at 1900 MHz.

Calibration Equipment used:

Manufacturer	Model	Description	Cal Date	Cal Interval	Cal Due	Serial Number
Control Company	4040	Therm./Clock/Humidity Monitor	6/29/2019	Biennial	6/29/2021	192291470
Control Company	4352	Ultra Long Stem Thermometer	8/2/2018	Biennial	8/2/2020	181334684
Amplifier Research	15S1G6	Amplifier	CBT	N/A	CBT	433971
Narda	4772-3	Attenuator (3dB)	CBT	N/A	CBT	9406
Keysight Technologies	85033E	Standard Mechanical Calibration Kit (DC to 9GHz, 3.5mm)	7/2/2019	Annual	7/2/2020	MY53401181
Rohde & Schwarz	ZNLE6	Vector Network Analyzer	10/11/2019	Annual	10/11/2020	101307
Mini-Circuits	BW-N20W5+	DC to 18 GHz Precision Fixed 20 dB Attenuator	CBT	N/A	CBT	N/A
SPEAG	DAKS-3.5	Portable DAK	9/10/2019	Annual	9/10/2020	1045
Anritsu	MA2411B	Pulse Power Sensor	8/14/2019	Annual	8/14/2020	1315051
Anritsu	MA2411B	Pulse Power Sensor	8/8/2019	Annual	8/8/2020	1339008
Anritsu	ML2495A	Power Meter	12/17/2019	Annual	12/17/2020	941001
Agilent	N5182A	MXG Vector Signal Generator	8/19/2019	Annual	8/19/2020	MY47420837
Seekonk	NC-100	Torque Wrench	5/9/2018	Biennial	5/9/2020	22217
MiniCircuits	ZHDC-16-63-S+	Bidirectional Coupler	CBT	N/A	CBT	N/A
MiniCircuits	VLF-6000+	Low Pass Filter	CBT	N/A	CBT	N/A
SPEAG	EX3DV4	SAR Probe	9/19/2019	Annual	9/19/2020	7551
SPEAG	EX3DV4	SAR Probe	7/16/2019	Annual	7/16/2020	7410
SPEAG	DAE4	Dasy Data Acquisition Electronics	9/17/2019	Annual	9/17/2020	1333
SPEAG	DAE4	Dasy Data Acquisition Electronics	7/11/2019	Annual	7/11/2020	1322

Measurement Uncertainty = $\pm 23\%$ (k=2)

	Name	Function	Signature
Calibrated By:	Brodie Halfoster	Test Engineer	<i>BRODIE HALFOSTER</i>
Approved By:	Kaitlin O'Keefe	Senior Technical Manager	<i>KOK</i>

DIPOLE CALIBRATION EXTENSION

Per KDB 865664 D01, calibration intervals of up to three years may be considered for reference dipoles when it is demonstrated that the SAR target, impedance and return loss of a dipole have remained stable according to the following requirements:

1. The measured SAR does not deviate more than 10% from the target on the calibration certificate.
2. The return-loss does not deviate more than 20% from the previous measurement and meets the required 20dB minimum return-loss requirement.
3. The measurement of real or imaginary parts of impedance does not deviate more than 5Ω from the previous measurement.

The following dipole was checked to pass the above 3 requirements to have 2-year calibration period from the calibration date:

Calibration Date	Extension Date	Certificate Electrical Delay (ns)	Certificate SAR Target Head (1g) W/kg @ 20.0 dBm	Measured Head SAR (1g) W/kg @ 20.0 dBm	Deviation 1g (%)	Certificate SAR Target Head (10g) W/kg @ 20.0 dBm	Measured Head SAR (10g) W/kg @ 20.0 dBm	Deviation 10g (%)	Certificate Impedance Head (Ohm) Real	Measured Impedance Head (Ohm) Real	Difference (Ohm) Real	Certificate Impedance Head (Ohm) Imaginary	Measured Impedance Head (Ohm) Imaginary	Difference (Ohm) Imaginary	Certificate Return Loss Head (dB)	Measured Return Loss Head (dB)	Deviation (%)	PASS/FAIL
2/21/2019	2/21/2020	1.17	3.91	4.15	6.14%	2.04	2.13	4.41%	51.8	53.7	1.9	6.8	2.7	4.1	-23.2	-27.1	-16.70%	PASS
Calibration Date	Extension Date	Certificate Electrical Delay (ns)	Certificate SAR Target Body (1g) W/kg @ 20.0 dBm	Measured Body SAR (1g) W/kg @ 20.0 dBm	Deviation 1g (%)	Certificate SAR Target Body (10g) W/kg @ 20.0 dBm	Measured Body SAR (10g) W/kg @ 20.0 dBm	Deviation 10g (%)	Certificate Impedance Body (Ohm) Real	Measured Impedance Body (Ohm) Real	Difference (Ohm) Real	Certificate Impedance Body (Ohm) Imaginary	Measured Impedance Body (Ohm) Imaginary	Difference (Ohm) Imaginary	Certificate Return Loss Body (dB)	Measured Return Loss Body (dB)	Deviation (%)	PASS/FAIL
2/21/2019	2/21/2020	1.17	3.91	4.06	3.84%	2.05	2.08	1.46%	48.4	50.9	2.5	7.8	5.4	2.4	-21.9	-25.3	-15.60%	PASS

Impedance & Return-Loss Measurement Plot for Head TSL

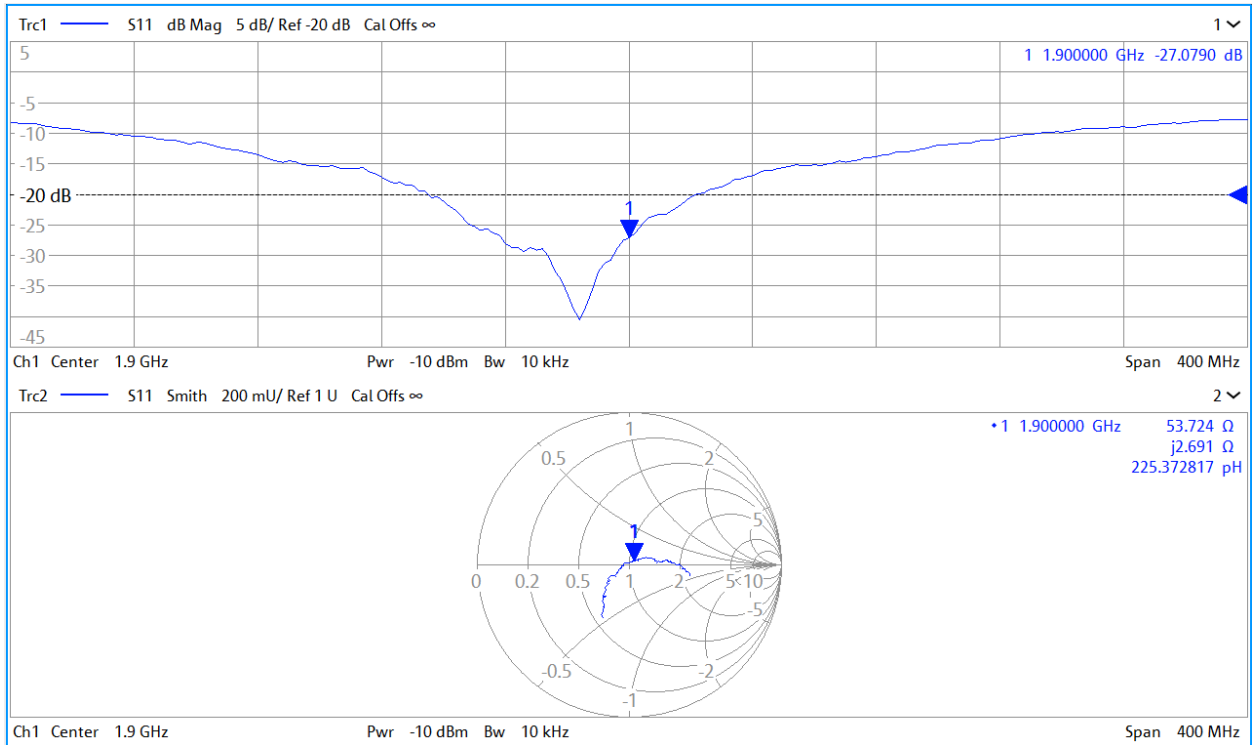

Impedance & Return-Loss Measurement Plot for Body TSL

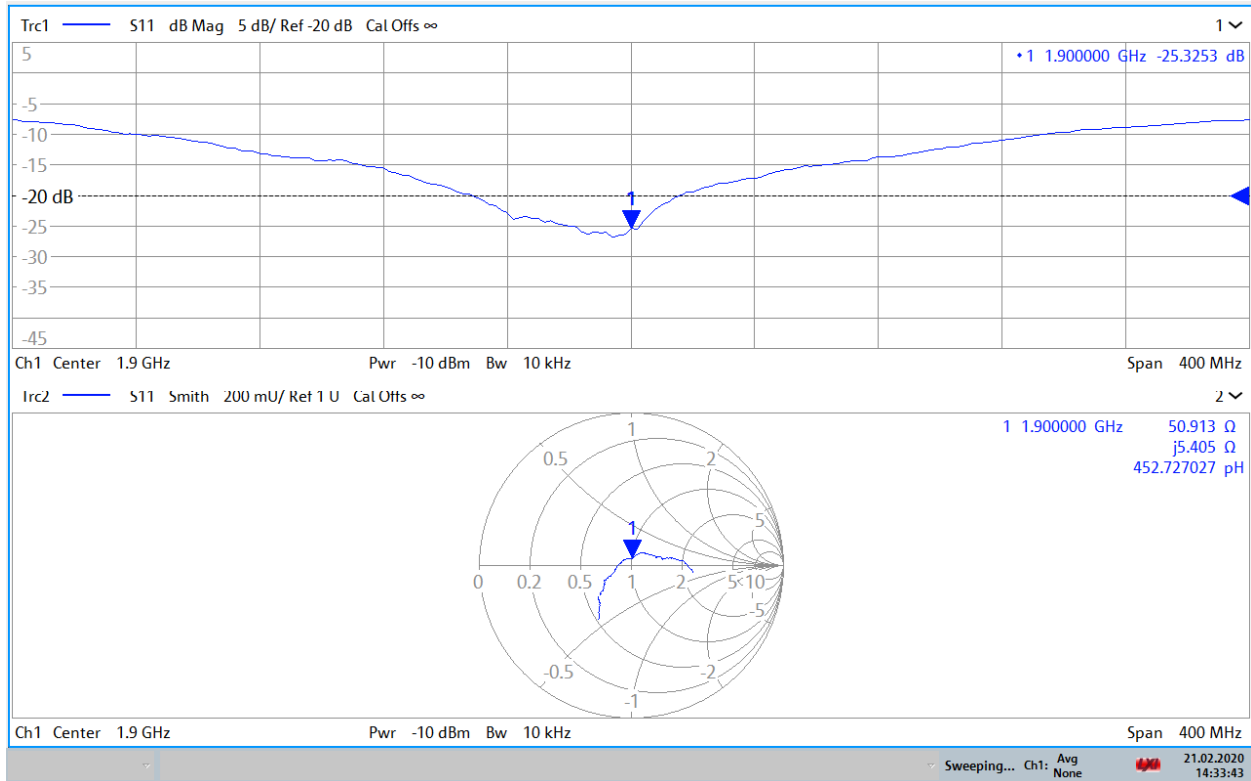

14:33:44 21.02.2020

Certification of Calibration

Object: D1900V2 – SN: 5d148

Calibration procedure(s): Procedure for Calibration Extension for SAR Dipoles.

Extension Calibration date: 2/21/2021

Description: SAR Validation Dipole at 1900 MHz.

Calibration Equipment used:

Manufacturer	Model	Description	Cal Date	Cal Interval	Cal Due	Serial Number
Control Company	4040	Therm./Clock/Humidity Monitor	6/29/2019	Biennial	6/29/2021	192291470
Control Company	4353	Long Stem Thermometer	10/28/2020	Biennial	10/28/2022	200670623
Amplifier Research	15S1G6	Amplifier	CBT	N/A	CBT	433971
Narda	4772-3	Attenuator (3dB)	CBT	N/A	CBT	9406
Agilent	85033E	3.5mm Standard Calibration Kit	6/6/2020	Annual	6/6/2021	MY53402352
Rohde & Schwarz	ZNLE6	Vector Network Analyzer	9/29/2020	Annual	9/29/2021	101307
Mini-Circuits	BW-N20W5+	DC to 18 GHz Precision Fixed 20 dB Attenuator	CBT	N/A	CBT	N/A
SPEAG	DAK-3.5	Dielectric Assessment Kit	5/12/2020	Annual	5/12/2021	1070
Anritsu	MA2411B	Pulse Power Sensor	8/12/2020	Annual	8/12/2021	1207364
Anritsu	MA2411B	Pulse Power Sensor	9/22/2020	Annual	9/22/2021	1315051
Anritsu	ML2495A	Power Meter	11/3/2020	Annual	11/3/2021	1039008
Anritsu	ML2495A	Power Meter	1/18/2021	Annual	1/18/2022	941001
Agilent	N5182A	MXG Vector Signal Generator	5/13/2020	Annual	5/13/2021	MY47420603
Pasternack	NC-100	Torque Wrench	8/4/2020	Biennial	8/4/2022	N/A
Mini-Circuits	NLP-2950+	Low Pass Filter DC to 2700 MHz	CBT	N/A	CBT	N/A
MiniCircuits	ZHDC-16-63-S+	Bidirectional Coupler	CBT	N/A	CBT	N/A
SPEAG	EX3DV4	SAR Probe	7/31/2020	Annual	7/31/2021	7308
SPEAG	EX3DV4	SAR Probe	12/15/2020	Annual	12/15/2021	7570
SPEAG	DAE4	Dasy Data Acquisition Electronics	12/7/2020	Annual	12/7/2021	859
SPEAG	DAE4	Dasy Data Acquisition Electronics	8/11/2020	Annual	8/11/2021	1450

Measurement Uncertainty = $\pm 23\%$ (k=2)

	Name	Function	Signature
Calibrated By:	Brodie Halfoster	Test Engineer	<i>BRODIE HALFOSTER</i>
Approved By:	Kaitlin O'Keefe	Senior Technical Manager	<i>KOK</i>

DIPOLE CALIBRATION EXTENSION

Per KDB 865664 D01, calibration intervals of up to three years may be considered for reference dipoles when it is demonstrated that the SAR target, impedance and return loss of a dipole have remained stable according to the following requirements:

1. The measured SAR does not deviate more than 10% from the target on the calibration certificate.
2. The return-loss does not deviate more than 20% from the previous measurement and meets the required 20dB minimum return-loss requirement.
3. The measurement of real or imaginary parts of impedance does not deviate more than 5Ω from the previous measurement.

The following dipole was checked to pass the above 3 requirements to have 3-year calibration period from the calibration date:

Calibration Date	Extension Date	Certificate Electrical Delay (ns)	Certificate SAR Target Head (1g) W/kg @ 20.0 dBm	Measured Head SAR (1g) W/kg @ 20.0 dBm	Deviation 1g (%)	Certificate SAR Target Head (10g) W/kg @ 20.0 dBm	Measured Head SAR (10g) W/kg @ 20.0 dBm	Deviation 10g (%)	Certificate Impedance Head (Ohm) Real	Measured Impedance Head (Ohm) Real	Difference (Ohm) Real	Certificate Impedance Head (Ohm) Imaginary	Measured Impedance Head (Ohm) Imaginary	Difference (Ohm) Imaginary	Certificate Return Loss Head (dB)	Measured Return Loss Head (dB)	Deviation (%)	PASS/FAIL
2/21/2019	2/21/2021	1.17	3.91	3.85	-1.53%	2.04	1.96	-3.92%	51.8	55.1	3.2	6.8	2.7	4.1	-23.2	-24.9	-7.30%	PASS
Calibration Date	Extension Date	Certificate Electrical Delay (ns)	Certificate SAR Target Body (1g) W/kg @ 20.0 dBm	Measured Body SAR (1g) W/kg @ 20.0 dBm	Deviation 1g (%)	Certificate SAR Target Body (10g) W/kg @ 20.0 dBm	Measured Body SAR (10g) W/kg @ 20.0 dBm	Deviation 10g (%)	Certificate Impedance Body (Ohm) Real	Measured Impedance Body (Ohm) Real	Difference (Ohm) Real	Certificate Impedance Body (Ohm) Imaginary	Measured Impedance Body (Ohm) Imaginary	Difference (Ohm) Imaginary	Certificate Return Loss Body (dB)	Measured Return Loss Body (dB)	Deviation (%)	PASS/FAIL
2/21/2019	2/21/2021	1.17	3.91	4.07	4.09%	2.05	2.1	2.44%	48.4	50.8	2.4	7.8	6.5	1.3	-21.9	-23.9	-8.90%	PASS

Impedance & Return-Loss Measurement Plot for Head TSL

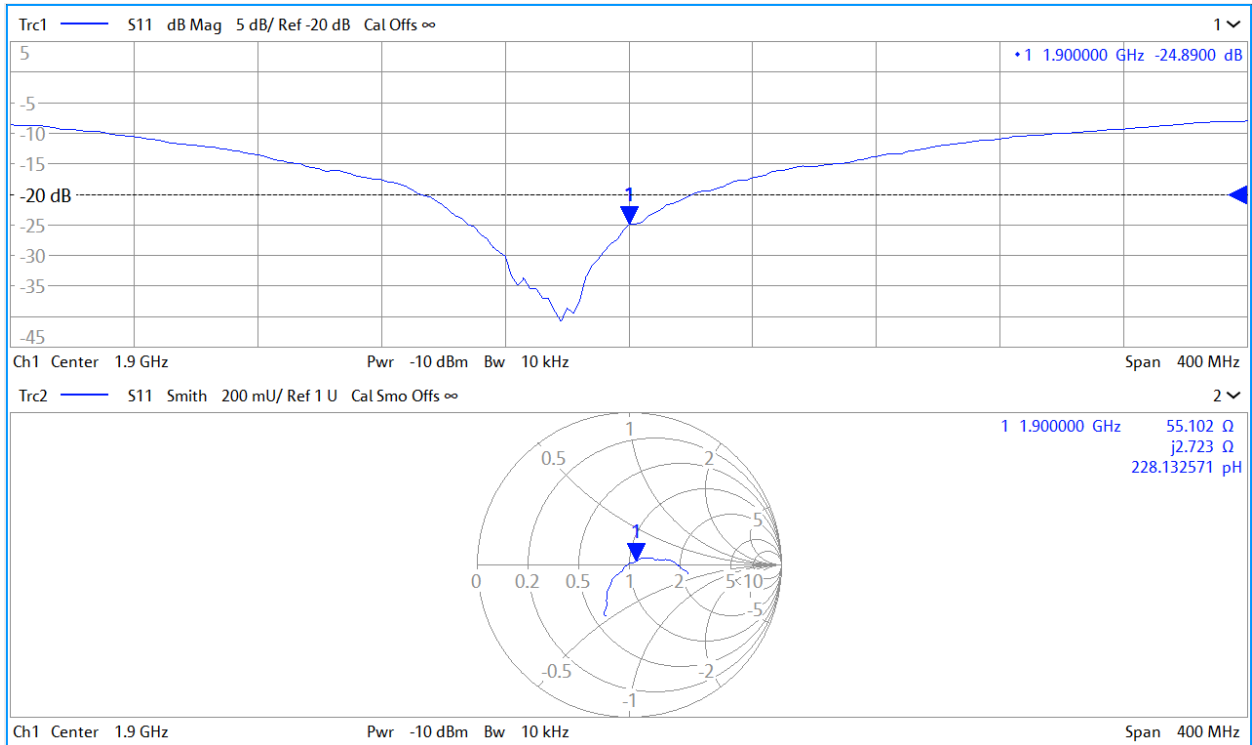

Impedance & Return-Loss Measurement Plot for Body TSL

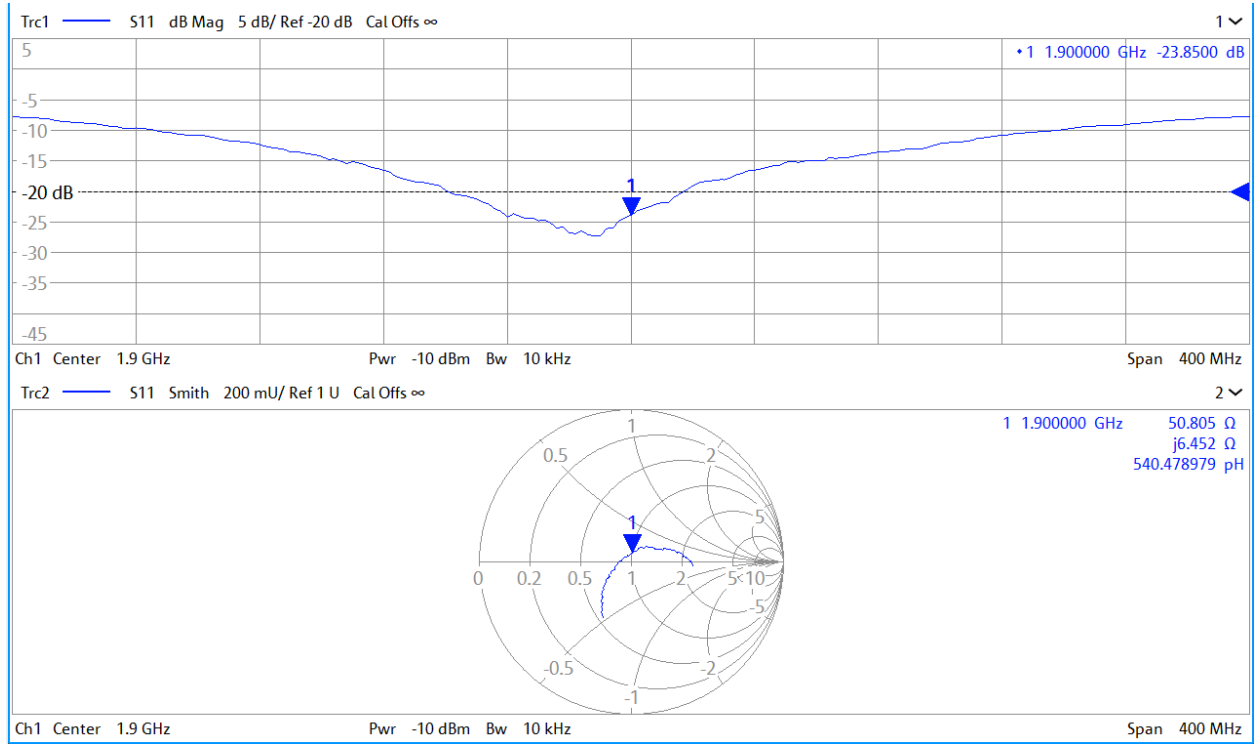



Accredited by the Swiss Accreditation Service (SAS)
The Swiss Accreditation Service is one of the signatories to the EA
Multilateral Agreement for the recognition of calibration certificates

Accreditation No.: **SCS 0108**

Client **PC Test**

Certificate No: **D1900V2-5d149_Oct18**

CALIBRATION CERTIFICATE

Object **D1900V2 - SN:5d149**

Calibration procedure(s) **QA CAL-05.v10
Calibration procedure for dipole validation kits above 700 MHz**

Calibration date: **October 23, 2018**

*BNV
10-30-2018
BNV
10-20-2018
BNV
10-23-20*

This calibration certificate documents the traceability to national standards, which realize the physical units of measurements (SI).
The measurements and the uncertainties with confidence probability are given on the following pages and are part of the certificate.

All calibrations have been conducted in the closed laboratory facility: environment temperature (22 ± 3)°C and humidity < 70%.

Calibration Equipment used (M&TE critical for calibration)

Primary Standards	ID #	Cal Date (Certificate No.)	Scheduled Calibration
Power meter NRP	SN: 104778	04-Apr-18 (No. 217-02672/02673)	Apr-19
Power sensor NRP-Z91	SN: 103244	04-Apr-18 (No. 217-02672)	Apr-19
Power sensor NRP-Z91	SN: 103245	04-Apr-18 (No. 217-02673)	Apr-19
Reference 20 dB Attenuator	SN: 5058 (20k)	04-Apr-18 (No. 217-02682)	Apr-19
Type-N mismatch combination	SN: 5047.2 / 06327	04-Apr-18 (No. 217-02683)	Apr-19
Reference Probe EX3DV4	SN: 7349	30-Dec-17 (No. EX3-7349_Dec17)	Dec-18
DAE4	SN: 601	04-Oct-18 (No. DAE4-601_Oct18)	Oct-19

Secondary Standards	ID #	Check Date (in house)	Scheduled Check
Power meter EPM-442A	SN: GB37480704	07-Oct-15 (in house check Oct-18)	In house check: Oct-20
Power sensor HP 8481A	SN: US37292783	07-Oct-15 (in house check Oct-18)	In house check: Oct-20
Power sensor HP 8481A	SN: MY41092317	07-Oct-15 (in house check Oct-18)	In house check: Oct-20
RF generator R&S SMT-06	SN: 100972	15-Jun-15 (in house check Oct-18)	In house check: Oct-20
Network Analyzer Agilent E8358A	SN: US41080477	31-Mar-14 (in house check Oct-18)	In house check: Oct-19

Calibrated by: **Jeton Kastrati** (Name) / **Laboratory Technician** (Function) / *[Signature]* (Signature)

Approved by: **Katja Pokovic** (Name) / **Technical Manager** (Function) / *[Signature]* (Signature)

Issued: October 23, 2018

This calibration certificate shall not be reproduced except in full without written approval of the laboratory.



Accredited by the Swiss Accreditation Service (SAS)
The Swiss Accreditation Service is one of the signatories to the EA
Multilateral Agreement for the recognition of calibration certificates

Accreditation No.: **SCS 0108**

Glossary:

TSL	tissue simulating liquid
ConvF	sensitivity in TSL / NORM x,y,z
N/A	not applicable or not measured

Calibration is Performed According to the Following Standards:

- IEEE Std 1528-2013, "IEEE Recommended Practice for Determining the Peak Spatial-Averaged Specific Absorption Rate (SAR) in the Human Head from Wireless Communications Devices: Measurement Techniques", June 2013
- IEC 62209-1, "Measurement procedure for the assessment of Specific Absorption Rate (SAR) from hand-held and body-mounted devices used next to the ear (frequency range of 300 MHz to 6 GHz)", July 2016
- IEC 62209-2, "Procedure to determine the Specific Absorption Rate (SAR) for wireless communication devices used in close proximity to the human body (frequency range of 30 MHz to 6 GHz)", March 2010
- KDB 865664, "SAR Measurement Requirements for 100 MHz to 6 GHz"

Additional Documentation:

- DASY4/5 System Handbook

Methods Applied and Interpretation of Parameters:

- Measurement Conditions:** Further details are available from the Validation Report at the end of the certificate. All figures stated in the certificate are valid at the frequency indicated.
- Antenna Parameters with TSL:** The dipole is mounted with the spacer to position its feed point exactly below the center marking of the flat phantom section, with the arms oriented parallel to the body axis.
- Feed Point Impedance and Return Loss:** These parameters are measured with the dipole positioned under the liquid filled phantom. The impedance stated is transformed from the measurement at the SMA connector to the feed point. The Return Loss ensures low reflected power. No uncertainty required.
- Electrical Delay:** One-way delay between the SMA connector and the antenna feed point. No uncertainty required.
- SAR measured:** SAR measured at the stated antenna input power.
- SAR normalized:** SAR as measured, normalized to an input power of 1 W at the antenna connector.
- SAR for nominal TSL parameters:** The measured TSL parameters are used to calculate the nominal SAR result.

The reported uncertainty of measurement is stated as the standard uncertainty of measurement multiplied by the coverage factor $k=2$, which for a normal distribution corresponds to a coverage probability of approximately 95%.

Measurement Conditions

DASY system configuration, as far as not given on page 1.

DASY Version	DASY5	V52.10.2
Extrapolation	Advanced Extrapolation	
Phantom	Modular Flat Phantom	
Distance Dipole Center - TSL	10 mm	with Spacer
Zoom Scan Resolution	dx, dy, dz = 5 mm	
Frequency	1900 MHz \pm 1 MHz	

Head TSL parameters

The following parameters and calculations were applied.

	Temperature	Permittivity	Conductivity
Nominal Head TSL parameters	22.0 °C	40.0	1.40 mho/m
Measured Head TSL parameters	(22.0 \pm 0.2) °C	40.3 \pm 6 %	1.40 mho/m \pm 6 %
Head TSL temperature change during test	< 0.5 °C	----	----

SAR result with Head TSL

SAR averaged over 1 cm³ (1 g) of Head TSL	Condition	
SAR measured	250 mW input power	9.80 W/kg
SAR for nominal Head TSL parameters	normalized to 1W	39.3 W/kg \pm 17.0 % (k=2)

SAR averaged over 10 cm³ (10 g) of Head TSL	condition	
SAR measured	250 mW input power	5.11 W/kg
SAR for nominal Head TSL parameters	normalized to 1W	20.5 W/kg \pm 16.5 % (k=2)

Body TSL parameters

The following parameters and calculations were applied.

	Temperature	Permittivity	Conductivity
Nominal Body TSL parameters	22.0 °C	53.3	1.52 mho/m
Measured Body TSL parameters	(22.0 \pm 0.2) °C	52.9 \pm 6 %	1.47 mho/m \pm 6 %
Body TSL temperature change during test	< 0.5 °C	----	----

SAR result with Body TSL

SAR averaged over 1 cm³ (1 g) of Body TSL	Condition	
SAR measured	250 mW input power	9.68 W/kg
SAR for nominal Body TSL parameters	normalized to 1W	39.4 W/kg \pm 17.0 % (k=2)

SAR averaged over 10 cm³ (10 g) of Body TSL	condition	
SAR measured	250 mW input power	5.11 W/kg
SAR for nominal Body TSL parameters	normalized to 1W	20.7 W/kg \pm 16.5 % (k=2)

Appendix (Additional assessments outside the scope of SCS 0108)

Antenna Parameters with Head TSL

Impedance, transformed to feed point	52.9 Ω + 6.3 j Ω
Return Loss	- 23.4 dB

Antenna Parameters with Body TSL

Impedance, transformed to feed point	48.5 Ω + 8.2 j Ω
Return Loss	- 21.5 dB

General Antenna Parameters and Design

Electrical Delay (one direction)	1.193 ns
----------------------------------	----------

After long term use with 100W radiated power, only a slight warming of the dipole near the feedpoint can be measured.

The dipole is made of standard semirigid coaxial cable. The center conductor of the feeding line is directly connected to the second arm of the dipole. The antenna is therefore short-circuited for DC-signals. On some of the dipoles, small end caps are added to the dipole arms in order to improve matching when loaded according to the position as explained in the "Measurement Conditions" paragraph. The SAR data are not affected by this change. The overall dipole length is still according to the Standard.

No excessive force must be applied to the dipole arms, because they might bend or the soldered connections near the feedpoint may be damaged.

Additional EUT Data

Manufactured by	SPEAG
Manufactured on	March 11, 2011

DASY5 Validation Report for Head TSL

Date: 23.10.2018

Test Laboratory: SPEAG, Zurich, Switzerland

DUT: Dipole 1900 MHz; Type: D1900V2; Serial: D1900V2 - SN:5d149

Communication System: UID 0 - CW; Frequency: 1900 MHz

Medium parameters used: $f = 1900$ MHz; $\sigma = 1.4$ S/m; $\epsilon_r = 40.3$; $\rho = 1000$ kg/m³

Phantom section: Flat Section

Measurement Standard: DASY5 (IEEE/IEC/ANSI C63.19-2011)

DASY52 Configuration:

- Probe: EX3DV4 - SN7349; ConvF(8.18, 8.18, 8.18) @ 1900 MHz; Calibrated: 30.12.2017
- Sensor-Surface: 1.4mm (Mechanical Surface Detection)
- Electronics: DAE4 Sn601; Calibrated: 04.10.2018
- Phantom: Flat Phantom 5.0 (front); Type: QD 000 P50 AA; Serial: 1001
- DASY52 52.10.2(1495); SEMCAD X 14.6.12(7450)

Dipole Calibration for Head Tissue/Pin=250 mW, d=10mm/Zoom Scan (7x7x7)/Cube 0:

Measurement grid: dx=5mm, dy=5mm, dz=5mm

Reference Value = 110.0 V/m; Power Drift = -0.03 dB

Peak SAR (extrapolated) = 18.5 W/kg

SAR(1 g) = 9.8 W/kg; SAR(10 g) = 5.11 W/kg

Maximum value of SAR (measured) = 15.4 W/kg

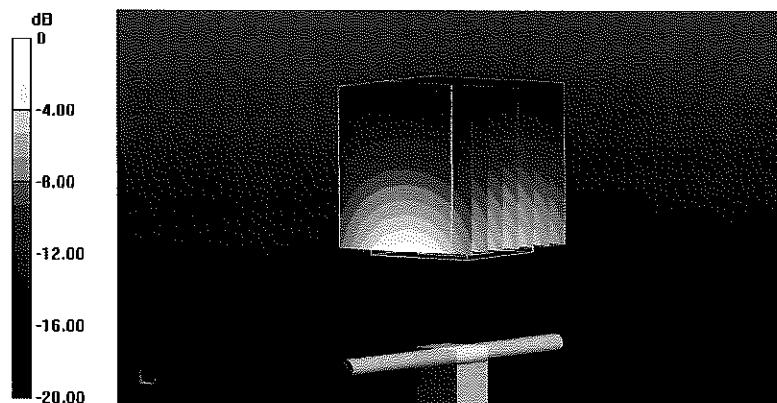

0 dB = 15.4 W/kg = 11.88 dBW/kg

Impedance Measurement Plot for Head TSL

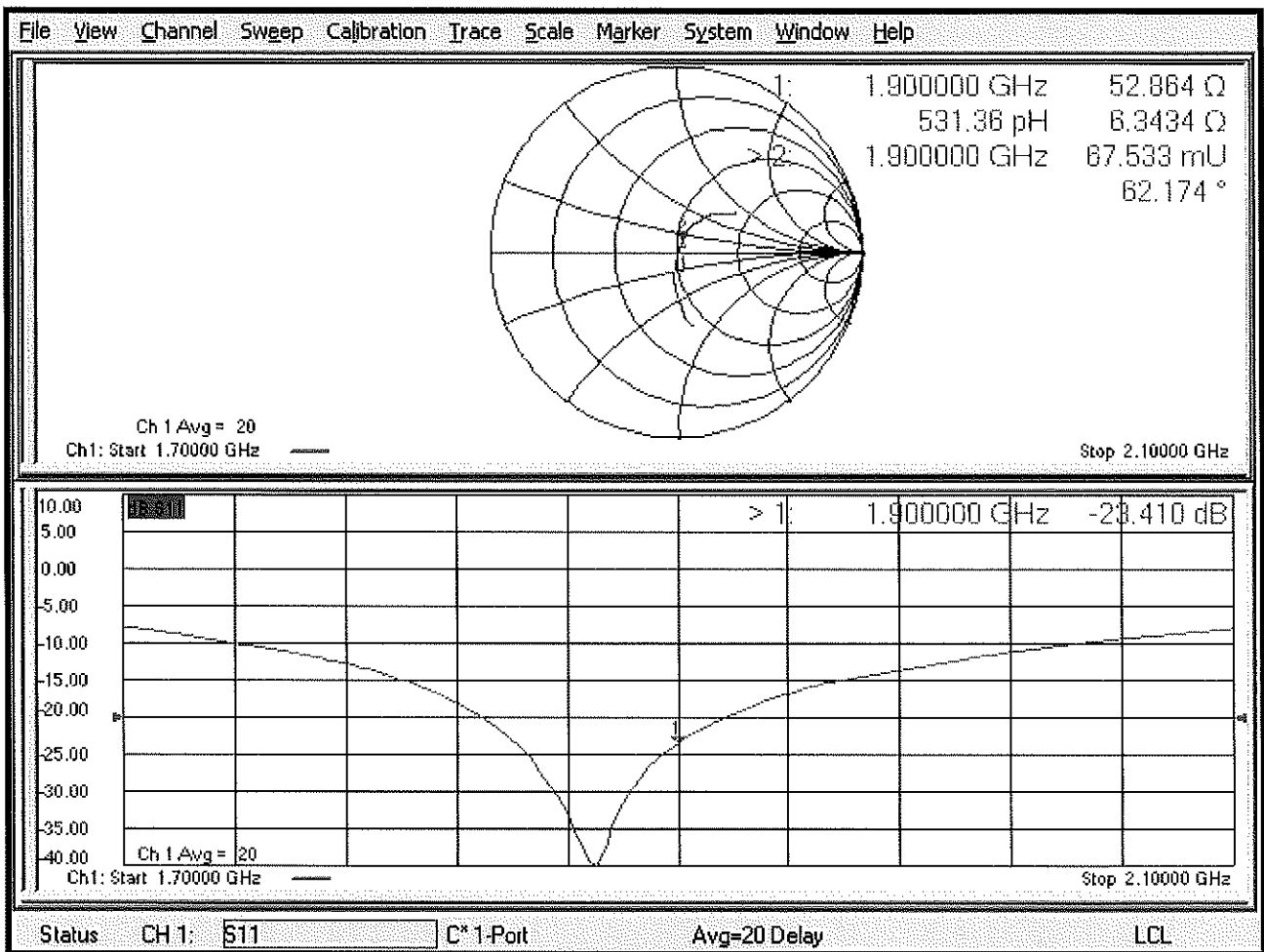

DASY5 Validation Report for Body TSL

Date: 23.10.2018

Test Laboratory: SPEAG, Zurich, Switzerland

DUT: Dipole 1900 MHz; Type: D1900V2; Serial: D1900V2 - SN:5d149

Communication System: UID 0 - CW; Frequency: 1900 MHz

Medium parameters used: $f = 1900$ MHz; $\sigma = 1.47$ S/m; $\epsilon_r = 52.9$; $\rho = 1000$ kg/m³

Phantom section: Flat Section

Measurement Standard: DASY5 (IEEE/IEC/ANSI C63.19-2011)

DASY52 Configuration:

- Probe: EX3DV4 - SN7349; ConvF(8.15, 8.15, 8.15) @ 1900 MHz; Calibrated: 30.12.2017
- Sensor-Surface: 1.4mm (Mechanical Surface Detection)
- Electronics: DAE4 Sn601; Calibrated: 04.10.2018
- Phantom: Flat Phantom 5.0 (back); Type: QD 000 P50 AA; Serial: 1002
- DASY52 52.10.2(1495); SEMCAD X 14.6.12(7450)

Dipole Calibration for Body Tissue/Pin=250 mW, d=10mm/Zoom Scan (7x7x7)/Cube 0:

Measurement grid: dx=5mm, dy=5mm, dz=5mm

Reference Value = 103.1 V/m; Power Drift = -0.03 dB

Peak SAR (extrapolated) = 17.5 W/kg

SAR(1 g) = 9.68 W/kg; SAR(10 g) = 5.11 W/kg

Maximum value of SAR (measured) = 14.2 W/kg

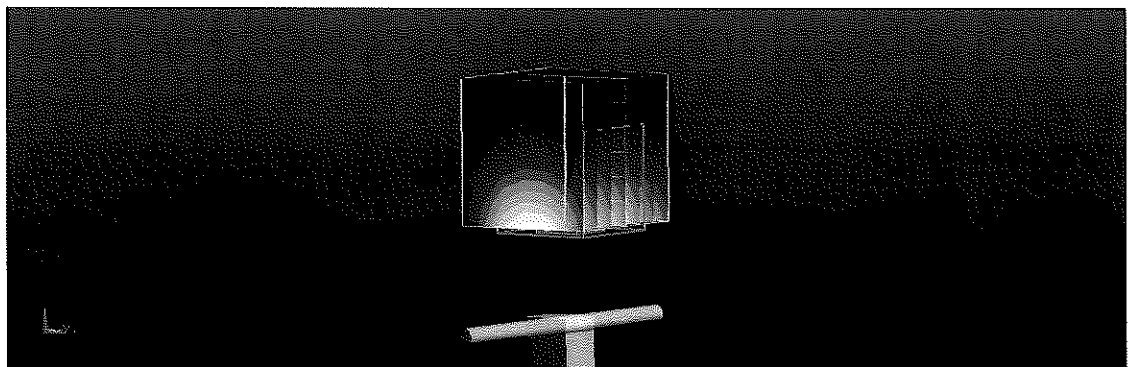
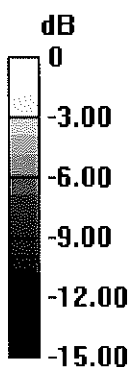

0 dB = 14.2 W/kg = 11.52 dBW/kg

Impedance Measurement Plot for Body TSL

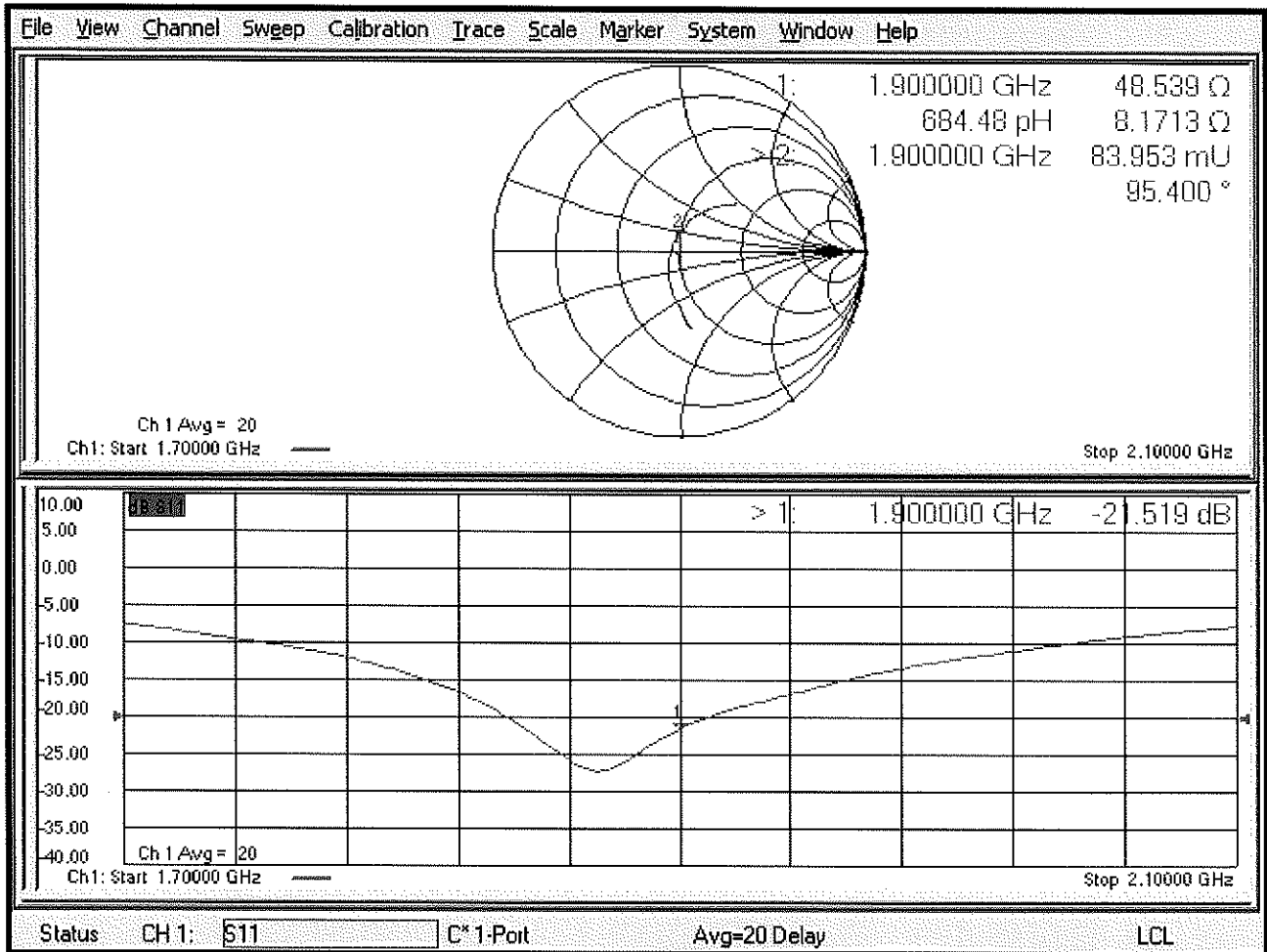

Certification of Calibration

Object D1900V2 – SN:5d149

Calibration procedure(s) Procedure for Calibration Extension for SAR Dipoles.

Extended Calibration date: October 18, 2019

Description: SAR Validation Dipole at 1900 MHz.

Calibration Equipment used:

Manufacturer	Model	Description	Cal Date	Cal Interval	Cal Due	Serial Number
Control Company	4040	Therm./Clock/Humidity Monitor	6/29/2019	Biennial	6/29/2021	192291470
Control Company	4352	Ultra Long Stem Thermometer	8/2/2018	Biennial	8/2/2020	181334684
Amplifier Research	15S1G6	Amplifier	CBT	N/A	CBT	433971
Narda	4772-3	Attenuator (3dB)	CBT	N/A	CBT	9406
Keysight Technologies	85033E	Standard Mechanical Calibration Kit (DC to 9GHz, 3.5mm)	7/2/2019	Annual	7/2/2020	MY53401181
Rohde & Schwarz	ZNLE6	Vector Network Analyzer	10/11/2019	Annual	10/11/2020	101307
Mini-Circuits	BW-N20W5+	DC to 18 GHz Precision Fixed 20 dB Attenuator	CBT	N/A	CBT	N/A
SPEAG	DAKS-3.5	Portable Dielectric Assessment Kit	8/13/2019	Annual	8/13/2020	1041
Anritsu	MA2411B	Pulse Power Sensor	8/14/2019	Annual	8/14/2020	1315051
Anritsu	MA2411B	Pulse Power Sensor	8/8/2019	Annual	8/8/2020	1339008
Anritsu	ML2495A	Power Meter	11/20/2018	Annual	11/20/2019	1039008
Agilent	N5182A	MXG Vector Signal Generator	8/19/2019	Annual	8/19/2020	MY47420837
Seekonk	NC-100	Torque Wrench	5/9/2018	Biennial	5/9/2020	22217
Mini-Circuits	NLP-2950+	Low Pass Filter DC to 2700 MHz	CBT	N/A	CBT	N/A
MiniCircuits	ZHDC-16-63-S+	Bidirectional Coupler	CBT	N/A	CBT	N/A
MiniCircuits	VLF-6000+	Low Pass Filter	CBT	N/A	CBT	N/A
SPEAG	EX3DV4	SAR Probe	2/19/2019	Annual	2/19/2020	3914
SPEAG	EX3DV4	SAR Probe	5/16/2019	Annual	5/16/2020	7406
SPEAG	DAE4	Dasy Data Acquisition Electronics	5/8/2019	Annual	5/8/2020	859
SPEAG	DAE4	Dasy Data Acquisition Electronics	2/14/2019	Annual	2/14/2020	1272

Note: CBT (Calibrated Before Testing). Prior to testing, the measurement paths containing a cable, amplifier, attenuator, coupler or filter were connected to a calibrated source (i.e. a signal generator) to determine the losses of the measurement path.

Measurement Uncertainty = $\pm 23\%$ (k=2)

	Name	Function	Signature
Calibrated By:	Brodie Halfoster	Team Lead Engineer	<i>BRODIE HALFOSTER</i>
Approved By:	Kaitlin O'Keefe	Senior Technical Manager	<i>KOK</i>

DIPOLE CALIBRATION EXTENSION

Per KDB 865664 D01, calibration intervals of up to three years may be considered for reference dipoles when it is demonstrated that the SAR target, impedance and return loss of a dipole have remained stable according to the following requirements:

1. The measured SAR does not deviate more than 10% from the target on the calibration certificate.
2. The return-loss does not deviate more than 20% from the previous measurement and meets the required 20dB minimum return-loss requirement.
3. The measurement of real or imaginary parts of impedance does not deviate more than 5Ω from the previous measurement.

The following dipole was checked to pass the above 3 requirements to have 2-year calibration period from the calibration date:

Calibration Date	Extension Date	Certificate Electrical Delay (ns)	Certificate SAR Target Head (1g) W/kg @ 20.0 dBm	Measured Head SAR (1g) W/kg @ 20.0 dBm	Deviation 1g (%)	Certificate SAR Target Head (10g) W/kg @ 20.0 dBm	Measured Head SAR (10g) W/kg @ 20.0 dBm	Deviation 10g (%)	Certificate Impedance Head (Ohm) Real	Measured Impedance Head (Ohm) Real	Difference (Ohm) Real	Certificate Impedance Head (Ohm) Imaginary	Measured Impedance Head (Ohm) Imaginary	Difference (Ohm) Imaginary	Certificate Return Loss Head (dB)	Measured Return Loss Head (dB)	Deviation (%)	PASS/FAIL
10/23/2018	10/18/2019	1.193	3.93	4.24	7.89%	2.05	2.18	6.34%	52.9	51.8	1.1	6.3	6.4	0.1	-23.4	-23.8	-1.80%	Pass
Calibration Date	Extension Date	Certificate Electrical Delay (ns)	Certificate SAR Target Body (1g) W/kg @ 20.0 dBm	Measured Body SAR (1g) W/kg @ 20.0 dBm	Deviation 1g (%)	Certificate SAR Target Body (10g) W/kg @ 20.0 dBm	Measured Body SAR (10g) W/kg @ 20.0 dBm	Deviation 10g (%)	Certificate Impedance Body (Ohm) Real	Measured Impedance Body (Ohm) Real	Difference (Ohm) Real	Certificate Impedance Body (Ohm) Imaginary	Measured Impedance Body (Ohm) Imaginary	Difference (Ohm) Imaginary	Certificate Return Loss Body (dB)	Measured Return Loss Body (dB)	Deviation (%)	PASS/FAIL
10/23/2018	10/18/2019	1.193	3.94	4.2	6.60%	2.07	2.15	3.96%	48.5	48.4	0.1	8.2	7.6	0.6	-21.5	-22.1	-2.60%	PASS

Impedance & Return-Loss Measurement Plot for Head TSL

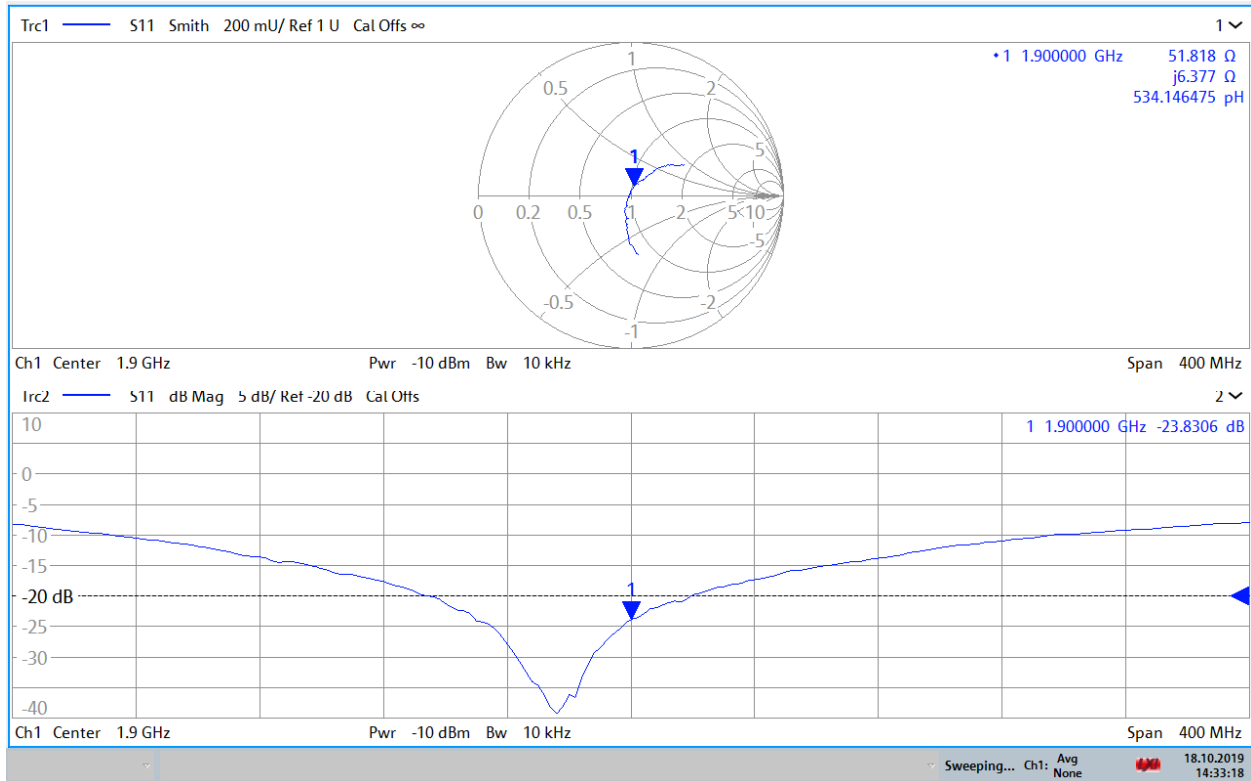

14:33:19 18.10.2019

Impedance & Return-Loss Measurement Plot for Body TSL

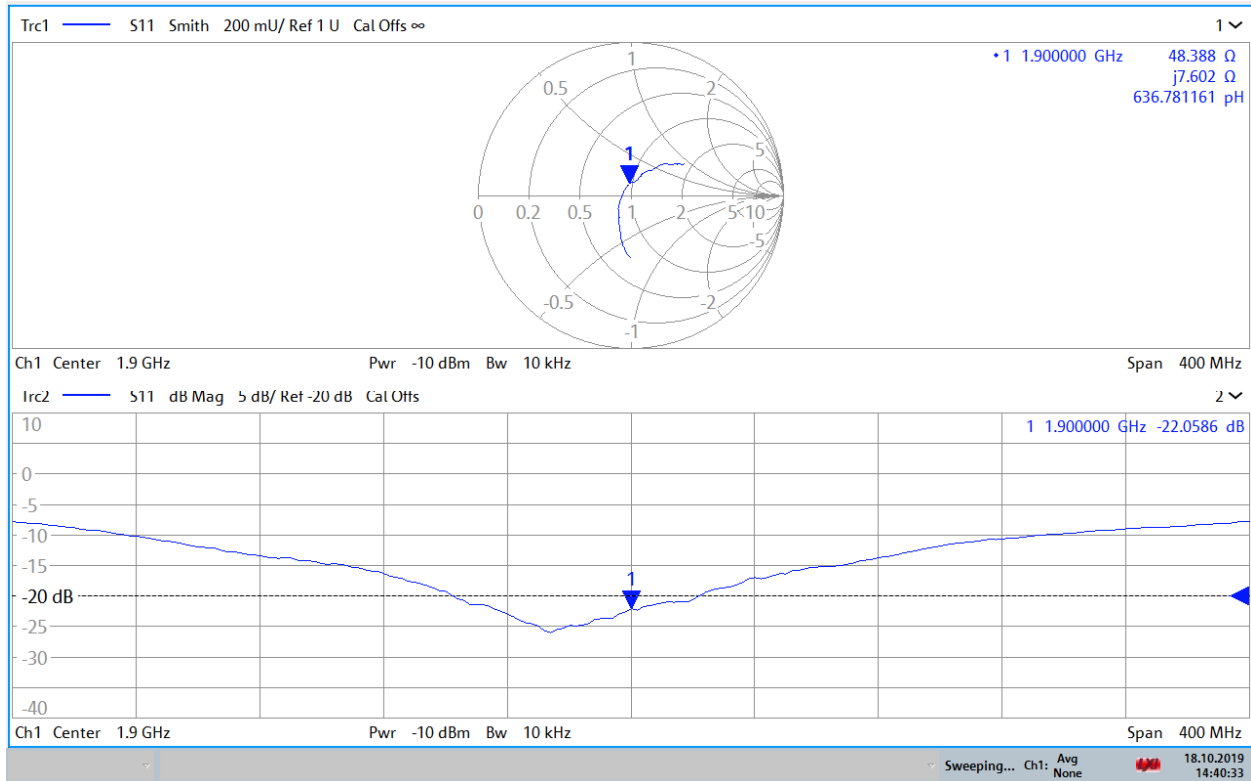

14:40:34 18.10.2019

Certification of Calibration

Object: D1900V2 – SN: 5d149

Calibration procedure(s): Procedure for Calibration Extension for SAR Dipoles.

Extension Calibration date: 10/18/2020

Description: SAR Validation Dipole at 1900 MHz.

Calibration Equipment used:

Manufacturer	Model	Description	Cal Date	Cal Interval	Cal Due	Serial Number
Control Company	4040	Therm./Clock/Humidity Monitor	6/29/2019	Biennial	6/29/2021	192291470
Control Company	4352	Ultra Long Stem Thermometer	11/29/2018	Biennial	11/29/2020	181766816
Amplifier Research	15S1G6	Amplifier	CBT	N/A	CBT	433971
Narda	4772-3	Attenuator (3dB)	CBT	N/A	CBT	9406
Agilent	85033E	3.5mm Standard Calibration Kit	6/6/2020	Annual	6/6/2021	MY53402352
Rohde & Schwarz	ZNLE6	Vector Network Analyzer	9/29/2020	Annual	9/29/2021	101307
Mini-Circuits	BW-N20W5+	DC to 18 GHz Precision Fixed 20 dB Attenuator	CBT	N/A	CBT	N/A
SPEAG	DAK-3.5	Dielectric Assessment Kit	5/12/2020	Annual	5/12/2021	1070
Anritsu	MA2411B	Pulse Power Sensor	8/12/2020	Annual	8/12/2021	1207364
Anritsu	MA2411B	Pulse Power Sensor	9/22/2020	Annual	9/22/2021	1315051
Anritsu	ML2495A	Power Meter	1/15/2020	Annual	1/15/2021	1328004
Anritsu	ML2495A	Power Meter	12/17/2019	Annual	12/17/2020	941001
Agilent	N5182A	MXG Vector Signal Generator	5/13/2020	Annual	5/13/2021	MY47420603
Pasternack	NC-100	Torque Wrench	8/4/2020	Biennial	8/4/2022	N/A
Mini-Circuits	NLP-2950+	Low Pass Filter DC to 2700 MHz	CBT	N/A	CBT	N/A
MiniCircuits	ZHDC-16-63-S+	Bidirectional Coupler	CBT	N/A	CBT	N/A
MiniCircuits	VLF-6000+	Low Pass Filter	CBT	N/A	CBT	N/A
SPEAG	EX3DV4	SAR Probe	12/11/2019	Annual	12/11/2020	7570
SPEAG	EX3DV4	SAR Probe	12/11/2019	Annual	12/11/2020	7571
SPEAG	DAE4	Dasy Data Acquisition Electronics	3/12/2020	Annual	3/12/2021	1368
SPEAG	DAE4	Data Acquisition Electronics	6/22/2020	Annual	12/7/2019	1533

Measurement Uncertainty = $\pm 23\%$ (k=2)

	Name	Function	Signature
Calibrated By:	Brodie Halfoster	Test Engineer	<i>BRODIE HALBFOSTER</i>
Approved By:	Kaitlin O'Keefe	Senior Technical Manager	<i>KOK</i>

DIPOLE CALIBRATION EXTENSION

Per KDB 865664 D01, calibration intervals of up to three years may be considered for reference dipoles when it is demonstrated that the SAR target, impedance and return loss of a dipole have remained stable according to the following requirements:

1. The measured SAR does not deviate more than 10% from the target on the calibration certificate.
2. The return-loss does not deviate more than 20% from the previous measurement and meets the required 20dB minimum return-loss requirement.
3. The measurement of real or imaginary parts of impedance does not deviate more than 5Ω from the previous measurement.

The following dipole was checked to pass the above 3 requirements to have 3-year calibration period from the calibration date:

Calibration Date	Extension Date	Certificate Electrical Delay (ns)	Certificate SAR Target Head (1g) W/kg @ 20.0 dBm	Measured Head SAR (1g) W/kg @ 20.0 dBm	Deviation 1g (%)	Certificate SAR Target Head (10g) W/kg @ 20.0 dBm	Measured Head SAR (10g) W/kg @ 20.0 dBm	Deviation 10g (%)	Certificate Impedance Head (Ohm) Real	Measured Impedance Head (Ohm) Real	Difference (Ohm) Real	Certificate Impedance Head (Ohm) Imaginary	Measured Impedance Head (Ohm) Imaginary	Difference (Ohm) Imaginary	Certificate Return Loss Head (dB)	Measured Return Loss Head (dB)	Deviation (%)	PASS/FAIL
10/23/2018	10/18/2020	1.193	3.93	4.02	2.29%	2.05	2.05	0.00%	52.9	49.1	3.8	6.3	4.6	1.7	-23.4	-26.5	-13.10%	PASS
Calibration Date	Extension Date	Certificate Electrical Delay (ns)	Certificate SAR Target Body (1g) W/kg @ 20.0 dBm	Measured Body SAR (1g) W/kg @ 20.0 dBm	Deviation 1g (%)	Certificate SAR Target Body (10g) W/kg @ 20.0 dBm	Measured Body SAR (10g) W/kg @ 20.0 dBm	Deviation 10g (%)	Certificate Impedance Body (Ohm) Real	Measured Impedance Body (Ohm) Real	Difference (Ohm) Real	Certificate Impedance Body (Ohm) Imaginary	Measured Impedance Body (Ohm) Imaginary	Difference (Ohm) Imaginary	Certificate Return Loss Body (dB)	Measured Return Loss Body (dB)	Deviation (%)	PASS/FAIL
10/23/2018	10/18/2020	1.193	3.94	4.07	3.30%	2.07	2.08	0.48%	48.5	47.3	1.2	8.2	4.7	3.5	-21.5	-25.1	-16.60%	PASS

Impedance & Return-Loss Measurement Plot for Head TSL

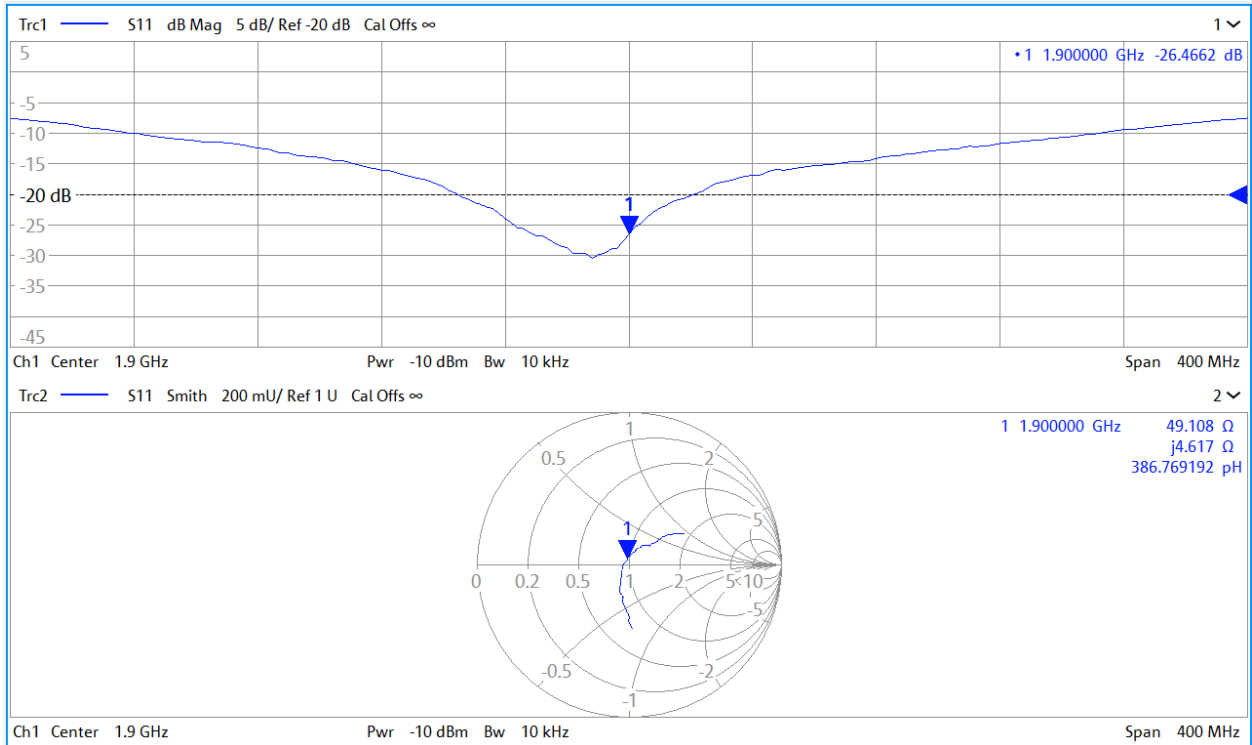

Impedance & Return-Loss Measurement Plot for Body TSL

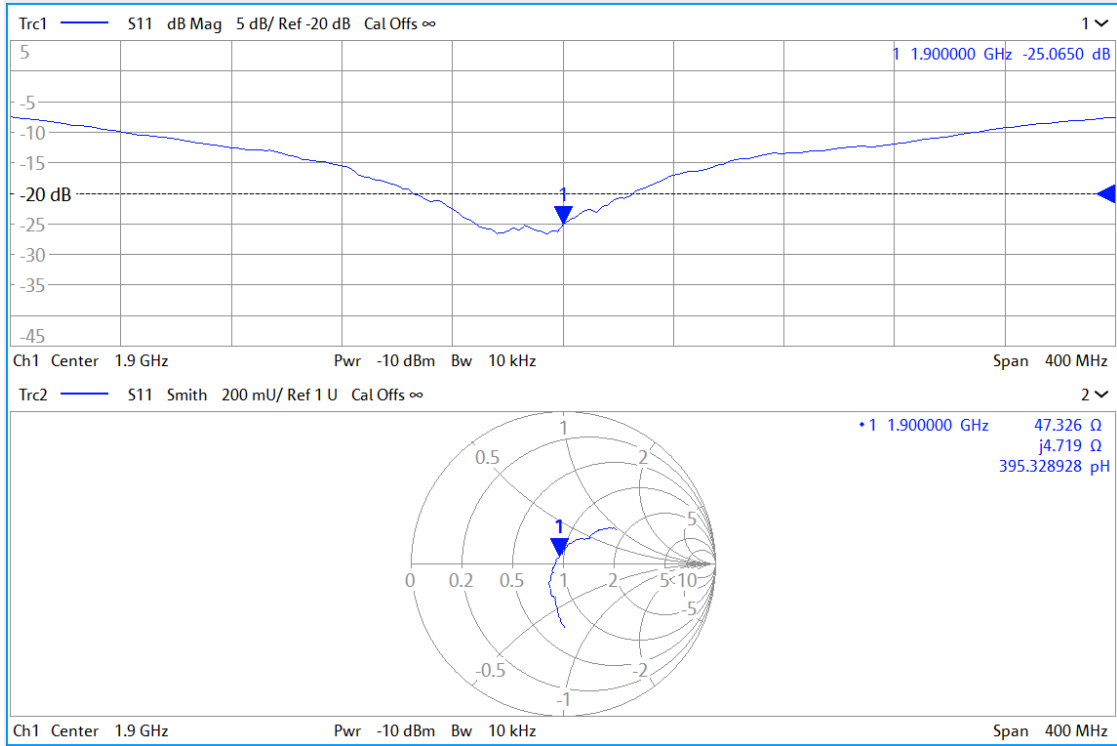



Accredited by the Swiss Accreditation Service (SAS)
The Swiss Accreditation Service is one of the signatories to the EA
Multilateral Agreement for the recognition of calibration certificates

Accreditation No.: **SCS 0108**

Client **PC Test**

Certificate No: **D2450V2-797_Sep20**

CALIBRATION CERTIFICATE

Object **D2450V2 - SN:797**

Calibration procedure(s) **QA CAL-05.v11
Calibration Procedure for SAR Validation Sources between 0.7-3 GHz**

Calibration date: **September 09, 2020**

*BNW
10-19-20*

This calibration certificate documents the traceability to national standards, which realize the physical units of measurements (SI).
The measurements and the uncertainties with confidence probability are given on the following pages and are part of the certificate.

All calibrations have been conducted in the closed laboratory facility: environment temperature (22 ± 3)°C and humidity < 70%.

Calibration Equipment used (M&TE critical for calibration)

Primary Standards	ID #	Cal Date (Certificate No.)	Scheduled Calibration
Power meter NRP	SN: 104778	01-Apr-20 (No. 217-03100/03101)	Apr-21
Power sensor NRP-Z91	SN: 103244	01-Apr-20 (No. 217-03100)	Apr-21
Power sensor NRP-Z91	SN: 103245	01-Apr-20 (No. 217-03101)	Apr-21
Reference 20 dB Attenuator	SN: BH9394 (20k)	31-Mar-20 (No. 217-03106)	Apr-21
Type-N mismatch combination	SN: 310982 / 06327	31-Mar-20 (No. 217-03104)	Apr-21
Reference Probe EX3DV4	SN: 7349	29-Jun-20 (No. EX3-7349_Jun20)	Jun-21
DAE4	SN: 601	27-Dec-19 (No. DAE4-601_Dec19)	Dec-20

Secondary Standards	ID #	Check Date (in house)	Scheduled Check
Power meter E4419B	SN: GB39512475	30-Oct-14 (in house check Feb-19)	In house check: Oct-20
Power sensor HP 8481A	SN: US37292783	07-Oct-15 (in house check Oct-18)	In house check: Oct-20
Power sensor HP 8481A	SN: MY41092317	07-Oct-15 (in house check Oct-18)	In house check: Oct-20
RF generator R&S SMT-06	SN: 100972	15-Jun-15 (in house check Oct-18)	In house check: Oct-20
Network Analyzer Agilent E8358A	SN: US41080477	31-Mar-14 (in house check Oct-19)	In house check: Oct-20

Calibrated by: **Jeffrey Katzman** Name: Jeffrey Katzman Function: Laboratory Technician

Approved by: **Katja Pokovic** Name: Katja Pokovic Function: Technical Manager

Signature *J. Katzman*

Signature *K. Pokovic*

Issued: September 10, 2020

This calibration certificate shall not be reproduced except in full without written approval of the laboratory.



Accredited by the Swiss Accreditation Service (SAS)

The Swiss Accreditation Service is one of the signatories to the EA
Multilateral Agreement for the recognition of calibration certificates

Accreditation No.: **SCS 0108**

Glossary:

TSL	tissue simulating liquid
ConvF	sensitivity in TSL / NORM x,y,z
N/A	not applicable or not measured

Calibration is Performed According to the Following Standards:

- IEEE Std 1528-2013, "IEEE Recommended Practice for Determining the Peak Spatial-Averaged Specific Absorption Rate (SAR) in the Human Head from Wireless Communications Devices: Measurement Techniques", June 2013
- IEC 62209-1, "Measurement procedure for the assessment of Specific Absorption Rate (SAR) from hand-held and body-mounted devices used next to the ear (frequency range of 300 MHz to 6 GHz)", July 2016
- IEC 62209-2, "Procedure to determine the Specific Absorption Rate (SAR) for wireless communication devices used in close proximity to the human body (frequency range of 30 MHz to 6 GHz)", March 2010
- KDB 865664, "SAR Measurement Requirements for 100 MHz to 6 GHz"

Additional Documentation:

- DASY4/5 System Handbook

Methods Applied and Interpretation of Parameters:

- Measurement Conditions:** Further details are available from the Validation Report at the end of the certificate. All figures stated in the certificate are valid at the frequency indicated.
- Antenna Parameters with TSL:** The dipole is mounted with the spacer to position its feed point exactly below the center marking of the flat phantom section, with the arms oriented parallel to the body axis.
- Feed Point Impedance and Return Loss:** These parameters are measured with the dipole positioned under the liquid filled phantom. The impedance stated is transformed from the measurement at the SMA connector to the feed point. The Return Loss ensures low reflected power. No uncertainty required.
- Electrical Delay:** One-way delay between the SMA connector and the antenna feed point. No uncertainty required.
- SAR measured:** SAR measured at the stated antenna input power.
- SAR normalized:** SAR as measured, normalized to an input power of 1 W at the antenna connector.
- SAR for nominal TSL parameters:** The measured TSL parameters are used to calculate the nominal SAR result.

The reported uncertainty of measurement is stated as the standard uncertainty of measurement multiplied by the coverage factor $k=2$, which for a normal distribution corresponds to a coverage probability of approximately 95%.

Measurement Conditions

DASY system configuration, as far as not given on page 1.

DASY Version	DASY5	V52.10.4
Extrapolation	Advanced Extrapolation	
Phantom	Modular Flat Phantom	
Distance Dipole Center - TSL	10 mm	with Spacer
Zoom Scan Resolution	dx, dy, dz = 5 mm	
Frequency	2450 MHz ± 1 MHz	

Head TSL parameters

The following parameters and calculations were applied.

	Temperature	Permittivity	Conductivity
Nominal Head TSL parameters	22.0 °C	39.2	1.80 mho/m
Measured Head TSL parameters	(22.0 ± 0.2) °C	38.2 ± 6 %	1.85 mho/m ± 6 %
Head TSL temperature change during test	< 0.5 °C	----	----

SAR result with Head TSL

SAR averaged over 1 cm³ (1 g) of Head TSL	Condition	
SAR measured	250 mW input power	13.4 W/kg
SAR for nominal Head TSL parameters	normalized to 1W	52.4 W/kg ± 17.0 % (k=2)

SAR averaged over 10 cm³ (10 g) of Head TSL	condition	
SAR measured	250 mW input power	6.22 W/kg
SAR for nominal Head TSL parameters	normalized to 1W	24.6 W/kg ± 16.5 % (k=2)

Body TSL parameters

The following parameters and calculations were applied.

	Temperature	Permittivity	Conductivity
Nominal Body TSL parameters	22.0 °C	52.7	1.95 mho/m
Measured Body TSL parameters	(22.0 ± 0.2) °C	51.8 ± 6 %	2.02 mho/m ± 6 %
Body TSL temperature change during test	< 0.5 °C	----	----

SAR result with Body TSL

SAR averaged over 1 cm³ (1 g) of Body TSL	Condition	
SAR measured	250 mW input power	12.6 W/kg
SAR for nominal Body TSL parameters	normalized to 1W	49.4 W/kg ± 17.0 % (k=2)

SAR averaged over 10 cm³ (10 g) of Body TSL	condition	
SAR measured	250 mW input power	5.92 W/kg
SAR for nominal Body TSL parameters	normalized to 1W	23.4 W/kg ± 16.5 % (k=2)

Appendix (Additional assessments outside the scope of SCS 0108)

Antenna Parameters with Head TSL

Impedance, transformed to feed point	53.0 Ω + 6.8 j Ω
Return Loss	- 22.9 dB

Antenna Parameters with Body TSL

Impedance, transformed to feed point	49.1 Ω + 9.2 j Ω
Return Loss	- 20.6 dB

General Antenna Parameters and Design

Electrical Delay (one direction)	1.152 ns
----------------------------------	----------

After long term use with 100W radiated power, only a slight warming of the dipole near the feedpoint can be measured.

The dipole is made of standard semirigid coaxial cable. The center conductor of the feeding line is directly connected to the second arm of the dipole. The antenna is therefore short-circuited for DC-signals. On some of the dipoles, small end caps are added to the dipole arms in order to improve matching when loaded according to the position as explained in the "Measurement Conditions" paragraph. The SAR data are not affected by this change. The overall dipole length is still according to the Standard.

No excessive force must be applied to the dipole arms, because they might bend or the soldered connections near the feedpoint may be damaged.

Additional EUT Data

Manufactured by	SPEAG
-----------------	-------

DASY5 Validation Report for Head TSL

Date: 08.09.2020

Test Laboratory: SPEAG, Zurich, Switzerland

DUT: Dipole 2450 MHz; Type: D2450V2; Serial: D2450V2 - SN:797

Communication System: UID 0 - CW; Frequency: 2450 MHz

Medium parameters used: $f = 2450$ MHz; $\sigma = 1.85$ S/m; $\epsilon_r = 38.2$; $\rho = 1000$ kg/m³

Phantom section: Flat Section

Measurement Standard: DASY5 (IEEE/IEC/ANSI C63.19-2011)

DASY52 Configuration:

- Probe: EX3DV4 - SN7349; ConvF(7.74, 7.74, 7.74) @ 2450 MHz; Calibrated: 29.06.2020
- Sensor-Surface: 1.4mm (Mechanical Surface Detection)
- Electronics: DAE4 Sn601; Calibrated: 27.12.2019
- Phantom: Flat Phantom 5.0 (front); Type: QD 000 P50 AA; Serial: 1001
- DASY52 52.10.4(1527); SEMCAD X 14.6.14(7483)

Dipole Calibration for Head Tissue/Pin=250 mW, d=10mm/Zoom Scan (7x7x7)/Cube 0:

Measurement grid: dx=5mm, dy=5mm, dz=5mm

Reference Value = 115.0 V/m; Power Drift = -0.04 dB

Peak SAR (extrapolated) = 26.2 W/kg

SAR(1 g) = 13.4 W/kg; SAR(10 g) = 6.22 W/kg

Smallest distance from peaks to all points 3 dB below = 9 mm

Ratio of SAR at M2 to SAR at M1 = 51.2%

Maximum value of SAR (measured) = 21.8 W/kg

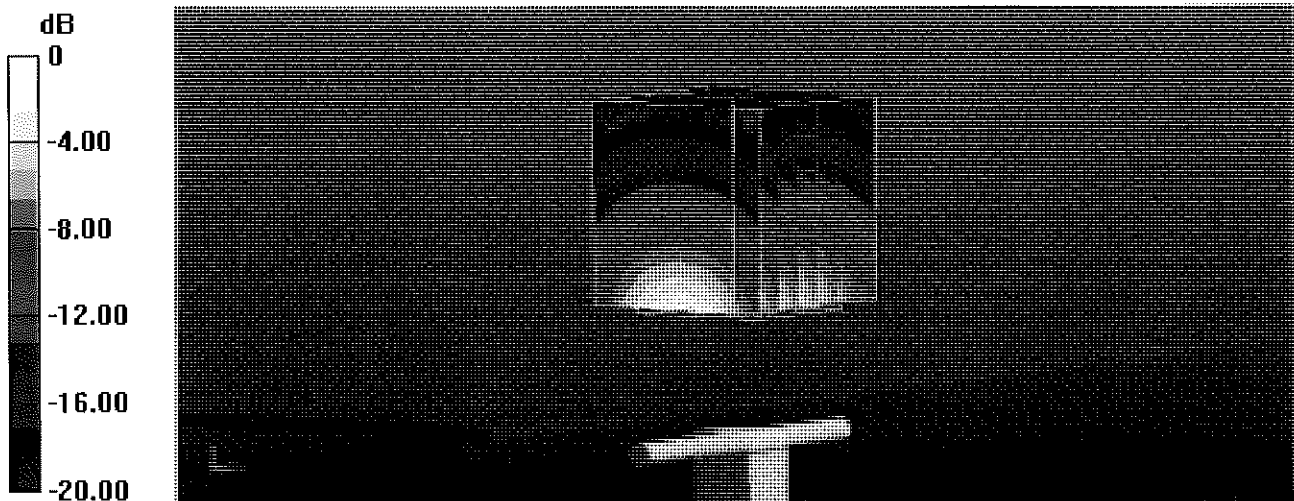

Impedance Measurement Plot for Head TSL

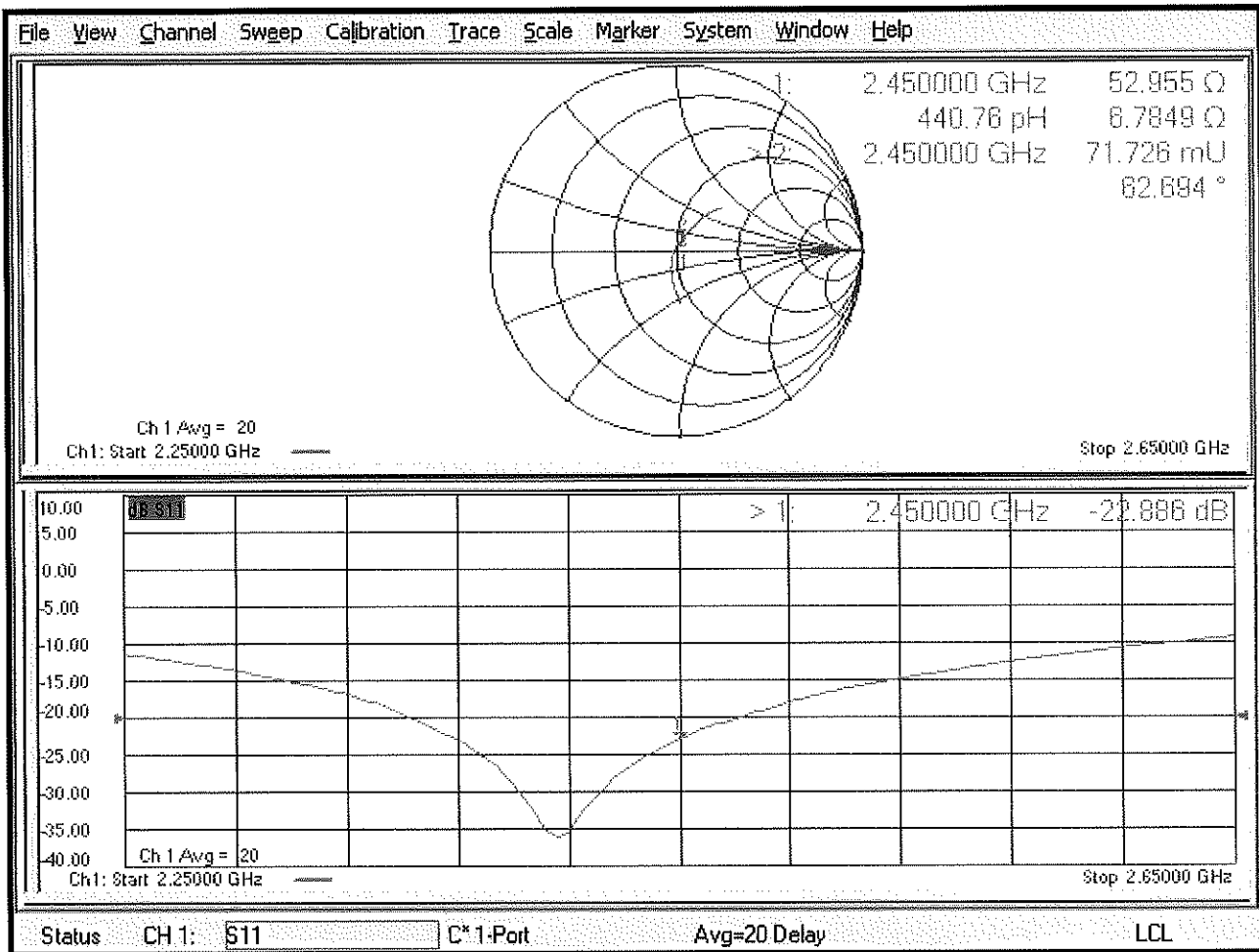

DASY5 Validation Report for Body TSL

Date: 09.09.2020

Test Laboratory: SPEAG, Zurich, Switzerland

DUT: Dipole 2450 MHz; Type: D2450V2; Serial: D2450V2 - SN:797

Communication System: UID 0 - CW; Frequency: 2450 MHz

Medium parameters used: $f = 2450$ MHz; $\sigma = 2.02$ S/m; $\epsilon_r = 51.8$; $\rho = 1000$ kg/m³

Phantom section: Flat Section

Measurement Standard: DASY5 (IEEE/IEC/ANSI C63.19-2011)

DASY52 Configuration:

- Probe: EX3DV4 - SN7349; ConvF(7.82, 7.82, 7.82) @ 2450 MHz; Calibrated: 29.06.2020
- Sensor-Surface: 1.4mm (Mechanical Surface Detection)
- Electronics: DAE4 Sn601; Calibrated: 27.12.2019
- Phantom: Flat Phantom 5.0 (back); Type: QD 000 P50 AA; Serial: 1002
- DASY52 52.10.4(1527); SEMCAD X 14.6.14(7483)

Dipole Calibration for Body Tissue/Pin=250 mW, d=10mm/Zoom Scan (7x7x7)/Cube 0:

Measurement grid: dx=5mm, dy=5mm, dz=5mm

Reference Value = 106.8 V/m; Power Drift = -0.02 dB

Peak SAR (extrapolated) = 23.9 W/kg

SAR(1 g) = 12.6 W/kg; SAR(10 g) = 5.92 W/kg

Smallest distance from peaks to all points 3 dB below = 9 mm

Ratio of SAR at M2 to SAR at M1 = 53.7%

Maximum value of SAR (measured) = 20.0 W/kg

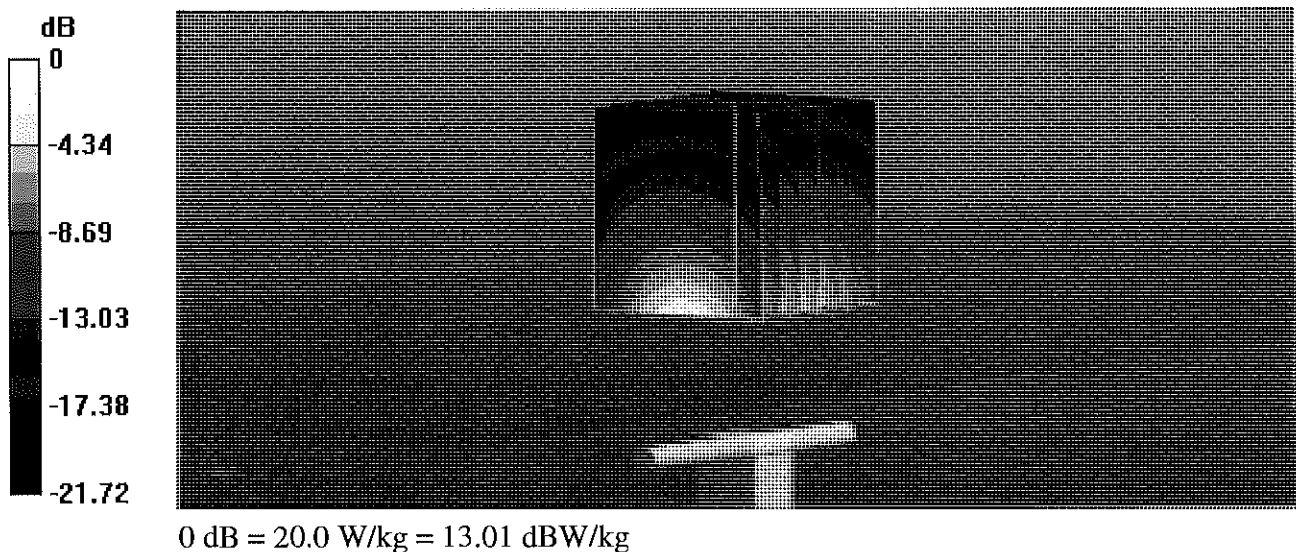

Impedance Measurement Plot for Body TSL

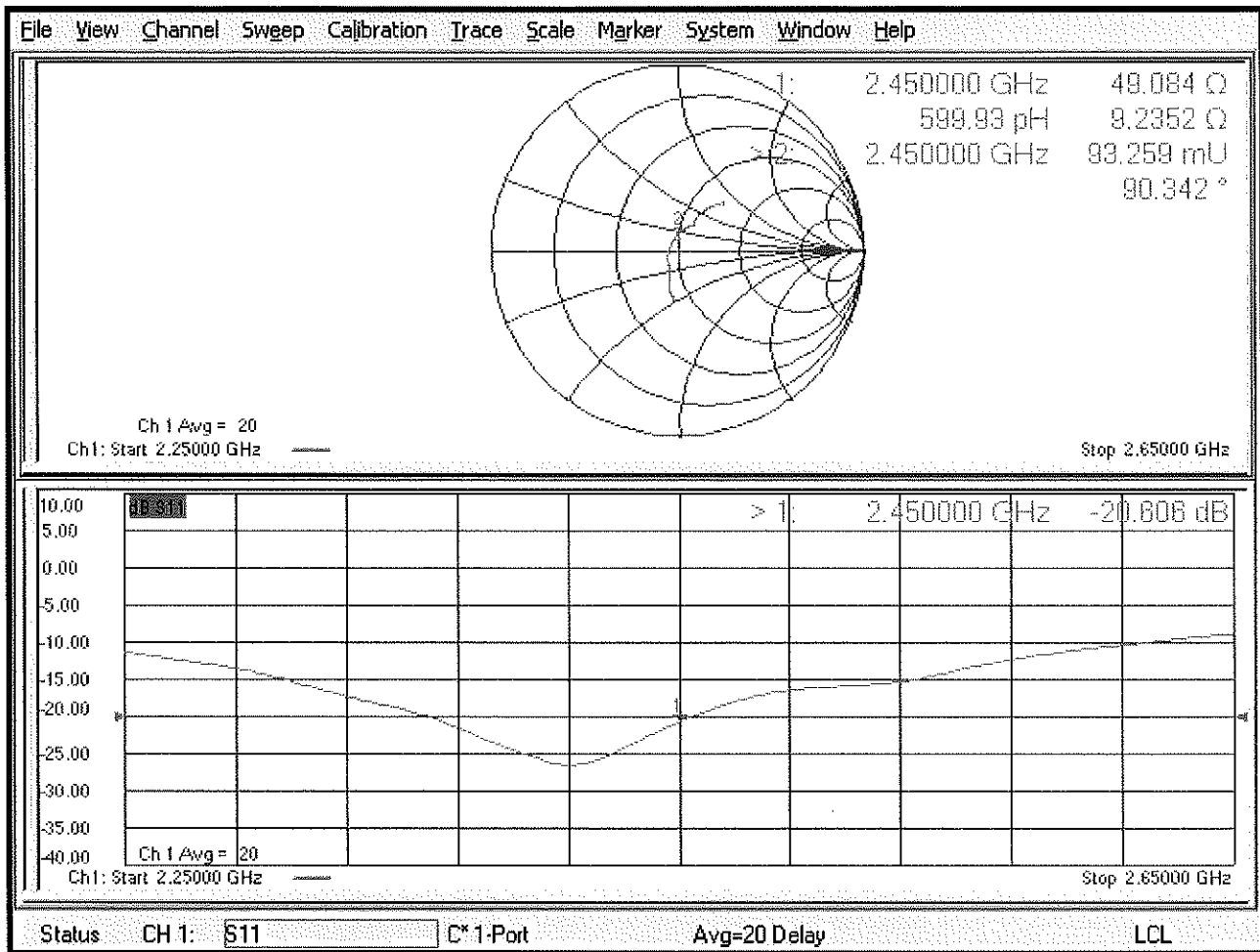



Accredited by the Swiss Accreditation Service (SAS)
The Swiss Accreditation Service is one of the signatories to the EA
Multilateral Agreement for the recognition of calibration certificates

Accreditation No.: **SCS 0108**

Client **PC Test**

Certificate No: **D2450V2-981_Jan21**

CALIBRATION CERTIFICATE

Object **D2450V2 - SN:981**

Calibration procedure(s) **QA CAL-05.v11
Calibration Procedure for SAR Validation Sources between 0.7-3 GHz**

Calibration date: **January 19, 2021**

*BNV
01-27-2021*

This calibration certificate documents the traceability to national standards, which realize the physical units of measurements (SI).
The measurements and the uncertainties with confidence probability are given on the following pages and are part of the certificate.

All calibrations have been conducted in the closed laboratory facility: environment temperature (22 ± 3)°C and humidity < 70%.

Calibration Equipment used (M&TE critical for calibration)

Primary Standards	ID #	Cal Date (Certificate No.)	Scheduled Calibration
Power meter NRP	SN: 104778	01-Apr-20 (No. 217-03100/03101)	Apr-21
Power sensor NRP-Z91	SN: 103244	01-Apr-20 (No. 217-03100)	Apr-21
Power sensor NRP-Z91	SN: 103245	01-Apr-20 (No. 217-03101)	Apr-21
Reference 20 dB Attenuator	SN: BH9394 (20k)	31-Mar-20 (No. 217-03106)	Apr-21
Type-N mismatch combination	SN: 310982 / 06327	31-Mar-20 (No. 217-03104)	Apr-21
Reference Probe EX3DV4	SN: 7349	28-Dec-20 (No. EX3-7349_Dec20)	Dec-21
DAE4	SN: 601	02-Nov-20 (No. DAE4-601_Nov20)	Nov-21
Secondary Standards	ID #	Check Date (in house)	Scheduled Check
Power meter E4419B	SN: GB39512475	30-Oct-14 (in house check Oct-20)	In house check: Oct-22
Power sensor HP 8481A	SN: US37292783	07-Oct-15 (in house check Oct-20)	In house check: Oct-22
Power sensor HP 8481A	SN: MY41092317	07-Oct-15 (in house check Oct-20)	In house check: Oct-22
RF generator R&S SMT-06	SN: 100972	15-Jun-15 (in house check Oct-20)	In house check: Oct-22
Network Analyzer Agilent E8358A	SN: US41080477	31-Mar-14 (in house check Oct-20)	In house check: Oct-21

Calibrated by: **Jeffrey Katzman** Name: Jeffrey Katzman Function: Laboratory Technician

Signature

Approved by: **Katja Pokovic** Name: Katja Pokovic Function: Technical Manager

Issued: January 20, 2021

This calibration certificate shall not be reproduced except in full without written approval of the laboratory.



Accredited by the Swiss Accreditation Service (SAS)

Accreditation No.: **SCS 0108**

The Swiss Accreditation Service is one of the signatories to the EA
Multilateral Agreement for the recognition of calibration certificates

Glossary:

TSL	tissue simulating liquid
ConvF	sensitivity in TSL / NORM x,y,z
N/A	not applicable or not measured

Calibration is Performed According to the Following Standards:

- IEEE Std 1528-2013, "IEEE Recommended Practice for Determining the Peak Spatial-Averaged Specific Absorption Rate (SAR) in the Human Head from Wireless Communications Devices: Measurement Techniques", June 2013
- IEC 62209-1, "Measurement procedure for the assessment of Specific Absorption Rate (SAR) from hand-held and body-mounted devices used next to the ear (frequency range of 300 MHz to 6 GHz)", July 2016
- IEC 62209-2, "Procedure to determine the Specific Absorption Rate (SAR) for wireless communication devices used in close proximity to the human body (frequency range of 30 MHz to 6 GHz)", March 2010
- KDB 865664, "SAR Measurement Requirements for 100 MHz to 6 GHz"

Additional Documentation:

- DASY4/5 System Handbook

Methods Applied and Interpretation of Parameters:

- Measurement Conditions:** Further details are available from the Validation Report at the end of the certificate. All figures stated in the certificate are valid at the frequency indicated.
- Antenna Parameters with TSL:** The dipole is mounted with the spacer to position its feed point exactly below the center marking of the flat phantom section, with the arms oriented parallel to the body axis.
- Feed Point Impedance and Return Loss:** These parameters are measured with the dipole positioned under the liquid filled phantom. The impedance stated is transformed from the measurement at the SMA connector to the feed point. The Return Loss ensures low reflected power. No uncertainty required.
- Electrical Delay:** One-way delay between the SMA connector and the antenna feed point. No uncertainty required.
- SAR measured:** SAR measured at the stated antenna input power.
- SAR normalized:** SAR as measured, normalized to an input power of 1 W at the antenna connector.
- SAR for nominal TSL parameters:** The measured TSL parameters are used to calculate the nominal SAR result.

The reported uncertainty of measurement is stated as the standard uncertainty of measurement multiplied by the coverage factor $k=2$, which for a normal distribution corresponds to a coverage probability of approximately 95%.

Measurement Conditions

DASY system configuration, as far as not given on page 1.

DASY Version	DASY5	V52.10.4
Extrapolation	Advanced Extrapolation	
Phantom	Modular Flat Phantom	
Distance Dipole Center - TSL	10 mm	with Spacer
Zoom Scan Resolution	dx, dy, dz = 5 mm	
Frequency	2450 MHz \pm 1 MHz	

Head TSL parameters

The following parameters and calculations were applied.

	Temperature	Permittivity	Conductivity
Nominal Head TSL parameters	22.0 °C	39.2	1.80 mho/m
Measured Head TSL parameters	(22.0 \pm 0.2) °C	38.1 \pm 6 %	1.87 mho/m \pm 6 %
Head TSL temperature change during test	< 0.5 °C	----	----

SAR result with Head TSL

SAR averaged over 1 cm³ (1 g) of Head TSL	Condition	
SAR measured	250 mW input power	13.4 W/kg
SAR for nominal Head TSL parameters	normalized to 1W	52.3 W/kg \pm 17.0 % (k=2)

SAR averaged over 10 cm³ (10 g) of Head TSL	condition	
SAR measured	250 mW input power	6.20 W/kg
SAR for nominal Head TSL parameters	normalized to 1W	24.4 W/kg \pm 16.5 % (k=2)

Body TSL parameters

The following parameters and calculations were applied.

	Temperature	Permittivity	Conductivity
Nominal Body TSL parameters	22.0 °C	52.7	1.95 mho/m
Measured Body TSL parameters	(22.0 \pm 0.2) °C	51.4 \pm 6 %	2.03 mho/m \pm 6 %
Body TSL temperature change during test	< 0.5 °C	----	----

SAR result with Body TSL

SAR averaged over 1 cm³ (1 g) of Body TSL	Condition	
SAR measured	250 mW input power	12.9 W/kg
SAR for nominal Body TSL parameters	normalized to 1W	50.1 W/kg \pm 17.0 % (k=2)

SAR averaged over 10 cm³ (10 g) of Body TSL	condition	
SAR measured	250 mW input power	6.02 W/kg
SAR for nominal Body TSL parameters	normalized to 1W	23.7 W/kg \pm 16.5 % (k=2)

Appendix (Additional assessments outside the scope of SCS 0108)

Antenna Parameters with Head TSL

Impedance, transformed to feed point	53.5 Ω + 5.4 j Ω
Return Loss	- 24.2 dB

Antenna Parameters with Body TSL

Impedance, transformed to feed point	50.7 Ω + 6.8 j Ω
Return Loss	- 23.4 dB

General Antenna Parameters and Design

Electrical Delay (one direction)	1.165 ns
----------------------------------	----------

After long term use with 100W radiated power, only a slight warming of the dipole near the feedpoint can be measured.

The dipole is made of standard semirigid coaxial cable. The center conductor of the feeding line is directly connected to the second arm of the dipole. The antenna is therefore short-circuited for DC-signals. On some of the dipoles, small end caps are added to the dipole arms in order to improve matching when loaded according to the position as explained in the "Measurement Conditions" paragraph. The SAR data are not affected by this change. The overall dipole length is still according to the Standard.

No excessive force must be applied to the dipole arms, because they might bend or the soldered connections near the feedpoint may be damaged.

Additional EUT Data

Manufactured by	SPEAG
-----------------	-------

DASY5 Validation Report for Head TSL

Date: 19.01.2021

Test Laboratory: SPEAG, Zurich, Switzerland

DUT: Dipole 2450 MHz; Type: D2450V2; Serial: D2450V2 - SN:981

Communication System: UID 0 - CW; Frequency: 2450 MHz

Medium parameters used: $f = 2450$ MHz; $\sigma = 1.87$ S/m; $\epsilon_r = 38.1$; $\rho = 1000$ kg/m³

Phantom section: Flat Section

Measurement Standard: DASY5 (IEEE/IEC/ANSI C63.19-2011)

DASY52 Configuration:

- Probe: EX3DV4 - SN7349; ConvF(7.96, 7.96, 7.96) @ 2450 MHz; Calibrated: 28.12.2020
- Sensor-Surface: 1.4mm (Mechanical Surface Detection)
- Electronics: DAE4 Sn601; Calibrated: 02.11.2020
- Phantom: Flat Phantom 5.0 (front); Type: QD 000 P50 AA; Serial: 1001
- DASY52 52.10.4(1527); SEMCAD X 14.6.14(7483)

Dipole Calibration for Head Tissue/Pin=250 mW, d=10mm/Zoom Scan (7x7x7)/Cube 0:

Measurement grid: dx=5mm, dy=5mm, dz=5mm

Reference Value = 115.1 V/m; Power Drift = 0.07 dB

Peak SAR (extrapolated) = 26.6 W/kg

SAR(1 g) = 13.4 W/kg; SAR(10 g) = 6.2 W/kg

Smallest distance from peaks to all points 3 dB below = 9 mm

Ratio of SAR at M2 to SAR at M1 = 50.4%

Maximum value of SAR (measured) = 21.9 W/kg

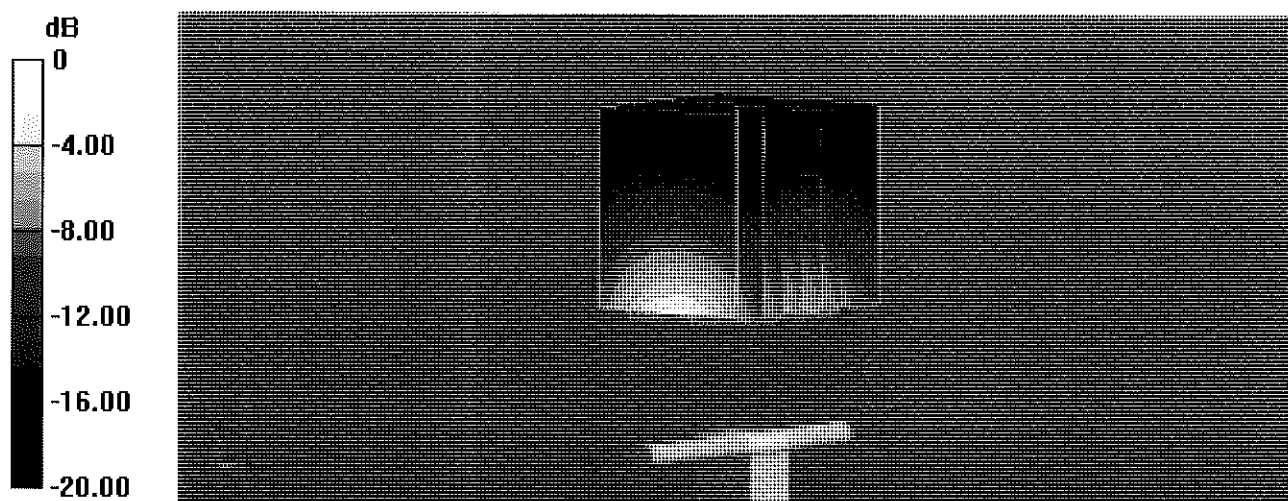

0 dB = 21.9 W/kg = 13.40 dBW/kg

Impedance Measurement Plot for Head TSL

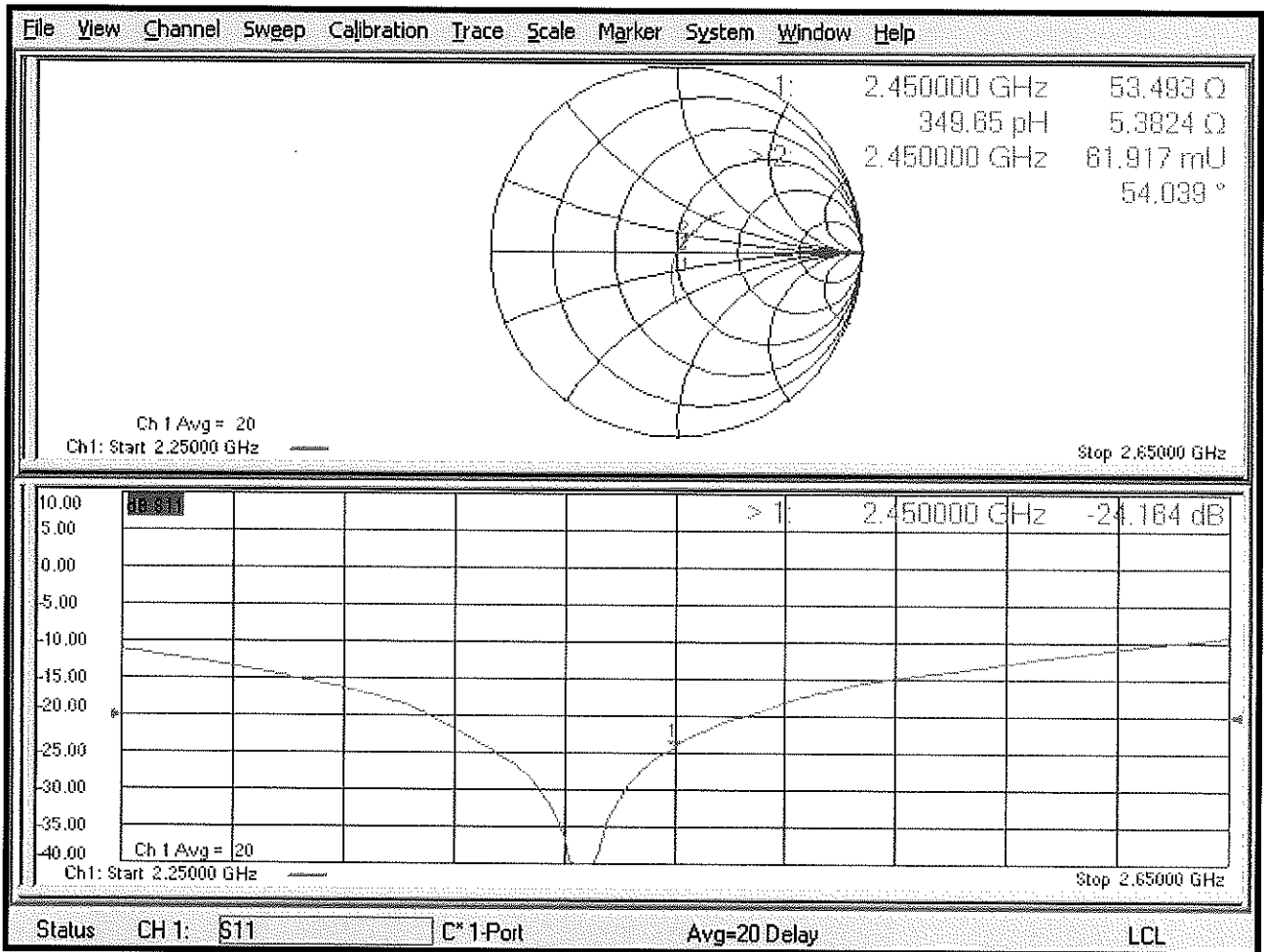

DASY5 Validation Report for Body TSL

Date: 19.01.2021

Test Laboratory: SPEAG, Zurich, Switzerland

DUT: Dipole 2450 MHz; Type: D2450V2; Serial: D2450V2 - SN:981

Communication System: UID 0 - CW; Frequency: 2450 MHz

Medium parameters used: $f = 2450$ MHz; $\sigma = 2.03$ S/m; $\epsilon_r = 51.4$; $\rho = 1000$ kg/m³

Phantom section: Flat Section

Measurement Standard: DASY5 (IEEE/IEC/ANSI C63.19-2011)

DASY52 Configuration:

- Probe: EX3DV4 - SN7349; ConvF(8.12, 8.12, 8.12) @ 2450 MHz; Calibrated: 28.12.2020
- Sensor-Surface: 1.4mm (Mechanical Surface Detection)
- Electronics: DAE4 Sn601; Calibrated: 02.11.2020
- Phantom: Flat Phantom 5.0 (back); Type: QD 000 P50 AA; Serial: 1002
- DASY52 52.10.4(1527); SEMCAD X 14.6.14(7483)

Dipole Calibration for Body Tissue/Pin=250 mW, d=10mm/Zoom Scan (7x7x7)/Cube 0:

Measurement grid: dx=5mm, dy=5mm, dz=5mm

Reference Value = 107.9 V/m; Power Drift = -0.03 dB

Peak SAR (extrapolated) = 23.9 W/kg

SAR(1 g) = 12.9 W/kg; SAR(10 g) = 6.02 W/kg

Smallest distance from peaks to all points 3 dB below = 8.2 mm

Ratio of SAR at M2 to SAR at M1 = 54.3%

Maximum value of SAR (measured) = 20.4 W/kg

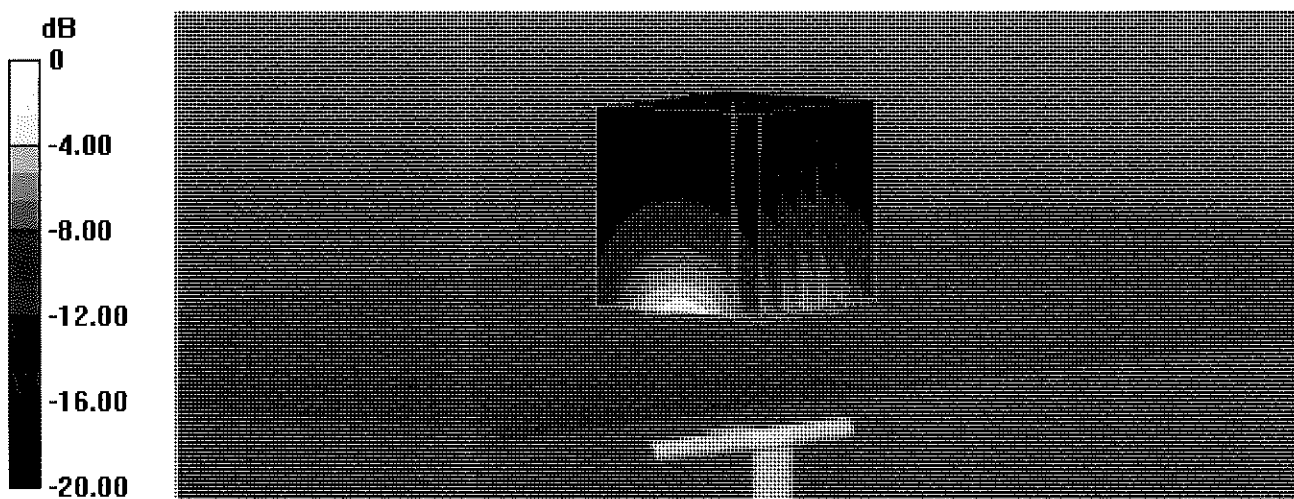

Impedance Measurement Plot for Body TSL

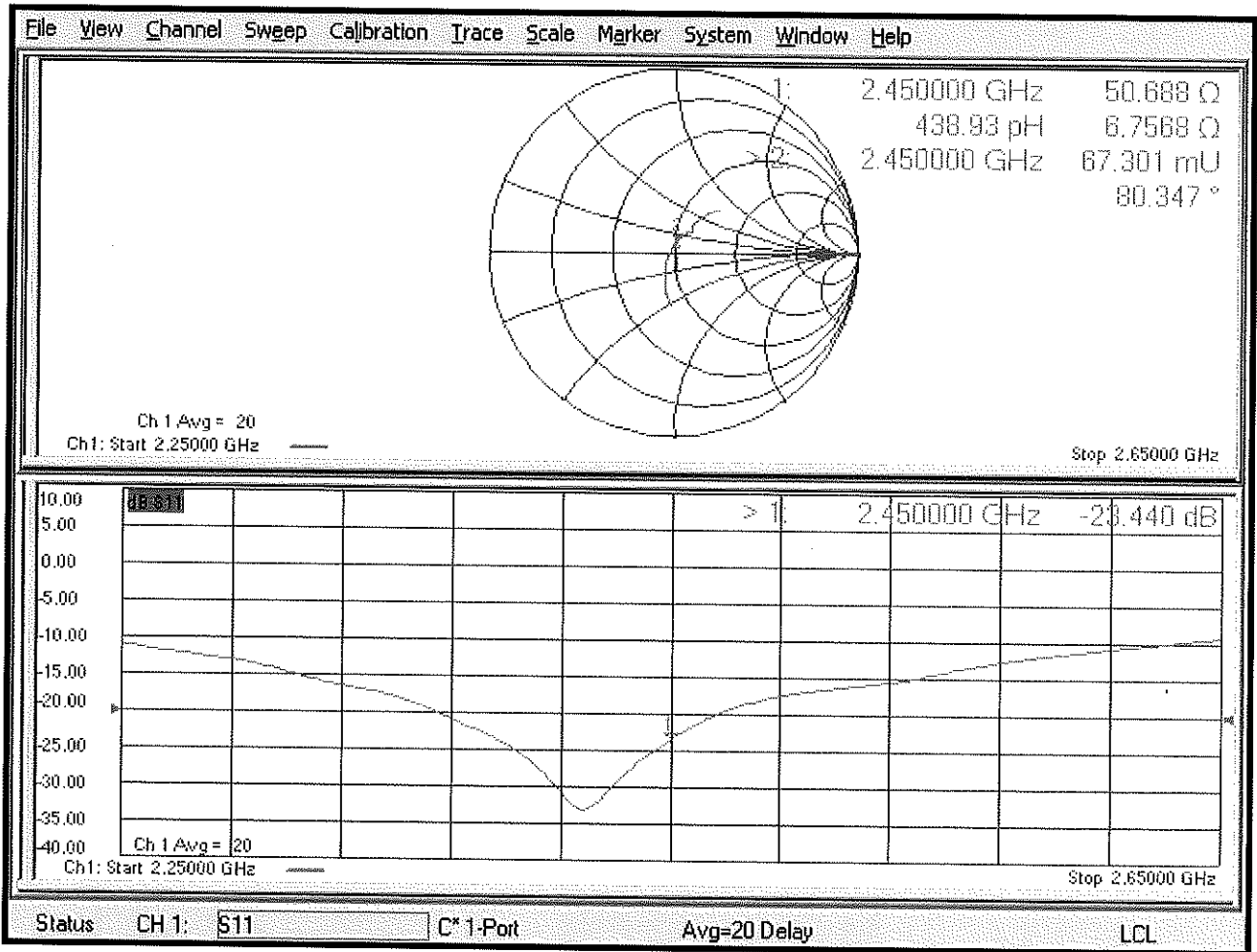



Accredited by the Swiss Accreditation Service (SAS)
The Swiss Accreditation Service is one of the signatories to the EA
Multilateral Agreement for the recognition of calibration certificates

Accreditation No.: **SCS 0108**

Client **PC Test**

Certificate No: **D2600V2-1004_Apr21**

CALIBRATION CERTIFICATE

Object **D2600V2 - SN:1004**

Calibration procedure(s) **QA CAL-05.v11
Calibration Procedure for SAR Validation Sources between 0.7-3 GHz**

Calibration date: **April 14, 2021**

*BN ✓
4-27-2021*

This calibration certificate documents the traceability to national standards, which realize the physical units of measurements (SI).
The measurements and the uncertainties with confidence probability are given on the following pages and are part of the certificate.

All calibrations have been conducted in the closed laboratory facility: environment temperature (22 ± 3)°C and humidity < 70%.

Calibration Equipment used (M&TE critical for calibration)

Primary Standards	ID #	Cal Date (Certificate No.)	Scheduled Calibration
Power meter NRP	SN: 104778	09-Apr-21 (No. 217-03291/03292)	Apr-22
Power sensor NRP-Z91	SN: 103244	09-Apr-21 (No. 217-03291)	Apr-22
Power sensor NRP-Z91	SN: 103245	09-Apr-21 (No. 217-03292)	Apr-22
Reference 20 dB Attenuator	SN: BH9394 (20k)	09-Apr-21 (No. 217-03343)	Apr-22
Type-N mismatch combination	SN: 310982 / 06327	09-Apr-21 (No. 217-03344)	Apr-22
Reference Probe EX3DV4	SN: 7349	28-Dec-20 (No. EX3-7349_Dec20)	Dec-21
DAE4	SN: 601	02-Nov-20 (No. DAE4-601_Nov20)	Nov-21
Secondary Standards	ID #	Check Date (in house)	Scheduled Check
Power meter E4419B	SN: GB39512475	30-Oct-14 (in house check Oct-20)	In house check: Oct-22
Power sensor HP 8481A	SN: US37292783	07-Oct-15 (in house check Oct-20)	In house check: Oct-22
Power sensor HP 8481A	SN: MY41092317	07-Oct-15 (in house check Oct-20)	In house check: Oct-22
RF generator R&S SMT-06	SN: 100972	15-Jun-15 (in house check Oct-20)	In house check: Oct-22
Network Analyzer Agilent E8358A	SN: US41080477	31-Mar-14 (in house check Oct-20)	In house check: Oct-21

Calibrated by:	Name Jeffrey Katzman	Function Laboratory Technician	Signature
Approved by:	Katja Pokovic	Technical Manager	

Issued: April 14, 2021

This calibration certificate shall not be reproduced except in full without written approval of the laboratory.



Accredited by the Swiss Accreditation Service (SAS)
The Swiss Accreditation Service is one of the signatories to the EA
Multilateral Agreement for the recognition of calibration certificates

Accreditation No.: **SCS 0108**

Glossary:

TSL	tissue simulating liquid
ConvF	sensitivity in TSL / NORM x,y,z
N/A	not applicable or not measured

Calibration is Performed According to the Following Standards:

- IEEE Std 1528-2013, "IEEE Recommended Practice for Determining the Peak Spatial-Averaged Specific Absorption Rate (SAR) in the Human Head from Wireless Communications Devices: Measurement Techniques", June 2013
- IEC 62209-1, "Measurement procedure for the assessment of Specific Absorption Rate (SAR) from hand-held and body-mounted devices used next to the ear (frequency range of 300 MHz to 6 GHz)", July 2016
- IEC 62209-2, "Procedure to determine the Specific Absorption Rate (SAR) for wireless communication devices used in close proximity to the human body (frequency range of 30 MHz to 6 GHz)", March 2010
- KDB 865664, "SAR Measurement Requirements for 100 MHz to 6 GHz"

Additional Documentation:

- DASY4/5 System Handbook

Methods Applied and Interpretation of Parameters:

- Measurement Conditions:** Further details are available from the Validation Report at the end of the certificate. All figures stated in the certificate are valid at the frequency indicated.
- Antenna Parameters with TSL:** The dipole is mounted with the spacer to position its feed point exactly below the center marking of the flat phantom section, with the arms oriented parallel to the body axis.
- Feed Point Impedance and Return Loss:** These parameters are measured with the dipole positioned under the liquid filled phantom. The impedance stated is transformed from the measurement at the SMA connector to the feed point. The Return Loss ensures low reflected power. No uncertainty required.
- Electrical Delay:** One-way delay between the SMA connector and the antenna feed point. No uncertainty required.
- SAR measured:** SAR measured at the stated antenna input power.
- SAR normalized:** SAR as measured, normalized to an input power of 1 W at the antenna connector.
- SAR for nominal TSL parameters:** The measured TSL parameters are used to calculate the nominal SAR result.

The reported uncertainty of measurement is stated as the standard uncertainty of measurement multiplied by the coverage factor $k=2$, which for a normal distribution corresponds to a coverage probability of approximately 95%.

Measurement Conditions

DASY system configuration, as far as not given on page 1.

DASY Version	DASY5	V52.10.4
Extrapolation	Advanced Extrapolation	
Phantom	Modular Flat Phantom	
Distance Dipole Center - TSL	10 mm	with Spacer
Zoom Scan Resolution	dx, dy, dz = 5 mm	
Frequency	2600 MHz \pm 1 MHz	

Head TSL parameters

The following parameters and calculations were applied.

	Temperature	Permittivity	Conductivity
Nominal Head TSL parameters	22.0 °C	39.0	1.96 mho/m
Measured Head TSL parameters	(22.0 \pm 0.2) °C	37.5 \pm 6 %	2.03 mho/m \pm 6 %
Head TSL temperature change during test	< 0.5 °C	----	----

SAR result with Head TSL

SAR averaged over 1 cm³ (1 g) of Head TSL	Condition	
SAR measured	250 mW input power	14.8 W/kg
SAR for nominal Head TSL parameters	normalized to 1W	57.8 W/kg \pm 17.0 % (k=2)

SAR averaged over 10 cm³ (10 g) of Head TSL	condition	
SAR measured	250 mW input power	6.52 W/kg
SAR for nominal Head TSL parameters	normalized to 1W	25.7 W/kg \pm 16.5 % (k=2)

Body TSL parameters

The following parameters and calculations were applied.

	Temperature	Permittivity	Conductivity
Nominal Body TSL parameters	22.0 °C	52.5	2.16 mho/m
Measured Body TSL parameters	(22.0 \pm 0.2) °C	51.0 \pm 6 %	2.22 mho/m \pm 6 %
Body TSL temperature change during test	< 0.5 °C	----	----

SAR result with Body TSL

SAR averaged over 1 cm³ (1 g) of Body TSL	Condition	
SAR measured	250 mW input power	14.1 W/kg
SAR for nominal Body TSL parameters	normalized to 1W	55.4 W/kg \pm 17.0 % (k=2)

SAR averaged over 10 cm³ (10 g) of Body TSL	condition	
SAR measured	250 mW input power	6.26 W/kg
SAR for nominal Body TSL parameters	normalized to 1W	24.8 W/kg \pm 16.5 % (k=2)

Appendix (Additional assessments outside the scope of SCS 0108)

Antenna Parameters with Head TSL

Impedance, transformed to feed point	48.9 Ω - 4.8 j Ω
Return Loss	- 26.1 dB

Antenna Parameters with Body TSL

Impedance, transformed to feed point	45.9 Ω - 3.6 j Ω
Return Loss	- 25.0 dB

General Antenna Parameters and Design

Electrical Delay (one direction)	1.150 ns
----------------------------------	----------

After long term use with 100W radiated power, only a slight warming of the dipole near the feedpoint can be measured.

The dipole is made of standard semirigid coaxial cable. The center conductor of the feeding line is directly connected to the second arm of the dipole. The antenna is therefore short-circuited for DC-signals. On some of the dipoles, small end caps are added to the dipole arms in order to improve matching when loaded according to the position as explained in the "Measurement Conditions" paragraph. The SAR data are not affected by this change. The overall dipole length is still according to the Standard.

No excessive force must be applied to the dipole arms, because they might bend or the soldered connections near the feedpoint may be damaged.

Additional EUT Data

Manufactured by	SPEAG
-----------------	-------

DASY5 Validation Report for Head TSL

Date: 14.04.2021

Test Laboratory: SPEAG, Zurich, Switzerland

DUT: Dipole 2600 MHz; Type: D2600V2; Serial: D2600V2 - SN:1004

Communication System: UID 0 - CW; Frequency: 2600 MHz

Medium parameters used: $f = 2600$ MHz; $\sigma = 2.03$ S/m; $\epsilon_r = 37.5$; $\rho = 1000$ kg/m³

Phantom section: Flat Section

Measurement Standard: DASY5 (IEEE/IEC/ANSI C63.19-2011)

DASY52 Configuration:

- Probe: EX3DV4 - SN7349; ConvF(7.84, 7.84, 7.84) @ 2600 MHz; Calibrated: 28.12.2020
- Sensor-Surface: 1.4mm (Mechanical Surface Detection)
- Electronics: DAE4 Sn601; Calibrated: 02.11.2020
- Phantom: Flat Phantom 5.0 (front); Type: QD 000 P50 AA; Serial: 1001
- DASY52 52.10.4(1527); SEMCAD X 14.6.14(7483)

Dipole Calibration for Head Tissue/Pin=250 mW, d=10mm/Zoom Scan (7x7x7)/Cube 0:

Measurement grid: dx=5mm, dy=5mm, dz=5mm

Reference Value = 120.6 V/m; Power Drift = 0.05 dB

Peak SAR (extrapolated) = 29.8 W/kg

SAR(1 g) = 14.8 W/kg; SAR(10 g) = 6.52 W/kg

Smallest distance from peaks to all points 3 dB below = 8.5 mm

Ratio of SAR at M2 to SAR at M1 = 49.5%

Maximum value of SAR (measured) = 24.8 W/kg

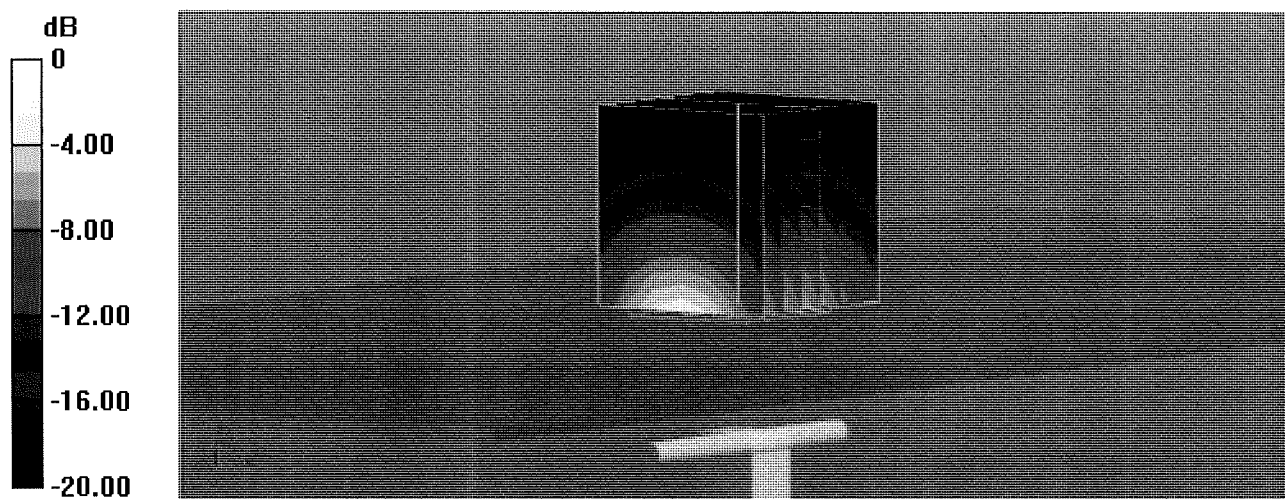

0 dB = 24.8 W/kg = 13.94 dBW/kg

Impedance Measurement Plot for Head TSL

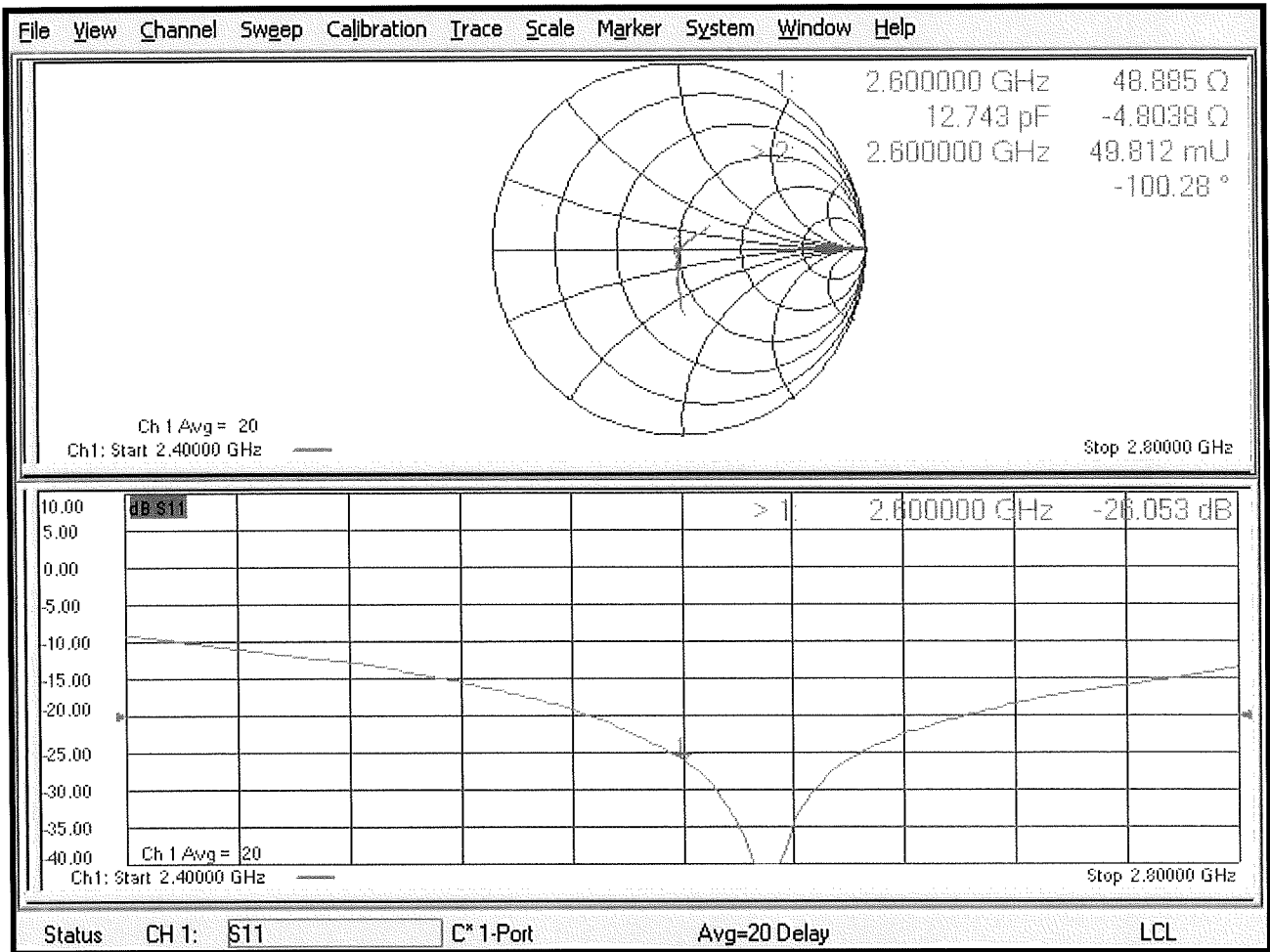

DASY5 Validation Report for Body TSL

Date: 14.04.2021

Test Laboratory: SPEAG, Zurich, Switzerland

DUT: Dipole 2600 MHz; Type: D2600V2; Serial: D2600V2 - SN:1004

Communication System: UID 0 - CW; Frequency: 2600 MHz

Medium parameters used: $f = 2600$ MHz; $\sigma = 2.22$ S/m; $\epsilon_r = 51.0$; $\rho = 1000$ kg/m³

Phantom section: Flat Section

Measurement Standard: DASY5 (IEEE/IEC/ANSI C63.19-2011)

DASY52 Configuration:

- Probe: EX3DV4 - SN7349; ConvF(7.91, 7.91, 7.91) @ 2600 MHz; Calibrated: 28.12.2020
- Sensor-Surface: 1.4mm (Mechanical Surface Detection)
- Electronics: DAE4 Sn601; Calibrated: 02.11.2020
- Phantom: Flat Phantom 5.0 (back); Type: QD 000 P50 AA; Serial: 1002
- DASY52 52.10.4(1527); SEMCAD X 14.6.14(7483)

Dipole Calibration for Body Tissue/Pin=250 mW, d=10mm/Zoom Scan (7x7x7)/Cube 0:

Measurement grid: dx=5mm, dy=5mm, dz=5mm

Reference Value = 111.6 V/m; Power Drift = -0.02 dB

Peak SAR (extrapolated) = 28.1 W/kg

SAR(1 g) = 14.1 W/kg; SAR(10 g) = 6.26 W/kg

Smallest distance from peaks to all points 3 dB below = 8.2 mm

Ratio of SAR at M2 to SAR at M1 = 51%

Maximum value of SAR (measured) = 23.4 W/kg

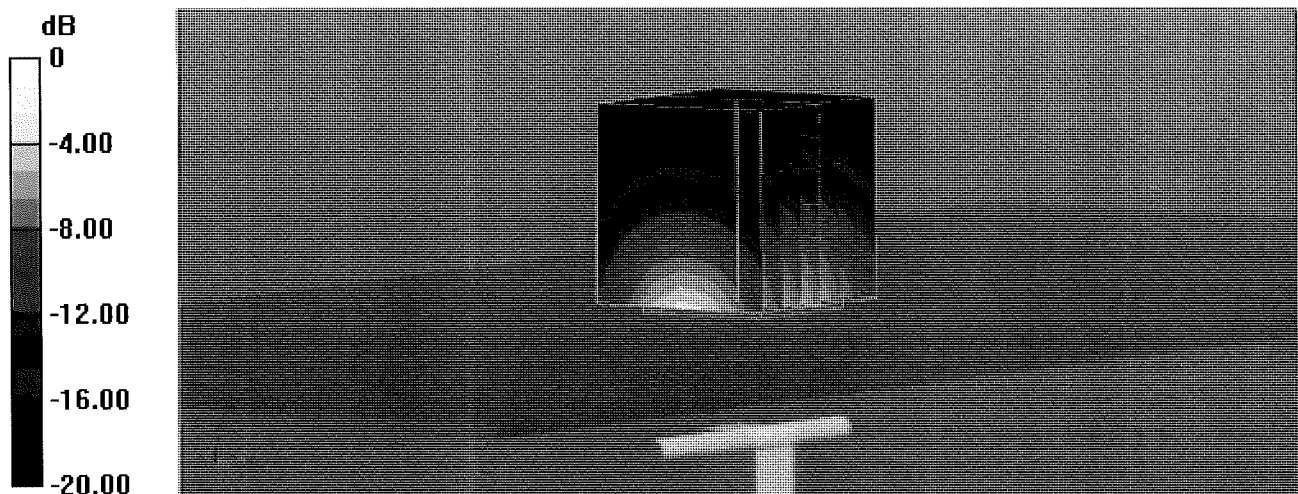

0 dB = 23.4 W/kg = 13.69 dBW/kg

Impedance Measurement Plot for Body TSL

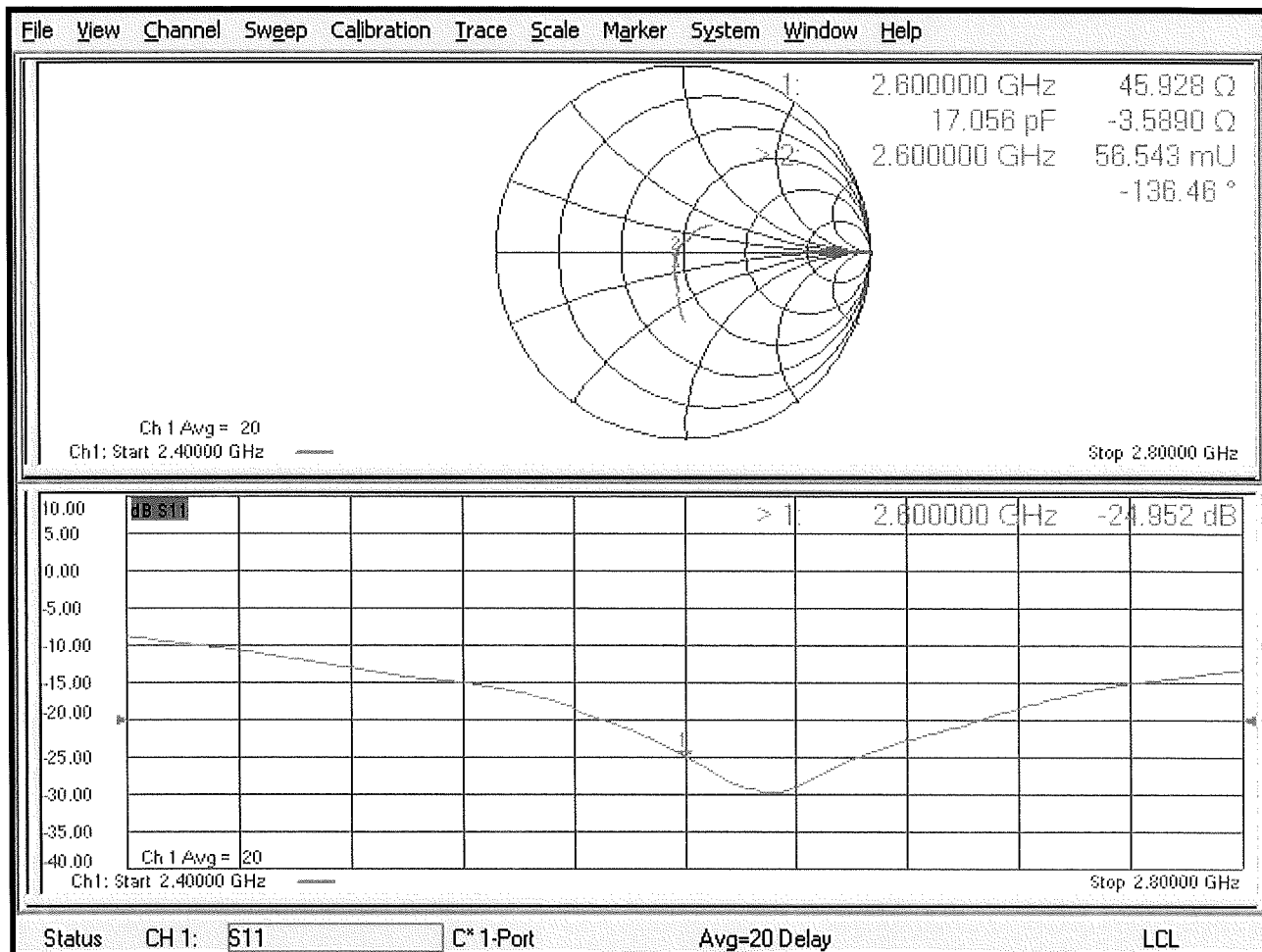



Accredited by the Swiss Accreditation Service (SAS)
The Swiss Accreditation Service is one of the signatories to the EA
Multilateral Agreement for the recognition of calibration certificates

Accreditation No.: **SCS 0108**

Client **PC Test**

Certificate No: **D2600V2-1064_Jun19**

CALIBRATION CERTIFICATE

Object **D2600V2 - SN:1064**

Calibration procedure(s) **QA CAL-05.v11
Calibration Procedure for SAR Validation Sources between 0.7-3 GHz**

BNV
07/31/2019

BNV
06-20-20

Calibration date: **June 14, 2019**

BNV
06-20-21

This calibration certificate documents the traceability to national standards, which realize the physical units of measurements (SI).
The measurements and the uncertainties with confidence probability are given on the following pages and are part of the certificate.

All calibrations have been conducted in the closed laboratory facility: environment temperature (22 ± 3)°C and humidity < 70%.

Calibration Equipment used (M&TE critical for calibration)

Primary Standards	ID #	Cal Date (Certificate No.)	Scheduled Calibration
Power meter NRP	SN: 104778	03-Apr-19 (No. 217-02892/02893)	Apr-20
Power sensor NRP-Z91	SN: 103244	03-Apr-19 (No. 217-02892)	Apr-20
Power sensor NRP-Z91	SN: 103245	03-Apr-19 (No. 217-02893)	Apr-20
Reference 20 dB Attenuator	SN: 5058 (20k)	04-Apr-19 (No. 217-02894)	Apr-20
Type-N mismatch combination	SN: 5047.2 / 06327	04-Apr-19 (No. 217-02895)	Apr-20
Reference Probe EX3DV4	SN: 7349	29-May-19 (No. EX3-7349_May19)	May-20
DAE4	SN: 601	30-Apr-19 (No. DAE4-601_Apr19)	Apr-20
Secondary Standards	ID #	Check Date (in house)	Scheduled Check
Power meter E4419B	SN: GB39512475	30-Oct-14 (in house check Feb-19)	In house check: Oct-20
Power sensor HP 8481A	SN: US37292783	07-Oct-15 (in house check Oct-18)	In house check: Oct-20
Power sensor HP 8481A	SN: MY41092317	07-Oct-15 (in house check Oct-18)	In house check: Oct-20
RF generator R&S SMT-06	SN: 100972	15-Jun-15 (in house check Oct-18)	In house check: Oct-20
Network Analyzer Agilent E8358A	SN: US41080477	31-Mar-14 (in house check Oct-18)	In house check: Oct-19

Calibrated by: **Michael Weber** Function: **Laboratory Technician**

Signature
M. Weber

Approved by: **Katja Pokovic** Technical Manager

Katja Pokovic

Issued: June 20, 2019

This calibration certificate shall not be reproduced except in full without written approval of the laboratory.



Accredited by the Swiss Accreditation Service (SAS)

Accreditation No.: **SCS 0108**

The Swiss Accreditation Service is one of the signatories to the EA Multilateral Agreement for the recognition of calibration certificates

Glossary:

TSL	tissue simulating liquid
ConvF	sensitivity in TSL / NORM x,y,z
N/A	not applicable or not measured

Calibration is Performed According to the Following Standards:

- IEEE Std 1528-2013, "IEEE Recommended Practice for Determining the Peak Spatial-Averaged Specific Absorption Rate (SAR) in the Human Head from Wireless Communications Devices: Measurement Techniques", June 2013
- IEC 62209-1, "Measurement procedure for the assessment of Specific Absorption Rate (SAR) from hand-held and body-mounted devices used next to the ear (frequency range of 300 MHz to 6 GHz)", July 2016
- IEC 62209-2, "Procedure to determine the Specific Absorption Rate (SAR) for wireless communication devices used in close proximity to the human body (frequency range of 30 MHz to 6 GHz)", March 2010
- KDB 865664, "SAR Measurement Requirements for 100 MHz to 6 GHz"

Additional Documentation:

- DASY4/5 System Handbook

Methods Applied and Interpretation of Parameters:

- Measurement Conditions:** Further details are available from the Validation Report at the end of the certificate. All figures stated in the certificate are valid at the frequency indicated.
- Antenna Parameters with TSL:** The dipole is mounted with the spacer to position its feed point exactly below the center marking of the flat phantom section, with the arms oriented parallel to the body axis.
- Feed Point Impedance and Return Loss:** These parameters are measured with the dipole positioned under the liquid filled phantom. The impedance stated is transformed from the measurement at the SMA connector to the feed point. The Return Loss ensures low reflected power. No uncertainty required.
- Electrical Delay:** One-way delay between the SMA connector and the antenna feed point. No uncertainty required.
- SAR measured:** SAR measured at the stated antenna input power.
- SAR normalized:** SAR as measured, normalized to an input power of 1 W at the antenna connector.
- SAR for nominal TSL parameters:** The measured TSL parameters are used to calculate the nominal SAR result.

The reported uncertainty of measurement is stated as the standard uncertainty of measurement multiplied by the coverage factor $k=2$, which for a normal distribution corresponds to a coverage probability of approximately 95%.

Measurement Conditions

DASY system configuration, as far as not given on page 1.

DASY Version	DASY5	V52.10.2
Extrapolation	Advanced Extrapolation	
Phantom	Modular Flat Phantom	
Distance Dipole Center - TSL	10 mm	with Spacer
Zoom Scan Resolution	dx, dy, dz = 5 mm	
Frequency	2600 MHz \pm 1 MHz	

Head TSL parameters

The following parameters and calculations were applied.

	Temperature	Permittivity	Conductivity
Nominal Head TSL parameters	22.0 °C	39.0	1.96 mho/m
Measured Head TSL parameters	(22.0 \pm 0.2) °C	37.3 \pm 6 %	2.03 mho/m \pm 6 %
Head TSL temperature change during test	< 0.5 °C	---	---

SAR result with Head TSL

SAR averaged over 1 cm³ (1 g) of Head TSL	Condition	
SAR measured	250 mW input power	14.9 W/kg
SAR for nominal Head TSL parameters	normalized to 1W	58.1 W/kg \pm 17.0 % (k=2)

SAR averaged over 10 cm³ (10 g) of Head TSL	condition	
SAR measured	250 mW input power	6.59 W/kg
SAR for nominal Head TSL parameters	normalized to 1W	26.0 W/kg \pm 16.5 % (k=2)

Body TSL parameters

The following parameters and calculations were applied.

	Temperature	Permittivity	Conductivity
Nominal Body TSL parameters	22.0 °C	52.5	2.16 mho/m
Measured Body TSL parameters	(22.0 \pm 0.2) °C	50.5 \pm 6 %	2.22 mho/m \pm 6 %
Body TSL temperature change during test	< 0.5 °C	---	---

SAR result with Body TSL

SAR averaged over 1 cm³ (1 g) of Body TSL	Condition	
SAR measured	250 mW input power	14.2 W/kg
SAR for nominal Body TSL parameters	normalized to 1W	55.6 W/kg \pm 17.0 % (k=2)

SAR averaged over 10 cm³ (10 g) of Body TSL	condition	
SAR measured	250 mW input power	6.33 W/kg
SAR for nominal Body TSL parameters	normalized to 1W	25.0 W/kg \pm 16.5 % (k=2)

Appendix (Additional assessments outside the scope of SCS 0108)

Antenna Parameters with Head TSL

Impedance, transformed to feed point	49.8 Ω - 6.9 j Ω
Return Loss	- 23.2 dB

Antenna Parameters with Body TSL

Impedance, transformed to feed point	46.6 Ω - 4.4 j Ω
Return Loss	- 24.9 dB

General Antenna Parameters and Design

Electrical Delay (one direction)	1.151 ns
----------------------------------	----------

After long term use with 100W radiated power, only a slight warming of the dipole near the feedpoint can be measured.

The dipole is made of standard semirigid coaxial cable. The center conductor of the feeding line is directly connected to the second arm of the dipole. The antenna is therefore short-circuited for DC-signals. On some of the dipoles, small end caps are added to the dipole arms in order to improve matching when loaded according to the position as explained in the "Measurement Conditions" paragraph. The SAR data are not affected by this change. The overall dipole length is still according to the Standard.

No excessive force must be applied to the dipole arms, because they might bend or the soldered connections near the feedpoint may be damaged.

Additional EUT Data

Manufactured by	SPEAG
-----------------	-------

DASY5 Validation Report for Head TSL

Date: 14.06.2019

Test Laboratory: SPEAG, Zurich, Switzerland

DUT: Dipole 2600 MHz; Type: D2600V2; Serial: D2600V2 - SN:1064

Communication System: UID 0 - CW; Frequency: 2600 MHz

Medium parameters used: $f = 2600$ MHz; $\sigma = 2.03$ S/m; $\epsilon_r = 37.3$; $\rho = 1000$ kg/m³

Phantom section: Flat Section

Measurement Standard: DASY5 (IEEE/IEC/ANSI C63.19-2011)

DASY52 Configuration:

- Probe: EX3DV4 - SN7349; ConvF(7.69, 7.69, 7.69) @ 2600 MHz; Calibrated: 29.05.2019
- Sensor-Surface: 1.4mm (Mechanical Surface Detection)
- Electronics: DAE4 Sn601; Calibrated: 30.04.2019
- Phantom: Flat Phantom 5.0 (front); Type: QD 000 P50 AA; Serial: 1001
- DASY52 52.10.2(1504); SEMCAD X 14.6.12(7470)

Dipole Calibration for Head Tissue/Pin=250 mW, d=10mm/Zoom Scan (7x7x7)/Cube 0:

Measurement grid: dx=5mm, dy=5mm, dz=5mm

Reference Value = 120.9 V/m; Power Drift = 0.01 dB

Peak SAR (extrapolated) = 30.2 W/kg

SAR(1 g) = 14.9 W/kg; SAR(10 g) = 6.59 W/kg

Maximum value of SAR (measured) = 25.1 W/kg

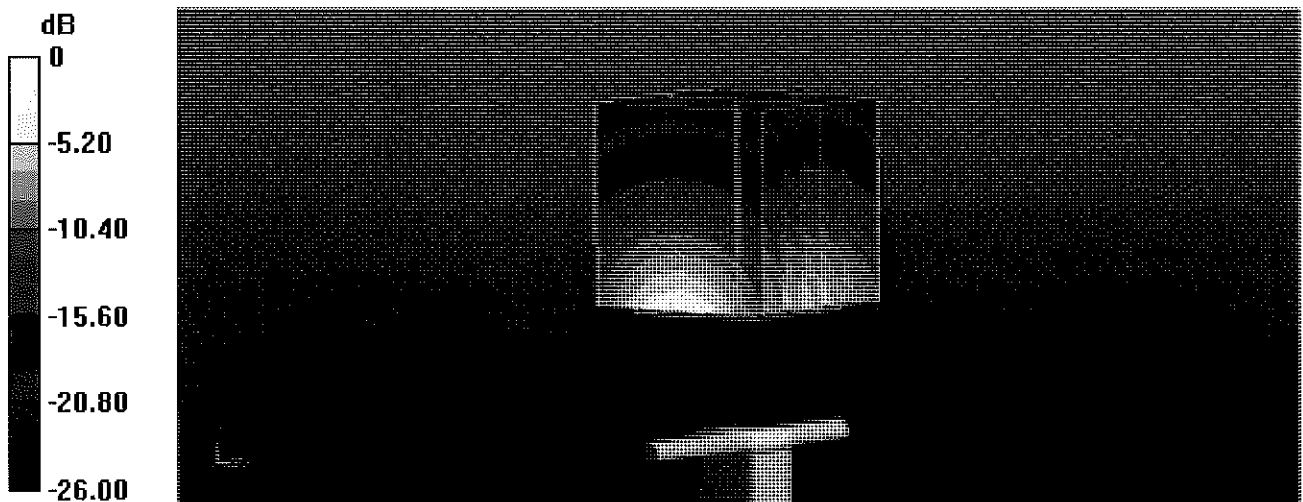

0 dB = 25.1 W/kg = 14.00 dBW/kg

Impedance Measurement Plot for Head TSL

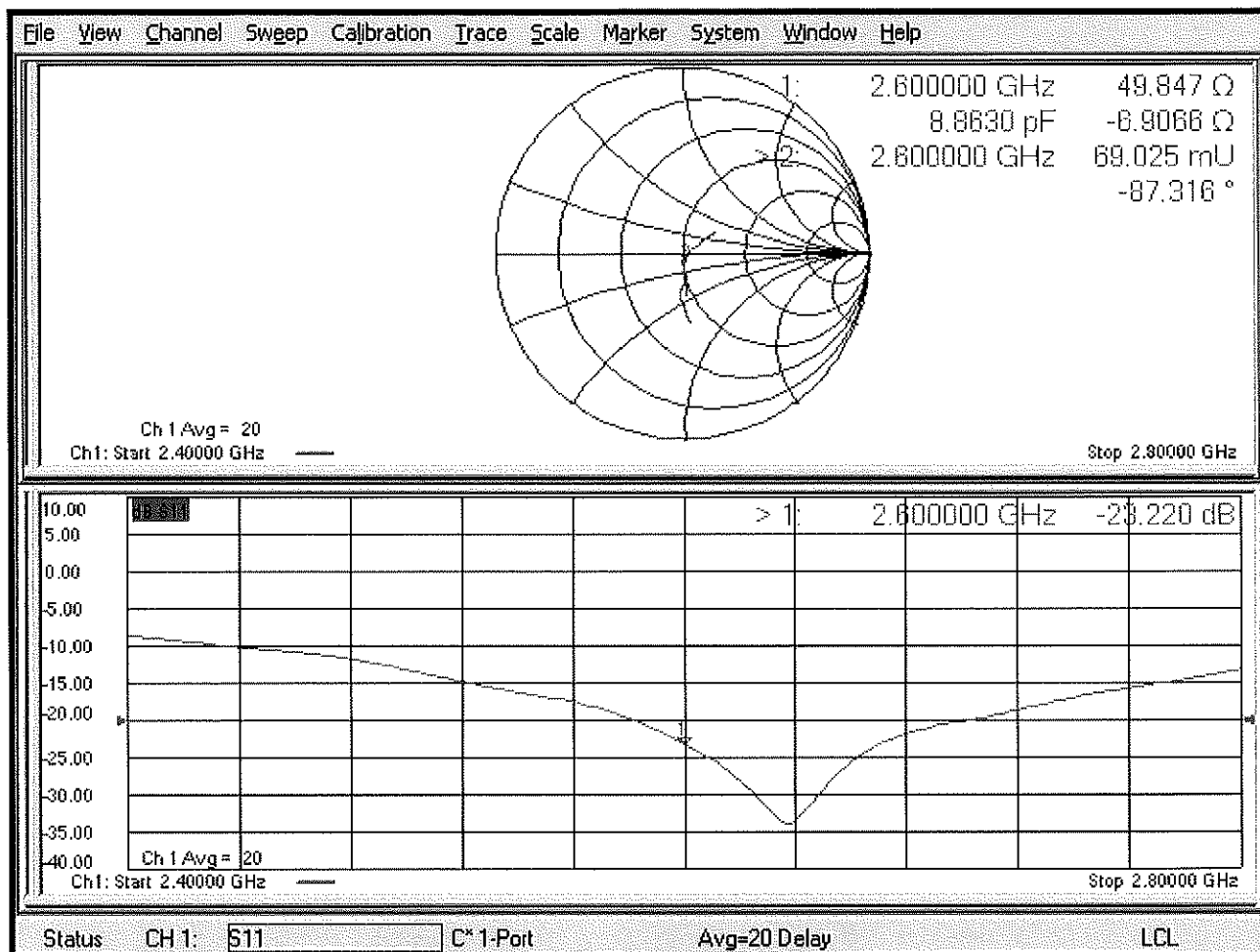

DASY5 Validation Report for Body TSL

Date: 14.06.2019

Test Laboratory: SPEAG, Zurich, Switzerland

DUT: Dipole 2600 MHz; Type: D2600V2; Serial: D2600V2 - SN:1064

Communication System: UID 0 - CW; Frequency: 2600 MHz

Medium parameters used: $f = 2600$ MHz; $\sigma = 2.22$ S/m; $\epsilon_r = 50.5$; $\rho = 1000$ kg/m³

Phantom section: Flat Section

Measurement Standard: DASY5 (IEEE/IEC/ANSI C63.19-2011)

DASY52 Configuration:

- Probe: EX3DV4 - SN7349; ConvF(7.8, 7.8, 7.8) @ 2600 MHz; Calibrated: 29.05.2019
- Sensor-Surface: 1.4mm (Mechanical Surface Detection)
- Electronics: DAE4 Sn601; Calibrated: 30.04.2019
- Phantom: Flat Phantom 5.0 (back); Type: QD 000 P50 AA; Serial: 1002
- DASY52 52.10.2(1504); SEMCAD X 14.6.12(7470)

Dipole Calibration for Body Tissue/Pin=250 mW, d=10mm/Zoom Scan (7x7x7)/Cube 0:

Measurement grid: dx=5mm, dy=5mm, dz=5mm

Reference Value = 110.6 V/m; Power Drift = -0.05 dB

Peak SAR (extrapolated) = 28.9 W/kg

SAR(1 g) = 14.2 W/kg; SAR(10 g) = 6.33 W/kg

Maximum value of SAR (measured) = 23.6 W/kg

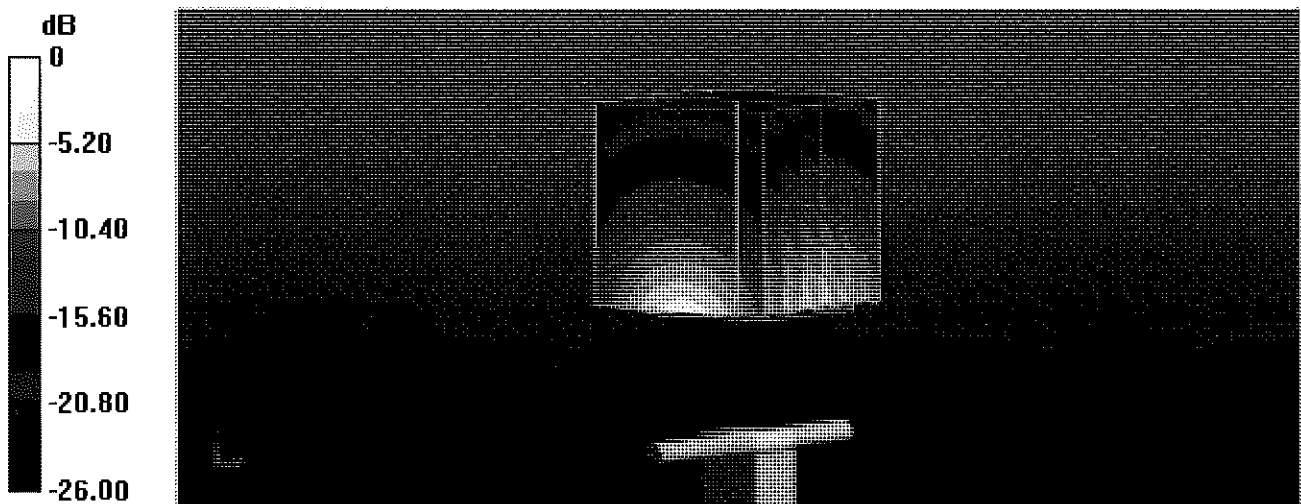

0 dB = 23.6 W/kg = 13.73 dBW/kg

Impedance Measurement Plot for Body TSL

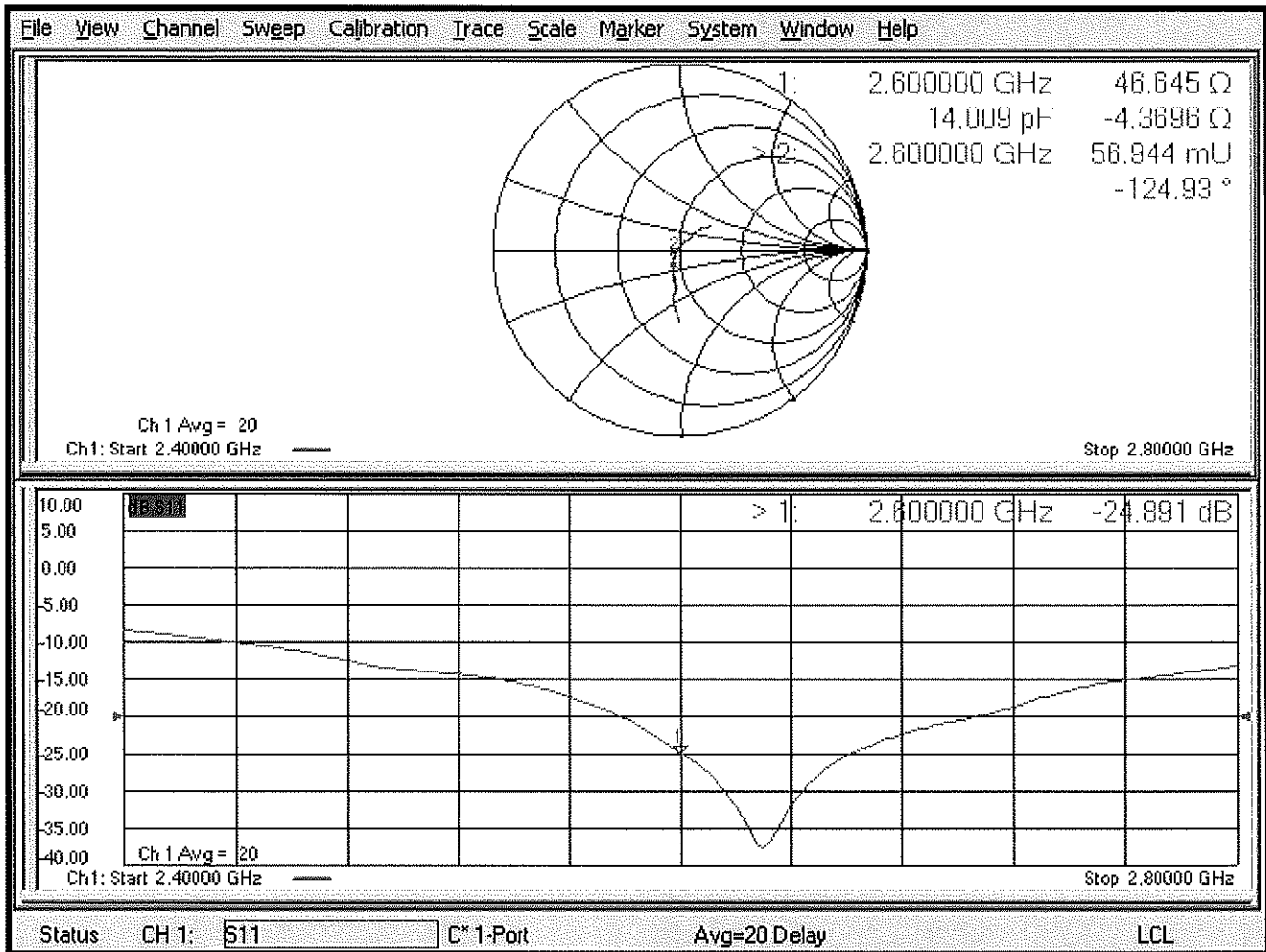

Certification of Calibration

Object: D2600V2 – SN: 1064
 Calibration procedure(s): Procedure for Calibration Extension for SAR Dipoles.
 Extended Calibration date: June 14, 2020
 Description: SAR Validation Dipole at 2600 MHz.

Calibration Equipment used:

Manufacturer	Model	Description	Cal Date	Cal Interval	Cal Due	Serial Number
Control Company	4040	Therm./Clock/Humidity Monitor	6/29/2019	Biennial	6/29/2021	192291470
Control Company	4352	Ultra Long Stem Thermometer	8/2/2018	Biennial	8/2/2020	181334684
Amplifier Research	15S1G6	Amplifier	CBT	N/A	CBT	433971
Narda	4772-3	Attenuator (3dB)	CBT	N/A	CBT	9406
Keysight Technologies	85033E	Standard Mechanical Calibration Kit (DC to 9GHz, 3.5mm)	7/2/2019	Annual	7/2/2020	MY53401181
Rohde & Schwarz	ZNLE6	Vector Network Analyzer	10/11/2019	Annual	10/11/2020	101307
Mini-Circuits	BW-N20W5+	DC to 18 GHz Precision Fixed 20 dB Attenuator	CBT	N/A	CBT	N/A
SPEAG	DAKS-3.5	Portable DAK	9/10/2019	Annual	9/10/2020	1045
Anritsu	MA2411B	Pulse Power Sensor	8/14/2019	Annual	8/14/2020	1315051
Anritsu	MA2411B	Pulse Power Sensor	8/8/2019	Annual	8/8/2020	1339008
Anritsu	ML2495A	Power Meter	12/17/2019	Annual	12/17/2020	941001
Agilent	N5182A	MXG Vector Signal Generator	8/19/2019	Annual	8/19/2020	MY47420837
Seekonk	NC-100	Torque Wrench	7/18/2019	Annual	7/18/2020	N/A
MiniCircuits	ZHDC-16-63-S+	Bidirectional Coupler	CBT	N/A	CBT	N/A
MiniCircuits	VLf-6000+	Low Pass Filter	CBT	N/A	CBT	N/A
SPEAG	EX3DV4	SAR Probe	1/21/2020	Annual	1/21/2021	3589
SPEAG	EX3DV4	SAR Probe	7/15/2019	Annual	7/15/2020	7547
SPEAG	DAE4	Dasy Data Acquisition Electronics	7/11/2019	Annual	7/11/2020	1323
SPEAG	DAE4	Dasy Data Acquisition Electronics	1/13/2020	Annual	1/13/2021	1558

Measurement Uncertainty = $\pm 23\%$ (k=2)

	Name	Function	Signature
Calibrated By:	Test Engineer	Test Engineer	<i>BRODIE HALBFOSTER</i>
Approved By:	Kaitlin O'Keefe	Managing Director	<i>KOK</i>

DIPOLE CALIBRATION EXTENSION

Per KDB 865664 D01, calibration intervals of up to three years may be considered for reference dipoles when it is demonstrated that the SAR target, impedance and return loss of a dipole have remained stable according to the following requirements:

1. The measured SAR does not deviate more than 10% from the target on the calibration certificate.
2. The return-loss does not deviate more than 20% from the previous measurement and meets the required 20dB minimum return-loss requirement.
3. The measurement of real or imaginary parts of impedance does not deviate more than 5Ω from the previous measurement.

The following dipole was checked to pass the above 3 requirements to have 2-year calibration period from the calibration date:

Calibration Date	Extension Date	Certificate Electrical Delay (ns)	Certificate SAR Target Head (1g) W/kg @ 20.0 dBm	Measured Head SAR (1g) W/kg @ 20.0 dBm	Deviation 1g (%)	Certificate SAR Target Head (10g) W/kg @ 20.0 dBm	Measured Head SAR (10g) W/kg @ 20.0 dBm	Deviation 10g (%)	Certificate Impedance Head (Ohm) Real	Measured Impedance Head (Ohm) Real	Difference (Ohm) Real	Certificate Impedance Head (Ohm) Imaginary	Measured Impedance Head (Ohm) Imaginary	Difference (Ohm) Imaginary	Certificate Return Loss Head (dB)	Measured Return Loss Head (dB)	Deviation (%)	PASS/FAIL
6/14/2019	6/14/2020	1.151	5.81	5.65	-2.24%	2.5	2.56	-1.54%	49.8	49.6	1.2	-6.9	-5.8	1.1	-23.2	-24.4	-5.00%	PASS
Calibration Date	Extension Date	Certificate Electrical Delay (ns)	Certificate SAR Target Body (1g) W/kg @ 20.0 dBm	Measured Body SAR (1g) W/kg @ 20.0 dBm	Deviation 1g (%)	Certificate SAR Target Body (10g) W/kg @ 20.0 dBm	Measured Body SAR (10g) W/kg @ 20.0 dBm	Deviation 10g (%)	Certificate Impedance Body (Ohm) Real	Measured Impedance Body (Ohm) Real	Difference (Ohm) Real	Certificate Impedance Body (Ohm) Imaginary	Measured Impedance Body (Ohm) Imaginary	Difference (Ohm) Imaginary	Certificate Return Loss Body (dB)	Measured Return Loss Body (dB)	Deviation (%)	PASS/FAIL
6/14/2019	6/14/2020	1.151	5.56	5.43	-2.34%	2.5	2.39	-4.40%	46.6	48.1	1.5	-4.4	-3.6	0.8	-24.9	-27.6	-10.80%	PASS

Impedance & Return-Loss Measurement Plot for Head TSL

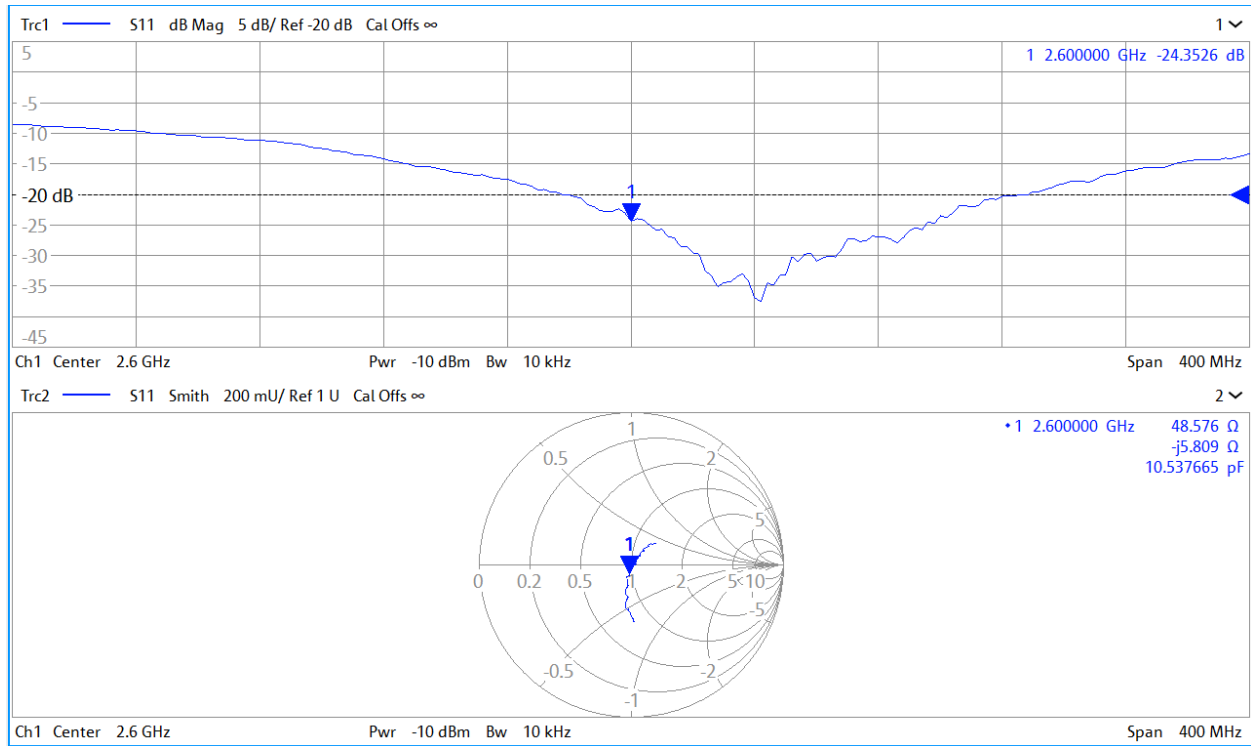

Impedance & Return-Loss Measurement Plot for Body TSL

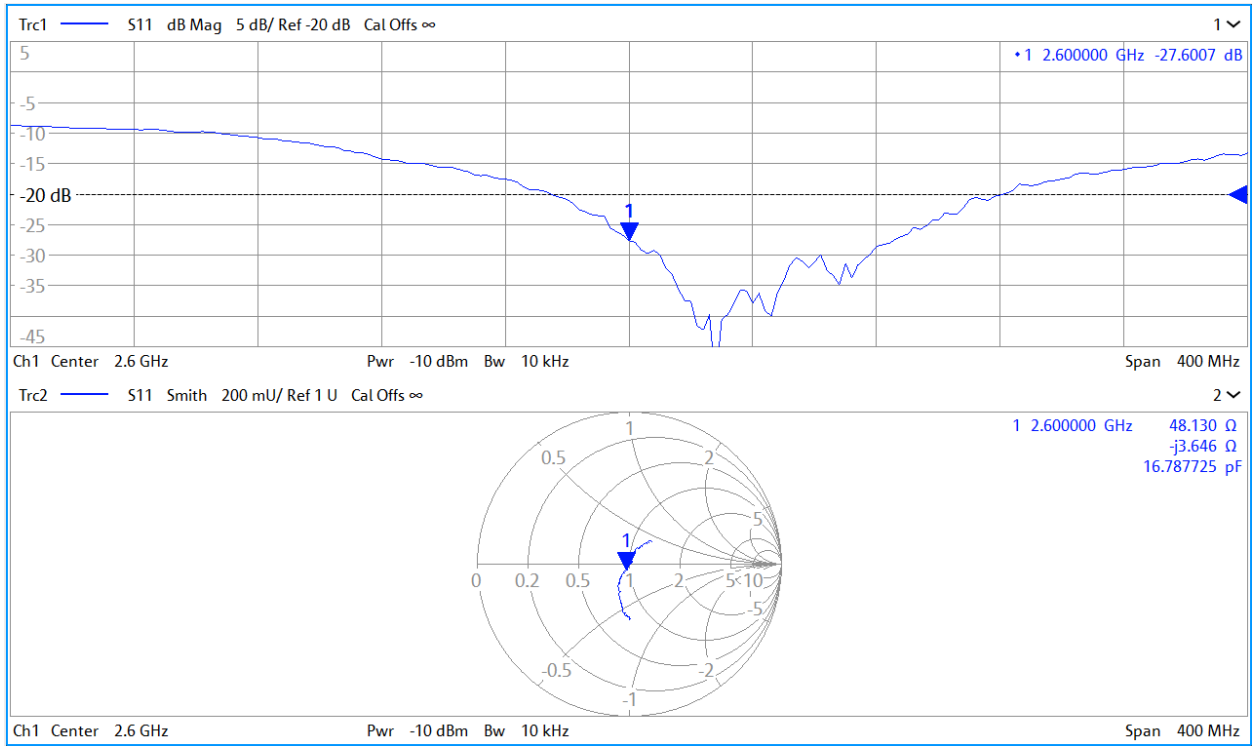

Certification of Calibration

Object: D2600V2 – SN: 1064

Calibration procedure(s): Procedure for Calibration Extension for SAR Dipoles.



Extension Calibration date: 06/14/2021

Description: SAR Validation Dipole at 2600 MHz.

Calibration Equipment used:

Manufacturer	Model	Description	Cal Date	Cal Interval	Cal Due	Serial Number
Control Company	4040	Therm./ Clock/ Humidity Monitor	2/23/2021	Annual	2/23/2022	160574418
Control Company	4353	Long Stem Thermometer	10/28/2020	Biennial	10/28/2022	200670623
Amplifier Research	1551G6	Amplifier	CBT	N/A	CBT	433971
Narda	4772-3	Attenuator (3dB)	CBT	N/A	CBT	9406
Keysight Technologies	85033E	Standard Mechanical Calibration Kit (DC to 9GHz, 3.5mm)	9/1/2020	Annual	9/1/2021	MY53401181
Rohde & Schwarz	ZNLE6	Vector Network Analyzer	9/29/2020	Annual	9/29/2021	101307
Mini-Circuits	BW-N20W5+	DC to 18 GHz Precision Fixed 20 dB Attenuator	CBT	N/A	CBT	N/A
SPEAG	DAK-3.5	Dielectric Assessment Kit	10/14/2020	Annual	10/14/2021	1091
Anritsu	MA2411B	Pulse Power Sensor	8/12/2020	Annual	8/12/2021	1207364
Anritsu	MA2411B	Pulse Power Sensor	9/22/2020	Annual	9/22/2021	1315051
Anritsu	ML2495A	Power Meter	11/3/2020	Annual	11/3/2021	1039008
Anritsu	ML2495A	Power Meter	1/18/2021	Annual	1/18/2022	941001
Agilent	N5182A	MXG Vector Signal Generator	12/1/2020	Annual	12/1/2021	MY47420837
Pasternack	NC-100	Torque Wrench	8/4/2020	Biennial	8/4/2022	N/A
Mini-Circuits	NLP-2950+	Low Pass Filter DC to 2700 MHz	CBT	N/A	CBT	N/A
MiniCircuits	ZHDC-16-63-S+	Bidirectional Coupler	CBT	N/A	CBT	N/A
MiniCircuits	VLF-6000+	Low Pass Filter	CBT	N/A	CBT	N/A
SPEAG	EX3DV4	SAR Probe	7/20/2020	Annual	7/20/2021	7410
SPEAG	DAE4	Dasy Data Acquisition Electronics	7/15/2020	Annual	7/15/2021	1322

Measurement Uncertainty = $\pm 23\%$ (k=2)

	Name	Function	Signature
Calibrated By:	Hyun Kim	Test Engineer	
Approved By:	Kaitlin O'Keefe	Senior Technical Manager	

DIPOLE CALIBRATION EXTENSION

Per KDB 865664 D01, calibration intervals of up to three years may be considered for reference dipoles when it is demonstrated that the SAR target, impedance and return loss of a dipole have remained stable according to the following requirements:

1. The measured SAR does not deviate more than 10% from the target on the calibration certificate.
2. The return-loss does not deviate more than 20% from the previous measurement and meets the required 20dB minimum return-loss requirement.
3. The measurement of real or imaginary parts of impedance does not deviate more than 5Ω from the previous measurement.

The following dipole was checked to pass the above 3 requirements to have 3-year calibration period from the calibration date:

Calibration Date	Extension Date	Certificate Electrical Delay (ns)	Certificate SAR Target Head (1g) W/kg @ 20.0 dBm	Measured Head SAR (1g) W/kg @ 20.0 dBm	Deviation 1g (%)	Certificate SAR Target Head (10g) W/kg @ 20.0 dBm	Measured Head SAR (10g) W/kg @ 20.0 dBm	Deviation 10g (%)	Certificate Impedance Head (Ohm) Real	Measured Impedance Head (Ohm) Real	Difference (Ohm) Real	Certificate Impedance Head (Ohm) Imaginary	Measured Impedance Head (Ohm) Imaginary	Difference (Ohm) Imaginary	Certificate Return Loss Head (dB)	Measured Return Loss Head (dB)	Deviation (%)	PASS/FAIL
6/14/2020	6/14/2021	1.151	5.81	6.16	6.02%	2.60	2.76	6.15%	49.8	48.4	1.4	-6.9	-6.5	0.4	-23.2	-23.4	-0.90%	PASS
Calibration Date	Extension Date	Certificate Electrical Delay (ns)	Certificate SAR Target Body (1g) W/kg @ 20.0 dBm	Measured Body SAR (1g) W/kg @ 20.0 dBm	Deviation 1g (%)	Certificate SAR Target Body (10g) W/kg @ 20.0 dBm	Measured Body SAR (10g) W/kg @ 20.0 dBm	Deviation 10g (%)	Certificate Impedance Body (Ohm) Real	Measured Impedance Body (Ohm) Real	Difference (Ohm) Real	Certificate Impedance Body (Ohm) Imaginary	Measured Impedance Body (Ohm) Imaginary	Difference (Ohm) Imaginary	Certificate Return Loss Body (dB)	Measured Return Loss Body (dB)	Deviation (%)	PASS/FAIL
6/14/2020	6/14/2021	1.151	5.56	5.51	-0.90%	2.50	2.43	-2.80%	46.6	45.7	0.9	-4.4	-5.2	0.8	-24.9	-23.0	7.50%	PASS

Impedance & Return-Loss Measurement Plot for Head TSL

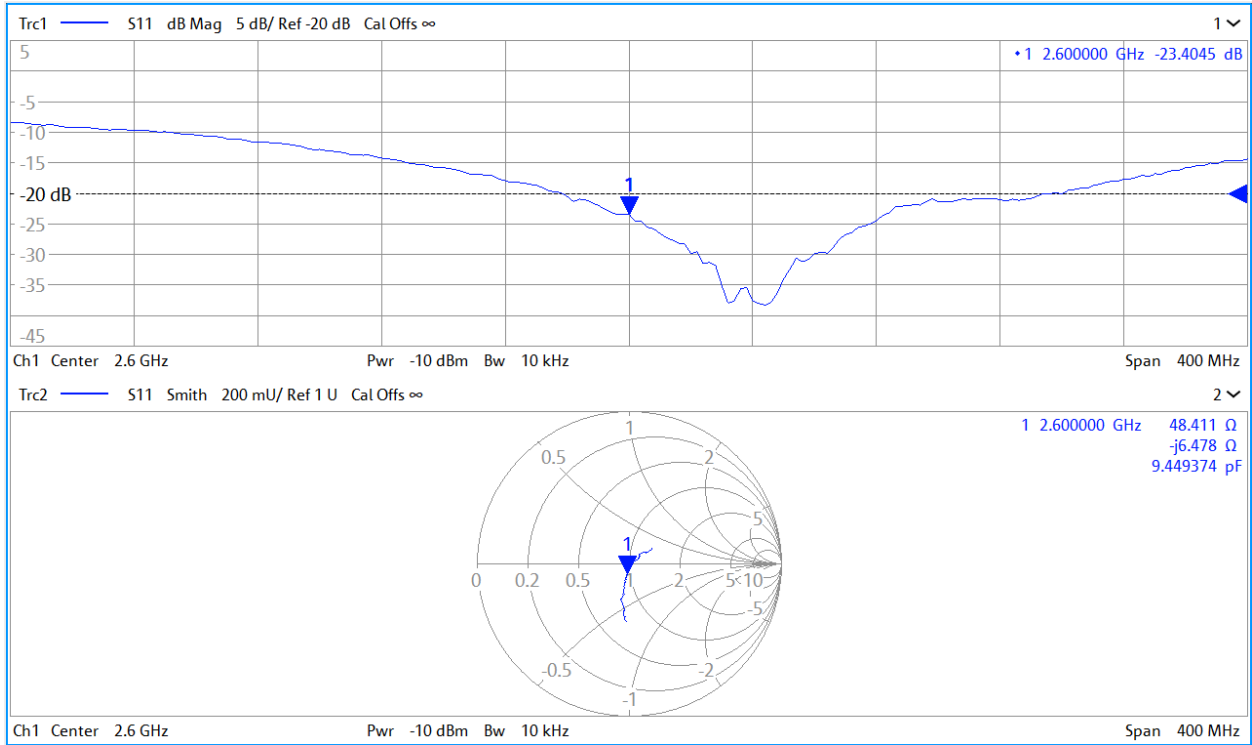

Impedance & Return-Loss Measurement Plot for Body TSL

