

11.4.3. TX ABOVE 1GHz 802.11n HT40 2Tx MODE IN THE 5.8GHz BAND

BANDEDGE (LOW CHANNEL)

HORIZONTAL PEAK DATA

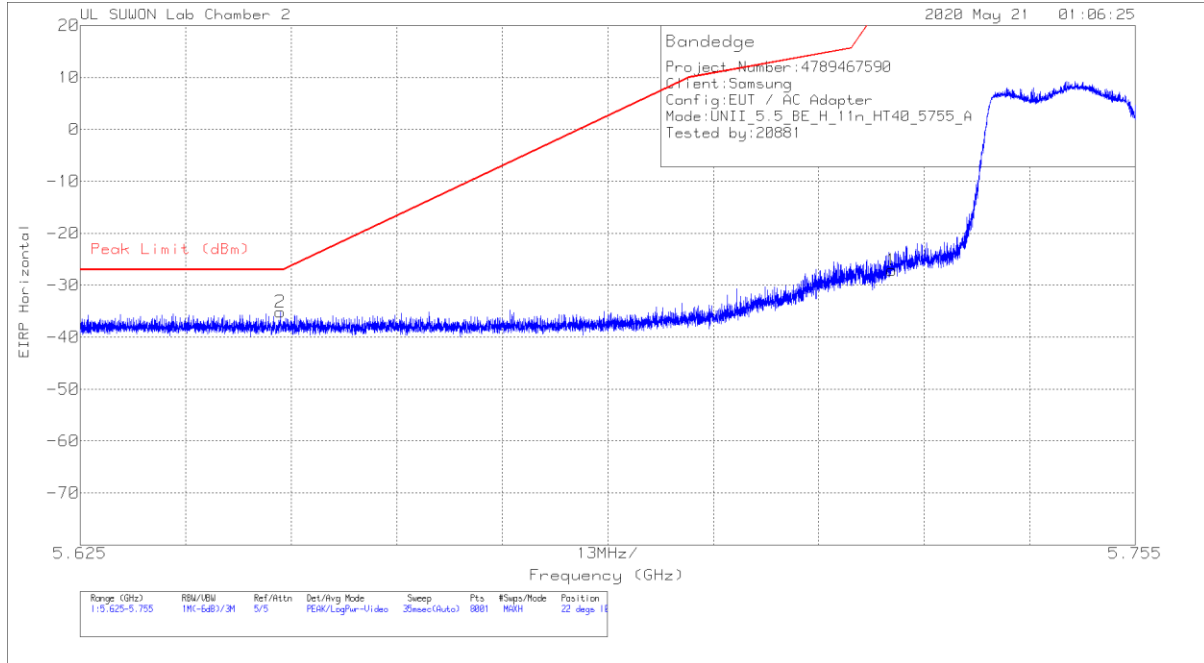

Trace Markers

Marker	Frequency (GHz)	Meter Reading (dBm)	Det	170531_3117(0 0168724)	10dB_ATT[dB]	Conversion Factor (dB)	DC Corr (dB)	Corrected Reading EIRP	Peak Limit (dBm)	PK Margin (dB)	Azimuth (Degs)	Height (cm)	Polarity
1	5.72499	-55.91	Pk	34.5	-17.5	11.8	0	-27.11	26.97	-54.08	22	104	H
2	5.64965	-63.65	Pk	34.4	-17.7	11.8	0	-35.15	-27	-8.15	22	104	H

Pk - Peak detector

VERTICAL PEAK DATA

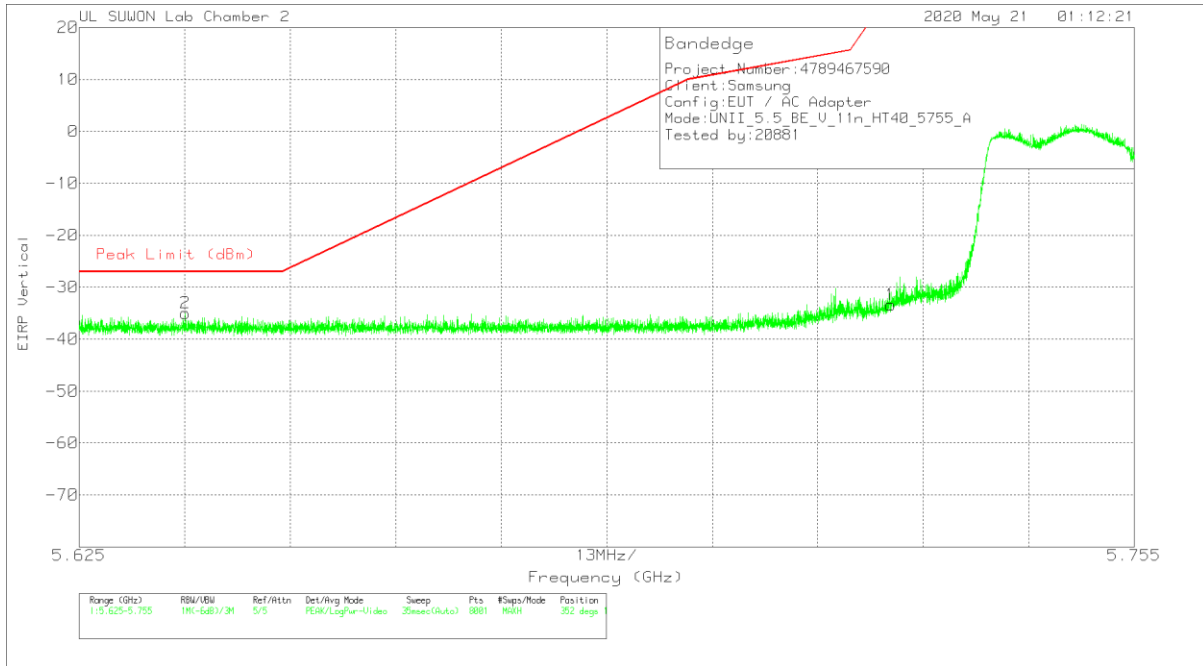

Trace Markers

Marker	Frequency (GHz)	Meter Reading (dBm)	Det	170531_31170 0168724	10dB_ATT[dB]	Conversion Factor (dB)	DC Corr (dB)	Corrected Reading EIRP	Peak Limit (dBm)	PK Margin (dB)	Azimuth (Degs)	Height (cm)	Polarity
1	5.72499	-62.19	Pk		-17.5	11.8	0	-33.39	26.97	-60.36	352	100	V
2	5.63807	-63.47	Pk		-17.7	11.8	0	-34.97	-27	-7.97	352	100	V

Pk - Peak detector

BANDEDGE (HIGH CHANNEL)

HORIZONTAL PEAK DATA

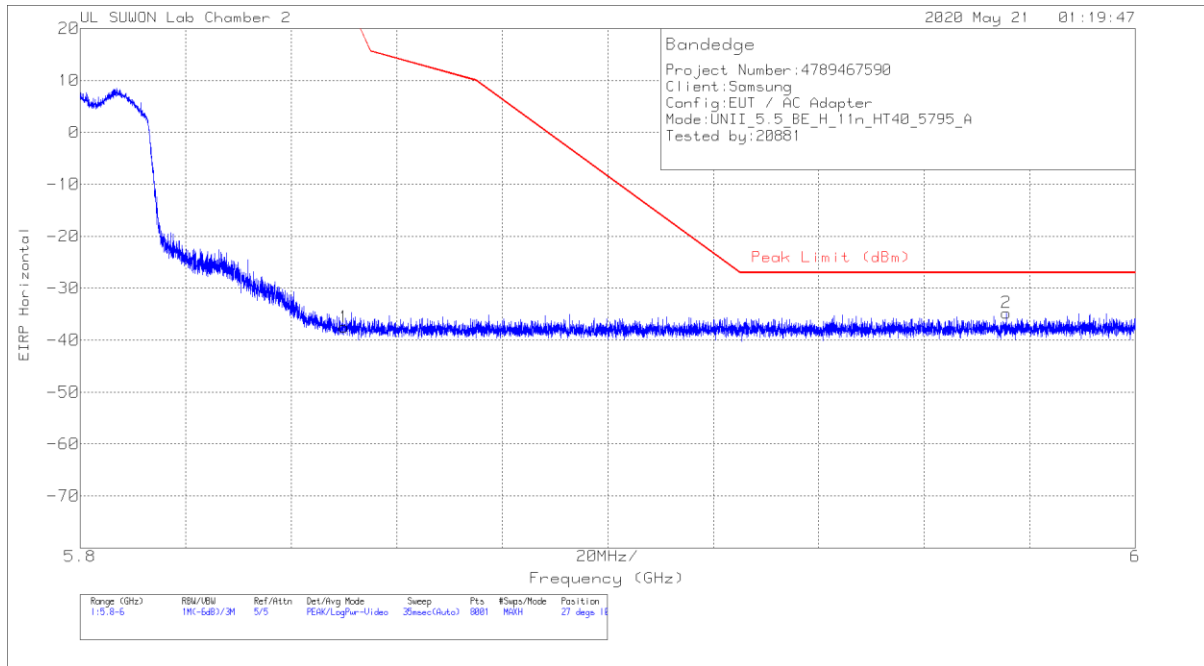

Trace Markers

Marker	Frequency (GHz)	Meter Reading (dBm)	Det	170531_3117(0 0168724)	10dB_ATT[dB]	Conversion Factor (dB)	DC Corr (dB)	Corrected Reading EIRP	Peak Limit (dBm)	PK Margin (dB)	Azimuth (Degs)	Height (cm)	Polarity
1	5.85003	-66.46	Pk		-17.3	11.8	0	-37.46	26.94	-64.4	27	103	H
2	5.97553	-64.04	Pk		-17.2	11.8	0	-34.74	-27	-7.74	27	103	H

Pk - Peak detector

VERTICAL PEAK DATA

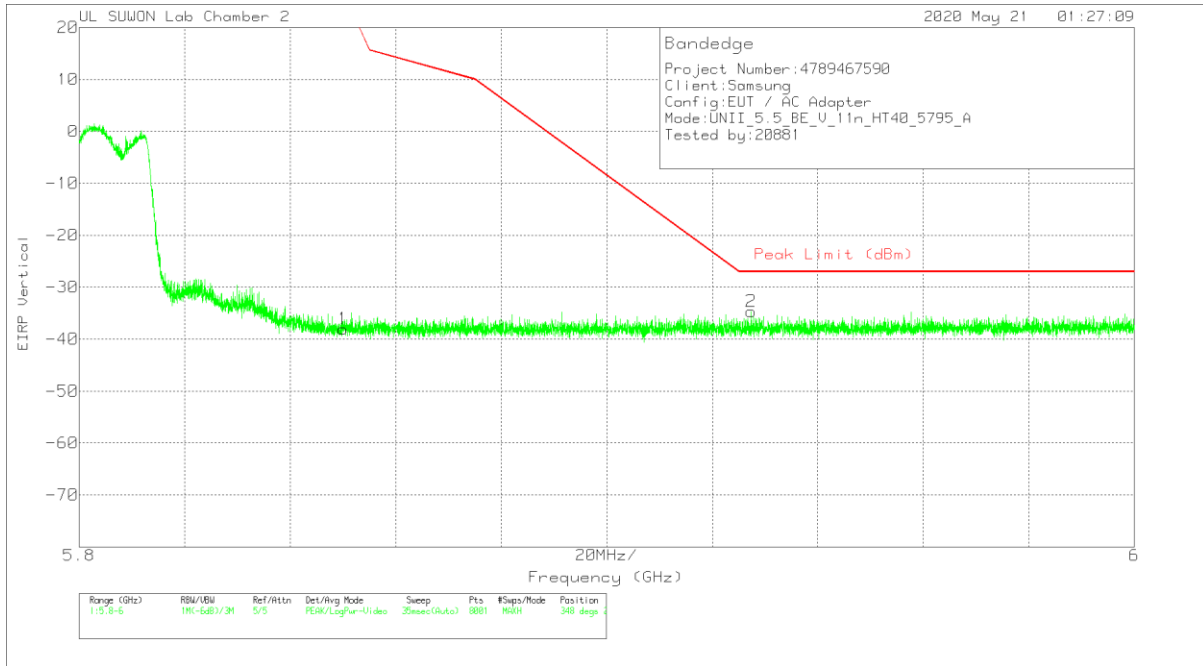

Trace Markers

Marker	Frequency (GHz)	Meter Reading (dBm)	Det	170531_31170 0168724]	10dB_ATT[dB]	Conversion Factor (dB)	DC Corr (dB)	Corrected Reading EIRP	Peak Limit (dBm)	PK Margin (dB)	Azimuth (Degs)	Height (cm)	Polarity
1	5.85003	-67.04	Pk		-17.3	11.8	0	-38.04	26.94	-64.98	348	282	V
2	5.92738	-63.76	Pk		-17.3	11.8	0	-34.66	-27	-7.66	348	282	V

PK - Peak detector

HARMONICS AND SPURIOUS EMISSIONS

LOW CHANNEL HORIZONTAL

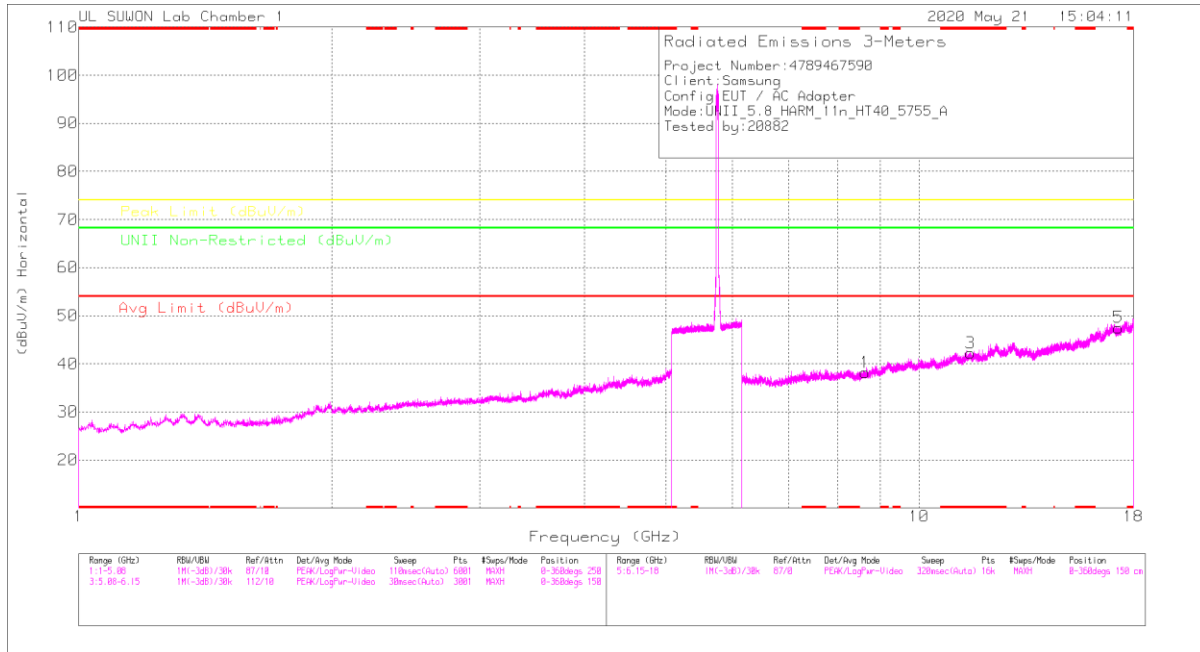

LOW CHANNEL VERTICAL

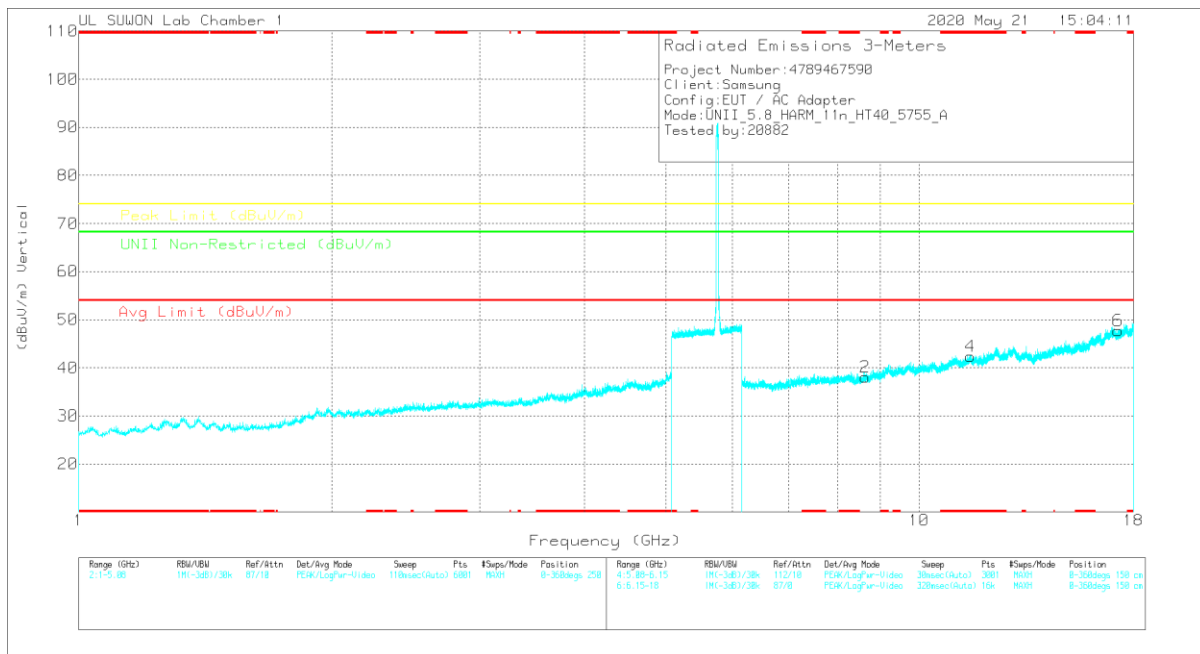

Note: Emission was scanned up to 40GHz; No emissions were detected above the noise floor which was at least 20dB below the specification limit.

LOW CHANNEL DATA

Trace Markers

Marker	Frequency (GHz)	Mean Reading (dBm)	Det	317_00168717	6GHz_HP(SB)	DC Corr (dB)	Corrected Reading (dBm)	Avg Limit (dBuV/m)	Margin (dB)	Peak Limit (dBuV/m)	Margin (dB)	Limit Non-Restricted (dBuV/m)	Margin (dB)	Asimuth (Degs)	Height (cm)	Polarity
1	8.63538	26.86	PK	36.3	-25	0	38.16	-	-	-	-	68.2	-30.04	0-360	250	H
3	* 11.51179	26.14	PK	38.5	-22.4	0	42.24	-	-	74	-31.76	-	-	0-360	250	H
5	17.27053	23.93	PK	41.3	-17.7	0	47.53	-	-	-	-	68.2	-20.67	0-360	250	H
2	8.6339	26.63	PK	36.3	-24.9	0	38.03	-	-	-	-	68.2	-30.17	0-360	150	V
4	* 11.51624	26.22	PK	38.5	-22.4	0	42.32	-	-	74	-31.68	-	-	0-360	150	V
6	17.2572	23.85	PK	41.3	-17.4	0	47.75	-	-	-	-	68.2	-20.45	0-360	150	V

* - indicates frequency in CFR47 Pt 15 / IC RSS-Restricted Band
 PK – Peak Detector

Radiated Emissions

Frequency (GHz)	Mean Reading (dBuV)	Det	317_00168717	6GHz_HP(SB)	DC Corr (dB)	Corrected Reading (dBuV/m)	Avg Limit (dBuV/m)	Margin (dB)	Peak Limit (dBuV/m)	Margin (dB)	Limit Non-Restricted (dBuV/m)	Margin (dB)	Asimuth (Degs)	Height (cm)	Polarity
8.63405	37.01	PK-U	36.3	-25	0	48.31	-	-	-	-	68.2	-19.89	0	100	H
8.63429	37.01	PK-U	36.3	-25	0	48.31	-	-	-	-	68.2	-19.89	0	100	V
* 11.51321	36.66	PK-U	38.5	-22.3	0	52.86	-	-	74	-21.14	-	-	0	100	H
* 11.51133	37.02	PK-U	38.5	-22.4	0	53.12	-	-	74	-20.88	-	-	0	100	V
17.27235	34.54	PK-U	41.3	-17.8	0	56.04	-	-	-	-	68.2	-10.16	0	100	H
17.27189	34.32	PK-U	41.3	-17.8	0	57.62	-	-	-	-	68.2	-10.38	0	100	V

* - indicates frequency in CFR47 Pt 15 / IC RSS-Restricted Band
 PK-U - U-NII: Maximum Peak

HIGH CHANNEL HORIZONTAL

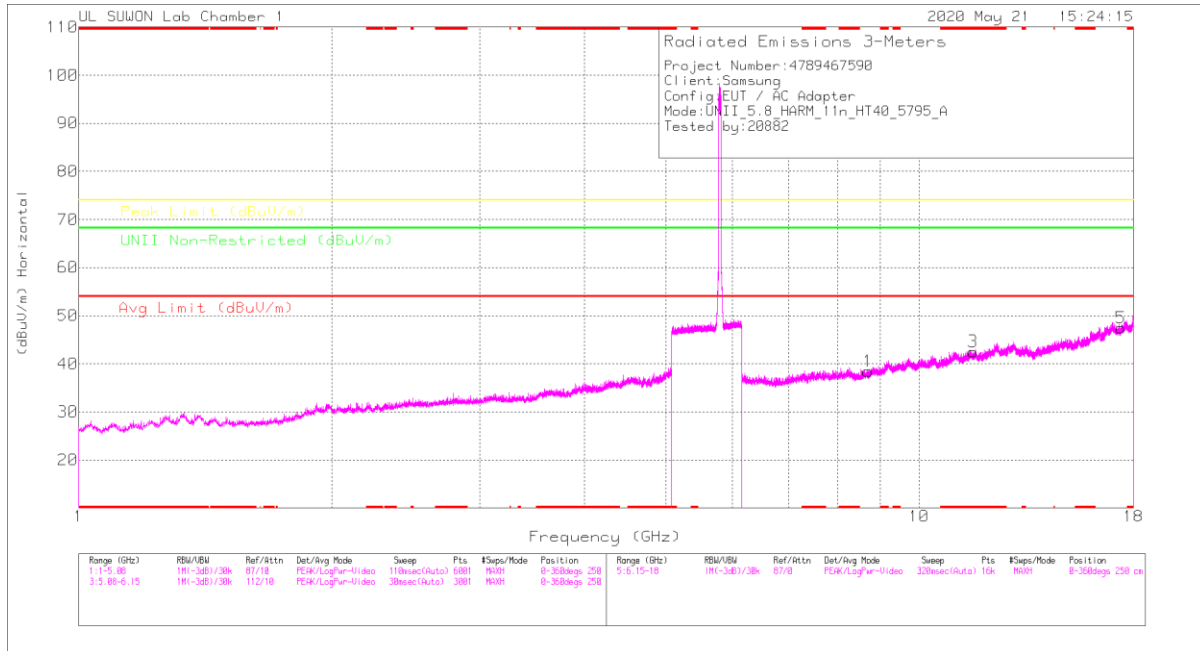

HIGH CHANNEL VERTICAL

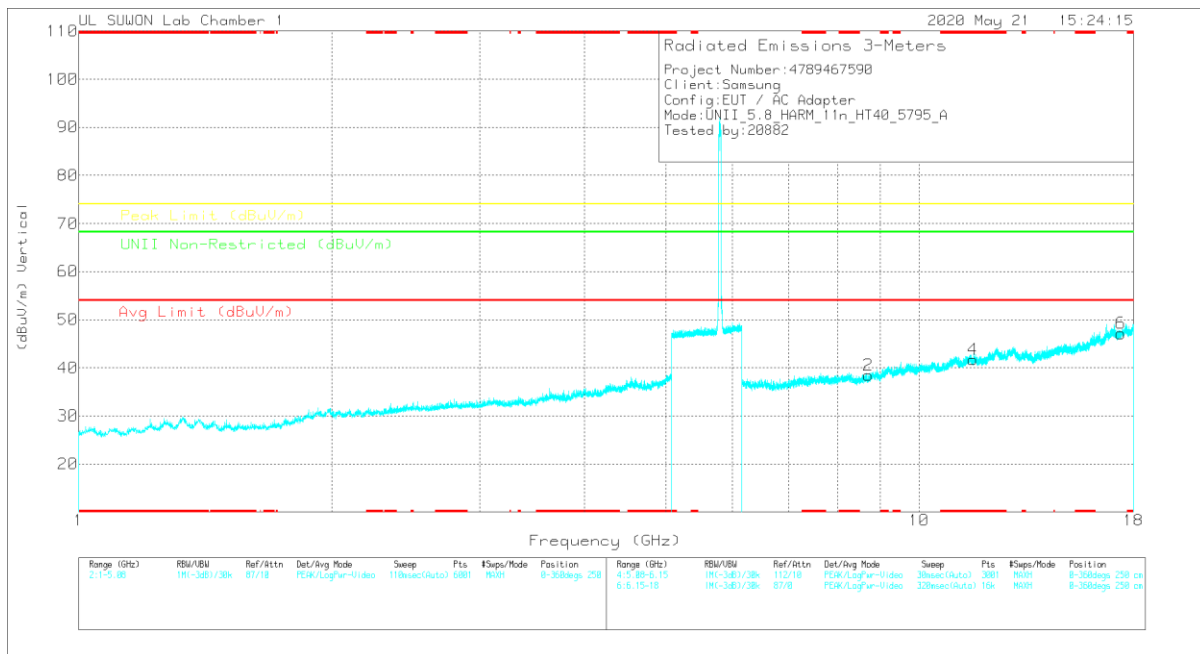

Note: Emission was scanned up to 40GHz; No emissions were detected above the noise floor which was at least 20dB below the specification limit.

HIGH CHANNEL DATA

Trace Markers

Marker	Frequency (GHz)	Mean Reading (dBm)	Det	317_00168717	6GHz_HP(SB)	DC Corr (dB)	Corrected Reading (dBm)	Avg Limit (dBuV/m)	Margin (dB)	Peak Limit (dBuV/m)	Margin (dB)	Limit Non-Restricted (dBuV/m)	Margin (dB)	Asimuth (Degs)	Height (cm)	Polarity
1	8.69685	27.53	PK	36.4	-25.6	0	38.43	-	-	-	-	68.2	-29.77	0-360	150	H
3	* 11.59177	26.07	PK	38.6	-22.1	0	42.57	-	-	74	-31.43	-	-	0-360	250	H
5	17.38681	24.01	PK	41.2	-17.7	0	47.51	-	-	-	-	68.2	-20.69	0-360	250	H
2	8.69759	27.68	PK	36.4	-25.6	0	38.48	-	-	-	-	68.2	-29.72	0-360	149	V
4	* 11.58733	25.37	PK	38.6	-22.2	0	41.77	-	-	74	-32.23	-	-	0-360	149	V
6	17.38681	23.64	PK	41.2	-17.7	0	47.14	-	-	-	-	68.2	-21.06	0-360	149	V

* - indicates frequency in CFR47 Pt 15 / IC RSS-Restricted Band
 PK – Peak Detector

Radiated Emissions

Frequency (GHz)	Mean Reading (dBm)	Det	317_00168717	6GHz_HP(SB)	DC Corr (dB)	Corrected Reading (dBm)	Avg Limit (dBuV/m)	Margin (dB)	Peak Limit (dBuV/m)	Margin (dB)	Limit Non-Restricted (dBuV/m)	Margin (dB)	Asimuth (Degs)	Height (cm)	Polarity
8.69759	38.09	PK-U	36.4	-25.6	0	48.89	-	-	-	-	68.2	-19.31	0	100	H
8.69716	38	PK-U	36.4	-25.6	0	48.8	-	-	-	-	68.2	-19.4	0	100	V
* 11.5922	36.37	PK-U	38.6	-22.1	0	52.87	-	-	74	-21.13	-	-	0	100	H
* 11.59365	36.38	PK-U	38.6	-22.2	0	52.78	-	-	74	-21.22	-	-	0	100	V
17.38493	34.61	PK-U	41.2	-17.6	0	56.21	-	-	-	-	68.2	-9.99	0	100	H
17.38475	34.44	PK-U	41.2	-17.6	0	56.04	-	-	-	-	68.2	-10.16	0	100	V

* - indicates frequency in CFR47 Pt 15 / IC RSS-Restricted Band
 PK-U - U-NII: Maximum Peak

11.4.4. TX ABOVE 1GHz 802.11ac VHT80 2Tx MODE IN THE 5.8GHz BAND

BANDEDGE (Lower side)

HORIZONTAL PEAK DATA

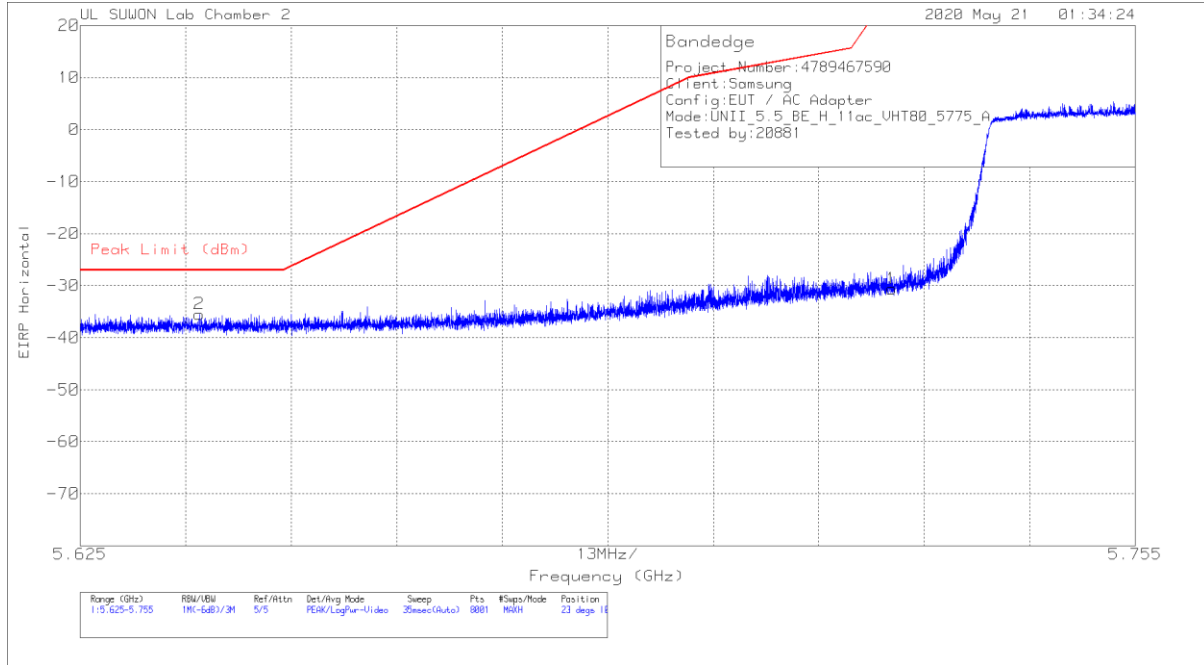

Trace Markers

Marker	Frequency (GHz)	Meter Reading (dBm)	Det	170531_3117[0 0168724]	10dB_ATT[dB]	Conversion Factor (dB)	DC Corr (dB)	Corrected Reading EIRP	Peak Limit (dBm)	PK Margin (dB)	Azimuth (Degs)	Height (cm)	Polarity
1	5.72499	-59.4	Pk	34.5	-17.5	11.8	0	-30.6	26.97	-57.57	23	101	H
2	5.63966	-63.97	Pk	34.4	-17.7	11.8	0	-35.47	-27	-8.47	23	101	H

Pk - Peak detector

VERTICAL PEAK DATA

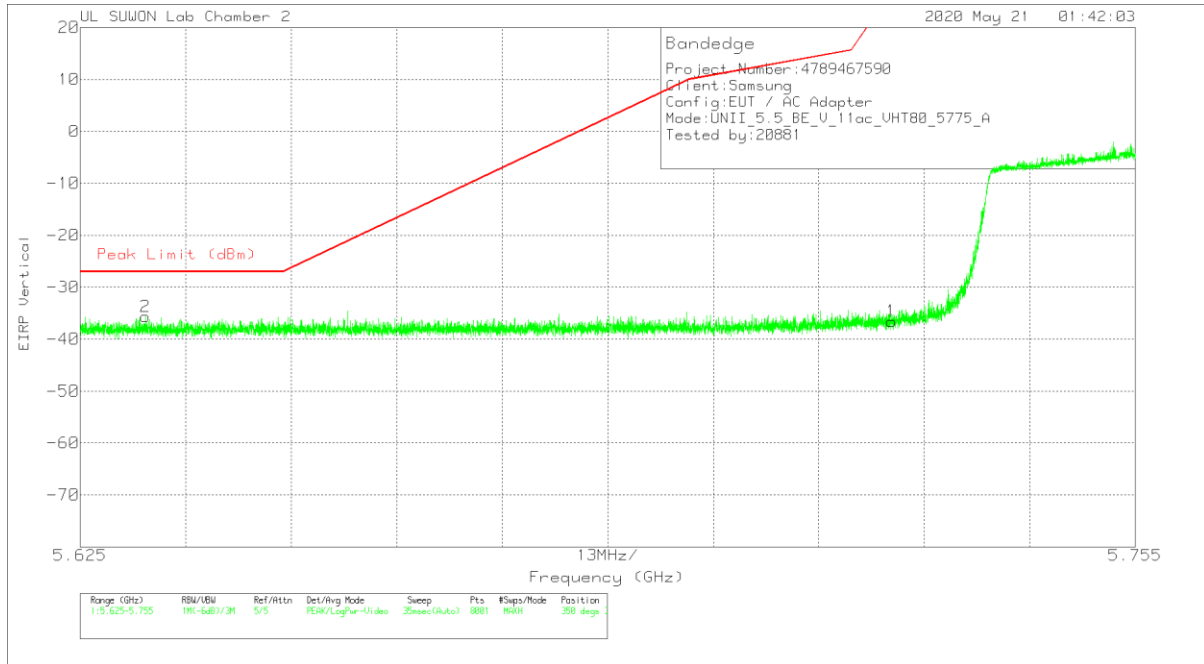

Trace Markers

Marker	Frequency (GHz)	Meter Reading (dBm)	Det	170531_31170 0168724	10dB_ATT[dB]	Conversion Factor (dB)	DC Corr (dB)	Corrected Reading EIRP	Peak Limit (dBm)	PK Margin (dB)	Azimuth (Degs)	Height (cm)	Polarity
1	5.72499	-65.39	Pk		-17.5	11.8	0	-36.59	26.97	-63.56	350	318	V
2	5.63303	-64.15	Pk		-17.7	11.8	0	-35.65	-27	-8.65	350	318	V

PK - Peak detector

BANDEDGE (Upper side)

HORIZONTAL PEAK DATA

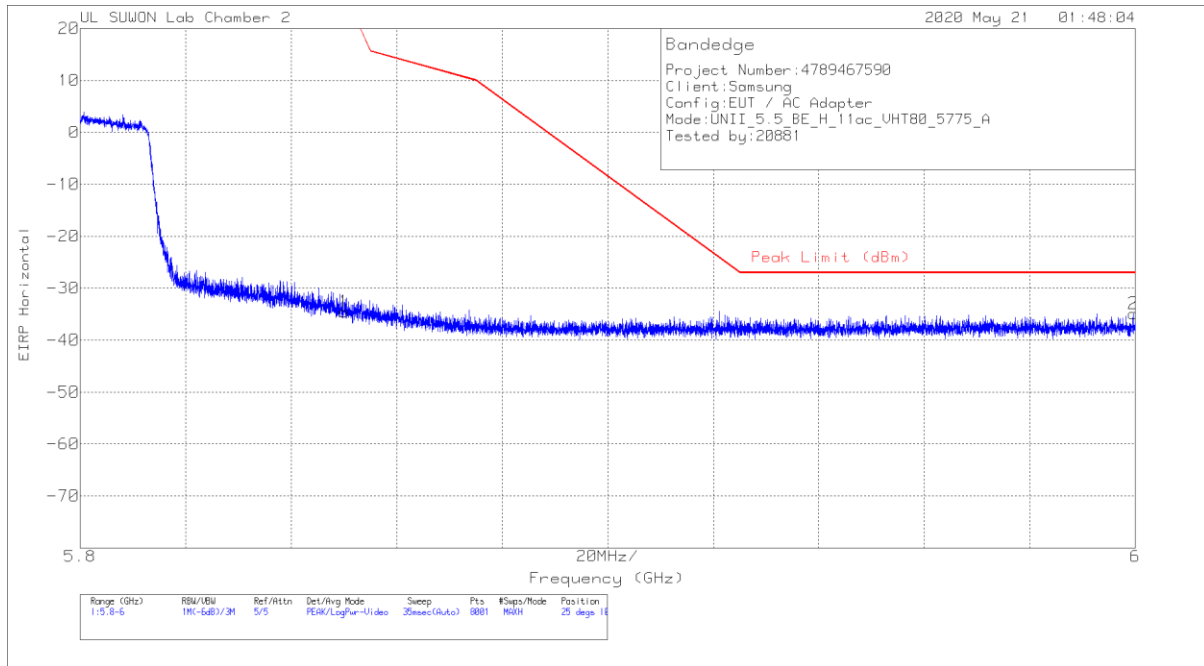

Trace Markers

Marker	Frequency (GHz)	Meter Reading (dBm)	Det	170531_31170 0168724	10dB_ATT[dB]	Conversion Factor (dB)	DC Corr (dB)	Corrected Reading EIRP	Peak Limit (dBm)	PK Margin (dB)	Azimuth (Degs)	Height (cm)	Polarity
1	5.85003	-63.53	Pk		-17.3	11.8	0	-34.53	26.94	-61.47	25	100	H
2	5.99963	-64.2	Pk		-17.3	11.8	0	-34.9	-27	-7.9	25	100	H

Pk - Peak detector

VERTICAL PEAK DATA

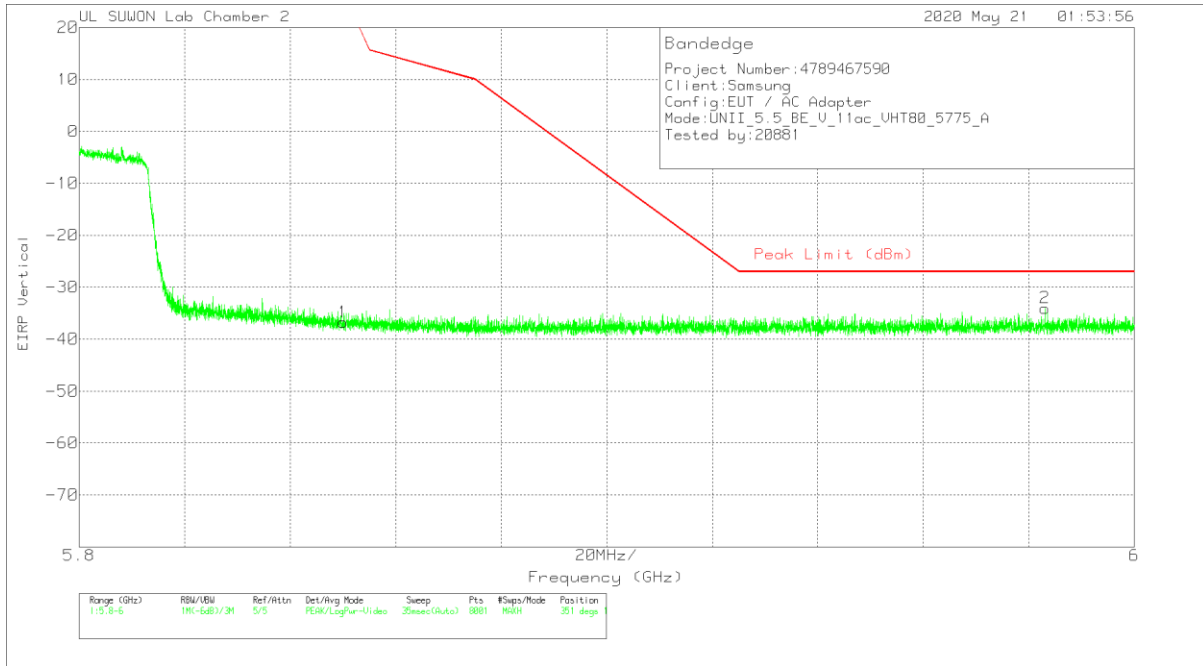

Trace Markers

Marker	Frequency (GHz)	Meter Reading (dBm)	Det	170531_3117(0 0168724)	10dB_ATT[dB]	Conversion Factor (dB)	DC Corr (dB)	Corrected Reading EIRP	Peak Limit (dBm)	PK Margin (dB)	Azimuth (Degs)	Height (cm)	Polarity
1	5.85003	-65.74	Pk	34.5	-17.3	11.8	0	-36.74	26.94	-63.68	351	103	V
2	5.98308	-63.21	Pk	34.7	-17.3	11.8	0	-34.01	-27	-7.01	351	103	V

Pk - Peak detector

HARMONICS AND SPURIOUS EMISSIONS

MID CHANNEL HORIZONTAL

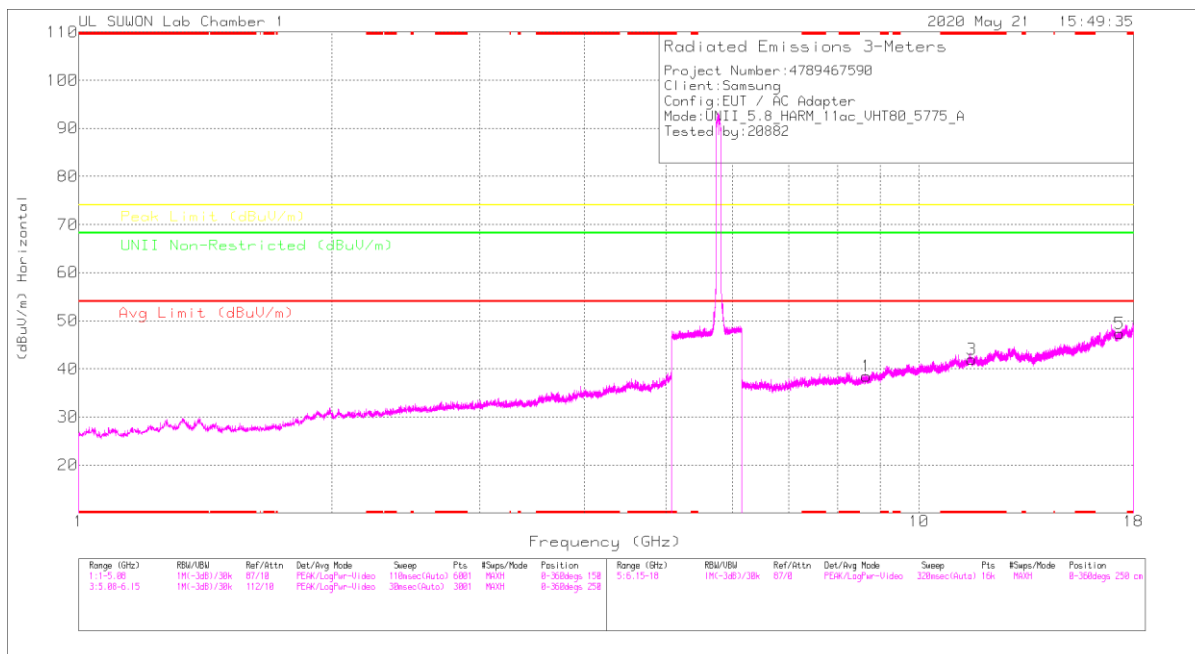

MID CHANNEL VERTICAL

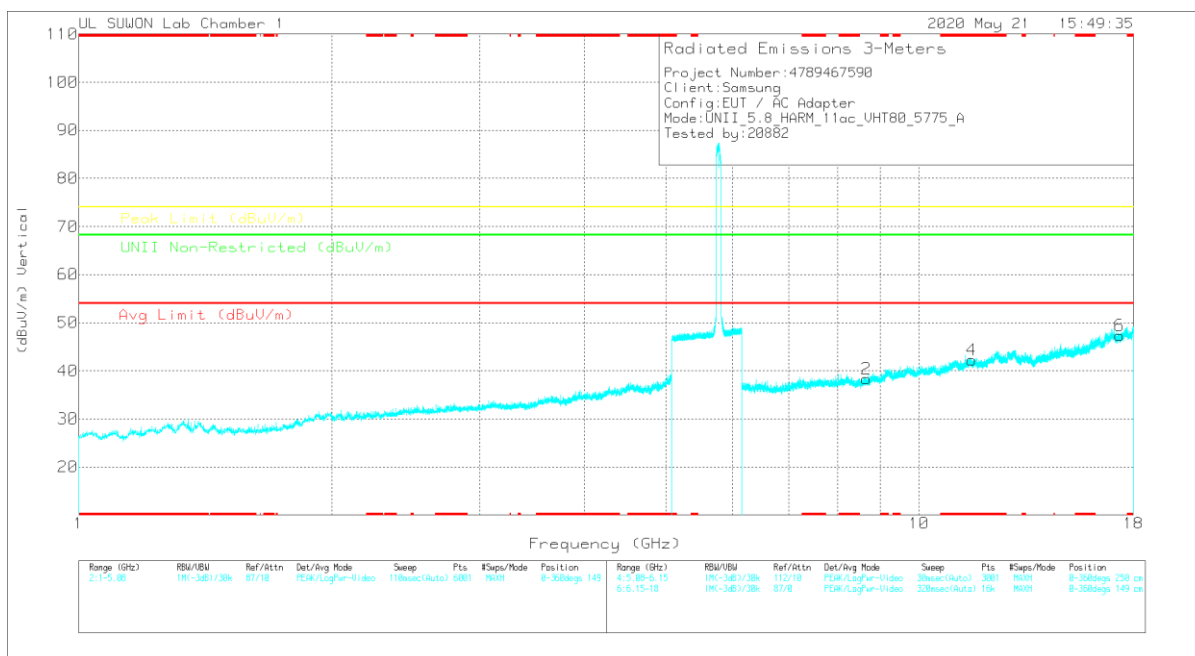

Note: Emission was scanned up to 40GHz; No emissions were detected above the noise floor which was at least 20dB below the specification limit.

MID CHANNEL DATA

Trace Markers

Marker	Frequency (GHz)	Mean Reading (dBm)	Det	317_00168717	6GHz_HPt(B)	DC Corr (dB)	Corrected Reading (dBm)	Avg Limit (dBuV/m)	Margin (dB)	Peak Limit (dBuV/m)	Margin (dB)	UNI Non-Restricted (dBuV/m)	Margin (dB)	Asimuth (Degs)	Height (cm)	Polarity
1	8.66204	27.23	PK	36.4	-25.1	0	38.51	-	-	-	-	68.2	-29.69	0-360	250	H
3	* 11.54866	25.8	PK	38.5	-22.3	0	42	-	-	74	-32	-	-	0-360	149	H
5	17.32163	23.48	PK	41.3	-17.5	0	47.28	-	-	-	-	68.2	-20.92	0-360	149	H
2	8.66056	26.94	PK	36.4	-25	0	38.34	-	-	-	-	68.2	-29.86	0-360	250	V
4	* 11.55363	26	PK	38.6	-22.4	0	42.2	-	-	74	-31.8	-	-	0-360	250	V
6	17.32978	23.69	PK	41.2	-17.6	0	47.29	-	-	-	-	68.2	-20.91	0-360	149	V

* - indicates frequency in CFR47 Pt 15 / IC RSS-Restricted Band
 PK – Peak Detector

Radiated Emissions

Frequency (GHz)	Mean Reading (dBm)	Det	317_00168717	6GHz_HPt(B)	DC Corr (dB)	Corrected Reading (dBm)	Avg Limit (dBuV/m)	Margin (dB)	Peak Limit (dBuV/m)	Margin (dB)	UNI Non-Restricted (dBuV/m)	Margin (dB)	Asimuth (Degs)	Height (cm)	Polarity
8.66372	37.12	PK-U	36.4	-25.1	0	48.42	-	-	-	-	68.2	-19.78	0	100	H
8.66374	38.32	PK-U	36.4	-25.1	0	49.62	-	-	-	-	68.2	-18.58	0	100	V
* 11.54848	37.28	PK-U	38.5	-22.3	0	53.48	-	-	74	-20.52	-	-	0	100	H
* 11.54996	35.97	PK-U	38.5	-22.3	0	52.17	-	-	74	-21.83	-	-	0	100	V
17.32358	34.08	PK-U	41.3	-17.5	0	57.78	-	-	-	-	68.2	-10.42	0	100	H
17.32595	34.6	PK-U	41.2	-17.5	0	58.3	-	-	-	-	68.2	-9.9	0	100	V

* - indicates frequency in CFR47 Pt 15 / IC RSS-Restricted Band
 PK-U - U-NII: Maximum Peak

11.5. Spurious Emissions for Simultaneous Transmission

11.5.1. Worst test case RSDB condition

Case 1	2.4 GHz WLAN Antenna ALL	5GHz WLAN Antenna ALL
Mode	802.11b	802.11a
Channel	1	48
Frequency[MHz]	2412	5240
Data Rate	1Mbps	6Mbps
Foldable condition	Full-folded	
Axis (Worst)	Y	

Case 2	2.4 GHz WLAN Antenna ALL	5GHz WLAN Antenna ALL
Mode	802.11b	802.11a
Channel	1	48
Frequency[MHz]	2412	5240
Data Rate	1Mbps	6Mbps
Foldable condition	Half-folded	
Axis (Worst)	X	

11.5.2. Worst test case RSDB + Bluetooth condition

Case 3	Bluetooth Antenna 1	2.4 GHz WLAN Antenna 2	5GHz WLAN Antenna ALL
Mode	BDR	802.11b	802.11a
Channel	77	1	48
Frequency[MHz]	2479	2412	5240
Data Rate	1Mbps	1Mbps	6Mbps
Foldable condition	Open		
Axis (Worst)	Y		

NOTE

The lowest margin condition among the channels and modes were selected for test. Low, mid, and high channels of 2.4GH WLAN were tested, and the worst case configuration & data were listed in the test report.

11.5.3. Test Results

Spurious emission for Simultaneous Transmission

Case1. – Full-folded & Y axis

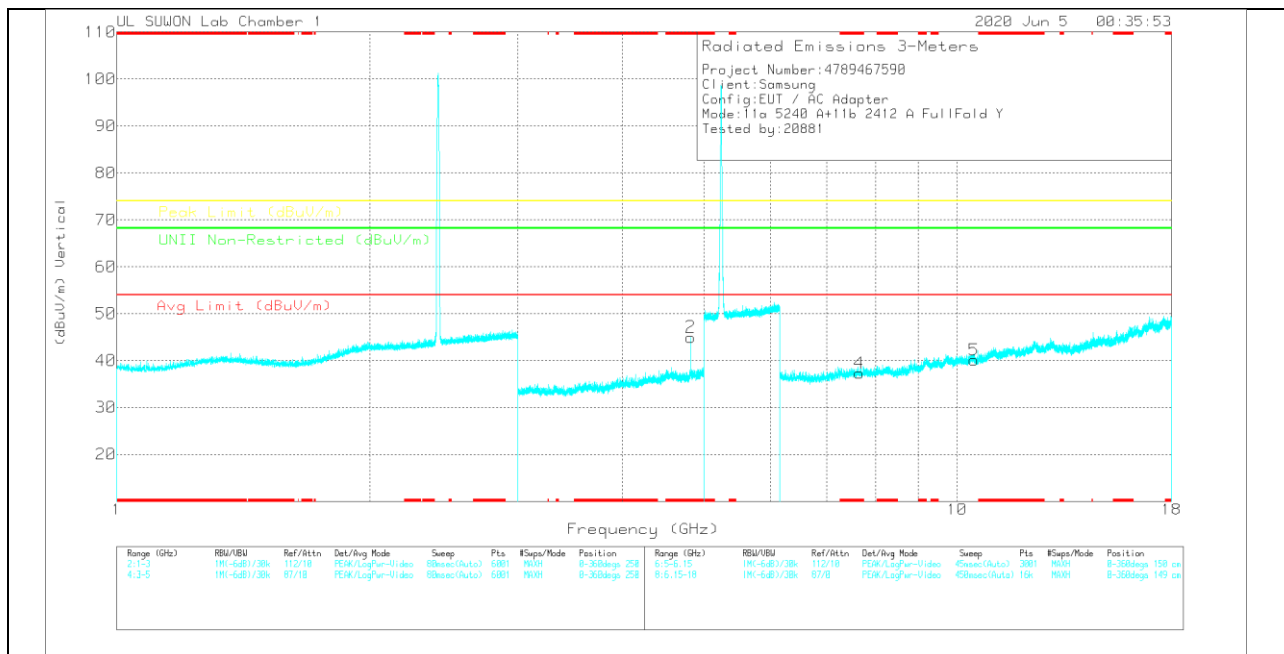
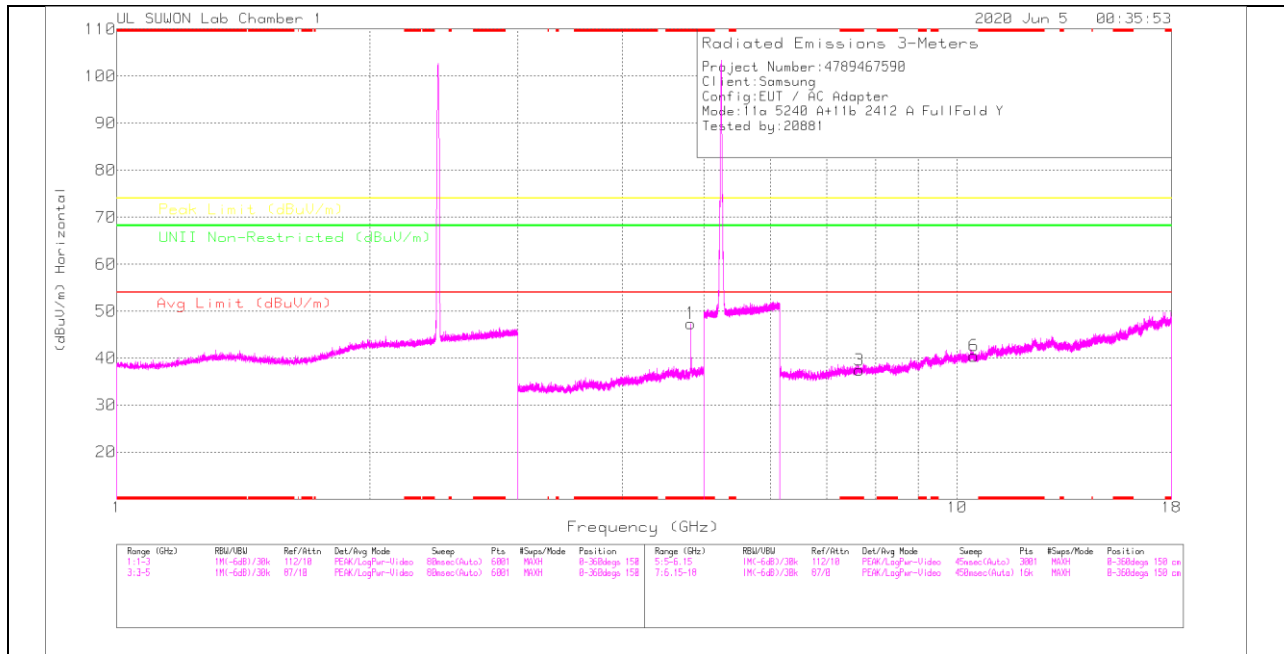

Trace Markers

Marker	Frequency (GHz)	Mask Reading (dBu)	Det	3117_00168717	5GHz_LP1(B)	DTS_Noise(B)	DC Corr (dB)	Corrected Reading (dBu/m)	Avg Limit (dBu/m)	Margin (dB)	Peak Limit (dBu/m)	Margin (dB)	UNI Non-Restricted (dBu/m)	Margin (dB)	Azimuth (Deg)	Height (m)	Polarity
1	* 4.82433	43.49	PK	34.2	-30.6	.3	0	47.39	-	-	74	-26.61	-	-	0-360	250	H
2	* 4.82433	41.09	PK	34.2	-30.6	.3	0	44.99	-	-	74	-29.01	-	-	0-360	150	V

Marker	Frequency (GHz)	Mask Reading (dBu)	Det	3117_00168717	5GHz_LP1(B)	DTS_Noise(B)	DC Corr (dB)	Corrected Reading (dBu/m)	Avg Limit (dBu/m)	Margin (dB)	Peak Limit (dBu/m)	Margin (dB)	UNI Non-Restricted (dBu/m)	Margin (dB)	Azimuth (Deg)	Height (m)	Polarity
3	* 7.65169	29.58	PK	35.8	-26.9	0	0	37.48	-	-	74	-36.52	-	-	0-360	150	H
6	10.48091	25.16	PK	37.7	-22.4	0	0	40.48	-	-	-	-	68.2	-27.74	0-360	250	H
4	* 7.65263	29.48	PK	35.8	-26.9	0	0	37.38	-	-	74	-36.62	-	-	0-360	140	V
5	10.48017	24.85	PK	37.7	-22.4	0	0	40.15	-	-	-	-	68.2	-28.05	0-360	250	V

* - indicates frequency in CFR47 Pt 15 / IC RSS-Restricted Band
 PK – Peak Detector

Radiated Emissions

Frequency (GHz)	Mask Reading (dBu)	Det	3117_00168717	5GHz_LP1(B)	DTS_Noise(B)	DC Corr (dB)	Corrected Reading (dBu/m)	Avg Limit (dBu/m)	Margin (dB)	Peak Limit (dBu/m)	Margin (dB)	UNI Non-Restricted (dBu/m)	Margin (dB)	Azimuth (Deg)	Height (m)	Polarity
* 4.82404	48.27	PK2	34.2	-30.6	.3	0	52.17	-	-	74	-21.83	-	-	42	106	V
* 4.82396	43.31	MAV1	34.2	-30.6	.3	0	47.21	54	-6.79	-	-	-	-	42	106	V
* 4.82396	48.22	PK2	34.2	-30.6	.3	0	52.12	-	-	74	-21.88	-	-	322	234	H
* 4.82404	43.33	MAV1	34.2	-30.6	.3	0	47.23	54	-6.77	-	-	-	-	322	234	H

Frequency (GHz)	Mask Reading (dBu)	Det	3117_00168717	5GHz_LP1(B)	DTS_Noise(B)	DC Corr (dB)	Corrected Reading (dBu/m)	Avg Limit (dBu/m)	Margin (dB)	Peak Limit (dBu/m)	Margin (dB)	UNI Non-Restricted (dBu/m)	Margin (dB)	Azimuth (Deg)	Height (m)	Polarity
* 7.65	36.71	PK-U	35.8	-27	0	0	45.51	-	-	74	-28.49	-	-	0	100	H
* 7.65058	36.55	PK-U	35.8	-27	0	0	45.35	-	-	74	-28.65	-	-	0	100	V
10.48015	34.32	PK-U	37.7	-22.4	0	0	49.62	-	-	-	-	68.2	-18.58	0	100	H
10.4824	33.48	PK-U	37.7	-22.4	0	0	48.78	-	-	-	-	68.2	-19.42	0	100	V

* - indicates frequency in CFR47 Pt 15 / IC RSS-Restricted Band
 PK2 - KDB558074 Method: Maximum Peak
 PK-U - U-NII: Maximum Peak

Case2. – Half-folded & X axis

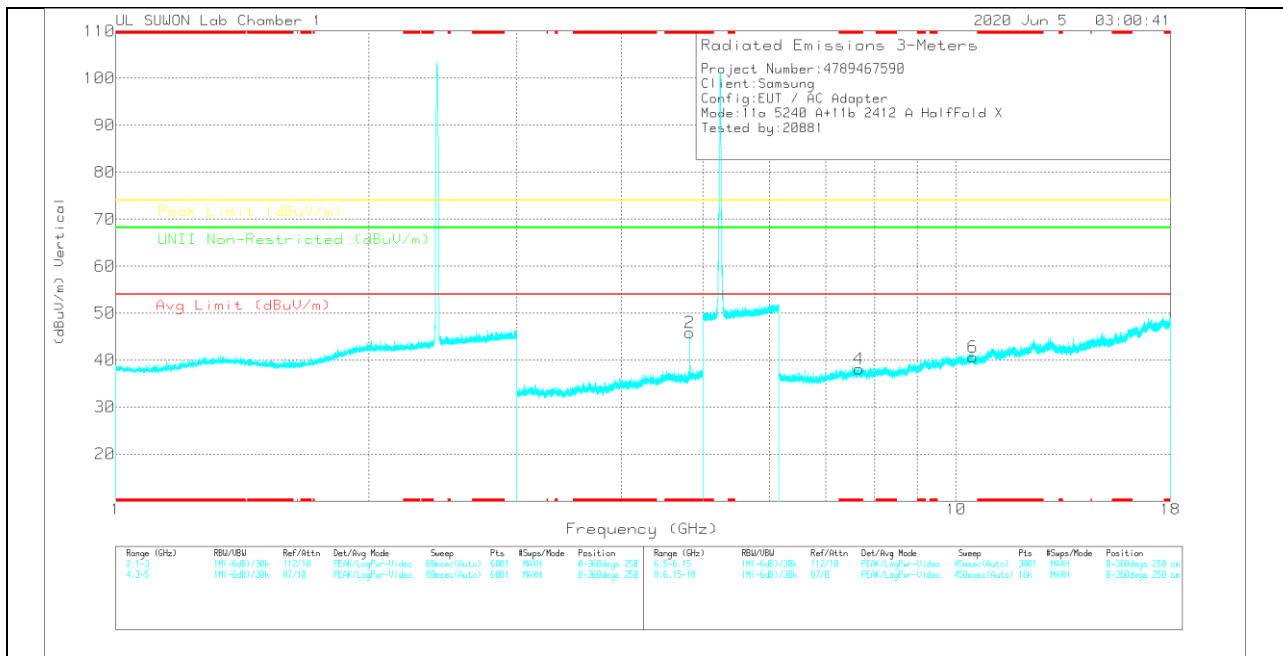
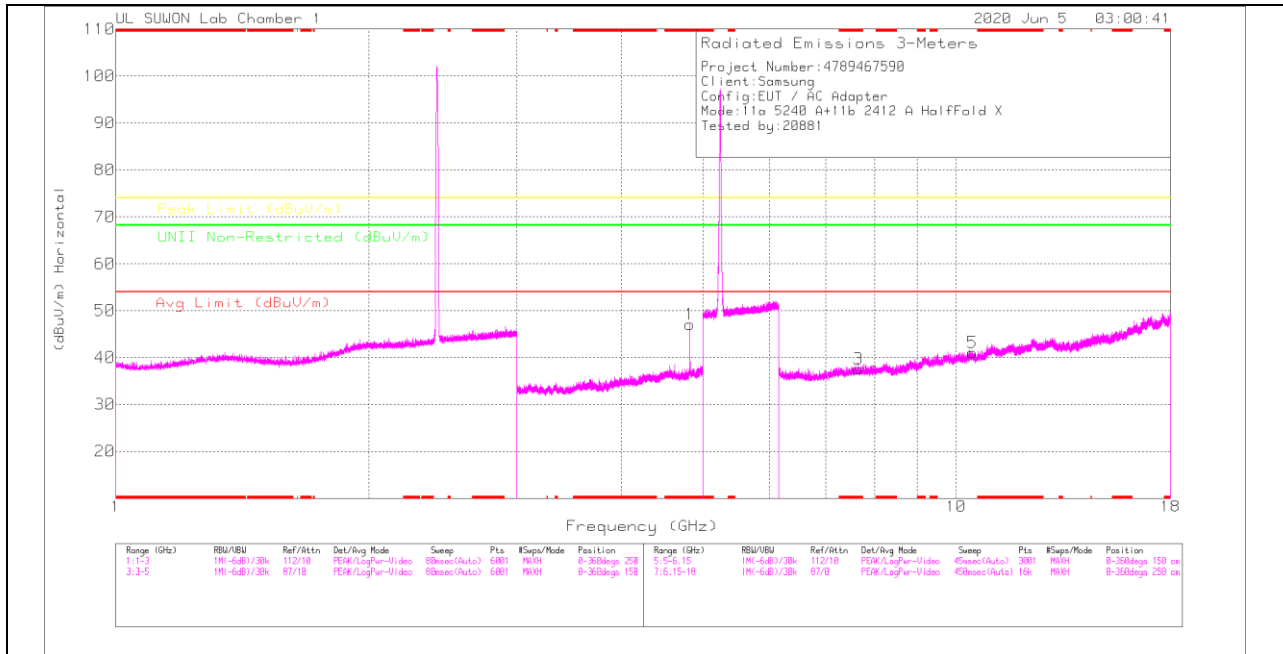

Trace Markers

Marker	Frequency (GHz)	Marker Reading (dBuV)	Det	3117_00168717	5GHz_LP1(dB)	DTS_Noise(dB)	DC Corr (dB)	Corrected Reading (dBuV/m)	Avg Limit (dBuV/m)	Margin (dB)	Peak Limit (dBuV/m)	Margin (dB)	Limit Non-Restricted (dBuV/m)	Margin (dB)	Azimuth (Degs)	Height (cm)	Polarity
1	* 4.82433	43.17	PK	34.2	-30.6	.3	0	47.07	-	-	74	-26.93	-	-	0-360	250	H
2	* 4.82433	41.96	PK	34.2	-30.6	.3	0	45.86	-	-	74	-28.14	-	-	0-360	250	V

Marker	Frequency (GHz)	Marker Reading (dBuV)	Det	3117_00168717	5GHz_LP1(dB)	DTS_Noise(dB)	DC Corr (dB)	Corrected Reading (dBuV/m)	Avg Limit (dBuV/m)	Margin (dB)	Peak Limit (dBuV/m)	Margin (dB)	Limit Non-Restricted (dBuV/m)	Margin (dB)	Azimuth (Degs)	Height (cm)	Polarity
3	* 7.65115	28.76	PK	35.8	-27	0	0	37.56	-	-	74	-36.44	-	-	0-360	150	H
5	10.45869	28.4	PK	37.7	-22.1	0	0	41	-	-	-	-	68.2	-27.2	0-360	150	H
4	* 7.66004	29.16	PK	35.8	-26.9	0	0	38.06	-	-	74	-35.94	-	-	0-360	250	V
6	10.47128	25.25	PK	37.7	-22.3	0	0	40.65	-	-	-	-	68.2	-27.55	0-360	250	V

* - indicates frequency in CFR47 Pt 15 / IC RSS-Restricted Band
 PK – Peak Detector

Radiated Emissions

Frequency (GHz)	Marker Reading (dBuV)	Det	3117_00168717	5GHz_LP1(dB)	DTS_Noise(dB)	DC Corr (dB)	Corrected Reading (dBuV/m)	Avg Limit (dBuV/m)	Margin (dB)	Peak Limit (dBuV/m)	Margin (dB)	Limit Non-Restricted (dBuV/m)	Margin (dB)	Azimuth (Degs)	Height (cm)	Polarity
* 4.82394	48.64	PK2	34.2	-30.6	.3	0	52.54	-	-	74	-21.46	-	-	224	104	H
* 4.82398	43.75	MAv1	34.2	-30.6	.3	0	47.65	54	-6.35	-	-	-	-	224	104	H
* 4.824	46.58	PK2	34.2	-30.6	.3	0	50.48	-	-	74	-23.52	-	-	227	100	V
* 4.82398	40.68	MAv1	34.2	-30.6	.3	0	44.58	54	-9.42	-	-	-	-	227	100	V

Frequency (GHz)	Marker Reading (dBuV)	Det	3117_00168717	5GHz_LP1(dB)	DTS_Noise(dB)	DC Corr (dB)	Corrected Reading (dBuV/m)	Avg Limit (dBuV/m)	Margin (dB)	Peak Limit (dBuV/m)	Margin (dB)	Limit Non-Restricted (dBuV/m)	Margin (dB)	Azimuth (Degs)	Height (cm)	Polarity
* 7.65043	36.75	PK-U	35.8	-27	0	0	45.55	-	-	74	-28.45	-	-	360	100	H
* 7.65005	36.74	PK-U	35.8	-27	0	0	45.54	-	-	74	-28.46	-	-	360	100	V
10.47645	33.45	PK-U	37.7	-22.4	0	0	48.75	-	-	-	-	68.2	-19.45	360	100	H
10.48007	33.63	PK-U	37.7	-22.4	0	0	48.93	-	-	-	-	68.2	-19.27	360	100	V

* - indicates frequency in CFR47 Pt 15 / IC RSS-Restricted Band
 PK2 - KDB558074 Method: Maximum Peak
 MAv1 - KDB558074 Option 1 Maximum RMS Average
 PK-U - U-NII: Maximum Peak

Case3. – Open & Y axis

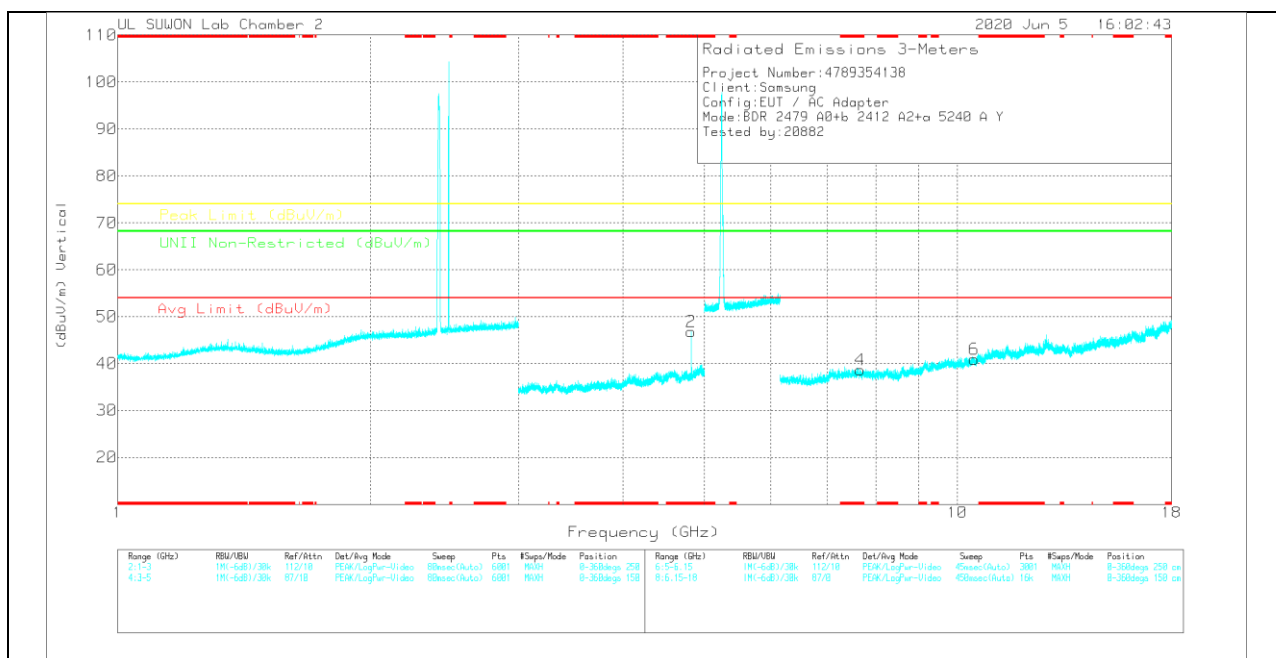
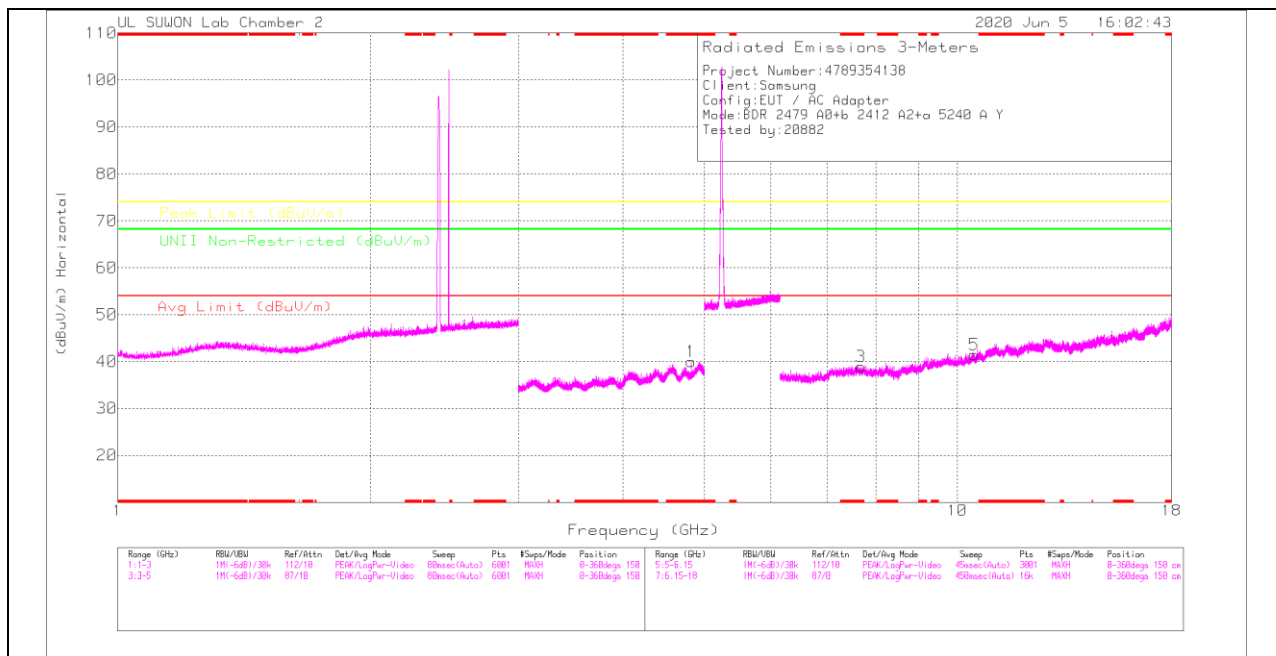

Trace Markers

Marker	Frequency (GHz)	Mask Reading (dBuV)	Det	3117_00168724	5GHz_LF1(B)	DTS_Noise(dB)	DC Corr (dB)	Corrected Reading (dBuV/m)	Avg Limit (dBuV/m)	Margin (dB)	Peak Limit (dBuV/m)	Margin (dB)	Limit Non-Restricted (dBuV/m)	Margin (dB)	Azimuth (Degs)	Height (m)	Polarity
1	* 4.82433	33.22	PK	34	-27.5	.3	0	40.02	-	-	74	-33.98	-	-	0-360	250	H
2	* 4.824	39.99	PK	34	-27.5	.3	0	46.79	-	-	74	-27.21	-	-	0-360	250	V

Marker	Frequency (GHz)	Mask Reading (dBuV)	Det	3117_00168724	5GHz_LF1(B)	DTS_Noise(dB)	DC Corr (dB)	Corrected Reading (dBuV/m)	Avg Limit (dBuV/m)	Margin (dB)	Peak Limit (dBuV/m)	Margin (dB)	Limit Non-Restricted (dBuV/m)	Margin (dB)	Azimuth (Degs)	Height (m)	Polarity
3	* 7.67813	26.78	PK	36	-23.9	0	0	38.88	-	-	74	-35.12	-	-	0-360	250	H
5	10.47865	23.51	PK	37.7	-20.1	0	0	41.51	-	-	-	-	68.2	-26.68	0-360	250	H
4	* 7.66152	26.52	PK	36	-23.9	0	0	38.82	-	-	74	-35.38	-	-	0-360	150	V
6	10.47646	23.32	PK	37.7	-20.1	0	0	40.92	-	-	-	-	68.2	-27.28	0-360	150	V

* - indicates frequency in CFR47 Pt 15 / IC RSS-Restricted Band
 PK – Peak Detector

Radiated Emissions

Frequency (GHz)	Mask Reading (dBuV)	Det	3117_00168724	5GHz_LF1(B)	DTS_Noise(dB)	DC Corr (dB)	Corrected Reading (dBuV/m)	Avg Limit (dBuV/m)	Margin (dB)	Peak Limit (dBuV/m)	Margin (dB)	Limit Non-Restricted (dBuV/m)	Margin (dB)	Azimuth (Degs)	Height (m)	Polarity
* 4.82389	44.68	PK2	34	-27.5	.3	0	51.48	-	-	74	-22.52	-	-	356	100	H
* 4.82397	37.95	MAv1	34	-27.5	.3	0	44.75	54	-9.25	-	-	-	-	356	100	H
* 4.82397	44.85	PK2	34	-27.5	.3	0	51.65	-	-	74	-22.35	-	-	228	175	V
* 4.82401	40.29	MAv1	34	-27.5	.3	0	47.09	54	-6.91	-	-	-	-	228	175	V

Frequency (GHz)	Mask Reading (dBuV)	Det	3117_00168724	5GHz_LF1(B)	DTS_Noise(dB)	DC Corr (dB)	Corrected Reading (dBuV/m)	Avg Limit (dBuV/m)	Margin (dB)	Peak Limit (dBuV/m)	Margin (dB)	Limit Non-Restricted (dBuV/m)	Margin (dB)	Azimuth (Degs)	Height (m)	Polarity
* 7.67292	34.56	PK-U	36	-24	0	0	46.56	-	-	74	-27.44	-	-	360	100	H
* 7.67558	34.46	PK-U	36	-24	0	0	46.46	-	-	74	-27.54	-	-	360	100	V
10.47933	33.36	PK-U	37.7	-20.2	0	0	50.86	-	-	-	-	68.2	-17.34	360	100	H
10.47995	31.73	PK-U	37.7	-20.2	0	0	49.23	-	-	-	-	68.2	-18.97	360	100	V

* - indicates frequency in CFR47 Pt 15 / IC RSS-Restricted Band
 PK2 - KDB558074 Method: Maximum Peak
 MAv1 - KDB558074 Option 1 Maximum RMS Average
 PK-U - U-NII: Maximum Peak

12. WORST-CASE BELOW 1 GHz

SPURIOUS EMISSIONS 30 TO 1000 MHz (WORST-CASE CONFIGURATION, HORIZONTAL)

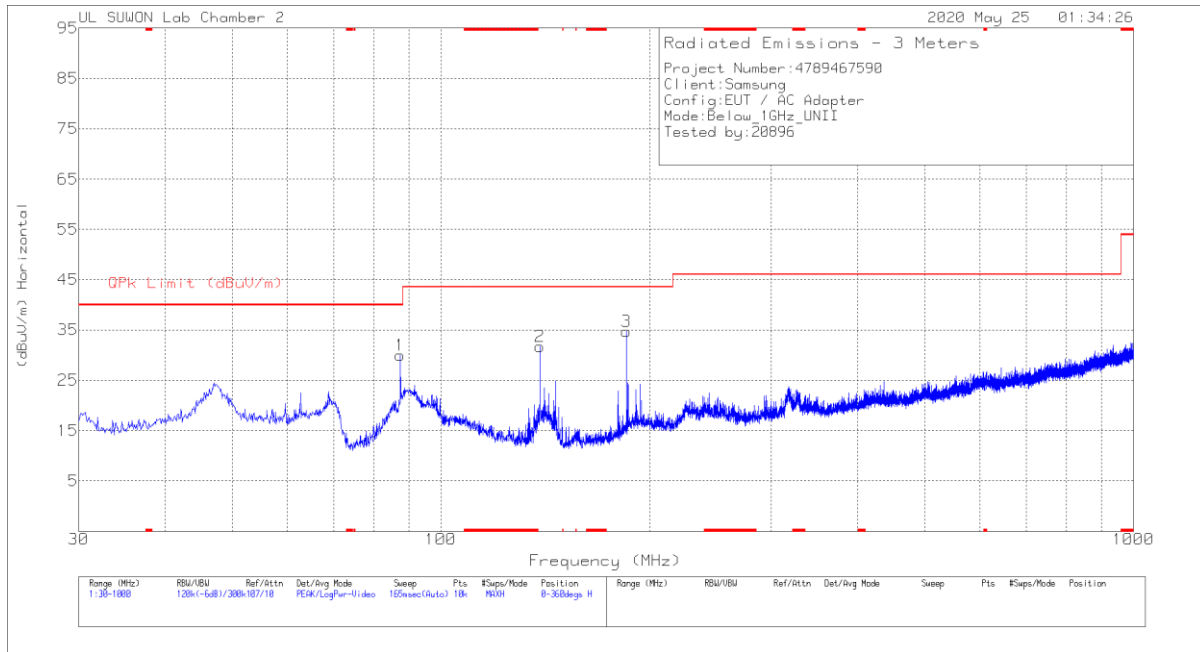

SPURIOUS EMISSIONS 30 TO 1000 MHz (WORST-CASE CONFIGURATION, VERTICAL)

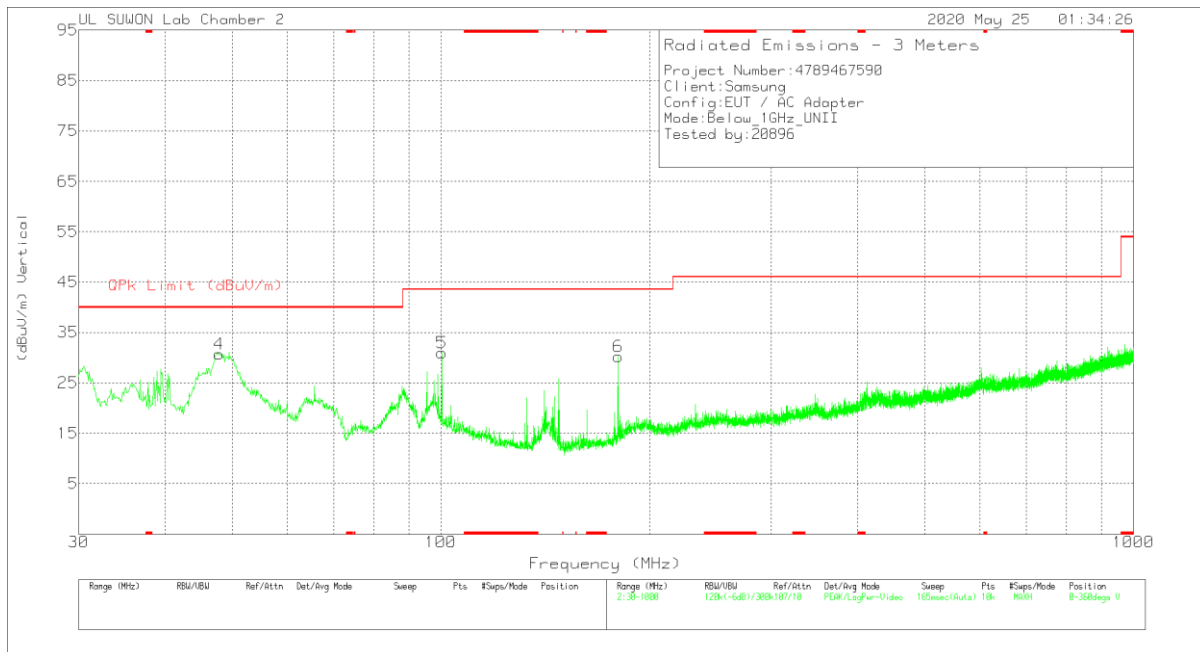

Below 1G Data

Trace Markers

Marker	Frequency (MHz)	Meter Reading (dBuV)	Det	VULB9163_749	Below_1G[dB]	DC Corr (dB)	Corrected Reading (dBuV/m)	QPk Limit (dBuV/m)	Margin (dB)	Azimuth (Degs)	Height (cm)	Polarity
1	87.424	47.03	Pk	14.5	-31.5	0	30.03	40	-9.97	0-360	200	H
2	139.028	48.7	Pk	14.1	-31.1	0	31.7	43.52	-11.82	0-360	200	H
3	185.394	49.16	Pk	16.4	-30.9	0	34.66	43.52	-8.86	0-360	100	H
4	47.7995	42.72	Pk	19.8	-31.8	0	30.72	40	-9.28	0-360	100	V
5	100.325	44.72	Pk	17.7	-31.4	0	31.02	43.52	-12.5	0-360	100	V
6	180.253	45.3	Pk	15.8	-30.9	0	30.2	43.52	-13.32	0-360	100	V

* - indicates frequency in CFR47 Pt 15 / IC RSS-Restricted Band

Pk - Peak detector

13. AC POWER LINE CONDUCTED EMISSIONS

LIMITS

FCC §15.207 (a)
IC RSS-GEN Clause 8.8

Frequency of Emission (MHz)	Conducted Limit (dBuV)	
	Quasi-peak	Average
0.15-0.5	66 to 56 [*]	56 to 46 [*]
0.5-5	56	46
5-30	60	50

^{*}Decreases with the logarithm of the frequency.

TEST PROCEDURE

The EUT is placed on a non-conducting table 40 cm from the vertical ground plane and 80 cm above the horizontal ground plane. The EUT is configured in accordance with ANSI C63.10.

The receiver is set to a resolution bandwidth of 9 kHz. Peak detection is used unless otherwise noted as quasi-peak or average.

Line conducted data is recorded for both NEUTRAL and HOT lines.

RESULTS

WORST EMISSIONS

LINE 1 DATA

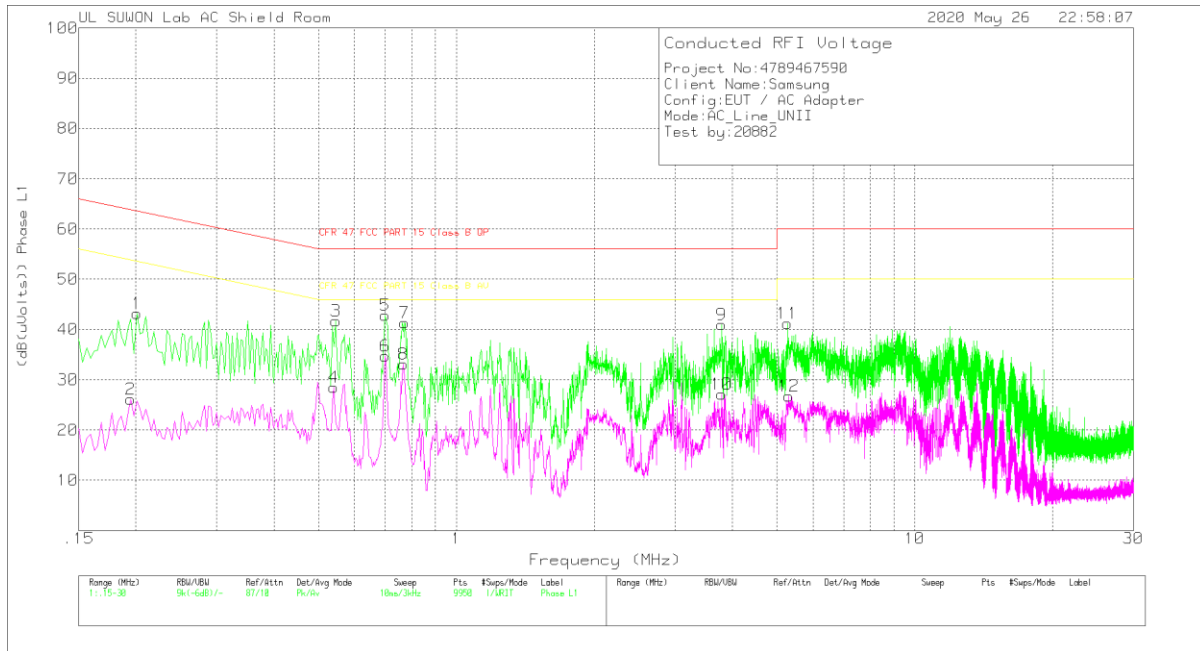

Trace Markers

Range 1: Phase L1 .15 - 30MHz

Marker	Frequency (MHz)	Meter Reading (dBuV)	Det	101836_Wit h Ex_L1[dB]	CABLELOS S(dB)	Corrected Reading (dB(uVolts))	CFR 47 FCC PART 15 Class B QP	Margin (dB)	CFR 47 FCC PART 15 Class B AV	Margin (dB)
1	.201	33.15	Pk	9.9	.2	43.25	63.57	-20.32	-	-
2	.195	16.06	Av	9.9	.2	26.16	-	-	53.82	-27.66
3	.546	31.57	Pk	9.9	.2	41.67	56	-14.33	-	-
4	.54	18.37	Av	9.9	.2	28.47	-	-	46	-17.53
5	.699	32.72	Pk	9.9	.2	42.82	56	-13.18	-	-
6	.699	24.63	Av	9.9	.2	34.73	-	-	46	-11.27
7	.771	31.22	Pk	9.9	.2	41.32	56	-14.68	-	-
8	.765	23.02	Av	9.9	.2	33.12	-	-	46	-12.88
9	3.795	30.85	Pk	9.8	.3	40.95	56	-15.05	-	-
10	3.795	17.05	Av	9.8	.3	27.15	-	-	46	-18.85
11	5.274	31.06	Pk	9.8	.3	41.16	60	-18.84	-	-
12	5.31	16.68	Av	9.8	.3	26.78	-	-	50	-23.22

Pk - Peak detector

Av - Average detection

LINE 2 DATA

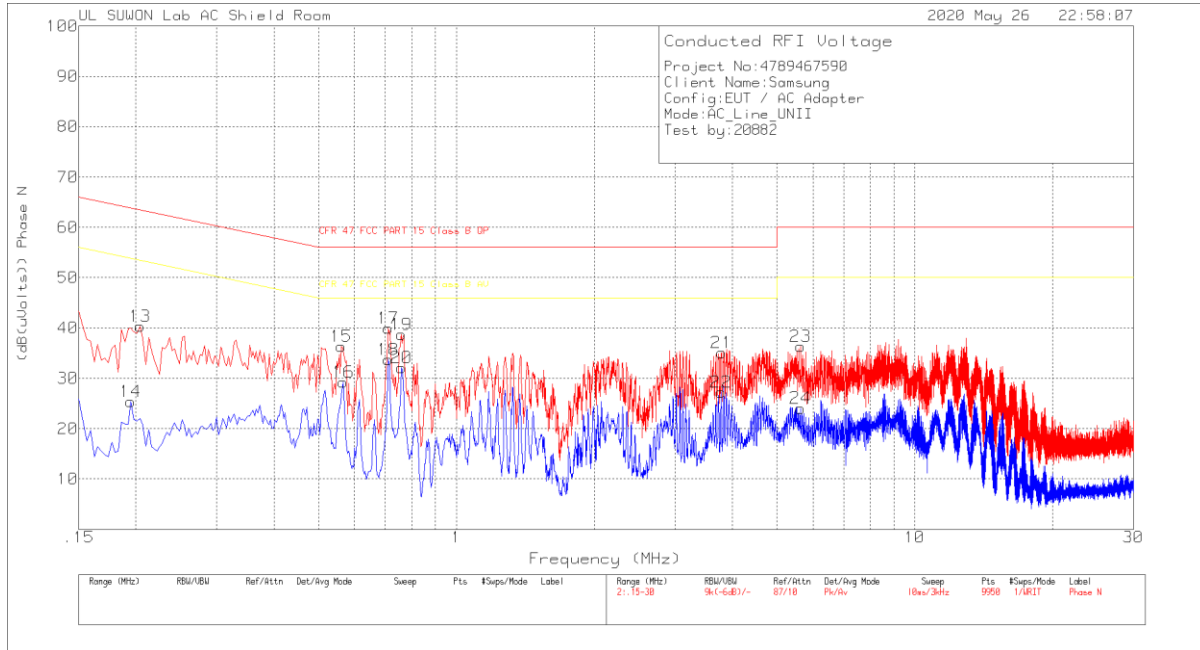

Trace Markers

Range 2: Phase N .15 - 30MHz

Marker	Frequency (MHz)	Meter Reading (dBuV)	Det	101836_Wit h EX_N[dB]	CABLELOS S(dB)	Corrected Reading (dB(uVolts))	CFR 47 FCC PART 15 Class B QP	Margin (dB)	CFR 47 FCC PART 15 Class B AV	Margin (dB)
13	.204	30.28	Pk	9.9	.2	40.38	63.45	-23.07	-	-
14	.195	15.33	Av	9.9	.2	25.43	-	-	53.82	-28.39
15	.561	26.28	Pk	9.9	.2	36.38	56	-19.62	-	-
16	.567	19.14	Av	9.9	.2	29.24	-	-	46	-16.76
17	.711	29.91	Pk	9.9	.2	40.01	56	-15.99	-	-
18	.711	23.59	Av	9.9	.2	33.69	-	-	46	-12.31
19	.759	28.58	Pk	9.9	.2	38.68	56	-17.32	-	-
20	.759	21.99	Av	9.9	.2	32.09	-	-	46	-13.91
21	3.786	25.02	Pk	9.8	.3	35.12	56	-20.88	-	-
22	3.777	17.13	Av	9.8	.3	27.23	-	-	46	-18.77
23	5.634	26.23	Pk	9.8	.3	36.33	60	-23.67	-	-
24	5.631	13.97	Av	9.8	.3	24.07	-	-	50	-25.93

Pk - Peak detector
 Av - Average detection

14. DYNAMIC FREQUENCY SELECTION

14.1. OVERVIEW

14.1.1. LIMITS

FCC

§15.407 (h), FCC KDB 905462 D02 “COMPLIANCE MEASUREMENT PROCEDURES FOR UNLICENSED-NATIONAL INFORMATION INFRASTRUCTURE DEVICES OPERATING IN THE 5250-5350 MHz AND 5470-5725 MHz BANDS INCORPORATING DYNAMIC FREQUENCY SELECTION” and KDB 905462 D03 “U-NII CLIENT DEVICES WITHOUT RADAR DETECTION CAPABILITY”.

Table 1: Applicability of DFS requirements prior to use of a channel

Requirement	Operational Mode		
	Master	Client (without radar detection)	Client (with radar detection)
Non-Occupancy Period	Yes	Not required	Yes
DFS Detection Threshold	Yes	Not required	Yes
Channel Availability Check Time	Yes	Not required	Not required
U-NII Detection Bandwidth	Yes	Not required	Yes

Table 2: Applicability of DFS requirements during normal operation

Requirement	Operational Mode		
	Master	Client (without DFS)	Client (with DFS)
DFS Detection Threshold	Yes	Not required	Yes
Channel Closing Transmission Time	Yes	Yes	Yes
Channel Move Time	Yes	Yes	Yes
U-NII Detection Bandwidth	Yes	Not required	Yes

Additional requirements for devices with multiple bandwidth modes	Master Device or Client with Radar DFS	Client (without DFS)
U-NII Detection Bandwidth and Statistical Performance Check	All BW modes must be tested	Not required
Channel Move Time and Channel Closing Transmission Time	Test using widest BW mode available	Test using the widest BW mode available for the link
All other tests	Any single BW mode	Not required

Note: Frequencies selected for statistical performance check (Section 7.8.4) should include several frequencies within the radar detection bandwidth and frequencies near the edge of the radar detection bandwidth. For 802.11 devices it is suggested to select frequencies in all 20 MHz channel blocks and a null frequency between the bonded 20 MHz channel blocks.

Table 3: Interference Threshold values, Master or Client incorporating In-Service Monitoring

Maximum Transmit Power	Value (see notes)
E.I.R.P. \geq 200 mill watt	-64 dBm
E.I.R.P. < 200 mill watt and power spectral density < 10 dBm/MHz	-62 dBm
E.I.R.P. < 200 mill watt that do not meet power spectral density requirement	-64 dBm
<p>Note 1: This is the level at the input of the receiver assuming a 0 dBi receive antenna Note 2: Throughout these test procedures an additional 1 dB has been added to the amplitude of the test transmission waveforms to account for variations in measurement equipment. This will ensure that the test signal is at or above the detection threshold level to trigger a DFS response. Note 3: E.I.R.P. is based on the highest antenna gain. For MIMO devices refer to KDB publication 662911 D01.</p>	

Table 4: DFS Response requirement values

Parameter	Value
<i>Non-occupancy period</i>	30 minutes
<i>Channel Availability Check Time</i>	60 seconds
<i>Channel Move Time</i>	10 seconds (See Note 1)
<i>Channel Closing Transmission Time</i>	200 milliseconds + approx. 60 milliseconds over remaining 10 second period. (See Notes 1 and 2)
<i>U-NII Detection Bandwidth</i>	Minimum 100% of the U- NII 99% transmission power bandwidth. (See Note 3)
<p>Note 1: <i>Channel Move Time</i> and the <i>Channel Closing Transmission Time</i> should be performed with Radar Type 0. The measurement timing begins at the end of the Radar Type 0 burst. Note 2: The <i>Channel Closing Transmission Time</i> is comprised of 200 milliseconds starting at the beginning of the <i>Channel Move Time</i> plus any additional intermittent control signals required to facilitate a <i>Channel</i> move (an aggregate of 60 milliseconds) during the remainder of the 10 second period. The aggregate duration of control signals will not count quiet periods in between transmissions. Note 3: During the <i>U-NII Detection Bandwidth</i> detection test, radar type 0 should be used. For each frequency step the minimum percentage of detection is 90 percent. Measurements are performed with no data traffic.</p>	

Table 5 – Short Pulse Radar Test Waveforms

Radar Type	Pulse Width (usec)	PRI (usec)	Pulses	Minimum Percentage of Successful Detection	Minimum Trials
0	1	1428	18	See Note 1	See Note 1
1	1	Test A: 15 unique PRI values randomly selected from the list of 23 PRI values in table 5a	Roundup: $\{(1/360) \times (19 \times 10^6 \text{ PRI}_{\text{usec}})\}$	60%	30
		Test B: 15 unique PRI values randomly selected within the range of 518-3066 usec. With a minimum increment of 1 usec, excluding PRI values selected in Test A			
2	1-5	150-230	23-29	60%	30
3	6-10	200-500	16-18	60%	30
4	11-20	200-500	12-16	60%	30
Aggregate (Radar Types 1-4)				80%	120
Note 1: Short Pulse Radar Type 0 should be used for the <i>Detection Bandwidth</i> test, <i>Channel Move Time</i> , and <i>Channel Closing Time</i> tests.					

Table 6 – Long Pulse Radar Test Signal

Radar Waveform Type	Pulse Width (µsec)	Chirp Width (MHz)	PRI (µsec)	Pulses per Burst	Number of Bursts	Minimum Percentage of Successful Detection	Minimum Trials
5	50-100	5-20	1000-2000	1-3	8-20	80%	30

Table 7 – Frequency Hopping Radar Test Signal

Radar Waveform Type	Pulse Width (µsec)	PRI (µsec)	Pulses per Hop	Hopping Rate (kHz)	Hopping Sequence Length (msec)	Minimum Percentage of Successful Detection	Minimum Trials
6	1	333	9	0.333	300	70%	30

14.1.2. TEST AND MEASUREMENT SYSTEM

CONDUCTED METHOD SYSTEM BLOCK DIAGRAM

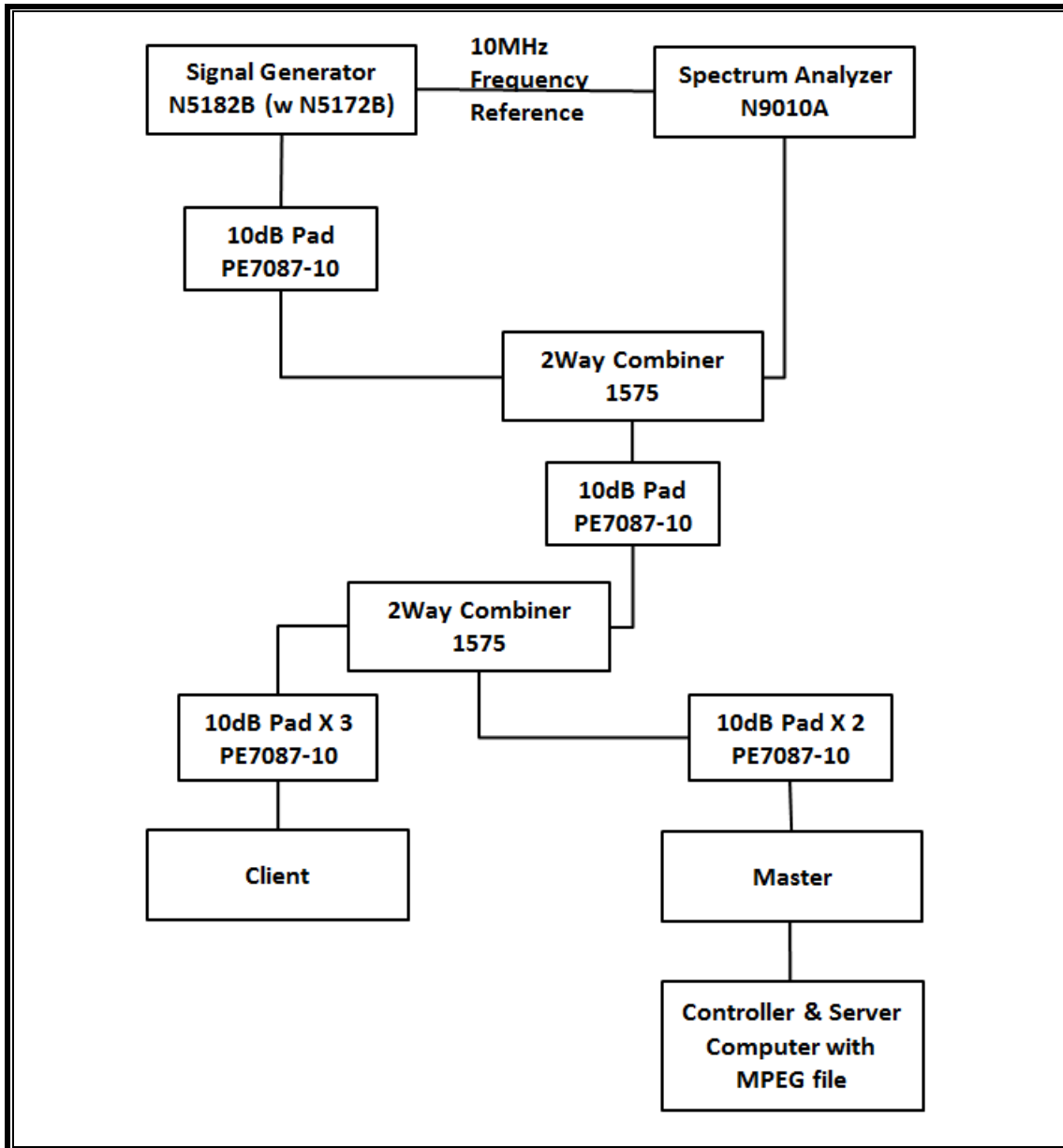

SYSTEM OVERVIEW

The short pulse and long pulse signal generating system utilizes the Keysite Signal Studio for Pulse Building as N5172B. The Vector Signal Generator has been validated by the NTIA. The hopping signal generating system utilizes the CCS simulated hopping method and system, which has been validated by the DoD, FCC and NTIA. The software selects waveform parameters from within the bounds of the signal type on a random basis using uniform distribution.

The short pulse types 1, 2, 3 and 4, and the long pulse type 5 parameters are randomized at run-time.

The hopping type 6 pulse parameters are fixed while the hopping sequence is based on the August 2005 NTIA Hopping Frequency List. The initial starting point randomized at run-time and each subsequent starting point is incremented by 475. Each frequency in the 100-length segment is compared to the boundaries of the EUT Detection Bandwidth and the software creates a hopping burst pattern in accordance with Section 7.4.1.3 Method #2 Simulated Frequency Hopping Radar Waveform Generating Subsystem of KDB 905462 D02. The frequency of the signal generator is incremented in 1 MHz steps from F_L to F_H for each successive trial. This incremental sequence is repeated as required to generate a minimum of 30 total trials and to maintain a uniform frequency distribution over the entire Detection Bandwidth.

The signal monitoring equipment consists of a spectrum analyzer. The aggregate ON time is calculated by multiplying the number of bins above a threshold during a particular observation period by the dwell time per bin, with the analyzer set to peak detection and max hold.

SYSTEM CALIBRATION

A 50-ohm load is connected in place of the spectrum analyzer, and the spectrum analyzer is connected to a horn antenna via a coaxial cable, with the reference level offset set to (horn antenna gain – coaxial cable loss). The signal generator is set to CW mode. The amplitude of the signal generator is adjusted to yield a level of –64 dBm as measured on the spectrum analyzer.

Without changing any of the instrument settings, the spectrum analyzer is reconnected to the Common port of the Spectrum Analyzer Combiner/Divider. The Reference Level Offset of the spectrum analyzer is adjusted so that the displayed amplitude of the signal is –64 dBm.

The spectrum analyzer displays the level of the signal generator as received at the antenna ports of the Master Device. The interference detection threshold may be varied from the calibrated value of –64 dBm and the spectrum analyzer will still indicate the level as received by the Master Device.

ADJUSTMENT OF DISPLAYED TRAFFIC LEVEL

A link is established between the Master and Slave and the distance between the units is adjusted as needed to provide a suitable received level at the Master and Slave devices. The video test file is streamed to generate WLAN traffic. The monitoring antenna is adjusted so that the WLAN traffic level, as displayed on the spectrum analyzer, is at lower amplitude than the radar detection threshold.

TEST AND MEASUREMENT EQUIPMENT

The following test and measurement equipment was utilized for the DFS tests documented in this report:

TEST EQUIPMENT LIST				
Description	Manufacturer	Model	S/N	Next Cal Due
Spectrum Analyzer, 7 GHz	Agilent / HP	N9010A	MY54200580	08-07-20
Vector Signal Generator, 6GHz	Agilent / HP	N5182B	MY53051241	08-06-20
Combiner	AEROFLEX/WEINSCHL	1575	2150	08-08-20
Combiner	AEROFLEX/WEINSCHL	1575	2781	08-08-20

14.1.3. SETUP OF EUT

CONDUCTED METHOD EUT TEST SETUP

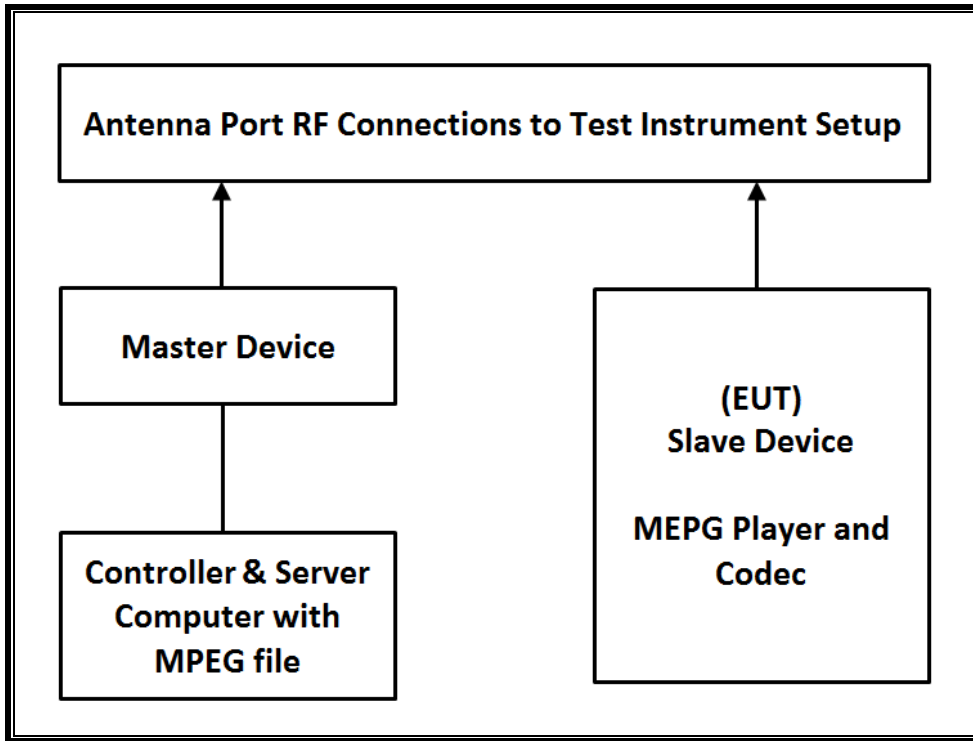

SUPPORT EQUIPMENT

The following support equipment was utilized for the DFS tests documented in this report:

PERIPHERAL SUPPORT EQUIPMENT LIST				
Description	Manufacturer	Model	Serial Number	FCC ID
Wireless Access Point	Cisco	AIR-CAP3702E-A-K9	FTX182276QX	LDK102087
Notebook PC (Controller/Server)	HP	HP EliteDesk 800 G1 TWR	CZC4125J25	DoC

14.1.4. DESCRIPTION OF EUT

The EUT operates over the 5250-5350 MHz and 5470-5725 MHz ranges.

The EUT is a Slave Device without Radar Detection.

The highest power level of the widest bandwidth (802.11ac VHT80) within these bands is 14.55 dBm in the 5250-5350 MHz band and 14.73 dBm in the 5470-5725 MHz band.

The antenna assembly utilized two antenna.

Gain of ANT1 : -2.24 dBi for UNII 2A and -4.53 dBi for UNII 2C.

Gain of ANT2 : -0.48 dBi for UNII 2A and -4.75 dBi for UNII 2C.

The rated output power of the Master unit is > 23dBm (EIRP). Therefore the required interference threshold level is -64 dBm. After correction for procedural adjustments, the required conducted threshold at the antenna port is $-64 + 1 = -63$ dBm.

The calibrated radiated DFS Detection Threshold level is set to -64 dBm. The tested level is lower than the required level hence it provides a margin to the limit.

The EUT uses one transmitter/receiver chain connected to an antenna to perform radiated tests.

WLAN traffic that meets or exceeds the minimum required loading was generated by transferring a data stream from the controller/server PC to the EUT using iPerf version 2.0.5 software package.

TPC is not required since the maximum EIRP is less than 500 mW (27 dBm).

The EUT utilizes the 802.11 architecture. Three nominal channel bandwidths are implemented: 20 MHz, 40 MHz and 80 MHz.

The software installed in the access point is 12.4(25d)JA1.

UNIFORM CHANNEL SPREADING

This requirement is not applicable to Slave radio devices.

OVERVIEW OF MASTER DEVICE WITH RESPECT TO §15.407 (h) REQUIREMENTS

The Master Device is a Cisco Access Point, FCC ID: LDK102087. The minimum antenna gain for the Master Device is 6 dBi.

The rated output power of the Master unit is > 23dBm (EIRP). Therefore the required interference threshold level is -64 dBm. After correction for procedural adjustments, the required radiated threshold at the antenna port is $-64 + 1 = -63$ dBm.

The calibrated radiated DFS Detection Threshold level is set to -64 dBm. The tested level is lower than the required level hence it provides a margin to the limit.

14.2. RESULTS FOR 80 MHz BANDWIDTH (UNII-2A BAND)

14.2.1. TEST CHANNEL

All tests were performed at a channel center frequency of 5290 MHz.

14.2.2. RADAR WAVEFORM AND TRAFFIC

RADAR WAVEFORM

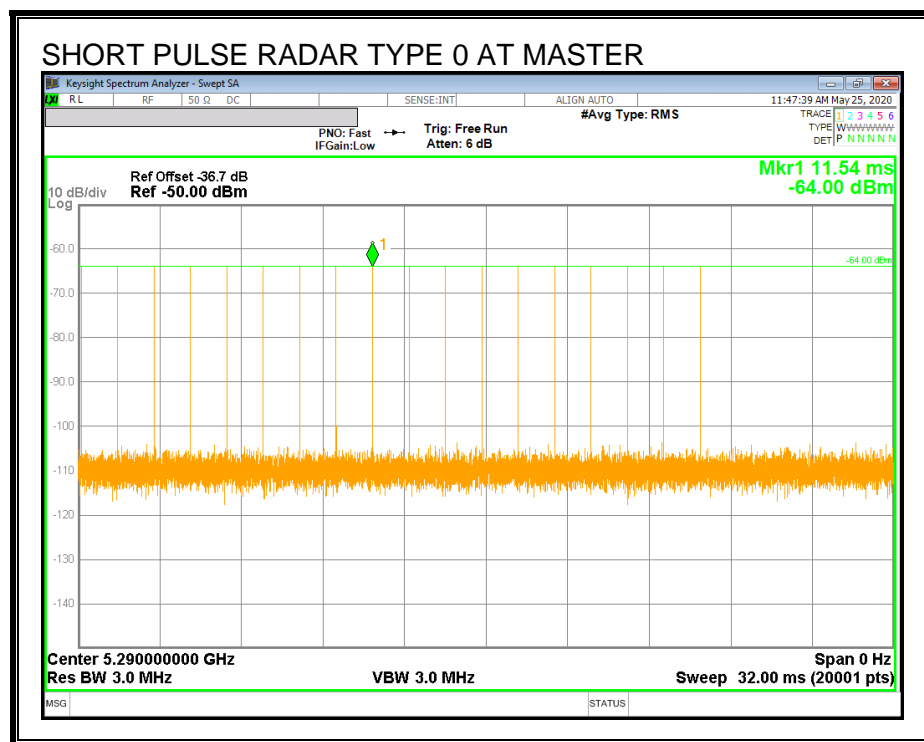

TRAFFIC

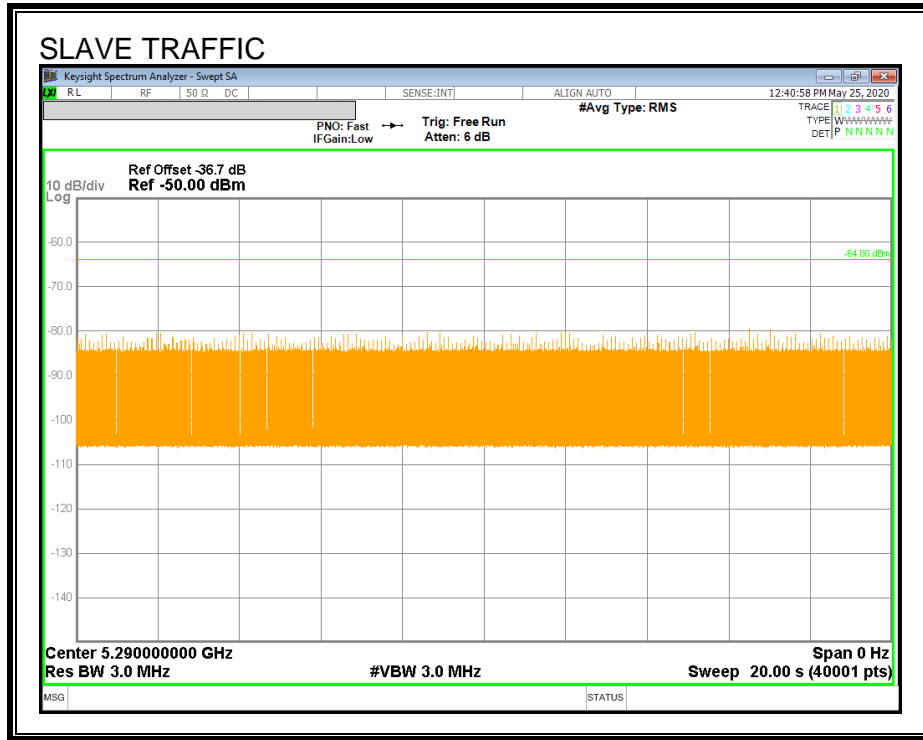

14.2.3. OVERLAPPING CHANNEL TESTS

RESULTS

These tests are not applicable.

14.2.4. MOVE AND CLOSING TIME

REPORTING NOTES

The reference marker is set at the end of last radar pulse.

The delta marker is set at the end of the last WLAN transmission following the radar pulse. This delta is the channel move time.

The aggregate channel closing transmission time is calculated as follows:

Aggregate Transmission Time =
(Number of analyzer bins showing transmission) * (dwell time per bin)

The observation period over which the aggregate time is calculated begins at (Reference Marker + 200 msec) and ends no earlier than (Reference Marker + 10 sec).

RESULTS

Channel Move Time (sec)	Limit (sec)
0.727	10

Aggregate Channel Closing Transmission Time (msec)	Limit (msec)
4.125	60

MOVE TIME & CHANNEL CLOSING TIME

AGGREGATE CHANNEL CLOSING TRANSMISSION TIME

No transmissions are observed during the aggregate monitoring period.

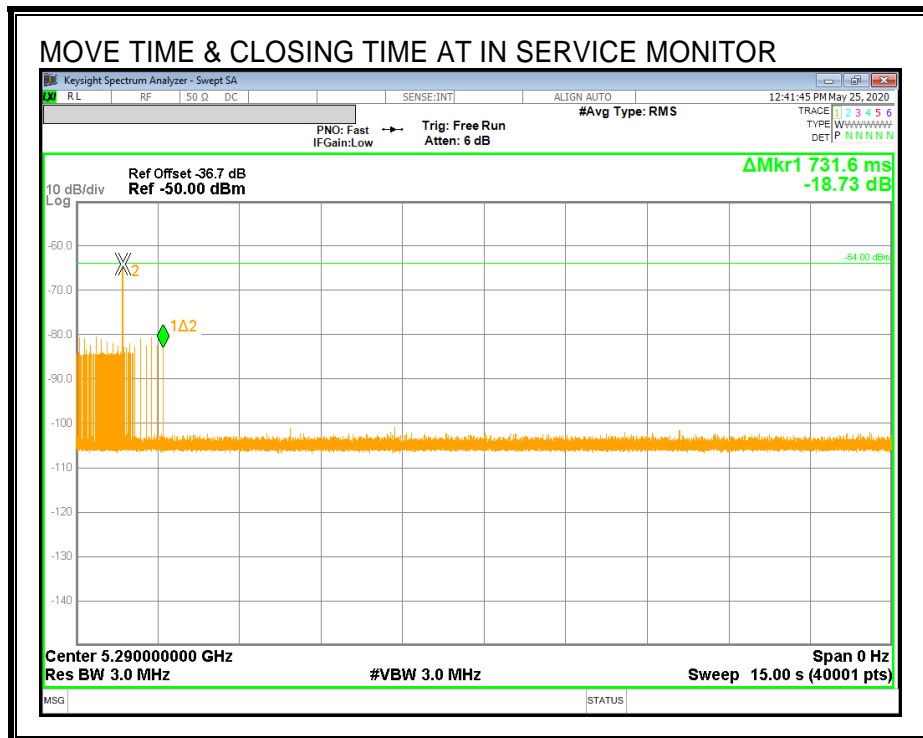
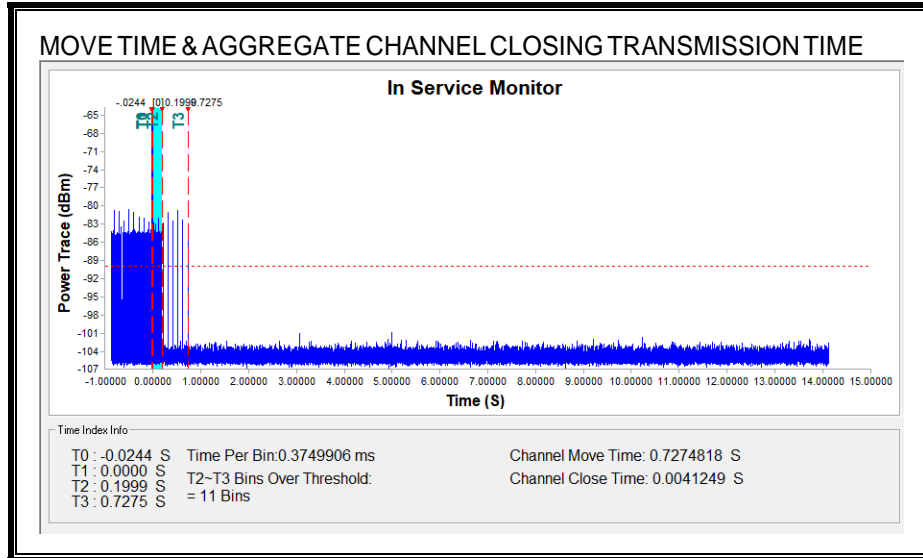

NON-OCCUPANCY PERIOD

RESULTS

No EUT transmissions were observed on the test channel during the 10-minute observation time.

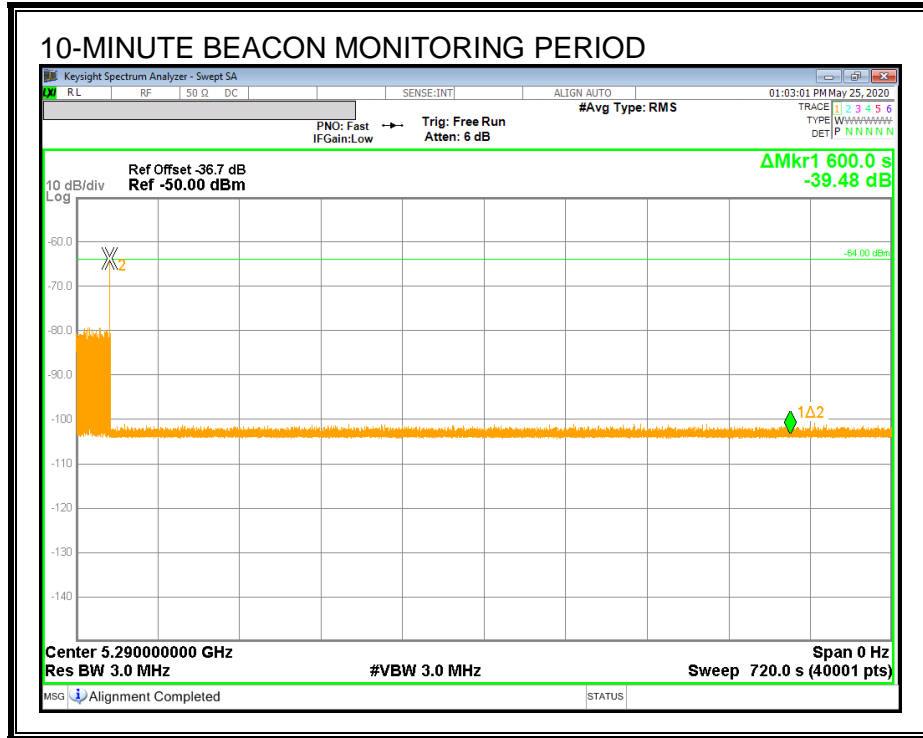

14.3. RESULTS FOR 80 MHz BANDWIDTH (UNII-2C BAND)

14.3.1. TEST CHANNEL

All tests were performed at a channel center frequency of 5530 MHz.

14.3.2. RADAR WAVEFORM AND TRAFFIC

RADAR WAVEFORM

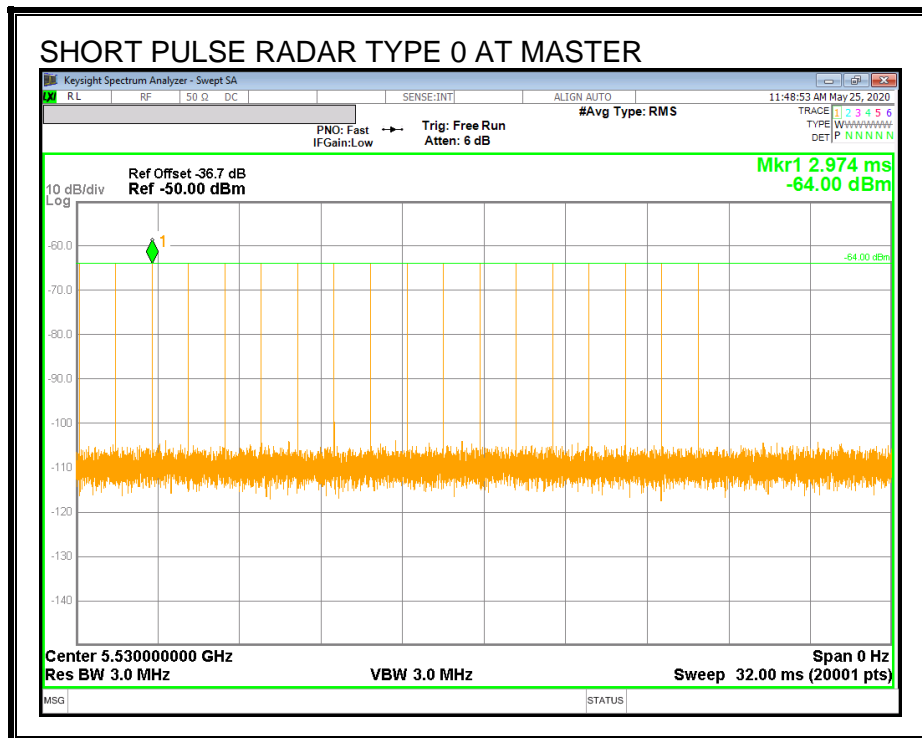

TRAFFIC

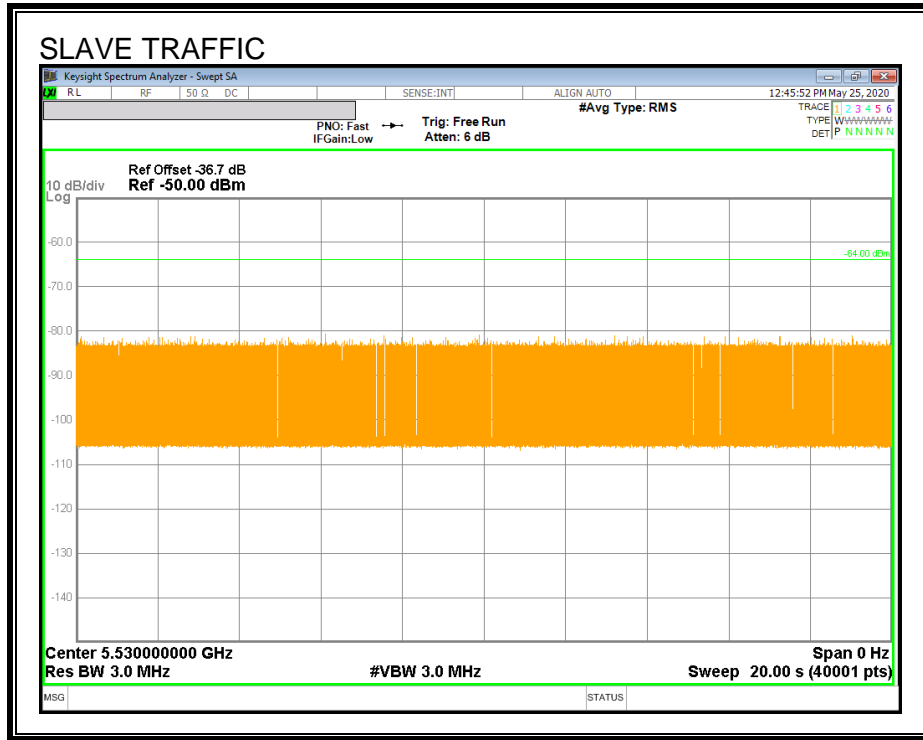

14.3.3. OVERLAPPING CHANNEL TESTS

RESULTS

These tests are not applicable.

14.3.4. MOVE AND CLOSING TIME

REPORTING NOTES

The reference marker is set at the end of last radar pulse.

The delta marker is set at the end of the last WLAN transmission following the radar pulse. This delta is the channel move time.

The aggregate channel closing transmission time is calculated as follows:

Aggregate Transmission Time =
(Number of analyzer bins showing transmission) * (dwell time per bin)

The observation period over which the aggregate time is calculated begins at (Reference Marker + 200 msec) and ends no earlier than (Reference Marker + 10 sec).

RESULTS

Channel Move Time (sec)	Limit (sec)
0.772	10

Aggregate Channel Closing Transmission Time (msec)	Limit (msec)
4.875	60

MOVE TIME & CHANNEL CLOSING TIME

AGGREGATE CHANNEL CLOSING TRANSMISSION TIME

No transmissions are observed during the aggregate monitoring period.

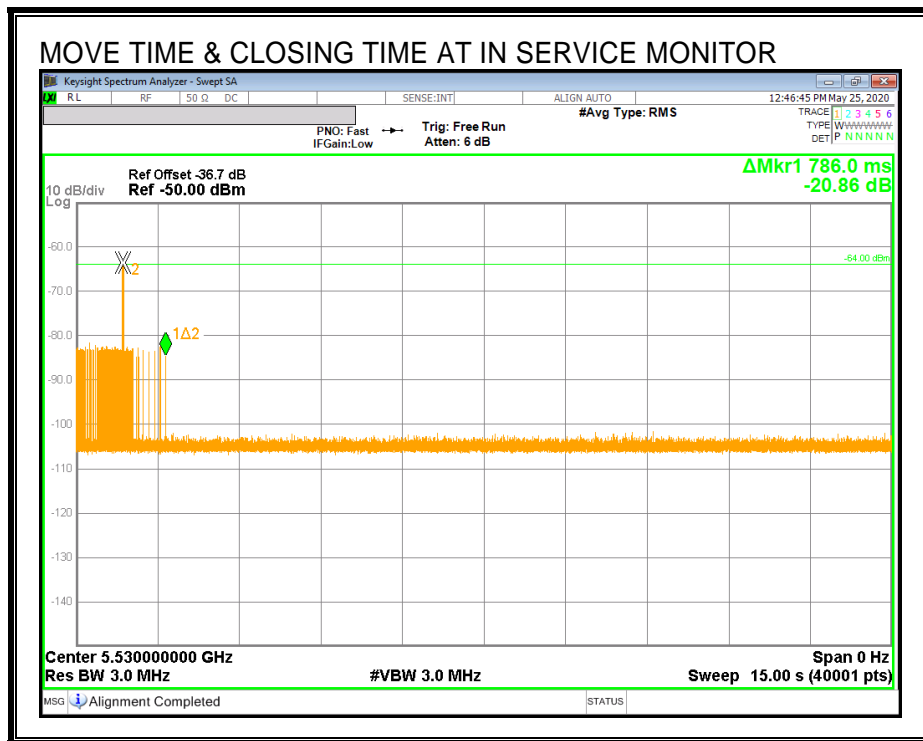
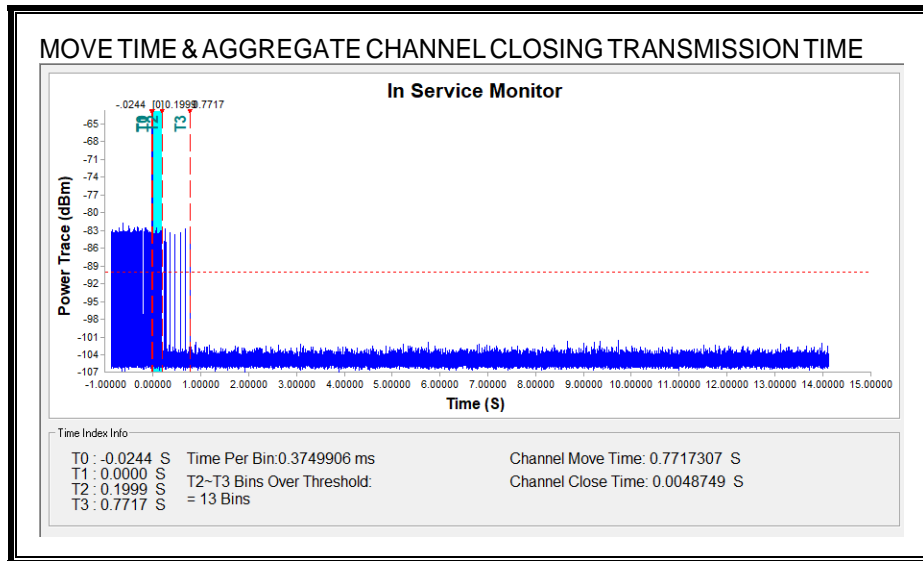

NON-OCCUPANCY PERIOD

RESULTS

No EUT transmissions were observed on the test channel during the 10-minute observation time.

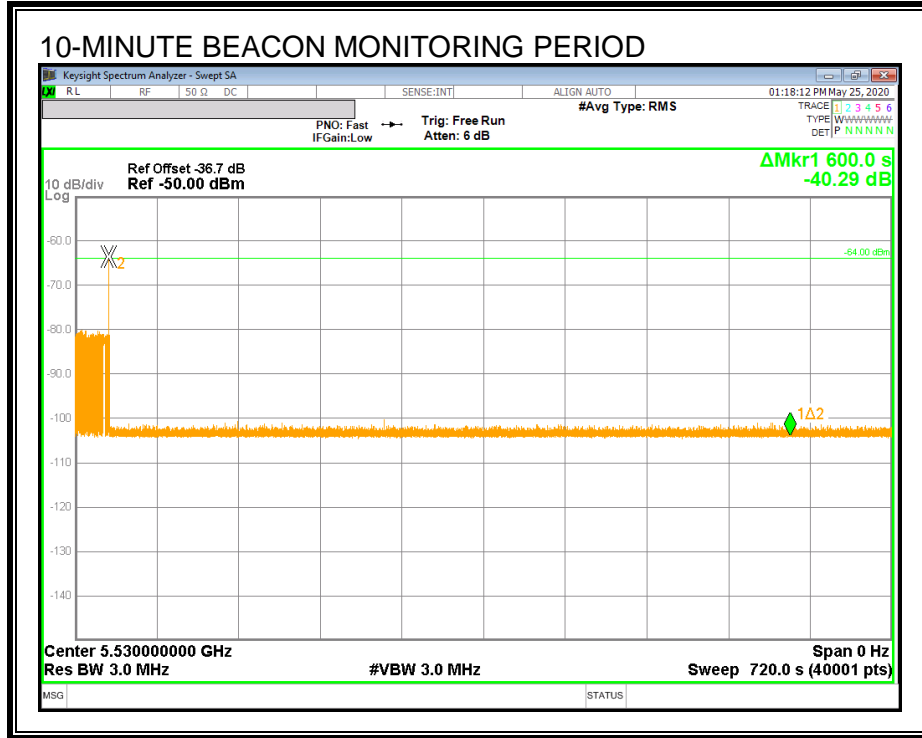

END OF TEST REPORT