



# FCC RF Test Report

**APPLICANT** : Samsung Electronics Co., Ltd.  
**EQUIPMENT** : MOBILE PHONE  
**BRAND NAME** : SAMSUNG  
**MODEL NAME** : SM-B550H  
**FCC ID** : A3LSMB550H  
**STANDARD** : FCC 47 CFR Part 2, 22(H), 24(E)  
**CLASSIFICATION** : PCS Licensed Transmitter Held to Ear (PCE)

The product was received on Mar. 05, 2015 and testing was completed on Mar. 10, 2015. We, SPORTON INTERNATIONAL (SHENZHEN) INC., would like to declare that the tested sample has been evaluated in accordance with the test procedures given in ANSI / TIA / EIA-603-C-2004 and has been in compliance with the applicable technical standards.

The test results in this report apply exclusively to the tested model / sample. Without written approval of SPORTON INTERNATIONAL (SHENZHEN) INC., the test report shall not be reproduced except in full.

Reviewed by: Joseph Lin / Supervisor

Approved by: Jones Tsai / Manager



## **SPORTON INTERNATIONAL (SHENZHEN) INC.**

**1F & 2F, Building A, Morning Business Center, No. 4003 ShiGu Rd., Xili Town,  
Nanshan District, Shenzhen, Guangdong, P. R. China**



# TABLE OF CONTENTS

**REVISION HISTORY..... 3**

**SUMMARY OF TEST RESULT ..... 4**

**1 GENERAL DESCRIPTION ..... 5**

    1.1 Applicant..... 5

    1.2 Manufacturer ..... 5

    1.3 Product Feature of Equipment Under Test ..... 5

    1.4 Product Specification subjective to this standard..... 5

    1.5 Modification of EUT ..... 6

    1.6 Maximum ERP/EIRP Power, Frequency Tolerance, and Emission Designator ..... 6

    1.7 Testing Location ..... 7

    1.8 Applicable Standards ..... 7

**2 TEST CONFIGURATION OF EQUIPMENT UNDER TEST ..... 8**

    2.1 Test Mode..... 8

    2.2 Connection Diagram of Test System ..... 9

    2.3 Measurement Results Explanation Example ..... 9

**3 TEST RESULT ..... 10**

    3.1 Conducted Output Power Measurement..... 10

    3.2 Peak-to-Average Ratio ..... 12

    3.3 Effective Radiated Power and Effective Isotropic Radiated Power Measurement ..... 16

    3.4 99% Occupied Bandwidth and 26dB Bandwidth Measurement..... 21

    3.5 Band Edge Measurement..... 29

    3.6 Conducted Spurious Emission Measurement ..... 34

    3.7 Field Strength of Spurious Radiation Measurement ..... 41

    3.8 Frequency Stability Measurement..... 49

**4 LIST OF MEASURING EQUIPMENT ..... 53**

**5 UNCERTAINTY OF EVALUATION ..... 54**





## SUMMARY OF TEST RESULT

Report Section	FCC Rule	Description	Limit	Result	Remark
3.1	§2.1046	Conducted Output Power	N/A	PASS	-
3.2	§24.232(d)	Peak-to-Average Ratio	<13 dB	PASS	-
3.3	§22.913(a)(2)	Effective Radiated Power	< 7 Watts	PASS	-
	§24.232(c)	Equivalent Isotropic Radiated Power	< 2 Watts	PASS	-
3.4	§2.1049 §22.917(b) §24.238(b)	Occupied Bandwidth	N/A	PASS	-
3.5	§2.1051 §22.917(a) §24.238(a)	Band Edge Measurement	< 43+10log <sub>10</sub> (P[Watts])	PASS	-
3.6	§2.1051 §22.917(a) §24.238(a)	Conducted Spurious Emission	< 43+10log <sub>10</sub> (P[Watts])	PASS	-
3.7	§2.1053 §22.917(a) §24.238(a)	Field Strength of Spurious Radiation	< 43+10log <sub>10</sub> (P[Watts])	PASS	Under limit 27.06 dB at 5729.400 MHz
3.8	§2.1055 §22.355	Frequency Stability for Temperature & Voltage	< 2.5 ppm	PASS	-
	§2.1055 §24.235		Within Authorized Band		



# 1 General Description

## 1.1 Applicant

Samsung Electronics Co., Ltd.

No. 9 WeiWu Rd., Micro Electronic Industrial Park, Jingang Highway, Xiqing District, Tianjin, China

## 1.2 Manufacturer

Samsung Electronics Co., Ltd.

Chenjiang Town zhongkai 6th Road 256 Huizhou Guangdong China

## 1.3 Product Feature of Equipment Under Test

Product Feature	
Equipment	MOBILE PHONE
Brand Name	SAMSUNG
Model Name	SM-B550H
FCC ID	A3LSMB550H
GSM Operating Band(s)	GSM1900/850MHz
GPRS/EGPRS Multi-slot Class	GPRS Class 12, EGPRS Class 12(Downlink Only)
WCDMA Operating Band(s)	FDD Band I/VIII
Bluetooth Version	Bluetooth v3.0 + EDR
IMEI Code	Conducted: 358635060015576 Radiated: 358635060027449 EIRP/ERP: 358635060012425
HW Version	REV1.0
SW Version	B550H.001
EUT Stage	Pre-Production

Remark: The above EUT's information was declared by manufacturer. Please refer to the specifications or user's manual for more detailed description.

## 1.4 Product Specification subjective to this standard

Product Specification subjective to this standard	
Tx Frequency	GSM850: 824.2 MHz ~ 848.8 MHz GSM1900: 1850.2 MHz ~ 1909.8MHz
Rx Frequency	GSM850: 869.2 MHz ~ 893.8 MHz GSM1900: 1930.2 MHz ~ 1989.8 MHz
Maximum Output Power to Antenna	GSM850 : 32.82 dBm GSM1900 : 30.12 dBm
Antenna Type	PIFA-Carrier Antenna
Type of Modulation	GSM: GMSK GPRS: GMSK EDGE: GMSK / 8PSK(Downlink Only)



### 1.5 Modification of EUT

No modifications are made to the EUT during all test items.

### 1.6 Maximum ERP/EIRP Power, Frequency Tolerance, and Emission Designator

FCC Rule	System	Type of Modulation	Maximum ERP/EIRP (W)	Frequency Tolerance (ppm)	Emission Designator
Part 22	GSM850 GSM	GMSK	0.8650	0.0741 ppm	247KGXW
Part 24	GSM1900 GSM	GMSK	1.2417	0.0074 ppm	245KGXW



### 1.7 Testing Location

<b>Test Site</b>	SPORTON INTERNATIONAL (SHENZHEN) INC.	
<b>Test Site Location</b>	1F & 2F, Building A, Morning Business Center, No. 4003 ShiGu Rd., Xili Town, Nanshan District, Shenzhen, Guangdong, P. R. China TEL: +86-755-8637-9589 FAX: +86-755-8637-9595	
<b>Test Site No.</b>	<b>Sporton Site No.</b>	
	TH01-SZ	

<b>Test Site</b>	SPORTON INTERNATIONAL (SHENZHEN) INC.	
<b>Test Site Location</b>	No. 3 Building, the third floor of south, Shahe River west, Fengzeyuan warehouse, Nanshan District, Shenzhen, Guangdong, P. R. China TEL: +86-755- 3320-2398	
<b>Test Site No.</b>	<b>Sporton Site No.</b>	<b>FCC Registration No.</b>
	03CH01-SZ	831040

### 1.8 Applicable Standards

According to the specifications of the manufacturer, the EUT must comply with the requirements of the following standards:

- ♦ FCC 47 CFR Part 2, 22(H), 24(E)
- ♦ ANSI / TIA / EIA-603-C-2004
- ♦ FCC KDB 971168 D01 Power Meas. License Digital Systems v02r02

**Remark:**

1. All test items were verified and recorded according to the standards and without any deviation during the test.
2. This EUT has also been tested and complied with the requirements of FCC Part 15, Subpart B, recorded in a separate test report.

## 2 Test Configuration of Equipment Under Test

### 2.1 Test Mode

Antenna port conducted and radiated test items were performed according to KDB 971168 D01 Power Meas. License Digital Systems v02r02 with maximum output power.

Radiated measurements were performed with rotating EUT in different three orthogonal test planes to find the maximum emission.

Frequency range investigated for radiated emission: 30MHz to 10<sup>th</sup> harmonic.

All modes and data rates and positions were investigated.

Test modes are chosen to be reported as the worst case configuration below:

Test Modes		
Band	Radiated TCs	Conducted TCs
GSM 850	■ GSM Link	■ GSM Link
GSM 1900	■ GSM Link	■ GSM Link

#### Conducted Power Measurement Results:

Conducted Power (*Unit: dBm)						
Band	GSM850			GSM1900		
Channel	128	189	251	512	661	810
Frequency	824.2	836.4	848.8	1850.2	1880.0	1909.8
GSM	32.76	32.74	32.82	29.98	30.05	30.12
GPRS class 8, 1 Tx slot	32.75	32.73	32.80	29.96	30.03	30.10
GPRS class 10, 2 Tx slot	30.67	30.66	30.73	27.69	27.72	27.78
GPRS class 11, 3 Tx slot	28.74	28.72	28.78	26.41	26.44	26.50
GPRS class 12, 4 Tx slot	26.53	26.52	26.57	24.73	24.74	24.81

## 2.2 Connection Diagram of Test System

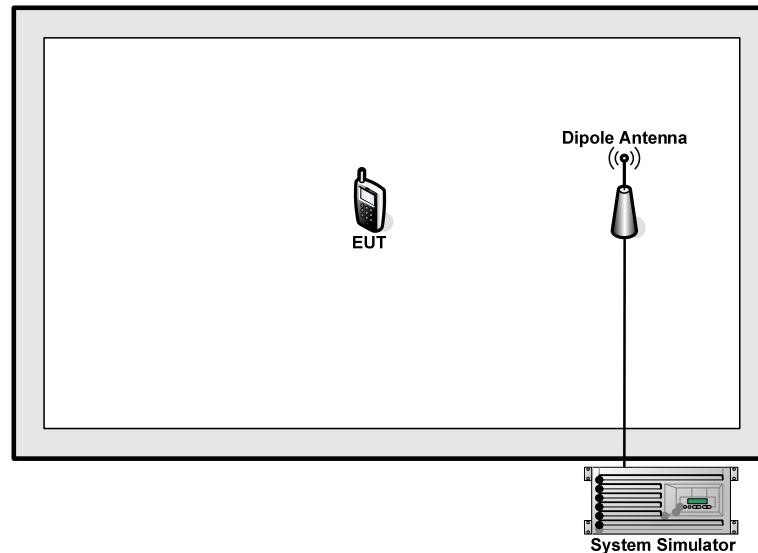

## 2.3 Measurement Results Explanation Example

**For all conducted test items:**

The offset level is set in the spectrum analyzer to compensate the RF cable loss and attenuator factor between RF conducted output port and spectrum analyzer. With the offset compensation, the spectrum analyzer reading level will be exactly the RF output level.

The spectrum analyzer offset is derived from RF cable loss and attenuator factor.

*Offset = RF cable loss + attenuator factor.*

The following shows an offset computation example with RF cable loss 4.5 dB and a 10dB attenuator.

Example :

$$\begin{aligned} \text{Offset(dB)} &= \text{RF cable loss(dB)} + \text{attenuator factor(dB)}. \\ &= 4.5 + 10 = 14.5 \text{ (dB)} \end{aligned}$$

### **3 Test Result**

#### **3.1 Conducted Output Power Measurement**

##### **3.1.1 Description of the Conducted Output Power Measurement**

A system simulator was used to establish communication with the EUT. Its parameters were set to enforce EUT transmitting at the maximum power. The measured power in the radio frequency on the transmitter output terminals shall be reported.

##### **3.1.2 Measuring Instruments**

The measuring equipment is listed in the section 4 of this test report.

##### **3.1.3 Test Procedures**

1. The transmitter output port was connected to the system simulator.
2. Set EUT at maximum power through system simulator.
3. Select lowest, middle, and highest channels for each band and different modulation.
4. Measure the maximum burst average power for GSM and maximum average power for other modulation signal.

##### **3.1.4 Test Setup**

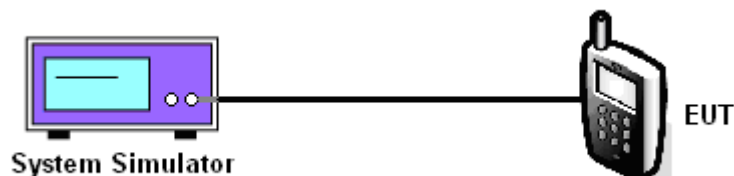



3.1.5 Test Result of Conducted Output Power

Cellular Band			
Modes	GSM850 (GSM)		
Channel	128 (Low)	189 (Mid)	251 (High)
Frequency (MHz)	824.2	836.4	848.8
Conducted Power (dBm)	32.76	32.74	32.82

PCS Band			
Modes	GSM1900 (GSM)		
Channel	512 (Low)	661 (Mid)	810 (High)
Frequency (MHz)	1850.2	1880	1909.8
Conducted Power (dBm)	29.98	30.05	30.12

Note: Maximum burst average power for GSM.

## 3.2 Peak-to-Average Ratio

### 3.2.1 Description of the PAR Measurement

The peak-to-average ratio (PAR) of the transmission may not exceed 13 dB.

### 3.2.2 Measuring Instruments

The measuring equipment is listed in the section 4 of this test report.

### 3.2.3 Test Procedures

1. The testing follows FCC KDB 971168 v02r02 Section 5.7.1.
2. The EUT was connected to the spectrum analyzer and system simulator via a power divider.
3. For GSM/GPRS operating modes:
  - a. Set EUT in maximum power output.
  - b. Set the RBW = 1MHz, VBW = 3MHz, Peak detector on spectrum analyzer for first trace.
  - c. Set the RBW = 1MHz, VBW = 3MHz, RMS detector on spectrum analyzer for second trace.
  - d. The wanted burst signal is triggered by spectrum analyzer, and measured respectively the peak level and Mean level without burst-off time, after system simulator has synchronized with the spectrum analyzer.
4. Record the deviation as Peak to Average Ratio.

### 3.2.4 Test Setup

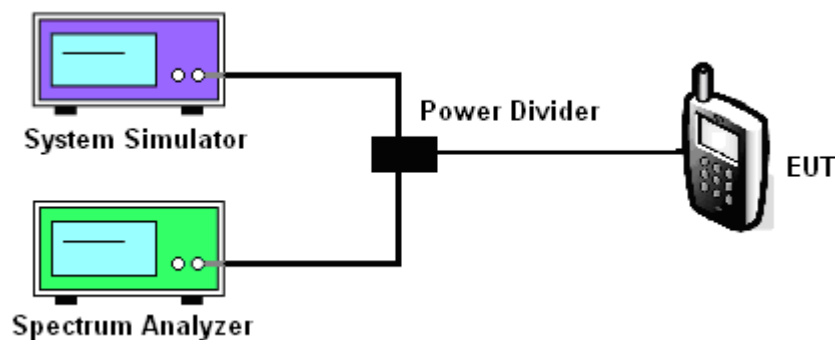



### 3.2.5 Test Result of Peak-to-Average Ratio

PCS Band			
Modes	GSM1900 (GSM)		
Channel	512 (Low)	661 (Mid)	810 (High)
Frequency (MHz)	1850.2	1880	1909.8
Peak-to-Average Ratio (dB)	0.31	0.32	0.32



### 3.2.6 Test Result (Plots) of Peak-to-Average Ratio

Band :	GSM 1900	Test Mode :	GSM Link (GMSK)
--------	----------	-------------	-----------------

Peak-to-Average Ratio on Channel 512 (1850.2 MHz)

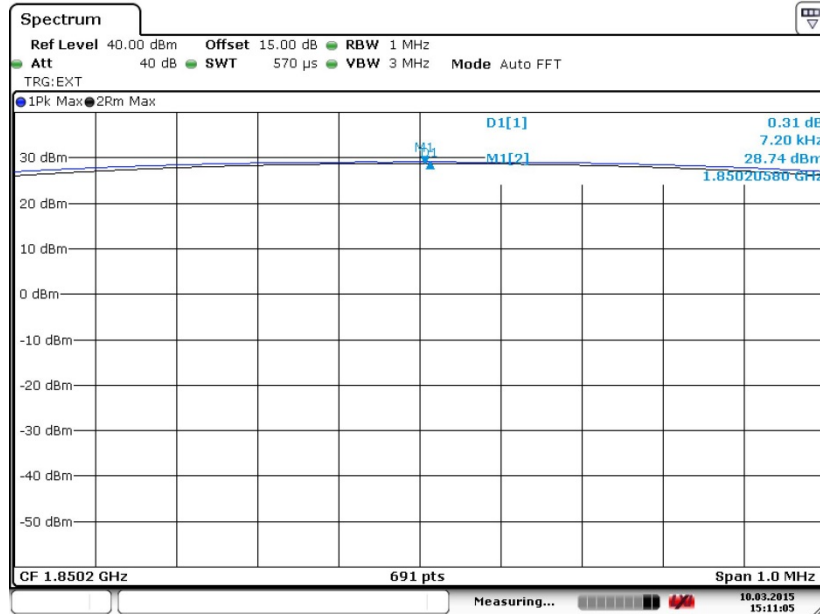

Date: 10.MAR.2015 15:11:05

Peak-to-Average Ratio on Channel 661 (1880.0 MHz)

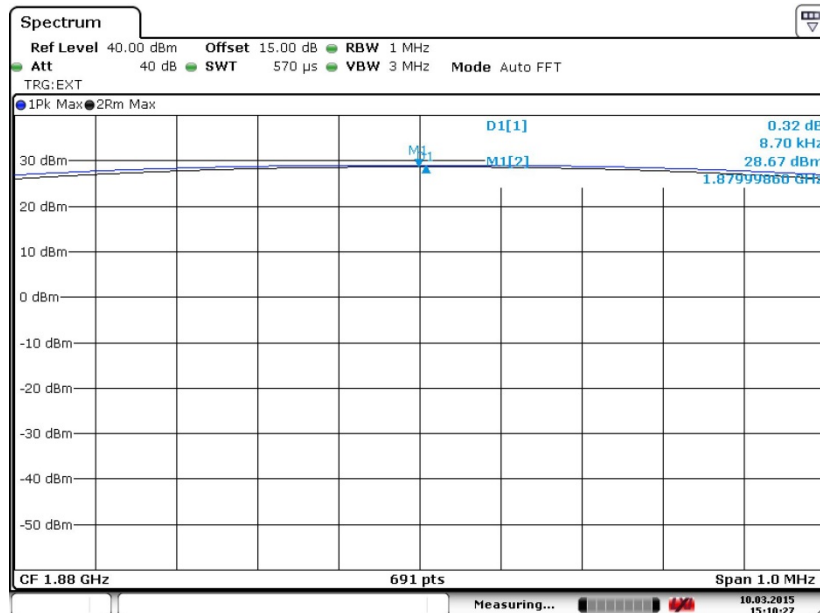

Date: 10.MAR.2015 15:10:27



Peak-to-Average Ratio on Channel 810 (1909.8 MHz)

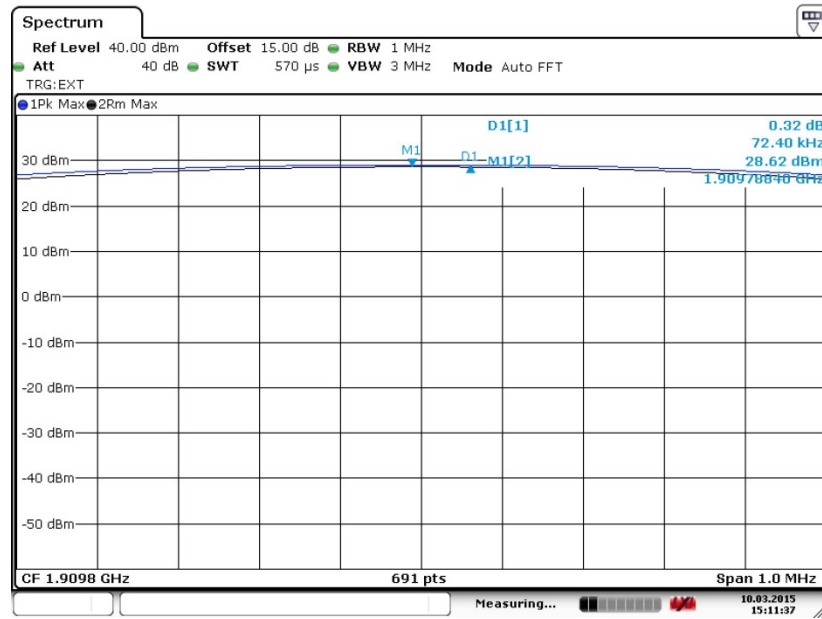

Date: 10.MAR.2015 15:11:37



### **3.3 Effective Radiated Power and Effective Isotropic Radiated Power Measurement**

#### **3.3.1 Description of the ERP/EIRP Measurement**

The substitution method, in ANSI / TIA / EIA-603-C-2004, was used for ERP/EIRP measurement, and the spectrum analyzer configuration follows KDB 971168 D01 Power Meas. License Digital Systems v02r02. The ERP of mobile transmitters must not exceed 7 Watts and the EIRP of mobile transmitters are limited to 2 Watts.

#### **3.3.2 Measuring Instruments**

The measuring equipment is listed in the section 4 of this test report.

### 3.3.3 Test Procedures

1. The testing follows FCC KDB 971168 v02r02 Section 5.2.2.2 (for GSM/GPRS/EDGE) and ANSI / TIA-603-C-2004 Section 2.2.17.
2. The EUT was placed on a non-conductive rotating platform 0.8 meters high in a semi-anechoic chamber. The radiated emission at the fundamental frequency was measured at 3 m with a test antenna and a spectrum analyzer with RMS detector per section 5. of KDB 971168 D01.
3. During the measurement, the system simulator parameters were set to force the EUT transmitting at maximum output power. The maximum emission was recorded from analyzer power level (LVL) from the 360 degrees rotation of the turntable and the test antenna raised and lowered over a range from 1 to 4 meters in both horizontally and vertically polarized orientations.
4. Effective Isotropic Radiated Power (EIRP) was measured by substitution method according to TIA/EIA-603-C. The EUT was replaced by dipole antenna (substitution antenna) at the same location, and then a known power from S.G. was applied into the dipole antenna through a Tx cable, and then recorded the maximum Analyzer reading through raised and lowered the test antenna. The correction factor (in dB) = S.G. - Tx Cable loss + Substitution antenna gain - Analyzer reading. Then the EUT's EIRP was calculated with the correction factor,  $EIRP = LVL + \text{Correction factor}$  and  $ERP = EIRP - 2.15$ .

	GSM/GPRS
SPAN	500kHz
RBW	10kHz
VBW	30kHz
Detector	RMS
Trace	Average
Average Type	Power
Sweep Count	100

### 3.3.4 Test Setup

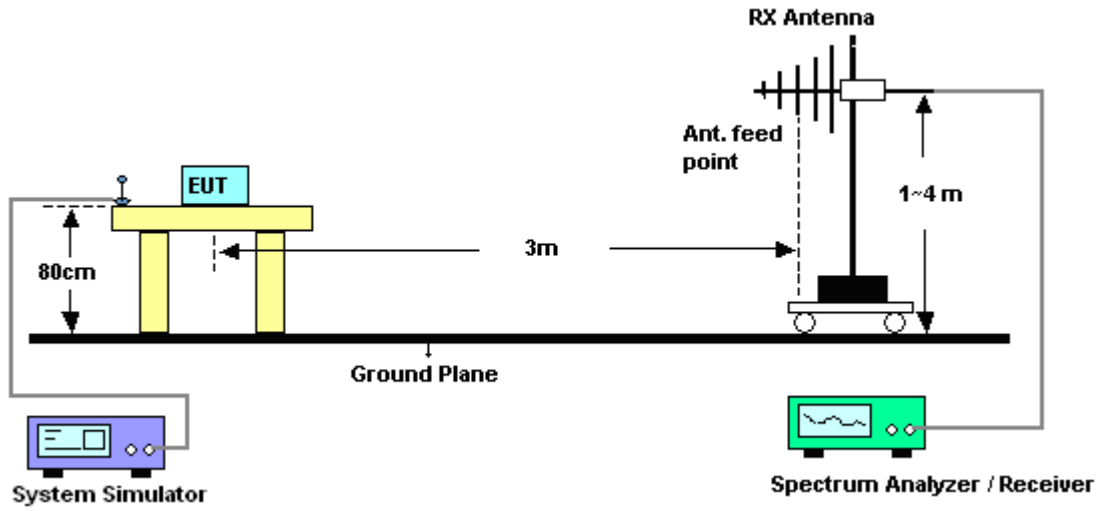



3.3.5 Test Result of ERP

GSM850 (GSM) Radiated Power ERP				
Horizontal Polarization				
Frequency (MHz)	LVL (dBm)	Correction Factor (dB)	ERP (dBm)	ERP (W)
824.2	-4.36	30.23	23.72	0.2355
836.4	-2.67	31.09	26.27	0.4236
848.8	-1.67	30.51	26.69	0.4667
Vertical Polarization				
Frequency (MHz)	LVL (dBm)	Correction Factor (dB)	ERP (dBm)	ERP (W)
824.2	-4.49	35.14	28.50	0.7079
836.4	-5.41	36.01	28.45	0.6998
848.8	-3.59	35.11	29.37	0.8650

\* ERP = LVL (dBm) + Correction Factor (dB) – 2.15



3.3.6 Test Result of EIRP

GSM1900 (GSM) Radiated Power EIRP				
Horizontal Polarization				
Frequency (MHz)	LVL (dBm)	Correction Factor (dB)	EIRP (dBm)	EIRP (W)
1850.2	-15.08	46.02	30.94	1.2417
1880.0	-14.01	44.73	30.72	1.1803
1909.8	-15.12	45.20	30.08	1.0186
Vertical Polarization				
Frequency (MHz)	LVL (dBm)	Correction Factor (dB)	EIRP (dBm)	EIRP (W)
1850.2	-21.04	45.58	24.54	0.2844
1880.0	-23.36	45.75	22.39	0.1734
1909.8	-22.99	47.21	24.22	0.2642

\* EIRP = LVL (dBm) + Correction Factor (dB)

## 3.4 99% Occupied Bandwidth and 26dB Bandwidth Measurement

### 3.4.1 Description of 99% Occupied Bandwidth and 26dB Bandwidth Measurement

The 99% occupied bandwidth is the width of a frequency band such that, below the lower and above the upper frequency limits, the mean powers emitted are each equal to a specified percentage 0.5% of the total mean transmitted power.

The emission bandwidth is defined as the width of the signal between two points, located at the 2 sides of the carrier frequency, outside of which all emissions are attenuated at least 26 dB below the transmitter power.

### 3.4.2 Measuring Instruments

The measuring equipment is listed in the section 4 of this test report.

### 3.4.3 Test Procedures

1. The testing follows FCC KDB 971168 v02r02 Section 4.2.
2. The EUT was connected to the spectrum analyzer and system simulator via a power divider.
3. The RF output of the EUT was connected to the spectrum analyzer by RF cable and attenuator. The path loss was compensated to the results for each measurement.
4. The 99% occupied bandwidth were measured, set RBW= 1% of span, VBW= 3\*RBW, peak detector, trace maximum hold.
5. The 26dB bandwidth were measured, set RBW= 1% of EBW, VBW= 3\*RBW, peak detector, trace maximum hold.

### 3.4.4 Test Setup

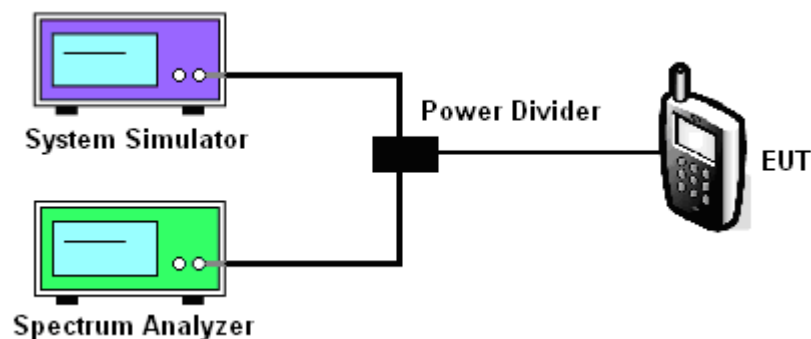



3.4.5 Test Result of 99% Occupied Bandwidth and 26dB Bandwidth

Cellular Band			
Modes	GSM850 (GSM)		
Channel	128 (Low)	189 (Mid)	251 (High)
Frequency (MHz)	824.2	836.4	848.8
99% OBW (kHz)	247.00	243.00	245.00
26dB BW (kHz)	312.00	312.00	313.00

PCS Band			
Modes	GSM1900 (GSM)		
Channel	512 (Low)	661 (Mid)	810 (High)
Frequency (MHz)	1850.2	1880	1909.8
99% OBW (kHz)	245.00	244.00	242.00
26dB BW (kHz)	301.00	309.00	309.00



### 3.4.6 Test Result (Plots) of Occupied Bandwidth and 26dB Bandwidth

Band :	GSM 850	Test Mode :	GSM Link (GMSK)
--------	---------	-------------	-----------------

#### 99% Occupied Bandwidth Plot on Channel 128 (824.2 MHz)

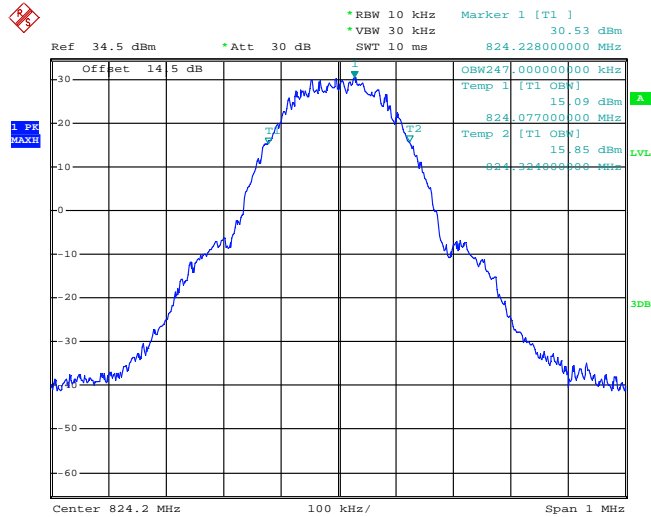

Date: 10.MAR.2015 10:28:10

#### 26dB Bandwidth Plot on Channel 128 (824.2 MHz)

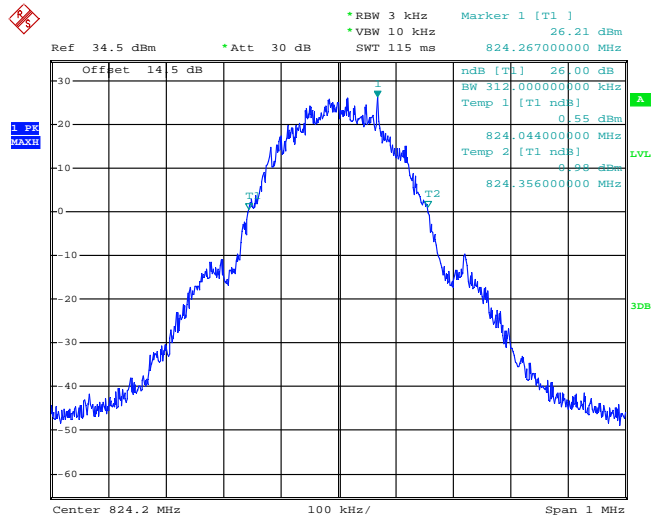

Date: 10.MAR.2015 14:13:09



99% Occupied Bandwidth Plot on Channel 189 (836.4 MHz)

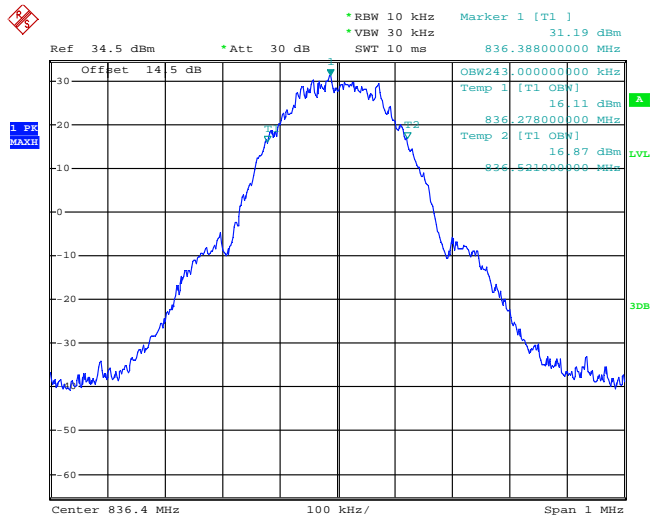

Date: 10.MAR.2015 10:28:38

26dB Bandwidth Plot on Channel 189 (836.4 MHz)

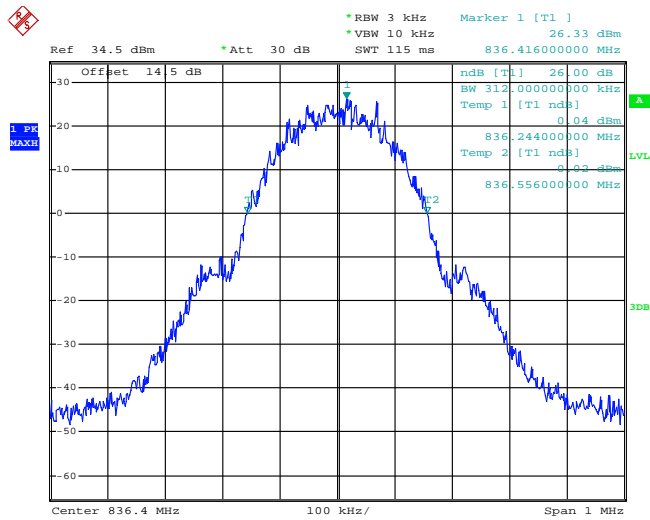

Date: 10.MAR.2015 14:13:37



99% Occupied Bandwidth Plot on Channel 251 (848.8 MHz)

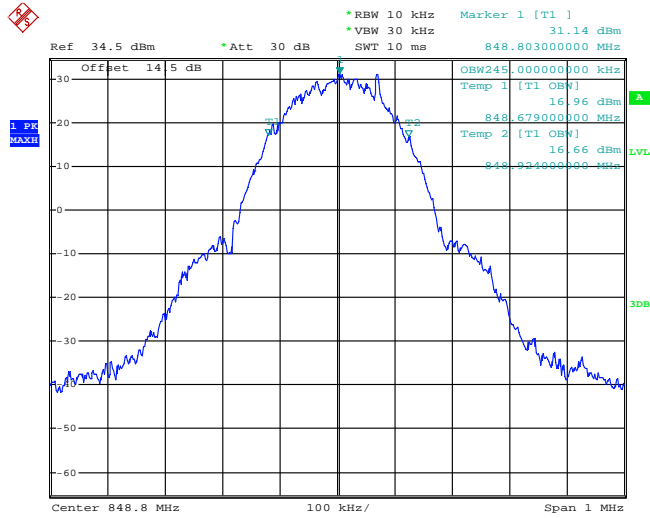

Date: 10.MAR.2015 10:29:05

26dB Bandwidth Plot on Channel 251 (848.8 MHz)

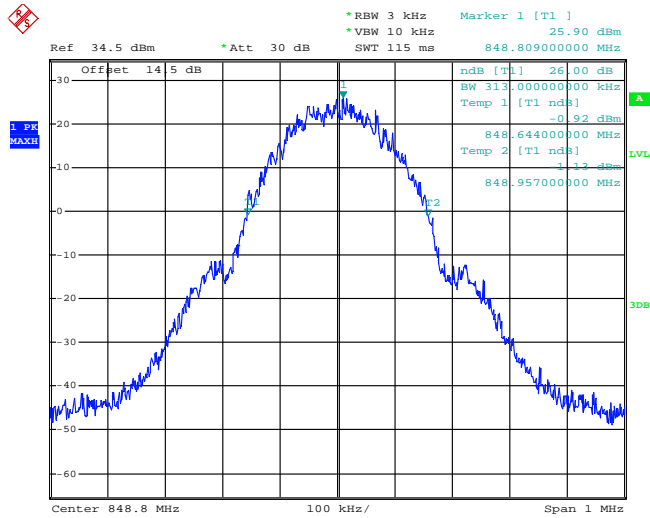

Date: 10.MAR.2015 14:14:05



Band :	GSM 1900	Test Mode :	GSM Link (GMSK)
--------	----------	-------------	-----------------

99% Occupied Bandwidth Plot on Channel 512 (1850.2 MHz)

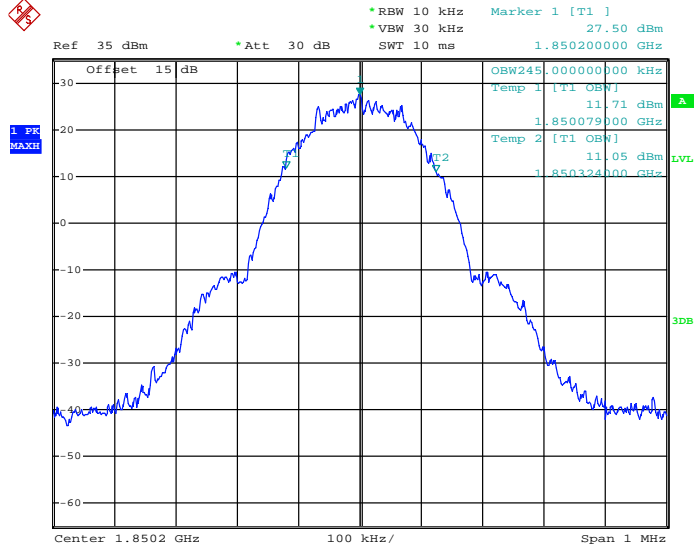

Date: 10.MAR.2015 11:41:31

26dB Bandwidth Plot on Channel 512 (1850.2 MHz)

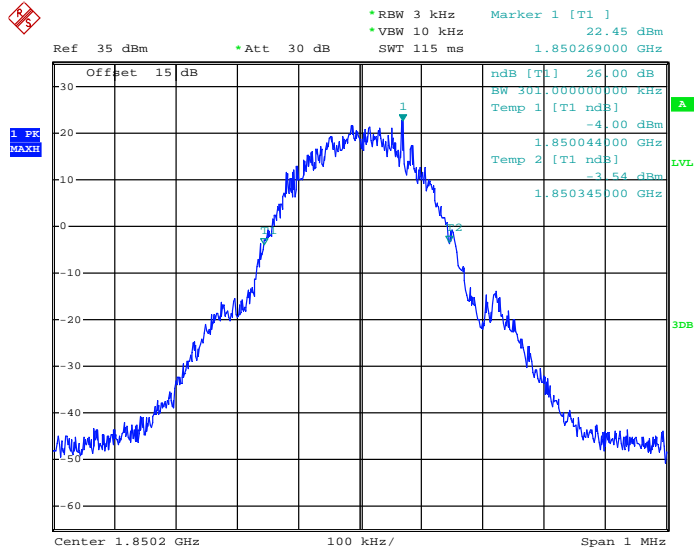

Date: 10.MAR.2015 11:39:40



99% Occupied Bandwidth Plot on Channel 661 (1880.0 MHz)

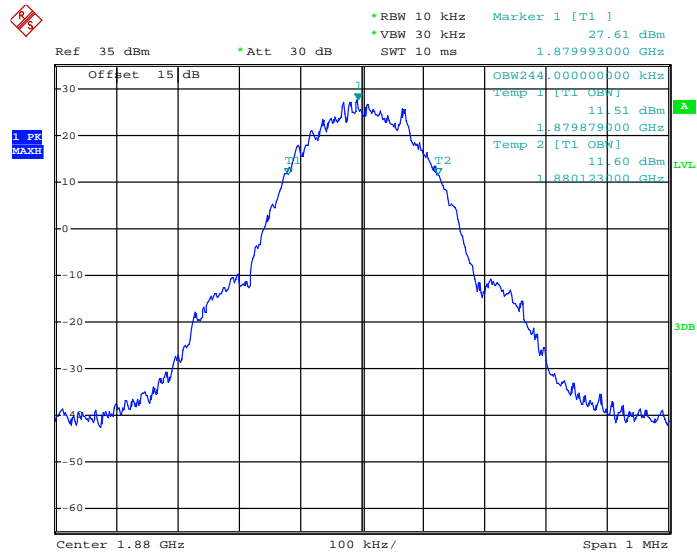

Date: 10.MAR.2015 11:41:58

26dB Bandwidth Plot on Channel 661 (1880.0 MHz)

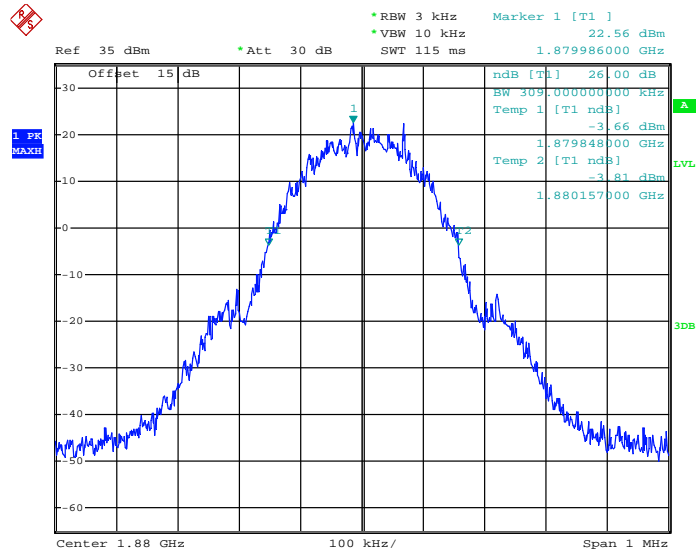

Date: 10.MAR.2015 11:40:08



## 3.5 Band Edge Measurement

### 3.5.1 Description of Band Edge Measurement

The power of any emission outside of the authorized operating frequency ranges must be lower than the transmitter power (P) by a factor of at least  $43 + 10 \log (P)$  dB.

### 3.5.2 Measuring Instruments

The measuring equipment is listed in the section 4 of this test report.

### 3.5.3 Test Procedures

1. The testing follows FCC KDB 971168 v02r02 Section 6.0.
2. The EUT was connected to the spectrum analyzer and system simulator via a power divider.
3. The RF output of EUT was connected to the spectrum analyzer by an RF cable and attenuator. The path loss was compensated to the results for each measurement.
4. The band edges of low and high channels for the highest RF powers were measured.
5. The RF fundamental frequency should be excluded against the limit line in the operating frequency band.
6. The limit line is derived from  $43 + 10\log(P)$  dB below the transmitter power P(Watts)  
 $= P(W) - [43 + 10\log(P)] \text{ (dB)}$   
 $= [30 + 10\log(P)] \text{ (dBm)} - [43 + 10\log(P)] \text{ (dB)}$   
 $= -13\text{dBm}.$

### 3.5.4 Test Setup

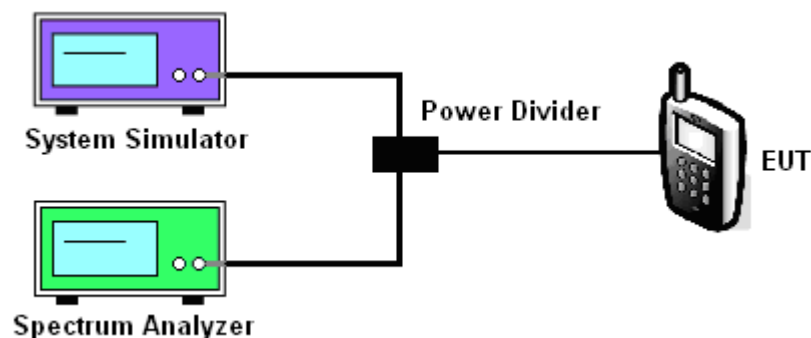



### 3.5.5 Test Result (Plots) of Conducted Band Edge

Band :	GSM850	Test Mode :	GSM Link (GMSK)
--------	--------	-------------	-----------------

Lower Band Edge Plot on Channel 128 (824.2 MHz)

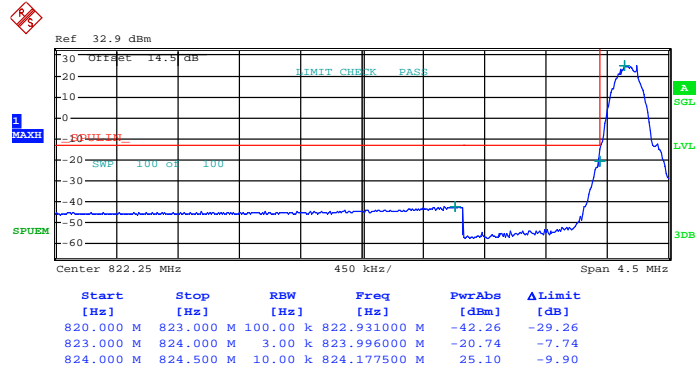

Date: 10.MAR.2015 11:09:52



Band :	GSM850	Test Mode :	GSM Link (GMSK)
--------	--------	-------------	-----------------

Higher Band Edge Plot on Channel 251 (848.8 MHz)

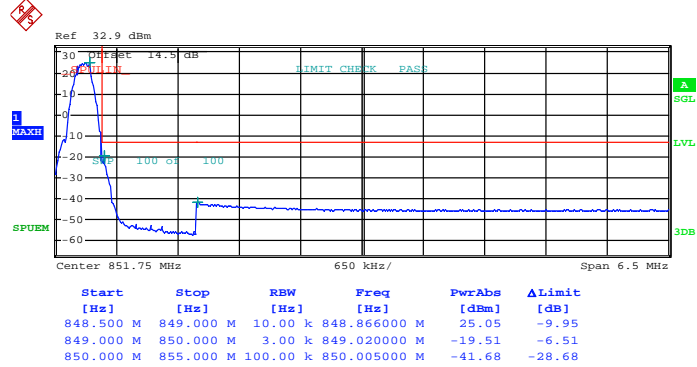

Date: 10.MAR.2015 10:57:04



Band :	GSM1900	Test Mode :	GSM Link (GMSK)
--------	---------	-------------	-----------------

Lower Band Edge Plot on Channel 512 (1850.2 MHz)

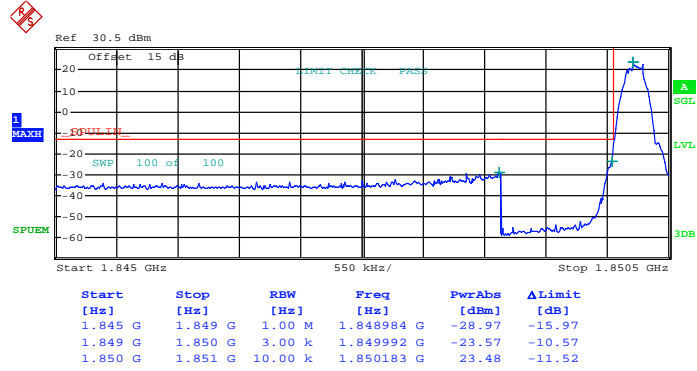

Date: 10.MAR.2015 11:30:50



Band :	GSM1900	Test Mode :	GSM Link (GMSK)
--------	---------	-------------	-----------------

Higher Band Edge Plot on Channel 810 (1909.8 MHz)

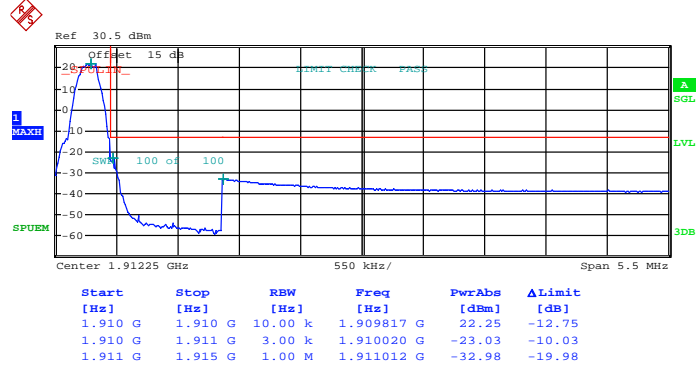

Date: 10.MAR.2015 11:37:44

## 3.6 Conducted Spurious Emission Measurement

### 3.6.1 Description of Conducted Spurious Emission Measurement

The power of any emission outside of the authorized operating frequency ranges must be lower than the transmitter power (P) by a factor of at least  $43 + 10 \log (P)$  dB.

It is measured by means of a calibrated spectrum analyzer and scanned from 30 MHz up to a frequency including its 10<sup>th</sup> harmonic.

### 3.6.2 Measuring Instruments

The measuring equipment is listed in the section 4 of this test report.

### 3.6.3 Test Procedures

1. The testing follows FCC KDB 971168 v02r02 Section 6.0.
2. The EUT was connected to the spectrum analyzer and system simulator via a power divider.
3. The RF output of EUT was connected to the spectrum analyzer by an RF cable and attenuator. The path loss was compensated to the results for each measurement.
4. The middle channel for the highest RF power within the transmitting frequency was measured.
5. The conducted spurious emission for the whole frequency range was taken.
6. The RF fundamental frequency should be excluded against the limit line in the operating frequency band.
7. The limit line is derived from  $43 + 10\log(P)$  dB below the transmitter power P(Watts)  
 $= P(W) - [43 + 10\log(P)]$  (dB)  
 $= [30 + 10\log(P)]$  (dBm) -  $[43 + 10\log(P)]$  (dB)  
 $= -13\text{dBm}$ .

### 3.6.4 Test Setup

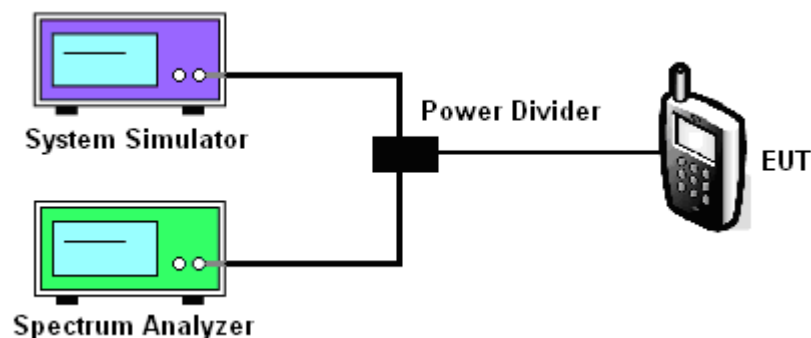



### 3.6.5 Test Result (Plots) of Conducted Spurious Emission

Band :	GSM850	Channel :	CH128
Test Mode :	GSM Link (GMSK)	Frequency :	824.2 MHz

Conducted Spurious Emission Plot between 30MHz ~ 9GHz

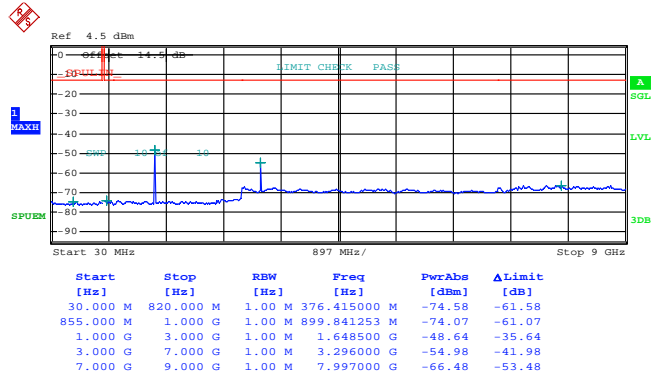

Date: 10.MAR.2015 13:55:40



<b>Band :</b>	GSM850	<b>Channel :</b>	CH189
<b>Test Mode :</b>	GSM Link (GMSK)	<b>Frequency :</b>	836.4 MHz

Conducted Spurious Emission Plot between 30MHz ~ 9GHz

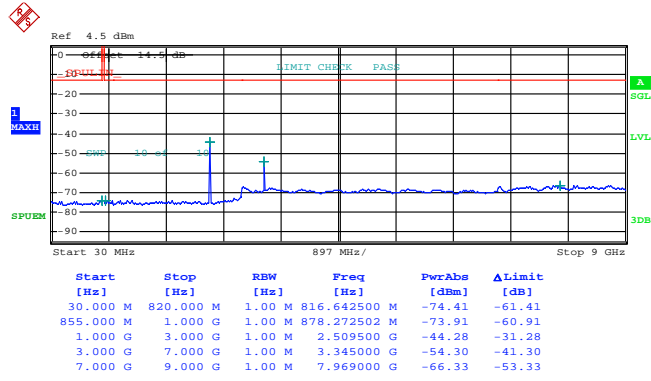

Date: 10.MAR.2015 13:56:04



Band :	GSM850	Channel :	CH251
Test Mode :	GSM Link (GMSK)	Frequency :	848.8 MHz

Conducted Spurious Emission Plot between 30MHz ~ 9GHz

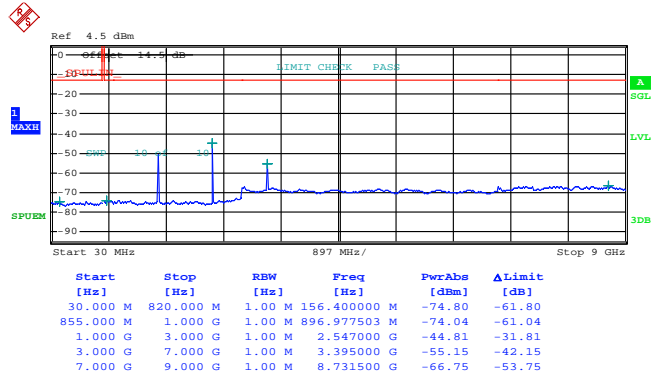

Date: 10.MAR.2015 13:56:29



Band :	GSM1900	Channel :	CH512
Test Mode :	GSM Link (GMSK)	Frequency :	1850.2 MHz

Conducted Spurious Emission Plot between 30MHz ~ 19.1GHz

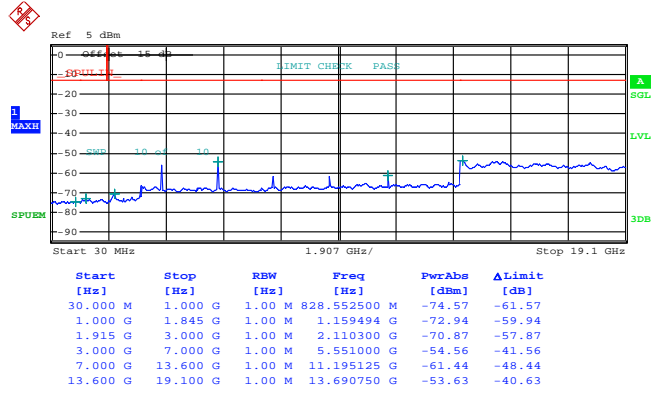

Date: 10.MAR.2015 13:51:17



Band :	GSM1900	Channel :	CH661
Test Mode :	GSM Link (GMSK)	Frequency :	1880.0 MHz

Conducted Spurious Emission Plot between 30MHz ~ 19.1GHz

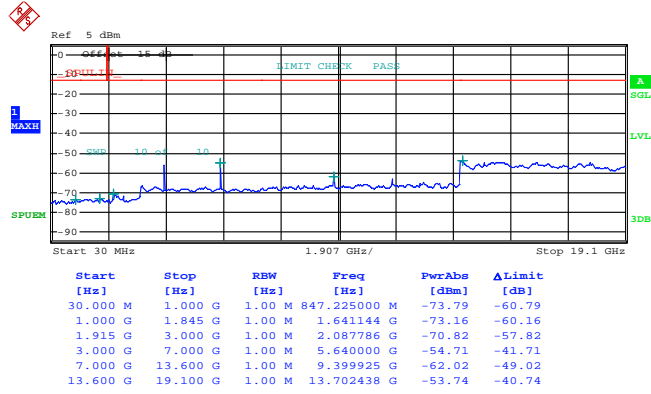

Date: 10.MAR.2015 13:51:42



Band :	GSM1900	Channel :	CH810
Test Mode :	GSM Link (GMSK)	Frequency :	1909.8 MHz

Conducted Spurious Emission Plot between 30MHz ~ 19.1GHz

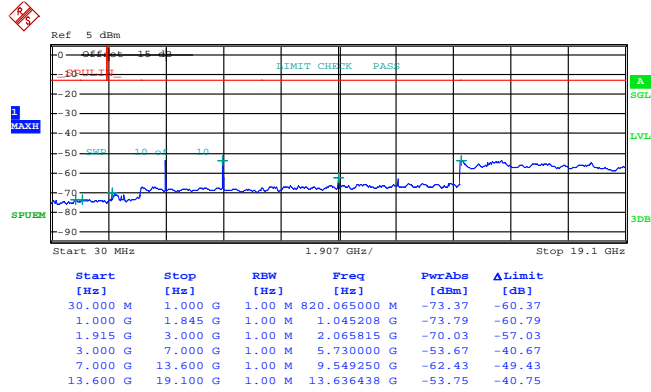

Date: 10.MAR.2015 13:52:07



### 3.7 Field Strength of Spurious Radiation Measurement

#### 3.7.1 Description of Field Strength of Spurious Radiated Measurement

The power of any emission outside of the authorized operating frequency ranges must be attenuated below the transmitter power (P) by a factor of at least  $43 + 10 \log (P)$  dB. The spectrum is scanned from 30 MHz up to a frequency including its 10th harmonic.

#### 3.7.2 Measuring Instruments

The measuring equipment is listed in the section 4 of this test report.

#### 3.7.3 Test Procedures

1. The testing follows FCC KDB 971168 v02r02 Section 5.8 and ANSI / TIA-603-C-2004 Section 2.2.12.
2. The EUT was placed on a rotatable wooden table 0.8 meters above the ground.
3. The EUT was set 3 meters from the receiving antenna, which was mounted on the antenna tower.
4. The table was rotated 360 degrees to determine the position of the highest spurious emission.
5. The height of the receiving antenna is varied between one meter and four meters to search for the maximum spurious emission for both horizontal and vertical polarizations.
6. Make the measurement with the spectrum analyzer's RBW = 1MHz, VBW = 3MHz, taking record of maximum spurious emission.
7. A horn antenna was substituted in place of the EUT and was driven by a signal generator.
8. Tune the output power of signal generator to the same emission level with EUT maximum spurious emission.
9. Taking the record of output power at antenna port.
10. Repeat step 7 to step 8 for another polarization.
11.  $EIRP (dBm) = S.G. Power - Tx Cable Loss + Tx Antenna Gain$
12.  $ERP (dBm) = EIRP - 2.15$
13. The RF fundamental frequency should be excluded against the limit line in the operating frequency band.
14. The limit line is derived from  $43 + 10\log(P)$  dB below the transmitter power P(Watts)  
=  $P(W) - [43 + 10\log(P)] (dB)$   
=  $[30 + 10\log(P)] (dBm) - [43 + 10\log(P)] (dB)$   
= -13dBm.

### 3.7.4 Test Setup

For radiated emissions from 30MHz to 1GHz

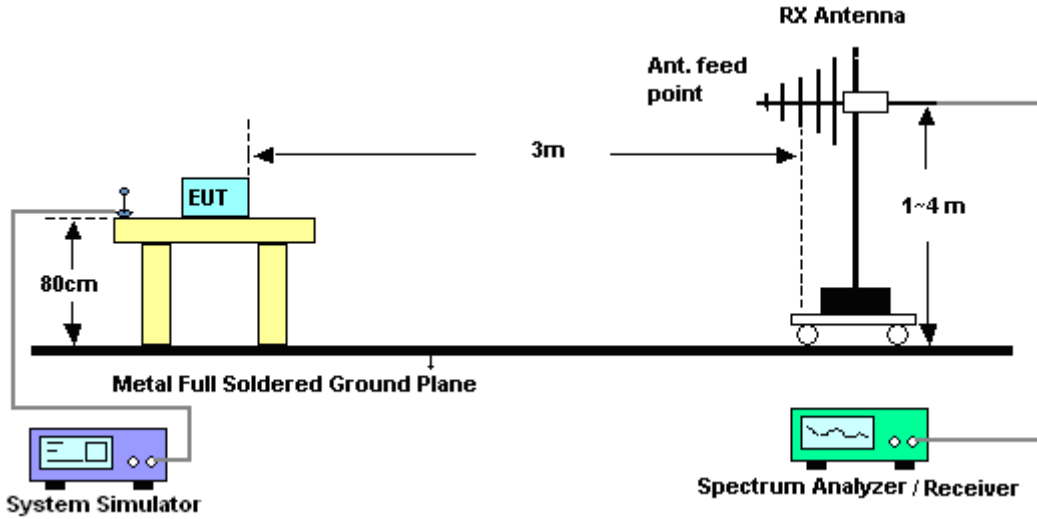

For radiated emissions above 1GHz

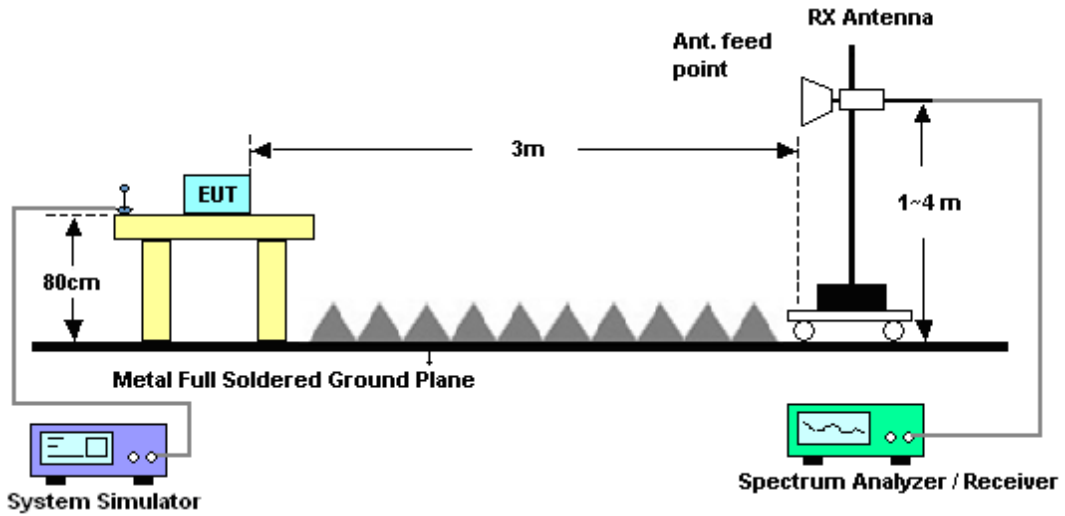



3.7.5 Test Result of Field Strength of Spurious Radiated

<b>Band :</b>	GSM850 for CH128		<b>Temperature :</b>	23~25°C					
<b>Test Mode :</b>	GSM Link (GMSK)		<b>Relative Humidity :</b>	48~52%					
<b>Test Engineer :</b>	Kear Huang		<b>Polarization :</b>	Horizontal					
<b>Remark :</b>	Spurious emissions within 30-1000MHz were found more than 20dB below limit line.								
Frequency ( MHz )	ERP ( dBm )	Limit ( dBm )	Over Limit ( dB )	SPA Reading ( dBm )	S.G. Power ( dBm )	TX Cable loss ( dB )	TX Antenna Gain ( dBi )	Polarization ( H/V )	Result
1648.4	-50.59	-13	-37.59	-65.28	-57.27	0.57	9.40	H	Pass
2472.6	-51.04	-13	-38.04	-71.41	-58.74	0.75	10.60	H	Pass
3296.8	-44.54	-13	-31.54	-70.47	-54.12	0.87	12.60	H	Pass

<b>Band :</b>	GSM850 for CH128		<b>Temperature :</b>	23~25°C					
<b>Test Mode :</b>	GSM Link (GMSK)		<b>Relative Humidity :</b>	48~52%					
<b>Test Engineer :</b>	Kear Huang		<b>Polarization :</b>	Vertical					
<b>Remark :</b>	Spurious emissions within 30-1000MHz were found more than 20dB below limit line.								
Frequency ( MHz )	ERP ( dBm )	Limit ( dBm )	Over Limit ( dB )	SPA Reading ( dBm )	S.G. Power ( dBm )	TX Cable loss ( dB )	TX Antenna Gain ( dBi )	Polarization ( H/V )	Result
1648.4	-54.22	-13	-41.22	-68.83	-60.90	0.57	9.40	V	Pass
2472.6	-47.73	-13	-34.73	-70.97	-55.43	0.75	10.60	V	Pass
3296.8	-43.18	-13	-30.18	-72.08	-52.76	0.87	12.60	V	Pass



<b>Band :</b>	GSM850 for CH189		<b>Temperature :</b>	23~25°C					
<b>Test Mode :</b>	GSM Link (GMSK)		<b>Relative Humidity :</b>	48~52%					
<b>Test Engineer :</b>	Kear Huang		<b>Polarization :</b>	Horizontal					
<b>Remark :</b>	Spurious emissions within 30-1000MHz were found more than 20dB below limit line.								
Frequency ( MHz )	ERP ( dBm )	Limit ( dBm )	Over Limit ( dB )	SPA Reading ( dBm )	S.G. Power ( dBm )	TX Cable loss ( dB )	TX Antenna Gain ( dBi )	Polarization ( H/V )	Result
1672	-52.19	-13	-39.19	-66.66	-58.87	0.57	9.40	H	Pass
2510	-48.61	-13	-35.61	-69.72	-56.31	0.75	10.60	H	Pass
3346	-46.89	-13	-33.89	-71.80	-56.47	0.87	12.60	H	Pass

<b>Band :</b>	GSM850 for CH189		<b>Temperature :</b>	23~25°C					
<b>Test Mode :</b>	GSM Link (GMSK)		<b>Relative Humidity :</b>	48~52%					
<b>Test Engineer :</b>	Kear Huang		<b>Polarization :</b>	Vertical					
<b>Remark :</b>	Spurious emissions within 30-1000MHz were found more than 20dB below limit line.								
Frequency ( MHz )	ERP ( dBm )	Limit ( dBm )	Over Limit ( dB )	SPA Reading ( dBm )	S.G. Power ( dBm )	TX Cable loss ( dB )	TX Antenna Gain ( dBi )	Polarization ( H/V )	Result
1672	-55.71	-13	-42.71	-70.49	-62.39	0.57	9.40	V	Pass
2510	-47.44	-13	-34.44	-70.76	-55.14	0.75	10.60	V	Pass
3346	-43.36	-13	-30.36	-72.23	-52.94	0.87	12.60	V	Pass



<b>Band :</b>	GSM850 for CH251		<b>Temperature :</b>	23~25°C					
<b>Test Mode :</b>	GSM Link (GMSK)		<b>Relative Humidity :</b>	48~52%					
<b>Test Engineer :</b>	Kear Huang		<b>Polarization :</b>	Horizontal					
<b>Remark :</b>	Spurious emissions within 30-1000MHz were found more than 20dB below limit line.								
Frequency ( MHz )	ERP ( dBm )	Limit ( dBm )	Over Limit ( dB )	SPA Reading ( dBm )	S.G. Power ( dBm )	TX Cable loss ( dB )	TX Antenna Gain ( dBi )	Polarization ( H/V )	Result
1697.6	-52.32	-13	-39.32	-66.76	-59.00	0.57	9.40	H	Pass
2546.4	-47.78	-13	-34.78	-69.22	-55.48	0.75	10.60	H	Pass
3395.2	-46.98	-13	-33.98	-71.85	-56.56	0.87	12.60	H	Pass

<b>Band :</b>	GSM850 for CH251		<b>Temperature :</b>	23~25°C					
<b>Test Mode :</b>	GSM Link (GMSK)		<b>Relative Humidity :</b>	48~52%					
<b>Test Engineer :</b>	Kear Huang		<b>Polarization :</b>	Vertical					
<b>Remark :</b>	Spurious emissions within 30-1000MHz were found more than 20dB below limit line.								
Frequency ( MHz )	ERP ( dBm )	Limit ( dBm )	Over Limit ( dB )	SPA Reading ( dBm )	S.G. Power ( dBm )	TX Cable loss ( dB )	TX Antenna Gain ( dBi )	Polarization ( H/V )	Result
1697.6	-54.97	-13	-41.97	-69.75	-61.65	0.57	9.40	V	Pass
2546.4	-46.65	-13	-33.65	-70.13	-54.35	0.75	10.60	V	Pass
3395.2	-43.25	-13	-30.25	-72.14	-52.83	0.87	12.60	V	Pass



<b>Band :</b>	GSM1900 for CH512	<b>Temperature :</b>	23~25°C						
<b>Test Mode :</b>	GSM Link (GMSK)	<b>Relative Humidity :</b>	48~52%						
<b>Test Engineer :</b>	Kear Huang	<b>Polarization :</b>	Horizontal						
<b>Remark :</b>	Spurious emissions within 30-1000MHz were found more than 20dB below limit line.								
Frequency ( MHz )	EIRP ( dBm )	Limit ( dBm )	Over Limit ( dB )	SPA Reading ( dBm )	S.G. Power ( dBm )	TX Cable loss ( dB )	TX Antenna Gain ( dBi )	Polarization ( H/V )	Result
3700.4	-44.22	-13	-31.22	-72.86	-55.95	0.87	12.60	H	Pass
5550.6	-43.67	-13	-30.67	-73.99	-55.70	1.07	13.10	H	Pass
7400.8	-44.36	-13	-31.36	-76.02	-53.79	1.87	11.30	H	Pass

<b>Band :</b>	GSM1900 for CH512	<b>Temperature :</b>	23~25°C						
<b>Test Mode :</b>	GSM Link (GMSK)	<b>Relative Humidity :</b>	48~52%						
<b>Test Engineer :</b>	Kear Huang	<b>Polarization :</b>	Vertical						
<b>Remark :</b>	Spurious emissions within 30-1000MHz were found more than 20dB below limit line.								
Frequency ( MHz )	EIRP ( dBm )	Limit ( dBm )	Over Limit ( dB )	SPA Reading ( dBm )	S.G. Power ( dBm )	TX Cable loss ( dB )	TX Antenna Gain ( dBi )	Polarization ( H/V )	Result
3700.4	-43.62	-13	-30.62	-72.07	-55.35	0.87	12.6	V	Pass
5550.6	-42.60	-13	-29.60	-73.73	-54.63	1.07	13.1	V	Pass
7400.8	-43.75	-13	-30.75	-75.64	-53.18	1.87	11.3	V	Pass



<b>Band :</b>	GSM1900 for CH661		<b>Temperature :</b>	23~25°C					
<b>Test Mode :</b>	GSM Link (GMSK)		<b>Relative Humidity :</b>	48~52%					
<b>Test Engineer :</b>	Kear Huang		<b>Polarization :</b>	Horizontal					
<b>Remark :</b>	Spurious emissions within 30-1000MHz were found more than 20dB below limit line.								
Frequency ( MHz )	EIRP ( dBm )	Limit ( dBm )	Over Limit ( dB )	SPA Reading ( dBm )	S.G. Power ( dBm )	TX Cable loss ( dB )	TX Antenna Gain ( dBi )	Polarization ( H/V )	Result
3760	-44.71	-13	-31.71	-73.35	-56.44	0.87	12.60	H	Pass
5640	-43.69	-13	-30.69	-74.01	-55.72	1.07	13.10	H	Pass
7520	-43.95	-13	-30.95	-75.61	-53.38	1.87	11.30	H	Pass

<b>Band :</b>	GSM1900 for CH661		<b>Temperature :</b>	23~25°C					
<b>Test Mode :</b>	GSM Link (GMSK)		<b>Relative Humidity :</b>	48~52%					
<b>Test Engineer :</b>	Kear Huang		<b>Polarization :</b>	Vertical					
<b>Remark :</b>	Spurious emissions within 30-1000MHz were found more than 20dB below limit line.								
Frequency ( MHz )	EIRP ( dBm )	Limit ( dBm )	Over Limit ( dB )	SPA Reading ( dBm )	S.G. Power ( dBm )	TX Cable loss ( dB )	TX Antenna Gain ( dBi )	Polarization ( H/V )	Result
3760	-43.72	-13	-30.72	-72.17	-55.45	0.87	12.6	V	Pass
5640	-40.83	-13	-27.83	-71.96	-52.86	1.07	13.1	V	Pass
7520	-43.07	-13	-30.07	-74.96	-52.50	1.87	11.3	V	Pass



<b>Band :</b>	GSM1900 for CH810	<b>Temperature :</b>	23~25°C						
<b>Test Mode :</b>	GSM Link (GMSK)	<b>Relative Humidity :</b>	48~52%						
<b>Test Engineer :</b>	Kear Huang	<b>Polarization :</b>	Horizontal						
<b>Remark :</b>	Spurious emissions within 30-1000MHz were found more than 20dB below limit line.								
Frequency ( MHz )	EIRP ( dBm )	Limit ( dBm )	Over Limit ( dB )	SPA Reading ( dBm )	S.G. Power ( dBm )	TX Cable loss ( dB )	TX Antenna Gain ( dBi )	Polarization ( H/V )	Result
3819.6	-45.22	-13	-32.22	-73.86	-56.95	0.87	12.60	H	Pass
5729.4	-43.78	-13	-30.78	-74.10	-55.81	1.07	13.10	H	Pass
7639.2	-43.60	-13	-30.60	-75.26	-53.03	1.87	11.30	H	Pass

<b>Band :</b>	GSM1900 for CH810	<b>Temperature :</b>	23~25°C						
<b>Test Mode :</b>	GSM Link (GMSK)	<b>Relative Humidity :</b>	48~52%						
<b>Test Engineer :</b>	Kear Huang	<b>Polarization :</b>	Vertical						
<b>Remark :</b>	Spurious emissions within 30-1000MHz were found more than 20dB below limit line.								
Frequency ( MHz )	EIRP ( dBm )	Limit ( dBm )	Over Limit ( dB )	SPA Reading ( dBm )	S.G. Power ( dBm )	TX Cable loss ( dB )	TX Antenna Gain ( dBi )	Polarization ( H/V )	Result
3819.6	-43.93	-13	-30.93	-72.38	-55.66	0.87	12.6	V	Pass
5729.4	-40.06	-13	-27.06	-71.19	-52.09	1.07	13.1	V	Pass
7639.2	-43.90	-13	-30.90	-75.79	-53.33	1.87	11.3	V	Pass

## 3.8 Frequency Stability Measurement

### 3.8.1 Description of Frequency Stability Measurement

The frequency stability shall be measured by variation of ambient temperature and variation of primary supply voltage to ensure that the fundamental emission stays within the authorized frequency block. The frequency stability of the transmitter shall be maintained within  $\pm 0.00025\%$  ( $\pm 2.5\text{ppm}$ ) of the center frequency.

### 3.8.2 Measuring Instruments

The measuring equipment is listed in the section 4 of this test report.

### 3.8.3 Test Procedures for Temperature Variation

1. The testing follows FCC KDB 971168 v02r02 Section 9.0.
2. The EUT was set up in the thermal chamber and connected with the system simulator.
3. With power OFF, the temperature was decreased to  $-30^{\circ}\text{C}$  and the EUT was stabilized before testing. Power was applied and the maximum change in frequency was recorded within one minute.
4. With power OFF, the temperature was raised in  $10^{\circ}\text{C}$  steps up to  $50^{\circ}\text{C}$ . The EUT was stabilized at each step for at least half an hour. Power was applied and the maximum frequency change was recorded within one minute.

### 3.8.4 Test Procedures for Voltage Variation

1. The testing follows FCC KDB 971168 v02r02 Section 9.0.
2. The EUT was placed in a temperature chamber at  $25\pm 5^{\circ}\text{C}$  and connected with the system simulator.
3. The power supply voltage to the EUT was varied from BEP to 115% of the nominal value measured at the input to the EUT.
4. The variation in frequency was measured for the worst case.

### 3.8.5 Test Setup

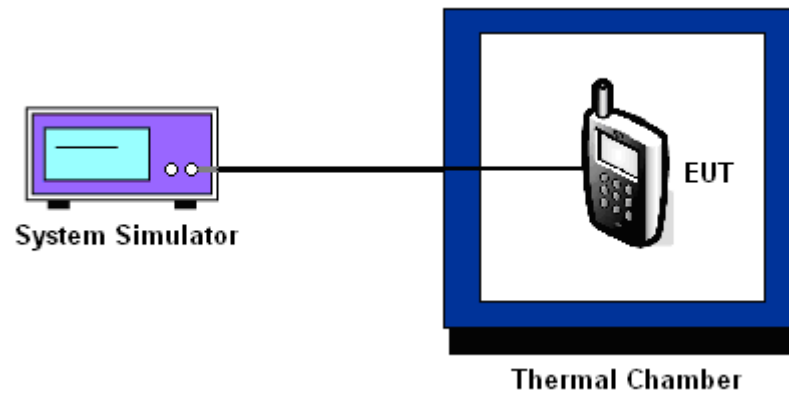



3.8.6 Test Result of Temperature Variation

Band :	GSM 850	Channel :	189
Limit (ppm) :	2.5	Frequency :	836.4 MHz

Temperature (°C)	GSM	Result
	Deviation (ppm)	
50	0.0108	PASS
40	0.0072	
30	0.0036	
20(Ref.)	0.0000	
10	0.0024	
0	0.0084	
-10	0.0012	
-20	0.0036	
-30	0.0741	

Band :	GSM 1900	Channel :	661
Limit (ppm) :	within authorized band	Frequency :	1880.0 MHz

Temperature (°C)	GSM	Result
	Deviation (ppm)	
50	0.0011	PASS
40	0.0016	
30	0.0000	
20(Ref.)	0.0000	
10	0.0032	
0	0.0016	
-10	0.0000	
-20	0.0016	
-30	0.0074	

Note: The frequency fundamental emissions stay within the authorized frequency block based on the frequency deviation measured is small.



3.8.7 Test Result of Voltage Variation

Band & Channel	Mode	Voltage (Volt)	Deviation (ppm)	Limit (ppm)	Result
GSM 850 CH189	GSM	3.80	0.0108	2.5	PASS
		BEP	0.0359		
		4.35	0.0120		
GSM 1900 CH661	GSM	3.80	0.0005	(Note 3.)	
		BEP	0.0048		
		4.35	0.0059		

Note:

1. Normal Voltage = 3.80V.
2. Battery End Point (BEP) = 3.50 V.
3. The frequency fundamental emissions stay within the authorized frequency block based on the frequency deviation measured is small.



## 4 List of Measuring Equipment

Instrument	Manufacturer	Model No.	Serial No.	Characteristics	Calibration Date	Test Date	Due Date	Remark
Spectrum Analyzer	R&S	FSP30	101400	9kHz~30GHz	Jan. 28, 2015	Mar. 10, 2015	Jan. 27, 2016	Conducted (TH01-SZ)
Spectrum Analyzer	R&S	FSV40	101078	10Hz~40GHz	May 08, 2014	Mar. 10, 2015	May 07, 2015	Conducted (TH01-SZ)
Thermal Chamber	Hongzhangroup	LP-150U	HD20120425	-40°C~150°C	Jan. 28, 2015	Mar. 10, 2015	Jan. 27, 2016	Conducted (TH01-SZ)
DC Power Supply	GWINSTEK	GPS-3030D	EM882636	DC 10~30V	May 08, 2014	Mar. 10, 2015	May 07, 2015	Conducted (TH01-SZ)
EMI TEST Receiver	R&S	ESCI7	100768	9kHz~3GHz	May 04, 2014	Mar. 09, 2015	May 03, 2015	Radiation (03CH01-SZ)
Spectrum Analyzer	Agilent Technologies	N9038A	MY52260185	20Hz~26.5GHz	May 26, 2014	Mar. 09, 2015	May 25, 2015	Radiation (03CH01-SZ)
Bilog Antenna	TESEQ	CBL 6112D	37877	30MHz~2GHz	Oct. 15, 2014	Mar. 09, 2015	Oct. 14, 2015	Radiation (03CH01-SZ)
Double Ridge Horn Antenna	ETS Lindgren	3117	00119436	1GHz~18GHz	Oct. 15, 2014	Mar. 09, 2015	Oct. 14, 2015	Radiation (03CH01-SZ)
Double Ridged Horn Antenna	COM-POWER	AH-840	101073	18GHz~40GHz	Jun. 09, 2014	Mar. 09, 2015	Jun. 08, 2015	Radiation (03CH01-SZ)
Amplifier	com-power	PA-103A	161069	1~1000MHz	May 04, 2014	Mar. 09, 2015	May 03, 2015	Radiation (03CH01-SZ)
Amplifier	Yiai	AV3860B	04030	2GHz~26.5GHz	May 08, 2014	Mar. 09, 2015	May 07, 2015	Radiation (03CH01-SZ)
AC Source	Chroma	61601ACSO URCE	61601000247 0	100Vac~240Vac	NCR	Mar. 09, 2015	NCR	Radiation (03CH01-SZ)
Turn Table	EM Electronics	EM 1000	N/A	0~360 degree	NCR	Mar. 09, 2015	NCR	Radiation (03CH01-SZ)
Antenna Mast	EM Electronics	EM 1000	N/A	1 m~4 m	NCR	Mar. 09, 2015	NCR	Radiation (03CH01-SZ)
System Simulator	R&S	CMU 200	116456	Full-Band	Aug. 11, 2014	Mar. 09, 2015	Aug. 10, 2015	Radiation (03CH01-SZ)



## 5 Uncertainty of Evaluation

### Uncertainty of Radiated Emission Measurement (30 MHz ~ 1000 MHz)

Measuring Uncertainty for a Level of Confidence of 95% ( $U = 2Uc(y)$ )	3.9 dB
---	--------