



FCC CFR47 PART 22 SUBPART H
FCC CFR47 PART 24 SUBPART E
FCC CFR47 PART 27 SUBPART H
FCC CFR47 PART 27 SUBPART L
FCC CFR47 PART 27 SUBPART M

WWAN

CERTIFICATION TEST REPORT

FOR

CDMA/GSM/WCDMA/LTE Phone + BT/BLE, DTS/UNII a/b/g/n/ac, ANT+ and NFC

MODEL NUMBER : SM-A8050

FCC ID: A3LSMA8050

REPORT NUMBER: 4788886237-E1V1

ISSUE DATE: APR 17, 2019

Prepared for
SAMSUNG ELECTRONICS CO., LTD.
129 SAMSUNG-RO, YEONGTONG-GU, SUWON-SI,
GYEONGGI-DO, 16677, KOREA

Prepared by
UL Korea, Ltd.
26th floor, 152, Teheran-ro, Gangnam-gu Seoul, 06236, Korea
Suwon Test Site: UL Korea, Ltd. Suwon Laboratory
218 Maeyeong-ro, Yeongtong-gu,
Suwon-si, Gyeonggi-do, 16675, Korea
TEL: (031) 337-9902
FAX: (031) 213-5433



ACCREDITED*

Testing
Laboratory

TL-637

Revision History

<u>Rev.</u>	<u>Issue Date</u>	<u>Revisions</u>	<u>Revised By</u>
V1	04/17/19	Initial issue	Junwhan Lee

TABLE OF CONTENTS

1. ATTESTATION OF TEST RESULTS	5
1.1. INTRODUCTION OF TEST DATA REUSE	6
1.2. DIFFERENCE	6
1.3. SPOT CHECK VERIFICATION DATA	6
1.4. REFERENCE DETAIL	7
2. TEST METHODOLOGY	8
3. FACILITIES AND ACCREDITATION	8
4. CALIBRATION AND UNCERTAINTY	9
4.1. MEASURING INSTRUMENT CALIBRATION	9
4.2. SAMPLE CALCULATION	9
4.3. MEASUREMENT UNCERTAINTY	9
5. EQUIPMENT UNDER TEST	10
5.1. DESCRIPTION OF EUT	10
5.2. MAXIMUM OUTPUT POWER	10
5.3. DESCRIPTION OF AVAILABLE ANTENNAS	13
5.4. WORST-CASE ORIENTATION	14
5.5. DESCRIPTION OF TEST SETUP	15
6. TEST AND MEASUREMENT EQUIPMENT	17
7. SUMMARY TABLE	18
8. PEAK TO AVERAGE RATIO	19
8.1. CONDUCTED PEAK TO AVERAGE RESULT	20
9. LIMITS AND CONDUCTED RESULTS	28
9.1. OCCUPIED BANDWIDTH	28
9.1.1. OCCUPIED BANDWIDTH RESULTS	29
9.2. BAND EDGE EMISSIONS	53
9.2.1. BAND EDGE RESULT	55
9.2.2. EMISSION MASK RESULT	72
9.3. OUT OF BAND EMISSIONS	77
9.3.1. OUT OF BAND EMISSIONS RESULT	78
9.4. FREQUENCY STABILITY	87
9.4.1. FREQUENCY STABILITY RESULTS	88
10. RADIATED TEST RESULTS	93

10.1. RADIATED POWER (ERP & EIRP)	93
10.1.1. ERP/EIRP Results	94
10.1.2. ERP/EIRP DATA	100
10.2. FIELD STRENGTH OF SPURIOUS RADIATION.....	123
10.2.1. SPURIOUS RADIATION PLOTS.....	124
11. Appendix A: SETUP PHOTOS	133

Appendix B : Cellular receiver Part 15B test results

1. ATTESTATION OF TEST RESULTS

COMPANY NAME: SAMSUNG ELECTRONICS CO., LTD.

EUT DESCRIPTION: CDMA/GSM/WCDMA/LTE Phone + BT/BLE, DTS/UNII a/b/g/n/ac, ANT+ and NFC

MODEL NUMBER: SM-A8050

SERIAL NUMBER: R38M10EX4RZ, R38M10EX58W, R38M308CRXH (CONDUCTED, Original)
R38M10EX4EH, R38M308CJ1K (RADIATED, Original);
R38M10QK33K (CONDUCTED, Additional test)
R38M10QK2VL, R38M10QK2SP, R38M30952GW, R38M30952MF (RADIATED, Spot check & Additional test);

DATE TESTED: FEB 27, 2019 – MAR 27, 2019; (Original)
APR 09, 2019 – APR 17, 2019; (Spot check & Additional test)

APPLICABLE STANDARDS	
STANDARD	TEST RESULTS
FCC PART 22H, 24E, 27H, 27L and 27M	Pass

UL Korea, Ltd. tested the above equipment in accordance with the requirements set forth in the above standards. All indications of Pass/Fail in this report are opinions expressed by UL Korea, Ltd. based on interpretations and/or observations of test results. Measurement Uncertainties were not taken into account and are published for informational purposes only. The test results show that the equipment tested is capable of demonstrating compliance with the requirements as documented in this report.

Note: The results documented in this report apply only to the tested sample, under the conditions and modes of operation as described herein. This document may not be altered or revised in any way unless done so by UL Korea, Ltd. and all revisions are duly noted in the revisions section. Any alteration of this document not carried out by UL Korea, Ltd. will constitute fraud and shall nullify the document. This report must not be used by the client to claim product certification, approval, or endorsement by IAS, any agency of the Federal Government, or any agency of any government.

Approved & Released For
UL Korea, Ltd. By:



SungGil Park
Suwon Lab Engineer
UL Korea, Ltd.

Tested By:



Junwhan Lee
Suwon Lab Engineer
UL Korea, Ltd.

1.1. INTRODUCTION OF TEST DATA REUSE

This report referenced from the FCC ID: A3LSMA805F PCE WWAN(FCC CFR 47 Part 22, 24, 27).And the applicant takes full responsibility that the test data as referenced in this report represent compliance for this FCC ID.

1.2. DIFFERENCE

The FCC ID: A3LSMA8050 shares the same enclosure and circuit board as FCC ID: A3LSMA805F. The WWAN antennas and surrounding circuitry and layout for re-used bands are identical between these two units.

After confirming through preliminary radiated emissions that the performance of the FCC ID: A3LSMA805F remains representative of FCC ID: A3LSMA8050. The test data of FCC ID: A3LSMA805F being submitted for this application to cover WWAN features.

- Test data re-use bands : GSM850/1900, WCDMA B5/B2, LTE B5
- Test band : CDMA BC0, LTE B4, LTE B12, LTE B41

1.3. SPOT CHECK VERIFICATION DATA

Band	Test Item	Worst Mode	Frequency	Test Limit	Original model	Spot check model	Deviation	Remark
					SM-A805F/DS Results	SM-A8050 Results		
					FCC ID : A3LSMA805F	FCC ID : A3LSMA8050		
GSM850	ERP	GPRS	836.6 MHz	38.50 dBm	25.49 dBm	26.84 dBm	1.35 dB	
	RSE	GPRS	824.2 MHz	-13.00 dBm	-43.39 dBm	-41.30 dBm	2.09 dB	2nd Harmonic
GSM1900	EIRP	GPRS	1880.0 MHz	33.00 dBm	27.23 dBm	26.65 dBm	-0.58 dB	
	RSE	GPRS	1909.8 MHz	-13.00 dBm	-38.80 dBm	-44.00 dBm	-5.20 dB	3rd Harmonic
WCDMA Band 2	EIRP	Rel99	1880.0 MHz	33.00 dBm	20.03 dBm	20.21 dBm	0.18 dB	
	RSE	Rel99	1852.4 MHz	-13.00 dBm	-44.52 dBm	-47.40 dBm	-2.88 dB	2nd Harmonic
WCDMA Band 5	ERP	Rel99	826.4 MHz	38.50 dBm	15.39 dBm	16.48 dBm	1.09 dB	
	RSE	HDSPA	846.6 MHz	-13.00 dBm	-52.64 dBm	-52.70 dBm	-0.06 dB	4th Harmonic
LTE Band 5	ERP	10M QPSK	829.0 MHz	38.50 dBm	16.53 dBm	17.03 dBm	0.50 dB	
	RSE	15M QPSK	836.5 MHz	-13.00 dBm	-47.82 dBm	-49.00 dBm	-1.18 dB	5th Harmonic

Comparison of two models, upper deviation is within 3dB range and all test results are under FCC Technical Limits.

1.4. REFERENCE DETAIL

Reference application that contains the reused reference data.

Equipment Class	Reference FCC ID	Type Grant/Permissive Change	Reference Application	Folder Test/RF Exposure	Report Title / Section
PCE	A3LSMA805F	Grant	4788886234-E1	Test	FCC Report WWAN / GSM,WCDMA, LTE B5
DTS	A3LSMA805F	Grant	4788886234-E2	Test	FCC Report DTS WLAN / All sections
			4788886234-E3	Test	FCC Report BLE / All sections
DSS	A3LSMA805F	Grant	4788886234-E4	Test	FCC Report BT / All sections
NII	A3LSMA805F	Grant	4788886234-E5	Test	FCC Report UNII/ All sections
DXX	A3LSMA805F	Grant	4788886234-E6	Test	FCC Report ANT+/ All sections
			4788886234-E7	Test	FCC Report NFC/ All sections

2. TEST METHODOLOGY

The tests documented in this report were performed in accordance with following methods.

1. FCC CFR 47 Part 2.
2. FCC CFR 47 Part 22.
3. FCC CFR 47 Part 24.
4. FCC CFR 47 Part 27.
5. ANSI TIA-603-E, 2016
6. ANSI C63.26, 2015
7. KDB 971168 D01 Power Meas License Digital Systems v03r01
8. KDB 484596 D01 Referencing Test Data v01

3. FACILITIES AND ACCREDITATION

The test sites and measurement facilities used to collect data are located at 218 Maeyeong-ro, Yeongtong-gu, Suwon-si, Gyeonggi-do, 16675, Korea. Line conducted emissions are measured only at the 218 address. The following table identifies which facilities were utilized for radiated emission measurements documented in this report. Specific facilities are also identified in the test results sections.

218 Maeyeong-ro	
<input checked="" type="checkbox"/>	Chamber 1
<input checked="" type="checkbox"/>	Chamber 2
<input type="checkbox"/>	Chamber 3

UL Korea, Ltd. is accredited by IAS, Laboratory Code TL-637. The full scope of accreditation can be viewed at <http://www.iasonline.org/PDF/TL/TL-637.pdf>.

4. CALIBRATION AND UNCERTAINTY

4.1. MEASURING INSTRUMENT CALIBRATION

The measuring equipment utilized to perform the tests documented in this report has been calibrated in accordance with the manufacturer's recommendations, and is traceable to recognized national standards.

4.2. SAMPLE CALCULATION

Where relevant, the following sample calculation is provided:

$EIRP = \text{PSA reading with EUT worst orientation (dBm)} + \text{Path loss (dB)} - \text{cable loss (between the SG and substitution antenna)} + \text{Substitution Antenna Factor (dBi)}$

$ERP = \text{PSA reading with EUT worst orientation (dBm)} + \text{Path loss (dB)} - \text{cable loss (between the SG and substitution antenna)}$

(Path loss = Signal generator output – PSA reading with substitution antenna)

4.3. MEASUREMENT UNCERTAINTY

Where relevant, the following measurement uncertainty levels have been estimated for tests performed on the apparatus:

PARAMETER	UNCERTAINTY
Conducted Disturbance, 0.15 to 30 MHz	2.32 dB
Radiated Disturbance, Below 1GHz	3.86 dB
Radiated Disturbance, Above 1 GHz	5.97 dB

Uncertainty figures are valid to a confidence level of 95%.

5. EQUIPMENT UNDER TEST

5.1. DESCRIPTION OF EUT

The EUT is a CDMA/GSM/WCDMA/LTE Phone + BT/BLE, DTS/UNII a/b/g/n/ac, ANT+ and NFC. This test report addresses the WWAN operational mode.

5.2. MAXIMUM OUTPUT POWER

The transmitter has a maximum average radiated ERP / EIRP output powers as follows:

GSM

FCC Part 22/24				
Band	Frequency Range	Modulation	Radiated	
	[MHz]		Avg [dBm]	Avg [mW]
GSM850	824~849	GPRS	25.49	354.00
		EGPRS	20.09	102.09
GSM1900	1850~1910	GPRS	27.27	533.33
		EGPRS	23.53	225.42

WCDMA

FCC Part 22/24				
Band	Frequency Range	Modulation	Radiated	
	[MHz]		Avg [dBm]	Avg [mW]
Band 5	824~849	REL99	15.39	34.59
		HSDPA	14.17	26.12
Band 2	1850~1910	REL99	20.03	100.69
		HSDPA	18.50	70.79

CDMA

FCC Part 22				
Band	Frequency Range	Modulation	Radiated	
	[MHz]	Peak	Avg [dBm]	Avg [mW]
BC0	824~849	1xRTT	17.89	61.52
		EVDO REL. 0	17.00	50.12

LTE Band 4

FCC Part 27					
Band	Frequency Range [MHz]	BandWidth [MHz]	Modulation Peak	Radiated	
				Avg [dBm]	Avg [mW]
Band 4	1710 ~ 1755	20	QPSK	23.42	219.79
			16QAM	22.68	185.35
		15	QPSK	24.00	251.19
			16QAM	22.88	194.09
		10	QPSK	24.19	262.42
			16QAM	23.25	211.35
		5	QPSK	24.06	254.68
			16QAM	23.08	203.24
		3	QPSK	24.23	264.85
			16QAM	22.71	186.64
		1.4	QPSK	23.77	238.23
			16QAM	22.67	184.93

LTE Band 5

FCC Part 22					
Band	Frequency Range [MHz]	BandWidth [MHz]	Modulation	Radiated	
				Avg [dBm]	Avg [mW]
Band 5	824 ~ 849	10	QPSK	16.53	44.98
			16QAM	15.83	38.28
		5	QPSK	16.22	41.88
			16QAM	15.68	36.98
		3	QPSK	16.19	41.59
			16QAM	15.27	33.65
		1.4	QPSK	16.03	40.09
			16QAM	15.39	34.59

LTE Band 12

FCC Part 27					
Band	Frequency Range [MHz]	BandWidth [MHz]	Modulation	Radiated	
				Avg [dBm]	Avg [mW]
Band 12	699 ~ 716	10	QPSK	14.90	30.90
			16QAM	13.89	24.49
		5	QPSK	15.72	37.33
			16QAM	14.94	31.19
		3	QPSK	15.84	38.37
			16QAM	14.54	28.44
		1.4	QPSK	15.93	39.17
			16QAM	14.59	28.77

LTE Band 17

LTE Band 17 (Frequency range: 704-716 MHz) is covered by LTE Band 12 (Frequency range: 699-716 MHz) due to overlapping frequency range, same maximum tune-up limit and same channel bandwidth.

LTE Band 41

FCC Part 27					
Band	Frequency Range [MHz]	BandWidth [MHz]	Modulation	Radiated	
				Avg [dBm]	Avg [mW]
Band 41	2555 - 2655	20	QPSK	21.67	146.89
			16QAM	22.06	160.69
		15	QPSK	21.92	155.60
			16QAM	21.80	151.36
		10	QPSK	21.58	143.88
			16QAM	22.13	163.31
		5	QPSK	22.11	162.55
			16QAM	21.90	154.88

5.3. DESCRIPTION OF AVAILABLE ANTENNAS

The radio utilizes a internal antenna for the [List the bands supported] with a maximum peak gain as follow:

Frequency (MHz)	Peak Gain (dBi)
GSM1900 / WCDMA Band 2 1850 ~ 1910 MHz	-4.51
LTE Band 4 1710 ~ 1755 MHz	-4.86
CDMA BC0 / GSM850 / WCDMA Band 5 / LTE Band 5 824 ~ 849 MHz	-6.32
LTE Band 12 / LTE Band 17 699 ~ 716 MHz	-6.60
LTE Band 41 2555 ~ 2655 MHz	-4.53

5.4. WORST-CASE ORIENTATION

The fundamental and radiated spurious emission were investigated in three orthogonal orientations X, Y and Z, it was determined that below orientation was worst-case orientation for each band. Also this EUT have a camera pop up function when user operate front camera function. This condition was also considered.

Band	ERP/EIRP						RSE					
	Camera Pou-up			Normal			Camera Pou-up			Normal		
	X	Y	Z	X	Y	Z	X	Y	Z	X	Y	Z
CDMA BC0						○					○	
GSM850						○			○			
GSM1900						○					○	
WCDMA B5						○						○
WCDMA B2					○			○				
LTE B4				○							○	
LTE B5						○						○
LTE B12						○		○				
LTE B41	○										○	

Following modes should be considered as worst-case scenario for all other measurements.

- GSM : GPRS/EGPRS,
- UMTS : REL 99/HSDPA

For LTE Bands, the worst-case scenario for all measurements is based on the average conducted output power measurement investigation results. Output power measurements were measured on QPSK, 16QAM and 64QAM modulations. It was found that QPSK and 16QAM results were worst case. All testing was performed using QPSK and 16QAM modulations to represent the worst case. However, the out of band emissions and spurious radiation were only performed on bandwidth and RB offset(with RB size 1) with the highest power in QPSK. (LTE Band 17 didn't support 64QAM modulation)

Highest power setting for each bands				
LTE Band	Frequency (MHz)	Bandwidth (MHz)	RB size	RB offset
4	1717.5	15	1	74
	1732.5		1	0
	1747.5		1	0
5	826.5	5	1	0
	836.5		1	24
	846.5		1	24
12	700.5	3	1	8
	707.5		1	8
	714.5		1	8
41	2565.0	20	1	99
	2593.0		1	0
	2645.0		1	0

5.5. DESCRIPTION OF TEST SETUP

SUPPORT EQUIPMENT

Support Equipment List				
Description	Manufacturer	Model	Serial Number	FCC ID
Charger	SAMSUNG	EP-TA800	R37M1E50KV1SE3	N/A
Data Cable	SAMSUNG	EP-DA905BBE	N/A	N/A
Earphone	SAMSUNG	GHSS028-W4	N/A	N/A

I/O CABLE

I/O Cable List						
Cable No	Port	# of identical ports	Connector Type	Cable Type	Cable Length (m)	Remarks
1	DC Power	1	C Type	Shielded	1.1m	N/A
2	Audio	2	C Type	Unshielded	1.2m	N/A

TEST SETUP

The EUT is continuously communicated to the call box during the tests.

SETUP DIAGRAM FOR TESTS (CONDUCTED TEST SETUP)

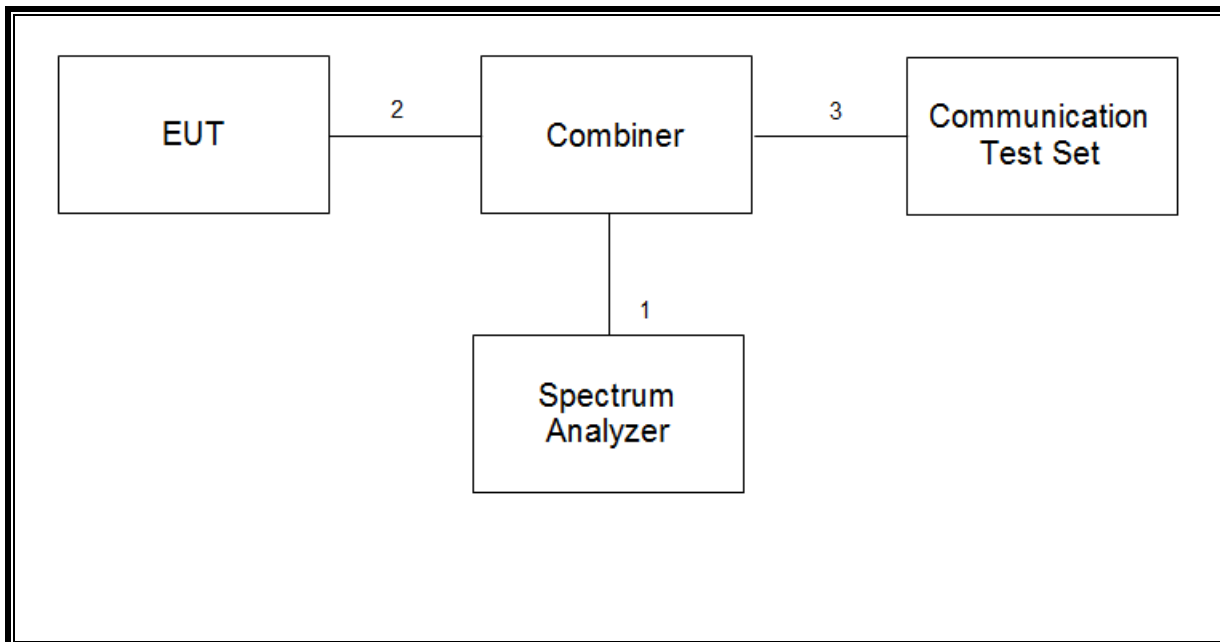

SETUP DIAGRAM FOR TESTS (RADIATED TEST SETUP)

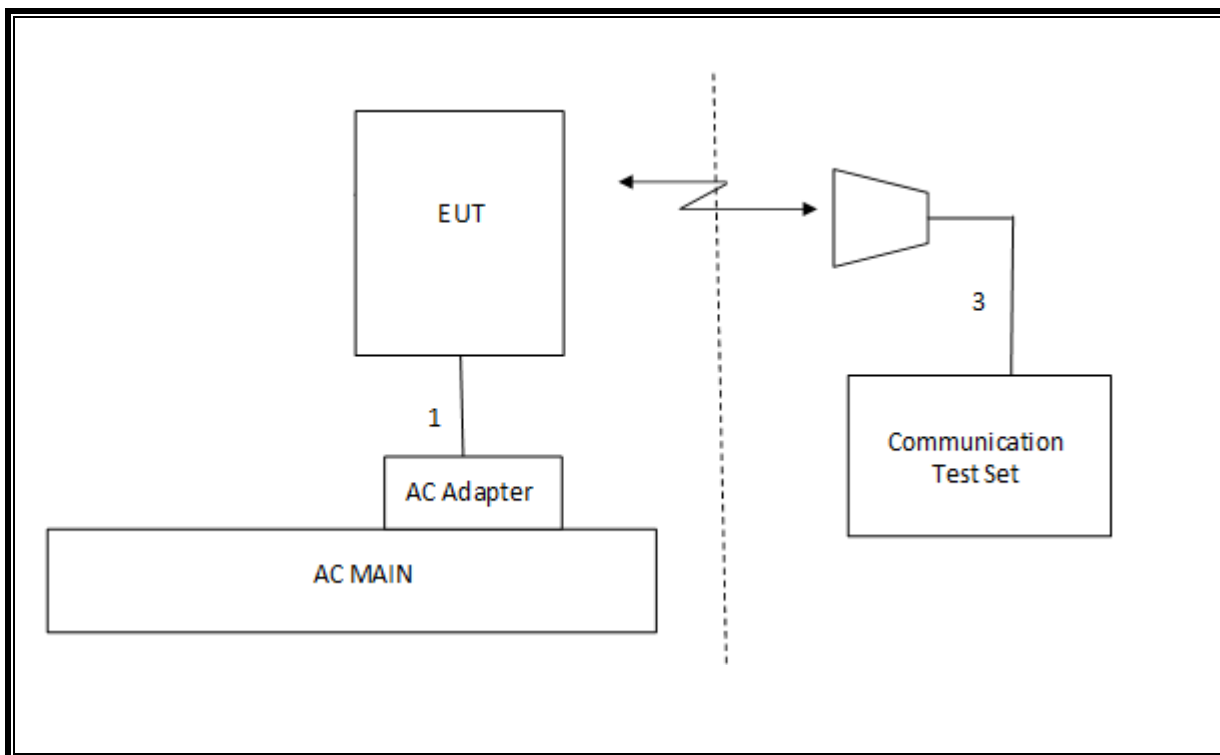

6. TEST AND MEASUREMENT EQUIPMENT

The following test and measurement equipment was utilized for the tests documented in this report:

Test Equipment List				
Description	Manufacturer	Model	S/N	Cal Due
Antenna, Tuned Dipole 400-1000 MHz	ETS	3121D DB4	00164753	06-30-19
Antenna, Horn, 40 GHz	ETS	3116C	00166155	08-14-20
Preamplifier	ETS	3116C-PA	00168841	08-09-19
Antenna, Horn, 40 GHz	ETS	3116C	00168645	12-04-19
Antenna, Bilog, 30MHz-1GHz	SCHWARZBECK	VULB9163	750	08-04-20
Antenna, Bilog, 30MHz-1GHz	SCHWARZBECK	VULB9163	845	08-04-20
Antenna, Bilog, 30MHz-1GHz	SCHWARZBECK	VULB9163	749	08-04-20
Antenna, Horn, 18 GHz	ETS	3115	00167211	08-04-20
Antenna, Horn, 18 GHz	ETS	3115	00161451	08-04-20
Antenna, Horn, 18 GHz	ETS	3117	00168724	08-04-20
Antenna, Horn, 18 GHz	ETS	3117	00205959	08-04-20
Antenna, Horn, 18 GHz	ETS	3117	00168717	08-04-20
Combiner	WEINSCHEL	1575	2150	08-08-19
Communications Test Set	R&S	CMW500	115331	08-07-19
DC Power Supply	Agilent / HP	E3640A	MY54226395	08-06-19
Preamplifier, 1000 MHz	Sonoma	310N	341282	08-07-19
Preamplifier, 1000 MHz	Sonoma	310N	370599	08-06-19
Preamplifier, 1000 MHz	Sonoma	310N	351741	08-07-19
Preamplifier, 18 GHz	Miteq	AFS42-00101800-25-S-42	1876511	08-07-19
Preamplifier, 18 GHz	Miteq	AFS42-00101800-25-S-42	2029169	08-07-19
Preamplifier, 18 GHz	Miteq	AFS42-00101800-25-S-42	1896138	08-07-19
Spectrum Analyzer, 44 GHz	Agilent / HP	N9030A	MY54490312	08-06-19
EMI Test Receive, 40 GHz	R&S	ESU40	100439	08-06-19
EMI Test Receive, 40 GHz	R&S	ESU40	100457	08-06-19
EMI Test Receive, 44 GHz	R&S	ESW40	101590	08-06-19
High Pass Filter 1.2GHz	Micro-Tronics	HPM50108-02	G005	08-08-19
High Pass Filter 1.2GHz	Micro-Tronics	HPM50108-02	G006	08-08-19
High Pass Filter 2.8GHz	Micro-Tronics	HPM50111-02	010	08-08-19
High Pass Filter 2.8GHz	Micro-Tronics	HPM50111-02	011	08-08-19
High Pass Filter 4GHz	Micro-Tronics	HPM50118-02	G001	08-08-19
High Pass Filter 4GHz	Micro-Tronics	HPM50118-02	G002	08-08-19
Attenuator	PASTERNAK	PE7087-10	A009	08-08-19
Attenuator	PASTERNAK	PE7087-10	A001	08-08-19
Attenuator	PASTERNAK	PE7087-10	A008	08-08-19
Attenuator	PASTERNAK	PE7087-10	2	08-07-19
Attenuator	PASTERNAK	PE7395-10	A011	08-08-19
Antenna, Loop, 9kHz-30MHz	R&S	HFH2-Z2	100418	10-26-19
Temperature Chamber	ESPEC	SH-642	93001109	08-06-19
UL Software				
Description	Manufacturer	Model	Version	
Antenna port test software	UL	CLT	Ver 2.5	

7. SUMMARY TABLE

FCC Part Section	Test Description	Test Limit	Test Condition	Test Result
2.1049	Occupied Band width (99%)	N/A	Conducted	Pass
22.917(a) 24.238(a) 27.53(g),(h)	Band Edge / Conducted Spurious Emission	-13dBm		Pass
27.53(m)	Conducted Spurious Emission	-25 dBm		Pass
27.53(m)	Emission mask	Section 9.2.2		Pass
2.1046	Conducted output power	N/A		See the RF exposure test report. (4788886237-S1 FCC Report SAR)
22.355 24.235 27.54	Frequency Stability	2.5PPM		Pass
22.913(a)(5)	Effective Radiated Power	38.5 dBm	Radiated	Pass
27.50(c)(10)		34.77 dBm		Pass
24.232(c) 27.50(h)(2)	Equivalent Isotropic Radiated Power	33dBm		Pass
27.50(d)(4)		30dBm		Pass
22.917(a) 24.238(a) 27.53(g),(h)	Radiated Spurious Emission	-13dBm		Pass
27.53 (m)		-25dBm		Pass

8. PEAK TO AVERAGE RATIO

Test Procedure

Per KDB 971168 D01 Power Meas License Digital Systems v03r01;

The transmitter output was connected to a CMW500 Test Set and configured to operate at maximum power. The PAR were measured on the Spectrum Analyzer.

Test Spec

In addition, when the transmitter power is measured in terms of average value, the peak-to-average ratio of the power shall not exceed 13 dB.

RESULTS

8.1. CONDUCTED PEAK TO AVERAGE RESULT

GSM

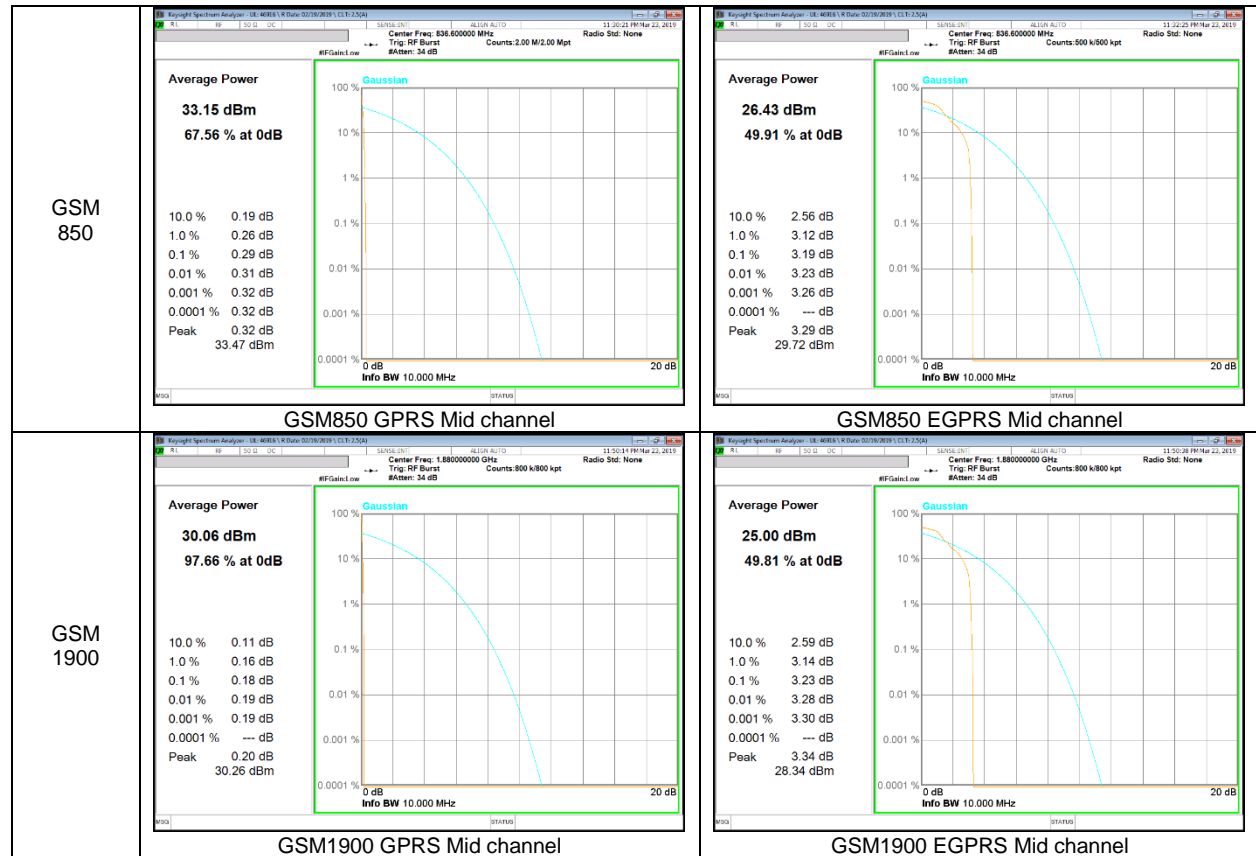

CDMA

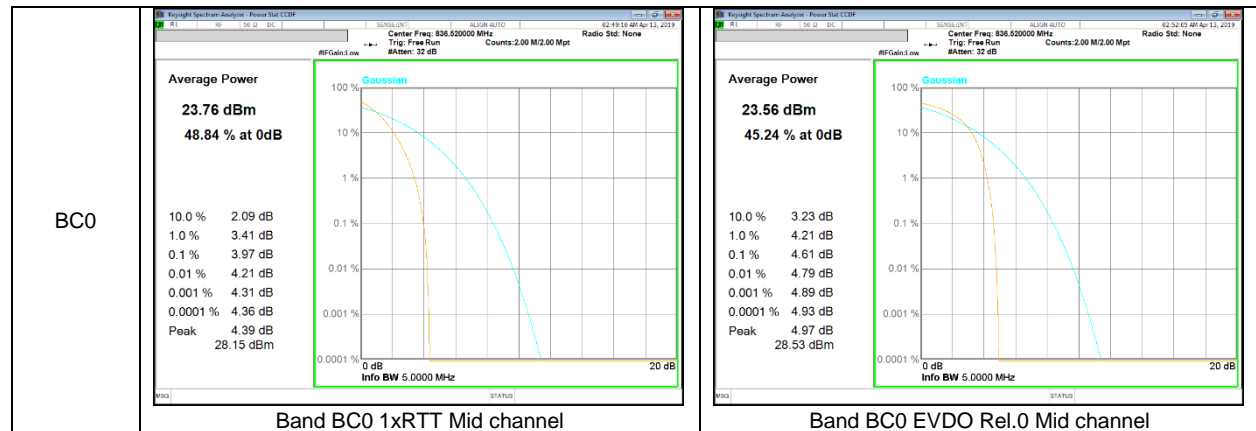

WCDMA

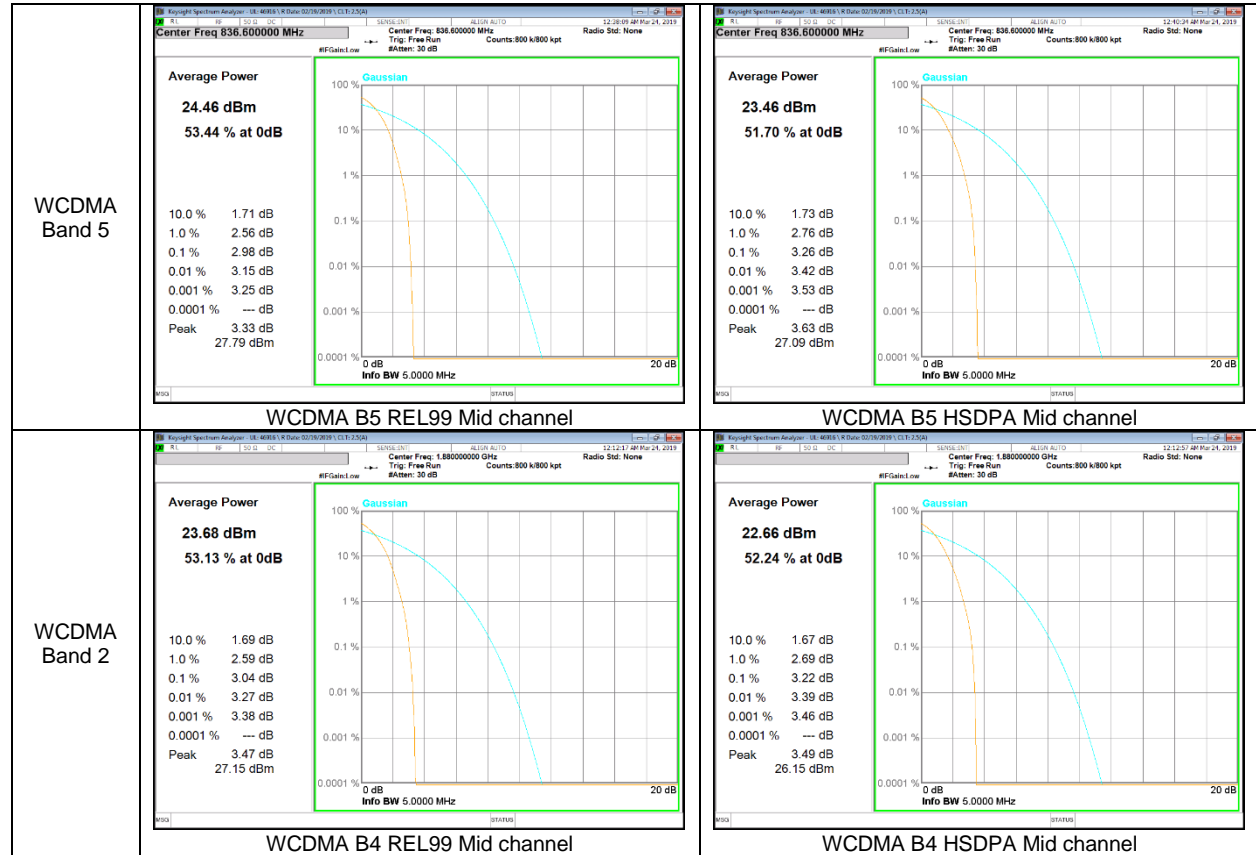

LTE Band 4

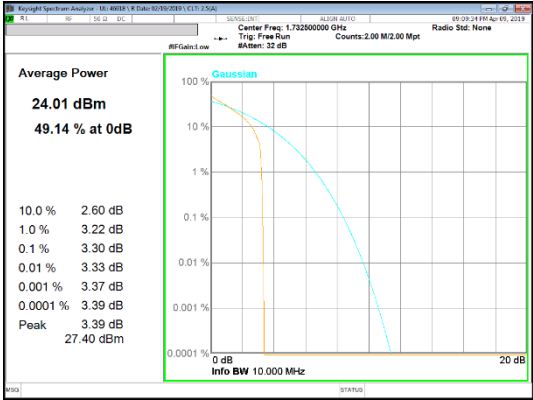
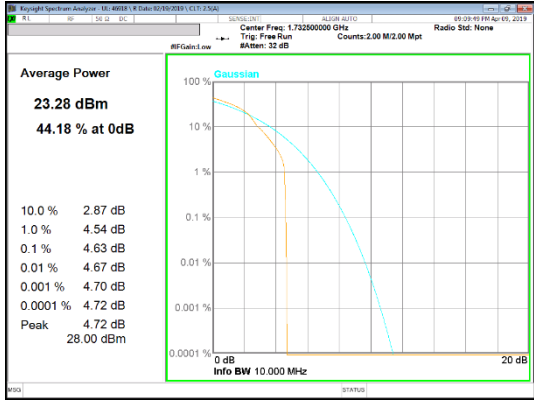
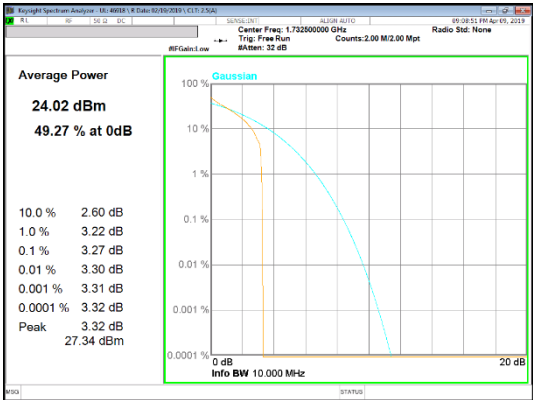
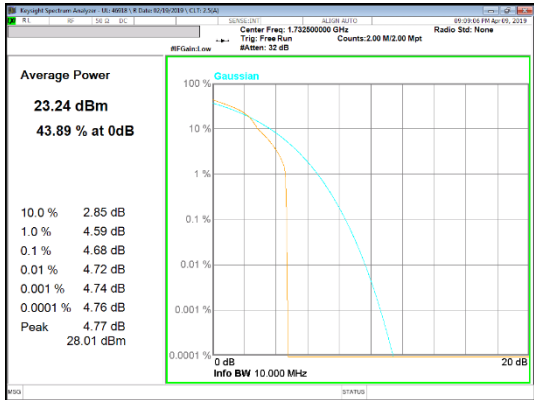
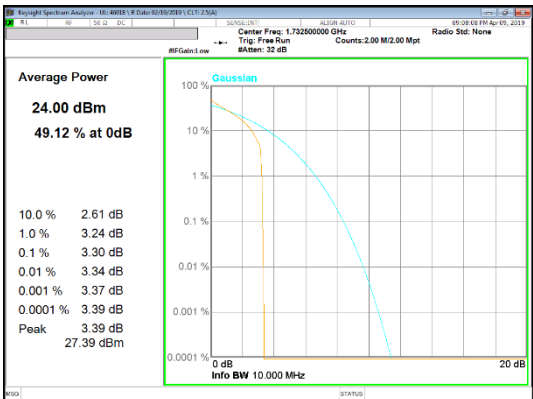
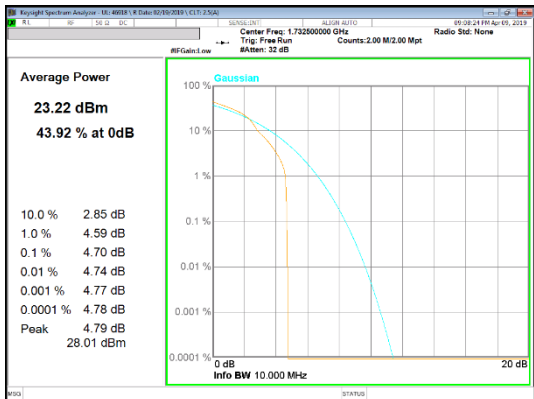
<p>LTE Band 4 20 MHz</p>	 <p>Average Power 24.01 dBm 49.14 % at 0dB</p> <table border="1"> <tr><td>10.0 %</td><td>2.60 dB</td></tr> <tr><td>1.0 %</td><td>3.22 dB</td></tr> <tr><td>0.1 %</td><td>3.30 dB</td></tr> <tr><td>0.01 %</td><td>3.33 dB</td></tr> <tr><td>0.001 %</td><td>3.37 dB</td></tr> <tr><td>0.0001 %</td><td>3.39 dB</td></tr> <tr><td>Peak</td><td>3.39 dB</td></tr> <tr><td>Peak</td><td>27.40 dBm</td></tr> </table> <p>LTE B4 20MHz QPSK Mid channel</p>	10.0 %	2.60 dB	1.0 %	3.22 dB	0.1 %	3.30 dB	0.01 %	3.33 dB	0.001 %	3.37 dB	0.0001 %	3.39 dB	Peak	3.39 dB	Peak	27.40 dBm	 <p>Average Power 23.28 dBm 44.18 % at 0dB</p> <table border="1"> <tr><td>10.0 %</td><td>2.87 dB</td></tr> <tr><td>1.0 %</td><td>4.54 dB</td></tr> <tr><td>0.1 %</td><td>4.63 dB</td></tr> <tr><td>0.01 %</td><td>4.67 dB</td></tr> <tr><td>0.001 %</td><td>4.70 dB</td></tr> <tr><td>0.0001 %</td><td>4.72 dB</td></tr> <tr><td>Peak</td><td>4.72 dB</td></tr> <tr><td>Peak</td><td>28.00 dBm</td></tr> </table> <p>LTE B4 20MHz 16QAM Mid channel</p>	10.0 %	2.87 dB	1.0 %	4.54 dB	0.1 %	4.63 dB	0.01 %	4.67 dB	0.001 %	4.70 dB	0.0001 %	4.72 dB	Peak	4.72 dB	Peak	28.00 dBm
10.0 %	2.60 dB																																	
1.0 %	3.22 dB																																	
0.1 %	3.30 dB																																	
0.01 %	3.33 dB																																	
0.001 %	3.37 dB																																	
0.0001 %	3.39 dB																																	
Peak	3.39 dB																																	
Peak	27.40 dBm																																	
10.0 %	2.87 dB																																	
1.0 %	4.54 dB																																	
0.1 %	4.63 dB																																	
0.01 %	4.67 dB																																	
0.001 %	4.70 dB																																	
0.0001 %	4.72 dB																																	
Peak	4.72 dB																																	
Peak	28.00 dBm																																	
<p>LTE Band 4 15 MHz</p>	 <p>Average Power 24.02 dBm 49.27 % at 0dB</p> <table border="1"> <tr><td>10.0 %</td><td>2.60 dB</td></tr> <tr><td>1.0 %</td><td>3.22 dB</td></tr> <tr><td>0.1 %</td><td>3.27 dB</td></tr> <tr><td>0.01 %</td><td>3.30 dB</td></tr> <tr><td>0.001 %</td><td>3.31 dB</td></tr> <tr><td>0.0001 %</td><td>3.32 dB</td></tr> <tr><td>Peak</td><td>3.32 dB</td></tr> <tr><td>Peak</td><td>27.34 dBm</td></tr> </table> <p>LTE B4 15MHz QPSK Mid channel</p>	10.0 %	2.60 dB	1.0 %	3.22 dB	0.1 %	3.27 dB	0.01 %	3.30 dB	0.001 %	3.31 dB	0.0001 %	3.32 dB	Peak	3.32 dB	Peak	27.34 dBm	 <p>Average Power 23.24 dBm 43.89 % at 0dB</p> <table border="1"> <tr><td>10.0 %</td><td>2.85 dB</td></tr> <tr><td>1.0 %</td><td>4.59 dB</td></tr> <tr><td>0.1 %</td><td>4.68 dB</td></tr> <tr><td>0.01 %</td><td>4.72 dB</td></tr> <tr><td>0.001 %</td><td>4.74 dB</td></tr> <tr><td>0.0001 %</td><td>4.76 dB</td></tr> <tr><td>Peak</td><td>4.77 dB</td></tr> <tr><td>Peak</td><td>28.01 dBm</td></tr> </table> <p>LTE B4 15MHz 16QAM Mid channel</p>	10.0 %	2.85 dB	1.0 %	4.59 dB	0.1 %	4.68 dB	0.01 %	4.72 dB	0.001 %	4.74 dB	0.0001 %	4.76 dB	Peak	4.77 dB	Peak	28.01 dBm
10.0 %	2.60 dB																																	
1.0 %	3.22 dB																																	
0.1 %	3.27 dB																																	
0.01 %	3.30 dB																																	
0.001 %	3.31 dB																																	
0.0001 %	3.32 dB																																	
Peak	3.32 dB																																	
Peak	27.34 dBm																																	
10.0 %	2.85 dB																																	
1.0 %	4.59 dB																																	
0.1 %	4.68 dB																																	
0.01 %	4.72 dB																																	
0.001 %	4.74 dB																																	
0.0001 %	4.76 dB																																	
Peak	4.77 dB																																	
Peak	28.01 dBm																																	
<p>LTE Band 4 10 MHz</p>	 <p>Average Power 24.00 dBm 49.12 % at 0dB</p> <table border="1"> <tr><td>10.0 %</td><td>2.61 dB</td></tr> <tr><td>1.0 %</td><td>3.24 dB</td></tr> <tr><td>0.1 %</td><td>3.30 dB</td></tr> <tr><td>0.01 %</td><td>3.34 dB</td></tr> <tr><td>0.001 %</td><td>3.37 dB</td></tr> <tr><td>0.0001 %</td><td>3.39 dB</td></tr> <tr><td>Peak</td><td>3.39 dB</td></tr> <tr><td>Peak</td><td>27.39 dBm</td></tr> </table> <p>LTE B4 10MHz QPSK Mid channel</p>	10.0 %	2.61 dB	1.0 %	3.24 dB	0.1 %	3.30 dB	0.01 %	3.34 dB	0.001 %	3.37 dB	0.0001 %	3.39 dB	Peak	3.39 dB	Peak	27.39 dBm	 <p>Average Power 23.22 dBm 43.92 % at 0dB</p> <table border="1"> <tr><td>10.0 %</td><td>2.85 dB</td></tr> <tr><td>1.0 %</td><td>4.59 dB</td></tr> <tr><td>0.1 %</td><td>4.70 dB</td></tr> <tr><td>0.01 %</td><td>4.74 dB</td></tr> <tr><td>0.001 %</td><td>4.77 dB</td></tr> <tr><td>0.0001 %</td><td>4.78 dB</td></tr> <tr><td>Peak</td><td>4.79 dB</td></tr> <tr><td>Peak</td><td>28.01 dBm</td></tr> </table> <p>LTE B4 10MHz 16QAM Mid channel</p>	10.0 %	2.85 dB	1.0 %	4.59 dB	0.1 %	4.70 dB	0.01 %	4.74 dB	0.001 %	4.77 dB	0.0001 %	4.78 dB	Peak	4.79 dB	Peak	28.01 dBm
10.0 %	2.61 dB																																	
1.0 %	3.24 dB																																	
0.1 %	3.30 dB																																	
0.01 %	3.34 dB																																	
0.001 %	3.37 dB																																	
0.0001 %	3.39 dB																																	
Peak	3.39 dB																																	
Peak	27.39 dBm																																	
10.0 %	2.85 dB																																	
1.0 %	4.59 dB																																	
0.1 %	4.70 dB																																	
0.01 %	4.74 dB																																	
0.001 %	4.77 dB																																	
0.0001 %	4.78 dB																																	
Peak	4.79 dB																																	
Peak	28.01 dBm																																	

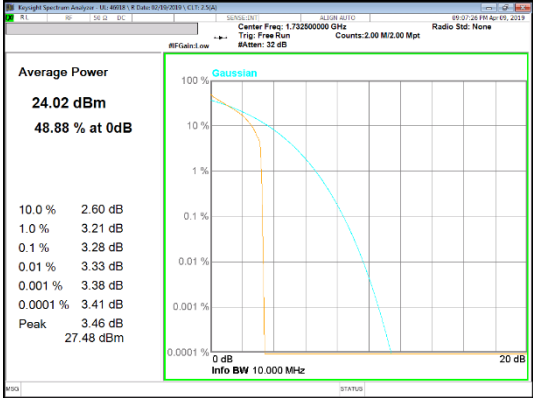
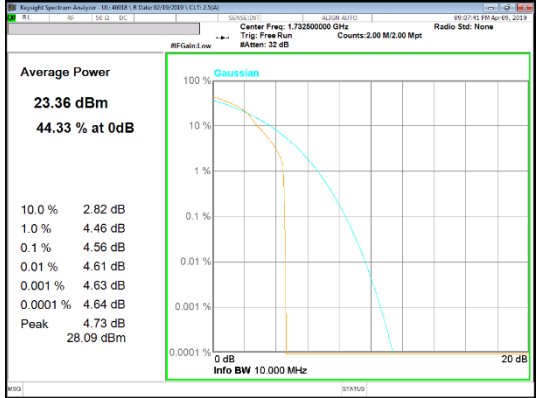
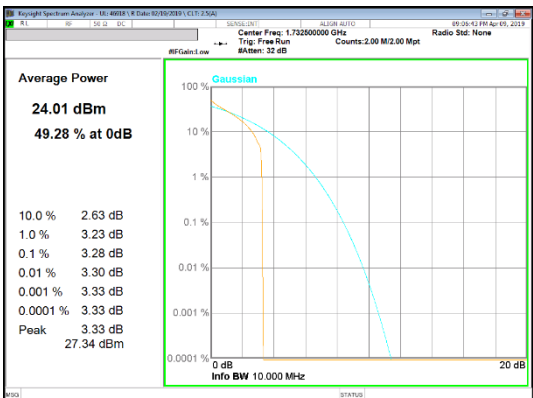
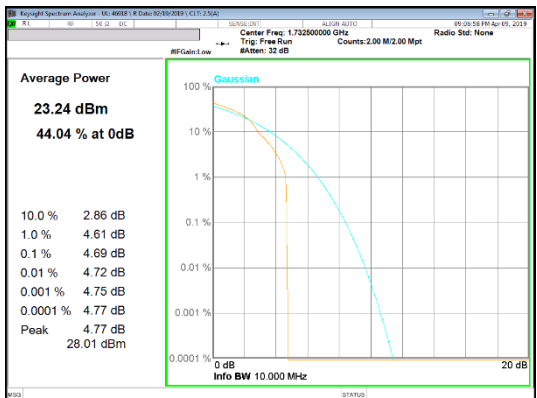
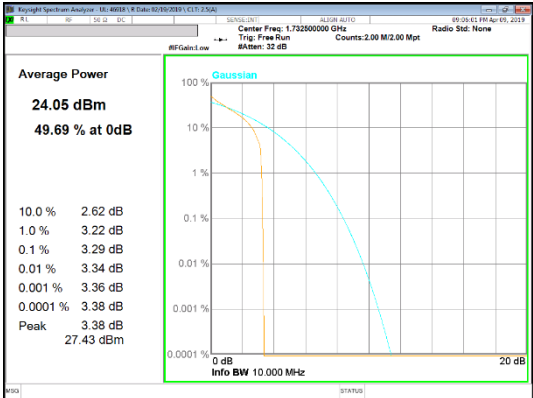
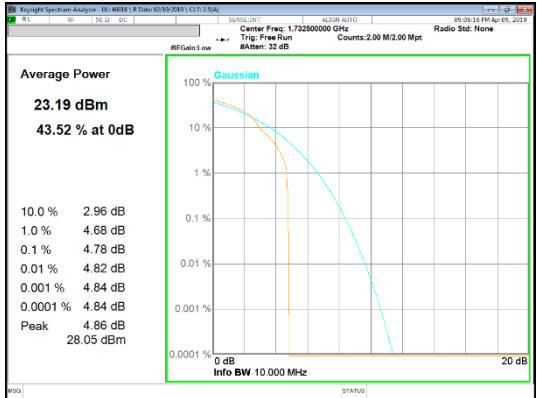
<p>LTE Band 4 5 MHz</p>	 <p>LTE B4 5MHz QPSK Mid channel</p>	 <p>LTE B4 5MHz 16QAM Mid channel</p>
<p>LTE Band 4 3 MHz</p>	 <p>LTE B4 3MHz QPSK Mid channel</p>	 <p>LTE B4 3MHz 16QAM Mid channel</p>
<p>LTE Band 4 1.4 MHz</p>	 <p>LTE B4 1.4MHz QPSK Mid channel</p>	 <p>LTE B4 1.4MHz 16QAM Mid channel</p>

LTE Band 5

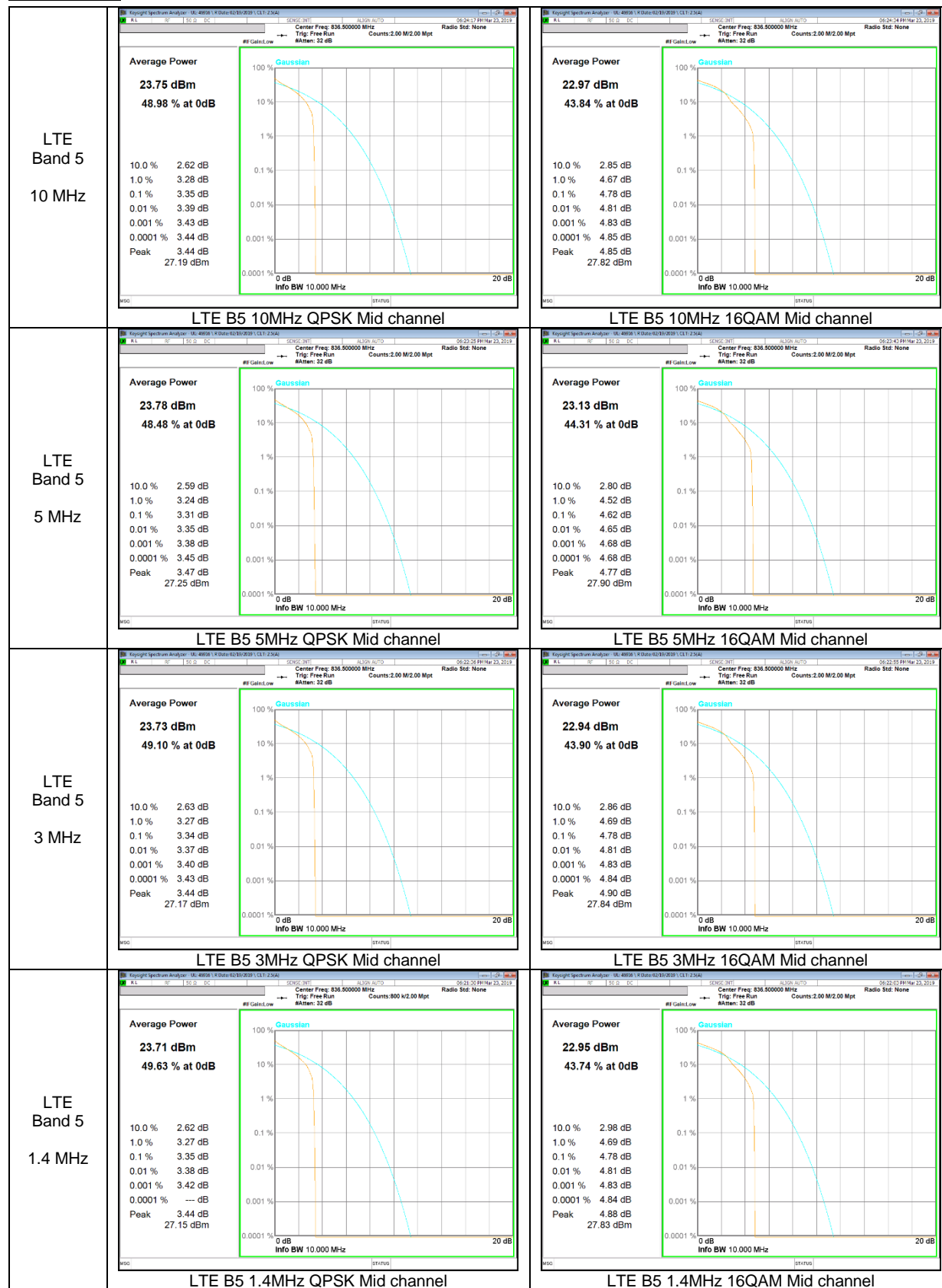

LTE Band 12

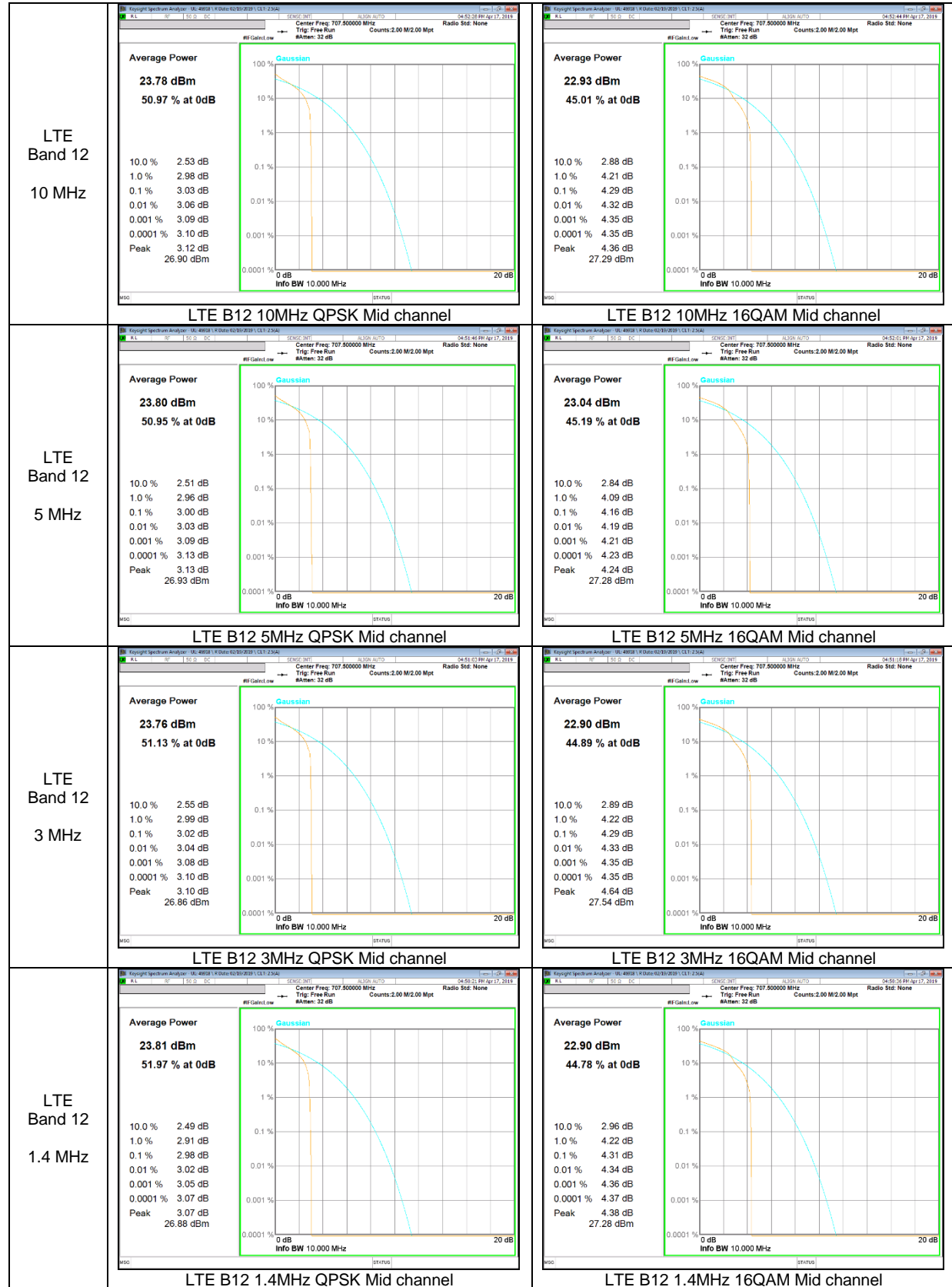

LTE Band 41

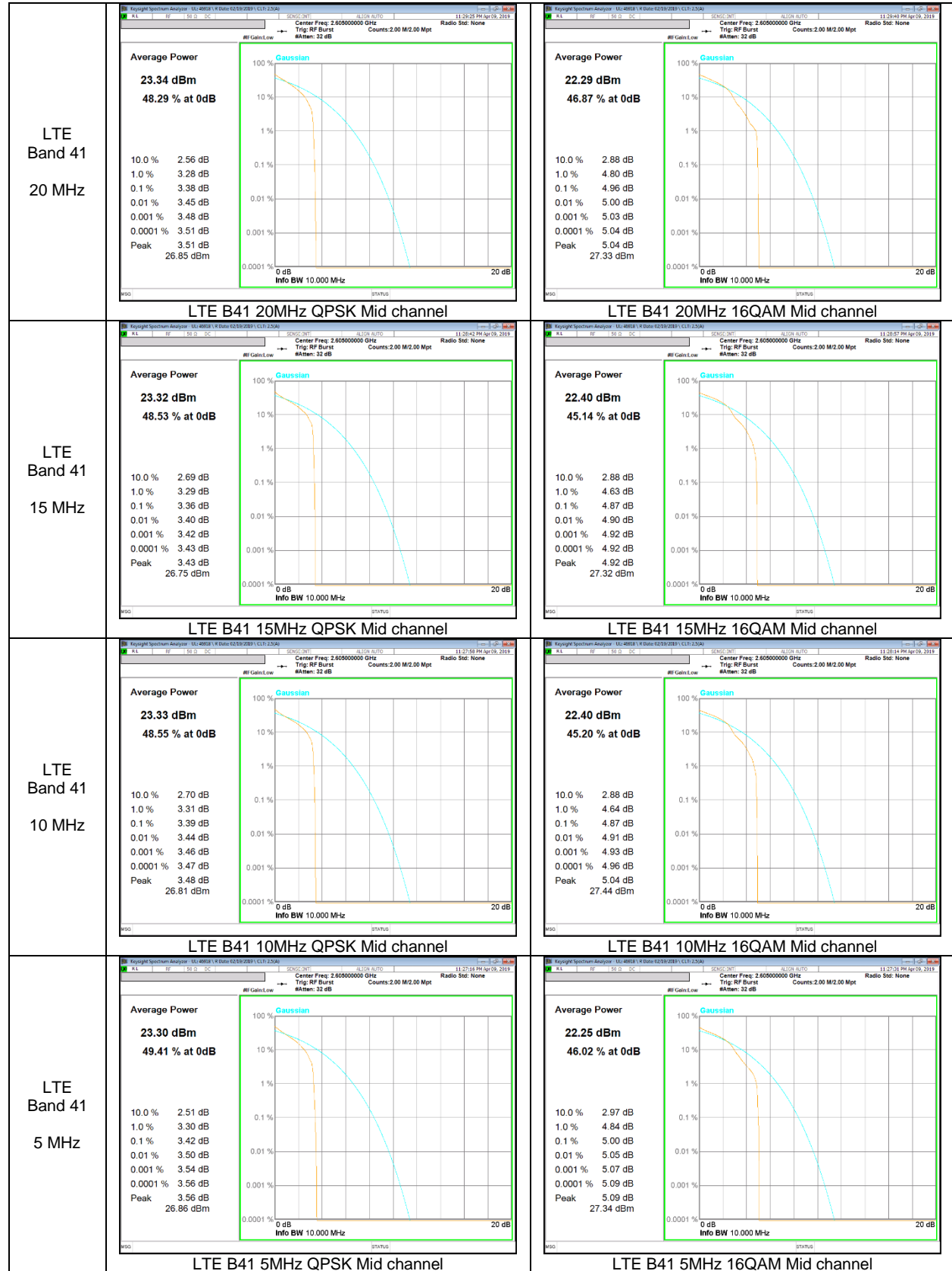

LTE Band 17

LTE Band 17 (Frequency range: 704-716 MHz) is covered by LTE Band 12 (Frequency range: 699-716 MHz) due to overlapping frequency range, same maximum tune-up limit and same channel bandwidth.

9. LIMITS AND CONDUCTED RESULTS

9.1. OCCUPIED BANDWIDTH

RULE PART(S)

FCC: §2.1049

LIMITS

For reporting purposes only

TEST PROCEDURE

The transmitter output was connected to a calibrated coaxial cable and coupler, the other end of which was connected to a spectrum analyzer. The occupied bandwidth was measured with the spectrum analyzer at the low, middle and high channel in each band. The -26dB bandwidth was also measured and recorded.

(KDB 971168 D01 Power Meas License Digital Systems v03r01)

RESULTS

See the following pages.

9.1.1. OCCUPIED BANDWIDTH RESULTS

GSM 850



GSM 1900



CDMA



WCDMA Band 5

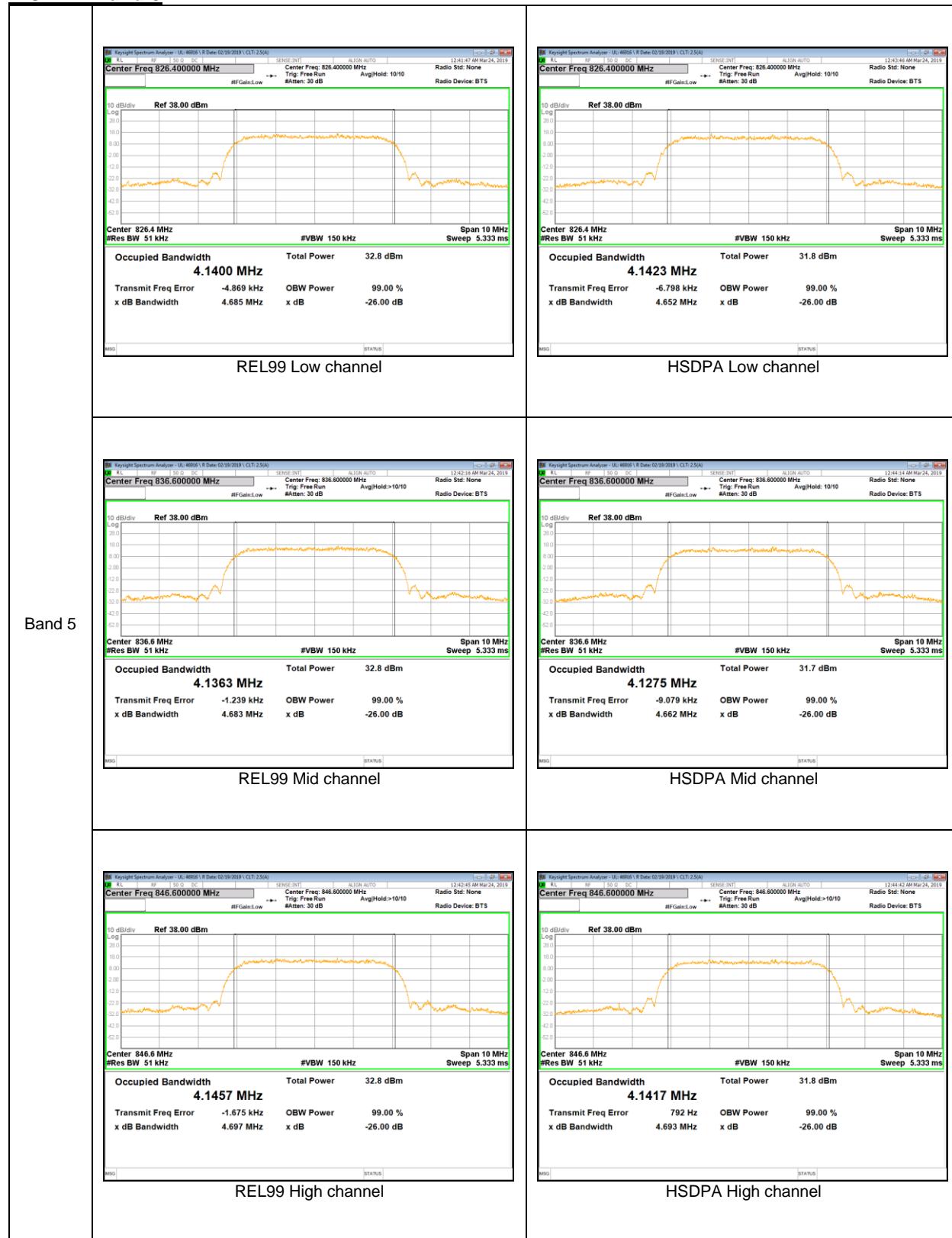

WCDMA Band 2

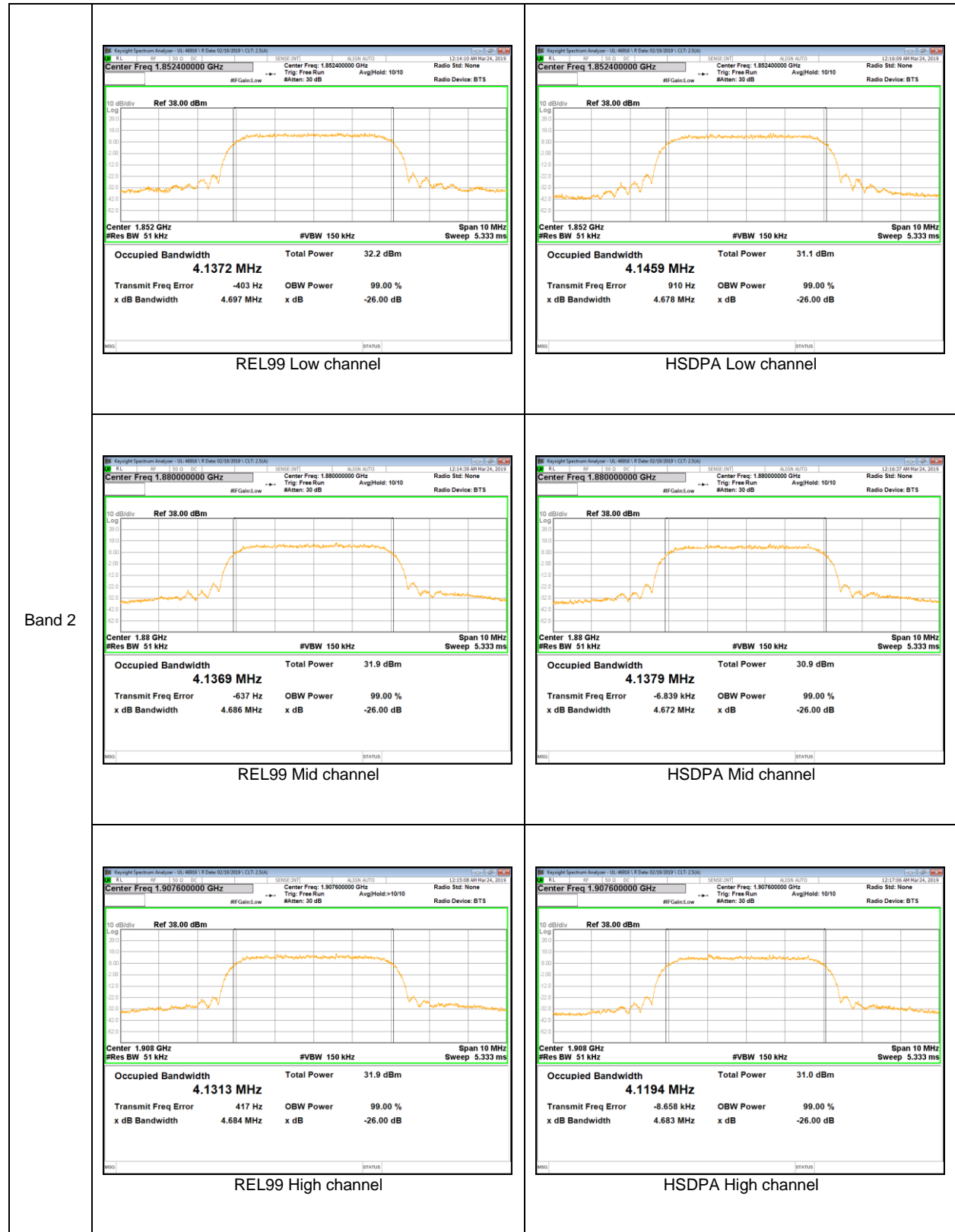

LTE Band 4

