



FCC CFR47 PART 15 SUBPART C

Bluetooth

CERTIFICATION TEST REPORT

FOR

CDMA/GSM/WCDMA/LTE Phone + BT/BLE, DTS/UNII a/b/g/n/ac, ANT+ and NFC

MODEL NUMBER : SM-A8050

FCC ID: A3LSMA8050

REPORT NUMBER: 4788886237-E3V1

ISSUE DATE: APR 16, 2019

Prepared for
SAMSUNG ELECTRONICS CO., LTD.
129 SAMSUNG-RO, YEONGTONG-GU, SUWON-SI,
GYEONGGI-DO, 16677, KOREA

Prepared by
UL Korea, Ltd.
26th floor, 152, Teheran-ro, Gangnam-gu Seoul, 06236, Korea

Suwon Test Site: UL Korea, Ltd. Suwon Laboratory
218 Maeyeong-ro, Yeongtong-gu,
Suwon-si, Gyeonggi-do, 16675, Korea
TEL: (031) 337-9902
FAX: (031) 213-5433



ACCREDITED*

Testing
Laboratory

TL-637

Revision History

<u>Rev.</u>	<u>Issue Date</u>	<u>Revisions</u>	<u>Revised By</u>
V1	04/16/19	Initial issue	Seokhwan Hong

TABLE OF CONTENTS

1. ATTESTATION OF TEST RESULTS	5
1.1. INTRODUCTION OF TEST DATA REUSE	6
1.2. DIFFERENCE	6
1.3. SPOT CHECK VERIFICATION DATA.....	6
1.4. REFERENCE DETAIL.....	7
2. TEST METHODOLOGY	8
3. FACILITIES AND ACCREDITATION	8
4. CALIBRATION AND UNCERTAINTY	8
4.1. MEASURING INSTRUMENT CALIBRATION.....	8
4.2. SAMPLE CALCULATION.....	8
4.3. MEASUREMENT UNCERTAINTY	8
5. EQUIPMENT UNDER TEST	9
5.1. DESCRIPTION OF EUT.....	9
5.1. MAXIMUM OUTPUT POWER.....	9
5.2. DESCRIPTION OF AVAILABLE ANTENNAS	9
5.3. WORST-CASE CONFIGURATION AND MODE	9
5.4. DESCRIPTION OF TEST SETUP.....	10
6. MEASUREMENT METHODS	12
7. TEST AND MEASUREMENT EQUIPMENT	13
8. REFERENCE MEASUREMENT RESULTS.....	14
8.1. ON TIME AND DUTY CYCLE RESULTS.....	14
8.2. 20 dB AND 99% BANDWIDTH.....	15
8.2.1. BASIC DATA RATE GFSK MODULATION.....	15
8.2.2. ENHANCED DATA RATE Pi/4-DQPSK MODULATION.....	15
8.2.3. ENHANCED DATA RATE 8PSK MODULATION	15
8.2.4. 20 dB AND 99% BANDWIDTH PLOTS.....	16
9. SUMMARY TABLE	19
10. ANTENNA PORT TEST RESULTS	20
10.1. HOPPING FREQUENCY SEPARATION	20
10.2. NUMBER OF HOPPING CHANNELS.....	21
10.3. AVERAGE TIME OF OCCUPANCY.....	25
10.4. OUTPUT POWER.....	33

10.4.1.	BASIC DATA RATE GFSK MODULATION.....	33
10.4.2.	ENHANCED DATA RATE Pi/4-DPSK MODULATION	33
10.4.3.	ENHANCED DATA RATE 8PSK MODULATION	33
10.4.4.	OUTPUT POWER PLOTS.....	34
10.5.	AVERAGE POWER.....	37
10.5.1.	BASIC DATA RATE GFSK MODULATION.....	37
10.5.2.	ENHANCED DATA RATE PI/4-DQPSK MODULATION	37
10.5.3.	ENHANCED DATA RATE 8PSK MODULATION	37
10.6.	CONDUCTED SPURIOUS EMISSIONS.....	38
10.6.1.	BASIC DATA RATE GFSK MODULATION.....	39
10.6.2.	ENHANCED DATA RATE PI/4-DQPSK MODULATION	43
10.6.3.	ENHANCED DATA RATE 8PSK MODULATION	47
11.	RADIATED TEST RESULTS	51
11.1.	LIMITS AND PROCEDURE.....	51
11.1.	TRANSMITTER ABOVE 1 GHz.....	53
11.1.1.	BASIC DATA RATE GFSK MODULATION.....	53
11.1.2.	ENHANCED DATA RATE 8PSK MODULATION	63
11.2.	WORST-CASE BELOW 1 GHz.....	73
12.	AC POWER LINE CONDUCTED EMISSIONS	75
13.	SETUP PHOTOS	78

1. ATTESTATION OF TEST RESULTS

COMPANY NAME: SAMSUNG ELECTRONICS CO., LTD.

EUT DESCRIPTION: CDMA/GSM/WCDMA/LTE Phone + BT/BLE, DTS/UNII a/b/g/n/ac, ANT+ and NFC

MODEL NUMBER: SM-A8050

SERIAL NUMBER: R38M10EZ6LM (RADIATED, Original);
R38M308CK1A (CONDUCTED, Original);
R38M10QK2VL (RADIATED, Spot check);

DATE TESTED: FEB 13, 2019 – APR 08, 2019(Original);
APR 08, 2019(Spot Check)

APPLICABLE STANDARDS	
STANDARD	TEST RESULTS
CFR 47 Part 15 Subpart C	Pass

UL Korea, Ltd. tested the above equipment in accordance with the requirements set forth in the above standards. All indications of Pass/Fail in this report are opinions expressed by UL Korea, Ltd. based on interpretations and/or observations of test results. Measurement Uncertainties were not taken into account and are published for informational purposes only. The test results show that the equipment tested is capable of demonstrating compliance with the requirements as documented in this report.

Note: The results documented in this report apply only to the tested sample, under the conditions and modes of operation as described herein. This document JUN not be altered or revised in any way unless done so by UL Korea, Ltd. and all revisions are duly noted in the revisions section. Any alteration of this document not carried out by UL Korea, Ltd. will constitute fraud and shall nullify the document. This report must not be used by the client to claim product certification, approval, or endorsement by IAS, any agency of the Federal Government, or any agency of any government.

Approved & Released For
UL Korea, Ltd. By:

Tested By:



SungGil Park
Suwon Lab Engineer
UL Korea, Ltd.

Seokhwan Hong
Suwon Lab Engineer
UL Korea, Ltd.

1.1. INTRODUCTION OF TEST DATA REUSE

This report referenced from the FCC ID: A3LSMA805F DSS BT(FCC CFR 47 Part 15). And the applicant takes full responsibility that the test data as referenced in this report represent compliance for this FCC ID.

1.2. DIFFERENCE

The FCC ID: A3LSMA8050 shares the same enclosure and circuit board as FCC ID: A3LSMA805F. The BT antennas and surrounding circuitry and layout are identical between these two units for re-used bands.

After confirming through preliminary radiated emissions that the performance of the FCC ID: A3LSMA805F remains representative of FCC ID: A3LSMA8050. The test data of FCC ID: A3LSMA805F being submitted for this application to cover BT features.

1.3. SPOT CHECK VERIFICATION DATA

Band	Test Item	Mode	Frequency	Test Limit	Original model	Spot check model	Deviation	Remark
					SM-A805F/DS Results	SM-A8050 Results		
					FCC ID : A3LSMA805F	FCC ID : A3LSMA8050		
DSS BT (2.4GHz)	Band Edge	8PSK	2480 MHz	54 dBuV/m	39.66 dBuV/m	42.58 dBuV/m	2.92 dB	
	RSE	GFSK	2402 MHz	54 dBuV/m	41.85 dBuV/m	40.12 dBuV/m	-1.73 dB	Noise Floor

Comparison of two models, upper deviation is within 3dB range and all test results are under FCC Technical Limits.

Output power verification was performed for the spot check model, all conducted power test results were in the tune up tolerance range. Also deviation for maximum output power result is within upper 0.5dB range.

1.4. REFERENCE DETAIL

Reference application that contains the reused reference data.

Equipment Class	Reference FCC ID	Type Grant/Permissive Change	Reference Application	Folder Test/RF Exposure	Report Title / Section
PCE	A3LSMA805F	Grant	478886234-E1	Test	FCC Report WWAN / GSM,WCDMA, LTE B5
DTS	A3LSMA805F	Grant	478886234-E2	Test	FCC Report DTS WLAN / All sections
			478886234-E3	Test	FCC Report BLE All sections
DSS	A3LSMA805F	Grant	478886234-E4	Test	FCC Report BT / All sections
NII	A3LSMA805F	Grant	478886234-E5	Test	FCC Report UNII WLAN / All sections
DXX	A3LSMA805F	Grant	478886234-E6	Test	FCC Report ANT+ / All sections
			478886234-E7	Test	FCC Report NFC / All sections

2. TEST METHODOLOGY

The tests documented in this report were performed in accordance with following methods.

1. FCC CFR 47 Part 2.
2. FCC CFR 47 Part 15.
3. 558074 D01 15.247 Meas Guidance v05r01
4. ANSI C63.10-2013.

3. FACILITIES AND ACCREDITATION

The test sites and measurement facilities used to collect data are located at 218 Maeyeong-ro, Yeongtong-gu, Suwon-si, Gyeonggi-do, 16675, Korea. Line conducted emissions are measured only at the 218 address. The following table identifies which facilities were utilized for radiated emission measurements documented in this report. Specific facilities are also identified in the test results sections.

218 Maeyeong-ro	
<input checked="" type="checkbox"/>	Chamber 1
<input checked="" type="checkbox"/>	Chamber 2
<input checked="" type="checkbox"/>	Chamber 3

UL Korea, Ltd. is accredited by IAS, Laboratory Code TL-637. The full scope of accreditation can be viewed at <http://www.iasonline.org/PDF/TL/TL-637.pdf>.

4. CALIBRATION AND UNCERTAINTY

4.1. MEASURING INSTRUMENT CALIBRATION

The measuring equipment utilized to perform the tests documented in this report has been calibrated in accordance with the manufacturer's recommendations, and is traceable to recognized national standards.

4.2. SAMPLE CALCULATION

Where relevant, the following sample calculation is provided:

$$\begin{aligned} \text{Field Strength (dBuV/m)} &= \text{Measured Voltage (dBuV)} + \text{Antenna Factor (dB/m)} + \\ &\text{Cable Loss (dB)} - \text{Preamp Gain (dB)} \\ 36.5 \text{ dBuV} + 18.7 \text{ dB/m} + 0.6 \text{ dB} - 26.9 \text{ dB} &= 28.9 \text{ dBuV/m} \end{aligned}$$

4.3. MEASUREMENT UNCERTAINTY

Where relevant, the following measurement uncertainty levels have been estimated for tests performed on the apparatus:

PARAMETER	UNCERTAINTY
Conducted Disturbance, 0.15 to 30 MHz	2.32 dB
Radiated Disturbance, Below 1GHz	3.86 dB
Radiated Disturbance, Above 1 GHz	5.97 dB

Uncertainty figures are valid to a confidence level of 95%.

5. EQUIPMENT UNDER TEST

5.1.DESCRPTION OF EUT

The EUT is a CDMA/GSM/WCDMA/LTE Phone + BT/BLE, DTS/UNII a/b/g/n/ac, ANT+ and NFC.

This test report addresses the DSS (BT) operational mode.

5.1.MAXIMUM OUTPUT POWER

The transmitter has a maximum conducted output power as follows:

Frequency Range [MHz]	Mode	Power Mode	Output Power [dBm]	Output Power [mW]
2402 - 2480	Basic GFSK	Average	14.155	26.032
		Peak	14.332	27.114
	Enhanced Pi/4-DPSK	Average	12.311	17.026
		Peak	13.926	24.694
	Enhanced 8PSK	Average	12.319	17.057
		Peak	14.126	25.858

5.2.DESCRPTION OF AVAILABLE ANTENNAS

The radio utilizes an internal antenna, with a maximum gain of -2.21 dBi.

5.3.WORST-CASE CONFIGURATION AND MODE

Radiated emission below 1GHz and power line conducted emission were performed with the EUT set to transmit at the channel with highest output power as worst-case scenario.

Radiated emission above 1GHz was performed with the EUT set to transmit low/mid/high channels.

This EUT have a camera pop up function when user operate front camera function. The fundamental of the EUT was investigated in three orthogonal orientations X, Y and Z. It was normal mode and camera pop up mode. It was determined that X on normal mode orientation was worst-case orientation; therefore, all final radiated testing was performed with the EUT in X on normal mode of orientation.

Note: GFSK, Pi/4-DQPSK, 8PSK average Power are all investigated, The GFSK & 8PSK Power are the worst case. Testing is based on this mode to showing compliance. For average power data please refer to section 9.5. All radiated and power line conducted tests were performed connected with charger for evaluation of worst case mode.

5.4.DESCRPTION OF TEST SETUP

SUPPORT EQUIPMENT

Support Equipment List				
Description	Manufacturer	Model	Serial Number	FCC ID
Charger	SAMSUNG	EP-TA800	R37M1E50KV1SE3	N/A
Data Cable	SAMSUNG	EP-DA905BBE	N/A	N/A
Earphone	SAMSUNG	GHSS028-W4	N/A	N/A

I/O CABLE

I/O Cable List						
Cable No	Port	# of identical ports	Connector Type	Cable Type	Cable Length (m)	Remarks
1	DC Power	1	C Type	Shielded	1.1m	N/A
2	Audio	2	C Type	Unshielded	1.2m	N/A

TEST SETUP

The EUT is continuously communicating to the Bluetooth tester during the tests.
 Test software enable BT communications.

SETUP DIAGRAM FOR TESTS (CONDUCTED TEST SETUP)

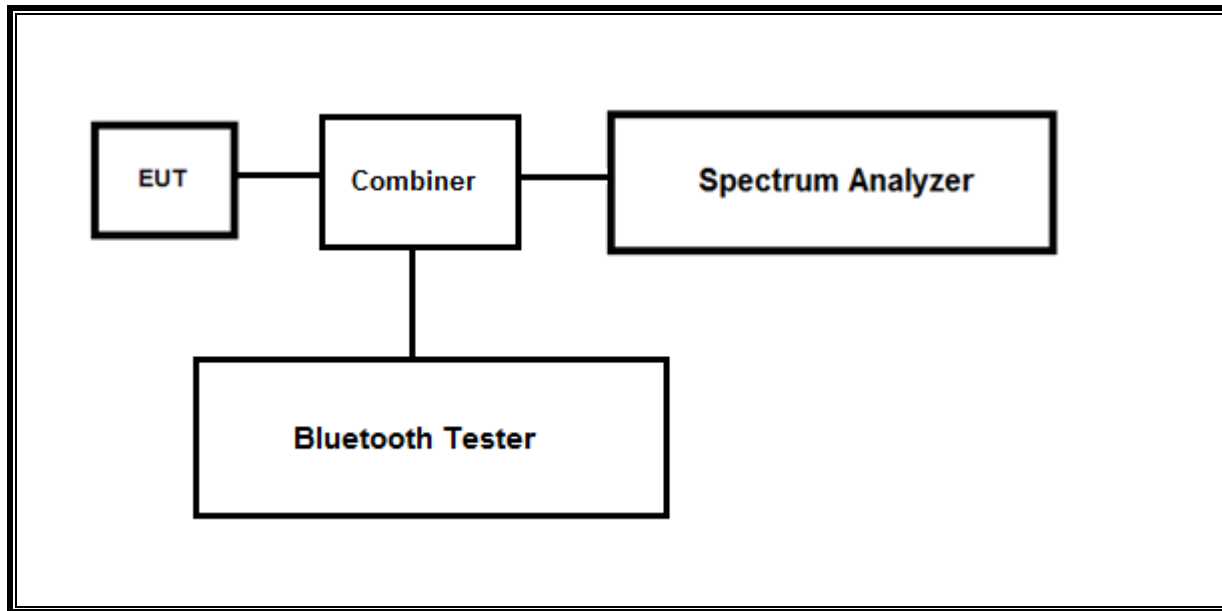

SETUP DIAGRAM FOR TESTS (RADIATED TEST SETUP)

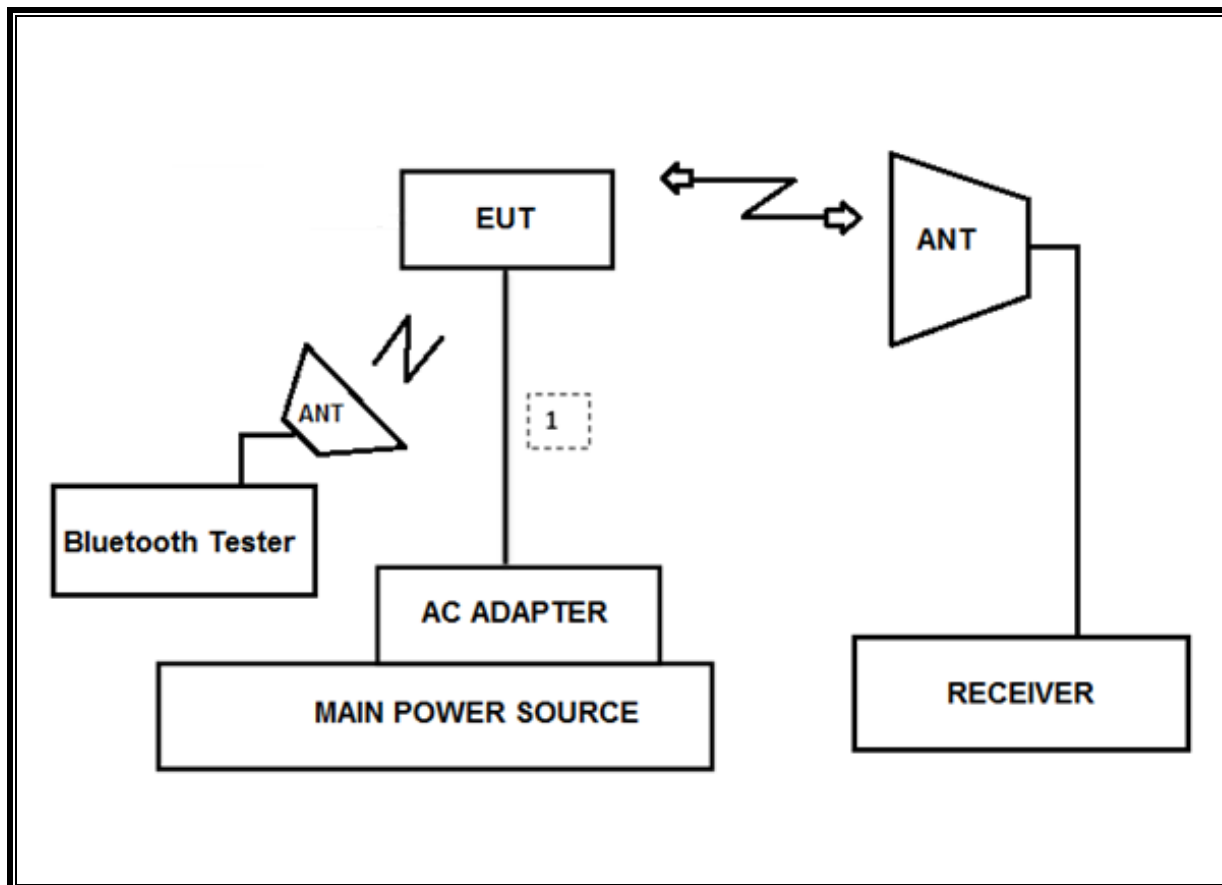

6. MEASUREMENT METHODS

20dB BW : ANSI C63.10, Section 6.9.2

99% BW : ANSI C63.10, Section 6.9.3

HOPPING FREQUENCY SEPARATION : ANSI C63.10, Section 7.8.2

NUMBER OF HOPPING CHANNELS : ANSI C63.10, Section 7.8.3

AVERAGE TIME OF OCCUPANCY : ANSI C63.10, Section 7.8.4

OUTPUT POWER : ANSI C63.10, Section 7.8.5.

Out-of-band EMISSIONS (Conducted) : ANSI C63.10, Section 7.8.6, 7.8.8

Out-of-band EMISSIONS IN NON-RESTRICTED BANDS: ANSI C63.10, Section 6.

Out-of-band EMISSIONS IN RESTRICTED BANDS : ANSI C63.10, Section 6.

AC Power Line Conducted Emission : ANSI C63.10-2013, Section 6.2.

7. TEST AND MEASUREMENT EQUIPMENT

The following test and measurement equipment was utilized for the tests documented in this report:

Test Equipment List				
Description	Manufacturer	Model	S/N	Cal Due
Antenna, Bilog, 30MHz-1GHz	SCHWARZBECK	VULB9163	750	08-04-20
Antenna, Bilog, 30MHz-1GHz	SCHWARZBECK	VULB9163	749	08-04-20
Antenna, Bilog, 30MHz-1GHz	SCHWARZBECK	VULB9163	845	08-04-20
Antenna, Horn, 18 GHz	ETS	3115	00167211	08-04-20
Antenna, Horn, 18 GHz	ETS	3115	00161451	08-04-20
Antenna, Horn, 18 GHz	ETS	3117	00168724	08-04-20
Antenna, Horn, 18 GHz	ETS	3117	00168717	08-04-20
Antenna, Horn, 18 GHz	ETS	3117	00205959	08-04-20
Antenna, Horn, 40 GHz	ETS	3116C	00166155	08-14-20
Antenna, Horn, 40 GHz	ETS	3116C	00168645	12-04-19
Antenna, Horn, 40 GHz	ETS	3116C-PA	00168841	08-09-19
Preamplifier, 1000 MHz	Sonoma	310N	341282	08-07-19
Preamplifier, 1000 MHz	Sonoma	310N	351741	08-07-19
Preamplifier, 1000 MHz	Sonoma	310N	370599	08-06-19
Preamplifier, 18 GHz	Miteq	AFS42-00101800-25-S-42	1876511	08-07-19
Preamplifier, 18 GHz	Miteq	AFS42-00101800-25-S-42	1896138	08-07-19
Preamplifier, 18 GHz	Miteq	AFS42-00101800-25-S-42	2029169	08-07-19
Spectrum Analyzer, 44 GHz	Agilent / HP	N9030A	MY54170614	08-07-19
Spectrum Analyzer, 44 GHz	Agilent / HP	N9030A	MY54490312	08-06-19
Average Power Sensor	Agilent / HP	U2000	MY54270007	08-07-19
Bluetooth Tester	TESCOM	TC-3000C	3000C000546	08-07-19
Combiner	WEINCHEL	1575	2150	08-08-19
Attenuator	PASTERNAK	PE7087-10	A001	08-08-19
Attenuator	PASTERNAK	PE7087-10	A008	08-08-19
Attenuator	PASTERNAK	PE7087-10	2	08-07-19
EMI Test Receive, 40 GHz	R&S	ESU40	100439	08-06-19
EMI Test Receive, 40 GHz	R&S	ESU40	100457	08-06-19
EMI Test Receive, 44 GHz	R&S	ESW44	101590	08-06-19
EMI Test Receive, 3 GHz	R&S	ESR3	101832	08-06-19
Low Pass Filter 5GHz	Micro-Tronics	LPS17541	009	08-07-19
Low Pass Filter 5GHz	Micro-Tronics	LPS17541	015	08-07-19
Low Pass Filter 5GHz	Micro-Tronics	LPS17541	020	08-06-19
High Pass Filter 3GHz	Micro-Tronics	HPM17543	010	08-07-19
High Pass Filter 3GHz	Micro-Tronics	HPM17543	015	08-07-19
High Pass Filter 3GHz	Micro-Tronics	HPM17543	020	08-06-19
High Pass Filter 6GHz	Micro-Tronics	HPS17542	009	08-07-19
High Pass Filter 6GHz	Micro-Tronics	HPS17542	016	08-07-19
High Pass Filter 6GHz	Micro-Tronics	HPS17542	021	08-06-19
LISN	R&S	ENV-216	101837	08-09-19
UL Software				
Description	Manufacturer	Model	Version	
Radiated software	UL	UL EMC	Ver 9.5	
AC Line Conducted software	UL	UL EMC	Ver 9.5	

8. REFERENCE MEASUREMENT RESULTS

8.1.ON TIME AND DUTY CYCLE RESULTS

LIMITS

None: for reporting purposes only.

Mode	ON Time B [msec]	Period [msec]	Duty Cycle x [linear]	Duty Cycle [%]	Duty Cycle Correction Factor [dB]	1/T Minimum VBW [kHz]
2400MHz Bands						
BT	2.885	3.750	0.769	76.9%	1.14	0.347

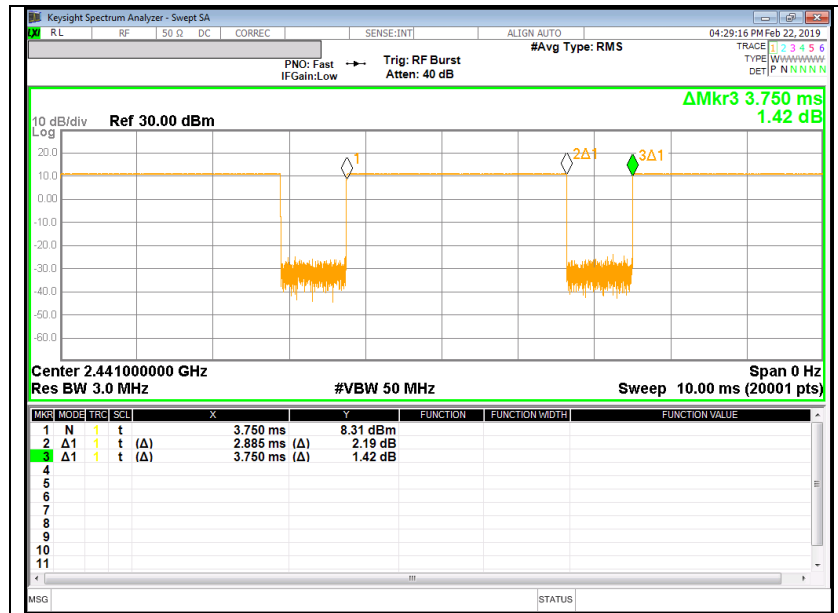

8.2.20 dB AND 99% BANDWIDTH

LIMITS

None; for reporting purposes only.

TEST PROCEDURE

The transmitter output is connected to a spectrum analyzer. The RBW is set to $\geq 1\%$ of the 20 dB bandwidth. The VBW is set to \geq RBW. The sweep time is coupled.

RESULTS

8.2.1. BASIC DATA RATE GFSK MODULATION

Channel	Frequency [MHz]	20 dB Bandwidth [MHz]	99% Bandwidth [kHz]
Low	2402	0.822	0.857
Mid	2441	0.931	0.829
High	2480	0.930	0.831
Worst		0.931	0.857

8.2.2. ENHANCED DATA RATE Pi/4-DQPSK MODULATION

Channel	Frequency [MHz]	20 dB Bandwidth [MHz]	99% Bandwidth [MHz]
Low	2402	1.227	1.167
Mid	2441	1.302	1.132
High	2480	1.347	1.204
Worst		1.347	1.204

8.2.3. ENHANCED DATA RATE 8PSK MODULATION

Channel	Frequency [MHz]	20 dB Bandwidth [MHz]	99% Bandwidth [MHz]
Low	2402	1.261	1.167
Mid	2441	1.267	1.163
High	2480	1.291	1.202
Worst		1.291	1.202

8.2.4. 20 dB AND 99% BANDWIDTH PLOTS

GFSK BANDWIDTH

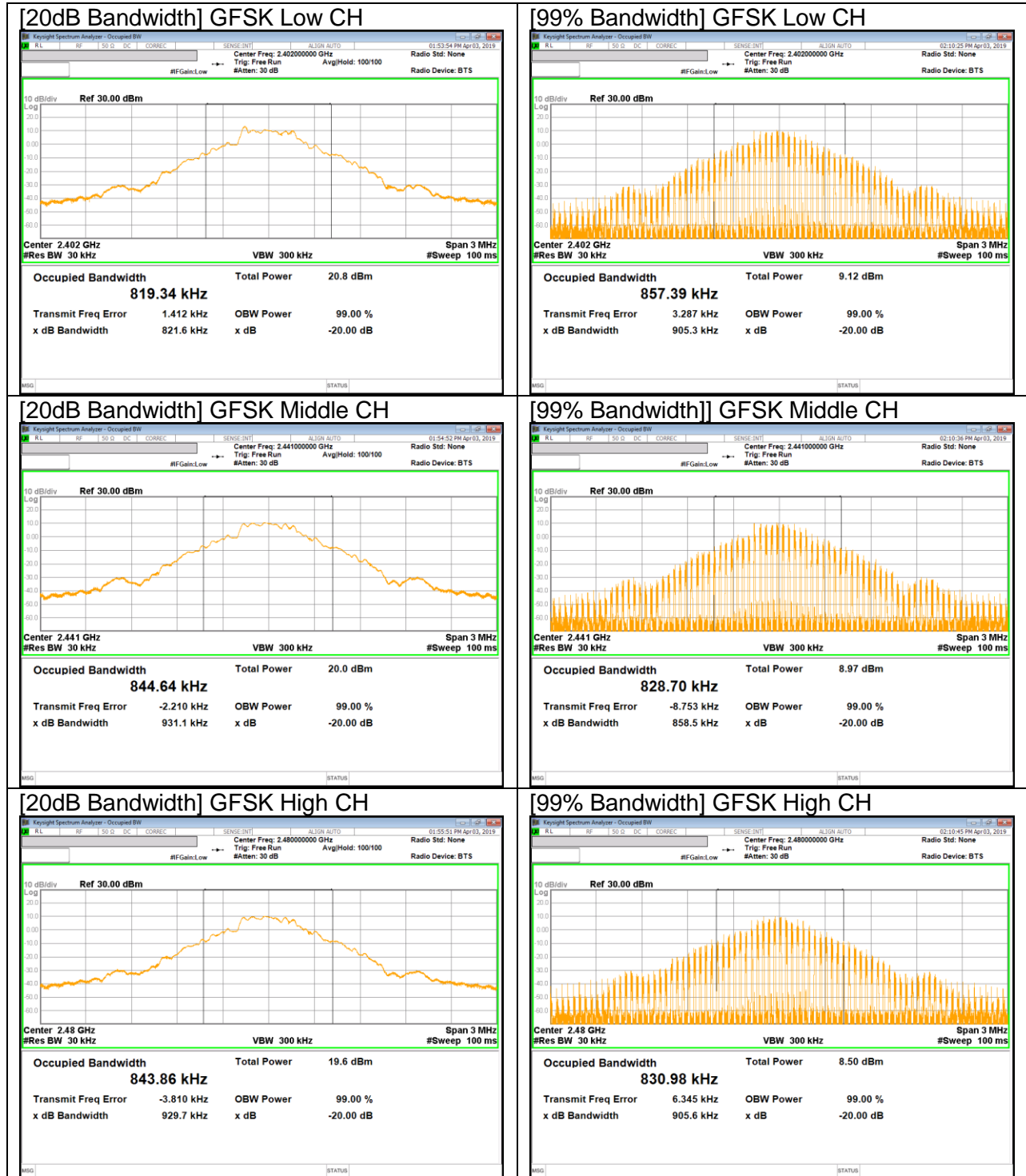

Pi/4-DQPSK BANDWIDTH

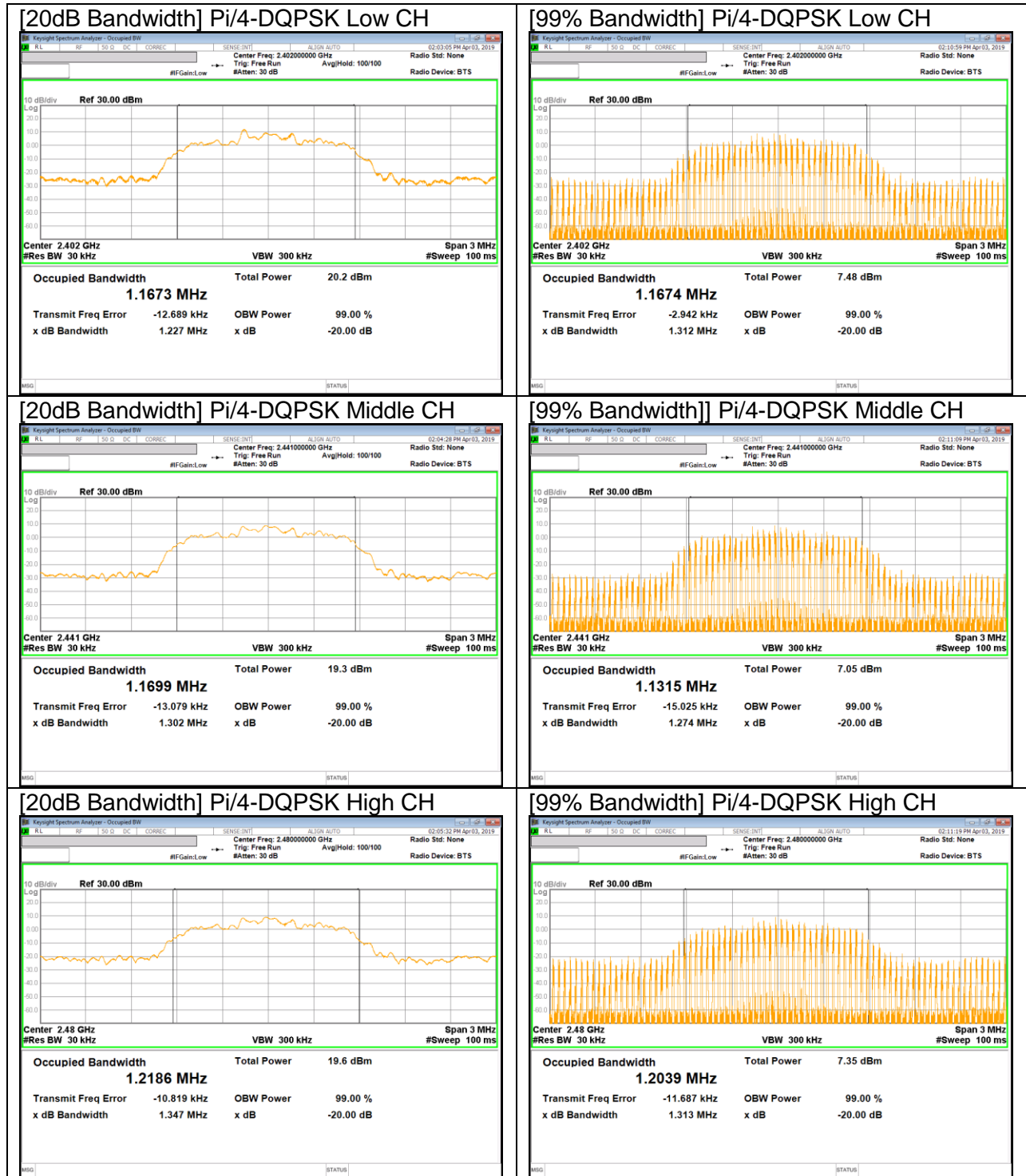

8PSK BANDWIDTH

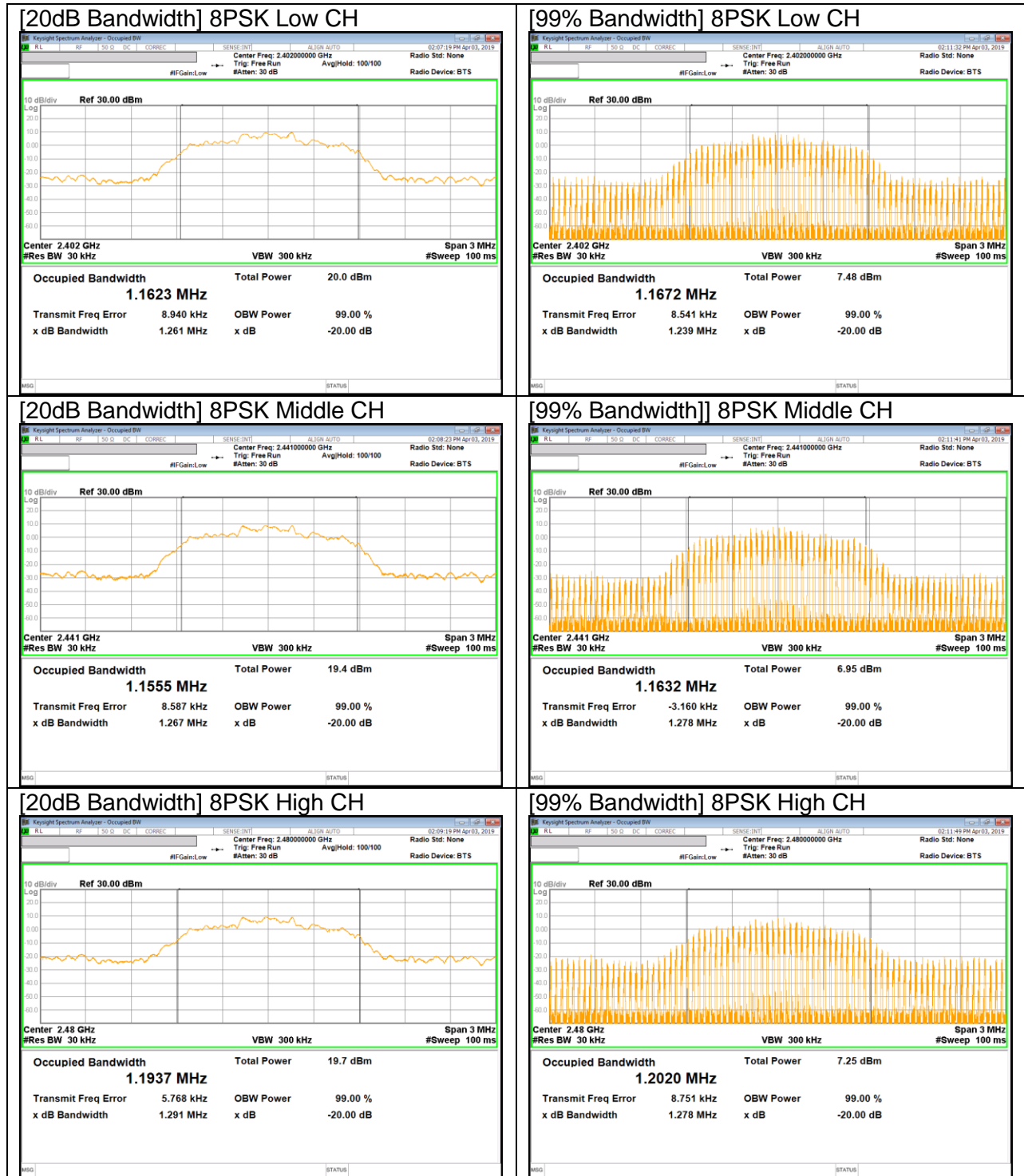

9. SUMMARY TABLE

FCC Part Section	Test Description	Test Limit	Test Condition	Test Result
2.1051, 15.247 (d)	Band Edge / Conducted Spurious Emission	-20dBc	Conducted	Pass
15.247 (b)(1)	TX conducted output power	<30dBm		Pass
15.247 (a)(1)	Hopping frequency separation	> two-thirds of the 20 dB bandwidth		Pass
15.247 (a)(1)(iii)	Number of Hopping channels	More than 15 non-overlapping channels		Pass
15.247 (a)(1)(iii)	Avg Time of Occupancy	< 0.4sec		Pass
15.207 (a)	AC Power Line conducted emissions	Section 10	Power Line conducted	Pass
15.205, 15.209	Radiated Spurious Emission	< 54dBuV/m	Radiated	Pass

10. ANTENNA PORT TEST RESULTS

10.1. HOPPING FREQUENCY SEPARATION

LIMIT

FCC §15.247 (a) (1)

Frequency hopping systems shall have hopping channel carrier frequencies separated by a minimum of 25 kHz or the 20 dB bandwidth of the hopping channel, whichever is greater.

Alternatively, frequency hopping systems operating in the 2400-2483.5 MHz band JUN have hopping channel carrier frequencies that are separated by 25 kHz or two-thirds of the 20 dB bandwidth of the hopping channel, whichever is greater, provided the systems operate with an output power no greater than 125 mW.

TEST PROCEDURE

The transmitter output is connected to a spectrum analyzer. The RBW is set to 300 kHz and the VBW is set to 300 kHz. The sweep time is coupled.

RESULTS

HOPPING FREQUENCY SEPARATION PLOT

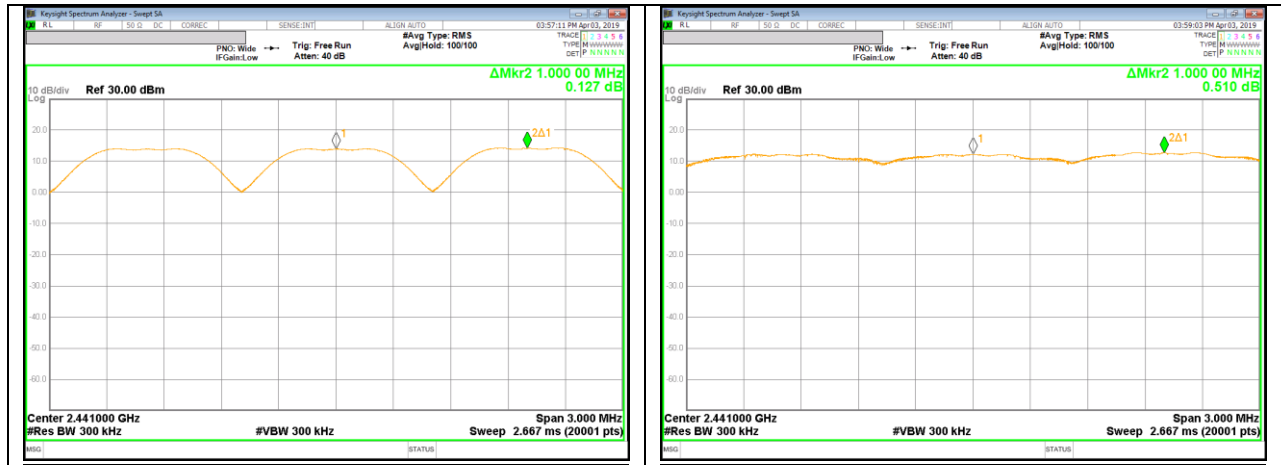

[GFSK]

[8PSK]

10.2. NUMBER OF HOPPING CHANNELS

LIMIT

FCC §15.247 (a) (1) (iii)

Frequency hopping systems in the 2400 – 2483.5 MHz band shall use at least 15 non-overlapping channels.

TEST PROCEDURE

The transmitter output is connected to a spectrum analyzer. The span is set to cover the entire authorized band, in either a single sweep or in multiple contiguous sweeps. The RBW is set to a maximum of 1 % of the span. The analyzer is set to Max Hold.

RESULTS

Normal Mode: 79 Channels observed.

NUMBER OF HOPPING CHANNELS (100 MHz SPAN)





NUMBER OF HOPPING CHANNELS PLOTS[8PSK]

NUMBER OF HOPPING CHANNELS (100 MHZ SPAN)

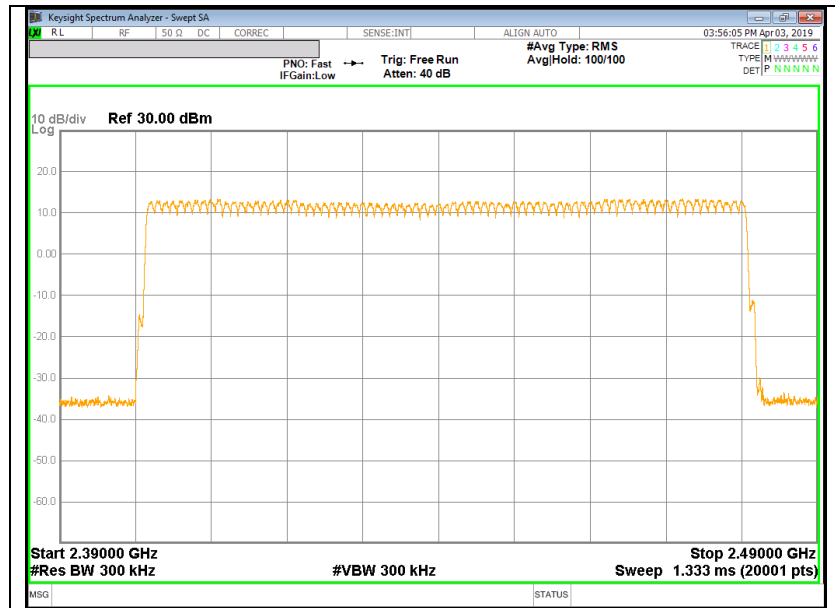

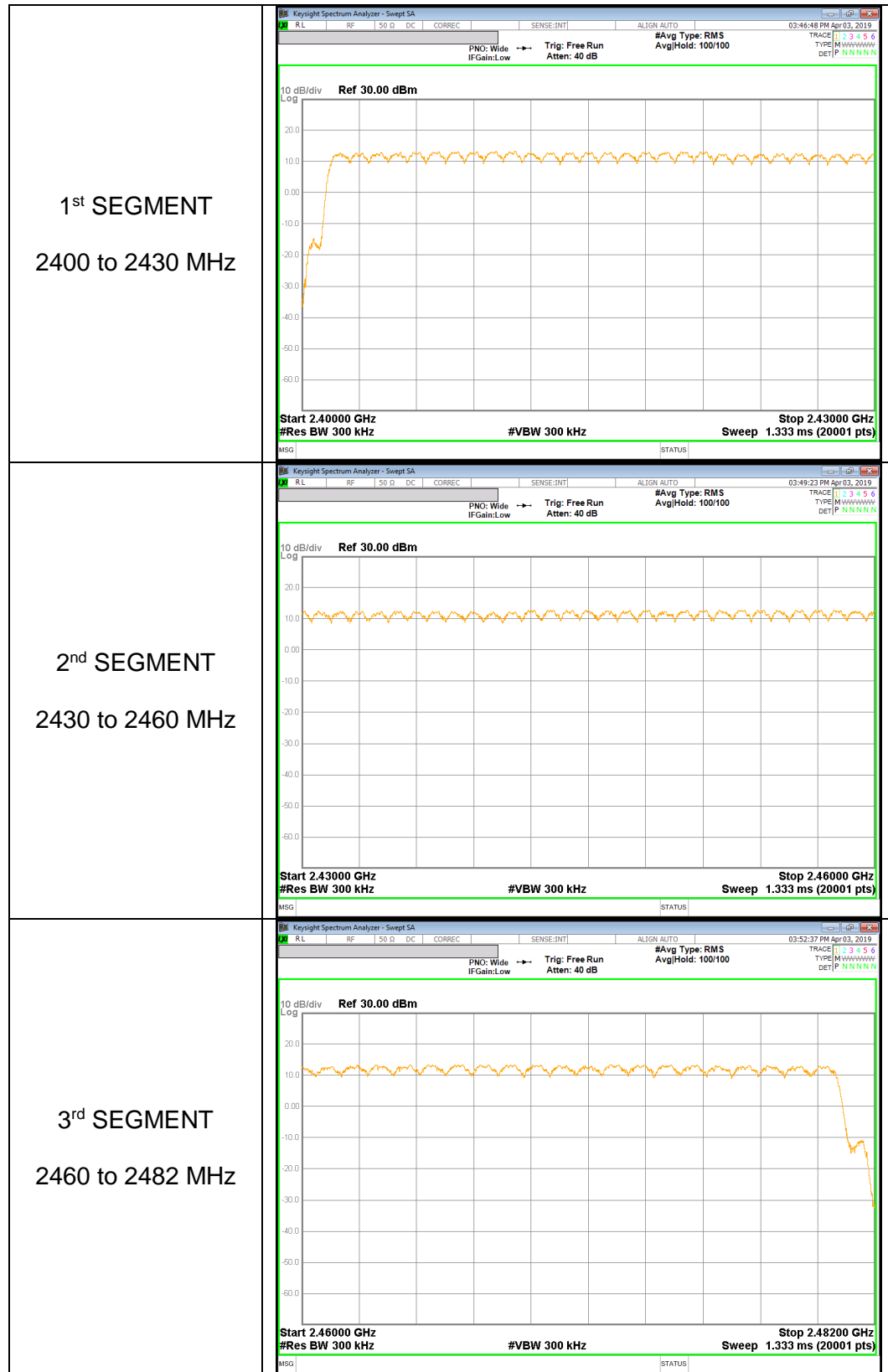

10.3. AVERAGE TIME OF OCCUPANCY

LIMIT

FCC §15.247 (a) (1) (iii)

The average time of occupancy on any channel shall not be greater than 0.4 seconds within a period of 0.4 seconds multiplied by the number of hopping channels employed.

TEST PROCEDURE

The transmitter output is connected to a spectrum analyzer. The span is set to 0 Hz, centered on a single, selected hopping channel. The width of a single pulse is measured in a fast scan. The number of pulses is measured in a 3.16 second scan, to enable resolution of each occurrence.

The average time of occupancy in the specified 31.6 second period (79 channels * 0.4 s) is equal to 10 * (# of pulses in 3.16 s) * pulse width.

For AFH mode, the average time of occupancy in the specified 8 second period (20 channels * 0.4 seconds) is equal to 10 * (# of pulses in 0.8 s) * pulse width.

RESULTS[GFSK]

DH Packet	Pulse Width [msec]	Number of Pulses in 3.16 seconds	Average Time of Occupancy [sec]	Limit [sec]	Margin [sec]
GFSK Normal					
DH1	0.380	32	0.121728	0.4	-0.2783
DH3	1.636	16	0.261760	0.4	-0.1382
DH5	2.884	12	0.346080	0.4	-0.0539
GFSK AFH					
DH Packet	Pulse Width [msec]	Number of Pulses in 0.8 seconds	Average Time of Occupancy [sec]	Limit [sec]	Margin [sec]
DH1	0.380	8	0.030432	0.4	-0.3696
DH3	1.636	4	0.065440	0.4	-0.3346
DH5	2.884	3	0.086520	0.4	-0.3135

DH1

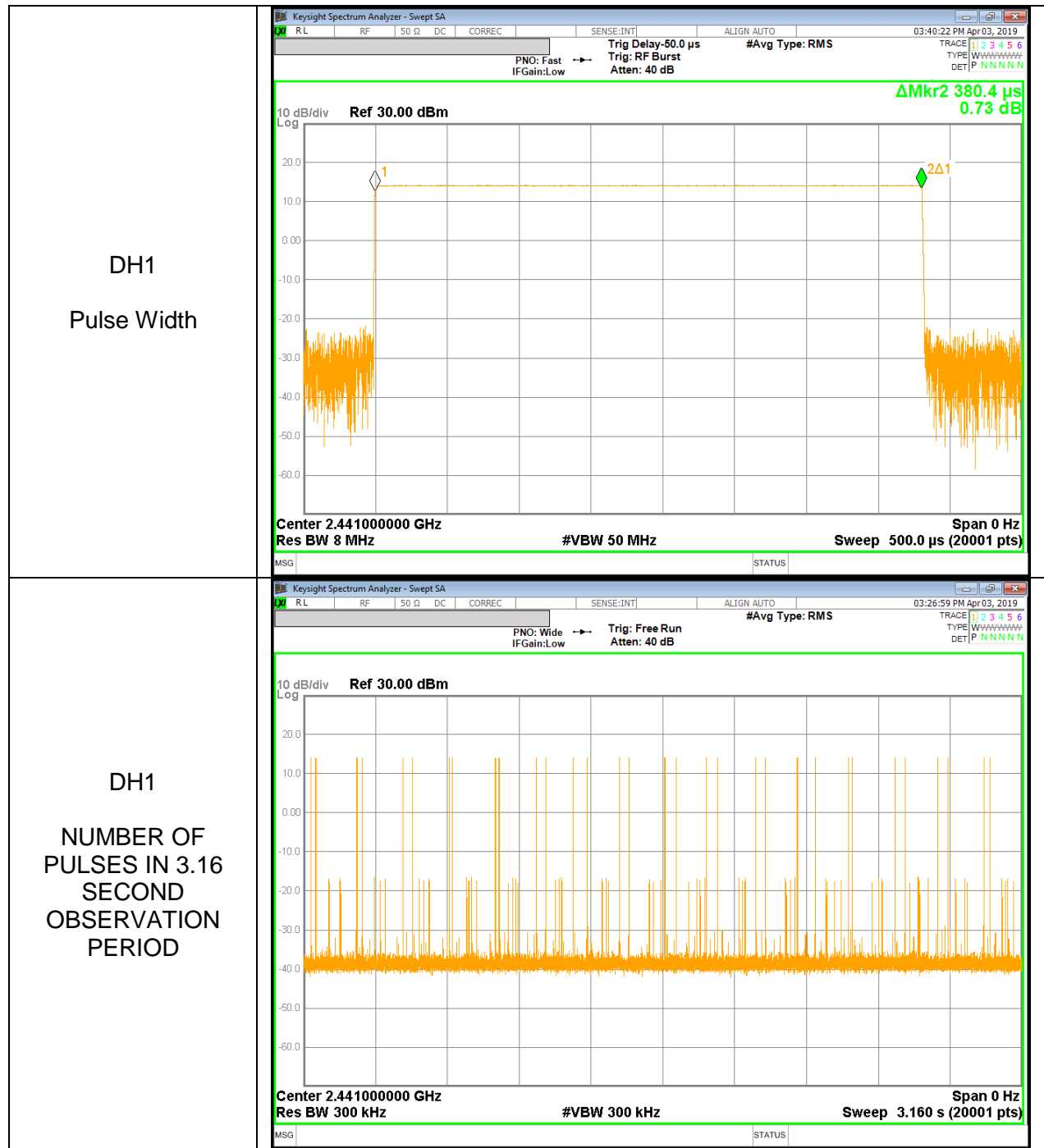

DH3

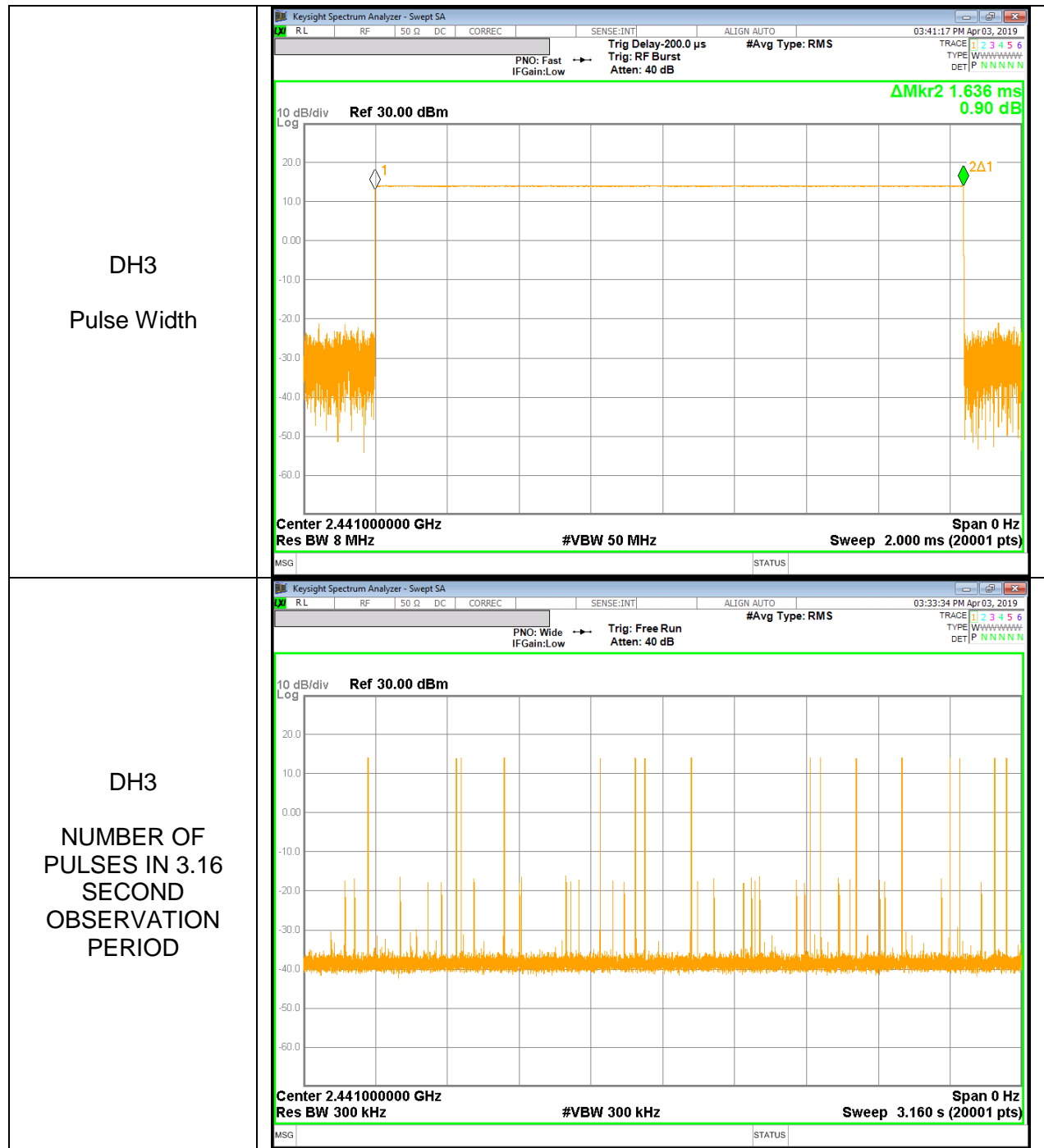

DH5

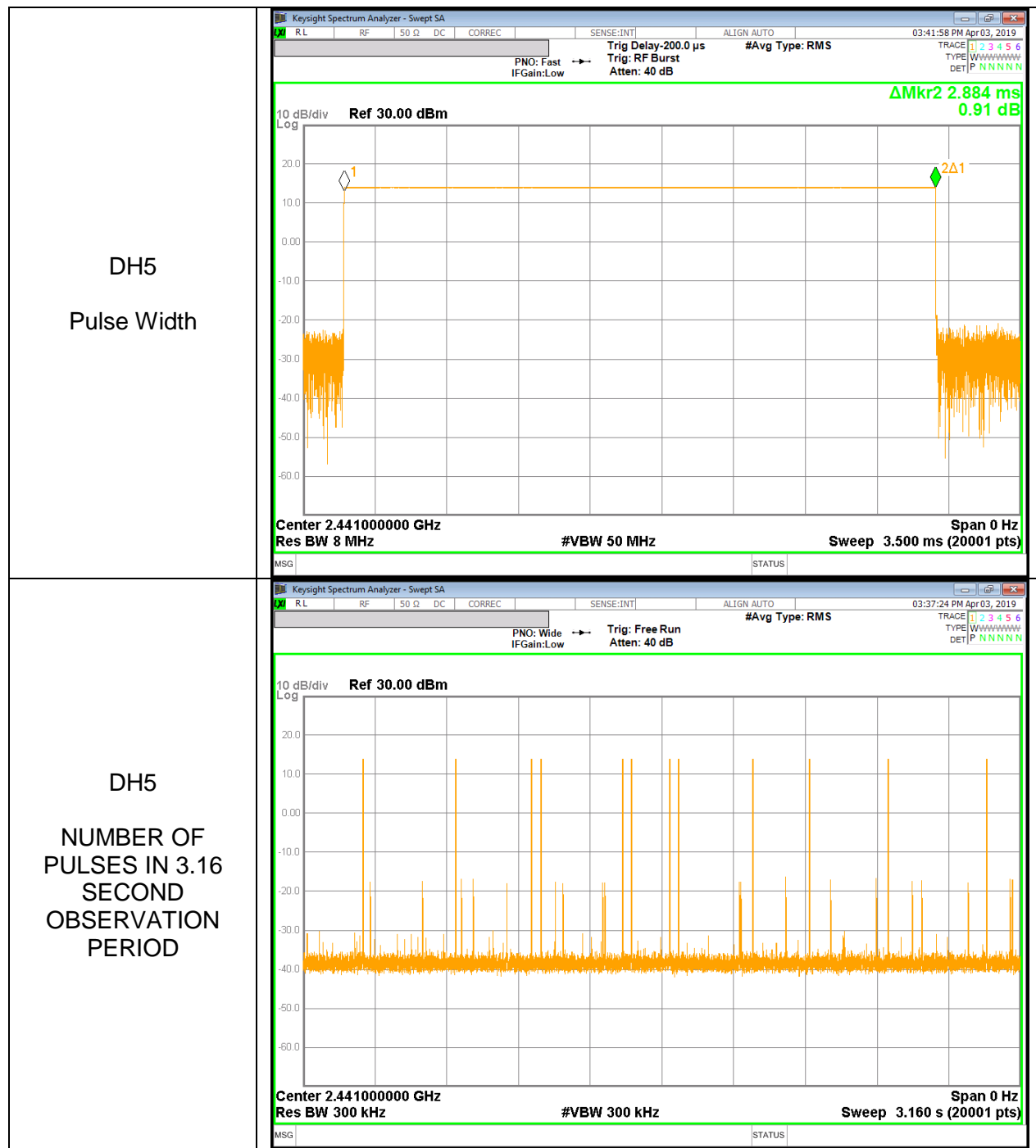

RESULTS[8PSK]

DH Packet	Pulse Width [msec]	Number of Pulses in 3.16 seconds	Average Time of Occupancy [sec]	Limit [sec]	Margin [sec]
GFSK Normal					
DH1	0.386	32	0.123616	0.4	-0.2764
DH3	1.637	16	0.261920	0.4	-0.1381
DH5	2.888	12	0.346560	0.4	-0.0534
GFSK AFH					
DH Packet	Pulse Width [msec]	Number of Pulses in 0.8 seconds	Average Time of Occupancy [sec]	Limit [sec]	Margin [sec]
DH1	0.386	8	0.030904	0.4	-0.3691
DH3	1.637	4	0.065480	0.4	-0.3345
DH5	2.888	3	0.086640	0.4	-0.3134

DH1

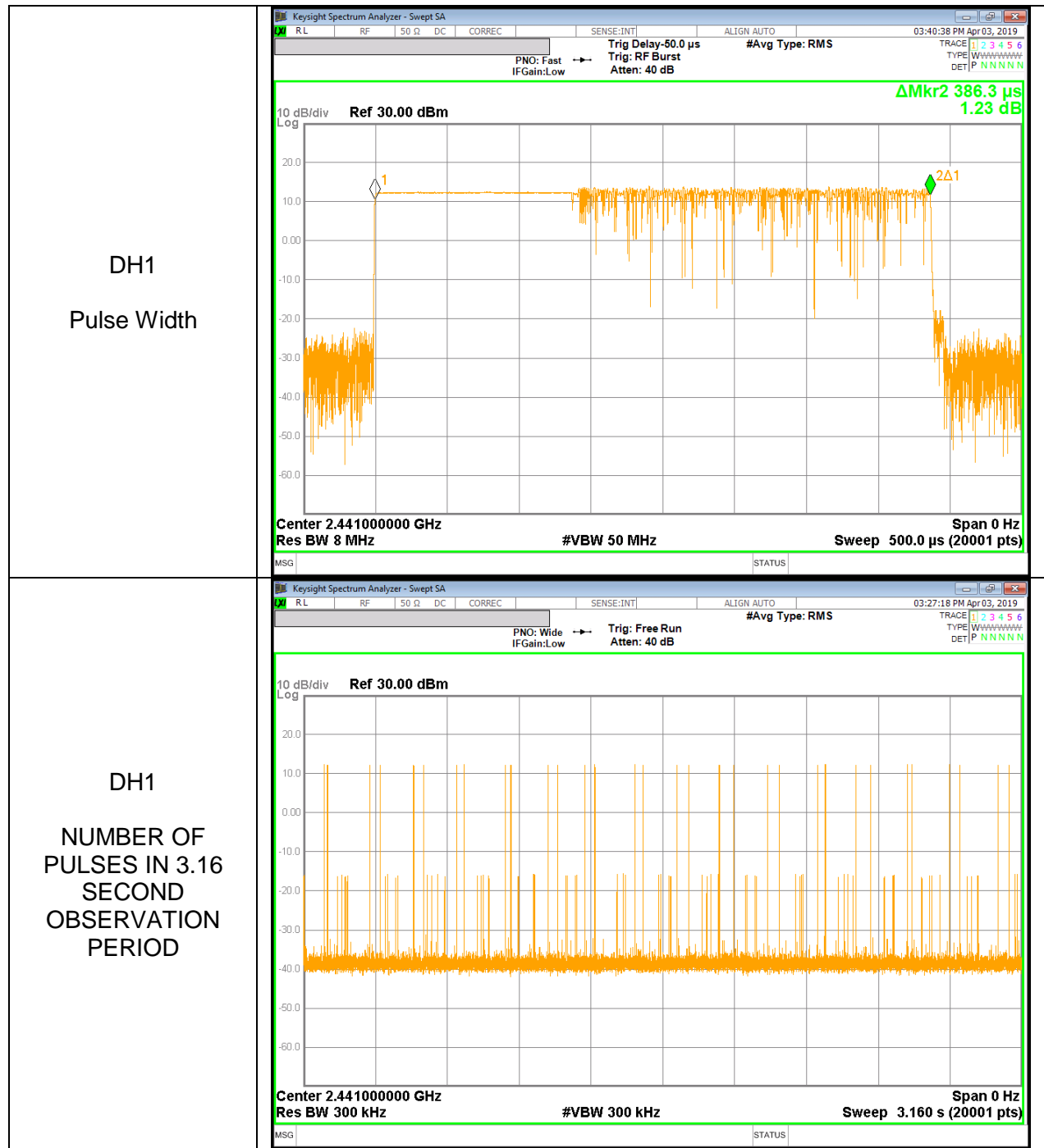

DH3

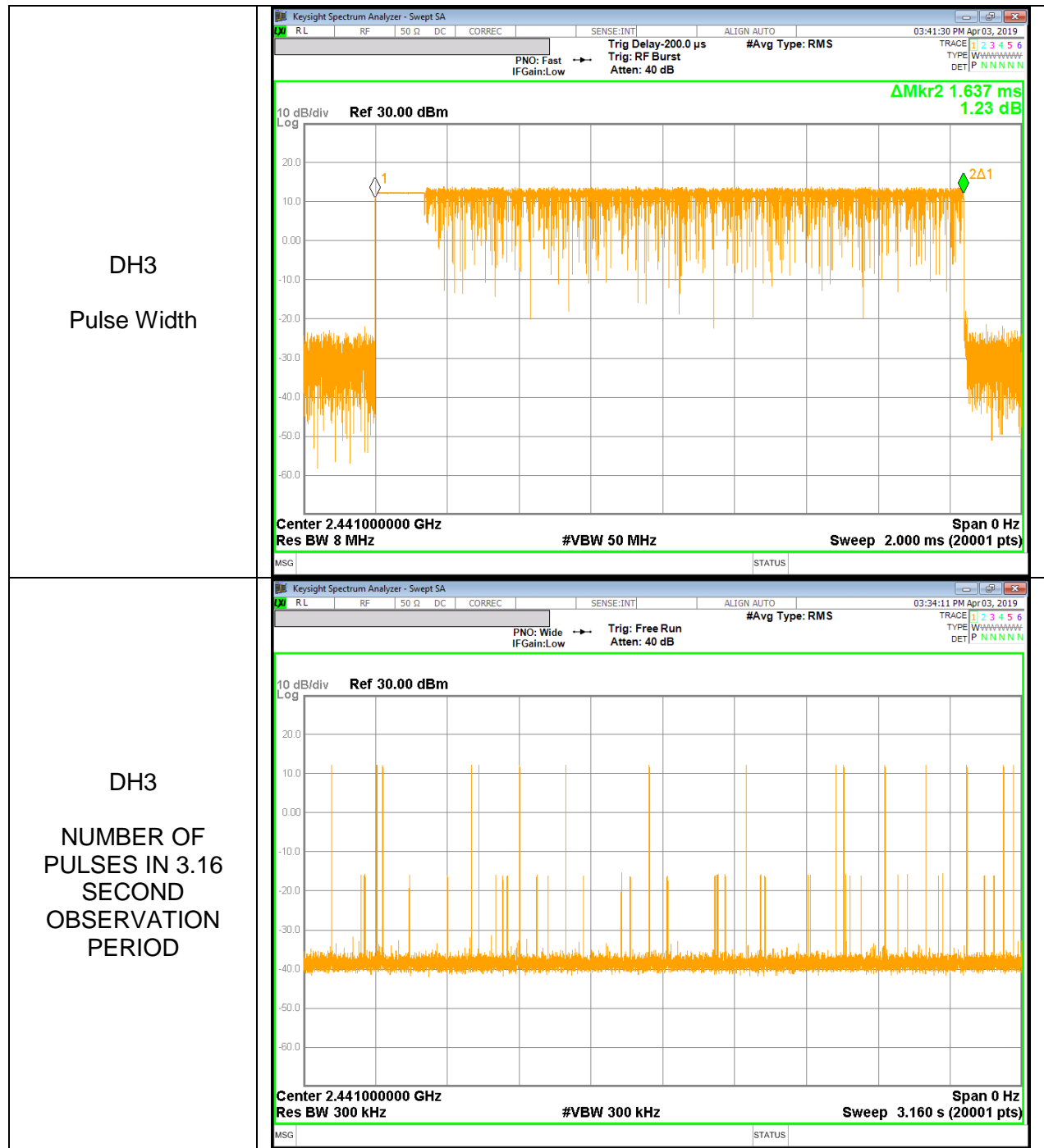

DH5

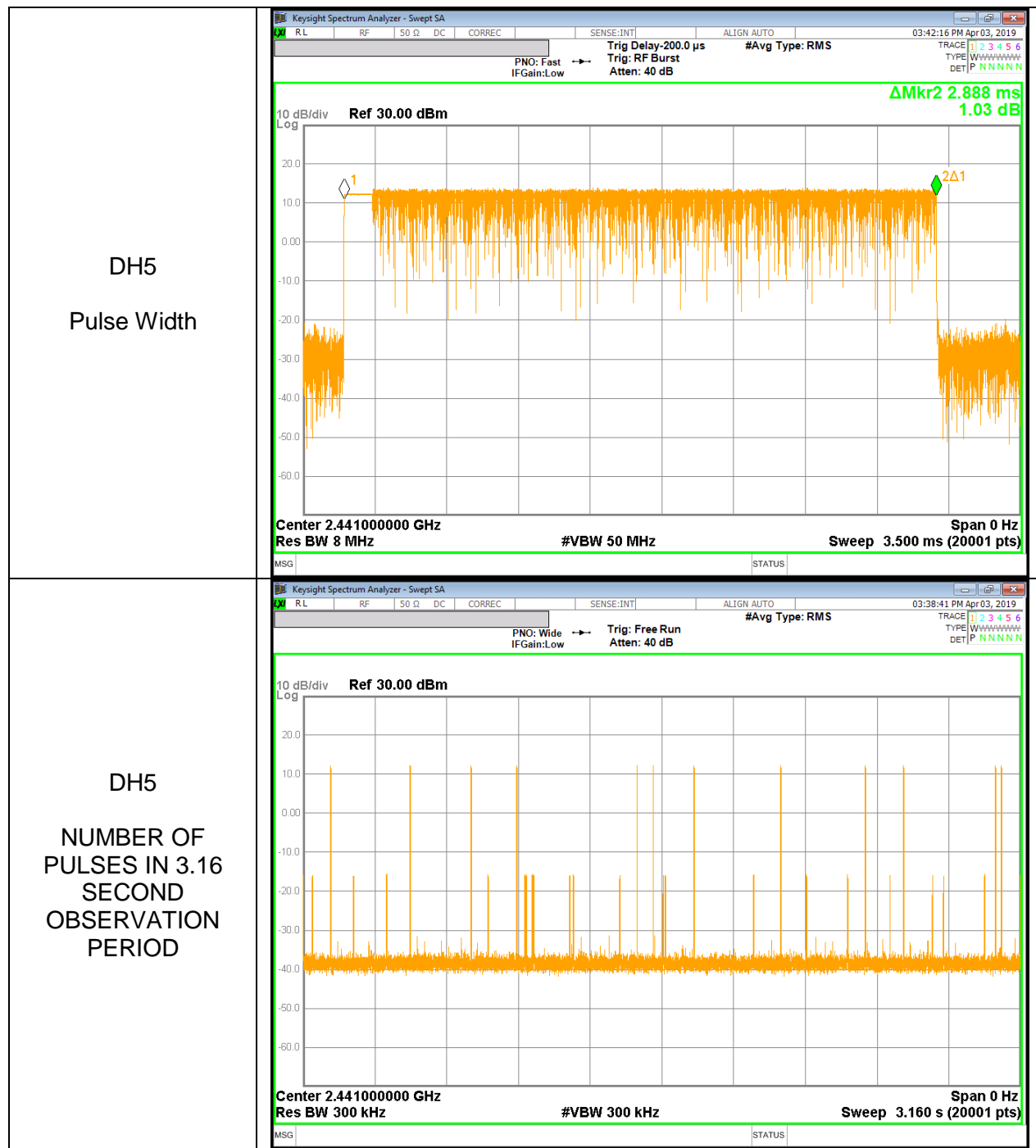

10.4. OUTPUT POWER

LIMIT

§15.247 (b) (1)

The maximum antenna gain is less than 6 dBi, therefore the limit is 21 dBm.

TEST PROCEDURE

The transmitter output is connected to a spectrum analyzer the analyzer bandwidth is set to a value greater than the 20 dB bandwidth of the EUT.

RESULTS

10.4.1. BASIC DATA RATE GFSK MODULATION

Channel	Frequency [MHz]	Output Power [dBm]	Limit [dBm]	Margin [dB]
Low	2402	14.332	21	-6.668
Middle	2441	14.327	21	-6.673
High	2480	13.665	21	-7.335
Worst		14.332	21	-6.668

10.4.2. ENHANCED DATA RATE Pi/4-DPSK MODULATION

Channel	Frequency [MHz]	Output Power [dBm]	Limit [dBm]	Margin [dB]
Low	2402	13.926	21	-7.074
Middle	2441	13.819	21	-7.181
High	2480	13.424	21	-7.576
Worst		13.926	21	-7.074

10.4.3. ENHANCED DATA RATE 8PSK MODULATION

Channel	Frequency [MHz]	Output Power [dBm]	Limit [dBm]	Margin [dB]
Low	2402	14.126	21	-6.874
Middle	2441	14.033	21	-6.967
High	2480	13.501	21	-7.499
Worst		14.126	21	-6.874

10.4.4. OUTPUT POWER PLOTS

GFSK OUTPUT POWER

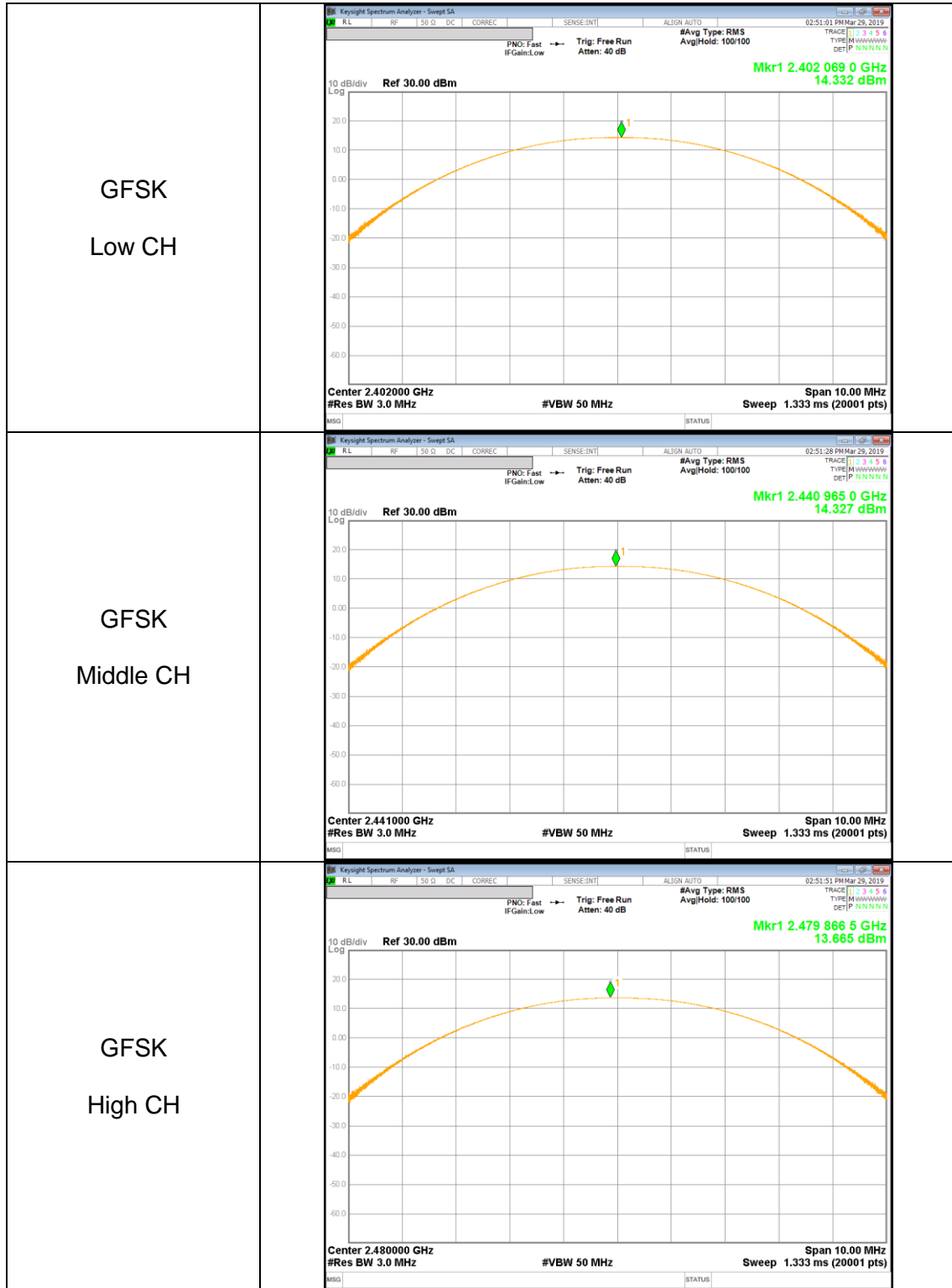

Pi/4-DPSK OUTPUT POWER

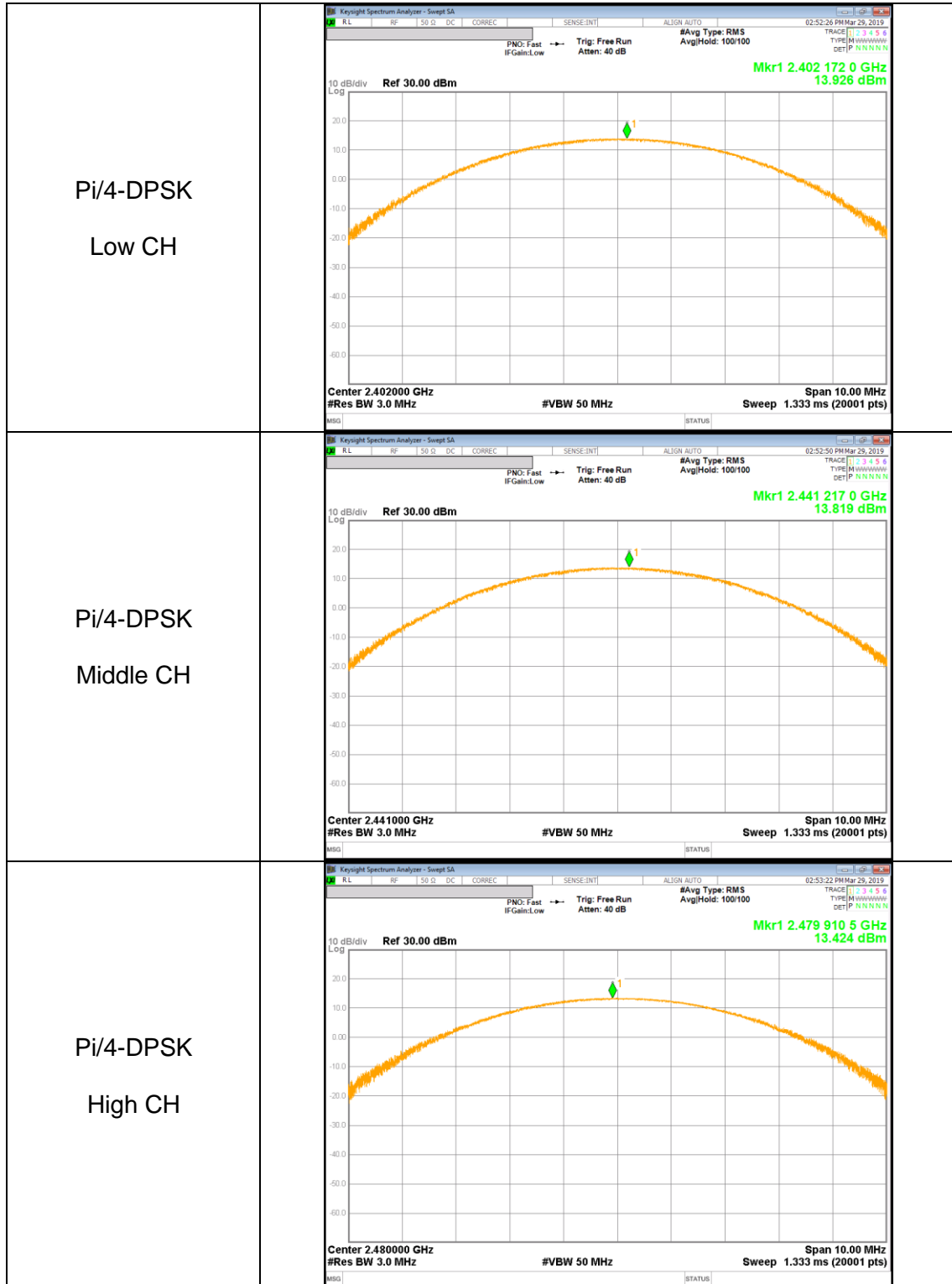

8PSK OUTPUT POWER

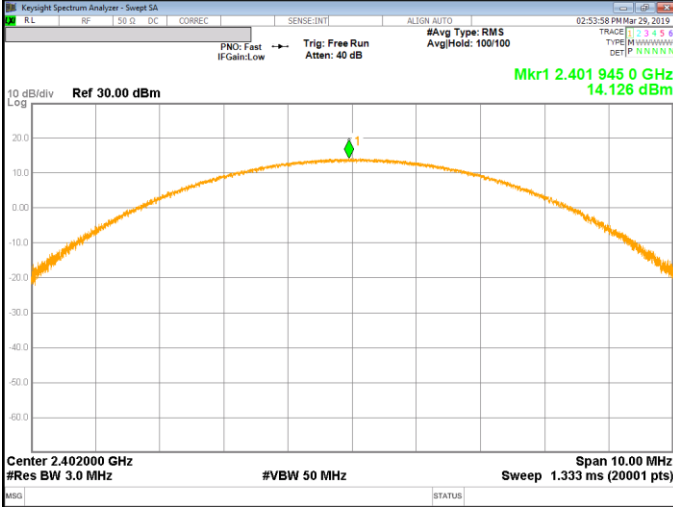
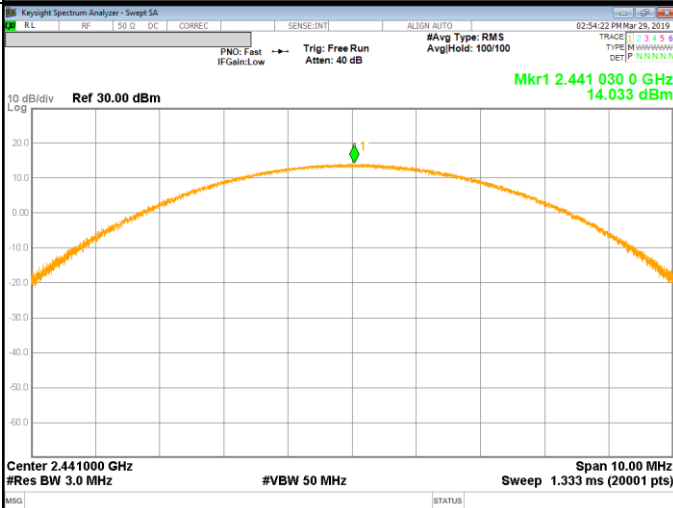
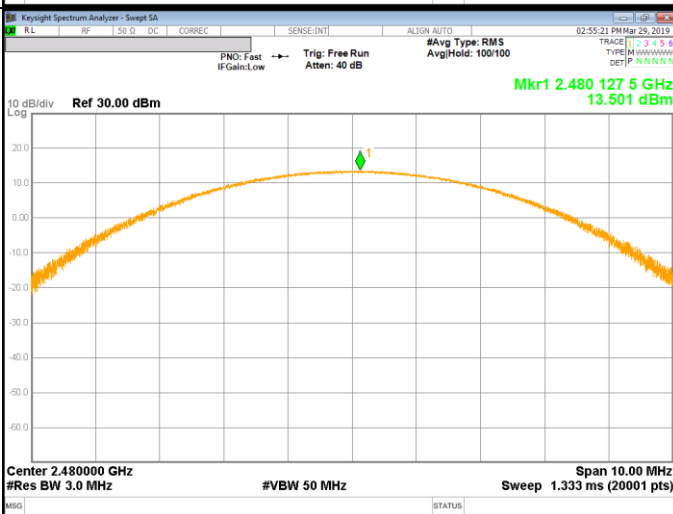
<p>8PSK Low CH</p>	 <p>KeySight Spectrum Analyzer - Swept SA RL RF 50 Ω DC CORREC SENSE:INT ALIGN AUTO 02:53:58 PM Mar 29, 2019 PNO: Fast Trig: Free Run #Avg Type: RMS IF Gain: Low Atten: 40 dB Avg Hold: 100/100 Mkr1 2.401 945 0 GHz 14.126 dBm Ref 30.00 dBm 10 dB/div LOG Center 2.402000 GHz Span 10.00 MHz #Res BW 3.0 MHz #VBW 50 MHz Sweep 1.333 ms (20001 pts) MSG STATUS</p>
<p>8PSK Middle CH</p>	 <p>KeySight Spectrum Analyzer - Swept SA RL RF 50 Ω DC CORREC SENSE:INT ALIGN AUTO 02:54:22 PM Mar 29, 2019 PNO: Fast Trig: Free Run #Avg Type: RMS IF Gain: Low Atten: 40 dB Avg Hold: 100/100 Mkr1 2.441 030 0 GHz 14.033 dBm Ref 30.00 dBm 10 dB/div LOG Center 2.441000 GHz Span 10.00 MHz #Res BW 3.0 MHz #VBW 50 MHz Sweep 1.333 ms (20001 pts) MSG STATUS</p>
<p>8PSK High CH</p>	 <p>KeySight Spectrum Analyzer - Swept SA RL RF 50 Ω DC CORREC SENSE:INT ALIGN AUTO 02:55:21 PM Mar 29, 2019 PNO: Fast Trig: Free Run #Avg Type: RMS IF Gain: Low Atten: 40 dB Avg Hold: 100/100 Mkr1 2.480 127 5 GHz 13.501 dBm Ref 30.00 dBm 10 dB/div LOG Center 2.480000 GHz Span 10.00 MHz #Res BW 3.0 MHz #VBW 50 MHz Sweep 1.333 ms (20001 pts) MSG STATUS</p>

10.5. AVERAGE POWER

LIMIT

None; for reporting purposes only.

TEST PROCEDURE

The transmitter output is connected to a power meter.

RESULTS

The cable assembly insertion loss was entered as an offset in the power meter to allow for direct reading of power.

10.5.1. BASIC DATA RATE GFSK MODULATION

Channel	Frequency [MHz]	AV power [dBm]	AV power [mW]
Low	2402	14.155	26.03
Middle	2441	14.130	25.88
High	2480	13.500	22.39

10.5.2. ENHANCED DATA RATE PI/4-DQPSK MODULATION

Channel	Frequency [MHz]	AV power [dBm]	AV power [mW]
Low	2402	12.311	17.03
Middle	2441	12.016	15.91
High	2480	12.162	16.45

10.5.3. ENHANCED DATA RATE 8PSK MODULATION

Channel	Frequency [MHz]	AV power [dBm]	AV power [mW]
Low	2402	12.319	17.06
Middle	2441	12.048	16.03
High	2480	12.186	16.54

10.6. CONDUCTED SPURIOUS EMISSIONS

LIMITS

FCC §15.247 (d)

Limit = -20 dBc

TEST PROCEDURE

The transmitter output is connected to a spectrum analyzer. The resolution bandwidth is set to 100 kHz. The video bandwidth is set to 300 kHz.

The spectrum from 30 MHz to 26 GHz is investigated with the transmitter set to the lowest, middle, and highest channels.

The bandedges at 2.4 and 2.4835 GHz are investigated with the transmitter set to the normal hopping mode.

RESULTS

10.6.1. BASIC DATA RATE GFSK MODULATION

GFSK Mode

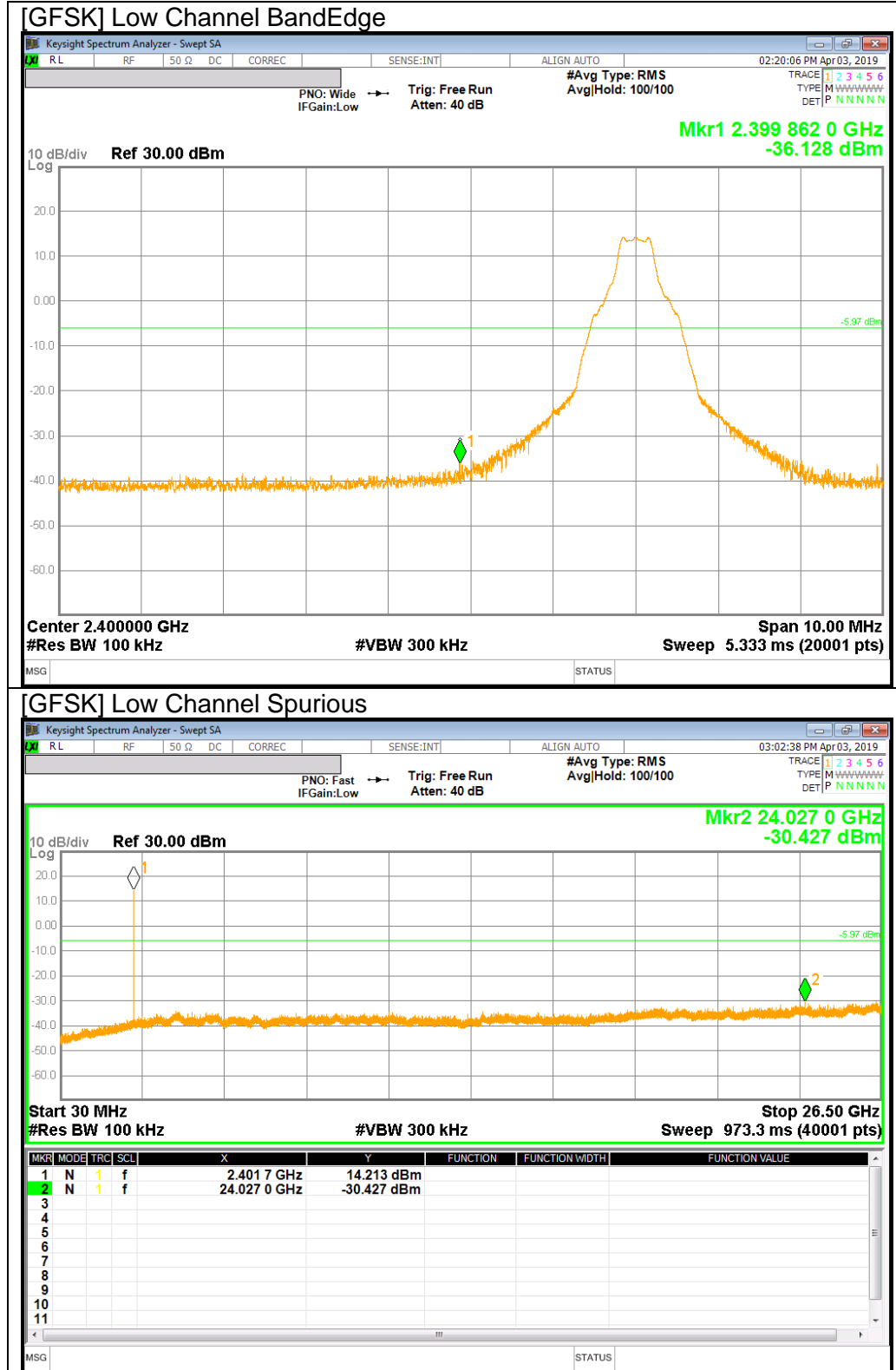

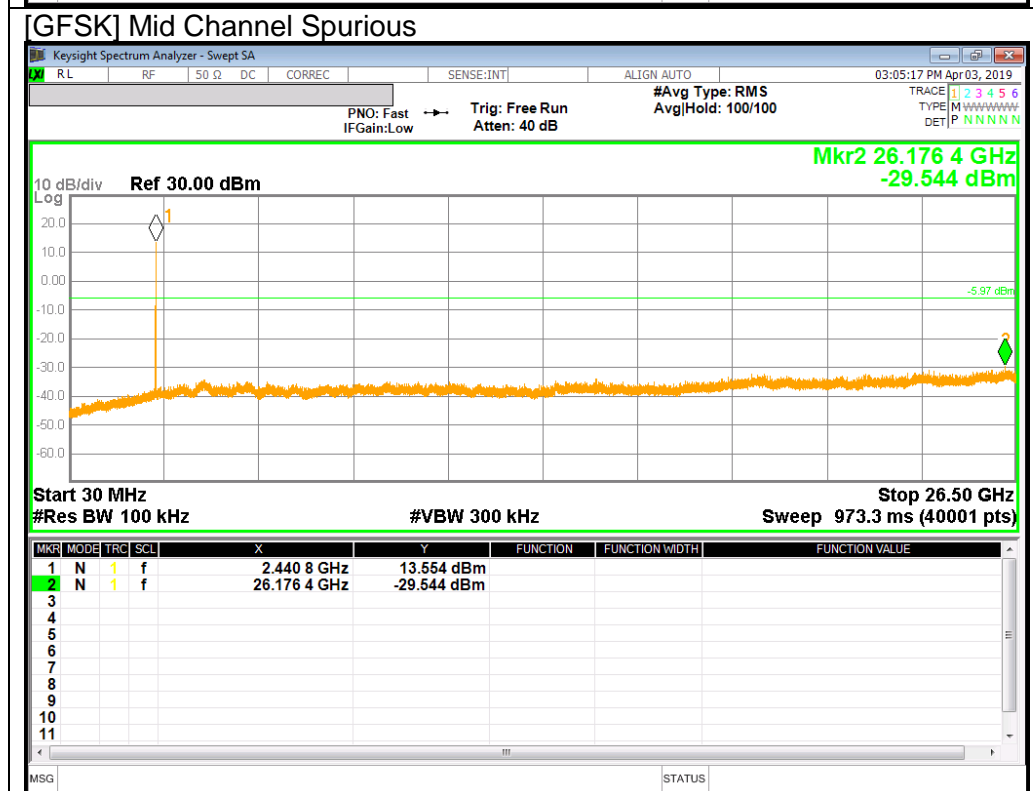
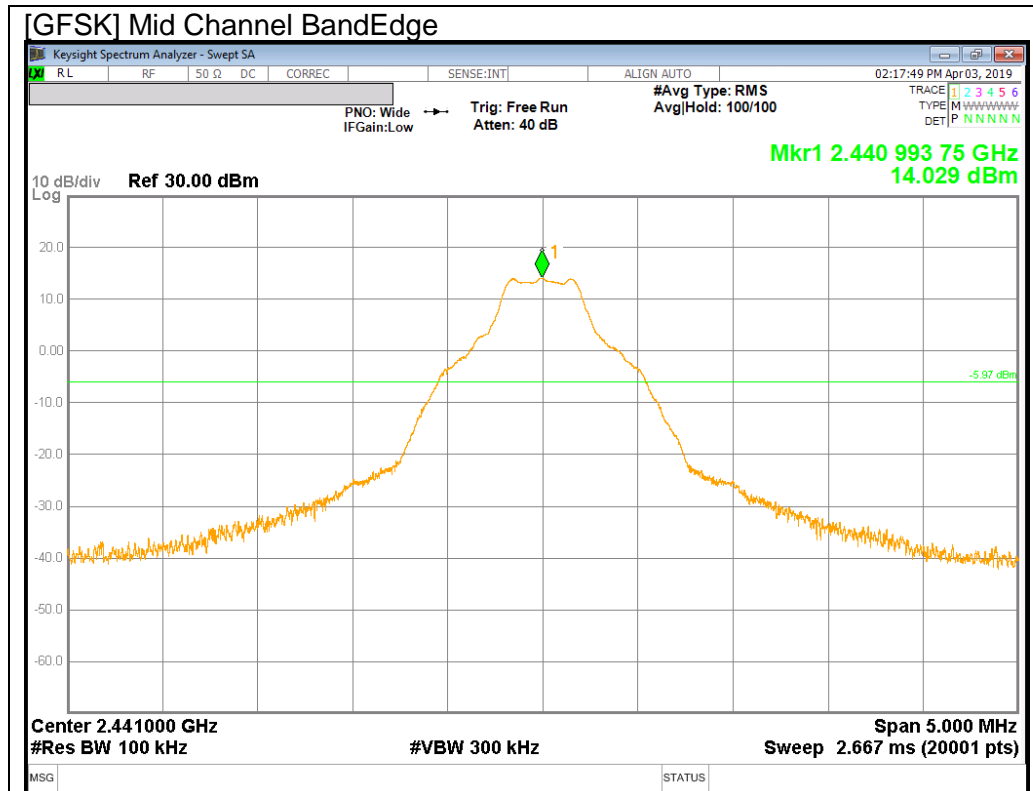

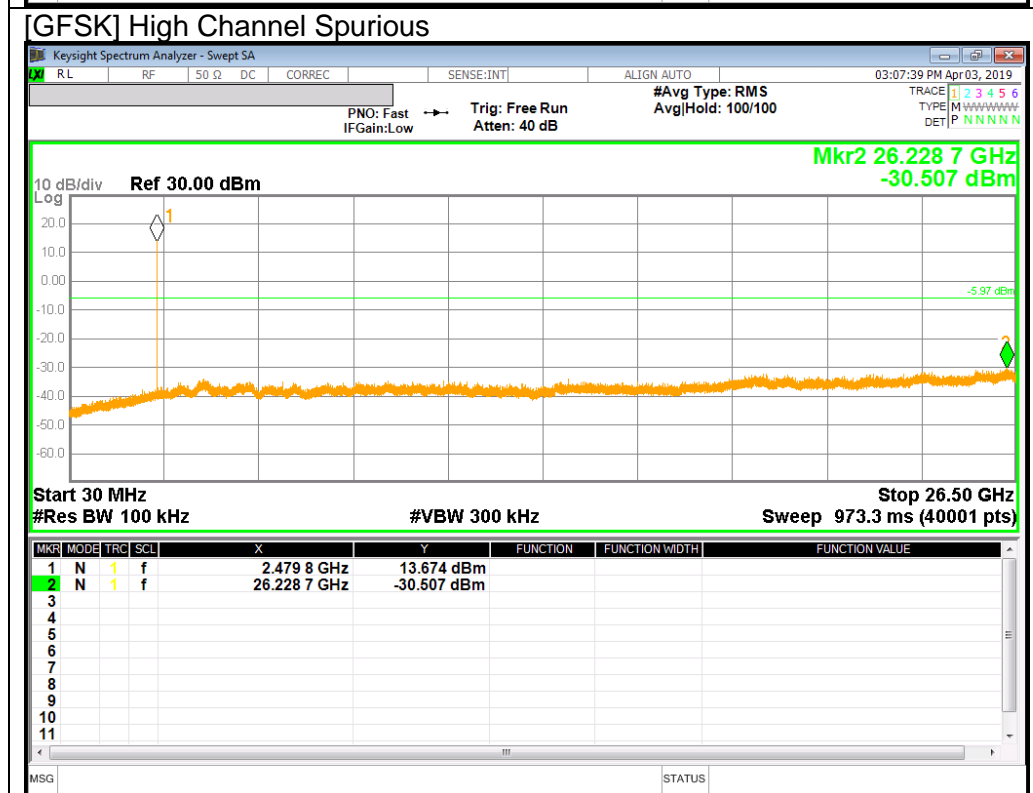
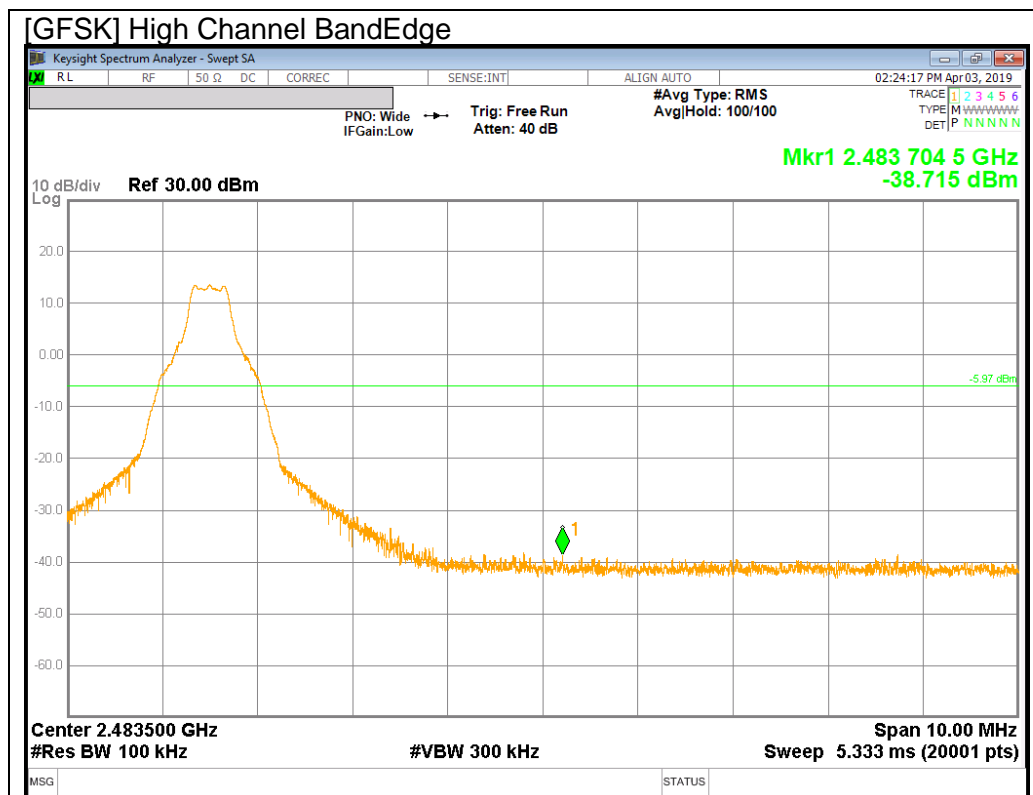

BandEdge Emission at GFSK Hopping Mode

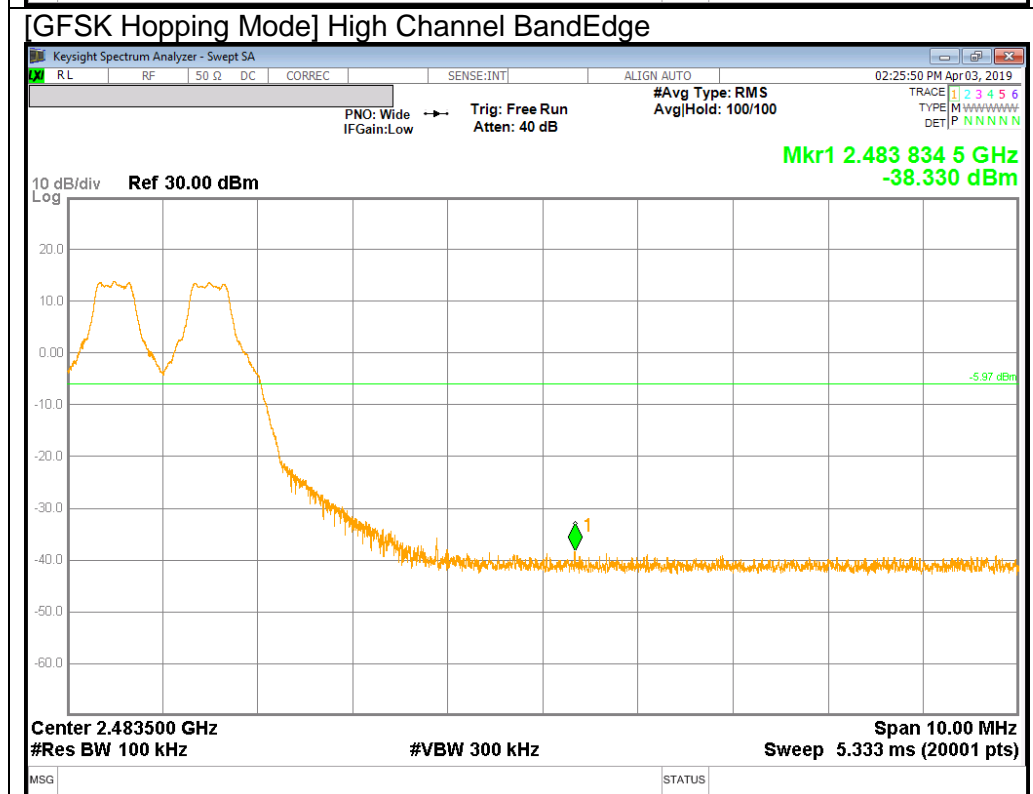
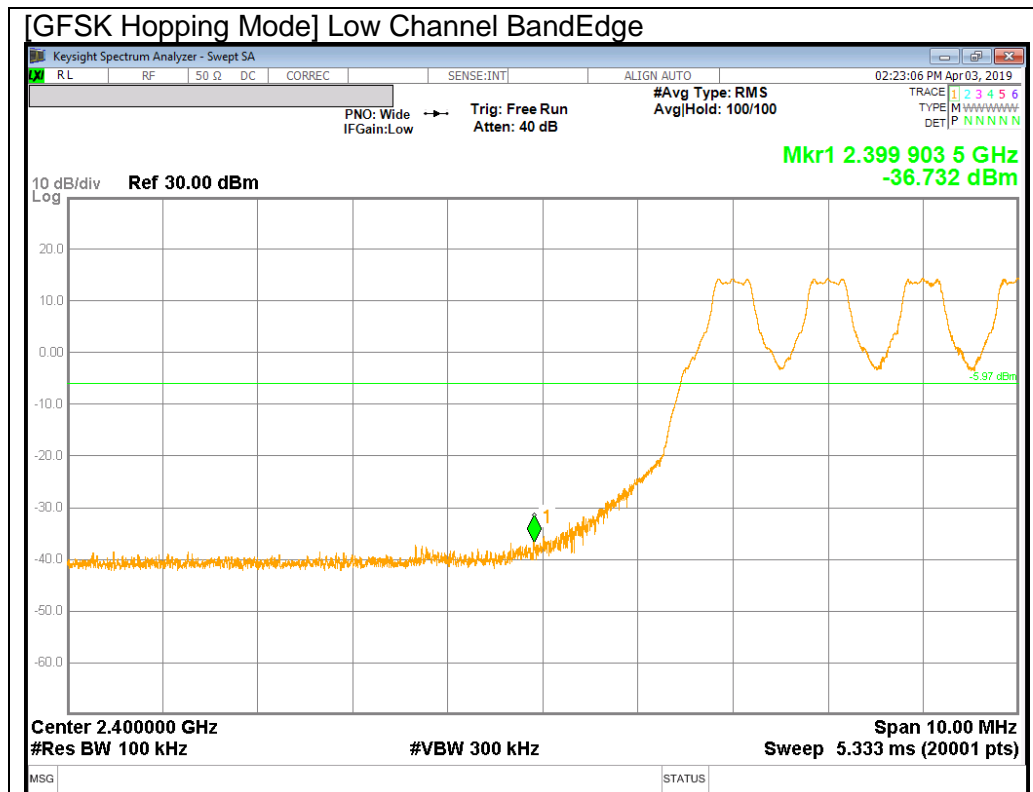

10.6.2. ENHANCED DATA RATE PI/4-DQPSK MODULATION

PI/4-DQPSK Mode

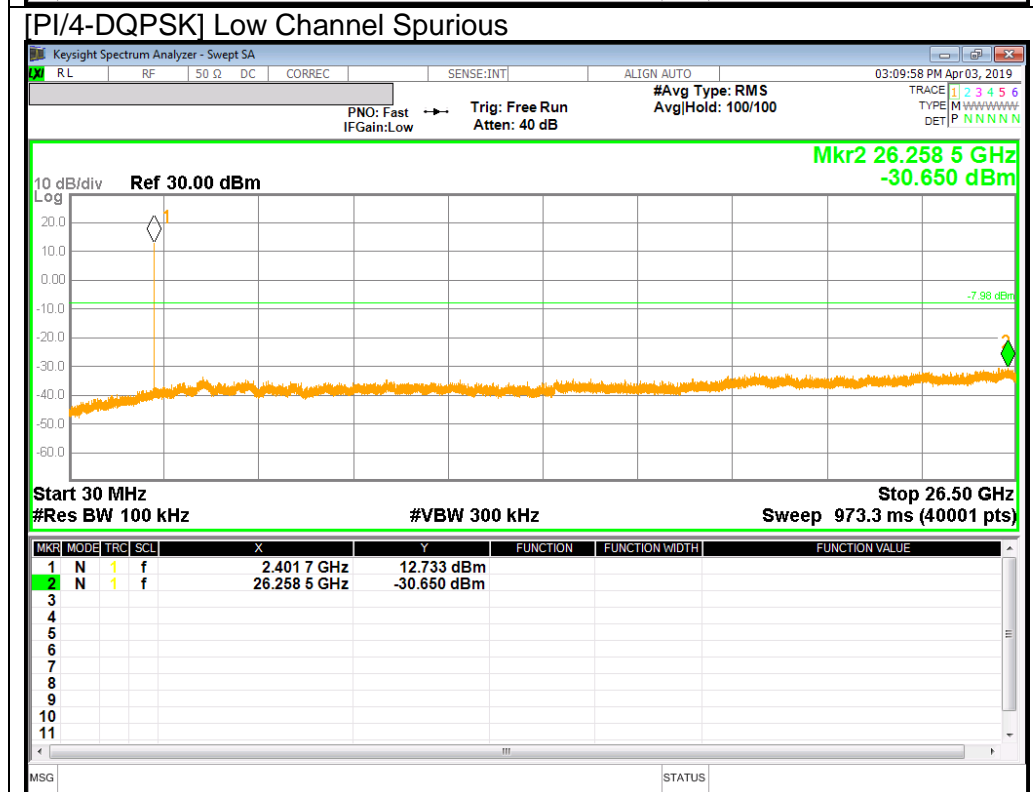
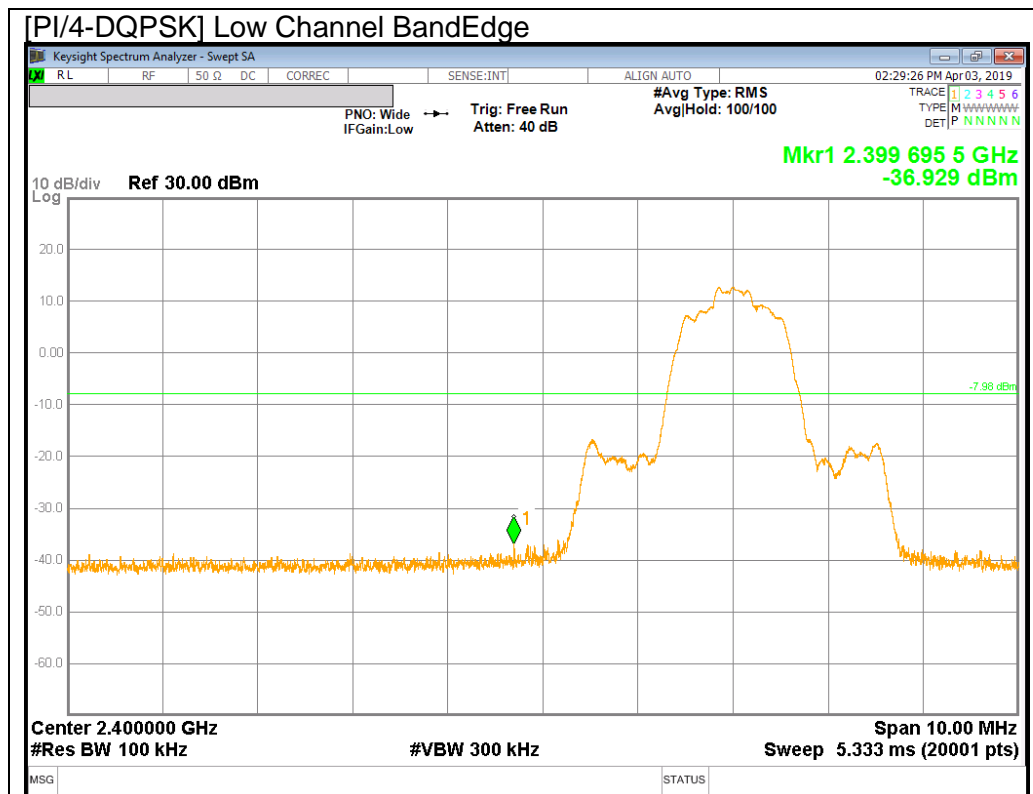

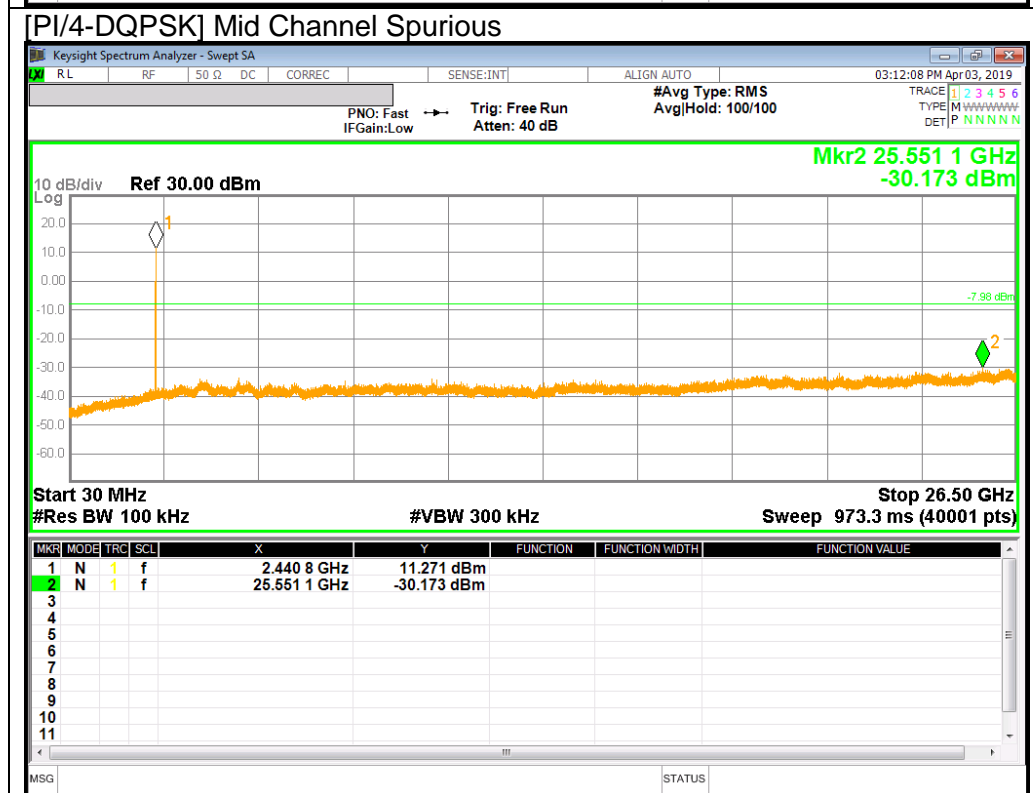
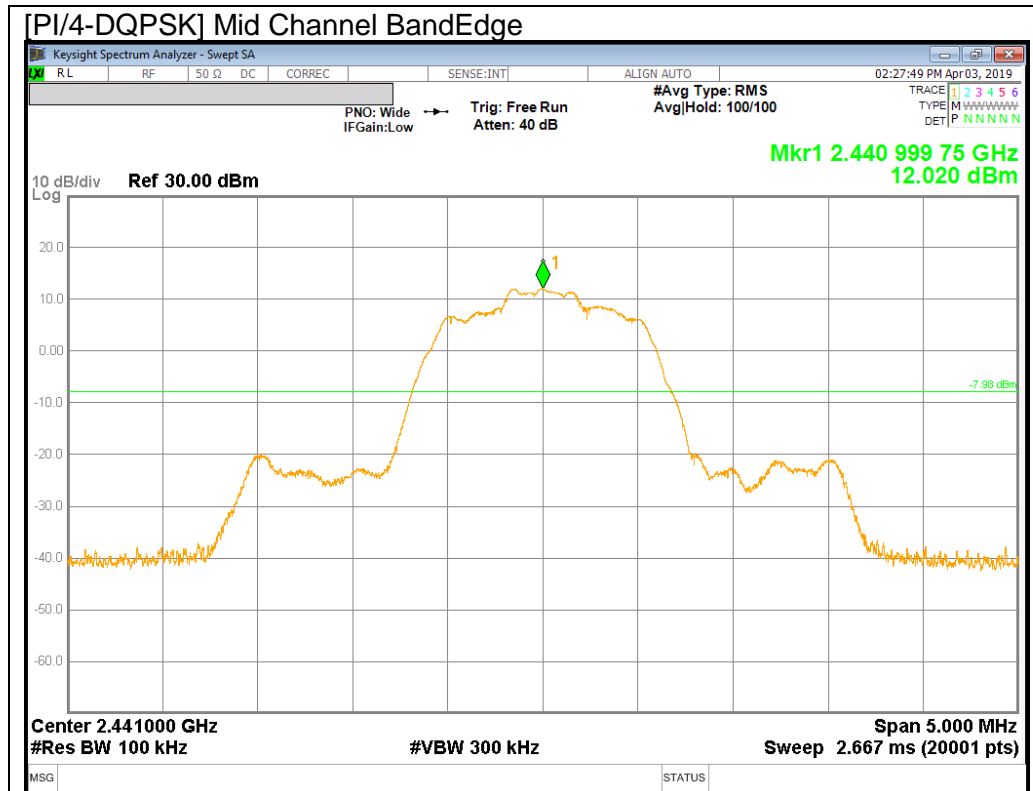

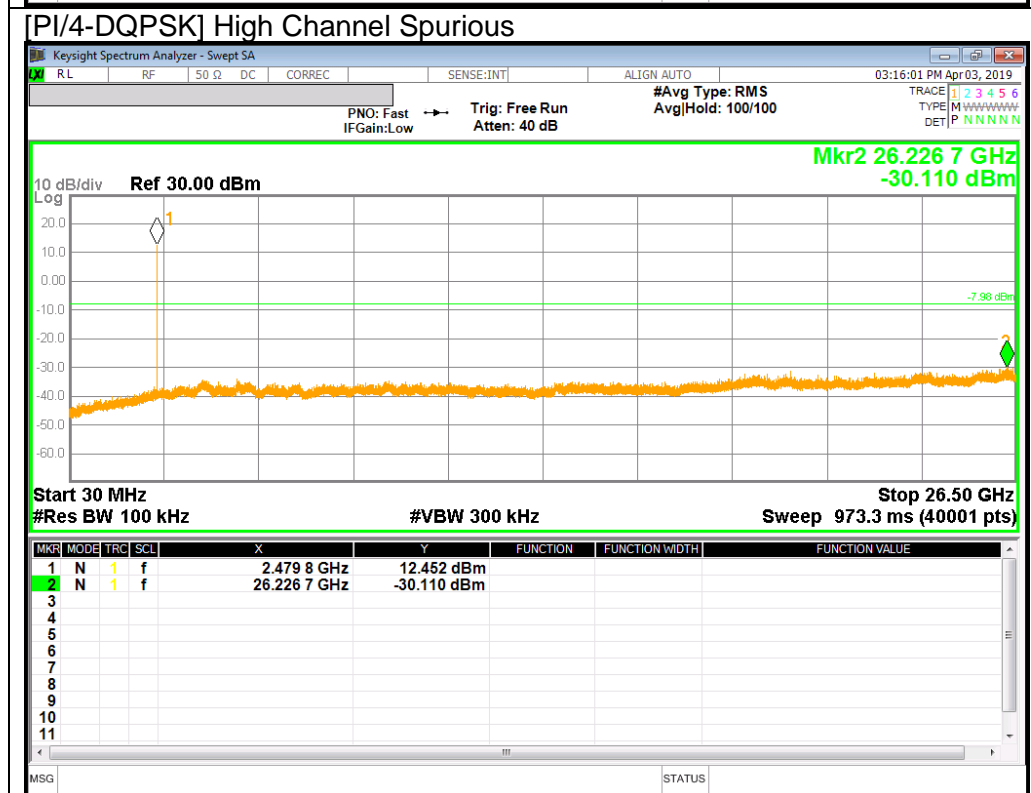
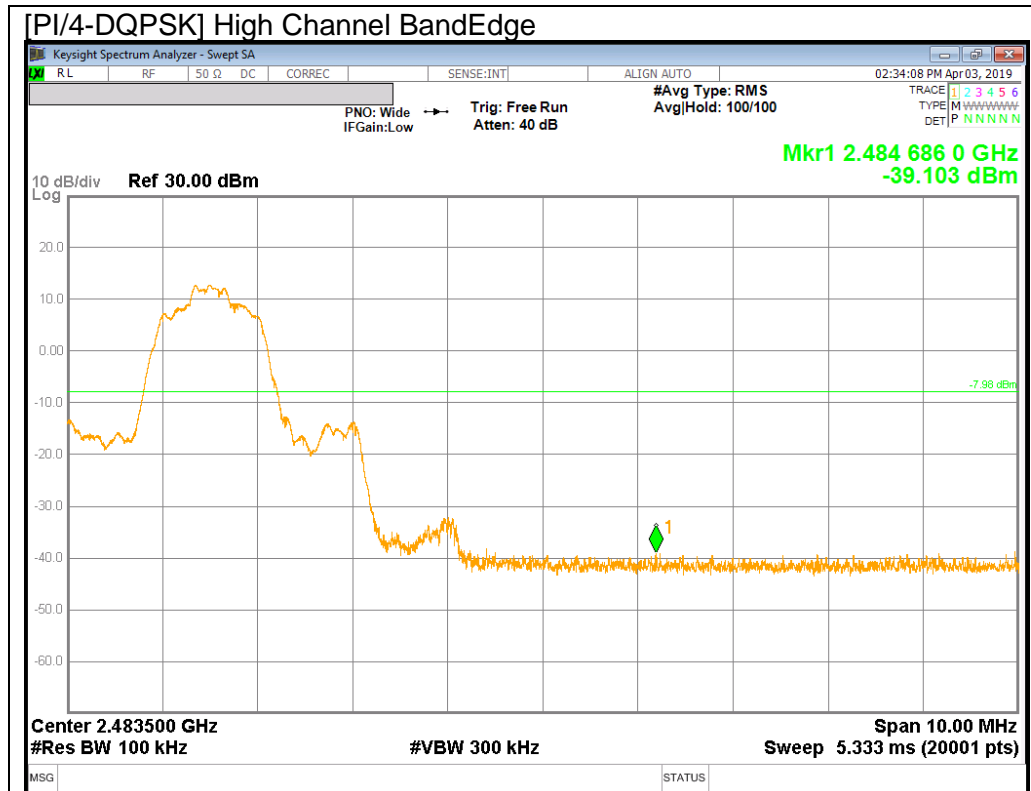

BandEdge Emission at PI/4-DQPSK Hopping Mode

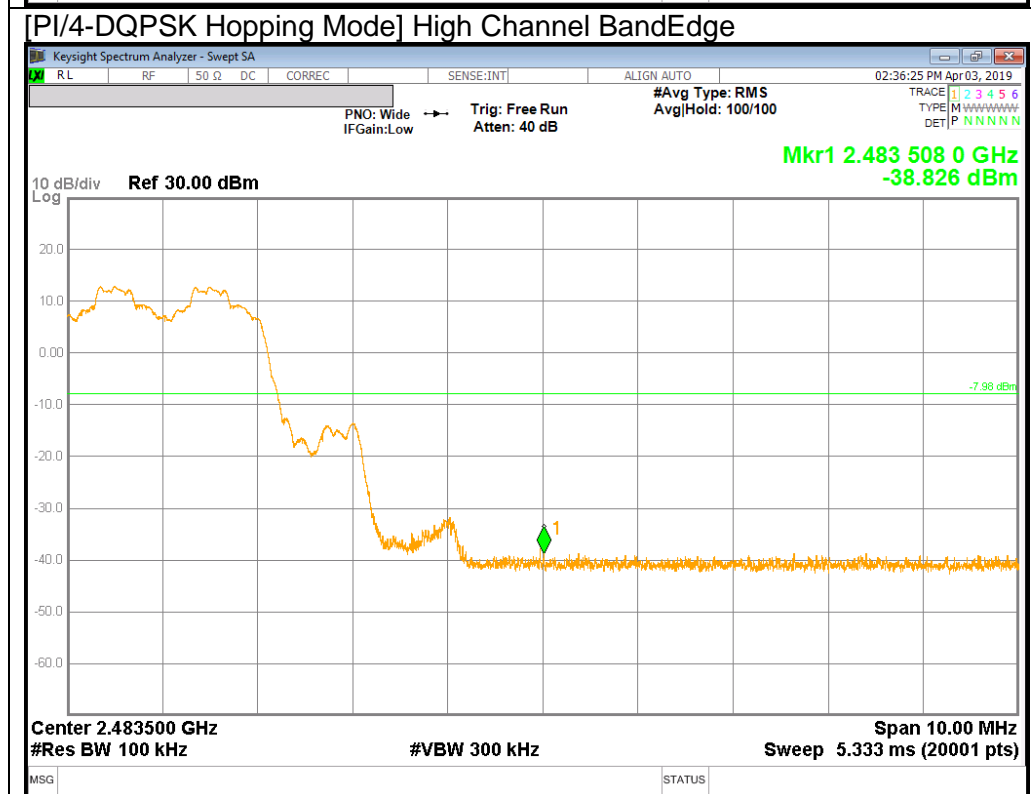
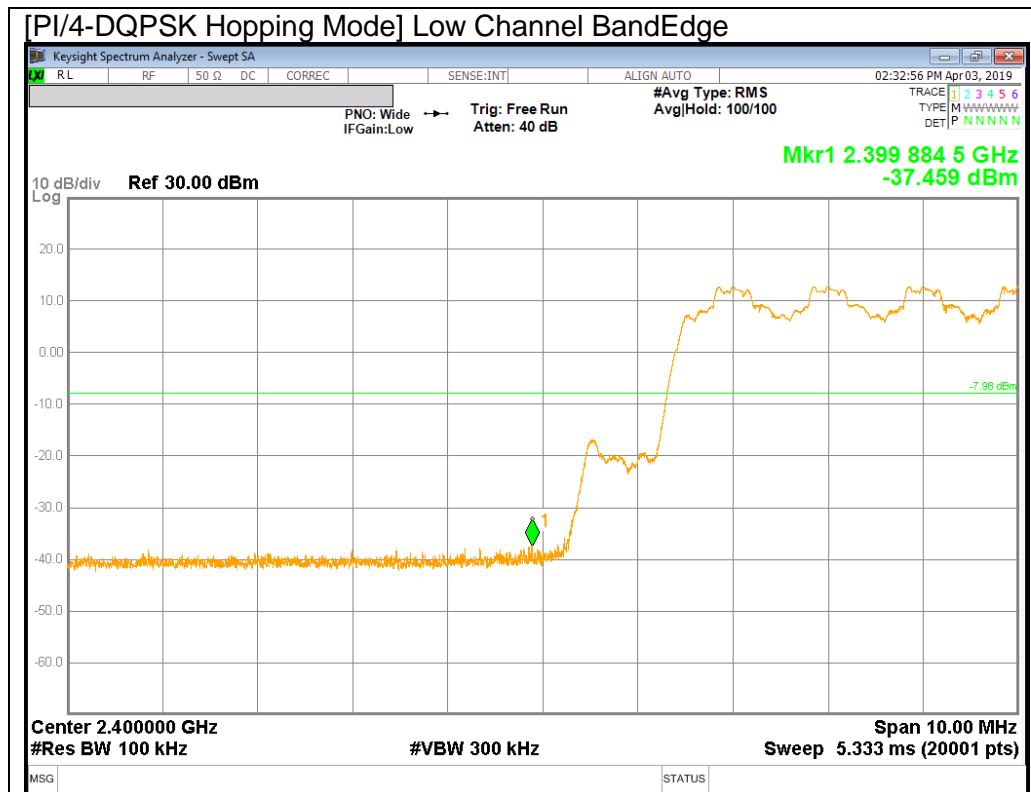

10.6.3. ENHANCED DATA RATE 8PSK MODULATION

8PSK Mode

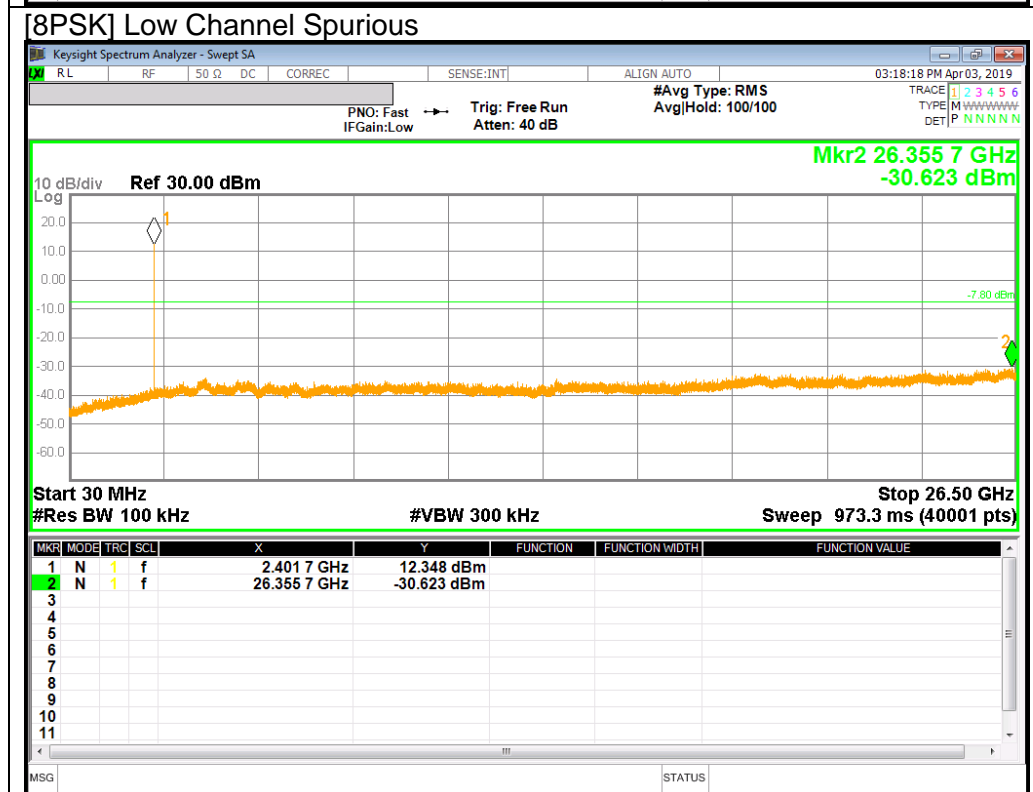
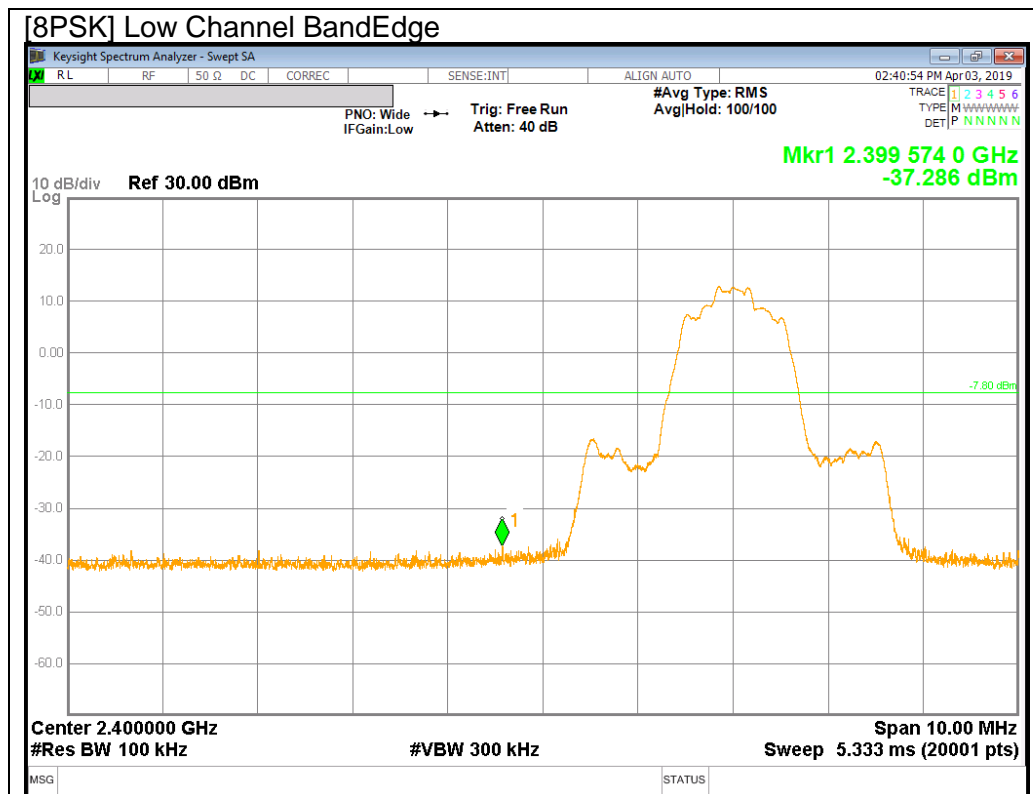

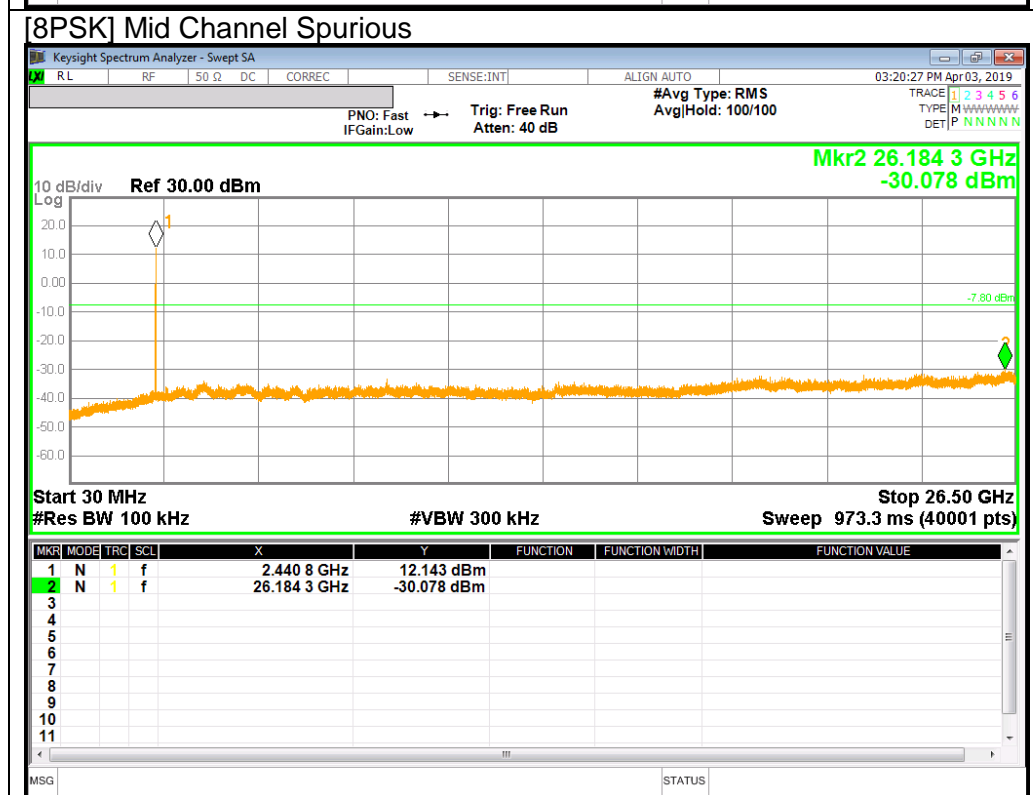
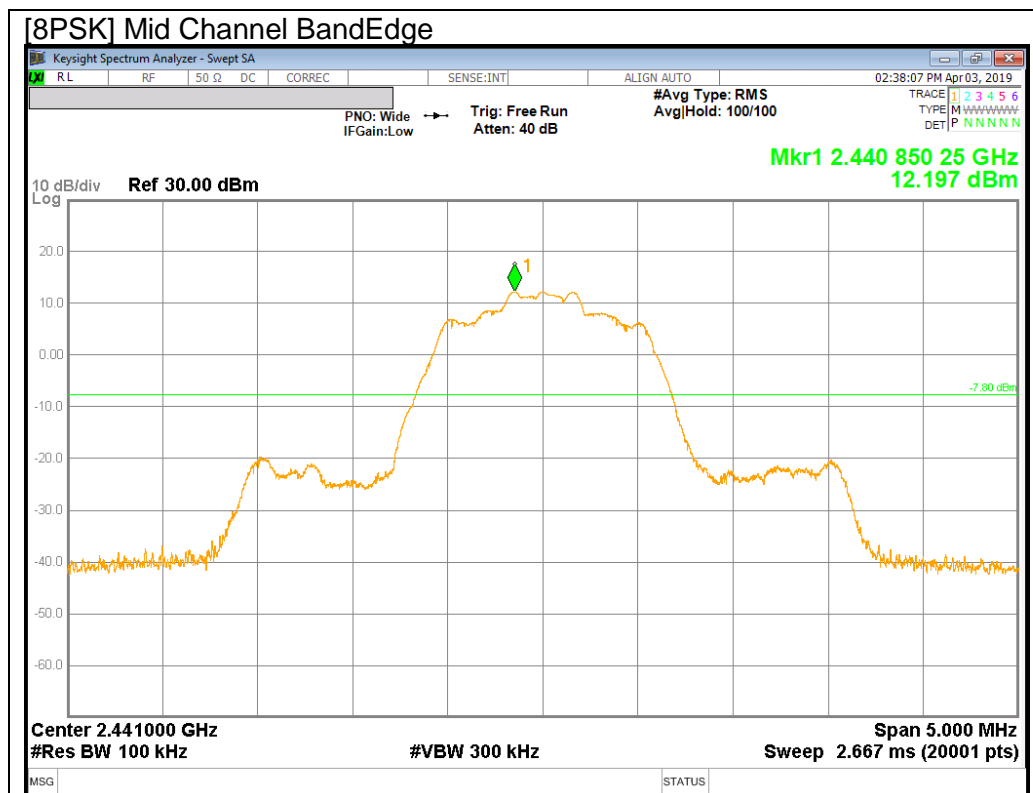

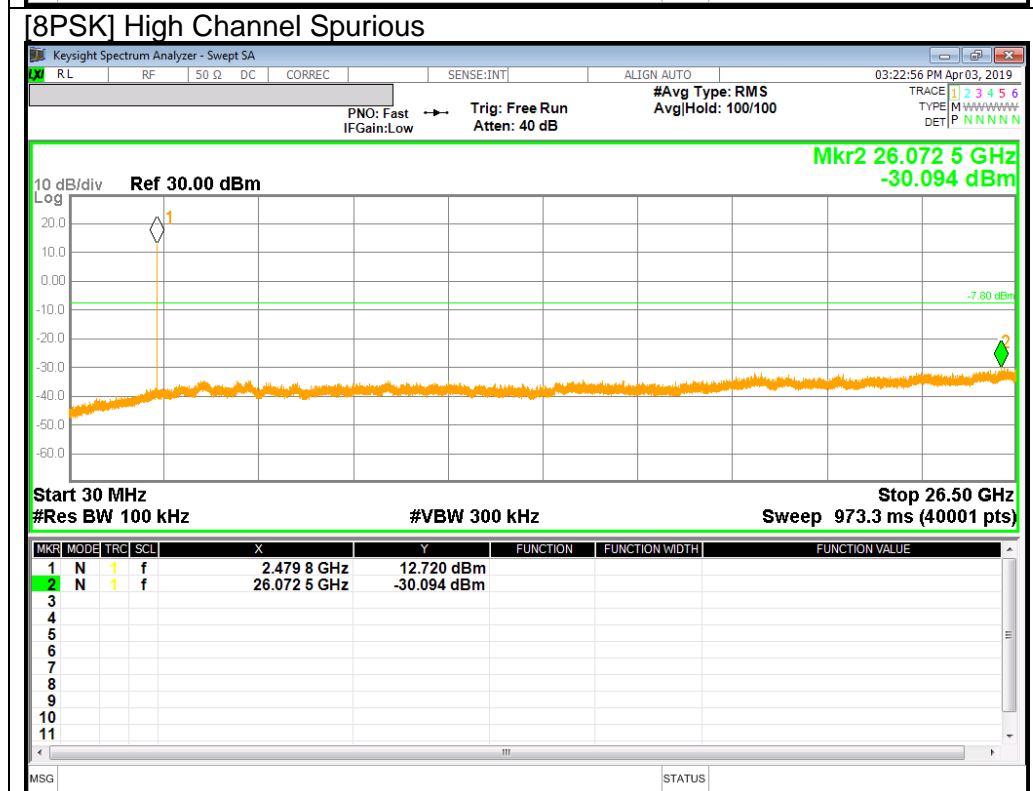
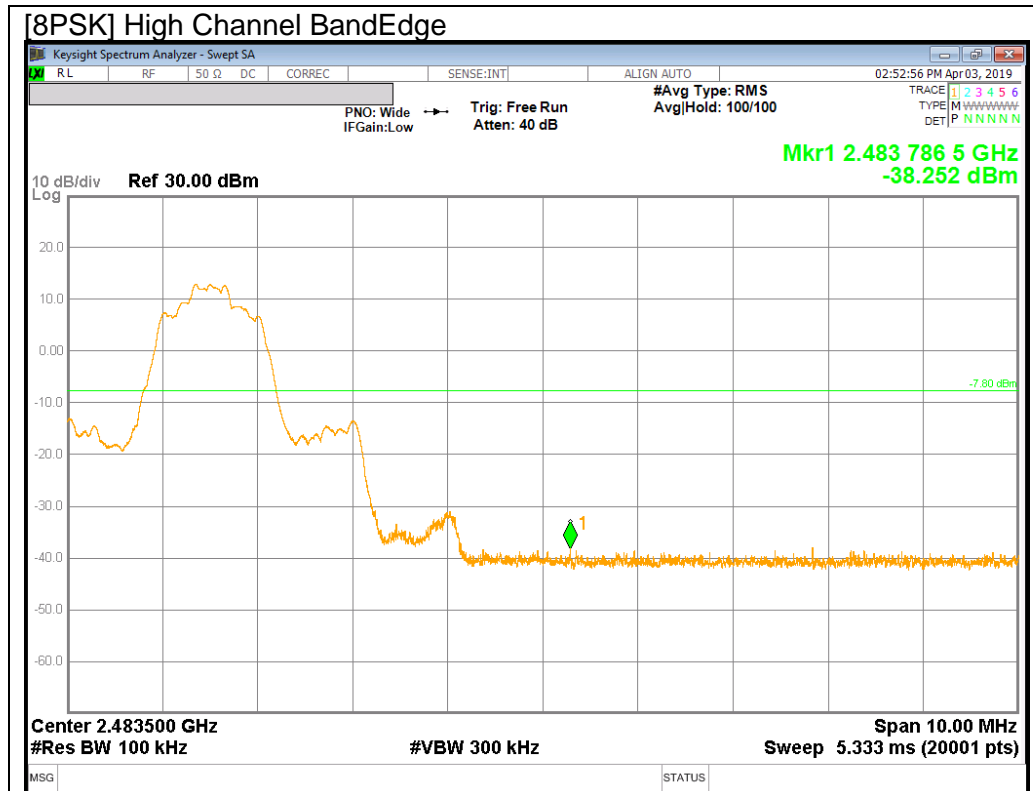

BandEdge Emission at 8PSK Hopping Mode

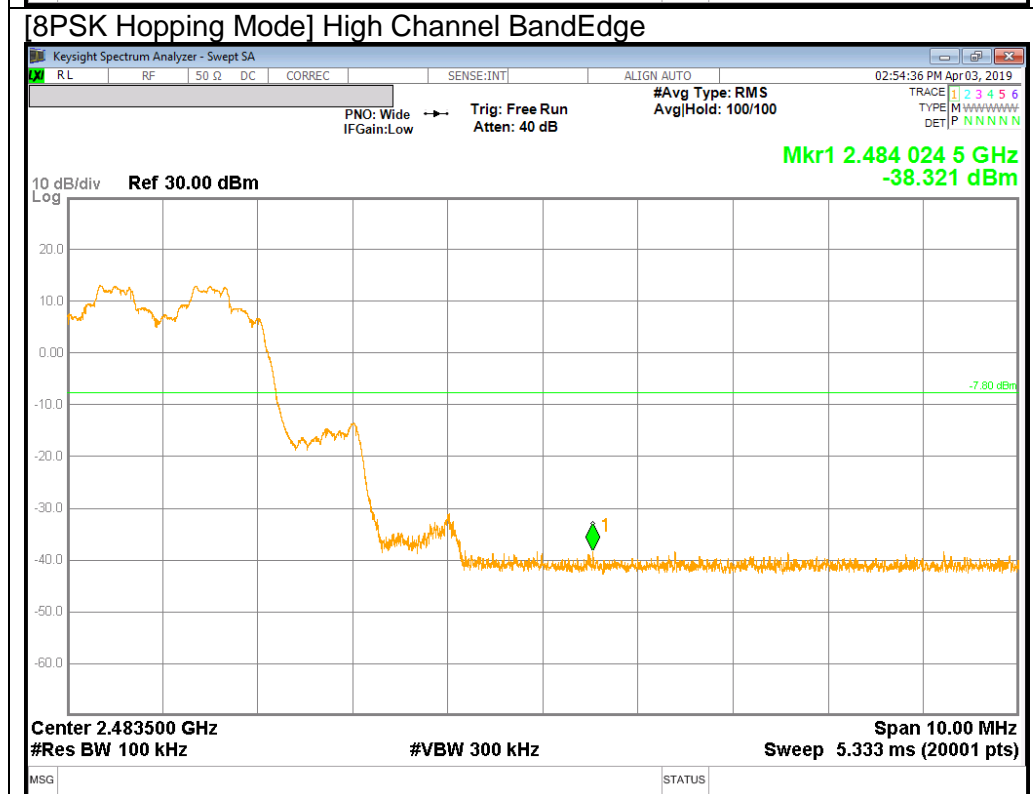
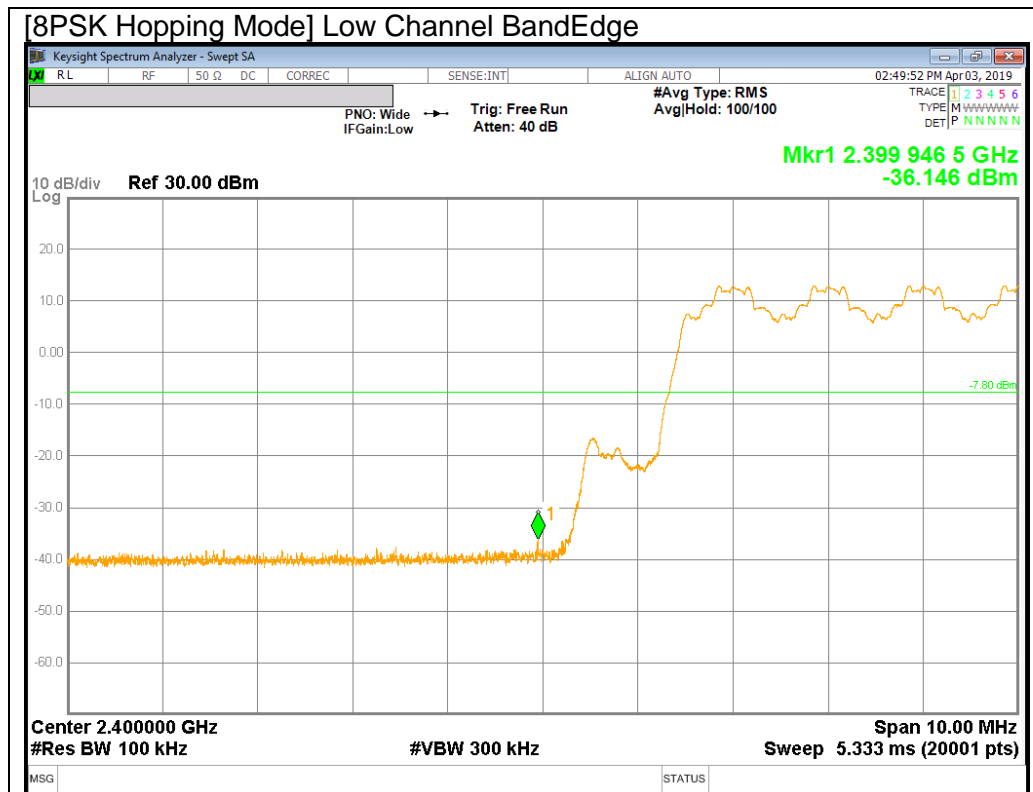

11. RADIATED TEST RESULTS

11.1. LIMITS AND PROCEDURE

LIMITS

FCC §15.205 and §15.209

Limits for radiated disturbance of an intentional radiator		
Frequency range (MHz)	Limits (µV/m)	Measurement Distance (m)
0.009 – 0.490	2400 / F (kHz)	300
0.490 – 1.705	24000 / F (kHz)	30
1.705 – 30.0	30	30
30 – 88	100**	3
88 - 216	150**	3
216 – 960	200**	3
Above 960	500	3

** Except as provided in paragraph (g), fundamental emissions from intentional radiators operating under this section shall not be located in the frequency bands 54-72 MHz, 76-88 MHz, 174-216 MHz or 470-806 MHz. However, operation within these frequency bands is permitted under other sections of this part, e.g. §§ 15.231 and 15.241.

TEST PROCEDURE

The EUT is placed on a non-conducting table 80 cm above the ground plane for below 1GHz and 150 cm for above 1GHz. The EUT is configured in accordance with ANSI C63.10. The EUT is set to transmit in a continuous mode.

For measurements below 1 GHz the resolution bandwidth is set to 100 kHz for peak detection measurements or 120 kHz for quasi-peak detection measurements. Peak detection is used unless otherwise noted as quasi-peak.

For measurements above 1 GHz the resolution bandwidth is set to 1 MHz; the video bandwidth is set to 3 MHz for peak measurements.(Pre-scans to detect harmonic and spurious emissions, the resolution bandwidth is set to 1 MHz; the video bandwidth is set to 30 KHz for peak measurements.)

For band edge measurements above 1 GHz the resolution bandwidth is set to 1 MHz, then the video bandwidth is set to 3 MHz for peak measurements and 1/T (on time) for average measurement.

$$\text{GFSK} = 1/T = 1 / 0.002885\text{S} = 347\text{Hz}.$$

The minimum VBW was 347Hz, but test receiver(ESU40) couldn't set value 347Hz. Due to this reason, testing VBW was set to 500Hz(Worst cases).

The spectrum from 1GHz to 26 GHz is investigated with the transmitter set to the lowest, middle, and highest channels in the 2.4 GHz band.
(From 30MHz to 1GHz, test was performed with the EUT set to transmit at the channel with highest output power)

The frequency range of interest is monitored at a fixed antenna height and EUT azimuth. The EUT is rotated through 360 degrees to maximize emissions received. The antenna is scanned from 1 to 4 meters above the ground plane to further maximize the emission. Measurements are made with the antenna polarized in both the vertical and the horizontal positions.

Note : Emission was pre-scanned from 9KHz to 30MHz; No emissions were detected which was at least 20dB below the specification limit (consider distance correction factor).
Per FCC part 15.31(o), test results were not reported.

Although these tests were performed other than open field test site, adequate comparison measurements were confirmed against 30 m open are test site.
Therefore sufficient tests were made to demonstrate that the alternative site produces results that correlate with the one of tests made in an open field based on KDB 414788.

11.1. TRANSMITTER ABOVE 1 GHz

11.1.1. BASIC DATA RATE GFSK MODULATION

RESTRICTED BANDEDGE (LOW CHANNEL)

HORIZONTAL PEAK AND AVERAGE PLOT

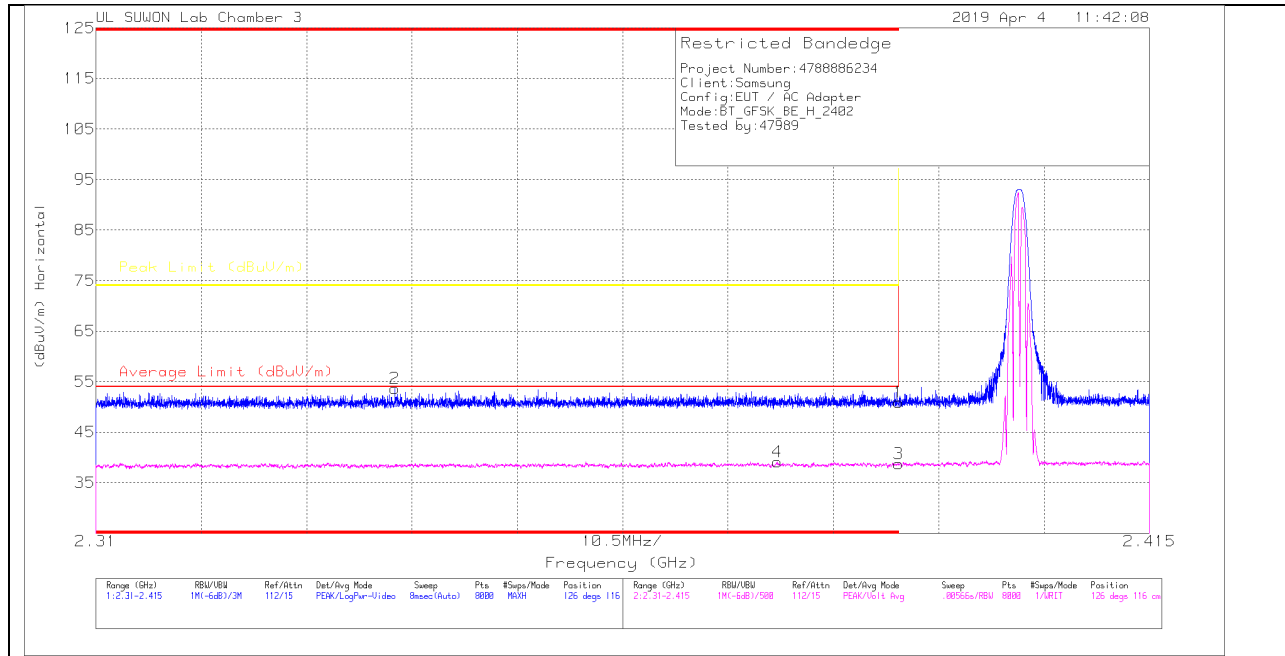

HORIZONTAL DATA

Trace Markers

Marker	Frequency (GHz)	Meter Reading (dBuV)	Det	3117_00205959	10dB(dB)	Corrected Reading (dBuV/m)	Average Limit (dBuV/m)	Margin (dB)	Peak Limit (dBuV/m)	PK Margin (dB)	Azimuth (Degs)	Height (cm)	Polarity
1	* 2.39	42.61	Pk	31.7	-23.4	50.91	-	-	74	-23.09	126	116	H
2	* 2.34	45.55	Pk	31.5	-23.4	53.65	-	-	74	-20.35	126	116	H
3	* 2.39	30.43	VA1T	31.7	-23.4	38.73	54	-15.27	-	-	126	116	H
4	* 2.378	30.95	VA1T	31.6	-23.4	39.15	54	-14.85	-	-	126	116	H

* - indicates frequency in CFR47 Pt 15 / IC RSS-Restricted Band

Pk - Peak detector

VA1T - FHSS: Linear Voltage Average $V_B=1/T_{on}$ where: T_{on} is transmit duration

VERTICAL PEAK AND AVERAGE PLOT

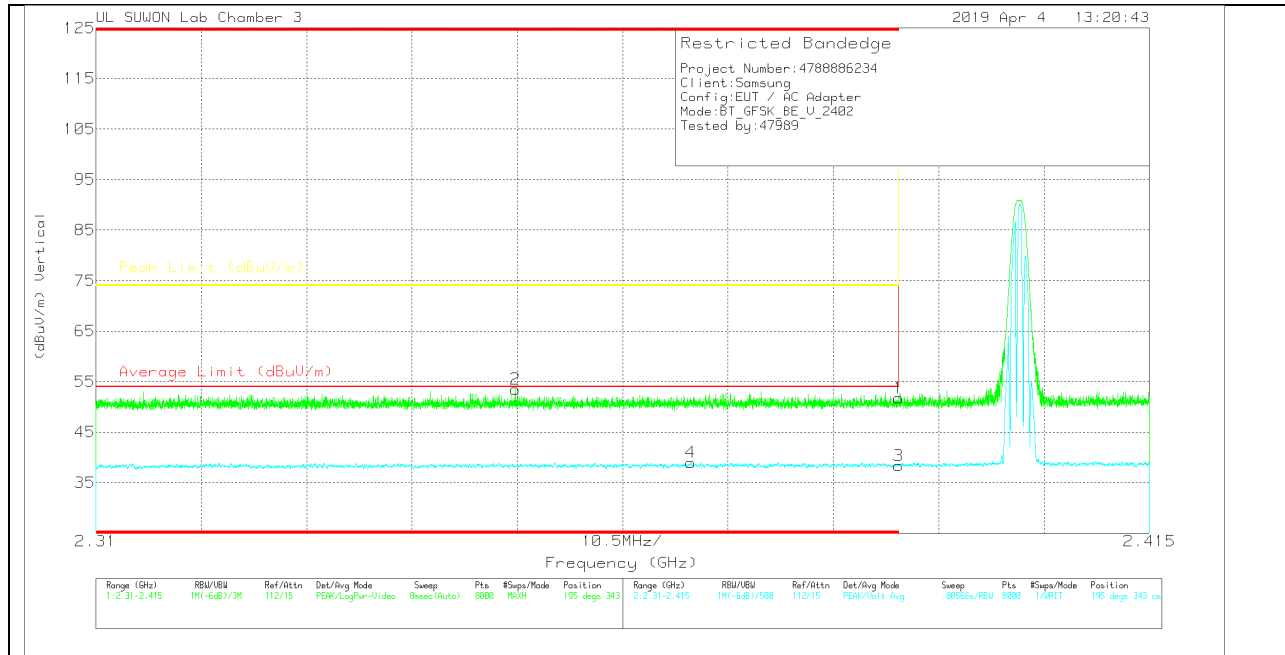

VERTICAL DATA

Trace Markers

Marker	Frequency (GHz)	Meter Reading (dBuV)	Det	3117_00205959	10dB[dB]	Corrected Reading (dBuV/m)	Average Limit (dBuV/m)	Margin (dB)	Peak Limit (dBuV/m)	PK Margin (dB)	Azimuth (Degs)	Height (cm)	Polarity
1	* 2.39	43.43	Pk	31.7	-23.4	51.73	-	-	74	-22.27	195	343	V
2	* 2.352	45.35	Pk	31.6	-23.4	53.55	-	-	74	-20.45	195	343	V
3	* 2.39	30.12	VA1T	31.7	-23.4	38.42	54	-15.58	-	-	195	343	V
4	* 2.369	30.84	VA1T	31.6	-23.4	39.04	54	-14.96	-	-	195	343	V

* - indicates frequency in CFR47 Pt 15 / IC RSS-Restricted Band

Pk - Peak detector

VA1T - FHSS: Linear Voltage Average VB=1/Ton where: Ton is transmit duration

AUTHORIZED BANDEDGE (HIGH CHANNEL)

HORIZONTAL PEAK AND AVERAGE PLOT

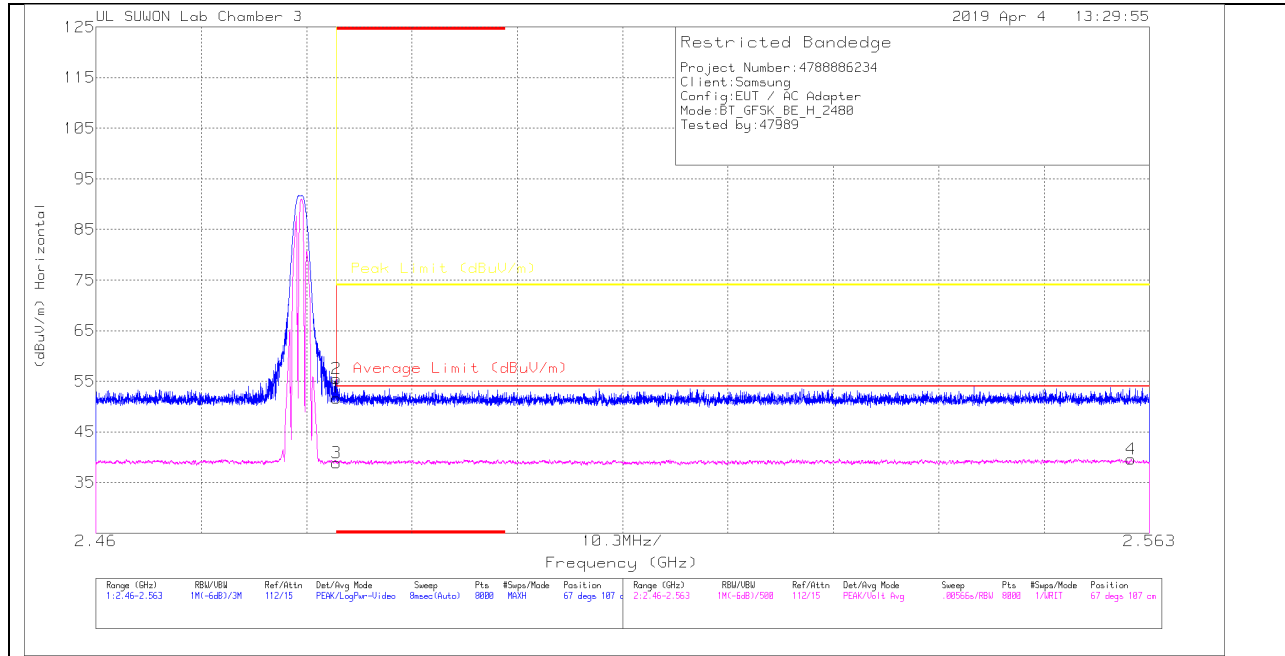

HORIZONTAL DATA

Trace Markers

Marker	Frequency (GHz)	Meter Reading (dBuV)	Det	3117_00205959	10dB[dB]	Corrected Reading (dBuV/m)	Average Limit (dBuV/m)	Margin (dB)	Peak Limit (dBuV/m)	PK Margin (dB)	Azimuth (Degs)	Height (cm)	Polarity
1	* 2.484	43.02	Pk	31.9	-23.2	51.72	-	-	74	-22.28	67	107	H
2	* 2.484	46.8	Pk	31.9	-23.2	55.5	-	-	74	-18.5	67	107	H
3	* 2.484	30.16	VA1T	31.9	-23.2	38.86	54	-15.14	-	-	67	107	H
4	2.561	30.86	VA1T	32	-23.2	39.66	54	-14.34	-	-	67	107	H

* - indicates frequency in CFR47 Pt 15 / IC RSS-Restricted Band

Pk - Peak detector

VA1T - FHSS: Linear Voltage Average $VB=1/Ton$ where: Ton is transmit duration

VERTICAL PEAK AND AVERAGE PLOT

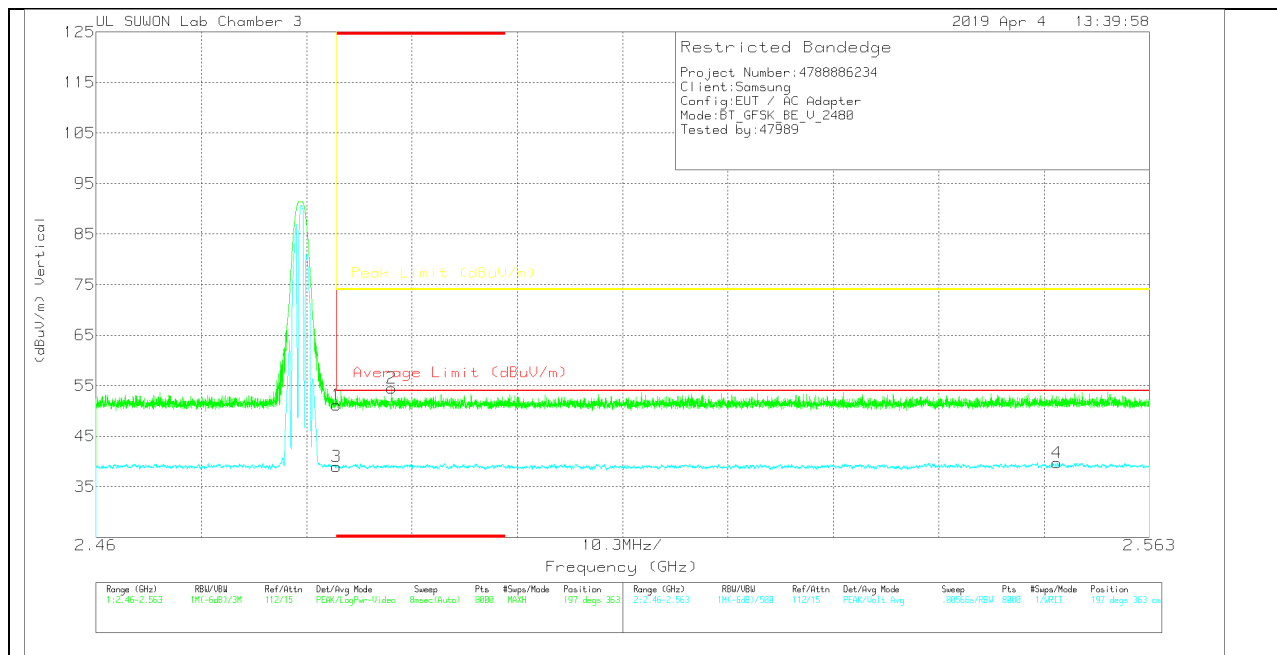

VERTICAL DATA

Trace Markers

Marker	Frequency (GHz)	Meter Reading (dBuV)	Det	3117_00205959	10dB[dB]	Corrected Reading (dBuV/m)	Average Limit (dBuV/m)	Margin (dB)	Peak Limit (dBuV/m)	PK Margin (dB)	Azimuth (Degs)	Height (cm)	Polarity
1	* 2.484	42.46	Pk	31.9	-23.2	51.16	-	-	74	-22.84	197	363	V
2	* 2.489	45.78	Pk	31.9	-23.2	54.48	-	-	74	-19.52	197	363	V
3	* 2.484	30.33	VA1T	31.9	-23.2	39.03	54	-14.97	-	-	197	363	V
4	2.554	30.72	VA1T	32	-23	39.72	54	-14.28	-	-	197	363	V

* - indicates frequency in CFR47 Pt 15 / IC RSS-Restricted Band

Pk - Peak detector

VA1T - FHSS: Linear Voltage Average VB=1/Ton where: Ton is transmit duration

HARMONICS AND SPURIOUS EMISSIONS

LOW CHANNEL HORIZONTAL

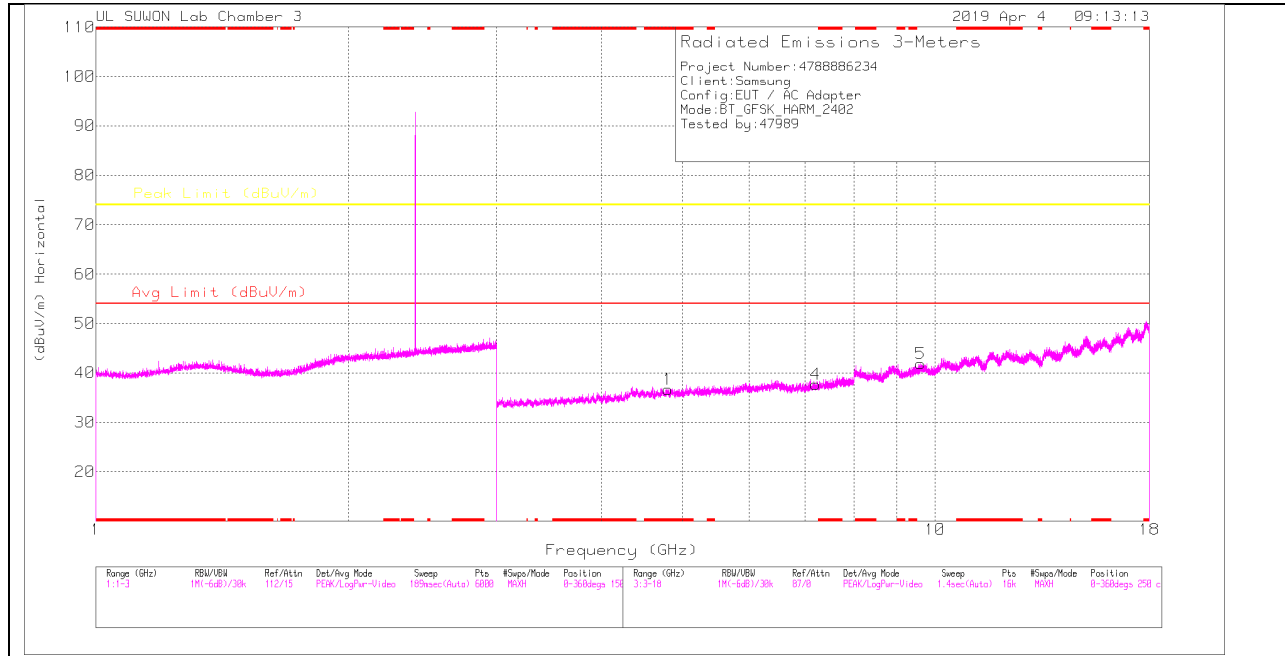

LOW CHANNEL VERTICAL

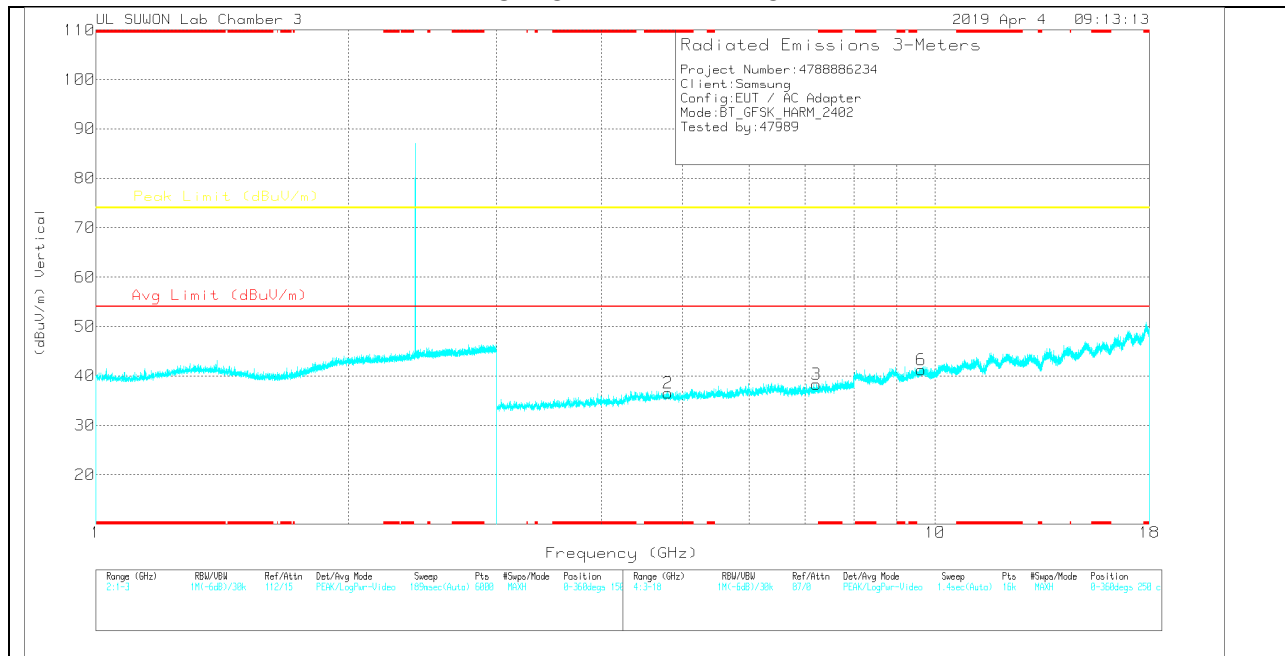

Note: Emission was scanned up to 26GHz; No emissions were detected above the noise floor which was at least 20dB below the specification limit.

LOW CHANNEL DATA

Trace Markers

Marker	Frequency (GHz)	Meter Reading (dBuV)	Det	3117_00205959	3GHz_HP[dB]	Corrected Reading (dBuV/m)	Avg Limit (dBuV/m)	Margin (dB)	Peak Limit (dBuV/m)	Margin (dB)	Azimuth (Degs)	Height (cm)	Polarity
1	* 4.806	30.82	PK	34.2	-28.4	36.62	-	-	74	-37.38	0-360	150	H
4	7.207	25.99	PK	35.8	-24.1	37.69	-	-	74	-36.31	0-360	250	H
5	9.612	24.85	PK	37	-20	41.85	-	-	74	-32.15	0-360	250	H
2	* 4.807	30.85	PK	34.2	-28.5	36.55	-	-	74	-37.45	0-360	150	V
3	7.211	26.56	PK	35.8	-24.1	38.26	-	-	74	-35.74	0-360	150	V
6	9.616	24.27	PK	37	-20	41.27	-	-	74	-32.73	0-360	250	V

* - indicates frequency in CFR47 Pt 15 / IC RSS-Restricted Band
 PK – Peak Detector

Note: Only peak measurement was performed. Because peak measurement result of unwanted emission is less than average limit (54dBuV/m).

MID CHANNEL HORIZONTAL

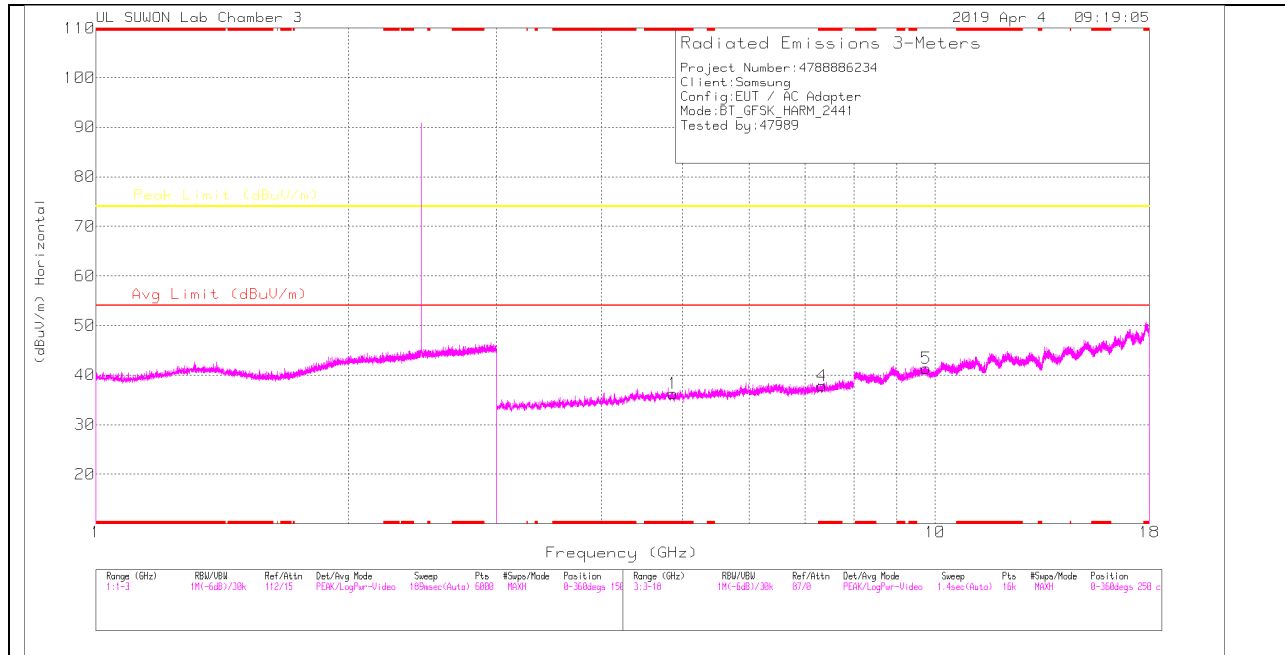

MID CHANNEL VERTICAL

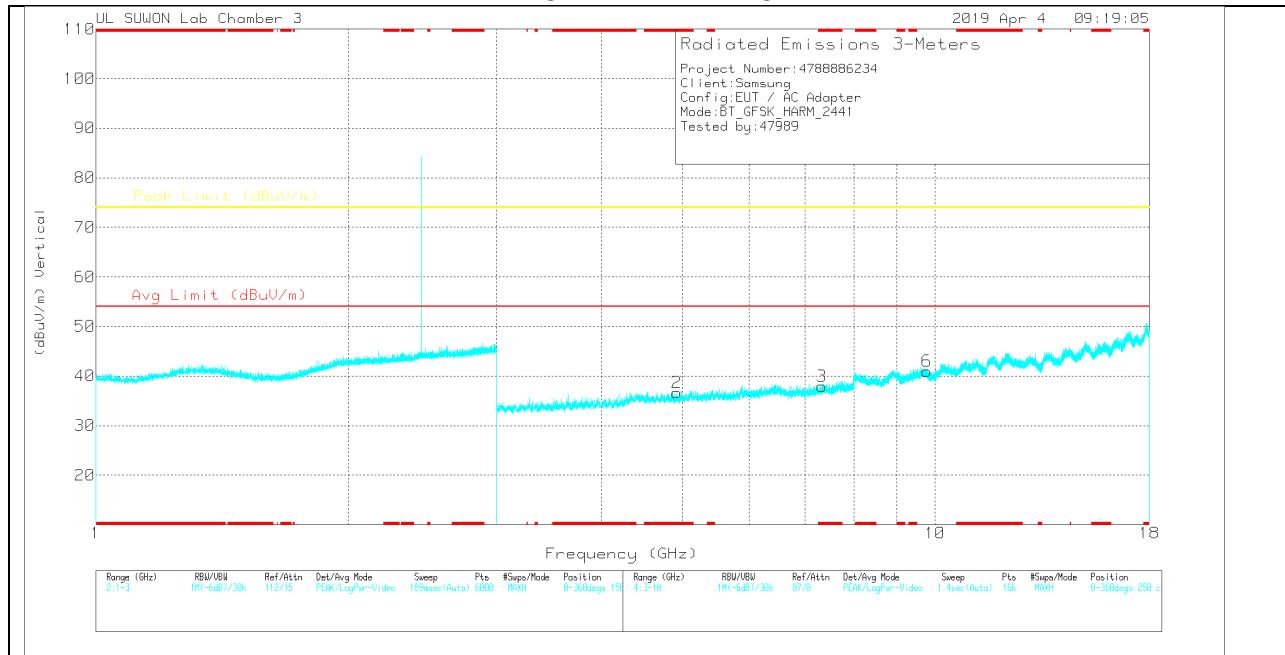

Note: Emission was scanned up to 26GHz; No emissions were detected above the noise floor which was at least 20dB below the specification limit.

MID CHANNEL DATA

Trace Markers

Marker	Frequency (GHz)	Meter Reading (dBuV)	Det	3117_00205959	3GHz_HP[dB]	Corrected Reading (dBuV/m)	Avg Limit (dBuV/m)	Margin (dB)	Peak Limit (dBuV/m)	Margin (dB)	Azimuth (Degs)	Height (cm)	Polarity
1	* 4.874	31.14	PK	34.2	-29	36.34	-	-	74	-37.66	0-360	250	H
4	* 7.333	25.56	PK	35.8	-23.5	37.86	-	-	74	-36.14	0-360	150	H
5	9.759	23.74	PK	37.2	-19.6	41.34	-	-	74	-32.66	0-360	250	H
2	* 4.921	31.73	PK	34.2	-29.3	36.63	-	-	74	-37.37	0-360	250	V
3	* 7.331	25.59	PK	35.8	-23.5	37.89	-	-	74	-36.11	0-360	250	V
6	9.765	23.31	PK	37.2	-19.5	41.01	-	-	74	-32.99	0-360	250	V

* - indicates frequency in CFR47 Pt 15 / IC RSS-Restricted Band

PK – Peak Detector

Note: Only peak measurement was performed. Because peak measurement result of unwanted emission is less than average limit (54dBuV/m).

HIGH CHANNEL HORIZONTAL

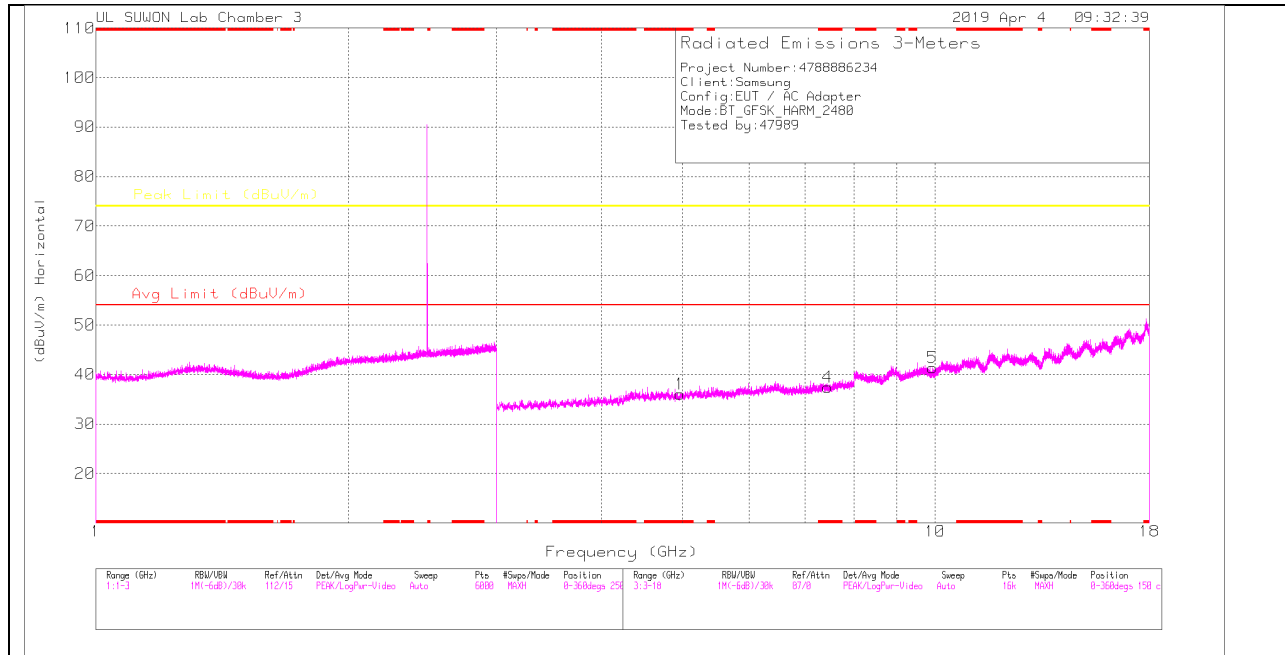

HIGH CHANNEL VERTICAL

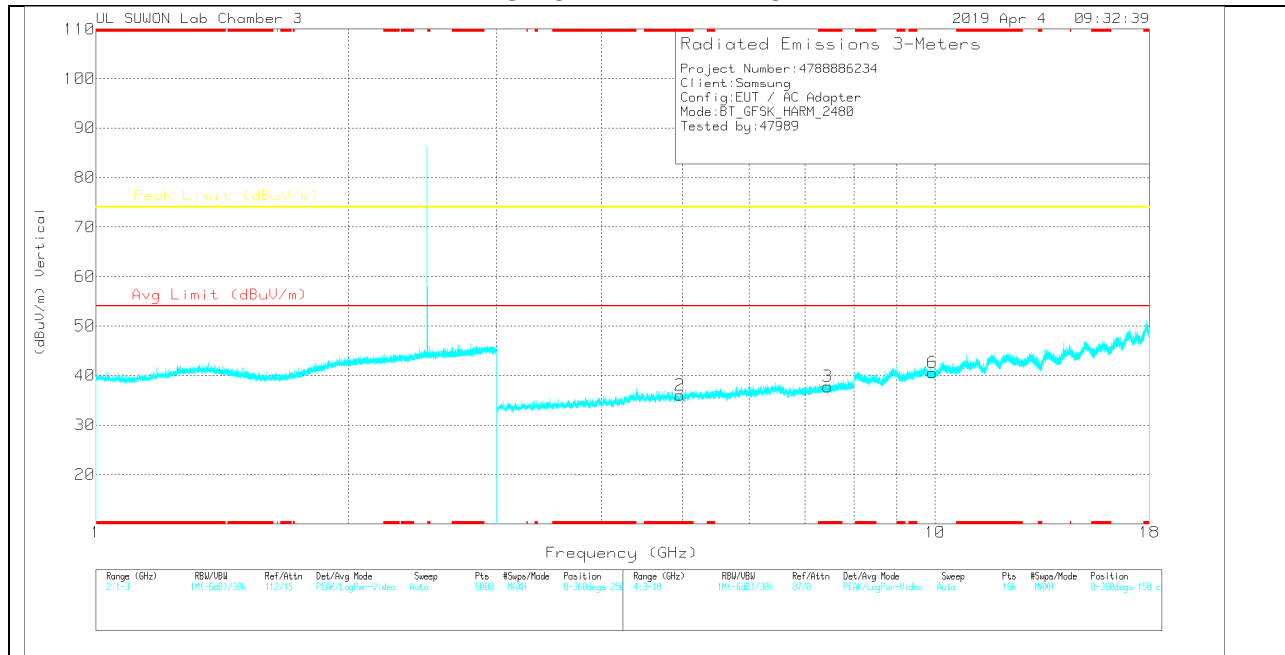

Note: Emission was scanned up to 26GHz; No emissions were detected above the noise floor which was at least 20dB below the specification limit.

HIGH CHANNEL DATA

Trace Markers

Marker	Frequency (GHz)	Meter Reading (dBuV)	Det	3117_00205959	3GHz_HP[dB]	Corrected Reading (dBuV/m)	Avg Limit (dBuV/m)	Margin (dB)	Peak Limit (dBuV/m)	Margin (dB)	Azimuth (Degs)	Height (cm)	Polarity
1	* 4.966	30.6	PK	34.2	-28.8	36	-	-	74	-38	0-360	150	H
4	* 7.45	25.14	PK	35.8	-23.5	37.44	-	-	74	-36.56	0-360	150	H
5	9.928	23.67	PK	37.5	-19.8	41.37	-	-	74	-32.63	0-360	250	H
2	* 4.967	30.54	PK	34.2	-28.7	36.04	-	-	74	-37.96	0-360	150	V
3	* 7.44	25.35	PK	35.8	-23.4	37.75	-	-	74	-36.25	0-360	250	V
6	9.921	22.78	PK	37.5	-19.7	40.58	-	-	74	-33.42	0-360	150	V

* - indicates frequency in CFR47 Pt 15 / IC RSS-Restricted Band

PK – Peak Detector

Note: Only peak measurement was performed. Because peak measurement result of unwanted emission is less than average limit (54dBuV/m).

11.1.2. ENHANCED DATA RATE 8PSK MODULATION RESTRICTED BANDEDGE (LOW CHANNEL)

HORIZONTAL PEAK AND AVERAGE PLOT

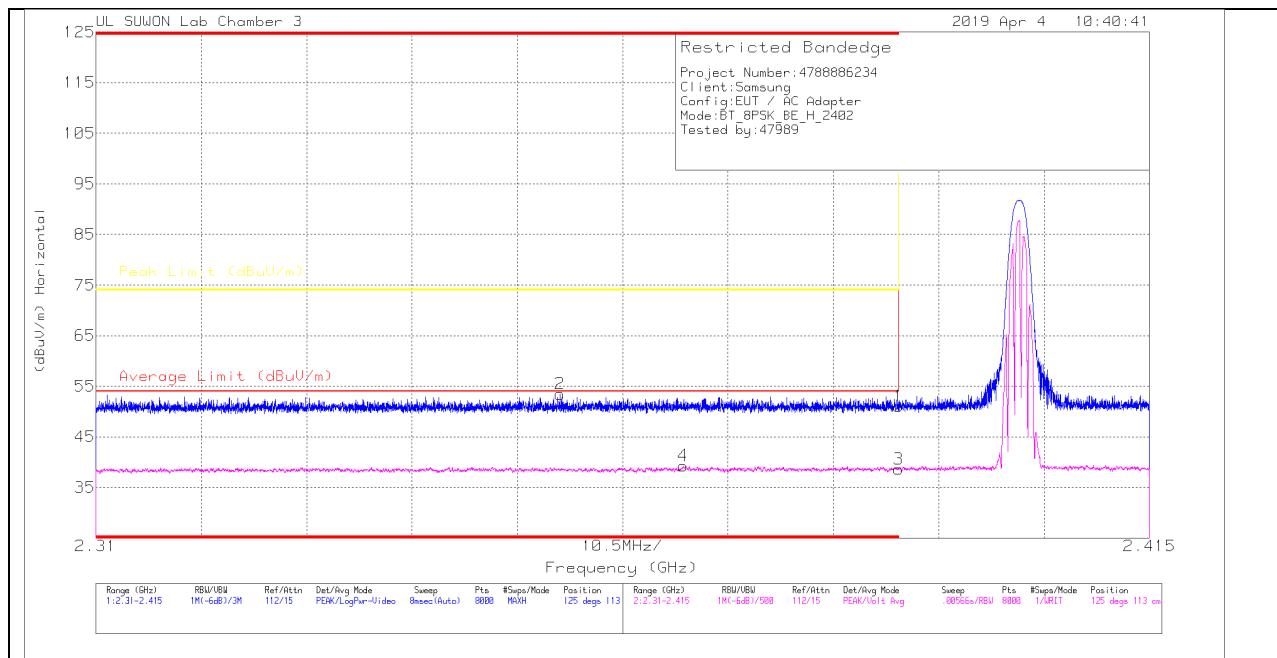

HORIZONTAL DATA

Trace Markers

Marker	Frequency (GHz)	Meter Reading (dBuV)	Det	3117_00205959	10dB(dB)	Corrected Reading (dBuV/m)	Average Limit (dBuV/m)	Margin (dB)	Peak Limit (dBuV/m)	PK Margin (dB)	Azimuth (Degs)	Height (cm)	Polarity
1	* 2.39	42.77	Pk	31.7	-23.4	51.07	-	-	74	-22.93	125	113	H
2	* 2.356	45.26	Pk	31.6	-23.4	53.46	-	-	74	-20.54	125	113	H
3	* 2.39	30.29	VA1T	31.7	-23.4	38.59	54	-15.41	-	-	125	113	H
4	* 2.369	31.1	VA1T	31.6	-23.4	39.3	54	-14.7	-	-	125	113	H

* - indicates frequency in CFR47 Pt 15 / IC RSS-Restricted Band

Pk - Peak detector

VA1T - FHSS: Linear Voltage Average $V_B=1/T_{on}$ where: T_{on} is transmit duration

VERTICAL PEAK AND AVERAGE PLOT

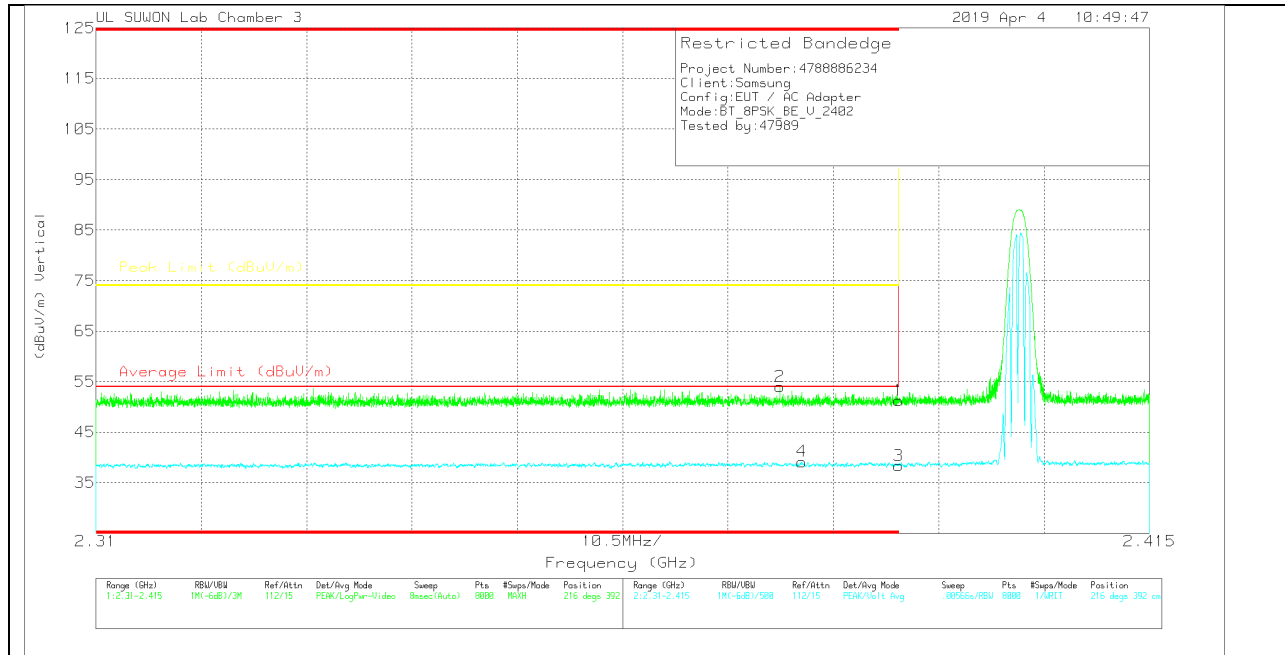

Trace Markers

Marker	Frequency (GHz)	Meter Reading (dBuV)	Det	3117_00205959	10dB(dB)	Corrected Reading (dBuV/m)	Average Limit (dBuV/m)	Margin (dB)	Peak Limit (dBuV/m)	PK Margin (dB)	Azimuth (Degs)	Height (cm)	Polarity
1	* 2.39	42.99	Pk	31.7	-23.4	51.29	-	-	74	-22.71	216	392	V
2	* 2.378	45.79	Pk	31.6	-23.4	53.99	-	-	74	-20.01	216	392	V
3	* 2.39	30.11	VA1T	31.7	-23.4	38.41	54	-15.59	-	-	216	392	V
4	* 2.38	30.98	VA1T	31.6	-23.4	39.18	54	-14.82	-	-	216	392	V

* - indicates frequency in CFR47 Pt 15 / IC RSS-Restricted Band

Pk - Peak detector

VA1T - FHSS: Linear Voltage Average $VB=1/Ton$ where: Ton is transmit duration

AUTHORIZED BANDEDGE (HIGH CHANNEL)

HORIZONTAL PEAK AND AVERAGE PLOT

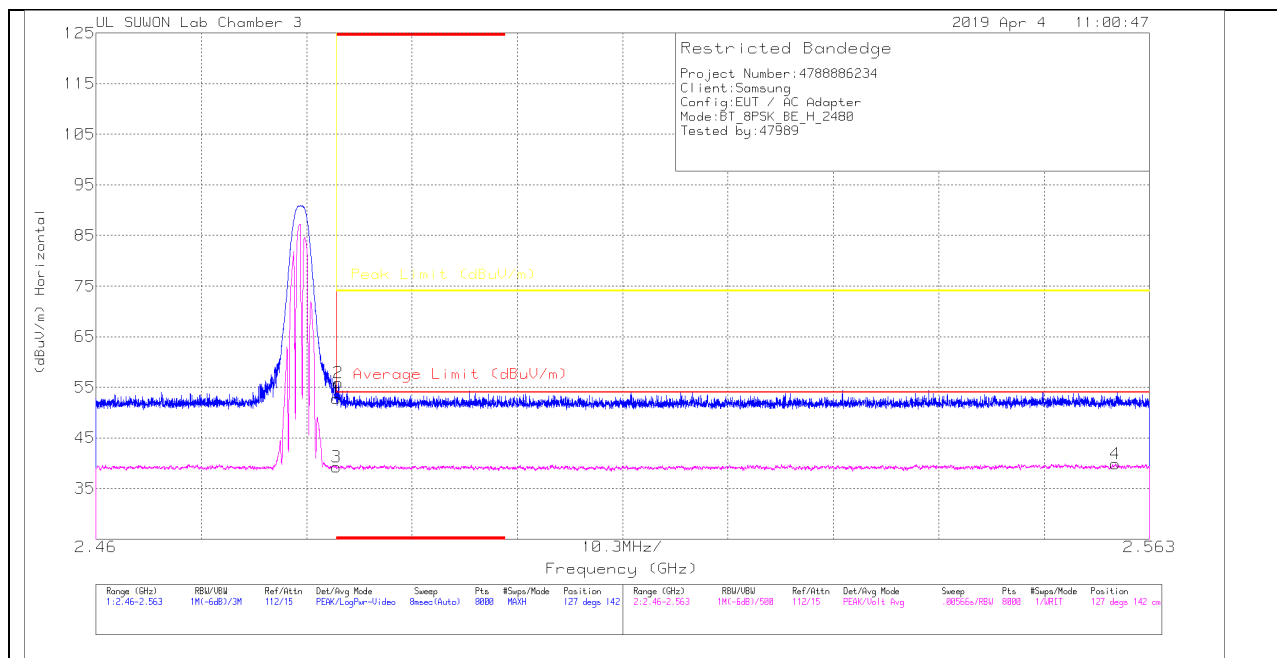

Trace Markers

Marker	Frequency (GHz)	Meter Reading (dBuV)	Det	3117_00205959	10dB[dB]	Corrected Reading (dBuV/m)	Average Limit (dBuV/m)	Margin (dB)	Peak Limit (dBuV/m)	PK Margin (dB)	Azimuth (Degs)	Height (cm)	Polarity
1	* 2.484	44.1	Pk	31.9	-23.2	52.8	-	-	74	-21.2	127	142	H
2	* 2.484	47.3	Pk	31.9	-23.3	55.9	-	-	74	-18.1	127	142	H
3	* 2.484	30.54	VA1T	31.9	-23.2	39.24	54	-14.76	-	-	127	142	H
4	2.56	30.93	VA1T	32	-23.1	39.83	54	-14.17	-	-	127	142	H

* - indicates frequency in CFR47 Pt 15 / IC RSS-Restricted Band

Pk - Peak detector

VA1T - FHSS: Linear Voltage Average $VB=1/Ton$ where: Ton is transmit duration

VERTICAL PEAK AND AVERAGE PLOT

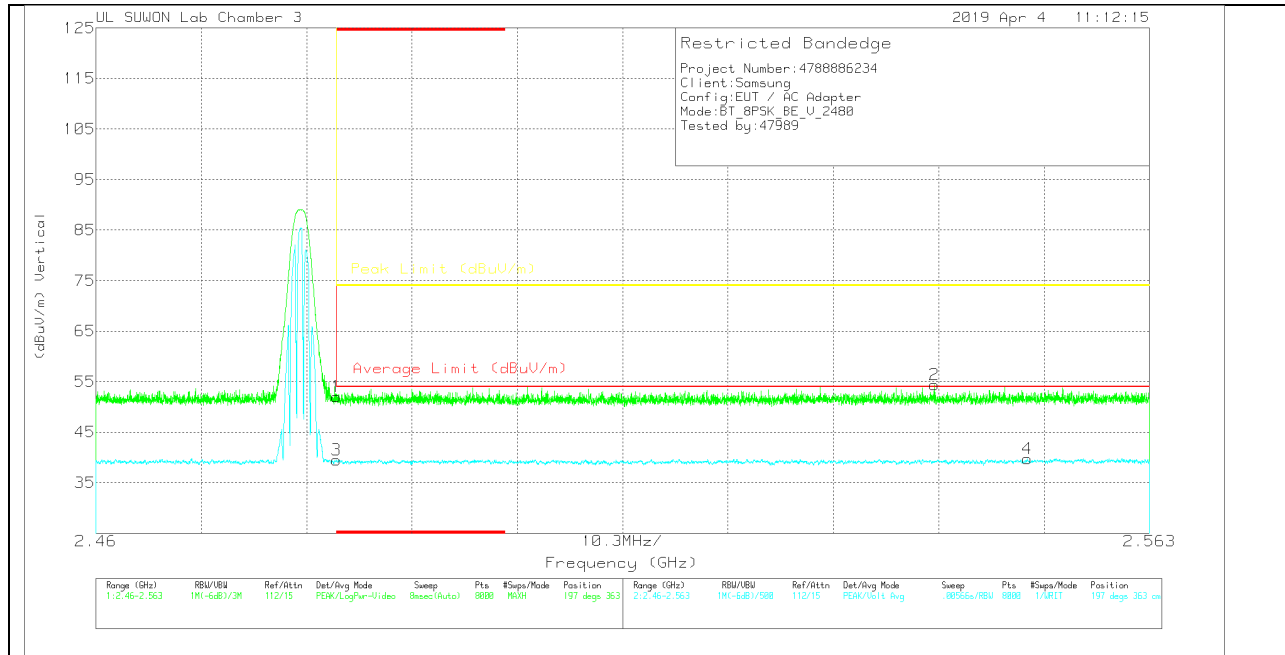

Trace Markers

Marker	Frequency (GHz)	Meter Reading (dBuV)	Det	3117_00205959	10dB(dB)	Corrected Reading (dBuV/m)	Average Limit (dBuV/m)	Margin (dB)	Peak Limit (dBuV/m)	PK Margin (dB)	Azimuth (Degs)	Height (cm)	Polarity
1	* 2.484	43.35	Pk	31.9	-23.2	52.05	-	-	74	-21.95	197	363	V
2	2.542	45.53	Pk	32	-23.1	54.43	-	-	74	-19.57	197	363	V
3	* 2.484	30.78	VA1T	31.9	-23.2	39.48	54	-14.52	-	-	197	363	V
4	2.551	30.79	VA1T	32	-23	39.79	54	-14.21	-	-	197	363	V

* - indicates frequency in CFR47 Pt 15 / IC RSS-Restricted Band

Pk - Peak detector

VA1T - FHSS: Linear Voltage Average VB=1/Ton where: Ton is transmit duration

HARMONICS AND SPURIOUS EMISSIONS

LOW CHANNEL HORIZONTAL

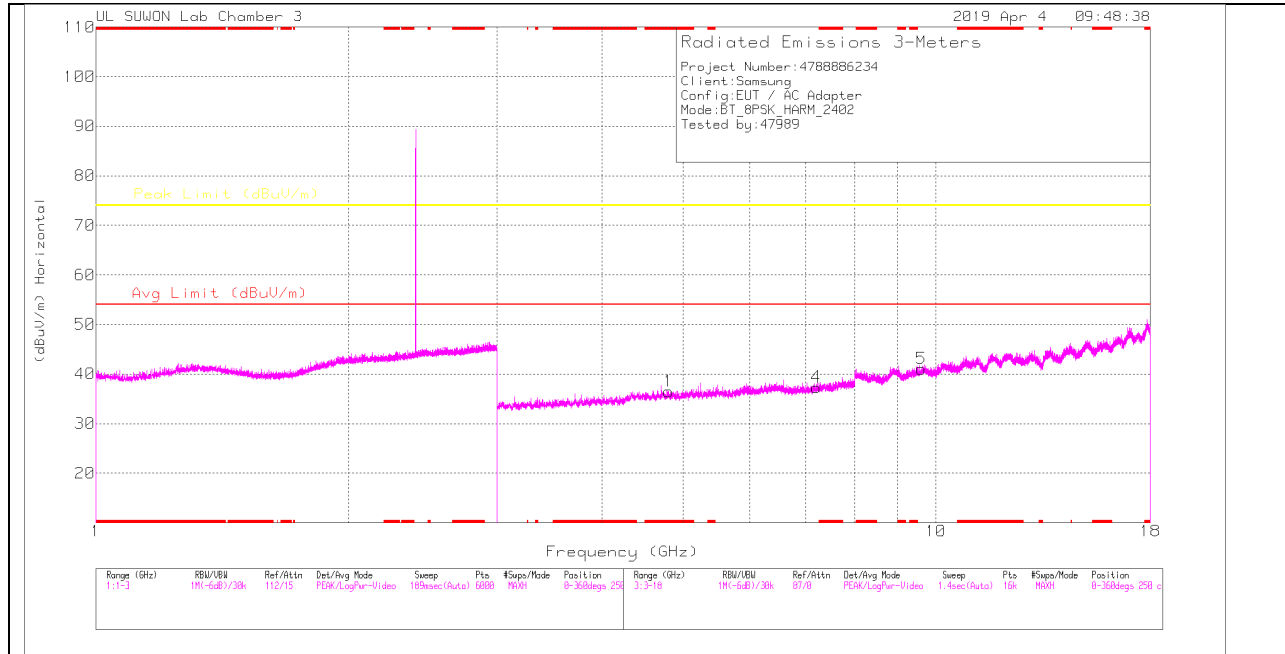

LOW CHANNEL VERTICAL

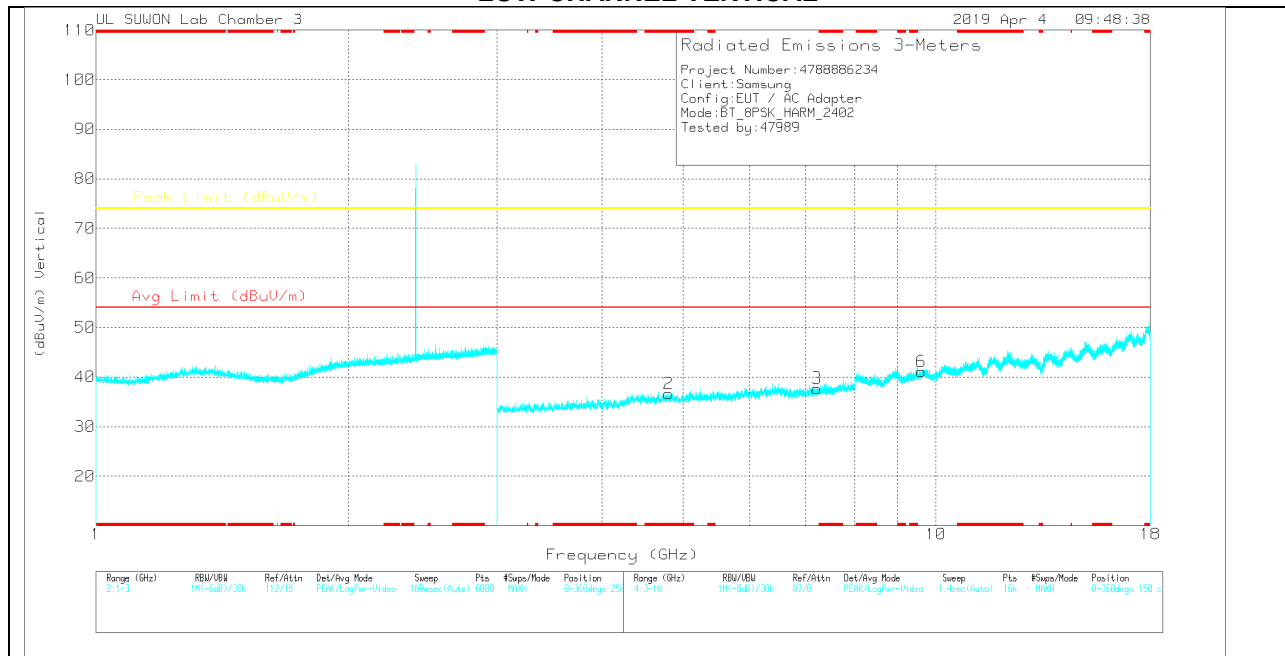

Note: Emission was scanned up to 26GHz; No emissions were detected above the noise floor which was at least 20dB below the specification limit.

LOW CHANNEL DATA

Trace Markers

Marker	Frequency (GHz)	Meter Reading (dBuV)	Det	3117_00205959	3GHz_HP[dB]	Corrected Reading (dBuV/m)	Avg Limit (dBuV/m)	Margin (dB)	Peak Limit (dBuV/m)	Margin (dB)	Azimuth (Degs)	Height (cm)	Polarity
1	* 4.805	30.68	PK	34.2	-28.4	36.48	-	-	74	-37.52	0-360	150	H
4	7.202	25.76	PK	35.8	-24.2	37.36	-	-	74	-36.64	0-360	150	H
5	9.603	24.05	PK	37	-20	41.05	-	-	74	-32.95	0-360	150	H
2	* 4.805	30.88	PK	34.2	-28.4	36.68	-	-	74	-37.32	0-360	250	V
3	7.217	26.04	PK	35.8	-24.1	37.74	-	-	74	-36.26	0-360	150	V
6	9.607	24.07	PK	37	-20	41.07	-	-	74	-32.93	0-360	250	V

* - indicates frequency in CFR47 Pt 15 / IC RSS-Restricted Band
 PK – Peak Detector

Note: Only peak measurement was performed. Because peak measurement result of unwanted emission is less than average limit (54dBuV/m).

MID CHANNEL HORIZONTAL

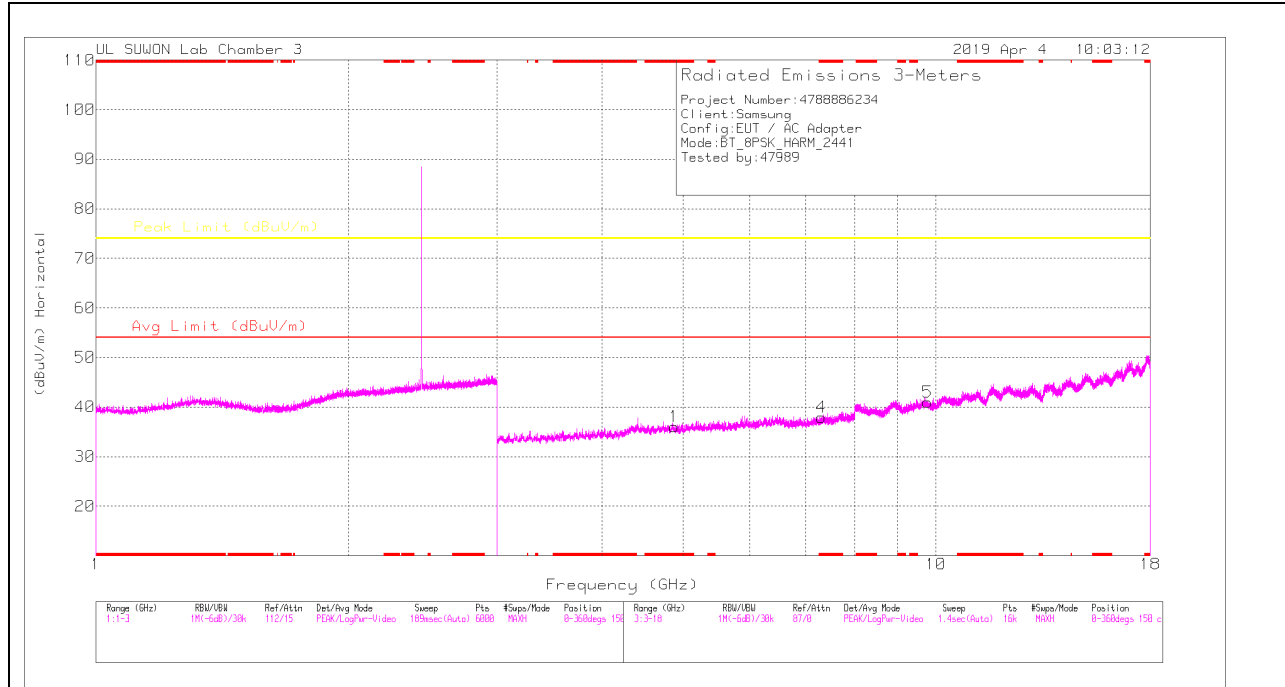

MID CHANNEL VERTICAL

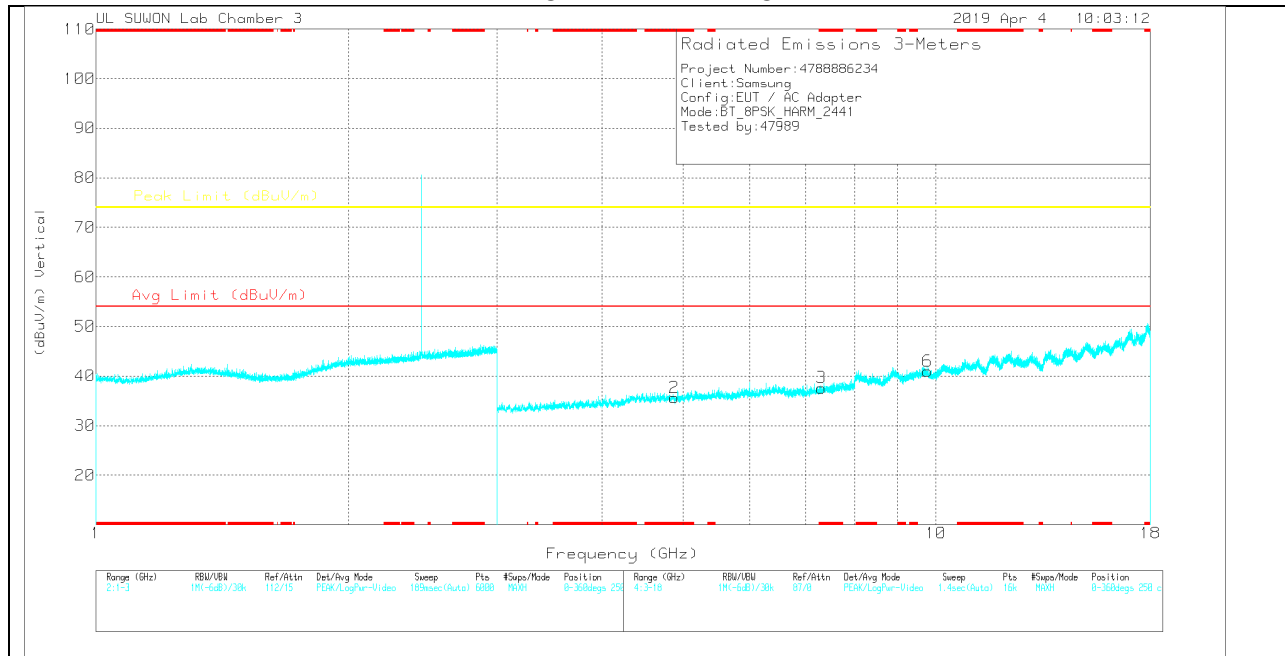

Note: Emission was scanned up to 26GHz; No emissions were detected above the noise floor which was at least 20dB below the specification limit.

MID CHANNEL DATA

Trace Markers

Marker	Frequency (GHz)	Meter Reading (dBuV)	Det	3117_00205959	3GHz_HP[dB]	Corrected Reading (dBuV/m)	Avg Limit (dBuV/m)	Margin (dB)	Peak Limit (dBuV/m)	Margin (dB)	Azimuth (Degs)	Height (cm)	Polarity
1	* 4.877	30.92	PK	34.2	-29.1	36.02	-	-	74	-37.98	0-360	150	H
4	* 7.306	25.9	PK	35.8	-23.8	37.9	-	-	74	-36.1	0-360	150	H
5	9.768	23.34	PK	37.3	-19.6	41.04	-	-	74	-32.96	0-360	250	H
2	* 4.88	30.52	PK	34.2	-29.1	35.62	-	-	74	-38.38	0-360	250	V
3	* 7.306	25.62	PK	35.8	-23.8	37.62	-	-	74	-36.38	0-360	150	V
6	9.777	23.23	PK	37.3	-19.6	40.93	-	-	74	-33.07	0-360	150	V

* - indicates frequency in CFR47 Pt 15 / IC RSS-Restricted Band

PK – Peak Detector

Note: Only peak measurement was performed. Because peak measurement result of unwanted emission is less than average limit (54dBuV/m).

HIGH CHANNEL HORIZONTAL

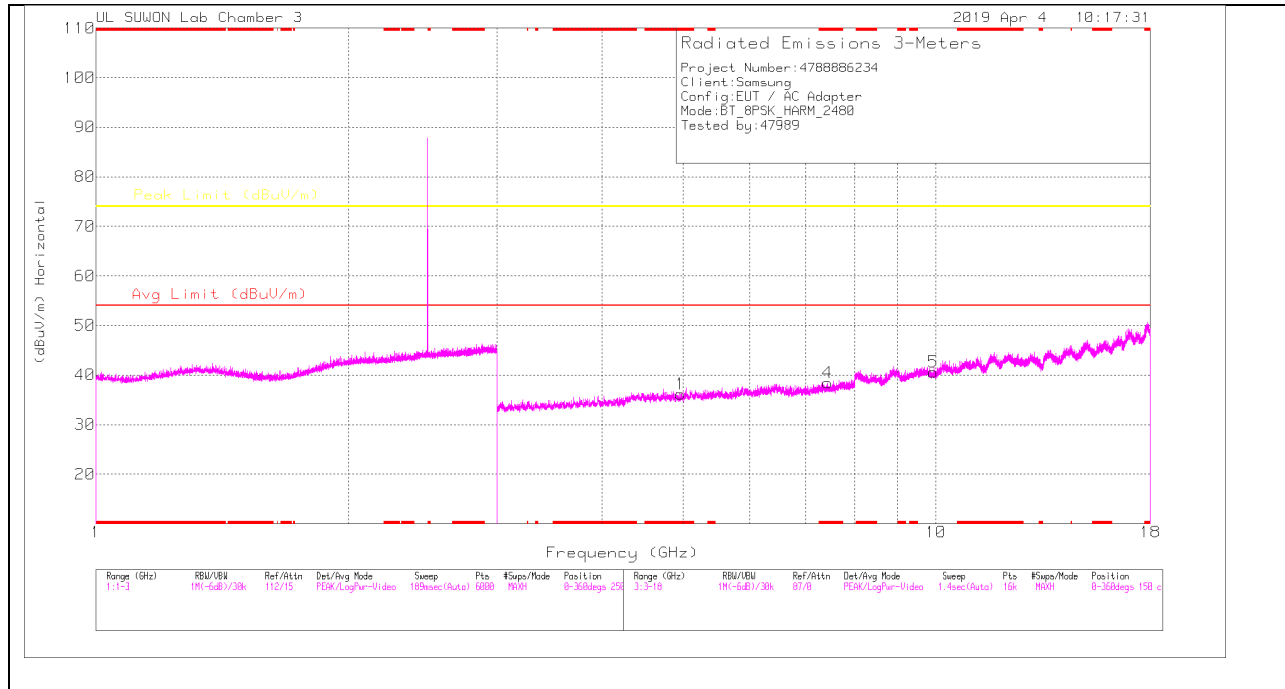

HIGH CHANNEL VERTICAL

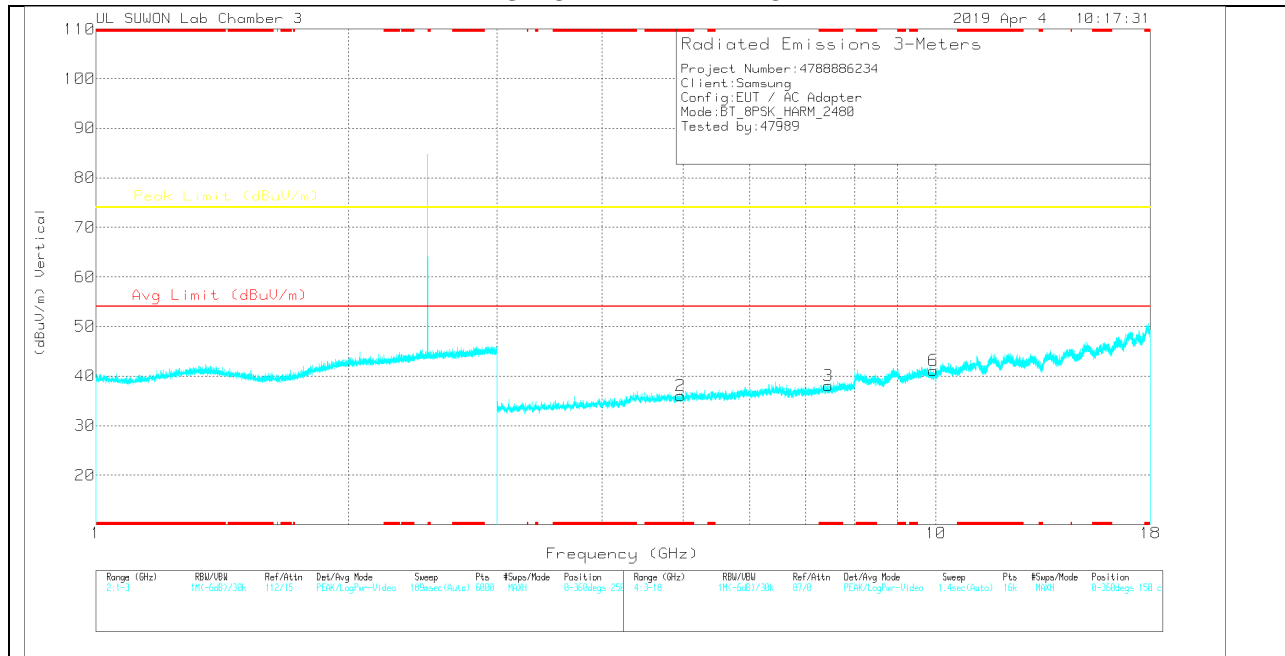

Note: Emission was scanned up to 26GHz; No emissions were detected above the noise floor which was at least 20dB below the specification limit.

HIGH CHANNEL DATA

Trace Markers

Marker	Frequency (GHz)	Meter Reading (dBuV)	Det	3117_00205959	3GHz_HP[dB]	Corrected Reading (dBuV/m)	Avg Limit (dBuV/m)	Margin (dB)	Peak Limit (dBuV/m)	Margin (dB)	Azimuth (Degs)	Height (cm)	Polarity
1	* 4.967	30.66	PK	34.2	-28.7	36.16	-	-	74	-37.84	0-360	250	H
4	* 7.435	26.05	PK	35.8	-23.4	38.45	-	-	74	-35.55	0-360	150	H
5	9.918	22.81	PK	37.5	-19.7	40.61	-	-	74	-33.39	0-360	250	H
2	* 4.963	30.67	PK	34.2	-28.8	36.07	-	-	74	-37.93	0-360	150	V
3	* 7.445	25.81	PK	35.8	-23.5	38.11	-	-	74	-35.89	0-360	250	V
6	9.92	23.26	PK	37.5	-19.7	41.06	-	-	74	-32.94	0-360	250	V

* - indicates frequency in CFR47 Pt 15 / IC RSS-Restricted Band
 PK – Peak Detector

Note: Only peak measurement was performed. Because peak measurement result of unwanted emission is less than average limit (54dBuV/m).

11.2. WORST-CASE BELOW 1 GHz

GFSK SPURIOUS EMISSIONS 30 TO 1000 MHz

HORIZONTAL PLOT

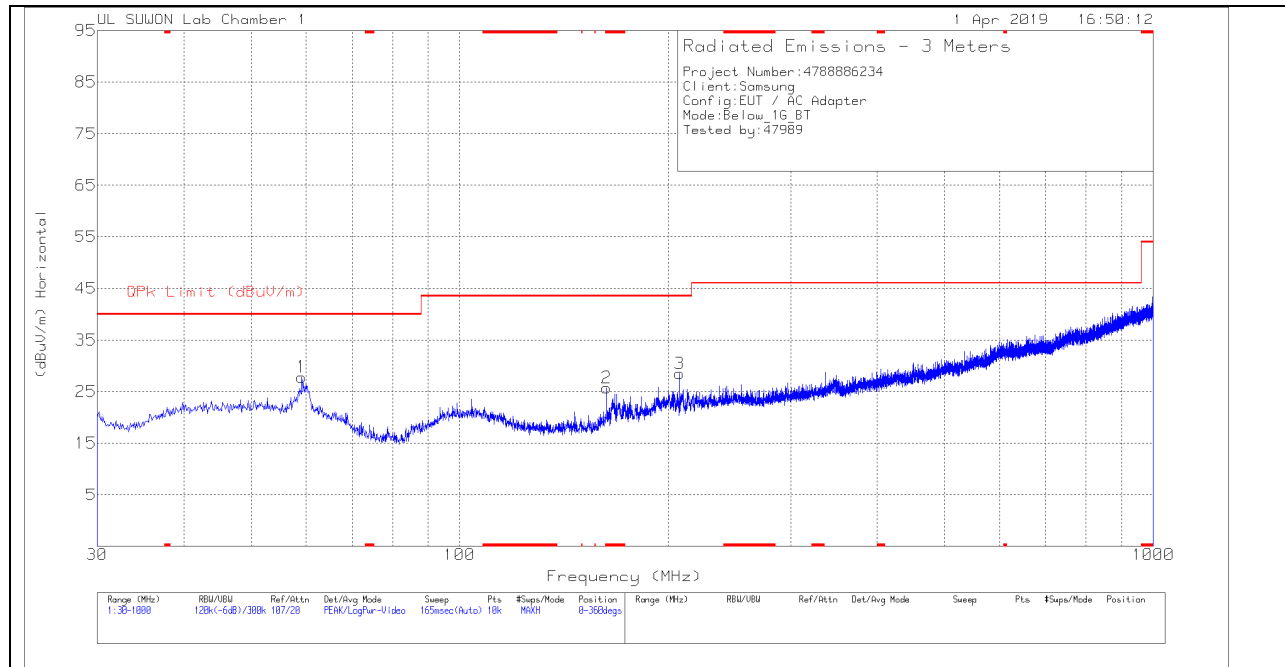

VERTICAL PLOT

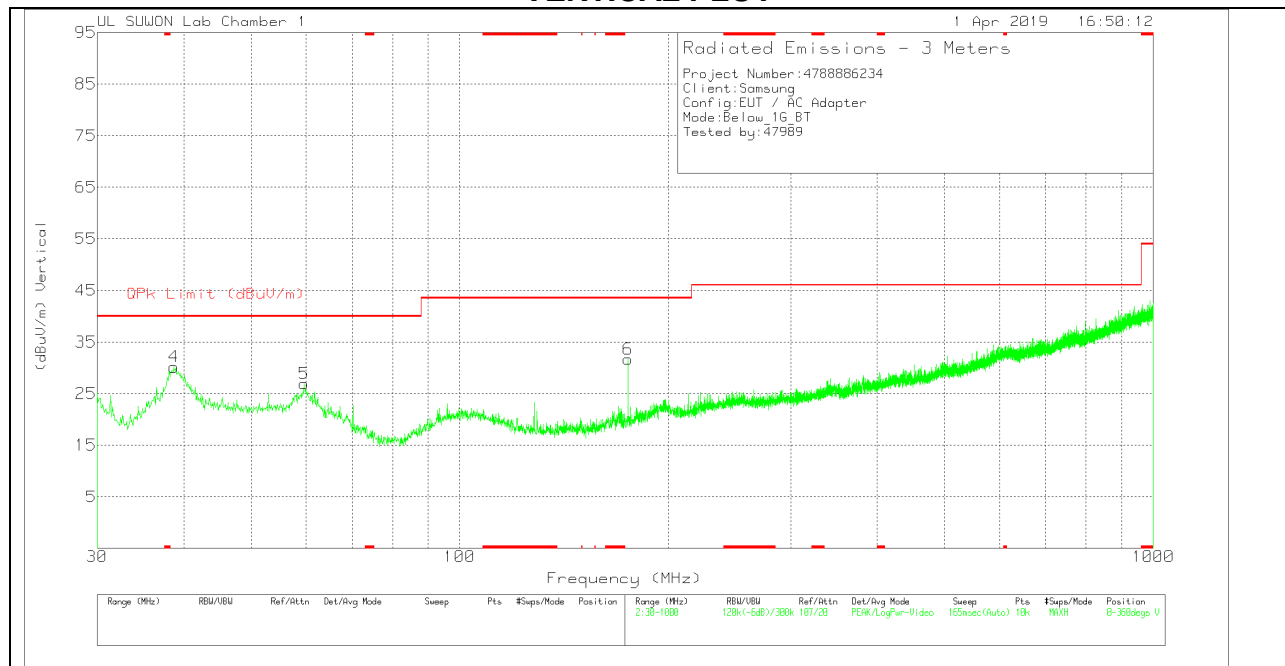

BELOW 1 GHz TABLE

Trace Markers

Marker	Frequency (MHz)	Meter Reading (dBuV)	Det	VULB9163_750	Below_1G[dB]	Corrected Reading (dBuV/m)	QPk Limit (dBuV/m)	Margin (dB)	Azimuth (Degs)	Height (cm)	Polarity
1	59.197	39.41	Pk	18.7	-30.3	27.81	40	-12.19	0-360	400	H
2	* 162.89	39.93	Pk	14.7	-28.9	25.73	43.52	-17.79	0-360	100	H
3	207.607	40.12	Pk	16.9	-28.5	28.52	43.52	-15	0-360	100	H
4	38.73	42.77	Pk	18.2	-30.8	30.17	40	-9.83	0-360	100	V
5	59.682	38.6	Pk	18.6	-30.3	26.9	40	-13.1	0-360	100	V
6	174.821	45.48	Pk	15	-28.8	31.68	43.52	-11.84	0-360	100	V

Pk - Peak detector

12. AC POWER LINE CONDUCTED EMISSIONS

LIMITS

FCC §15.207 (a)

Frequency of Emission (MHz)	Conducted Limit (dBuV)	
	Quasi-peak	Average
0.15-0.5	66 to 56	56 to 46
0.5-5	56	46
5-30	60	50

*Decreases with the logarithm of the frequency.

TEST PROCEDURE

The EUT is placed on a non-conducting table 40 cm from the vertical ground plane and 80 cm above the horizontal ground plane. The EUT is configured in accordance with ANSI C63.10.

The receiver is set to a resolution bandwidth of 9 kHz. Peak detection is used unless otherwise noted as quasi-peak or average.

Line conducted data is recorded for both NEUTRAL and HOT lines.

RESULTS

WORST EMISSIONS

LINE 1 PLOT

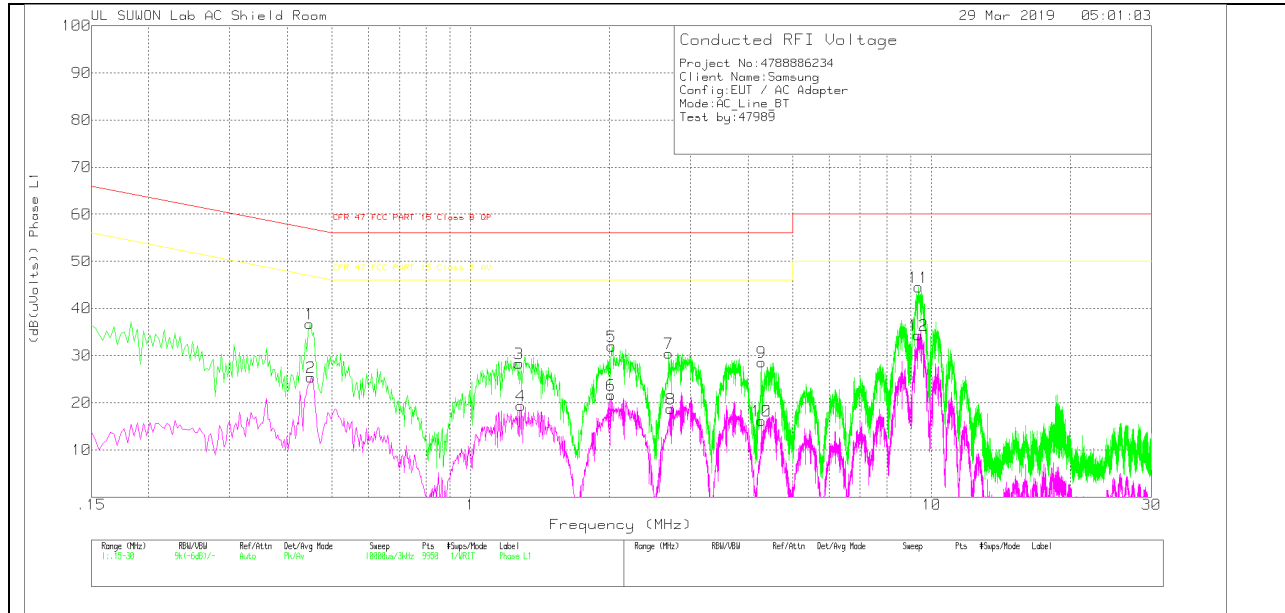

LINE 1 RESULTS

Trace Markers

Range 1: Phase L1 .15 - 30MHz

Marker	Frequency (MHz)	Meter Reading (dBuV)	Det	ENV216_10183 6_With ex-cord_L1	CABLELOSS(dB)	Corrected Reading (dB(uVolts))	CFR 47 FCC PART 15 Class B QP	Margin (dB)	CFR 47 FCC PART 15 Class B AV	Margin (dB)
3	.447	26.66	Pk	9.9	.2	36.76	56.93	-20.17	-	-
2	.45	15.33	Av	9.9	.2	25.43	-	-	46.88	-21.45
3	1.272	18.26	Pk	9.8	.3	28.36	56	-27.64	-	-
4	1.284	9.27	Av	9.8	.3	19.37	-	-	46	-26.63
5	2.022	21.9	Pk	9.8	.3	32	56	-24	-	-
6	2.016	11.55	Av	9.8	.3	21.65	-	-	46	-24.35
7	2.688	20.17	Pk	10	.3	30.47	56	-25.53	-	-
8	2.718	8.45	Av	10	.3	18.75	-	-	46	-27.25
9	4.275	18.5	Pk	9.8	.3	28.6	56	-27.4	-	-
10	4.275	6.09	Av	9.8	.3	16.19	-	-	46	-29.81
11	9.369	34.13	Pk	10	.4	44.53	60	-15.47	-	-
12	9.354	23.97	Av	10	.4	34.37	-	-	50	-15.63

Pk - Peak detector

Av - Average detection

LINE 2 PLOT

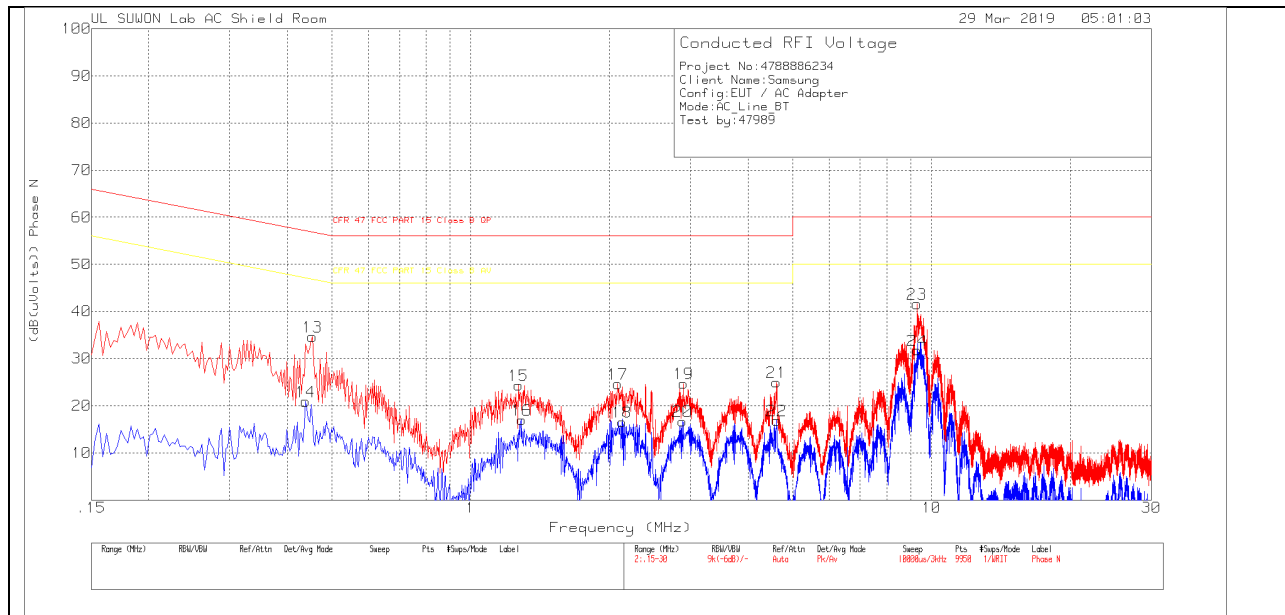

LINE 2 RESULTS

Trace Markers

Trace Markers

Range 2: Phase N .15 - 30MHz

Marker	Frequency (MHz)	Meter Reading (dBuV)	Det	ENV216_10183 6_With ex-cord_N	CABLELOSS(dB)	Corrected Reading (dB(uVolts))	CFR 47 FCC PART 15 Class B QP	Margin (dB)	CFR 47 FCC PART 15 Class B AV	Margin (dB)
13	.453	24.97	Pk	9.5	.2	34.67	56.82	-22.15	-	-
14	.438	11.42	Av	9.3	.2	20.92	-	-	47.1	-26.18
15	1.269	14.26	Pk	9.8	.3	24.36	56	-31.64	-	-
16	1.29	6.91	Av	9.8	.3	17.01	-	-	46	-28.99
17	2.085	14.66	Pk	9.7	.3	24.66	56	-31.34	-	-
18	2.13	6.56	Av	9.7	.3	16.56	-	-	46	-29.44
19	2.895	14.71	Pk	9.7	.3	24.71	56	-31.29	-	-
20	2.88	6.72	Av	9.7	.3	16.72	-	-	46	-29.28
21	4.605	14.88	Pk	9.8	.3	24.98	56	-31.02	-	-
22	4.611	6.78	Av	9.8	.3	16.88	-	-	46	-29.12
23	9.294	31.22	Pk	10	.4	41.62	60	-18.38	-	-
24	9.312	21.38	Av	10	.4	31.78	-	-	50	-18.22

Pk - Peak detector

Av - Average detection