



FCC CFR47 PART 15 SUBPART C

ANT+

CERTIFICATION TEST REPORT

FOR

CDMA/GSM/WCDMA/LTE Phone + BT/BLE, DTS/UNII a/b/g/n/ac, ANT+ and NFC

MODEL NUMBER : SM-A8050

FCC ID: A3LSMA8050

REPORT NUMBER: 4788886237-E6V1

ISSUE DATE: APR 16, 2019

Prepared for
SAMSUNG ELECTRONICS CO., LTD.
129 SAMSUNG-RO, YEONGTONG-GU, SUWON-SI,
GYEONGGI-DO, 16677, KOREA

Prepared by
UL Korea, Ltd.
26th floor, 152, Teheran-ro, Gangnam-gu Seoul, 06236, Korea

Suwon Test Site: UL Korea, Ltd. Suwon Laboratory
218 Maeyeong-ro, Yeongtong-gu,
Suwon-si, Gyeonggi-do, 16675, Korea
TEL: (031) 337-9902
FAX: (031) 213-5433



Testing
Laboratory

TL-637

Revision History

<u>Rev.</u>	<u>Issue Date</u>	<u>Revisions</u>	<u>Revised By</u>
V1	04/16/19	Initial issue	Junwhan Lee

TABLE OF CONTENTS

1. ATTESTATION OF TEST RESULTS	4
1.1. INTRODUCTION OF TEST DATA REUSE	5
1.2. DIFFERENCE	5
1.3. SPOT CHECK VERIFICATION DATA.....	5
1.4. REFERENCE DETAIL.....	6
2. TEST METHODOLOGY	7
3. FACILITIES AND ACCREDITATION	7
4. CALIBRATION AND UNCERTAINTY	7
4.1. MEASURING INSTRUMENT CALIBRATION.....	7
4.2. SAMPLE CALCULATION.....	7
4.3. MEASUREMENT UNCERTAINTY	7
5. EQUIPMENT UNDER TEST	8
5.1. DESCRIPTION OF EUT.....	8
5.2. MAXIMUM E-FIELD STRENGTH.....	8
5.3. DESCRIPTION OF AVAILABLE ANTENNAS	8
5.4. WORST-CASE CONFIGURATION AND MODE	8
5.5. DESCRIPTION OF TEST SETUP.....	9
6. TEST AND MEASUREMENT EQUIPMENT	11
7. LIMITS AND RESULTS.....	12
7.1. 99% BANDWIDTH	12
7.2. TRANSMITTER RADIATED EMISSIONS	14
7.2.1. DUTY CYCLE	16
7.2.1. FUNDAMENTAL FIELD STRENGTH LEVEL	17
7.2.2. TRANSMITTER BAND EDGES	23
7.2.3. HARMONICS AND SPURIOUS EMISSIONS	27
7.2.4. SPURIOUS BELOW 1 GHz	33
8. AC POWER LINE CONDUCTED EMISSIONS.....	35
9. SETUP PHOTOS.....	39

1. ATTESTATION OF TEST RESULTS

COMPANY NAME: SAMSUNG ELECTRONICS CO., LTD.

EUT DESCRIPTION: CDMA/GSM/WCDMA/LTE Phone + BT/BLE, DTS/UNII a/b/g/n/ac, ANT+ and NFC

MODEL NUMBER: SM-A8050

SERIAL NUMBER: R38M308CK1A (CONDUCTED, Original)
R38M308CJ1K (RADIATED, Original)
R38M30952GW (RADIATED, Spot check)

DATE TESTED: FEB 26, 2019 – APR 03, 2019(Original)
FEB 26, 2019 – APR 12, 2019(Spot check)

APPLICABLE STANDARDS	
STANDARD	TEST RESULTS
CFR 47 Part 15 Subpart C	Pass

UL Korea, Ltd. tested the above equipment in accordance with the requirements set forth in the above standards. All indications of Pass/Fail in this report are opinions expressed by UL Korea, Ltd. based on interpretations and/or observations of test results. Measurement Uncertainties were not taken into account and are published for informational purposes only. The test results show that the equipment tested is capable of demonstrating compliance with the requirements as documented in this report.

Note: The results documented in this report apply only to the tested sample, under the conditions and modes of operation as described herein. This document may not be altered or revised in any way unless done so by UL Korea, Ltd. and all revisions are duly noted in the revisions section. Any alteration of this document not carried out by UL Korea, Ltd. will constitute fraud and shall nullify the document. This report must not be used by the client to claim product certification, approval, or endorsement by IAS, any agency of the Federal Government, or any agency of any government.

Approved & Released For
UL Korea, Ltd. By:

Tested By:



SungGil Park
Suwon Lab Engineer
UL Korea, Ltd.

Junwhan Lee
Suwon Lab Engineer
UL Korea, Ltd.

1.1. INTRODUCTION OF TEST DATA REUSE

This report referenced from the FCC ID: A3LSMA805F DXX ANT+(FCC CFR 47 Part 15C).And the applicant takes full responsibility that the test data as referenced in this report represent compliance for this FCC ID.

1.2. DIFFERENCE

The FCC ID: A3LSMA8050 shares the same enclosure and circuit board as FCC ID: A3LSMA805F. The ANT+ antennas and surrounding circuitry and layout are identical between these two units.

After confirming through preliminary radiated emissions that the performance of the FCC ID: A3LSMA805F remains representative of FCC ID: A3LSMA8050. The test data of FCC ID: A3LSMA805F being submitted for this application to cover ANT+ features.

1.3. SPOT CHECK VERIFICATION DATA

Mode	Test Item	Frequency	Test Limit	Original model	Spot check model	Deviation	Remark
				SM-A805F/DS Results	SM-A8050 Results		
				FCC ID : A3LSMA805F	FCC ID : A3LSMA8050		
ANT+	Fundamental	2402 MHz	114 dBuV/m	91.62 dBuV/m	91.54 dBuV/m	-0.08 dB	
	Band Edge	2402 MHz	74 dBuV/m	54.93 dBuV/m	54.95 dBuV/m	0.02 dB	
	RSE	2480 MHz	74 dBuV/m	51.37 dBuV/m	39.23 dBuV/m	-12.14 dB	

Comparison of two models, upper deviation is within 3dB range and all test results are under FCC Technical Limits.

1.4. REFERENCE DETAIL

Reference application that contains the reused reference data.

Equipment Class	Reference FCC ID	Type Grant/Permissive Change	Reference Application	Folder Test/RF Exposure	Report Title / Section
PCE	A3LSMA805F	Grant	4788886234-E1	Test	FCC Report WWAN / GSM,WCDMA, LTE B5
DTS	A3LSMA805F	Grant	4788886234-E2	Test	FCC Report DTS WLAN / All sections
			4788886234-E3	Test	FCC Report BLE All sections
DSS	A3LSMA805F	Grant	4788886234-E4	Test	FCC Report BT / All sections
NII	A3LSMA805F	Grant	4788886234-E5	Test	FCC Report UNII/ All sections
DXX	A3LSMA805F	Grant	4788886234-E6	Test	FCC Report ANT+/ All sections
			4788886234-E7	Test	FCC Report NFC/ All sections

2. TEST METHODOLOGY

The tests documented in this report were performed in accordance with following methods.

1. FCC CFR 47 Part 2.
2. FCC CFR 47 Part 15.
3. ANSI C63.10-2013.

3. FACILITIES AND ACCREDITATION

The test sites and measurement facilities used to collect data are located at 218 Maeyeong-ro, Yeongtong-gu, Suwon-si, Gyeonggi-do, 16675, Korea. Line conducted emissions are measured only at the 218 address. The following table identifies which facilities were utilized for radiated emission measurements documented in this report. Specific facilities are also identified in the test results sections.

218 Maeyeong-ro	
<input checked="" type="checkbox"/>	Chamber 1
<input checked="" type="checkbox"/>	Chamber 2
<input type="checkbox"/>	Chamber 3

UL Korea, Ltd. is accredited by IAS, Laboratory Code TL-637. The full scope of accreditation can be viewed at <http://www.iasonline.org/PDF/TL/TL-637.pdf>.

4. CALIBRATION AND UNCERTAINTY

4.1. MEASURING INSTRUMENT CALIBRATION

The measuring equipment utilized to perform the tests documented in this report has been calibrated in accordance with the manufacturer's recommendations, and is traceable to recognized national standards.

4.2. SAMPLE CALCULATION

Where relevant, the following sample calculation is provided:

$$\begin{aligned} \text{Field Strength (dBuV/m)} &= \text{Measured Voltage (dBuV)} + \text{Antenna Factor (dB/m)} + \\ &\text{Cable Loss (dB)} - \text{Preamp Gain (dB)} \\ 36.5 \text{ dBuV} + 18.7 \text{ dB/m} + 0.6 \text{ dB} - 26.9 \text{ dB} &= 28.9 \text{ dBuV/m} \end{aligned}$$

4.3. MEASUREMENT UNCERTAINTY

Where relevant, the following measurement uncertainty levels have been estimated for tests performed on the apparatus:

PARAMETER	UNCERTAINTY
Conducted Disturbance, 0.15 to 30 MHz	2.32 dB
Radiated Disturbance, Below 1GHz	3.86 dB
Radiated Disturbance, Above 1 GHz	5.97 dB

Uncertainty figures are valid to a confidence level of 95%.

5. EQUIPMENT UNDER TEST

5.1. DESCRIPTION OF EUT

The EUT is a CDMA/GSM/WCDMA/LTE Phone + BT/BLE, DTS/UNII a/b/g/n/ac, ANT+ and NFC. This test report addresses the ANT+ operational mode.

5.2. MAXIMUM E-FIELD STRENGTH

The ANT+ mode has maximum output fundamental field strength as follows:

Frequency Range [MHz]	Mode	Peak E-field Strength [dBuV/m]	Avg E-field Strength [dBuV/m]	Distance [m]
2402 - 2480	ANT +	91.62	57.88	3.00

5.3. DESCRIPTION OF AVAILABLE ANTENNAS

The radio utilizes an internal antenna, with a maximum gain of -2.21 dBi

5.4. WORST-CASE CONFIGURATION AND MODE

Radiated emission below 1GHz and power line conducted emission were performed with the EUT set to transmit at the channel with highest output power as worst-case scenario.

Radiated emission above 1GHz was performed with the EUT set to transmit low/mid/high channels.

This EUT have a camera pop up function when user operate front camera function. The fundamental of the EUT was investigated in three orthogonal orientations X, Y and Z. It was normal mode and camera pop up mode. It was determined that X on normal mode orientation was worst-case orientation; therefore, all final radiated testing was performed with the EUT in X on normal mode of orientation.

Note : All radiated and power line conducted tests were performed connected with charger for evaluation of worst case mode.

5.5. DESCRIPTION OF TEST SETUP

SUPPORT EQUIPMENT

Support Equipment List				
Description	Manufacturer	Model	Serial Number	FCC ID
Charger	SAMSUNG	EP-TA800	R37M1E50KV1SE3	N/A
Data Cable	SAMSUNG	EP-DA905BBE	N/A	N/A
Earphone	SAMSUNG	GHSS028-W4	N/A	N/A

I/O CABLE

I/O Cable List						
Cable No	Port	# of identical ports	Connector Type	Cable Type	Cable Length (m)	Remarks
1	DC Power	1	Type-C	Shielded	1.1m	N/A
2	Audio	2	Type-C	Unshielded	1.2m	N/A

TEST SETUP

The EUT is set to continuously transmit in ANT + test mode.
 Test software in hidden menu exercised the EUT to enable ANT+ mode.

SETUP DIAGRAM FOR TESTS (CONDUCTED TEST SETUP)

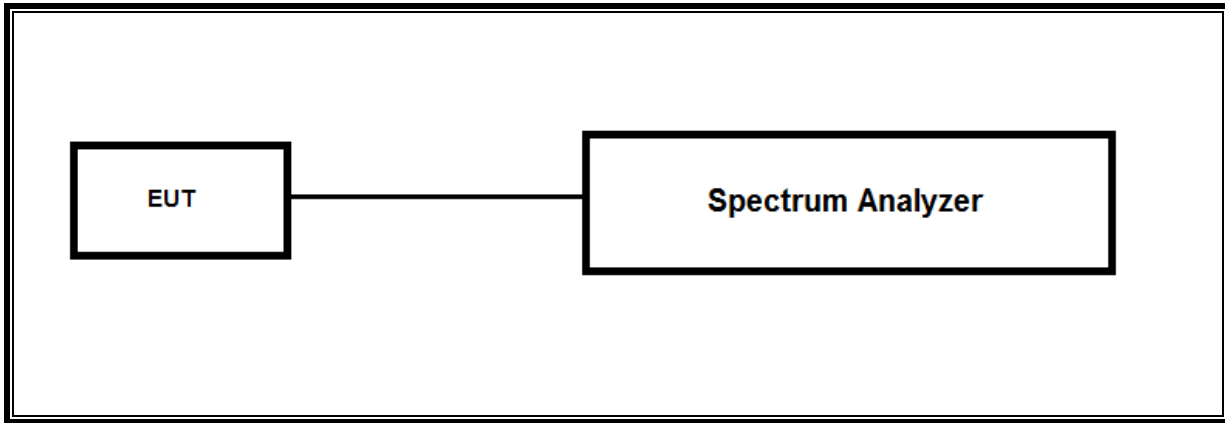

SETUP DIAGRAM FOR TESTS (RADIATED TEST SETUP)

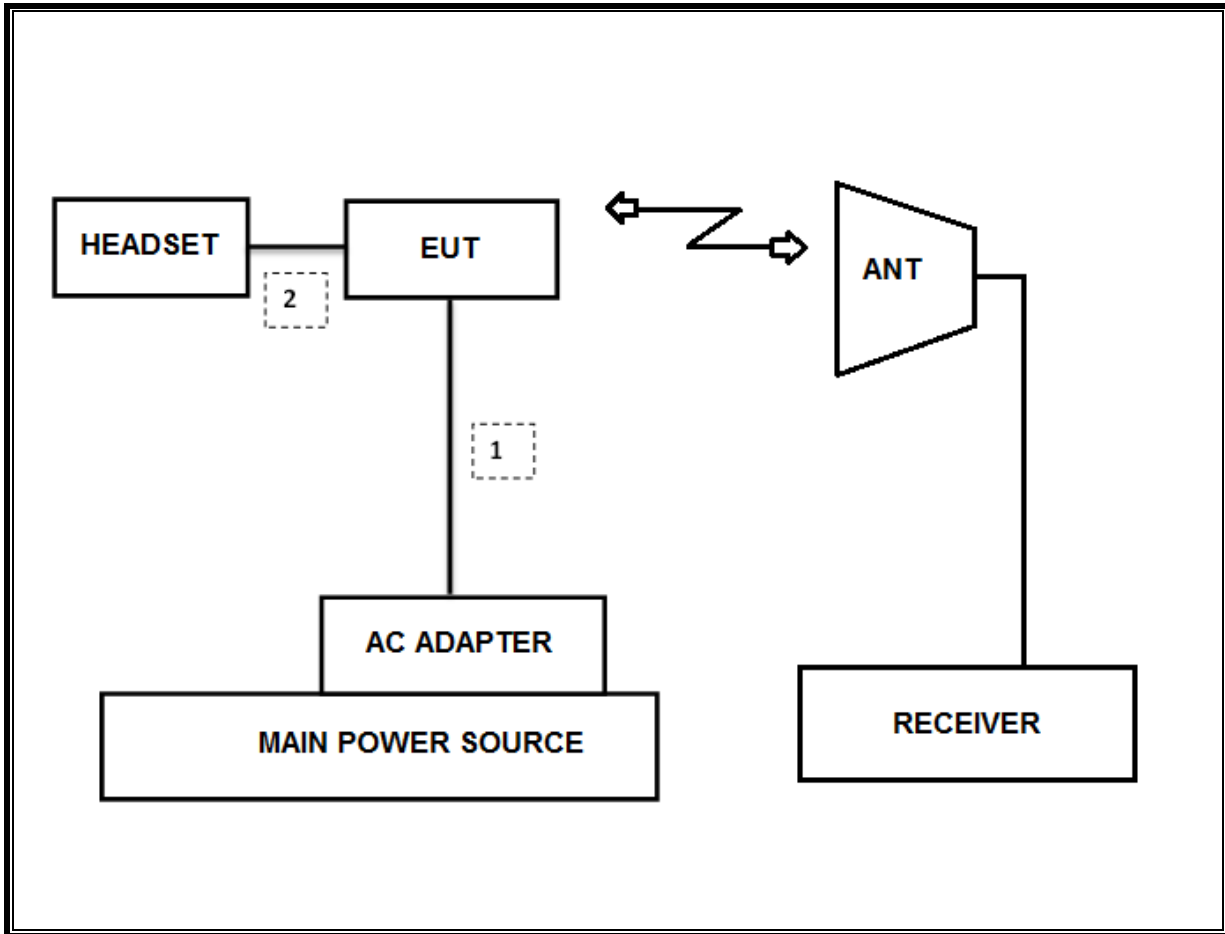

6. TEST AND MEASUREMENT EQUIPMENT

The following test and measurement equipment was utilized for the tests documented in this report:

Test Equipment List				
Description	Manufacturer	Model	S/N	New Cal Due
Antenna, Bilog, 30MHz-1GHz	SCHWARZBECK	VULB9163	750	08-04-20
Antenna, Bilog, 30MHz-1GHz	SCHWARZBECK	VULB9163	749	08-04-20
Antenna, Bilog, 30MHz-1GHz	SCHWARZBECK	VULB9163	845	08-04-20
Antenna, Loop, 9kHz-30MHz	R&S	HFH2-Z2	100418	10-26-19
Antenna, Horn, 18 GHz	ETS	3115	00167211	08-04-20
Antenna, Horn, 18 GHz	ETS	3115	00161451	08-04-20
Antenna, Horn, 18 GHz	ETS	3117	00168724	08-04-20
Antenna, Horn, 18 GHz	ETS	3117	00168717	08-04-20
Antenna, Horn, 18 GHz	ETS	3117	00205959	08-04-20
Antenna, Horn, 40 GHz	ETS	3116C	00166155	08-14-20
Antenna, Horn, 40 GHz	ETS	3116C	00168645	12-04-19
Antenna, Horn, 40 GHz	ETS	3116C-PA	00168841	08-09-19
Preamplifier, 1000 MHz	Sonoma	310N	341282	08-07-19
Preamplifier, 1000 MHz	Sonoma	310N	351741	08-07-19
Preamplifier, 1000 MHz	Sonoma	310N	370599	08-06-19
Preamplifier, 18 GHz	Miteq	AFS42-00101800-25-S-42	1876511	08-07-19
Preamplifier, 18 GHz	Miteq	AFS42-00101800-25-S-42	1896138	08-07-19
Preamplifier, 18 GHz	Miteq	AFS42-00101800-25-S-42	2029169	08-07-19
Spectrum Analyzer, 44 GHz	Agilent / HP	N9030A	MY54170614	08-07-19
Spectrum Analyzer, 44 GHz	Agilent / HP	N9030A	MY54490312	08-06-19
Spectrum Analyzer, 43.5 GHz	R&S	FSW43	104089	08-06-19
Average Power Sensor	Agilent / HP	U2000	MY54270007	08-07-19
Attenuator	PASTERNAK	PE7087-10	A001	08-08-19
Attenuator	PASTERNAK	PE7087-10	A008	08-08-19
Attenuator	PASTERNAK	PE7004-10	2	08-07-19
Attenuator	PASTERNAK	PE7087-10	A009	08-08-19
EMI Test Receive, 40 GHz	R&S	ESU40	100439	08-06-19
EMI Test Receive, 40 GHz	R&S	ESU40	100457	08-06-19
EMI Test Receive, 44 GHz	R&S	ESW44	101590	08-06-19
EMI Test Receive, 3 GHz	R&S	ESR3	101832	08-06-19
Low Pass Filter 5GHz	Micro-Tronics	LPS17541	009	08-07-19
Low Pass Filter 5GHz	Micro-Tronics	LPS17541	015	08-07-19
Low Pass Filter 5GHz	Micro-Tronics	LPS17541	020	08-06-19
High Pass Filter 3GHz	Micro-Tronics	HPM17543	010	08-07-19
High Pass Filter 3GHz	Micro-Tronics	HPM17543	015	08-07-19
High Pass Filter 3GHz	Micro-Tronics	HPM17543	020	08-06-19
High Pass Filter 6GHz	Micro-Tronics	HPS17542	009	08-07-19
High Pass Filter 6GHz	Micro-Tronics	HPS17542	016	08-07-19
High Pass Filter 6GHz	Micro-Tronics	HPS17542	021	08-06-19
LISN	R&S	ENV-216	101837	08-09-19
UL Software				
Description	Manufacturer	Model	Version	
Radiated software	UL	UL EMC	Ver 9.5	
AC Line Conducted software	UL	UL EMC	Ver 9.5	

7. LIMITS AND RESULTS

7.1. 99% BANDWIDTH

LIMITS

None; for reporting purposes only.

TEST PROCEDURE

The transmitter output is connected to the spectrum analyzer. The RBW is set to 1% to 3% of the 99 % bandwidth. The VBW is set to 3 times the RBW. The sweep time is coupled. The spectrum analyzer internal 99% bandwidth function is utilized.

RESULTS

Channel	Frequency [MHz]	99% Bandwidth [kHz]	20 dB Bandwidth [kHz]
Low	2402	766.63	582.5
Mid	2441	777.70	577.7
High	2480	770.93	588.4
Worst		777.70	588.4

99% BANDWIDTH PLOTS

LOW CHANNEL

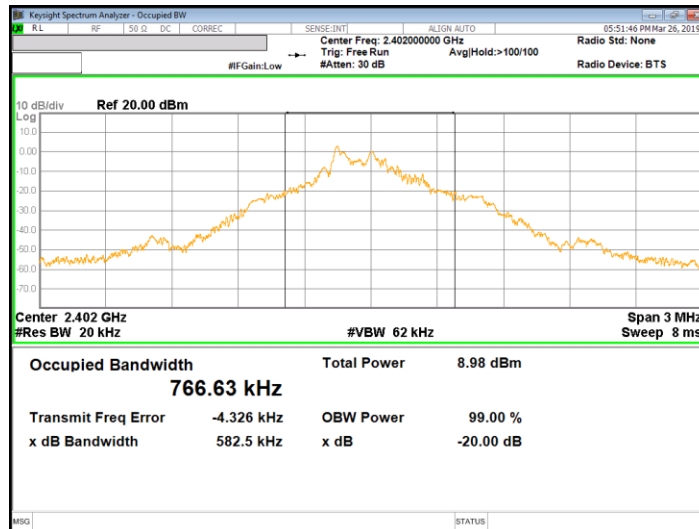

MID CHANNEL

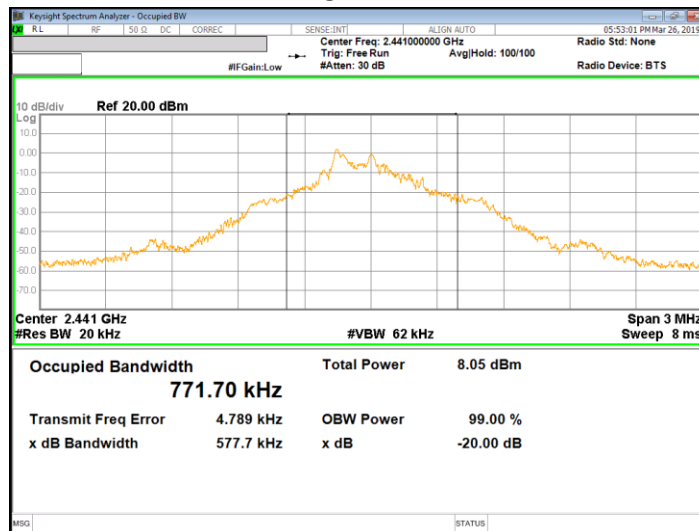

HIGH CHANNEL

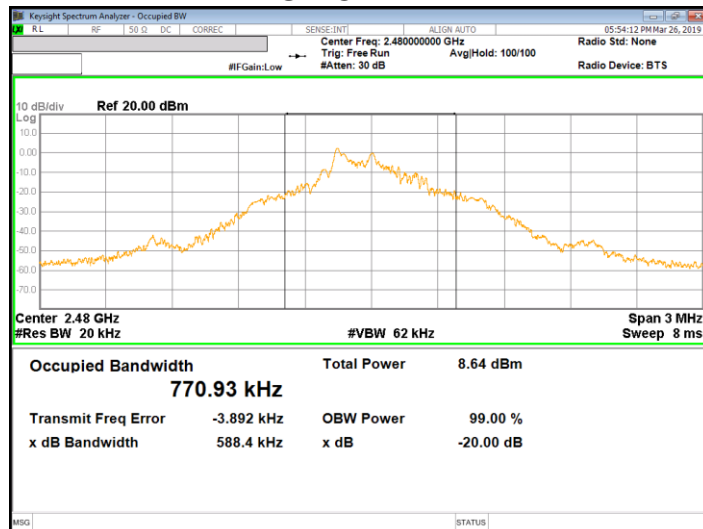

7.2. TRANSMITTER RADIATED EMISSIONS

TEST PROCEDURE

ANSI C63.10: 2013

The EUT is placed on a non-conducting table 80 cm above the ground plane for below 1GHz and 150 cm for above 1GHz. The antenna to EUT distance is 3 meters. The EUT is configured in accordance with ANSI C63.10. The EUT is set to transmit in a continuous mode.

For measurements below 1 GHz the resolution bandwidth is set to 100 kHz for peak detection measurements or 120 kHz for quasi-peak detection measurements. Peak detection is used unless otherwise noted as quasi-peak.

For measurements above 1 GHz the resolution bandwidth is set to 1 MHz, then the video bandwidth is set to 3 MHz for peak measurements and add duty cycle factor for average measurements.

Pre-scans to detect harmonic and spurious emissions, the resolution bandwidth is set to 1 MHz; the video bandwidth is set to 30 KHz for peak measurements.

LIMIT

FCC §15.249

Operation within the bands 902–928 MHz, 2400–2483.5 MHz, 5725–5875 MHz, and 24.0–24.25 GHz.

(a) Except as provided in paragraph (b) of this section, the field strength of emissions from intentional radiators operated within these frequency bands shall comply with the following:

Fundamental frequency	Field strength of fundamental (millivolts/meter)	Field strength of harmonics (microvolts/meter)
902-928 MHz	50	500
2400-2483.5 MHz	50	500
5725-5875 MHz	50	500
24.0-24.25 GHz	250	2500

(d) Emissions radiated outside of the specified frequency bands, except for harmonics, shall be attenuated by at least 50 dB below the level of the fundamental or to the general radiated emission limits in § 15.209, whichever is the lesser attenuation.

(e) As shown in Sec. 15.35(b), for frequencies above 1000 MHz, the field strength limits in paragraphs (a) and (b) of this section are based on average limits. However, the peak field strength of any emission shall not exceed the maximum permitted average limits specified above by more than 20 dB under any condition of modulation.

FCC §15.205 and §15.209

Limits for radiated disturbance of an intentional radiator		
Frequency range (MHz)	Limits (µV/m)	Measurement Distance (m)
0.009 – 0.490	2400 / F (kHz)	300
0.490 – 1.705	24000 / F (kHz)	30
1.705 – 30.0	30	30
30 – 88	100**	3
88 - 216	150**	3
216 – 960	200**	3
Above 960	500	3

** Except as provided in paragraph (g), fundamental emissions from intentional radiators operating under this section shall not be located in the frequency bands 54-72 MHz, 76-88 MHz, 174-216 MHz or 470-806 MHz. However, operation within these frequency bands is permitted under other sections of this part, e.g. §§ 15.231 and 15.241.

Note : Emission was pre-scanned from 9KHz to 30MHz; No emissions were detected which was at least 20dB below the specification limit (consider distance correction factor).
 Per FCC part 15.31(o), test results were not reported.

Although these tests were performed other than open field test site, adequate comparison measurements were confirmed against 30 m open are test site.
 Therefore sufficient tests were made to demonstrate that the alternative site produces results that correlate with the one of tests made in an open field based on KDB 414788.

RESULTS

7.2.1. DUTY CYCLE

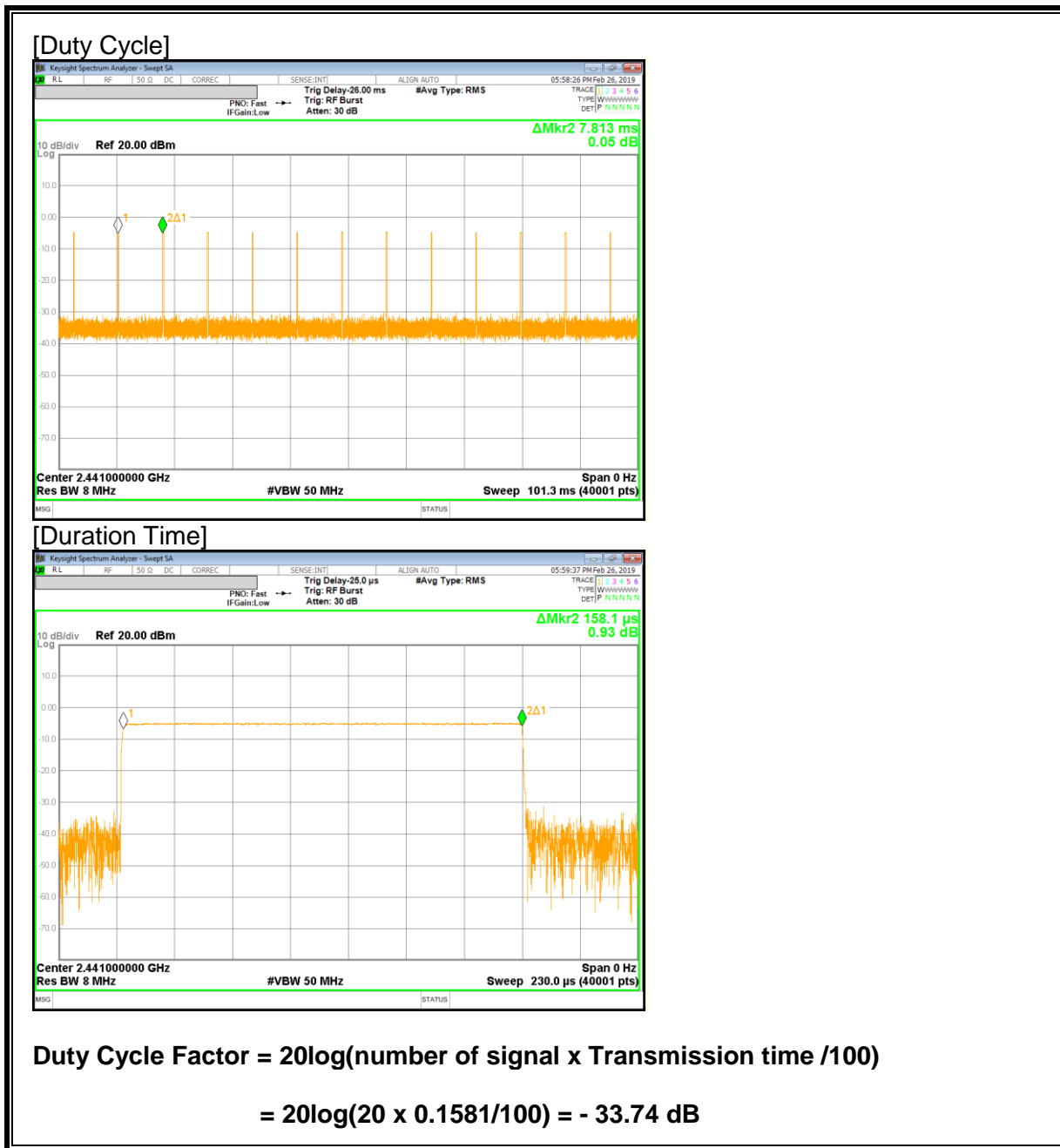

7.2.1. FUNDAMENTAL FIELD STRENGTH LEVEL

LOW CHANNEL, HORIZONTAL

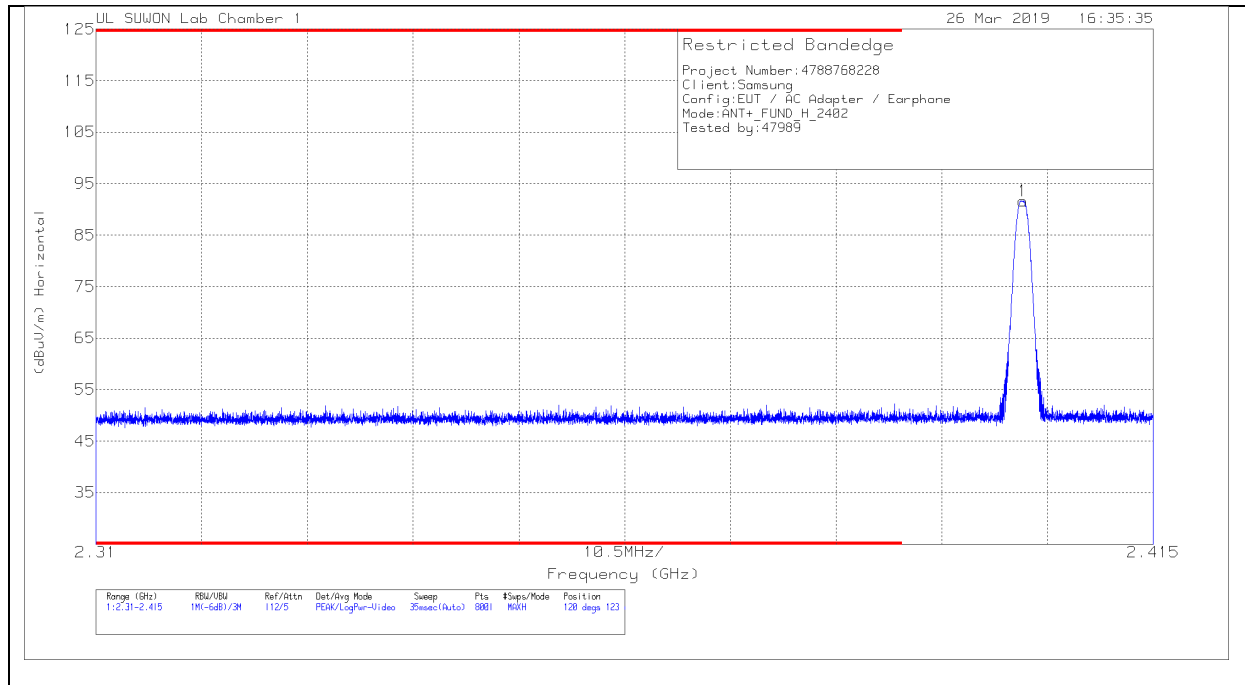

Trace Markers

Marker	Frequency (GHz)	Meter Reading (dBuV)	Det	3117_00168717	10dB[dB]	Corrected Reading (dBuV/m)	Azimuth (Degs)	Height (cm)	Polarity
1	2.402	85.32	Pk	31.7	-25.4	91.62	120	123	H

Pk - Peak detector

* Peak reading (dBuV/m)	Limit (dBuV/m)	Margin (dB)
91.62	114	22.38

** For marker 1 used the following method to do averaging:

DCCF = -33.74

Corrected AV reading = Peak Reading + DCCF

= 91.62 + -33.74 = 57.88 dBuV/m, AVG Limit : 94 dBuV/m, Margin 36.12 dB]

LOW CHANNEL, VERTICAL

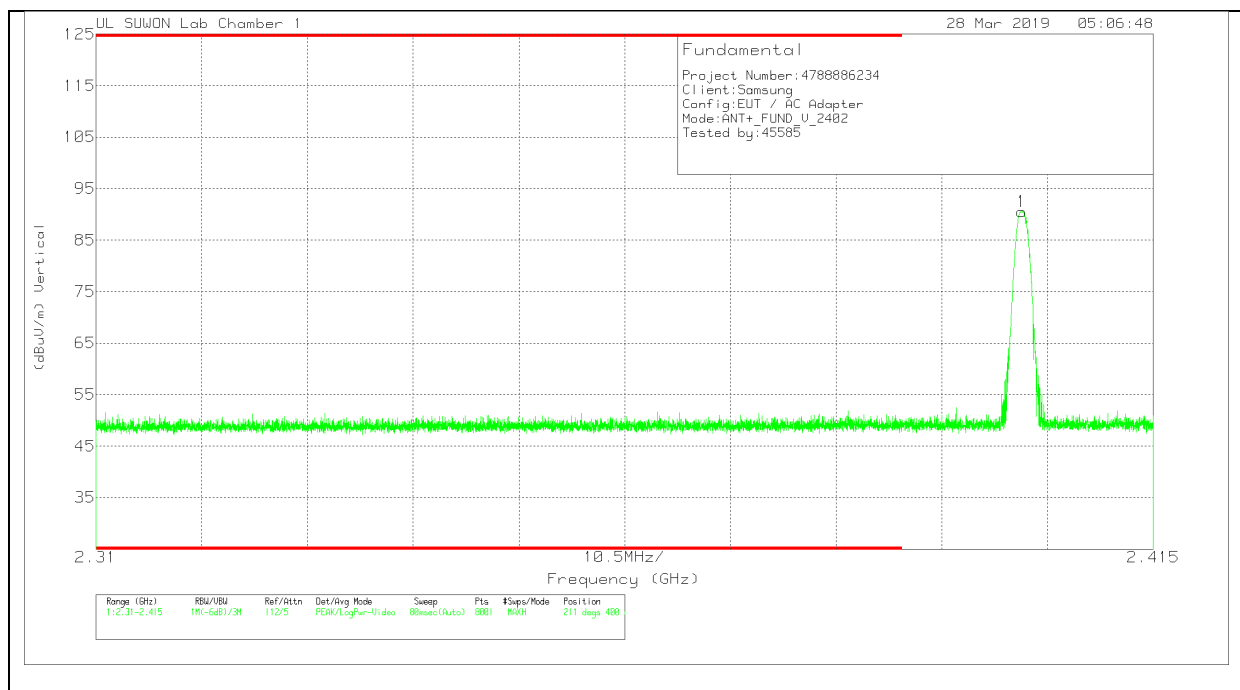

Trace Markers

Marker	Frequency (GHz)	Meter Reading (dBuV)	Det	3117_00168717	10dB[dB]	Corrected Reading (dBuV/m)	Azimuth (Degs)	Height (cm)	Polarity
1	2.402	84.27	Pk	31.7	-25.4	90.57	211	400	V

* - indicates frequency in CFR47 Pt 15 / IC RSS-Restricted Band
 Pk - Peak detector

Peak reading (dBuV/m)	Limit (dBuV/m)	Margin (dB)
90.57	114	23.43

** For marker 1 used the following method to do averaging:

DCCF = -33.74

Corrected AV reading = Peak Reading + DCCF

= 90.57 + -33.74 = 56.83 dBuV/m, AVG Limit : 94 dBuV/m, Margin 37.17 dB

MID CHANNEL, HORIZONTAL

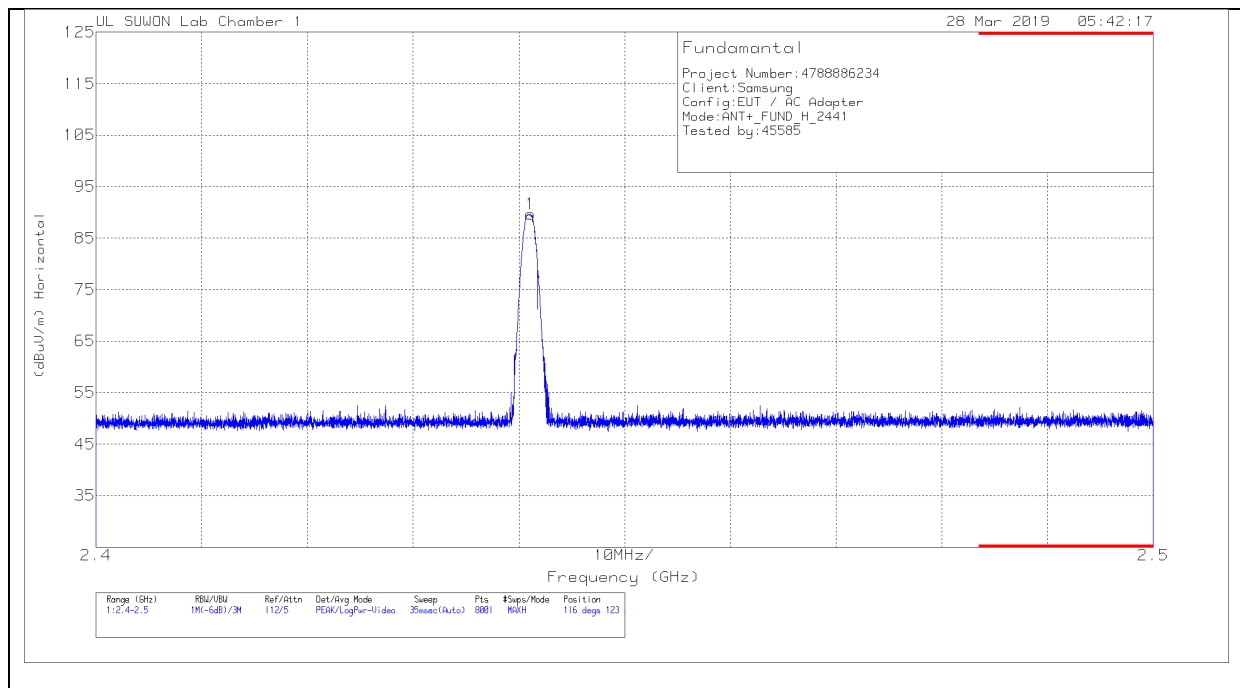

Trace Markers

Marker	Frequency (GHz)	Meter Reading (dBuV)	Det	3117_00168717	10dB[dB]	Corrected Reading (dBuV/m)	Azimuth (Degs)	Height (cm)	Polarity
1	2.441	83.13	Pk	31.8	-25.3	89.63	116	123	H

Pk - Peak detector

Peak reading (dBuV/m)	Limit (dBuV/m)	Margin (dB)
89.63	114	24.37

** For marker 1 used the following method to do averaging:

DCCF = -33.74

Corrected AV reading = Peak Reading + DCCF

= 89.63 + -33.74 = 55.89 dBuV/m, AVG Limit : 94 dBuV/m, Margin 38.11 dB

MID CHANNEL, VERTICAL

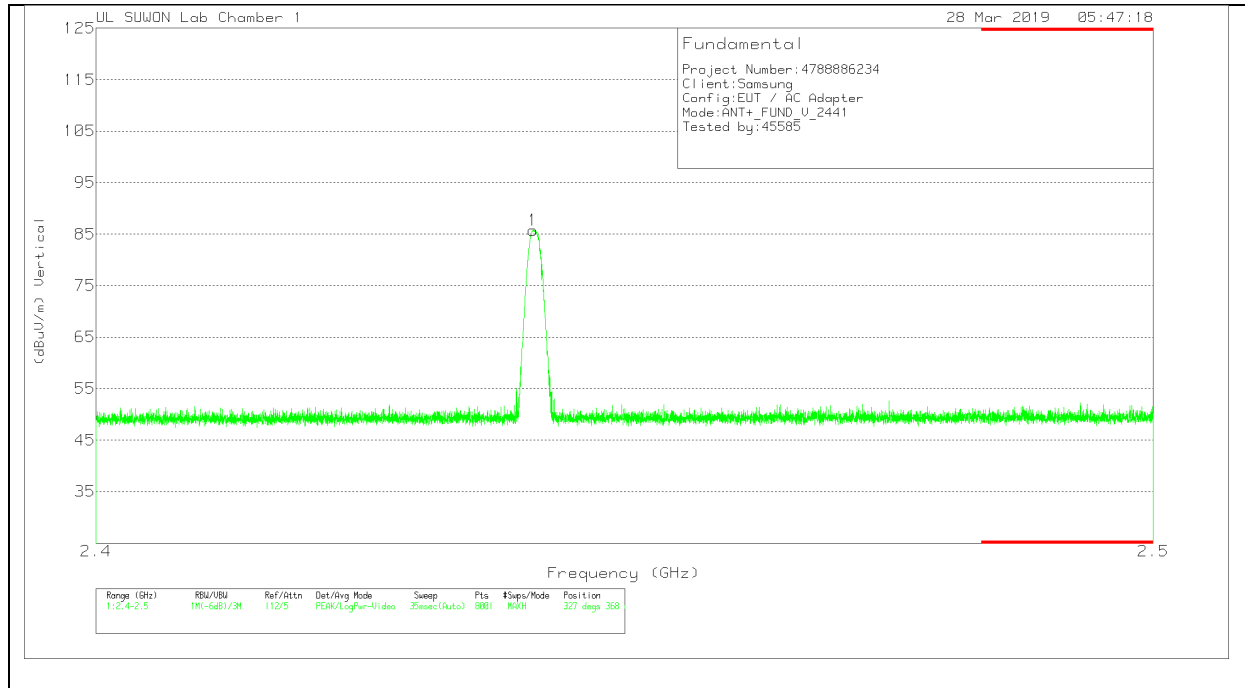

Trace Markers

Marker	Frequency (GHz)	Meter Reading (dBuV)	Det	3117_00168717	10dB[dB]	Corrected Reading (dBuV/m)	Azimuth (Degs)	Height (cm)	Polarity
1	2.441	79.32	Pk	31.8	-25.4	85.72	327	368	V

Pk - Peak detector

* Peak reading (dBuV/m)	Limit (dBuV/m)	Margin (dB)
85.72	114	28.28

** For marker 1 used the following method to do averaging:

DCCF = -33.74

Corrected AV reading = Peak Reading + DCCF

= 85.72 + -33.74 = 51.98 dBuV/m AVG Limit : 94 dBuV/m, Margin 42.02 dB]

HIGH CHANNEL, HORIZONTAL

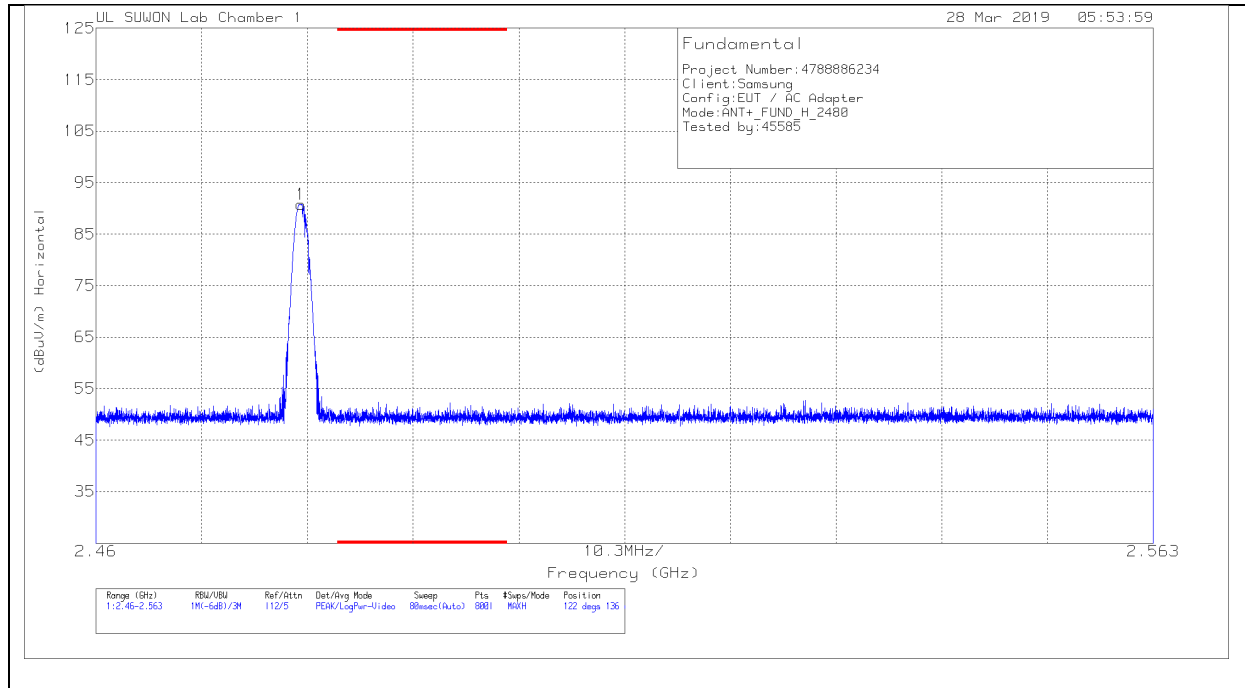

Trace Markers

Marker	Frequency (GHz)	Meter Reading (dBuV)	Det	3117_00168717	10dB[dB]	Corrected Reading (dBuV/m)	Azimuth (Degs)	Height (cm)	Polarity
1	2.48	84.2	Pk	31.9	-25.3	90.8	122	136	H

* - indicates frequency in CFR47 Pt 15 / IC RSS-Restricted Band
 Pk - Peak detector

* Peak reading (dBuV/m)	Limit (dBuV/m)	Margin (dB)
90.8	114	23.2

** For marker 1 used the following method to do averaging:

DCCF = -33.74

Corrected AV reading = Peak Reading + DCCF

= 90.8 + -33.74 = 57.06 dBuV/m AVG Limit : 94 dBuV/m, Margin 36.94 dB]

HIGH CHANNEL, VERTICAL

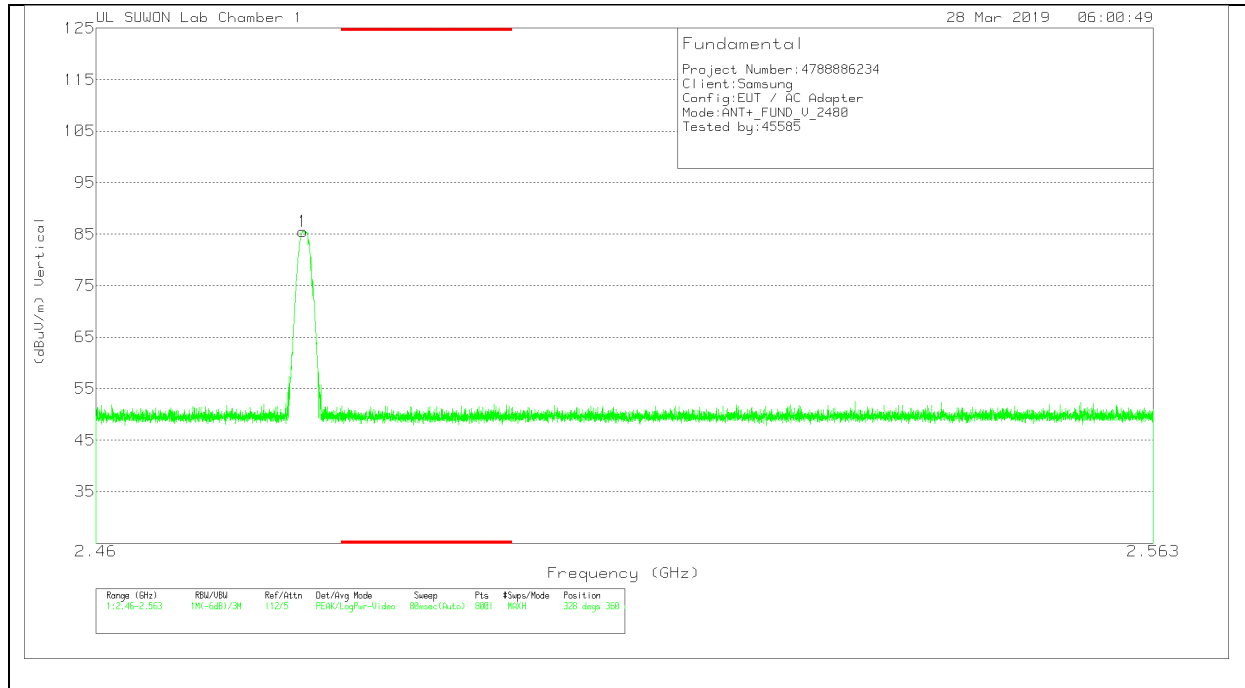

Trace Markers

Marker	Frequency (GHz)	Meter Reading (dBuV)	Det	3117_00168717	10dB[dB]	Corrected Reading (dBuV/m)	Azimuth (Degs)	Height (cm)	Polarity
1	2.48	78.94	Pk	31.9	-25.3	85.54	328	360	V

* - indicates frequency in CFR47 Pt 15 / IC RSS-Restricted Band
 Pk - Peak detector

* Peak reading (dBuV/m)	Limit (dBuV/m)	Margin (dB)
85.54	114	28.46

** For marker 1 used the following method to do averaging:

DCCF = -33.74

Corrected AV reading = Peak Reading + DCCF

= 85.54 + -33.74 = 51.8 dBuV/m AVG Limit : 94 dBuV/m, Margin 42.2 dB]

7.2.2. TRANSMITTER BAND EDGES

BANDEDGE (LOW CHANNEL, HORIZONTAL)

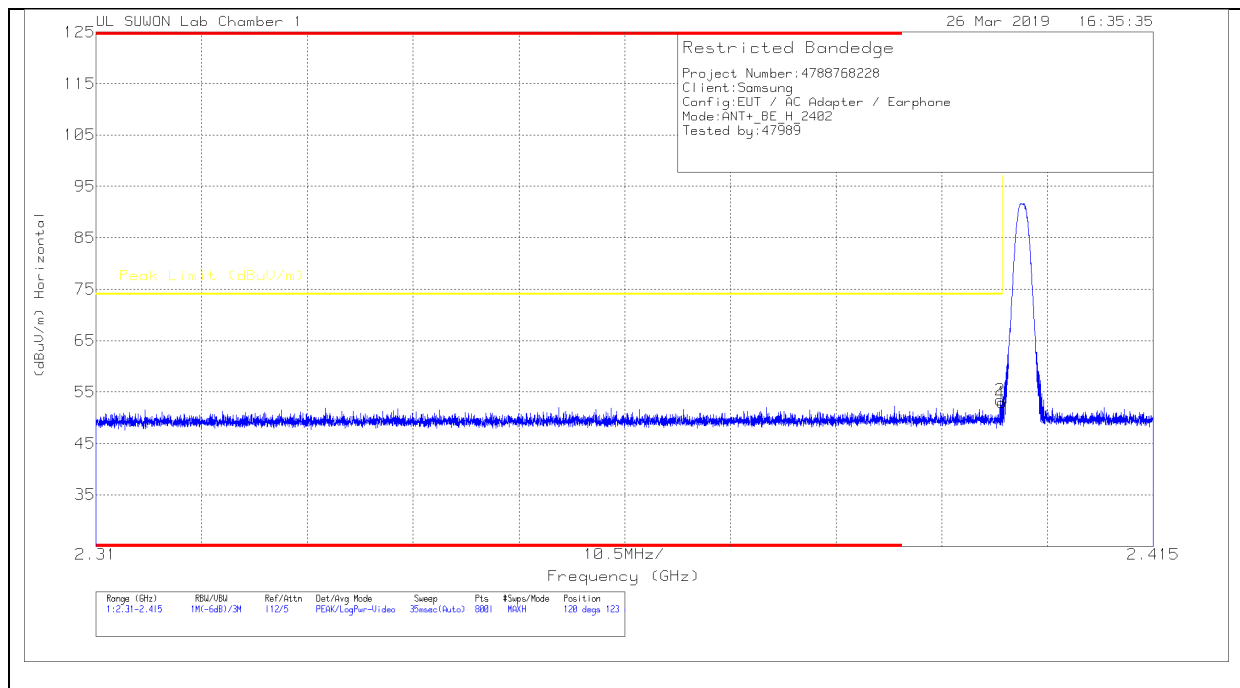

HORIZONTAL DATA

Trace Markers

Marker	Frequency (GHz)	Meter Reading (dBuV)	Det	3117_00168717	10dB[dB]	Corrected Reading (dBuV/m)	Peak Limit (dBuV/m)	PK Margin (dB)	Azimuth (Degs)	Height (cm)	Polarity
1	2.4	46.8	Pk	31.7	-25.5	53	74	-21	120	123	H
2	2.4	47.28	Pk	31.7	-25.5	53.48	74	-20.52	120	123	H

Pk - Peak detector

* For marker 1 used the following method to do averaging:

$$DCCF = -33.74 \quad / \quad \text{Peak Reading} = \underline{53} \text{ dBuV/m}$$

$$\text{Corrected AV reading} = \text{Peak Reading} + DCCF$$

$$= 53 + -33.74 = \underline{19.26} \text{ dBuV/m} \quad \text{AVG Limit : 54 dBuV/m, Margin } \underline{34.74} \text{ dB}$$

* For marker 2 used the following method to do averaging:

$$DCCF = -33.74 \quad / \quad \text{Peak Reading} = \underline{53.48} \text{ dBuV/m}$$

$$\text{Corrected AV reading} = \text{Peak Reading} + DCCF$$

$$= 53.48 + -33.74 = \underline{19.74} \text{ dBuV/m} \quad \text{AVG Limit : 54 dBuV/m, Margin } \underline{34.26} \text{ dB}$$

VERTICAL PEAK AND AVERAGE PLOT

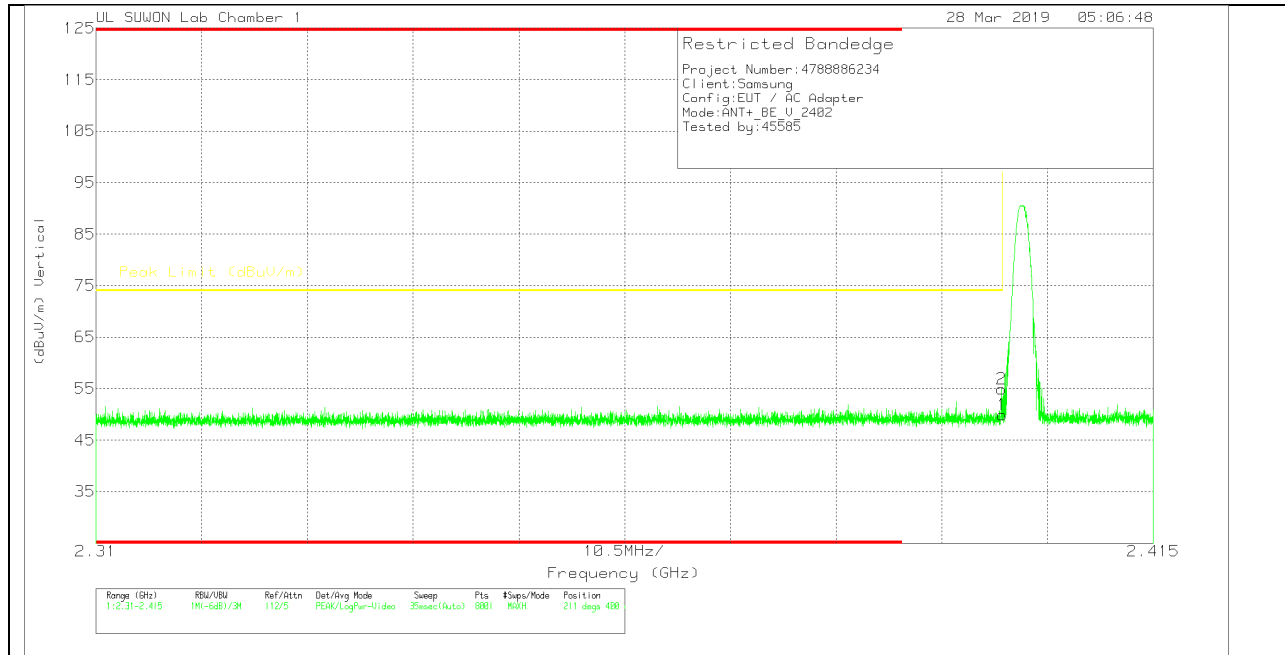

VERTICAL DATA

Trace Markers

Marker	Frequency (GHz)	Meter Reading (dBuV)	Det	3117_00168717	10dB[dB]	Corrected Reading (dBuV/m)	Peak Limit (dBuV/m)	PK Margin (dB)	Azimuth (Degs)	Height (cm)	Polarity
1	2.4	43.73	Pk	31.7	-25.5	49.93	74	-24.07	211	400	V
2	2.4	48.73	Pk	31.7	-25.5	54.93	74	-19.07	211	400	V

Pk - Peak detector

* For marker 1 used the following method to do averaging:

$$\begin{aligned}
 DCCF &= -33.74 \quad / \quad \text{Peak Reading} = 49.93 \text{ dBuVm} \\
 \text{Corrected AV reading} &= \text{Peak Reading} + DCCF \\
 &= 49.93 + -33.74 = 16.19 \text{ dBuVm} \quad \text{AVG Limit : 54 dBuVm, Margin 37.81 dB}
 \end{aligned}$$

* For marker 2 used the following method to do averaging:

$$\begin{aligned}
 DCCF &= -33.74 \quad / \quad \text{Peak Reading} = 54.93 \text{ dBuVm} \\
 \text{Corrected AV reading} &= \text{Peak Reading} + DCCF \\
 &= 54.93 + -33.74 = 21.19 \text{ dBuVm} \quad \text{AVG Limit : 54 dBuVm, Margin 32.81 dB}
 \end{aligned}$$

AUTHORIZED BANDEGE (HIGH CHANNEL)

HORIZONTAL PEAK AND AVERAGE PLOT

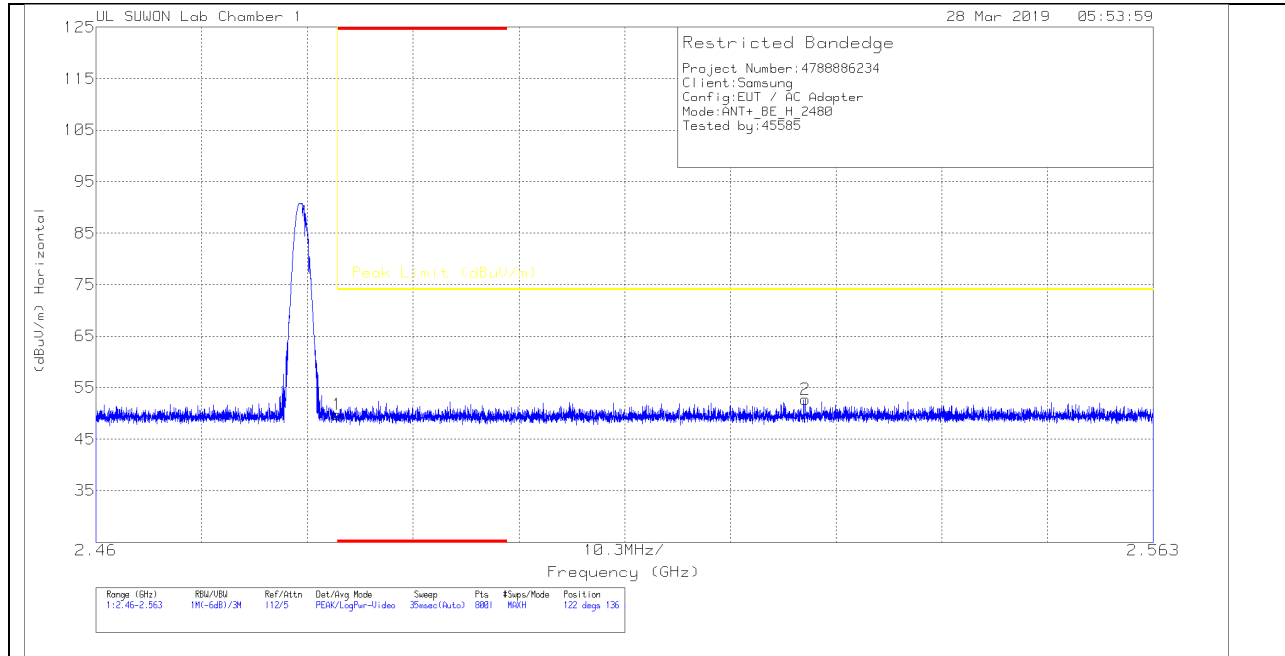

HORIZONTAL DATA

Trace Markers

Marker	Frequency (GHz)	Meter Reading (dBuV)	Det	3117_00168717	10dB[dB]	Corrected Reading (dBuV/m)	Peak Limit (dBuV/m)	PK Margin (dB)	Azimuth (Degs)	Height (cm)	Polarity
1	* 2.484	43.2	Pk	31.9	-25.3	49.8	74	-24.2	122	136	H
2	2.529	45.87	Pk	32	-25.2	52.67	74	-21.33	122	136	H

* - indicates frequency in CFR47 Pt 15 / IC RSS-Restricted Band
 Pk - Peak detector

* For marker 1 used the following method to do averaging:

$$\begin{aligned}
 \text{DCCF} &= -33.74 \quad / \quad \text{Peak Reading} = \underline{49.8} \text{ dBuV/m} \\
 \text{Corrected AV reading} &= \text{Peak Reading} + \text{DCCF} \\
 &= 49.8 + -33.74 = \underline{16.06} \text{ dBuV/m} \quad \text{AVG Limit : 54 dBuV/m, Margin } \underline{37.94} \text{ dB}
 \end{aligned}$$

* For marker 2 used the following method to do averaging:

$$\begin{aligned}
 \text{DCCF} &= -33.74 \quad / \quad \text{Peak Reading} = \underline{52.67} \text{ dBuV/m} \\
 \text{Corrected AV reading} &= \text{Peak Reading} + \text{DCCF} \\
 &= 52.67 + -33.74 = \underline{18.93} \text{ dBuV/m} \quad \text{AVG Limit : 54 dBuV/m, Margin } \underline{35.07} \text{ dB}
 \end{aligned}$$

VERTICAL PEAK AND AVERAGE PLOT

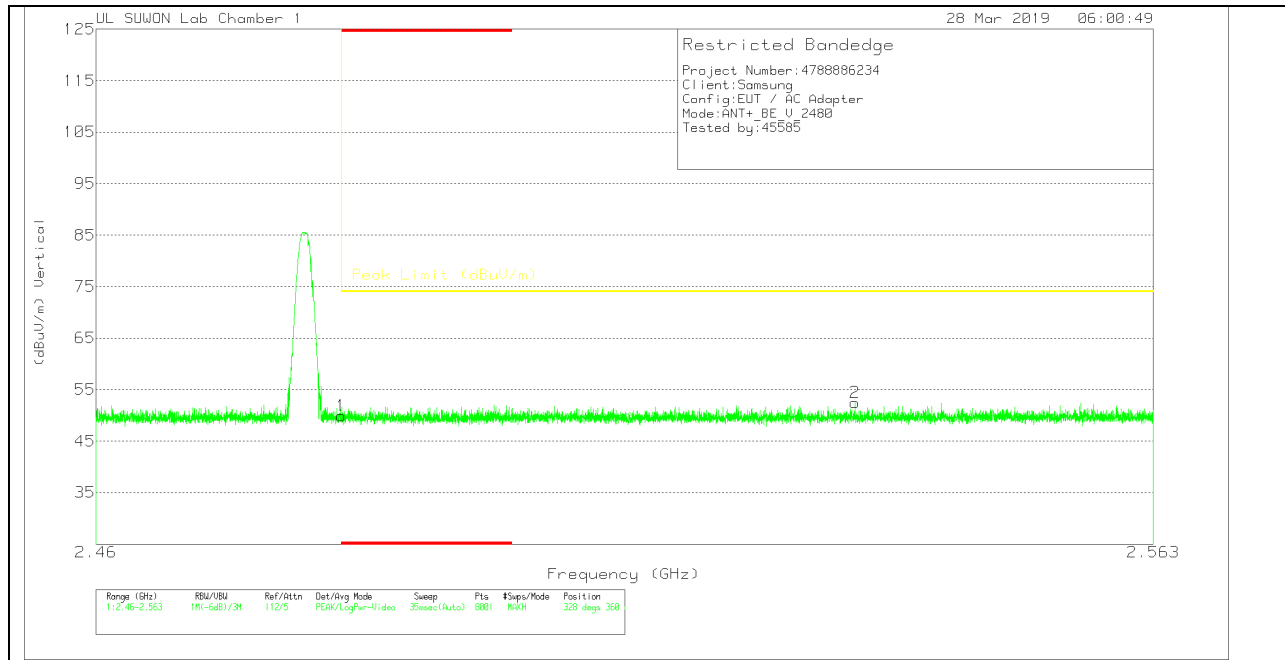

VERTICAL DATA

Trace Markers

Marker	Frequency (GHz)	Meter Reading (dBuV)	Det	3117_00168717	10dB[dB]	Corrected Reading (dBuV/m)	Peak Limit (dBuV/m)	PK Margin (dB)	Azimuth (Degs)	Height (cm)	Polarity
1	* 2.484	43.31	Pk	31.9	-25.3	49.91	74	-24.09	328	360	V
2	2.534	45.68	Pk	32	-25.2	52.48	74	-21.52	328	360	V

* - indicates frequency in CFR47 Pt 15 / IC RSS-Restricted Band

Pk - Peak detector

* For marker 1 used the following method to do averaging:

DCCF = -33.74 / Peak Reading = 49.91 dBuV/m

Corrected AV reading = Peak Reading + DCCF

= 49.91 + -33.74 = 16.17 dBuV/m AVG Limit : 54 dBuV/m, Margin 37.83 dB

* For marker 2 used the following method to do averaging:

DCCF = -33.74 / Peak Reading = 52.48 dBuV/m

Corrected AV reading = Peak Reading + DCCF

= 52.48 + -33.74 = 18.74 dBuV/m AVG Limit : 54 dBuV/m, Margin 35.26 dB

7.2.3. HARMONICS AND SPURIOUS EMISSIONS

LOW CHANNEL HORIZONTAL

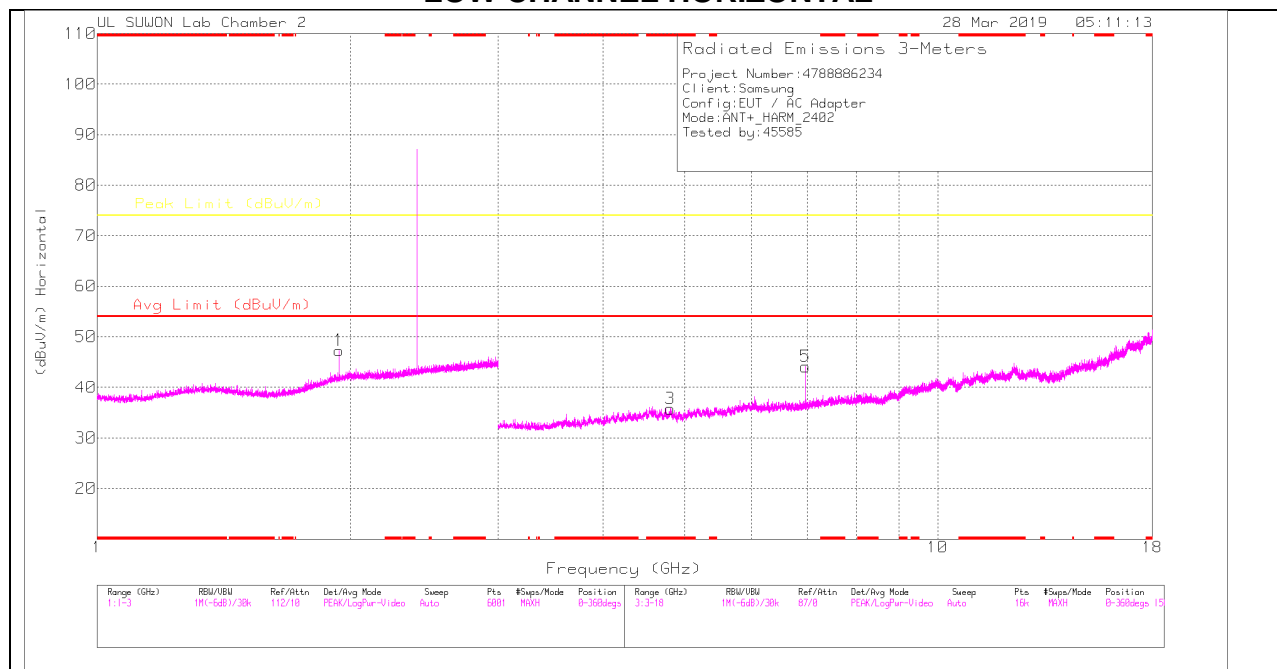

LOW CHANNEL VERTICAL

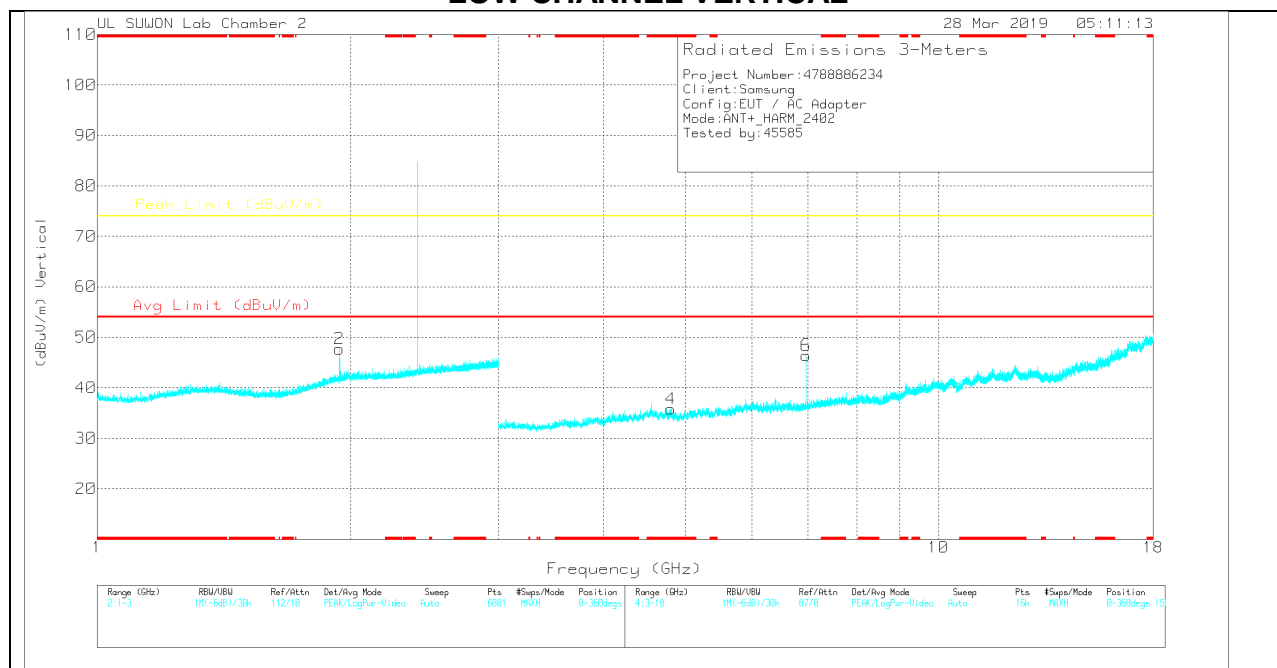

Note: Emission was scanned up to 26GHz; No emissions were detected above the noise floor which was at least 20dB below the specification limit.

LOW CHANNEL DATA

Trace Markers

Marker	Frequency (GHz)	Meter Reading (dBuV)	Det	3117_00168717	3GHz_HP[dB]	Corrected Reading (dBuV/m)	Avg Limit (dBuV/m)	Margin (dB)	Peak Limit (dBuV/m)	Margin (dB)	Azimuth (Degs)	Height (cm)	Polarity
1	1.941	42.71	PK	31	-26.4	47.31	-	-	74	-26.69	0-360	250	H
2	1.942	43.11	PK	31	-26.4	47.71	-	-	74	-26.29	0-360	250	V
3	* 4.805	32.97	PK	34.2	-31.4	35.77	-	-	74	-38.23	0-360	250	H
5	6.96	36.41	PK	35.7	-28	44.11	-	-	74	-29.89	0-360	150	H
4	* 4.805	33	PK	34.2	-31.4	35.8	-	-	74	-38.2	0-360	250	V
6	6.96	38.71	PK	35.7	-28	46.41	-	-	74	-27.59	0-360	150	V

* - indicates frequency in CFR47 Pt 15 / IC RSS-Restricted Band

PK – Peak Detector

Radiated Emissions

Frequency (GHz)	Meter Reading (dBuV)	Det	3117_00168717	3GHz_HP[dB]	Corrected Reading (dBuV/m)	Avg Limit (dBuV/m)	Margin (dB)	Peak Limit (dBuV/m)	Margin (dB)	Azimuth (Degs)	Height (cm)	Polarity
6.96	43.67	PK2	35.7	-28	51.37	-	-	74	-22.63	175	236	H
6.96	42.95	PK2	35.7	-28	50.65	-	-	74	-23.35	154	330	V

* - indicates frequency in CFR47 Pt 15 / IC RSS-Restricted Band

PK2 - KDB558074 Method: Maximum Peak

* For marker 5 used the following method to do averaging:

$$DCCF = -33.74 \quad / \quad \text{Peak Reading} = \underline{51.37} \text{ dBuV/m}$$

$$\text{Corrected AV reading} = \text{Peak Reading} + DCCF$$

$$= 51.37 + -33.74 = 17.63 \text{ dBuV/m ,AVG Limit : 54 dBuV/m, Margin } 36.37 \text{ dB}$$

* For marker 6 used the following method to do averaging:

$$DCCF = -33.74 \quad / \quad \text{Peak Reading} = \underline{50.65} \text{ dBuV/m}$$

$$\text{Corrected AV reading} = \text{Peak Reading} + DCCF$$

$$= 50.65 + -33.74 = 16.91 \text{ dBuV/m ,AVG Limit : 54 dBuV/m, Margin } 37.09 \text{ dB}$$

MID CHANNEL HORIZONTAL

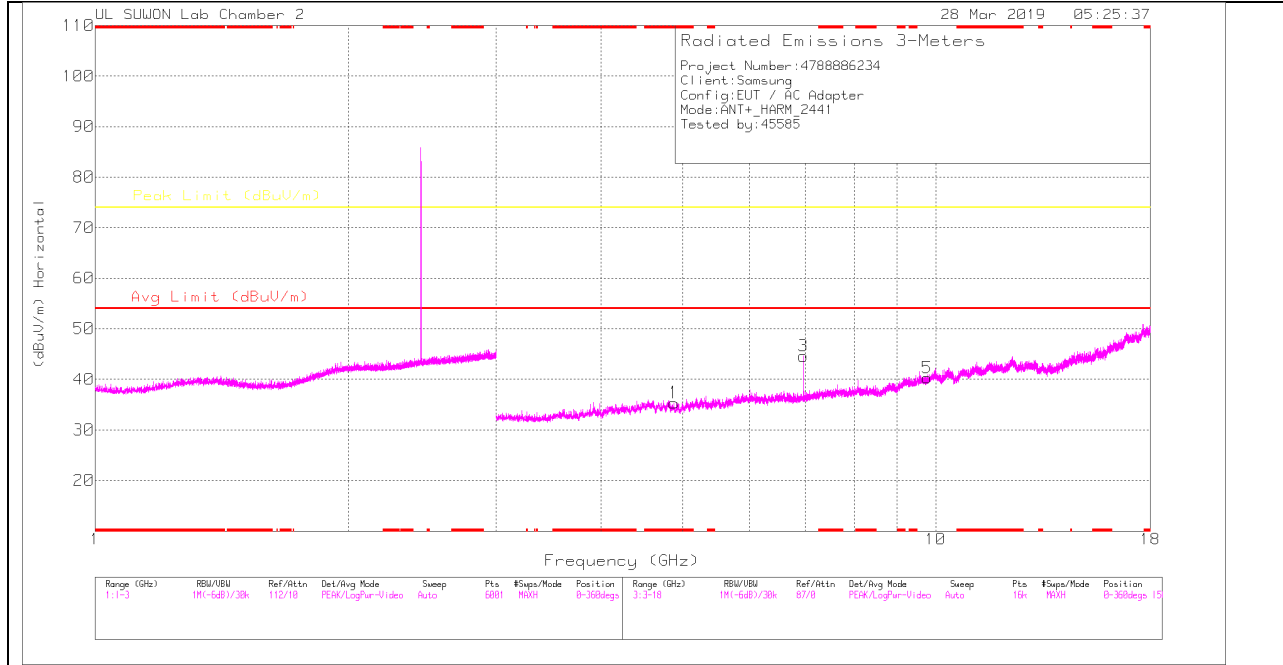

MID CHANNEL VERTICAL

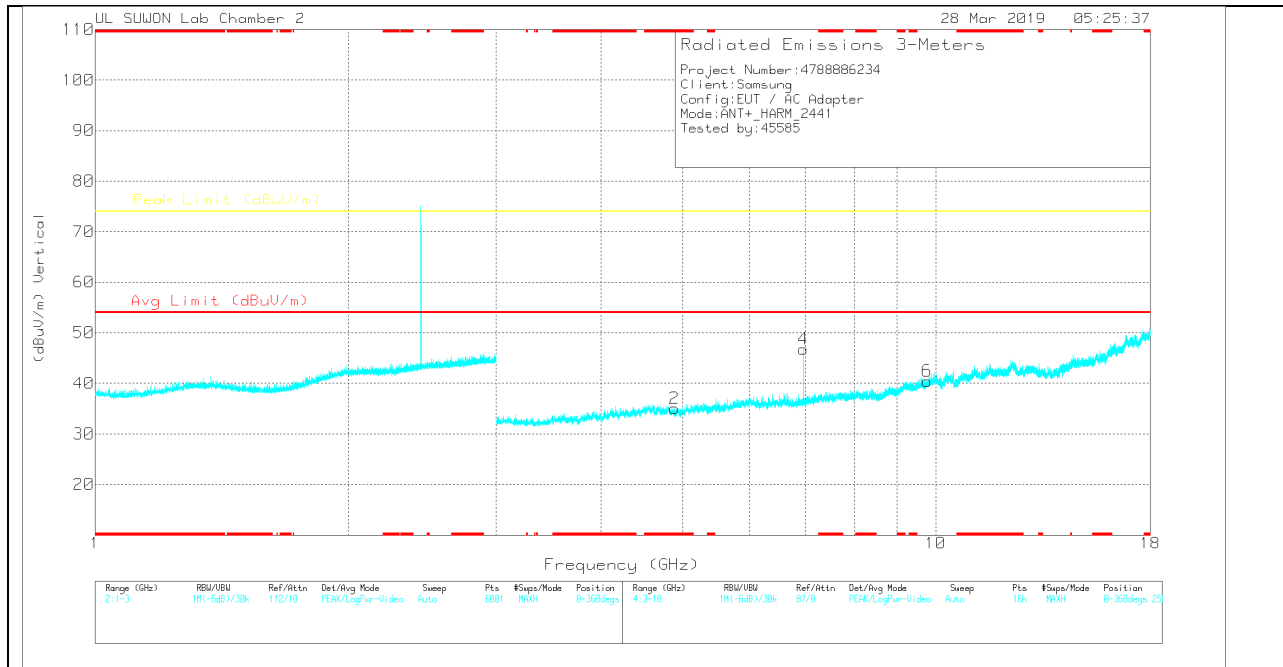

Note: Emission was scanned up to 26GHz; No emissions were detected above the noise floor which was at least 20dB below the specification limit.

MID CHANNEL DATA

Trace Markers

Marker	Frequency (GHz)	Meter Reading (dBuV)	Det	3117_00168717	3GHz_HP[dB]	Corrected Reading (dBuV/m)	Avg Limit (dBuV/m)	Margin (dB)	Peak Limit (dBuV/m)	Margin (dB)	Azimuth (Degs)	Height (cm)	Polarity
1	* 4.885	32.65	PK	34.2	-31.5	35.35	-	-	74	-38.65	0-360	150	H
3	6.96	36.91	PK	35.7	-28	44.61	-	-	74	-29.39	0-360	150	H
5	9.767	26.86	PK	37.3	-23.9	40.26	-	-	74	-33.74	0-360	150	H
2	* 4.889	32.34	PK	34.2	-31.5	35.04	-	-	74	-38.96	0-360	250	V
4	6.96	39.08	PK	35.7	-28	46.78	-	-	74	-27.22	0-360	150	V
6	9.77	27.07	PK	37.3	-23.9	40.47	-	-	74	-33.53	0-360	250	V

* - indicates frequency in CFR47 Pt 15 / IC RSS-Restricted Band
 PK – Peak Detector

Radiated Emissions

Frequency (GHz)	Meter Reading (dBuV)	Det	3117_00168717	3GHz_HP[dB]	Corrected Reading (dBuV/m)	Avg Limit (dBuV/m)	Margin (dB)	Peak Limit (dBuV/m)	Margin (dB)	Azimuth (Degs)	Height (cm)	Polarity
6.96	42.68	PK2	35.7	-28	50.38	-	-	74	-23.62	199	234	H
6.96	42.95	PK2	35.7	-28	50.65	-	-	74	-23.35	154	330	V

* - indicates frequency in CFR47 Pt 15 / IC RSS-Restricted Band
 PK2 - KDB558074 Method: Maximum Peak

* For marker 3 used the following method to do averaging:

$$DCCF = -33.74 \quad / \quad \text{Peak Reading} = \underline{50.38} \text{ dBuV/m}$$

$$\text{Corrected AV reading} = \text{Peak Reading} + DCCF$$

$$= 50.38 + -33.74 = 16.64 \text{ dBuV/m ; AVG Limit : 54 dBuV/m, Margin } 37.36 \text{ dB}$$

* For marker 4 used the following method to do averaging:

$$DCCF = -33.74 \quad / \quad \text{Peak Reading} = \underline{50.65} \text{ dBuV/m}$$

$$\text{Corrected AV reading} = \text{Peak Reading} + DCCF$$

$$= 50.65 + -33.74 = 16.91 \text{ dBuV/m ; AVG Limit : 54 dBuV/m, Margin } 37.09 \text{ dB}$$

HIGH CHANNEL HORIZONTAL

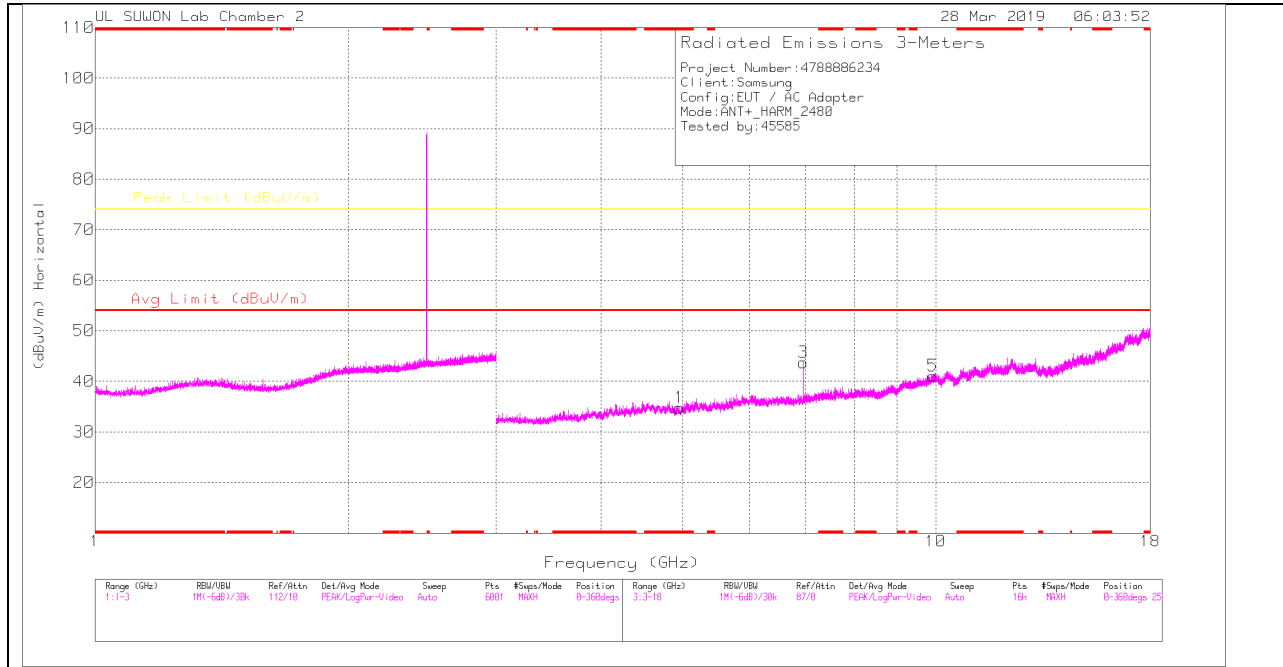

HIGH CHANNEL VERTICAL

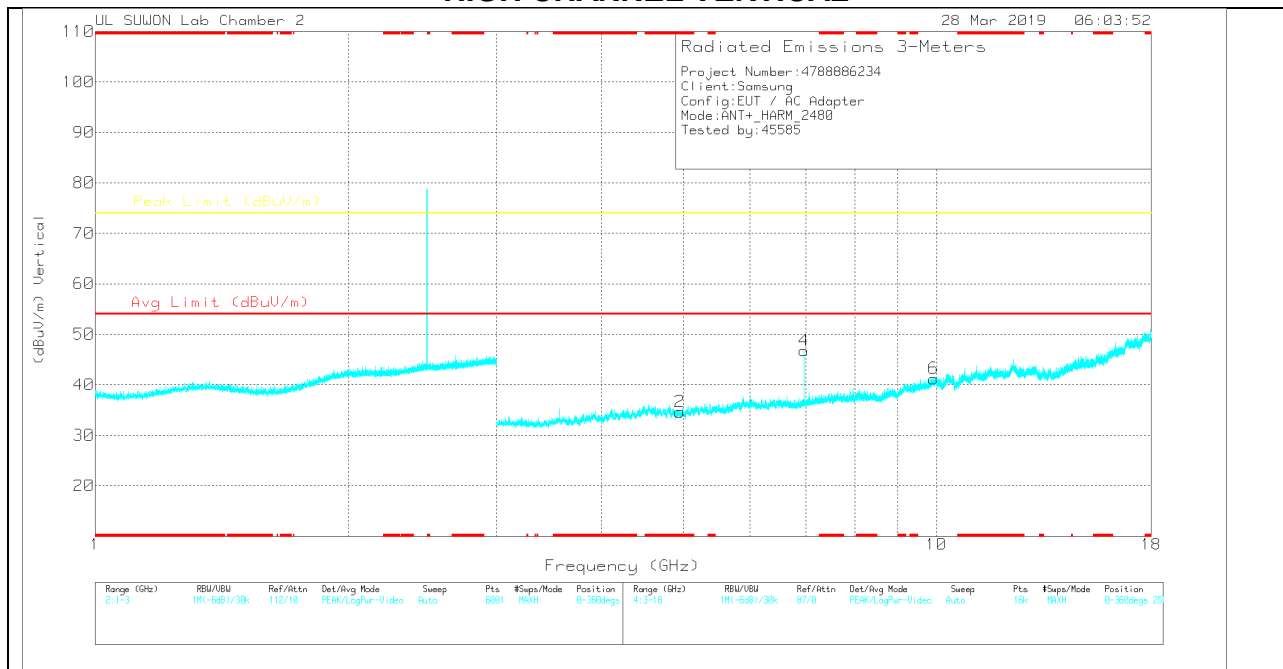

Note: Emission was scanned up to 26GHz; No emissions were detected above the noise floor which was at least 20dB below the specification limit.

HIGH CHANNEL DATA

Trace Markers

Marker	Frequency (GHz)	Meter Reading (dBuV)	Det	3117_00168717	3GHz_HP[dB]	Corrected Reading (dBuV/m)	Avg Limit (dBuV/m)	Margin (dB)	Peak Limit (dBuV/m)	Margin (dB)	Azimuth (Degs)	Height (cm)	Polarity
1	* 4.955	32.07	PK	34.2	-31.5	34.77	-	-	74	-39.23	0-360	150	H
3	6.96	36.03	PK	35.7	-28	43.73	-	-	74	-30.27	0-360	150	H
5	9.924	25.89	PK	37.5	-22.3	41.09	-	-	74	-32.91	0-360	150	H
2	* 4.955	31.95	PK	34.2	-31.5	34.65	-	-	74	-39.35	0-360	250	V
4	6.96	39.06	PK	35.7	-28	46.76	-	-	74	-27.24	0-360	150	V
6	9.924	26.03	PK	37.5	-22.3	41.23	-	-	74	-32.77	0-360	250	V

* - indicates frequency in CFR47 Pt 15 / IC RSS-Restricted Band
 PK – Peak Detector

Radiated Emissions

Frequency (GHz)	Meter Reading (dBuV)	Det	3117_00168717	3GHz_HP[dB]	Corrected Reading (dBuV/m)	Avg Limit (dBuV/m)	Margin (dB)	Peak Limit (dBuV/m)	Margin (dB)	Azimuth (Degs)	Height (cm)	Polarity
6.96	43.63	PK2	35.7	-28	51.33	-	-	74	-22.67	114	106	H
6.96	42.95	PK2	35.7	-28	50.65	-	-	74	-23.35	154	330	V

* - indicates frequency in CFR47 Pt 15 / IC RSS-Restricted Band
 PK2 - KDB558074 Method: Maximum Peak

* For marker 3 used the following method to do averaging:

$$\begin{aligned}
 \text{DCCF} &= -33.74 \quad / \quad \text{Peak Reading} = \underline{51.33} \text{ dBuV/m} \\
 \text{Corrected AV reading} &= \text{Peak Reading} + \text{DCCF} \\
 &= 51.33 + -33.74 = \underline{17.59} \text{ dBuV/m} \quad \text{AVG Limit : 54 dBuV/m, Margin } \underline{36.41} \text{ dB}
 \end{aligned}$$

* For marker 4 used the following method to do averaging:

$$\begin{aligned}
 \text{DCCF} &= -33.74 \quad / \quad \text{Peak Reading} = \underline{50.65} \text{ dBuV/m} \\
 \text{Corrected AV reading} &= \text{Peak Reading} + \text{DCCF} \\
 &= 50.65 + -33.74 = \underline{16.91} \text{ dBuV/m} \quad \text{AVG Limit : 54 dBuV/m, Margin } \underline{37.09} \text{ dB}
 \end{aligned}$$

7.2.4. SPURIOUS BELOW 1 GHz

SPURIOUS EMISSIONS 30 TO 1000 MHz (HORIZONTAL)

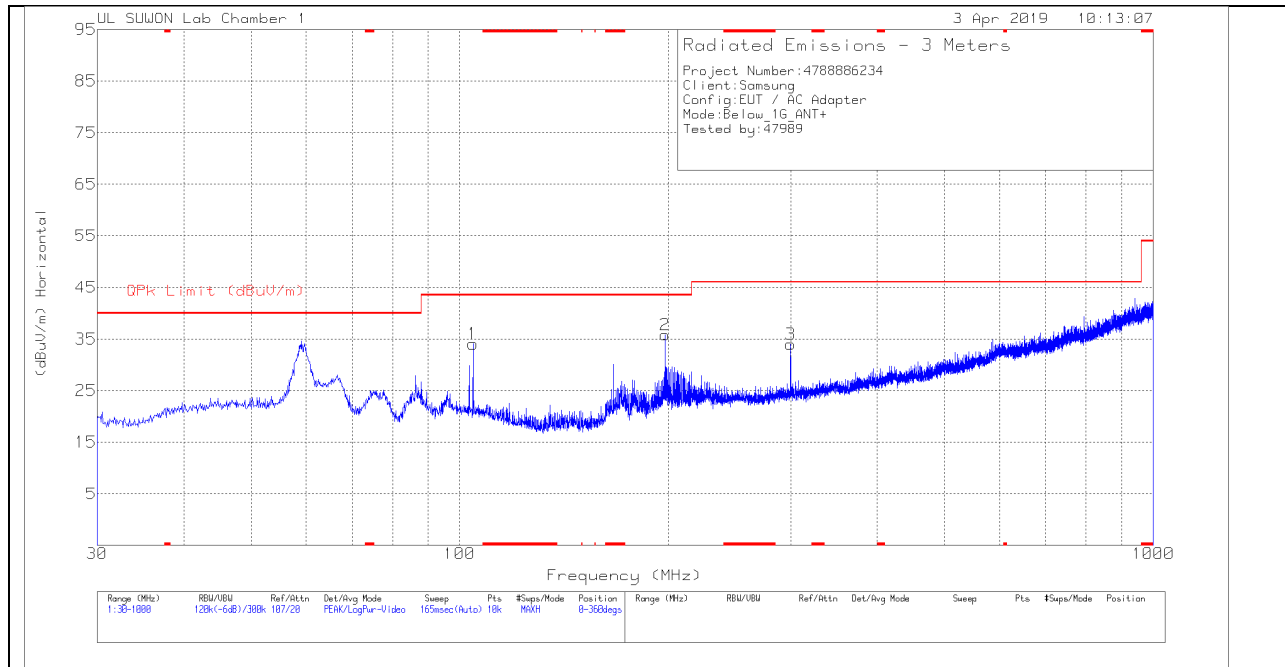

SPURIOUS EMISSIONS 30 TO 1000 MHz (VERTICAL)

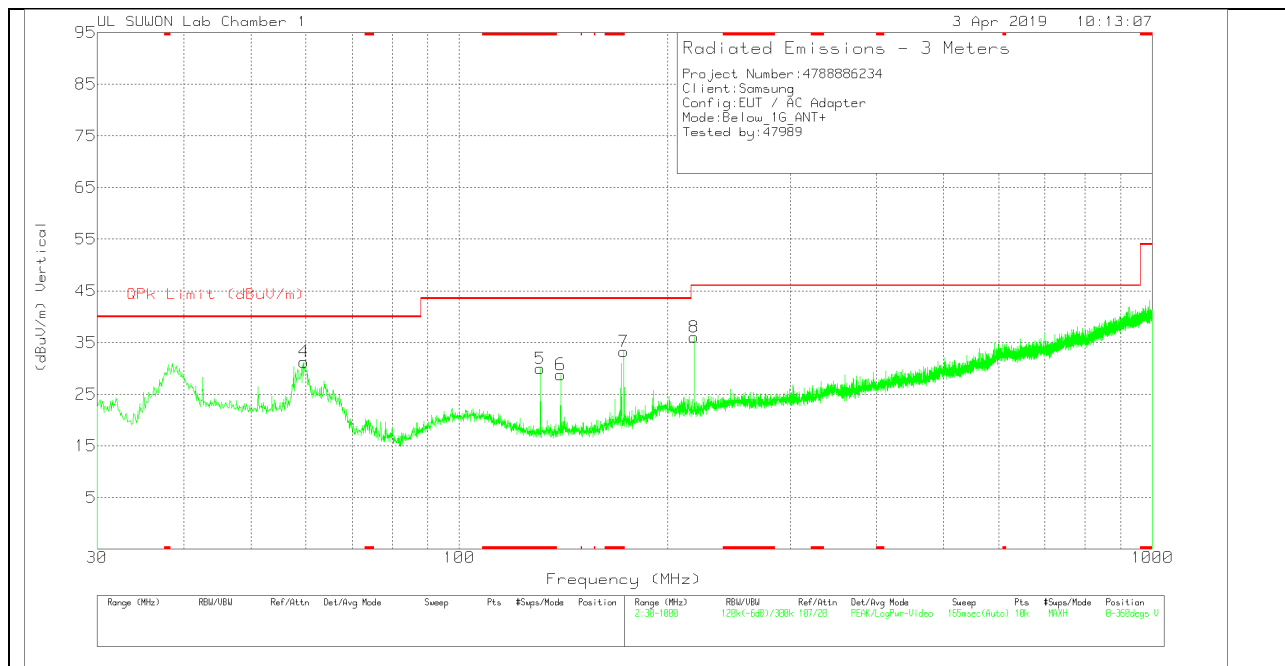

BELOW 1 GHz TABLE

Trace Markers

Marker	Frequency (MHz)	Meter Reading (dBuV)	Det	VULB9163_750	Below_1G[dB]	Corrected Reading (dBuV/m)	QPk Limit (dBuV/m)	Margin (dB)	Azimuth (Degs)	Height (cm)	Polarity
1	104.496	45.78	Pk	17.9	-29.6	34.08	43.52	-9.44	0-360	200	H
2	197.907	46.23	Pk	18.1	-28.5	35.83	43.52	-7.69	0-360	200	H
3	299.951	42.28	Pk	19.3	-27.6	33.98	46.02	-12.04	0-360	100	H
4	59.682	42.96	Pk	18.6	-30.3	31.26	40	-8.74	0-360	100	V
5	* 130.88	44.85	Pk	14.3	-29.2	29.95	43.52	-13.57	0-360	100	V
6	139.998	43.79	Pk	14.1	-29.1	28.79	43.52	-14.73	0-360	100	V
7	* 172.784	47.17	Pk	14.9	-28.8	33.27	43.52	-10.25	0-360	100	V
8	218.083	47.23	Pk	17.2	-28.4	36.03	46.02	-9.99	0-360	200	V

* - indicates frequency in CFR47 Pt 15 / IC RSS-Restricted Band

Pk - Peak detector

8. AC POWER LINE CONDUCTED EMISSIONS

LIMITS

FCC §15.207 (a)

Frequency of emission (MHz)	Conducted limit (dB μ V)	
	Quasi-peak	Average
0.15-0.5	66 to 56*	56 to 46*
0.5-5	56	46
5-30	60	50

*Decreases with the logarithm of the frequency.

TEST PROCEDURE

The EUT is placed on a non-conducting table 40 cm from the vertical ground plane and 80 cm above the horizontal ground plane. The EUT is configured in accordance with ANSI C63.10.

The receiver is set to a resolution bandwidth of 9 kHz. Peak detection is used unless otherwise noted as quasi-peak or average.

Line conducted data is recorded for both NEUTRAL and HOT lines.

RESULTS

6 WORST EMISSIONS

LINE 1 PLOT

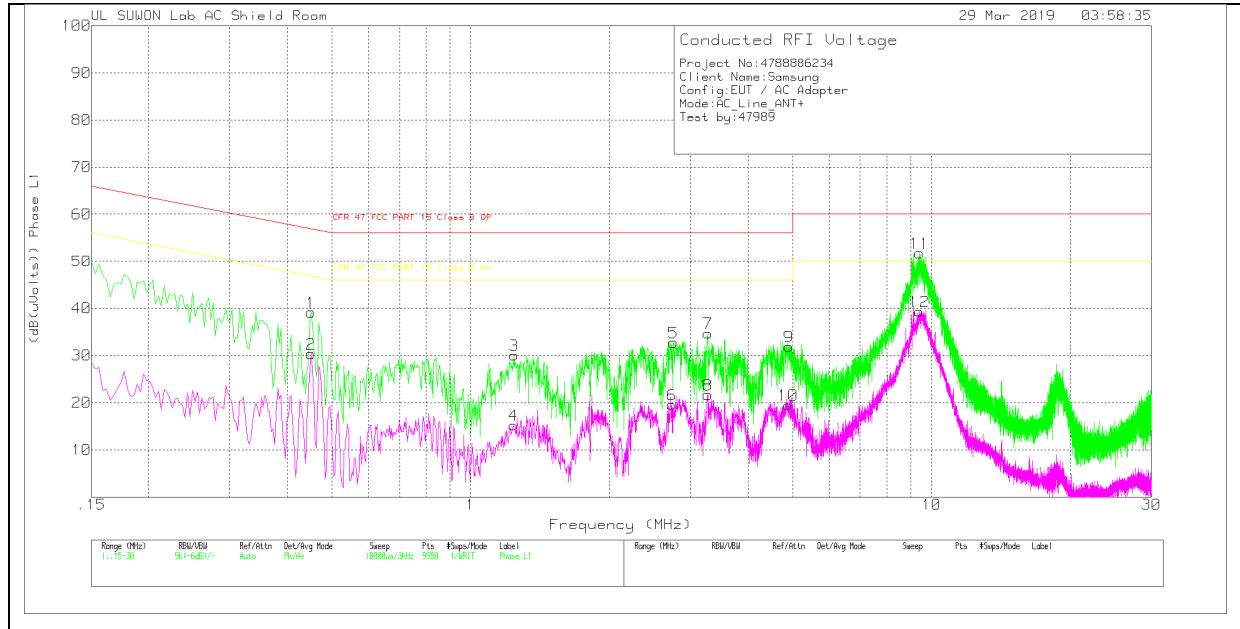

LINE 1 RESULTS

Trace Markers

Range 1: Phase L1 .15 - 30MHz

Marker	Frequency (MHz)	Meter Reading (dBuV)	Det	ENV216_101836_With excord_L1	CABLELOSS(dB)	Corrected Reading (dB(uVolts))	CFR 47 FCC PART 15 Class B QP	Margin (dB)	CFR 47 FCC PART 15 Class B AV	Margin (dB)
1	.45	29.1	Pk	9.9	.2	39.2	56.88	-17.68	-	-
2	.45	20.29	Av	9.9	.2	30.39	-	-	46.88	-16.49
3	1.242	20	Pk	9.8	.3	30.1	56	-25.9	-	-
4	1.239	5.17	Av	9.8	.3	15.27	-	-	46	-30.73
5	2.751	22.5	Pk	10	.3	32.8	56	-23.2	-	-
6	2.73	9.32	Av	10	.3	19.62	-	-	46	-26.38
7	3.27	24.54	Pk	9.9	.3	34.74	56	-21.26	-	-
8	3.27	11.51	Av	9.9	.3	21.71	-	-	46	-24.29
9	4.902	21.81	Pk	9.8	.3	31.91	56	-24.09	-	-
10	4.881	9.41	Av	9.8	.3	19.51	-	-	46	-26.49
11	9.414	41.38	Pk	10	.4	51.78	60	-8.22	-	-
12	9.408	28.98	Av	10	.4	39.38	-	-	50	-10.62

Pk - Peak detector

Av - Average detection

Quasi-Peak Emissions

Range 1: Phase L1 .15 - 30MHz

Frequency (MHz)	Meter Reading (dBuV)	Det	ENV216_101836_With excord_L1	CABLELOSS(dB)	Corrected Reading (dB(uVolts))	CFR 47 FCC PART 15 Class B QP	Margin (dB)	CFR 47 FCC PART 15 Class B AV	Margin (dB)
9.41415	34.98	Qp	10	.4	45.38	60	-14.62	-	-

Qp - Quasi-Peak detector

LINE 2 PLOT

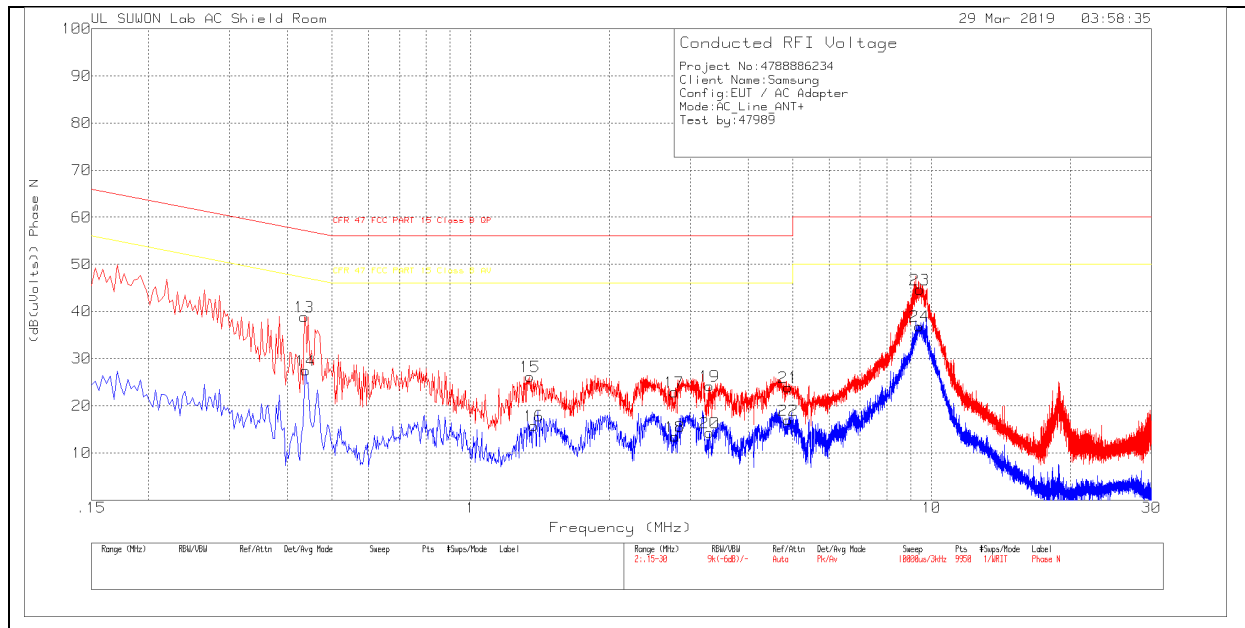

LINE 2 RESULTS

Trace Markers

Range 2: Phase N .15 - 30MHz

Marker	Frequency (MHz)	Meter Reading (dBuV)	Det	ENV216_10183 6_With ex-cord_N	CABLELOSS(dB)	Corrected Reading (dB(uVolts))	CFR 47 FCC PART 15 Class B QP	Margin (dB)	CFR 47 FCC PART 15 Class B AV	Margin (dB)
13	.435	29.37	Pk	9.3	.2	38.87	57.16	-18.29	-	-
14	.438	18	Av	9.3	.2	27.5	-	-	47.1	-19.6
15	1.344	16.1	Pk	9.8	.3	26.2	56	-29.8	-	-
16	1.371	5.79	Av	9.7	.3	15.79	-	-	46	-30.21
17	2.763	12.94	Pk	9.7	.3	22.94	56	-33.06	-	-
18	2.772	3.48	Av	9.7	.3	13.48	-	-	46	-32.52
19	3.297	14.21	Pk	9.7	.3	24.21	56	-31.79	-	-
20	3.297	4.29	Av	9.7	.3	14.29	-	-	46	-31.71
21	4.884	13.82	Pk	9.8	.3	23.92	56	-32.08	-	-
22	4.881	6.86	Av	9.8	.3	16.96	-	-	46	-29.04
23	9.426	34.27	Pk	10	.4	44.67	60	-15.33	-	-
24	9.405	26.49	Av	10	.4	36.89	-	-	50	-13.11

Pk - Peak detector

Av - Average detection

Quasi-Peak Emissions

Range 2: Phase N .15 - 30MHz

Frequency (MHz)	Meter Reading (dBuV)	Det	ENV216_101836_With ex-cord_N	CABLELOSS(dB)	Corrected Reading (dB(uVolts))	CFR 47 FCC PART 15 Class B QP	Margin (dB)	CFR 47 FCC PART 15 Class B AV	Margin (dB)
9.42615	31.12	Qp	10	.4	41.52	60	-18.48	-	-

Qp - Quasi-Peak detector