



CERTIFICATION TEST REPORT

Report Number. : 12440720-E5V2

Applicant : Samsung Electronics Co., Ltd.
129 Samsung-Ro, Yeongtong-Gu,
Suwon-Si, Gyeonggi-Do, 16677, Korea

Models : SM-A750G/DS and SM-A750G

FCC ID : A3LSMA750G

EUT Description : GSM/WCDMA/LTE Phone with BT, DTS/UNII a/b/g/n/ac, and ANT+

Test Standard(s) : FCC 47 CFR PART 15 SUBPART E (EXCEPT DFS)

Date Of Issue:
September 12, 2018

Prepared by:
UL Verification Services Inc.
47173 Benicia Street
Fremont, CA 94538 U.S.A.
TEL: (510) 771-1000
FAX: (510) 661-0888



NVLAP Lab code: 200065-0

REPORT REVISION HISTORY

Rev.	Issue Date	Revisions	Revised By
V1	8/31/2018	Initial Issue	
V2	9/12/2018	Updated Section 9.5.9	Dan Corona

TABLE OF CONTENTS

REPORT REVISION HISTORY	2
TABLE OF CONTENTS	3
1. ATTESTATION OF TEST RESULTS	6
2. INTRODUCTION OF TEST DATA REUSE.....	7
2.1. INTRODUCTION	7
2.2. DEVICES DIFFERENCES.....	7
2.3. SPOT CHECK VERIFICATION RESULTS SUMMARY	7
2.3.1. SPOT CHECK DATA.....	8
2.3.2. BANDEDGE (HIGH CHANNEL).....	8
2.3.3. HARMONICS AND SPURIOUS EMISSIONS	10
2.4. REFERENCE DETAIL	11
3. TEST METHODOLOGY	12
4. FACILITIES AND ACCREDITATION	12
5. CALIBRATION AND UNCERTAINTY	13
5.1. MEASURING INSTRUMENT CALIBRATION	13
5.2. SAMPLE CALCULATION	13
5.3. MEASUREMENT UNCERTAINTY.....	13
6. EQUIPMENT UNDER TEST.....	14
6.1. EUT DESCRIPTION	14
6.2. MAXIMUM OUTPUT POWER.....	15
6.3. DESCRIPTION OF AVAILABLE ANTENNAS	16
6.4. SOFTWARE AND FIRMWARE.....	16
6.5. WORST-CASE CONFIGURATION AND MODE.....	16
6.6. DESCRIPTION OF TEST SETUP.....	17
7. MEASUREMENT METHOD.....	20
8. TEST AND MEASUREMENT EQUIPMENT	21
9. ANTENNA PORT TEST RESULTS	23
9.1. ON TIME AND DUTY CYCLE.....	23
9.2. 26 dB BANDWIDTH.....	25
9.2.1. 802.11a MODE IN THE 5.2 GHz BAND.....	26
9.2.2. 802.11n HT20 MODE IN THE 5.2 GHz BAND	27
9.2.3. 802.11n HT40 MODE IN THE 5.2 GHz BAND	28

9.2.4.	802.11ac VHT80 MODE IN THE 5.2 GHz BAND	29
9.2.5.	802.11a MODE IN THE 5.3 GHz BAND	30
9.2.6.	802.11n HT20 MODE IN THE 5.3 GHz BAND	31
9.2.7.	802.11n HT40 MODE IN THE 5.3 GHz BAND	32
9.2.8.	802.11ac VHT80 MODE IN THE 5.3 GHz BAND	33
9.2.9.	802.11a MODE IN THE 5.6 GHz BAND	34
9.2.10.	802.11n HT20 MODE IN THE 5.6 GHz BAND	35
9.2.11.	802.11n HT40 MODE IN THE 5.6 GHz BAND	36
9.2.12.	802.11ac VHT80 MODE IN THE 5.6 GHz BAND	37
9.2.13.	802.11a MODE IN THE 5.8 GHz BAND	38
9.2.14.	802.11n HT20 MODE IN THE 5.8 GHz BAND	39
9.2.15.	802.11n HT40 MODE IN THE 5.8 GHz BAND	40
9.2.16.	802.11ac VHT80 MODE IN THE 5.8 GHz BAND	41
9.3.	99% BANDWIDTH	42
9.3.1.	802.11a MODE IN THE 5.2 GHz BAND	43
9.3.2.	802.11n HT20 MODE IN THE 5.2 GHz BAND	44
9.3.3.	802.11n HT40 MODE IN THE 5.2 GHz BAND	45
9.3.4.	802.11ac VHT80 MODE IN THE 5.2 GHz BAND	46
9.3.5.	802.11a MODE IN THE 5.3 GHz BAND	47
9.3.6.	802.11n HT20 MODE IN THE 5.3 GHz BAND	48
9.3.7.	802.11n HT40 MODE IN THE 5.3 GHz BAND	49
9.3.8.	802.11ac VHT80 MODE IN THE 5.3 GHz BAND	50
9.3.9.	802.11a MODE IN THE 5.6 GHz BAND	51
9.3.10.	802.11n HT20 MODE IN THE 5.6 GHz BAND	52
9.3.11.	802.11n HT40 MODE IN THE 5.6 GHz BAND	53
9.3.12.	802.11ac VHT80 MODE IN THE 5.6 GHz BAND	54
9.3.13.	802.11a MODE IN THE 5.8 GHz BAND	55
9.3.14.	802.11n HT20 MODE IN THE 5.8 GHz BAND	56
9.3.15.	802.11n HT40 MODE IN THE 5.8 GHz BAND	57
9.3.16.	802.11ac VHT80 MODE IN THE 5.8 GHz BAND	58
9.4.	6 dB BANDWIDTH	59
9.4.1.	802.11a MODE IN THE 5.8 GHz BAND	60
9.4.2.	802.11n HT20 MODE IN THE 5.8 GHz BAND	61
9.4.3.	802.11n HT40 MODE IN THE 5.8 GHz BAND	62
9.4.4.	802.11ac VHT80 MODE IN THE 5.8 GHz BAND	63
9.5.	OUTPUT POWER AND PSD	64
9.5.1.	802.11a MODE IN THE 5.2 GHz BAND	67
9.5.2.	802.11n HT20 MODE IN THE 5.2 GHz BAND	69
9.5.3.	802.11n HT40 MODE IN THE 5.2 GHz BAND	71
9.5.4.	802.11ac VHT80 MODE IN THE 5.2 GHz BAND	73
9.5.5.	802.11a MODE IN THE 5.3 GHz BAND	75
9.5.6.	802.11n HT20 MODE IN THE 5.3 GHz BAND	77
9.5.7.	802.11n HT40 MODE IN THE 5.3 GHz BAND	79
9.5.8.	802.11ac VHT80 MODE IN THE 5.3 GHz BAND	81
9.5.9.	802.11a MODE IN THE 5.6 GHz BAND	83
9.5.10.	802.11n HT20 MODE IN THE 5.6 GHz BAND	85
9.5.11.	802.11n HT40 MODE IN THE 5.6 GHz BAND	87
9.5.12.	802.11ac VHT80 MODE IN THE 5.6 GHz BAND	89
9.5.13.	802.11a MODE IN THE 5.8 GHz BAND	91
9.5.14.	802.11n HT20 MODE IN THE 5.8 GHz BAND	93
9.5.15.	802.11n HT40 MODE IN THE 5.8 GHz BAND	95
9.5.16.	802.11ac VHT80 MODE IN THE 5.8 GHz BAND	97

10. RADIATED TEST RESULTS.....	99
10.1. TRANSMITTER ABOVE 1 GHz.....	100
10.1.1. TX ABOVE 1 GHz 802.11a MODE IN THE 5.2 GHz BAND	100
10.1.2. TX ABOVE 1 GHz 802.11n HT20 MODE IN THE 5.2 GHz BAND.....	108
10.1.3. TX ABOVE 1 GHz 802.11n HT40 MODE IN THE 5.2 GHz BAND.....	116
10.1.4. TX ABOVE 1 GHz 802.11ac VHT80 MODE IN THE 5.2 GHz BAND	122
10.1.5. TX ABOVE 1 GHz 802.11a MODE IN THE 5.3 GHz BAND	126
10.1.6. TX ABOVE 1 GHz 802.11n HT20 MODE IN THE 5.3 GHz BAND.....	134
10.1.7. TX ABOVE 1 GHz 802.11n HT40 MODE IN THE 5.3 GHz BAND.....	142
10.1.8. TX ABOVE 1 GHz 802.11ac VHT80 MODE IN THE 5.3 GHz BAND	148
10.1.9. TX ABOVE 1 GHz 802.11a MODE IN THE 5.6 GHz BAND	152
10.1.10. TX ABOVE 1 GHz 802.11n HT20 MODE IN THE 5.6 GHz BAND.....	164
10.1.11. TX ABOVE 1 GHz 802.11n HT40 MODE IN THE 5.6 GHz BAND.....	176
10.1.12. TX ABOVE 1 GHz 802.11ac VHT80 MODE IN THE 5.6 GHz BAND	188
10.1.13. TX ABOVE 1 GHz 802.11a MODE IN THE 5.8 GHz BAND	198
10.1.14. TX ABOVE 1 GHz 802.11n HT20 MODE IN THE 5.8 GHz BAND.....	208
10.1.15. TX ABOVE 1 GHz 802.11n HT40 MODE IN THE 5.8 GHz BAND.....	218
10.1.16. TX ABOVE 1 GHz 802.11ac VHT80 MODE IN THE 5.8 GHz BAND	226
10.2. Worst Case Below 30 MHz.....	232
10.3. Worst Case Below 1 GHz.....	234
10.4. Worst Case 18-26 GHz	236
10.5. Worst Case 26-40 GHz	238
11. AC POWER LINE CONDUCTED EMISSIONS.....	240
12. SETUP PHOTOS (ORIGINAL)	243
13. SETUP PHOTOS (SPOT CHECK)	246

1. ATTESTATION OF TEST RESULTS

COMPANY NAME: Samsung Electronics Co., Ltd.
129 Samsung-Ro, Yeongtong-Gu,
Suwon-Si, Gyeonggi-Do, 16677, Korea

EUT DESCRIPTION: GSM/WCDMA/LTE Phone with BT, DTS/UNII a/b/g/n/ac, and ANT+

MODELS: SM-A750G/DS and SM-A750G

SERIAL NUMBER: Conducted: R38K70KQF9N, R38K70KQGDH (Original)
Radiated: R38K70KQFNY, R38K70KQFAH, R38K70KQF8A (Original)
Conducted: R38K70MNSEF (Spot Check)
Radiated: R38K70MNRBF, R38K70MNQ6Z (Spot Check)

DATE TESTED: August 6 – 16, 2018 (Original)
August 29, 2018 (Spot Check)

APPLICABLE STANDARDS	
STANDARD	TEST RESULTS
CFR 47 Part 15 Subpart E	Complies

UL Verification Services Inc. tested the above equipment in accordance with the requirements set forth in the above standards. All indications of Pass/Fail in this report are opinions expressed by UL Verification Services Inc. based on interpretations and/or observations of test results. Measurement Uncertainties were not taken into account and are published for informational purposes only. The test results show that the equipment tested is capable of demonstrating compliance with the requirements as documented in this report.

Note: The results documented in this report apply only to the tested sample, under the conditions and modes of operation as described herein. This document may not be altered or revised in any way unless done so by UL Verification Services Inc. and all revisions are duly noted in the revisions section. Any alteration of this document not carried out by UL Verification Services Inc. will constitute fraud and shall nullify the document. This report must not be used by the client to claim product certification, approval, or endorsement by NVLAP, NIST, any agency of the Federal Government, or any agency of the U.S. government.

Approved & Released For
UL Verification Services Inc. By:

Reviewed By:



DAN CORONIA
CONSUMER TECHNOLOGY DIVISION
OPERATIONS LEADER
UL Verification Services Inc.

STEVEN TRAN
CONSUMER TECHNOLOGY DIVISION
TEST ENGINEER
UL Verification Services Inc.

2. INTRODUCTION OF TEST DATA REUSE

2.1. INTRODUCTION

According to the manufacturer, the WLAN, Bluetooth, ANT+ and WWAN hardware of A3LSMA750G are identical to A3LSMA750GN. In addition A3LSMA750G digital circuit is identical to A3LSMA750GN. Therefore the following report/data of A3LSMA750G may be represented from A3LSMA750GN along with the spot check verification data.

- WLAN
- Bluetooth
- ANT+
- WWAN

2.2. DEVICES DIFFERENCES

Difference between A3LSMA750G and A3LSMA750GN:

Samsung Electronics Co., Ltd. hereby declares that between A3LSMA750G and A3LSMA750GN:

Hardware:

- AP/CP/TRCV/PMIC are same.
- Deleted NFC circuit and NFC antennas.
- BT/WIFI/FM/GPS parts are exactly same.
- PCB layout is exactly same.
- Mechanic parts are exactly same.

Software:

- SW was updated to reflect the HW changes
- PROTOCOL PART is same.
- All applications of MMS, SATK/USATK, SMS, SS, SUPL, DM, VOLTE feature is same.

In addition, the A3LSMA750G does not support NFC.

Therefore the WLAN, Bluetooth, ANT+, WWAN report and data of A3LSMA750GN may represent for A3LSMA750G.

2.3. SPOT CHECK VERIFICATION RESULTS SUMMARY

Spot check verification has been done on device A3LSMA750G for radiated harmonic spurious and radiated band-edge. The data from the application has been verified through appropriate spot checks to demonstrate compliance for this device as shown in the summary below.

SM-A750G/DS SPOT CHECK RESULTS										
Technology	Mode	Test Item	Channel	Measured Frequency	SM-A750GN_DS		SM-A750G_DS		Delta (dB)	
					Peak	Ave	Peak	Ave	Peak	Ave
UNII	11n HT40	RBE	38	5150MHz	56.09	41.08	69.54	51.53	2.93	-0.16
	11ac VHT80	RSE	122	7480MHz	47.03	40.93	50.5	46.97	-0.2	2.28

Comparison of two models, higher deviation is within 3dB range and all test are under FCC Technical Limits.

2.3.1. SPOT CHECK DATA

2.3.2. BANDEDGE (HIGH CHANNEL)

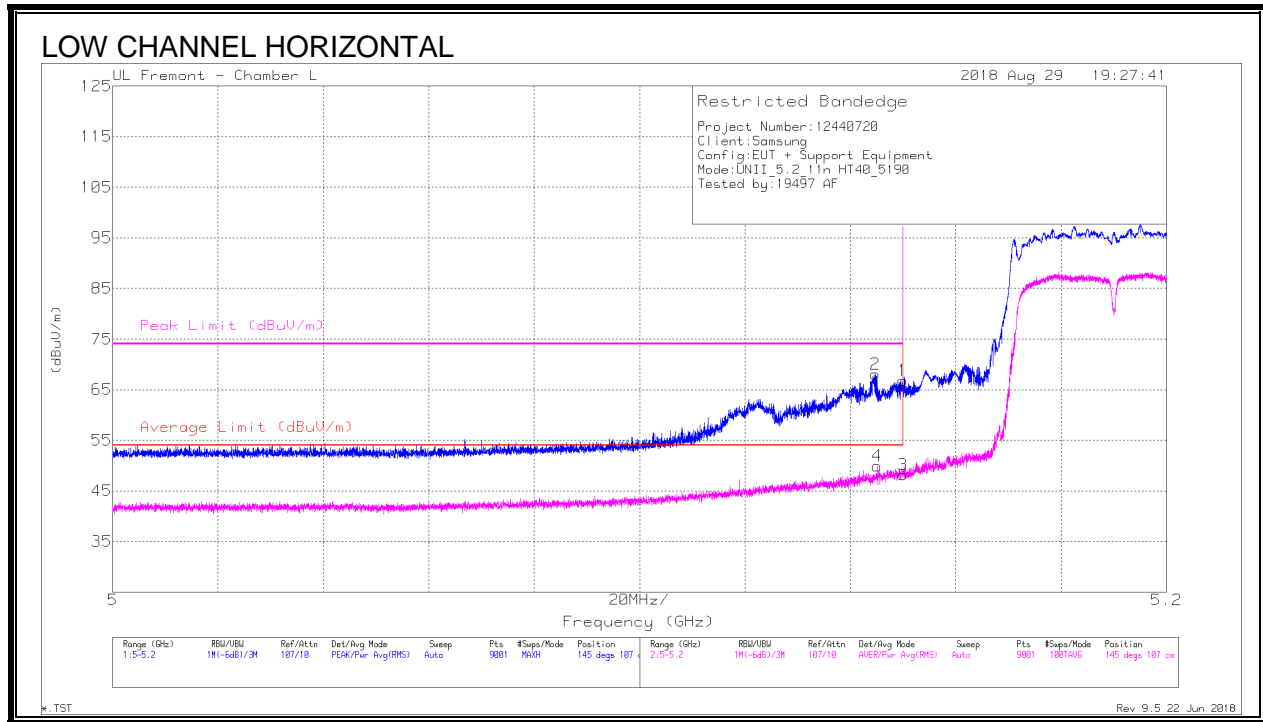

Trace Markers

Marker	Frequency (GHz)	Meter Reading (dBuV)	Det	AF EMC4294 (dB/m)	Amp/Cb1/Fitr/Pad (dB)	DC Corr (dB)	Corrected Reading (dBuV/m)	Average Limit (dBuV/m)	Margin (dB)	Peak Limit (dBuV/m)	PK Margin (dB)	Azimuth (Degs)	Height (cm)	Polarity
1	* 5.15	51.64	Pk	34.4	-19.2	0	66.84	-	-	74	-7.16	145	107	H
2	* 5.145	52.86	Pk	34.4	-19.2	0	68.06	-	-	74	-5.94	145	107	H
3	* 5.15	32.7	RMS	34.4	-19.2	.33	48.23	54	-5.77	-	-	145	107	H
4	* 5.145	34.41	RMS	34.4	-19.2	.33	49.94	54	-4.06	-	-	145	107	H

* - indicates frequency in CFR47 Pt 15 Restricted Band
 Pk - Peak detector
 RMS - RMS detection

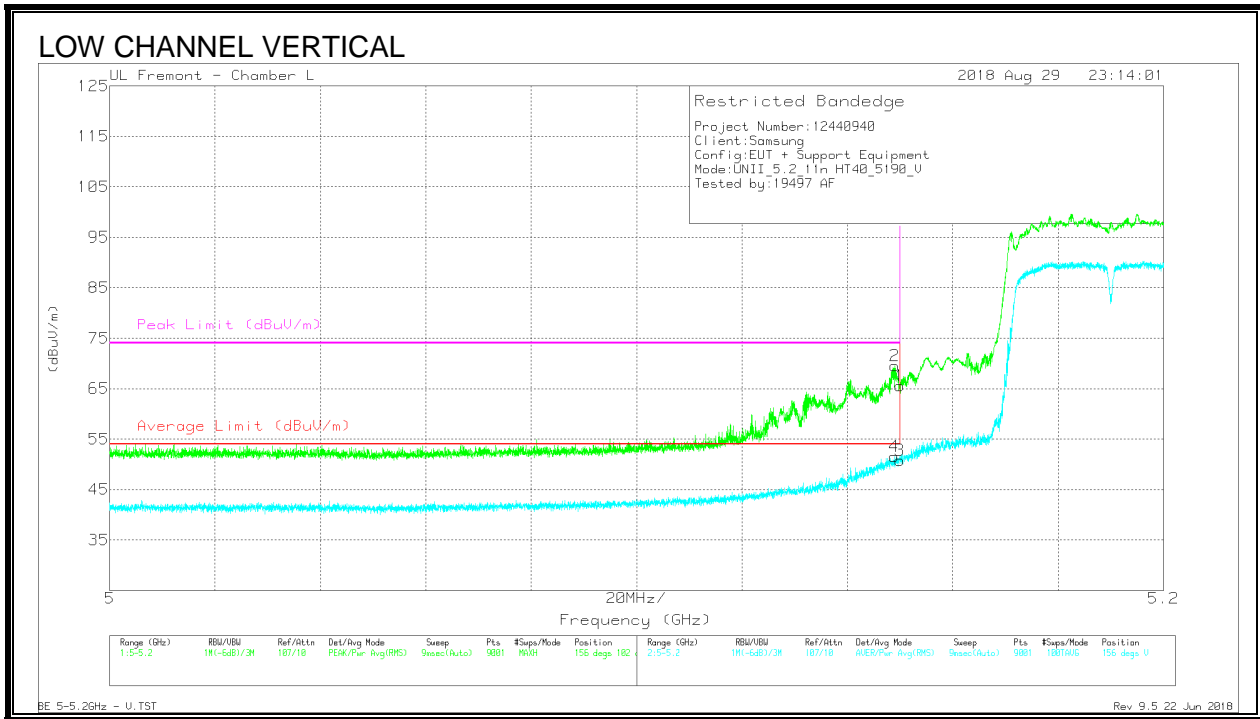

Trace Markers

Marker	Frequency (GHz)	Meter Reading (dBuV)	Det	AF EMC4294 (dB/m)	Amp/Cbl/Filtr/Pad (dB)	DC Corr (dB)	Corrected Reading (dBuV/m)	Average Limit (dBuV/m)	Margin (dB)	Peak Limit (dBuV/m)	PK Margin (dB)	Azimuth (Degs)	Height (cm)	Polarity
1	* 5.15	50.33	Pk	34.4	-19.2	0	65.53	-	-	74	-8.47	156	102	V
2	* 5.149	54.34	Pk	34.4	-19.2	0	69.54	-	-	74	-4.46	156	102	V
3	* 5.15	35.38	RMS	34.4	-19.2	.17	50.75	54	-3.25	-	-	156	102	V
4	* 5.149	36.16	RMS	34.4	-19.2	.17	51.53	54	-2.47	-	-	156	102	V

* - indicates frequency in CFR47 Pt 15 Restricted Band
 Pk - Peak detector
 RMS - RMS detection

2.3.3. HARMONICS AND SPURIOUS EMISSIONS

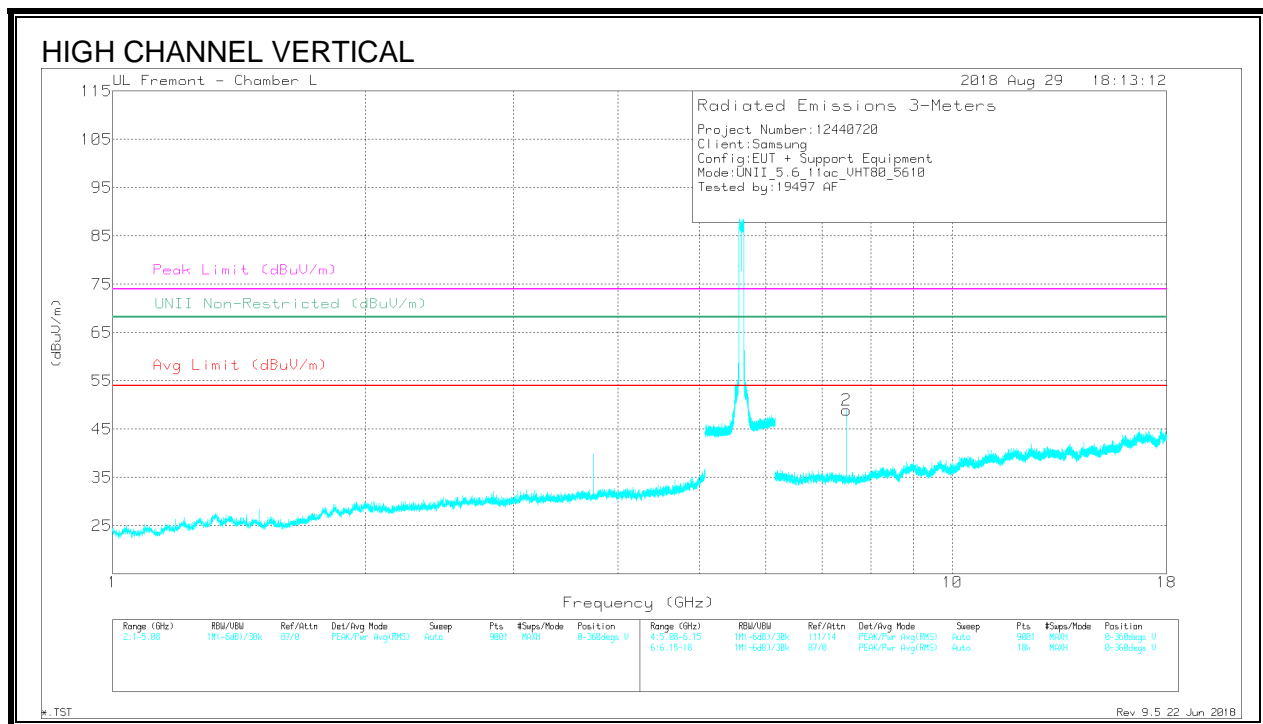
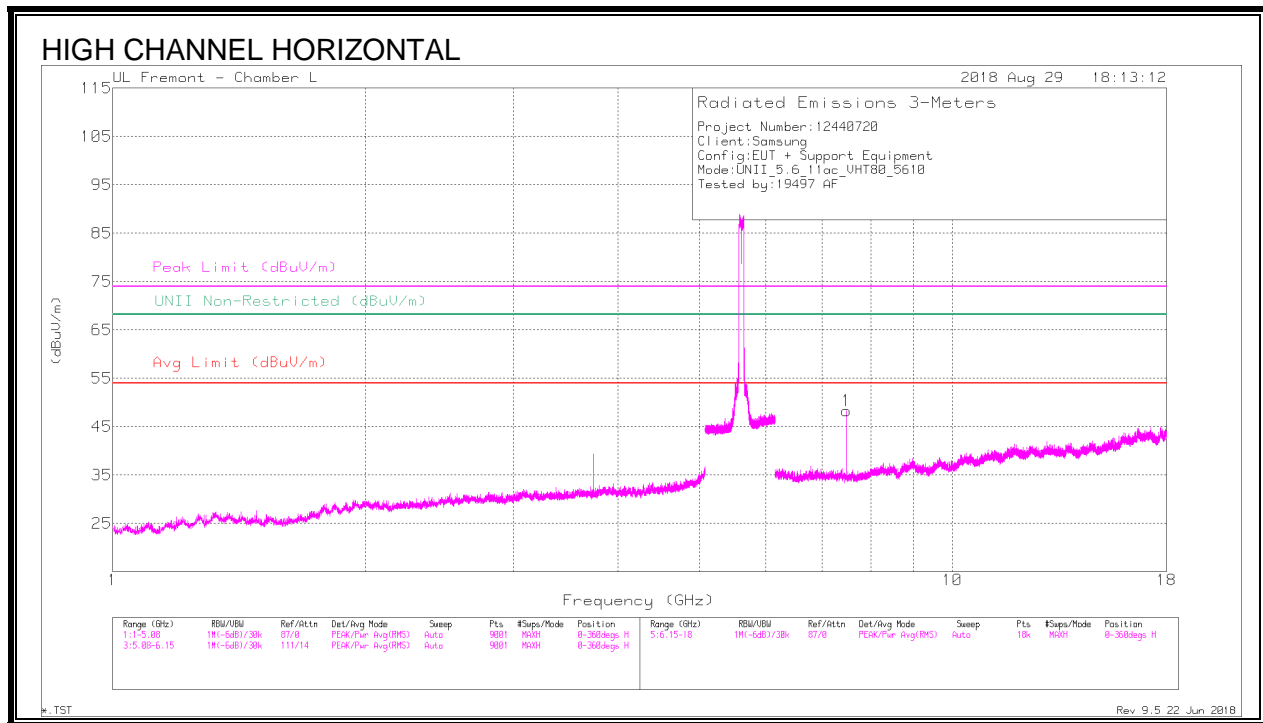

Radiated Emissions

Marker	Frequency (GHz)	Meter Reading (dBuV)	Det	AF EMC4294 (dB/m)	Amp/Cbl/Filtr/Pad (dB)	DC Corr (dB)	Corrected Reading (dBuV/m)	Avg Limit (dBuV/m)	Margin (dB)	Peak Limit (dBuV/m)	PK Margin (dB)	UNII Non-Restricted (dBuV/m)	PK Margin (dB)	Azimuth (Degs)	Height (cm)	Polarity
1	* 7.48	39.63	PK-U	35.7	-25.1	0	50.23	-	-	74	-23.77	-	-	119	100	H
	* 7.48	35.43	ADR	35.7	-25.1	.33	46.36	54	-7.64	-	-	-	-	119	100	H
2	* 7.48	39.9	PK-U	35.7	-25.1	0	50.5	-	-	74	-23.5	-	-	118	101	V
	* 7.48	36.04	ADR	35.7	-25.1	.33	46.97	54	-7.03	-	-	-	-	118	101	V

* - indicates frequency in CFR47 Pt 15 Restricted Band

PK-U - U-NII: Maximum Peak

ADR - U-NII AD primary method, RMS average

2.4. REFERENCE DETAIL

Equipment Class	Reference FCC ID	Report Title/Section
NII (UNII WLAN)	A3LSMA750GN	12440598-E5V1 FCC Report UNII WLAN

3. TEST METHODOLOGY

The tests documented in this report were performed in accordance with FCC CFR 47 Part 2, FCC CFR 47 Part 15, FCC 14-30, FCC KDB 905462 D06 v02, FCC KDB 789033 D02 v02r01, ANSI C63.10-2013, FCC 06-96, FCC KDB 905462 D02 and D03.

4. FACILITIES AND ACCREDITATION

The test sites and measurement facilities used to collect data are located at 47173 and 47266 Benicia Street, and 47658 Kato Road, Fremont, California, USA. Line conducted emissions are measured only at the 47173 address. The following table identifies which facilities were utilized for radiated emission measurements documented in this report. Specific facilities are also identified in the test results sections.

47173 Benicia Street	47266 Benicia Street	47658 Kato Rd.
<input type="checkbox"/> Chamber A (IC:2324B-1)	<input type="checkbox"/> Chamber D (IC:22541-1)	<input type="checkbox"/> Chamber I (IC: 2324A-5)
<input type="checkbox"/> Chamber B (IC:2324B-2)	<input type="checkbox"/> Chamber E (IC:22541-2)	<input type="checkbox"/> Chamber J (IC: 2324A-6)
<input type="checkbox"/> Chamber C (IC:2324B-3)	<input type="checkbox"/> Chamber F (IC:22541-3)	<input type="checkbox"/> Chamber K (IC: 2324A-1)
	<input type="checkbox"/> Chamber G (IC:22541-4)	<input checked="" type="checkbox"/> Chamber L (IC: 2324A-3)
	<input type="checkbox"/> Chamber H (IC:22541-5)	

The above test sites and facilities are covered under FCC Test Firm Registration # 208313. Chambers above are covered under Industry Canada company address and respective code.

UL Verification Services Inc. is accredited by NVLAP, Laboratory Code 200065-0

5. CALIBRATION AND UNCERTAINTY

5.1. MEASURING INSTRUMENT CALIBRATION

The measuring equipment utilized to perform the tests documented in this report has been calibrated in accordance with the manufacturer's recommendations, and is traceable to recognized national standards.

5.2. SAMPLE CALCULATION

Where relevant, the following sample calculation is provided:

$$\begin{aligned} \text{Field Strength (dBuV/m)} &= \text{Measured Voltage (dBuV)} + \text{Antenna Factor (dB/m)} + \\ &\text{Cable Loss (dB)} - \text{Preamp Gain (dB)} \\ 36.5 \text{ dBuV} + 18.7 \text{ dB/m} + 0.6 \text{ dB} - 26.9 \text{ dB} &= 28.9 \text{ dBuV/m} \end{aligned}$$

5.3. MEASUREMENT UNCERTAINTY

Where relevant, the following measurement uncertainty levels have been estimated for tests performed on the apparatus:

PARAMETER	UNCERTAINTY
Worst Case Conducted Disturbance, 9KHz to 0.15 MHz	3.84 dB
Worst Case Conducted Disturbance, 0.15 to 30 MHz	3.65 dB
Worst Case Radiated Disturbance, 9KHz to 30 MHz	3.15 dB
Worst Case Radiated Disturbance, 30 to 1000 MHz	5.36 dB
Worst Case Radiated Disturbance, 1000 to 18000 MHz	4.32 dB
Worst Case Radiated Disturbance, 18000 to 26000 MHz	4.45 dB
Worst Case Radiated Disturbance, 26000 to 40000 MHz	5.24 dB

Uncertainty figures are valid to a confidence level of 95%.

6. EQUIPMENT UNDER TEST

6.1. EUT DESCRIPTION

The EUT is a GSM/WCDMA/LTE phone with BT, DTS/UNII a/b/g/n/ac, ANT+ and NFC.

6.2. MAXIMUM OUTPUT POWER

The transmitter has a maximum conducted output power as follows:

5.2 GHz BAND

Frequency Range (MHz)	Mode	Output Power (dBm)	Output Power (mW)
5.2 GHz band, 1TX			
5180-5240	802.11a	15.62	36.48
5180-5240	802.11n HT20	15.68	36.98
5190-5230	802.11n HT40	13.61	22.96
5210	802.11ac VHT80	10.44	11.07

5.3 GHz BAND

Frequency Range (MHz)	Mode	Output Power (dBm)	Output Power (mW)
5.3 GHz band, 1TX			
5260 - 5320	802.11a	14.95	31.26
5260 - 5320	802.11n HT20	14.79	30.13
5270 - 5310	802.11n HT40	13.86	24.32
5290	802.11ac VHT80	12.62	18.28

5.6 GHz BAND

Frequency Range (MHz)	Mode	Output Power (dBm)	Output Power (mW)
5.6 GHz band, 1TX			
5500-5720	802.11a	15.12	32.51
5500-5720	802.11n HT20	15.01	31.70
5510-5710	802.11n HT40	13.88	24.43
5530-5690	802.11ac VHT80	13.27	21.23

5.8 GHz BAND

Frequency Range (MHz)	Mode	Output Power (dBm)	Output Power (mW)
5.8 GHz band, 1TX			
5745-5825	802.11a	15.10	32.36
5745-5825	802.11n HT20	14.95	31.26
5755-5795	802.11n HT40	13.57	22.75
5775	802.11ac VHT80	12.81	19.10

6.3. DESCRIPTION OF AVAILABLE ANTENNAS

The radio utilizes an internal antenna, with the following maximum gains:

Frequency (GHz)	Peak Antenna Gain (dBi)
5180-5240	-6.90
5260-5320	-6.90
5500-5700	-4.31
5725-5850	-5.88

6.4. SOFTWARE AND FIRMWARE

The test utility software used during testing was A750GN.001

6.5. WORST-CASE CONFIGURATION AND MODE

Radiated emissions below 1GHz, above 18GHz, and power line conducted emission were performed with the EUT set to transmit at the channel with highest output power as worst-case scenario.

Band edge and radiated emissions between 1GHz and 18GHz were performed with the EUT set to transmit at the highest power on low, middle and high channels.

The fundamental of the EUT was investigated in three orthogonal orientations X,Y and Z it was determined that X orientation was worst-case orientation; therefore, all final radiated testing was performed with the EUT in X orientation.

Worst-case data rates as provided by the client were:

802.11a mode: 6 Mbps
802.11n HT20mode: MCS0
802.11n HT40mode: MCS0
802.11ac VHT80 mode: MCS0

802.11ac VHT20 and VHT40 mode are different from 802.11nHT20 and HT40 only in control messages and have the same power settings.

6.6. DESCRIPTION OF TEST SETUP

SUPPORT EQUIPMENT

Support Equipment List				
Description	Manufacturer	Model	Serial Number	FCC ID
AC Adapter	Samsung	EP-TA50EWE	DW3J719AS/A-E	N/A
Earphone	Samsung	N/A	N/A	N/A

I/O CABLES (CONDUCTED TEST)

I/O Cable List						
Cable No	Port	# of identical ports	Connector Type	Cable Type	Cable Length (m)	Remarks
1	Antenna	1	RF	Shielded	0.2	To spectrum Analyzer
2	USB	1	USB	Un-shielded	1	EUT to AC Mains

I/O CABLES (RADIATED AND CONDUCTED EMISSIONS)

I/O Cable List						
Cable No	Port	# of identical ports	Connector Type	Cable Type	Cable Length (m)	Remarks
1	USB	1	USB	Shielded	1	N/A
2	earphone	1	3.5mm	Un-shielded	1	N/A

TEST SETUP

The EUT is a stand alone. Test software exercised the radio card.

CONDUCTED TEST SETUP DIAGRAM

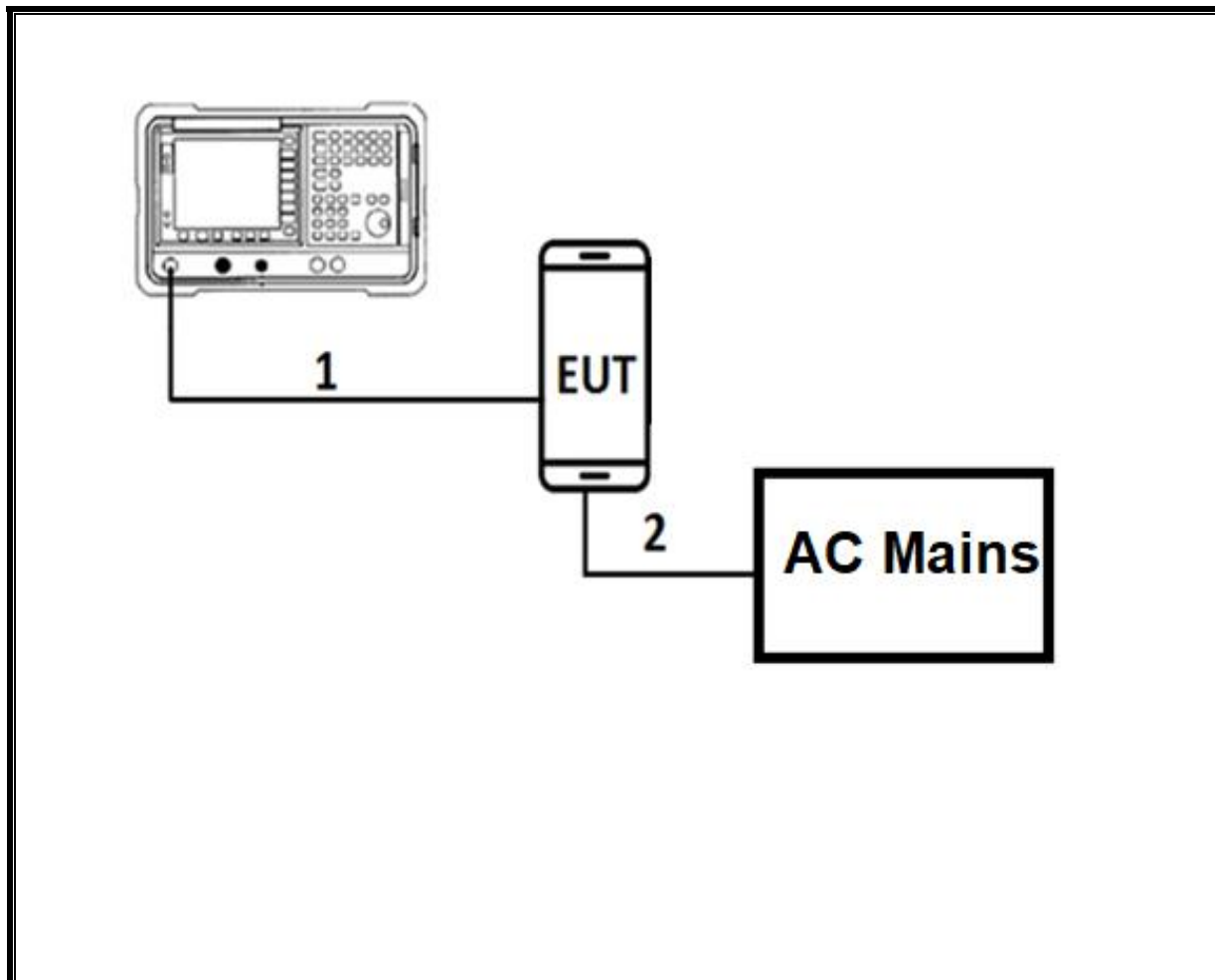

TEST SETUP

For conducted tests: the EUT was Stand alone. The test software exercises the radio.

RADIATED AND AC LINE CONDUCTED EMISSIONS SETUP DIAGRAM

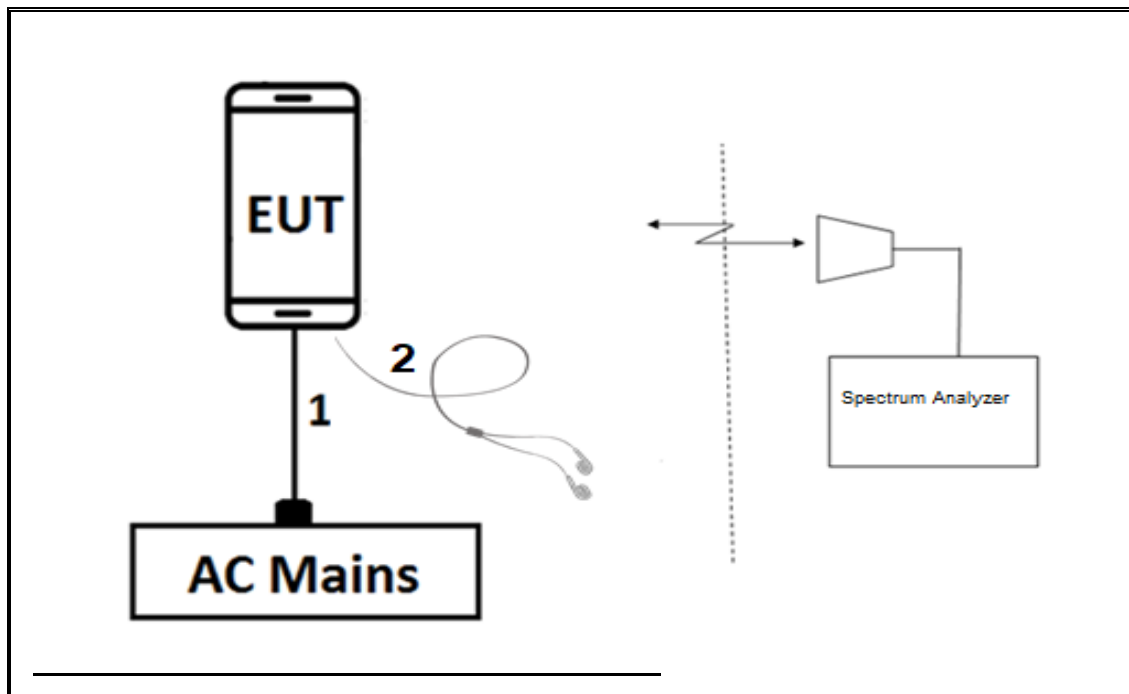

TEST SETUP

For radiated tests: EUT is Stand alone. The test software exercises the radio.

7. MEASUREMENT METHOD

On Time and Duty Cycle: KDB 789033 D02 v02r01, Section B.

6 dB Emission BW: KDB 789033 D02 v02r01, Section C.2

26 dB Emission BW: KDB 789033 D02 v02r01, Section C.1

99% Occupied BW: KDB 789033 D02 v02r01, Section D.

Conducted Output Power: KDB 789033 D02 v02r01, Section E.3.b (Method PM-G) and KDB 789033 D02 v02r01, Section E.2.b (Method SA-1)

Power Spectral Density: KDB 789033 D02 v02r01, Section F

Unwanted emissions in restricted bands: KDB 789033 D02 v02r01, Sections G.3, G.4, G.5, and G.6.

Unwanted emissions in non-restricted bands: KDB 789033 D02 v02r01, Sections G.3, G.4, and G.5.

AC Power Line Conducted Emissions: ANSI C63.10-2013, Section 6.2.

8. TEST AND MEASUREMENT EQUIPMENT

The following test and measurement equipment was utilized for the tests documented in this report:

TEST EQUIPMENT LIST (ORIGINAL)				
Description	Manufacturer	Model	ID Num	Cal Due
Amplifier, 100kHz to 1GHz, 32dB	Hewlet Packard	8447D	T10	02/14/2019
Antenna, Broadband Hybrid, 30MHz to 2000MHz	Sunol Sciences Corp.	JB1	T407	05/10/2019
Antenna, Horn 1-18GHz	ETS-Lindgren	3117	T862	05/24/2019
Antenna, Horn 1-18GHz	ETS-Lindgren	3117	T345	04/25/2019
Antenna, Horn 1-18GHz	ETS-Lindgren	3117	T344	04/30/2019
Amplifier, 1 to 18GHz, 35dB	AMPLICAL	AMP1G18-35	T1569	06/03/2019
RF Amplifier	MITEQ	AFS42-00101800-25-S-42	T1165	04/23/2019
RF Amplifier	MITEQ	AFS42-00101800-25-S-42	171460	08/01/2019
Amplifier, 1 to 7.0GHz, 20.0dB Gain minimum, 6dB NF	AMPLICAL	AMP1G7-20-27	T1563	06/03/2019
Amplifier, 1 to 7.0GHz, 20.0dB Gain minimum, 6dB NF	AMPLICAL	AMP1G7-20-27	T1370	06/12/2019
Amplifier 1-8GHz 30dB gain	L3 Narda	AMF-4D-01000800-30-29P	167494	08/01/2019
EMI TEST RECEIVER	Rohde & Schwarz	ESW44	PRE0179367	04/25/2019
EMI TEST RECEIVER	Rohde & Schwarz	ESW44	PRE0179377	05/03/2019
Spectrum Analyzer, PSA, 3Hz to 44GHz	Agilent (Keysight) Technologies	N9030A	T1466	04/16/2019
Spectrum Analyzer, PXA, 3Hz to 44GHz	Agilent (Keysight) Technologies	N9030A	T1450	02/05/2019
Spectrum Analyzer, PXA, 3Hz to 44GHz	Agilent (Keysight) Technologies	N9030A	T1113	12/21/2018
Spectrum Analyzer, PSA, 3Hz to 44GHz	Agilent (Keysight) Technologies	N9030A	T1454	01/08/2019
Spectrum Analyzer, PSA, 3Hz to 44GHz	Agilent (Keysight) Technologies	N9030A	T200	11/18/2018
Power Meter, P-series single channel	Agilent (Keysight) Technologies	N1911A	T1269	04/05/2019
Power Sensor, P-series, 50MHz to 18GHz, Wideband	Agilent (Keysight) Technologies	N1921A	T1225	04/10/2019
Antenna, Active Loop 9kHz-30MHz	Com-Power Corp.	AL-130R	T1866	10/10/2018
18 - 26.5 GHz Horn Antenna	Seavey Division	MWH-1826/B	T89	01/18/2019
26.5 - 40 GHz Horn Antenna	ARA	MWH-2640/B	T90	08/25/2018
Pre-Amp 1-26.5 GHz	Agilent	8449B	T404	03/09/2019
Pre-Amp, 26-40GHz	MITEQ	NSTTA2640-35-HG	T1864	03/09/2019
EMI Receiver	Rohde & Schwarz	ESR	T1436	02/21/2019
L.I.S.N.	FCC INC.	FCC LISN 50/250	T1310	06/15/2019
L.I.S.N.	FCC INC.	FCC LISN 50/250	T24	03/06/2019
Thermometer - Digital	Control Company	14-650-118	PRE0177862	02/22/2019

Test Software List			
Description	Manufacturer	Model	Version
Radiated Software	UL	UL EMC	Rev 9.5, Jun 22, 2018
Antenna Port Software	UL	UL RF	Ver 8.7, Aug 9, 2018

TEST EQUIPMENT LIST (SPOT CHECK)				
Description	Manufacturer	Model	ID Num	Cal Due
Antenna, Horn 1-18GHz	ETS-Lindgren	3117	T862	05/24/2019
RF Amplifier, 1-18GHz	MITEQ Inc	AFS42-00101800-25-S-42	T1573	06/12/2019
Spectrum Analyzer, PXA, 3Hz to 44GHz	Agilent (Keysight) Technologies	N9030A	171460	08/01/2019
Filter, HPF 3.0GHz	MICRO-TRONICS	HPM17543	171903	08/01/2019
Filter, LPF 5.0GHz	MICRO-TRONICS	LPS17541	171905	08/01/2019
Filter, HPF 6.0GHz	MICRO-TRONICS	HPS17542	171908	08/01/2019
RF Filter Box, 1-18GHz	UL (IN HOUSE)		171389	08/01/2019
3 Port RF Switch	Pasternack	PE7141	171390	08/01/2019
3 Port RF Switch	Pasternack	PE7141	171391	08/01/2019
6 port rf switch, 1-18GHz	Pasternack	PE7159	171455	08/01/2019
6 port rf switch, 1-18GHz	Pasternack	PE7159	171456	08/01/2019

Test Software List			
Description	Manufacturer	Model	Version
Radiated Software	UL	UL EMC	Ver 9.5, June 22, 2018

9. ANTENNA PORT TEST RESULTS

9.1. ON TIME AND DUTY CYCLE

LIMITS

None; for reporting purposes only.

PROCEDURE

KDB 789033 Zero-Span Spectrum Analyzer Method.

ON TIME AND DUTY CYCLE RESULTS

Mode	ON Time B (msec)	Period (msec)	Duty Cycle x (linear)	Duty Cycle (%)	Duty Cycle Correction Factor (dB)	1/B Minimum VBW (kHz)
802.11a	1.428	1.452	0.983	98.35%	0.00	0.010
802.11n HT20	1.336	1.360	0.982	98.24%	0.00	0.010
802.11n HT40	0.664	0.690	0.962	96.23%	0.17	1.506
802.11ac VHT80	0.332	0.358	0.927	92.74%	0.33	3.012

DUTY CYCLE PLOTS

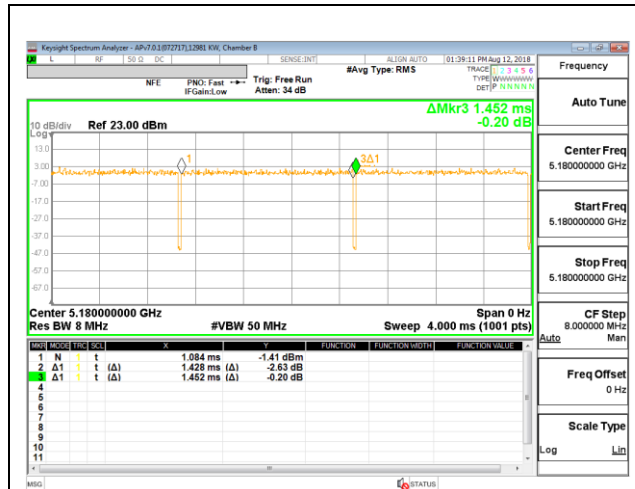

DUTY CYCLE 802.11a

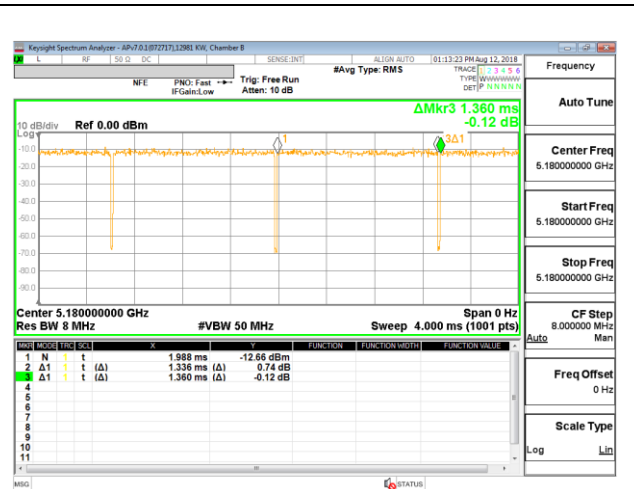

DUTY CYCLE 802.11n HT20

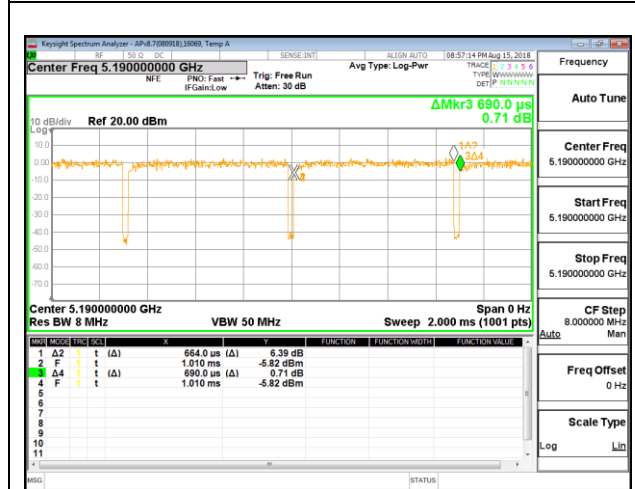

DUTY CYCLE 802.11n HT40

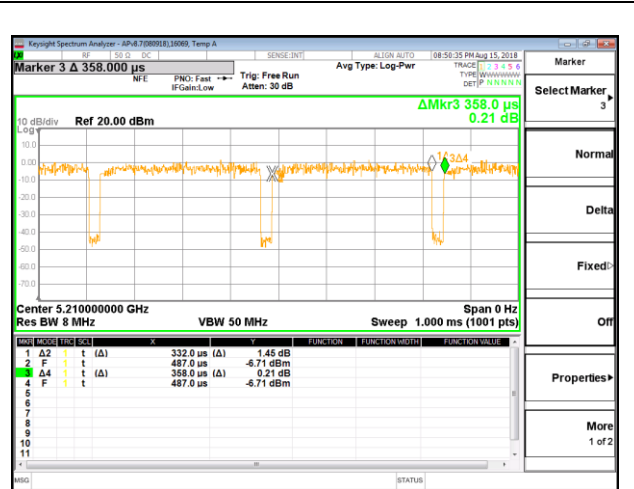

DUTY CYCLE 802.11ac VHT80

9.2. 26 dB BANDWIDTH

LIMITS

None; for reporting purposes only.

RESULTS

9.2.1. 802.11a MODE IN THE 5.2 GHz BAND

1TX Antenna 1 MODE

Channel	Frequency (MHz)	26 dB Bandwidth (MHz)
Low	5180	29.55
Mid	5200	29.45
High	5240	27.10

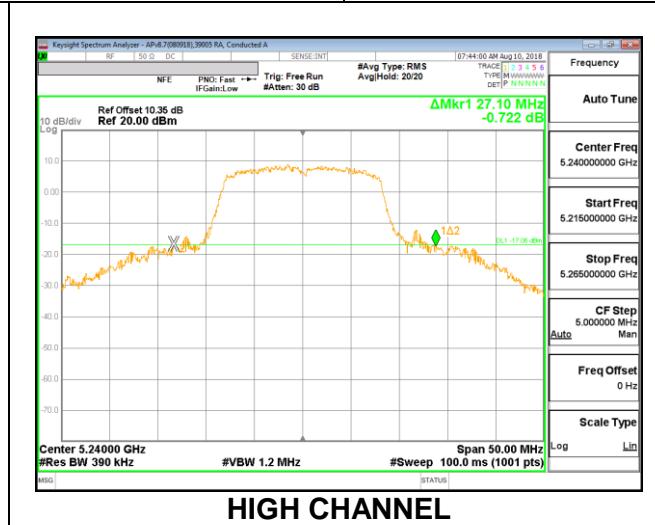
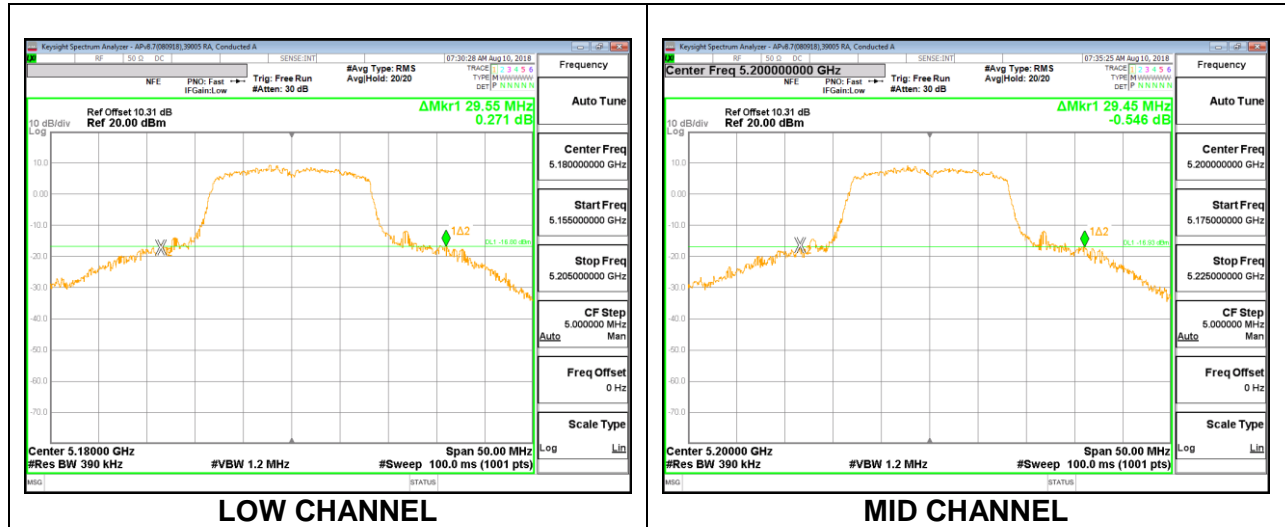

9.2.2. 802.11n HT20 MODE IN THE 5.2 GHz BAND

1TX Antenna 1 MODE

Channel	Frequency (MHz)	26 dB Bandwidth (MHz)
Low	5180	31.75
Mid	5200	31.35
High	5240	34.50

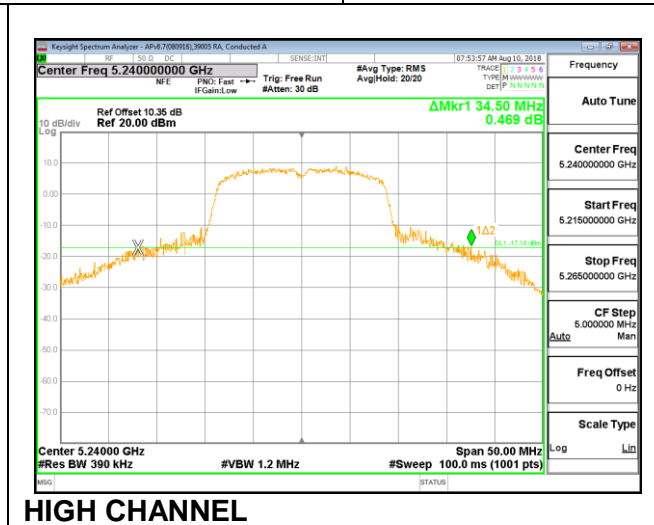
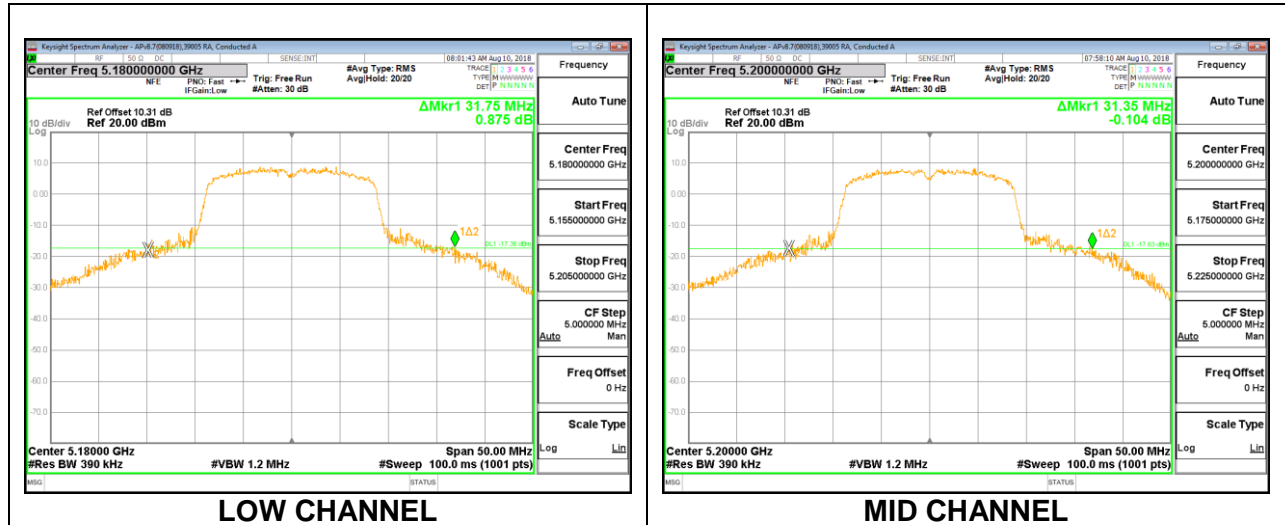

9.2.3. 802.11n HT40 MODE IN THE 5.2 GHz BAND

1TX Antenna 1 MODE

Channel	Frequency (MHz)	26dB Bandwidth (MHz)
Low	5190	74.00
High	5230	74.30

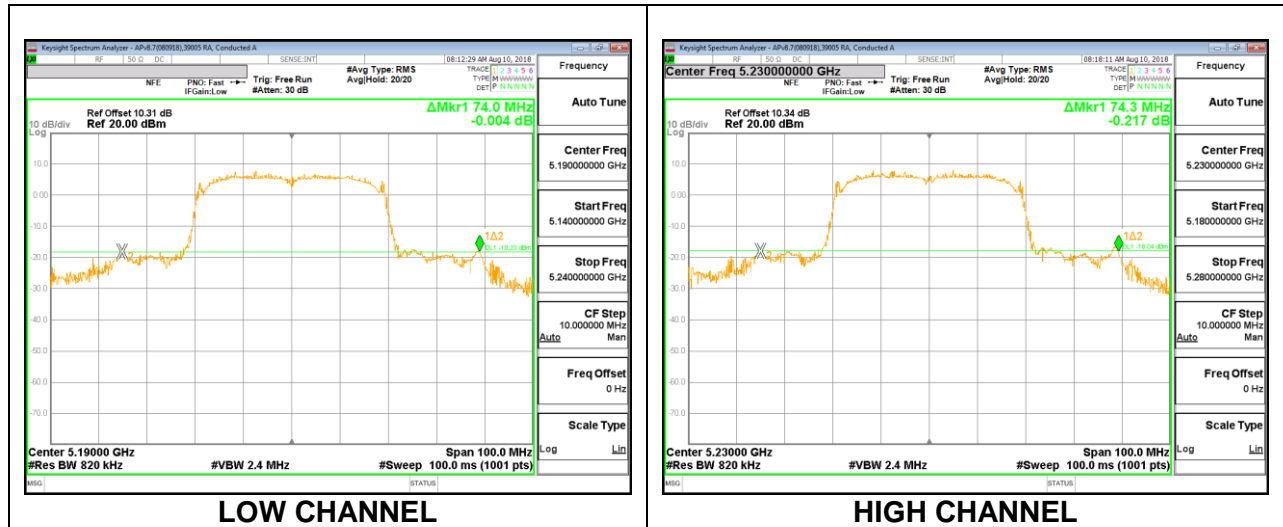

9.2.4. 802.11ac VHT80 MODE IN THE 5.2 GHz BAND

1TX Antenna 1 MODE

Channel	Frequency	26 dB Bandwidth
	(MHz)	(MHz)
Mid	5210	128.80

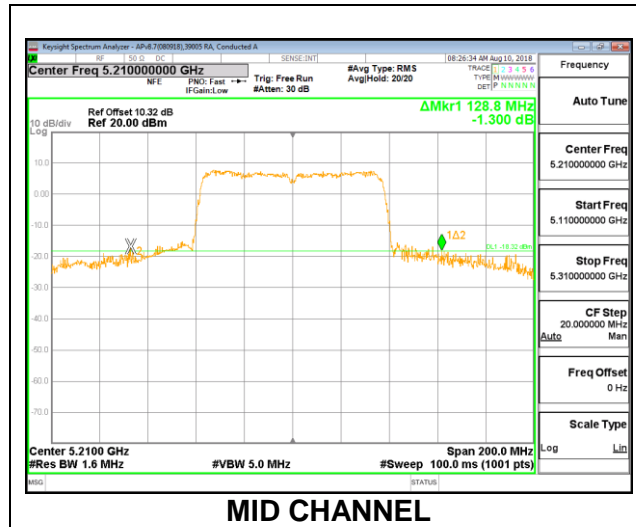

9.2.5. 802.11a MODE IN THE 5.3 GHz BAND

1TX Antenna 1 MODE

Channel	Frequency (MHz)	26 dB Bandwidth (MHz)
Low	5260	29.55
Mid	5300	26.00
High	5320	27.25

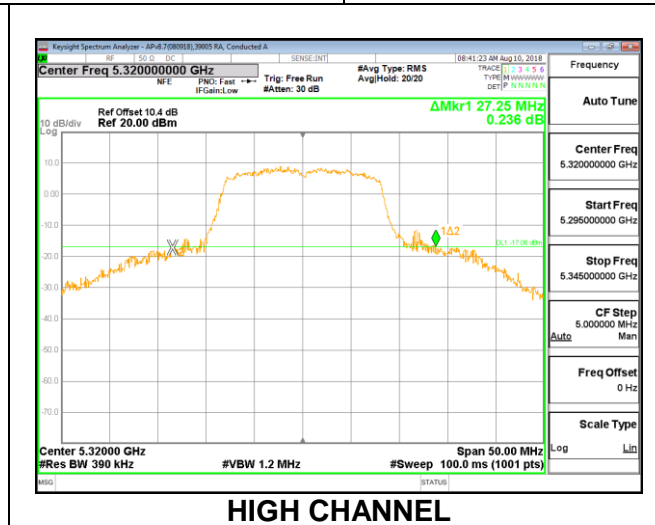
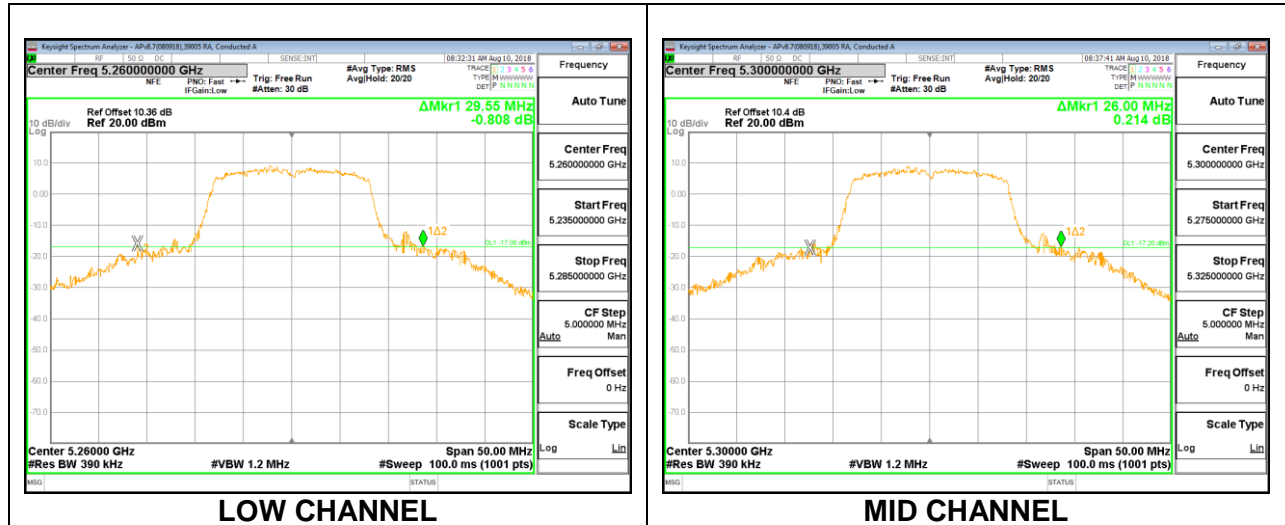

9.2.6. 802.11n HT20 MODE IN THE 5.3 GHz BAND

1TX Antenna 1 MODE

Channel	Frequency (MHz)	26 dB Bandwidth (MHz)
Low	5260	33.85
Mid	5300	32.65
High	5320	31.65

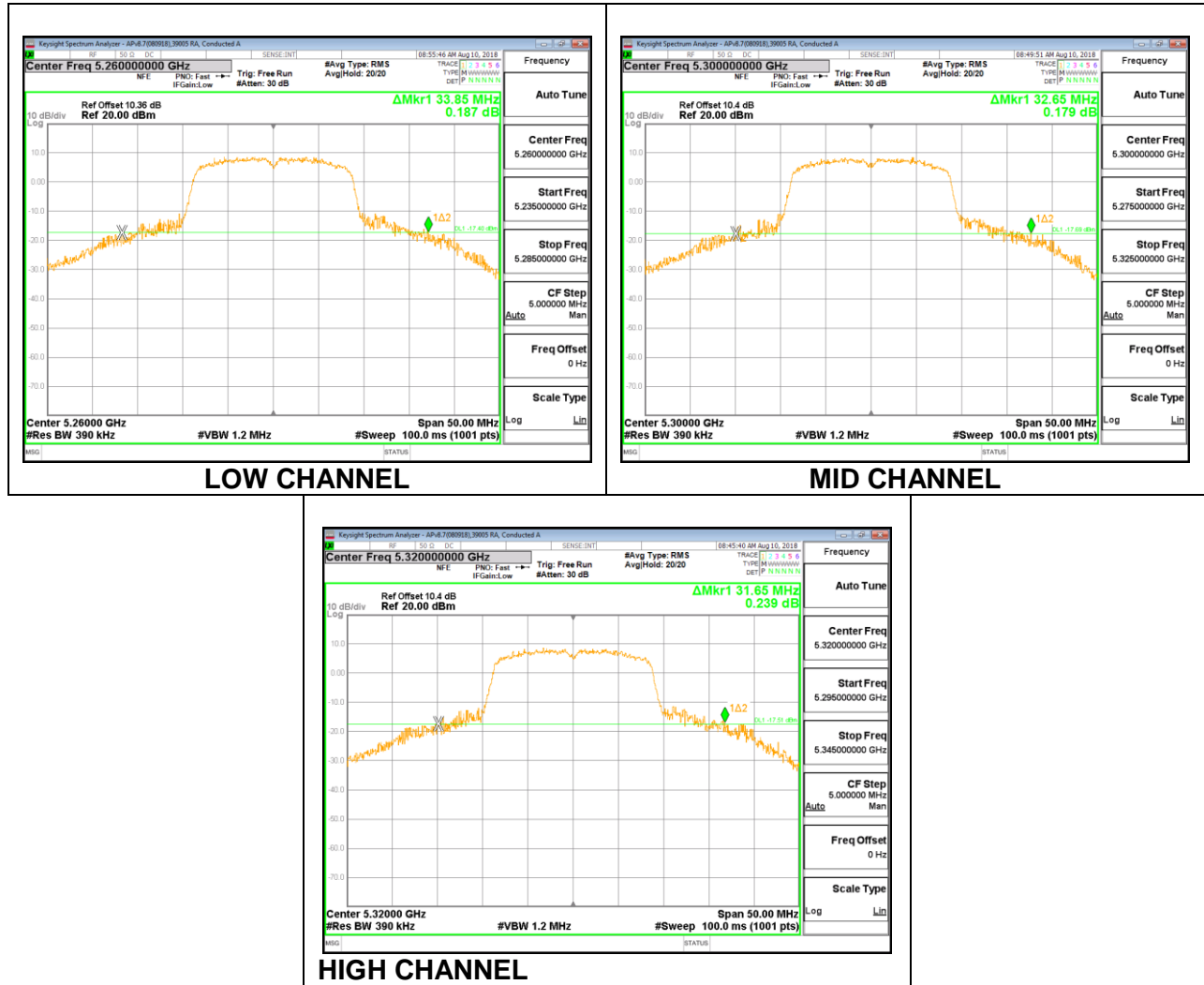

9.2.7. 802.11n HT40 MODE IN THE 5.3 GHz BAND

1TX Antenna 1 MODE

Channel	Frequency (MHz)	26dB Bandwidth (MHz)
Low	5270	74.20
High	5310	73.90

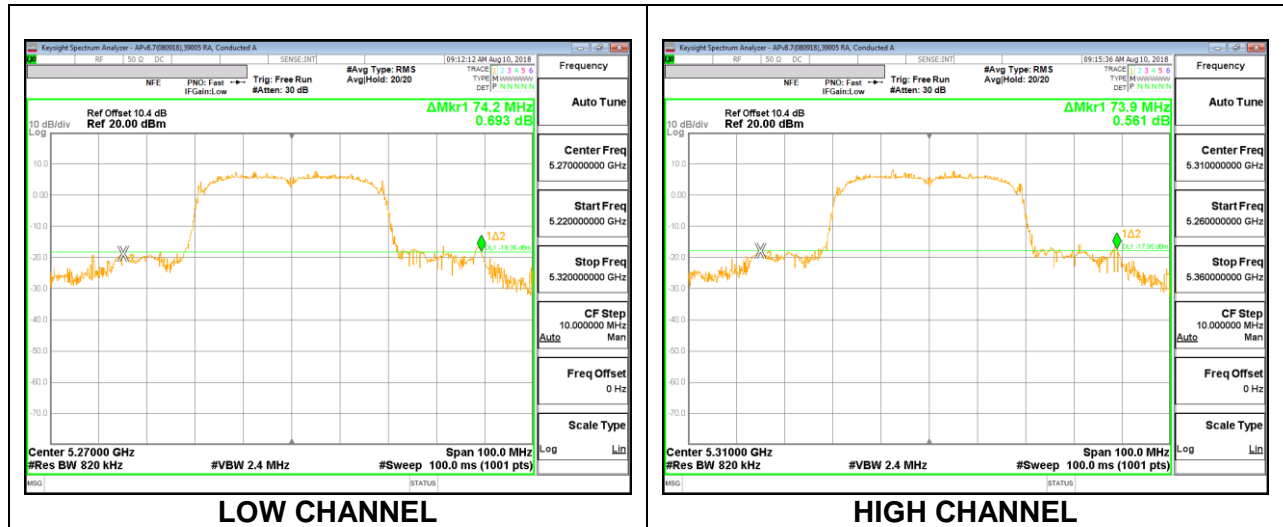

9.2.8. 802.11ac VHT80 MODE IN THE 5.3 GHz BAND

1TX Antenna 1 MODE

Channel	Frequency	26 dB Bandwidth
	(MHz)	(MHz)
Mid	5290	122.40

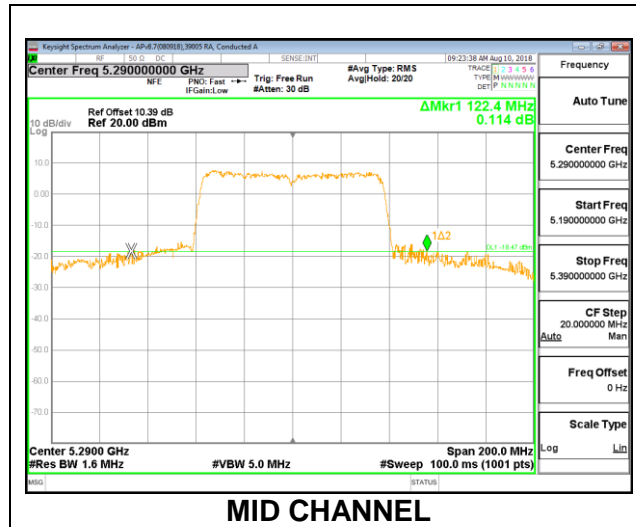

9.2.9. 802.11a MODE IN THE 5.6 GHz BAND

1TX Antenna 1 MODE

Channel	Frequency (MHz)	26 dB Bandwidth (MHz)
Low	5500	26.35
Mid	5580	25.80
High	5700	25.85
144	5720	24.35

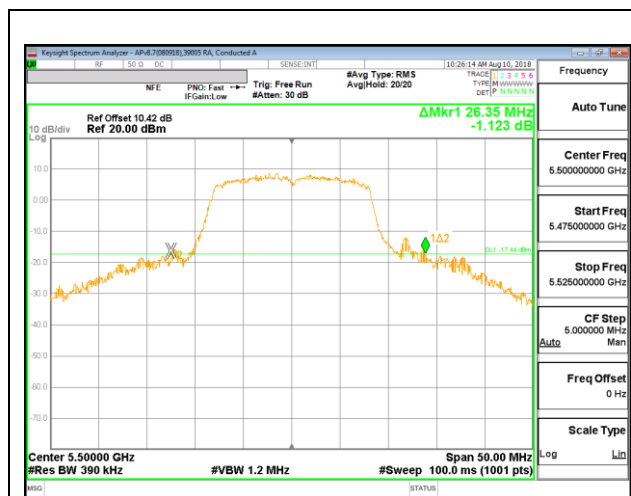

LOW CHANNEL

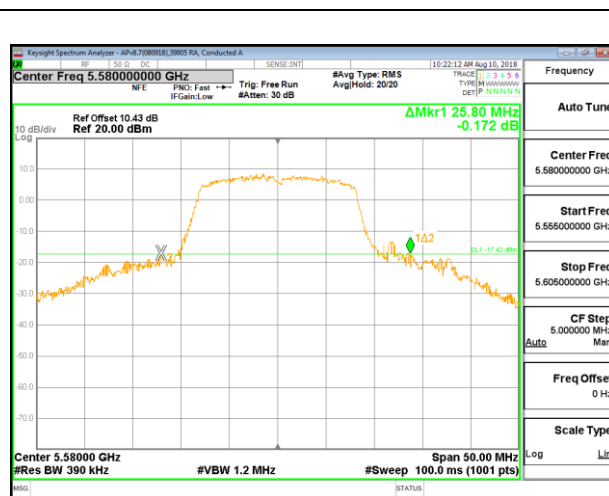

MID CHANNEL

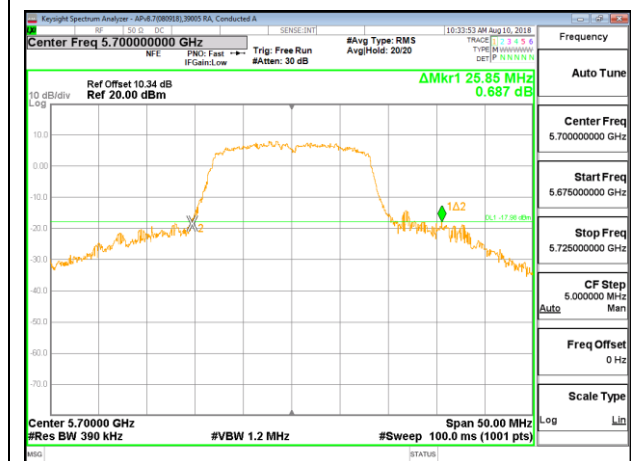

HIGH CHANNEL

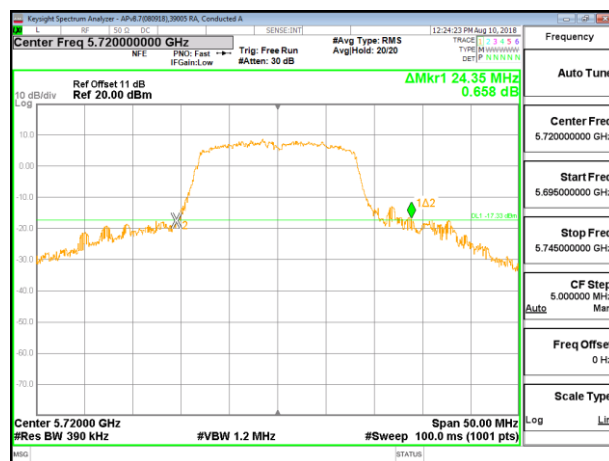

CHANNEL 144

9.2.10. 802.11n HT20 MODE IN THE 5.6 GHz BAND

1TX Antenna 1 MODE

Channel	Frequency (MHz)	26 dB Bandwidth (MHz)
Low	5500	31.50
Mid	5580	30.20
High	5700	28.55
144	5720	30.10

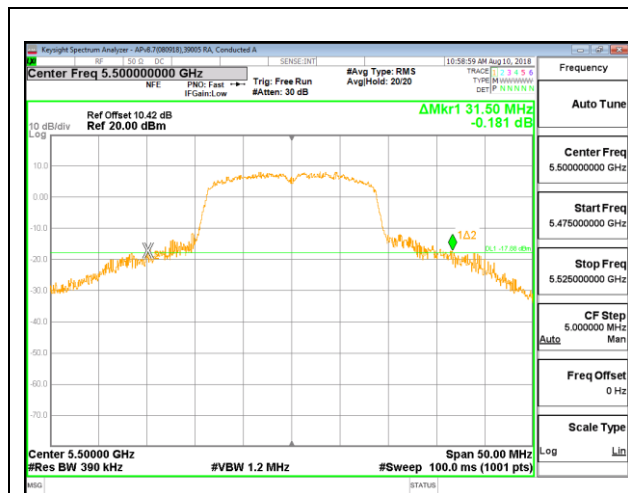

LOW CHANNEL



MID CHANNEL

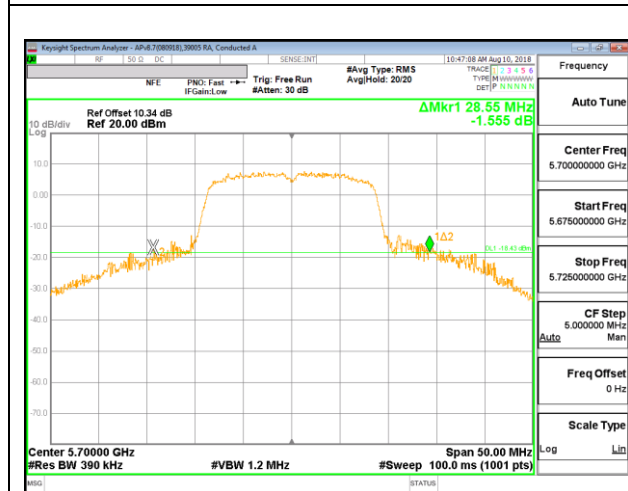

HIGH CHANNEL



CHANNEL 144

9.2.11. 802.11n HT40 MODE IN THE 5.6 GHz BAND

1TX Antenna 1 MODE

Channel	Frequency (MHz)	26 dB Bandwidth (MHz)
Low	5510	61.80
Mid	5550	61.20
High	5670	60.80
142	5710	44.20

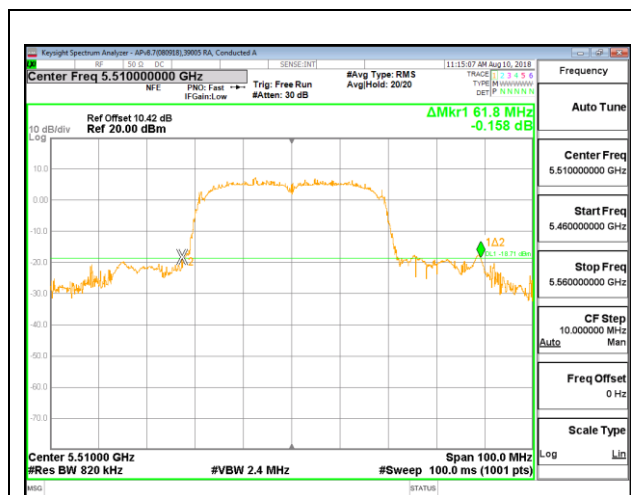

LOW CHANNEL

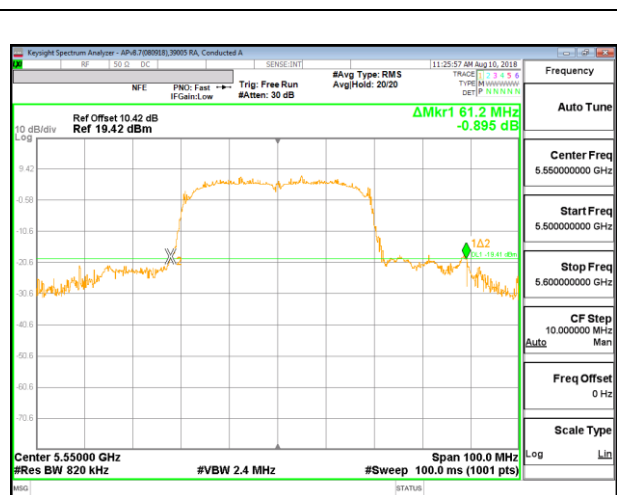

MID CHANNEL

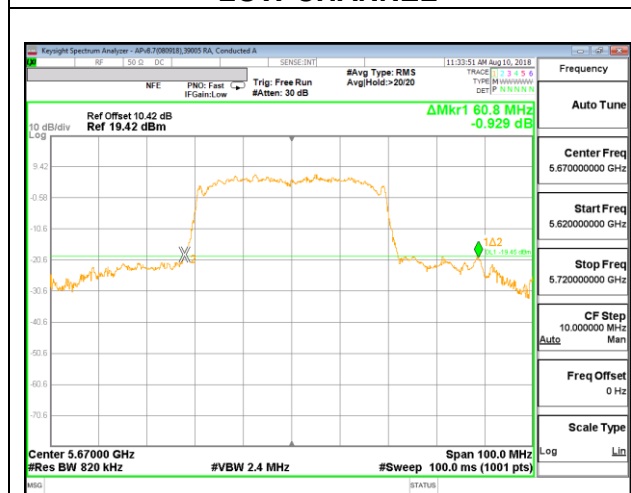

HIGH CHANNEL

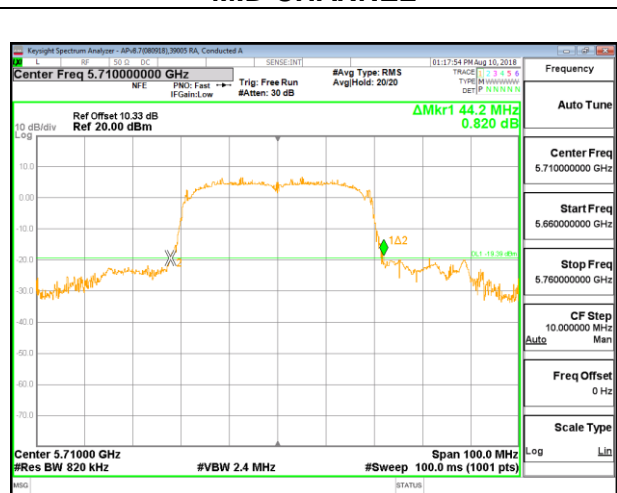

CHANNEL 142

9.2.12. 802.11ac VHT80 MODE IN THE 5.6 GHz BAND

1TX Antenna 1 MODE

Channel	Frequency (MHz)	26 dB Bandwidth (MHz)
Low	5530	114.20
High	5610	114.40
138	5690	114.20

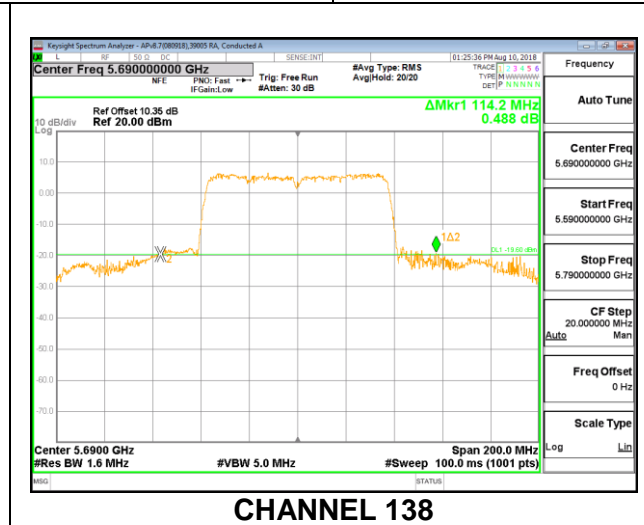
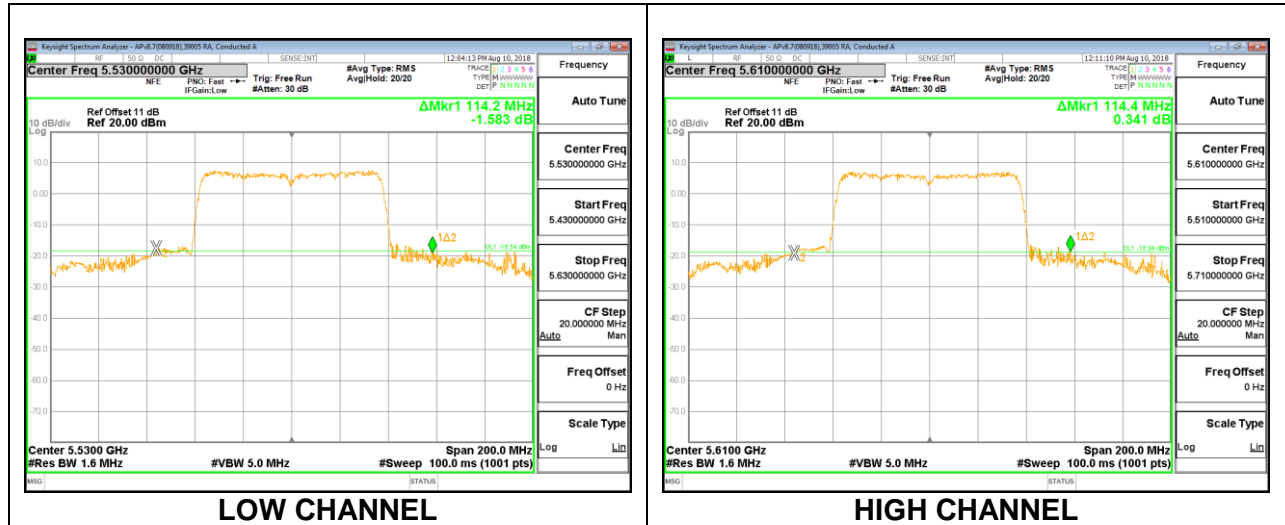

9.2.13. 802.11a MODE IN THE 5.8 GHz BAND

1TX Antenna 1 MODE

Channel	Frequency (MHz)	26 dB Bandwidth (MHz)
Low	5745	24.00
Mid	5785	24.00
High	5825	26.05

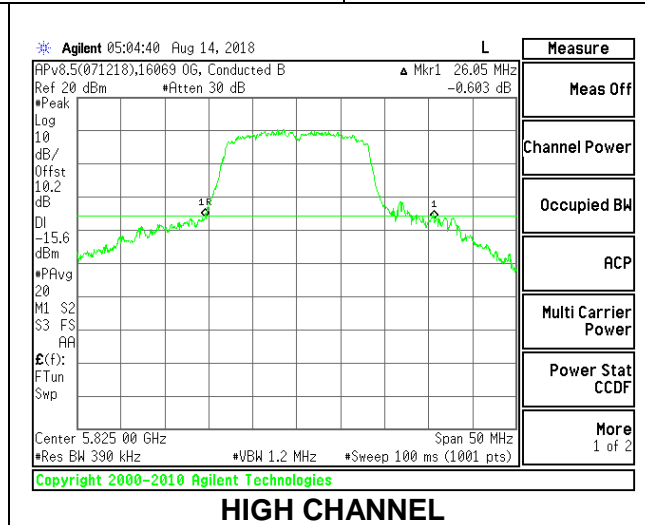
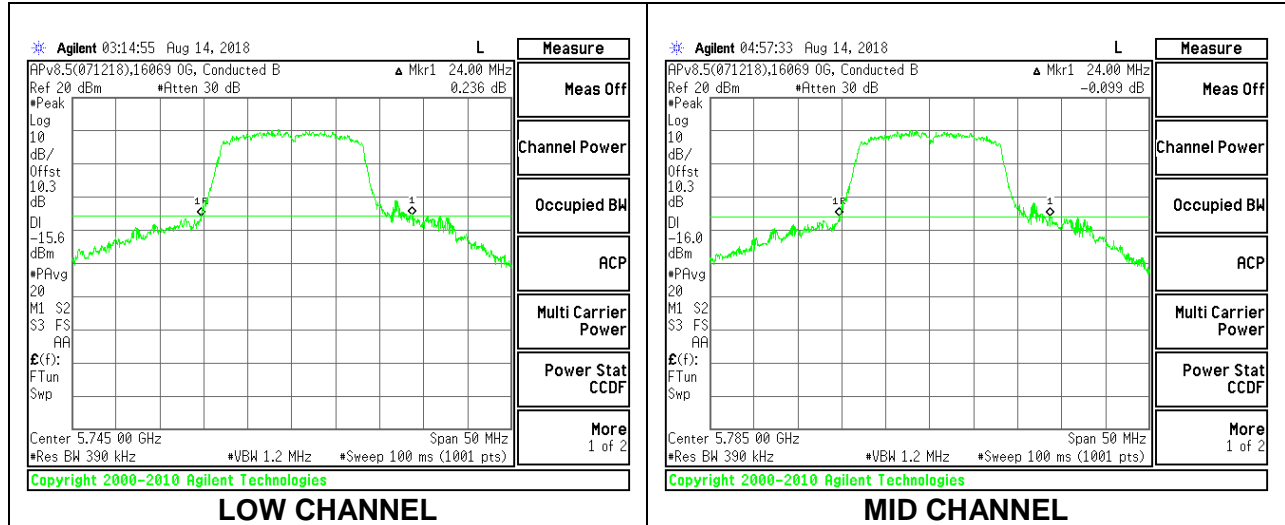

9.2.14. 802.11n HT20 MODE IN THE 5.8 GHz BAND

1TX Antenna 1 MODE

Channel	Frequency (MHz)	26 dB Bandwidth (MHz)
Low	5745	31.30
Mid	5785	31.35
High	5825	31.45

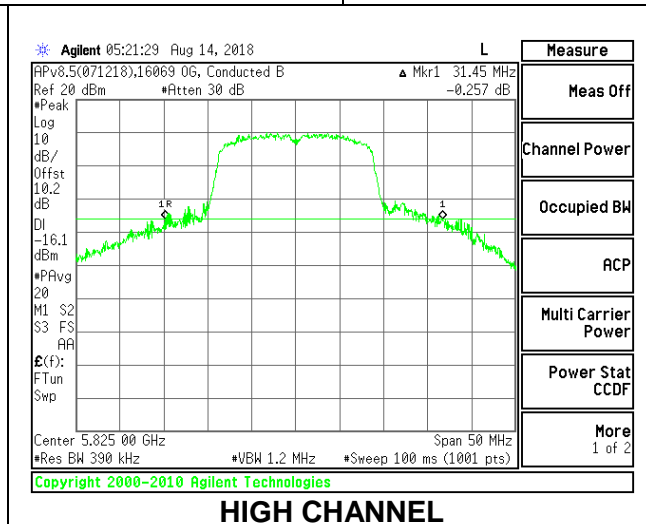
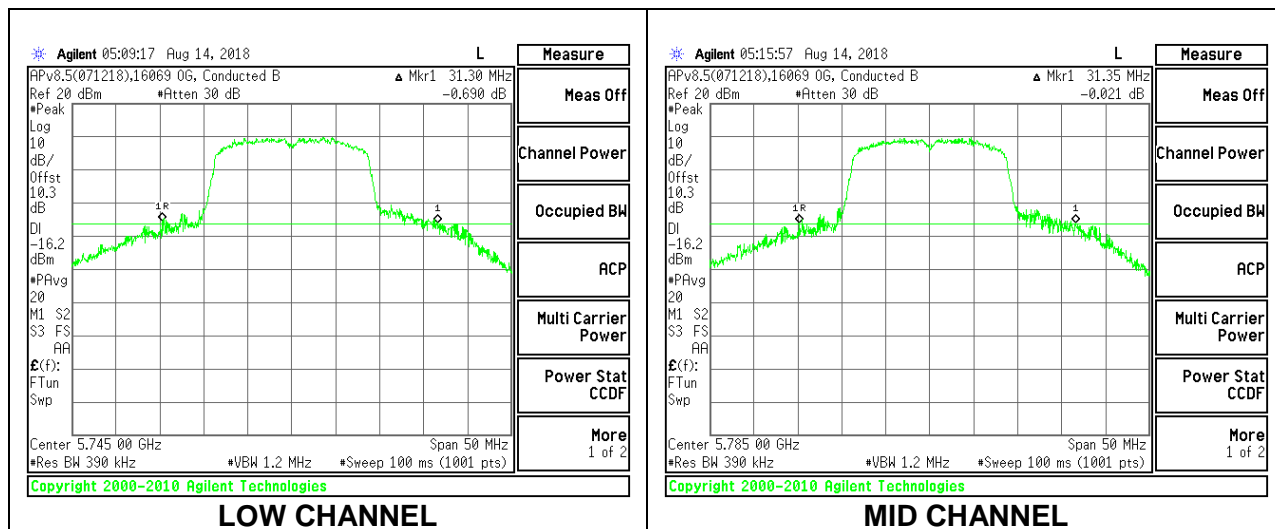

9.2.15. 802.11n HT40 MODE IN THE 5.8 GHz BAND

1TX Antenna 1 MODE

Channel	Frequency (MHz)	26dB Bandwidth (MHz)
Low	5755	61.30
High	5795	60.80

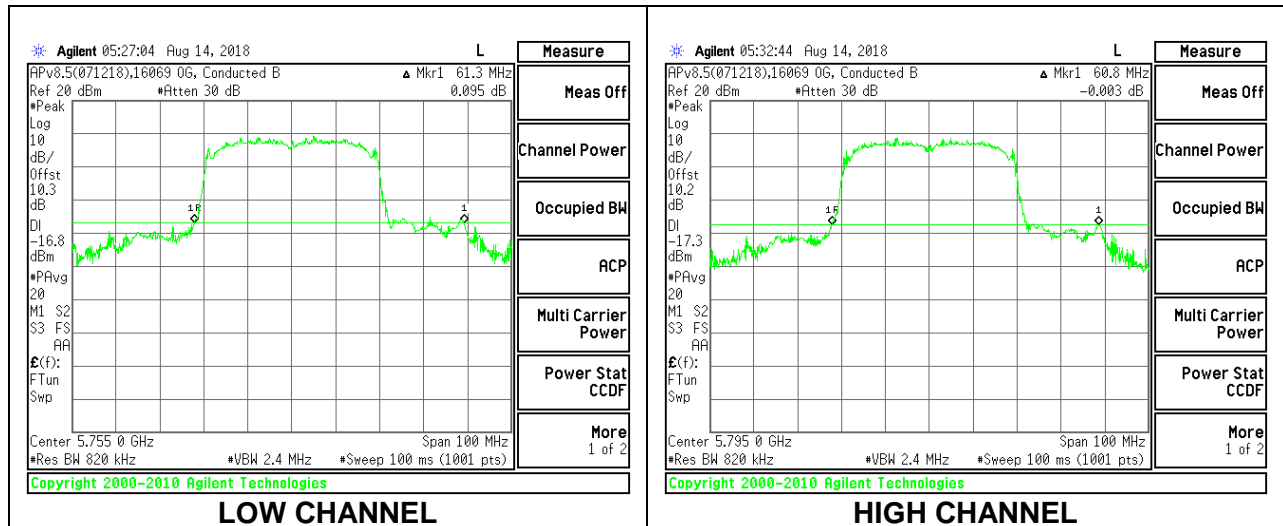

9.2.16. 802.11ac VHT80 MODE IN THE 5.8 GHz BAND

1TX Antenna 1 MODE

Channel	Frequency (MHz)	26 dB Bandwidth (MHz)
Mid	5775	129.20

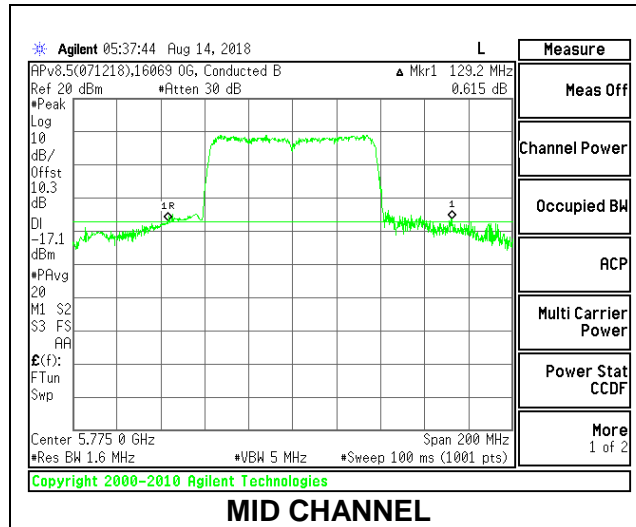

9.3. 99% BANDWIDTH

LIMITS

None; for reporting purposes only.

RESULTS

9.3.1. 802.11a MODE IN THE 5.2 GHz BAND

1TX Antenna 1 MODE

Channel	Frequency (MHz)	99% Bandwidth (MHz)
Low	5180	16.2970
Mid	5200	16.4970
High	5240	16.3630

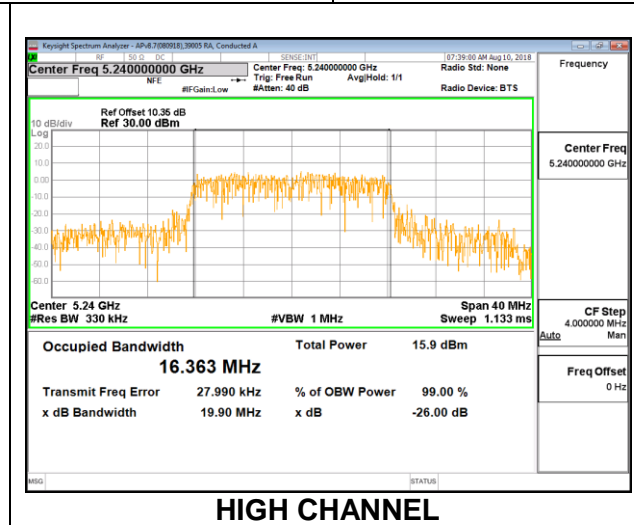
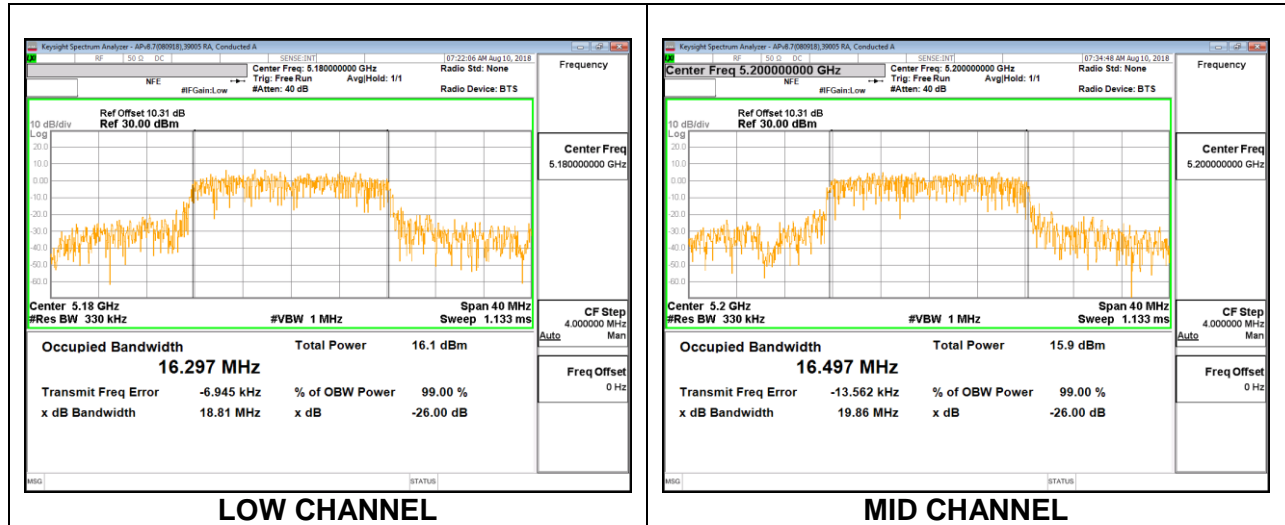

9.3.2. 802.11n HT20 MODE IN THE 5.2 GHz BAND

1TX Antenna 1 MODE

Channel	Frequency (MHz)	99% Bandwidth (MHz)
Low	5180	17.5150
Mid	5200	17.5120
High	5240	17.5550

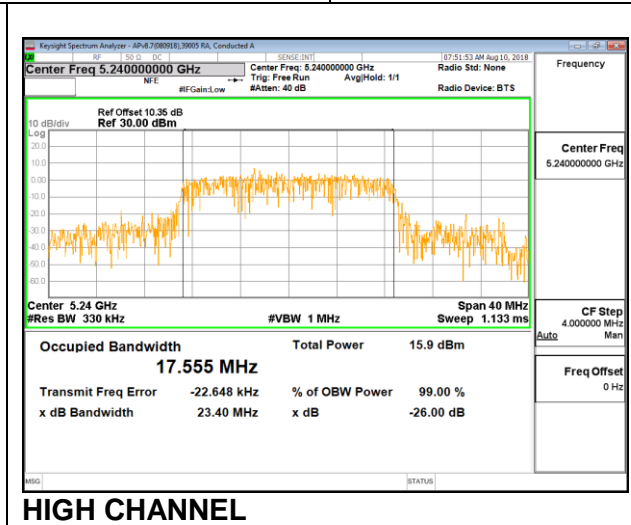
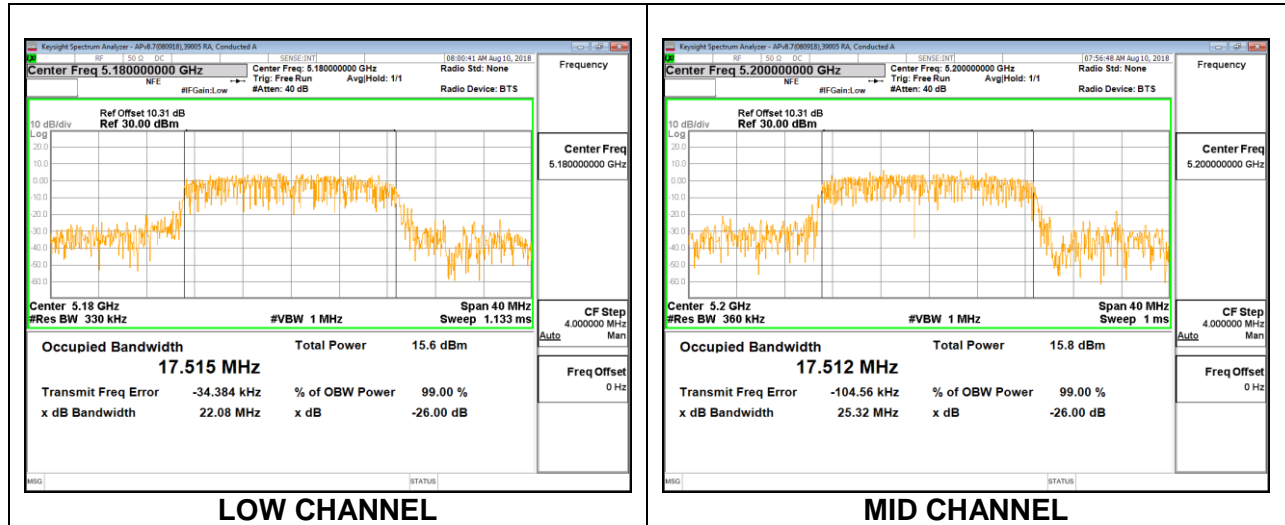

9.3.3. 802.11n HT40 MODE IN THE 5.2 GHz BAND

1TX Antenna 1 MODE

Channel	Frequency (MHz)	99% Bandwidth (MHz)
Low	5190	36.1090
High	5230	36.1090

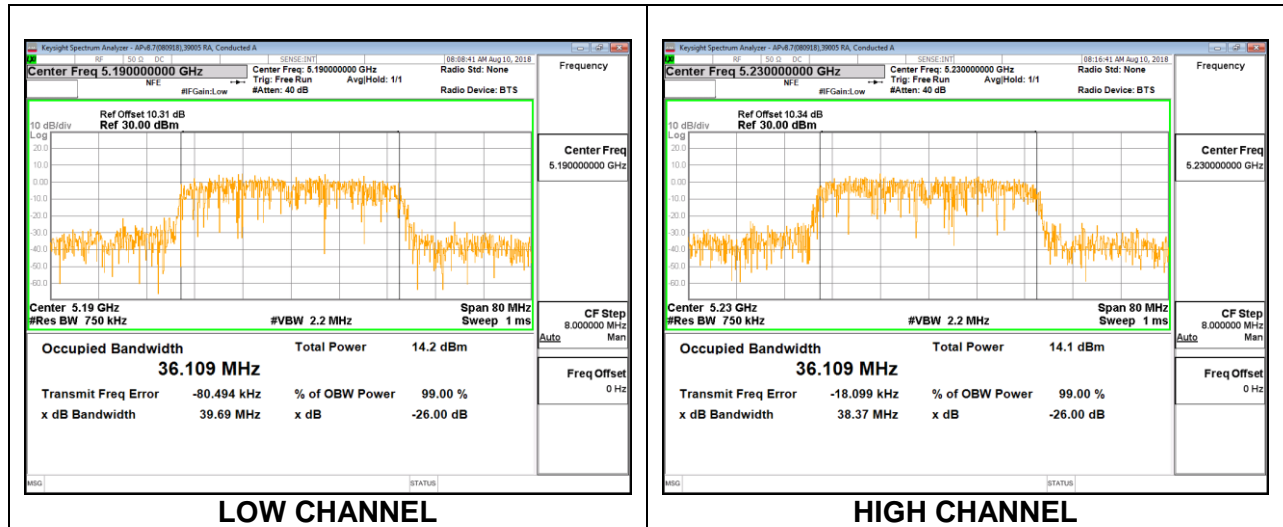

9.3.4. 802.11ac VHT80 MODE IN THE 5.2 GHz BAND

1TX Antenna 1 MODE

Channel	Frequency	99% Bandwidth
	(MHz)	(MHz)
Mid	5210	75.6830

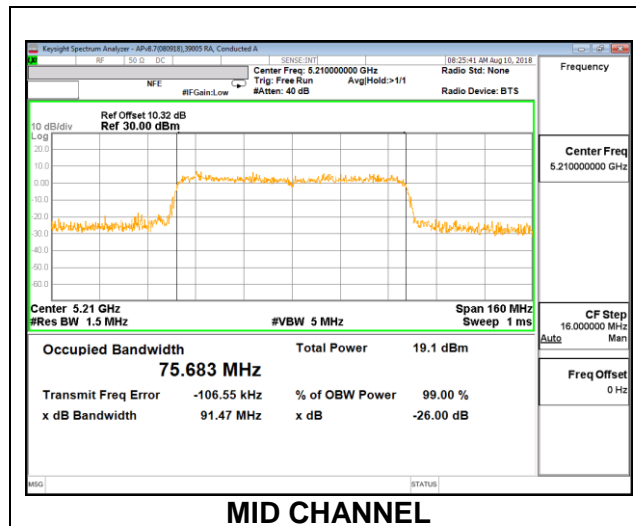

9.3.5. 802.11a MODE IN THE 5.3 GHz BAND

1TX Antenna 1 MODE

Channel	Frequency (MHz)	99% Bandwidth (MHz)
Low	5260	16.3500
Mid	5300	16.4260
High	5320	16.4020

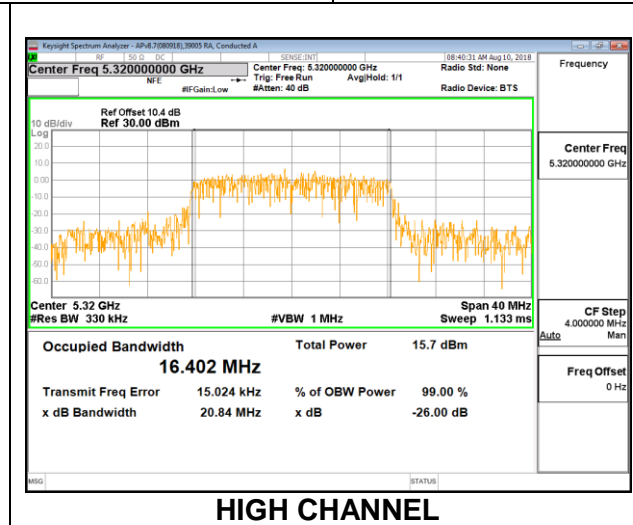
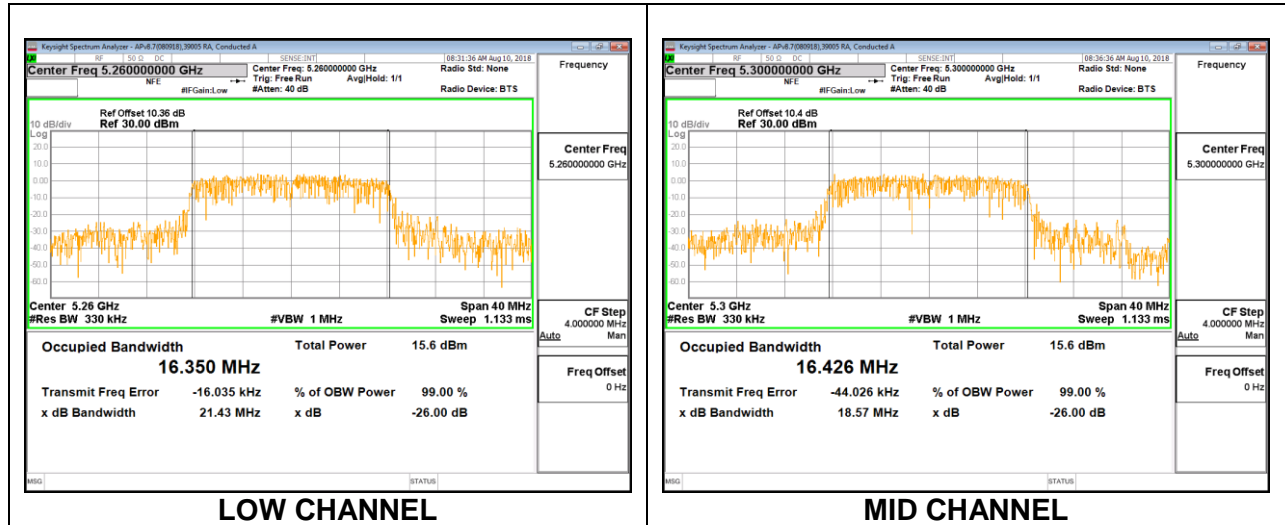

9.3.6. 802.11n HT20 MODE IN THE 5.3 GHz BAND

1TX Antenna 1 MODE

Channel	Frequency (MHz)	99% Bandwidth (MHz)
Low	5260	17.5000
Mid	5300	17.3830
High	5320	17.5810

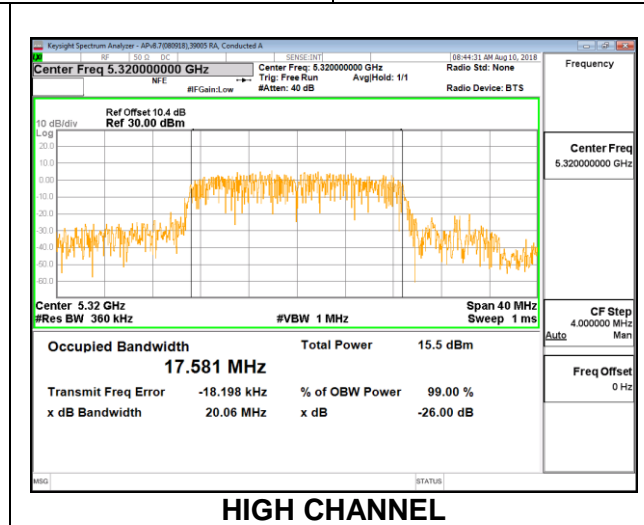
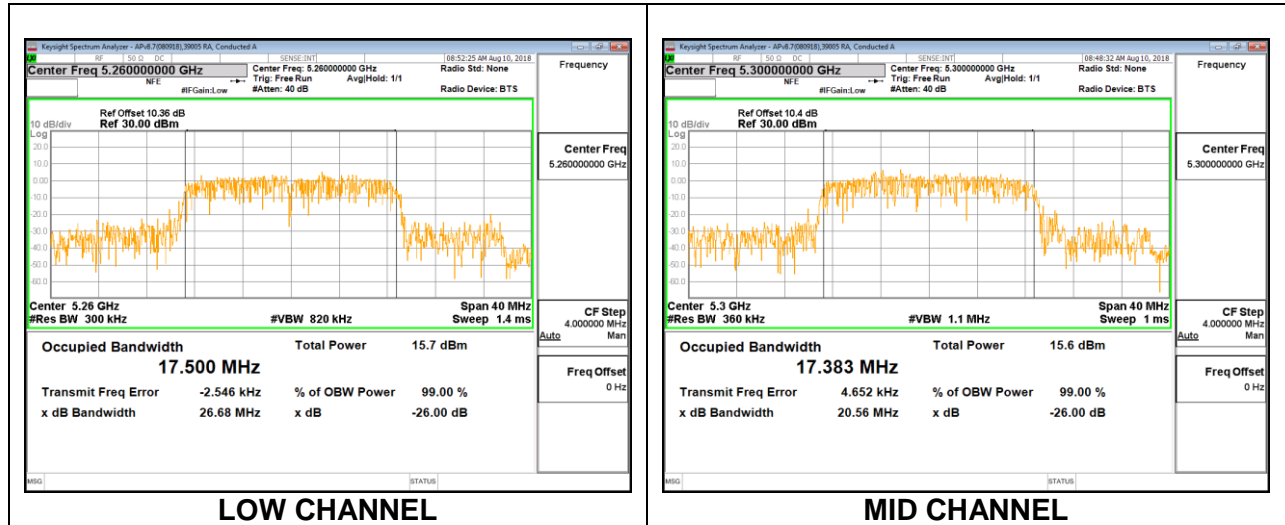

9.3.7. 802.11n HT40 MODE IN THE 5.3 GHz BAND

1TX Antenna 1 MODE

Channel	Frequency (MHz)	99% Bandwidth (MHz)
Low	5270	36.1560
High	5310	36.0590

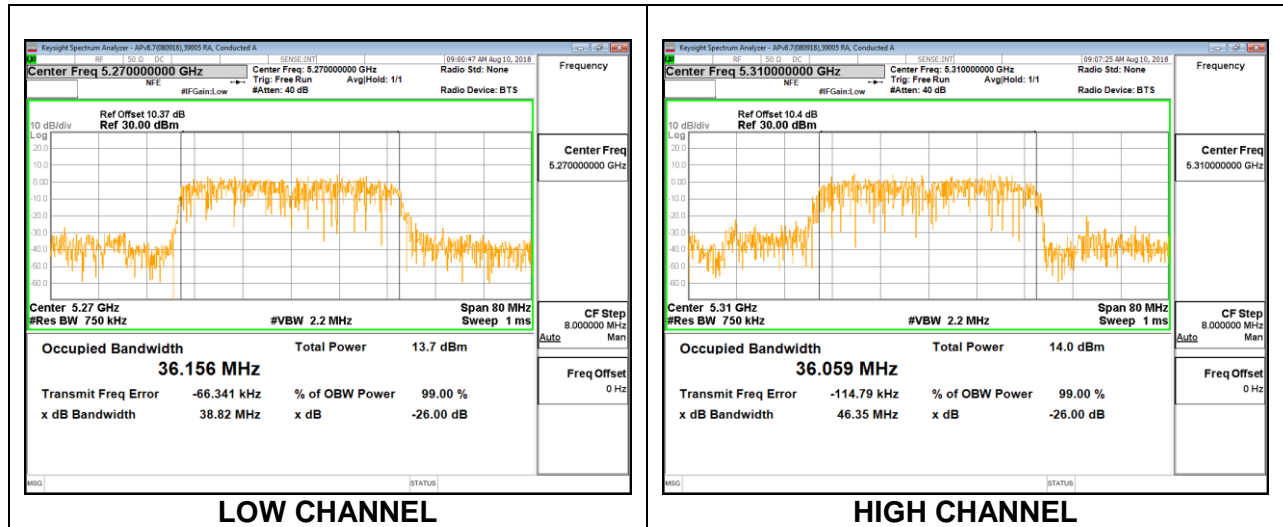

9.3.8. 802.11ac VHT80 MODE IN THE 5.3 GHz BAND

1TX Antenna 1 MODE

Channel	Frequency	99% Bandwidth
	(MHz)	(MHz)
Mid	5290	75.7540

