



CERTIFICATION TEST REPORT

Report Number. : 12440720-E2V1

Applicant : Samsung Electronics Co., Ltd.
129 Samsung-Ro, Yeongtong-Gu,
Suwon-Si, Gyeonggi-Do, 16677, Korea

Models : SM-A750G/DS and SM-A750G

FCC ID : A3LSMA750G

EUT Description : GSM/WCDMA/LTE Phone with BT, DTS/UNII a/b/g/n/ac, and ANT+

Test Standard(s) : FCC 47 CFR PART 15 SUBPART C

Date Of Issue:
August 31, 2018

Prepared by:
UL Verification Services Inc.
47173 Benicia Street
Fremont, CA 94538 U.S.A.
TEL: (510) 771-1000
FAX: (510) 661-0888



REPORT REVISION HISTORY

Rev.	Issue Date	Revisions	Revised By
V1	8/31/2018	Initial Issue	

TABLE OF CONTENTS

REPORT REVISION HISTORY	2
TABLE OF CONTENTS	3
1. ATTESTATION OF TEST RESULTS	5
2. INTRODUCTION OF TEST DATA REUSE.....	6
2.1. INTRODUCTION	6
2.2. DEVICES DIFFERENCES.....	6
2.3. SPOT CHECK VERIFICATION RESULTS SUMMARY	6
2.3.1. SPOT CHECK DATA.....	7
2.3.2. BANDEDGE (HIGH CHANNEL).....	7
2.3.3. HARMONICS AND SPURIOUS EMISSIONS	9
2.4. REFERENCE DETAIL	10
3. TEST METHODOLOGY	11
4. FACILITIES AND ACCREDITATION	11
5. CALIBRATION AND UNCERTAINTY	12
5.1. MEASURING INSTRUMENT CALIBRATION	12
5.2. SAMPLE CALCULATION	12
5.3. MEASUREMENT UNCERTAINTY.....	12
6. EQUIPMENT UNDER TEST.....	13
6.1. EUT DESCRIPTION	13
6.2. MAXIMUM OUTPUT POWER.....	13
6.3. DESCRIPTION OF AVAILABLE ANTENNAS	13
6.4. SOFTWARE AND FIRMWARE.....	13
6.5. WORST-CASE CONFIGURATION AND MODE.....	13
6.6. DESCRIPTION OF TEST SETUP.....	14
7. TEST AND MEASUREMENT EQUIPMENT	17
8. MEASUREMENT METHODS	19
9. ANTENNA PORT TEST RESULTS	20
9.1. ON TIME AND DUTY CYCLE.....	20
9.2. 20 dB AND 99% BANDWIDTH	22
9.2.1. BLUETOOTH BASIC DATA RATE GFSK MODULATION	23
9.2.2. BLUETOOTH ENHANCED DATA RATE 8PSK MODULATION.....	24
9.3. HOPPING FREQUENCY SEPARATION	25

9.3.1.	BLUETOOTH BASIC DATA RATE GFSK MODULATION	26
9.3.2.	BLUETOOTH ENHANCED DATA RATE 8PSK MODULATION.....	27
9.4.	<i>NUMBER OF HOPPING CHANNELS</i>	28
9.4.1.	BLUETOOTH BASIC DATA RATE GFSK MODULATION	29
9.4.2.	BLUETOOTH ENHANCED DATA RATE 8PSK MODULATION.....	31
9.5.	<i>AVERAGE TIME OF OCCUPANCY</i>	33
9.5.1.	BLUETOOTH BASIC DATA RATE GFSK MODULATION	34
9.5.2.	BLUETOOTH ENHANCED DATA RATE 8PSK MODULATION.....	36
9.6.	<i>OUTPUT POWER</i>	38
9.6.1.	BLUETOOTH BASIC DATA RATE GFSK MODULATION	39
9.6.2.	BLUETOOTH ENHANCED DATA RATE 8PSK MODULATION.....	40
9.7.	<i>AVERAGE POWER</i>	41
9.7.1.	BLUETOOTH BASIC DATA RATE GFSK MODULATION	42
9.7.2.	BLUETOOTH ENHANCED DATA RATE 8PSK MODULATION.....	43
9.8.	<i>CONDUCTED SPURIOUS EMISSIONS</i>	44
9.8.1.	BLUETOOTH BASIC DATA RATE GFSK MODULATION	45
9.8.2.	BLUETOOTH ENHANCED DATA RATE 8PSK MODULATION.....	47
10.	RADIATED TEST RESULTS	49
10.1.	<i>TRANSMITTER ABOVE 1 GHz</i>	50
10.1.1.	BLUETOOTH BASIC DATA RATE GFSK MODULATION.....	50
10.1.2.	BLUETOOTH ENHANCED DATA RATE 8PSK MODULATION	60
10.2.	<i>Worst Case Below 30 MHz</i>	70
10.3.	<i>Worst Case Below 1 GHz</i>	72
10.4.	<i>Worst Case 18-26 GHz</i>	74
11.	AC POWER LINE CONDUCTED EMISSIONS	76
11.1.1.	AC Power Line Norm.....	77
12.	SETUP PHOTOS (ORIGINAL).....	79
13.	SETUP PHOTOS (SPOT CHECK).....	82

1. ATTESTATION OF TEST RESULTS

COMPANY NAME: Samsung Electronics Co., Ltd.
129 Samsung-Ro, Yeongtong-Gu,
Suwon-Si, Gyeonggi-Do, 16677, Korea

EUT DESCRIPTION: GSM/WCDMA/LTE Phone with BT, DTS/UNII a/b/g/n/ac, and ANT+

MODELS: SM-A750G/DS and SM-A750G

SERIAL NUMBER: Conducted: R38K70KQF9N, R38K70KQGDH (Original)
Radiated: R38K70KQFNY, R38K70KQFAH, R38K70KQF8A (Original)
Conducted: R38K70MNSEF (Spot Check)
Radiated: R38K70MNRBF, R38K70MNQ6Z (Spot Check)

DATE TESTED: August 6 – 15, 2018 (Original)
August 20-28, 2018 (Spot Check)

APPLICABLE STANDARDS	
STANDARD	TEST RESULTS
CFR 47 Part 15 Subpart C	Complies

UL Verification Services Inc. tested the above equipment in accordance with the requirements set forth in the above standards. All indications of Pass/Fail in this report are opinions expressed by UL Verification Services Inc. based on interpretations and/or observations of test results. Measurement Uncertainties were not taken into account and are published for informational purposes only. The test results show that the equipment tested is capable of demonstrating compliance with the requirements as documented in this report.

Note: The results documented in this report apply only to the tested sample, under the conditions and modes of operation as described herein. This document may not be altered or revised in any way unless done so by UL Verification Services Inc. and all revisions are duly noted in the revisions section. Any alteration of this document not carried out by UL Verification Services Inc. will constitute fraud and shall nullify the document. This report must not be used by the client to claim product certification, approval, or endorsement by NVLAP, NIST, any agency of the Federal Government, or any agency of the U.S. government.

Approved & Released For
UL Verification Services Inc. By:

Reviewed By:



DAN CORONIA
CONSUMER TECHNOLOGY DIVISION
Operations Leader
UL Verification Services Inc.

STEVEN TRAN
CONSUMER TECHNOLOGY DIVISION
Project Engineer
UL Verification Services Inc.

2. INTRODUCTION OF TEST DATA REUSE

2.1. INTRODUCTION

According to the manufacturer, the WLAN, Bluetooth, ANT+ and WWAN hardware of A3LSMA750G are identical to A3LSMA750GN. In addition A3LSMA750G digital circuit is identical to A3LSMA750GN. Therefore the following report/data of A3LSMA750G may be represented from A3LSMA750GN along with the spot check verification data.

- WLAN
- Bluetooth
- ANT+
- WWAN

2.2. DEVICES DIFFERENCES

Difference between A3LSMA750G and A3LSMA750GN:

Samsung Electronics Co., Ltd. hereby declares that between A3LSMA750G and A3LSMA750GN:

Hardware:

- AP/CP/TRCV/PMIC are same.
- Deleted NFC circuit and NFC antennas.
- BT/WIFI/FM/GPS parts are exactly same.
- PCB layout is exactly same.
- Mechanic parts are exactly same.

Software:

- SW was updated to reflect the HW changes
- PROTOCOL PART is same.
- All applications of MMS, SATK/USATK, SMS, SS, SUPL, DM, VOLTE feature is same.

In addition, the A3LSMA750G does not support NFC.

Therefore the WLAN, Bluetooth, ANT+, WWAN report and data of A3LSMA750GN may represent for A3LSMA750G.

2.3. SPOT CHECK VERIFICATION RESULTS SUMMARY

Spot check verification has been done on device A3LSMA750G for radiated harmonic spurious and radiated band-edge. The data from the application has been verified through appropriate spot checks to demonstrate compliance for this device as shown in the summary below.

SM-A750G/DS SPOT CHECK RESULTS										
Technology	Mode	Test Item	Channel	Measured Frequency	SM-A750GN_DS		SM-A750G_DS		Delta (dB)	
					Peak	Ave	Peak	Ave	Peak	Ave
BT	8PSK	RBE	78	2485MHz	62.97	44.45	62.68	36.52	-0.29	-7.93
	8PSK	RSE	78	1989MHz	42.43	31.51	41.75	28.95	-0.68	-2.56

Comparison of two models, higher deviation is within 3dB range and all test are under FCC Technical Limits.

2.3.1. SPOT CHECK DATA

2.3.2. BANDEDGE (HIGH CHANNEL)

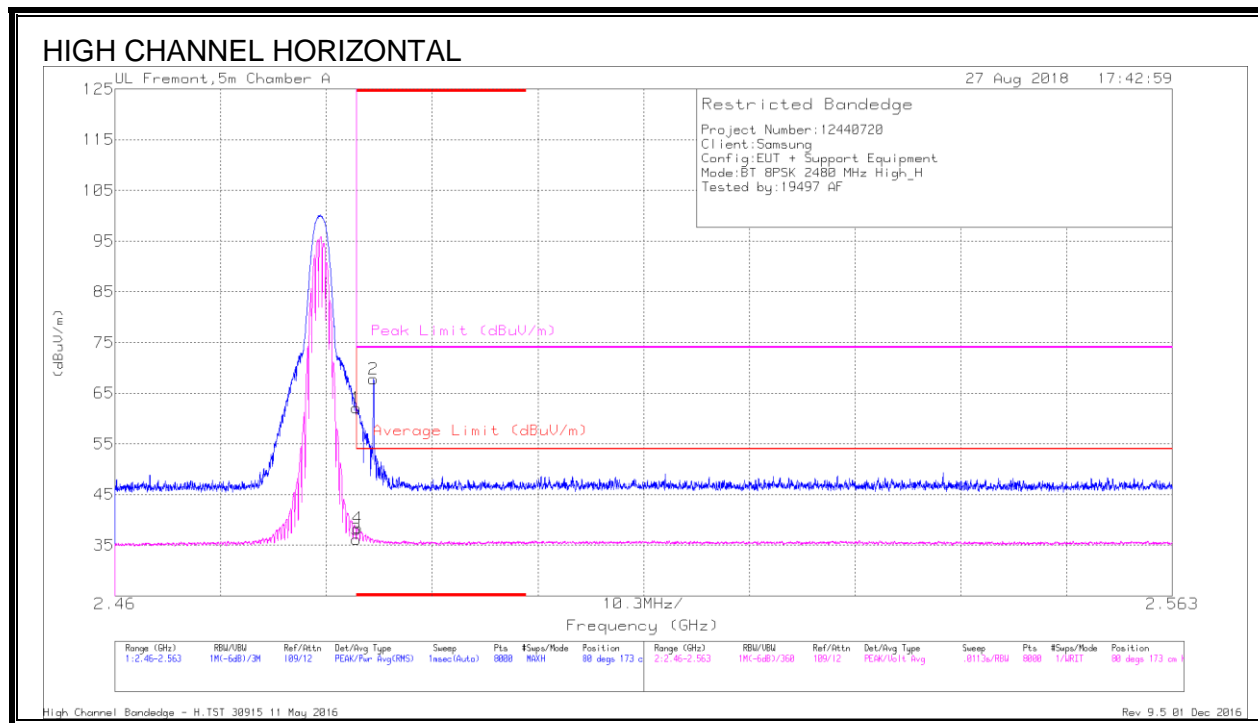

Trace Markers

Marker	Frequency (GHz)	Meter Reading (dBuV)	Det	AF T862 (dB/m)	Amp/Cb/Filtr/Pad (dB)	Corrected Reading (dBuV/m)	Average Limit (dBuV/m)	Margin (dB)	Peak Limit (dBuV/m)	PK Margin (dB)	Azimuth (Degs)	Height (cm)	Polarity
1	* 2.484	52.69	Pk	32.3	-22.9	62.09	-	-	74	-11.91	80	173	H
2	* 2.485	58.29	Pk	32.3	-22.8	67.79	-	-	74	-6.21	80	173	H
3	* 2.484	26.73	VA1T	32.3	-22.9	36.13	54	-17.87	-	-	80	173	H
4	* 2.484	28.92	VA1T	32.3	-22.9	38.32	54	-15.68	-	-	80	173	H

* - indicates frequency in CFR47 Pt 15 Restricted Band

Pk - Peak detector

VA1T - FHSS: Linear Voltage Average $V_B=1/T_{on}$ where: T_{on} is transmit duration

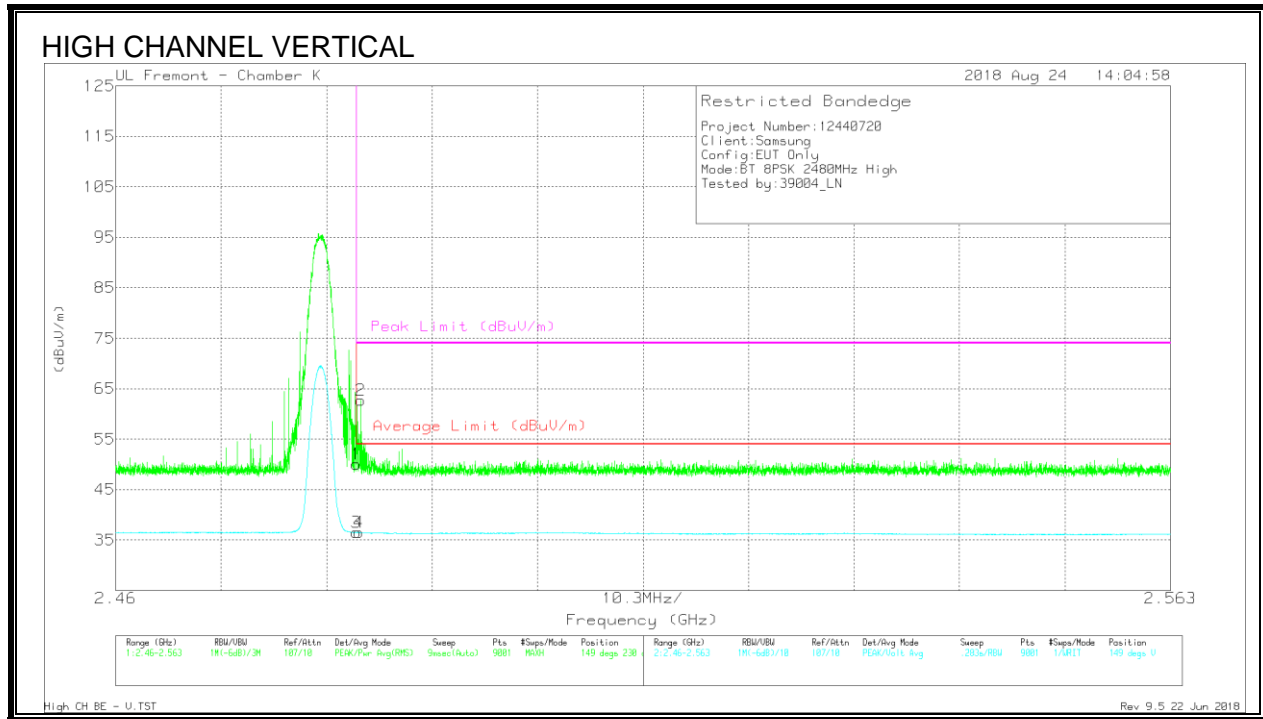

Trace Markers

Marker	Frequency (GHz)	Meter Reading (dBuV)	Det	AF T344 (dB/m)	Amp/Cb/Fitr/P ad (dB)	Corrected Reading (dBuV/m)	Average Limit (dBuV/m)	Margin (dB)	Peak Limit (dBuV/m)	PK Margin (dB)	Azimuth (Degs)	Height (cm)	Polarity
1	* 2.484	42.57	Pk	32.3	-24.8	50.07	-	-	74	-23.93	149	230	V
2	* 2.484	55.18	Pk	32.3	-24.8	62.68	-	-	74	-11.32	149	230	V
3	* 2.484	29.01	VA1T	32.3	-24.8	36.51	54	-17.49	-	-	149	230	V
4	* 2.484	29.02	VA1T	32.3	-24.8	36.52	54	-17.48	-	-	149	230	V

* - indicates frequency in CFR47 Pt 15 Restricted Band

Pk - Peak detector

VA1T - FHSS: Linear Voltage Average VB=1/Ton where: Ton is transmit duration

2.3.3. HARMONICS AND SPURIOUS EMISSIONS

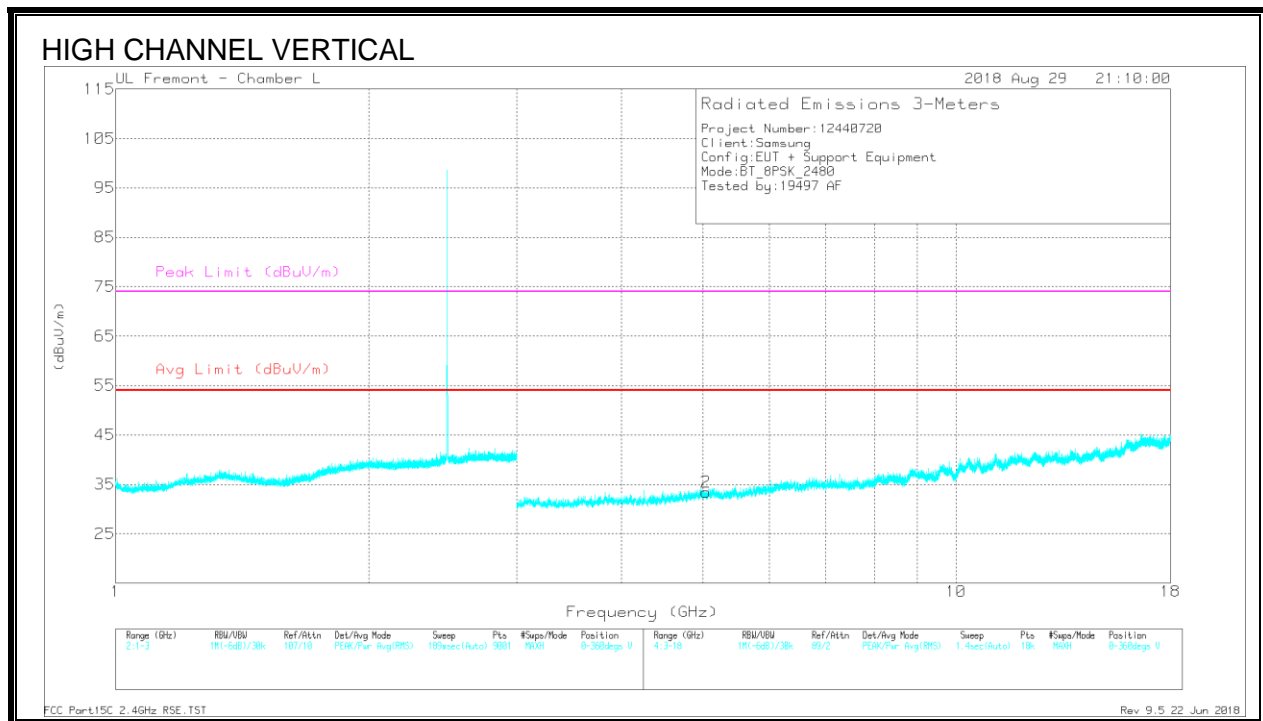
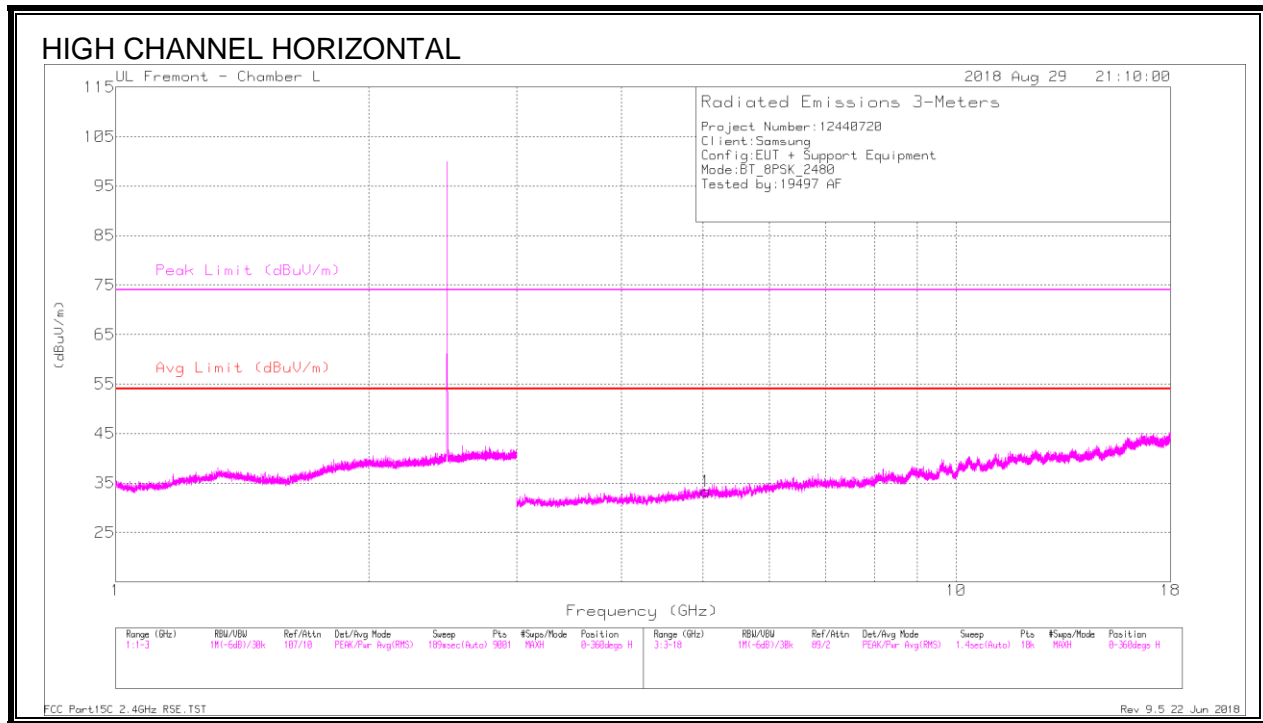

Radiated Emissions

Frequency (GHz)	Meter Reading (dBuV)	Det	AF EMC4294 (dB/m)	Amp/Cbl/Fitr/P ad (dB)	Corrected Reading (dBuV/m)	Avg Limit (dBuV/m)	Margin (dB)	Peak Limit (dBuV/m)	PK Margin (dB)	Azimuth (Degs)	Height (cm)	Polarity
* 5.044	34.78	PKFH	34.4	-28.7	40.48	-	-	74	-33.52	42	133	H
* 5.042	23.24	VA1T	34.4	-28.6	29.04	54	-24.96	-	-	42	133	H
* 5.041	35.95	PKFH	34.4	-28.6	41.75	-	-	74	-32.25	344	139	V
* 5.041	23.15	VA1T	34.4	-28.6	28.95	54	-25.05	-	-	344	139	V

* - indicates frequency in CFR47 Pt 15 Restricted Band

PKFH - FHSS: RB=100k/1MHz VB=3 x RB, Peak

VA1T - FHSS: Linear Voltage Average VB=1/Ton where: Ton is transmit duration

2.4. REFERENCE DETAIL

Equipment Class	Reference FCC ID	Report Title/Section
DSS (BT)	A3LSMA750GN	BT 12440598-E2V1 FCC Report BT

3. TEST METHODOLOGY

The tests documented in this report were performed in accordance with FCC CFR 47 Part 2, FCC CFR 47 Part 15, and ANSI C63.10-2013.

4. FACILITIES AND ACCREDITATION

The test sites and measurement facilities used to collect data are located at 47173 and 47266 Benicia Street, and 47658 Kato Road, Fremont, California, USA. Line conducted emissions are measured only at the 47173 address. The following table identifies which facilities were utilized for radiated emission measurements documented in this report. Specific facilities are also identified in the test results sections.

47173 Benicia Street	47266 Benicia Street	47658 Kato Rd.
<input checked="" type="checkbox"/> Chamber A (IC:2324B-1)	<input type="checkbox"/> Chamber D (IC:22541-1)	<input type="checkbox"/> Chamber I (IC: 2324A-5)
<input type="checkbox"/> Chamber B (IC:2324B-2)	<input type="checkbox"/> Chamber E (IC:22541-2)	<input type="checkbox"/> Chamber J (IC: 2324A-6)
<input type="checkbox"/> Chamber C (IC:2324B-3)	<input type="checkbox"/> Chamber F (IC:22541-3)	<input checked="" type="checkbox"/> Chamber K (IC: 2324A-1)
	<input type="checkbox"/> Chamber G (IC:22541-4)	<input checked="" type="checkbox"/> Chamber L (IC: 2324A-3)
	<input type="checkbox"/> Chamber H (IC:22541-5)	

The above test sites and facilities are covered under FCC Test Firm Registration # 208313. Chambers above are covered under Industry Canada company address and respective code.

UL Verification Services Inc. is accredited by NVLAP, Laboratory Code 200065-0

5. CALIBRATION AND UNCERTAINTY

5.1. MEASURING INSTRUMENT CALIBRATION

The measuring equipment utilized to perform the tests documented in this report has been calibrated in accordance with the manufacturer's recommendations, and is traceable to recognized national standards.

5.2. SAMPLE CALCULATION

Where relevant, the following sample calculation is provided:

$$\begin{aligned} \text{Field Strength (dBuV/m)} &= \text{Measured Voltage (dBuV)} + \text{Antenna Factor (dB/m)} + \\ &\text{Cable Loss (dB)} - \text{Preamp Gain (dB)} \\ 36.5 \text{ dBuV} + 18.7 \text{ dB/m} + 0.6 \text{ dB} - 26.9 \text{ dB} &= 28.9 \text{ dBuV/m} \end{aligned}$$

5.3. MEASUREMENT UNCERTAINTY

Where relevant, the following measurement uncertainty levels have been estimated for tests performed on the apparatus:

PARAMETER	UNCERTAINTY
Worst Case Conducted Disturbance, 9KHz to 0.15 MHz	3.84 dB
Worst Case Conducted Disturbance, 0.15 to 30 MHz	3.65 dB
Worst Case Radiated Disturbance, 9KHz to 30 MHz	3.15 dB
Worst Case Radiated Disturbance, 30 to 1000 MHz	5.36 dB
Worst Case Radiated Disturbance, 1000 to 18000 MHz	4.32 dB
Worst Case Radiated Disturbance, 18000 to 26000 MHz	4.45 dB
Worst Case Radiated Disturbance, 26000 to 40000 MHz	5.24 dB

Uncertainty figures are valid to a confidence level of 95%.

6. EQUIPMENT UNDER TEST

6.1. EUT DESCRIPTION

The EUT is a GSM/WCDMA/LTE phone with BT, DTS/UNII a/b/g/n/ac, ANT+ and NFC.

6.2. MAXIMUM OUTPUT POWER

The transmitter has a maximum peak conducted output power as follows:

Frequency Range (MHz)	Mode	Output Power (dBm)	Output Power (mW)
2402 - 2480	Basic GFSK	8.96	7.87
2402 - 2480	Enhanced 8PSK	8.06	6.40

Note: GFSK, DQPSK, 8PSK average Power are all investigated, The GFSK & 8PSK Power are the worst case. Testing is based on these modes to showing compliance

6.3. DESCRIPTION OF AVAILABLE ANTENNAS

The radio utilizes an internal antenna with maximum gain of -1.7dBi.

6.4. SOFTWARE AND FIRMWARE

The test utility software used during testing was A750GN.001

6.5. WORST-CASE CONFIGURATION AND MODE

Radiated emissions below 1GHz, above 18GHz, and power line conducted emission were performed with the EUT set to transmit at the channel with highest output power as worst-case scenario.

Band edge and radiated emissions between 1GHz and 18GHz were performed with the EUT set to transmit at the highest power on low, middle and high channels.

The fundamental of the EUT was investigated in three orthogonal orientations X,Y and Z it was determined that X orientation was worst-case orientation; therefore, all final radiated testing was performed with the EUT in X orientation.

Worst-case data rates as provided by the client were:

GFSK mode: DH5
8PSK mode: 3-DH5

6.6. DESCRIPTION OF TEST SETUP

SUPPORT EQUIPMENT

Support Equipment List				
Description	Manufacturer	Model	Serial Number	FCC ID
AC Adapter	Samsung	EP-TA50EWE	DW3J719AS/A-E	N/A
Earphone	Samsung	N/A	N/A	N/A

I/O CABLES (CONDUCTED TEST)

I/O Cable List						
Cable No	Port	# of identical ports	Connector Type	Cable Type	Cable Length (m)	Remarks
1	Antenna	1	RF	Shielded	0.2	To PSA and BT Tester
2	USB	1	USB	Un-shielded	1	EUT to AC Mains

I/O CABLES (RADIATED AND CONDUCTED EMISSIONS)

I/O Cable List						
Cable No	Port	# of identical ports	Connector Type	Cable Type	Cable Length (m)	Remarks
1	USB	1	USB	Shielded	1	N/A
2	earphone	1	3.5mm	Un-shielded	1	N/A

TEST SETUP

The EUT is a stand alone. Test software exercised the radio card.

CONDCUTED TEST SETUP DIAGRAM

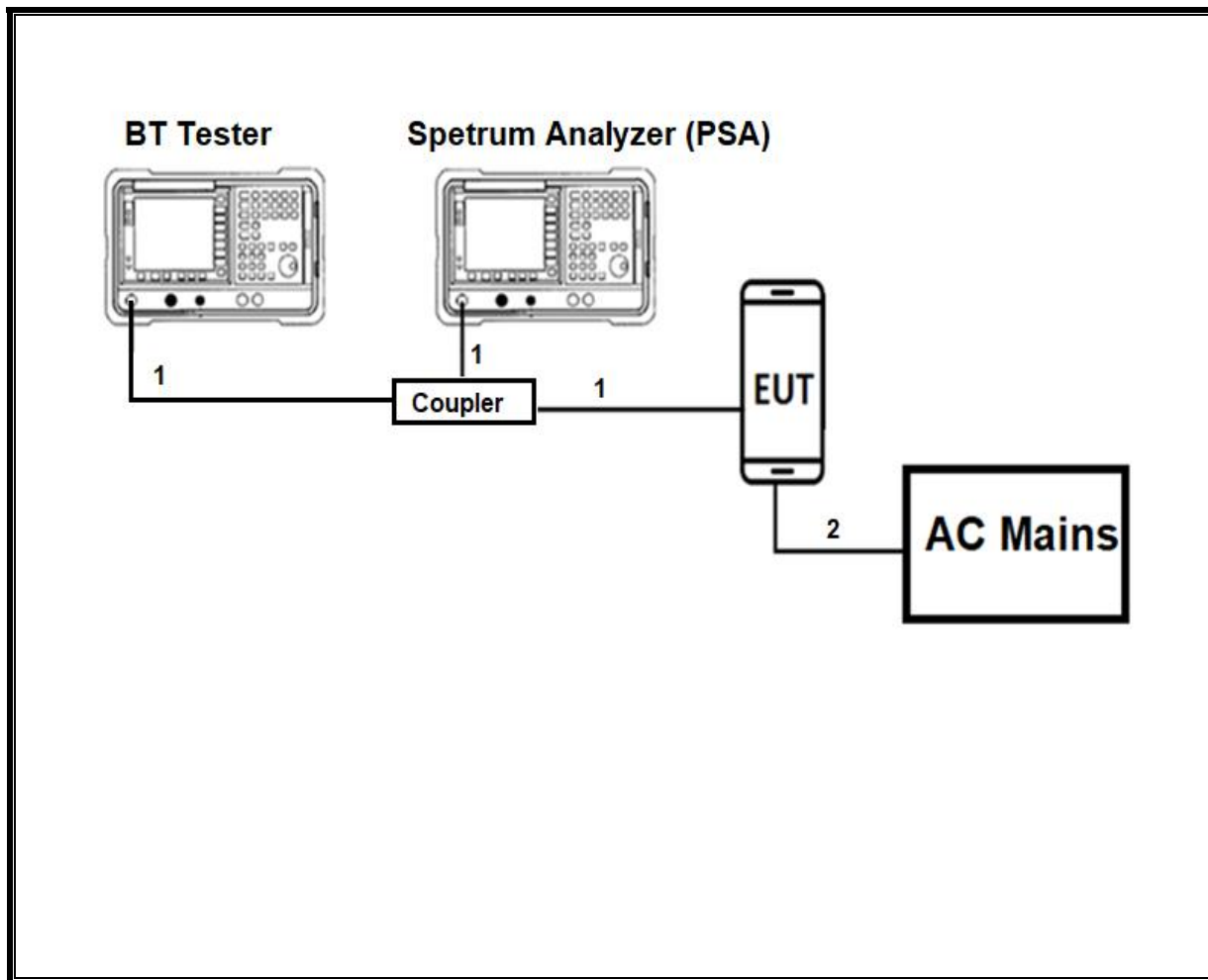

TEST SETUP

For conducted tests: the EUT was Stand alone. The test software exercises the radio.

RADIATED AND AC LINE CONDUCTED EMISSIONS SETUP DIAGRAM

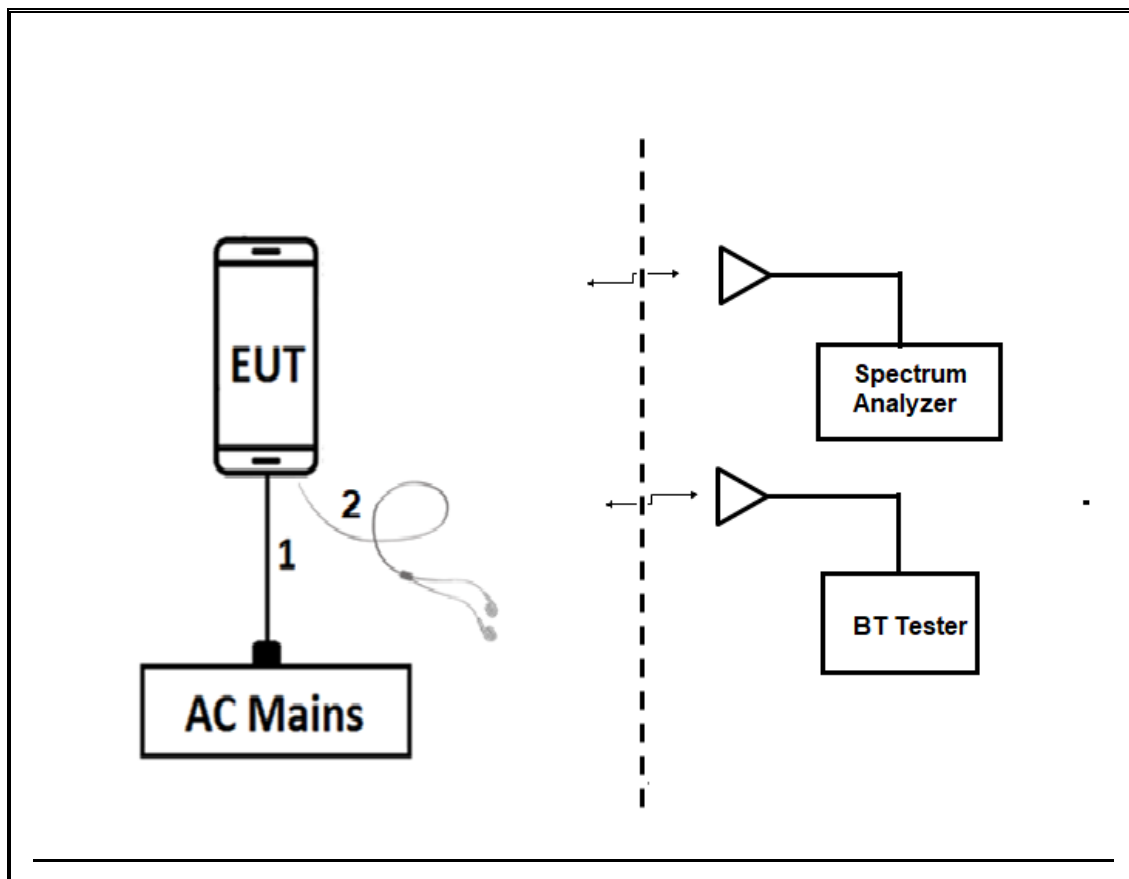

TEST SETUP

For radiated tests: EUT is Stand alone. The test software exercises the radio.

7. TEST AND MEASUREMENT EQUIPMENT

The following test and measurement equipment was utilized for the tests documented in this report:

TEST EQUIPMENT LIST (ORIGINAL)					
Description	Manufacturer	Model	ID Num	Cal Due	Last Cal
Amplifier, 10KHz to 1GHz, 32dB	Agilent (Keysight) Technologies	8447D	T10	02/14/2019	02/14/2018
Antenna, Broadband Hybrid, 30MHz to 2000MHz	Sunol Sciences Corp.	JB3	T407	05/10/2019	05/10/2018
Antenna, Horn 1-18GHz	ETS-Lindgren	3117	T345	04/25/2019	04/25/2018
Antenna, Horn 1-18GHz	ETS-Lindgren	3117	T119	04/03/2019	04/03/2018
Bluetooth Tester	Rohde & Schwarz (Koeln) GmbH & Co. KG	CBT	T258	02/23/2019	02/23/2018
RF Amplifier, 1-18GHz	MITEQ	AFS42-00101800-25-S-42	T740	12/30/2018	12/30/2017
RF Amplifier, 1-18GHz	MITEQ	AFS42-00101800-25-S-42	T493	04/03/2019	04/03/2018
Directional Coupler	Mini-Circuits	ZUDC10-183+	T1136	06/18/2019	06/18/2018
Power Meter, P-series single channel	Agilent (Keysight) Technologies	N1911A	T1269	04/05/2019	04/05/2018
Power Sensor, P-series, 50MHz to 18GHz, Wideband	Agilent (Keysight) Technologies	N1921A	T1225	04/10/2019	04/10/2018
EMI Reciever	Rohde & Schwarz	ESR	T1436	02/21/2019	02/21/2018
L.I.S.N.	FCC INC.	FCC LISN 50/250	T1310	06/15/2019	06/15/2018
L.I.S.N.	FCC INC.	FCC LISN 50/250	T24	03/06/2019	03/06/2018
Antenna, Active Loop 9kHz-30MHz	Com-Power Corp.	AL-130R	T1866	10/10/2018	10/10/2017
Spectrum Analyzer, PXA, 3Hz to 44GHz	Agilent (Keysight) Technologies	N9030A	T200	11/18/2018	11/18/2017
Spectrum Analyzer, PXA, 3Hz to 44GHz	Agilent (Keysight) Technologies	N9030A	T341	11/12/2018	11/12/2017
Spectrum Analyzer, PXA, 3Hz to 44GHz	Agilent (Keysight) Technologies	N9030A	T1466	04/16/2019	04/16/2018
Spectrum Analyzer, PXA, 3Hz to 44GHz	Agilent (Keysight) Technologies	N9030A	T1454	01/08/2019	01/08/2018
18 - 26.5 GHz Horn Antenna	Seavey Division	MWH-1826/B	T89	01/18/2019	01/18/2018
Pre-Amp 1-26.5 GHz	Agilent	8449B	T404	03/09/2019	023/09/2018
Thermometer - Digital	Control Company	14-650-118	PRE0177862	02/22/2019	02/22/2018
Thermometer - Digital	Control Company	14-650-118	PRE0177861	02/26/2019	02/26/2018

Test Software List			
Description	Manufacturer	Model	Version
Radiated Software	UL	UL EMC	Ver 9.5, June 22, 2018
Antenna Port Software	UL	UL RF	Ver 8.5, July 12, 2018

TEST EQUIPMENT LIST (SPOT CHECK)					
Description	Manufacturer	Model	ID Num	Cal Due	Last Cal
Antenna, Horn 1-18GHz	ETS-Lindgren	3117	T345	04/25/2019	04/25/2018
RF Amplifier, 1-18GHz, 35dB	MITEQ Inc	AMF-4D-01000800-30-29P	T1573	06/12/2019	06/12/2018
Spectrum Analyzer, PXA, 3Hz to 44GHz	Agilent (Keysight) Technologies	N9030A	T1466	04/16/2019	04/16/2018
Filter, LPF 5.0GHz	MICRO-TRONICS	LPS17541	T481	06/12/2019	06/12/2018
Filter, HPF 6.0HPF	MICRO-TRONICS	HPS17542	T484	06/12/2019	06/12/2018
Filter, HPF 3.0GHz	MICRO-TRONICS	HPM17543	T486	06/12/2019	06/12/2018
Thermometer - Digital	Control Company	14-650-118	PRE0177861	02/26/2019	02/26/2018

Test Software List			
Description	Manufacturer	Model	Version
Radiated Software	UL	UL EMC	Ver 9.5, June 22, 2018

8. MEASUREMENT METHODS

On Time and Duty Cycle: ANSI C63.10-2013 Section 11.6

Occupied BW (20dB): ANSI C63.10-2013 Section 6.9.2

Occupied BW (99%): ANSI C63.10-2013 Section 6.9.3

Carrier Frequency Separation: ANSI C63.10-2013 Section 7.8.2

Number of Hopping Frequencies: ANSI C63.10-2013 Section 7.8.3

Time of Occupancy (Dwell Time): ANSI C63.10-2013 Section 7.8.4

Peak Output Power: ANSI C63.10-2013 Section 7.8.5

Conducted Spurious Emissions: ANSI C63.10-2013 Section 7.8.8

Conducted Band-Edge: ANSI C63.10-2013 Section 6.10.4

Radiated Spurious Emissions 30-1000MHz: ANSI C63.10-2013 Section 6.3 and 6.5

Radiated Spurious Emissions above 1GHz: ANSI C63.10-2013 Section 6.3 and 6.6

Radiated Band-edge: ANSI C63.10-2013 Section 6.10.5

AC Power-line conducted emissions: ANSI C63.10-2013, Section 6.2.

9. ANTENNA PORT TEST RESULTS

9.1. ON TIME AND DUTY CYCLE

LIMITS

None; for reporting purposes only.

PROCEDURE

KDB 789033 Zero-Span Spectrum Analyzer Method.

ON TIME AND DUTY CYCLE RESULTS

Mode	ON Time B (msec)	Period (msec)	Duty Cycle x (linear)	Duty Cycle (%)	Duty Cycle Correction Factor (dB)	1/T Minimum VBW (kHz)
Bluetooth GFSK	2.879	3.765	0.765	76.5%	1.17	0.347
Bluetooth 8PSK	2.881	3.751	0.768	76.8%	1.15	0.347

DUTY CYCLE PLOTS

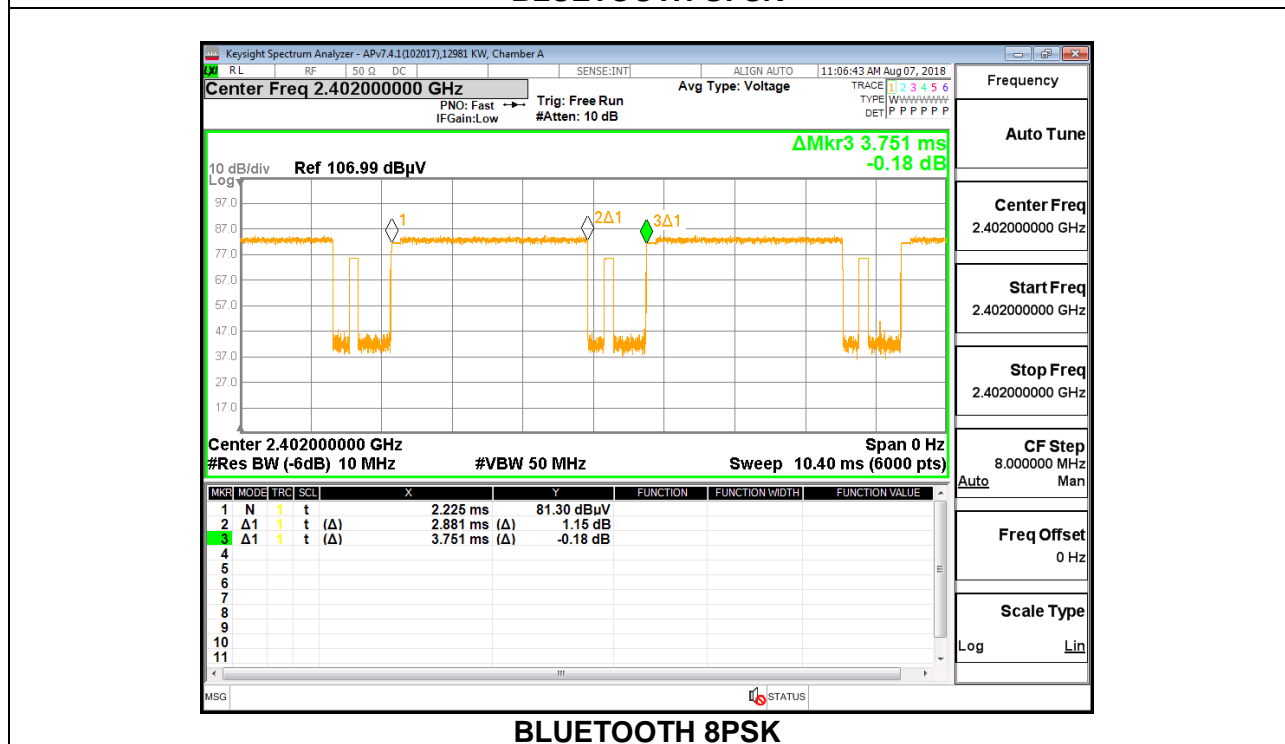
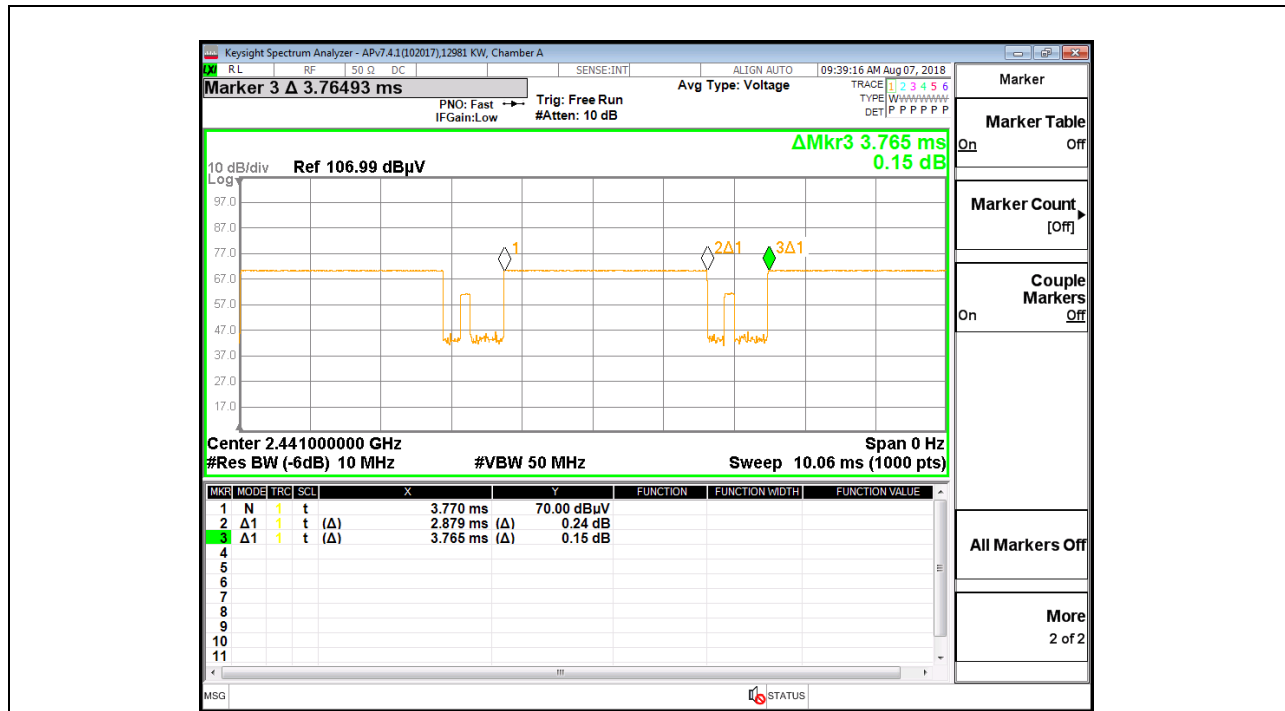

9.2. 20 dB AND 99% BANDWIDTH

LIMITS

None; for reporting purposes only.

TEST PROCEDURE

The transmitter output is connected to a spectrum analyzer. The RBW is set to $\geq 1\%$ of the 20 dB bandwidth. The VBW is set to \geq RBW. The sweep time is coupled.

RESULTS

9.2.1. BLUETOOTH BASIC DATA RATE GFSK MODULATION

Channel	Frequency (MHz)	20dB Bandwidth (MHz)	99% Bandwidth (MHz)
Low	2402	1.040	0.918
Mid	2441	1.039	0.914
High	2480	1.042	0.911

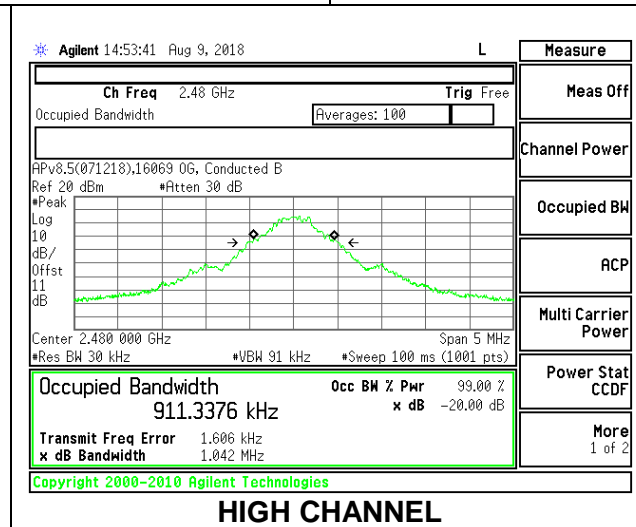
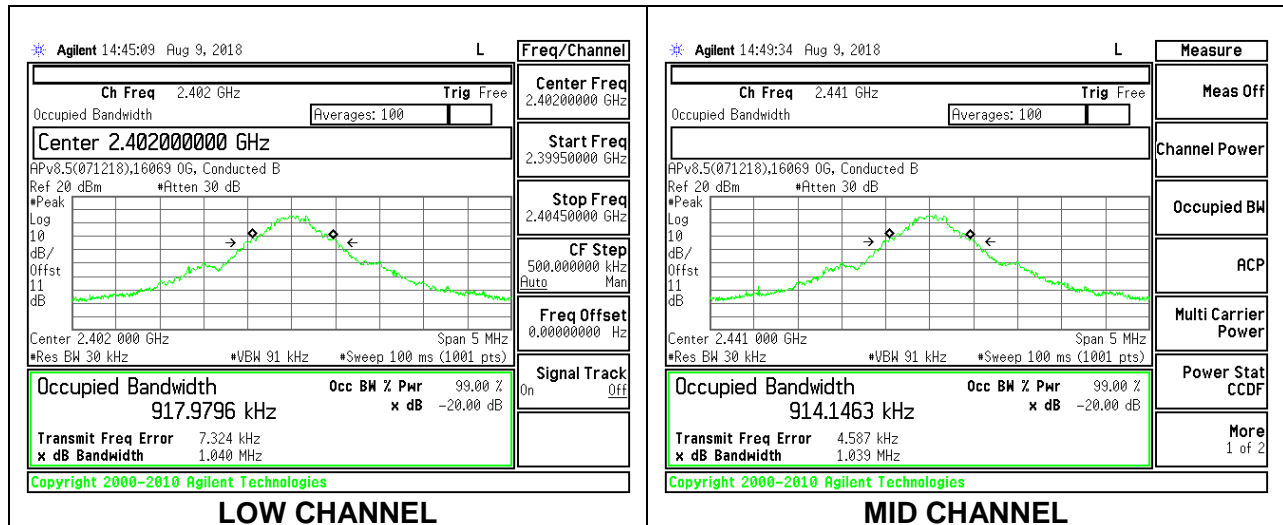

9.2.2. BLUETOOTH ENHANCED DATA RATE 8PSK MODULATION

Channel	Frequency (MHz)	20dB Bandwidth (MHz)	99% Bandwidth (MHz)
Low	2402	1.326	1.1981
Mid	2441	1.331	1.2067
High	2480	1.333	1.2133

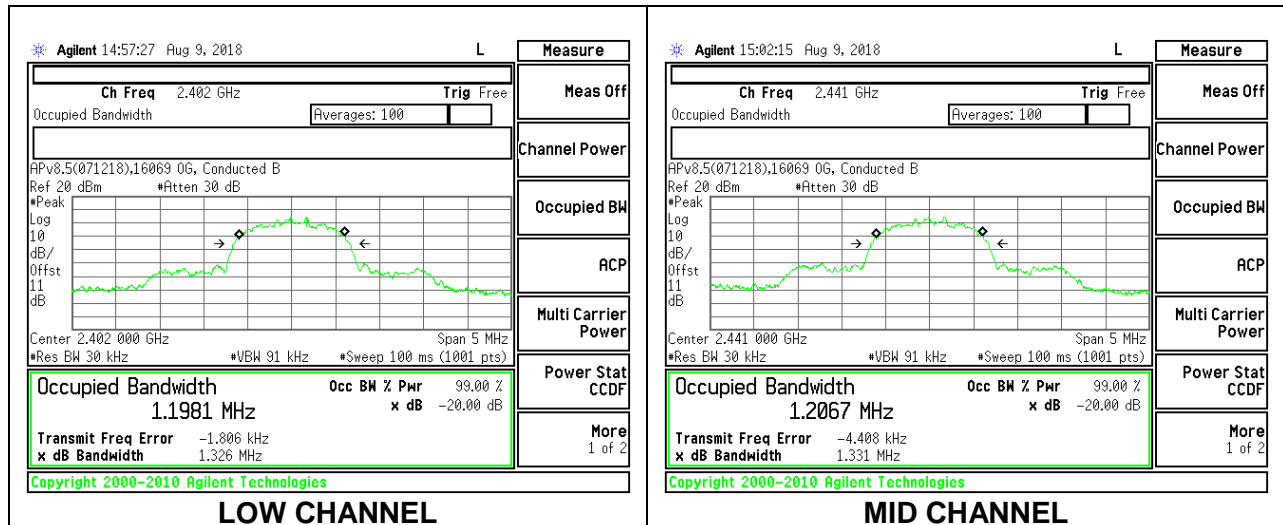

LOW CHANNEL

MID CHANNEL

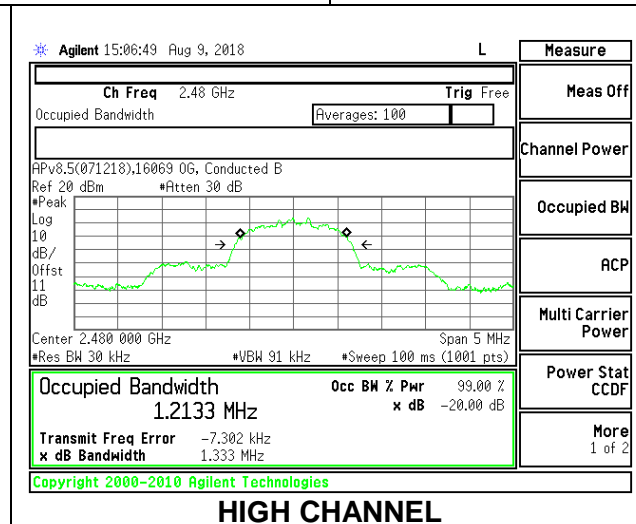

HIGH CHANNEL

9.3. HOPPING FREQUENCY SEPARATION

LIMITS

FCC §15.247 (a) (1)

Frequency hopping systems shall have hopping channel carrier frequencies separated by a minimum of 25 kHz or the 20 dB bandwidth of the hopping channel, whichever is greater.

Alternatively, frequency hopping systems operating in the 2400-2483.5 MHz band may have hopping channel carrier frequencies that are separated by 25 kHz or two-thirds of the 20 dB bandwidth of the hopping channel, whichever is greater, provided the systems operate with an output power no greater than 125 mW.

TEST PROCEDURE

The transmitter output is connected to a spectrum analyzer. The RBW is set to 300 kHz and the VBW is set to 300 kHz. The sweep time is coupled.

RESULTS

9.3.1. BLUETOOTH BASIC DATA RATE GFSK MODULATION

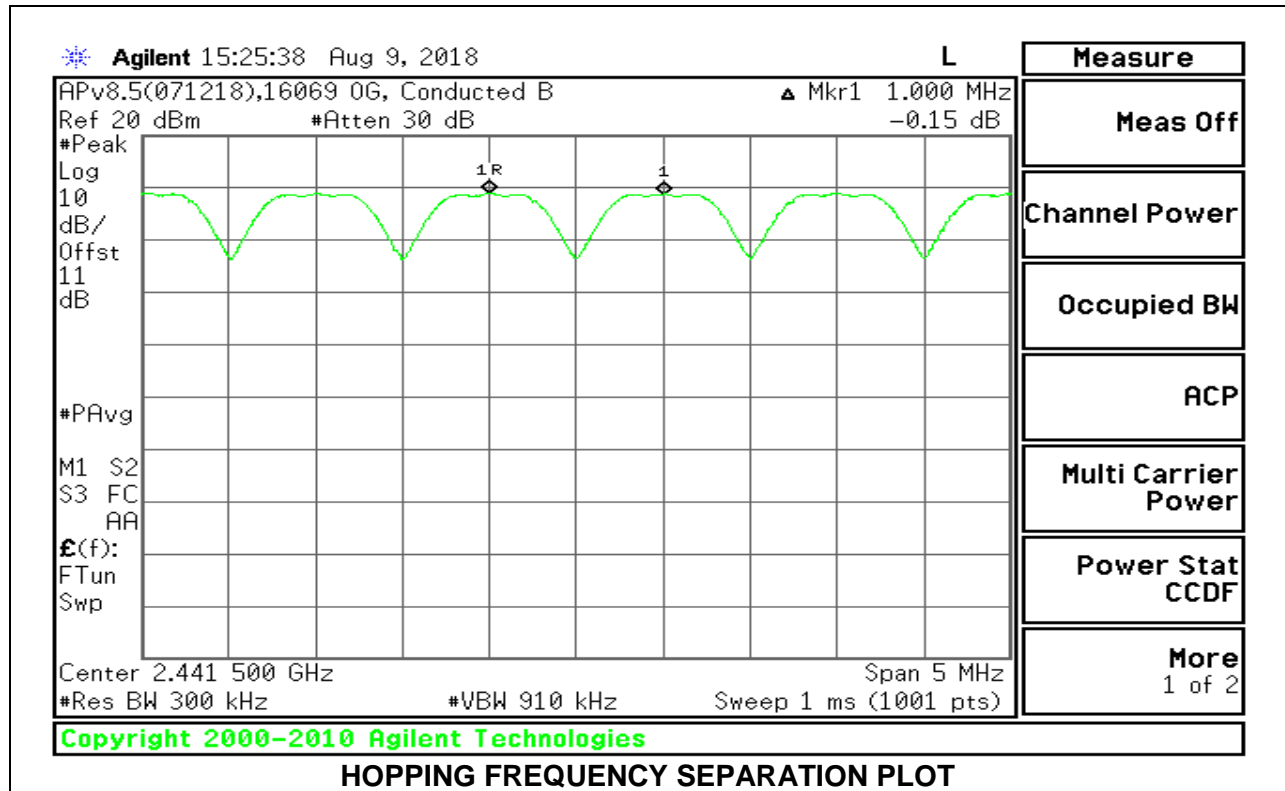

9.3.2. BLUETOOTH ENHANCED DATA RATE 8PSK MODULATION

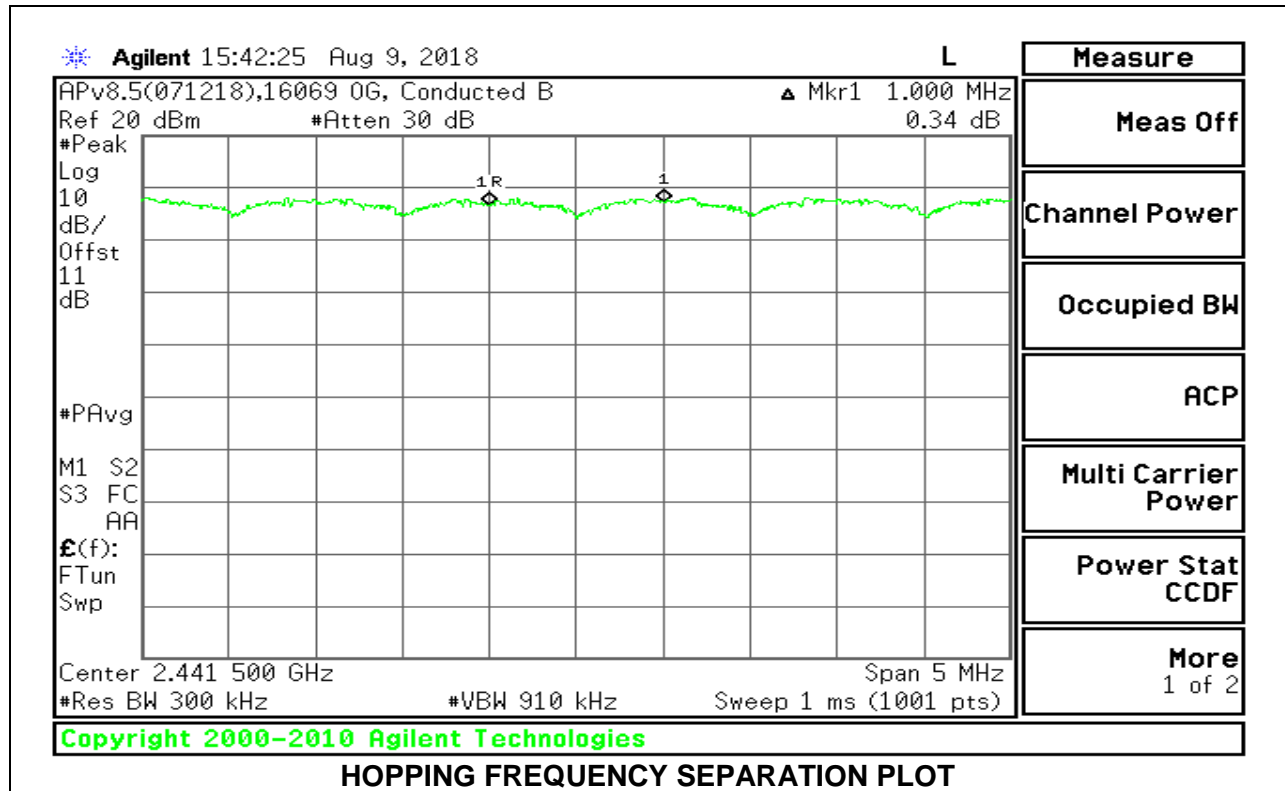

9.4. NUMBER OF HOPPING CHANNELS

LIMITS

FCC §15.247 (a) (1) (iii)

Frequency hopping systems in the 2400 – 2483.5 MHz band shall use at least 15 non-overlapping channels.

TEST PROCEDURE

The transmitter output is connected to a spectrum analyzer. The span is set to cover the entire authorized band, in either a single sweep or in multiple contiguous sweeps. The RBW is set to a maximum of 1 % of the span. The analyzer is set to Max Hold.

RESULTS

Normal Mode: 79 Channels Observed

9.4.1. BLUETOOTH BASIC DATA RATE GFSK MODULATION

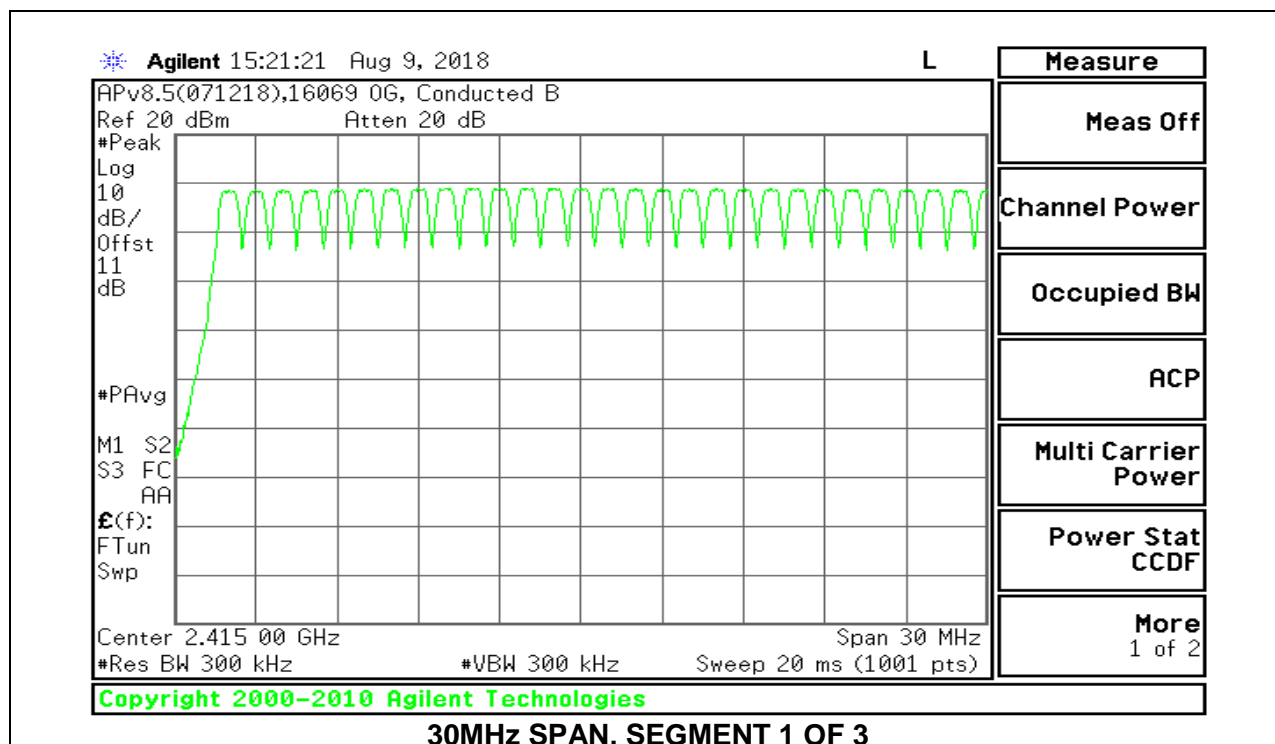
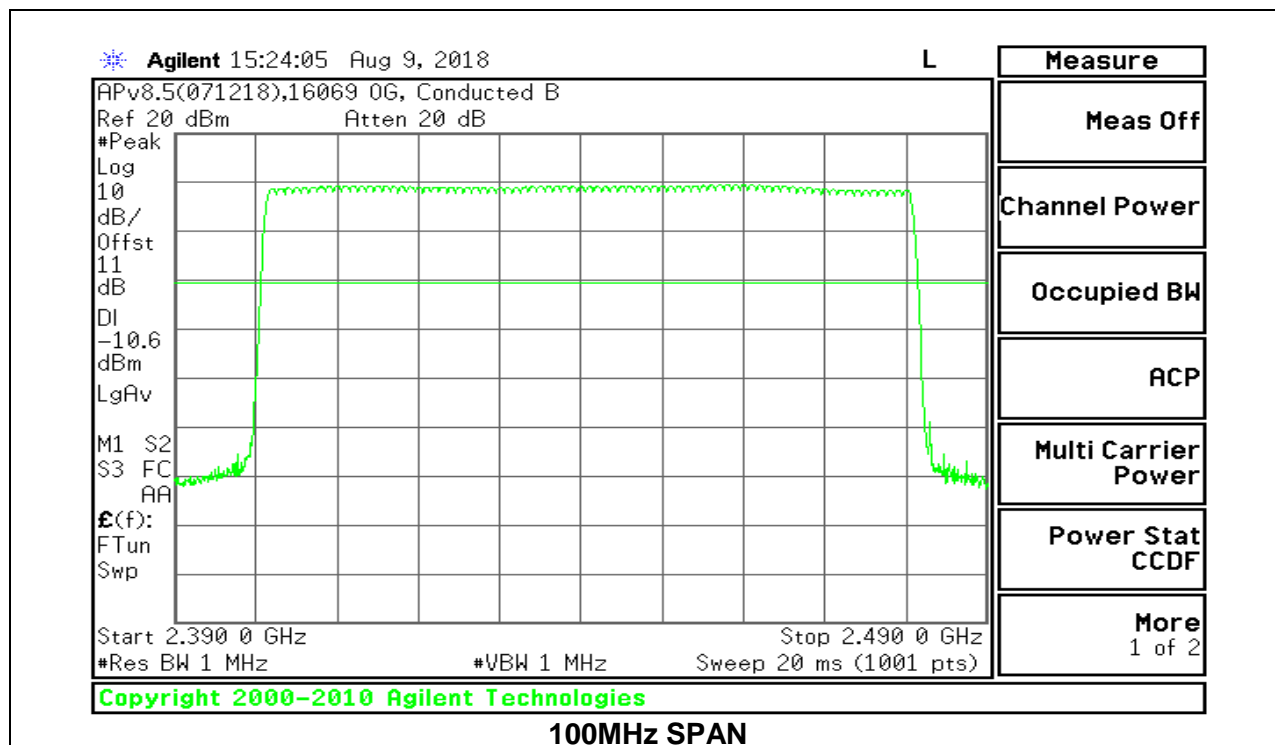

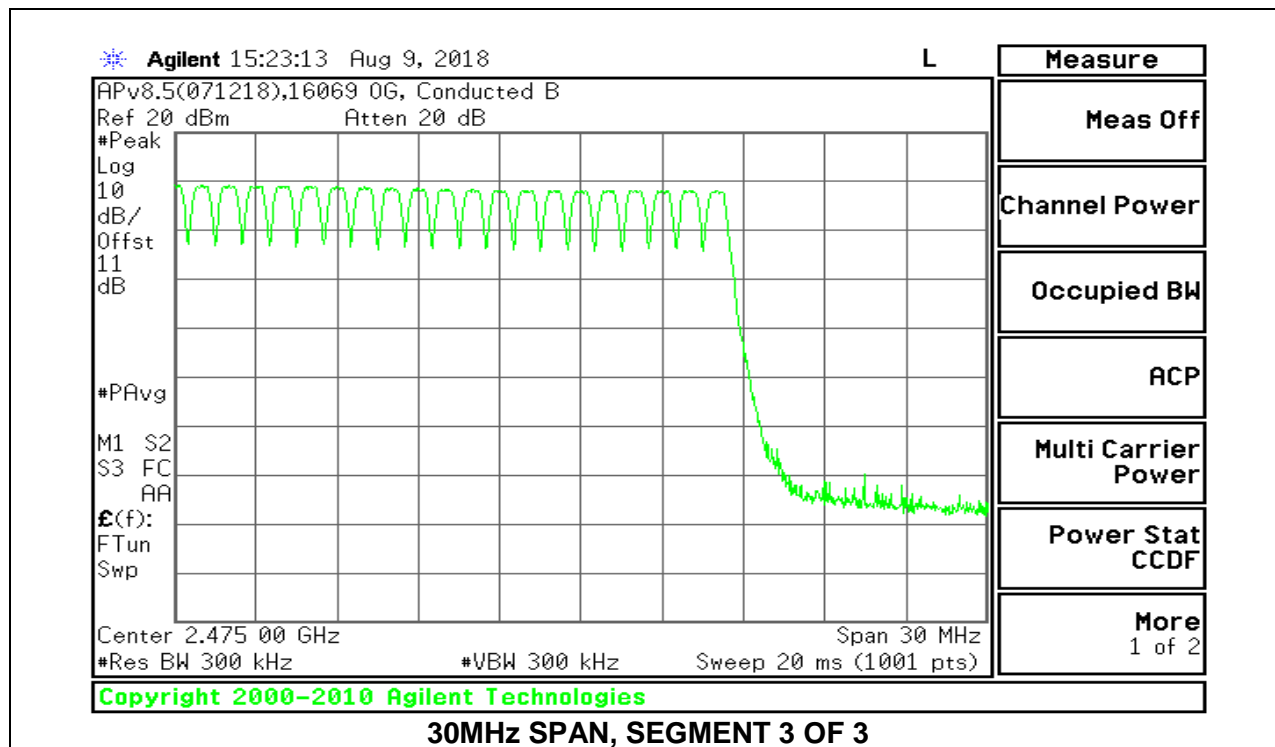
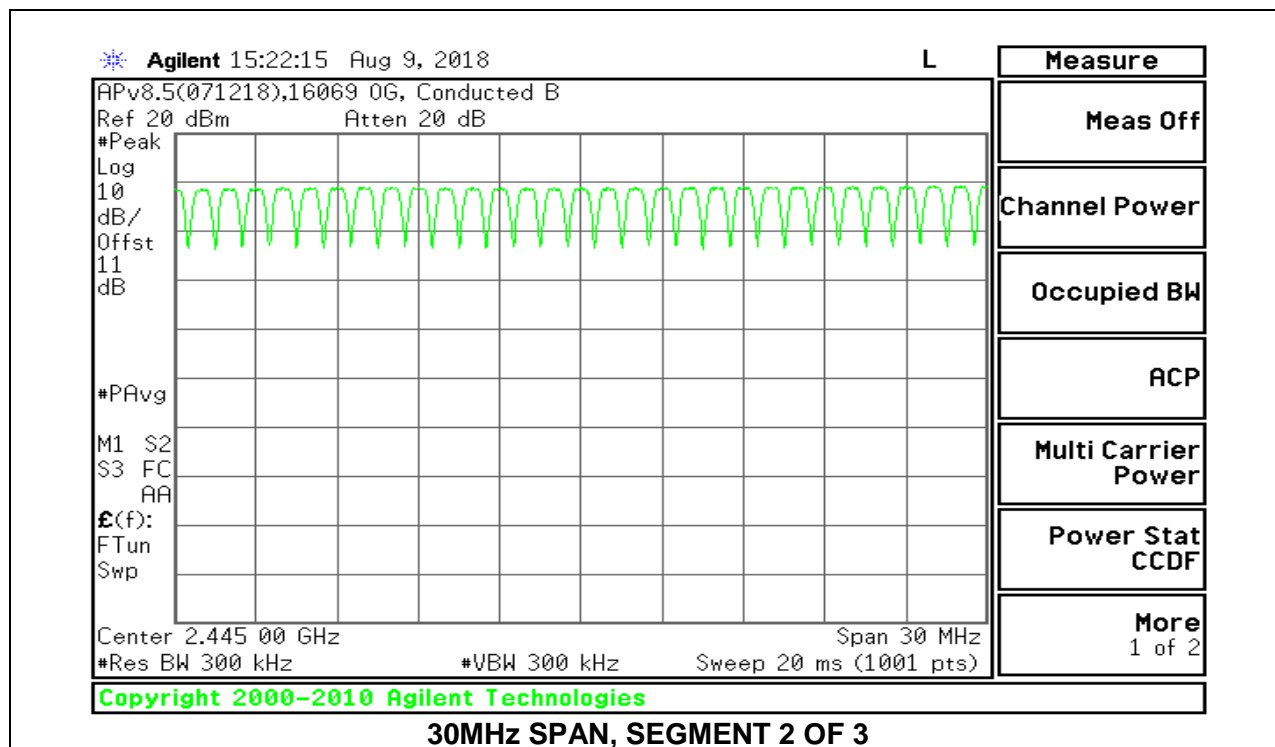

9.4.2. BLUETOOTH ENHANCED DATA RATE 8PSK MODULATION

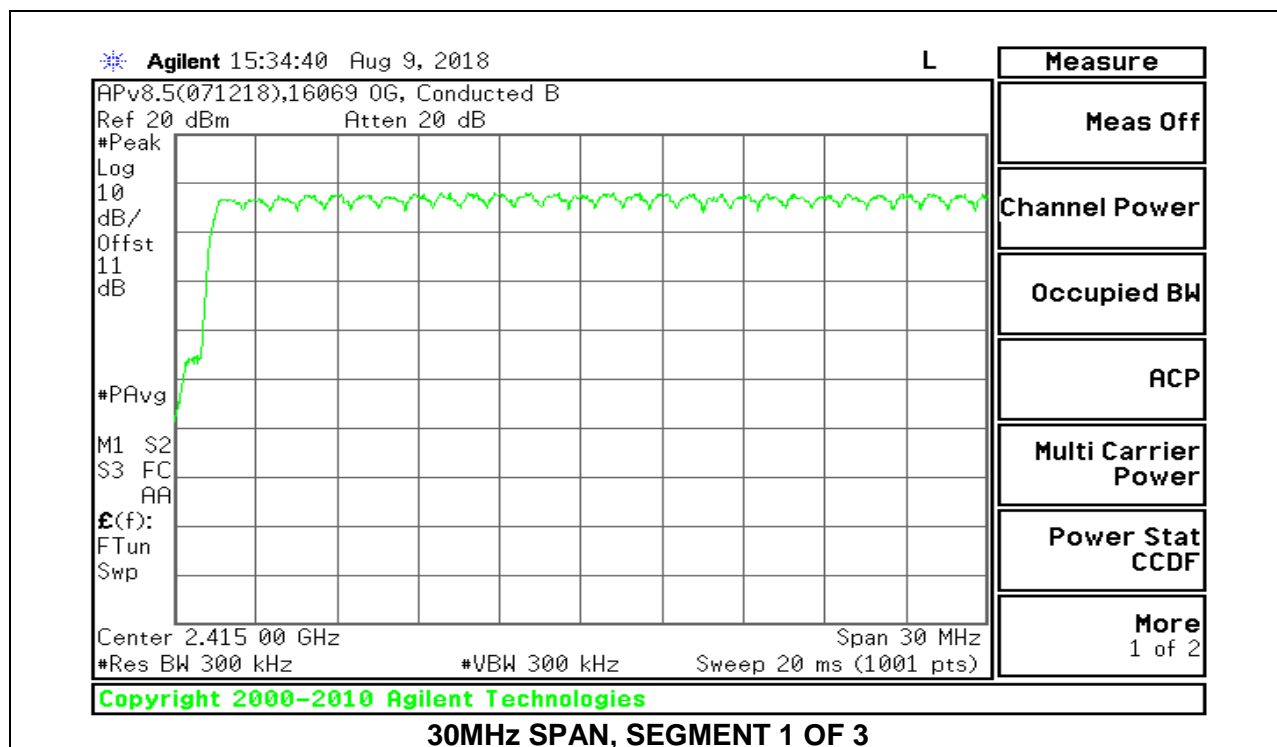
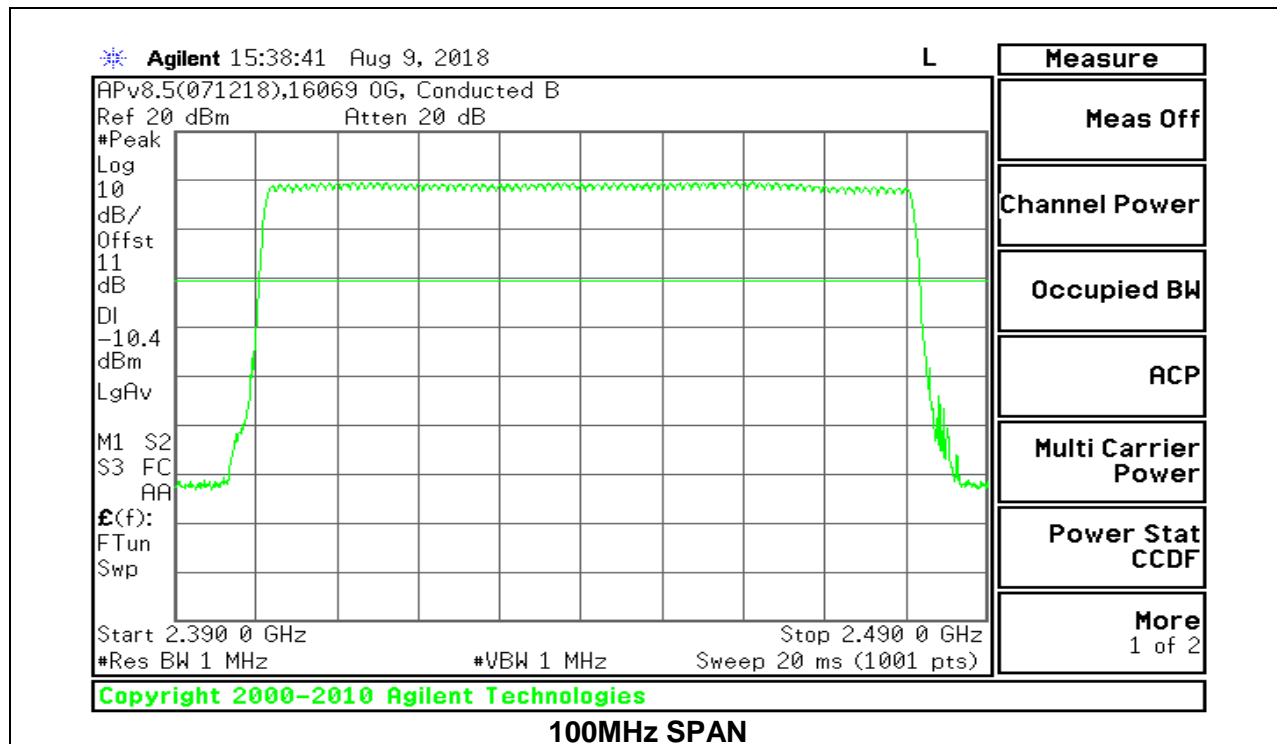

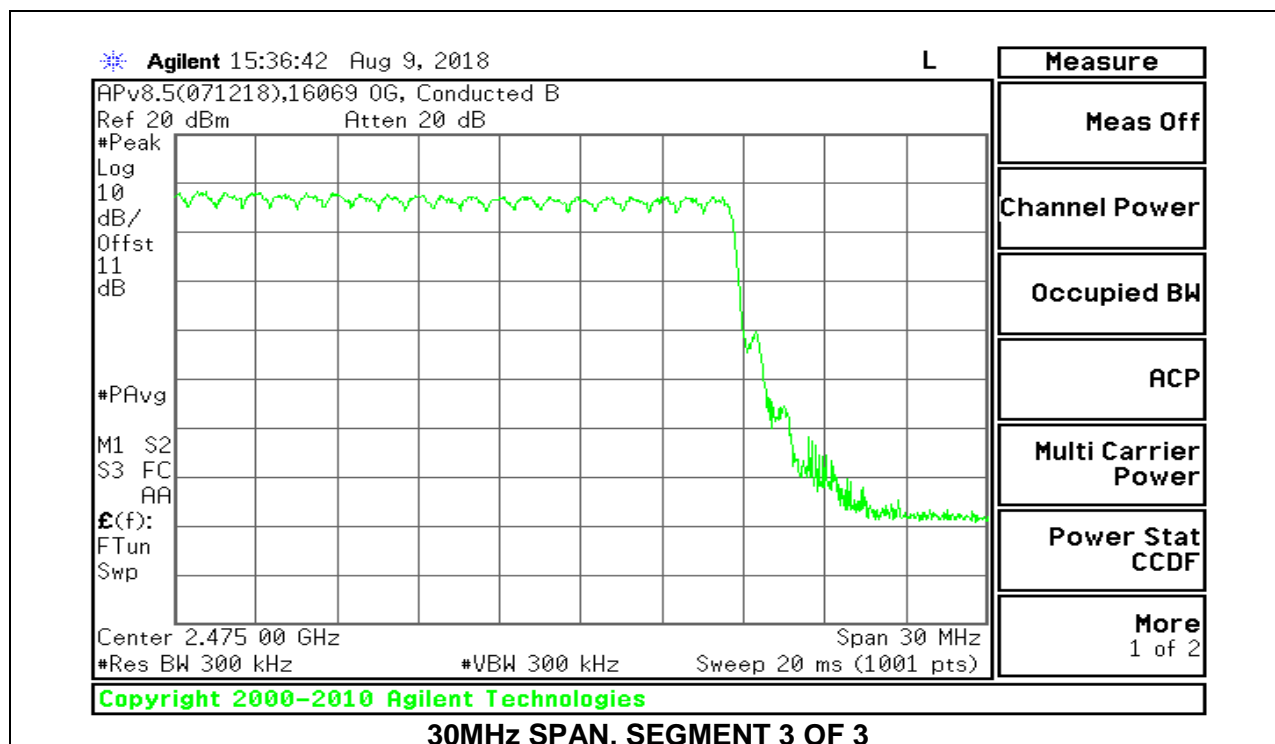
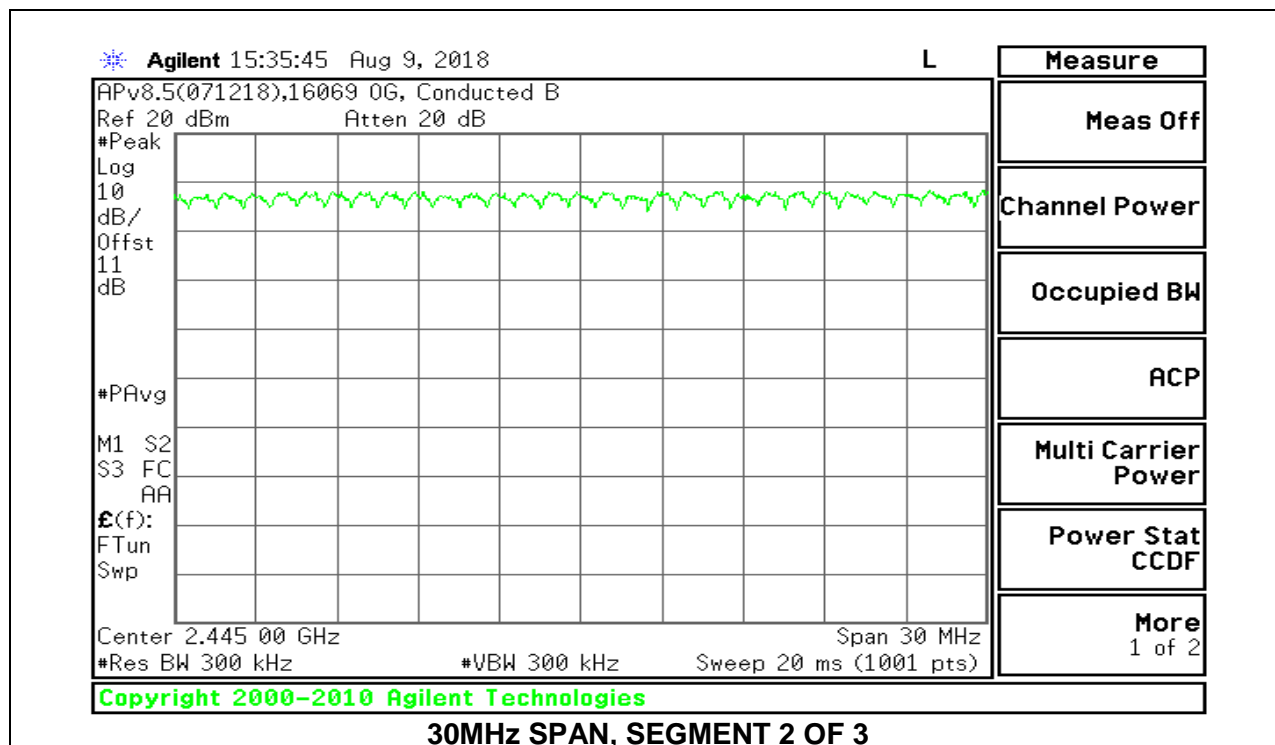

9.5. AVERAGE TIME OF OCCUPANCY

LIMITS

FCC §15.247 (a) (1) (iii)

The average time of occupancy on any channel shall not be greater than 0.4 seconds within a period of 0.4 seconds multiplied by the number of hopping channels employed.

TEST PROCEDURE

The transmitter output is connected to a spectrum analyzer. The span is set to 0 Hz, centered on a single, selected hopping channel. The width of a single pulse is measured in a fast scan. The number of pulses is measured in a 3.16 second scan, to enable resolution of each occurrence.

The average time of occupancy in the specified 3.16 second period (79 channels * 0.4 s) is equal to $10 * (\# \text{ of pulses in } 3.16 \text{ s}) * \text{ pulse width}$.

For AFH mode, the average time of occupancy in the specified 8 second period (20 channels * 0.4 seconds) is equal to $10 * (\# \text{ of pulses in } 0.8 \text{ s}) * \text{ pulse width}$.

RESULTS

9.5.1. BLUETOOTH BASIC DATA RATE GFSK MODULATION

DH Packet	Pulse Width (msec)	Number of Pulses in 3.16 seconds	Average Time of Occupancy (sec)	Limit (sec)	Margin (sec)
GFSK Normal Mode					
DH1	0.381	31	0.1181	0.4	-0.2819
DH3	1.637	18	0.2947	0.4	-0.1053
DH5	2.885	13	0.3751	0.4	-0.0250
DH Packet	Pulse Width (sec)	Number of Pulses in 0.8 seconds	Average Time of Occupancy (sec)	Limit (sec)	Margin (sec)
GFSK AFH Mode					
DH1	0.381	7.75	0.02953	0.4	-0.3705
DH3	1.637	4.5	0.07367	0.4	-0.3263
DH5	2.885	3.25	0.09376	0.4	-0.3062

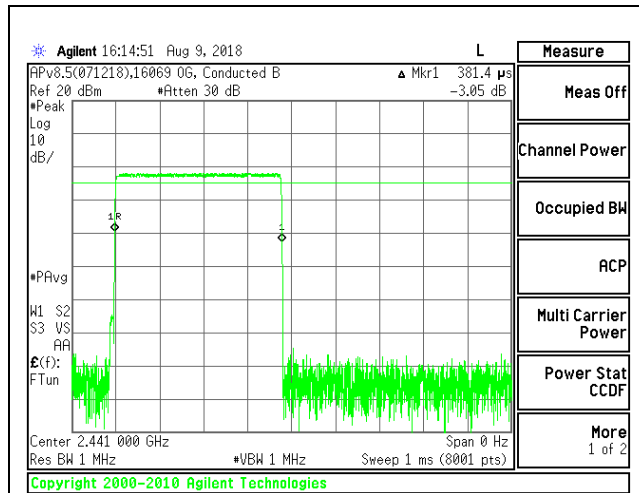

PULSE WIDTH - DH1

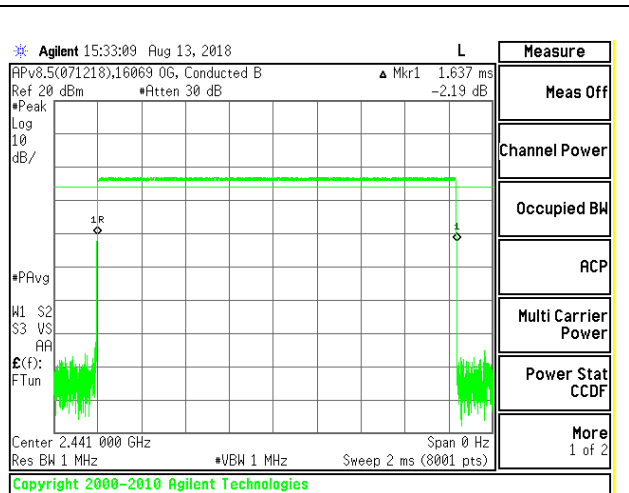

PULSE WIDTH - DH3

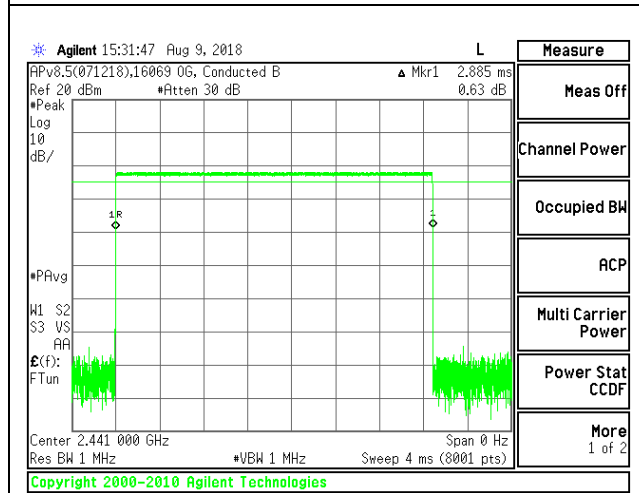

PULSE WIDTH - DH5

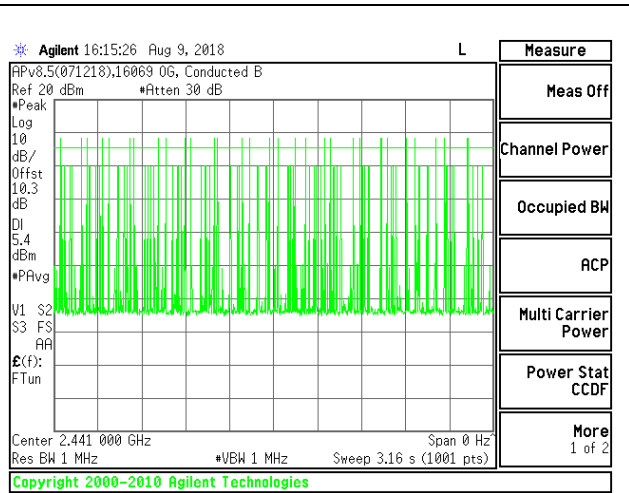

NUMBER OF PULSES IN 3.16 SECOND OBSERVATION PERIOD - DH1

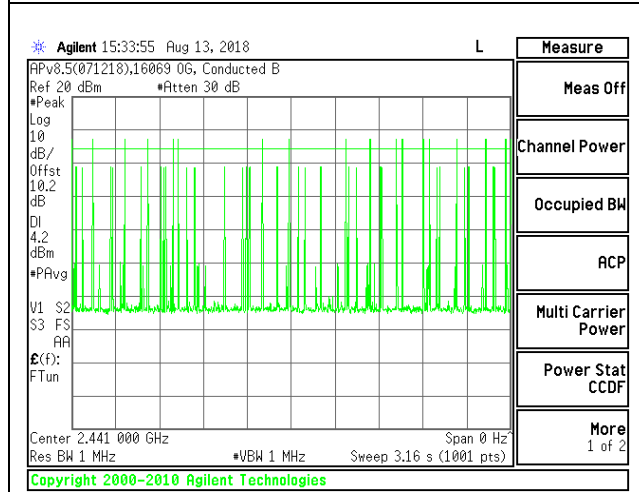

NUMBER OF PULSES IN 3.16 SECOND OBSERVATION PERIOD - DH3

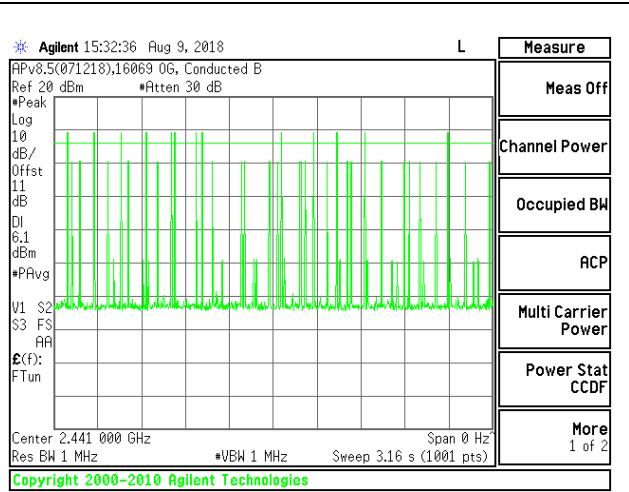

NUMBER OF PULSES IN 3.16 SECOND OBSERVATION PERIOD - DH5

9.5.2. BLUETOOTH ENHANCED DATA RATE 8PSK MODULATION

DH Packet	Pulse Width (msec)	Number of Pulses in 3.16 seconds	Average Time of Occupancy (sec)	Limit (sec)	Margin (sec)
8PSK Normal Mode					
DH1	0.393	32	0.12576	0.4	-0.27424
DH3	1.642	15	0.2463	0.4	-0.1537
DH5	2.892	11	0.31812	0.4	-0.08188

Note: for AFH(8PSK) mode, please refer to the results of AFH(GFSK) mode; the channel selection and hopping rate are the same for both EDR and Basic Rate operation, data for Basic Rate in section 4.5.1 demonstrates compliance with channel occupancy when AFH is employed.

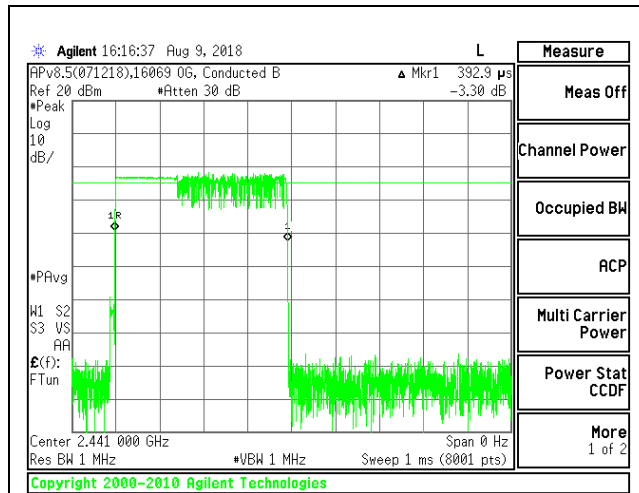

PULSE WIDTH - DH1

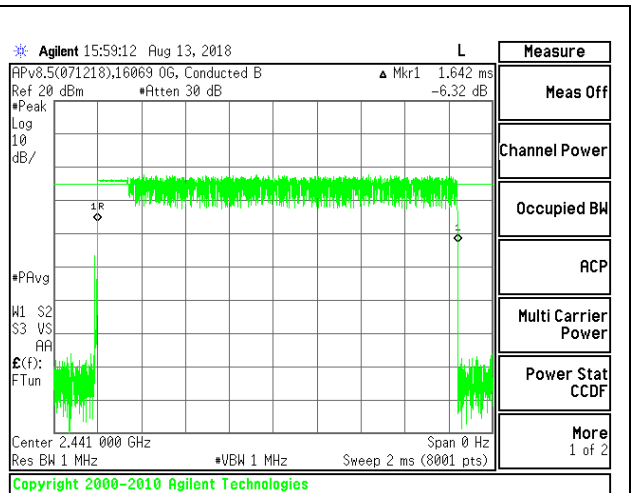

PULSE WIDTH - DH3

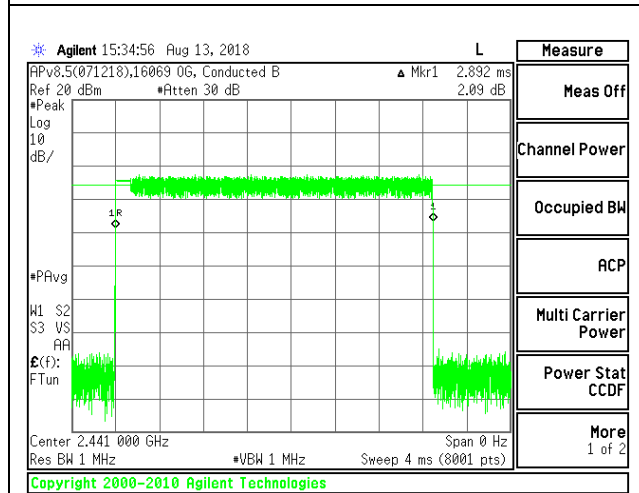

PULSE WIDTH - DH5

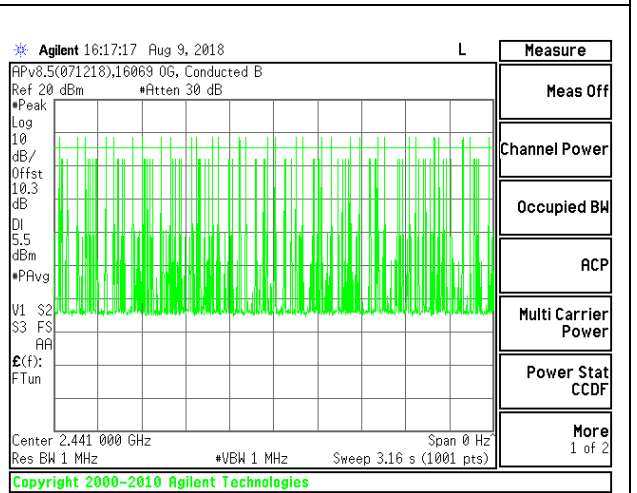

NUMBER OF PULSES IN 3.16 SECOND OBSERVATION PERIOD - DH1

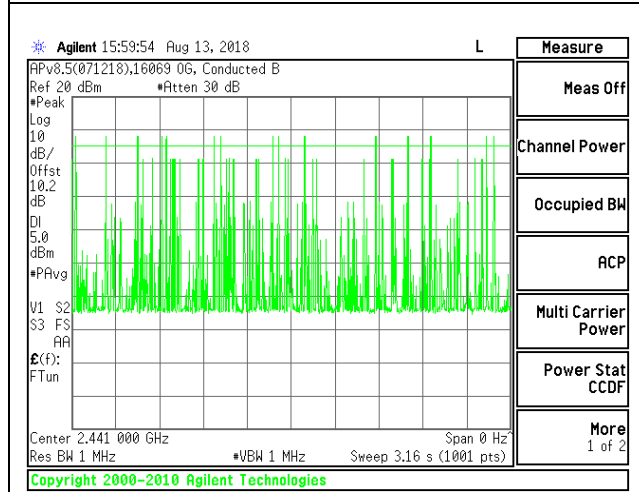

NUMBER OF PULSES IN 3.16 SECOND OBSERVATION PERIOD - DH3

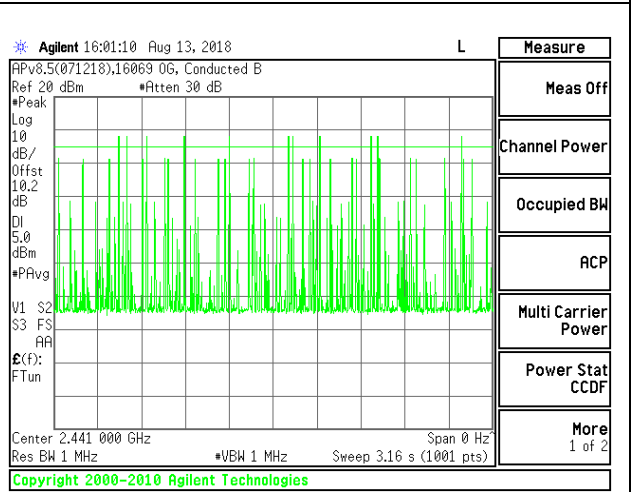

NUMBER OF PULSES IN 3.16 SECOND OBSERVATION PERIOD - DH5

9.6. OUTPUT POWER

LIMITS

§15.247 (b) (1)

The maximum antenna gain is less than 6 dBi, therefore the limit is 30 dBm. Alternatively, frequency hopping systems operating in the 2400-2483.5 MHz band may have hopping channel carrier frequencies that are separated by 25 kHz or two-thirds of the 20 dB bandwidth of the hopping channel, whichever is greater, provided the systems operate with an output power no greater than 125 mW.

TEST PROCEDURE

The transmitter output is connected to a power meter. The cable assembly insertion loss was entered as an offset in the power meter to allow for a gated peak reading of power.

RESULTS

9.6.1. BLUETOOTH BASIC DATA RATE GFSK MODULATION

Tested By:	16069 OG
Date:	8/10/2018

Channel	Frequency (MHz)	Output Power (dBm)	Limit (dBm)	Margin (dB)
Low	2402	8.75	30	-21.25
Middle	2441	8.96	30	-21.04
High	2480	8.23	30	-21.77

9.6.2. BLUETOOTH ENHANCED DATA RATE 8PSK MODULATION

Tested By:	16069 OG
Date:	8/10/2018

Channel	Frequency (MHz)	Output Power (dBm)	Limit (dBm)	Margin (dB)
Low	2402	7.57	21	-13.43
Middle	2441	8.06	21	-12.94
High	2480	7.33	21	-13.67

9.7. AVERAGE POWER

LIMITS

None; for reporting purposes only

TEST PROCEDURE

The transmitter output is connected to a power meter. The cable assembly insertion loss of was entered as an offset in the power meter to allow for a gated average reading of power.

RESULTS

9.7.1. BLUETOOTH BASIC DATA RATE GFSK MODULATION

Tested By:	16069 OG
Date	8/10/2018

Channel	Frequency (MHz)	Average Power (dBm)
Low	2402	8.05
Middle	2441	8.33
High	2480	7.63

9.7.2. BLUETOOTH ENHANCED DATA RATE 8PSK MODULATION

Tested By:	16069 OG
Date	8/10/2018

Channel	Frequency (MHz)	Average Power (dBm)
Low	2402	7.35
Middle	2441	7.84
High	2480	7.13

9.8. CONDUCTED SPURIOUS EMISSIONS

LIMITS

FCC §15.247 (d)

Limit = -20 dBc

TEST PROCEDURE

The transmitter output is connected to a spectrum analyzer. The resolution bandwidth is set to 100 kHz. The video bandwidth is set to 300 kHz.

The spectrum from 30 MHz to 26 GHz is investigated with the transmitter set to the lowest, middle, and highest channels.

The bandedges at 2.4 and 2.4835 GHz are investigated with the transmitter set to the normal hopping mode.

RESULTS

9.8.1. BLUETOOTH BASIC DATA RATE GFSK MODULATION

SPURIOUS EMISSIONS, NON-HOPPING

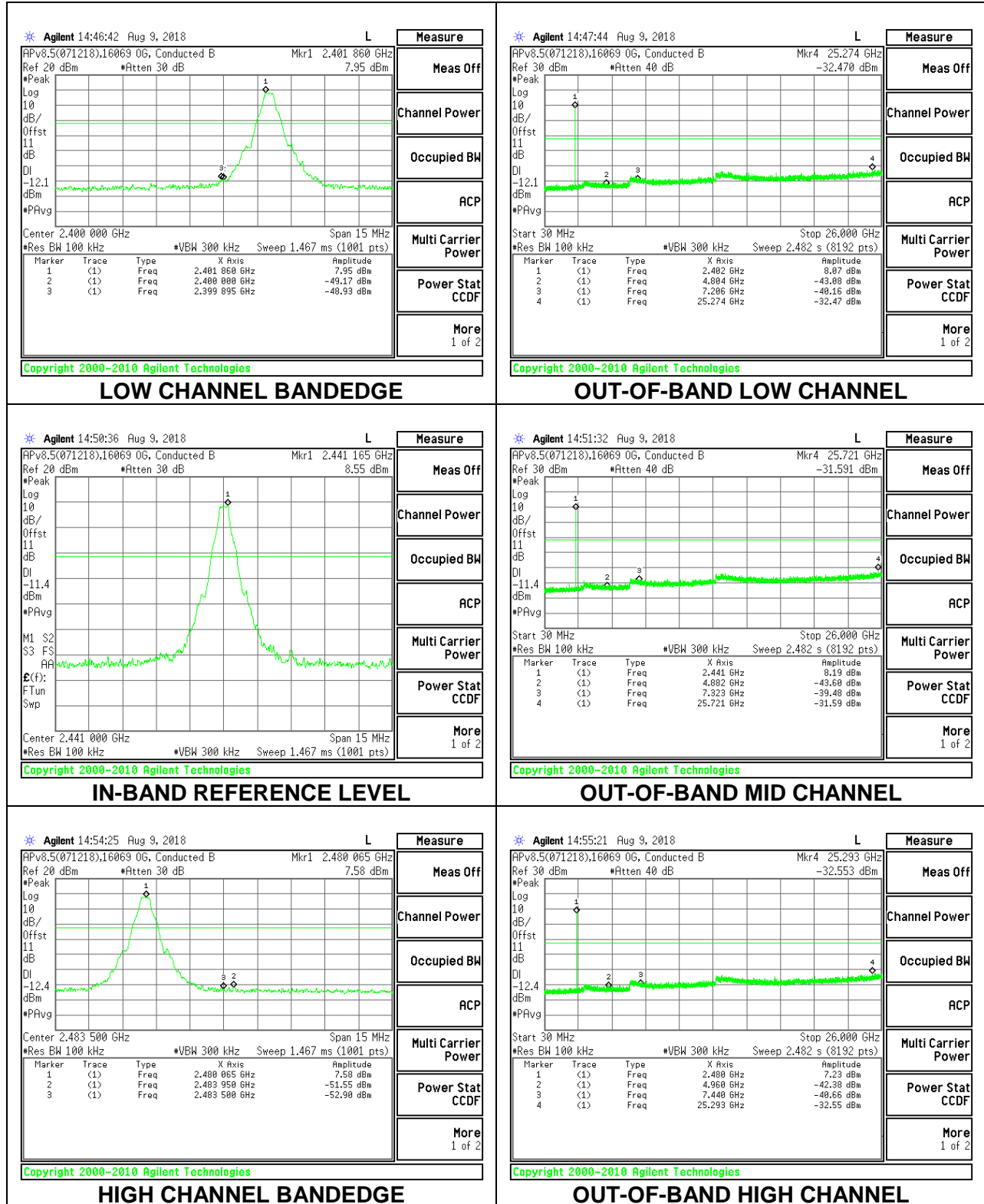

SPURIOUS BANDEGE EMISSIONS WITH HOPPING ON

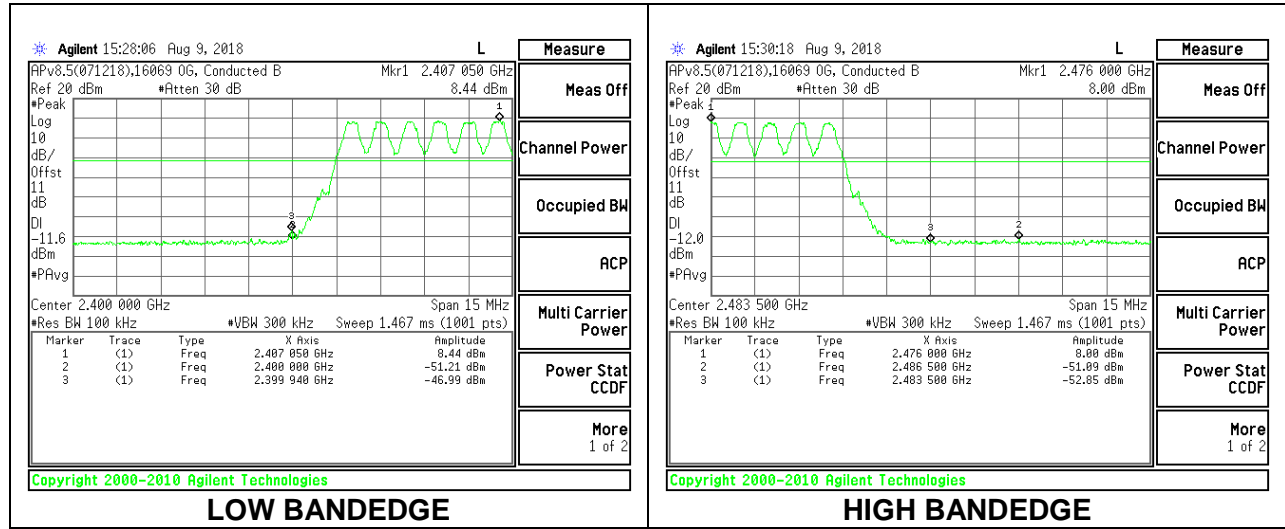

9.8.2. BLUETOOTH ENHANCED DATA RATE 8PSK MODULATION

SPURIOUS EMISSIONS, NON-HOPPING

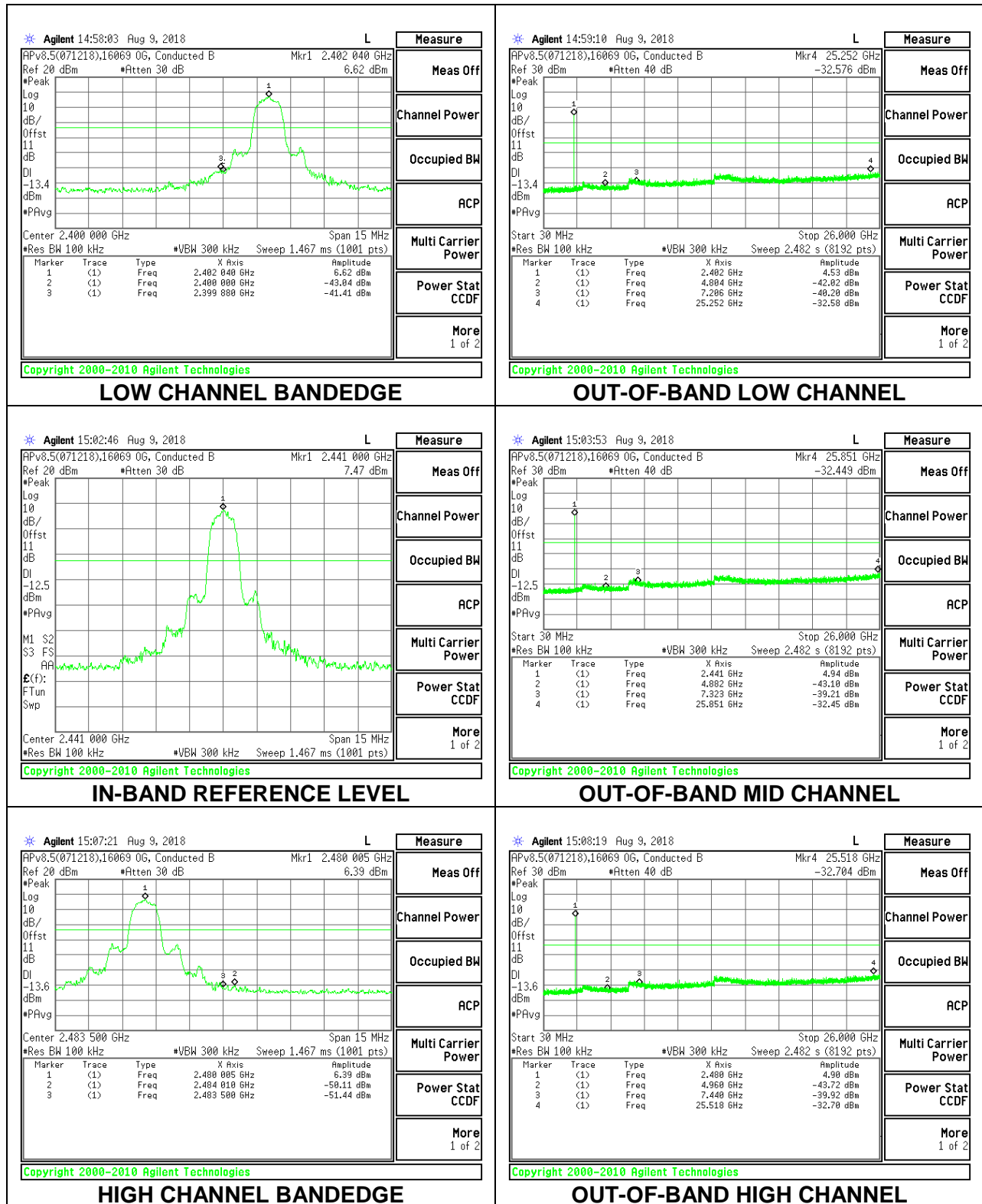

SPURIOUS BANDEGE EMISSIONS WITH HOPPING ON

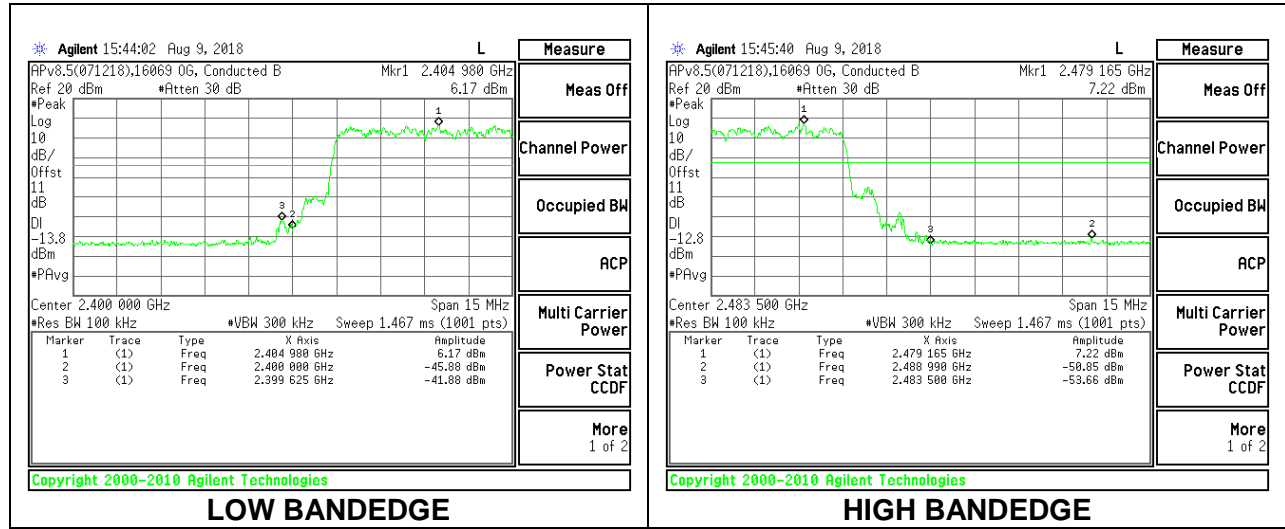

10. RADIATED TEST RESULTS

LIMITS

FCC §15.205 and §15.209

Frequency Range (MHz)	Field Strength Limit (uV/m) at 3 m	Field Strength Limit (dBuV/m) at 3 m
0.009-0.490	2400/F(kHz) @ 300 m	-
0.490-1.705	24000/F(kHz) @ 30 m	-
1.705 - 30	30 @ 30m	-
30 - 88	100	40
88 - 216	150	43.5
216 - 960	200	46
Above 960	500	54

TEST PROCEDURE

The EUT is placed on a non-conducting table 80 cm above the ground plane for measurement below 1GHz; 1.5 m above the ground plane for measurement above 1GHz. The antenna to EUT distance is 3 meters. The EUT is configured in accordance with ANSI C63.10. The EUT is set to transmit in a continuous mode.

For measurements below 1 GHz the resolution bandwidth is set to 100 kHz for peak detection measurements or 120 kHz for quasi-peak detection measurements. Peak detection is used unless otherwise noted as quasi-peak.

For pre-scans above 1 GHz the resolution bandwidth is set to 1 MHz; the video bandwidth is set to 30 KHz for peak measurements.

For measurements above 1 GHz the resolution bandwidth is set to 1 MHz, then the video bandwidth is set to 3 MHz for peak measurements and 1 MHz resolution bandwidth with 1/T (360Hz) video bandwidth with peak detector for average measurements.

The spectrum from 1 GHz to 18 GHz is investigated with the transmitter set to the lowest, middle, and highest channels in each applicable band. Below 1GHz and above 18GHz emissions, the channel with the highest output power was tested.

The frequency range of interest is monitored at a fixed antenna height and EUT azimuth. The EUT is rotated through 360 degrees to maximize emissions received. The antenna is scanned from 1 to 4 meters above the ground plane to further maximize the emission. Measurements are made with the antenna polarized in both the vertical and the horizontal positions.

10.1. TRANSMITTER ABOVE 1 GHz

10.1.1. BLUETOOTH BASIC DATA RATE GFSK MODULATION

BANDEDGE (LOW CHANNEL)

HORIZONTAL RESULT

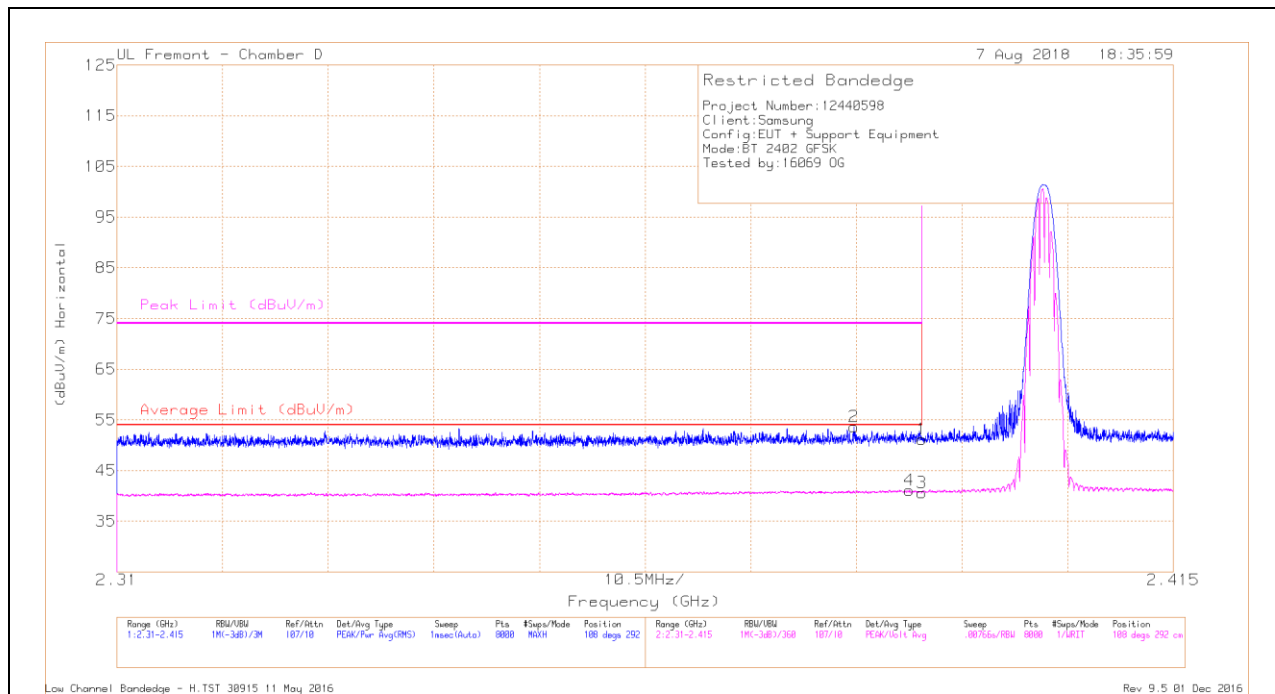

Trace Markers

Marker	Frequency (GHz)	Meter Reading (dBuV)	Det	AF T119 (dB/m)	Amp/Cbl/Filtr/Pad (dB)	Corrected Reading (dBuV/m)	Average Limit (dBuV/m)	Margin (dB)	Peak Limit (dBuV/m)	PK Margin (dB)	Azimuth (Degs)	Height (cm)	Polarity
1	* 2.39	39.56	Pk	32.1	-20.5	51.16	-	-	74	-22.84	108	292	H
2	* 2.383	41.89	Pk	32.2	-20.5	53.59	-	-	74	-20.41	108	292	H
3	* 2.39	29.05	VA1T	32.1	-20.5	40.65	54	-13.35	-	-	108	292	H
4	* 2.389	29.52	VA1T	32.1	-20.5	41.12	54	-12.88	-	-	108	292	H

* - indicates frequency in CFR47 Pt 15 / IC RSS-Restricted Band

Pk - Peak detector

VA1T - FHSS: Linear Voltage Average $VB=1/T_{on}$ where: T_{on} is transmit duration

VERTICAL RESULT

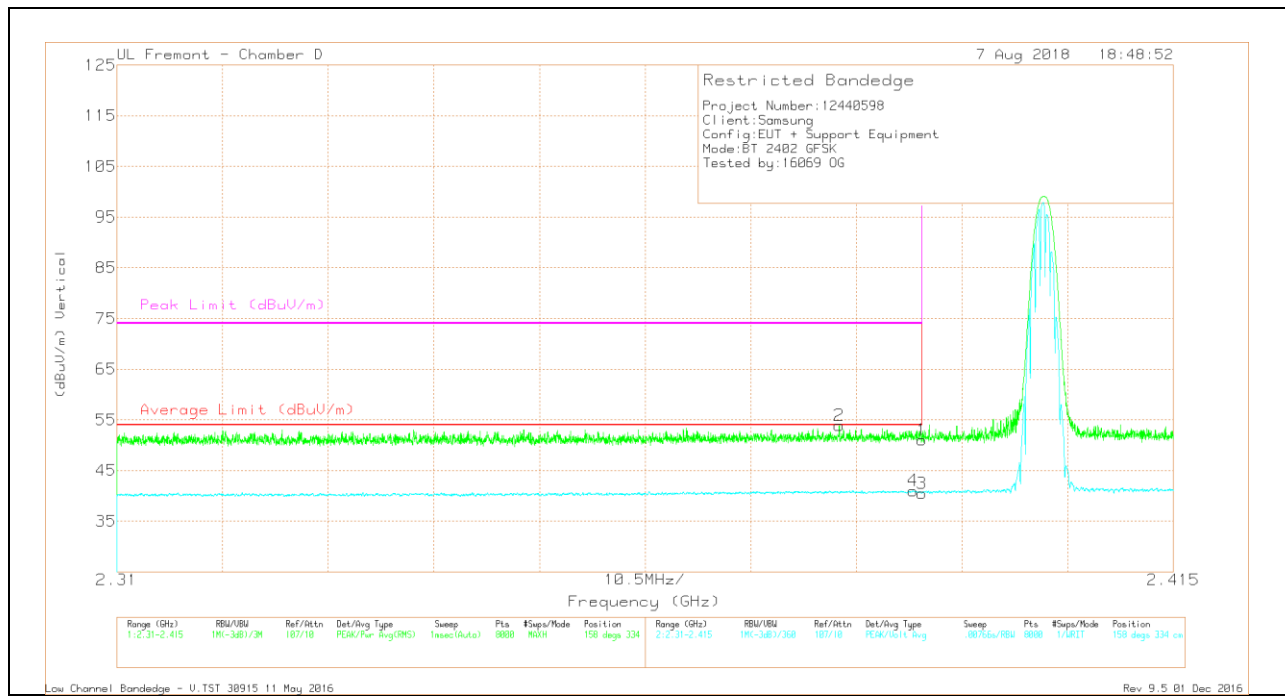

Trace Markers

Marker	Frequency (GHz)	Meter Reading (dBuV)	Det	AF T119 (dB/m)	Amp/Cbl/Filtr/Pad (dB)	Corrected Reading (dBuV/m)	Average Limit (dBuV/m)	Margin (dB)	Peak Limit (dBuV/m)	PK Margin (dB)	Azimuth (Degs)	Height (cm)	Polarity
1	* 2.39	39.39	Pk	32.1	-20.5	50.99	-	-	74	-23.01	158	334	V
2	* 2.382	42.24	Pk	32.1	-20.5	53.84	-	-	74	-20.16	158	334	V
3	* 2.39	28.88	VA1T	32.1	-20.5	40.48	54	-13.52	-	-	158	334	V
4	* 2.389	29.44	VA1T	32.1	-20.5	41.04	54	-12.96	-	-	158	334	V

* - indicates frequency in CFR47 Pt 15 / IC RSS-Restricted Band

Pk - Peak detector

VA1T - FHSS: Linear Voltage Average $V_B=1/T_{on}$ where: T_{on} is transmit duration

BANDEDGE (HIGH CHANNEL)

HORIZONTAL RESULT

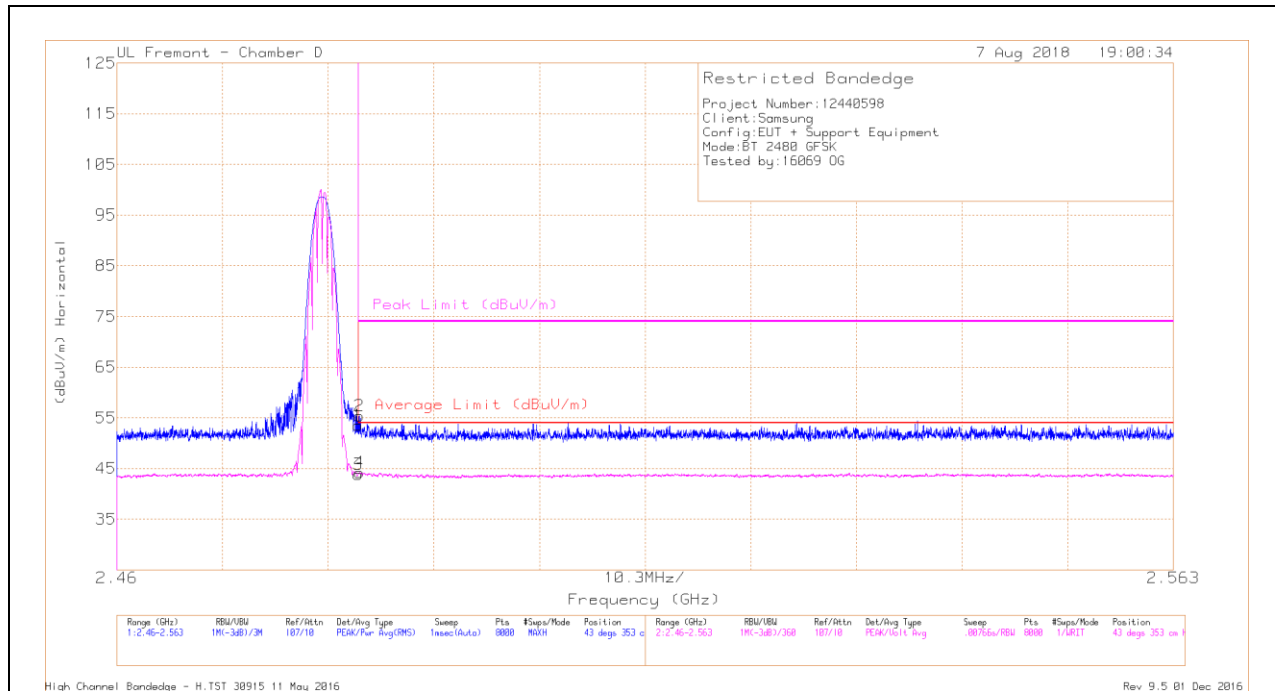

Trace Markers

Marker	Frequency (GHz)	Meter Reading (dBuV)	Det	AF T119 (dB/m)	Amp/Cbl/Filtr/Pad (dB)	Corrected Reading (dBuV/m)	Average Limit (dBuV/m)	Margin (dB)	Peak Limit (dBuV/m)	PK Margin (dB)	Azimuth (Degs)	Height (cm)	Polarity
1	* 2.484	41.42	Pk	32.5	-20.4	53.52	-	-	74	-20.48	43	353	H
2	* 2.484	43.42	Pk	32.5	-20.5	55.42	-	-	74	-18.58	43	353	H
3	* 2.484	31.75	VA1T	32.5	-20.4	43.85	54	-10.15	-	-	43	353	H
4	* 2.484	32.22	VA1T	32.5	-20.5	44.22	54	-9.78	-	-	43	353	H

* - indicates frequency in CFR47 Pt 15 / IC RSS-Restricted Band

Pk - Peak detector

VA1T - FHSS: Linear Voltage Average VB=1/Ton where: Ton is transmit duration

VERTICAL RESULT

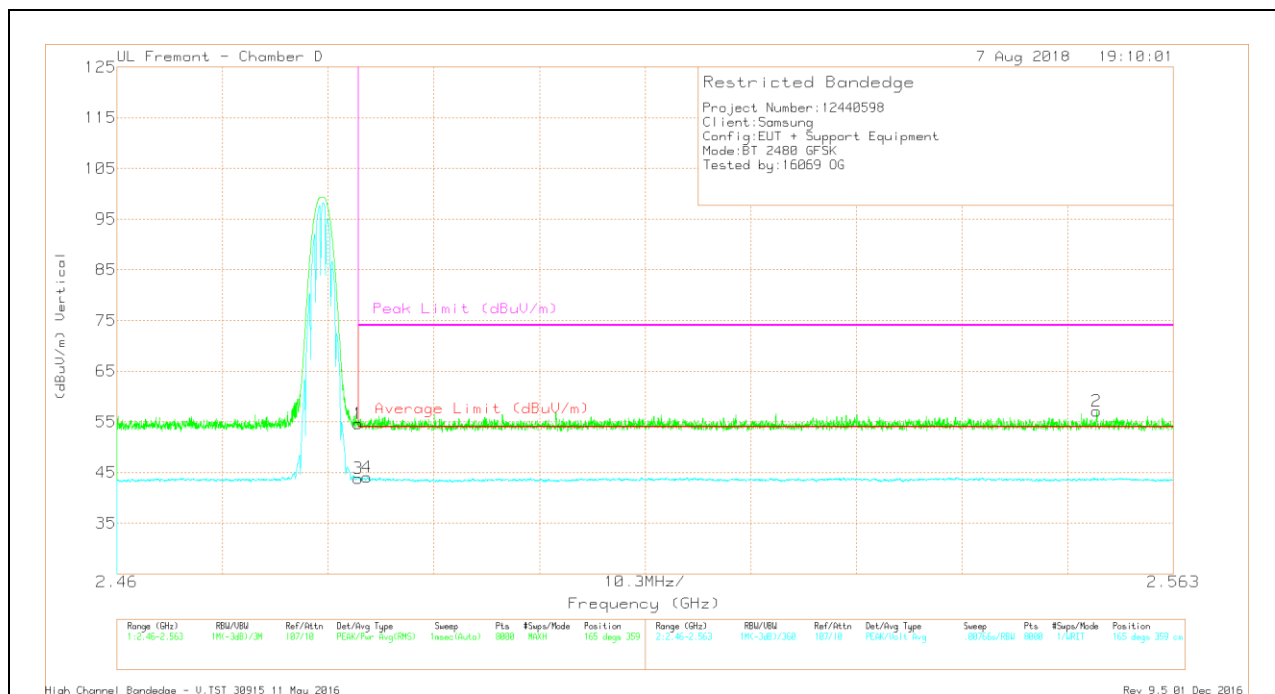

Trace Markers

Marker	Frequency (GHz)	Meter Reading (dBuV)	Det	AF T119 (dB/m)	Amp/Cbl/Filtr/Pad (dB)	Corrected Reading (dBuV/m)	Average Limit (dBuV/m)	Margin (dB)	Peak Limit (dBuV/m)	PK Margin (dB)	Azimuth (Degs)	Height (cm)	Polarity
1	* 2.484	42.54	Pk	32.5	-20.4	54.64	-	-	74	-19.36	165	359	V
3	* 2.484	31.79	VA1T	32.5	-20.4	43.89	54	-10.11	-	-	165	359	V
4	* 2.484	32.04	VA1T	32.5	-20.5	44.04	54	-9.96	-	-	165	359	V
2	2.556	44.78	Pk	32.6	-20.3	57.08	-	-	74	-16.92	165	359	V

* - indicates frequency in CFR47 Pt 15 / IC RSS-Restricted Band

Pk - Peak detector

VA1T - FHSS: Linear Voltage Average VB=1/Ton where: Ton is transmit duration

HARMONICS AND SPURIOUS EMISSIONS

LOW CHANNEL RESULTS

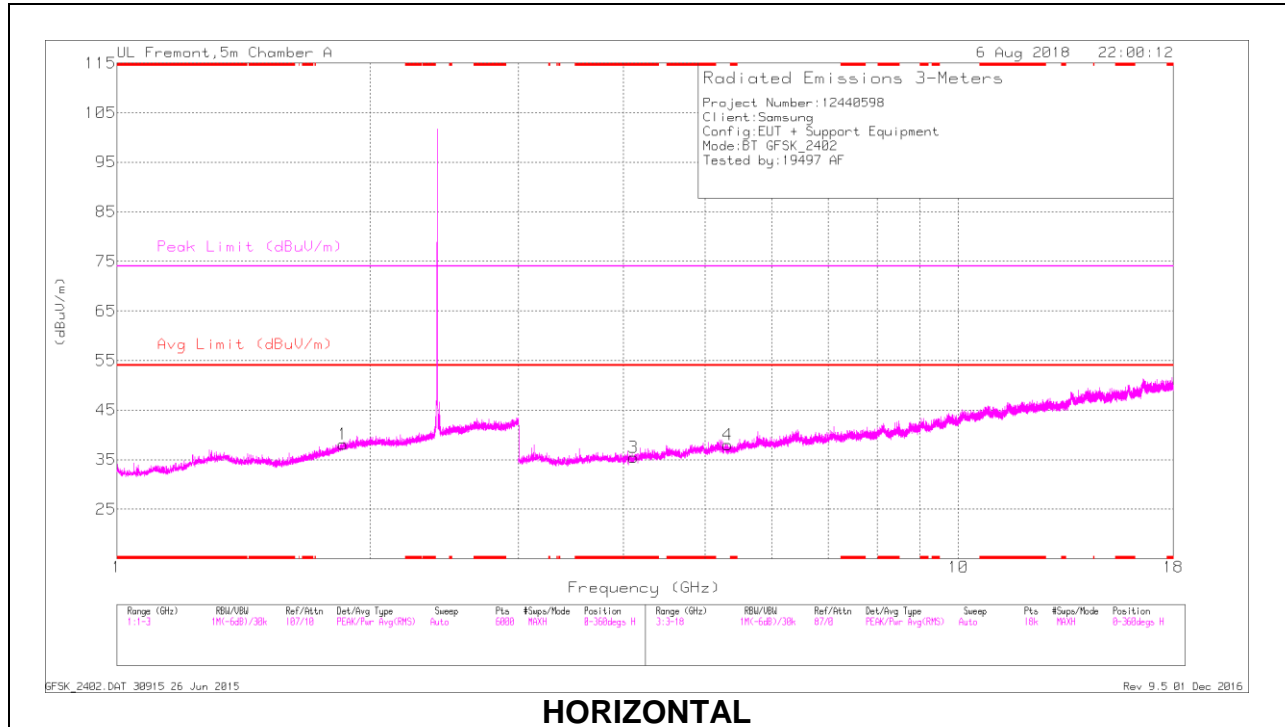

HORIZONTAL

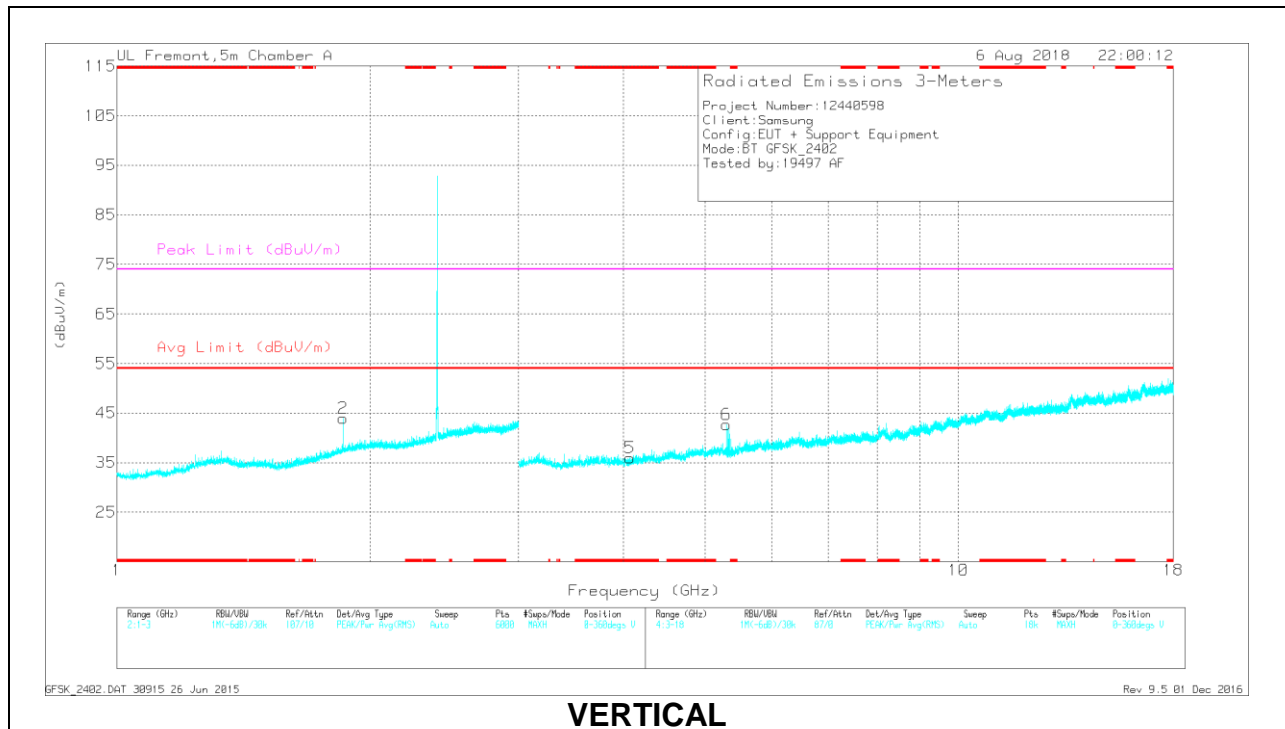

VERTICAL

RADIATED EMISSIONS

Marker	Frequency (GHz)	Meter Reading (dBuV)	Det	AF T345 (dB/m)	Amp/Cbl/Filtr/Pad (dB)	Corrected Reading (dBuV/m)	Avg Limit (dBuV/m)	Margin (dB)	Peak Limit (dBuV/m)	PK Margin (dB)	Azimuth (Degs)	Height (cm)	Polarity
3	* 4.108	34.52	PKFH	33.4	-27.6	40.32	-	-	74	-33.68	355	122	H
	* 4.111	23.97	VA1T	33.4	-27.6	29.77	54	-24.23	-	-	355	122	H
5	* 4.07	34.75	PKFH	33.4	-27.7	40.45	-	-	74	-33.55	241	126	V
	* 4.069	24.18	VA1T	33.4	-27.7	29.88	54	-24.12	-	-	241	126	V
1	1.855	34.76	PKFH	30.9	-22.9	42.76	-	-	-	-	82	342	H
2	1.857	34.97	PKFH	30.9	-22.9	42.97	-	-	-	-	139	360	V
6	5.298	34.95	PKFH	34.6	-26.4	43.15	-	-	-	-	169	148	V
4	5.32	34.85	PKFH	34.6	-26.5	42.95	-	-	-	-	122	239	H

* - indicates frequency in CFR47 Pt 15 / IC RSS-Restricted Band

PKFH - FHSS: RB=100k/1MHz VB=3 x RB, Peak

VA1T - FHSS: Linear Voltage Average VB=1/Ton where: Ton is transmit duration

MID CHANNEL RESULTS

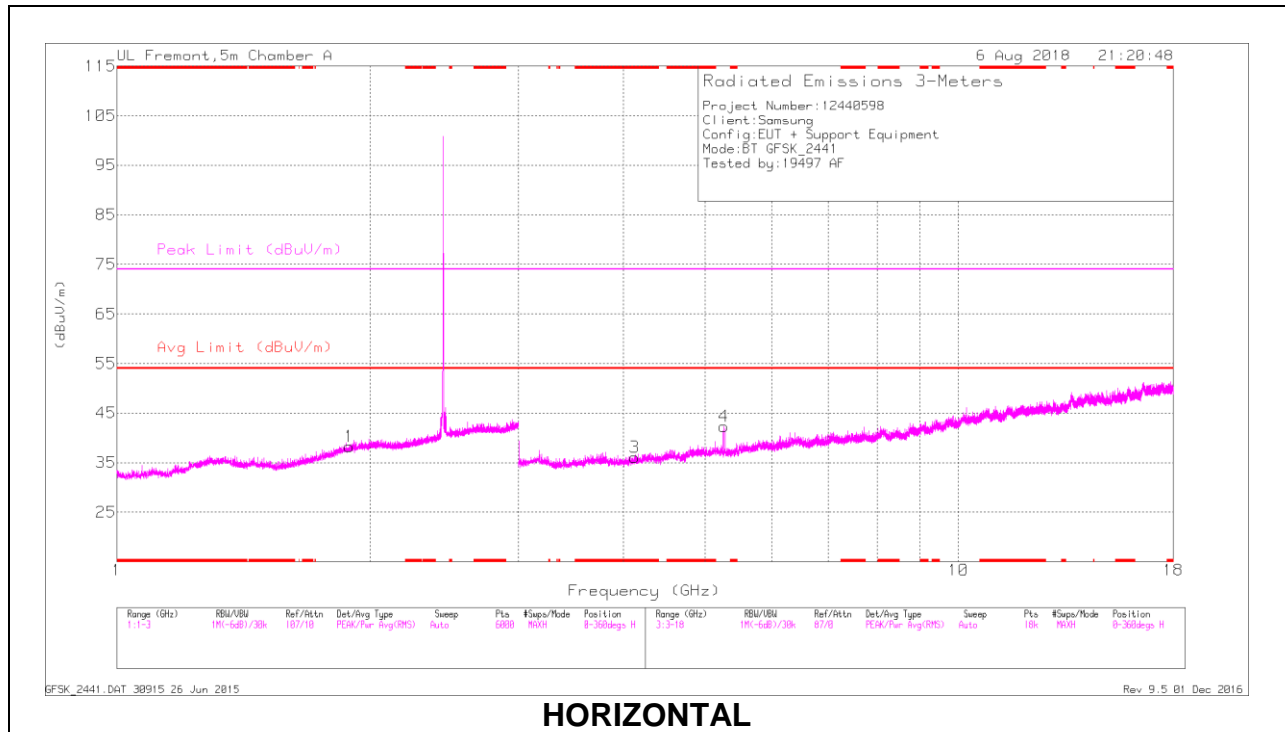

HORIZONTAL

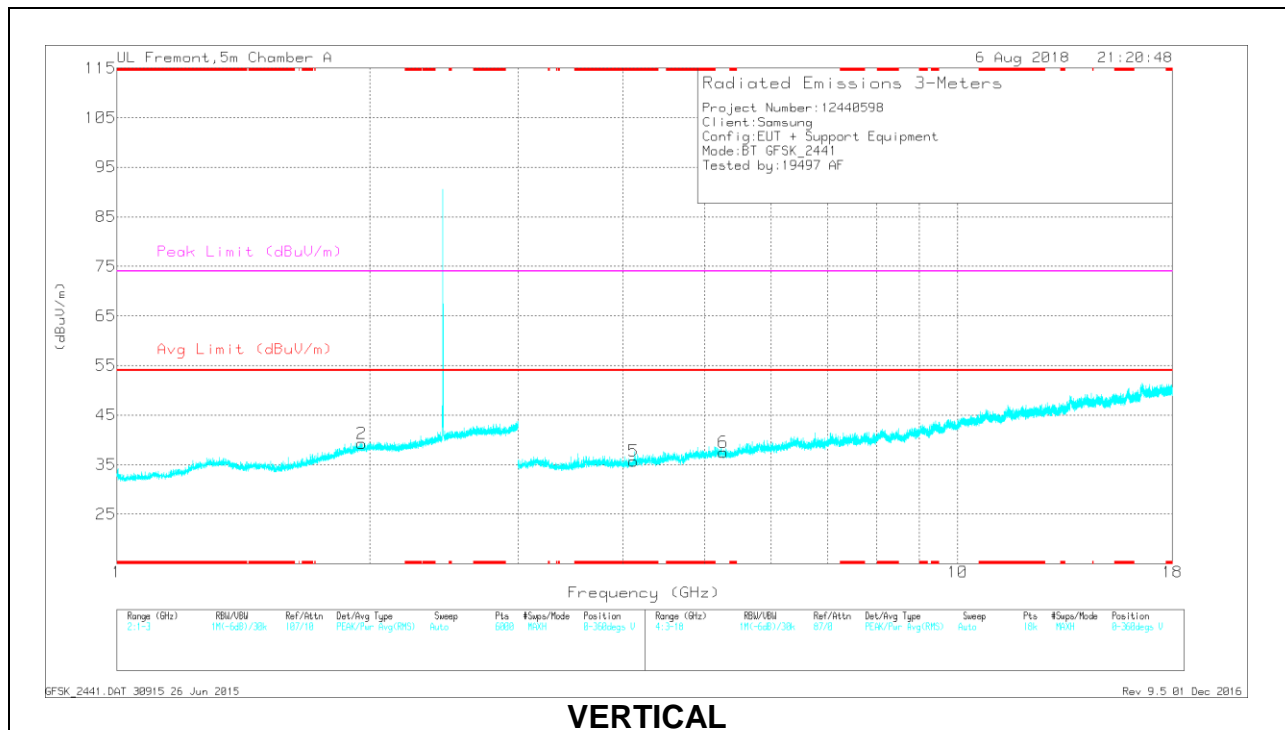

VERTICAL

RADIATED EMISSIONS

Marker	Frequency (GHz)	Meter Reading (dBuV)	Det	AF T345 (dB/m)	Amp/Cbl/Filtr/Pad (dB)	Corrected Reading (dBuV/m)	Avg Limit (dBuV/m)	Margin (dB)	Peak Limit (dBuV/m)	PK Margin (dB)	Azimuth (Degs)	Height (cm)	Polarity
3	* 4.119	35.03	PKFH	33.4	-27.7	40.73	-	-	74	-33.27	200	150	H
	* 4.121	24.22	VA1T	33.4	-27.6	30.02	54	-23.98	-	-	200	150	H
5	* 4.114	34.89	PKFH	33.4	-27.6	40.69	-	-	74	-33.31	82	220	V
	* 4.114	24.15	VA1T	33.4	-27.6	29.95	54	-24.05	-	-	82	220	V
1	1.889	34.96	PKFH	31	-22.9	43.06	-	-	-	-	3	307	H
2	1.956	34.54	PKFH	31.4	-22.9	43.04	-	-	-	-	86	181	V
4	5.264	33.81	PKFH	34.5	-26.2	42.11	-	-	-	-	348	371	H
6	5.264	33.23	PKFH	34.5	-26.2	41.53	-	-	-	-	77	290	V

* - indicates frequency in CFR47 Pt 15 / IC RSS-Restricted Band

PKFH - FHSS: RB=100k/1MHz VB=3 x RB, Peak

VA1T - FHSS: Linear Voltage Average VB=1/Ton where: Ton is transmit duration

HIGH CHANNEL RESULTS

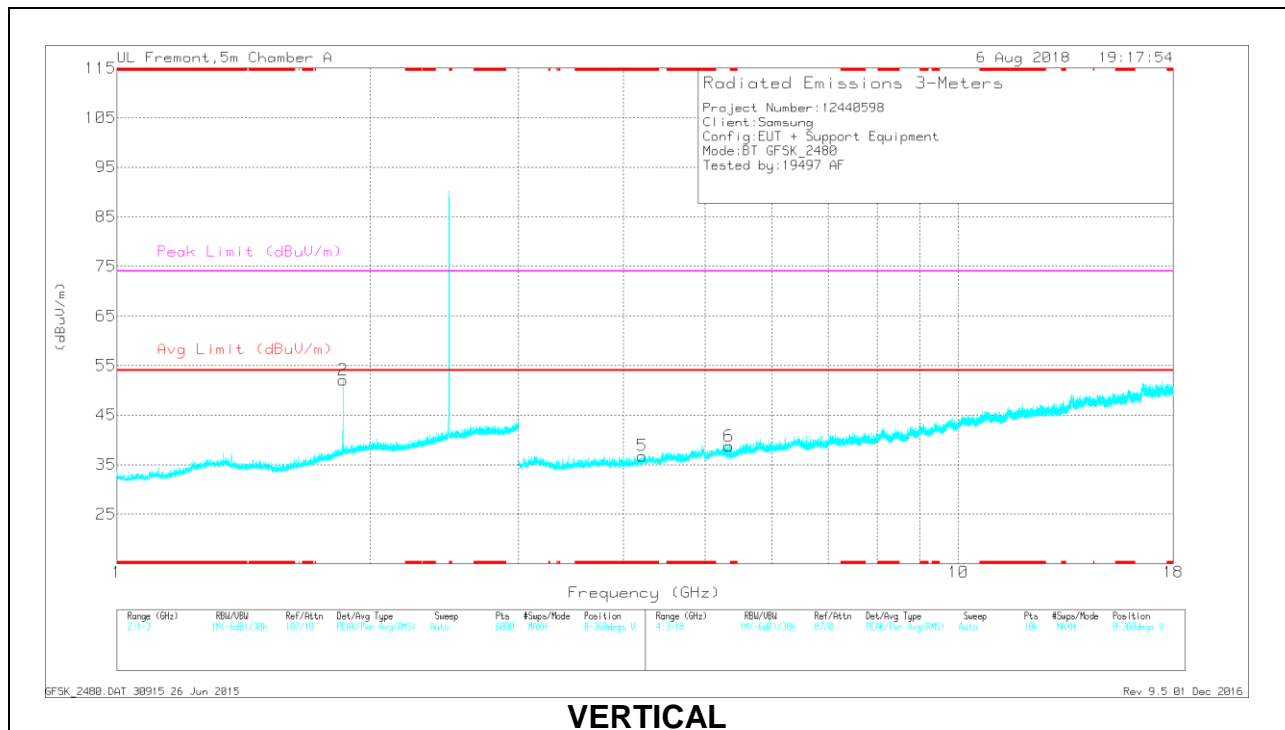
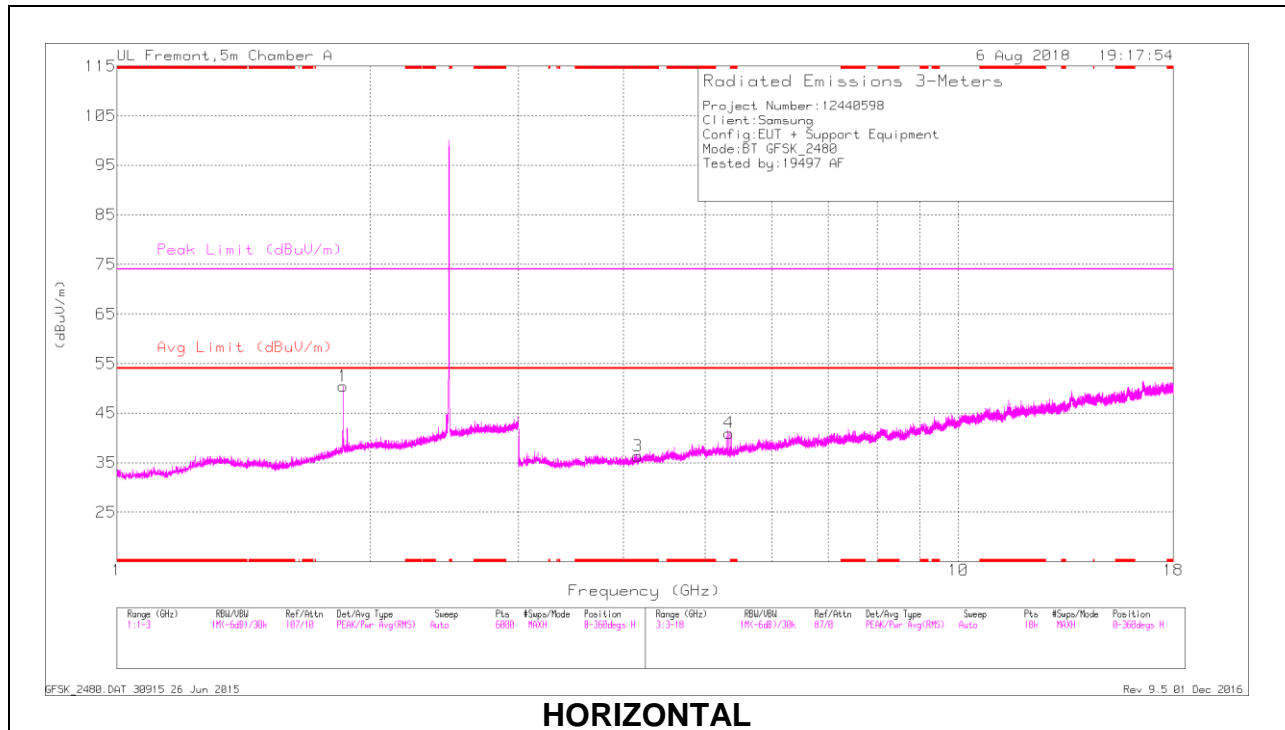

RADIATED EMISSIONS

Marker	Frequency (GHz)	Meter Reading (dBuV)	Det	AF T345 (dB/m)	Amp/Cbl/Filtr/Pad (dB)	Corrected Reading (dBuV/m)	Avg Limit (dBuV/m)	Margin (dB)	Peak Limit (dBuV/m)	PK Margin (dB)	Azimuth (Degs)	Height (cm)	Polarity
3	* 4.16	35.73	PKFH	33.4	-27.6	41.53	-	-	74	-32.47	273	101	H
	* 4.163	24.27	VA1T	33.4	-27.6	30.07	54	-23.93	-	-	273	101	H
5	* 4.207	34.3	PKFH	33.4	-27.3	40.4	-	-	74	-33.6	139	360	V
	* 4.21	23.69	VA1T	33.4	-27.3	29.79	54	-24.21	-	-	139	360	V
2	1.856	39.6	PKFH	30.9	-22.9	47.6	-	-	-	-	197	257	H
1	1.856	34.46	PKFH	30.9	-22.9	42.46	-	-	-	-	72	215	V
6	5.331	34.79	PKFH	34.6	-26.5	42.89	-	-	-	-	338	230	V
4	5.337	33.83	PKFH	34.6	-26.6	41.83	-	-	-	-	55	310	H

* - indicates frequency in CFR47 Pt 15 / IC RSS-Restricted Band

PKFH - FHSS: RB=100k/1MHz VB=3 x RB, Peak

VA1T - FHSS: Linear Voltage Average VB=1/Ton where: Ton is transmit duration

10.1.2. BLUETOOTH ENHANCED DATA RATE 8PSK MODULATION

BANDEDGE (LOW CHANNEL)

HORIZONTAL RESULT

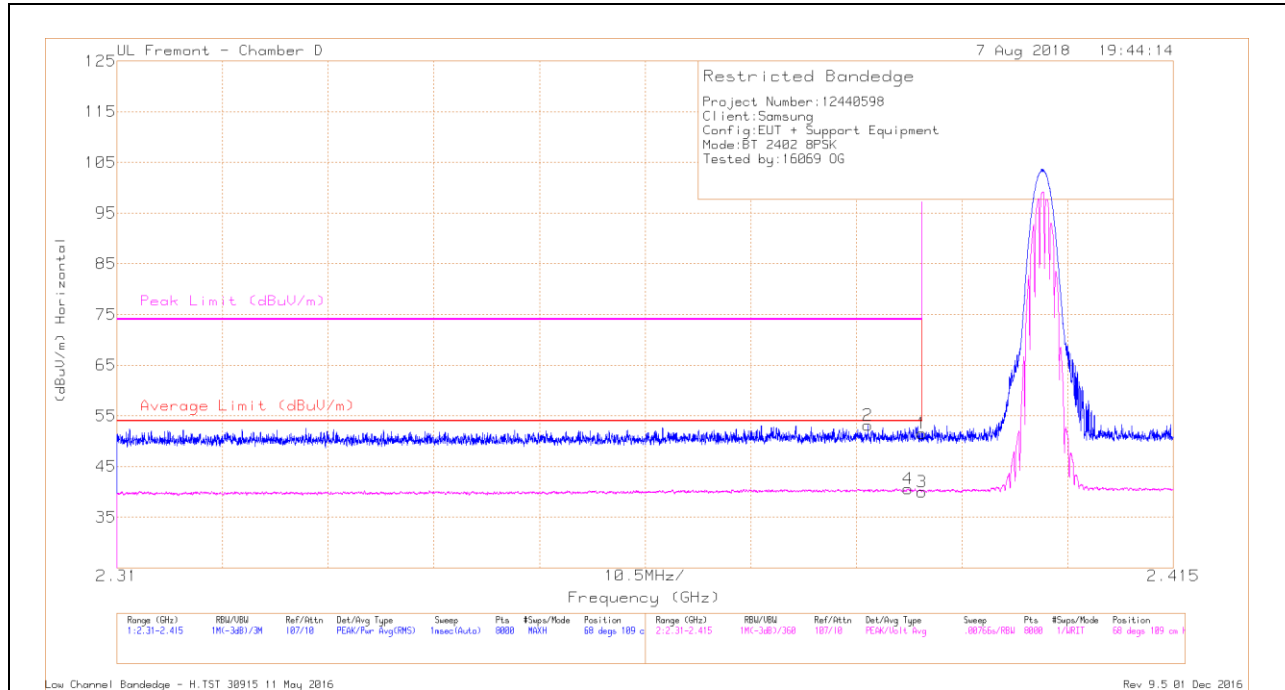

Trace Markers

Marker	Frequency (GHz)	Meter Reading (dBuV)	Det	AF T119 (dB/m)	Amp/Cb1/Fitr/Pad (dB)	Corrected Reading (dBuV/m)	Average Limit (dBuV/m)	Margin (dB)	Peak Limit (dBuV/m)	PK Margin (dB)	Azimuth (Degs)	Height (cm)	Polarity
1	* 2.39	39.95	Pk	32.1	-20.5	51.55	-	-	74	-22.45	68	109	H
2	* 2.385	41.41	Pk	32.2	-20.5	53.11	-	-	74	-20.89	68	109	H
3	* 2.39	28.41	VA1T	32.1	-20.5	40.01	54	-13.99	-	-	68	109	H
4	* 2.389	29.02	VA1T	32.1	-20.5	40.62	54	-13.38	-	-	68	109	H

* - indicates frequency in CFR47 Pt 15 / IC RSS-Restricted Band

Pk - Peak detector

VA1T - FHSS: Linear Voltage Average $V_B=1/T_{on}$ where: T_{on} is transmit duration

VERTICAL RESULT

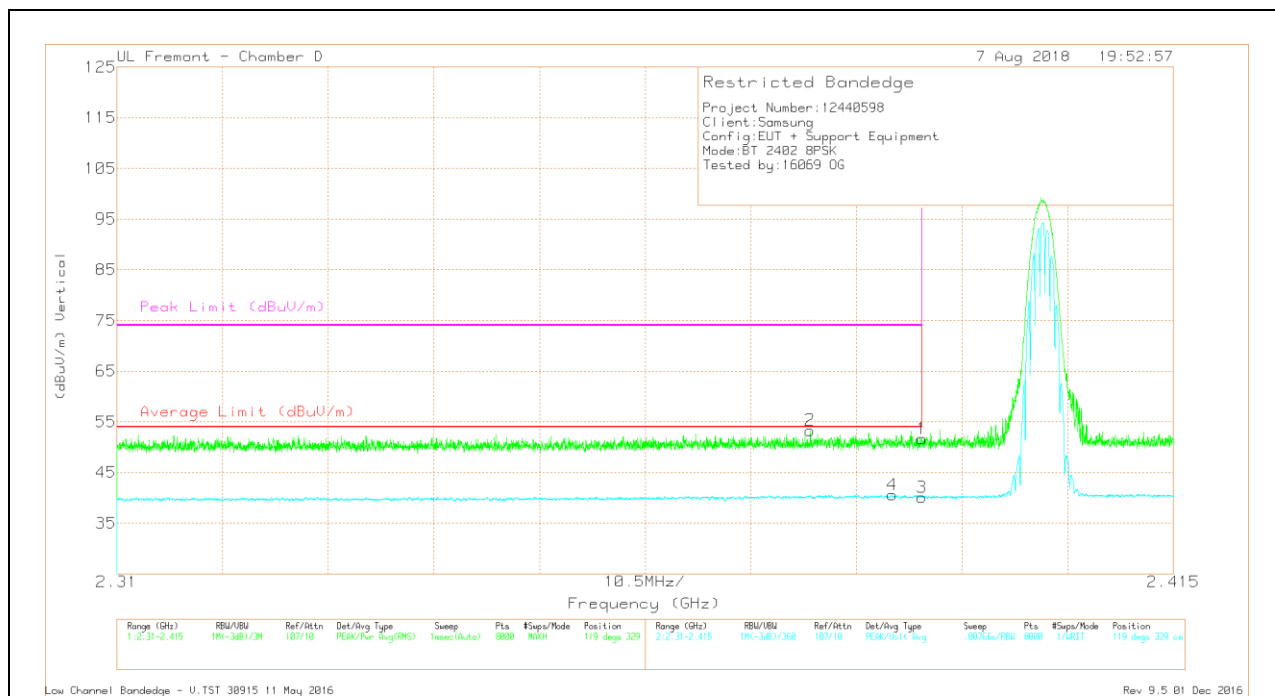

Trace Markers

Marker	Frequency (GHz)	Meter Reading (dBuV)	Det	AF T119 (dB/m)	Amp/Cbl/Filtr/Pad (dB)	Corrected Reading (dBuV/m)	Average Limit (dBuV/m)	Margin (dB)	Peak Limit (dBuV/m)	PK Margin (dB)	Azimuth (Degs)	Height (cm)	Polarity
1	* 2.39	40.09	Pk	32.1	-20.5	51.69	-	-	74	-22.31	119	329	V
2	* 2.379	41.63	Pk	32.1	-20.4	53.33	-	-	74	-20.67	119	329	V
3	* 2.39	28.52	VA1T	32.1	-20.5	40.12	54	-13.88	-	-	119	329	V
4	* 2.387	28.91	VA1T	32.2	-20.5	40.61	54	-13.39	-	-	119	329	V

* - indicates frequency in CFR47 Pt 15 / IC RSS-Restricted Band

Pk - Peak detector

VA1T - FHSS: Linear Voltage Average $V_B=1/T_{on}$ where: T_{on} is transmit duration

BANDEDGE (HIGH CHANNEL)

HORIZONTAL RESULT

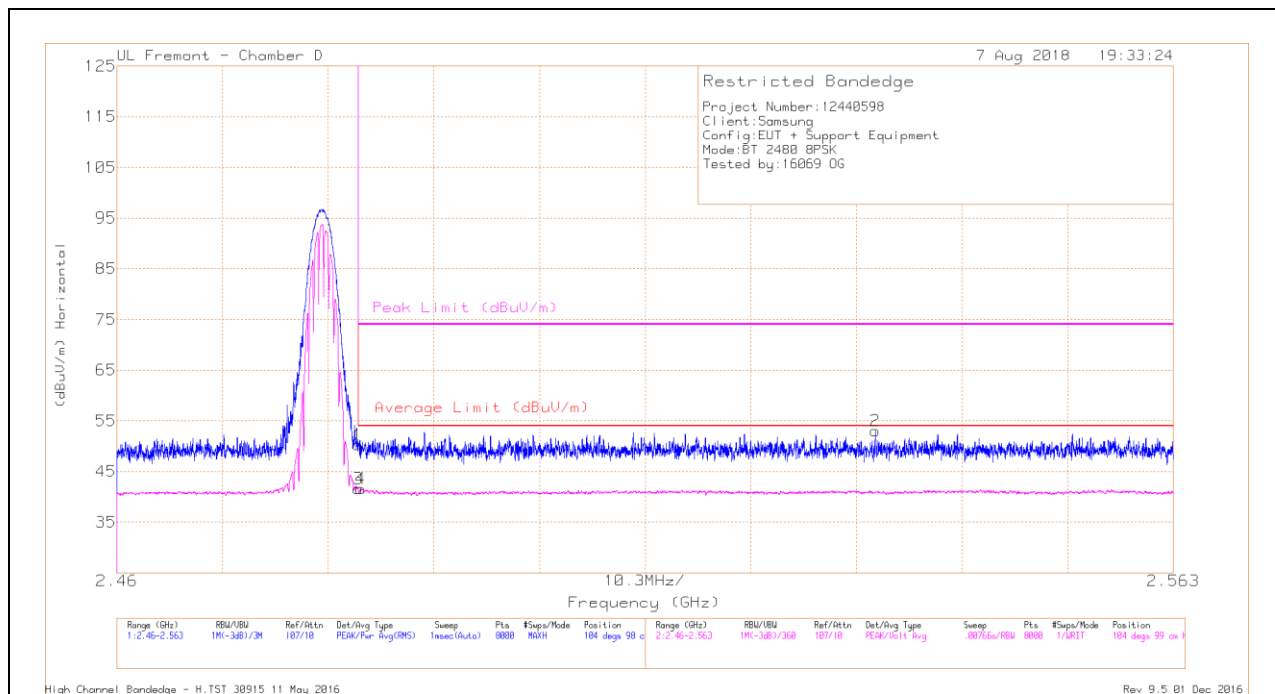

Trace Markers

Marker	Frequency (GHz)	Meter Reading (dBuV)	Det	AF T119 (dB/m)	Amp/Cb/Filtr/Pad (dB)	Corrected Reading (dBuV/m)	Average Limit (dBuV/m)	Margin (dB)	Peak Limit (dBuV/m)	PK Margin (dB)	Azimuth (Degs)	Height (cm)	Polarity
1	* 2.484	38.23	Pk	32.5	-20.4	50.33	-	-	74	-23.67	104	98	H
3	* 2.484	29.47	VA1T	32.5	-20.4	41.57	54	-12.43	-	-	104	99	H
4	* 2.484	29.62	VA1T	32.5	-20.5	41.62	54	-12.38	-	-	104	99	H
2	2.534	40.74	Pk	32.7	-20.4	53.04	-	-	74	-20.96	104	98	H

* - indicates frequency in CFR47 Pt 15 / IC RSS-Restricted Band

Pk - Peak detector

VA1T - FHSS: Linear Voltage Average VB=1/Ton where: Ton is transmit duration

VERTICAL RESULT

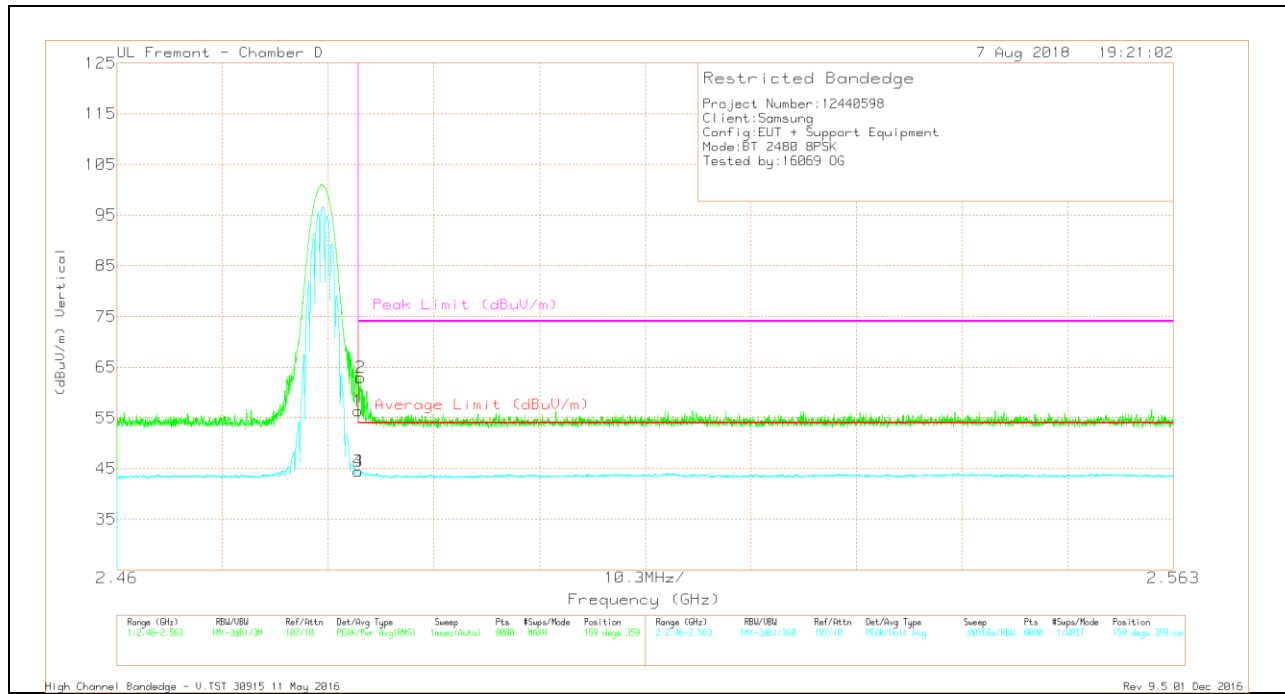

Trace Markers

Marker	Frequency (GHz)	Meter Reading (dBuV)	Det	AF T119 (dB/m)	Amp/Cbl/Filtr/Pad (dB)	Corrected Reading (dBuV/m)	Average Limit (dBuV/m)	Margin (dB)	Peak Limit (dBuV/m)	PK Margin (dB)	Azimuth (Degs)	Height (cm)	Polarity
1	* 2.484	44.32	Pk	32.5	-20.4	56.42	-	-	74	-17.58	159	359	V
2	* 2.484	50.97	Pk	32.5	-20.5	62.97	-	-	74	-11.03	159	359	V
3	* 2.484	32.32	VA1T	32.5	-20.4	44.42	54	-9.58	-	-	159	359	V
4	* 2.484	32.35	VA1T	32.5	-20.4	44.45	54	-9.55	-	-	159	359	V

* - indicates frequency in CFR47 Pt 15 / IC RSS-Restricted Band

Pk - Peak detector

VA1T - FHSS: Linear Voltage Average $V_B=1/T_{on}$ where: T_{on} is transmit duration

HARMONICS AND SPURIOUS EMISSIONS

LOW CHANNEL RESULTS

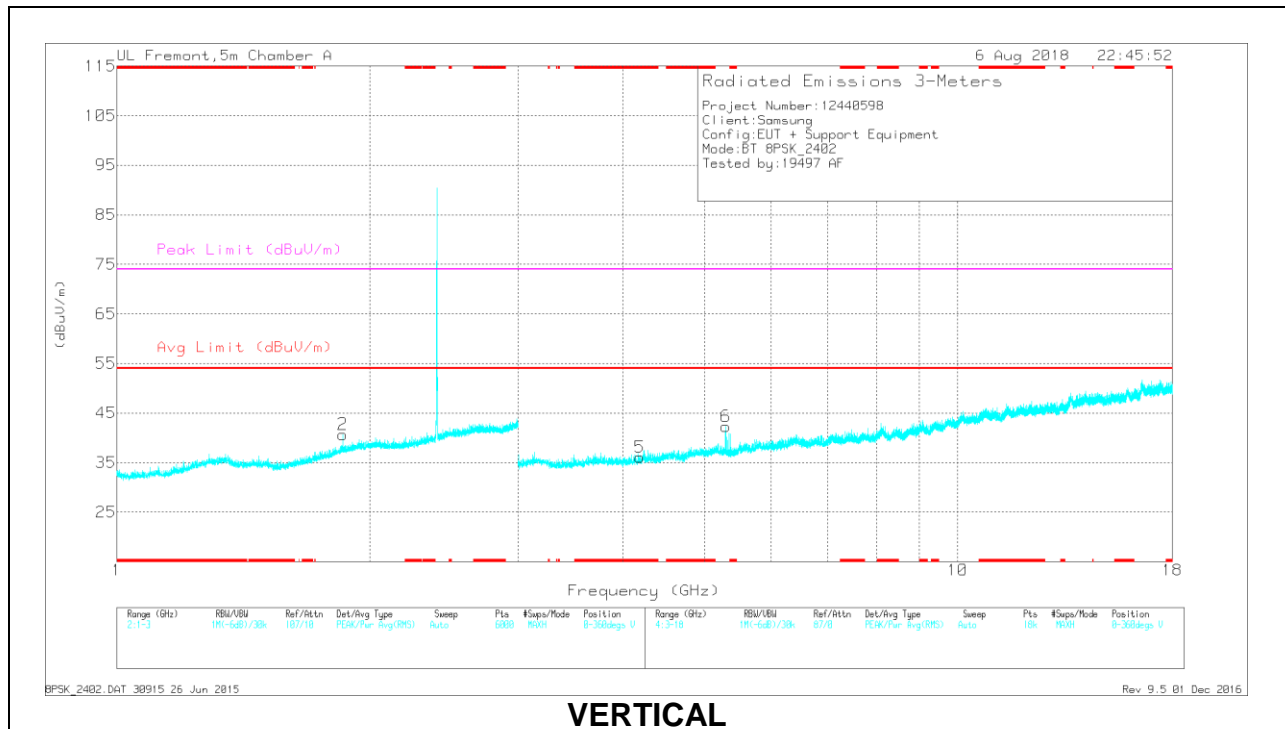
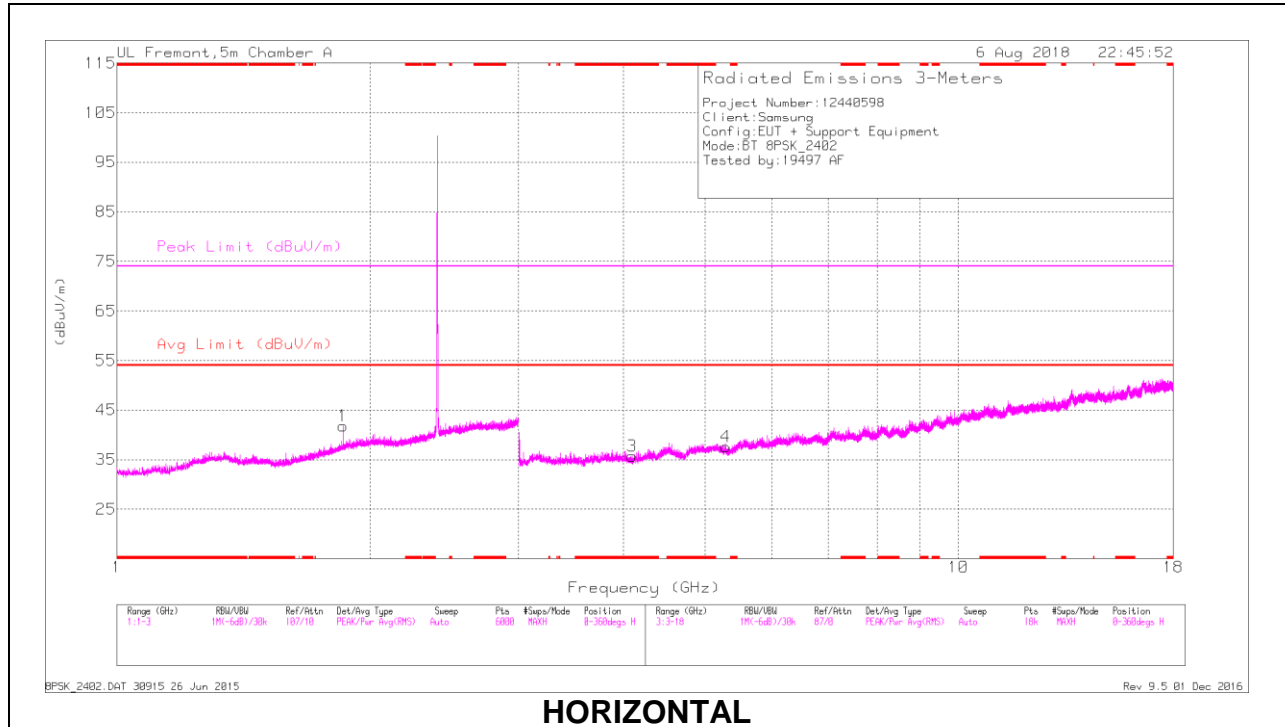

RADIATED EMISSIONS

Marker	Frequency (GHz)	Meter Reading (dBuV)	Det	AF T862 (dB/m)	Amp/Cbl/Filtr/Pad (dB)	Corrected Reading (dBuV/m)	Avg Limit (dBuV/m)	Margin (dB)	Peak Limit (dBuV/m)	PK Margin (dB)	Azimuth (Degs)	Height (cm)	Polarity
3	* 4.099	34.69	PKFH	33.4	-27.6	40.49	-	-	74	-33.51	179	372	H
	* 4.099	23.91	VA1T	33.4	-27.6	29.71	54	-24.29	-	-	179	372	H
5	* 4.185	34.8	PKFH	33.4	-27.4	40.8	-	-	74	-33.2	182	159	V
	* 4.185	24.25	VA1T	33.4	-27.4	30.25	54	-23.75	-	-	182	159	V
1	1.855	34.52	PKFH	30.9	-22.9	42.52	-	-	-	-	188	371	V
2	1.856	34.86	PKFH	30.9	-22.9	42.86	-	-	-	-	337	183	H
4	5.294	34.78	PKFH	34.6	-26.3	43.08	-	-	-	-	40	164	H
6	5.295	33.67	PKFH	34.6	-26.3	41.97	-	-	-	-	354	336	V

* - indicates frequency in CFR47 Pt 15 / IC RSS-Restricted Band

PKFH - FHSS: RB=100k/1MHz VB=3 x RB, Peak

VA1T - FHSS: Linear Voltage Average VB=1/Ton where: Ton is transmit duration

MID CHANNEL RESULTS

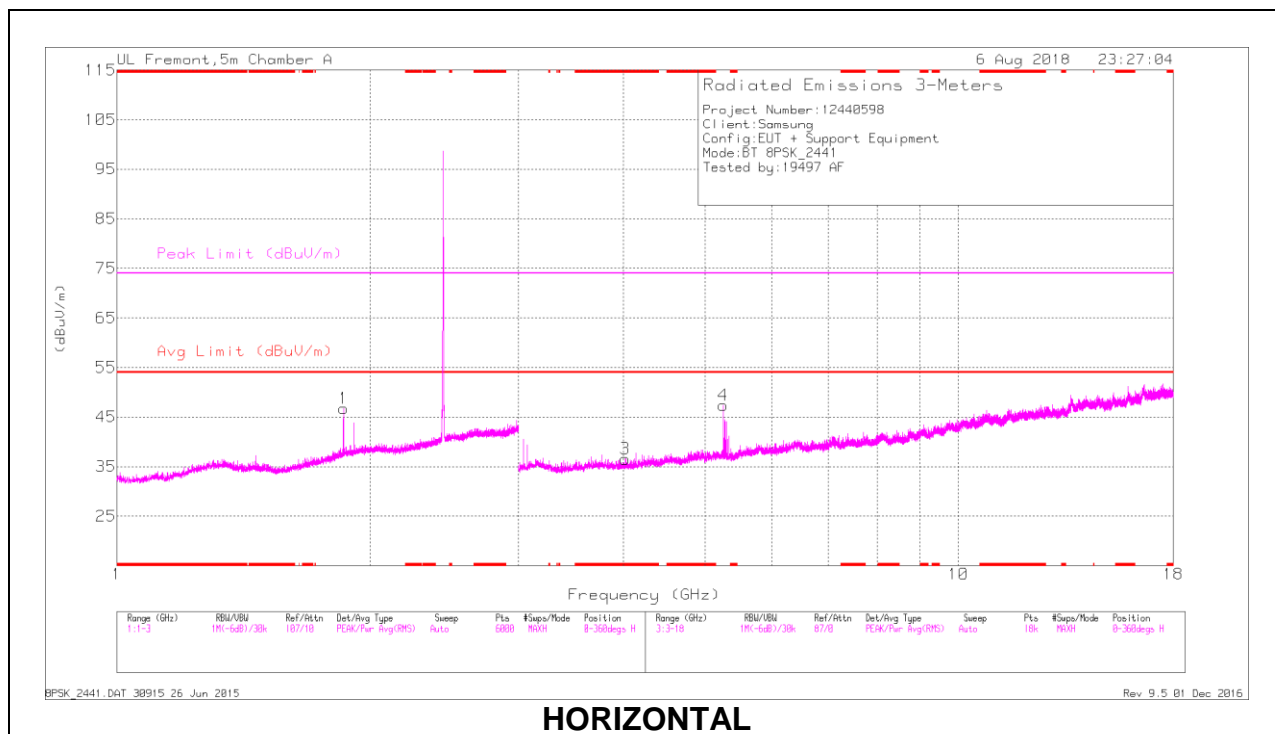

HORIZONTAL

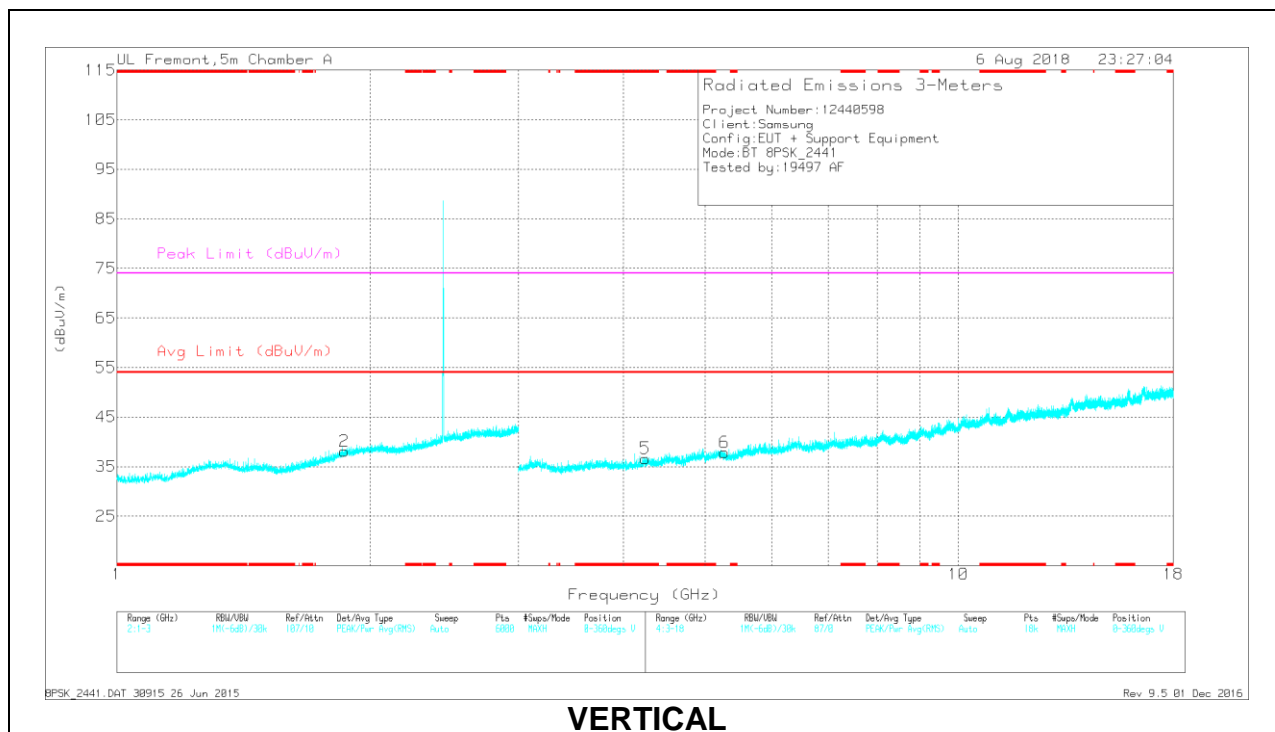

VERTICAL

RADIATED EMISSIONS

Marker	Frequency (GHz)	Meter Reading (dBuV)	Det	AF T862 (dB/m)	Amp/Cbl/Filtr/Pad (dB)	Corrected Reading (dBuV/m)	Avg Limit (dBuV/m)	Margin (dB)	Peak Limit (dBuV/m)	PK Margin (dB)	Azimuth (Degs)	Height (cm)	Polarity
3	* 4.017	35.77	PKFH	33.4	-27.9	41.27	-	-	74	-32.73	248	124	H
	* 4.018	24.47	VA1T	33.4	-27.9	29.97	54	-24.03	-	-	248	124	H
5	* 4.245	34.66	PKFH	33.5	-26.9	41.26	-	-	74	-32.74	218	174	V
	* 4.245	23.79	VA1T	33.5	-26.9	30.39	54	-23.61	-	-	218	174	V
1	1.861	33.65	PKFH	30.9	-22.9	41.65	-	-	-	-	223	203	H
2	1.864	34.81	PKFH	30.9	-22.9	42.81	-	-	-	-	224	258	V
4	5.251	34.25	PKFH	34.5	-26.1	42.65	-	-	-	-	278	122	H
6	5.27	33.68	PKFH	34.5	-26.1	42.08	-	-	-	-	139	238	V

* - indicates frequency in CFR47 Pt 15 / IC RSS-Restricted Band

PKFH - FHSS: RB=100k/1MHz VB=3 x RB, Peak

VA1T - FHSS: Linear Voltage Average VB=1/Ton where: Ton is transmit duration

HIGH CHANNEL RESULTS

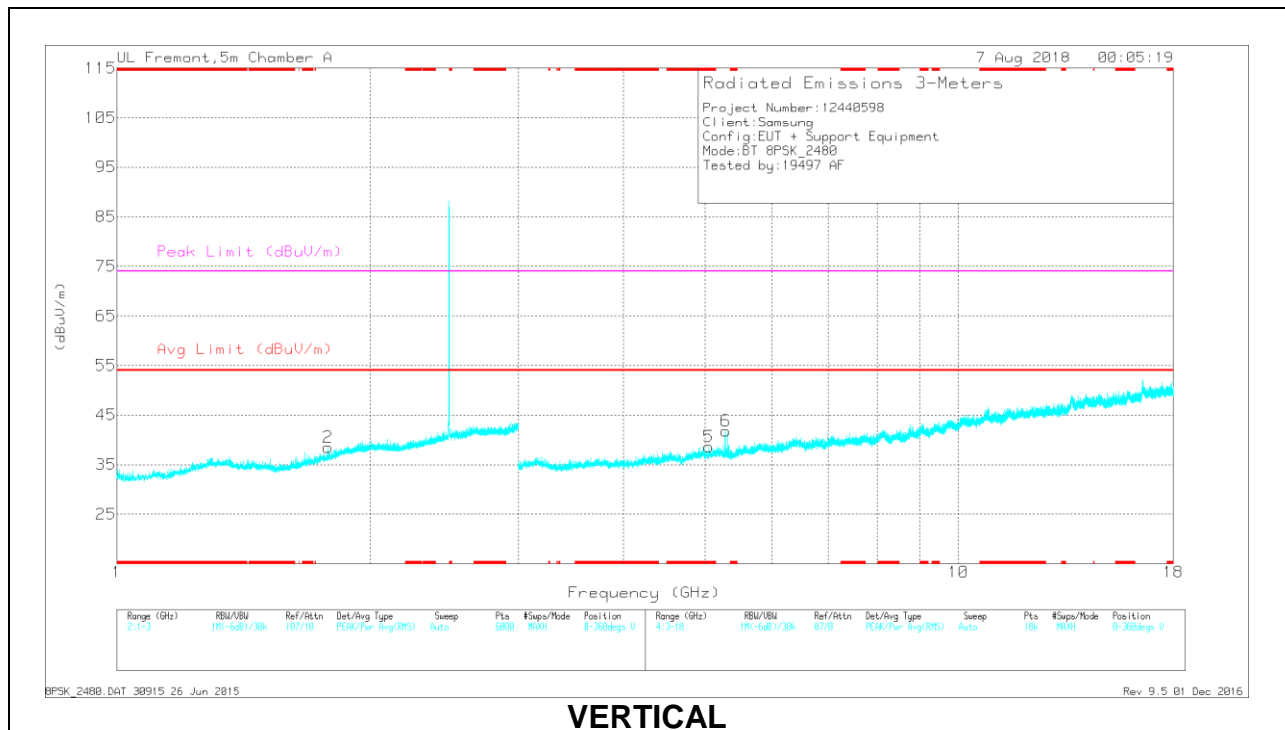
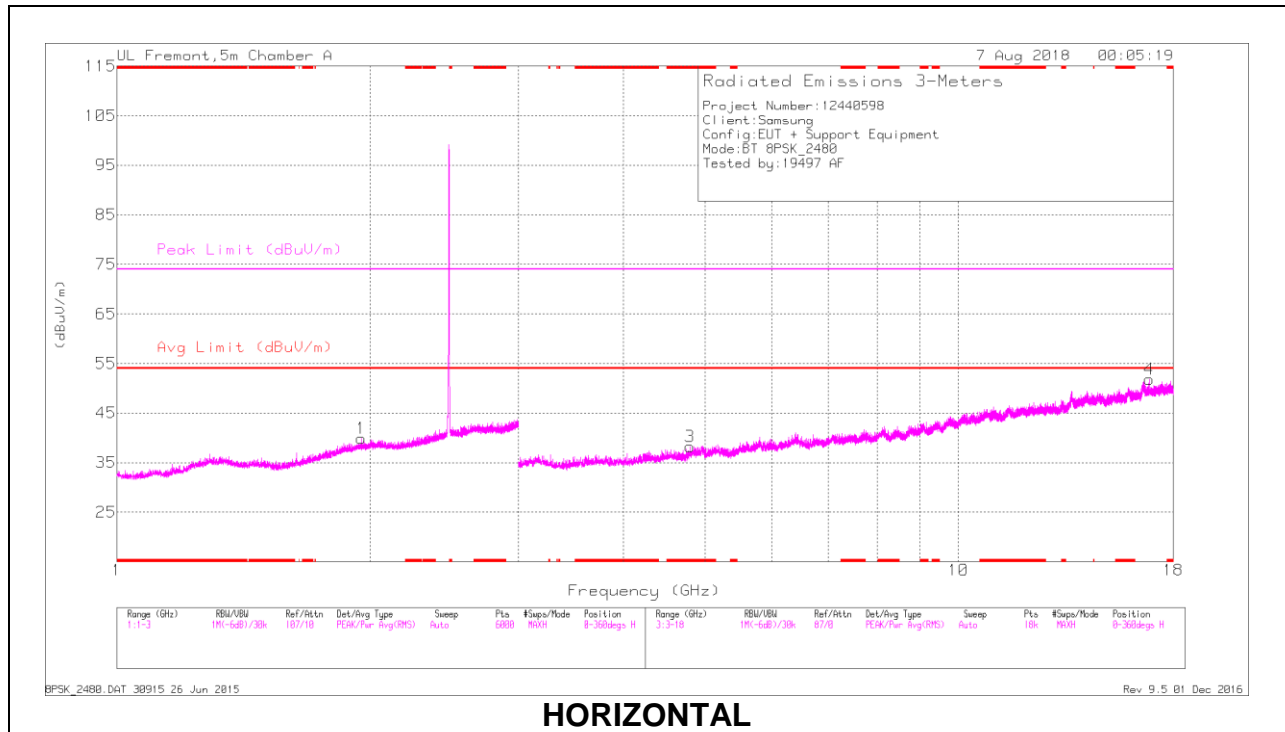

RADIATED EMISSIONS

Marker	Frequency (GHz)	Meter Reading (dBuV)	Det	AF T862 (dB/m)	Amp/Cbl/Filtr/Pad (dB)	Corrected Reading (dBuV/m)	Avg Limit (dBuV/m)	Margin (dB)	Peak Limit (dBuV/m)	PK Margin (dB)	Azimuth (Degs)	Height (cm)	Polarity
3	* 4.795	34.35	PKFH	34.2	-26.1	42.45	-	-	74	-31.55	256	208	H
	* 4.797	23.09	VA1T	34.2	-26.1	31.19	54	-22.81	-	-	256	208	H
5	* 5.05	35.03	PKFH	34.4	-27	42.43	-	-	74	-31.57	1	148	V
	* 5.047	24.11	VA1T	34.4	-27	31.51	54	-22.49	-	-	1	148	V
2	1.781	34.56	PKFH	30	-23	41.56	-	-	-	-	112	174	V
1	1.952	35.47	PKFH	31.4	-22.9	43.97	-	-	-	-	95	242	H
6	5.29	33.83	PKFH	34.6	-26.2	42.23	-	-	-	-	315	255	V
4	16.851	33.6	PKFH	41.7	-17.6	57.7	-	-	-	-	73	143	H

* - indicates frequency in CFR47 Pt 15 / IC RSS-Restricted Band

PKFH - FHSS: RB=100k/1MHz VB=3 x RB, Peak

VA1T - FHSS: Linear Voltage Average VB=1/Ton where: Ton is transmit duration

10.2. Worst Case Below 30 MHz

SPURIOUS EMISSIONS 9 kHz TO 30 MHz (WORST-CASE CONFIGURATION)

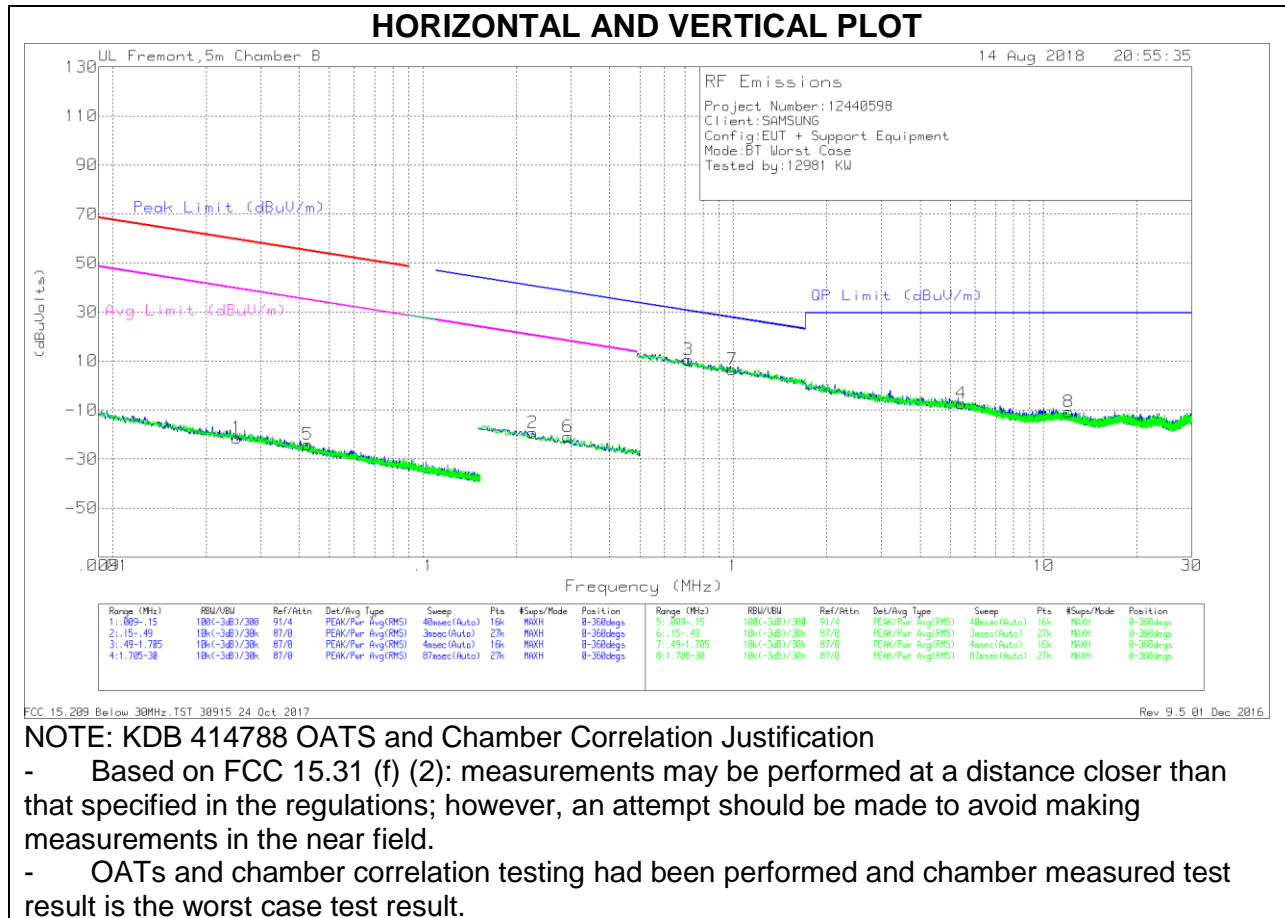

Below 30 MHz Data

Trace Markers

Marker	Frequency (MHz)	Meter Reading (dBuV)	Det	Loop Antenna (dB/m)	Cbl (dB)	Dist Corr 300m	Corrected Reading (dBuVolts)	Peak Limit (dBuV/m)	Margin (dB)	Avg Limit (dBuV/m)	Margin (dB)	Azimuth (Degs)
1	.02513	42.01	Pk	15.1	1.4	-80	-21.49	59.58	-81.07	39.58	-61.07	0-360
5	.04259	39.72	Pk	14.7	1.4	-80	-24.18	55	-79.18	35	-59.18	0-360
2	.22585	45.21	Pk	13.9	1.5	-80	-19.39	40.54	-59.93	20.54	-39.93	0-360
6	.29308	43.92	Pk	13.8	1.5	-80	-20.78	38.27	-59.05	18.27	-39.05	0-360

Pk - Peak detector

Marker	Frequency (MHz)	Meter Reading (dBuV)	Det	Loop Antenna (dB/m)	Cbl (dB)	Dist Corr (dB) 40Log	Corrected Reading (dBuVolts)	QP Limit (dBuV/m)	Margin (dB)	Azimuth (Degs)
3	.71542	34.86	Pk	14	1.5	-40	10.36	30.52	-20.16	0-360
7	.99342	30.58	Pk	14.3	1.5	-40	6.38	27.68	-21.3	0-360
4	5.43588	16.67	Pk	14.4	1.5	-40	-7.43	29.5	-36.93	0-360
8	12.04719	13.02	Pk	14.7	1.6	-40	-10.68	29.5	-40.18	0-360

Pk - Peak detector

10.3. Worst Case Below 1 GHz

SPURIOUS EMISSIONS 30 TO 1000 MHz (WORST-CASE CONFIGURATION)

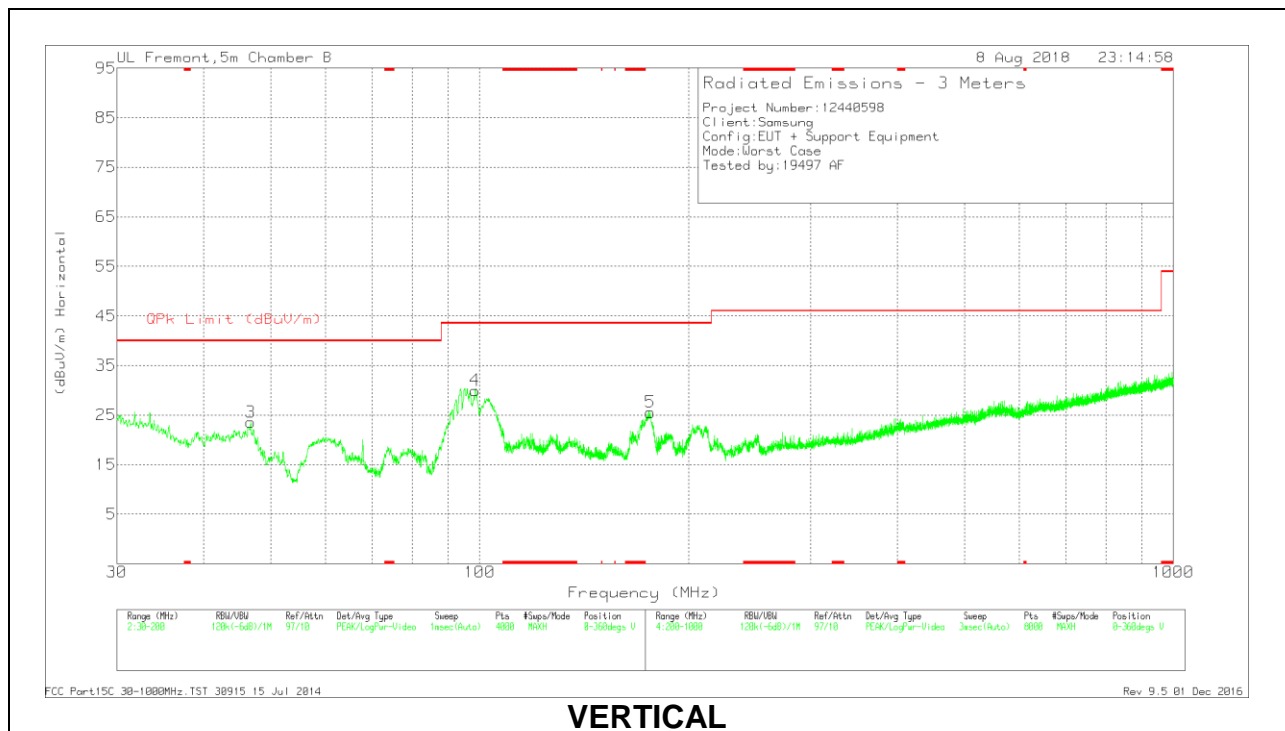
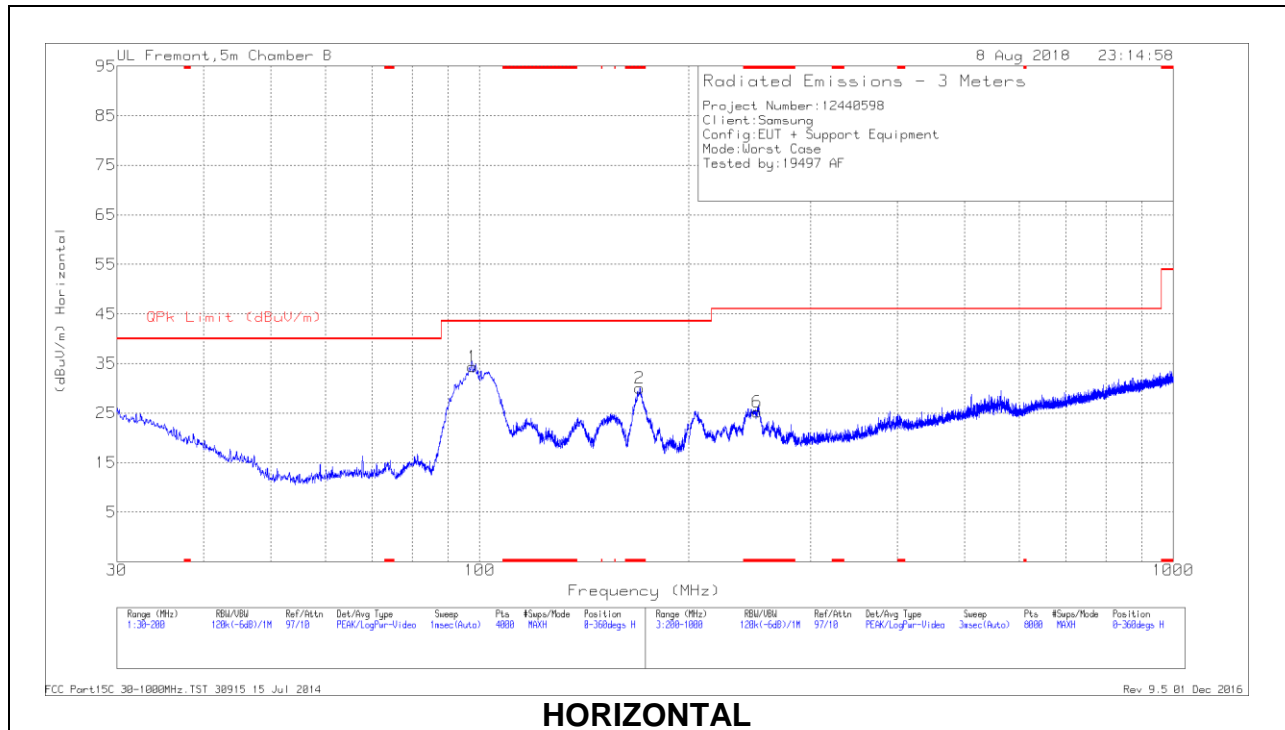

Below 1GHz Data

Marker	Frequency (MHz)	Meter Reading (dBuV)	Det	AF T407 (dB/m)	Amp/Cbl (dB)	Corrected Reading (dBuV/m)	QPk Limit (dBuV/m)	Margin (dB)	Azimuth (Degs)	Height (cm)	Polarity
2	* 170.1163	41.45	Pk	15.8	-27.2	30.05	43.52	-13.47	0-360	200	H
6	* 251.2067	36.02	Pk	15.5	-26.3	25.22	46.02	-20.8	0-360	100	H
3	46.7918	38.91	Pk	13.3	-28.6	23.61	40	-16.39	0-360	100	V
1	97.6775	48.77	Pk	13.6	-28	34.37	43.52	-9.15	0-360	200	H
4	98.4852	44.18	Pk	13.8	-28	29.98	43.52	-13.54	0-360	100	V
5	176.1103	37.24	Pk	15.4	-27.1	25.54	43.52	-17.98	0-360	100	V

* - indicates frequency in CFR47 Pt 15 / IC RSS-Restricted Band

Pk - Peak detector

10.4. Worst Case 18-26 GHz

SPURIOUS EMISSIONS 18-26 GHz (WORST-CASE CONFIGURATION)

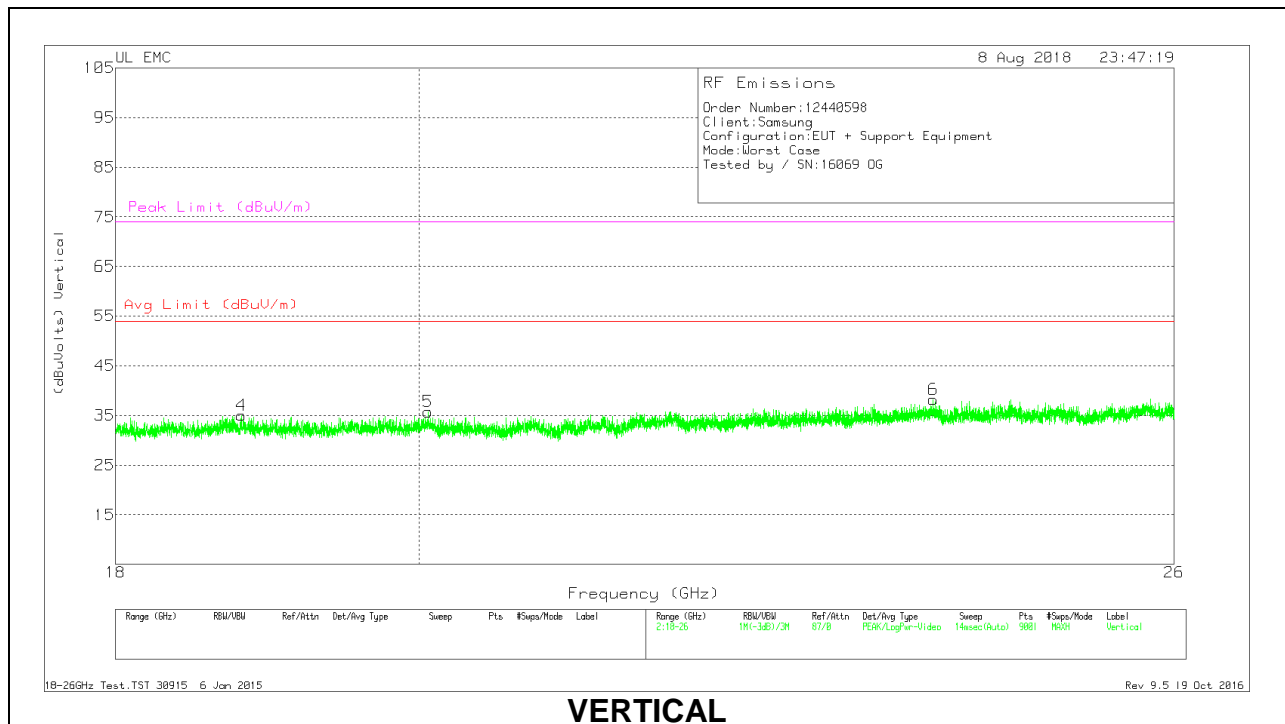
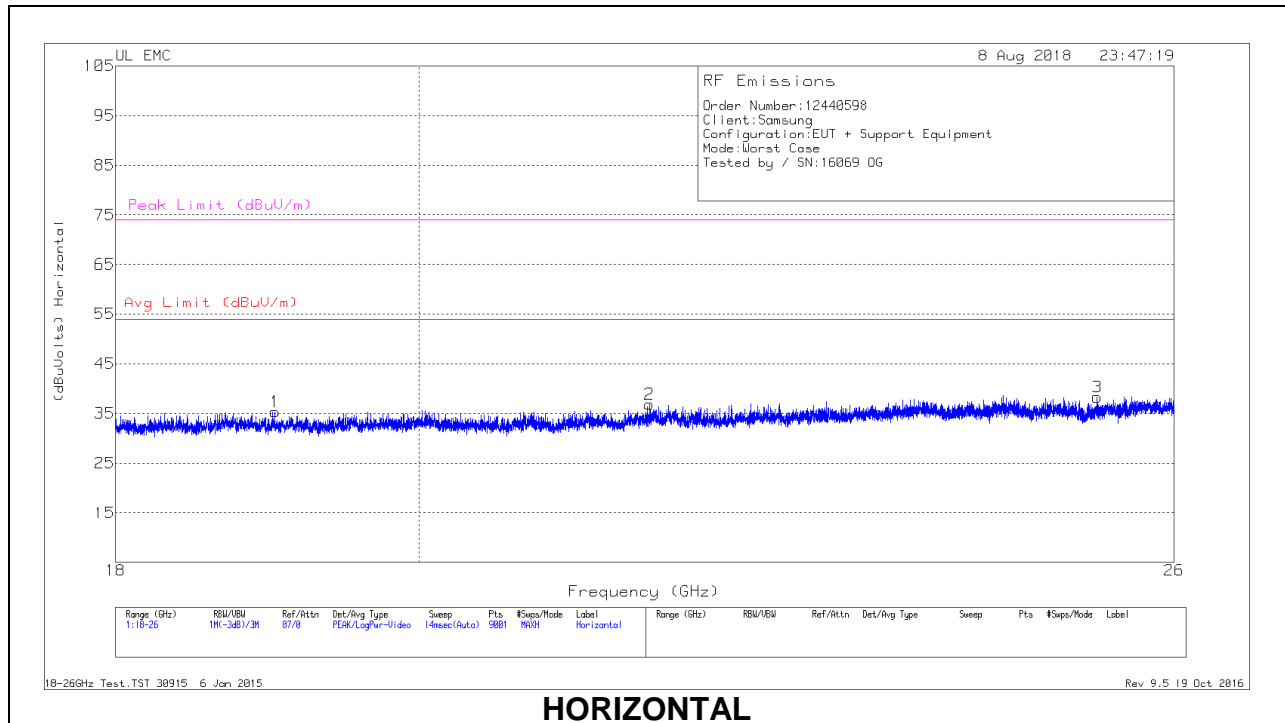

18 – 26GHz DATA

Marker	Frequency (GHz)	Meter Reading (dBuV)	Det	T89 AF (dB/m)	Amp/Cbl (dB)	Dist Corr (dB)	Corrected Reading (dBuVolts)	Avg Limit (dBuV/m)	Margin (dB)	Peak Limit (dBuV/m)	PK Margin (dB)
1	19.025	37.29	Pk	32.2	-24.7	-9.5	35.29	54	-18.71	74	-38.71
2	21.668	38.23	Pk	33.2	-25.1	-9.5	36.83	54	-17.17	74	-37.17
3	25.314	38.69	Pk	33.6	-24.5	-9.5	38.29	54	-15.71	74	-35.71
4	18.804	36.81	Pk	32.5	-24.8	-9.5	35.01	54	-18.99	74	-38.99
5	20.065	37.32	Pk	32.9	-25	-9.5	35.72	54	-18.28	74	-38.28
6	23.911	38.22	Pk	33.4	-23.9	-9.5	38.22	54	-15.78	74	-35.78

Pk - Peak detector

11. AC POWER LINE CONDUCTED EMISSIONS

LIMITS

FCC §15.207 (a)

Frequency of Emission (MHz)	Conducted Limit (dBuV)	
	Quasi-peak	Average
0.15-0.5	66 to 56*	56 to 46*
0.5-5	56	46
5-30	60	50

*Decreases with the logarithm of the frequency.

TEST PROCEDURE

The EUT is placed on a non-conducting table 40 cm from the vertical ground plane and 80 cm above the horizontal ground plane. The EUT is configured in accordance with ANSI C63.4.

The receiver is set to a resolution bandwidth of 9 kHz. Peak detection is used unless otherwise noted as quasi-peak or average.

Line conducted data is recorded for both NEUTRAL and HOT lines.

RESULTS

11.1.1. AC Power Line Norm

LINE 1 RESULTS

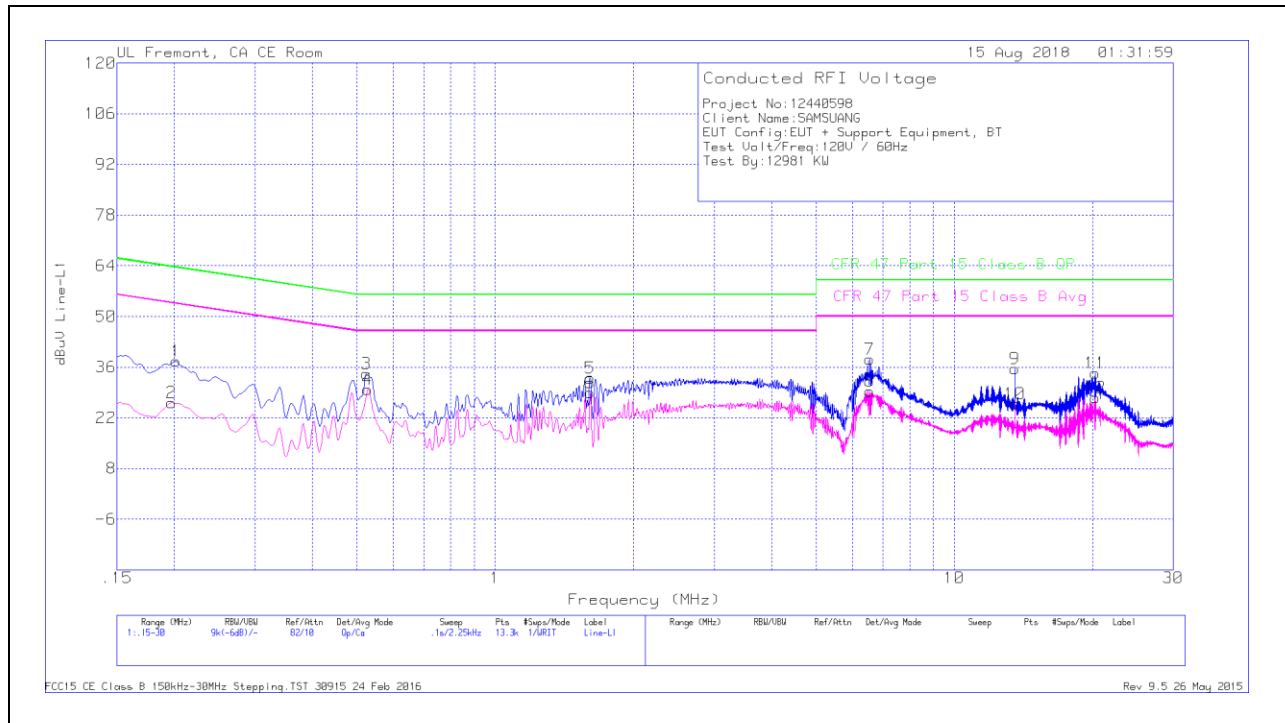

Trace Markers

Range 1: Line-L1 .15 - 30MHz											
Marker	Frequency (MHz)	Meter Reading (dBuV)	Det	LISN L1	LC Cables C1&C3	Limiter (dB)	Corrected Reading dBuV	CFR 47 Part 15 Class B QP	QP Margin (dB)	CFR 47 Part 15 Class B Avg	Av(CISPR) Margin (dB)
1	.20175	27.56	Qp	0	0	10.1	37.66	63.54	-25.88	-	-
2	.19725	16.04	Ca	0	0	10.1	26.14	-	-	53.73	-27.59
3	.5235	24.05	Qp	0	0	10.1	34.15	56	-21.85	-	-
4	.528	19.79	Ca	0	0	10.1	29.89	-	-	46	-16.11
5	1.60913	22.84	Qp	0	.1	10.1	33.04	56	-22.96	-	-
6	1.61025	18.69	Ca	0	.1	10.1	28.89	-	-	46	-17.11
7	6.54225	27.81	Qp	0	.2	10.2	38.21	60	-21.79	-	-
8	6.5445	18.85	Ca	0	.2	10.2	29.25	-	-	50	-20.75
9	13.56	25.01	Qp	.1	.2	10.2	35.51	60	-24.49	-	-
10	13.56	15.26	Ca	.1	.2	10.2	25.76	-	-	50	-24.24
11	20.26725	23.69	Qp	.1	.3	10.3	34.39	60	-25.61	-	-
12	20.27175	16.81	Ca	.1	.3	10.3	27.51	-	-	50	-22.49

Qp - Quasi-Peak detector
 Ca - CISPR average detection

LINE 2 RESULTS

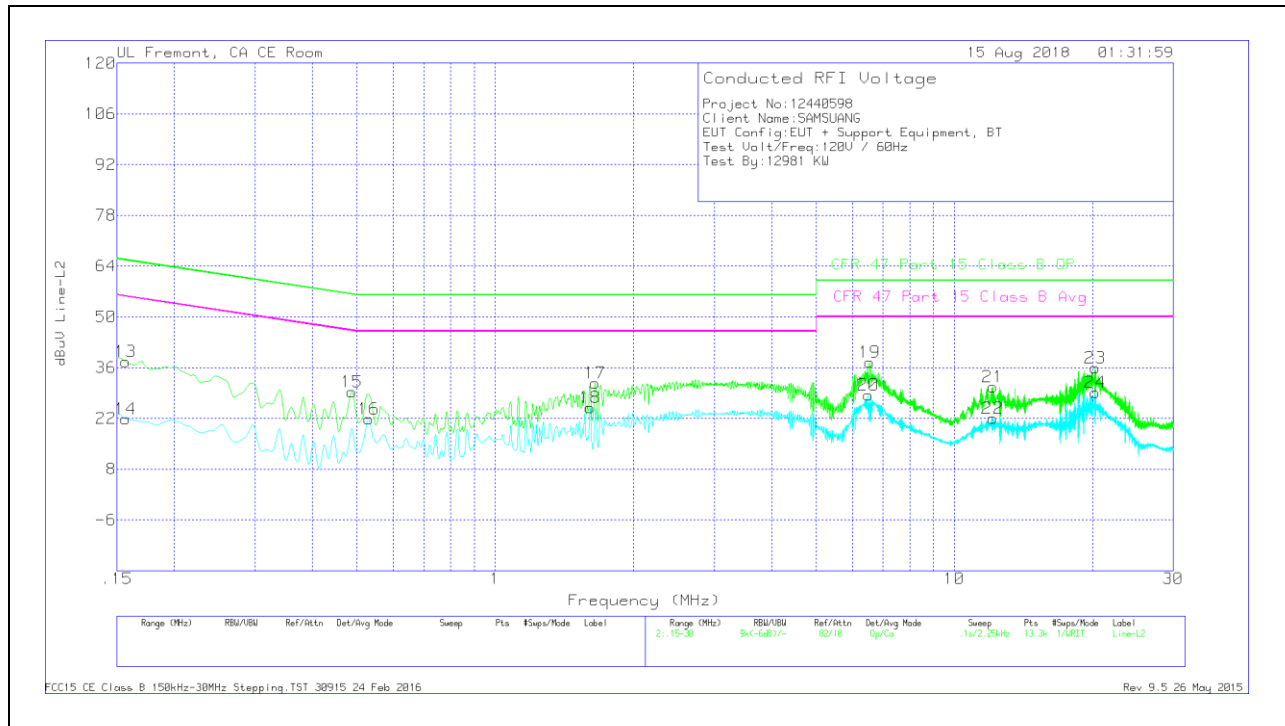

Trace Markers

Range 2: Line-L2 .15 - 30MHz											
Marker	Frequency (MHz)	Meter Reading (dBuV)	Det	LISN L2	LC Cables C2&C3	Limiter (dB)	Corrected Reading dBuV	CFR 47 Part 15 Class B QP	QP Margin (dB)	CFR 47 Part 15 Class B Avg	Av(CISPR) Margin (dB)
13	.15675	27.48	Qp	.1	0	10.1	37.68	65.63	-27.95	-	-
14	.15675	11.7	Ca	.1	0	10.1	21.9	-	-	55.63	-33.73
15	.4875	19.18	Qp	0	0	10.1	29.28	56.21	-26.93	-	-
16	.53025	11.8	Ca	0	0	10.1	21.9	-	-	46	-24.1
17	1.65075	21.5	Qp	0	.1	10.1	31.7	56	-24.3	-	-
18	1.61025	14.79	Ca	0	.1	10.1	24.99	-	-	46	-21.01
19	6.5445	27.13	Qp	0	.2	10.2	37.53	60	-22.47	-	-
20	6.50175	17.99	Ca	0	.2	10.2	28.39	-	-	50	-21.61
21	12.12	20.28	Qp	.1	.2	10.2	30.78	60	-29.22	-	-
22	12.11775	11.49	Ca	.1	.2	10.2	21.99	-	-	50	-28.01
23	20.27175	25.28	Qp	.1	.3	10.3	35.98	60	-24.02	-	-
24	20.27625	18.42	Ca	.1	.3	10.3	29.12	-	-	50	-20.88

Qp - Quasi-Peak detector
 Ca - CISPR average detection