



CERTIFICATION TEST REPORT

Report Number. : 12810836-E4V2

Applicant : Samsung Electronics Co., Ltd.
129 Samsung-Ro, Yeongtong-Gu,
Suwon-Si, Gyeonggi-Do, 16677, Korea

Model : SM-A705YN

FCC ID : A3LSMA705YN

EUT Description : GSM/WCDMA/LTE Phone with BT, DTS/UNII a/b/g/n/ac, ANT+ and NFC

Test Standard(s) : FCC 47 CFR PART 15 SUBPART C

Date Of Issue:

April 29, 2019

Prepared by:

UL Verification Services Inc.
47173 Benicia Street
Fremont, CA 94538 U.S.A.
TEL: (510) 319-4000
FAX: (510) 661-0888



NVLAP Lab code: 200065-0

REPORT REVISION HISTORY

Rev.	Issue Date	Revisions	Revised By
V1	4/22/2019	Initial Issue	
V2	4/29/2019	Updated Section 3 & 12.1	K.Kedida

REPORT REVISION HISTORY2

1. ATTESTATION OF TEST RESULTS5

2. INTRODUCTION OF TEST DATA REUSE.....6

 2.1. INTRODUCTION6

 2.2. DIFFERENCES.....6

 2.3. SPOT CHECK VERIFICATION RESULTS SUMMARY.....6

 2.4. REFERENCE DETAIL 11

3. TEST METHODOLOGY12

4. FACILITIES AND ACCREDITATION12

5. CALIBRATION AND UNCERTAINTY13

 5.1. MEASURING INSTRUMENT CALIBRATION 13

 5.2. SAMPLE CALCULATION 13

 5.3. MEASUREMENT UNCERTAINTY..... 13

6. EQUIPMENT UNDER TEST14

 6.1. EUT DESCRIPTION 14

 6.2. MAXIMUM OUTPUT POWER..... 14

 6.3. DESCRIPTION OF AVAILABLE ANTENNAS 14

 6.4. SOFTWARE AND FIRMWARE..... 14

 6.5. WORST-CASE CONFIGURATION AND MODE..... 14

 6.6. DESCRIPTION OF TEST SETUP..... 15

7. MEASUREMENT METHOD.....18

8. TEST AND MEASUREMENT EQUIPMENT19

9. ANTENNA PORT TEST RESULTS20

 9.1. ON TIME AND DUTY CYCLE20

 9.2. 6 dB BANDWIDTH.....22

 9.2.1. 802.11b MODE23

 9.2.2. 802.11g MODE25

 9.2.3. 802.11n HT20 MODE27

 9.3. OUTPUT POWER.....29

 9.3.1. 802.11b MODE30

 9.3.2. 802.11g MODE31

 9.3.3. 802.11n HT20 MODE32

 9.4. POWER SPECTRAL DENSITY33

 9.4.1. 802.11b MODE34

 9.4.2. 802.11g MODE36

9.4.3.	802.11n HT20 MODE	38
9.5.	<i>CONDUCTED SPURIOUS EMISSIONS</i>	40
9.5.1.	802.11b MODE	41
9.5.2.	802.11g MODE	43
9.5.3.	802.11n HT20 MODE	45
10.	RADIATED TEST RESULTS	47
10.1.	<i>TRANSMITTER ABOVE 1 GHz</i>	49
10.1.1.	<i>TX ABOVE 1 GHz 802.11b MODE IN THE 2.4 GHz BAND</i>	49
10.1.2.	<i>TX ABOVE 1 GHz 802.11g MODE IN THE 2.4 GHz BAND</i>	63
10.1.3.	<i>TX ABOVE 1 GHz 802.11n HT20 MODE IN THE 2.4 GHz BAND</i>	79
10.2.	<i>WORST CASE BELOW 30MHZ</i>	95
10.3.	<i>WORST CASE BELOW 1 GHZ</i>	96
10.4.	<i>WORST CASE 18-26 GHZ</i>	98
11.	AC POWER LINE CONDUCTED EMISSIONS	100
12.	SETUP PHOTOS	103
12.1.	<i>SM-A705FN/DS (ORIGINAL)</i>	103
12.2.	<i>SM-A705YN (Spot Check)</i>	106

1. ATTESTATION OF TEST RESULTS

COMPANY NAME: Samsung Electronics Co., Ltd.
129 Samsung-Ro, Yeongtong-Gu,
Suwon-Si, Gyeonggi-Do, 16677, Korea

EUT DESCRIPTION: GSM/WCDMA/LTE Phone with BT, DTS/UNII a/b/g/n/ac, ANT+ and NFC

MODEL: SM-A705YN

SERIAL NUMBER: Radiated (Original):R38M10NPF1Y, R38M10CSH8Z
Conducted (Original):R38M10CT1JE
Radiated (Spot Check): R38M4046MZN

DATE TESTED: FEBRUARY 18 to MARCH 15, 2019 (Original)
April 11, 2019 (Spot Check)

APPLICABLE STANDARDS	
STANDARD	TEST RESULTS
CFR 47 Part 15 Subpart C	Complies

UL Verification Services Inc. tested the above equipment in accordance with the requirements set forth in the above standards. The test results show that the equipment tested is capable of demonstrating compliance with the requirements as documented in this report.

The results documented in this report apply only to the tested sample, under the conditions and modes of operation as described herein. It is the manufacturer's responsibility to assure that additional production units of this model are manufactured with identical electrical and mechanical components. All samples tested were in good operating condition throughout the entire test program. Measurement Uncertainties are published for informational purposes only and were not taken into account unless noted otherwise.

This document may not be altered or revised in any way unless done so by UL Verification Services Inc. and all revisions are duly noted in the revisions section. Any alteration of this document not carried out by UL Verification Services Inc. will constitute fraud and shall nullify the document. This report must not be used by the client to claim product certification, approval, or endorsement by NVLAP, NIST, any agency of the Federal Government, or any agency of the U.S. government.

Approved & Released For
UL Verification Services Inc. By:

Reviewed By:



Dan Corona
Operations Leader
Consumer Technology Division
UL Verification Services Inc.

Kiya Kedida
Senior Project Engineer
Consumer Technology Division
UL Verification Services Inc.

2. INTRODUCTION OF TEST DATA REUSE

2.1. INTRODUCTION

According to the manufacturer, FCC ID: A3LSMA705FN and FCC ID: A3LSMA705YN non-licensed radios are electrically identical. The FCC ID: A3LSMA705FN test data shall remain representative of FCC ID: A3LSMA705YN.

The applicant takes full responsibility that the test data as referenced in this section represents compliance for this FCC ID.

2.2. DIFFERENCES

The FCC ID: A3LSMA705FN, shares the same enclosure and circuit board as FCC ID: A3LSMA705YN. The DTS WLAN antennas and surrounding circuitry and layout are identical between two models.

After confirming through preliminary radiated emissions that the performance of the FCC ID: A3LSMG705FN remains representative of FCC ID: A3LSMA705YN. The test data of FCC ID: A3LSMG705FN being submitted for this application to cover DTS WLAN features.

2.3. SPOT CHECK VERIFICATION RESULTS SUMMARY

Spot check verification has been done on device A3LSMA705YN for radiated harmonic spurious and radiated band-edge. The data from the application has been verified through appropriate spot checks to demonstrate compliance for this device in accordance to FCC public KDB 484596 D01 as shown in the summary below.

A3LSMA705YN SPOT CHECK RESULTS										
Technology	Mode	Test Item	Channel	Measured Frequency	Original model		Spot check model		Delta (dB)	
					SM-A705FN/DS		SM-A705YN			
					A3LSMA705FN		A3LSMA705YN			
					Peak	Ave	Peak	Ave	Peak	Ave
DTS	11n HT20	RBE	11	2484MHz	65.58	51.86	58.67	44.81	-6.91	-7.05
	11b	RSE	11	4924MHz	45.98	41.69	40.35	31.31	-5.63	-10.38

Comparison of the models, upper deviation is within 3dB range and all tests are under FCC Technical Limits.

SPOT CHECK DATA

BANDEDGE (HIGH CHANNEL)

HORIZONTAL RESULT

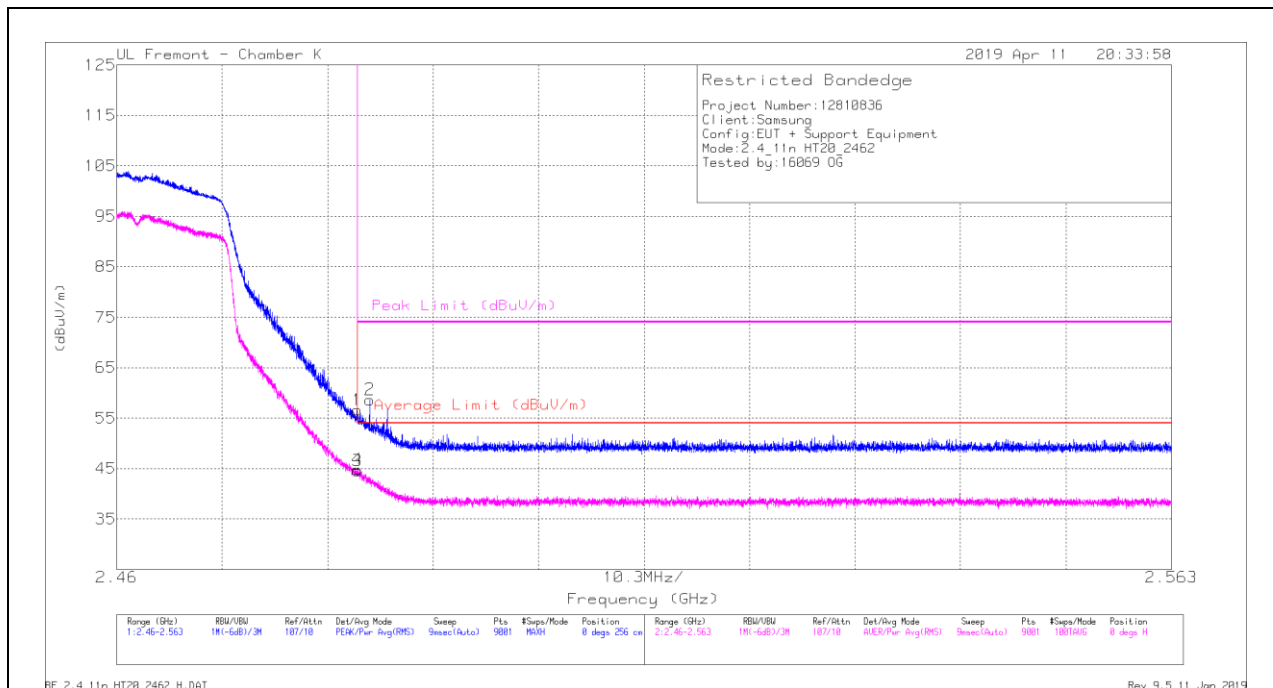

Trace Markers

Marker	Frequency (GHz)	Meter Reading (dBuV)	Det	AF T344 (dB/m)	Amp/Cbl/Filtr/Pad (dB)	DC Corr (dB)	Corrected Reading (dBuV/m)	Average Limit (dBuV/m)	Margin (dB)	Peak Limit (dBuV/m)	PK Margin (dB)	Azimuth (Degs)	Height (cm)	Polarity
1	* 2.484	49.14	Pk	32.3	-24.8	0	56.64	-	-	74	-17.36	0	256	H
2	* 2.485	51.17	Pk	32.3	-24.8	0	58.67	-	-	74	-15.33	0	256	H
3	* 2.484	36.93	RMS	32.3	-24.8	.1	44.53	54	-9.47	-	-	0	256	H
4	* 2.484	37.21	RMS	32.3	-24.8	.1	44.81	54	-9.19	-	-	0	256	H

* - indicates frequency in CFR47 Pt 15 / IC RSS-Restricted Band

Pk - Peak detector

RMS - RMS detection

VERTICAL RESULT

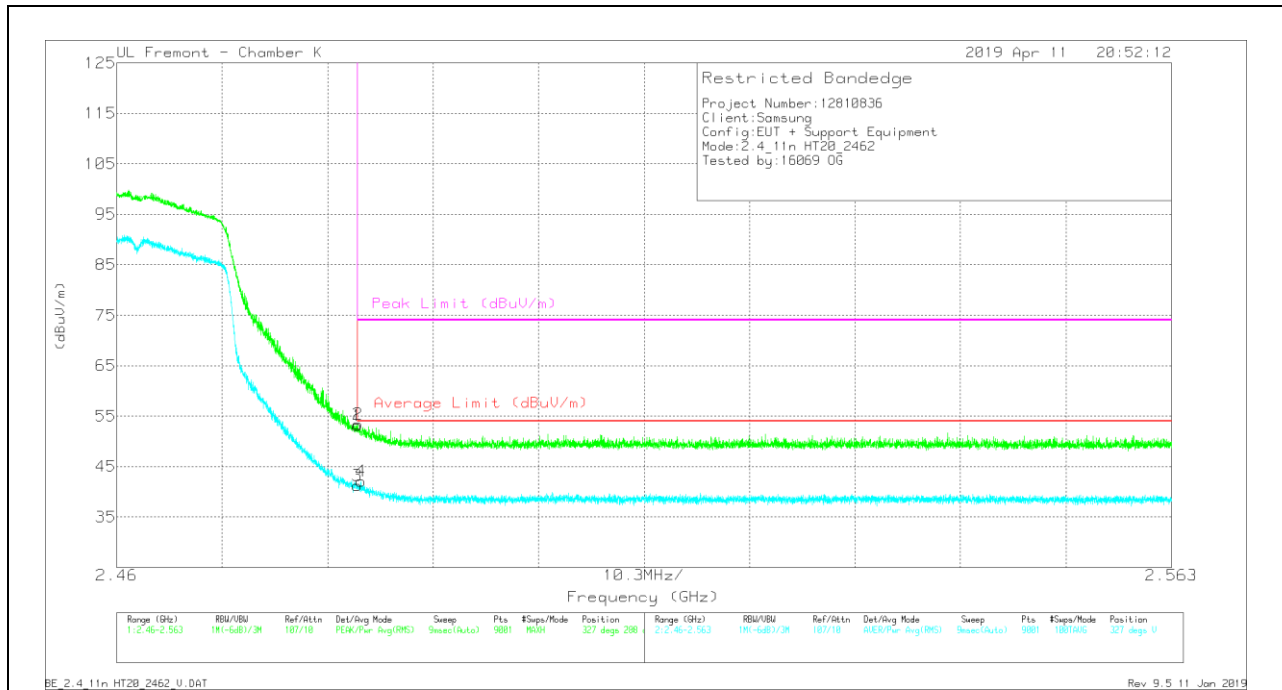

Trace Markers

Marker	Frequency (GHz)	Meter Reading (dBuV)	Det	AF T344 (dB/m)	Amp/CB/Ftr/Pad (dB)	DC Corr (dB)	Corrected Reading (dBuV/m)	Average Limit (dBuV/m)	Margin (dB)	Peak Limit (dBuV/m)	PK Margin (dB)	Azimuth (Degs)	Height (cm)	Polarity
1	* 2.484	43.61	Pk	32.3	-24.8	0	53.11	-	-	74	-20.89	327	288	V
2	* 2.484	45.9	Pk	32.3	-24.8	0	53.4	-	-	74	-20.6	327	288	V
3	* 2.484	33.68	RMS	32.3	-24.8	.1	41.28	54	-12.72	-	-	327	288	V
4	* 2.484	34.47	RMS	32.3	-24.8	.1	42.07	54	-11.93	-	-	327	288	V

* - indicates frequency in CFR47 Pt 15 / IC RSS-Restricted Band

Pk - Peak detector

RMS - RMS detection

HARMONICS AND SPURIOUS EMISSIONS

HIGH CHANNEL RESULTS

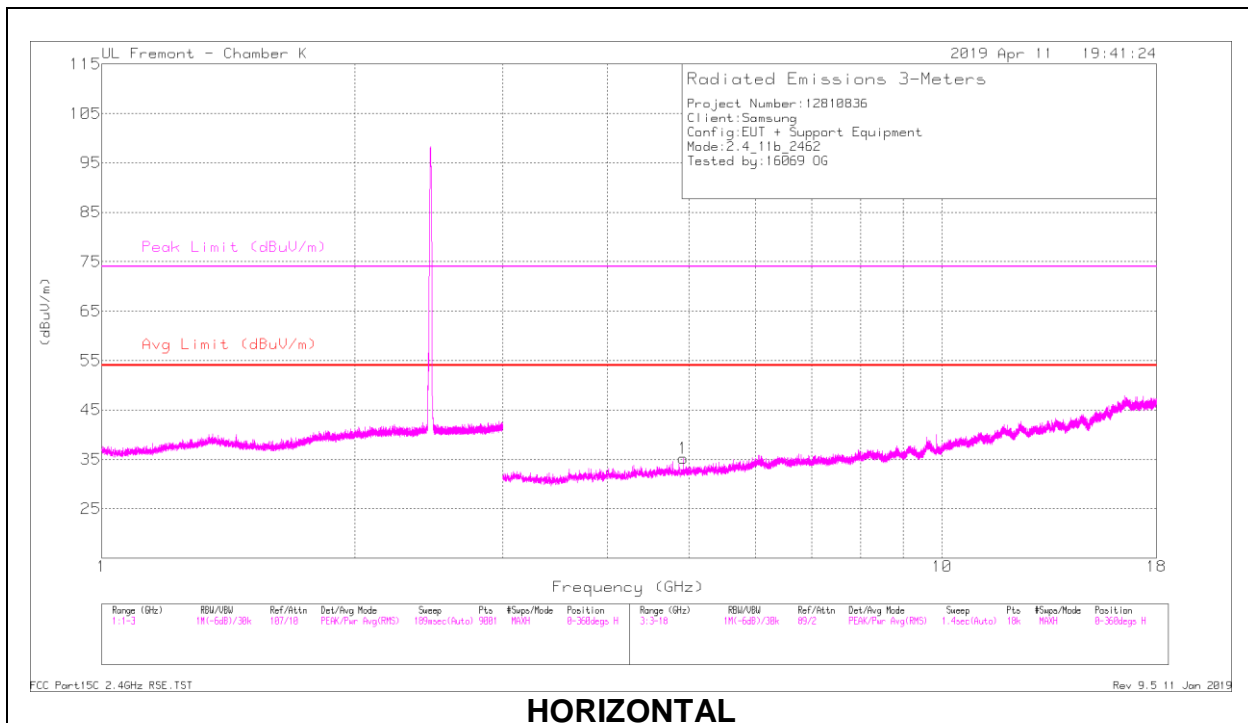

HORIZONTAL

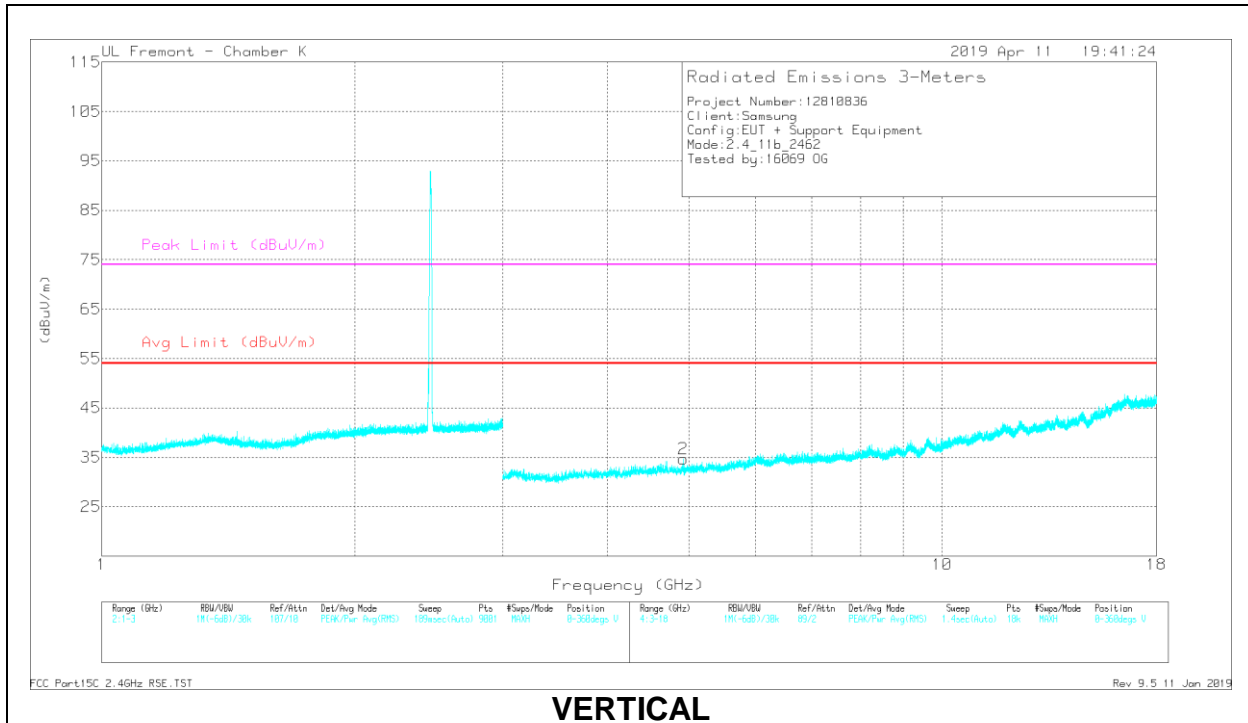

VERTICAL

Radiated Emissions

Frequency (GHz)	Meter Reading (dBuV)	Det	AF T344 (dB/m)	Amp/Cb/FI tr/Pad (dB)	DC Corr (dB)	Corrected Reading (dBuV/m)	Avg Limit (dBuV/m)	Margin (dB)	Peak Limit (dBuV/m)	PK Margin (dB)	Azimuth (Degs)	Height (cm)	Polarity
* 4.923	25.55	PK2	34.2	-30.6	0	29.15	-	-	74	-44.85	227	129	H
* 4.924	31.35	MAv1	34.2	-30.6	.1	35.05	54	-18.95	-	-	227	129	H
* 4.922	36.75	PK2	34.2	-30.6	0	40.35	-	-	74	-33.65	334	133	V
* 4.924	27.61	MAv1	34.2	-30.6	.1	31.31	54	-22.69	-	-	334	133	V

* - indicates frequency in CFR47 Pt 15 / IC RSS-Restricted Band

PK2 - KDB558074 Method: Maximum Peak

MAv1 - KDB558074 Option 1 Maximum RMS Average

2.4. REFERENCE DETAIL

Reference application that contains the reused reference data

Equipment Class	Reference FCC ID	Type Grant/ Permissive Change	Reference Application	Folder Test/RF Exposure	Report Title/Section
DTS	A3LSMA705FN	Grant	12726900-E4	Test	FCC Report DTS WLAN / All sections

3. TEST METHODOLOGY

The tests documented in this report were performed in accordance with FCC CFR 47 Part 2, FCC CFR 47 Part 15, ANSI C63.10-2013, KDB 558074 D01 15.247 Meas Guidance v05 v05r02.

4. FACILITIES AND ACCREDITATION

The test sites and measurement facilities used to collect data are located at 47173 and 47266 Benicia Street, and 47658 Kato Road, Fremont, California, USA. Line conducted emissions are measured only at the 47173 address. The following table identifies which facilities were utilized for radiated emission measurements documented in this report. Specific facilities are also identified in the test results sections.

47173 Benicia Street	47266 Benicia Street	47658 Kato Rd
<input checked="" type="checkbox"/> Chamber A (ISED:2324B-1)	<input type="checkbox"/> Chamber D (ISED:22541-1)	<input checked="" type="checkbox"/> Chamber I (ISED:2324A-5)
<input type="checkbox"/> Chamber B (ISED:2324B-2)	<input type="checkbox"/> Chamber E (ISED:22541-2)	<input type="checkbox"/> Chamber J (ISED:2324A-6)
<input type="checkbox"/> Chamber C (ISED:2324B-3)	<input type="checkbox"/> Chamber F (ISED:22541-3)	<input checked="" type="checkbox"/> Chamber K (ISED:2324A-1)
	<input type="checkbox"/> Chamber G (ISED:22541-4)	<input type="checkbox"/> Chamber L (ISED:2324A-3)
	<input type="checkbox"/> Chamber H (ISED:22541-5)	

The above test sites and facilities are covered under FCC Test Firm Registration # 208313. Chambers above are covered under Industry Canada company address and respective code

UL Verification Services Inc. is accredited by NVLAP, Laboratory Code 200065-0

5. CALIBRATION AND UNCERTAINTY

5.1. MEASURING INSTRUMENT CALIBRATION

The measuring equipment utilized to perform the tests documented in this report has been calibrated in accordance with the manufacturer's recommendations, and is traceable to recognized national standards.

5.2. SAMPLE CALCULATION

RADIATED EMISSIONS

Where relevant, the following sample calculation is provided:

Field Strength (dBuV/m) = Measured Voltage (dBuV) + Antenna Factor (dB/m) + Cable Loss (dB) – Preamp Gain (dB)

$$36.5 \text{ dBuV} + 18.7 \text{ dB/m} + 0.6 \text{ dB} - 26.9 \text{ dB} = 28.9 \text{ dBuV/m}$$

MAINS CONDUCTED EMISSIONS

Where relevant, the following sample calculation is provided:

Final Voltage (dBuV) = Measured Voltage (dBuV) + Cable Loss (dB) + Limiter Factor (dB) + LISN Insertion Loss.

$$36.5 \text{ dBuV} + 0 \text{ dB} + 10.1 \text{ dB} + 0 \text{ dB} = 46.6 \text{ dBuV}$$

5.3. MEASUREMENT UNCERTAINTY

Where relevant, the following measurement uncertainty levels have been estimated for tests performed on the apparatus:

PARAMETER	UNCERTAINTY
Worst Case Conducted Disturbance, 9KHz to 0.15 MHz	3.84 dB
Worst Case Conducted Disturbance, 0.15 to 30 MHz	3.65 dB
Worst Case Radiated Disturbance, 9KHz to 30 MHz	2.52 dB
Worst Case Radiated Disturbance, 30 to 1000 MHz	4.88 dB
Worst Case Radiated Disturbance, 1000 to 18000 MHz	4.24 dB
Worst Case Radiated Disturbance, 18000 to 26000 MHz	4.37 dB
Worst Case Radiated Disturbance, 26000 to 40000 MHz	5.17 dB

Uncertainty figures are valid to a confidence level of 95%.

6. EQUIPMENT UNDER TEST

6.1. EUT DESCRIPTION

The EUT is a GSM/WCDMA/LTE Phone with BT, DTS/UNII a/b/g/n/ac, ANT+ and NFC. The model SM-A705FN/DS was used for final testing and is representative of the test results in this report.

6.2. MAXIMUM OUTPUT POWER

The transmitter has a maximum conducted output power as follows:

Frequency Range (MHz)	Mode	Output Power (dBm)	Output Power (mW)
2412 - 2472	802.11b	18.83	76.38
2412 - 2472	802.11g	17.59	57.41
2412 - 2472	802.11n HT20	17.31	53.83

6.3. DESCRIPTION OF AVAILABLE ANTENNAS

The radio utilizes an FPCB antenna, with a maximum gain of -4.88 dBi.

6.4. SOFTWARE AND FIRMWARE

The test utility software used during testing was A705FN.001

6.5. WORST-CASE CONFIGURATION AND MODE

Radiated emissions below 1GHz, above 18GHz, and power line conducted emission were performed with the EUT set to transmit at the channel with highest output power as worst-case scenario.

Band edge and radiated emissions between 1GHz and 18GHz were performed with the EUT set to transmit at the highest power on low, middle and high channels.

The fundamental of the EUT was investigated in three orthogonal orientations X,Y,Z, it was determined that X orientation was worst-case orientation; therefore, all final radiated testing was performed with the EUT in X orientation.

Worst-case data rates as provided by the client were:

802.11b mode: 1 Mbps
802.11g mode: 6 Mbps
802.11n HT20mode: MCS0

6.6. DESCRIPTION OF TEST SETUP

SUPPORT EQUIPMENT

Support Equipment List				
Description	Manufacturer	Model	Serial Number	FCC ID
AC Adapter	Samsung	EP-TA50EWE	DW3J719AS/A-E	N/A
Earphone	Samsung	N/A	N/A	N/A

I/O CABLES (CONDUCTED TEST)

I/O Cable List						
Cable No	Port	# of identical ports	Connector Type	Cable Type	Cable Length (m)	Remarks
1	Antenna	1	RF	Shielded	0.2	To spectrum Analyzer
2	USB	1	USB	Un-shielded	1	EUT to AC Mains

I/O CABLES (RADIATED AND CONDUCTED EMISSIONS)

I/O Cable List						
Cable No	Port	# of identical ports	Connector Type	Cable Type	Cable Length (m)	Remarks
1	USB	1	USB	Shielded	1	N/A
2	earphone	1	3.5mm	Un-shielded	1	N/A

TEST SETUP

The EUT is a stand alone unit. Test software exercised the radio card.

CONDUCTED TEST SETUP DIAGRAM

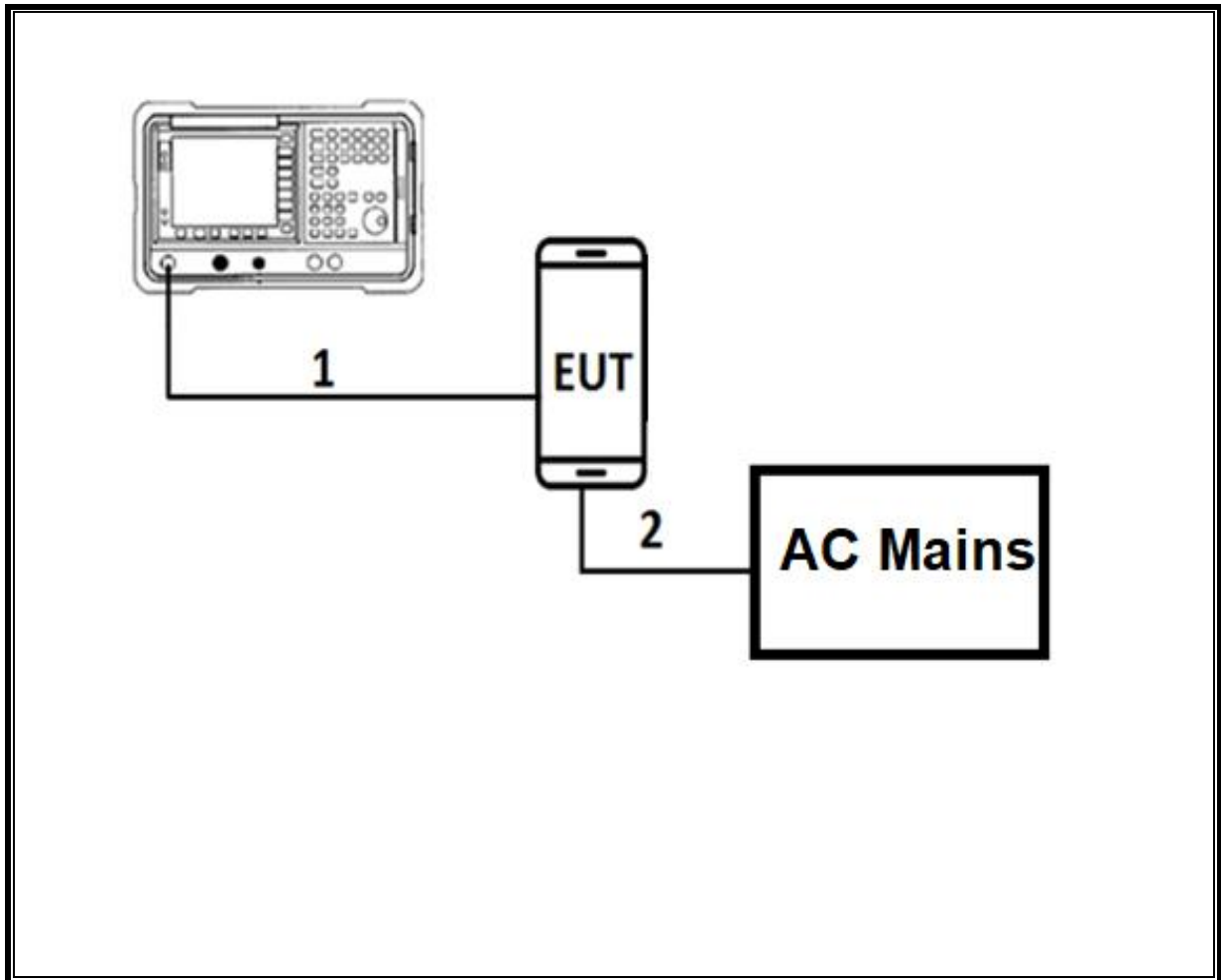

TEST SETUP

For conducted tests: the EUT was stand alone. The test software exercises the radio.

RADIATED AND AC LINE CONDUCTED EMISSIONS SETUP DIAGRAM

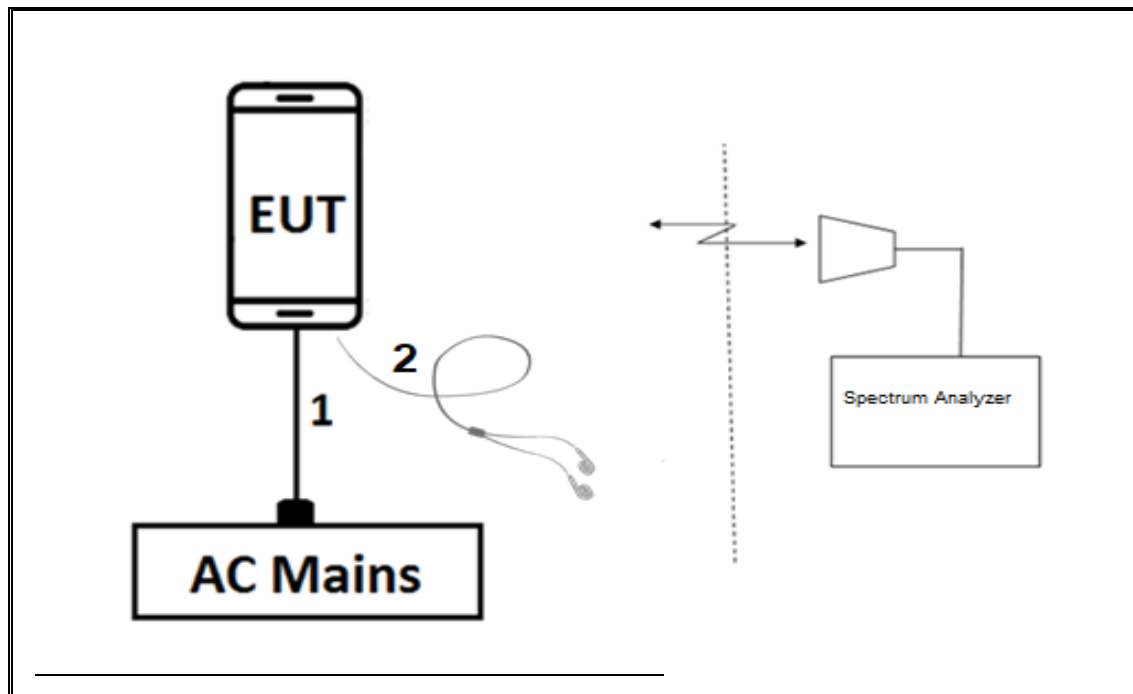

TEST SETUP

For radiated tests: EUT is stand alone. The test software exercises the radio.

7. MEASUREMENT METHOD

On Time and Duty Cycle: ANSI C63.10 Section 11.6

6 dB BW: ANSI C63.10 Section 11.8.1

Output Power: ANSI C63.10 Section 11.9.2.3.2 Method AVGPM-G (Measurement using a gated RF average-reading power meter)

PSD: ANSI C63.10 Section 11.10.2 Method PKPSD (peak PSD)

Band-edge: ANSI C63.10 Section 11.13.3.4 Trace averaging across ON and OFF times of the EUT transmissions followed by duty cycle correction factor

Radiated emissions non-restricted frequency bands: ANSI C63.10 Section 11.11

Radiated emissions restricted frequency bands: ANSI C63.10 Section 11.12.1

Radiated Spurious Emissions Below 30MHz: ANSI C63.10-2013 Section 6.4

Conducted emissions in restricted frequency bands: ANSI C63.10 Section 11.12.

AC Power Line Conducted Emissions: ANSI C63.10-2013, Section 6.2.

8. TEST AND MEASUREMENT EQUIPMENT

The following test and measurement equipment was utilized for the tests documented in this report:

TEST EQUIPMENT LIST					
Description	Manufacturer	Model	ID Num	Cal Due	Last Cal
Power Meter, P-series single channel	Agilent (Keysight) Technologies	N1911A	T1271	07/26/2019	07/26/2018
Power Sensor, P-series, 50MHz to 18GHz, Wideband	Agilent (Keysight) Technologies	N1921A	T1224	10/09/2019	10/09/2018
Antenna, Active Loop 9kHz-30MHz	ETS-Lindgren	6502	T757	09/25/2019	09/25/2018
Antenna, Horn 1-18GHz	ETS-Lindgren	3117	T344	04/30/2019	04/30/2018
Amplifier, 1 to18GHz, 35dB	AMOLICAL	AMP1G18-35	T1569	06/03/2019	06/03/2018
Antenna, Horn 1-18GHz	ETS-Lindgren	3117	T862	05/25/2019	05/25/2018
Amplifier, 1 to18GHz,	MITEQ	AFS42-00101800-25-S-42	PRE018078	08/01/2019	08/01/2018
EMI TEST RECEIVER	Rohde & Schwarz	ESW44	PRE0179367	04/25/2019	04/25/2018
EMI TEST RECEIVER	Rohde & Schwarz	ESW44	PRE0179375	05/08/2019	05/08/2018
Spectrum Analyzer, PXA, 3Hz to 44GHz	Agilent (Keysight) Technologies	N9030A	T908	01/23/2020	01/23/2019
Spectrum Analyzer, PXA, 3Hz to 44GHz	Agilent (Keysight) Technologies	N9030A	T341	09/26/2019	09/26/2018
Amplifier, 100kHz to 1GHz, 32 dB	Sonoma Instrument	310	PRE0186650	12/13/2019	12/23/2018
Hybrid Antenna, 30MHz to 3GHz	SunAR rf motion	JB3	PRE0184052	10/24/2019	10/24/2018
Antenna, Horn 18 to 26.5GHz	ARA	MWH-1826/B	T447	06/16/2019	06/16/2018
Pre-Amp, 1-26.5GHz	Agilent	8449B	T404	03/09/2019	03/09/2018
AC Line Conducted					
EMI Receiver	Rohde & Schwarz	ESR	T1436	02/14/2020	02/14/2019
LISN for Conducted Emissions CISPR-16	FCC INC.	FCC LISN 50/250	T1310	06/15/2019	06/15/2018
Test Software List					
Radiated Software	UL	UL EMC		Ver 9.5, June 22, 2018	
Antenna Port Software	UL	UL RF		Ver 9.3.2, Jan. 07, 2019	
AC Line Conducted Software	UL	UL EMC		Ver 9.5, May 26, 2015	

NOTES:

1. Equipment listed above that calibrated during the testing period was set for test after the calibration.
2. Equipment listed above that has a calibration due date during the testing period, the testing is completed before equipment expiration date.

9. ANTENNA PORT TEST RESULTS

9.1. ON TIME AND DUTY CYCLE

LIMITS

None; for reporting purposes only.

PROCEDURE

ANSI C63.10, Section 11.6 : Zero-Span Spectrum Analyzer Method.

ON TIME AND DUTY CYCLE RESULTS

Mode	ON Time B (msec)	Period (msec)	Duty Cycle x (linear)	Duty Cycle (%)	Duty Cycle Correction Factor (dB)	1/B Minimum VBW (kHz)
2.4GHz Band						
802.11b 1TX	8.52	8.72	0.977	97.71%	0.10	0.117
802.11g 1TX	1.44	1.47	0.980	97.96%	0.09	0.694
802.11n HT20 1TX	1.35	1.38	0.978	97.83%	0.10	0.741

DUTY CYCLE PLOTS

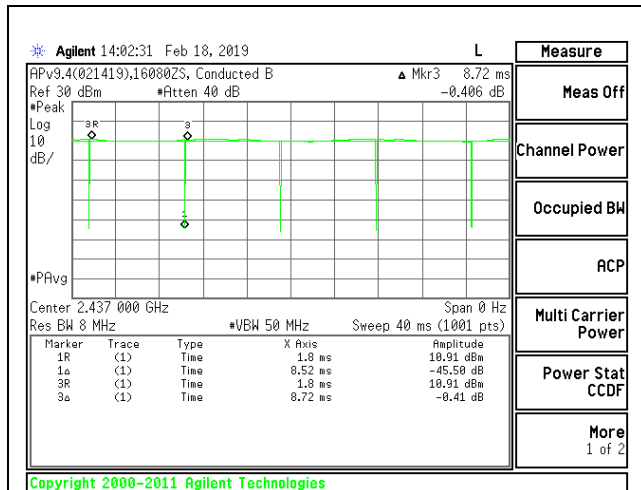

DUTY CYCLE 802.11b MODE

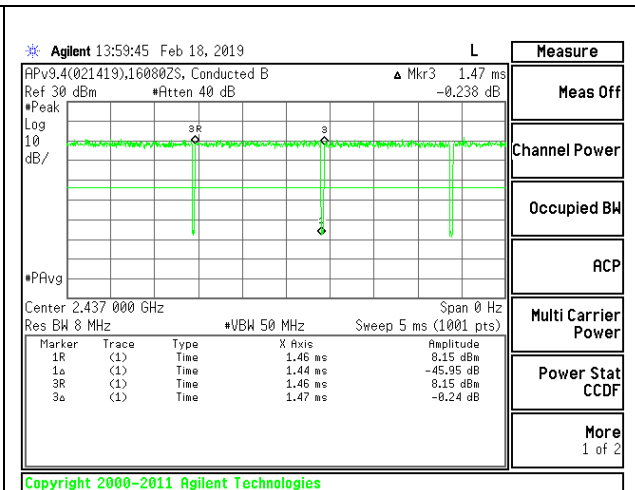

DUTY CYCLE 802.11g MODE

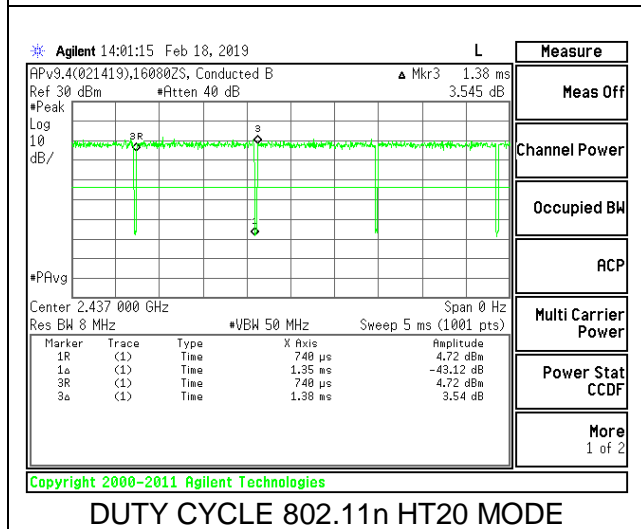

DUTY CYCLE 802.11n HT20 MODE

9.2. 6 dB BANDWIDTH

LIMITS

FCC §15.247 (a) (2)

The minimum 6 dB bandwidth shall be at least 500 kHz.

RESULTS

9.2.1. 802.11b MODE

1TX Antenna 1 MODE

Channel	Frequency (MHz)	6 dB Bandwidth (MHz)	Minimum Limit (MHz)
Low 1	2412	8.64	0.5
Mid 6	2437	8.68	0.5
High 11	2462	8.24	0.5
High 12	2467	8.64	0.5
High 13	2472	8.12	0.5

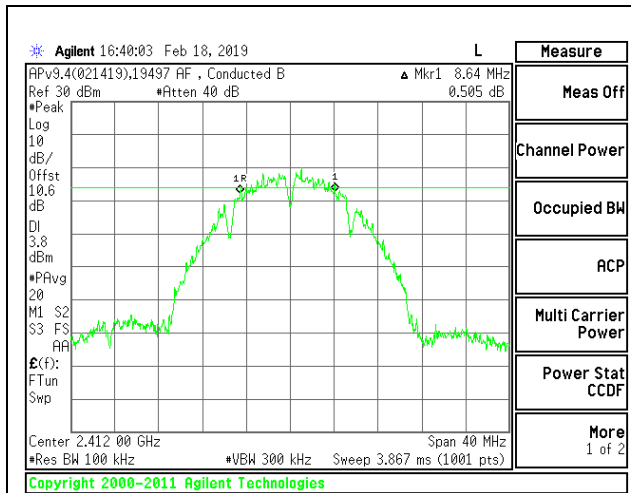

LOW CHANNEL 1

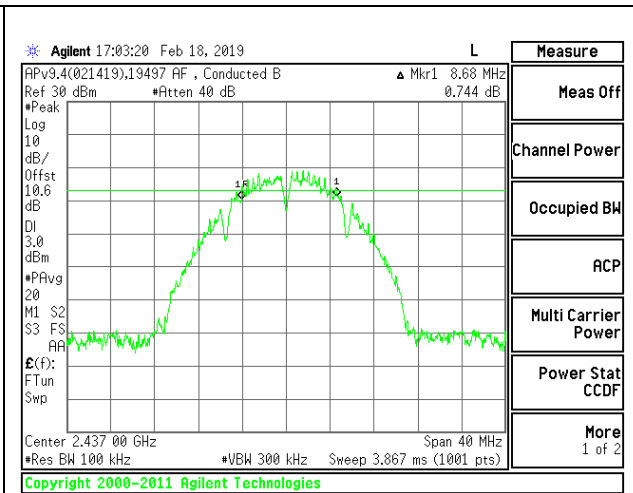

MID CHANNEL 6

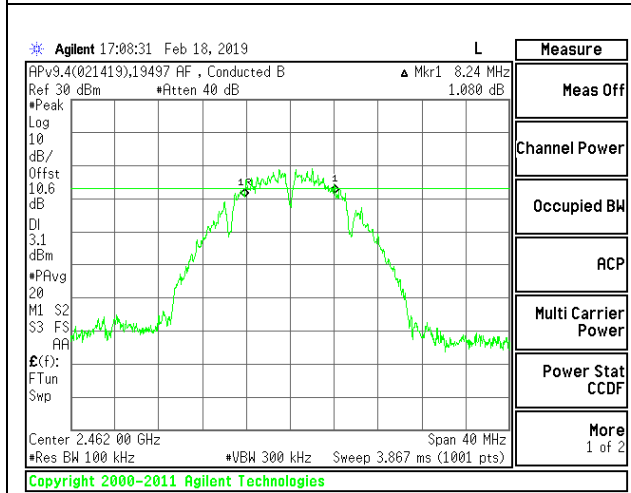

HIGH CHANNEL 11

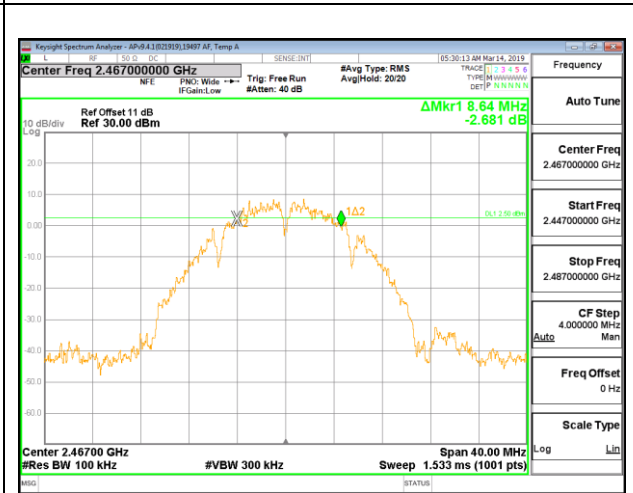

HIGH CHANNEL 12

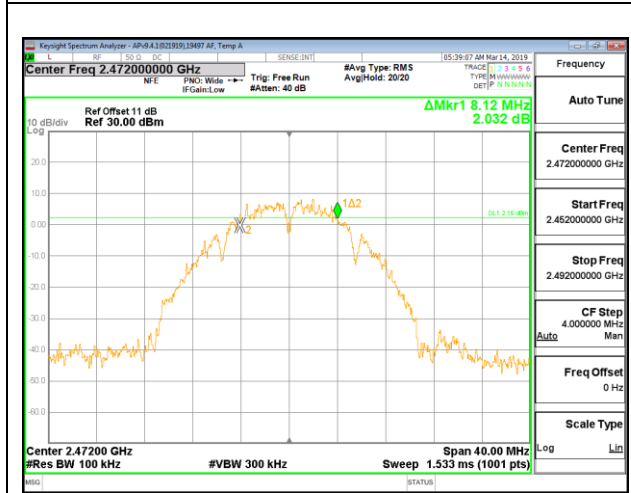

HIGH CHANNEL 13

Intentionally Left Blank

9.2.2. 802.11g MODE

1TX Antenna 1 MODE

Channel	Frequency (MHz)	6 dB Bandwidth (MHz)	Minimum Limit (MHz)
Low 1	2412	16.36	0.5
Low 2	2417	16.44	0.5
Mid 6	2437	16.48	0.5
High 11	2462	16.36	0.5
High 12	2467	16.48	0.5
High 13	2472	16.40	0.5

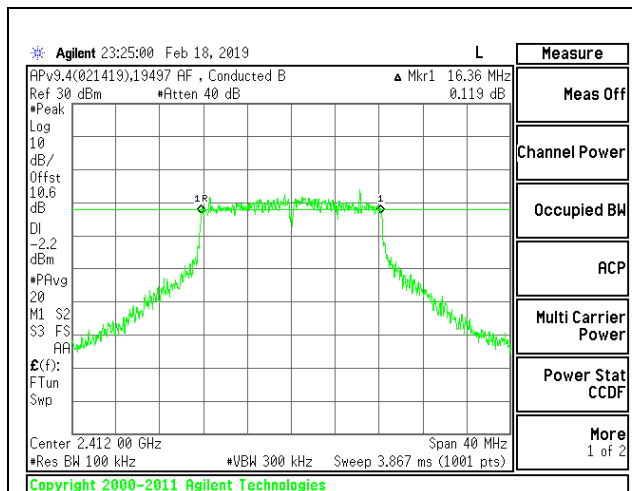

LOW CHANNEL 1

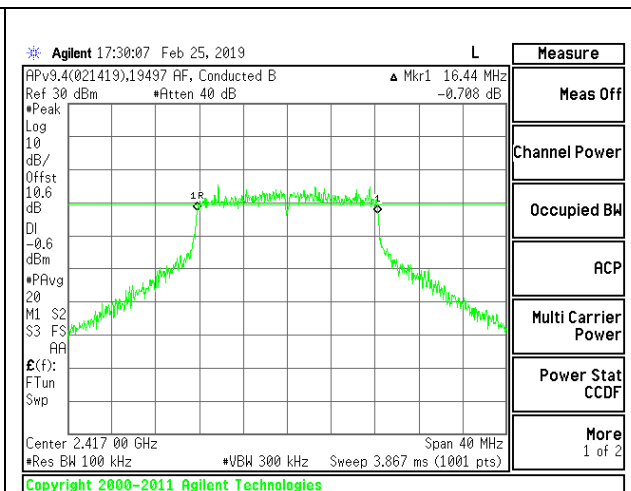

LOW CHANNEL 2

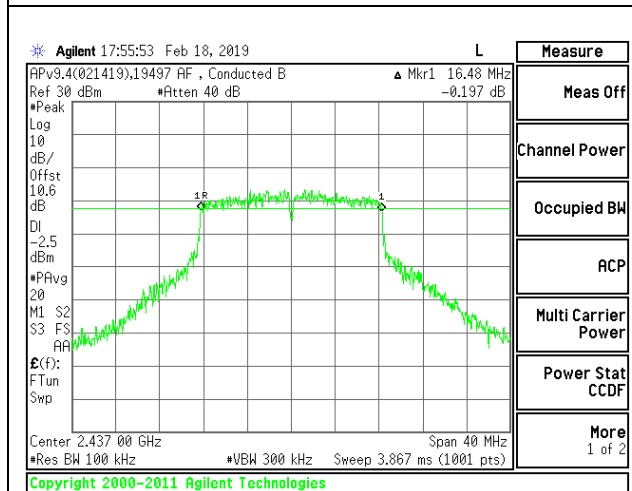

MID CHANNEL 6

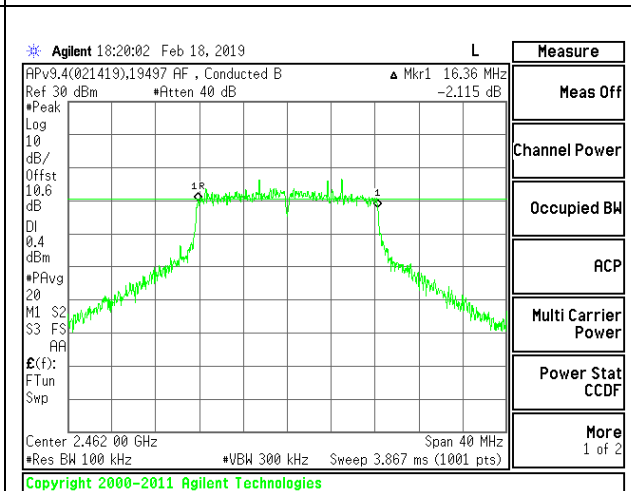

HIGH CHANNEL 11

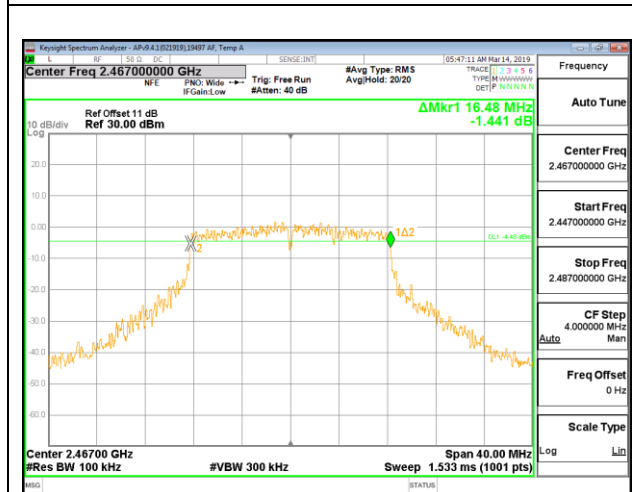

HIGH CHANNEL 12

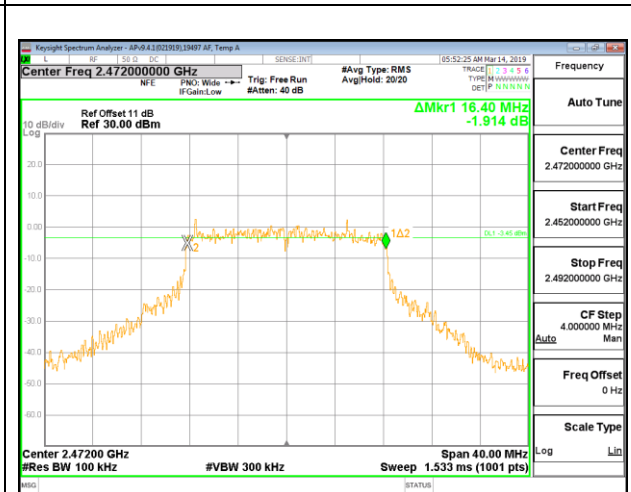

HIGH CHANNEL 13

9.2.3. 802.11n HT20 MODE

1TX Antenna 1 MODE

Channel	Frequency (MHz)	6 dB Bandwidth (MHz)	Minimum Limit (MHz)
Low 1	2412	17.64	0.5
Low 2	2417	17.64	0.5
Mid 6	2437	17.28	0.5
High 11	2462	17.64	0.5
High 12	2467	17.68	0.5
High 13	2472	17.64	0.5

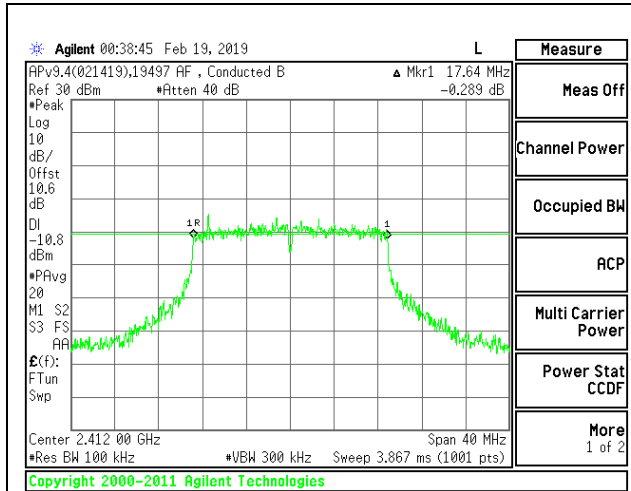

LOW CHANNEL 1

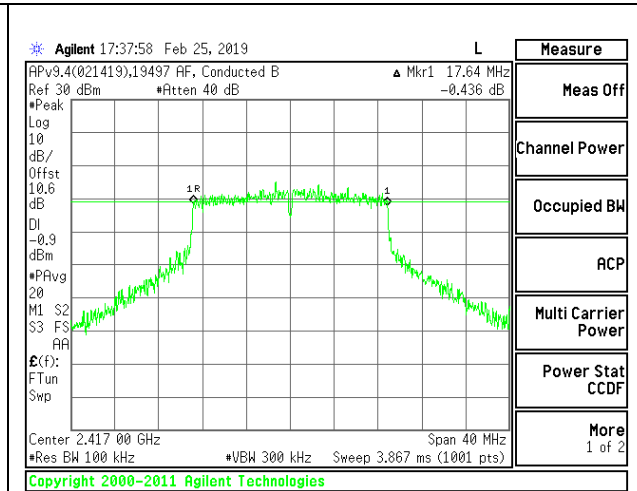

LOW CHANNEL 2

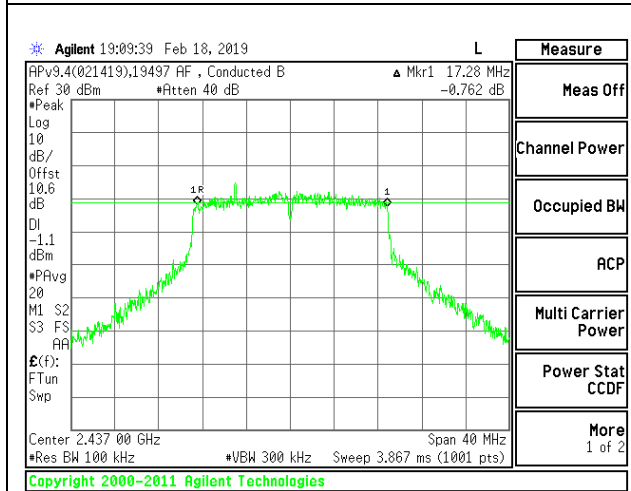

MID CHANNEL 6

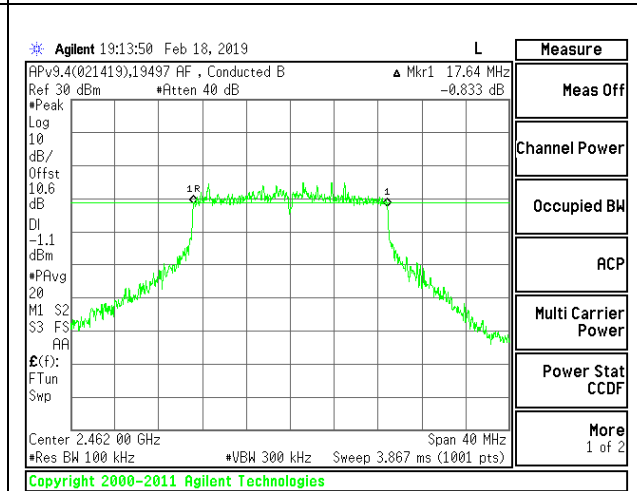

HIGH CHANNEL 11

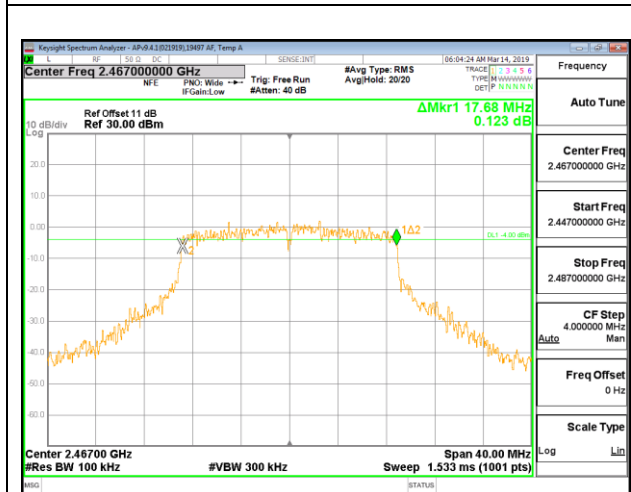

HIGH CHANNEL 12

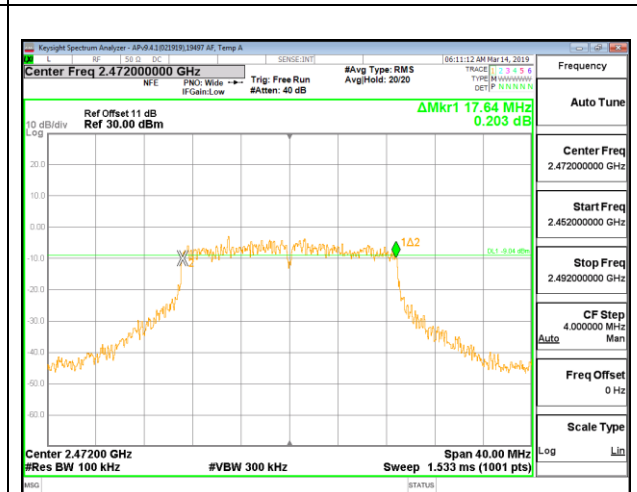

HIGH CHANNEL 13

9.3. OUTPUT POWER

LIMITS

FCC §15.247 (b) (3)

For systems using digital modulation in the 902–928 MHz, 2400–2483.5 MHz, and 5725–5850 MHz bands: 1 Watt, based on the use of antennas with directional gains that do not exceed 6 dBi. If transmitting antennas of directional gain greater than 6 dBi are used, the conducted output power from the intentional radiator shall be reduced by the amount in dB that the directional gain of the antenna exceeds 6 dBi.

TEST PROCEDURE

The transmitter output is connected to a power meter. The cable assembly insertion loss was entered as an offset in the power meter to allow for a gated average reading of power.

DIRECTIONAL ANTENNA GAIN

There is only one transmitter output therefore the directional gain is equal to the antenna gain.

RESULTS

9.3.1. 802.11b MODE

1TX Antenna 1 MODE

Limits

Channel	Frequency (MHz)	Directional Gain (dBi)	FCC Power Limit (dBm)	ISED Power Limit (dBm)	ISED EIRP Limit (dBm)	Max Power (dBm)
Low 1	2412	-4.88	30.00	30	36	30.00
Mid 6	2437	-4.88	30.00	30	36	30.00
High 11	2462	-4.88	30.00	30	36	30.00
High 12	2467	-4.88	30.00	30	36	30.00
High 13	2472	-4.88	30.00	30	36	30.00

Results

Channel	Frequency (MHz)	Meas Power (dBm)	Total Corr'd Power (dBm)	Power Limit (dBm)	Margin (dB)
Low 1	2412	18.45	18.45	30.00	-11.55
Mid 6	2437	18.16	18.16	30.00	-11.84
High 11	2462	18.48	18.48	30.00	-11.52
High 12	2467	18.83	18.83	30.00	-11.17
High 13	2472	18.50	18.50	30.00	-11.50

9.3.2. 802.11g MODE

1TX Antenna 1 MODE

Limits

Channel	Frequency (MHz)	Directional Gain (dBi)	FCC Power Limit (dBm)	ISED Power Limit (dBm)	ISED EIRP Limit (dBm)	Max Power (dBm)
Low 1	2412	-4.88	30.00	30	36	30.00
Low 2	2417	-4.88	30.00	30	36	30.00
Mid 6	2437	-4.88	30.00	30	36	30.00
High 11	2462	-4.88	30.00	30	36	30.00
High 12	2467	-4.88	30.00	30	36	30.00
High 13	2472	-4.88	30.00	30	36	30.00

Results

Channel	Frequency (MHz)	Meas Power (dBm)	Total Corr'd Power (dBm)	Power Limit (dBm)	Margin (dB)
Low 1	2412	15.02	15.02	30.00	-14.98
Low 2	2417	17.12	17.12	30.00	-12.88
Mid 6	2437	17.18	17.18	30.00	-12.82
High 11	2462	17.38	17.38	30.00	-12.62
High 12	2467	17.59	17.59	30.00	-12.41
High 13	2472	3.77	3.77	30.00	-26.23

9.3.3. 802.11n HT20 MODE

1TX Antenna 1 MODE

Limits

Channel	Frequency (MHz)	Directional Gain (dBi)	FCC Power Limit (dBm)	ISED Power Limit (dBm)	ISED EIRP Limit (dBm)	Max Power (dBm)
Low 1	2412	-4.88	30.00	30	36	30.00
Low 2	2417	-4.88	30.00	30	36	30.00
Mid 6	2437	-4.88	30.00	30	36	30.00
High 11	2462	-4.88	30.00	30	36	30.00
High 12	2467	-4.88	30.00	30	36	30.00
High 13	2472	-4.88	30.00	30	36	30.00

Results

Channel	Frequency (MHz)	Meas Power (dBm)	Total Corr'd Power (dBm)	Power Limit (dBm)	Margin (dB)
Low 1	2412	15.28	15.28	30.00	-14.72
Low 2	2417	17.15	17.15	30.00	-12.85
Mid 6	2437	16.93	16.93	30.00	-13.07
High 11	2462	17.31	17.31	30.00	-12.69
High 12	2467	15.84	15.84	30.00	-14.16
High 13	2472	2.59	2.59	30.00	-27.41

9.4. POWER SPECTRAL DENSITY

LIMITS

FCC §15.247 (e)

The power spectral density conducted from the transmitter to the antenna shall not be greater than 8 dBm in any 3 kHz band during any time interval of continuous transmission.

RESULTS

9.4.1. 802.11b MODE

1TX Antenna 1 MODE

Duty Cycle CF (dB)	0.10	Included in Calculations of Corr'd PSD
---------------------------	------	---

PSD Results

Channel	Frequency (MHz)	Chain 0 Meas (dBm/ 30kHz)	Total Corr'd PSD (dBm/ 30kHz)	Limit (dBm/ 30kHz)	Margin (dB)
Low 1	2412	-3.351	-3.25	8.0	-11.3
Mid 6	2437	-3.756	-3.66	8.0	-11.7
High 11	2462	-3.221	-3.12	8.0	-11.1
High 12	2467	-3.56	-3.46	8.0	-11.5
High 13	2472	-3.06	-2.96	8.0	-11.0

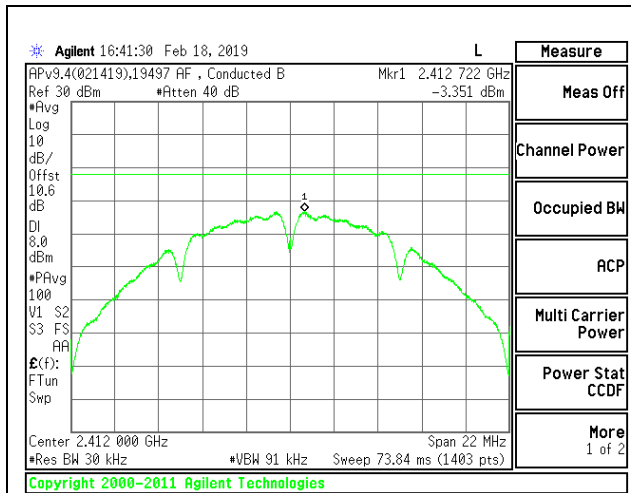

LOW CHANNEL 1

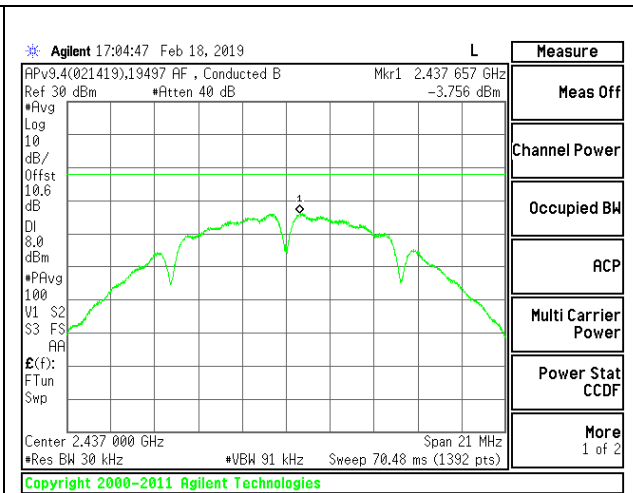

MID CHANNEL 6

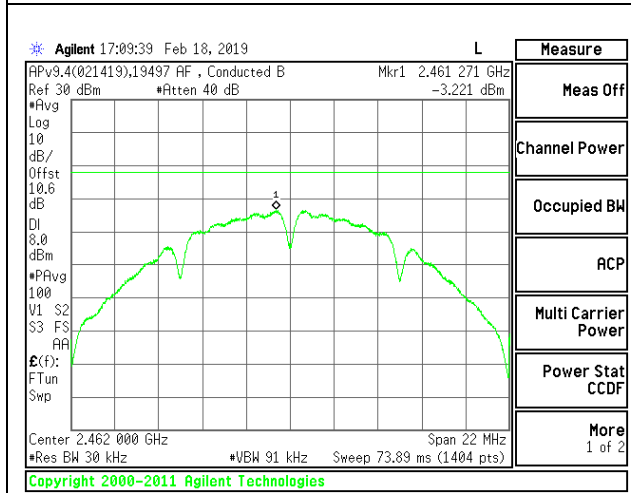

HIGH CHANNEL 11

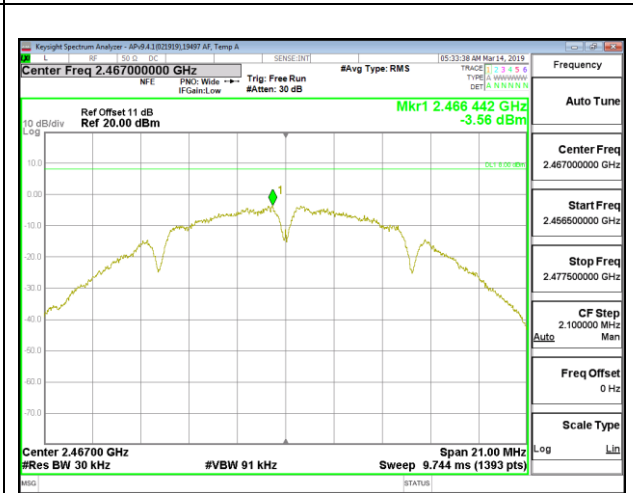

HIGH CHANNEL 12

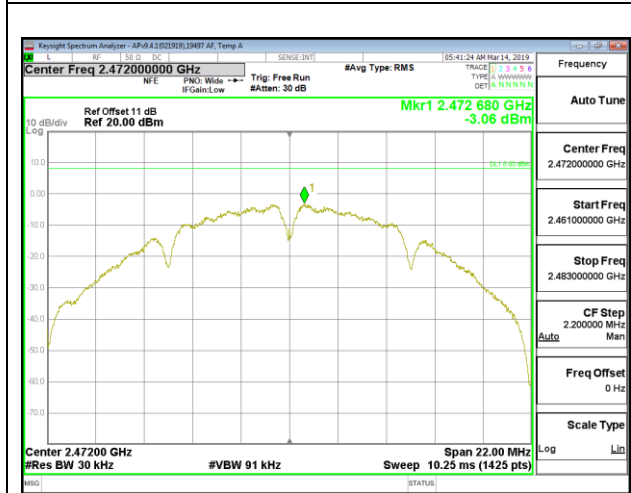

HIGH CHANNEL 13

Intentionally Left Blank

9.4.2. 802.11g MODE

1TX Antenna 1 MODE

Duty Cycle CF (dB)	0.09	Included in Calculations of Corr'd PSD
---------------------------	------	---

PSD Results

Channel	Frequency (MHz)	Chain 0 Meas (dBm/ 30kHz)	Total Corr'd PSD (dBm/ 30kHz)	Limit (dBm/ 30kHz)	Margin (dB)
Low 1	2412	-8.591	-8.50	8.0	-16.5
Low 2	2417	-6.698	-6.61	8.0	-14.6
Mid 6	2437	-7.331	-7.24	8.0	-15.2
High 11	2462	-6.620	-6.53	8.0	-14.5
High 12	2467	-6.55	-6.46	8.0	-14.5
High 13	2472	-20.50	-20.41	8.0	-28.4

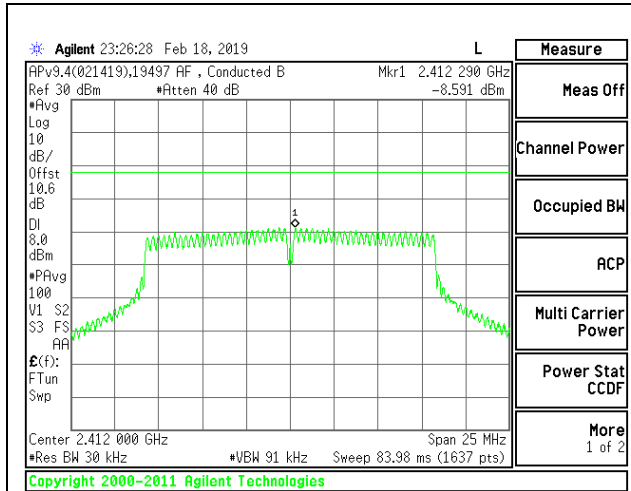

LOW CHANNEL 1

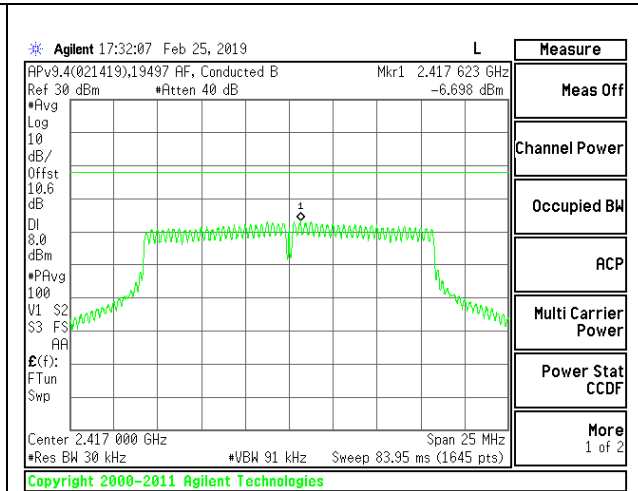

LOW CHANNEL 2

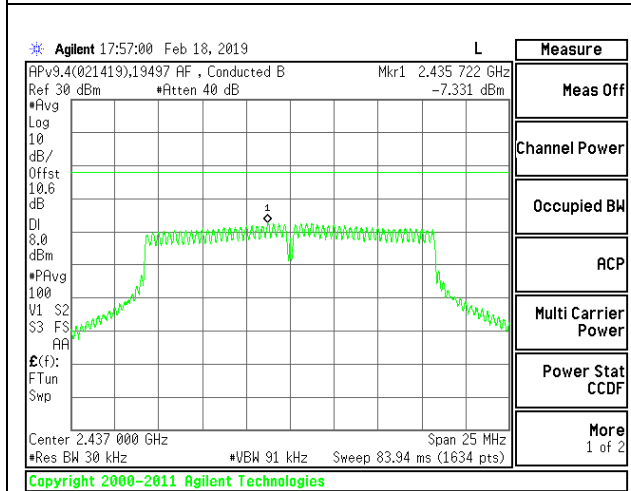

MID CHANNEL 6

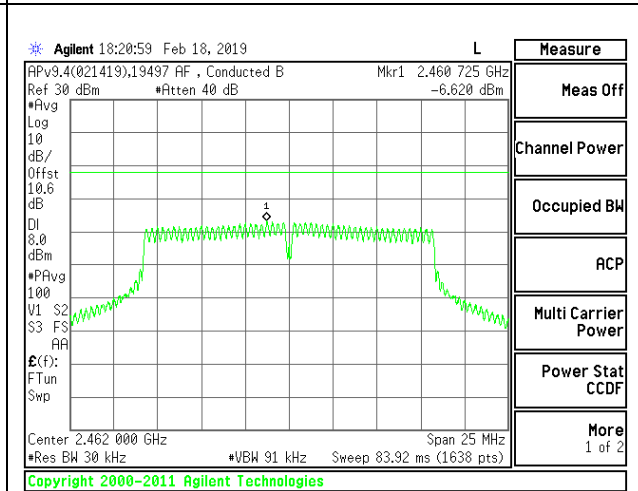

HIGH CHANNEL 11

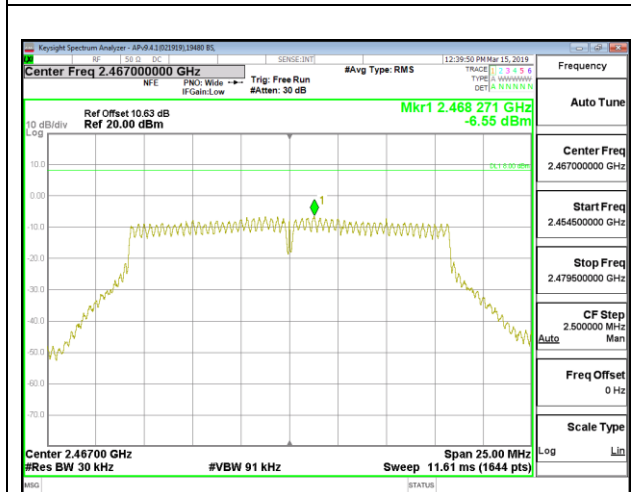

HIGH CHANNEL 12

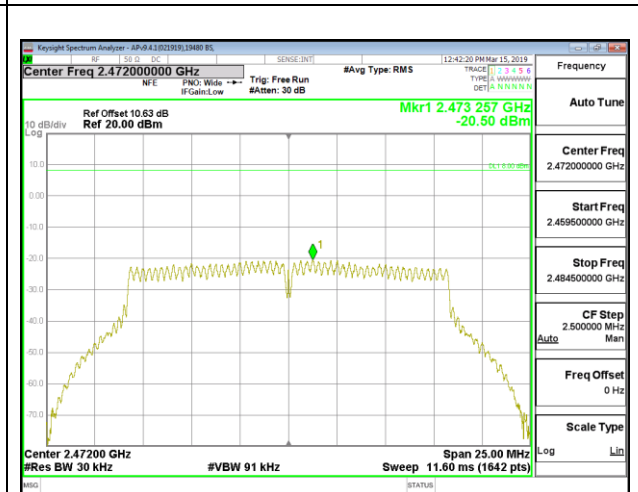

HIGH CHANNEL 13

9.4.3. 802.11n HT20 MODE

1TX Antenna 1 MODE

Duty Cycle CF (dB)	0.10	Included in Calculations of Corr'd PSD
---------------------------	------	---

PSD Results

Channel	Frequency (MHz)	Chain 0 Meas (dBm/ 30kHz)	Total Corr'd PSD (dBm/ 30kHz)	Limit (dBm/ 30kHz)	Margin (dB)
Low 1	2412	-15.951	-15.85	8.0	-23.9
Low 2	2417	-6.896	-6.80	8.0	-14.8
Mid 6	2437	-8.004	-7.90	8.0	-15.9
High 11	2462	-7.353	-7.25	8.0	-15.3
High 12	2467	-8.25	-8.15	8.0	-16.2
High 13	2472	-21.43	-21.33	8.0	-29.3

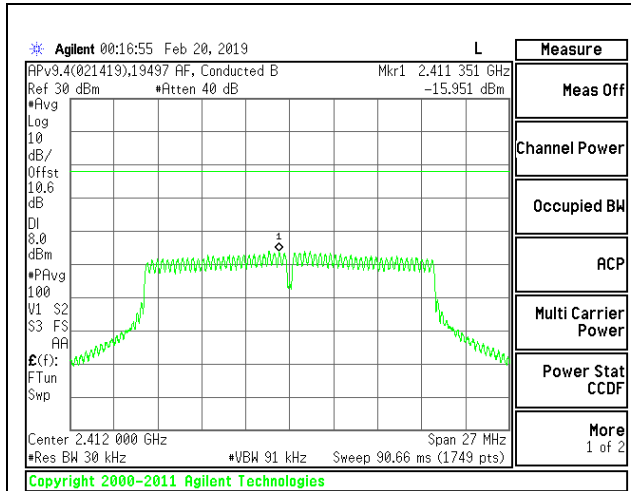

LOW CHANNEL 1

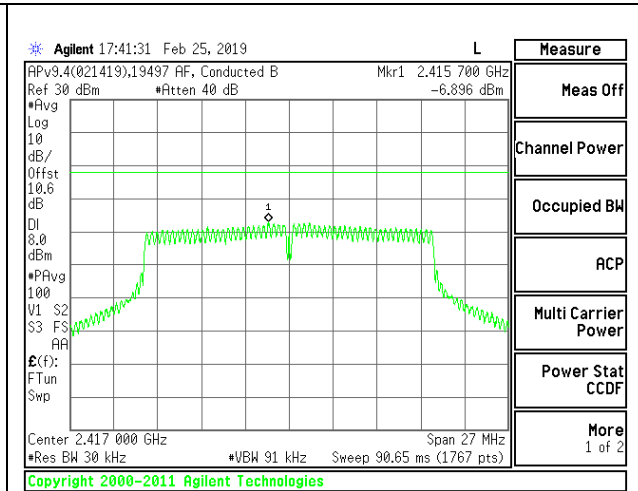

LOW CHANNEL 2

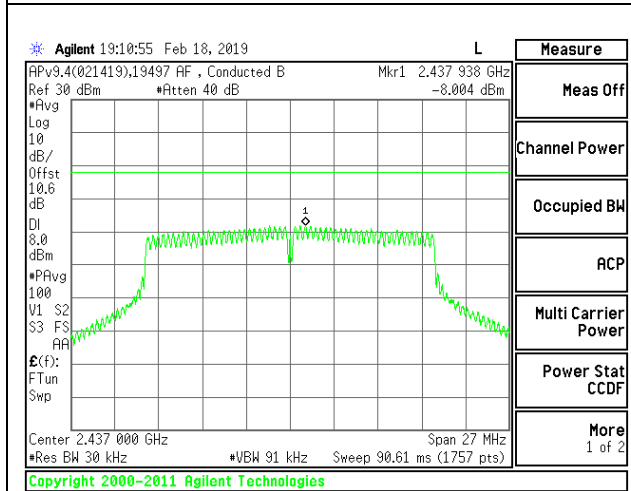

MID CHANNEL 6

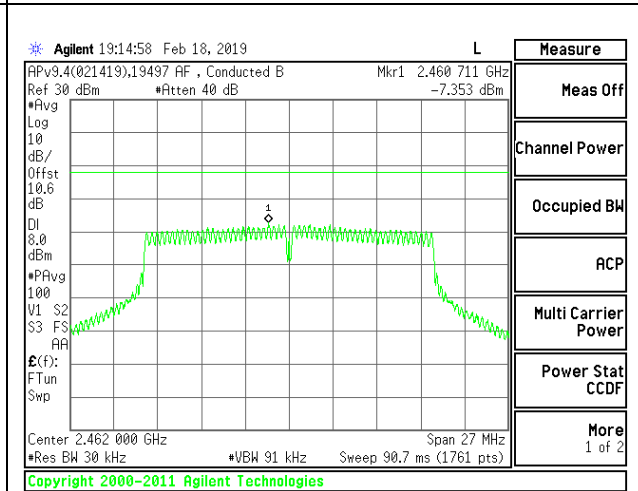

HIGH CHANNEL 11

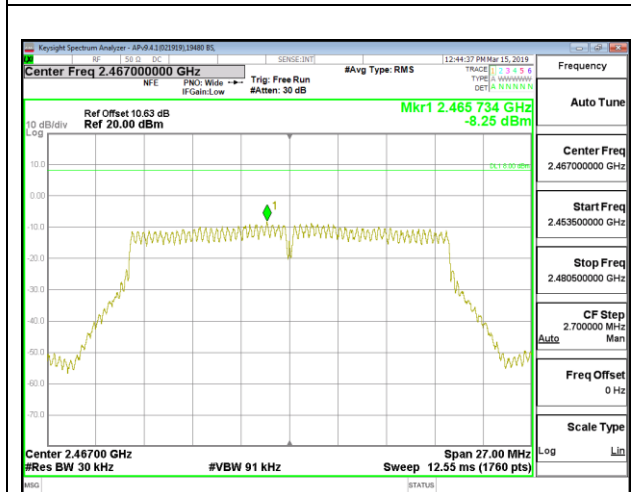

HIGH CHANNEL 12

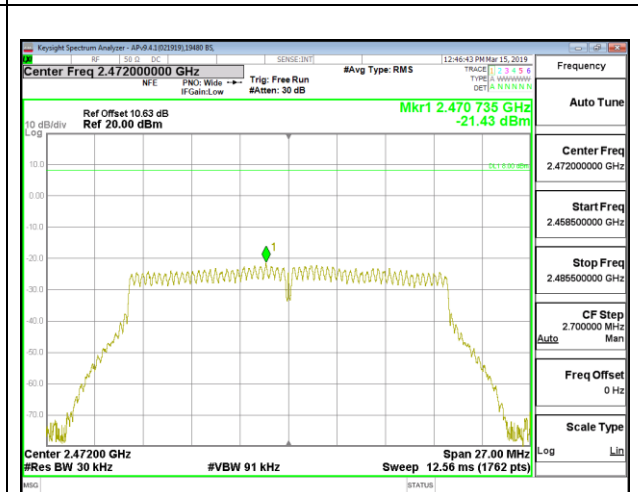

HIGH CHANNEL 13

9.5. CONDUCTED SPURIOUS EMISSIONS

LIMITS

FCC §15.247 (d)

Output power was measured based on the use of peak measurement, therefore the required attenuation is 30 dB.

RESULTS

9.5.1. 802.11b MODE

1TX Antenna 1 MODE

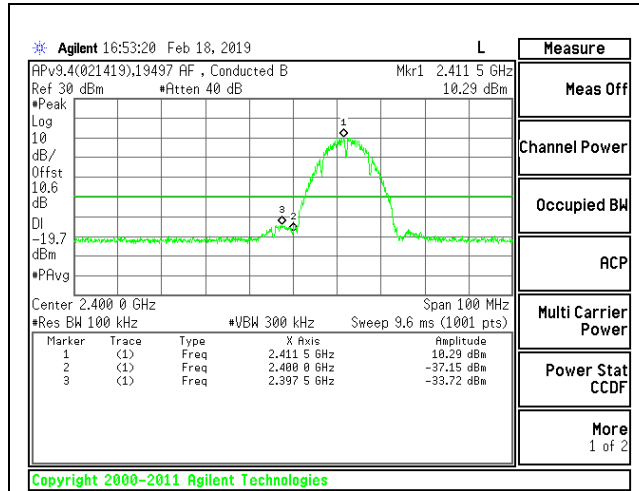

LOW CHANNEL 1 BANDEDGE

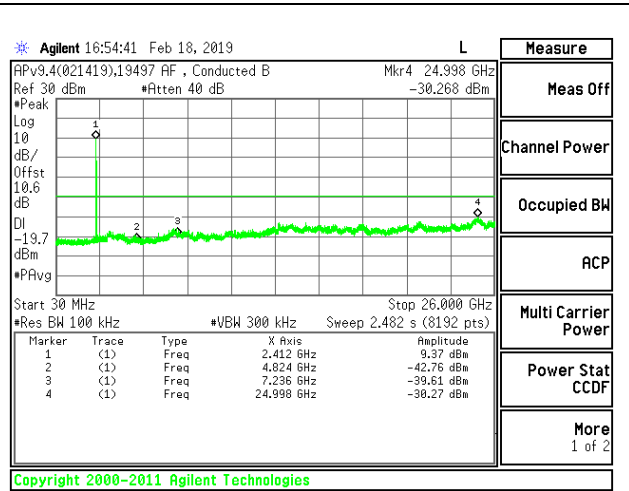

OUT-OF-BAND LOW CHANNEL 1

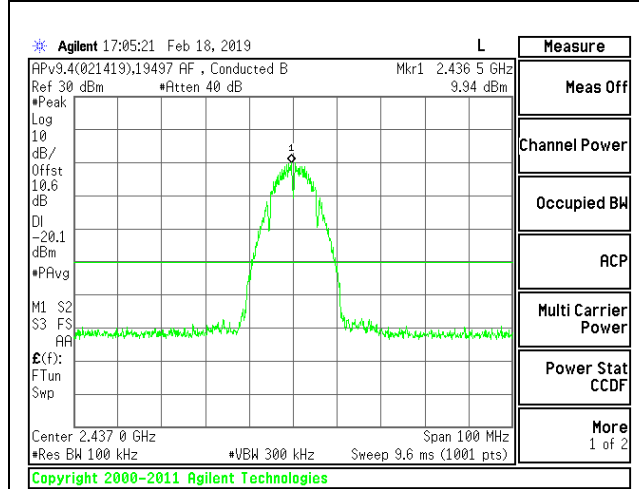

IN-BAND REFERENCE LEVEL

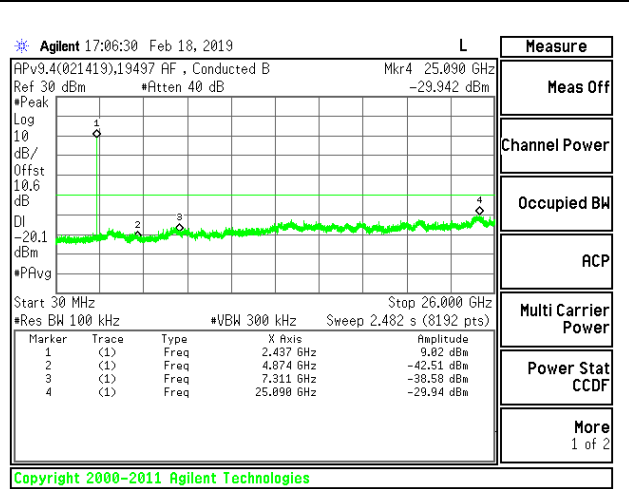

OUT-OF-BAND MID CHANNEL

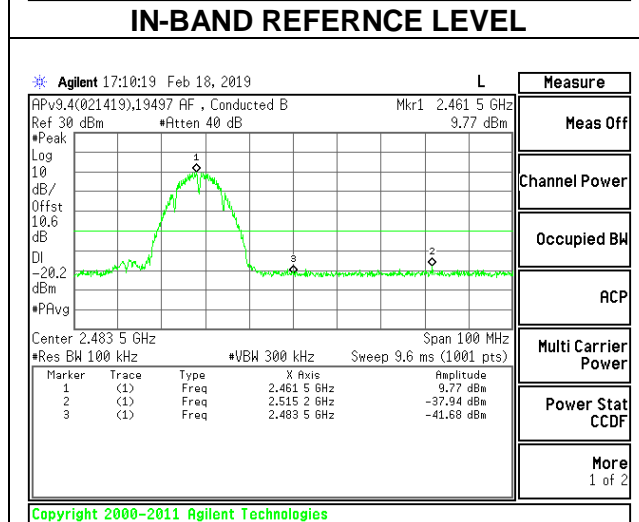

HIGH CHANNEL 11 BANDEDGE

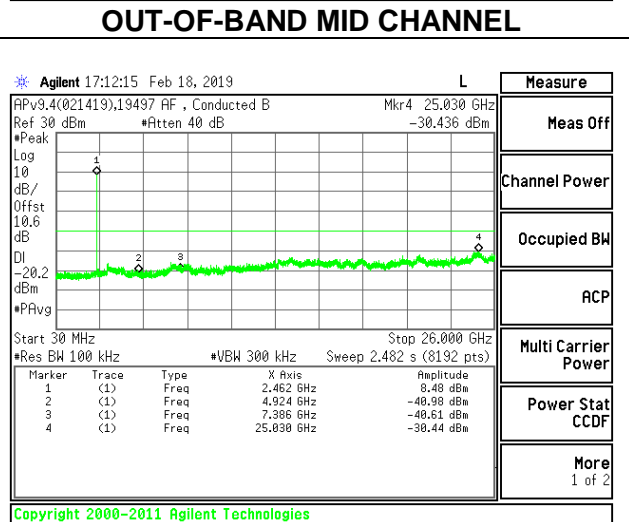

OUT-OF-BAND HIGH CHANNEL 11

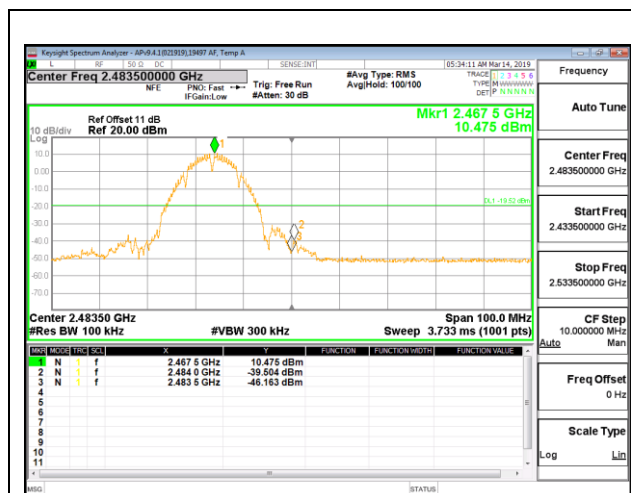

HIGH CHANNEL 12 BANDEDGE

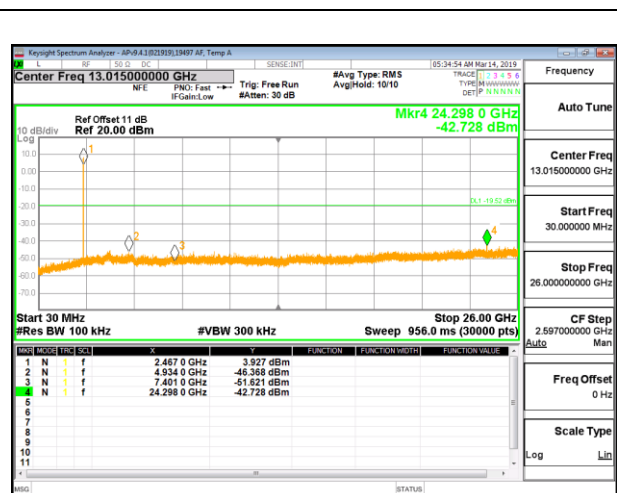

OUT-OF-BAND HIGH CHANNEL 12

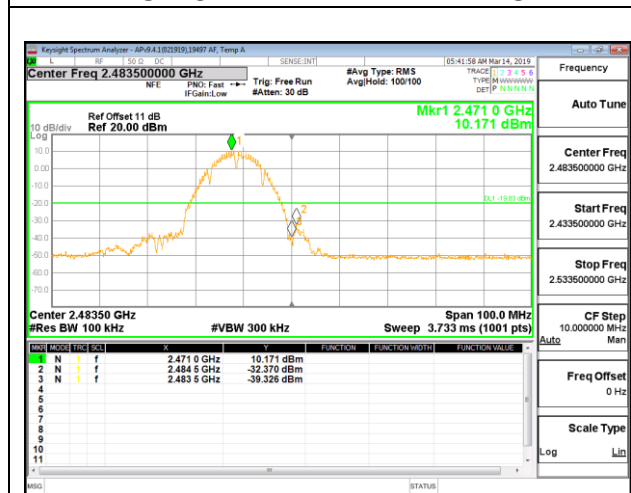

HIGH CHANNEL 13 BANDEDGE

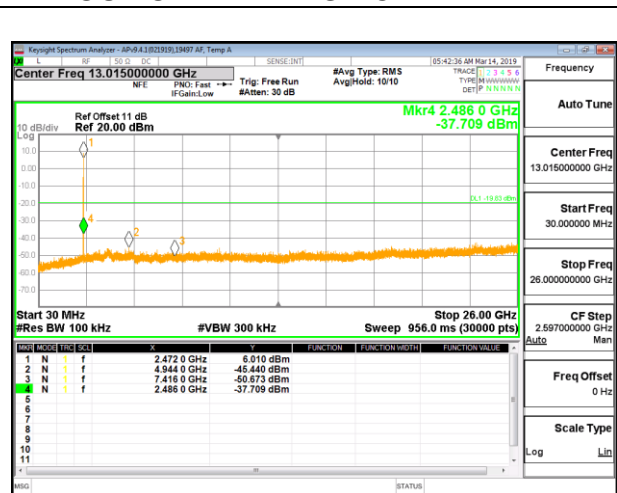

OUT-OF-BAND HIGH CHANNEL 13

9.5.2. 802.11g MODE

1TX Antenna 1 MODE

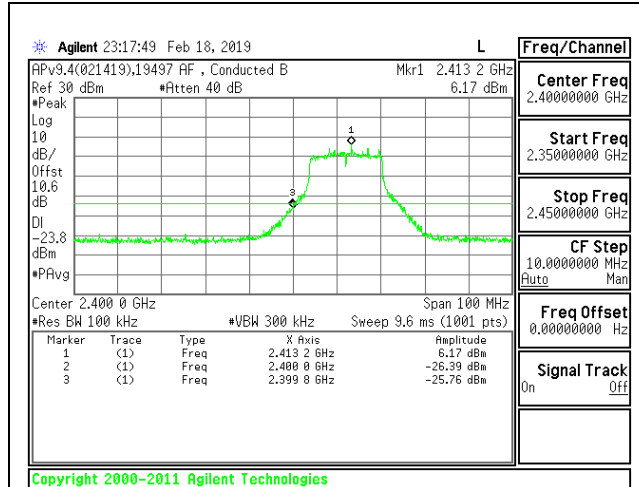

LOW CHANNEL 1 BANDEDGE

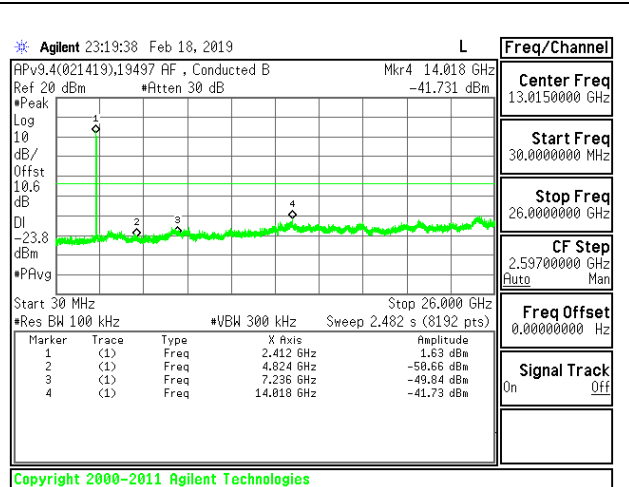

OUT-OF-BAND LOW CHANNEL 1

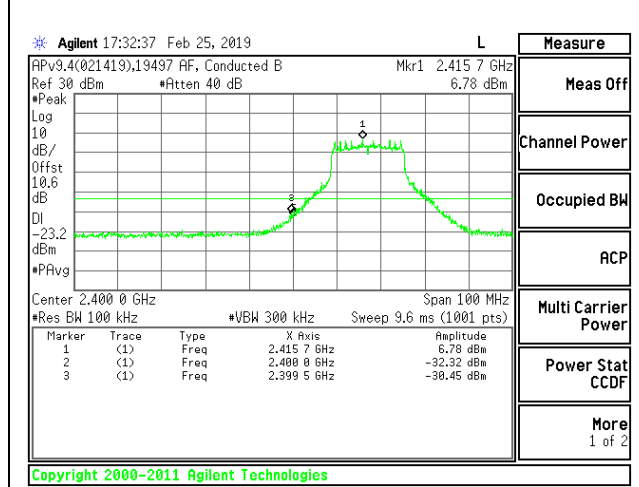

LOW CHANNEL 2 BANDEDGE

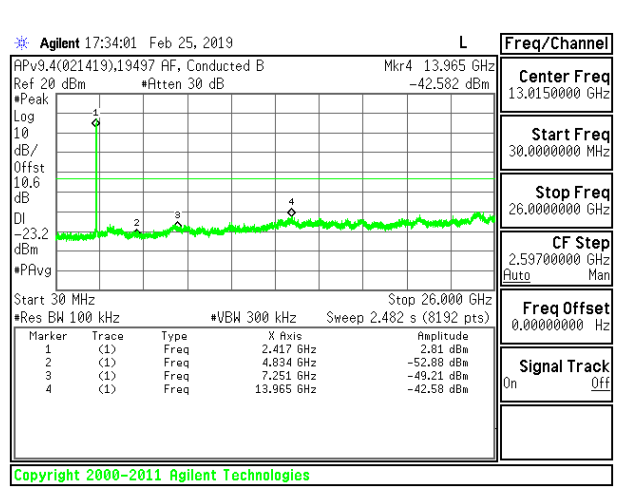

OUT-OF-BAND LOW CHANNEL 2

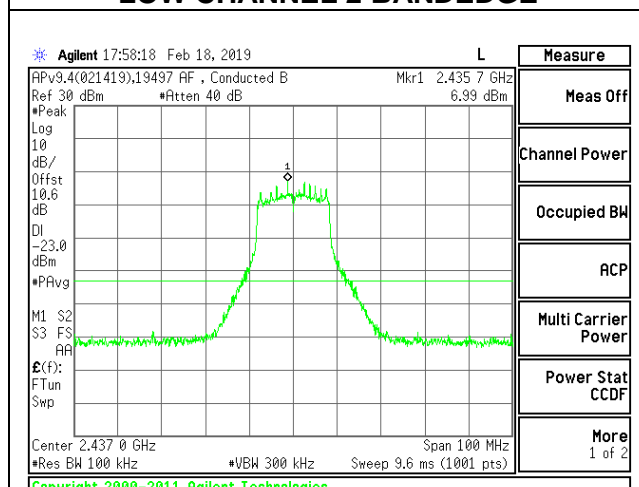

IN-BAND REFERENCE LEVEL

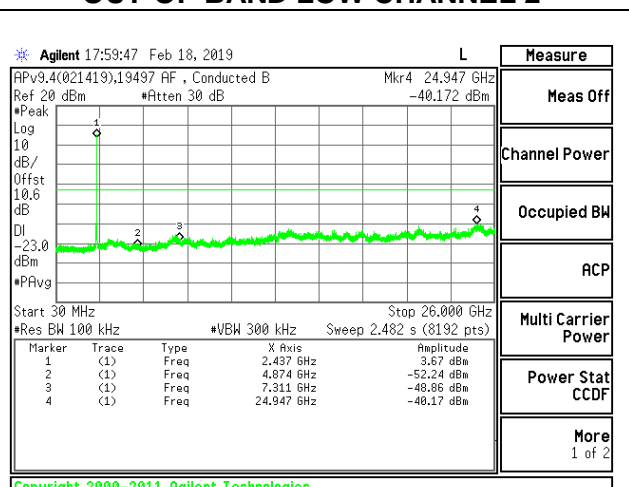

OUT-OF-BAND MID CHANNEL

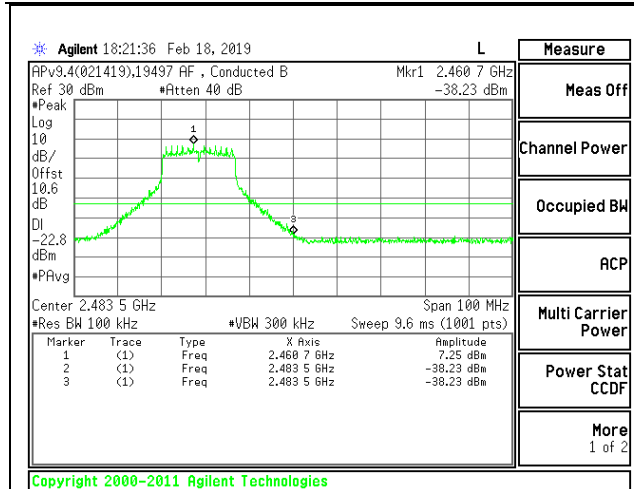

HIGH CHANNEL 11 BANDEGE

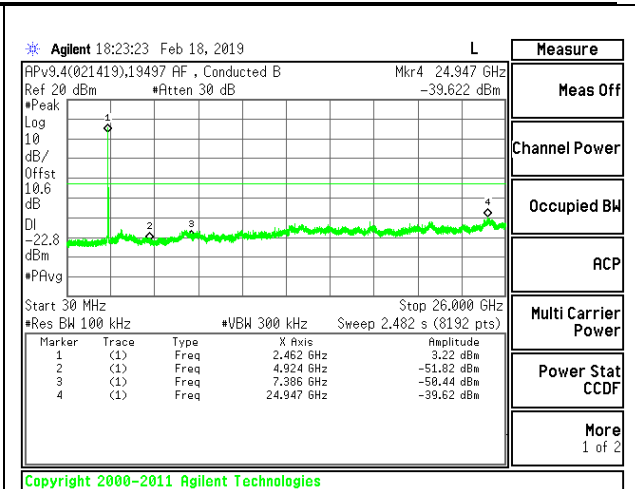

OUT-OF-BAND HIGH CHANNEL 11

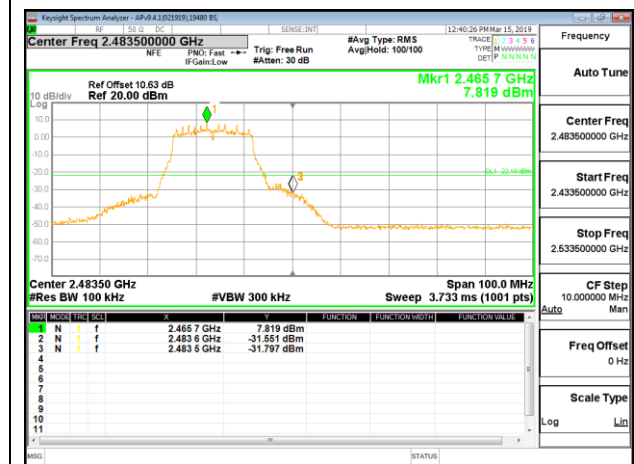

HIGH CHANNEL 12 BANDEGE

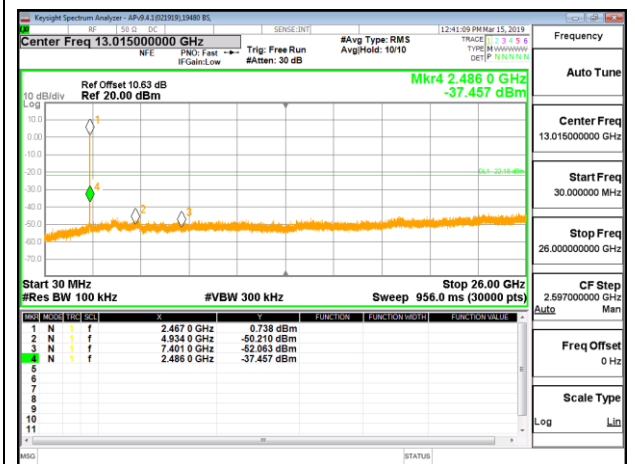

OUT-OF-BAND HIGH CHANNEL 12

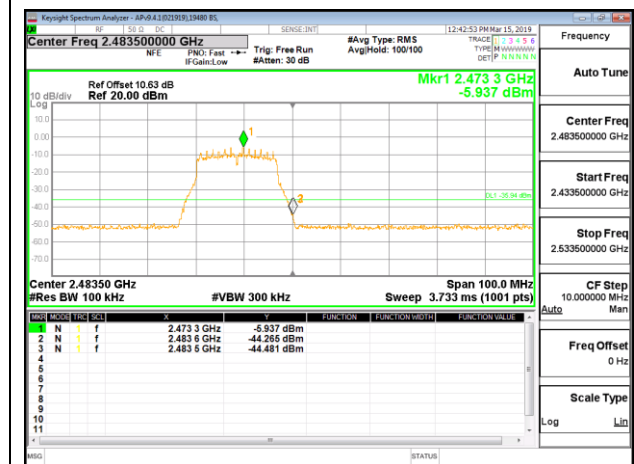

HIGH CHANNEL 13 BANDEGE



OUT-OF-BAND HIGH CHANNEL 13

9.5.3. 802.11n HT20 MODE

1TX Antenna 1 MODE

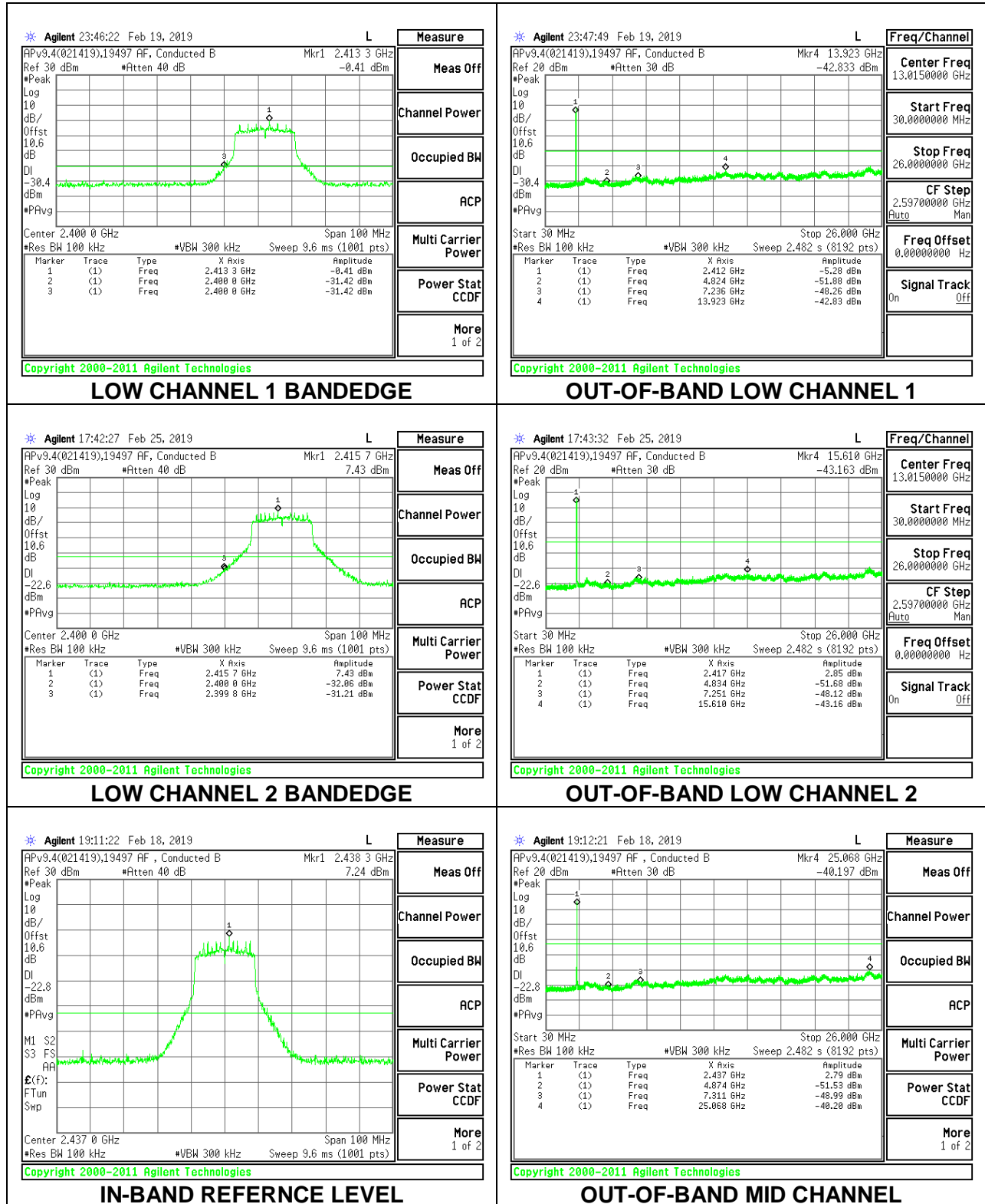

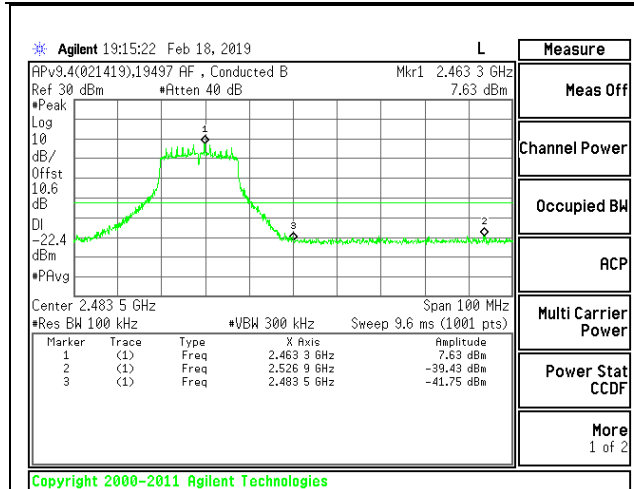

HIGH CHANNEL 11 BANDEGE

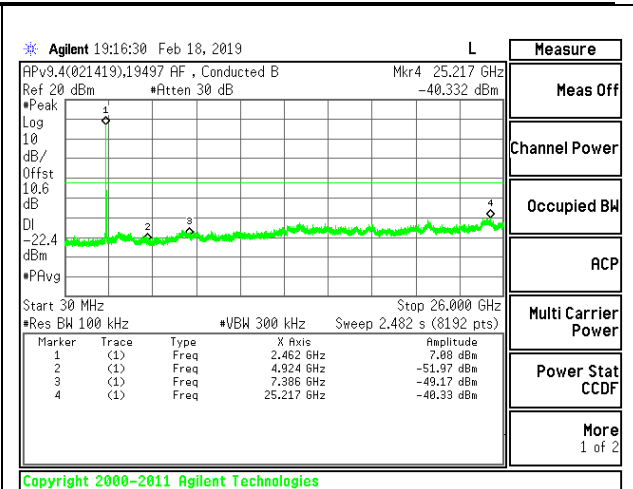

OUT-OF-BAND HIGH CHANNEL 11

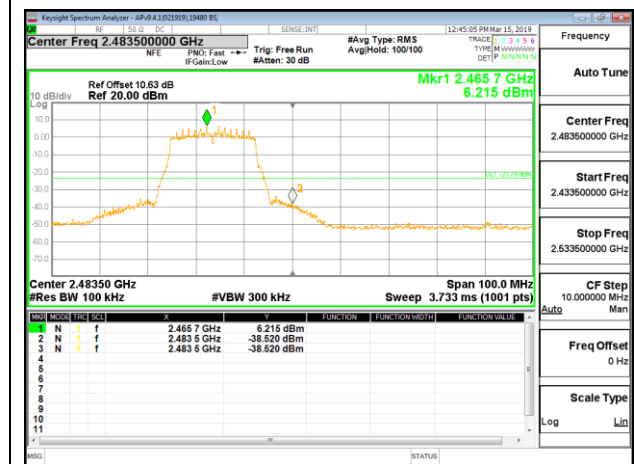

HIGH CHANNEL 12 BANDEGE

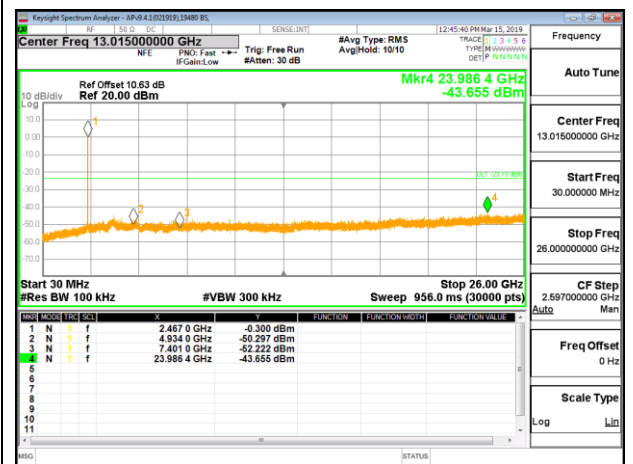

OUT-OF-BAND HIGH CHANNEL 12

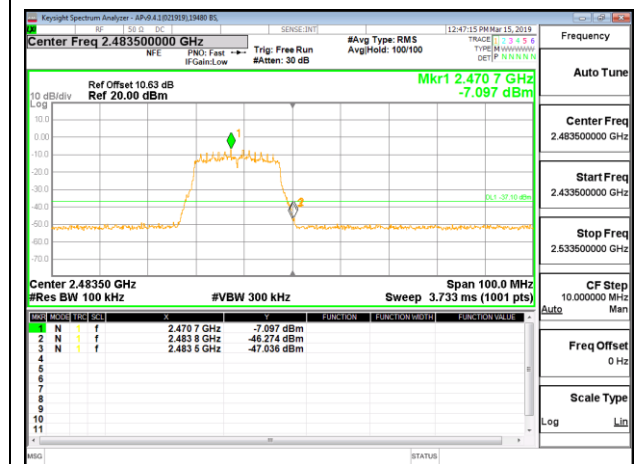

HIGH CHANNEL 13 BANDEGE

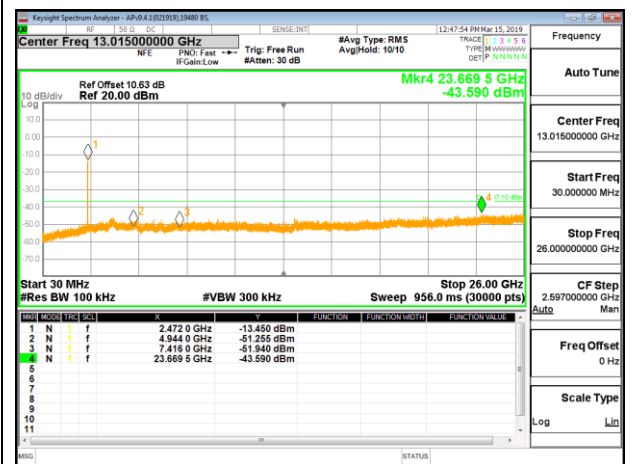

OUT-OF-BAND HIGH CHANNEL 13

10. RADIATED TEST RESULTS

LIMITS

FCC §15.205 and §15.209

Frequency Range (MHz)	Field Strength Limit (uV/m) at 3 m	Field Strength Limit (dBuV/m) at 3 m
0.009-0.490	2400/F(kHz) @ 300 m	-
0.490-1.705	24000/F(kHz) @ 30 m	-
1.705 - 30	30 @ 30m	-
30 - 88	100	40
88 - 216	150	43.5
216 - 960	200	46
Above 960	500	54

TEST PROCEDURE

The EUT is placed on a non-conducting table 80 cm above the ground plane for measurement below 1GHz; 1.5 m above the ground plane for measurement above 1GHz. The antenna to EUT distance is 3 meters. The EUT is configured in accordance with ANSI C63.10. The EUT is set to transmit in a continuous mode.

For measurements below 1 GHz the resolution bandwidth is set to 100 kHz for peak detection measurements or 120 kHz for quasi-peak detection measurements. Peak detection is used unless otherwise noted as quasi-peak.

For pre-scans above 1 GHz the resolution bandwidth is set to 1 MHz; the video bandwidth is set to 30 KHz for peak measurements.

For final measurements above 1 GHz the resolution bandwidth is set to 1 MHz; the video bandwidth is set to 3 MHz for peak measurements and as applicable for average measurements.

The spectrum from 1 GHz to 18 GHz is investigated with the transmitter set to the lowest, middle, and highest channels in each applicable band. Below 1GHz and above 18GHz emissions, the channel with the highest output power was tested.

The frequency range of interest is monitored at a fixed antenna height and EUT azimuth. The EUT is rotated through 360 degrees to maximize emissions received. The antenna is scanned from 1 to 4 meters above the ground plane to further maximize the emission. Measurements are made with the antenna polarized in both the vertical and the horizontal positions.

2D antenna use - For below 30MHz testing, investigation was done on three antenna orientations (parallel, perpendicular, and ground-parallel), parallel and perpendicular are the worst orientations, therefore testing was performed on these two orientations only.

KDB 414788 OFS and Chamber Correlation Justification

Base on FCC 15.31 (f) (2): measurements may be performed at a distance closer than that specified in the regulations; however, an attempt should be made to avoid making measurements in the near field.

OFS and chamber correlation testing had been performed and chamber measured test result is the worst case test result.

10.1. TRANSMITTER ABOVE 1 GHz

10.1.1. TX ABOVE 1 GHz 802.11b MODE IN THE 2.4 GHz BAND

1TX Antenna 1 MODE

BANDEDGE (LOW CHANNEL, CH 1)

HORIZONTAL RESULT

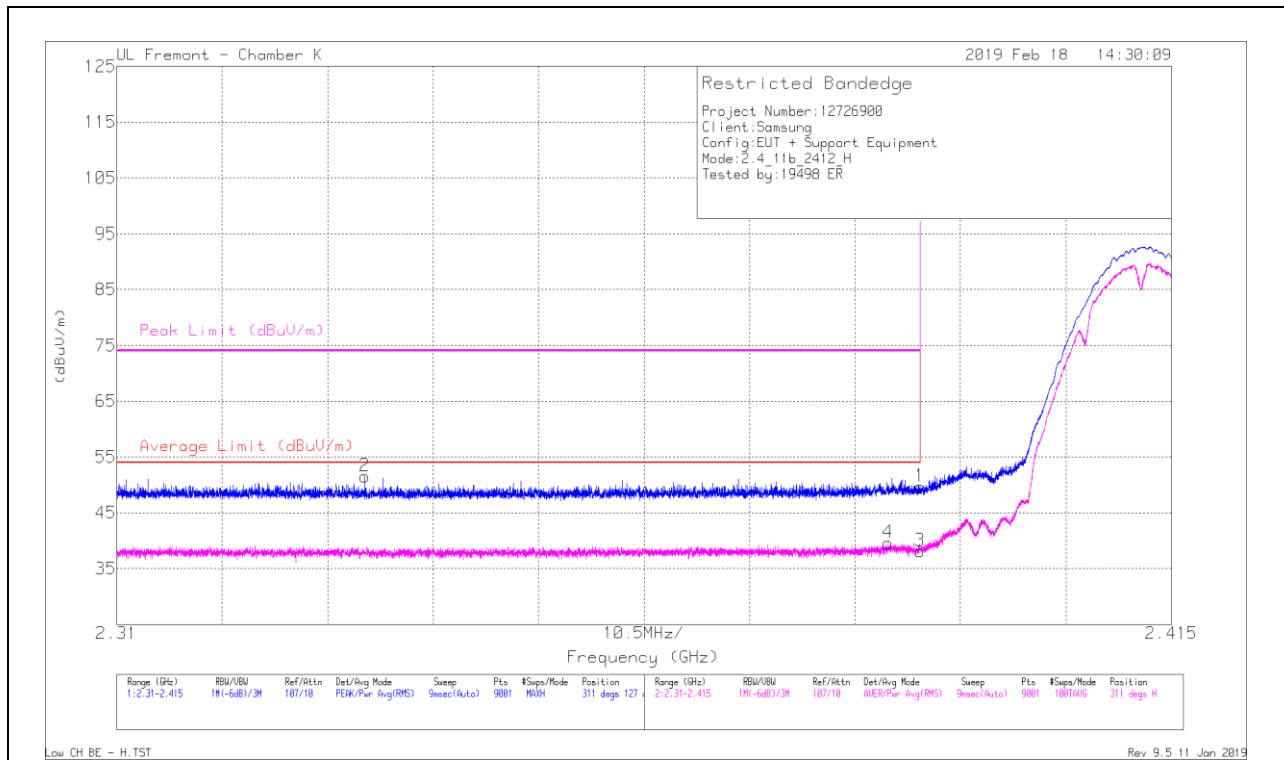

Trace Markers

Marker	Frequency (GHz)	Meter Reading (dBuV)	Det	AF T344 (dB/m)	Amp/Cb/Ftr/Pad (dB)	DC Corr (dB)	Corrected Reading (dBuV/m)	Average Limit (dBuV/m)	Margin (dB)	Peak Limit (dBuV/m)	PK Margin (dB)	Azimuth (Degs)	Height (cm)	Polarity
1	* 2.39	42.44	Pk	31.9	-24.7	0	49.64	-	-	74	-24.36	311	127	H
2	* 2.335	44.5	Pk	31.7	-24.7	0	51.5	-	-	74	-22.5	311	127	H
3	* 2.39	30.94	RMS	31.9	-24.7	.1	38.24	54	-15.76	-	-	311	127	H
4	* 2.387	32.27	RMS	31.9	-24.6	.1	39.67	54	-14.33	-	-	311	127	H

* - indicates frequency in CFR47 Pt 15 / IC RSS-Restricted Band

Pk - Peak detector

RMS - RMS detection

VERTICAL RESULT

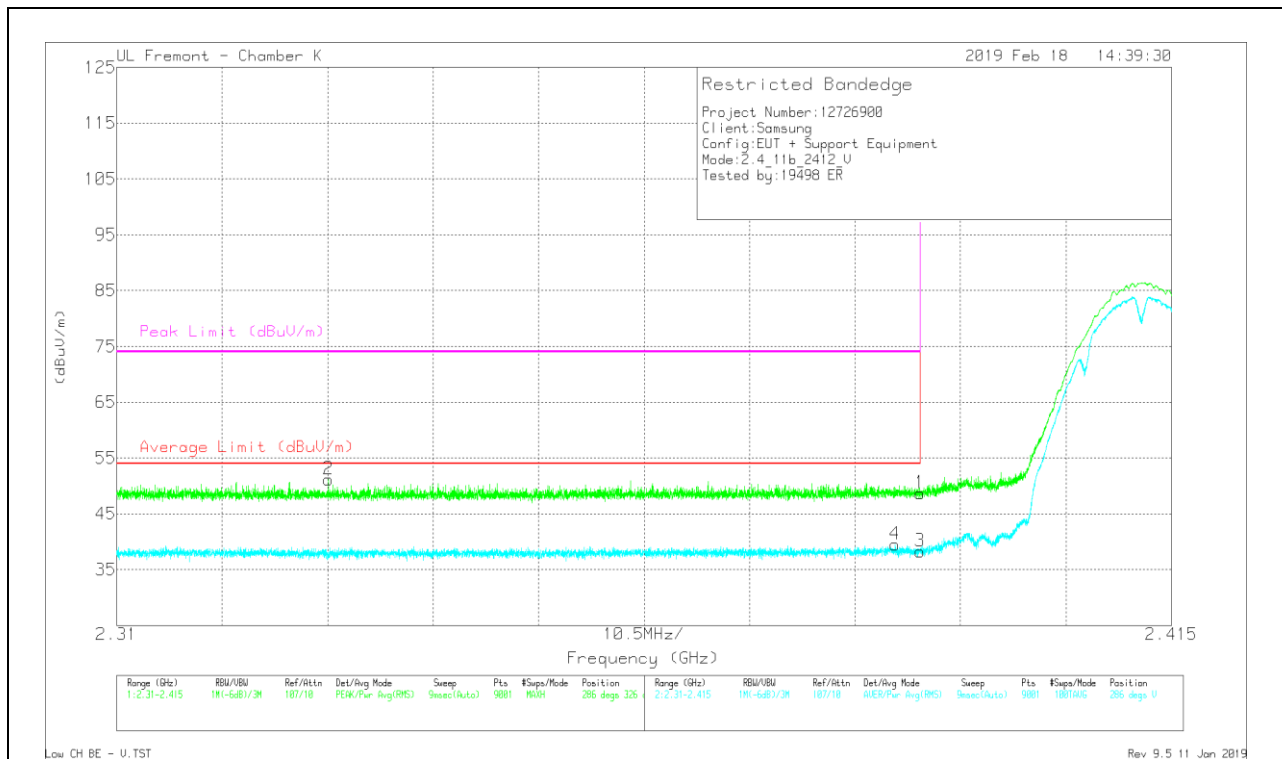

Trace Markers

Marker	Frequency (GHz)	Meter Reading (dBuV)	Det	AF T344 (dB/m)	Amp/Cb/Flr/Pad (dB)	DC Corr (dB)	Corrected Reading (dBuV/m)	Average Limit (dBuV/m)	Margin (dB)	Peak Limit (dBuV/m)	PK Margin (dB)	Azimuth (Degs)	Height (cm)	Polarity
1	* 2.39	41.47	Pk	31.9	-24.7	0	48.67	-	-	74	-25.33	286	326	V
2	* 2.331	44.1	Pk	31.7	-24.6	0	51.2	-	-	74	-22.8	286	326	V
3	* 2.39	31	RMS	31.9	-24.7	.1	38.3	54	-15.7	-	-	286	326	V
4	* 2.388	32.07	RMS	31.9	-24.6	.1	39.47	54	-14.53	-	-	286	326	V

* - indicates frequency in CFR47 Pt 15 / IC RSS-Restricted Band

Pk - Peak detector

RMS - RMS detection

BANDEDGE (HIGH CHANNEL, CH 11)

HORIZONTAL RESULT

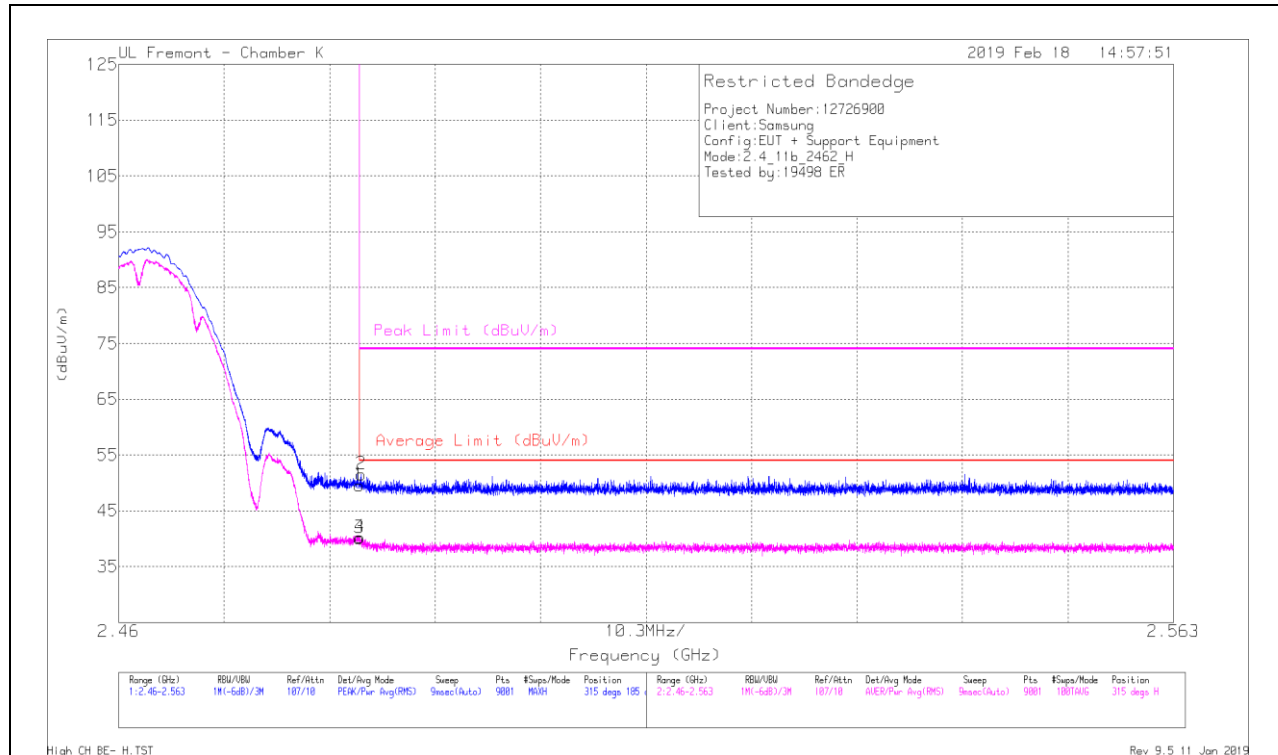

Trace Markers

Marker	Frequency (GHz)	Meter Reading (dBuV)	Det	AF T344 (dB/m)	Amp/Cb/Filt/Pad (dB)	DC Corr (dB)	Corrected Reading (dBuV/m)	Average Limit (dBuV/m)	Margin (dB)	Peak Limit (dBuV/m)	PK Margin (dB)	Azimuth (Degs)	Height (cm)	Polarity
1	* 2.484	42.09	Pk	32.3	-24.8	0	49.59	-	-	74	-24.41	315	185	H
2	* 2.484	44.04	Pk	32.3	-24.8	0	51.54	-	-	74	-22.46	315	185	H
3	* 2.484	32.5	RMS	32.3	-24.8	.1	40.1	54	-13.9	-	-	315	185	H
4	* 2.484	32.68	RMS	32.3	-24.8	.1	40.28	54	-13.72	-	-	315	185	H

* - indicates frequency in CFR47 Pt 15 / IC RSS-Restricted Band
 Pk - Peak detector
 RMS - RMS detection

VERTICAL RESULT

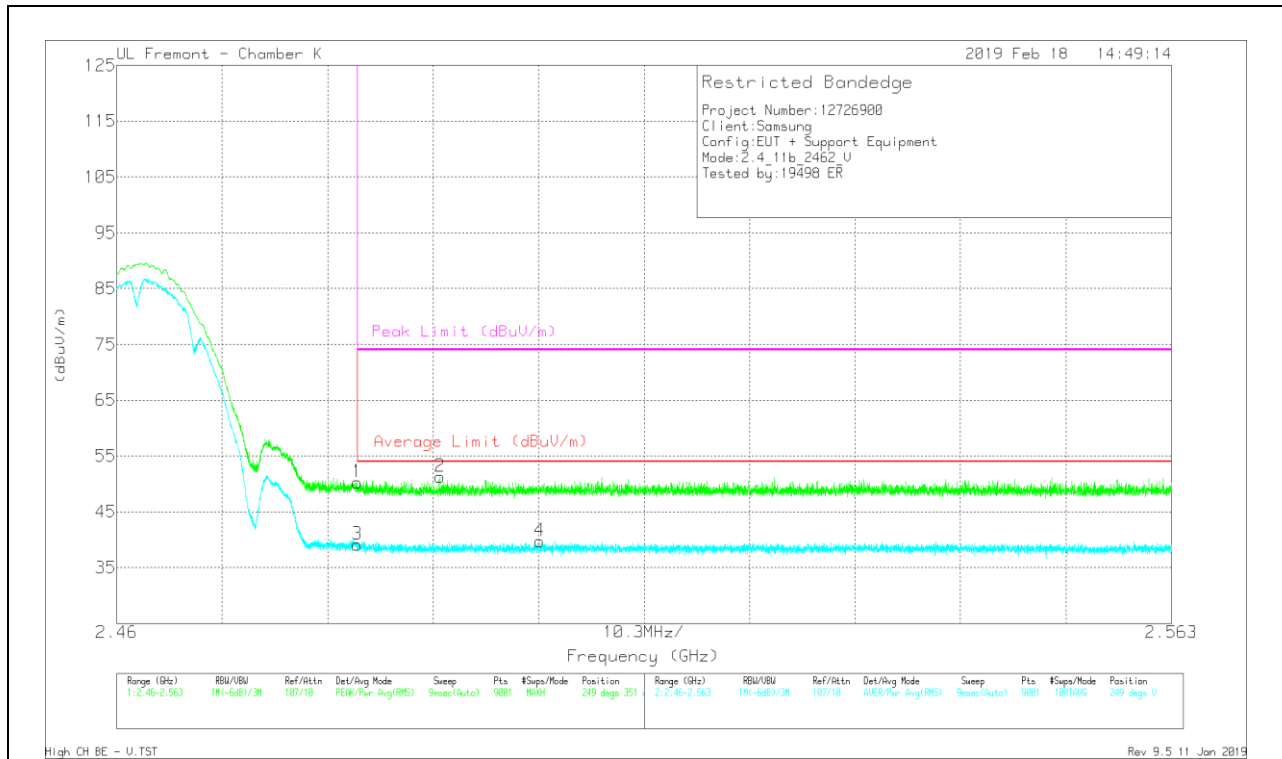

Trace Markers

Marker	Frequency (GHz)	Meter Reading (dBuV)	Det	AF T344 (dB/m)	Amp/Cb/Flr/Pad (dB)	DC Corr (dB)	Corrected Reading (dBuV/m)	Average Limit (dBuV/m)	Margin (dB)	Peak Limit (dBuV/m)	PK Margin (dB)	Azimuth (Degs)	Height (cm)	Polarity
1	* 2.484	42.79	Pk	32.3	-24.8	0	50.29	-	-	74	-23.71	249	351	V
2	* 2.492	43.78	Pk	32.3	-24.8	0	51.28	-	-	74	-22.72	249	351	V
3	* 2.484	31.56	RMS	32.3	-24.8	.1	39.16	54	-14.84	-	-	249	351	V
4	2.501	32.03	RMS	32.3	-24.7	.1	39.73	54	-14.27	-	-	249	351	V

* - indicates frequency in CFR47 Pt 15 / IC RSS-Restricted Band

Pk - Peak detector

RMS - RMS detection

BANDEDGE (HIGH CHANNEL, CH 12)

HORIZONTAL RESULT

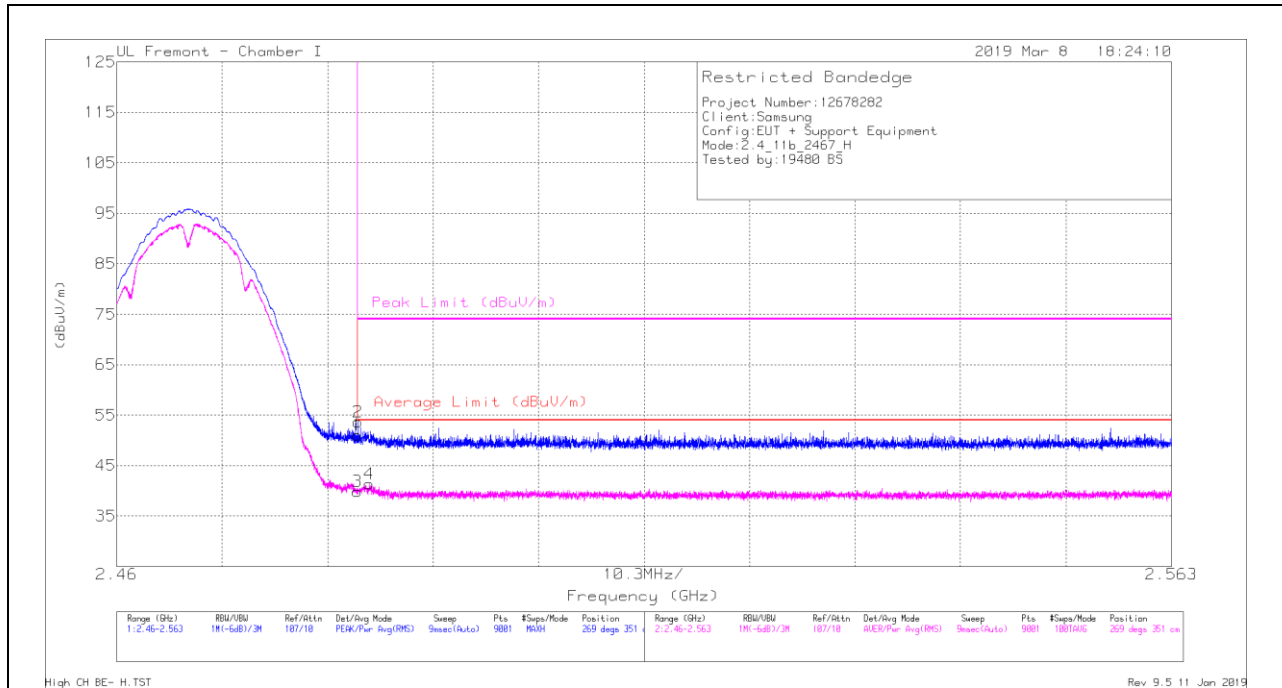

Trace Markers

Marker	Frequency (GHz)	Meter Reading (dBuV)	Det	AF T862 (dB/m)	Amp/Cb/Flr/Pad (dB)	DC Corr (dB)	Corrected Reading (dBuV/m)	Average Limit (dBuV/m)	Margin (dB)	Peak Limit (dBuV/m)	PK Margin (dB)	Azimuth (Degs)	Height (cm)	Polarity
1	* 2.484	40.28	Pk	32.4	-21.7	0	50.98	-	-	74	-23.02	269	351	H
2	* 2.484	42.91	Pk	32.4	-21.7	0	53.61	-	-	74	-20.39	269	351	H
3	* 2.484	29.1	RMS	32.4	-21.7	.1	39.9	54	-14.1	-	-	269	351	H
4	* 2.485	30.64	RMS	32.4	-21.8	.1	41.34	54	-12.66	-	-	269	351	H

* - indicates frequency in CFR47 Pt 15 / IC RSS-Restricted Band
 Pk - Peak detector
 RMS - RMS detection

VERTICAL RESULT

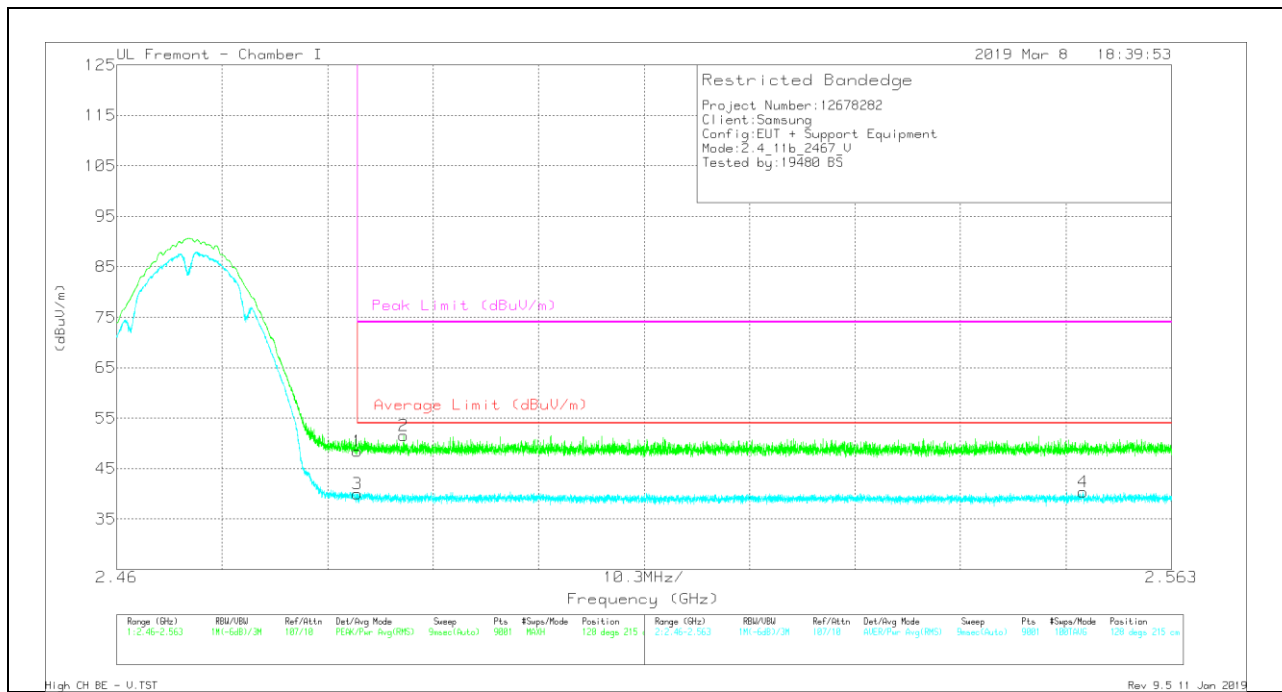

Trace Markers

Marker	Frequency (GHz)	Meter Reading (dBuV)	Det	AF T862 (dB/m)	Amp/Cb/Ftr/Pad (dB)	DC Corr (dB)	Corrected Reading (dBuV/m)	Average Limit (dBuV/m)	Margin (dB)	Peak Limit (dBuV/m)	PK Margin (dB)	Azimuth (Degs)	Height (cm)	Polarity
1	* 2.484	37.69	Pk	32.4	-21.7	0	48.39	-	-	74	-25.61	128	215	V
2	* 2.488	40.88	Pk	32.4	-21.7	0	51.58	-	-	74	-22.42	128	215	V
3	* 2.484	29.2	RMS	32.4	-21.7	.1	40	54	-14	-	-	128	215	V
4	2.554	29.59	RMS	32.4	-21.7	.1	40.39	54	-13.61	-	-	128	215	V

* - indicates frequency in CFR47 Pt 15 / IC RSS-Restricted Band
 Pk - Peak detector
 RMS - RMS detection

BANDEDGE (HIGH CHANNEL, CH 13)

HORIZONTAL RESULT

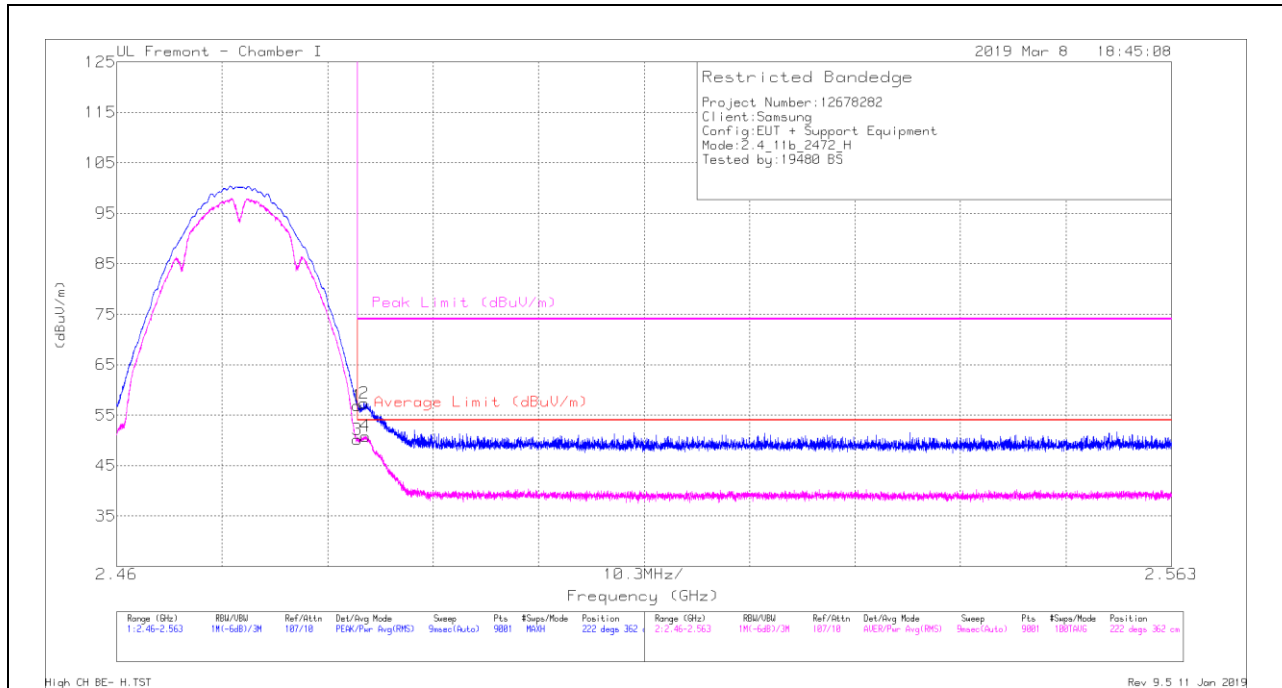

Trace Markers

Marker	Frequency (GHz)	Meter Reading (dBuV)	Det	AF T862 (dB/m)	Amp/Cb/Ftr/Pad (dB)	DC Corr (dB)	Corrected Reading (dBuV/m)	Average Limit (dBuV/m)	Margin (dB)	Peak Limit (dBuV/m)	PK Margin (dB)	Azimuth (Degs)	Height (cm)	Polarity
1	* 2.484	46.17	Pk	32.4	-21.7	0	56.87	-	-	74	-17.13	222	362	H
2	* 2.484	46.7	Pk	32.4	-21.7	0	57.4	-	-	74	-16.6	222	362	H
3	* 2.484	39.41	RMS	32.4	-21.7	.1	50.21	54	-3.79	-	-	222	362	H
4	* 2.484	40.05	RMS	32.4	-21.7	.1	50.85	54	-3.15	-	-	222	362	H

* - indicates frequency in CFR47 Pt 15 / IC RSS-Restricted Band
 Pk - Peak detector
 RMS - RMS detection

VERTICAL RESULT

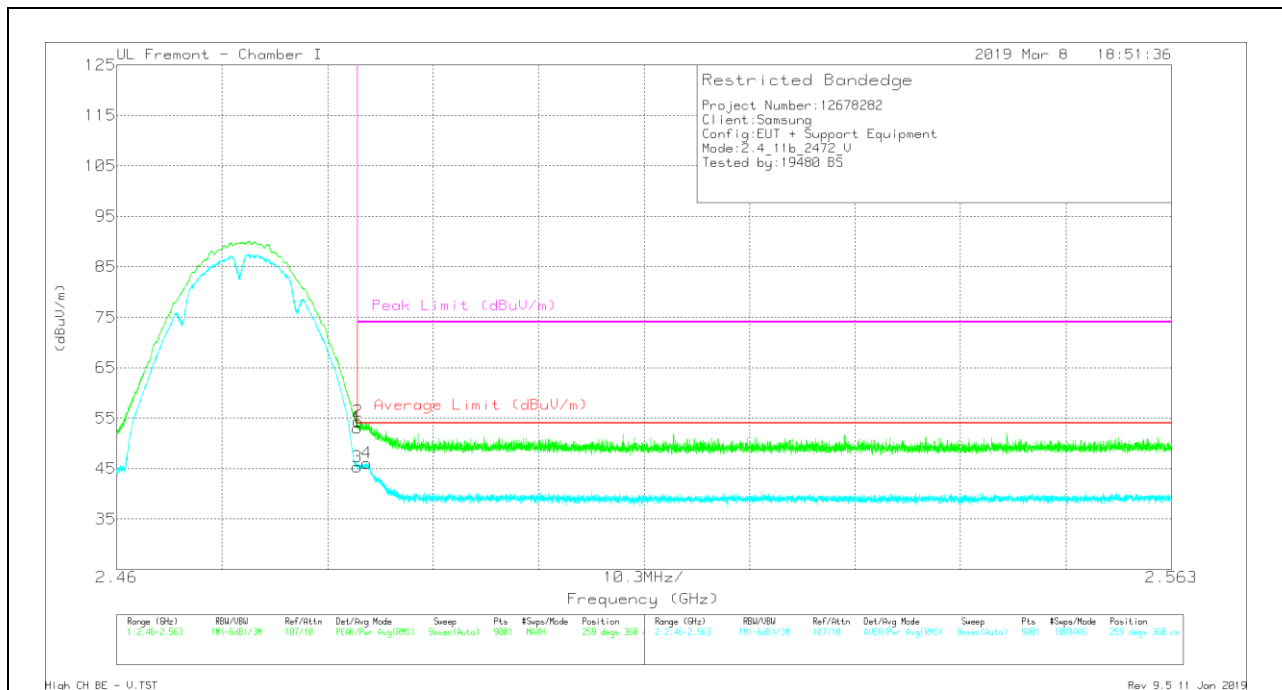

Trace Markers

Marker	Frequency (GHz)	Meter Reading (dBuV)	Det	AF T862 (dB/m)	Amp/Cb/Ftr/Pad (dB)	DC Corr (dB)	Corrected Reading (dBuV/m)	Average Limit (dBuV/m)	Margin (dB)	Peak Limit (dBuV/m)	PK Margin (dB)	Azimuth (Degs)	Height (cm)	Polarity
1	* 2.484	42.27	Pk	32.4	-21.7	0	52.97	-	-	74	-21.03	259	360	V
2	* 2.484	43.64	Pk	32.4	-21.7	0	54.34	-	-	74	-19.66	259	360	V
3	* 2.484	34.51	RMS	32.4	-21.7	.1	45.31	54	-8.69	-	-	259	360	V
4	* 2.484	35.29	RMS	32.4	-21.7	.1	46.09	54	-7.91	-	-	259	360	V

* - indicates frequency in CFR47 Pt 15 / IC RSS-Restricted Band
 Pk - Peak detector
 RMS - RMS detection

HARMONICS AND SPURIOUS EMISSIONS

LOW CHANNEL, CH 1 RESULTS

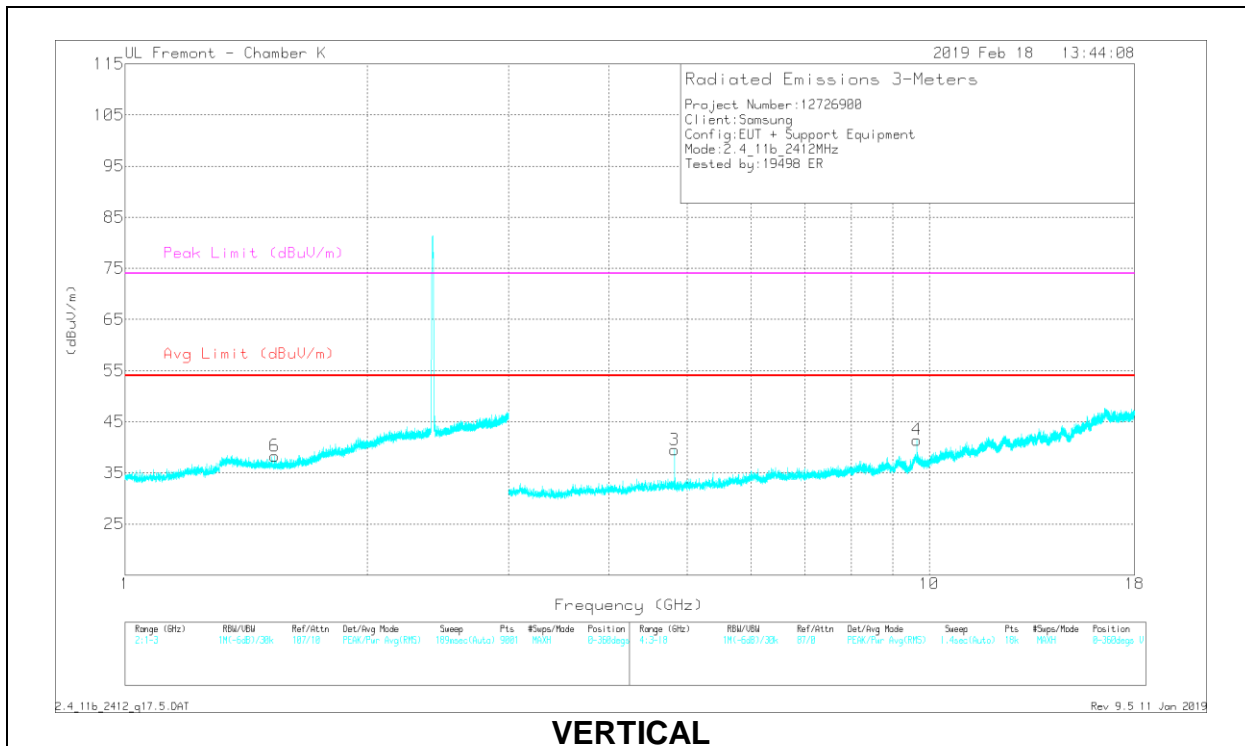
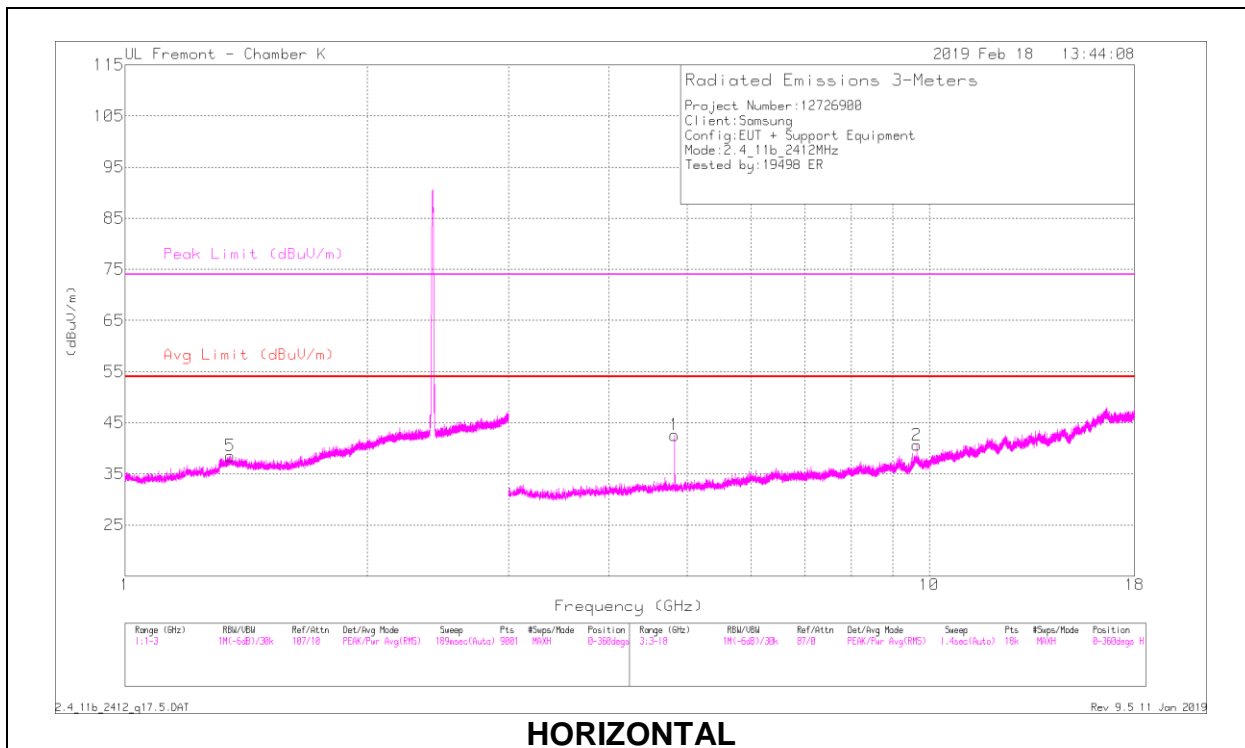

RADIATED EMISSIONS

Frequency (GHz)	Meter Reading (dBuV)	Det	AF T344 (dB/m)	Amp/Cb/FI tr/Pad (dB)	DC Corr (dB)	Corrected Reading (dBuV/m)	Avg Limit (dBuV/m)	Margin (dB)	Peak Limit (dBuV/m)	PK Margin (dB)	Azimuth (Degs)	Height (cm)	Polarity
* 1.35	31.47	Pk	29.4	-16.9	0	43.97	-	-	74	-30.03	99	126	H
* 1.35	12.44	Av	29.4	-16.9	.1	25.04	54	-28.96	-	-	99	126	H
* 1.537	32.23	PK2	28.1	-16.4	0	43.93	-	-	74	-30.07	130	174	V
* 1.536	22.66	MAv1	28.1	-16.4	.1	34.46	54	-19.54	-	-	130	174	V
* 4.824	41.48	Pk	34.1	-30.4	0	45.18	-	-	74	-28.82	149	113	H
* 4.824	36.85	Av	34.1	-30.4	.1	40.65	54	-13.35	-	-	149	113	H
9.648	34.3	Pk	36.8	-23.4	0	47.7	-	-	-	-	89	106	H
* 4.824	40.14	Pk	34.1	-30.4	0	43.84	-	-	74	-30.16	286	102	V
* 4.824	35.26	Av	34.1	-30.4	.1	39.06	54	-14.94	-	-	286	102	V
9.648	34.21	Pk	36.8	-23.4	0	47.61	-	-	-	-	174	104	V

* - indicates frequency in CFR47 Pt 15 / IC RSS-Restricted Band

Pk - Peak detector

Av - Average detection

PK2 - KDB558074 Method: Maximum Peak

MAv1 - KDB558074 Option 1 Maximum RMS Average

MID CHANNEL, CH 6 RESULTS

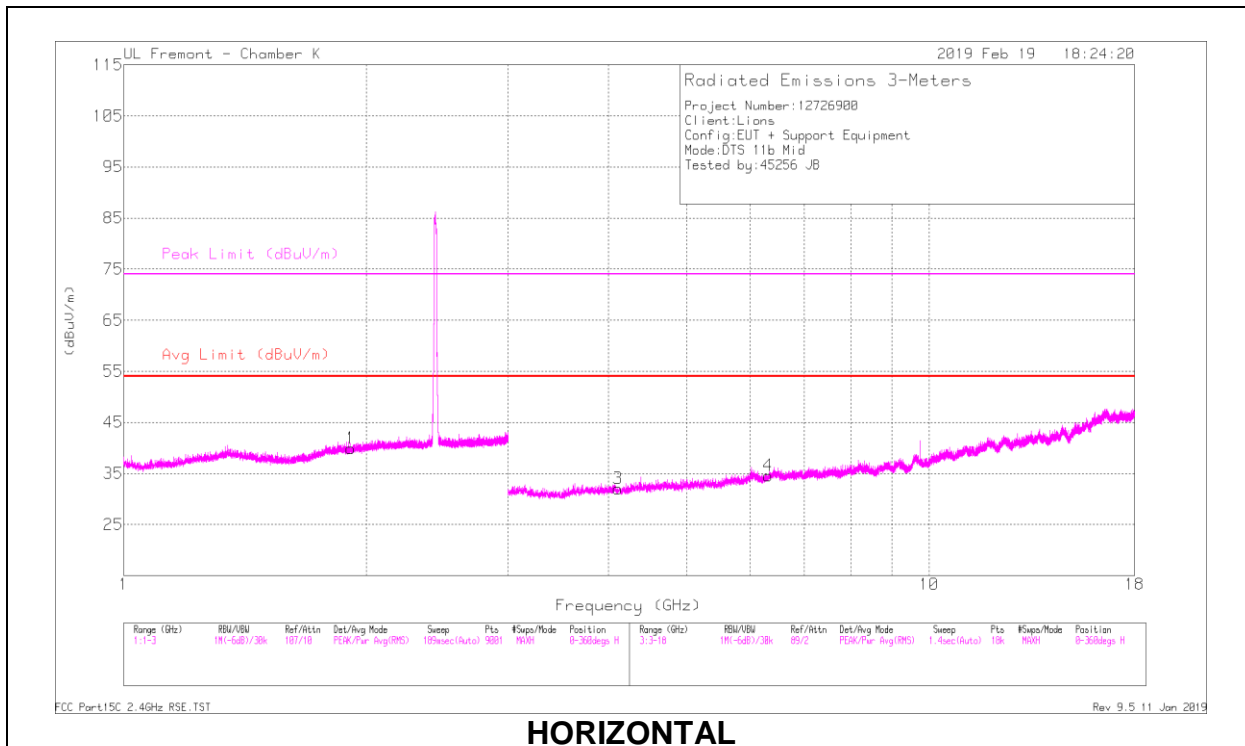

HORIZONTAL

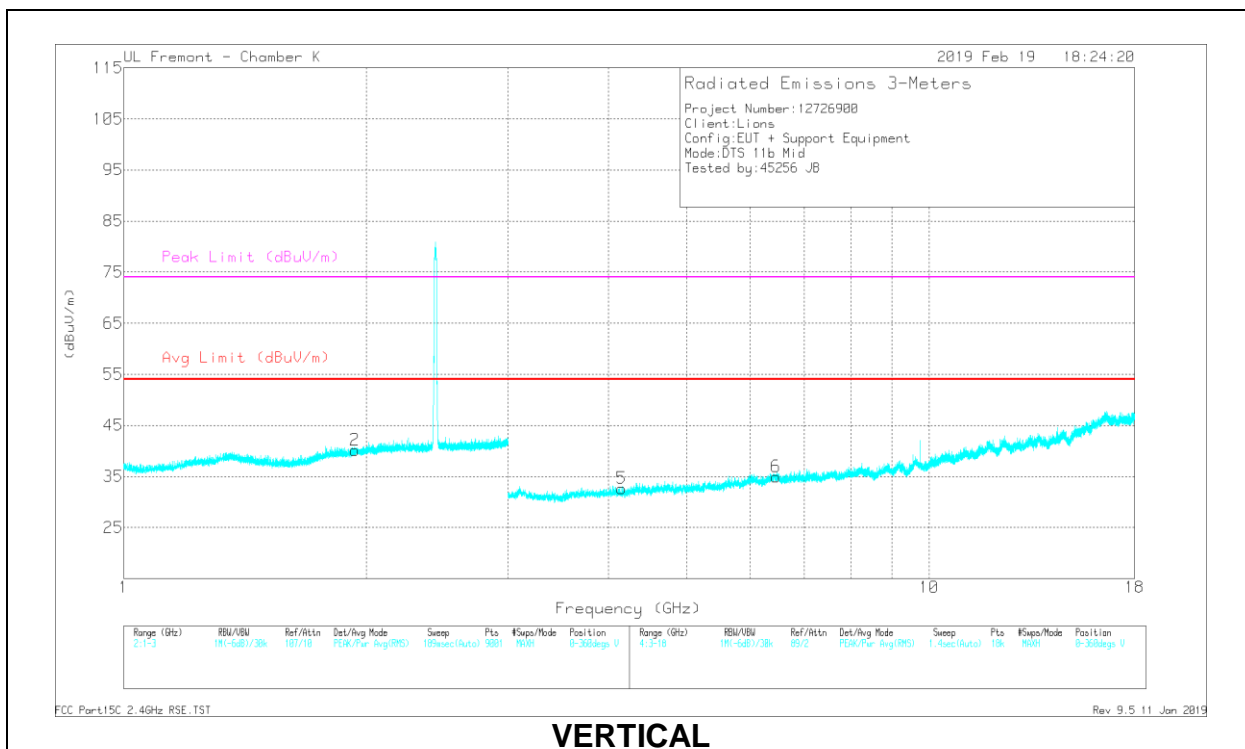

VERTICAL

RADIATED EMISSIONS

Frequency (GHz)	Meter Reading (dBuV)	Det	AF T344 (dB/m)	Amp/Cb/FI tr/Pad (dB)	DC Corr (dB)	Corrected Reading (dBuV/m)	Avg Limit (dBuV/m)	Margin (dB)	Peak Limit (dBuV/m)	PK Margin (dB)	Azimuth (Degs)	Height (cm)	Polarity
* 4.111	36.54	PK2	33.5	-30.7	0	39.34	-	-	74	-34.66	115	158	H
* 4.113	26.55	MAv1	33.5	-30.7	.1	29.45	54	-24.55	-	-	115	158	H
* 4.152	37.9	PK2	33.4	-31	0	40.3	-	-	74	-33.7	72	285	V
* 4.152	27.13	MAv1	33.4	-31	.1	29.63	54	-24.37	-	-	72	285	V
1.914	33.69	Pk	30.5	-24.3	0	39.89	-	-	-	-	0-360	200	H
1.938	33.62	Pk	30.7	-24.2	0	40.12	-	-	-	-	0-360	100	V
6.316	26.87	Pk	35.4	-27.7	0	34.57	-	-	-	-	0-360	100	H
6.454	25.9	Pk	35.4	-26.4	0	34.9	-	-	-	-	0-360	200	V

* - indicates frequency in CFR47 Pt 15 / IC RSS-Restricted Band
 Pk - Peak detector
 PK2 - KDB558074 Method: Maximum Peak
 MAv1 - KDB558074 Option 1 Maximum RMS Average