



# **CERTIFICATION TEST REPORT**

**Report Number. :** 12810836-E3V2

**Applicant :** Samsung Electronics Co., Ltd.  
129 Samsung-Ro, Yeongtong-Gu,  
Suwon-Si, Gyeonggi-Do, 16677, Korea

**Model :** SM-A705YN/DS

**FCC ID :** A3LSMA705YN

**EUT Description :** GSM/WCDMA/LTE Phone with BT, DTS/UNII a/b/g/n/ac, ANT+, and NFC

**Test Standard(s) :** FCC 47 CFR PART 15 SUBPART C

**Date Of Issue:**

April 29, 2019

**Prepared by:**

UL Verification Services Inc.  
47173 Benicia Street  
Fremont, CA 94538 U.S.A.  
TEL: (510) 319-4000  
FAX: (510) 661-0888



NVLAP Lab code: 200065-0

---

## REPORT REVISION HISTORY

Rev.	Issue Date	Revisions	Revised By
V1	4/22/2019	Initial Issue	
V2	4/29/2019	Updated Section 1, 3 & 12.1	K.Kedida

---

## TABLE OF CONTENTS

<b>REPORT REVISION HISTORY .....</b>	<b>2</b>
<b>TABLE OF CONTENTS .....</b>	<b>3</b>
<b>1. ATTESTATION OF TEST RESULTS .....</b>	<b>5</b>
<b>2. INTRODUCTION OF TEST DATA REUSE.....</b>	<b>6</b>
2.1. INTRODUCTION .....	6
2.2. DIFFERENCES.....	6
2.3. SPOT CHECK VERIFICATION RESULTS SUMMARY.....	6
2.4. REFERENCE DETAIL .....	11
<b>3. TEST METHODOLOGY .....</b>	<b>12</b>
<b>4. FACILITIES AND ACCREDITATION .....</b>	<b>12</b>
<b>5. CALIBRATION AND UNCERTAINTY .....</b>	<b>13</b>
5.1. MEASURING INSTRUMENT CALIBRATION .....	13
5.2. SAMPLE CALCULATION .....	13
5.3. MEASUREMENT UNCERTAINTY.....	13
<b>6. EQUIPMENT UNDER TEST.....</b>	<b>14</b>
6.1. EUT DESCRIPTION .....	14
6.2. MAXIMUM OUTPUT POWER.....	14
6.3. DESCRIPTION OF AVAILABLE ANTENNAS .....	14
6.4. SOFTWARE AND FIRMWARE.....	14
6.5. WORST-CASE CONFIGURATION AND MODE.....	14
6.6. DESCRIPTION OF TEST SETUP.....	15
<b>7. MEASUREMENT METHOD.....</b>	<b>18</b>
<b>8. TEST AND MEASUREMENT EQUIPMENT .....</b>	<b>19</b>
<b>9. ANTENNA PORT TEST RESULTS .....</b>	<b>20</b>
9.1. ON TIME AND DUTY CYCLE.....	20
9.2. 6 dB BANDWIDTH.....	21
9.2.1. 1Mbps.....	22
9.2.2. 2Mbps.....	23
9.3. OUTPUT POWER.....	24
9.3.1. 1Mbps.....	24
9.3.2. 2Mbps.....	24
9.4. AVERAGE POWER.....	25

---

9.4.1.	1Mbps.....	25
9.4.2.	2Mbps.....	25
9.5.	<i>POWER SPECTRAL DENSITY</i> .....	26
9.5.1.	BLE (1Mbps).....	27
9.5.2.	2Mbps.....	28
9.6.	<i>CONDUCTED SPURIOUS EMISSIONS</i> .....	29
9.6.1.	1Mbps.....	30
9.6.2.	2Mbps.....	31
<b>10.</b>	<b>RADIATED TEST RESULTS</b> .....	<b>32</b>
10.1.	<i>LIMITS AND PROCEDURE</i> .....	32
10.2.	<i>TRANSMITTER ABOVE 1 GHz</i> .....	34
10.2.1.	1Mbps.....	34
10.2.2.	2Mbps.....	44
10.3.	<i>WORST CASE BELOW 30MHz</i> .....	54
10.4.	<i>WORST CASE BELOW 1 GHz</i> .....	55
10.5.	<i>WORST CASE 18-26 GHz</i> .....	57
<b>11.</b>	<b>AC POWER LINE CONDUCTED EMISSIONS</b> .....	<b>59</b>
<b>12.</b>	<b>SETUP PHOTOS</b> .....	<b>62</b>
12.1.	<i>SM-A705FN/DS (ORIGINAL)</i> .....	62
12.2.	<i>SM-A705YN (Spot Check)</i> .....	65

# 1. ATTESTATION OF TEST RESULTS

**COMPANY NAME:** Samsung Electronics Co., Ltd.  
129 Samsung-Ro, Yeongtong-Gu,  
Suwon-Si, Gyeonggi-Do, 16677, Korea

**EUT DESCRIPTION:** GSM/WCDMA/LTE Phone with BT, DTS/UNII a/b/g/n/ac, ANT+,  
and NFC

**MODEL:** SM-A705YN

**SERIAL NUMBER:** Radiated (Original):R38M10NPF1Y, R38M10CSH8Z  
Conducted (Original):R38M10CT1JE  
Radiated (Spot Check):R38M4046PCR

**DATE TESTED:** February 18 – March 05, 2019 (Original)  
April 11, 2019 (Spot Check)

APPLICABLE STANDARDS	
STANDARD	TEST RESULTS
CFR 47 Part 15 Subpart C	Complies

UL Verification Services Inc. tested the above equipment in accordance with the requirements set forth in the above standards. The test results show that the equipment tested is capable of demonstrating compliance with the requirements as documented in this report.

The results documented in this report apply only to the tested sample, under the conditions and modes of operation as described herein. It is the manufacturer's responsibility to assure that additional production units of this model are manufactured with identical electrical and mechanical components. All samples tested were in good operating condition throughout the entire test program. Measurement Uncertainties are published for informational purposes only and were not taken into account unless noted otherwise.

This document may not be altered or revised in any way unless done so by UL Verification Services Inc. and all revisions are duly noted in the revisions section. Any alteration of this document not carried out by UL Verification Services Inc. will constitute fraud and shall nullify the document. This report must not be used by the client to claim product certification, approval, or endorsement by NVLAP, NIST, any agency of the Federal Government, or any agency of the U.S. government.

Approved & Released For  
UL Verification Services Inc. By:



Dan Corona  
Operations Leader  
Consumer Technology Division  
UL Verification Services Inc.

Reviewed By:



Kiya Kedida  
Senior Project Engineer  
Consumer Technology Division  
UL Verification Services Inc.

## 2. INTRODUCTION OF TEST DATA REUSE

### 2.1. INTRODUCTION

According to the manufacturer, FCC ID: A3LSMA705FN and FCC ID: A3LSMA705YN non-licensed radios are electrically identical. The FCC ID: A3LSMA705FN test data shall remain representative of FCC ID: A3LSMA705YN.

The applicant takes full responsibility that the test data as referenced in this section represents compliance for this FCC ID.

### 2.2. DIFFERENCES

The FCC ID: A3LSMA705FN, shares the same enclosure and circuit board as FCC ID: A3LSMA705YN. The BLE antennas and surrounding circuitry and layout are identical between two models.

After confirming through preliminary radiated emissions that the performance of the FCC ID: A3LSMG705FN remains representative of FCC ID: A3LSMA705YN. The test data of FCC ID: A3LSMG705FN being submitted for this application to cover BLE features.

### 2.3. SPOT CHECK VERIFICATION RESULTS SUMMARY

Spot check verification has been done on device A3LSMA705YN for radiated harmonic spurious and radiated band-edge. The data from the application has been verified through appropriate spot checks to demonstrate compliance for this device in accordance to FCC public KDB 484596 D01 as shown in the summary below.

A3LSMA705GM SPOT CHECK RESULTS										
Technology	Mode	Test Item	Channel	Measured Frequency	Original model		Spot check model		Delta (dB)	
					SM-A705FN/DS		SM-A705YN		Peak Ave	
					A3LSMA705FN		A3LSMA705YN			
Peak	Ave	Peak	Ave	Peak	Ave					
BLE	2Mbps	RBE	39	2560MHz	51.59	44.84	52.35	45.02	0.76	0.18
	2Mbps	RSE	39	11845MHz	49.01	43.88	48.1	43.81	-0.91	-0.07

Comparison of the models, upper deviation is within 3dB range and all tests are under FCC Technical Limits.

**SPOT CHECK DATA**

**BANDEDGE (HIGH CHANNEL)**

**HORIZONTAL RESULT**

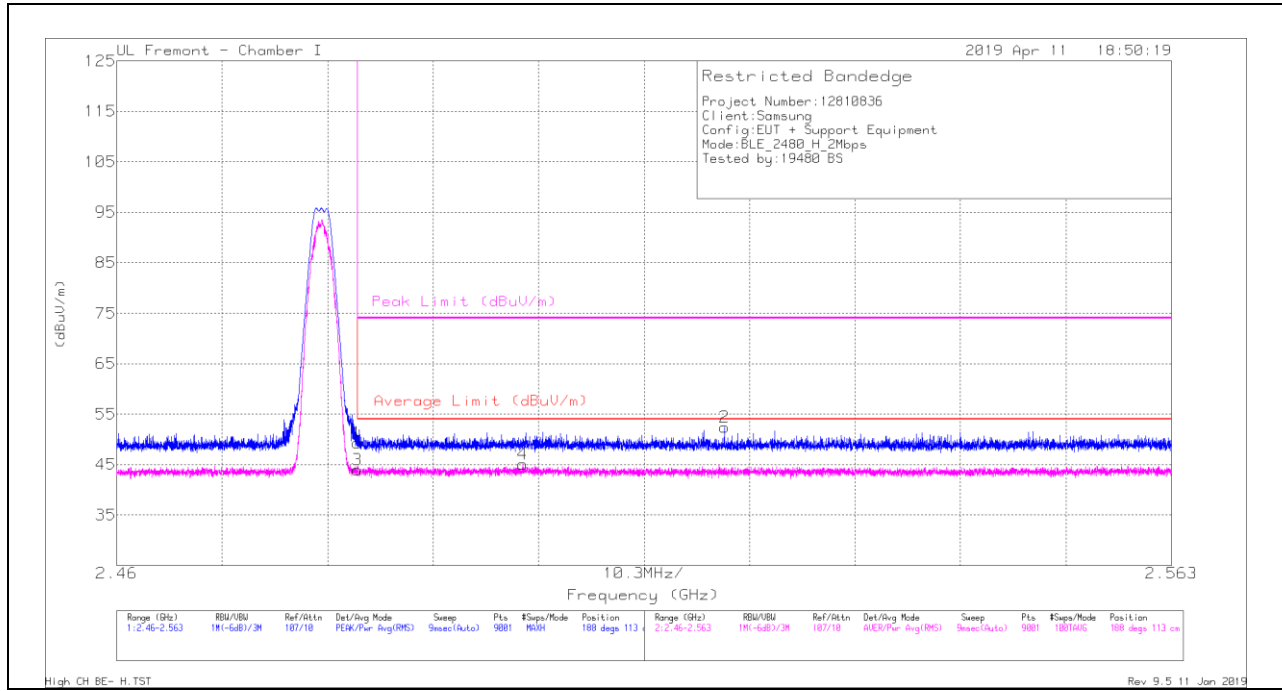

**Trace Markers**

Marker	Frequency (GHz)	Meter Reading (dBuV)	Det	AF T344 (dB/m)	Amp/Cbl/Ftr/Pad (dB)	DC Corr (dB)	Corrected Reading (dBuV/m)	Average Limit (dBuV/m)	Margin (dB)	Peak Limit (dBuV/m)	PK Margin (dB)	Azimuth (Degs)	Height (cm)	Polarity
1	* 2.484	38.61	Pk	32.4	-21.7	0	49.31	-	-	74	-24.69	188	113	H
2	2.519	41.65	Pk	32.4	-21.7	0	52.35	-	-	74	-21.65	188	113	H
3	* 2.484	28.51	RMS	32.4	-21.7	4.74	43.95	54	-10.05	-	-	188	113	H
4	* 2.5	29.48	RMS	32.5	-21.7	4.74	45.02	54	-8.98	-	-	188	113	H

\* - indicates frequency in CFR47 Pt 15 / IC RSS-Restricted Band

Pk - Peak detector

RMS - RMS detection

### VERTICAL RESULT

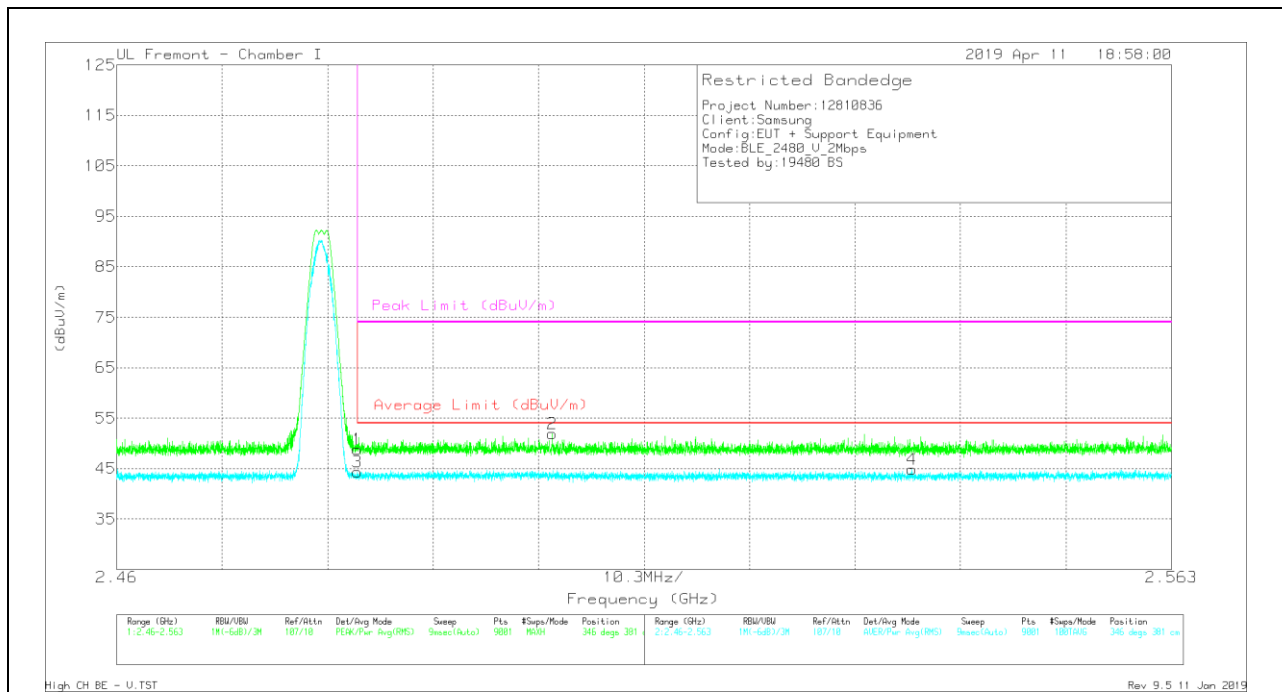

### Trace Markers

Marker	Frequency (GHz)	Meter Reading (dBuV)	Det	AF T344 (dB/m)	Amp/Cb/Filt/Pad (dB)	DC Corr (dB)	Corrected Reading (dBuV/m)	Average Limit (dBuV/m)	Margin (dB)	Peak Limit (dBuV/m)	PK Margin (dB)	Azimuth (Degs)	Height (cm)	Polarity
1	* 2.484	38.07	Pk	32.4	-21.7	0	48.77	-	-	74	-25.23	346	381	V
2	2.503	41.09	Pk	32.5	-21.7	0	51.89	-	-	74	-22.11	346	381	V
3	* 2.484	28.92	RMS	32.4	-21.7	4.74	44.36	54	-9.64	-	-	346	381	V
4	2.538	29.47	RMS	32.3	-21.7	4.74	44.81	54	-9.19	-	-	346	381	V

\* - indicates frequency in CFR47 Pt 15 / IC RSS-Restricted Band

Pk - Peak detector

RMS - RMS detection



# HARMONICS AND SPURIOUS EMISSIONS

## HIGH CHANNEL RESULTS

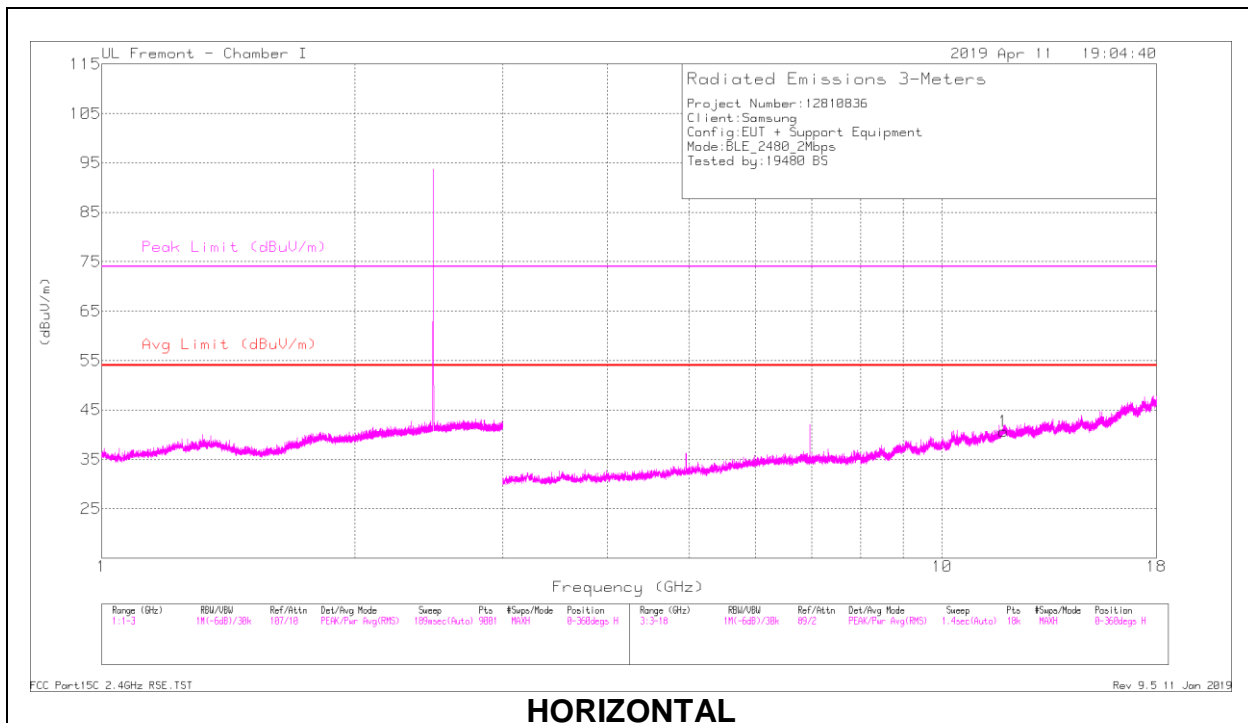

**HORIZONTAL**

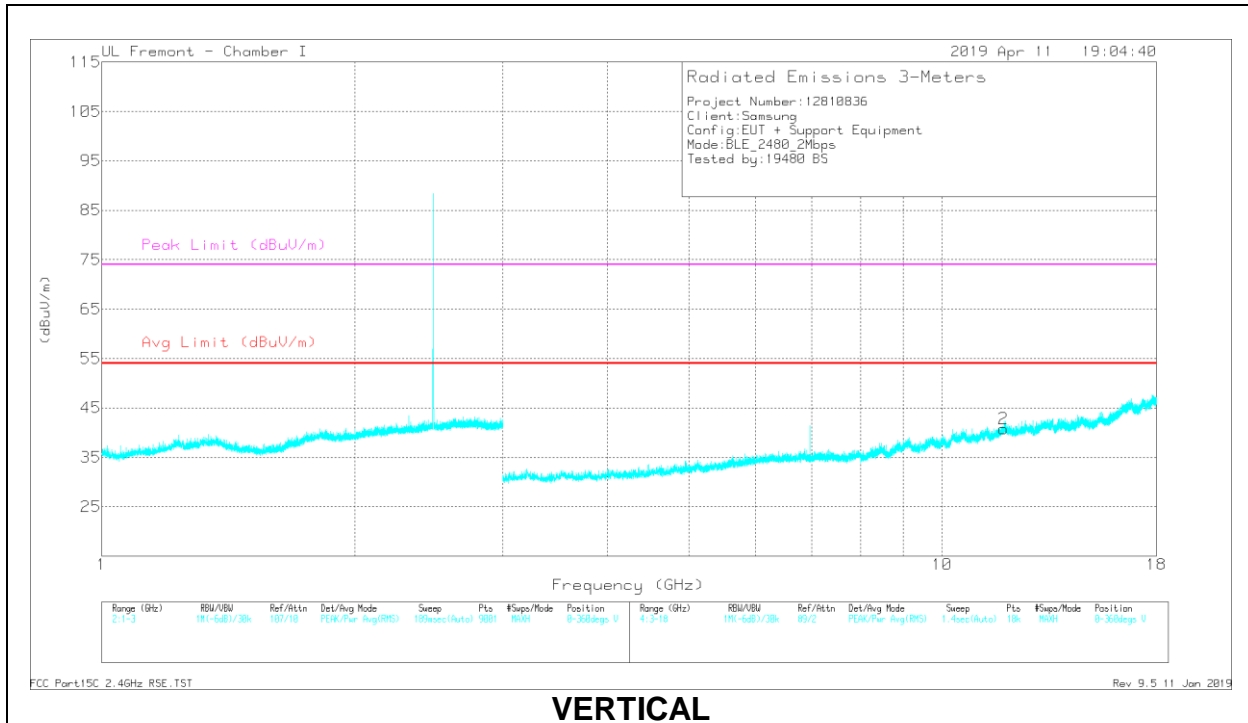

**VERTICAL**

**RADIATED EMISSIONS**

Marker	Frequency (GHz)	Meter Reading (dBuV)	Det	AF T344 (dB/m)	Amp/Cb/Filtr/Pad (dB)	DC Corr (dB)	Corrected Reading (dBuV/m)	Avg Limit (dBuV/m)	Margin (dB)	Peak Limit (dBuV/m)	PK Margin (dB)	Azimuth (Degs)	Height (cm)	Polarity
1	* 11.844	30.12	PK2	38.6	-20.8	0	47.92	-	-	74	-26.08	128	362	H
	* 11.845	20.79	MAv1	38.6	-20.8	4.74	43.33	54	-10.67	-	-	128	362	H
2	* 11.844	30.2	PK2	38.7	-20.8	0	48.1	-	-	74	-25.9	152	109	V
	* 11.843	21.17	MAv1	38.7	-20.8	4.74	43.81	54	-10.19	-	-	152	109	V

\* - indicates frequency in CFR47 Pt 15 / IC RSS-Restricted Band

PK2 - KDB558074 Method: Maximum Peak

MAv1 - KDB558074 Option 1 Maximum RMS Average

## 2.4. REFERENCE DETAIL

Reference application that contains the reused reference data

<b>Equipment Class</b>	<b>Reference FCC ID</b>	<b>Type Grant/ Permissive Change</b>	<b>Reference Application</b>	<b>Folder Test/RF Exposure</b>	<b>Report Title/Section</b>
DTS	A3LSMA705FN	Grant	12726900-E3	Test	FCC Report BLE / All sections

### 3. TEST METHODOLOGY

The tests documented in this report were performed in accordance with FCC CFR 47 Part 2, FCC CFR 47 Part 15, ANSI C63.10-2013, and KDB 558074 D01 15.247 Meas Guidance v05r02.

### 4. FACILITIES AND ACCREDITATION

The test sites and measurement facilities used to collect data are located at 47173 and 47266 Benicia Street, and 47658 Kato Road, Fremont, California, USA. Line conducted emissions are measured only at the 47173 address. The following table identifies which facilities were utilized for radiated emission measurements documented in this report. Specific facilities are also identified in the test results sections.

47173 Benicia Street	47266 Benicia Street	47658 Kato Rd
<input type="checkbox"/> Chamber A (ISED:2324B-1)	<input type="checkbox"/> Chamber D (ISED:22541-1)	<input checked="" type="checkbox"/> Chamber I (ISED:2324A-5)
<input type="checkbox"/> Chamber B (ISED:2324B-2)	<input type="checkbox"/> Chamber E (ISED:22541-2)	<input type="checkbox"/> Chamber J (ISED:2324A-6)
<input type="checkbox"/> Chamber C (ISED:2324B-3)	<input type="checkbox"/> Chamber F (ISED:22541-3)	<input checked="" type="checkbox"/> Chamber K (ISED:2324A-1)
	<input type="checkbox"/> Chamber G (ISED:22541-4)	<input type="checkbox"/> Chamber L (ISED:2324A-3)
	<input type="checkbox"/> Chamber H (ISED:22541-5)	

The above test sites and facilities are covered under FCC Test Firm Registration # 208313. Chambers above are covered under Industry Canada company address and respective code

UL Verification Services Inc. is accredited by NVLAP, Laboratory Code 200065-0

## 5. CALIBRATION AND UNCERTAINTY

### 5.1. MEASURING INSTRUMENT CALIBRATION

The measuring equipment utilized to perform the tests documented in this report has been calibrated in accordance with the manufacturer's recommendations, and is traceable to recognized national standards.

### 5.2. SAMPLE CALCULATION

#### RADIATED EMISSIONS

Where relevant, the following sample calculation is provided:

$$\text{Field Strength (dBuV/m)} = \text{Measured Voltage (dBuV)} + \text{Antenna Factor (dB/m)} + \text{Cable Loss (dB)} - \text{Preamp Gain (dB)}$$
$$36.5 \text{ dBuV} + 18.7 \text{ dB/m} + 0.6 \text{ dB} - 26.9 \text{ dB} = 28.9 \text{ dBuV/m}$$

#### MAINS CONDUCTED EMISSIONS

Where relevant, the following sample calculation is provided:

$$\text{Final Voltage (dBuV)} = \text{Measured Voltage (dBuV)} + \text{Cable Loss (dB)} + \text{Limiter Factor (dB)} + \text{LISN Insertion Loss.}$$
$$36.5 \text{ dBuV} + 0 \text{ dB} + 10.1 \text{ dB} + 0 \text{ dB} = 46.6 \text{ dBuV}$$

### 5.3. MEASUREMENT UNCERTAINTY

Where relevant, the following measurement uncertainty levels have been estimated for tests performed on the apparatus:

PARAMETER	UNCERTAINTY
Worst Case Conducted Disturbance, 9KHz to 0.15 MHz	3.84 dB
Worst Case Conducted Disturbance, 0.15 to 30 MHz	3.65 dB
Worst Case Radiated Disturbance, 9KHz to 30 MHz	2.52 dB
Worst Case Radiated Disturbance, 30 to 1000 MHz	4.88 dB
Worst Case Radiated Disturbance, 1000 to 18000 MHz	4.24 dB
Worst Case Radiated Disturbance, 18000 to 26000 MHz	4.37 dB
Worst Case Radiated Disturbance, 26000 to 40000 MHz	5.17 dB

Uncertainty figures are valid to a confidence level of 95%.

## 6. EQUIPMENT UNDER TEST

### 6.1. EUT DESCRIPTION

The EUT is a GSM/WCDMA/LTE Phone with BT, DTS/UNII a/b/g/n/ac, ANT+, and NFC. The model SM-A705FN/DS was used for final testing and is representative of the test results in this report.

### 6.2. MAXIMUM OUTPUT POWER

The transmitter has a maximum peak conducted output power as follows:

Frequency Range (MHz)	Mode	Output Power (dBm)	Output Power (mW)
2402 - 2480	BLE (1Mbps)	0.81	1.21
2402 - 2480	BLE (2Mbps)	0.81	1.21

### 6.3. DESCRIPTION OF AVAILABLE ANTENNAS

The radio utilizes an FPCB antenna, with a maximum gain of -4.88 dBi.

### 6.4. SOFTWARE AND FIRMWARE

The test utility software used during testing was A705FN.001

### 6.5. WORST-CASE CONFIGURATION AND MODE

Radiated emissions below 1GHz, above 18GHz, and power line conducted emission were performed with the EUT set to transmit at the channel with highest output power as worst-case scenario.

Band edge and radiated emissions between 1GHz and 18GHz were performed with the EUT set to transmit at the highest power on low, middle and high channels.

The fundamental of the EUT was investigated in three orthogonal orientations X,Y,Z, it was determined that X orientation was worst-case orientation; therefore, all final radiated testing was performed with the EUT in X orientation.

Worst-case data rates as provided by the client were 1Mbps and 2Mbps.

## 6.6. DESCRIPTION OF TEST SETUP

### SUPPORT EQUIPMENT

Support Equipment List				
Description	Manufacturer	Model	Serial Number	FCC ID
AC Adapter	Samsung	EP-TA50EWE	DW3J719AS/A-E	N/A
Earphone	Samsung	N/A	N/A	N/A

### I/O CABLES (CONDUCTED TEST)

I/O Cable List						
Cable No	Port	# of identical ports	Connector Type	Cable Type	Cable Length (m)	Remarks
1	Antenna	1	RF	Shielded	0.2	To spectrum Analyzer
2	USB	1	USB	Un-shielded	1	EUT to AC Mains

### I/O CABLES (RADIATED AND CONDUCTED EMISSIONS)

I/O Cable List						
Cable No	Port	# of identical ports	Connector Type	Cable Type	Cable Length (m)	Remarks
1	USB	1	USB	Shielded	1	N/A
2	Earphone	1	3.5mm	Un-shielded	1	N/A

### TEST SETUP

The EUT is a stand alone unit. Test software exercised the radio card.

**CONDUCTED TEST SETUP DIAGRAM**

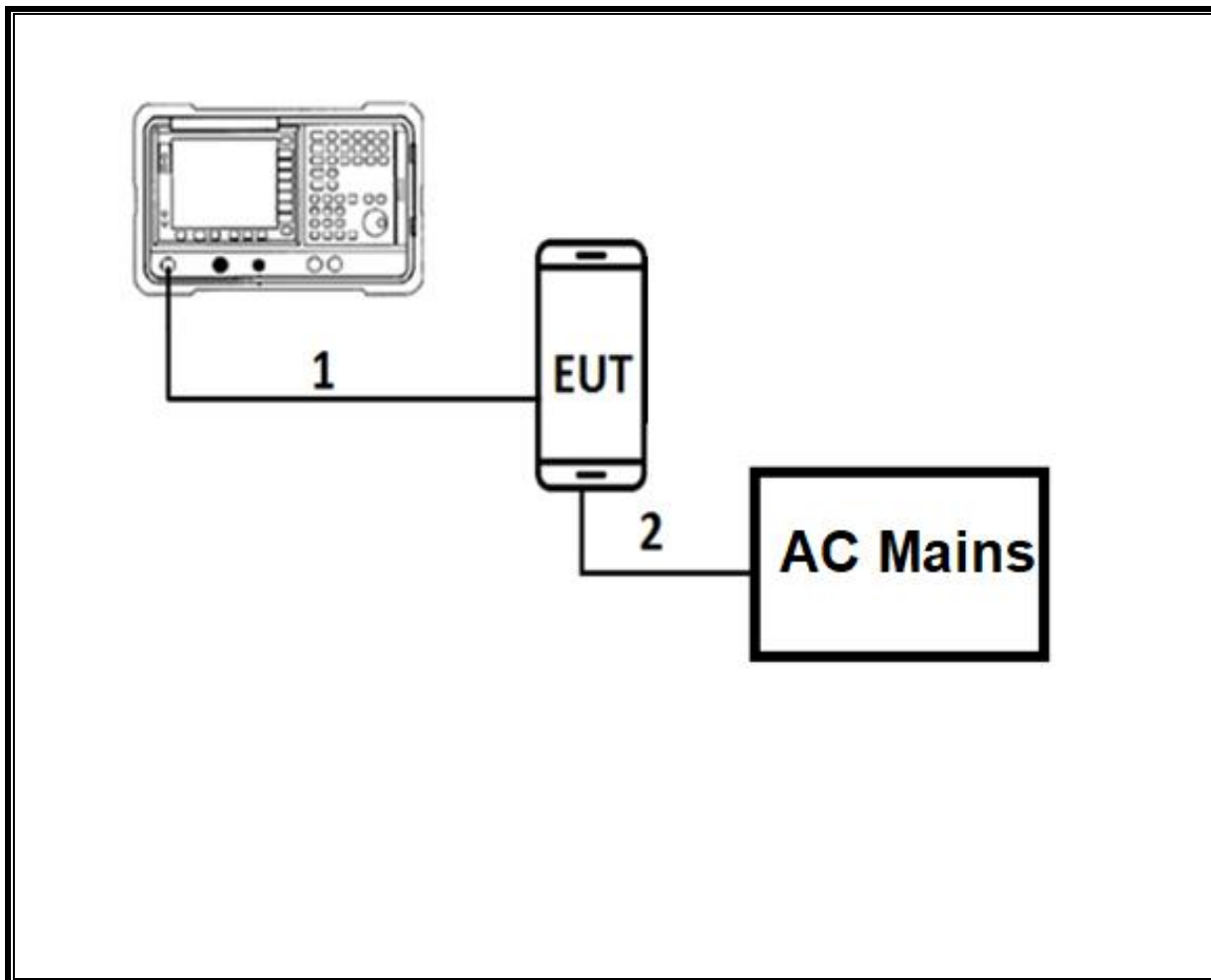

**TEST SETUP**

For conducted tests: the EUT was stand alone. The test software exercises the radio.



**RADIATED AND AC LINE CONDUCTED EMISSIONS SETUP DIAGRAM**

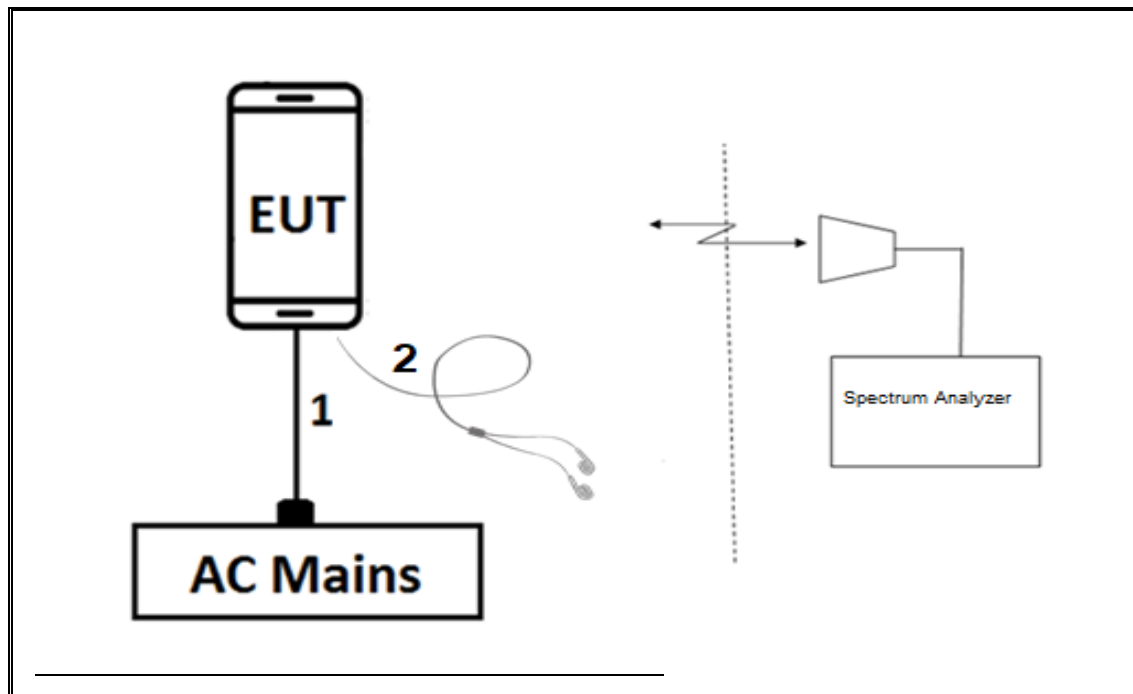

**TEST SETUP**

For radiated tests, the EUT is stand alone unit and the test software exercises the radio.

## 7. MEASUREMENT METHOD

On Time and Duty Cycle: ANSI C63.10 Section 11.6

6 dB BW: ANSI C63.10 Section 11.8.1

Occupied BW (99%): ANSI C63.10-2013 Section 6.9.3

Output Power: ANSI C63.10 Section 11.9.1.3 PKPM1 Peak power meter method

Average Power: ANSI C63.10 Section 11.9.2.3.2 Method AVGPM-G (Measurement using a gated RF average-reading power meter)

PSD: ANSI C63.10 Section 11.10.2 Method PKPSD (peak PSD)

Band-edge: ANSI C63.10 Section 11.13.3.4 Trace averaging across ON and OFF times of the EUT transmissions followed by duty cycle correction factor

Radiated emissions non-restricted frequency bands: ANSI C63.10 Section 11.11

Radiated emissions restricted frequency bands: ANSI C63.10 Section 11.12.1

Radiated Spurious Emissions Below 30MHz: ANSI C63.10-2013 Section 6.4

Conducted emissions in restricted frequency bands: ANSI C63.10 Section 11.12.

AC Power Line Conducted Emissions: ANSI C63.10-2013, Section 6.2.

## 8. TEST AND MEASUREMENT EQUIPMENT

The following test and measurement equipment was utilized for the tests documented in this report:

TEST EQUIPMENT LIST					
Description	Manufacturer	Model	ID Num	Cal Due	Last Cal
6 port rf switch, 1-18GHz	Pasternack	PE7159	171455	08/01/2019	08/01/2018
Power Meter, P-series single channel	Agilent (Keysight) Technologies	N1911A	T1271	07/26/2019	07/26/2018
Power Sensor, P-series, 50MHz to 18GHz, Wideband	Agilent (Keysight) Technologies	N1921A	T1224	10/09/2019	10/09/2018
Antenna, Active Loop 9kHz-30MHz	ETS-Lindgren	6502	T757	09/25/2019	09/25/2018
Antenna, Horn 1-18GHz	ETS-Lindgren	3117	T344	04/30/2019	04/30/2018
Antenna, Horn 1-18GHz	ETS-Lindgren	3117	T862	05/25/2019	05/25/2018
EMI TEST RECEIVER	Rohde & Schwarz	ESW44	PRE0179367	04/25/2019	04/25/2018
EMI TEST RECEIVER	Rohde & Schwarz	ESW44	PRE0179375	05/08/2019	05/08/2018
Spectrum Analyzer, PXA, 3Hz to 44GHz	Agilent (Keysight) Technologies	N9030A	T908	01/23/2020	01/23/2019
Spectrum Analyzer, PXA, 3Hz to 44GHz	Agilent (Keysight) Technologies	N9030A	T341	09/26/2019	09/26/2018
Amplifier, 1-18GHz, 35 dB	AMPLICAL	AMP1G18-35	T1569	06/03/2019	06/23/2018
RF Amplifier, 1-18GHz	MITEQ	AFS42-00101800-25-S-42	171460	08/01/2019	08/21/2018
Amplifier, 100kHz to 1GHz, 32 dB	Agilent (Keysight) Technologies	8447D	T15	10/20/2019	10/20/2018
Hybrid Antenna, 30MHz to 3GHz	SunAR rf motion	JB3	PRE0181574	08/21/2019	08/21/2018
Antenna, Horn 18 to 26.5GHz	ARA	MWH-1826/B	T447	06/16/2019	06/16/2018
Pre-Amp, 1-26.5GHz	Agilent	8449B	T404	03/09/2019	03/09/2018
AC Line Conducted					
EMI Receiver	Rohde & Schwarz	ESR	T1436	02/14/2020	02/14/2019
LISN for Conducted Emissions CISPR-16	FCC INC.	FCC LISN 50/250	T1310	06/15/2019	06/15/2018
Test Software List					
Radiated Software	UL	UL EMC		Ver 9.5, June 22, 2018	
Antenna Port Software	UL	UL RF		Ver 9.3.2, Jan. 07, 2019	
AC Line Conducted Software	UL	UL EMC		Ver 9.5, May 26, 2015	

### NOTES:

1. Equipment listed above that calibrated during the testing period was set for test after the calibration.
2. Equipment listed above that has a calibration due date during the testing period, the testing is completed before equipment expiration date.

## 9. ANTENNA PORT TEST RESULTS

### 9.1. ON TIME AND DUTY CYCLE

#### LIMITS

None; for reporting purposes only.

#### PROCEDURE

ANSI C63.10, Section 11.6 : Zero-Span Spectrum Analyzer Method.

#### ON TIME AND DUTY CYCLE RESULTS

Mode	ON Time B (msec)	Period (msec)	Duty Cycle x (linear)	Duty Cycle (%)	Duty Cycle Correction Factor (dB)	1/B Minimum VBW (kHz)
<b>2.4GHz Band</b>						
BLE (1Mbps)	0.395	0.626	0.632	63.16%	2.00	2.530
BLE (2Mbps)	0.210	0.626	0.336	33.61%	4.74	4.755

#### DUTY CYCLE PLOTS

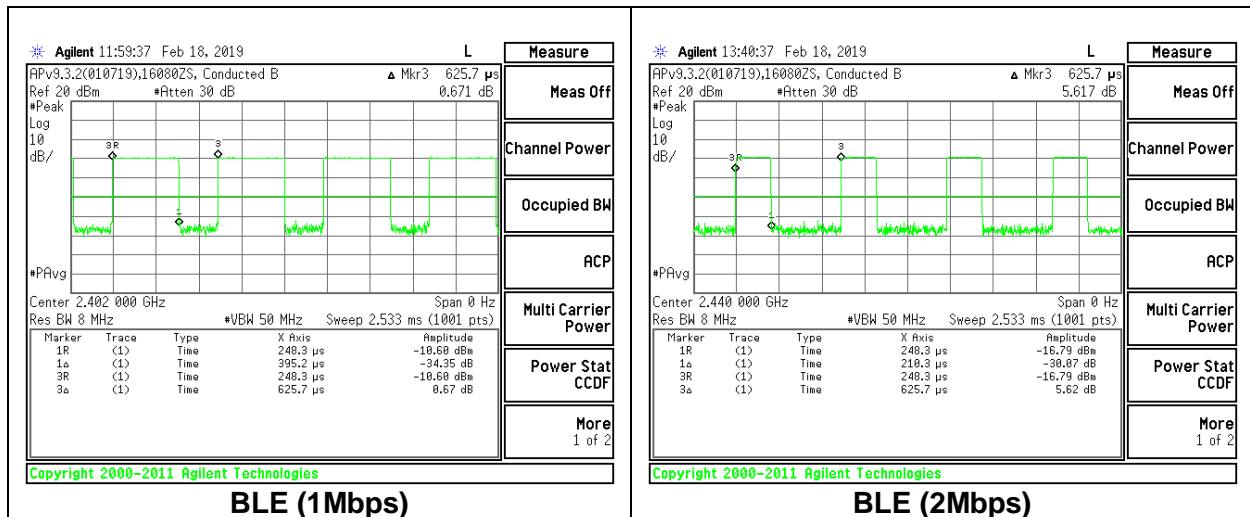

---

## **9.2. 6 dB BANDWIDTH**

### **LIMITS**

FCC §15.247 (a) (2)

The minimum 6 dB bandwidth shall be at least 500 kHz.

### **RESULTS**

**9.2.1. 1Mbps**

Channel	Frequency (MHz)	6 dB Bandwidth (MHz)	Minimum Limit (MHz)
Low	2402	0.6630	0.5
Middle	2440	0.6540	0.5
High	2480	0.6660	0.5

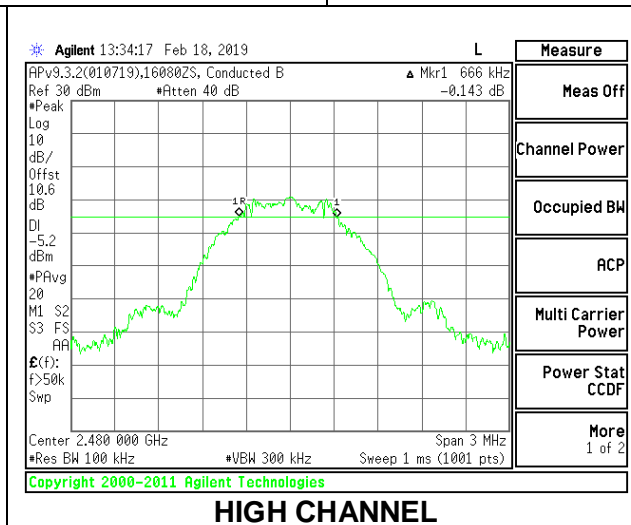
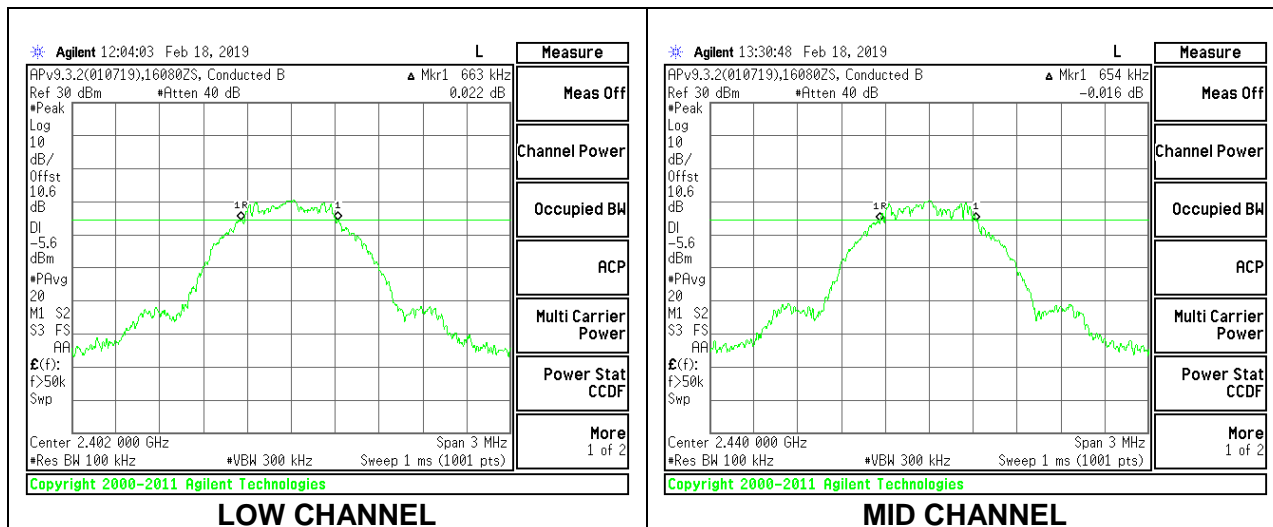

**9.2.2. 2Mbps**

Channel	Frequency (MHz)	6 dB Bandwidth (MHz)	Minimum Limit (MHz)
Low	2402	1.1010	0.5
Middle	2440	1.0770	0.5
High	2480	1.1040	0.5

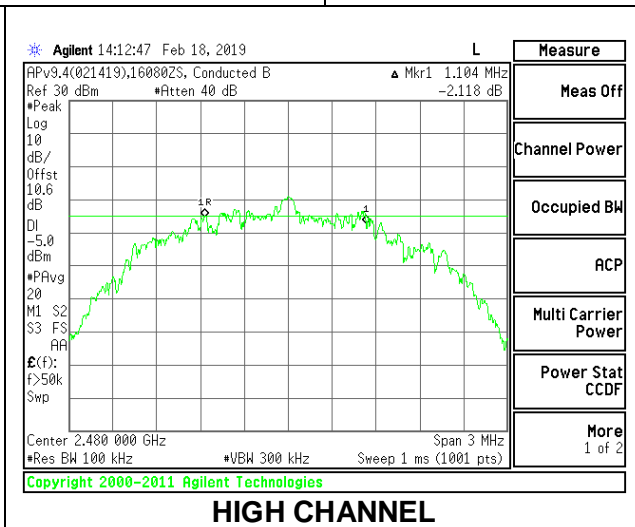
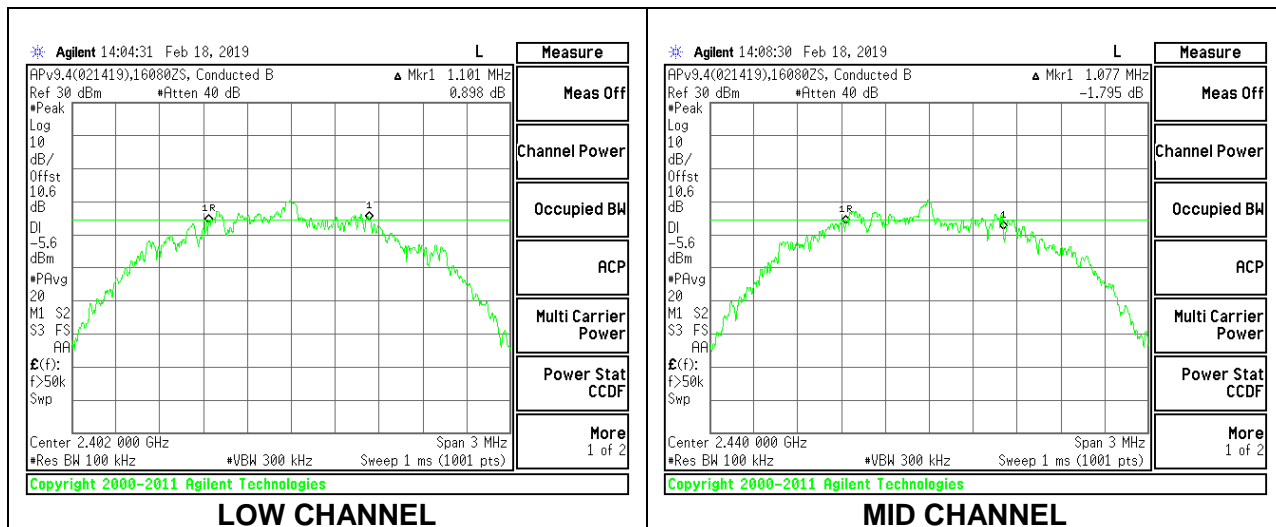

### 9.3. OUTPUT POWER

#### LIMITS

FCC §15.247 (b) (3)

The maximum antenna gain is less than or equal to 6 dBi, therefore the limit is 30 dBm.

#### TEST PROCEDURE

The transmitter output is connected to a power meter. The cable assembly insertion loss was entered as an offset in the power meter to allow for the peak reading of power.

#### RESULTS

##### 9.3.1. 1Mbps

<b>Tested By:</b>	16080 ZS
<b>Date:</b>	2/18/2019

Channel	Frequency (MHz)	Peak Power Reading (dBm)	Limit (dBm)	Margin (dB)
Low	2402	0.81	30	-29.190
Middle	2440	0.80	30	-29.200
High	2480	0.78	30	-29.220

##### 9.3.2. 2Mbps

<b>Tested By:</b>	16080 ZS
<b>Date:</b>	2/18/2019

Channel	Frequency (MHz)	Peak Power Reading (dBm)	Limit (dBm)	Margin (dB)
Low	2402	0.63	30	-29.370
Middle	2440	0.48	30	-29.520
High	2480	0.81	30	-29.190



## 9.4. AVERAGE POWER

### LIMITS

None; for reporting purposes only.

### TEST PROCEDURE

The transmitter output is connected to a power meter. The cable assembly insertion loss was entered as an offset in the power meter to allow for a gated average reading of power.

### RESULTS

#### 9.4.1. 1Mbps

<b>Tested By:</b>	16080 ZS
<b>Date:</b>	2/18/2019

<b>Channel</b>	<b>Frequency (MHz)</b>	<b>AV power (dBm)</b>
Low	2402	0.54
Middle	2440	0.53
High	2480	0.5

#### 9.4.2. 2Mbps

<b>Tested By:</b>	16080 ZS
<b>Date:</b>	2/18/2019

<b>Channel</b>	<b>Frequency (MHz)</b>	<b>AV power (dBm)</b>
Low	2402	0.32
Middle	2440	0.12
High	2480	0.57

---

## **9.5. POWER SPECTRAL DENSITY**

### **LIMITS**

FCC §15.247 (e)

The power spectral density conducted from the transmitter to the antenna shall not be greater than 8 dBm in any 3 kHz band during any time interval of continuous transmission.

### **RESULTS**

**9.5.1. BLE (1Mbps)**

Channel	Frequency (MHz)	PSD (dBm/3kHz)	Limit (dBm/3kHz)	Margin (dB)
Low	2402	-13.83	8	-21.83
Middle	2440	-13.99	8	-21.99
High	2480	-13.62	8	-21.62

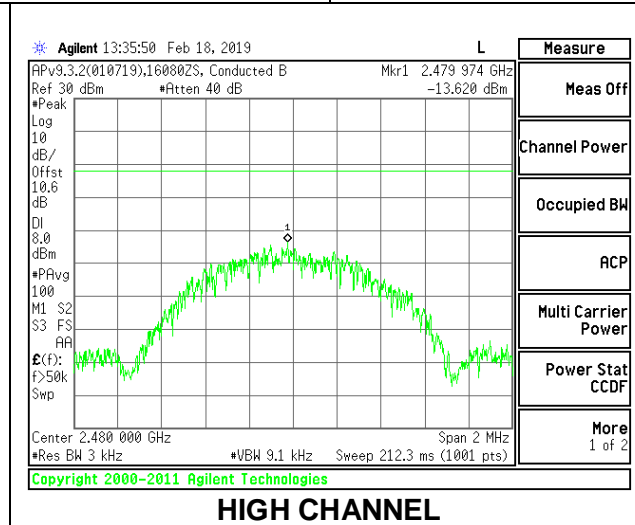
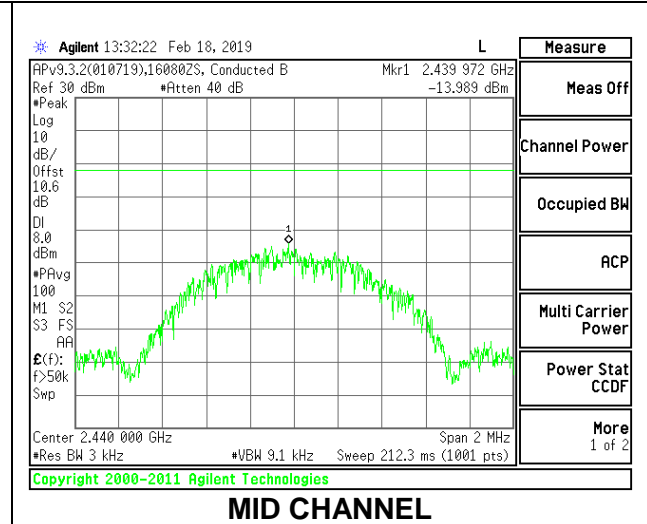
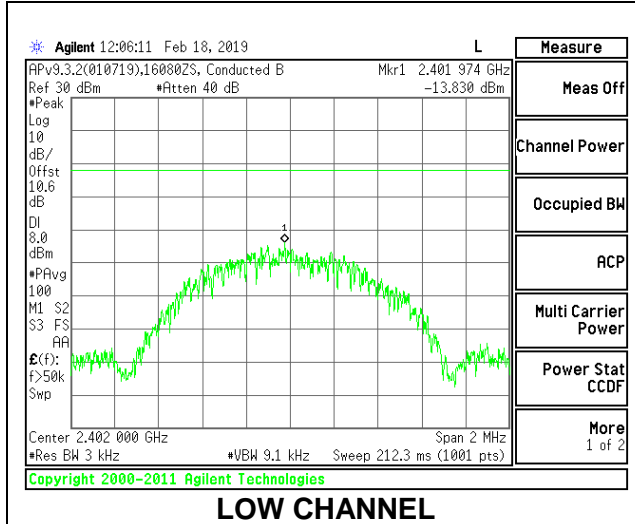

**9.5.2. 2Mbps**

Channel	Frequency (MHz)	PSD (dBm/3kHz)	Limit (dBm/3kHz)	Margin (dB)
Low	2402	-17.46	8	-25.46
Middle	2440	-17.60	8	-25.60
High	2480	-17.02	8	-25.02

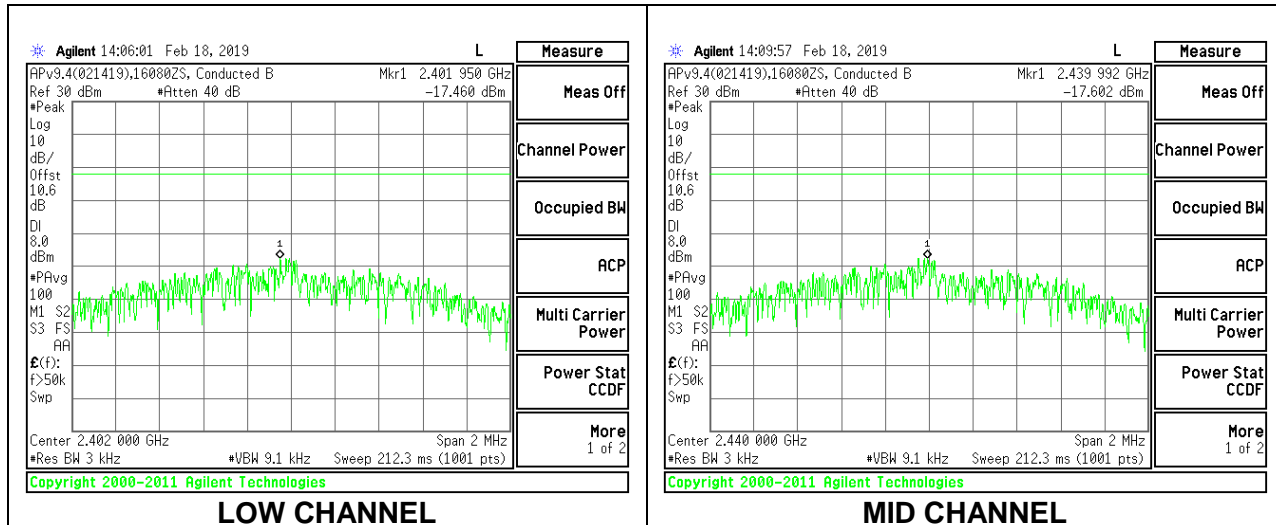

**LOW CHANNEL**

**MID CHANNEL**

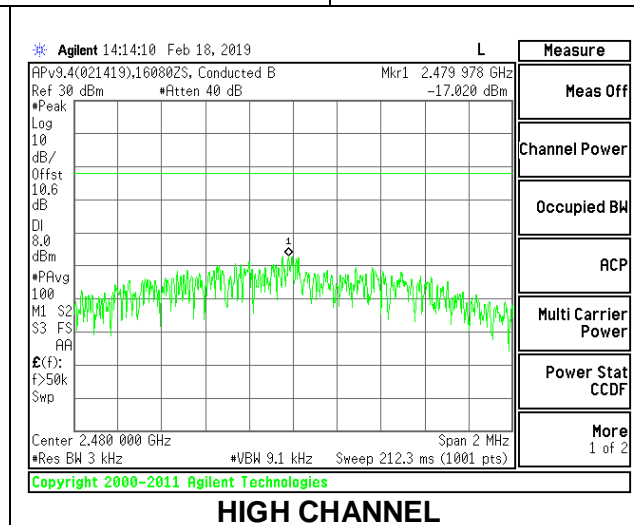

**HIGH CHANNEL**

---

## **9.6. CONDUCTED SPURIOUS EMISSIONS**

### **LIMITS**

FCC §15.247 (d)

Output power was measured based on the use of a peak measurement, therefore the required attenuation is 20 dB.

### **RESULTS**

**9.6.1. 1Mbps**

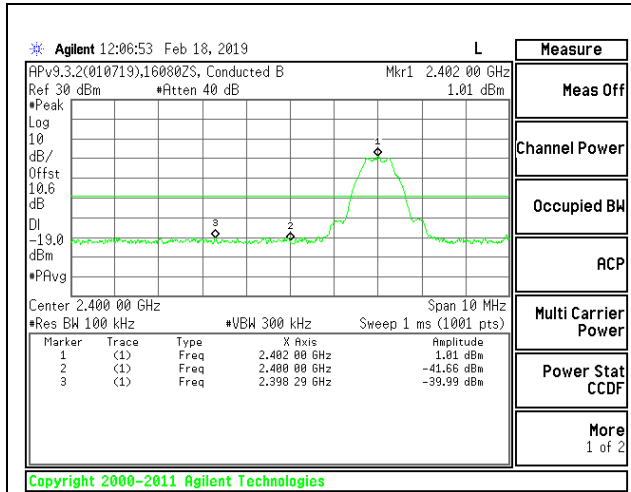

**LOW CHANNEL BANDEDGE**

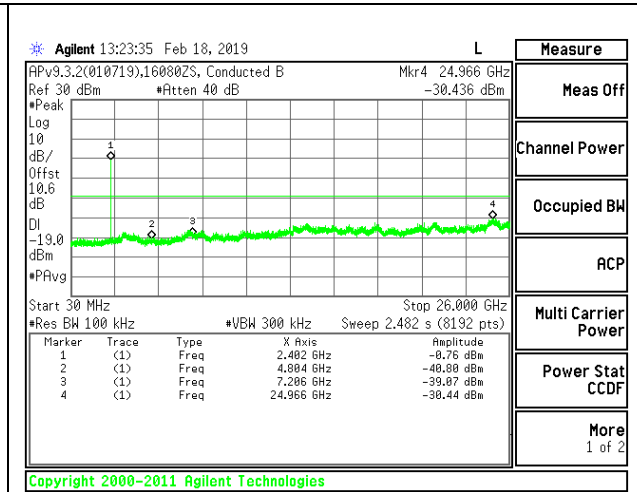

**OUT-OF-BAND LOW CHANNEL**

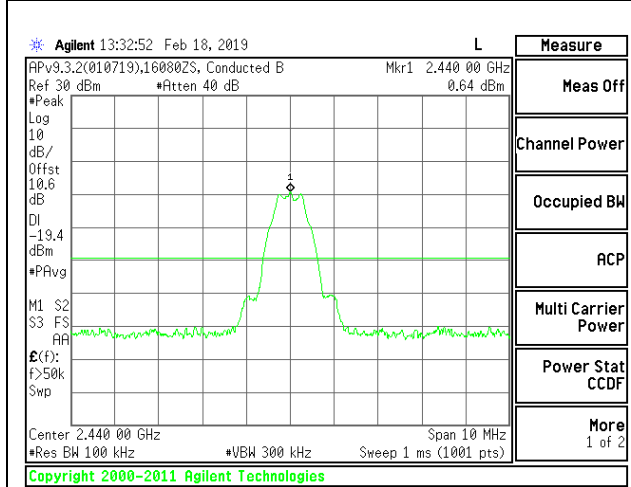

**IN-BAND REFERENCE LEVEL**

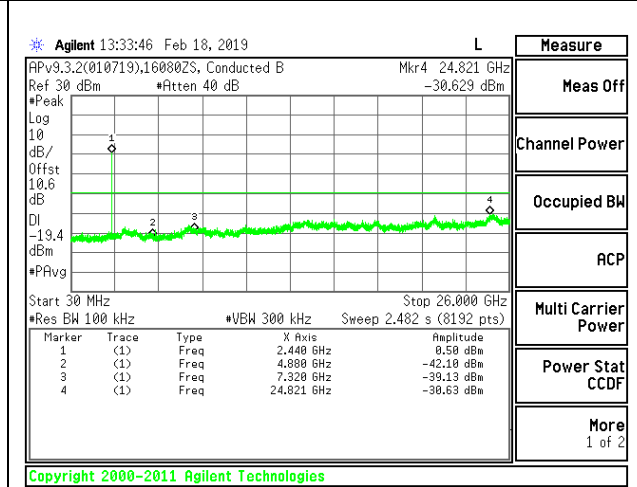

**OUT-OF-BAND MID CHANNEL**

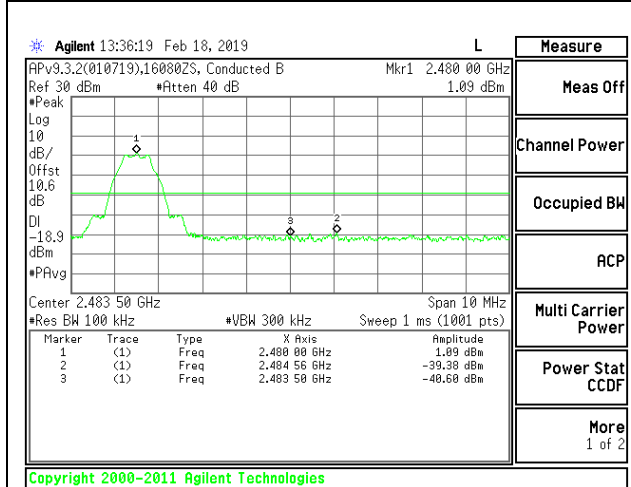

**HIGH CHANNEL BANDEDGE**

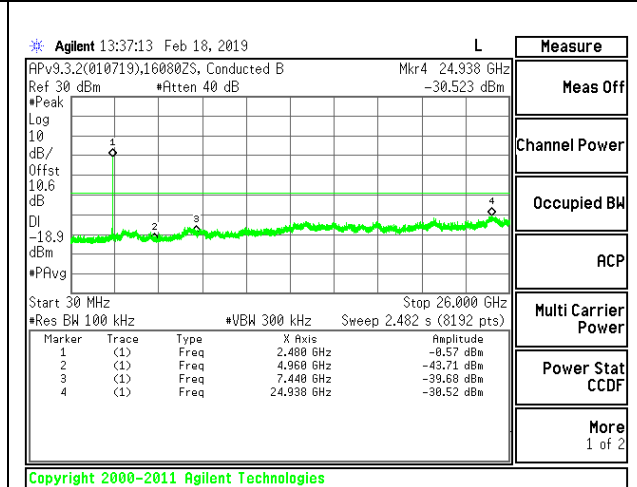

**OUT-OF-BAND HIGH CHANNEL**

**9.6.2. 2Mbps**

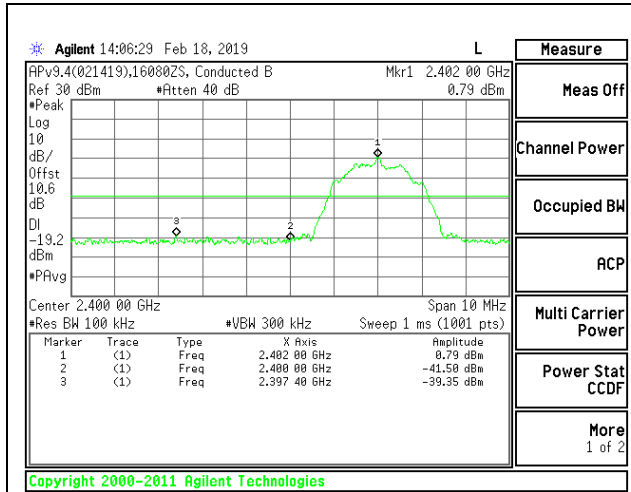

**LOW CHANNEL BANDEDGE**

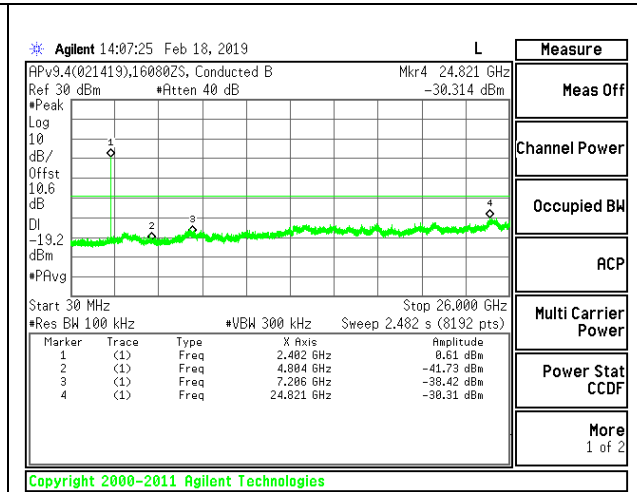

**OUT-OF-BAND LOW CHANNEL**

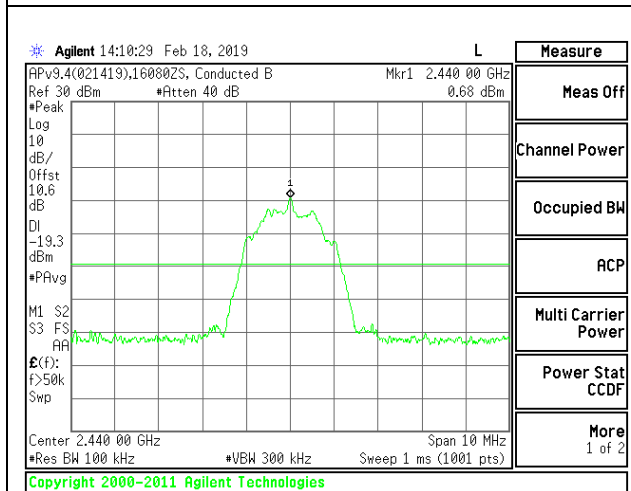

**IN-BAND REFERENCE LEVEL**

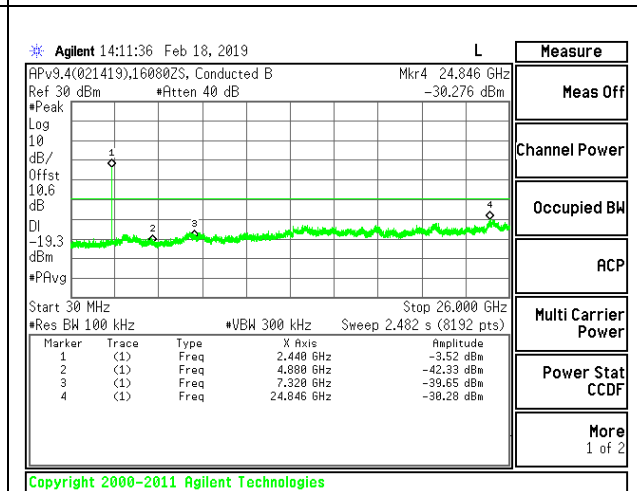

**OUT-OF-BAND MID CHANNEL**

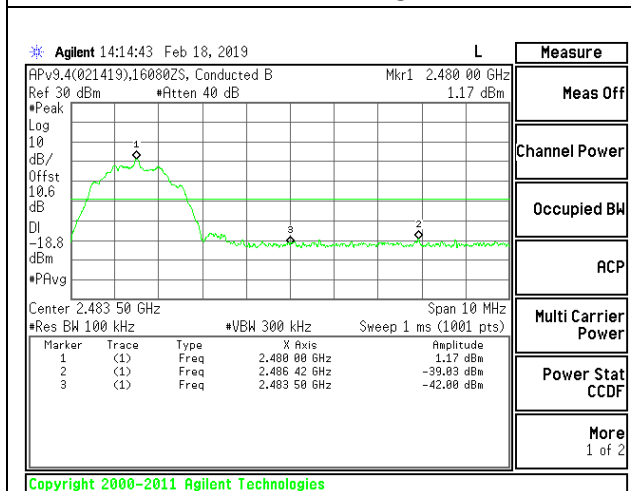

**HIGH CHANNEL BANDEDGE**

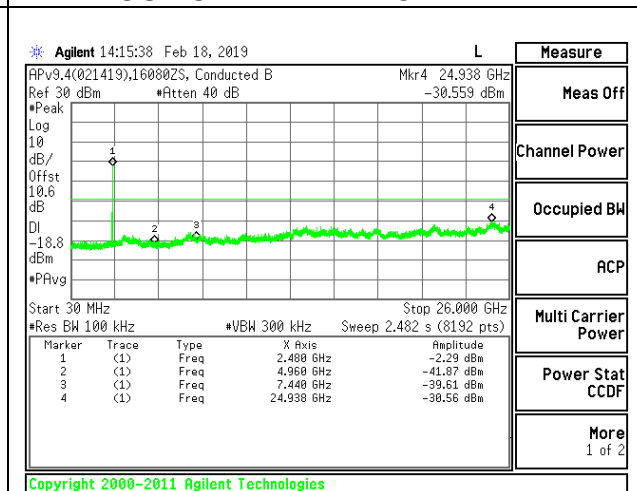

**OUT-OF-BAND HIGH CHANNEL**

## 10. RADIATED TEST RESULTS

### 10.1. LIMITS AND PROCEDURE

#### LIMITS

FCC §15.205 and §15.209

Frequency Range (MHz)	Field Strength Limit (uV/m) at 3 m	Field Strength Limit (dBuV/m) at 3 m
0.009-0.490	2400/F(kHz) @ 300 m	-
0.490-1.705	24000/F(kHz) @ 30 m	-
1.705 - 30	30 @ 30m	-
30 - 88	100	40
88 - 216	150	43.5
216 - 960	200	46
Above 960	500	54

#### TEST PROCEDURE

The EUT is placed on a non-conducting table 80 cm above the ground plane for measurement below 1GHz; 1.5 m above the ground plane for measurement above 1GHz. The antenna to EUT distance is 3 meters. The EUT is configured in accordance with ANSI C63.10. The EUT is set to transmit in a continuous mode.

For measurements below 1 GHz the resolution bandwidth is set to 100 kHz for peak detection measurements or 120 kHz for quasi-peak detection measurements. Peak detection is used unless otherwise noted as quasi-peak.

For pre-scans above 1 GHz the resolution bandwidth is set to 1 MHz; the video bandwidth is set to 30 KHz for peak measurements.

For final measurements above 1 GHz the resolution bandwidth is set to 1 MHz; the video bandwidth is set to 3 MHz for peak measurements and as applicable for average measurements.

The spectrum from 1 GHz to 18 GHz is investigated with the transmitter set to the lowest, middle, and highest channels in each applicable band. Below 1GHz and above 18GHz emissions, the channel with the highest output power was tested.

The frequency range of interest is monitored at a fixed antenna height and EUT azimuth. The EUT is rotated through 360 degrees to maximize emissions received. The antenna is scanned from 1 to 4 meters above the ground plane to further maximize the emission. Measurements are made with the antenna polarized in both the vertical and the horizontal positions.

2D antenna use - For below 30MHz testing, investigation was done on three antenna orientations (parallel, perpendicular, and ground-parallel), parallel and perpendicular are the worst orientations, therefore testing was performed on these two orientations only.



**KDB 414788 OFS and Chamber Correlation Justification**

Base on FCC 15.31 (f) (2): measurements may be performed at a distance closer than that specified in the regulations; however, an attempt should be made to avoid making measurements in the near field.

OFS and chamber correlation testing had been performed and chamber measured test result is the worst case test result.

## 10.2. TRANSMITTER ABOVE 1 GHz

### 10.2.1. 1Mbps

### BANDEDGE (LOW CHANNEL)

### HORIZONTAL RESULT

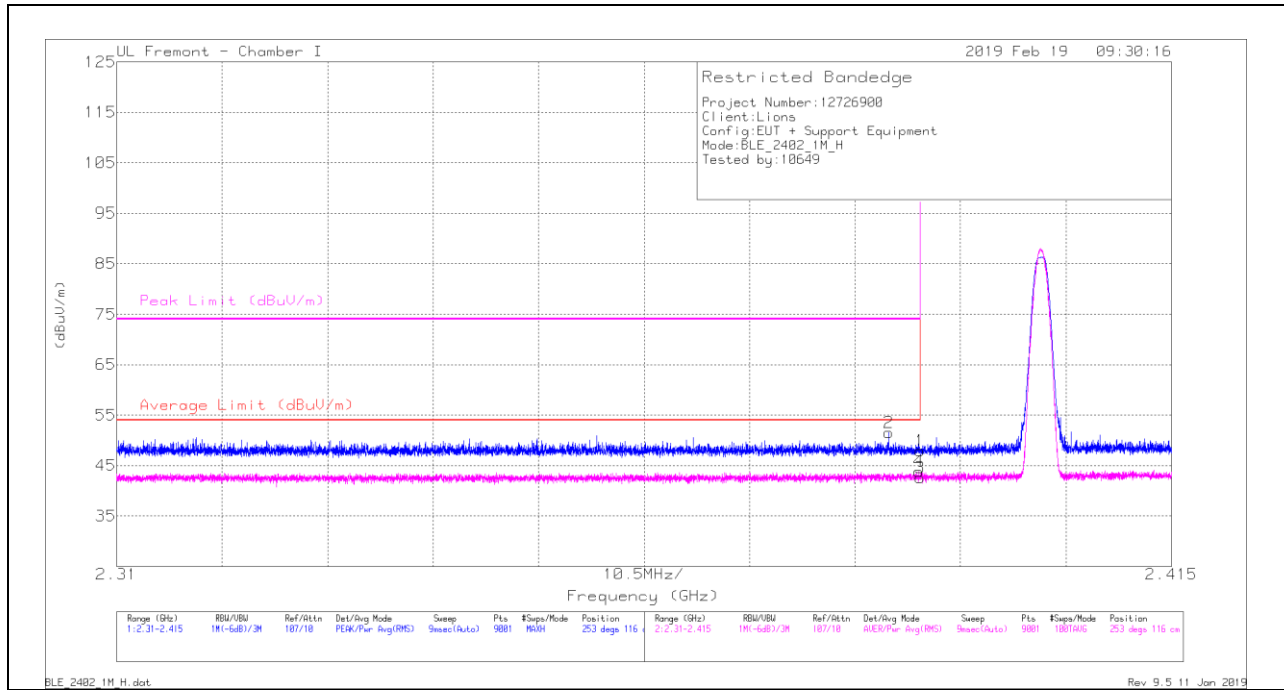

### Trace Markers

Marker	Frequency (GHz)	Meter Reading (dBuV)	Det	AF T862 (dB/m)	Amp/Cb/Ftr/Pad (dB)	DC Corr (dB)	Corrected Reading (dBuV/m)	Average Limit (dBuV/m)	Margin (dB)	Peak Limit (dBuV/m)	PK Margin (dB)	Azimuth (Degs)	Height (cm)	Polarity
1	* 2.39	37.78	Pk	31.8	-21.6	0	47.98	-	-	74	-26.02	253	116	H
2	* 2.387	41.37	Pk	31.8	-21.6	0	51.57	-	-	74	-22.43	253	116	H
3	* 2.39	27.66	RMS	31.8	-21.6	2	39.86	54	-14.14	-	-	253	116	H
4	* 2.39	28.84	RMS	31.8	-21.6	2	41.04	54	-12.96	-	-	253	116	H

\* - indicates frequency in CFR47 Pt 15 / IC RSS-Restricted Band

Pk - Peak detector

RMS - RMS detection

### VERTICAL RESULT

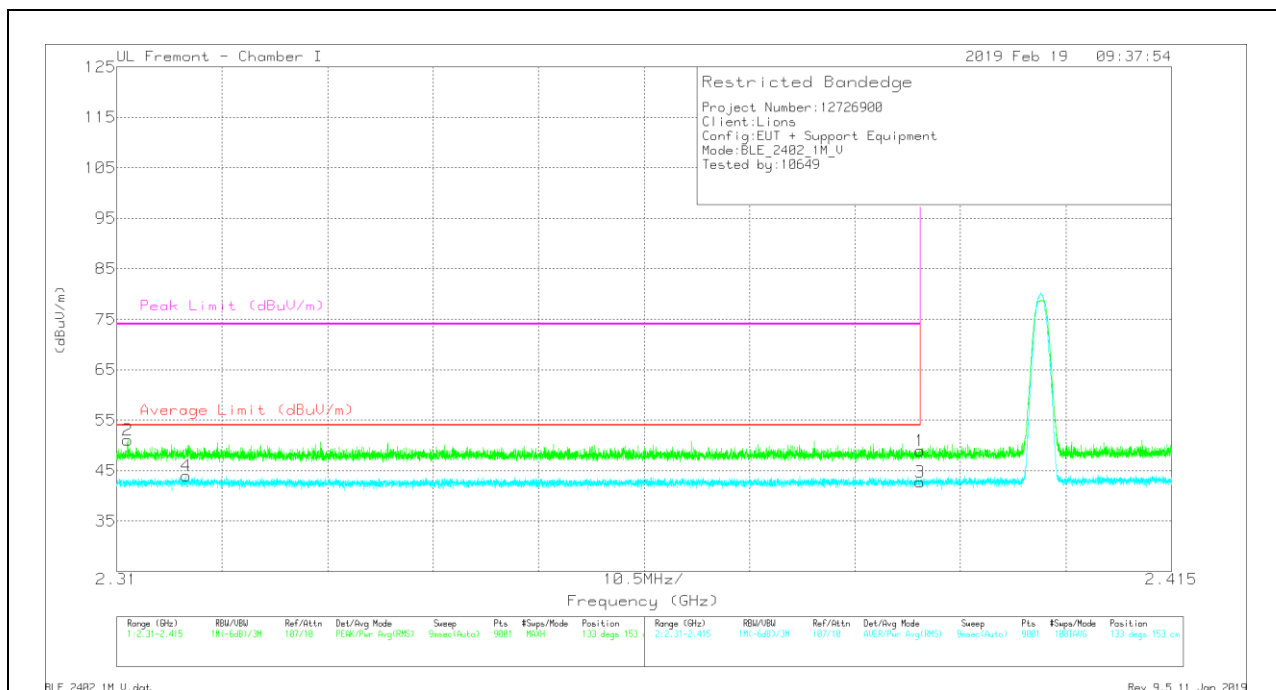

### Trace Markers

Marker	Frequency (GHz)	Meter Reading (dBuV)	Det	AF T862 (dB/m)	Amp/Cb/Ftr/Pad (dB)	DC Corr (dB)	Corrected Reading (dBuV/m)	Average Limit (dBuV/m)	Margin (dB)	Peak Limit (dBuV/m)	PK Margin (dB)	Azimuth (Degs)	Height (cm)	Polarity
1	* 2.39	38.71	Pk	31.8	-21.6	0	48.91	-	-	74	-25.09	133	153	V
2	* 2.311	41.08	Pk	31.5	-21.5	0	51.08	-	-	74	-22.92	133	153	V
3	* 2.39	27.81	RMS	31.8	-21.6	2	40.01	54	-13.99	-	-	133	153	V
4	* 2.317	29	RMS	31.6	-21.4	2	41.2	54	-12.8	-	-	133	153	V

\* - indicates frequency in CFR47 Pt 15 / IC RSS-Restricted Band

Pk - Peak detector

RMS - RMS detection

**BANEDGE (HIGH CHANNEL)**

**HORIZONTAL RESULT**

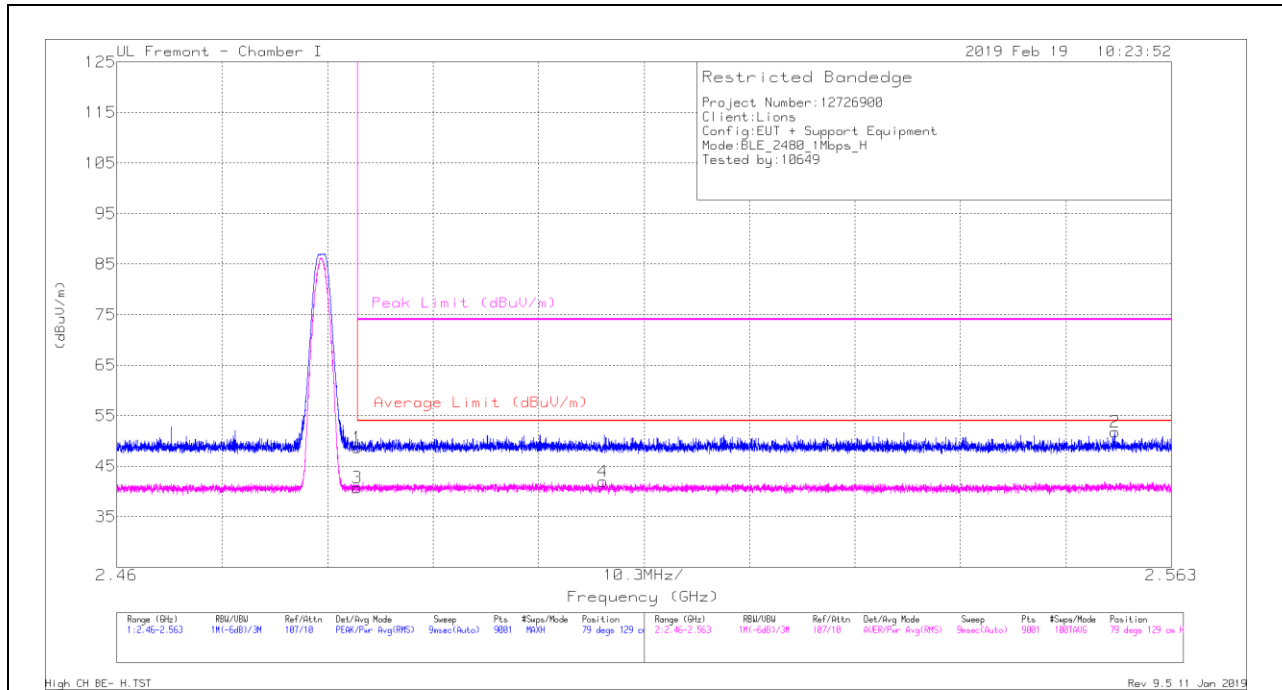

**Trace Markers**

Marker	Frequency (GHz)	Meter Reading (dBuV)	Det	AF T862 (dB/m)	Amp/Cb/Ftr/Pad (dB)	DC Corr (dB)	Corrected Reading (dBuV/m)	Average Limit (dBuV/m)	Margin (dB)	Peak Limit (dBuV/m)	PK Margin (dB)	Azimuth (Degs)	Height (cm)	Polarity
1	* 2.484	38.02	Pk	32.4	-21.7	0	48.72	-	-	74	-25.28	79	129	H
2	2.557	40.93	Pk	32.4	-21.6	0	51.73	-	-	74	-22.27	79	129	H
3	* 2.484	28.02	RMS	32.4	-21.7	2	40.72	54	-13.28	-	-	79	129	H
4	2.507	29.38	RMS	32.4	-21.8	2	41.98	54	-12.02	-	-	79	129	H

\* - indicates frequency in CFR47 Pt 15 / IC RSS-Restricted Band

Pk - Peak detector

RMS - RMS detection

### VERTICAL RESULT

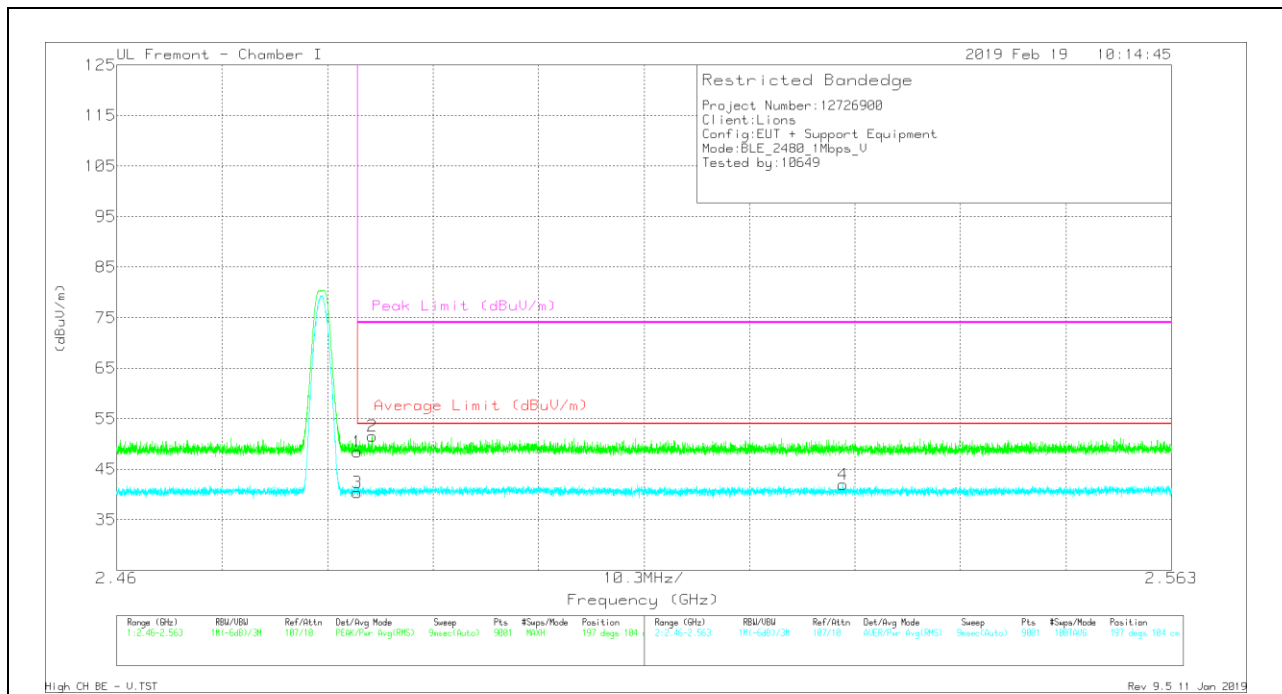

### Trace Markers

Marker	Frequency (GHz)	Meter Reading (dBuV)	Det	AF T862 (dB/m)	Amp/CbI/Ftr/Pad (dB)	DC Corr (dB)	Corrected Reading (dBuV/m)	Average Limit (dBuV/m)	Margin (dB)	Peak Limit (dBuV/m)	PK Margin (dB)	Azimuth (Degs)	Height (cm)	Polarity
1	* 2.484	37.78	Pk	32.4	-21.7	0	48.48	-	-	74	-25.52	197	104	V
2	* 2.485	40.96	Pk	32.4	-21.8	0	51.56	-	-	74	-22.44	197	104	V
3	* 2.484	27.65	RMS	32.4	-21.7	2	40.35	54	-13.65	-	-	197	104	V
4	2.531	29.23	RMS	32.4	-21.7	2	41.93	54	-12.07	-	-	197	104	V

\* - indicates frequency in CFR47 Pt 15 / IC RSS-Restricted Band  
 Pk - Peak detector  
 RMS - RMS detection

**HARMONICS AND SPURIOUS EMISSIONS**

**LOW CHANNEL RESULTS**

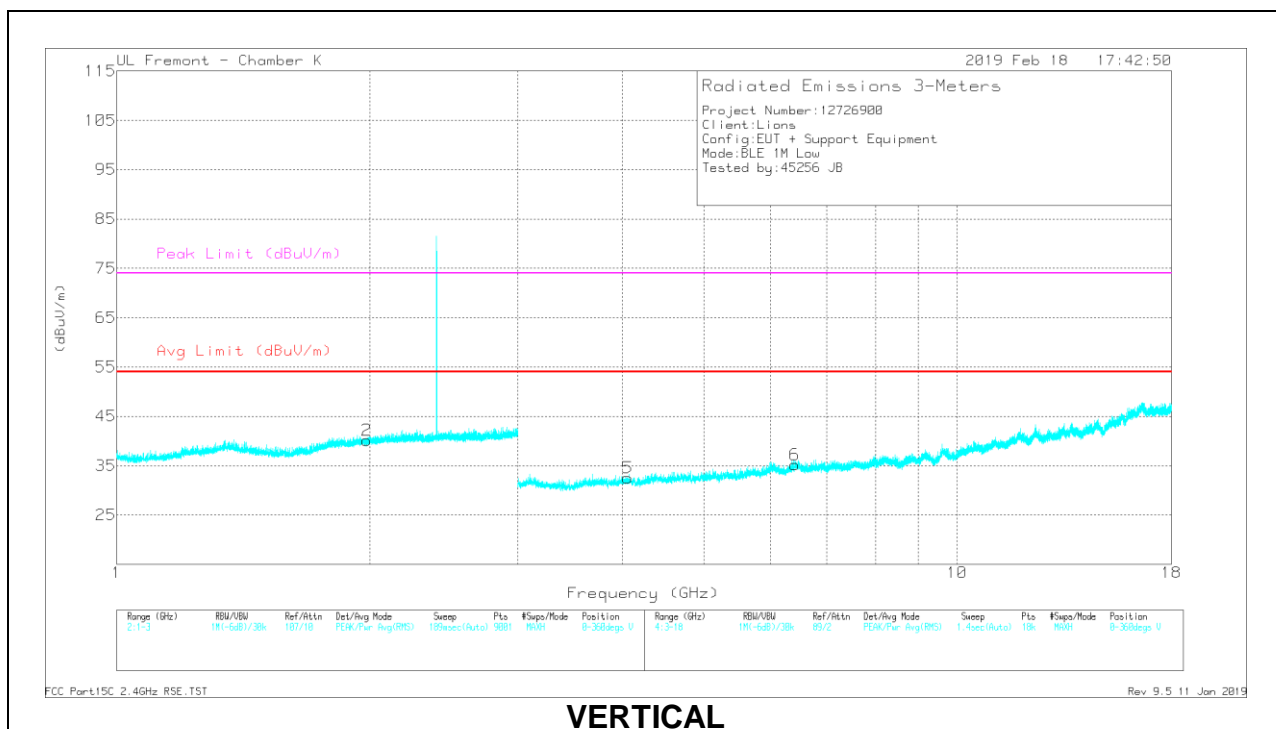
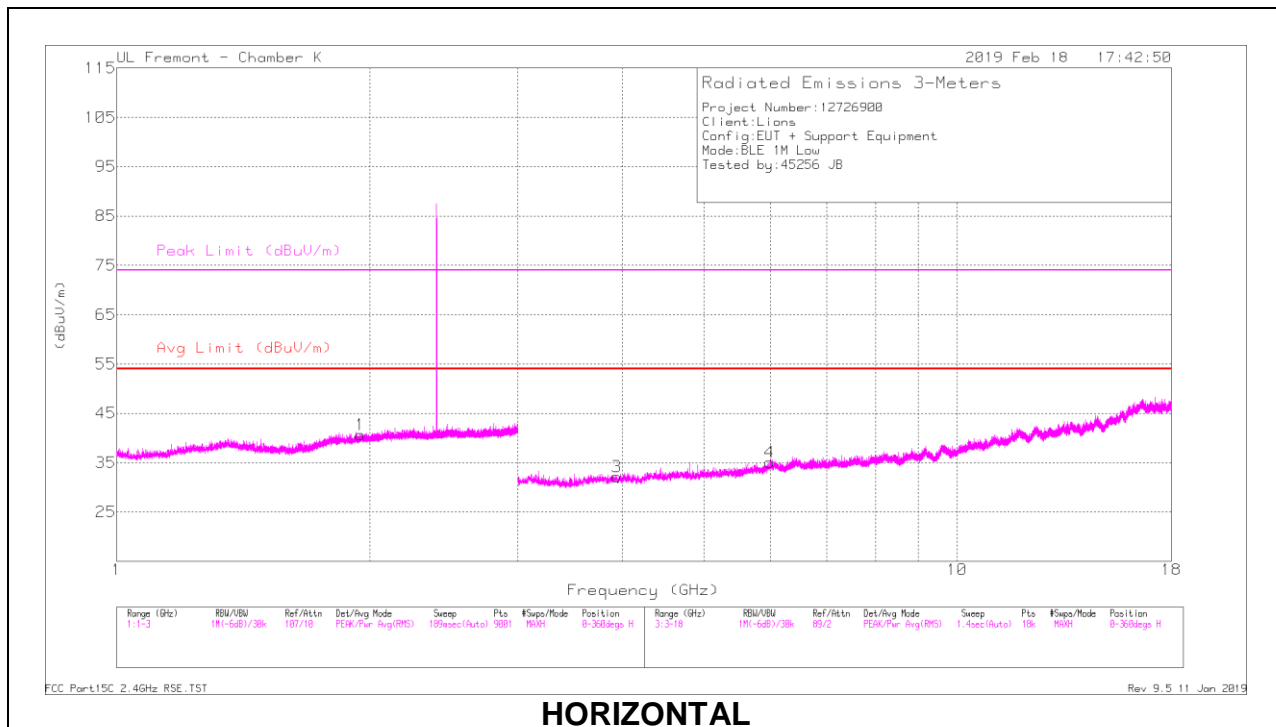

**RADIATED EMISSIONS**

Marker	Frequency (GHz)	Meter Reading (dBuV)	Det	AF T344 (dB/m)	Amp/Cbl/Filtr/Pad (dB)	DC Corr (dB)	Corrected Reading (dBuV/m)	Avg Limit (dBuV/m)	Margin (dB)	Peak Limit (dBuV/m)	PK Margin (dB)	Azimuth (Degs)	Height (cm)	Polarity
1	1.95	34.17	Pk	30.8	-24.3	0	40.67	-	-	-	-	0-360	201	H
2	1.985	33.66	Pk	30.9	-24.4	0	40.16	-	-	-	-	0-360	201	V
3	* 3.933	37.53	PK2	33.4	-31.6	0	39.33	-	-	74	-34.67	227	253	H
	* 3.935	27.99	MAv1	33.4	-31.7	2	31.69	54	-22.31	-	-	227	253	H
4	5.99	27.59	Pk	35.1	-27.6	0	35.09	-	-	-	-	0-360	201	H
5	* 4.058	38.48	PK2	33.4	-30.9	0	40.98	-	-	74	-33.02	106	249	V
	* 4.058	27.6	MAv1	33.4	-30.9	2	32.1	54	-21.9	-	-	106	249	V
6	6.413	26.39	Pk	35.4	-26.6	0	35.19	-	-	-	-	0-360	201	V

\* - indicates frequency in CFR47 Pt 15 / IC RSS-Restricted Band

Pk - Peak detector

PK2 - KDB558074 Method: Maximum Peak

MAv1 - KDB558074 Option 1 Maximum RMS Average

### MID CHANNEL RESULTS

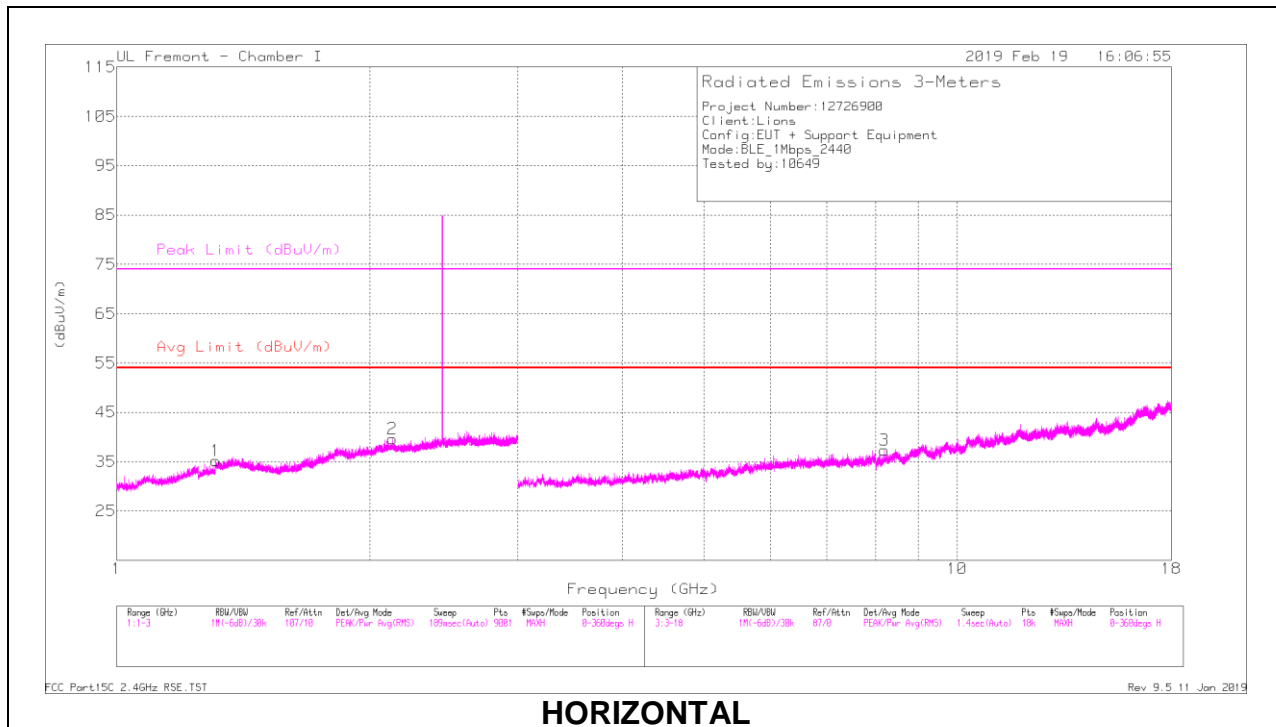

**HORIZONTAL**

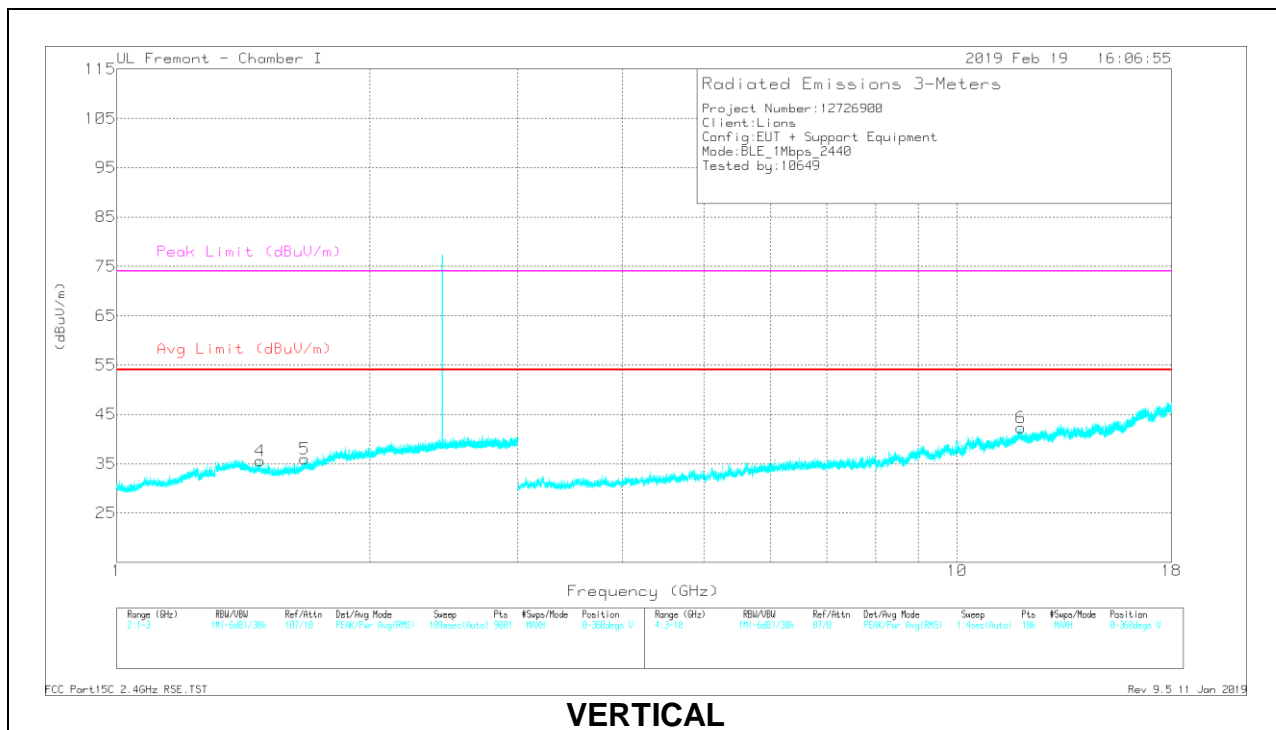

**VERTICAL**



**RADIATED EMISSIONS**

Marker	Frequency (GHz)	Meter Reading (dBuV)	Det	AF T862 (dB/m)	Amp/Cb/Filtr/Pad (dB)	DC Corr (dB)	Corrected Reading (dBuV/m)	Avg Limit (dBuV/m)	Margin (dB)	Peak Limit (dBuV/m)	PK Margin (dB)	Azimuth (Degs)	Height (cm)	Polarity
1	* 1.313	33.76	PK2	29.3	-21.7	0	41.36	-	-	74	-32.64	91	234	H
	* 1.312	24.5	MAv1	29.4	-21.7	2	34.2	54	-19.8	-	-	91	234	H
2	2.127	31.73	PK2	31.3	-19.4	0	43.63	-	-	-	-	117	311	H
4	* 1.48	32.94	PK2	28.2	-20.8	0	40.34	-	-	74	-33.66	221	280	V
	* 1.482	24.64	MAv1	28.2	-20.8	2	34.04	54	-19.96	-	-	221	280	V
5	* 1.676	32.29	PK2	29.1	-20	0	41.39	-	-	74	-32.61	142	186	V
	* 1.673	22.92	MAv1	29	-20	2	33.92	54	-20.08	-	-	142	186	V
3	* 8.189	32	PK2	35.7	-24	0	43.7	-	-	74	-30.3	184	114	H
	* 8.192	22.11	MAv1	35.7	-24	2	35.81	54	-18.19	-	-	184	114	H
6	* 11.923	28.97	PK2	38.7	-21	0	46.67	-	-	74	-27.33	203	145	V
	* 11.921	21.16	MAv1	38.7	-21	2	40.86	54	-13.14	-	-	203	145	V

\* - indicates frequency in CFR47 Pt 15 / IC RSS-Restricted Band

PK2 - KDB558074 Method: Maximum Peak

MAv1 - KDB558074 Option 1 Maximum RMS Average

### HIGH CHANNEL RESULTS

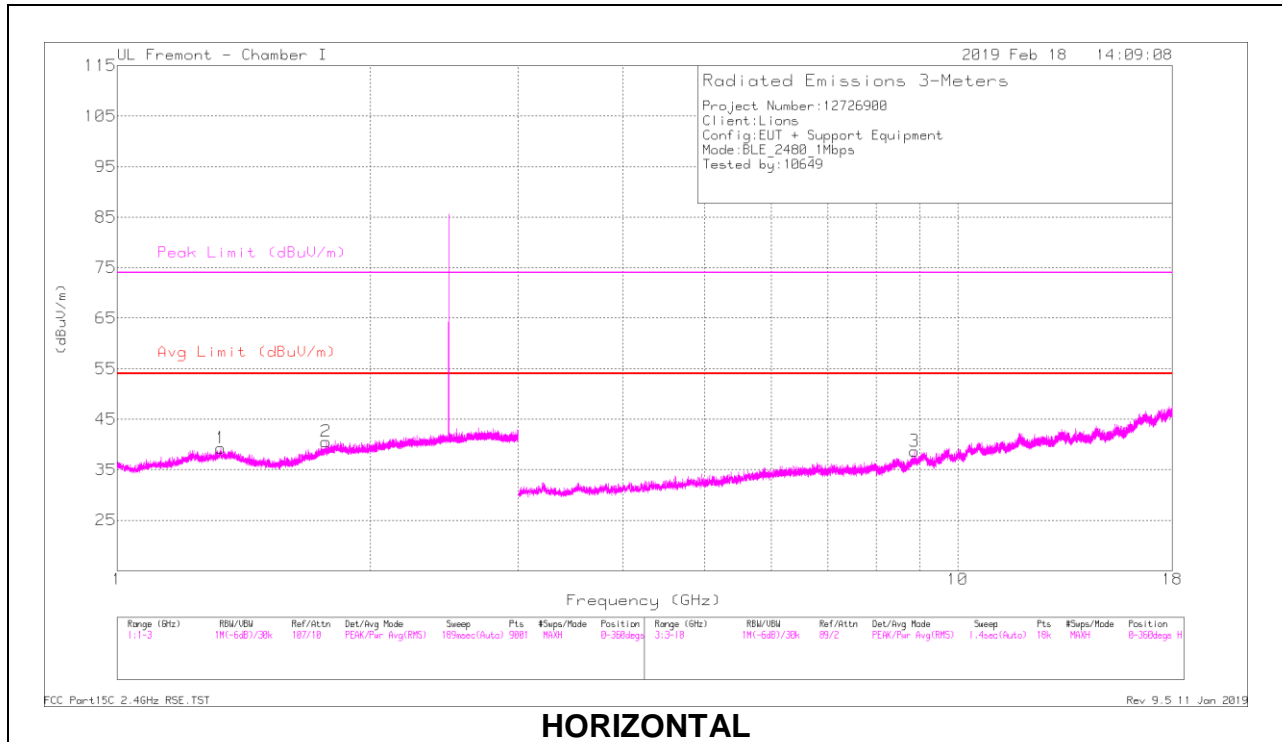

**HORIZONTAL**

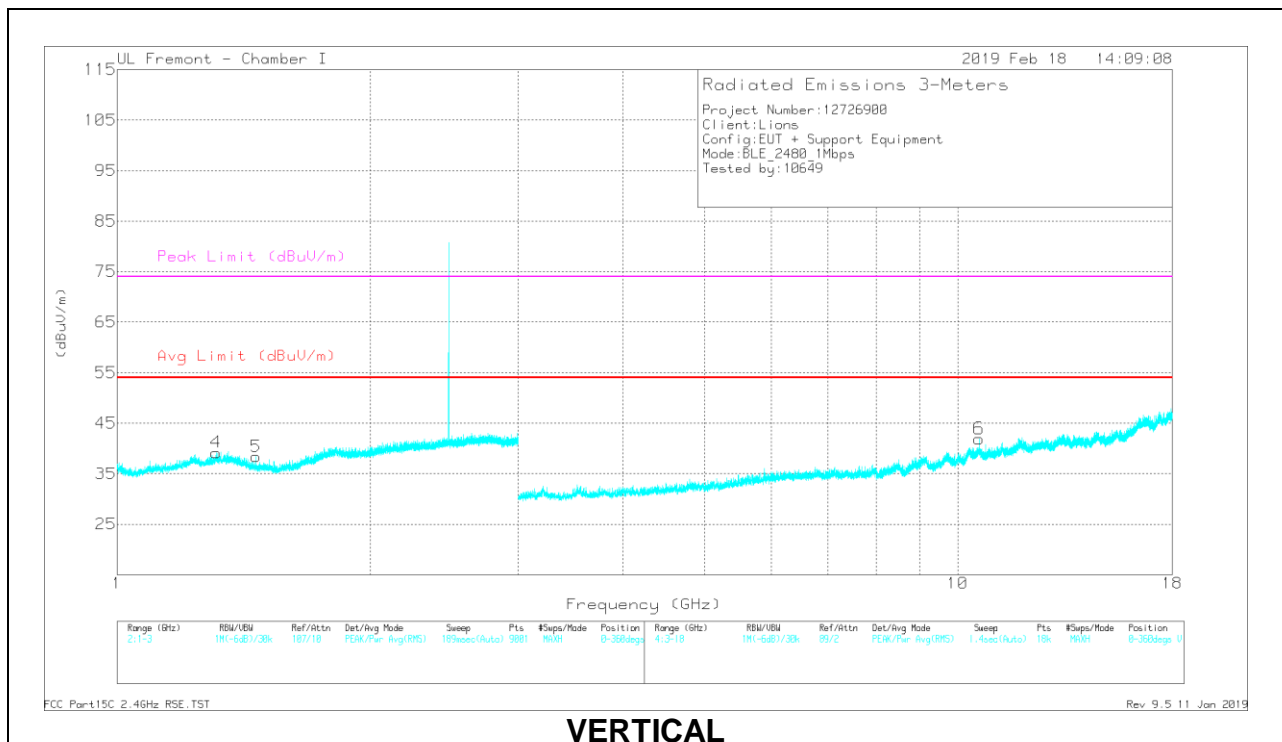

**VERTICAL**

**RADIATED EMISSIONS**

Marker	Frequency (GHz)	Meter Reading (dBuV)	Det	AF T862 (dB/m)	Amp/Cb/Filtr/Pad (dB)	DC Corr (dB)	Corrected Reading (dBuV/m)	Avg Limit (dBuV/m)	Margin (dB)	Peak Limit (dBuV/m)	PK Margin (dB)	Azimuth (Degs)	Height (cm)	Polarity
1	* 1.33	39.31	PK2	29.2	-23.1	0	45.41	-	-	74	-28.59	76	257	H
	* 1.327	30.03	MAv1	29.3	-23	2	38.33	54	-15.67	-	-	76	257	H
2	1.772	38.72	PK2	30.3	-22.2	0	46.82	-	-	-	-	159	140	H
4	* 1.311	39.63	PK2	29.4	-23	0	46.03	-	-	74	-27.97	49	234	V
	* 1.309	29.64	MAv1	29.4	-23	2	38.04	54	-15.96	-	-	49	234	V
5	* 1.462	39.02	PK2	28.1	-23.5	0	43.62	-	-	74	-30.38	85	145	V
	* 1.464	29.27	MAv1	28.1	-23.5	2	35.87	54	-18.13	-	-	85	145	V
3	8.881	31.93	PK2	36.2	-22.5	0	45.63	-	-	-	-	42	256	H
6	* 10.6	29.92	PK2	37.8	-20.2	0	47.52	-	-	74	-26.48	147	158	V
	* 10.6	19.79	MAv1	37.8	-20.2	2	39.39	54	-14.61	-	-	147	158	V

\* - indicates frequency in CFR47 Pt 15 / IC RSS-Restricted Band

PK2 - KDB558074 Method: Maximum Peak

MAv1 - KDB558074 Option 1 Maximum RMS Average

**10.2.2. 2Mbps**

**Antenna 1**

**BANDEDGE (LOW CHANNEL)**

**HORIZONTAL RESULT**

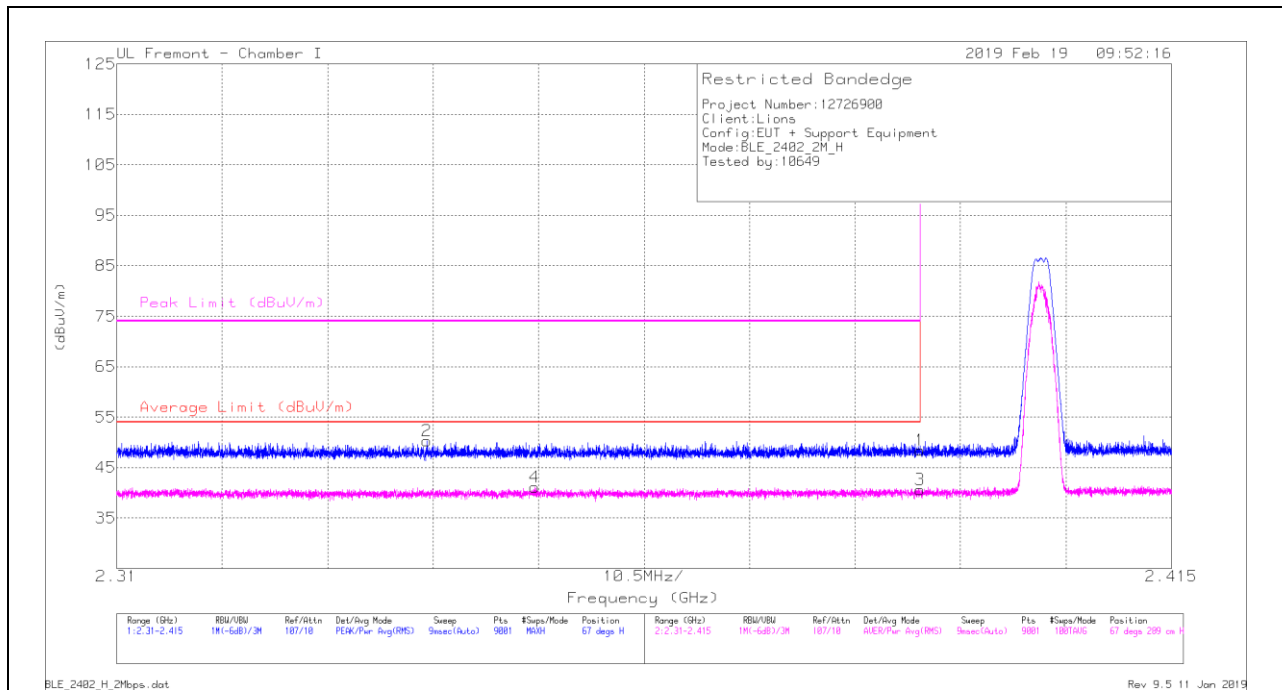

**Trace Markers**

Marker	Frequency (GHz)	Meter Reading (dBuV)	Det	AF T862 (dB/m)	Amp/Cb/Flr/Pad (dB)	DC Corr (dB)	Corrected Reading (dBuV/m)	Average Limit (dBuV/m)	Margin (dB)	Peak Limit (dBuV/m)	PK Margin (dB)	Azimuth (Degs)	Height (cm)	Polarity
1	* 2.39	38.22	Pk	31.8	-21.6	0	48.42	-	-	74	-25.58	67	289	H
2	* 2.341	40.26	Pk	31.5	-21.5	0	50.26	-	-	74	-23.74	67	289	H
3	* 2.39	28.36	RMS	31.8	-21.6	4.74	43.3	54	-10.7	-	-	67	289	H
4	* 2.352	28.98	RMS	31.6	-21.5	4.74	43.82	54	-10.18	-	-	67	289	H

\* - indicates frequency in CFR47 Pt 15 / IC RSS-Restricted Band  
 Pk - Peak detector  
 RMS - RMS detection

### VERTICAL RESULT

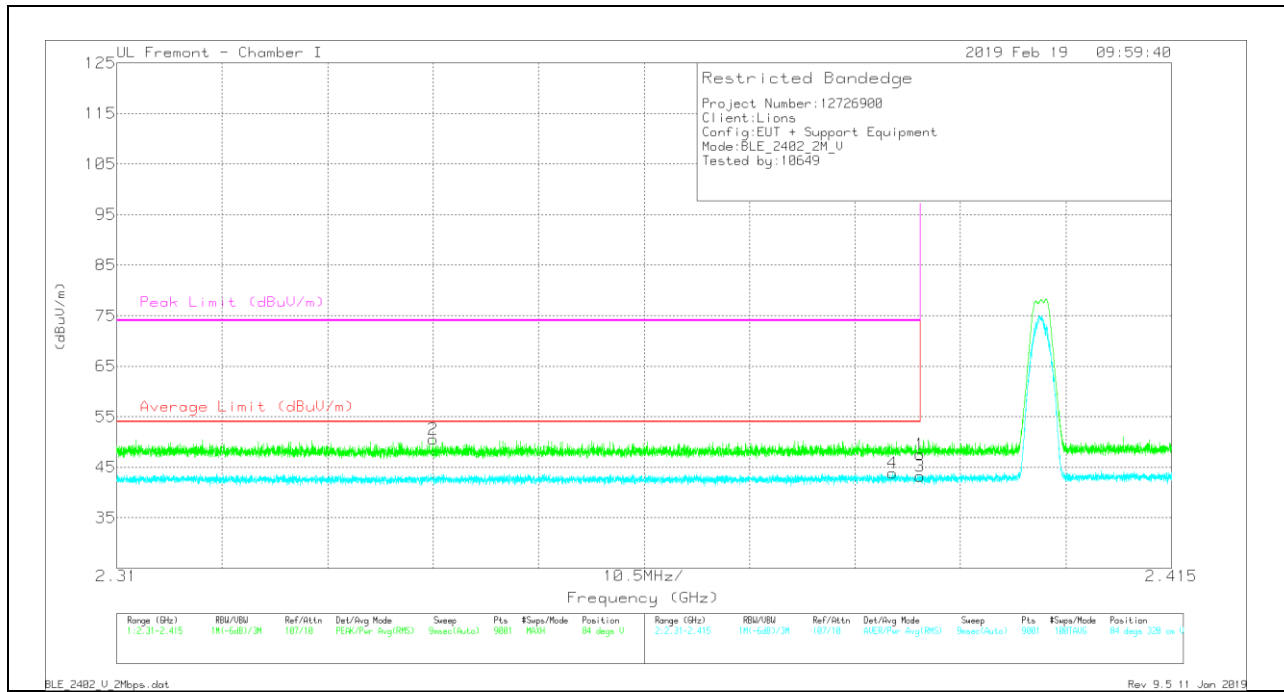

### Trace Markers

Marker	Frequency (GHz)	Meter Reading (dBuV)	Det	AF T862 (dB/m)	Amp/Cb/Filt/Pad (dB)	DC Corr (dB)	Corrected Reading (dBuV/m)	Average Limit (dBuV/m)	Margin (dB)	Peak Limit (dBuV/m)	PK Margin (dB)	Azimuth (Degs)	Height (cm)	Polarity
1	* 2.39	37.37	Pk	31.8	-21.6	0	47.57	-	-	74	-26.43	84	328	V
2	* 2.341	40.5	Pk	31.5	-21.5	0	50.5	-	-	74	-23.5	84	328	V
3	* 2.39	28.26	RMS	31.8	-21.6	4.74	43.2	54	-10.8	-	-	84	328	V
4	* 2.387	28.92	RMS	31.8	-21.6	4.74	43.86	54	-10.14	-	-	84	328	V

\* - indicates frequency in CFR47 Pt 15 / IC RSS-Restricted Band  
 Pk - Peak detector  
 RMS - RMS detection

**BANDEDGE (HIGH CHANNEL)**

**HORIZONTAL RESULT**

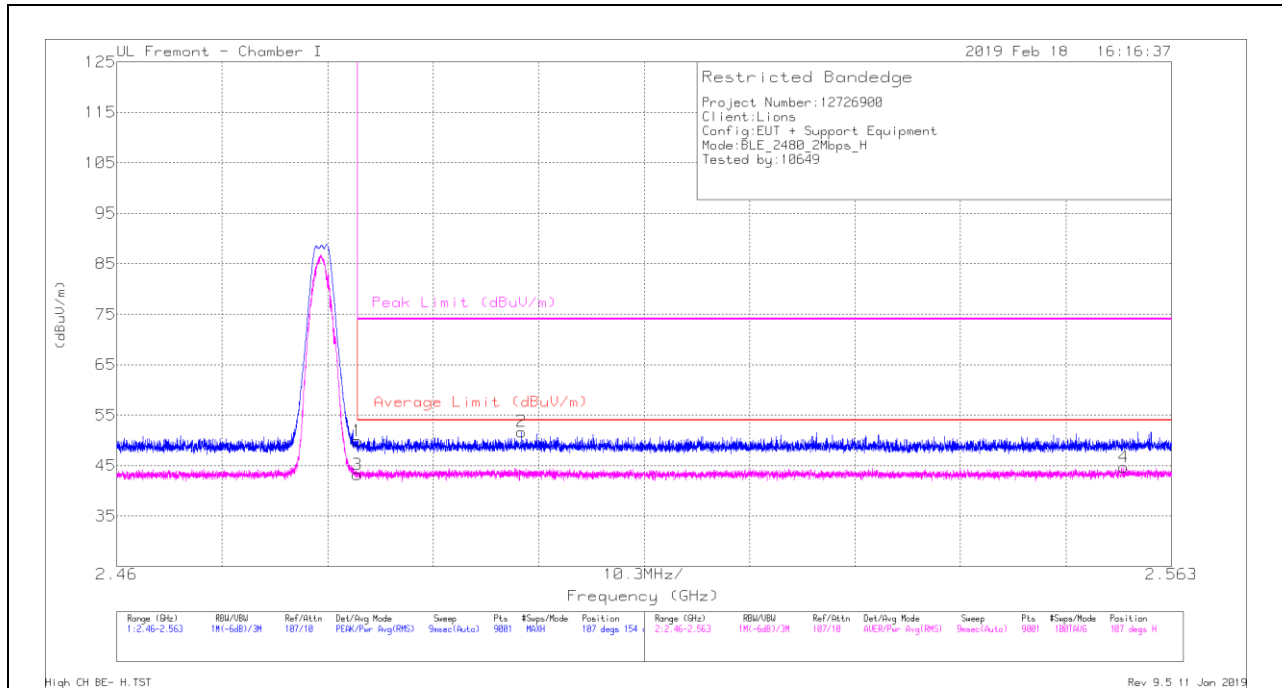

**Trace Markers**

Marker	Frequency (GHz)	Meter Reading (dBuV)	Det	AF T862 (dB/m)	Amp/Cb/Ftr/Pad (dB)	DC Corr (dB)	Corrected Reading (dBuV/m)	Average Limit (dBuV/m)	Margin (dB)	Peak Limit (dBuV/m)	PK Margin (dB)	Azimuth (Degs)	Height (cm)	Polarity
1	* 2.484	39.18	Pk	32.4	-21.7	0	49.88	-	-	74	-24.12	107	154	H
2	* 2.5	40.92	Pk	32.5	-21.7	0	51.72	-	-	74	-22.28	107	154	H
3	* 2.484	27.91	RMS	32.4	-21.7	4.74	43.35	54	-10.65	-	-	107	154	H
4	2.558	29.29	RMS	32.4	-21.6	4.74	44.83	54	-9.17	-	-	107	154	H

\* - indicates frequency in CFR47 Pt 15 / IC RSS-Restricted Band  
 Pk - Peak detector  
 RMS - RMS detection

### VERTICAL RESULT

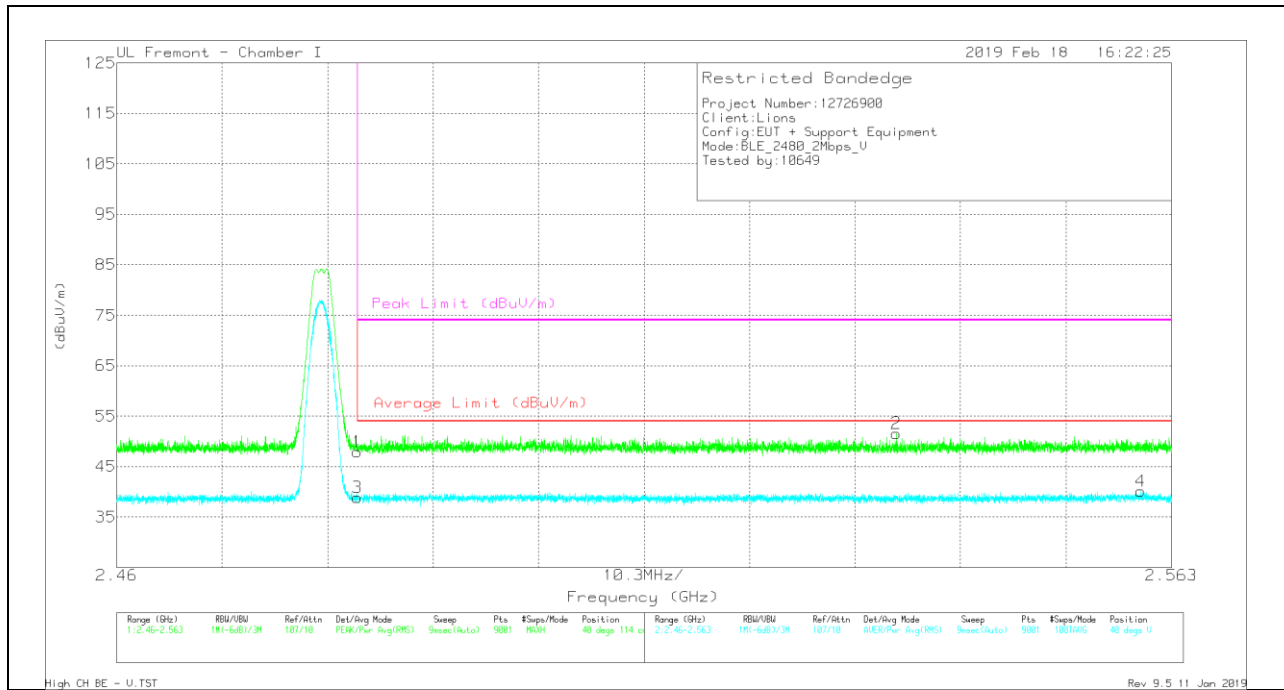

### Trace Markers

Marker	Frequency (GHz)	Meter Reading (dBuV)	Det	AF T862 (dB/m)	Amp/Cb/Filt/Pad (dB)	DC Corr (dB)	Corrected Reading (dBuV/m)	Average Limit (dBuV/m)	Margin (dB)	Peak Limit (dBuV/m)	PK Margin (dB)	Azimuth (Degs)	Height (cm)	Polarity
1	* 2.484	37.28	Pk	32.4	-21.7	0	47.98	-	-	74	-26.02	40	114	V
2	2.536	40.99	Pk	32.3	-21.7	0	51.59	-	-	74	-22.41	40	114	V
3	* 2.484	28.14	RMS	32.4	-21.7	4.74	43.58	54	-10.42	-	-	40	114	V
4	2.56	29.32	RMS	32.4	-21.6	4.74	44.84	54	-9.14	-	-	40	114	V

\* - indicates frequency in CFR47 Pt 15 / IC RSS-Restricted Band  
 Pk - Peak detector  
 RMS - RMS detection

**HARMONICS AND SPURIOUS EMISSIONS**

**LOW CHANNEL RESULTS**

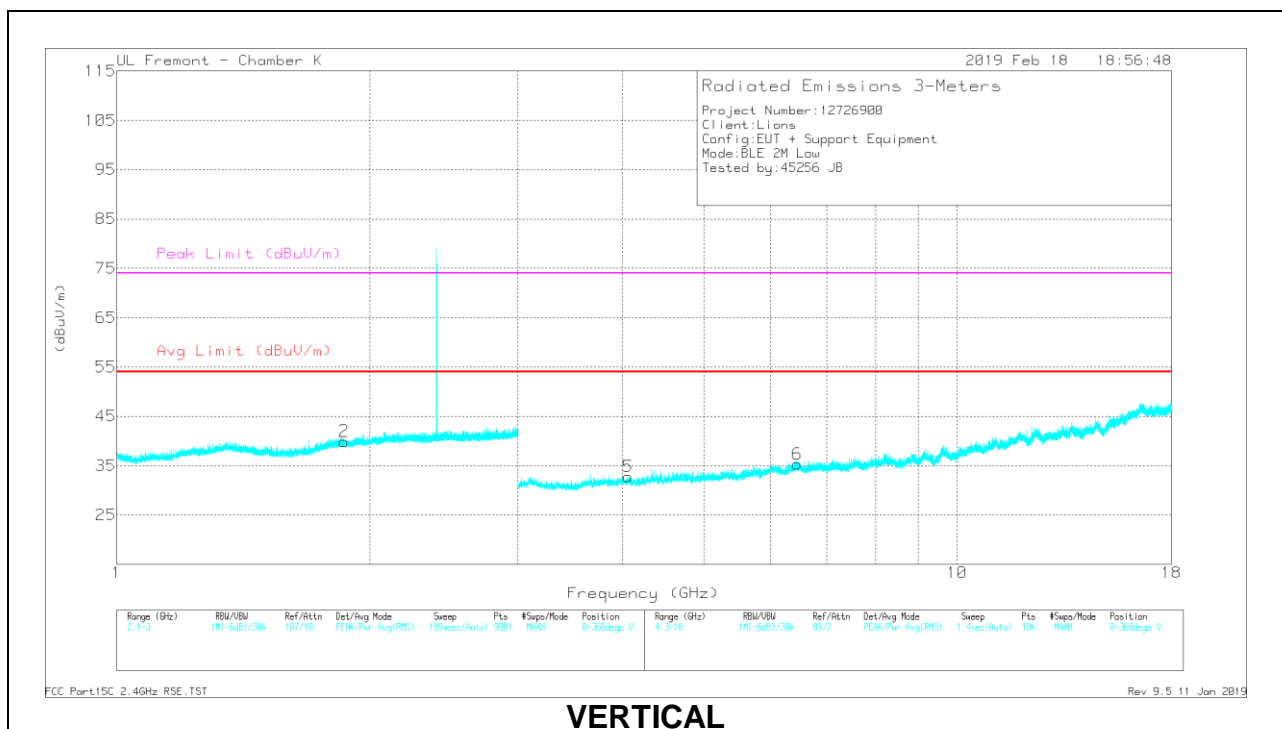
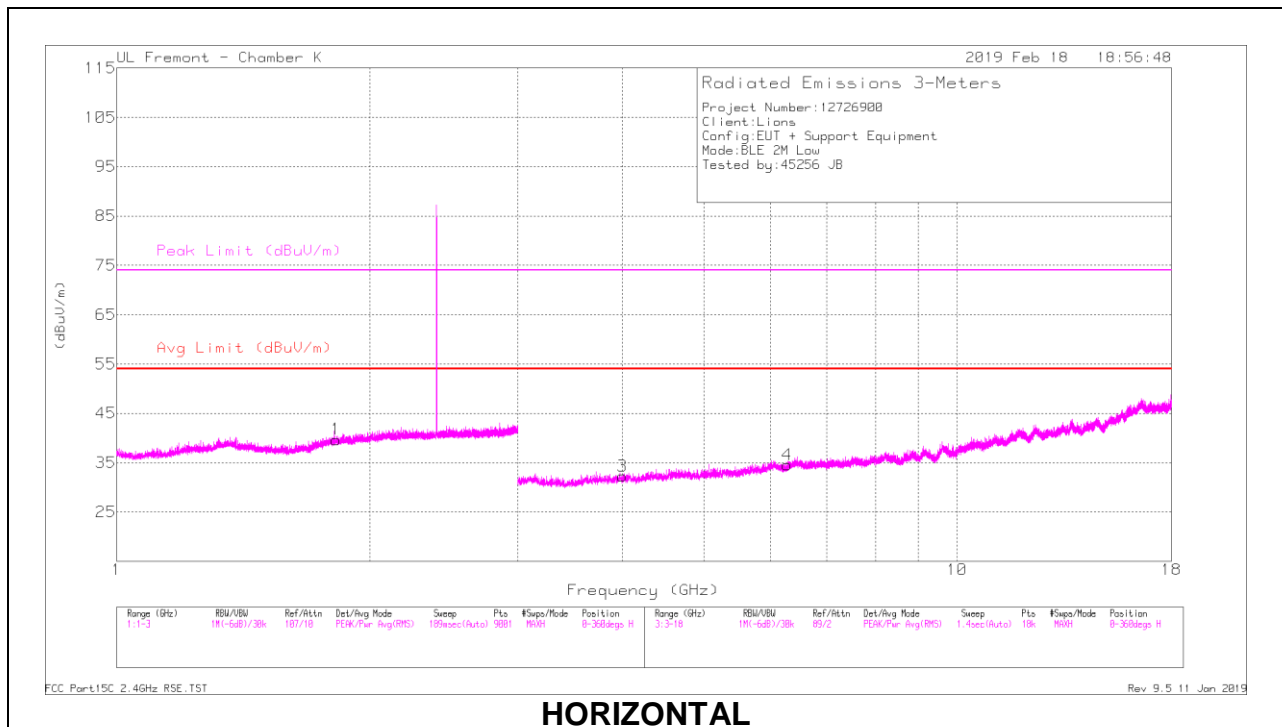



**RADIATED EMISSIONS**

Marker	Frequency (GHz)	Meter Reading (dBuV)	Det	AF T344 (dB/m)	Amp/Cb/Filtr/Pad (dB)	DC Corr (dB)	Corrected Reading (dBuV/m)	Avg Limit (dBuV/m)	Margin (dB)	Peak Limit (dBuV/m)	PK Margin (dB)	Azimuth (Degs)	Height (cm)	Polarity
1	1.825	33.6	Pk	30.3	-24.2	0	39.7	-	-	-	-	0-360	100	H
2	1.866	33.65	Pk	30.4	-24.1	0	39.95	-	-	-	-	0-360	200	V
3	* 3.999	36.99	PK2	33.4	-31.4	0	38.99	-	-	74	-35.01	219	358	H
	* 3.999	28.02	MAv1	33.4	-31.4	4.74	34.76	54	-19.24	-	-	219	358	H
4	6.283	27.11	Pk	35.4	-27.9	0	34.61	-	-	-	-	0-360	200	H
5	* 4.063	38.2	PK2	33.5	-30.8	0	40.9	-	-	74	-33.1	331	276	V
	* 4.061	28.11	MAv1	33.5	-30.8	4.74	35.55	54	-18.45	-	-	331	276	V
6	6.458	26.27	Pk	35.4	-26.4	0	35.27	-	-	-	-	0-360	100	V

\* - indicates frequency in CFR47 Pt 15 / IC RSS-Restricted Band

Pk - Peak detector

PK2 - KDB558074 Method: Maximum Peak

MAv1 - KDB558074 Option 1 Maximum RMS Average

### MID CHANNEL RESULTS

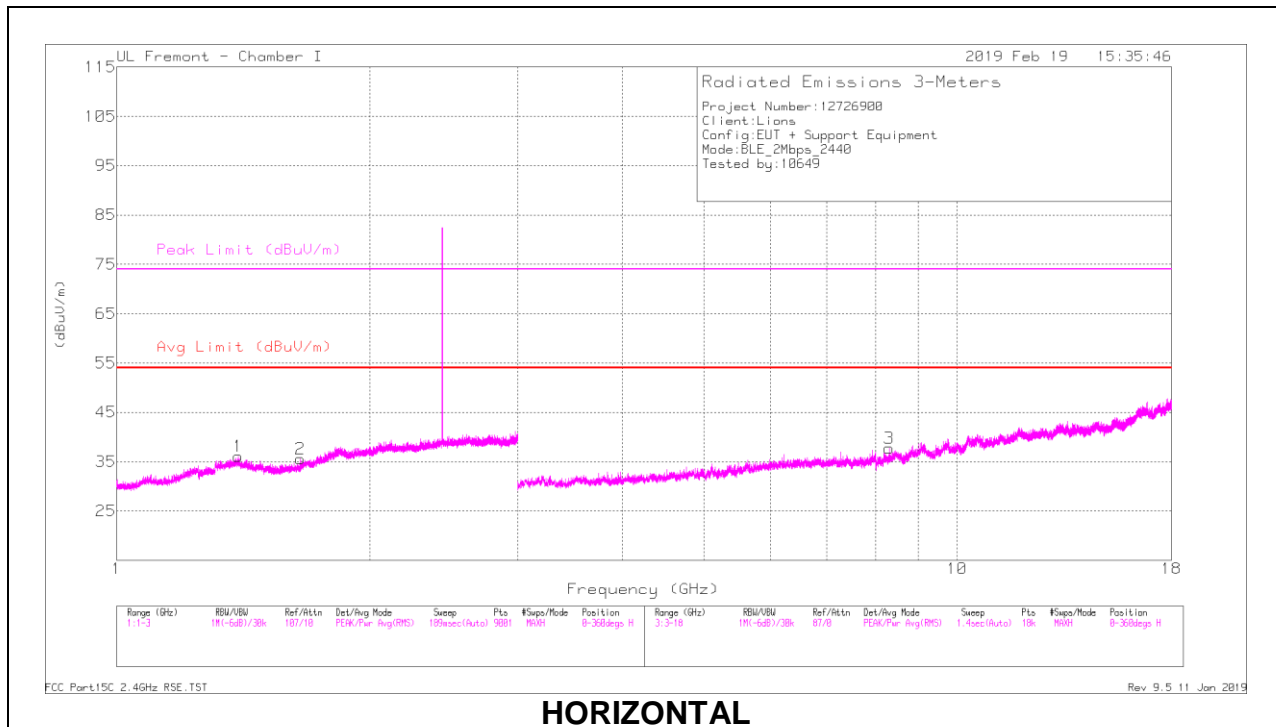

**HORIZONTAL**

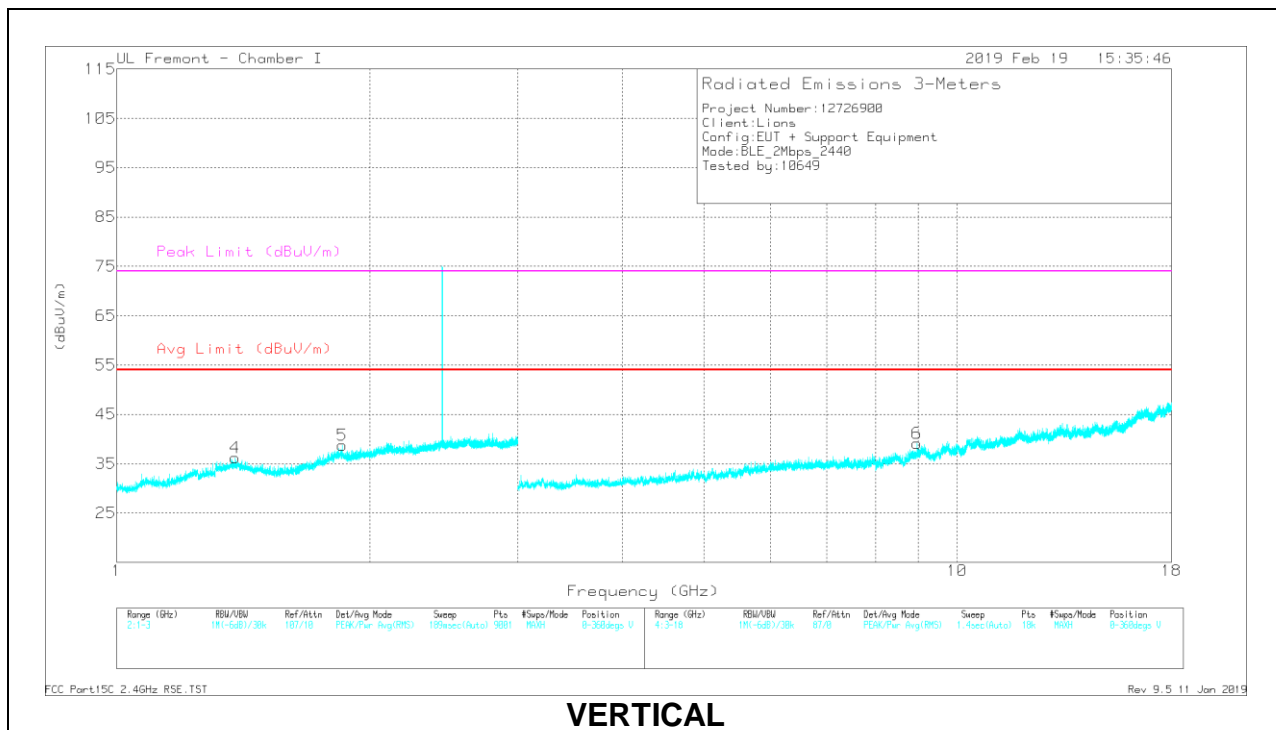

**VERTICAL**

**RADIATED EMISSIONS**

Marker	Frequency (GHz)	Meter Reading (dBuV)	Det	AF T862 (dB/m)	Amp/Cb/Filtr/Pad (dB)	DC Corr (dB)	Corrected Reading (dBuV/m)	Avg Limit (dBuV/m)	Margin (dB)	Peak Limit (dBuV/m)	PK Margin (dB)	Azimuth (Degs)	Height (cm)	Polarity
1	* 1.395	33.19	PK2	29.1	-21.1	0	41.19	-	-	74	-32.81	174	163	H
	* 1.394	24.74	MAv1	29.1	-21.1	4.74	37.48	54	-16.52	-	-	174	163	H
2	1.653	31.67	PK2	28.5	-20.1	0	40.07	-	-	-	-	139	185	H
4	* 1.383	33.92	PK2	29.4	-21.2	0	42.12	-	-	74	-31.88	181	296	V
	* 1.382	24.57	MAv1	29.4	-21.3	4.74	37.41	54	-16.59	-	-	181	296	V
5	1.856	32.35	PK2	30.8	-19.5	0	43.65	-	-	-	-	221	247	V
3	* 8.301	30.76	PK2	35.7	-24	0	42.46	-	-	74	-31.54	162	298	H
	* 8.305	22.45	MAv1	35.7	-24	4.74	38.89	54	-15.11	-	-	162	298	H
6	8.959	31.75	PK2	36.2	-23.6	0	44.35	-	-	-	-	310	288	V

\* - indicates frequency in CFR47 Pt 15 / IC RSS-Restricted Band

PK2 - KDB558074 Method: Maximum Peak

MAv1 - KDB558074 Option 1 Maximum RMS Average

### HIGH CHANNEL RESULTS

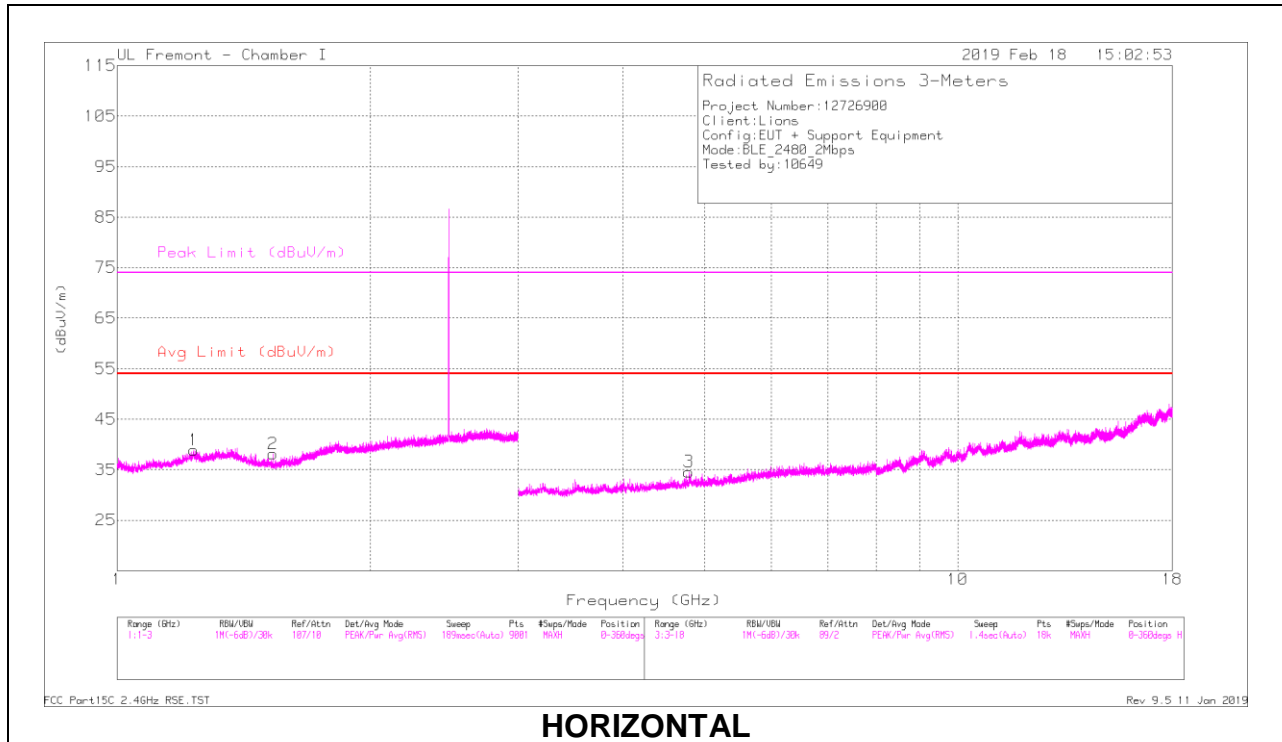

### HORIZONTAL

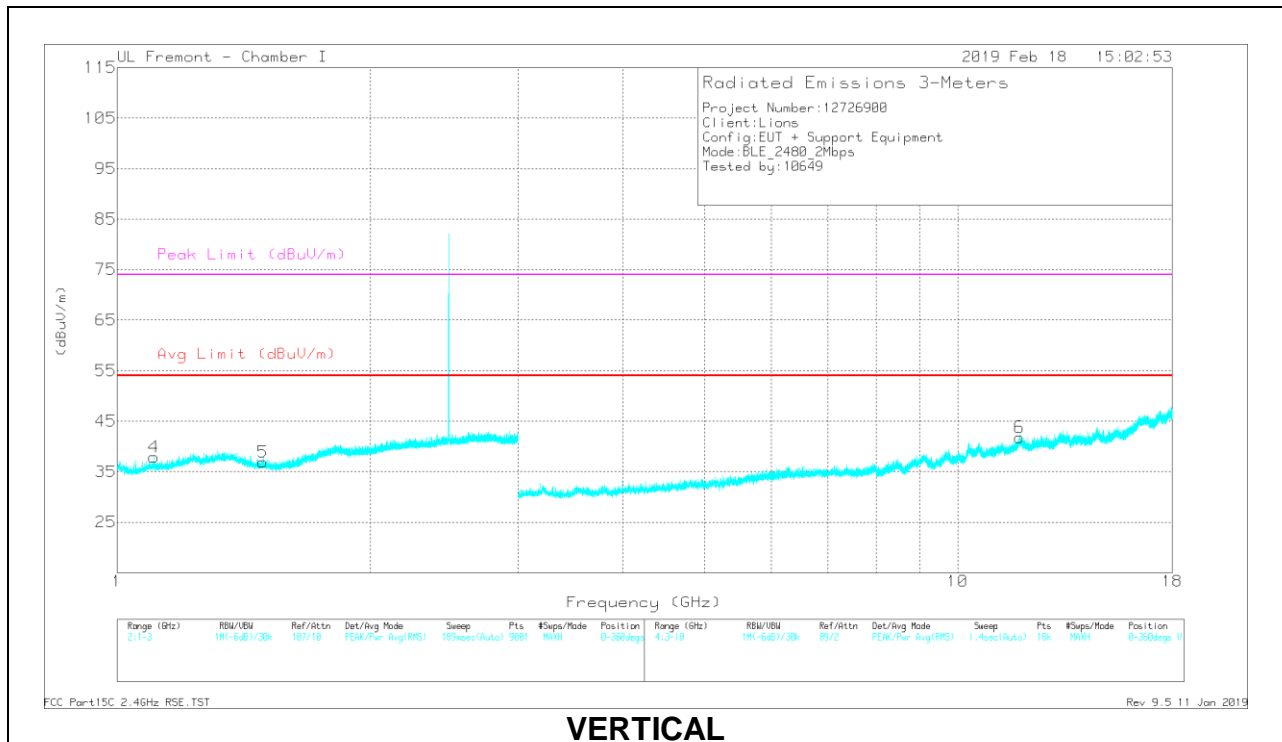

### VERTICAL

**RADIATED EMISSIONS**

Marker	Frequency (GHz)	Meter Reading (dBuV)	Det	AF T862 (dB/m)	Amp/Cb/Filtr/Pad (dB)	DC Corr (dB)	Corrected Reading (dBuV/m)	Avg Limit (dBuV/m)	Margin (dB)	Peak Limit (dBuV/m)	PK Margin (dB)	Azimuth (Degs)	Height (cm)	Polarity
1	* 1.234	38.99	PK2	29	-22.9	0	45.09	-	-	74	-28.91	37	149	H
	* 1.234	29.36	MAv1	29	-22.9	4.74	40.2	54	-13.8	-	-	37	149	H
2	* 1.534	39.96	PK2	27.8	-23.4	0	44.36	-	-	74	-29.64	129	244	H
	* 1.53	29.78	MAv1	27.8	-23.4	4.74	38.92	54	-15.08	-	-	129	244	H
4	* 1.11	38.64	PK2	27.7	-23.6	0	42.74	-	-	74	-31.26	233	298	V
	* 1.102	30.62	MAv1	27.6	-23.7	4.74	39.26	54	-14.74	-	-	233	298	V
5	* 1.491	38.43	PK2	28.2	-23.4	0	43.23	-	-	74	-30.77	108	156	V
	* 1.49	30.17	MAv1	28.2	-23.4	4.74	39.71	54	-14.29	-	-	108	156	V
3	* 4.785	33.81	PK2	34.1	-28.1	0	39.81	-	-	74	-34.19	323	133	H
	* 4.785	24.92	MAv1	34.1	-28.1	4.74	35.66	54	-18.34	-	-	323	133	H
6	* 11.848	31.21	PK2	38.6	-20.8	0	49.01	-	-	74	-24.99	187	288	V
	* 11.845	21.34	MAv1	38.6	-20.8	4.74	43.88	54	-10.12	-	-	187	288	V

\* - indicates frequency in CFR47 Pt 15 / IC RSS-Restricted Band

PK2 - KDB558074 Method: Maximum Peak

MAv1 - KDB558074 Option 1 Maximum RMS Average

### 10.3. WORST CASE BELOW 30MHz

#### SPURIOUS EMISSIONS BELOW 30 MHz (WORST-CASE CONFIGURATION)

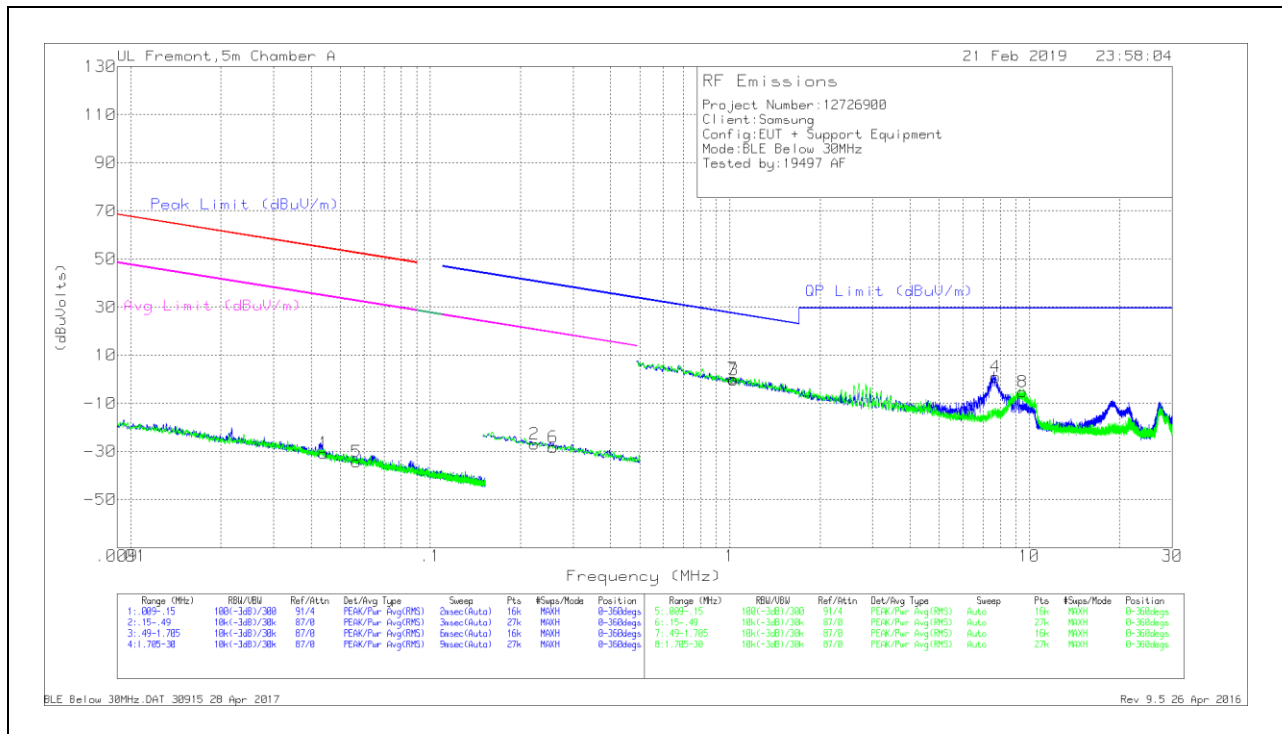

#### Below 30MHz Data

Marker	Frequency (MHz)	Meter Reading (dBuV)	Det	Loop Antenna (dBm)	Cables (dB)	Dist Corr 300m	Corrected Reading (dBuVolts)	Peak Limit (dBuV/m)	Margin (dB)	Avg Limit (dBuV/m)	Margin (dB)	Peak Limit (dBuV/m)	Margin (dB)	Avg Limit (dBuV/m)	Margin (dB)	Azimuth (Degs)
1	.04409	35.95	Pk	13.3	0	-80	-30.75	54.7	-85.45	34.7	-65.45	-	-	-	-	0-360
5	.05677	33.06	Pk	12.6	0	-80	-34.34	52.5	-86.84	32.5	-66.84	-	-	-	-	0-360
2	.22266	41.86	Pk	11.1	.1	-80	-26.94	-	-	-	-	40.66	-67.6	20.66	-47.6	0-360
6	.25739	40.6	Pk	11	.1	-80	-28.3	-	-	-	-	39.4	-67.7	19.4	-47.7	0-360

#### Pk - Peak detector

Marker	Frequency (MHz)	Meter Reading (dBuV)	Det	Loop Antenna (dBm)	Cables (dB)	Dist Corr 30m	Corrected Reading (dBuVolts)	QP Limit (dBuV/m)	Margin (dB)	Peak Limit (dBuV/m)	Margin (dB)	Avg Limit (dBuV/m)	Margin (dB)	Azimuth (Degs)
7	1.02398	28.86	Pk	11.3	.1	-40	.26	27.42	-27.16	-	-	-	-	0-360
3	1.02968	28.32	Pk	11.3	.1	-40	-.28	27.37	-27.65	-	-	-	-	0-360
4	7.71423	29.62	Pk	10.9	.4	-40	.92	29.5	-28.58	-	-	-	-	0-360
8	9.50107	23.54	Pk	10.8	.4	-40	-5.26	29.5	-34.76	-	-	-	-	0-360

#### Pk - Peak detector

### 10.4. WORST CASE BELOW 1 GHz

#### SPURIOUS EMISSIONS 30 TO 1000 MHz (WORST-CASE CONFIGURATION)

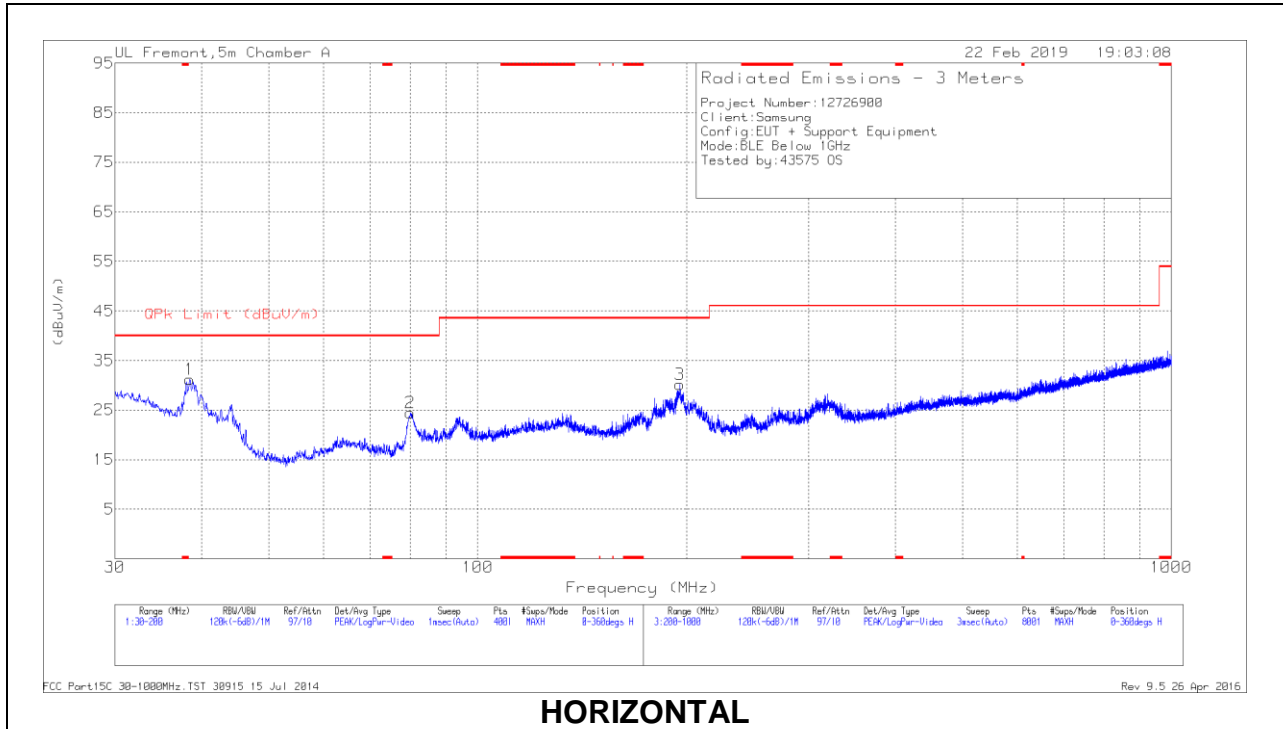

**HORIZONTAL**

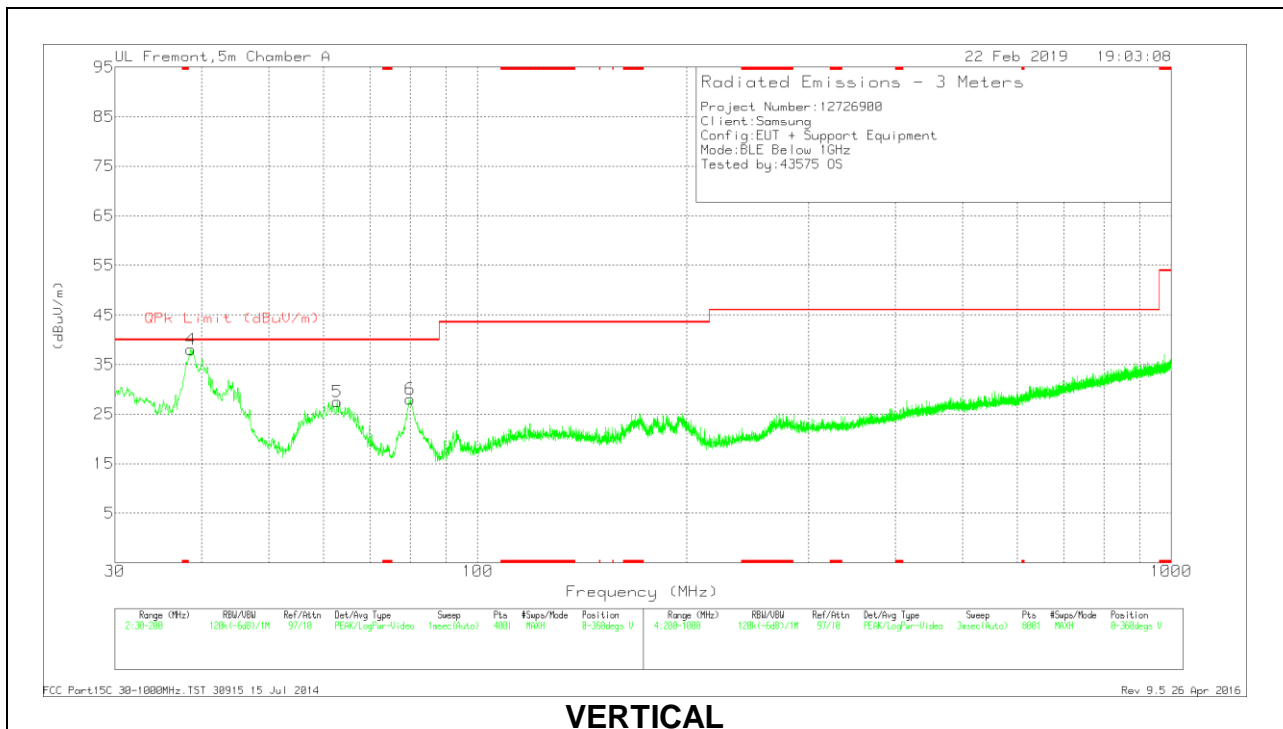

**VERTICAL**

**Below 1GHz Data**

Marker	Frequency (MHz)	Meter Reading (dBuV)	Det	AF PRE0181574 (dB/m)	Amp/Cbl (dB/m)	Corrected Reading (dBuV/m)	QPk Limit (dBuV/m)	Margin (dB)	Azimuth (Degs)	Height (cm)	Polarity
1	38.4575	37.53	Pk	20.7	-27.1	31.13	40	-8.87	0-360	200	H
4	38.4602	43.64	Pk	20.7	-27.1	37.24	40	-2.76	4	125	V
	38.4602	39.41	Qp	20.7	-27.1	33.01	40	-6.99	4	125	V
5	62.7675	40.55	Pk	13.7	-26.8	27.45	40	-12.55	0-360	100	V
2	79.98	37.59	Pk	13.4	-26.5	24.49	40	-15.51	0-360	200	H
6	80.0225	41.15	Pk	13.4	-26.5	28.05	40	-11.95	0-360	100	V
3	195.58	37.37	Pk	18	-25.2	30.17	43.52	-13.35	0-360	200	H

Pk - Peak detector

Qp - Quasi-Peak detector



### 10.5. WORST CASE 18-26 GHz

#### SPURIOUS EMISSIONS 18-26 GHz (WORST-CASE CONFIGURATION)

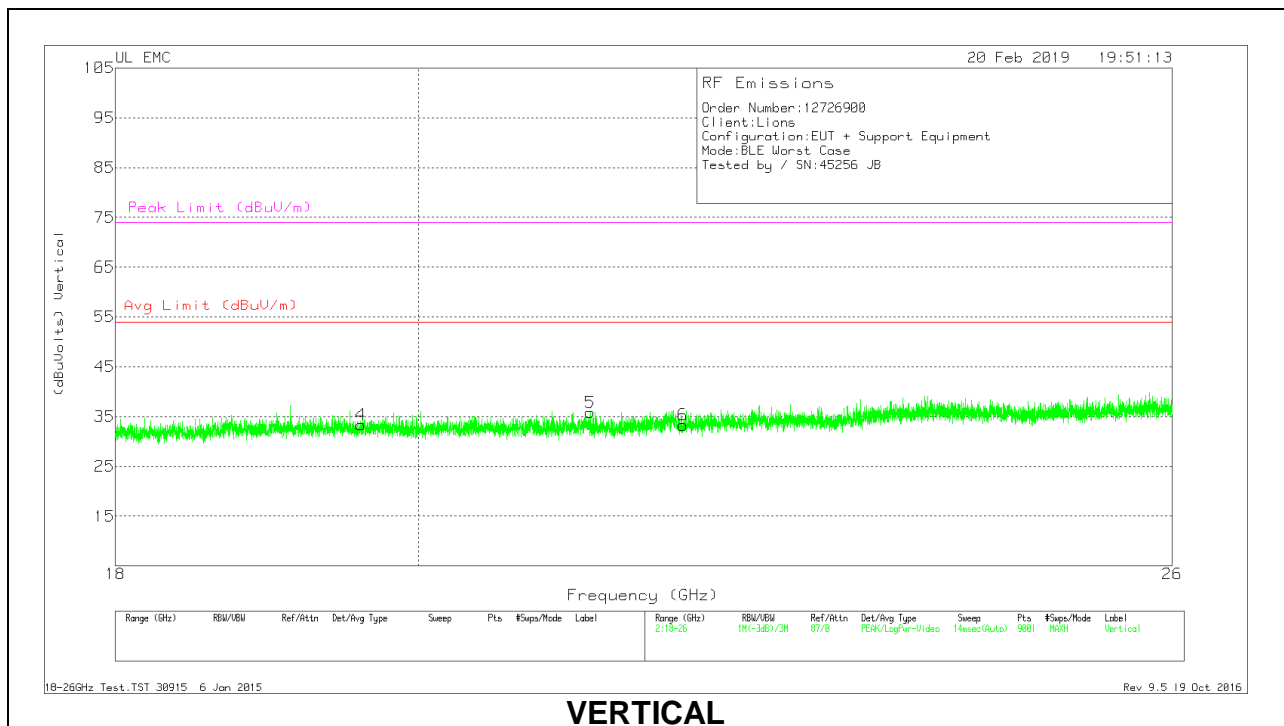
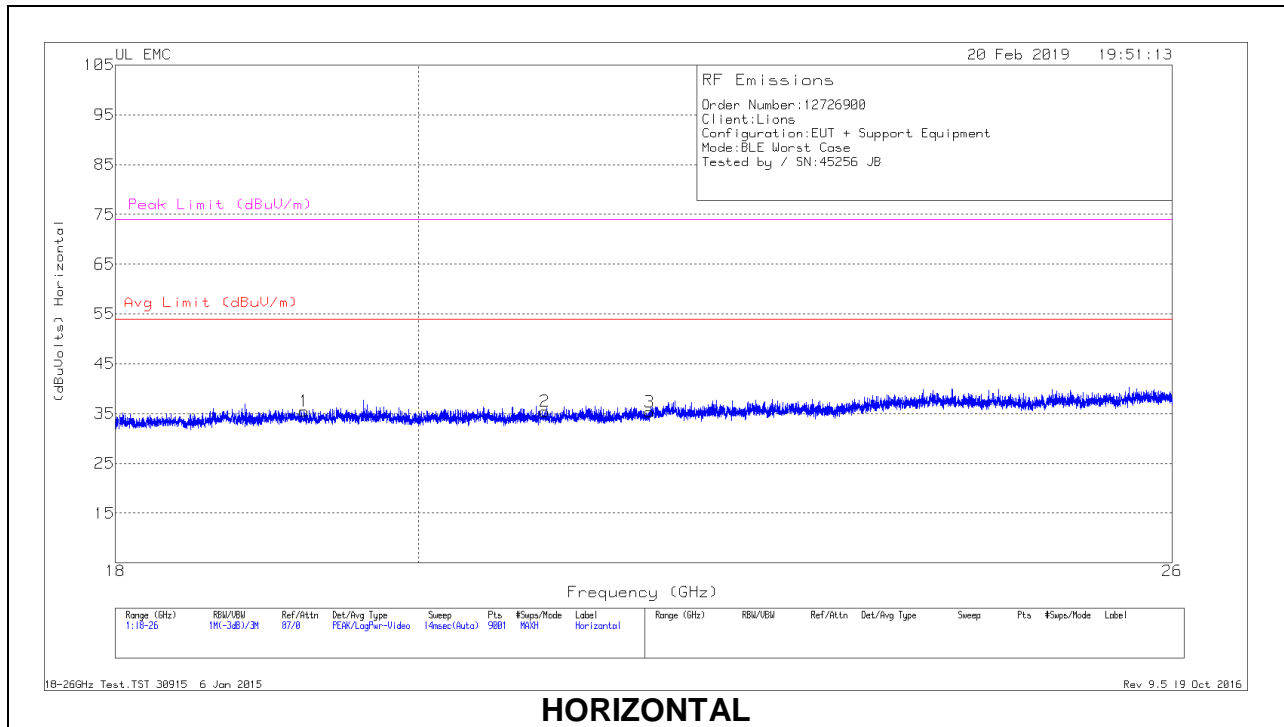

**18 – 26GHz DATA**

Marker	Frequency (GHz)	Meter Reading (dBuV)	Det	T447 AF (dB/m)	Amp/Cbl (dB)	Dist Corr (dB)	Corrected Reading (dBuVolts)	Avg Limit (dBuV/m)	Margin (dB)	Peak Limit (dBuV/m)	PK Margin (dB)
1	19.22	37.08	Pk	32.7	-24.8	-9.5	35.48	54	-18.52	74	-38.52
2	20.9	37.01	Pk	33.1	-25.2	-9.5	35.41	54	-18.59	74	-38.59
3	21.676	36.7	Pk	33.1	-25	-9.5	35.3	54	-18.7	74	-38.7
4	19.606	35.16	Pk	32.8	-25.1	-9.5	33.36	54	-20.64	74	-40.64
5	21.233	37.52	Pk	33	-25.2	-9.5	35.82	54	-18.18	74	-38.18
6	21.93	34.99	Pk	33.2	-25.4	-9.5	33.29	54	-20.71	74	-40.71

Pk - Peak detector

---

## 11. AC POWER LINE CONDUCTED EMISSIONS

### LIMITS

FCC §15.207 (a)

Frequency of Emission (MHz)	Conducted Limit (dBuV)	
	Quasi-peak	Average
0.15-0.5	66 to 56*	56 to 46*
0.5-5	56	46
5-30	60	50

\*Decreases with the logarithm of the frequency.

### RESULTS

AC Power Line Norm

LINE 1 RESULTS

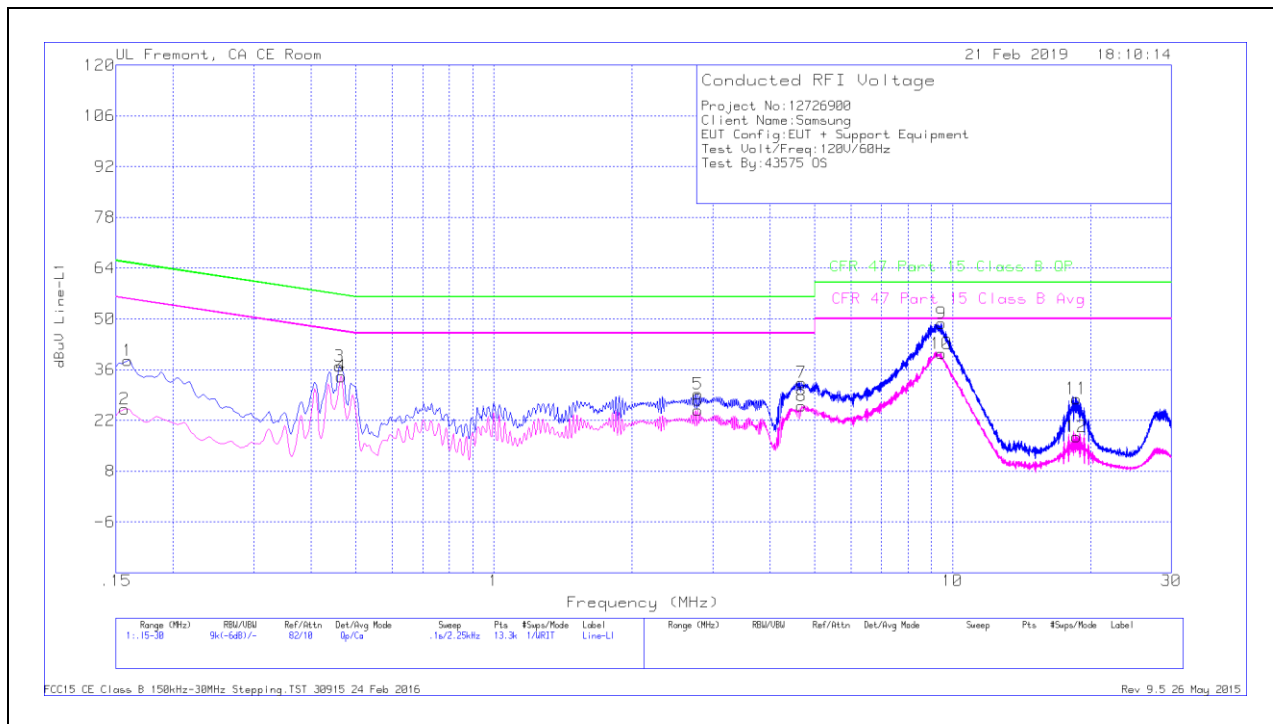

Trace Markers

Range 1: Line-L1 .15 - 30MHz											
Marker	Frequency (MHz)	Meter Reading (dBuV)	Det	LISN L1	LC Cables C1&C3	Limiter (dB)	Corrected Reading dBuV	CFR 47 Part 15 Class B QP	QP Margin (dB)	CFR 47 Part 15 Class B Avg	Av(CISPR) Margin (dB)
1	.159	28.37	Qp	.1	0	10.1	38.57	65.52	-26.95	-	-
2	.15675	14.97	Ca	.1	0	10.1	25.17	-	-	55.63	-30.46
3	.4605	26.83	Qp	0	0	10.1	36.93	56.68	-19.75	-	-
4	.465	24	Ca	0	0	10.1	34.1	-	-	46.6	-12.5
5	2.787	19.05	Qp	0	.1	10.1	29.25	56	-26.75	-	-
6	2.78475	14.65	Ca	0	.1	10.1	24.85	-	-	46	-21.15
7	4.6815	22.25	Qp	0	.1	10.1	32.45	56	-23.55	-	-
8	4.68375	15.75	Ca	0	.1	10.1	25.95	-	-	46	-20.05
9	9.4515	38.45	Qp	0	.2	10.2	48.85	60	-11.15	-	-
10	9.45375	29.98	Ca	0	.2	10.2	40.38	-	-	50	-9.62
11	18.60675	17.31	Qp	.1	.3	10.3	28.01	60	-31.99	-	-
12	18.60675	6.8	Ca	.1	.3	10.3	17.5	-	-	50	-32.5

Qp - Quasi-Peak detector

Ca - CISPR average detection

**LINE 2 RESULTS**

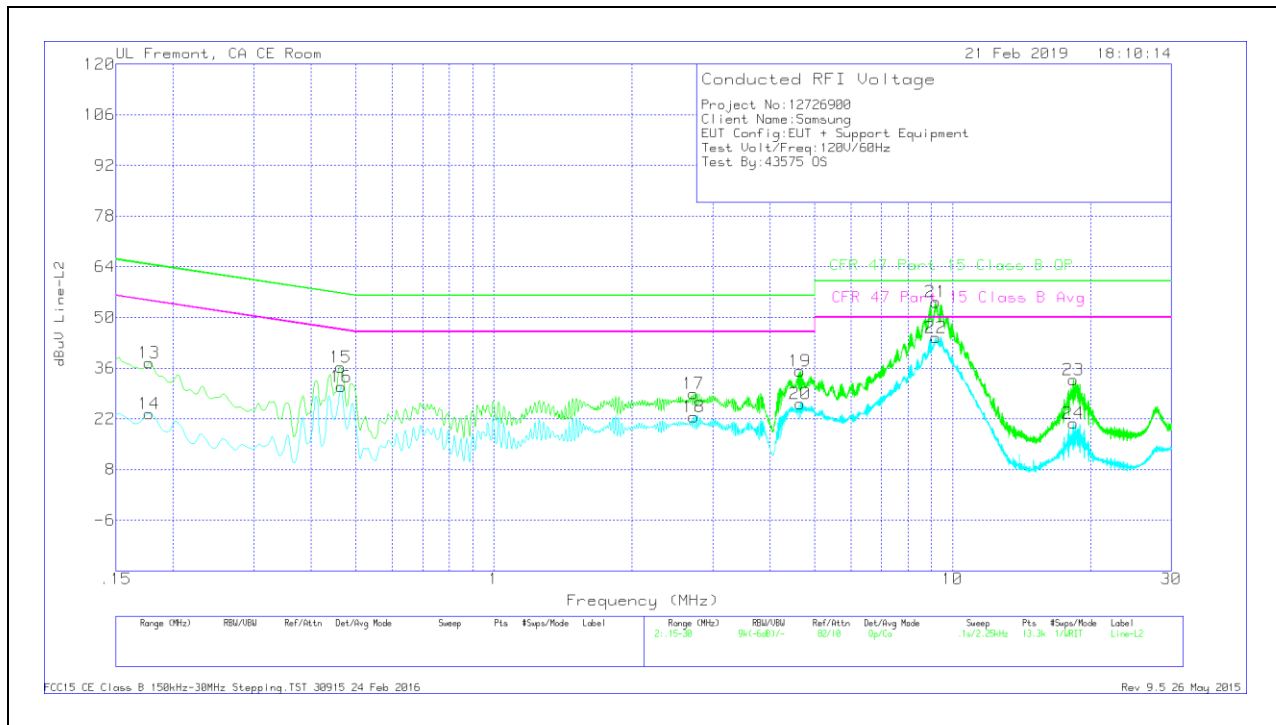

**Trace Markers**

Range 2: Line-L2 .15 - 30MHz											
Marker	Frequency (MHz)	Meter Reading (dBuV)	Det	LISN L2	LC Cables C2&C3	Limiter (dB)	Corrected Reading dBuV	CFR 47 Part 15 Class B QP	QP Margin (dB)	CFR 47 Part 15 Class B Avg	Av(CISPR) Margin (dB)
13	.177	27.39	Qp	0	0	10.1	37.49	64.63	-27.14	-	-
14	.177	13.3	Ca	0	0	10.1	23.4	-	-	54.63	-31.23
15	.46275	26.09	Qp	0	0	10.1	36.19	56.64	-20.45	-	-
16	.465	20.75	Ca	0	0	10.1	30.85	-	-	46.6	-15.75
17	2.72625	18.72	Qp	0	.1	10.1	28.92	56	-27.08	-	-
18	2.7285	12.3	Ca	0	.1	10.1	22.5	-	-	46	-23.5
19	4.64775	24.99	Qp	0	.1	10.1	35.19	56	-20.81	-	-
20	4.65	16.02	Ca	0	.1	10.1	26.22	-	-	46	-19.78
21	9.19725	43.86	Qp	0	.2	10.2	54.26	60	-5.74	-	-
22	9.19725	34.08	Ca	0	.2	10.2	44.48	-	-	50	-5.52
23	18.34125	22.03	Qp	.1	.3	10.3	32.73	60	-27.27	-	-
24	18.3435	10.03	Ca	.1	.3	10.3	20.73	-	-	50	-29.27

Qp - Quasi-Peak detector  
 Ca - CISPR average detection