



CERTIFICATION TEST REPORT

Report Number. : 12810836-E2V2

Applicant : Samsung Electronics Co., Ltd.
129 Samsung-Ro, Yeongtong-Gu,
Suwon-Si, Gyeonggi-Do, 16677, Korea

Model : SM-A705YN

FCC ID : A3LSMA705YN

EUT Description : GSM/WCDMA/LTE Phone with BT, DTS/UNII a/b/g/n/ac, ANT+ and NFC

Test Standard(s) : FCC 47 CFR PART 15 SUBPART C

Date Of Issue:

April 29, 2019

Prepared by:

UL Verification Services Inc.
47173 Benicia Street
Fremont, CA 94538 U.S.A.
TEL: (510) 319-4000
FAX: (510) 661-0888



NVLAP Lab code: 200065-0

REPORT REVISION HISTORY

Rev.	Issue Date	Revisions	Revised By
V1	4/22/2019	Initial Issue	
V2	4/29/2019	Updated Section 3, 6.1 & 12.1	K.Kedida

TABLE OF CONTENTS

REPORT REVISION HISTORY	2
TABLE OF CONTENTS	3
1. ATTESTATION OF TEST RESULTS	5
2. INTRODUCTION OF TEST DATA REUSE.....	6
2.1. INTRODUCTION	6
2.2. DIFFERENCES.....	6
2.3. SPOT CHECK VERIFICATION RESULTS SUMMARY.....	6
2.4. REFERENCE DETAIL	11
3. TEST METHODOLOGY	12
4. FACILITIES AND ACCREDITATION	12
5. CALIBRATION AND UNCERTAINTY	13
5.1. MEASURING INSTRUMENT CALIBRATION	13
5.2. SAMPLE CALCULATION	13
5.3. MEASUREMENT UNCERTAINTY.....	13
6. EQUIPMENT UNDER TEST.....	14
6.1. EUT DESCRIPTION	14
6.2. MAXIMUM OUTPUT POWER.....	14
6.3. DESCRIPTION OF AVAILABLE ANTENNAS	14
6.4. SOFTWARE AND FIRMWARE.....	14
6.5. WORST-CASE CONFIGURATION AND MODE.....	14
6.6. DESCRIPTION OF TEST SETUP.....	15
7. TEST AND MEASUREMENT EQUIPMENT	18
8. MEASUREMENT METHODS	19
9. ANTENNA PORT TEST RESULTS.....	20
9.1. ON TIME AND DUTY CYCLE.....	20
9.2. 20 dB AND 99% BANDWIDTH	22
9.2.1. BLUETOOTH BASIC DATA RATE GFSK MODULATION	23
9.2.2. BLUETOOTH ENHANCED DATA RATE 8PSK MODULATION.....	24
9.3. HOPPING FREQUENCY SEPARATION.....	25
9.3.1. BLUETOOTH BASIC DATA RATE GFSK MODULATION	26
9.3.2. BLUETOOTH ENHANCED DATA RATE 8PSK MODULATION.....	26
9.4. NUMBER OF HOPPING CHANNELS.....	27
9.4.1. BLUETOOTH BASIC DATA RATE GFSK MODULATION	28

9.4.2.	BLUETOOTH ENHANCED DATA RATE 8PSK MODULATION.....	30
9.5.	AVERAGE TIME OF OCCUPANCY.....	32
9.5.1.	BLUETOOTH BASIC DATA RATE GFSK MODULATION	33
9.5.2.	BLUETOOTH ENHANCED DATA RATE 8PSK MODULATION.....	35
9.6.	OUTPUT POWER.....	37
9.6.1.	BLUETOOTH BASIC DATA RATE GFSK MODULATION	38
9.6.2.	BLUETOOTH ENHANCED DATA RATE DQPSK MODULATION	38
9.6.3.	BLUETOOTH ENHANCED DATA RATE 8PSK MODULATION.....	38
9.7.	AVERAGE POWER.....	39
9.7.1.	BLUETOOTH BASIC DATA RATE GFSK MODULATION	40
9.7.2.	BLUETOOTH ENHANCED DATA RATE DQPSK MODULATION	40
9.7.3.	BLUETOOTH ENHANCED DATA RATE 8PSK MODULATION.....	40
9.8.	CONDUCTED SPURIOUS EMISSIONS.....	41
9.8.1.	BLUETOOTH BASIC DATA RATE GFSK MODULATION	42
9.8.2.	BLUETOOTH ENHANCED DATA RATE 8PSK MODULATION.....	44
10.	RADIATED TEST RESULTS	46
10.1.	TRANSMITTER ABOVE 1 GHz.....	48
10.1.1.	BLUETOOTH BASIC DATA RATE GFSK MODULATION	48
10.1.2.	BLUETOOTH ENHANCED DATA RATE 8PSK MODULATION	58
10.2.	WORST CASE BELOW 30MHz	68
10.3.	WORST CASE BELOW 1 GHz	69
10.4.	WORST CASE 18-26 GHz.....	71
11.	AC POWER LINE CONDUCTED EMISSIONS	73
12.	SETUP PHOTOS	76
12.1.	SM-A705FN/DS (ORIGINAL)	76
12.2.	SM-A705YN (Spot Check).....	79

1. ATTESTATION OF TEST RESULTS

COMPANY NAME: Samsung Electronics Co., Ltd.
129 Samsung-Ro, Yeongtong-Gu,
Suwon-Si, Gyeonggi-Do, 16677, Korea

EUT DESCRIPTION: GSM/WCDMA/LTE Phone with BT, DTS/UNII a/b/g/n/ac, ANT+
and NFC

MODEL: SM-A705YN

SERIAL NUMBER: Radiated (Original): R38M10NPF1Y, R38M10CSH8Z
Conducted (Original):R38M10CT1JE
Radiated (Spot Check): R38M4046MZN

DATE TESTED: February 18 – March 05, 2019 (Original)
April 11, 2019 (Spot Check)

APPLICABLE STANDARDS	
STANDARD	TEST RESULTS
CFR 47 Part 15 Subpart C	Complies

UL Verification Services Inc. tested the above equipment in accordance with the requirements set forth in the above standards. The test results show that the equipment tested is capable of demonstrating compliance with the requirements as documented in this report.

The results documented in this report apply only to the tested sample, under the conditions and modes of operation as described herein. It is the manufacturer's responsibility to assure that additional production units of this model are manufactured with identical electrical and mechanical components. All samples tested were in good operating condition throughout the entire test program. Measurement Uncertainties are published for informational purposes only and were not taken into account unless noted otherwise.

This document may not be altered or revised in any way unless done so by UL Verification Services Inc. and all revisions are duly noted in the revisions section. Any alteration of this document not carried out by UL Verification Services Inc. will constitute fraud and shall nullify the document. This report must not be used by the client to claim product certification, approval, or endorsement by NVLAP, NIST, any agency of the Federal Government, or any agency of the U.S. government.

Approved & Released For
UL Verification Services Inc. By:



Dan Corona
Operations Leader
Consumer Technology Division
UL Verification Services Inc.

Reviewed By:



Kiya Kedida
Senior Project Engineer
Consumer Technology Division
UL Verification Services Inc.

2. INTRODUCTION OF TEST DATA REUSE

2.1. INTRODUCTION

According to the manufacturer, FCC ID: A3LSMA705FN and FCC ID: A3LSMA705YN non-licensed radios are electrically identical. The FCC ID: A3LSMA705FN test data shall remain representative of FCC ID: A3LSMA705YN.

The applicant takes full responsibility that the test data as referenced in this section represents compliance for this FCC ID.

2.2. DIFFERENCES

The FCC ID: A3LSMA705FN, shares the same enclosure and circuit board as FCC ID: A3LSMA705YN. The BT antennas and surrounding circuitry and layout are identical between two models.

After confirming through preliminary radiated emissions that the performance of the FCC ID: A3LSMG705FN remains representative of FCC ID: A3LSMA705YN. The test data of FCC ID: A3LSMG705FN being submitted for this application to cover BT features.

2.3. SPOT CHECK VERIFICATION RESULTS SUMMARY

Spot check verification has been done on device A3LSMA705YN for radiated harmonic spurious and radiated band-edge. The data from the application has been verified through appropriate spot checks to demonstrate compliance for this device in accordance to FCC public KDB 484596 D01 as shown in the summary below.

A3LSMA705YN SPOT CHECK RESULTS										
Technology	Mode	Test Item	Channel	Measured Frequency	Original model		Spot check model		Delta (dB)	
					SM-A705FN/DS		SM-A705YN		Peak Ave	
					A3LSMA705FN		A3LSMA705YN			
Peak	Ave	Peak	Ave	Peak	Ave					
BT	GFSK	RBE	78	2497MHz	51.12	36.91	51.57	36.81	0.45	-0.1
	GFSK	RSE	78	4960MHz	48.01	42.69	47.81	43.17	-0.2	0.48

Comparison of the models, upper deviation is within 3dB range and all tests are under FCC Technical Limits.

SPOT CHECK DATA

BANDEDGE (HIGH CHANNEL)

HORIZONTAL RESULT

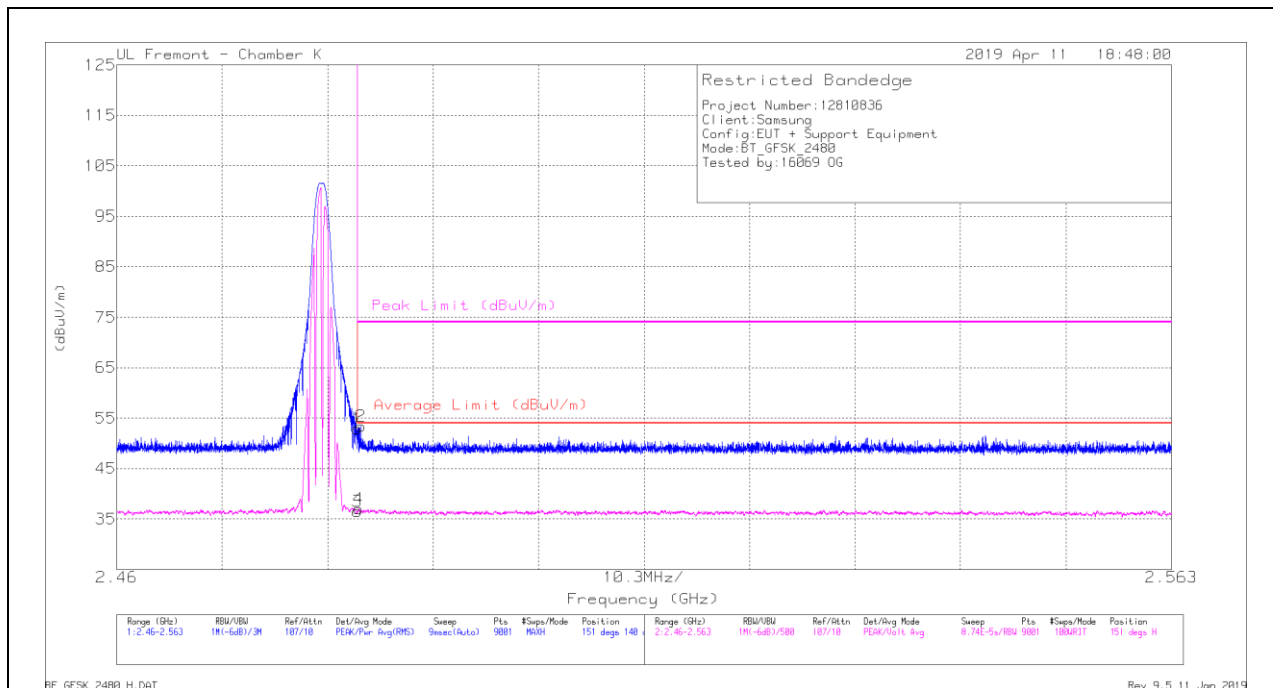

Trace Markers

Marker	Frequency (GHz)	Meter Reading (dBuV)	Det	AF T344 (dB/m)	Amp/Cb/Filtr /Pad (dB)	Corrected Reading (dBuV/m)	Average Limit (dBuV/m)	Margin (dB)	Peak Limit (dBuV/m)	PK Margin (dB)	Azimuth (Degs)	Height (cm)	Polarity
1	* 2.484	45.42	Pk	32.3	-24.8	52.92	-	-	74	-21.08	151	140	H
2	* 2.484	45.88	Pk	32.3	-24.8	53.38	-	-	74	-20.62	151	140	H
3	* 2.484	29.03	VA1T	32.3	-24.8	36.53	54	-17.47	-	-	151	140	H
4	* 2.484	29.53	VA1T	32.3	-24.8	37.03	54	-16.97	-	-	151	140	H

* - indicates frequency in CFR47 Pt 15 / IC RSS-Restricted Band

Pk - Peak detector

VA1T - FHSS: Linear Voltage Average $V_B=1/T_{on}$ where: T_{on} is transmit duration

VERTICAL RESULT

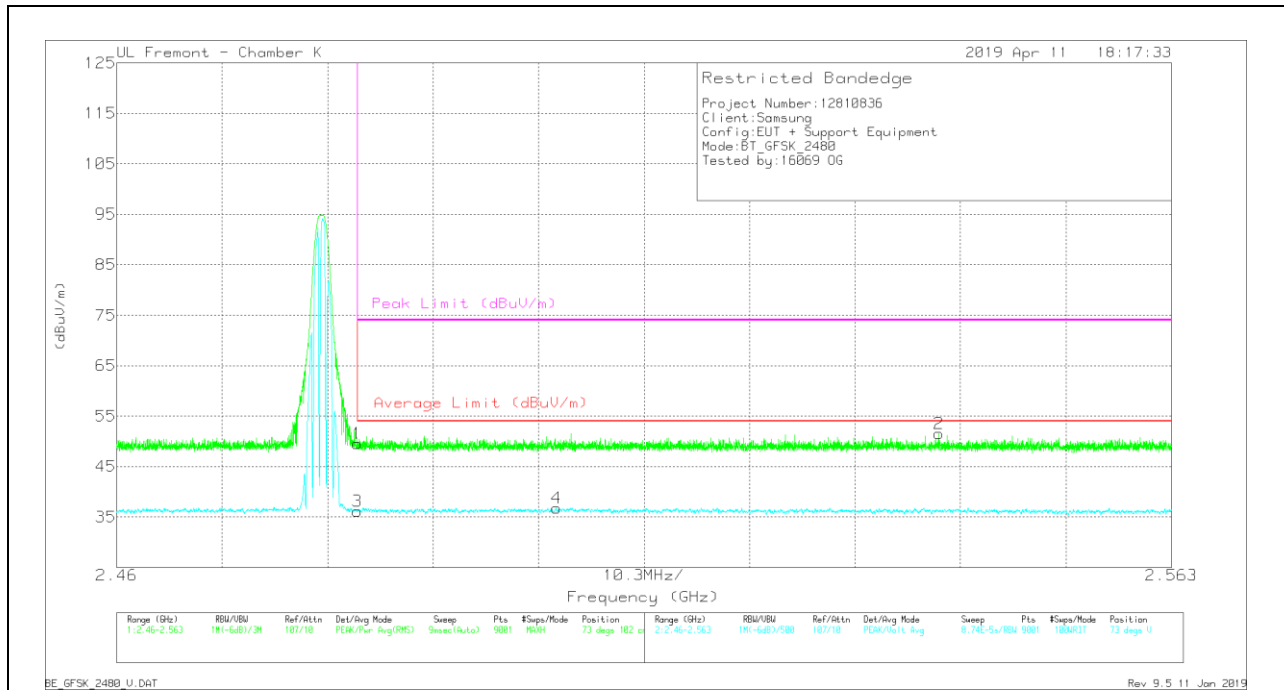

Trace Markers

Marker	Frequency (GHz)	Meter Reading (dBuV)	Det	AF T344 (dB/m)	Amp/Cb/Fitr /Pad (dB)	Corrected Reading (dBuV/m)	Average Limit (dBuV/m)	Margin (dB)	Peak Limit (dBuV/m)	PK Margin (dB)	Azimuth (Degs)	Height (cm)	Polarity
1	* 2.484	42.04	Pk	32.3	-24.8	49.54	-	-	74	-24.46	73	102	V
2	2.54	44.07	Pk	32.3	-24.8	51.57	-	-	74	-22.43	73	102	V
3	* 2.484	28.66	VA1T	32.3	-24.8	36.16	54	-17.84	-	-	73	101	V
4	2.503	29.21	VA1T	32.3	-24.7	36.81	54	-17.19	-	-	73	101	V

* - indicates frequency in CFR47 Pt 15 / IC RSS-Restricted Band

Pk - Peak detector

VA1T - FHSS: Linear Voltage Average $V_B=1/T_{on}$ where: T_{on} is transmit duration

HARMONICS AND SPURIOUS EMISSIONS

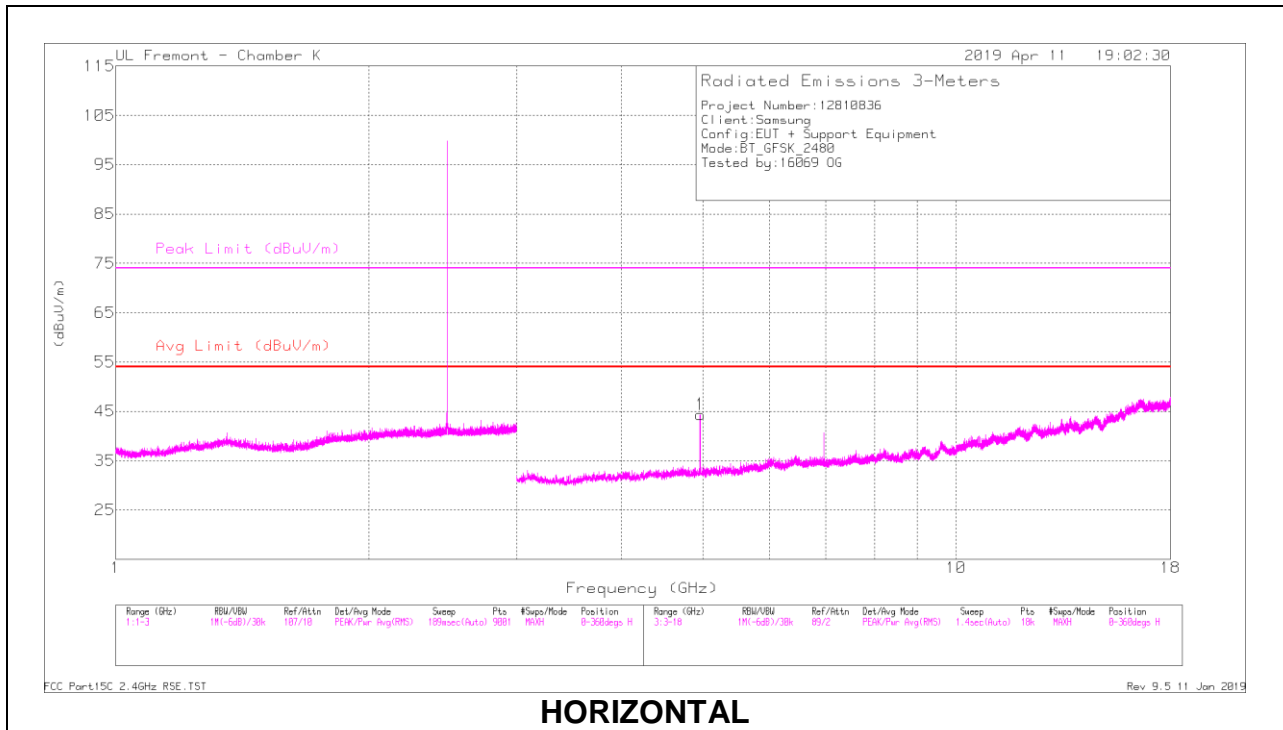

HORIZONTAL

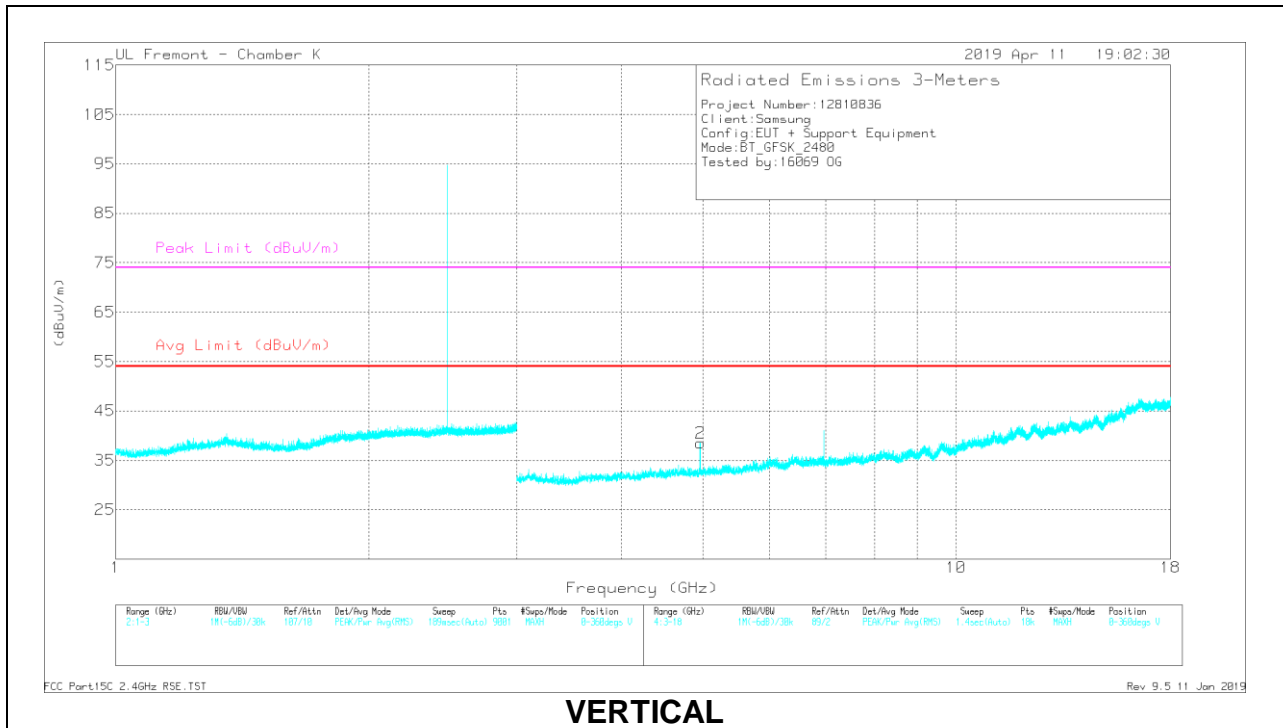

VERTICAL

RADIATED EMISSIONS

Frequency (GHz)	Meter Reading (dBuV)	Det	AF T344 (dB/m)	Amp/Cb/Fit r/Pad (dB)	Corrected Reading (dBuV/m)	Avg Limit (dBuV/m)	Margin (dB)	Peak Limit (dBuV/m)	PK Margin (dB)	Azimuth (Degs)	Height (cm)	Polarity
* 4.96	44.21	PKFH	34.2	-30.6	47.81	-	-	74	-26.19	143	113	H
* 4.96	39.57	VA1T	34.2	-30.6	43.17	54	-10.83	-	-	143	113	H
* 4.96	41.84	PKFH	34.2	-30.6	45.44	-	-	74	-28.56	41	113	V
* 4.96	34.67	VA1T	34.2	-30.6	38.27	54	-15.73	-	-	41	113	V

* - indicates frequency in CFR47 Pt 15 / IC RSS-Restricted Band
 PKFH FHSS/BT RB=100k for Frequencies<1GHz / RB=1MHz for Frequencies>1GHz, VB=3 x RB, Peak
 VA1T - FHSS: Linear Voltage Average VB=1/Ton where: Ton is transmit duration

2.4. REFERENCE DETAIL

Reference application that contains the reused reference data

Equipment Class	Reference FCC ID	Type Grant/ Permissive Change	Reference Application	Folder Test/RF Exposure	Report Title/Section
DSS	A3LSMA705FN	Grant	12726900-E2	Test	FCC Report BT / All sections

3. TEST METHODOLOGY

The tests documented in this report were performed in accordance with FCC CFR 47 Part 2, FCC CFR 47 Part 15, ANSI C63.10-2013, and KDB 558074 D01 15.247 Meas Guidance v05r02.

4. FACILITIES AND ACCREDITATION

The test sites and measurement facilities used to collect data are located at 47173 and 47266 Benicia Street, and 47658 Kato Road, Fremont, California, USA. Line conducted emissions are measured only at the 47173 address. The following table identifies which facilities were utilized for radiated emission measurements documented in this report. Specific facilities are also identified in the test results sections.

47173 Benicia Street	47266 Benicia Street	47658 Kato Rd
<input checked="" type="checkbox"/> Chamber A (ISED:2324B-1)	<input type="checkbox"/> Chamber D (ISED:22541-1)	<input checked="" type="checkbox"/> Chamber I (ISED:2324A-5)
<input type="checkbox"/> Chamber B (ISED:2324B-2)	<input type="checkbox"/> Chamber E (ISED:22541-2)	<input type="checkbox"/> Chamber J (ISED:2324A-6)
<input type="checkbox"/> Chamber C (ISED:2324B-3)	<input type="checkbox"/> Chamber F (ISED:22541-3)	<input checked="" type="checkbox"/> Chamber K (ISED:2324A-1)
	<input type="checkbox"/> Chamber G (ISED:22541-4)	<input type="checkbox"/> Chamber L (ISED:2324A-3)
	<input type="checkbox"/> Chamber H (ISED:22541-5)	

The above test sites and facilities are covered under FCC Test Firm Registration # 208313. Chambers above are covered under Industry Canada company address and respective code

UL Verification Services Inc. is accredited by NVLAP, Laboratory Code 200065-0

5. CALIBRATION AND UNCERTAINTY

5.1. MEASURING INSTRUMENT CALIBRATION

The measuring equipment utilized to perform the tests documented in this report has been calibrated in accordance with the manufacturer's recommendations, and is traceable to recognized national standards.

5.2. SAMPLE CALCULATION

RADIATED EMISSIONS

Where relevant, the following sample calculation is provided:

$$\text{Field Strength (dBuV/m)} = \text{Measured Voltage (dBuV)} + \text{Antenna Factor (dB/m)} + \text{Cable Loss (dB)} - \text{Preamp Gain (dB)}$$
$$36.5 \text{ dBuV} + 18.7 \text{ dB/m} + 0.6 \text{ dB} - 26.9 \text{ dB} = 28.9 \text{ dBuV/m}$$

MAINS CONDUCTED EMISSIONS

Where relevant, the following sample calculation is provided:

$$\text{Final Voltage (dBuV)} = \text{Measured Voltage (dBuV)} + \text{Cable Loss (dB)} + \text{Limiter Factor (dB)} + \text{LISN Insertion Loss.}$$
$$36.5 \text{ dBuV} + 0 \text{ dB} + 10.1 \text{ dB} + 0 \text{ dB} = 46.6 \text{ dBuV}$$

5.3. MEASUREMENT UNCERTAINTY

Where relevant, the following measurement uncertainty levels have been estimated for tests performed on the apparatus:

PARAMETER	UNCERTAINTY
Worst Case Conducted Disturbance, 9KHz to 0.15 MHz	3.84 dB
Worst Case Conducted Disturbance, 0.15 to 30 MHz	3.65 dB
Worst Case Radiated Disturbance, 9KHz to 30 MHz	2.52 dB
Worst Case Radiated Disturbance, 30 to 1000 MHz	4.88 dB
Worst Case Radiated Disturbance, 1000 to 18000 MHz	4.24 dB
Worst Case Radiated Disturbance, 18000 to 26000 MHz	4.37 dB
Worst Case Radiated Disturbance, 26000 to 40000 MHz	5.17 dB

Uncertainty figures are valid to a confidence level of 95%.

6. EQUIPMENT UNDER TEST

6.1. EUT DESCRIPTION

The EUT is a GSM/WCDMA/LTE Phone with BT, DTS/UNII a/b/g/n/ac, ANT+ and NFC. The model SM-A705FN/DS was used for final testing and is representative of the test results in this report. The test report addresses the BT operational mode.

6.2. MAXIMUM OUTPUT POWER

The transmitter has a maximum peak conducted output power as follows:

Frequency Range (MHz)	Mode	Output Power (dBm)	Output Power (mW)
2402 - 2480	Basic GFSK	9.73	9.40
2402 - 2480	Enhanced DQPSK	7.79	6.01
2402 - 2480	Enhanced 8PSK	9.32	8.55

Note: GFSK, DQPSK, 8PSK average Power are all investigated, The GFSK & 8PSK Power are the worst case. Testing is based on these modes to showing compliance. For average power data please refer to section 9.7.

6.3. DESCRIPTION OF AVAILABLE ANTENNAS

The radio utilizes an FPCB antenna, with a maximum gain of -4.88 dBi.

6.4. SOFTWARE AND FIRMWARE

The test utility software used during testing was A705FN.001

6.5. WORST-CASE CONFIGURATION AND MODE

Radiated emissions below 1GHz, above 18GHz, and power line conducted emission were performed with the EUT set to transmit at the channel with highest output power as worst-case scenario.

Band edge and radiated emissions between 1GHz and 18GHz were performed with the EUT set to transmit at the highest power on low, middle and high channels.

The fundamental of the EUT was investigated in three orthogonal orientations X,Y,Z, it was determined that X orientation was worst-case orientation; therefore, all final radiated testing was performed with the EUT in X orientation.

Worst-case data rates as provided by the client were:

GFSK mode: DH5
8PSK mode: 3-DH5

6.6. DESCRIPTION OF TEST SETUP

SUPPORT EQUIPMENT

Support Equipment List				
Description	Manufacturer	Model	Serial Number	FCC ID
AC Adapter	Samsung	EP-TA50EWE	DW3J719AS/A-E	N/A
Earphone	Samsung	N/A	N/A	N/A

I/O CABLES (CONDUCTED TEST)

I/O Cable List						
Cable No	Port	# of identical ports	Connector Type	Cable Type	Cable Length (m)	Remarks
1	Antenna	1	RF	Shielded	0.2	To PSA and BT Tester
2	USB	1	USB	Un-shielded	1	EUT to AC Mains

I/O CABLES (RADIATED AND CONDUCTED EMISSIONS)

I/O Cable List						
Cable No	Port	# of identical ports	Connector Type	Cable Type	Cable Length (m)	Remarks
1	USB	1	USB	Shielded	1	N/A
2	earphone	1	3.5mm	Un-shielded	1	N/A

TEST SETUP

The EUT is a stand alone unit. Test software exercised the radio card.

CONDCUTED TEST SETUP DIAGRAM

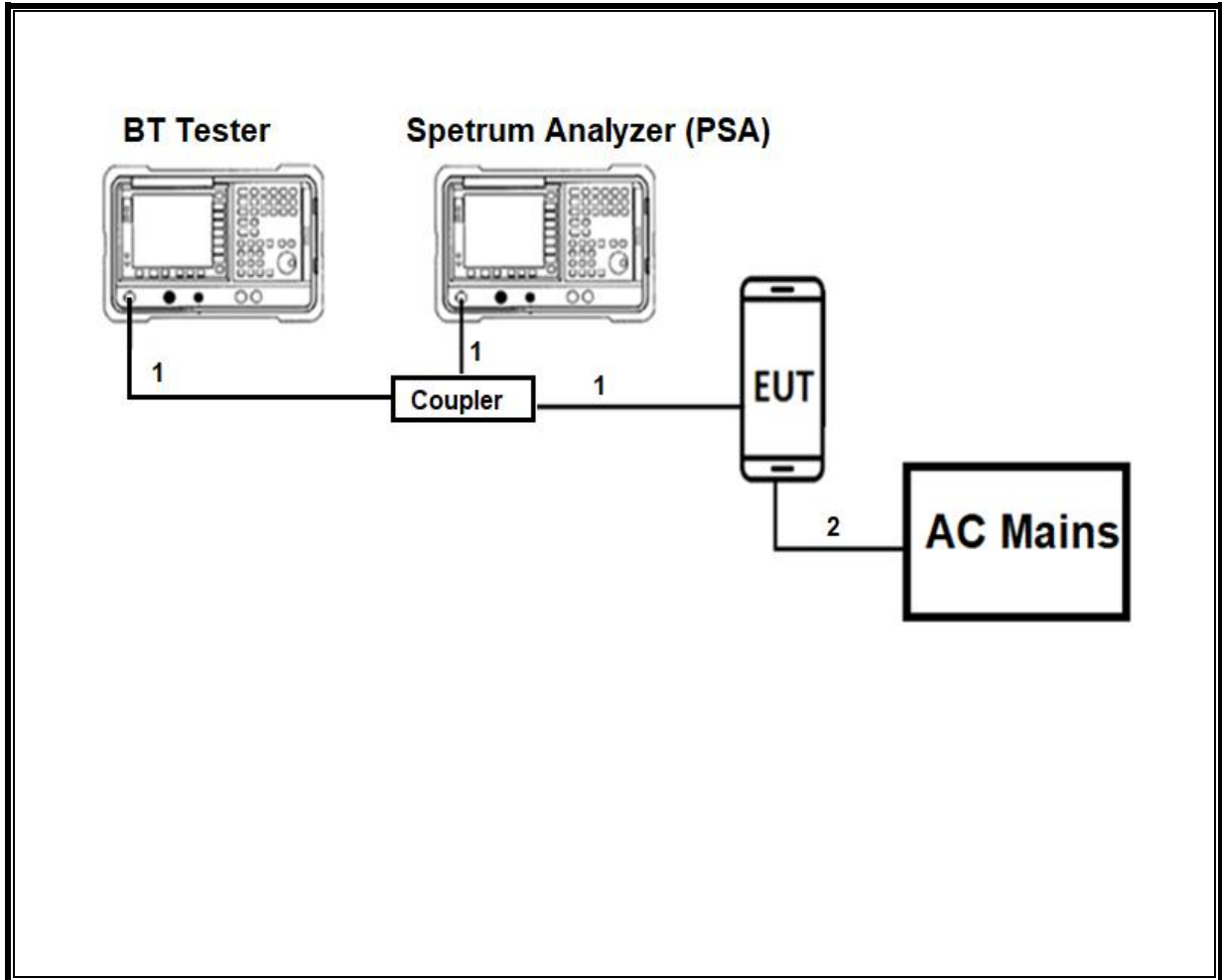

TEST SETUP

For conducted tests: the EUT was stand alone. The test software exercises the radio.

RADIATED AND AC LINE CONDUCTED EMISSIONS SETUP DIAGRAM

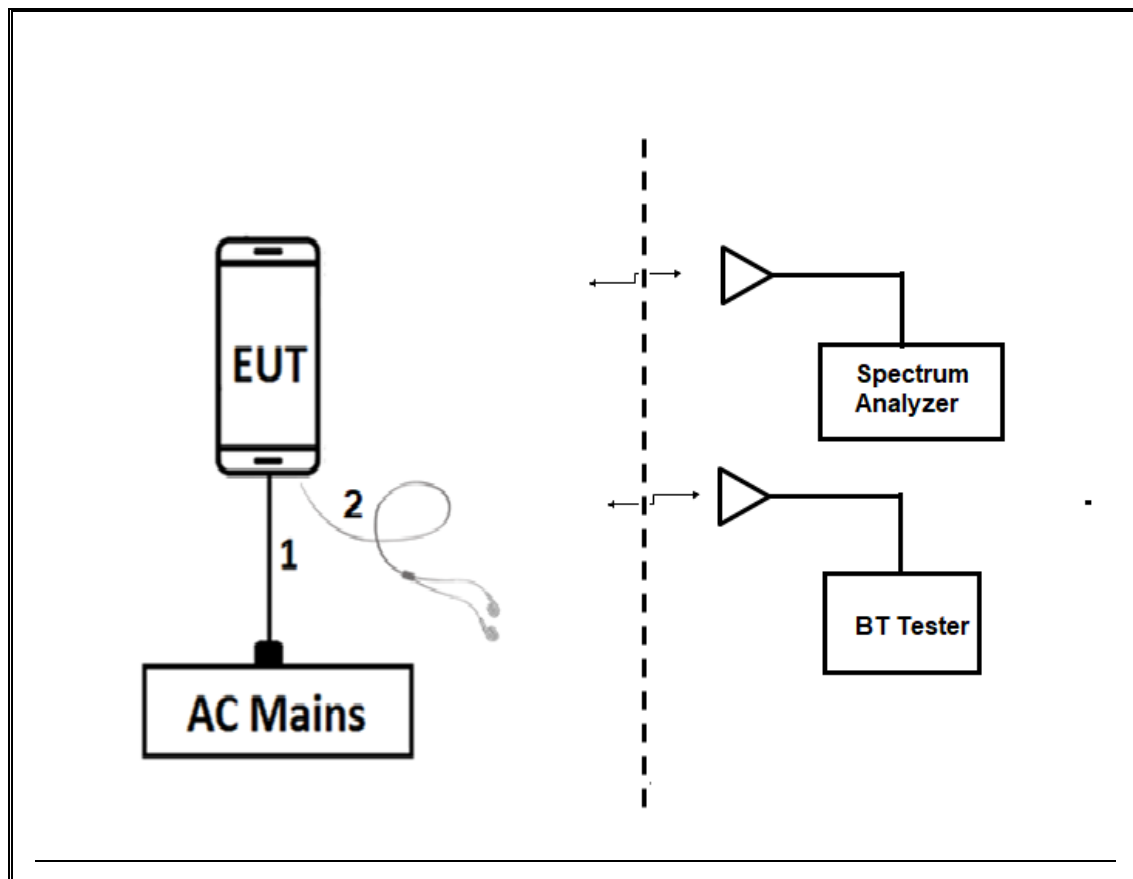

TEST SETUP

For radiated tests: EUT is stand alone. The test software exercises the radio.

7. TEST AND MEASUREMENT EQUIPMENT

The following test and measurement equipment was utilized for the tests documented in this report:

TEST EQUIPMENT LIST					
Description	Manufacturer	Model	ID Num	Cal Due	Last Cal
6 port rf switch, 1-18GHz	Pasternack	PE7159	171455	08/01/2019	08/01/2018
Bluetooth Tester	Rohde & Schwarz (Koeln) YNbH & Co. KG	CBT	T438	02/14/2020	02/14/2019
Power Meter, P-series single channel	Agilent (Keysight) Technologies	N1911A	T1271	07/26/2019	07/26/2018
Power Sensor, P-series, 50MHz to 18GHz, Wideband	Agilent (Keysight) Technologies	N1921A	T1224	10/09/2019	10/09/2018
Antenna, Active Loop 9kHz-30MHz	ETS-Lindgren	6502	T757	09/25/2019	09/25/2018
Antenna, Horn 1-18GHz	ETS-Lindgren	3117	T344	04/30/2019	04/30/2018
Antenna, Horn 1-18GHz	ETS-Lindgren	3117	T862	05/25/2019	05/25/2018
EMI TEST RECEIVER	Rohde & Schwarz	ESW44	PRE0179367	04/25/2019	04/25/2018
EMI TEST RECEIVER	Rohde & Schwarz	ESW44	PRE0179375	05/08/2019	05/08/2018
Spectrum Analyzer, PXA, 3Hz to 44GHz	Agilent (Keysight) Technologies	N9030A	T908	01/23/2020	01/23/2019
Spectrum Analyzer, PXA, 3Hz to 44GHz	Agilent (Keysight) Technologies	N9030A	T341	09/26/2019	09/26/2018
Amplifier, 1-18GHz, 35 dB	AMPLICAL	AMP1G18-35	T1569	06/03/2019	06/23/2018
RF Amplifier, 1-18GHz	MITEQ	AFS42-00101800-25-S-42	171460	08/01/2019	08/21/2018
Amplifier, 100kHz to 1GHz, 32 dB	Agilent (Keysight) Technologies	8447D	T15	10/20/2019	10/20/2018
Hybrid Antenna, 30MHz to 3GHz	SunAR rf motion	JB3	PRE0181574	08/21/2019	08/21/2018
Antenna, Horn 18 to 26.5GHz	ARA	MWH-1826/B	T447	06/16/2019	06/16/2018
Pre-Amp, 1-26.5GHz	Agilent	8449B	T404	03/09/2019	03/09/2018
AC Line Conducted					
EMI Receiver	Rohde & Schwarz	ESR	T1436	02/14/2020	02/14/2019
LISN for Conducted Emissions CISPR-16	FCC INC.	FCC LISN 50/250	T1310	06/15/2019	06/15/2018
Test Software List					
Radiated Software	UL	UL EMC		Ver 9.5, June 22, 2018	
Antenna Port Software	UL	UL RF		Ver 9.3.2, Jan. 07, 2019	
AC Line Conducted Software	UL	UL EMC		Ver 9.5, May 26, 2015	

NOTES:

1. Equipment listed above that calibrated during the testing period was set for test after the calibration.
2. Equipment listed above that has a calibration due date during the testing period, the testing is completed before equipment expiration date.

8. MEASUREMENT METHODS

On Time and Duty Cycle: ANSI C63.10-2013 Section 11.6

Occupied BW (20dB): ANSI C63.10-2013 Section 6.9.2

Occupied BW (99%): ANSI C63.10-2013 Section 6.9.3

Carrier Frequency Separation: ANSI C63.10-2013 Section 7.8.2

Number of Hopping Frequencies: ANSI C63.10-2013 Section 7.8.3

Time of Occupancy (Dwell Time): ANSI C63.10-2013 Section 7.8.4

Peak Output Power: ANSI C63.10-2013 Section 7.8.5

Conducted Spurious Emissions: ANSI C63.10-2013 Section 7.8.8

Conducted Band-Edge: ANSI C63.10-2013 Section 6.10.4

Radiated Spurious Emissions Below 30MHz: ANSI C63.10-2013 Section 6.4

Radiated Spurious Emissions 30-1000MHz: ANSI C63.10-2013 Section 6.3 and 6.5

Radiated Spurious Emissions above 1GHz: ANSI C63.10-2013 Section 6.3 and 6.6

Radiated Band-edge: ANSI C63.10-2013 Section 6.10.5

AC Power-line conducted emissions: ANSI C63.10-2013, Section 6.2.

9. ANTENNA PORT TEST RESULTS

9.1. ON TIME AND DUTY CYCLE

LIMITS

None; for reporting purposes only.

PROCEDURE

ANSI C63.10, Section 11.6 : Zero-Span Spectrum Analyzer Method.

ON TIME AND DUTY CYCLE RESULTS

Mode	ON Time B (msec)	Period (msec)	Duty Cycle x (linear)	Duty Cycle (%)	Duty Cycle Correction Factor (dB)	1/T Minimum VBW (kHz)
Bluetooth GFSK	2.90	3.75	0.773	77.3%	1.12	0.345
Bluetooth 8PSK	2.90	3.75	0.773	77.3%	1.12	0.345

DUTY CYCLE PLOTS

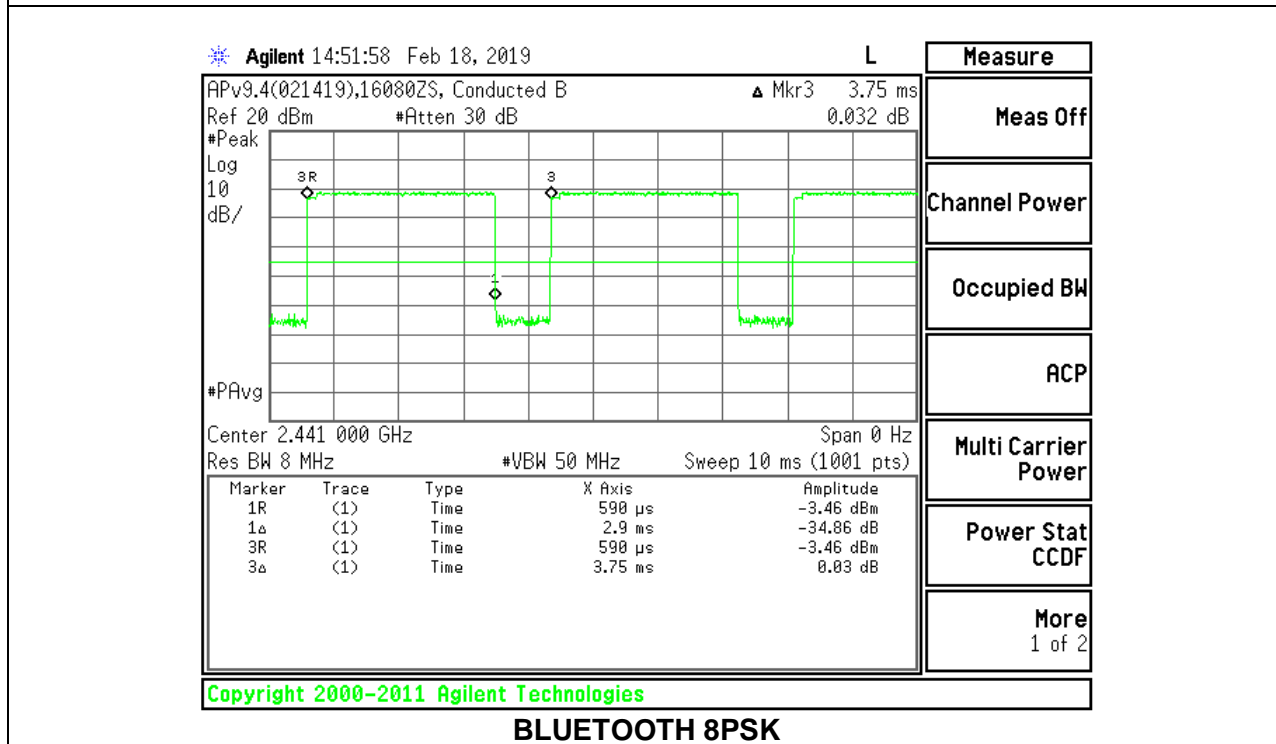
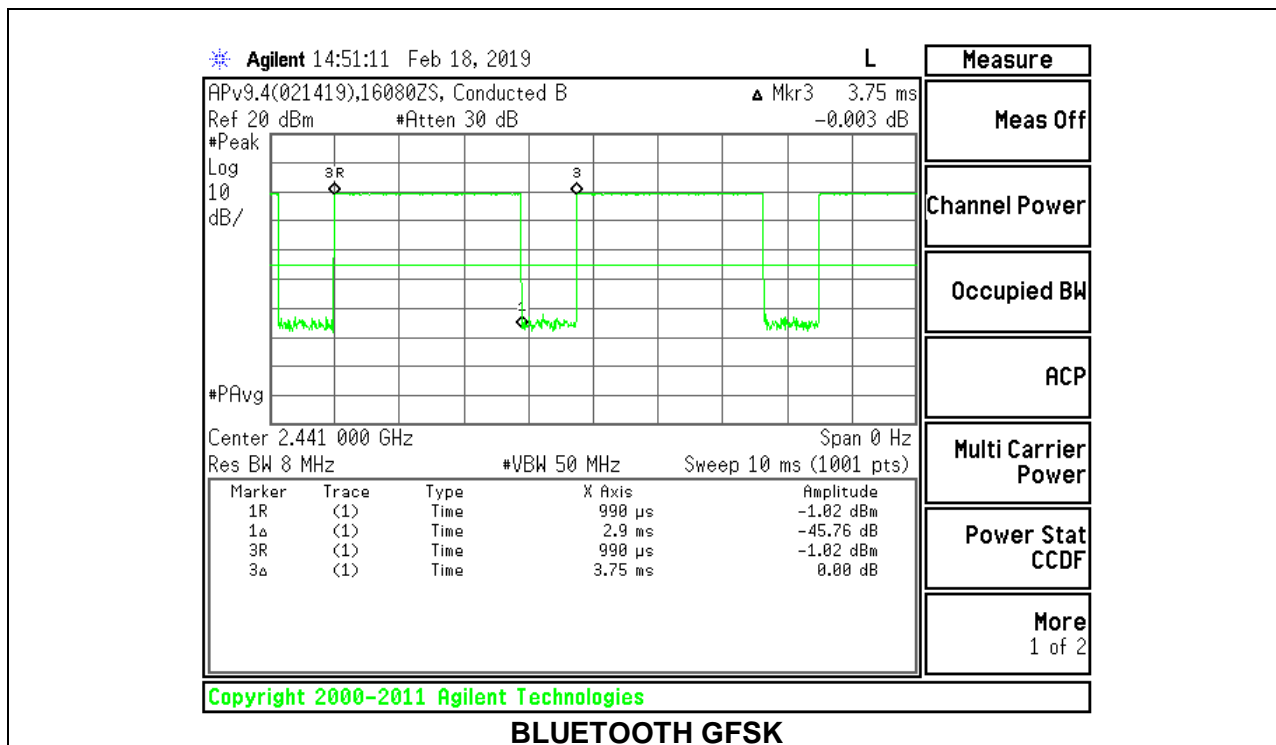

9.2. 20 dB AND 99% BANDWIDTH

LIMITS

None; for reporting purposes only.

TEST PROCEDURE

The transmitter output is connected to a spectrum analyzer. The RBW is set to $\geq 1\%$ of the 20 dB bandwidth. The VBW is set to \geq RBW. The sweep time is coupled.

RESULTS

9.2.1. BLUETOOTH BASIC DATA RATE GFSK MODULATION

Channel	Frequency (MHz)	20dB Bandwidth (kHz)	99% Bandwidth (kHz)
Low	2402	922.401	842.1821
Mid	2441	944.520	852.6359
High	2480	946.416	853.5638

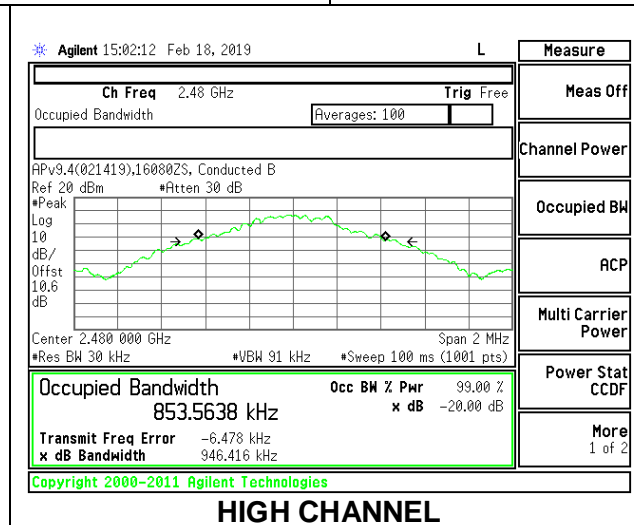
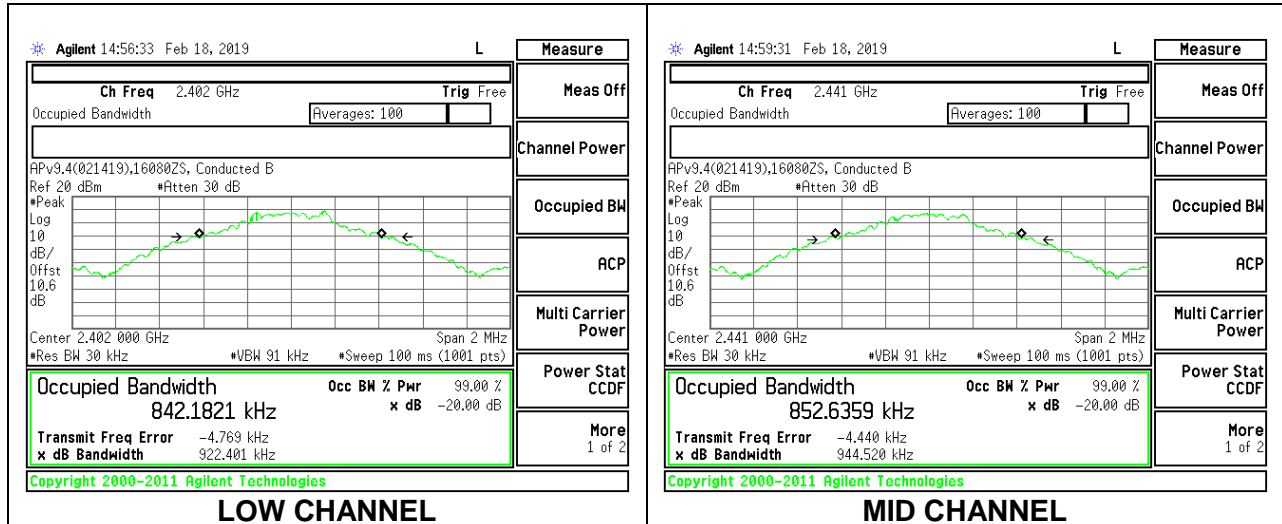

9.2.2. BLUETOOTH ENHANCED DATA RATE 8PSK MODULATION

Channel	Frequency (MHz)	20dB Bandwidth (MHz)	99% Bandwidth (MHz)
Low	2402	1.299	1.1821
Mid	2441	1.299	1.1811
High	2480	1.301	1.1861

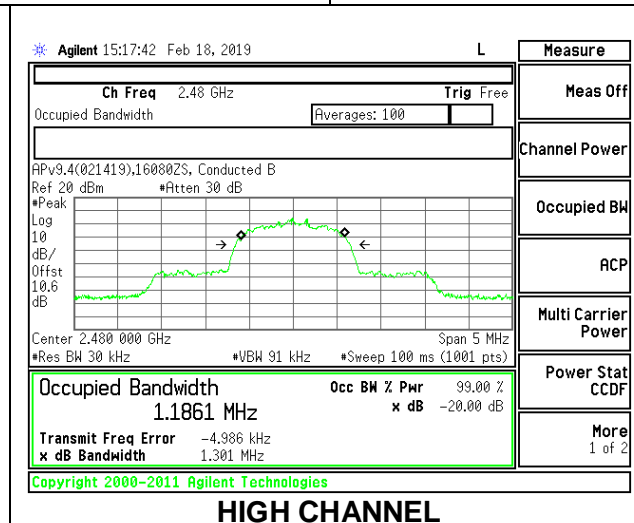
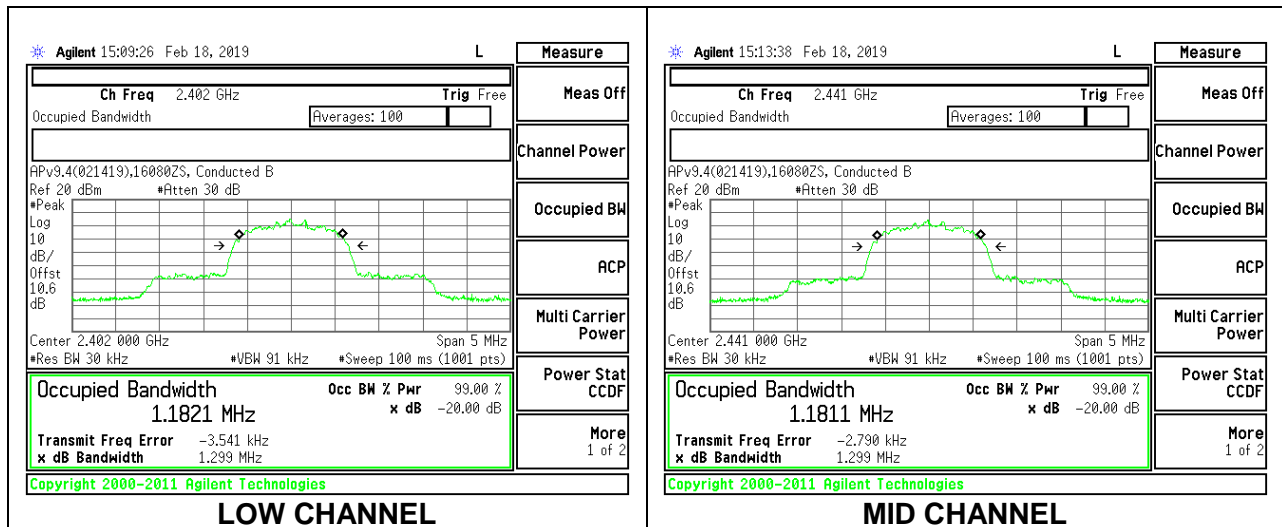

9.3. HOPPING FREQUENCY SEPARATION

LIMITS

FCC §15.247 (a) (1)

Frequency hopping systems shall have hopping channel carrier frequencies separated by a minimum of 25 kHz or the 20 dB bandwidth of the hopping channel, whichever is greater.

Alternatively, frequency hopping systems operating in the 2400-2483.5 MHz band may have hopping channel carrier frequencies that are separated by 25 kHz or two-thirds of the 20 dB bandwidth of the hopping channel, whichever is greater, provided the systems operate with an output power no greater than 125 mW.

TEST PROCEDURE

The transmitter output is connected to a spectrum analyzer. The RBW is set to 300 kHz and the VBW is set to 300 kHz. The sweep time is coupled.

RESULTS

9.3.1. BLUETOOTH BASIC DATA RATE GFSK MODULATION

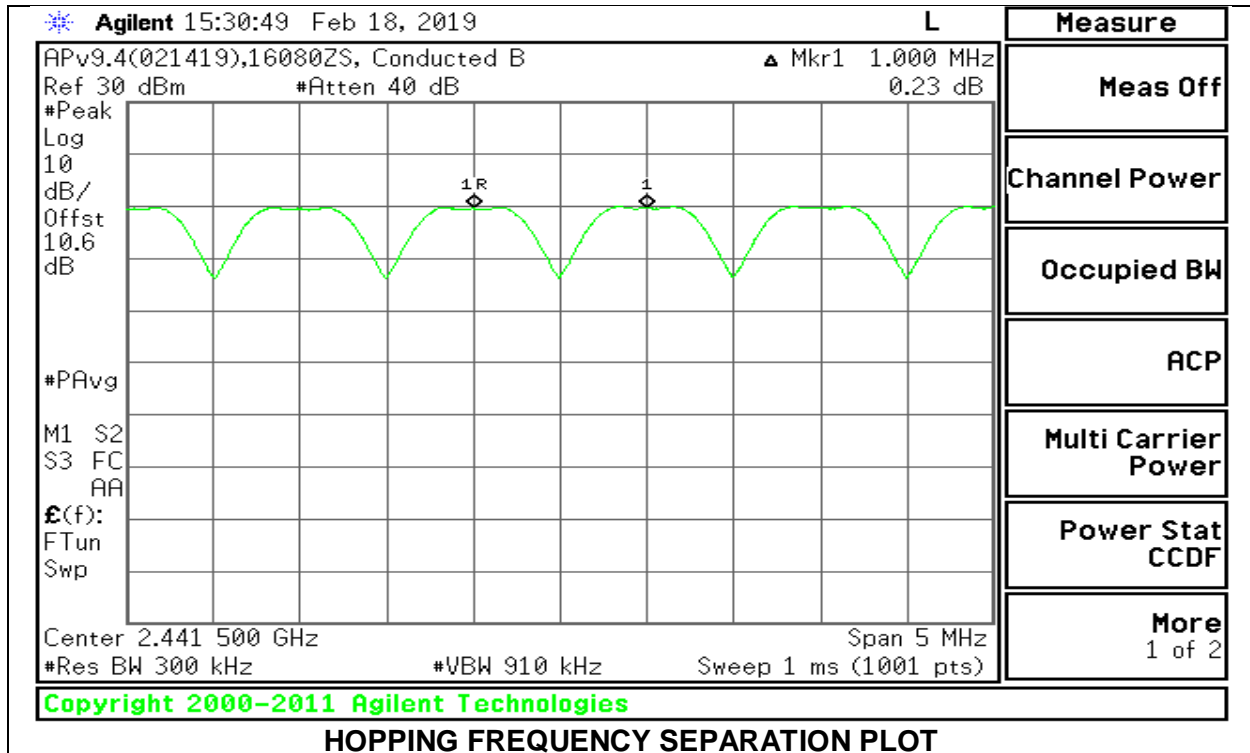

9.3.2. BLUETOOTH ENHANCED DATA RATE 8PSK MODULATION

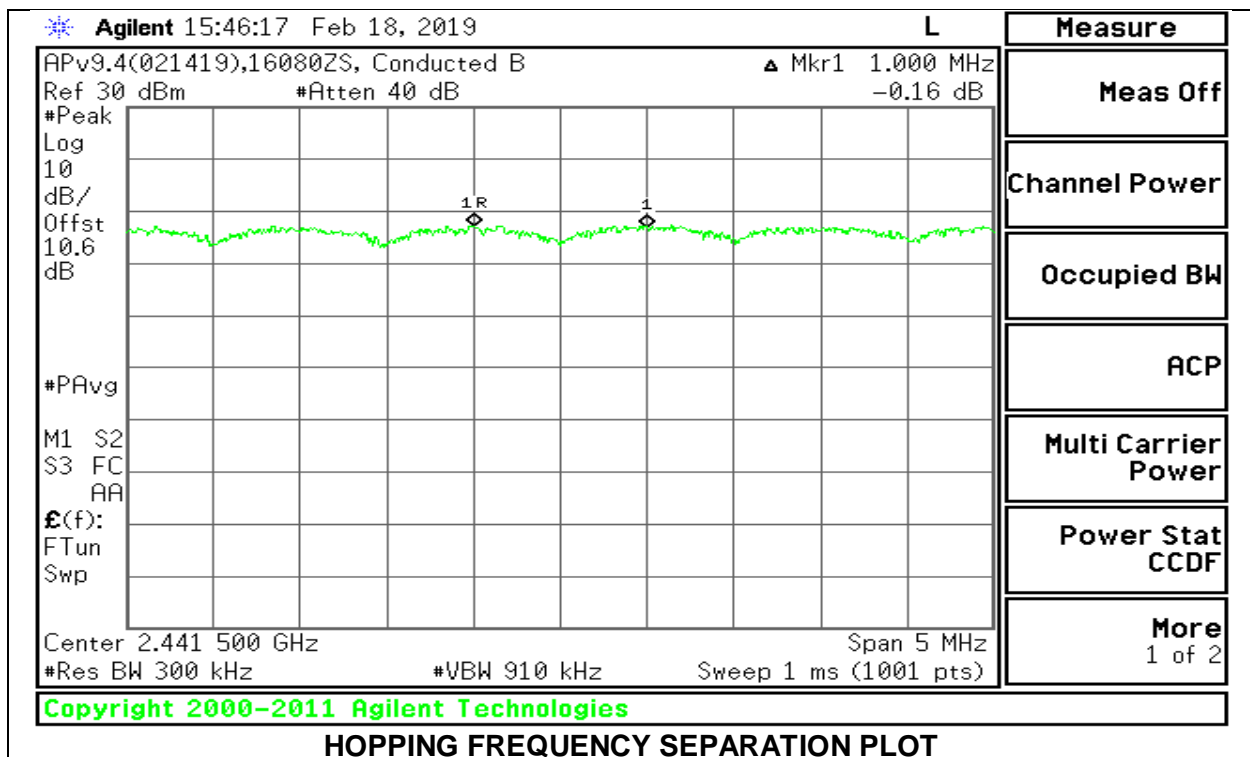

9.4. NUMBER OF HOPPING CHANNELS

LIMITS

FCC §15.247 (a) (1) (iii)

Frequency hopping systems in the 2400 – 2483.5 MHz band shall use at least 15 non-overlapping channels.

TEST PROCEDURE

The transmitter output is connected to a spectrum analyzer. The span is set to cover the entire authorized band, in either a single sweep or in multiple contiguous sweeps. The RBW is set to a maximum of 1 % of the span. The analyzer is set to Max Hold.

RESULTS

Normal Mode: 79 Channels Observed

9.4.1. BLUETOOTH BASIC DATA RATE GFSK MODULATION

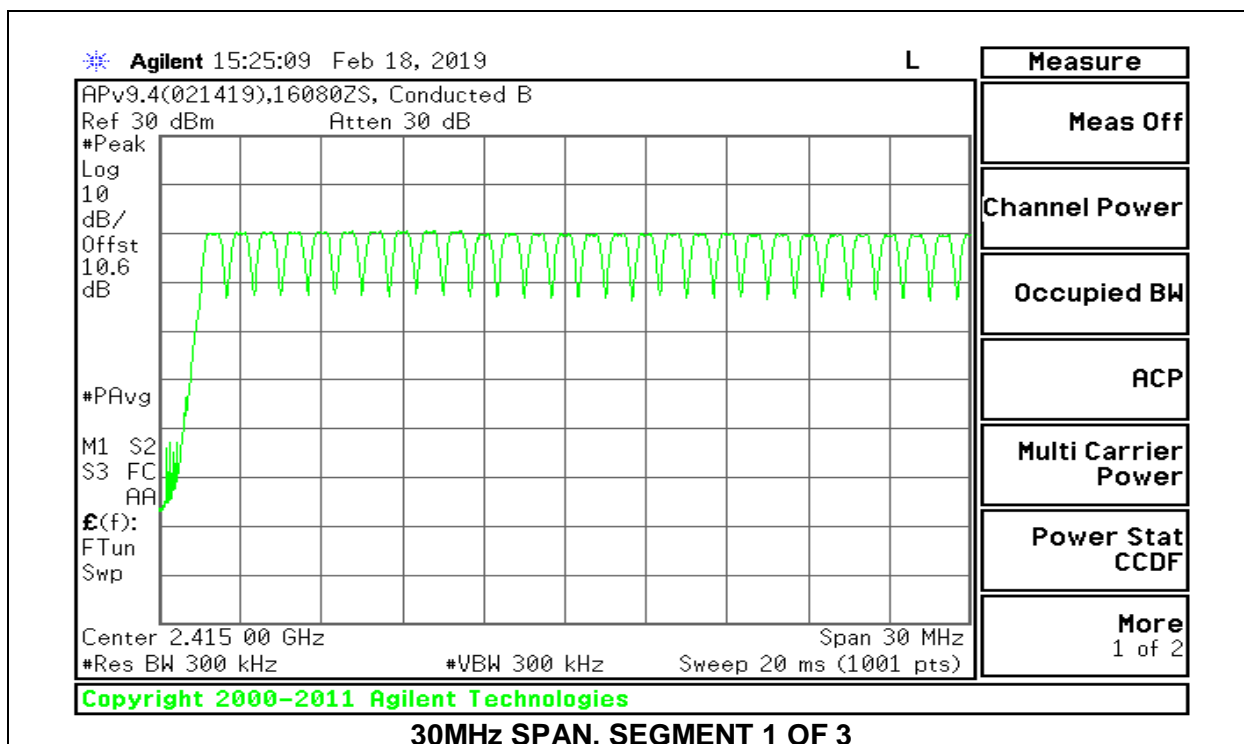
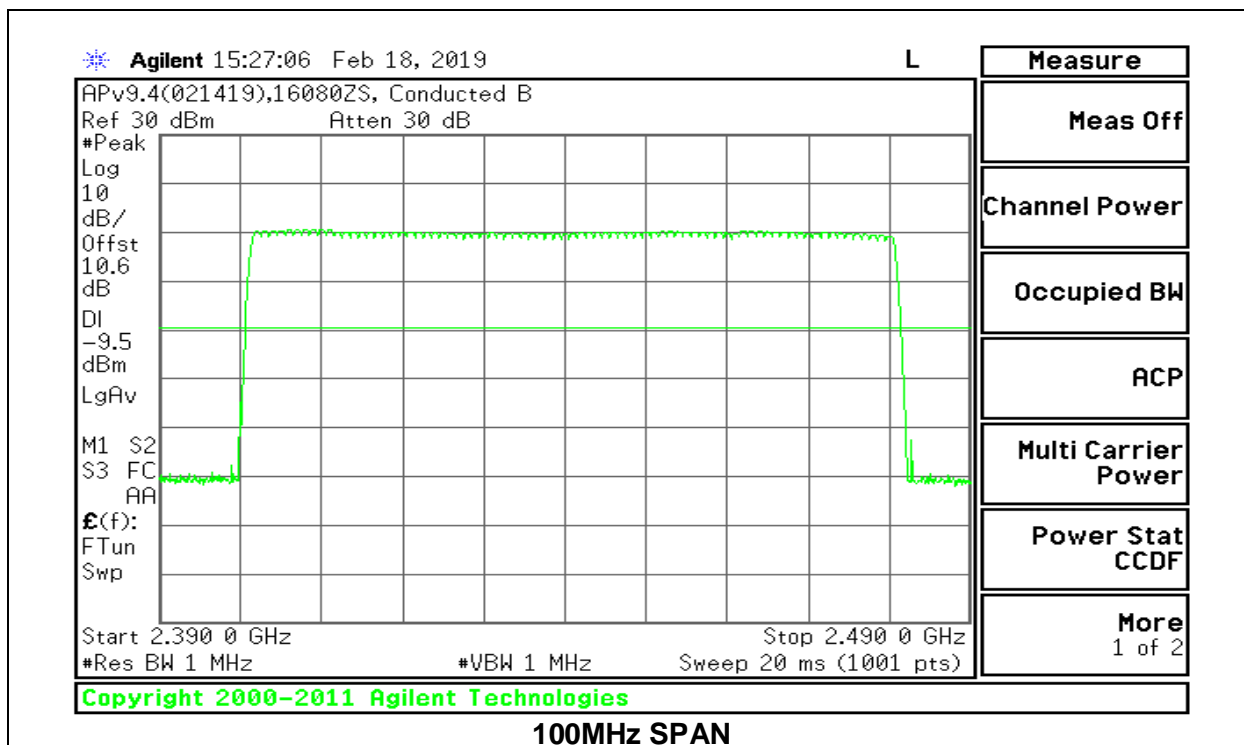

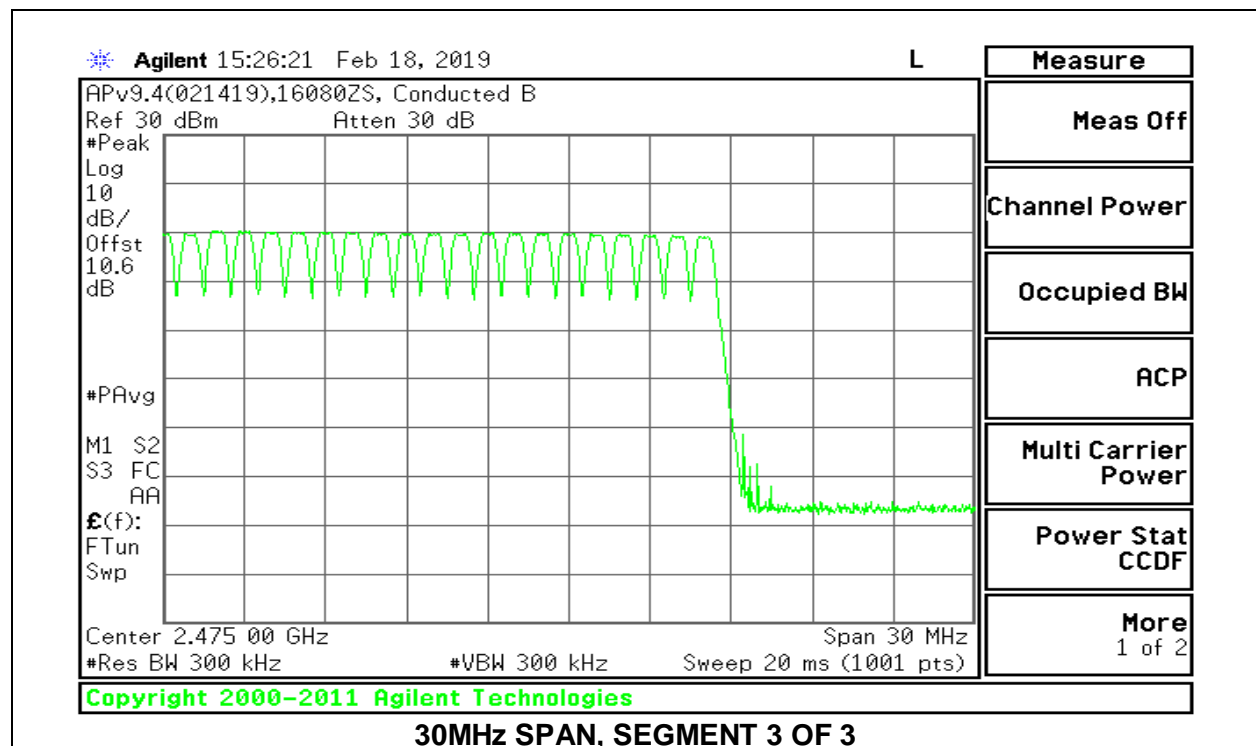
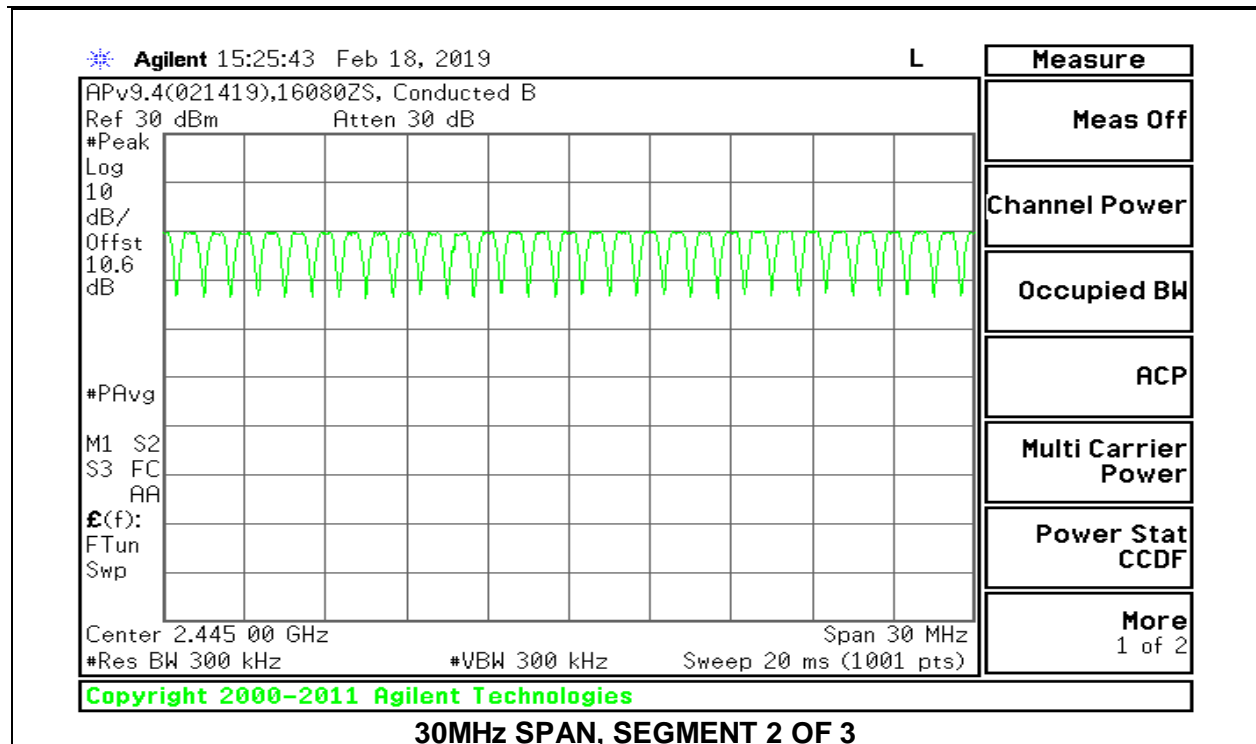

9.4.2. BLUETOOTH ENHANCED DATA RATE 8PSK MODULATION

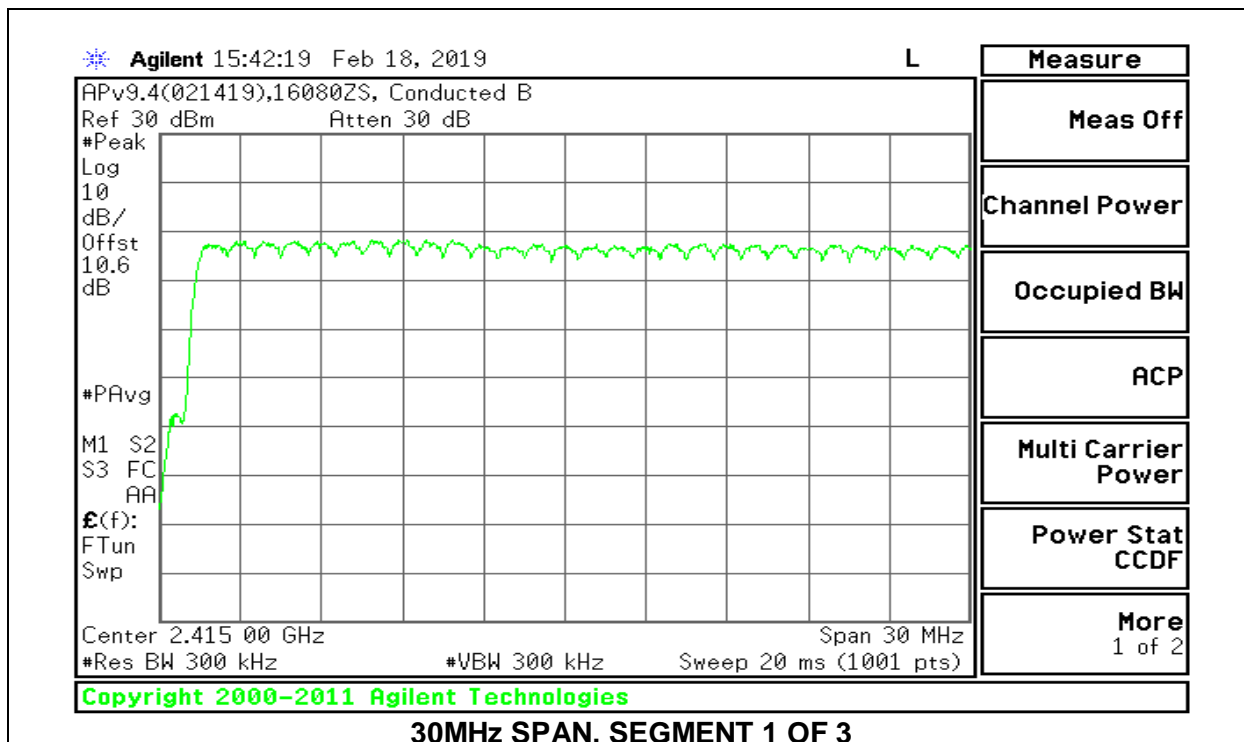
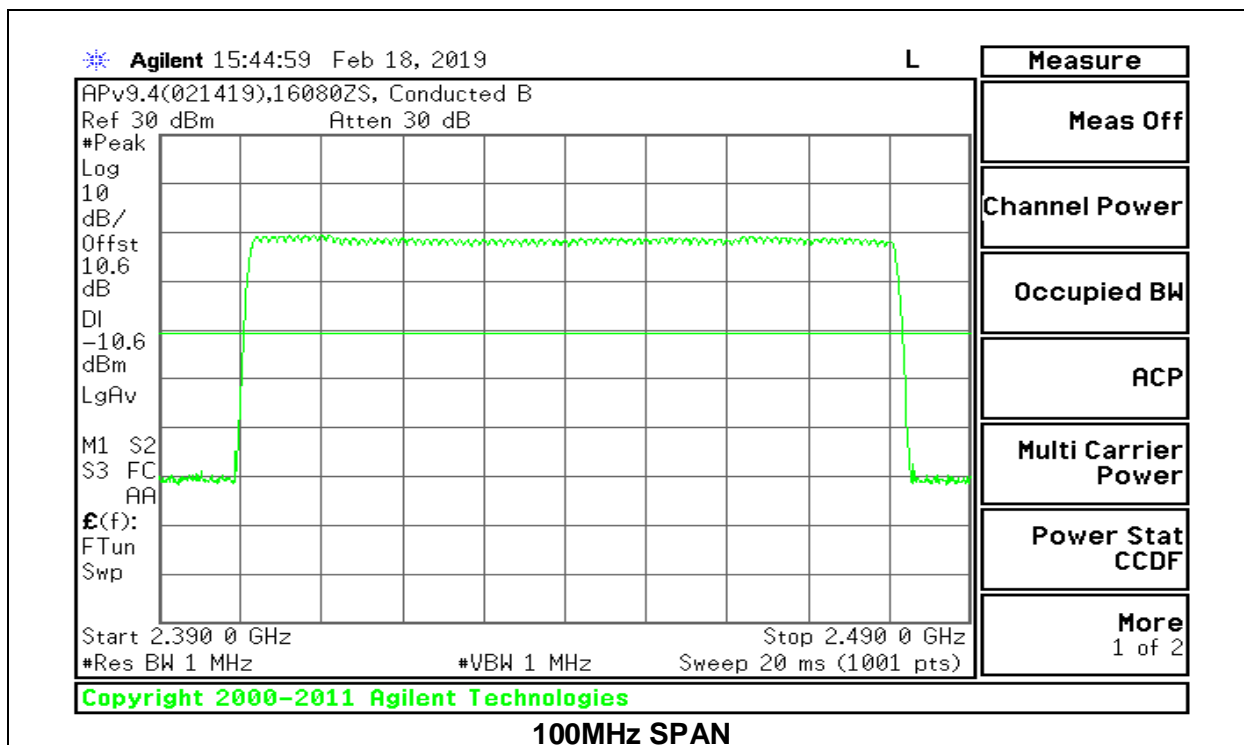

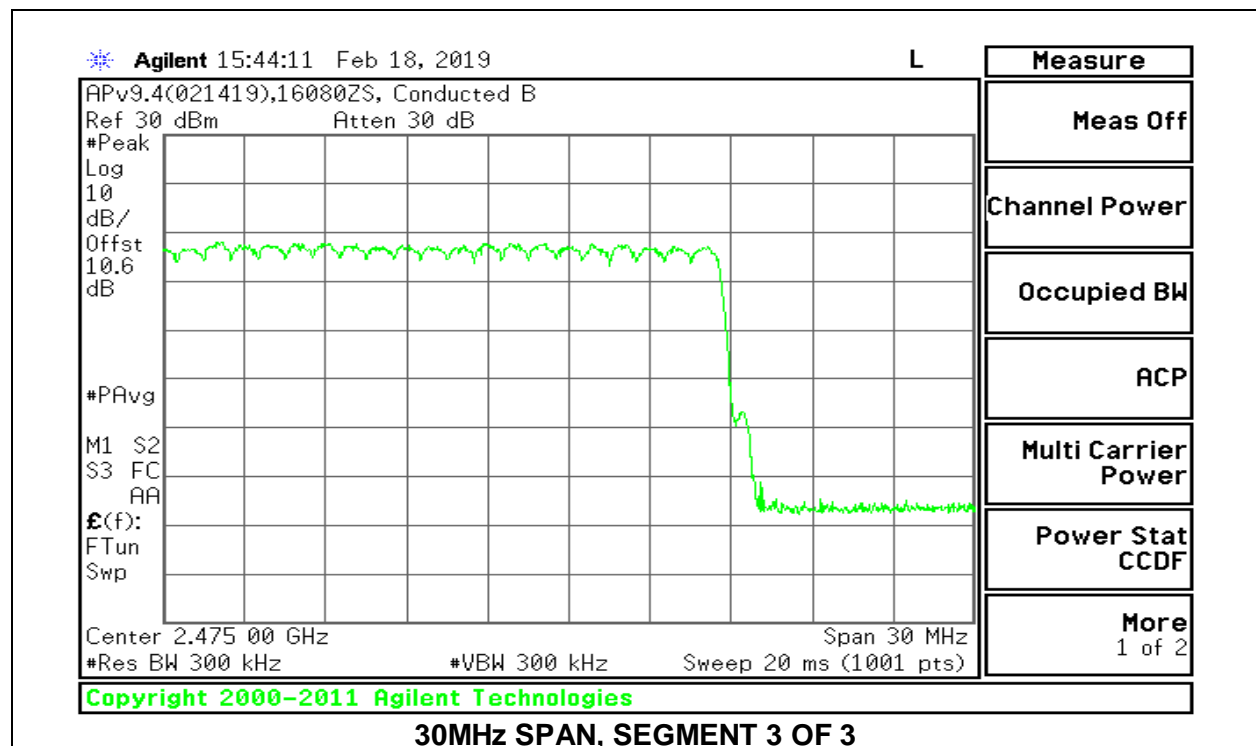
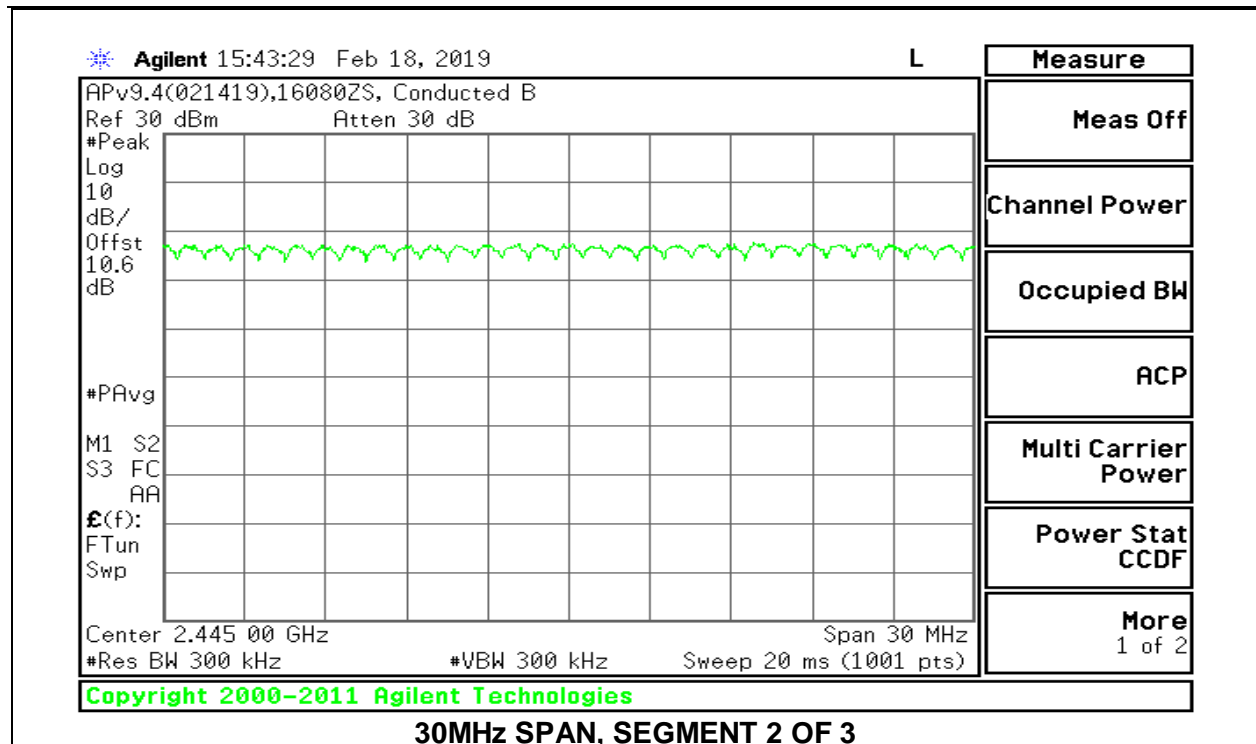

9.5. AVERAGE TIME OF OCCUPANCY

LIMITS

FCC §15.247 (a) (1) (iii)

The average time of occupancy on any channel shall not be greater than 0.4 seconds within a period of 0.4 seconds multiplied by the number of hopping channels employed.

TEST PROCEDURE

The transmitter output is connected to a spectrum analyzer. The span is set to 0 Hz, centered on a single, selected hopping channel. The width of a single pulse is measured in a fast scan. The number of pulses is measured in a 3.16 second scan, to enable resolution of each occurrence.

The average time of occupancy in the specified 3.16 second period (79 channels * 0.4 s) is equal to $10 * (\# \text{ of pulses in } 3.16 \text{ s}) * \text{ pulse width}$.

For AFH mode, the average time of occupancy in the specified 8 second period (20 channels * 0.4 seconds) is equal to $10 * (\# \text{ of pulses in } 0.8 \text{ s}) * \text{ pulse width}$.

RESULTS

9.5.1. BLUETOOTH BASIC DATA RATE GFSK MODULATION

DH Packet	Pulse Width (msec)	Number of Pulses in 3.16 seconds	Average Time of Occupancy (sec)	Limit (sec)	Margin (sec)
GFSK Normal Mode					
3DH1	0.3825	32	0.1224	0.4	-0.2776
3DH3	1.639	17	0.2786	0.4	-0.1214
3DH5	2.886	9	0.2597	0.4	-0.1403
GFSK AFH Mode					
DH Packet	Pulse Width (sec)	Number of Pulses in 0.8 seconds	Average Time of Occupancy (sec)	Limit (sec)	Margin (sec)
3DH1	0.3825	8	0.03060	0.4	-0.3694
3DH3	1.639	4.25	0.06966	0.4	-0.3303
3DH5	2.886	2.25	0.06494	0.4	-0.3351

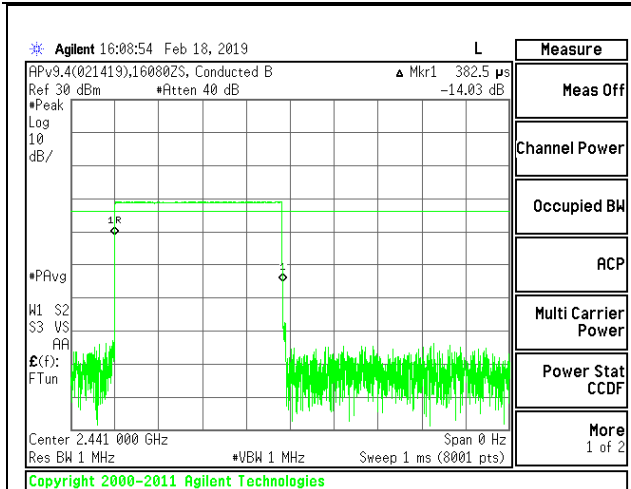

PULSE WIDTH – 3DH1

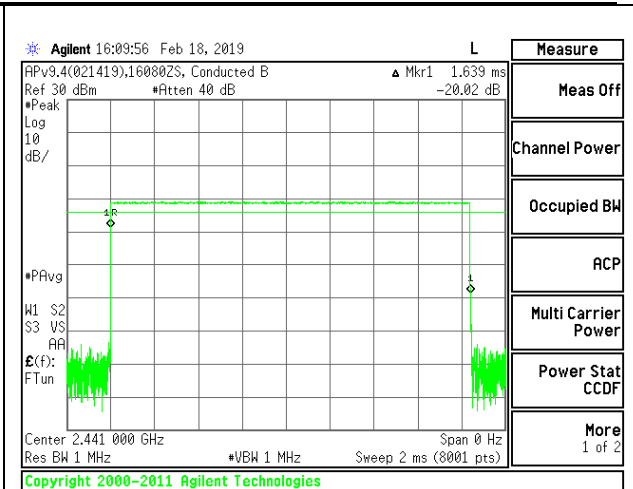

PULSE WIDTH – 3DH3

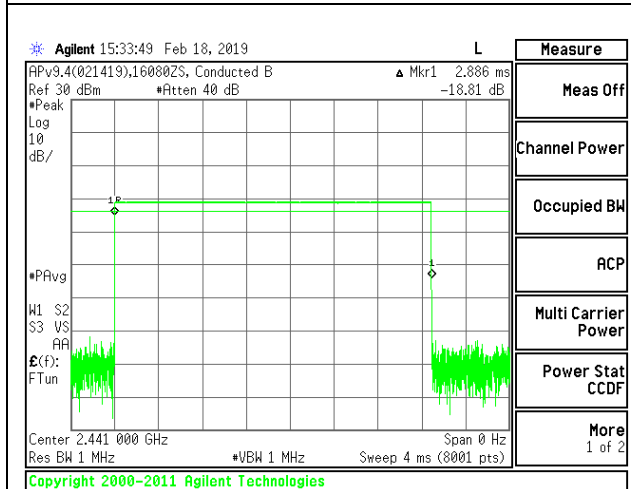

PULSE WIDTH – 3DH5

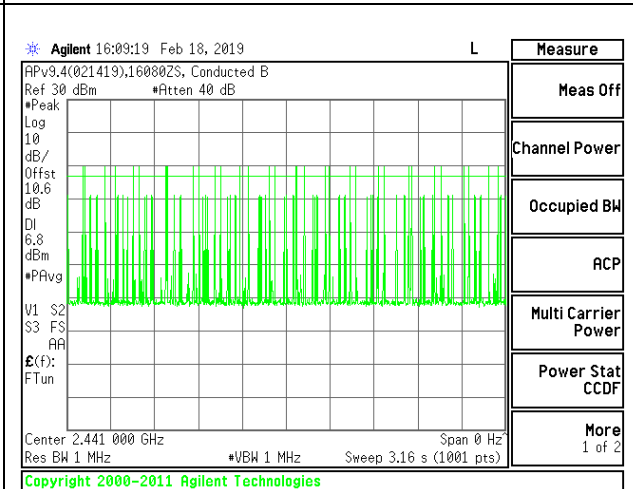

NUMBER OF PULSES IN 3.16 SECOND OBSERVATION PERIOD – 3DH1

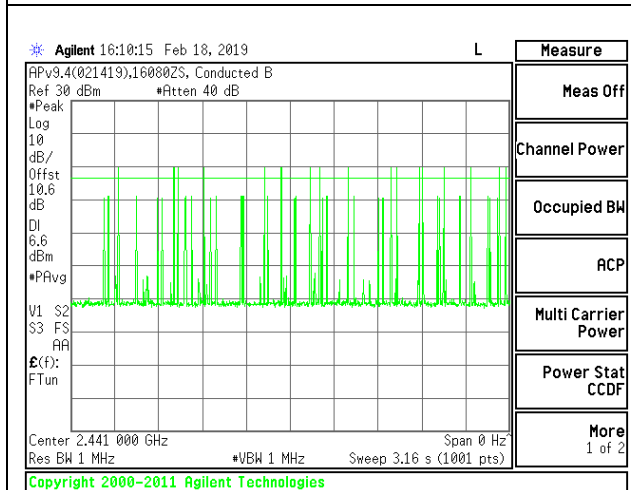

NUMBER OF PULSES IN 3.16 SECOND OBSERVATION PERIOD – 3DH3

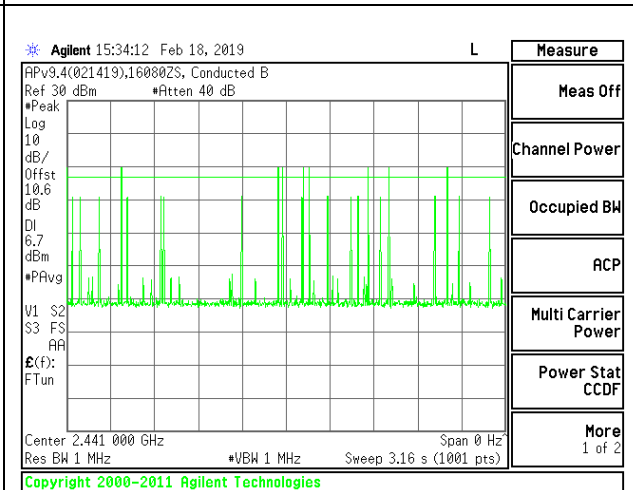

NUMBER OF PULSES IN 3.16 SECOND OBSERVATION PERIOD – 3DH5

9.5.2. BLUETOOTH ENHANCED DATA RATE 8PSK MODULATION

DH Packet	Pulse Width (msec)	Number of Pulses in 3.16 seconds	Average Time of Occupancy (sec)	Limit (sec)	Margin (sec)
8PSK Normal Mode					
3DH1	0.3884	32	0.124288	0.4	-0.27571
3DH3	1.64	16	0.2624	0.4	-0.1376
3DH5	2.89	8	0.2312	0.4	-0.1688

Note: for AFH(8PSK) mode, please refer to the results of AFH(GFSK) mode; the channel selection and hopping rate are the same for both EDR and Basic Rate operation, data for Basic Rate demonstrates compliance with channel occupancy when AFH is employed.

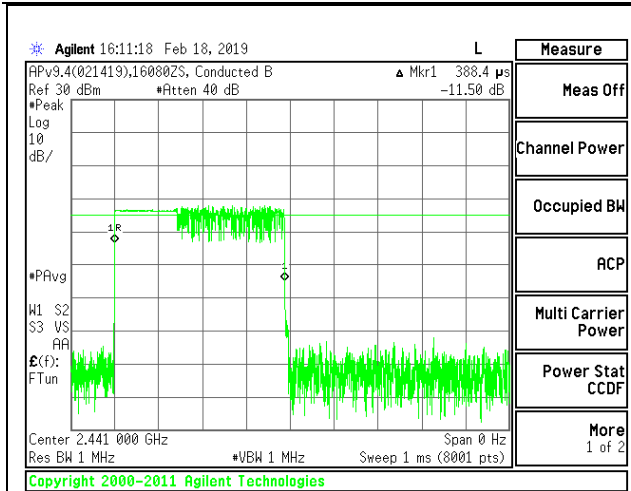

PULSE WIDTH – 3DH1

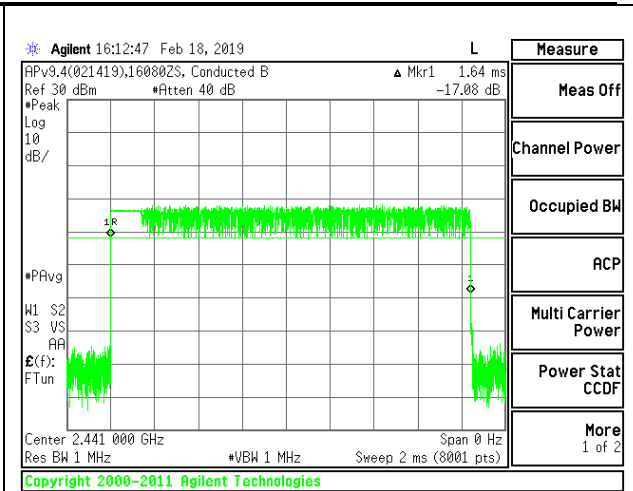

PULSE WIDTH – 3DH3

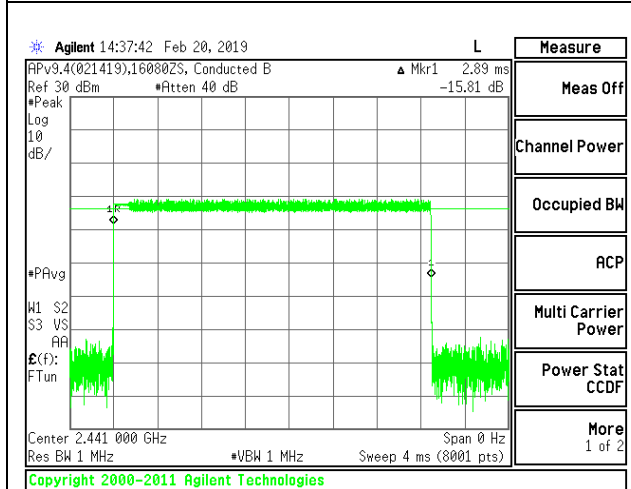

PULSE WIDTH – 3DH5

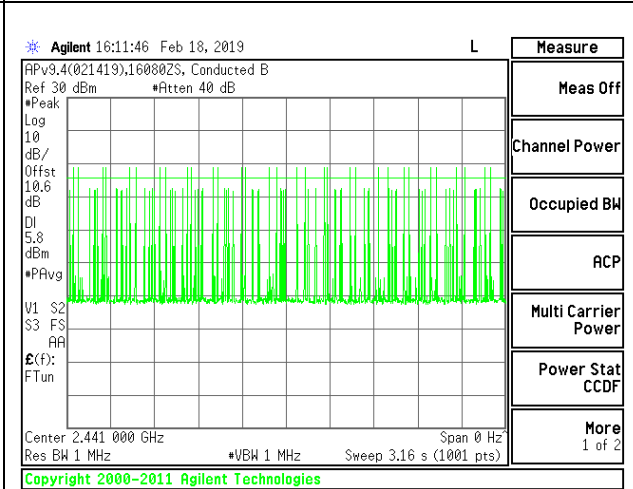

NUMBER OF PULSES IN 3.16 SECOND OBSERVATION PERIOD – 3DH1

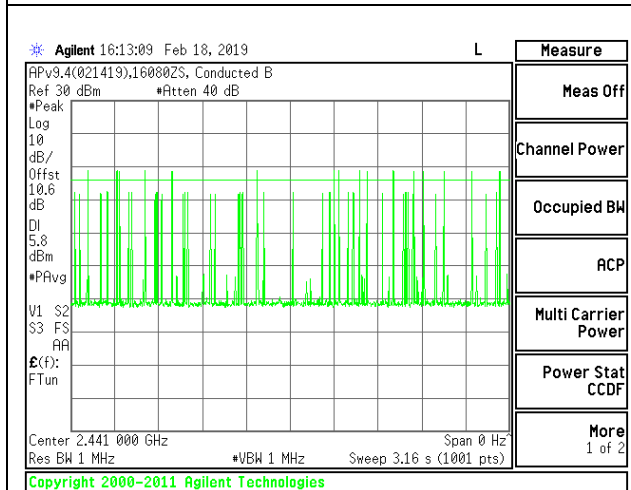

NUMBER OF PULSES IN 3.16 SECOND OBSERVATION PERIOD – 3DH3

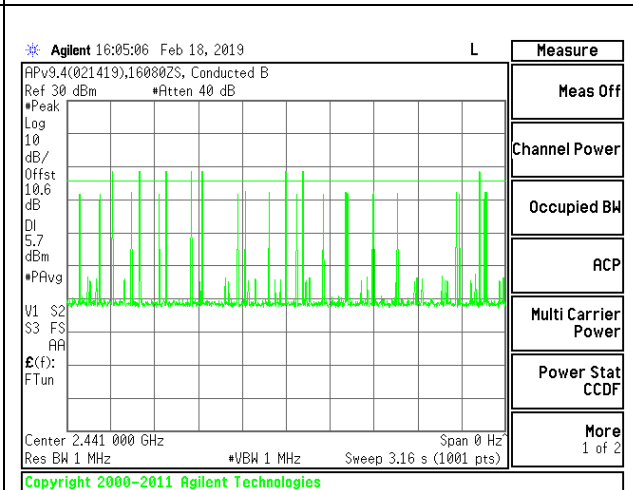

NUMBER OF PULSES IN 3.16 SECOND OBSERVATION PERIOD – 3DH5

9.6. OUTPUT POWER

LIMITS

§15.247 (b) (1)

The maximum antenna gain is less than 6 dBi, therefore the limit is 30 dBm. Alternatively, frequency hopping systems operating in the 2400-2483.5 MHz band may have hopping channel carrier frequencies that are separated by 25 kHz or two-thirds of the 20 dB bandwidth of the hopping channel, whichever is greater, provided the systems operate with an output power no greater than 125 mW.

TEST PROCEDURE

Measurements perform using a wideband gated RF power meter. The cable assembly insertion loss was entered as an offset in the power meter to allow for the peak reading of power.

RESULTS

9.6.1. BLUETOOTH BASIC DATA RATE GFSK MODULATION

Tested By:	16080 ZS
Date:	2/18/2019

Channel	Frequency (MHz)	Output Power (dBm)	Limit (dBm)	Margin (dB)
Low	2402	9.73	30	-20.27
Middle	2441	9.41	30	-20.59
High	2480	8.53	30	-21.47

9.6.2. BLUETOOTH ENHANCED DATA RATE DQPSK MODULATION

Tested By:	16080 ZS
Date:	2/18/2019

Channel	Frequency (MHz)	Output Power (dBm)	Limit (dBm)	Margin (dB)
Low	2402	7.79	21	-13.21
Middle	2441	7.04	21	-13.96
High	2480	6.97	21	-14.03

9.6.3. BLUETOOTH ENHANCED DATA RATE 8PSK MODULATION

Tested By:	16080 ZS
Date:	2/18/2019

Channel	Frequency (MHz)	Output Power (dBm)	Limit (dBm)	Margin (dB)
Low	2402	9.32	21	-11.68
Middle	2441	8.25	21	-12.75
High	2480	7.05	21	-13.95

9.7. AVERAGE POWER

LIMITS

None; for reporting purposes only

TEST PROCEDURE

Measurements perform using a wideband gated RF power meter. The cable assembly insertion loss was entered as an offset in the power meter to allow for a gated average reading of power.

RESULTS

9.7.1. BLUETOOTH BASIC DATA RATE GFSK MODULATION

Tested By:	16080 ZS
Date	2/18/2019

Channel	Frequency (MHz)	Average Power (dBm)
Low	2402	9.63
Middle	2441	9.27
High	2480	8.35

9.7.2. BLUETOOTH ENHANCED DATA RATE DQPSK MODULATION

Tested By:	16080 ZS
Date	2/18/2019

Channel	Frequency (MHz)	Average Power (dBm)
Low	2402	7.55
Middle	2441	6.11
High	2480	6.55

9.7.3. BLUETOOTH ENHANCED DATA RATE 8PSK MODULATION

Tested By:	16080 ZS
Date	2/18/2019

Channel	Frequency (MHz)	Average Power (dBm)
Low	2402	7.58
Middle	2441	6.43
High	2480	6.62

9.8. CONDUCTED SPURIOUS EMISSIONS

LIMITS

FCC §15.247 (d)

Limit = -20 dBc

TEST PROCEDURE

The transmitter output is connected to a spectrum analyzer. The resolution bandwidth is set to 100 kHz. The video bandwidth is set to 300 kHz.

The spectrum from 30 MHz to 26 GHz is investigated with the transmitter set to the lowest, middle, and highest channels.

The band edges at 2.4 and 2.4835 GHz are investigated with the transmitter set to the normal hopping mode.

RESULTS

9.8.1. BLUETOOTH BASIC DATA RATE GFSK MODULATION

Antenna 1 SPURIOUS EMISSIONS, NON-HOPPING

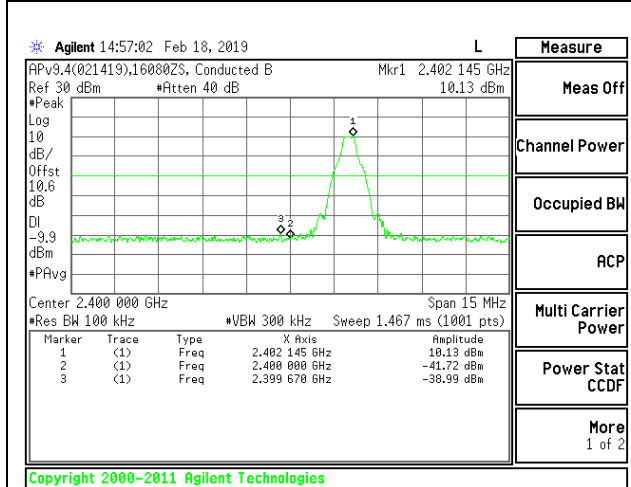

LOW CHANNEL BANDEDGE

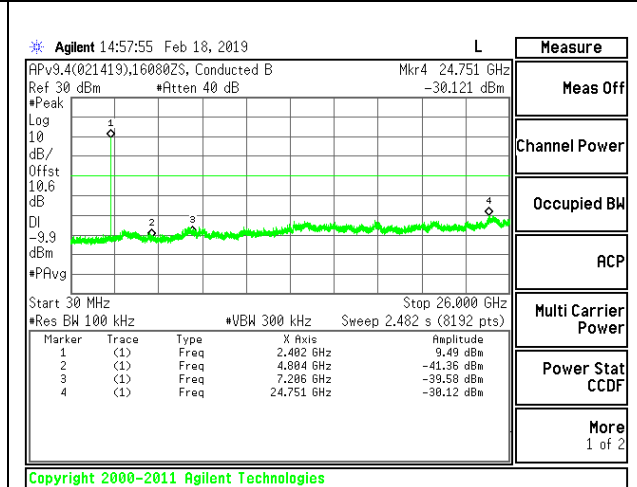

OUT-OF-BAND LOW CHANNEL

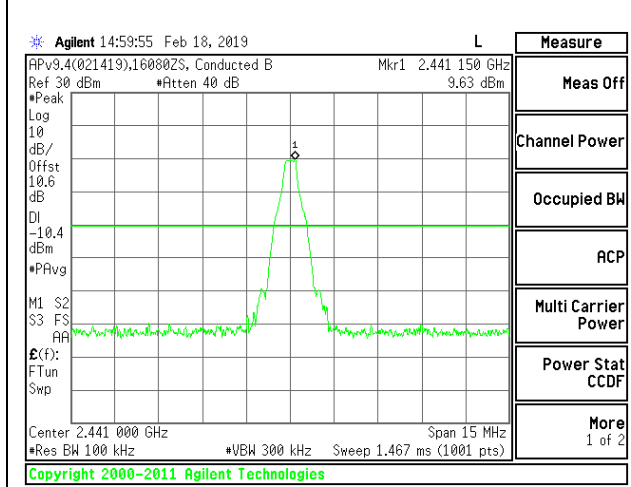

IN-BAND REFERENCE LEVEL

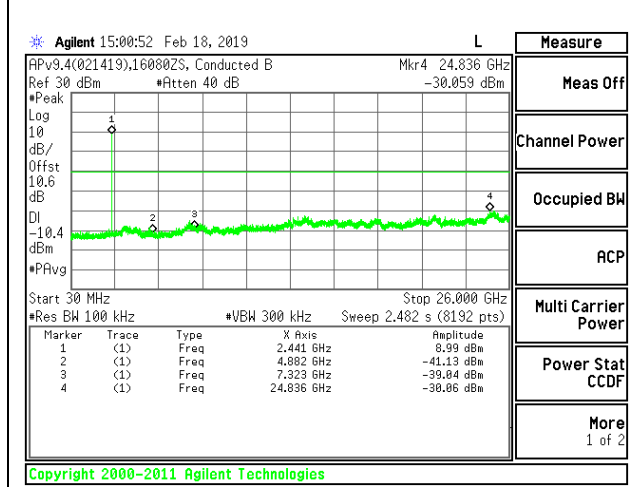

OUT-OF-BAND MID CHANNEL

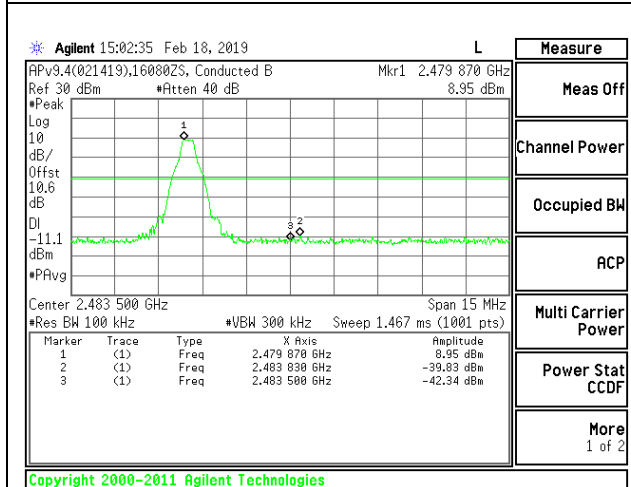

HIGH CHANNEL BANDEDGE

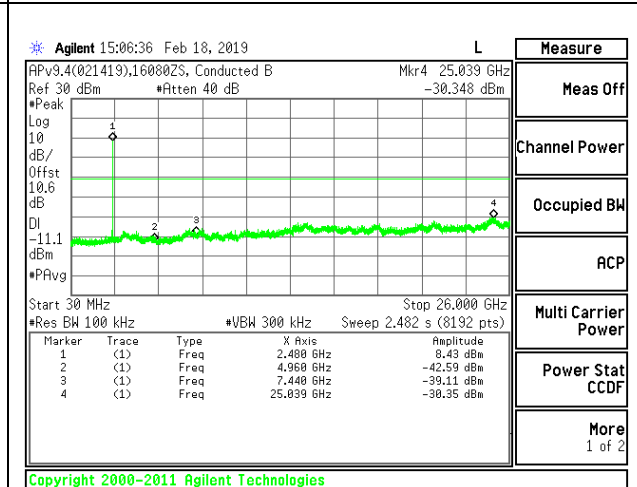

OUT-OF-BAND HIGH CHANNEL

Antenna 1 SPURIOUS BANDEDGE EMISSIONS WITH HOPPING ON

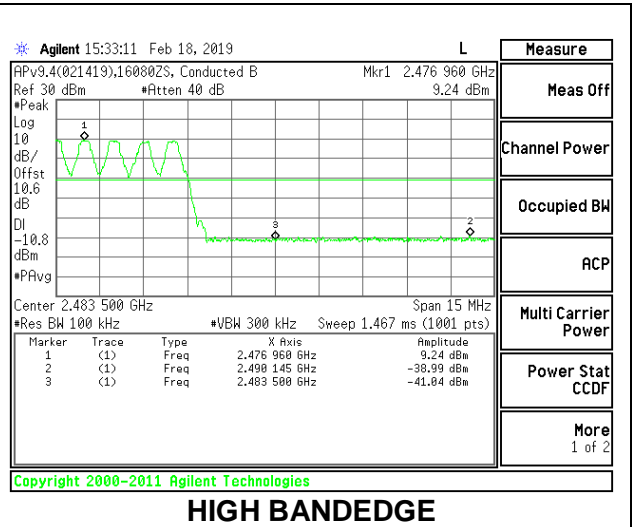
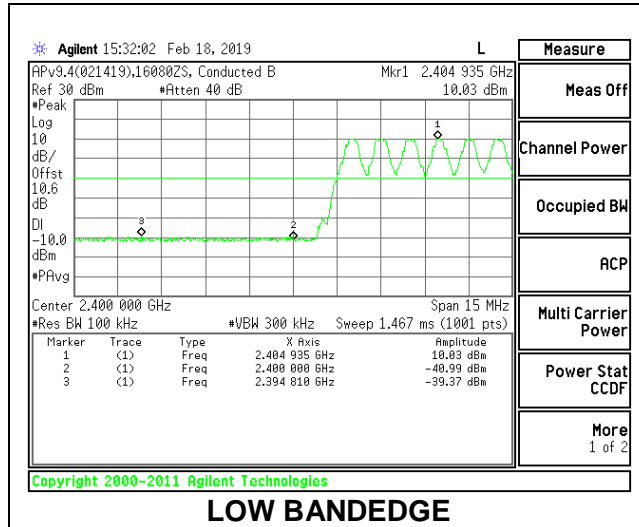

9.8.2. BLUETOOTH ENHANCED DATA RATE 8PSK MODULATION

Antenna 1 SPURIOUS EMISSIONS, NON-HOPPING

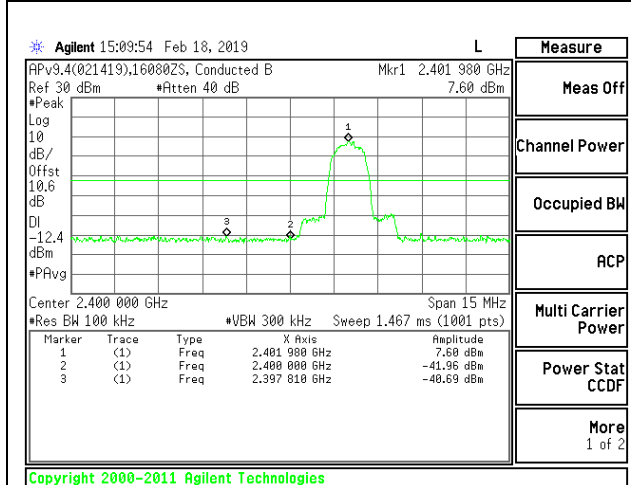

LOW CHANNEL BANDEDGE

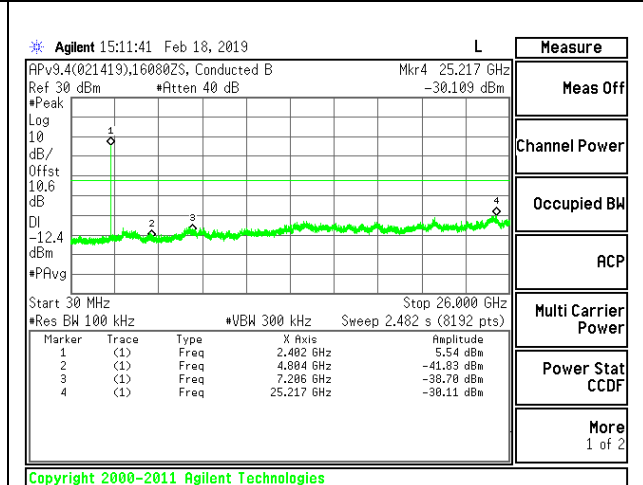

OUT-OF-BAND LOW CHANNEL

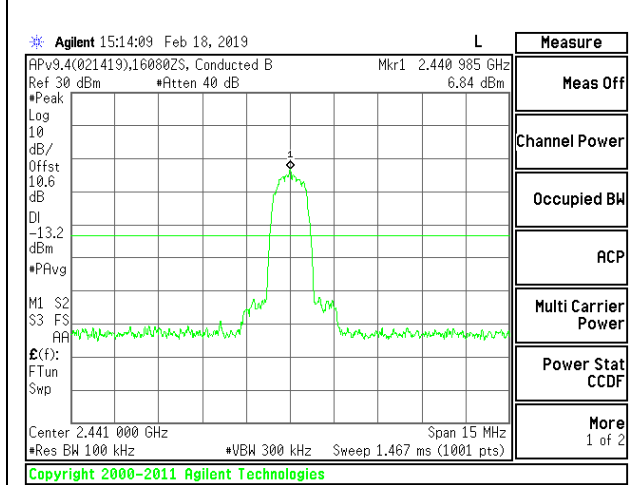

IN-BAND REFERENCE LEVEL

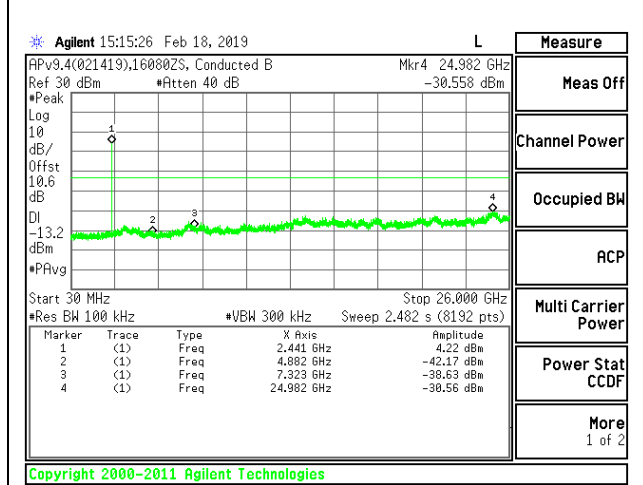

OUT-OF-BAND MID CHANNEL

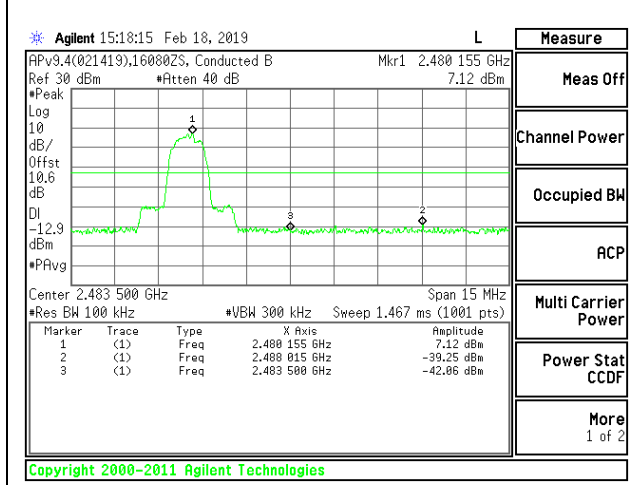

HIGH CHANNEL BANDEDGE

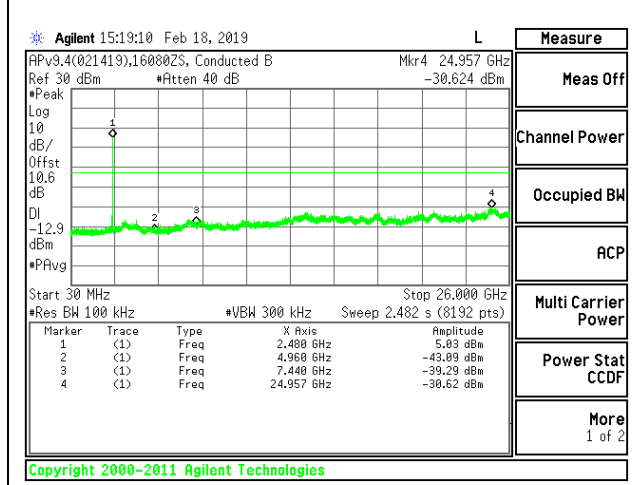

OUT-OF-BAND HIGH CHANNEL

Antenna 1 SPURIOUS BANDEDGE EMISSIONS WITH HOPPING ON

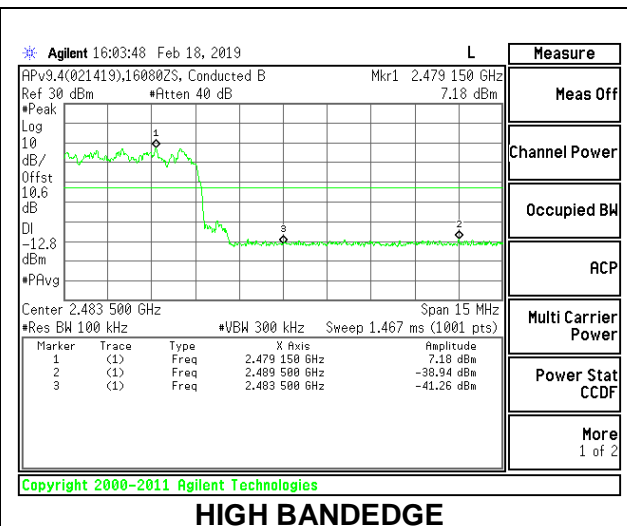
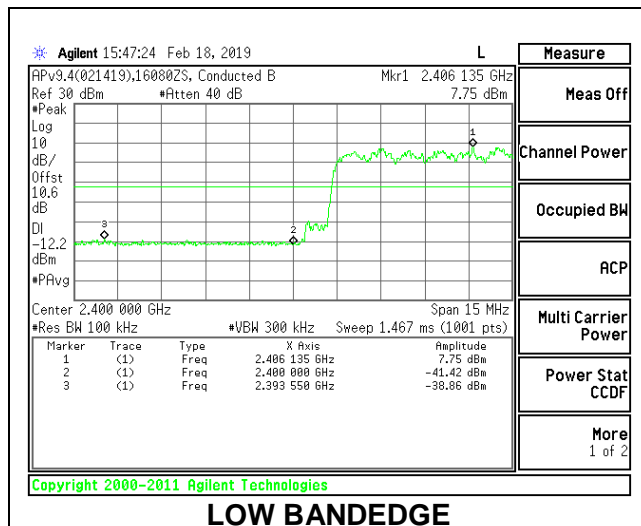

10. RADIATED TEST RESULTS

LIMITS

FCC §15.205 and §15.209

Frequency Range (MHz)	Field Strength Limit (uV/m) at 3 m	Field Strength Limit (dBuV/m) at 3 m
0.009-0.490	2400/F(kHz) @ 300 m	-
0.490-1.705	24000/F(kHz) @ 30 m	-
1.705 - 30	30 @ 30m	-
30 - 88	100	40
88 - 216	150	43.5
216 - 960	200	46
Above 960	500	54

TEST PROCEDURE

The EUT is placed on a non-conducting table 80 cm above the ground plane for measurement below 1GHz; 1.5 m above the ground plane for measurement above 1GHz. The antenna to EUT distance is 3 meters. The EUT is configured in accordance with ANSI C63.10. The EUT is set to transmit in a continuous mode.

For measurements below 1 GHz the resolution bandwidth is set to 100 kHz for peak detection measurements or 120 kHz for quasi-peak detection measurements. Peak detection is used unless otherwise noted as quasi-peak.

For pre-scans above 1 GHz the resolution bandwidth is set to 1 MHz; the video bandwidth is set to 30 KHz for peak measurements.

For measurements above 1 GHz the resolution bandwidth is set to 1 MHz, then the video bandwidth is set to 3 MHz for peak measurements and 1 MHz resolution bandwidth with 1/T (360Hz) video bandwidth with peak detector for average measurements.

The spectrum from 1 GHz to 18 GHz is investigated with the transmitter set to the lowest, middle, and highest channels in each applicable band. Below 1GHz and above 18GHz emissions, the channel with the highest output power was tested.

The frequency range of interest is monitored at a fixed antenna height and EUT azimuth. The EUT is rotated through 360 degrees to maximize emissions received. The antenna is scanned from 1 to 4 meters above the ground plane to further maximize the emission. Measurements are made with the antenna polarized in both the vertical and the horizontal positions.

2D antenna use - For below 30MHz testing, investigation was done on three antenna orientations (parallel, perpendicular, and ground-parallel), parallel and perpendicular are the worst orientations, therefore testing was performed on these two orientations only.

KDB 414788 OFS and Chamber Correlation Justification

Base on FCC 15.31 (f) (2): measurements may be performed at a distance closer than that specified in the regulations; however, an attempt should be made to avoid making measurements in the near field.

OFS and chamber correlation testing had been performed and chamber measured test result is the worst case test result.

10.1. TRANSMITTER ABOVE 1 GHz

10.1.1. BLUETOOTH BASIC DATA RATE GFSK MODULATION

BANDEDGE (LOW CHANNEL)

HORIZONTAL RESULT

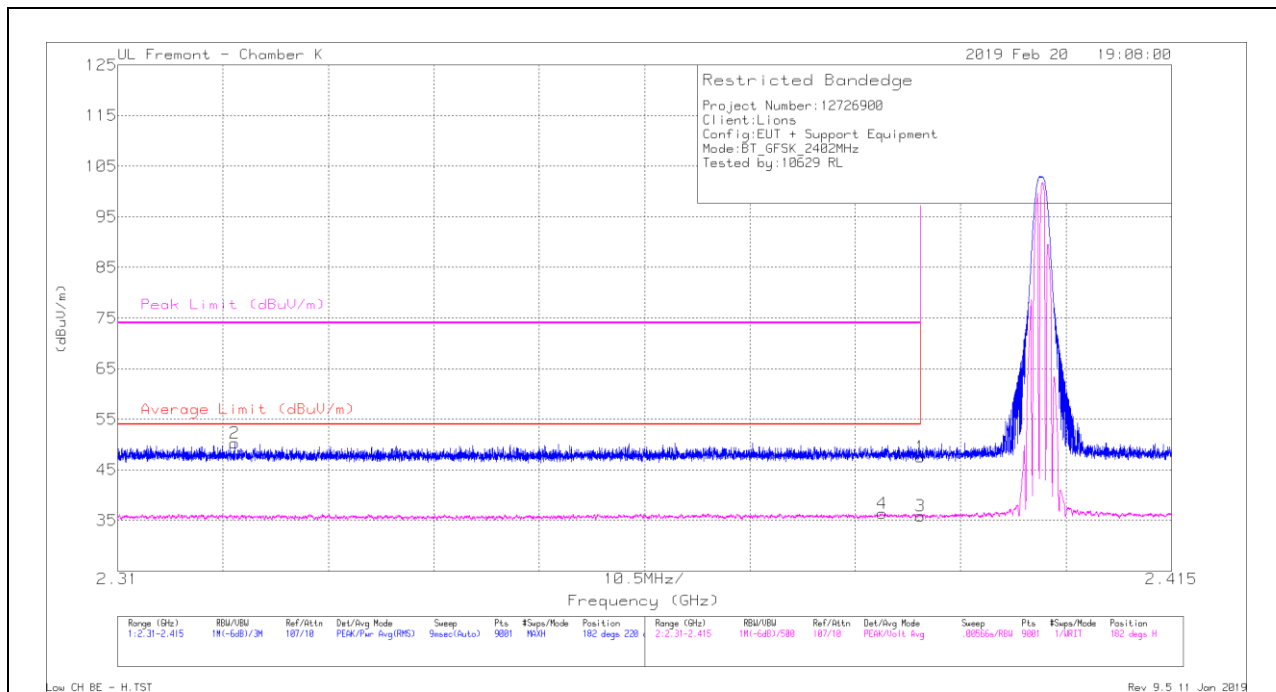

Trace Markers

Marker	Frequency (GHz)	Meter Reading (dBuV)	Det	AF T344 (dB/m)	Amp/Cbl/Filtr/Pad (dB)	Corrected Reading (dBuV/m)	Average Limit (dBuV/m)	Margin (dB)	Peak Limit (dBuV/m)	PK Margin (dB)	Azimuth (Degs)	Height (cm)	Polarity
1	* 2.39	40.41	Pk	31.9	-24.7	47.61	-	-	74	-26.39	182	220	H
2	* 2.322	43.29	Pk	31.7	-24.7	50.29	-	-	74	-23.71	182	220	H
3	* 2.39	28.66	VA1T	31.9	-24.7	35.86	54	-18.14	-	-	182	219	H
4	* 2.386	29.03	VA1T	31.9	-24.6	36.33	54	-17.67	-	-	182	219	H

* - indicates frequency in CFR47 Pt 15 / IC RSS-Restricted Band

Pk - Peak detector

VA1T - FHSS: Linear Voltage Average $V_B=1/T_{on}$ where: T_{on} is transmit duration

VERTICAL RESULT

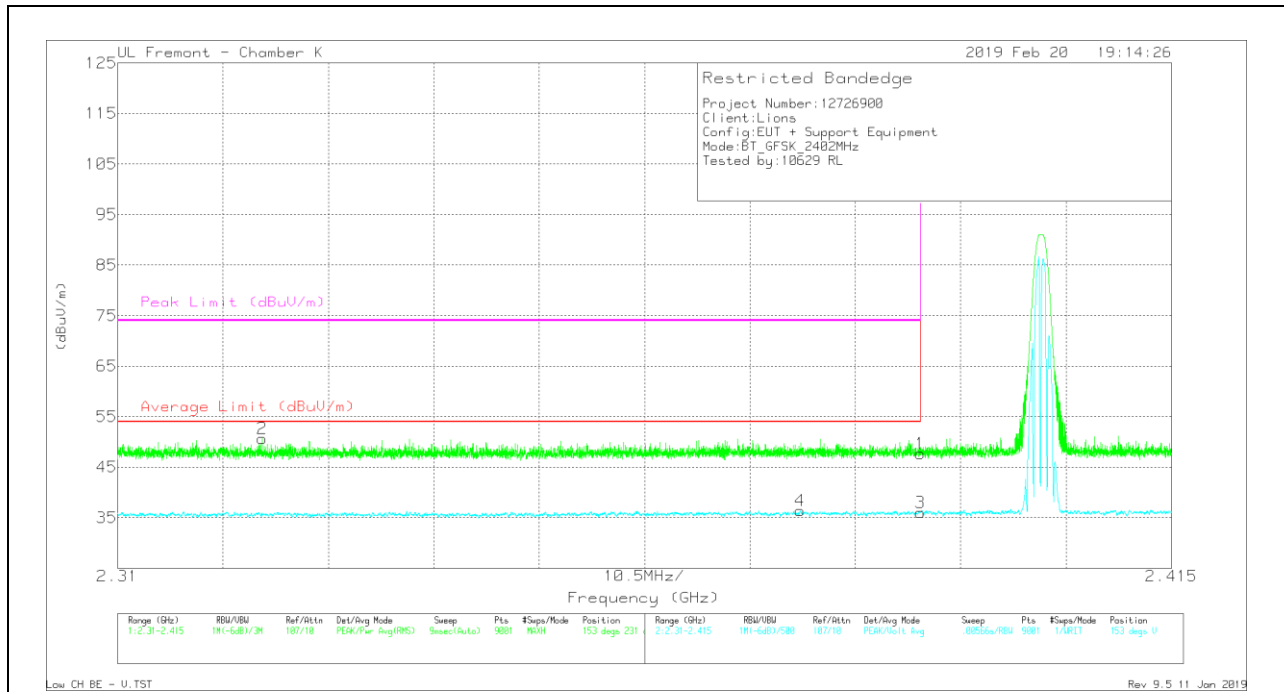

Trace Markers

Marker	Frequency (GHz)	Meter Reading (dBuV)	Det	AF T344 (dB/m)	Amp/Cbl/Fitr/Pad (dB)	Corrected Reading (dBuV/m)	Average Limit (dBuV/m)	Margin (dB)	Peak Limit (dBuV/m)	PK Margin (dB)	Azimuth (Degs)	Height (cm)	Polarity
1	* 2.39	40.54	Pk	31.9	-24.7	47.74	-	-	74	-26.26	153	231	V
2	* 2.324	43.64	Pk	31.7	-24.7	50.64	-	-	74	-23.36	153	231	V
3	* 2.39	28.83	VA1T	31.9	-24.7	36.03	54	-17.97	-	-	153	231	V
4	* 2.378	29.31	VA1T	31.8	-24.7	36.41	54	-17.59	-	-	153	231	V

* - indicates frequency in CFR47 Pt 15 / IC RSS-Restricted Band

Pk - Peak detector

VA1T - FHSS: Linear Voltage Average $V_B=1/T_{on}$ where: T_{on} is transmit duration

BANEDGE (HIGH CHANNEL)

HORIZONTAL RESULT

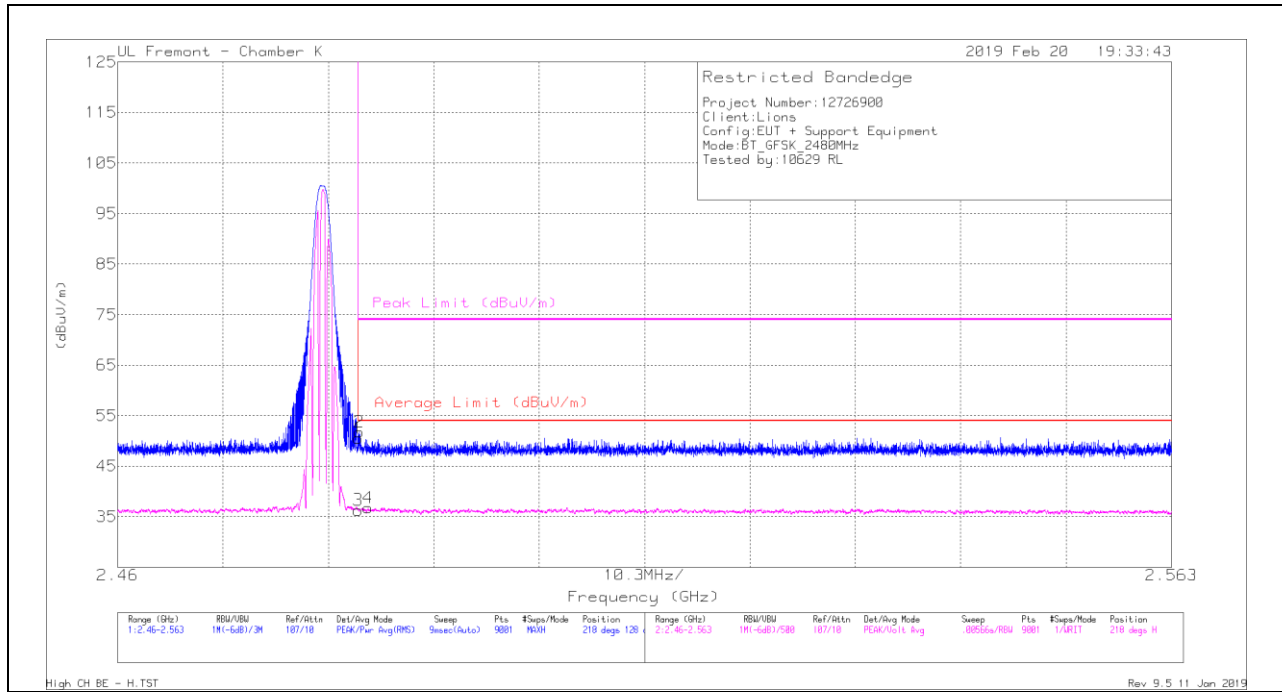

Trace Markers

Marker	Frequency (GHz)	Meter Reading (dBuV)	Det	AF T344 (dB/m)	Amp/Cbl/Fitr/Pad (dB)	Corrected Reading (dBuV/m)	Average Limit (dBuV/m)	Margin (dB)	Peak Limit (dBuV/m)	PK Margin (dB)	Azimuth (Degs)	Height (cm)	Polarity
1	* 2.484	43.07	Pk	32.3	-24.8	50.57	-	-	74	-23.43	218	128	H
2	* 2.484	44.33	Pk	32.3	-24.8	51.83	-	-	74	-22.17	218	128	H
3	* 2.484	28.82	VA1T	32.3	-24.8	36.32	54	-17.68	-	-	218	128	H
4	* 2.484	29.27	VA1T	32.3	-24.8	36.77	54	-17.23	-	-	218	128	H

* - indicates frequency in CFR47 Pt 15 / IC RSS-Restricted Band
 Pk - Peak detector
 VA1T - FHSS: Linear Voltage Average $V_B=1/T_{on}$ where: T_{on} is transmit duration

VERTICAL RESULT

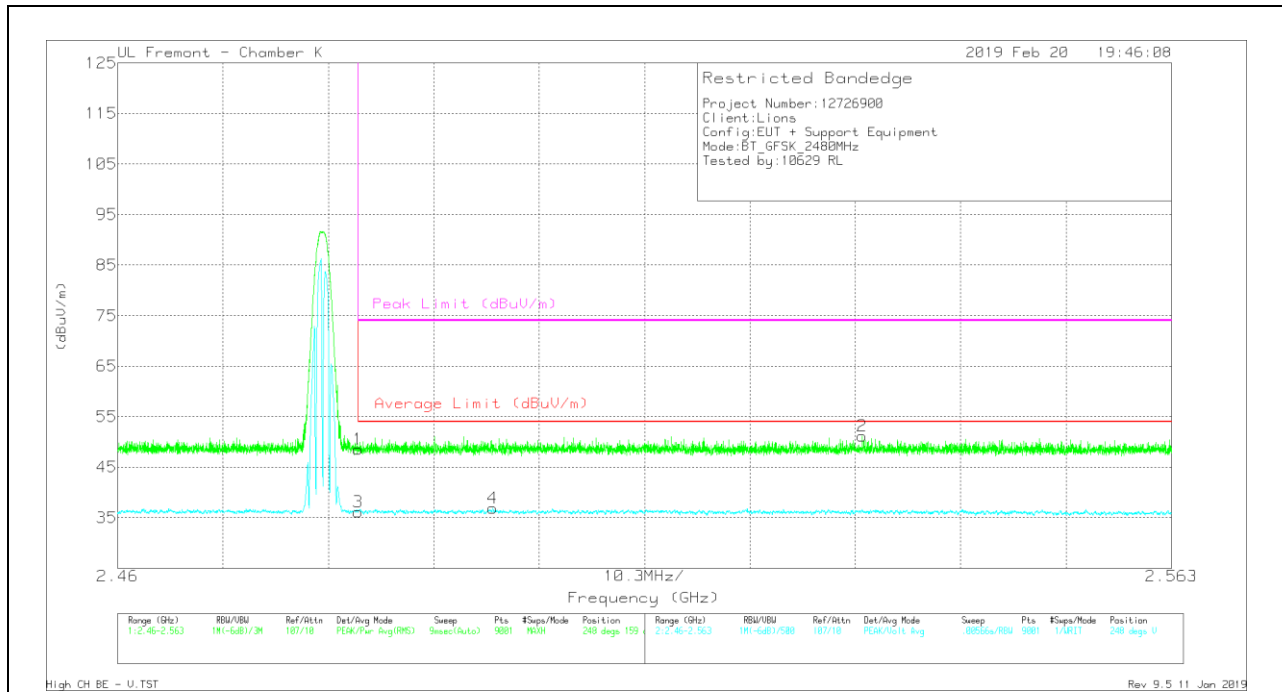

Trace Markers

Marker	Frequency (GHz)	Meter Reading (dBuV)	Det	AF T344 (dB/m)	Amp/Cbl/Filtr/Pad (dB)	Corrected Reading (dBuV/m)	Average Limit (dBuV/m)	Margin (dB)	Peak Limit (dBuV/m)	PK Margin (dB)	Azimuth (Degs)	Height (cm)	Polarity
1	*2.484	41.07	Pk	32.3	-24.8	48.57	-	-	74	-25.43	248	159	V
2	2.533	43.52	Pk	32.3	-24.7	51.12	-	-	74	-22.88	248	159	V
3	*2.484	28.69	VA1T	32.3	-24.8	36.19	54	-17.81	-	-	248	159	V
4	*2.497	29.41	VA1T	32.3	-24.8	36.91	54	-17.09	-	-	248	159	V

* - indicates frequency in CFR47 Pt 15 / IC RSS-Restricted Band

Pk - Peak detector

VA1T - FHSS: Linear Voltage Average $V_B=1/T_{on}$ where: T_{on} is transmit duration

HARMONICS AND SPURIOUS EMISSIONS

LOW CHANNEL RESULTS

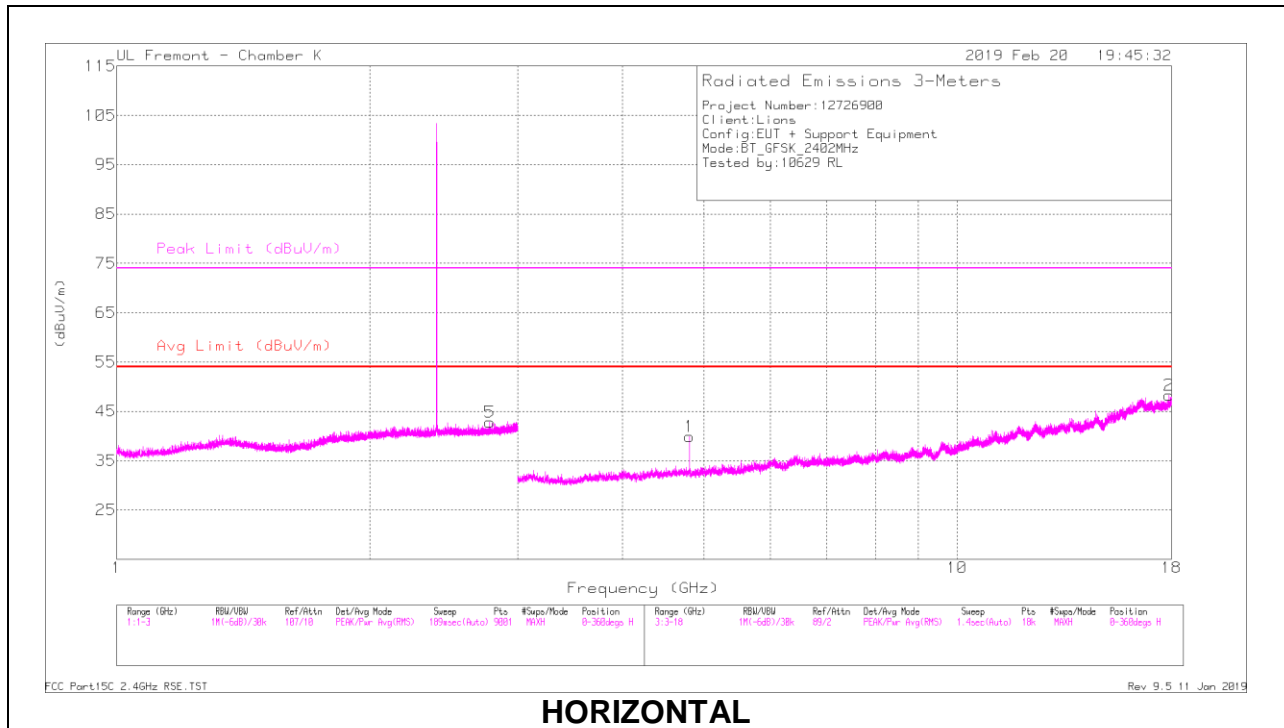

HORIZONTAL

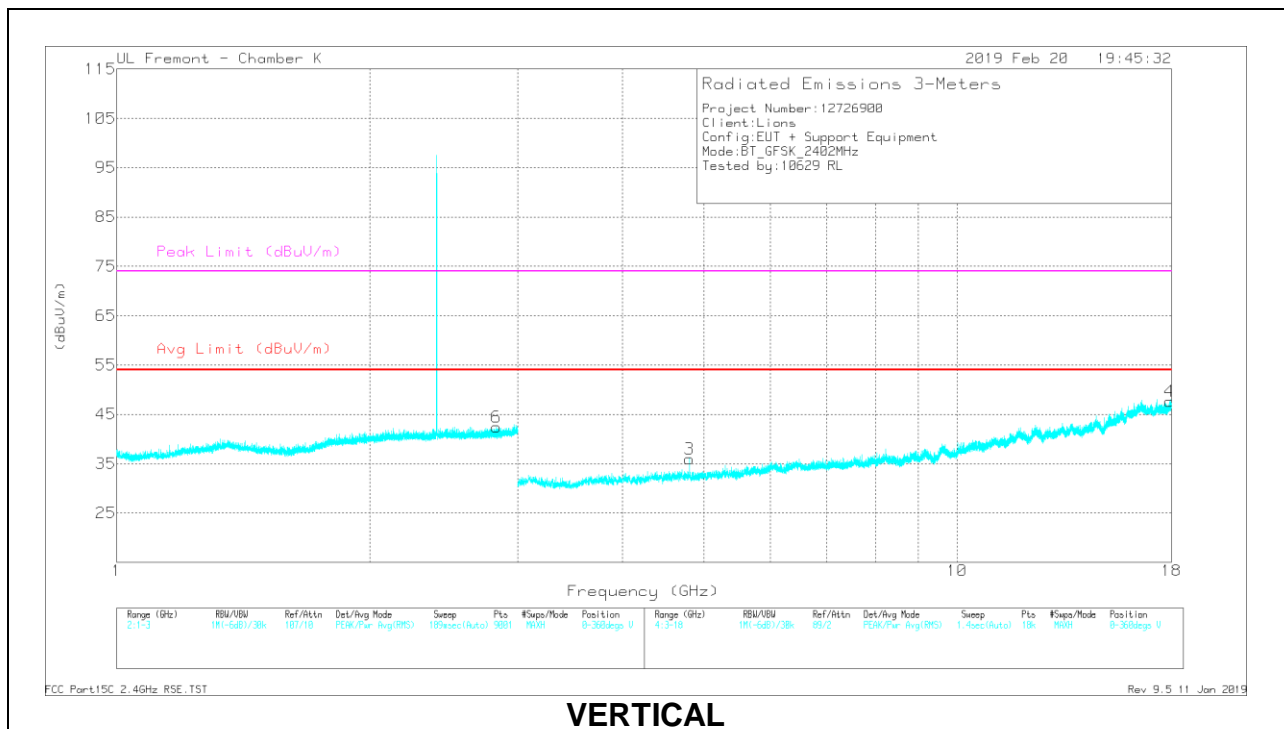

VERTICAL

RADIATED EMISSIONS

Marker	Frequency (GHz)	Meter Reading (dBuV)	Det	AF T344 (dB/m)	Amp/Cbl/Filtr/Pad (dB)	Corrected Reading (dBuV/m)	Avg Limit (dBuV/m)	Margin (dB)	Peak Limit (dBuV/m)	PK Margin (dB)	Azimuth (Degs)	Height (cm)	Polarity
5	* 2.779	41.66	PKFH	32.3	-24.6	49.36	-	-	74	-24.64	303	317	H
	* 2.782	28.92	VA1T	32.3	-24.5	36.72	54	-17.28	-	-	303	317	H
6	* 2.831	40.63	PKFH	32.3	-24.4	48.53	-	-	74	-25.47	73	253	V
	* 2.834	28.89	VA1T	32.3	-24.5	36.69	54	-17.31	-	-	73	253	V
1	* 4.804	41.37	PKFH	34.2	-30.3	45.27	-	-	74	-28.73	159	103	H
	* 4.804	35.34	VA1T	34.2	-30.3	39.24	54	-14.76	-	-	159	103	H
2	* 17.883	28.26	PKFH	41.2	-15.6	53.86	-	-	74	-20.14	293	176	H
	* 17.882	16.05	VA1T	41.2	-15.7	41.55	54	-12.45	-	-	293	176	H
3	* 4.804	39.11	PKFH	34.2	-30.3	43.01	-	-	74	-30.99	7	217	V
	* 4.804	29.84	VA1T	34.2	-30.3	33.74	54	-20.26	-	-	7	217	V
4	* 17.914	28.6	PKFH	41.2	-15.5	54.3	-	-	74	-19.7	259	328	V
	* 17.916	16.08	VA1T	41.2	-15.5	41.78	54	-12.22	-	-	259	328	V

* - indicates frequency in CFR47 Pt 15 / IC RSS-Restricted Band
 PKFH FHSS/BT RB=100k for Frequencies<1GHz / RB=1MHz for Frequencies>1GHz, VB=3 x RB, Peak
 VA1T - FHSS: Linear Voltage Average VB=1/Ton where: Ton is transmit duration

MID CHANNEL RESULTS

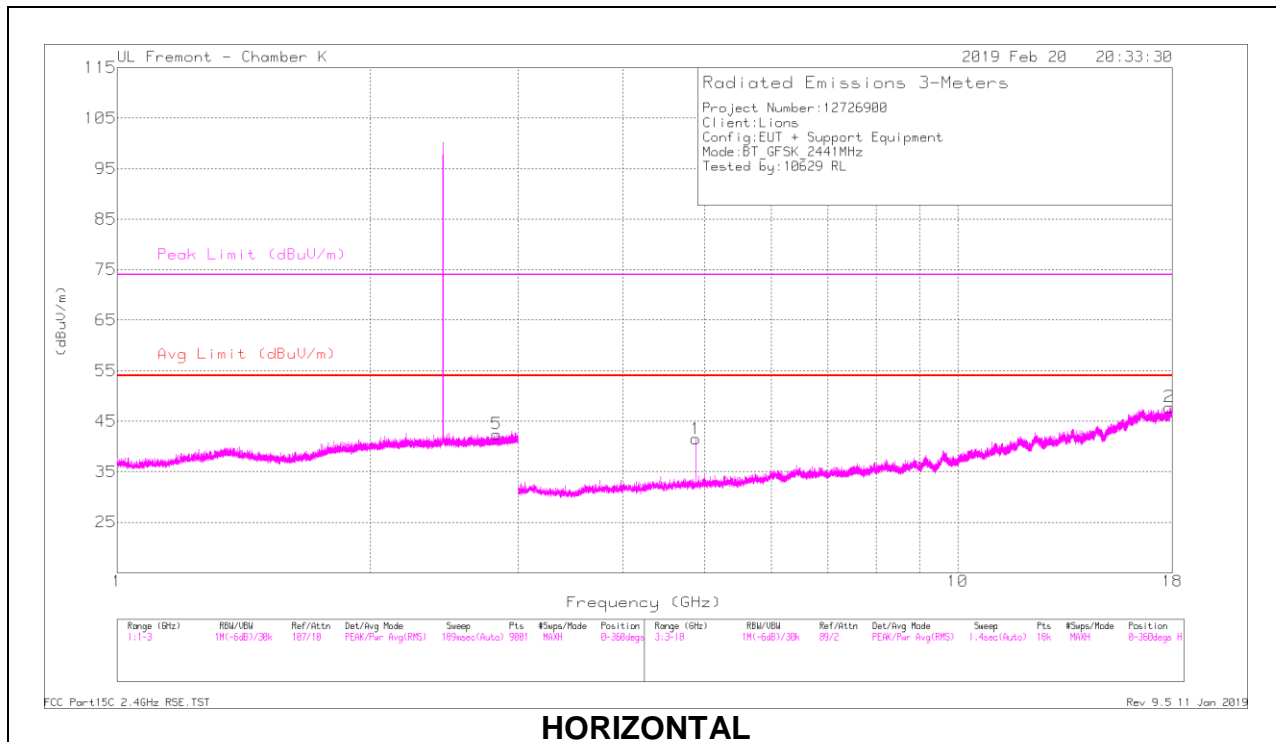

HORIZONTAL

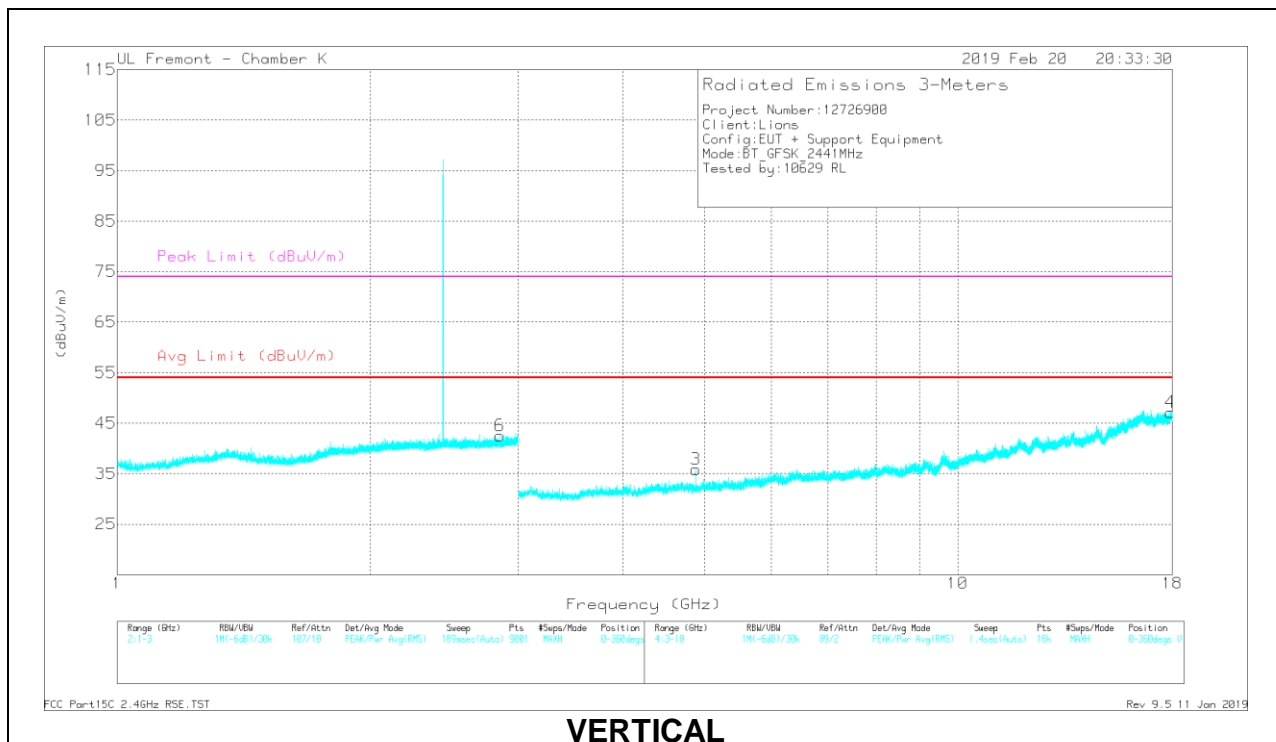

VERTICAL

RADIATED EMISSIONS

Marker	Frequency (GHz)	Meter Reading (dBuV)	Det	AF T344 (dB/m)	Amp/Cbl/Filtr/Pad (dB)	Corrected Reading (dBuV/m)	Avg Limit (dBuV/m)	Margin (dB)	Peak Limit (dBuV/m)	PK Margin (dB)	Azimuth (Degs)	Height (cm)	Polarity
5	* 2.827	41.53	PKFH	32.3	-24.4	49.43	-	-	74	-24.57	107	306	H
	* 2.827	28.89	VA1T	32.3	-24.4	36.79	54	-17.21	-	-	107	306	H
6	* 2.854	41.03	PKFH	32.3	-24.5	48.83	-	-	74	-25.17	278	381	V
	* 2.851	28.89	VA1T	32.3	-24.5	36.69	54	-17.31	-	-	278	381	V
2	* 17.858	28.79	PKFH	41.3	-15.6	54.49	-	-	74	-19.51	305	177	H
	* 17.857	15.92	VA1T	41.3	-15.6	41.62	54	-12.38	-	-	305	177	H
1	* 4.882	42.57	PKFH	34.1	-30.5	46.17	-	-	74	-27.83	161	135	H
	* 4.882	35.81	VA1T	34.1	-30.5	39.41	54	-14.59	-	-	161	135	H
4	* 17.912	28.62	PKFH	41.2	-15.5	54.32	-	-	74	-19.68	259	328	V
	* 17.911	16.05	VA1T	41.2	-15.5	41.75	54	-12.25	-	-	259	328	V
3	* 4.882	38.92	PKFH	34.1	-30.5	42.52	-	-	74	-31.48	12	110	V
	* 4.882	30.61	VA1T	34.1	-30.5	34.21	54	-19.79	-	-	12	110	V

* - indicates frequency in CFR47 Pt 15 / IC RSS-Restricted Band
 PKFH FHSS/BT RB=100k for Frequencies<1GHz / RB=1MHz for Frequencies>1GHz, VB=3 x RB, Peak
 VA1T - FHSS: Linear Voltage Average VB=1/Ton where: Ton is transmit duration

HIGH CHANNEL RESULTS

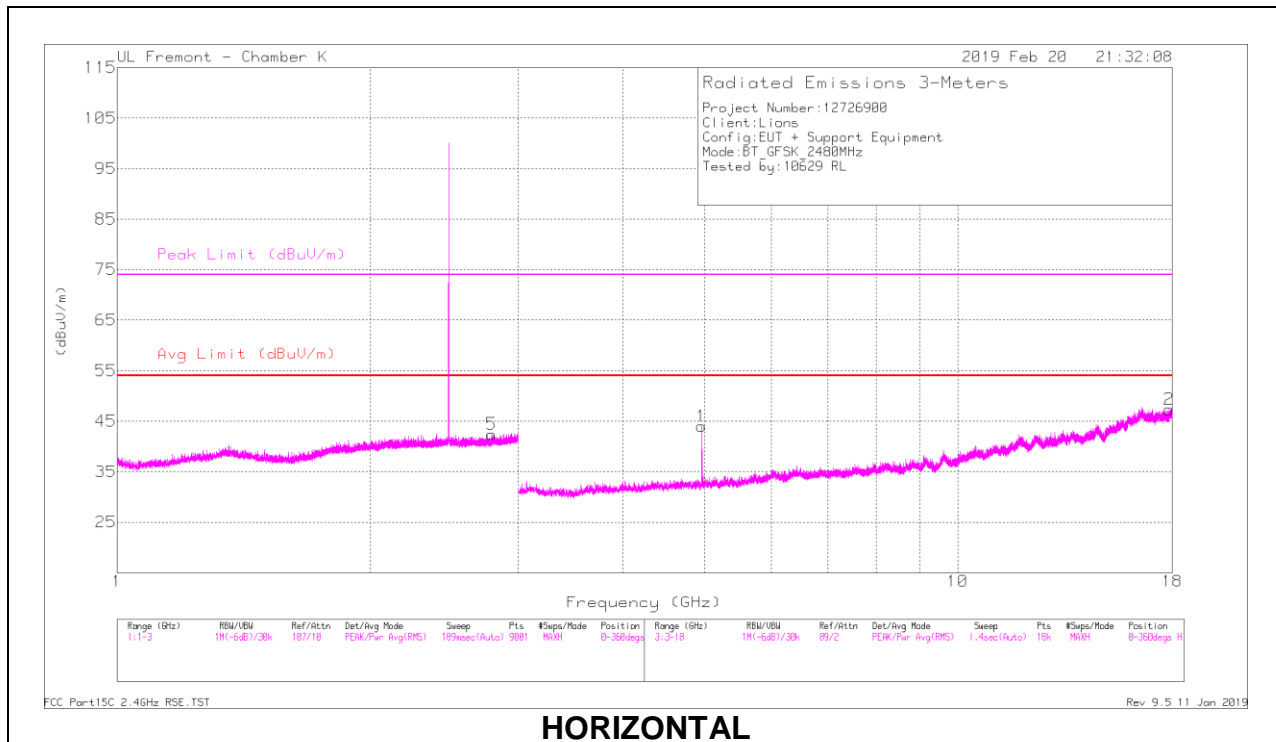

HORIZONTAL

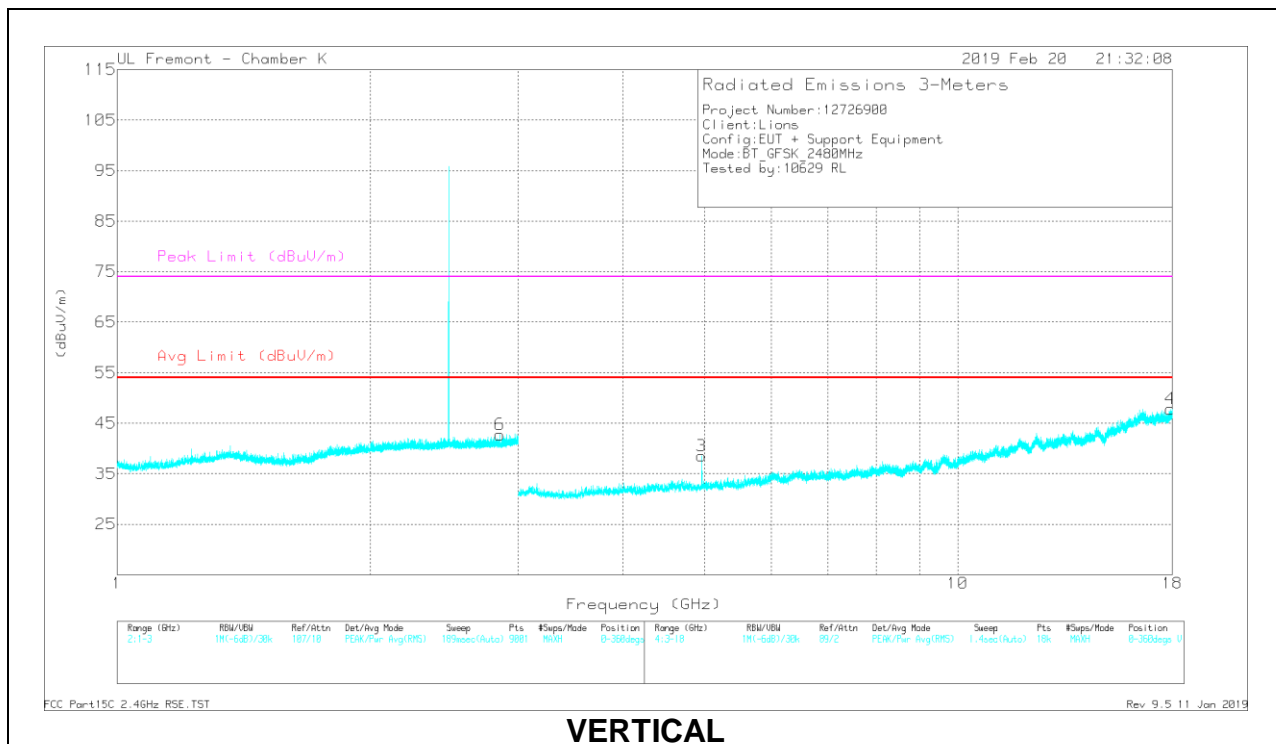

VERTICAL

RADIATED EMISSIONS

Marker	Frequency (GHz)	Meter Reading (dBuV)	Det	AF T344 (dB/m)	Amp/Cbl/Filtr/Pad (dB)	Corrected Reading (dBuV/m)	Avg Limit (dBuV/m)	Margin (dB)	Peak Limit (dBuV/m)	PK Margin (dB)	Azimuth (Degs)	Height (cm)	Polarity
5	* 2.788	42.47	PKFH	32.3	-24.6	50.17	-	-	74	-23.83	186	353	H
	* 2.786	28.95	VA1T	32.3	-24.5	36.75	54	-17.25	-	-	186	353	H
6	* 2.854	40.51	PKFH	32.3	-24.5	48.31	-	-	74	-25.69	17	128	V
	* 2.855	28.94	VA1T	32.3	-24.5	36.74	54	-17.26	-	-	17	128	V
2	* 17.844	28.29	PKFH	41.3	-15.7	53.89	-	-	74	-20.11	189	372	H
	* 17.842	16.27	VA1T	41.3	-15.7	41.87	54	-12.13	-	-	189	372	H
1	* 4.96	44.41	PKFH	34.2	-30.6	48.01	-	-	74	-25.99	172	104	H
	* 4.96	39.09	VA1T	34.2	-30.6	42.69	54	-11.31	-	-	172	104	H
4	* 17.91	28.87	PKFH	41.2	-15.5	54.57	-	-	74	-19.43	338	227	V
	* 17.91	15.88	VA1T	41.2	-15.5	41.58	54	-12.42	-	-	338	227	V
3	* 4.96	40.73	PKFH	34.2	-30.6	44.33	-	-	74	-29.67	8	102	V
	* 4.96	32.82	VA1T	34.2	-30.6	36.42	54	-17.58	-	-	8	102	V

* - indicates frequency in CFR47 Pt 15 / IC RSS-Restricted Band
 PKFH FHSS/BT RB=100k for Frequencies<1GHz / RB=1MHz for Frequencies>1GHz, VB=3 x RB, Peak
 VA1T - FHSS: Linear Voltage Average VB=1/Ton where: Ton is transmit duration

10.1.2. BLUETOOTH ENHANCED DATA RATE 8PSK MODULATION

BANDEDGE (LOW CHANNEL)

HORIZONTAL RESULT

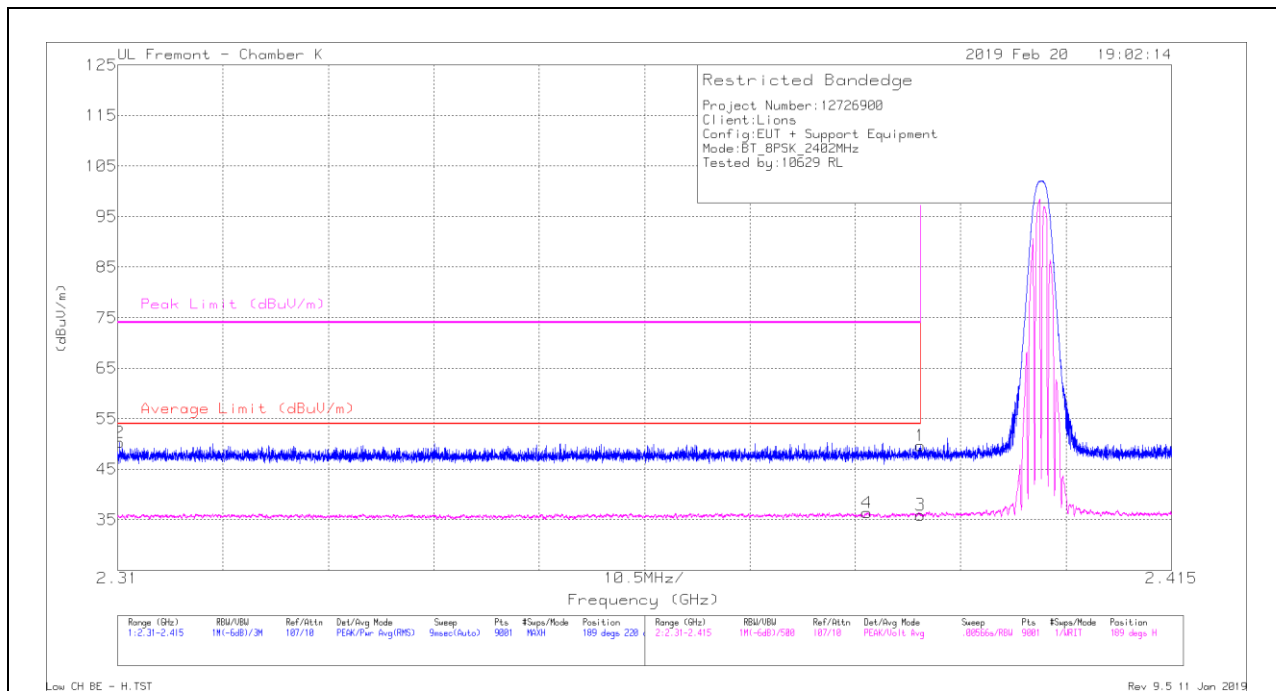

Trace Markers

Marker	Frequency (GHz)	Meter Reading (dBuV)	Det	AF T344 (dB/m)	Amp/Cbl/Filtr/Pad (dB)	Corrected Reading (dBuV/m)	Average Limit (dBuV/m)	Margin (dB)	Peak Limit (dBuV/m)	PK Margin (dB)	Azimuth (Degs)	Height (cm)	Polarity
1	* 2.39	42.45	Pk	31.9	-24.7	49.65	-	-	74	-24.35	189	220	H
2	* 2.31	43.31	Pk	31.7	-24.7	50.31	-	-	74	-23.69	189	220	H
3	* 2.39	28.75	VA1T	31.9	-24.7	35.95	54	-18.05	-	-	189	220	H
4	* 2.385	29.08	VA1T	31.9	-24.6	36.38	54	-17.62	-	-	189	220	H

* - indicates frequency in CFR47 Pt 15 / IC RSS-Restricted Band

Pk - Peak detector

VA1T - FHSS: Linear Voltage Average $V_B=1/T_{on}$ where: T_{on} is transmit duration

VERTICAL RESULT

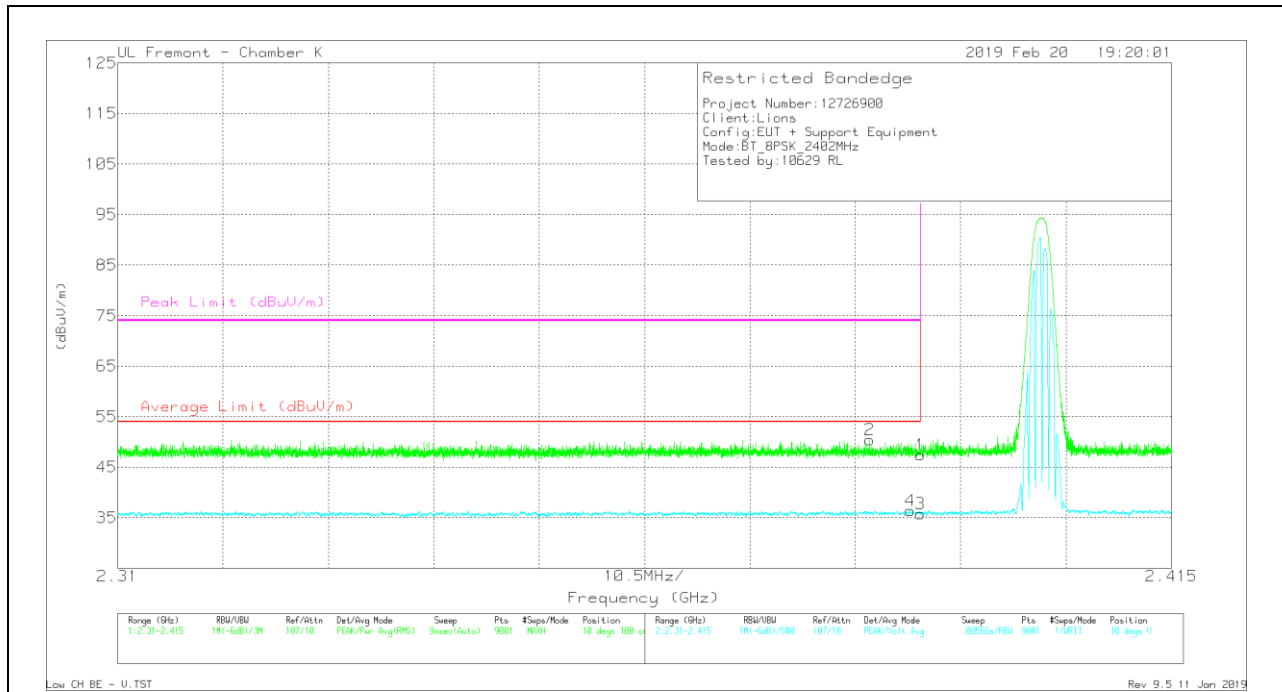

Trace Markers

Marker	Frequency (GHz)	Meter Reading (dBuV)	Det	AF T344 (dB/m)	Amp/Cbl/Fitr/Pad (dB)	Corrected Reading (dBuV/m)	Average Limit (dBuV/m)	Margin (dB)	Peak Limit (dBuV/m)	PK Margin (dB)	Azimuth (Degs)	Height (cm)	Polarity
1	* 2.39	40.24	Pk	31.9	-24.7	47.44	-	-	74	-26.56	10	100	V
2	* 2.385	43.13	Pk	31.9	-24.6	50.43	-	-	74	-23.57	10	100	V
3	* 2.39	28.62	VA1T	31.9	-24.7	35.82	54	-18.18	-	-	10	100	V
4	* 2.389	29.18	VA1T	31.9	-24.7	36.38	54	-17.62	-	-	10	100	V

* - indicates frequency in CFR47 Pt 15 / IC RSS-Restricted Band

Pk - Peak detector

VA1T - FHSS: Linear Voltage Average $V_B=1/T_{on}$ where: T_{on} is transmit duration

BANEDGE (HIGH CHANNEL)

HORIZONTAL RESULT

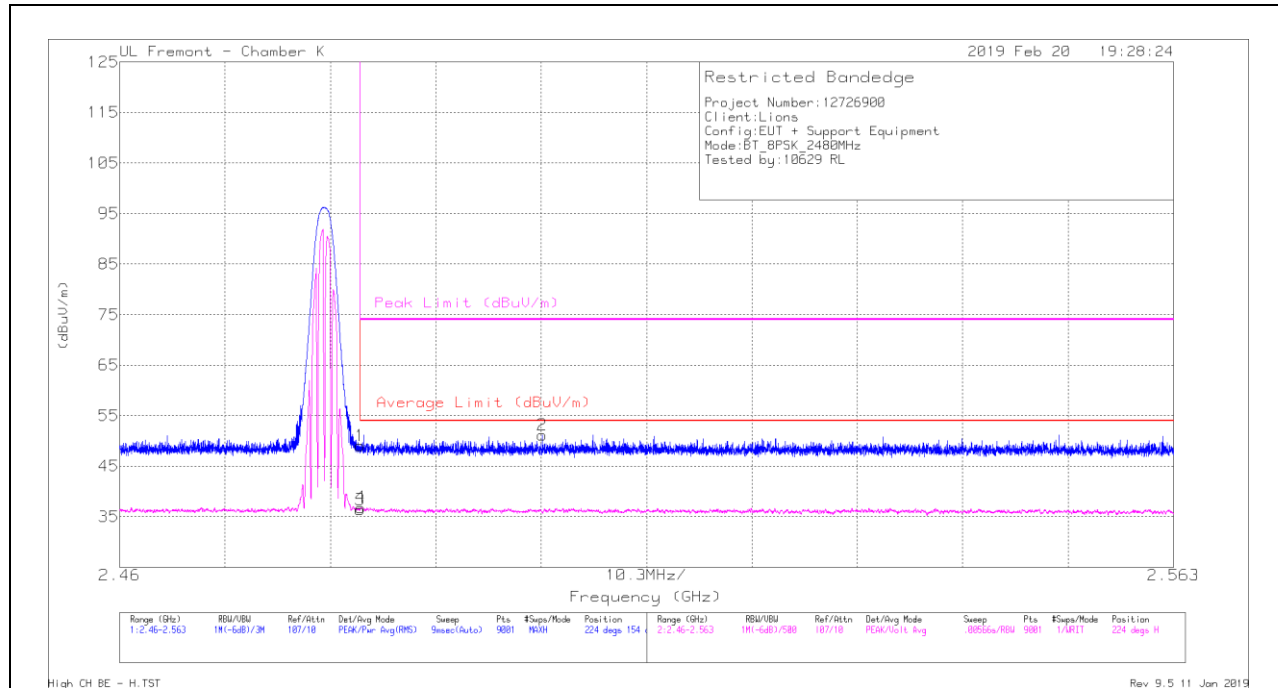

Trace Markers

Marker	Frequency (GHz)	Meter Reading (dBuV)	Det	AF T344 (dB/m)	Amp/Cbl/Fitr/Pad (dB)	Corrected Reading (dBuV/m)	Average Limit (dBuV/m)	Margin (dB)	Peak Limit (dBuV/m)	PK Margin (dB)	Azimuth (Degs)	Height (cm)	Polarity
1	* 2.484	41.56	Pk	32.3	-24.8	49.06	-	-	74	-24.94	224	154	H
2	2.501	43.6	Pk	32.3	-24.7	51.2	-	-	74	-22.8	224	154	H
3	* 2.484	28.92	VA1T	32.3	-24.8	36.42	54	-17.58	-	-	224	154	H
4	* 2.484	29.32	VA1T	32.3	-24.8	36.82	54	-17.18	-	-	224	154	H

* - indicates frequency in CFR47 Pt 15 / IC RSS-Restricted Band
 Pk - Peak detector
 VA1T - FHSS: Linear Voltage Average $V_B=1/T_{on}$ where: T_{on} is transmit duration

VERTICAL RESULT

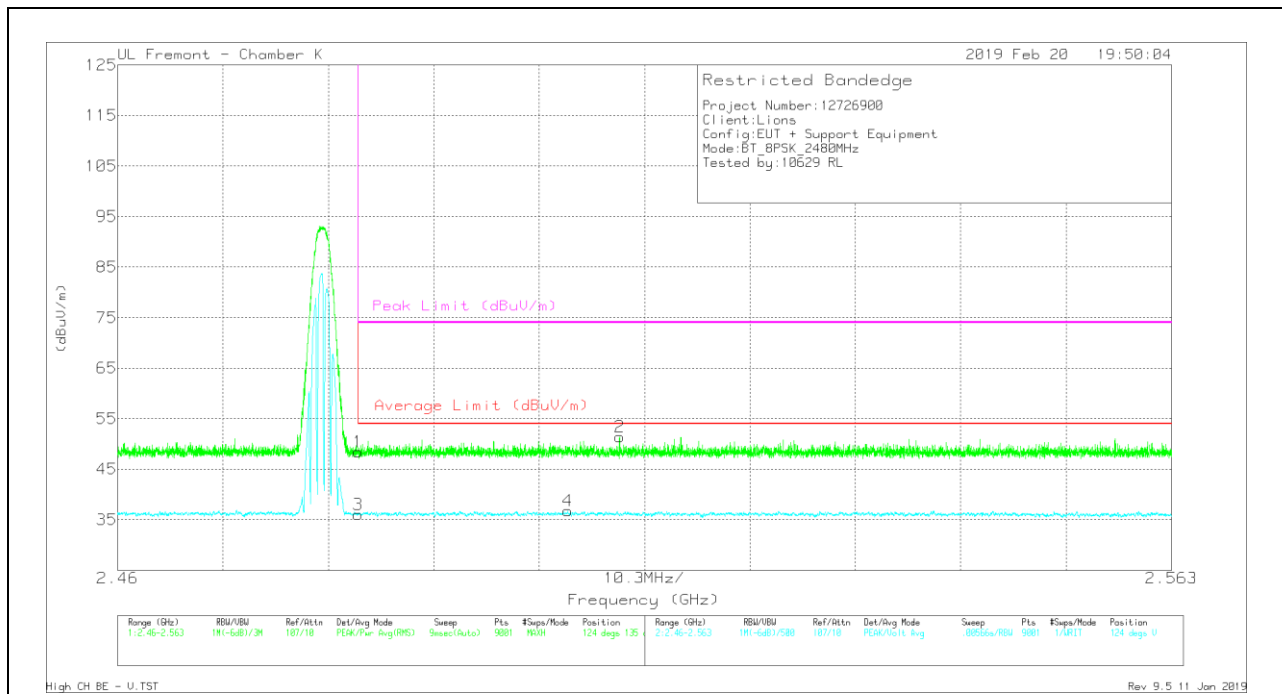

Trace Markers

Marker	Frequency (GHz)	Meter Reading (dBuV)	Det	AF T344 (dB/m)	Amp/Cbl/Filtr/Pad (dB)	Corrected Reading (dBuV/m)	Average Limit (dBuV/m)	Margin (dB)	Peak Limit (dBuV/m)	PK Margin (dB)	Azimuth (Degs)	Height (cm)	Polarity
1	*2.484	40.98	Pk	32.3	-24.8	48.48	-	-	74	-25.52	124	135	V
2	2.509	43.86	Pk	32.3	-24.8	51.36	-	-	74	-22.64	124	135	V
3	*2.484	28.51	VA1T	32.3	-24.8	36.01	54	-17.99	-	-	124	135	V
4	2.504	29.14	VA1T	32.3	-24.7	36.74	54	-17.26	-	-	124	135	V

* - indicates frequency in CFR47 Pt 15 / IC RSS-Restricted Band

Pk - Peak detector

VA1T - FHSS: Linear Voltage Average $V_B=1/T_{on}$ where: T_{on} is transmit duration

HARMONICS AND SPURIOUS EMISSIONS

LOW CHANNEL RESULTS

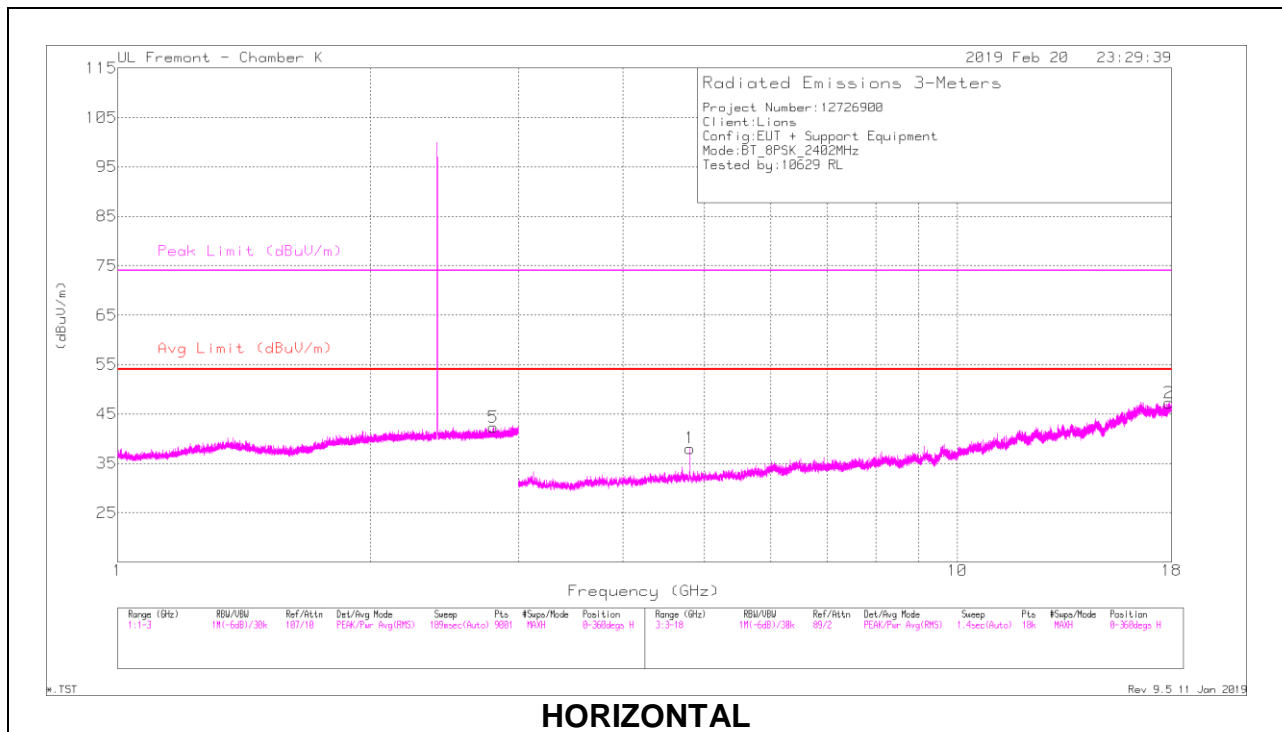

HORIZONTAL

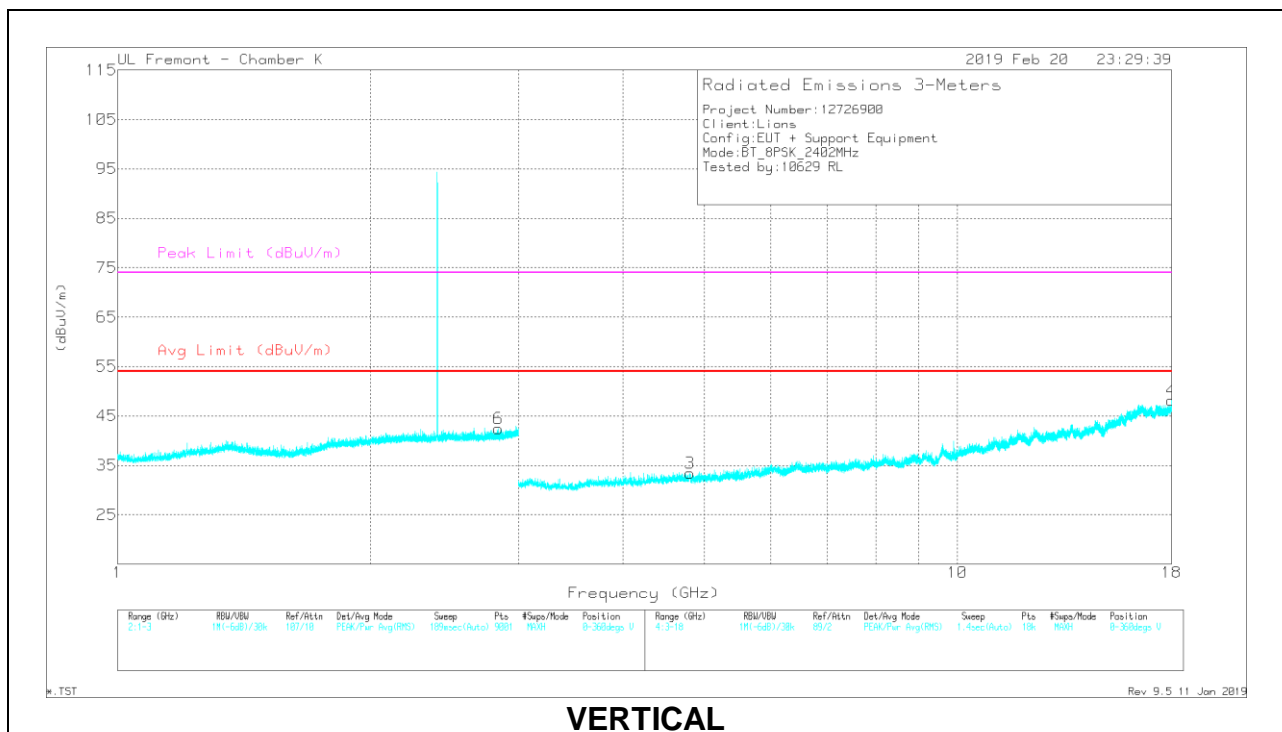

VERTICAL

RADIATED EMISSIONS

Marker	Frequency (GHz)	Meter Reading (dBuV)	Det	AF T344 (dB/m)	Amp/Cbl/Filtr/Pad (dB)	Corrected Reading (dBuV/m)	Avg Limit (dBuV/m)	Margin (dB)	Peak Limit (dBuV/m)	PK Margin (dB)	Azimuth (Degs)	Height (cm)	Polarity
5	* 2.801	41.1	PKFH	32.4	-24.5	49	-	-	74	-25	114	283	H
	* 2.801	29.16	VA1T	32.4	-24.5	37.06	54	-16.94	-	-	114	283	H
6	* 2.837	40.65	PKFH	32.3	-24.4	48.55	-	-	74	-25.45	251	108	V
	* 2.841	29	VA1T	32.3	-24.5	36.8	54	-17.2	-	-	251	108	V
2	* 17.884	27.95	PKFH	41.2	-15.6	53.55	-	-	74	-20.45	197	224	H
	* 17.885	16.03	VA1T	41.2	-15.6	41.63	54	-12.37	-	-	197	224	H
1	* 4.804	40.29	PKFH	34.2	-30.3	44.19	-	-	74	-29.81	169	116	H
	* 4.804	31.06	VA1T	34.2	-30.3	34.96	54	-19.04	-	-	169	116	H
4	* 17.994	28.28	PKFH	40.9	-15.3	53.88	-	-	74	-20.12	211	300	V
	* 17.997	15.86	VA1T	40.9	-15.3	41.46	54	-12.54	-	-	211	300	V
3	* 4.805	40.44	PKFH	34.2	-30.3	44.34	-	-	74	-29.66	61	115	V
	* 4.804	27.53	VA1T	34.2	-30.3	31.43	54	-22.57	-	-	61	115	V

* - indicates frequency in CFR47 Pt 15 / IC RSS-Restricted Band
 PKFH FHSS/BT RB=100k for Frequencies<1GHz / RB=1MHz for Frequencies>1GHz, VB=3 x RB, Peak
 VA1T - FHSS: Linear Voltage Average VB=1/Ton where: Ton is transmit duration

MID CHANNEL RESULTS

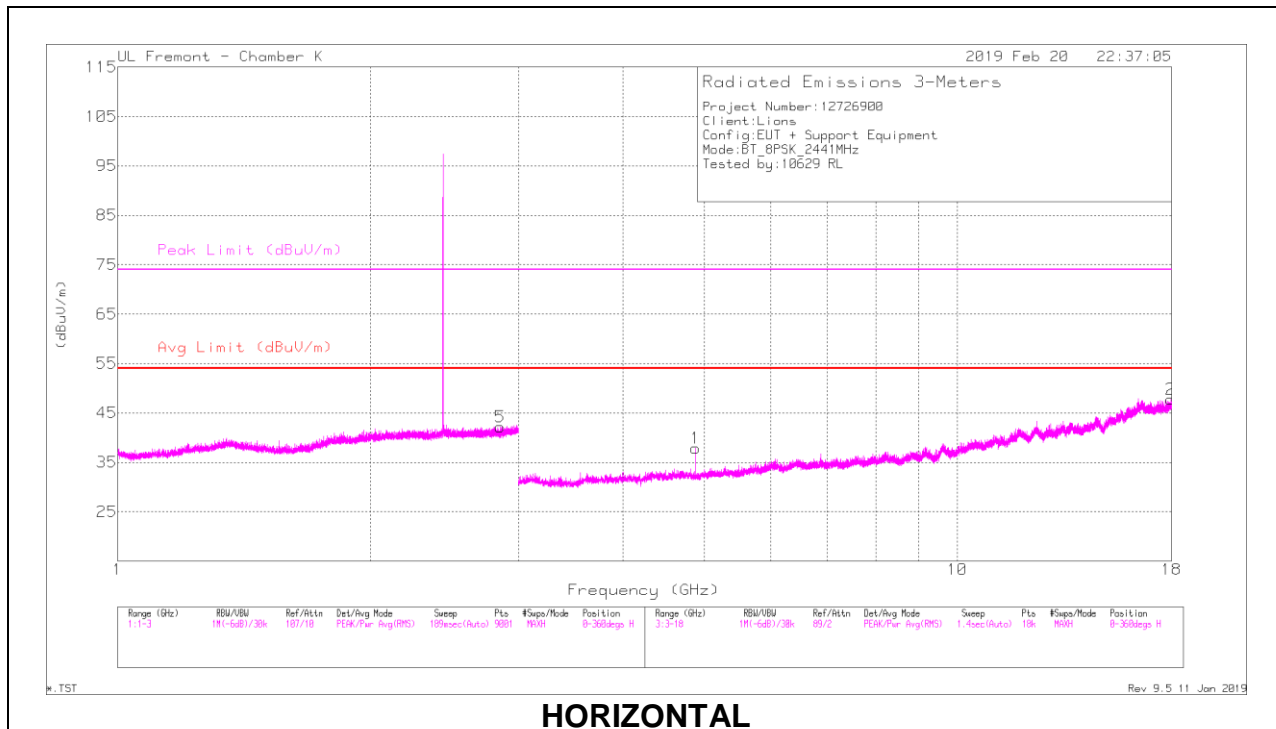

HORIZONTAL

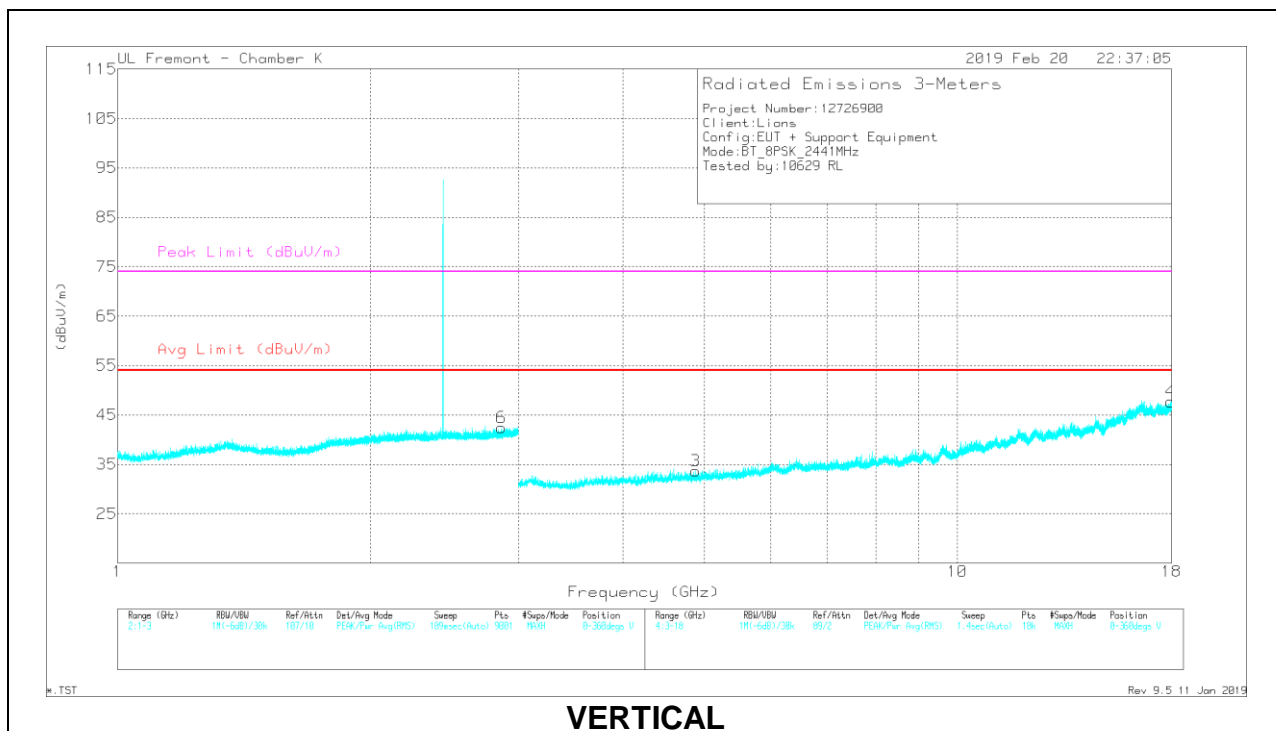

VERTICAL

RADIATED EMISSIONS

Marker	Frequency (GHz)	Meter Reading (dBuV)	Det	AF T344 (dB/m)	Amp/Cbl/Filtr/Pad (dB)	Corrected Reading (dBuV/m)	Avg Limit (dBuV/m)	Margin (dB)	Peak Limit (dBuV/m)	PK Margin (dB)	Azimuth (Degs)	Height (cm)	Polarity
5	* 2.856	40.96	PKFH	32.3	-24.5	48.76	-	-	74	-25.24	44	170	H
	* 2.856	28.89	VA1T	32.3	-24.5	36.69	54	-17.31	-	-	44	170	H
6	* 2.865	41.19	PKFH	32.4	-24.5	49.09	-	-	74	-24.91	206	283	V
	* 2.866	28.95	VA1T	32.4	-24.5	36.85	54	-17.15	-	-	206	283	V
2	* 17.983	27.92	PKFH	40.9	-15.3	53.52	-	-	74	-20.48	303	267	H
	* 17.98	15.63	VA1T	40.9	-15.3	41.23	54	-12.77	-	-	303	267	H
1	* 4.882	40.48	PKFH	34.1	-30.5	44.08	-	-	74	-29.92	172	115	H
	* 4.882	31.43	VA1T	34.1	-30.5	35.03	54	-18.97	-	-	172	115	H
4	* 17.956	27.78	PKFH	41	-15.4	53.38	-	-	74	-20.62	339	192	V
	* 17.958	15.56	VA1T	41	-15.4	41.16	54	-12.84	-	-	339	192	V
3	* 4.882	37.98	PKFH	34.1	-30.5	41.58	-	-	74	-32.42	8	135	V
	* 4.882	26.96	VA1T	34.1	-30.5	30.56	54	-23.44	-	-	8	135	V

* - indicates frequency in CFR47 Pt 15 / IC RSS-Restricted Band
 PKFH FHSS/BT RB=100k for Frequencies<1GHz / RB=1MHz for Frequencies>1GHz, VB=3 x RB, Peak
 VA1T - FHSS: Linear Voltage Average VB=1/Ton where: Ton is transmit duration

HIGH CHANNEL RESULTS

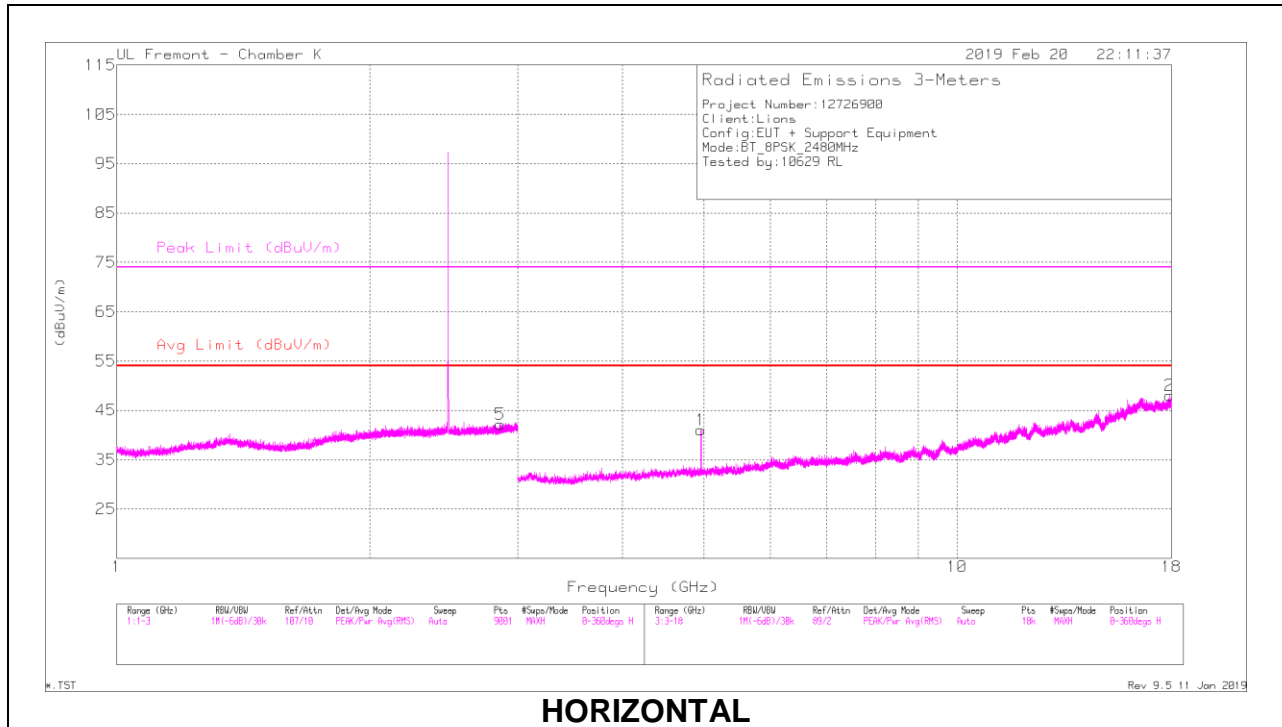

HORIZONTAL

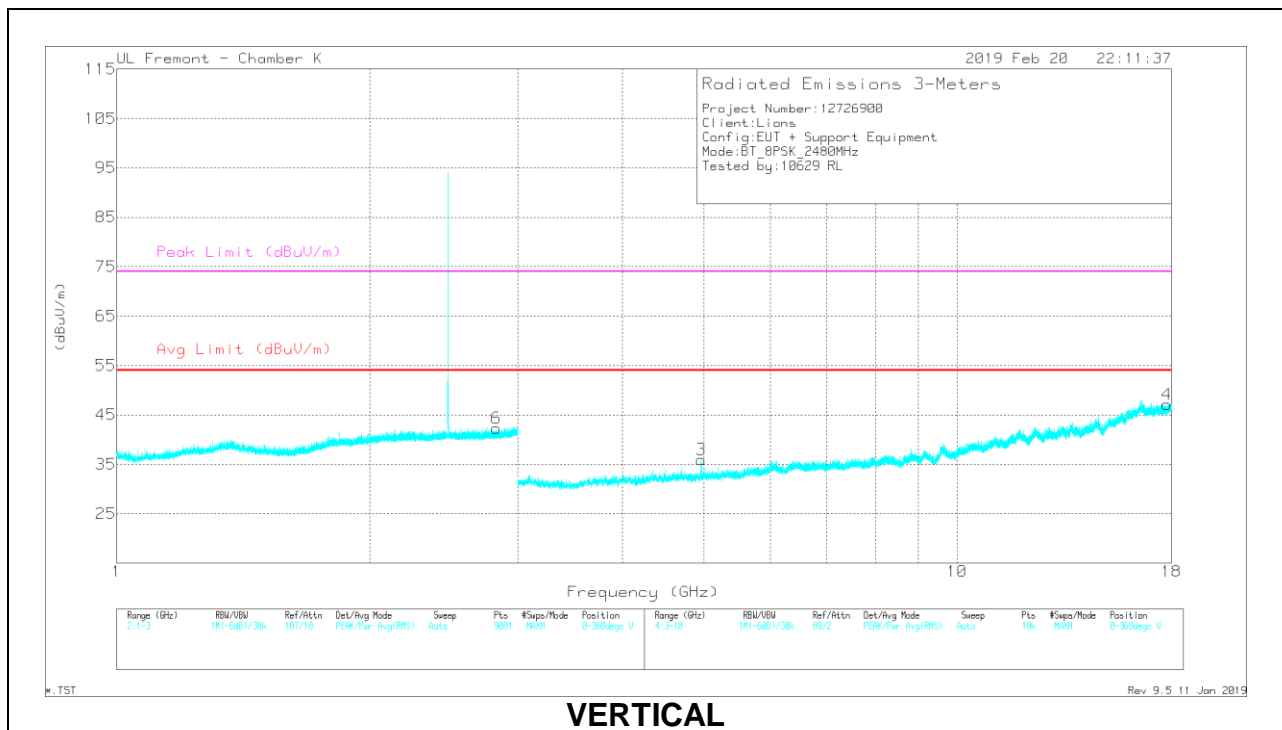

VERTICAL

RADIATED EMISSIONS

Marker	Frequency (GHz)	Meter Reading (dBuV)	Det	AF T344 (dB/m)	Amp/Cbl/Filtr/Pad (dB)	Corrected Reading (dBuV/m)	Avg Limit (dBuV/m)	Margin (dB)	Peak Limit (dBuV/m)	PK Margin (dB)	Azimuth (Degs)	Height (cm)	Polarity
5	* 2.859	42.19	PKFH	32.3	-24.5	49.99	-	-	74	-24.01	75	295	H
	* 2.862	29	VA1T	32.3	-24.5	36.8	54	-17.2	-	-	75	295	H
6	* 2.832	41.43	PKFH	32.3	-24.5	49.23	-	-	74	-24.77	184	121	V
	* 2.83	28.93	VA1T	32.3	-24.4	36.83	54	-17.17	-	-	184	121	V
2	* 17.907	28.66	PKFH	41.2	-15.6	54.26	-	-	74	-19.74	257	291	H
	* 17.905	16.04	VA1T	41.2	-15.6	41.64	54	-12.36	-	-	257	291	H
1	* 4.96	43.32	PKFH	34.2	-30.6	46.92	-	-	74	-27.08	168	142	H
	* 4.96	35.06	VA1T	34.2	-30.6	38.66	54	-15.34	-	-	168	142	H
4	* 17.783	29.01	PKFH	41.2	-15.9	54.31	-	-	74	-19.69	71	165	V
	* 17.783	16.55	VA1T	41.2	-15.9	41.85	54	-12.15	-	-	71	165	V
3	* 4.96	40.47	PKFH	34.2	-30.6	44.07	-	-	74	-29.93	58	111	V
	* 4.96	30.16	VA1T	34.2	-30.6	33.76	54	-20.24	-	-	58	111	V

* - indicates frequency in CFR47 Pt 15 / IC RSS-Restricted Band
 PKFH FHSS/BT RB=100k for Frequencies<1GHz / RB=1MHz for Frequencies>1GHz, VB=3 x RB, Peak
 VA1T - FHSS: Linear Voltage Average VB=1/Ton where: Ton is transmit duration

10.2. WORST CASE BELOW 30MHz

SPURIOUS EMISSIONS BELOW 30 MHz (WORST-CASE CONFIGURATION)

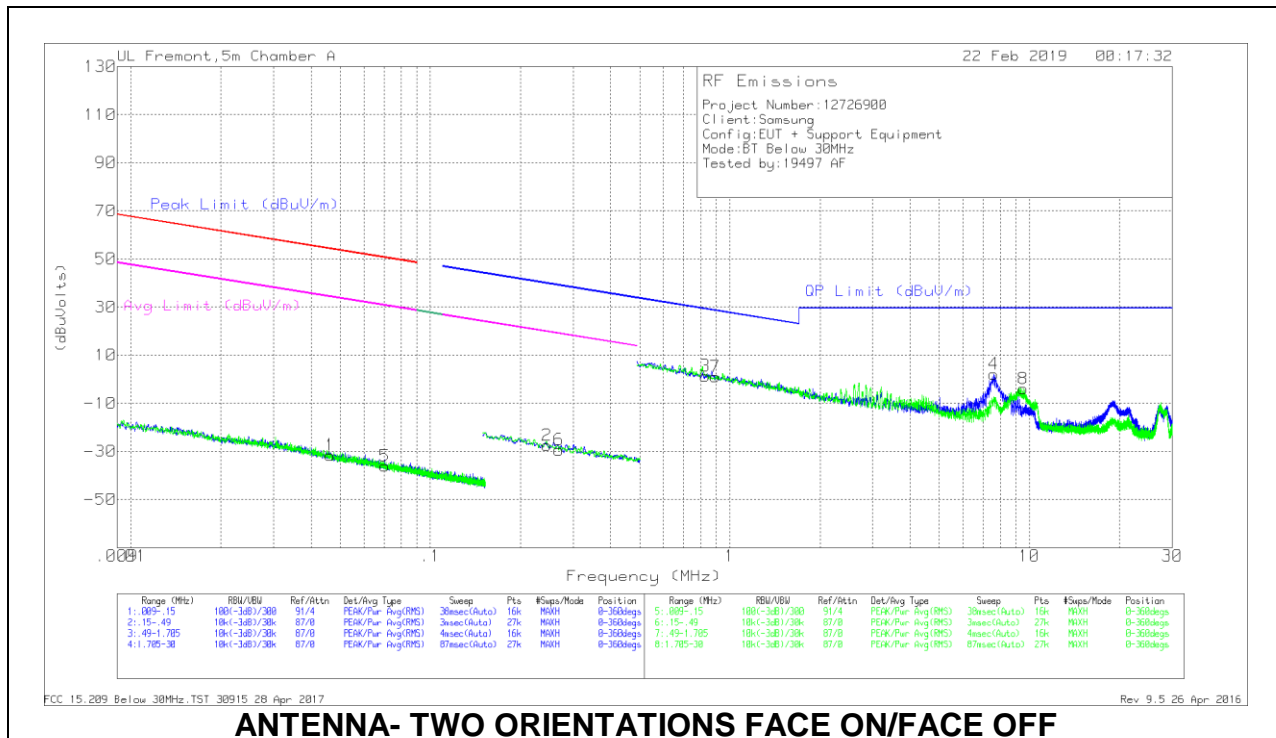

Below 30MHz Data

Marker	Frequency (MHz)	Meter Reading (dBuV)	Det	Loop Antenna (dBm)	Cables (dB)	Dist Corr 300m	Corrected Reading (dBuV/m)	Peak Limit (dBuV/m)	Margin (dB)	Avg Limit (dBuV/m)	Margin (dB)	Peak Limit (dBuV/m)	Margin (dB)	Avg Limit (dBuV/m)	Margin (dB)	Azimuth (Degs)
1	.04631	35.28	Pk	13.1	0	-80	-31.62	54.27	-85.89	34.27	-65.89	-	-	-	-	0-360
5	.07049	31.66	Pk	12.2	0	-80	-36.14	50.62	-86.76	30.62	-66.76	-	-	-	-	0-360
2	.24524	41.37	Pk	11	.1	-80	-27.53	-	-	-	-	39.82	-67.35	19.82	-47.35	0-360
6	.26882	39.5	Pk	11	.1	-80	-29.4	-	-	-	-	39.02	-68.42	19.02	-48.42	0-360

Pk - Peak detector

Marker	Frequency (MHz)	Meter Reading (dBuV)	Det	Loop Antenna (dBm)	Cables (dB)	Dist Corr 30m	Corrected Reading (dBuV/m)	QP Limit (dBuV/m)	Margin (dB)	Peak Limit (dBuV/m)	Margin (dB)	Avg Limit (dBuV/m)	Margin (dB)	Azimuth (Degs)
3	.82858	30.23	Pk	11	.1	-40	1.33	29.25	-27.92	-	-	-	-	0-360
7	.89516	29.84	Pk	11.1	.1	-40	1.04	28.58	-27.54	-	-	-	-	0-360
4	7.60524	30.83	Pk	10.9	.4	-40	2.13	29.5	-27.37	-	-	-	-	0-360
8	9.53775	24.81	Pk	10.8	.4	-40	-3.99	29.5	-33.49	-	-	-	-	0-360

Pk - Peak detector

10.3. WORST CASE BELOW 1 GHz

SPURIOUS EMISSIONS 30 TO 1000 MHz (WORST-CASE CONFIGURATION)

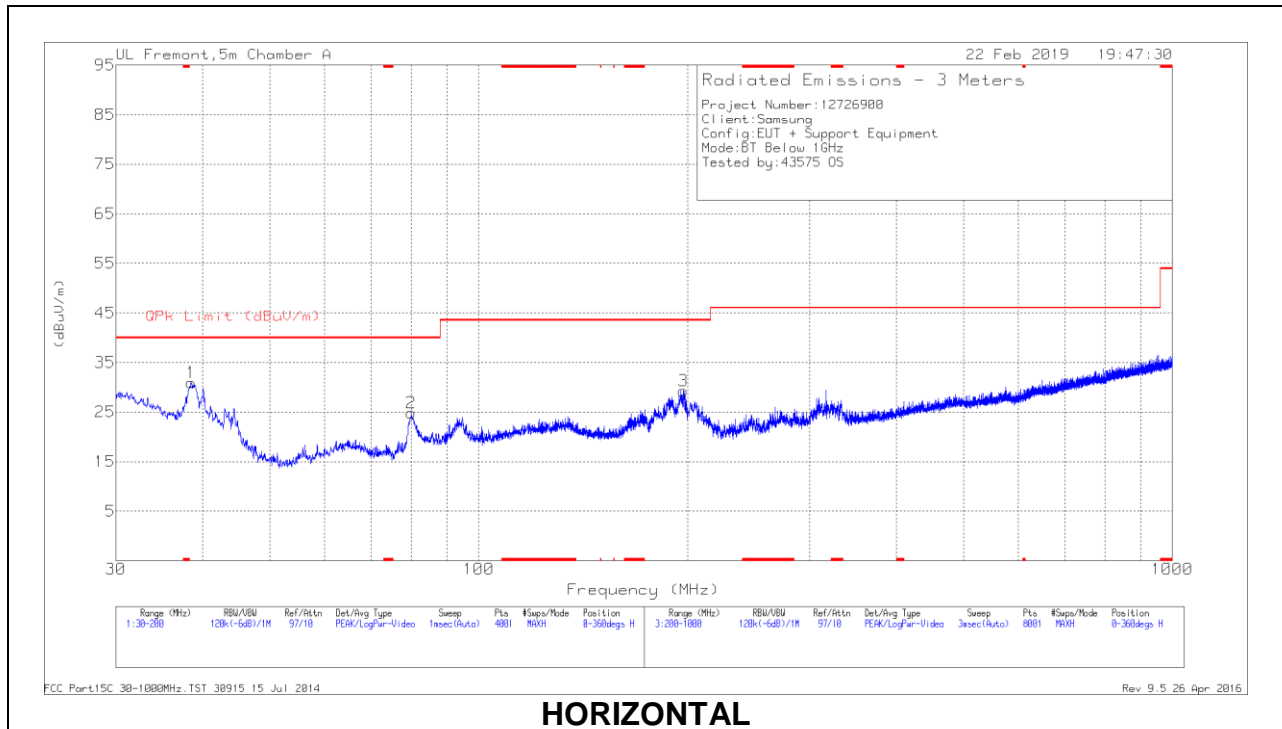

HORIZONTAL

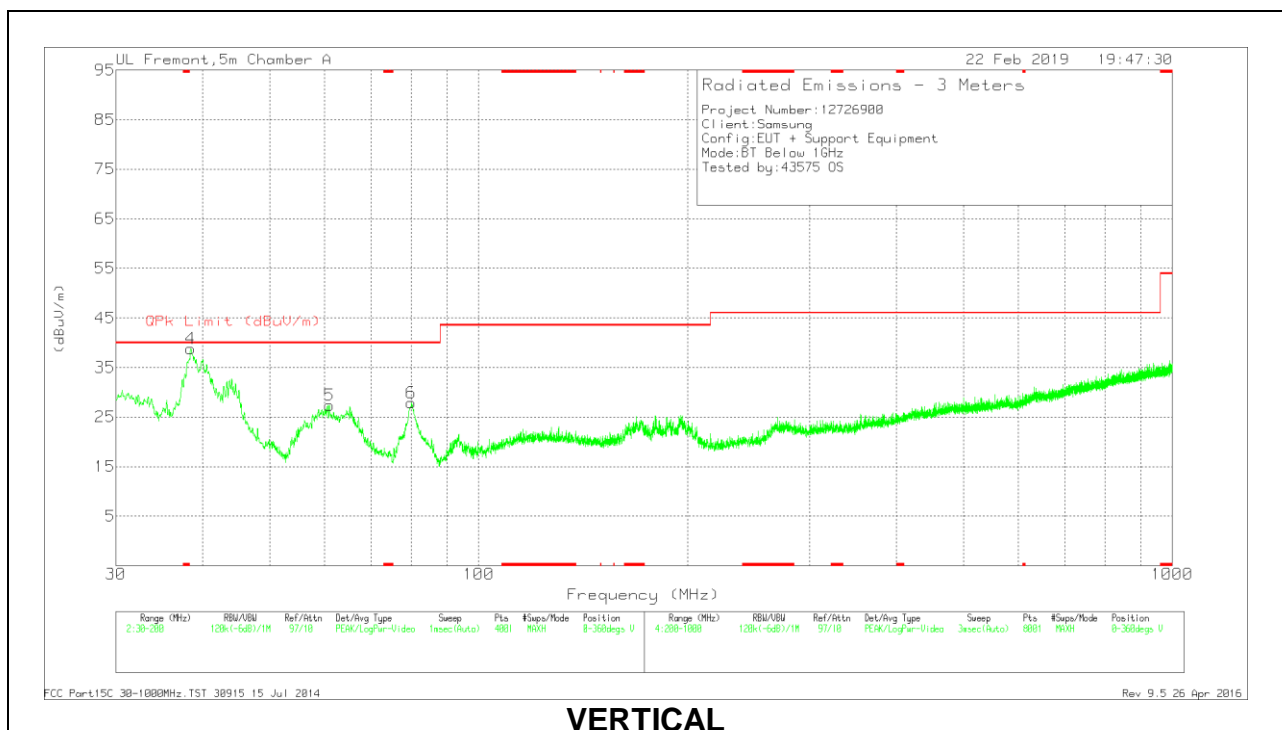

VERTICAL

Below 1GHz Data

Marker	Frequency (MHz)	Meter Reading (dBuV)	Det	AF PRE0181574 (dB/m)	Amp/Cbl (dB/m)	Corrected Reading (dBuV/m)	QPk Limit (dBuV/m)	Margin (dB)	Azimuth (Degs)	Height (cm)	Polarity
4	38.4752	43.14	Pk	20.7	-27.1	36.74	40	-3.26	8	143	V
	38.4752	38.01	Qp	20.7	-27.1	31.61	40	-8.39	8	143	V
1	38.5	37.36	Pk	20.7	-27.1	30.96	40	-9.04	0-360	299	H
5	60.8975	40.63	Pk	13.5	-26.8	27.33	40	-12.67	0-360	100	V
2	79.98	37.98	Pk	13.4	-26.5	24.88	40	-15.12	0-360	199	H
6	79.98	40.99	Pk	13.4	-26.5	27.89	40	-12.11	0-360	100	V
3	197.45	36.14	Pk	18.4	-25.2	29.34	43.52	-14.18	0-360	100	H

Pk - Peak detector

Qp - Quasi-Peak detector

10.4. WORST CASE 18-26 GHz

SPURIOUS EMISSIONS 18-26 GHz (WORST-CASE CONFIGURATION)

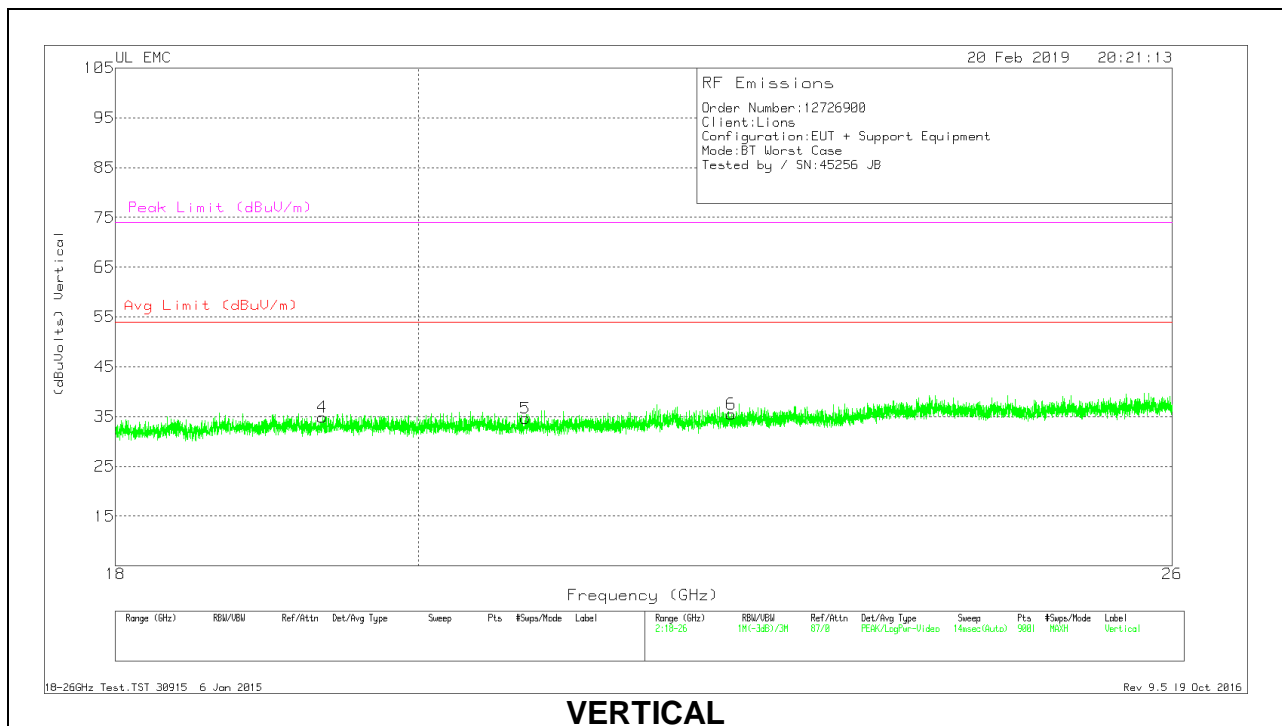
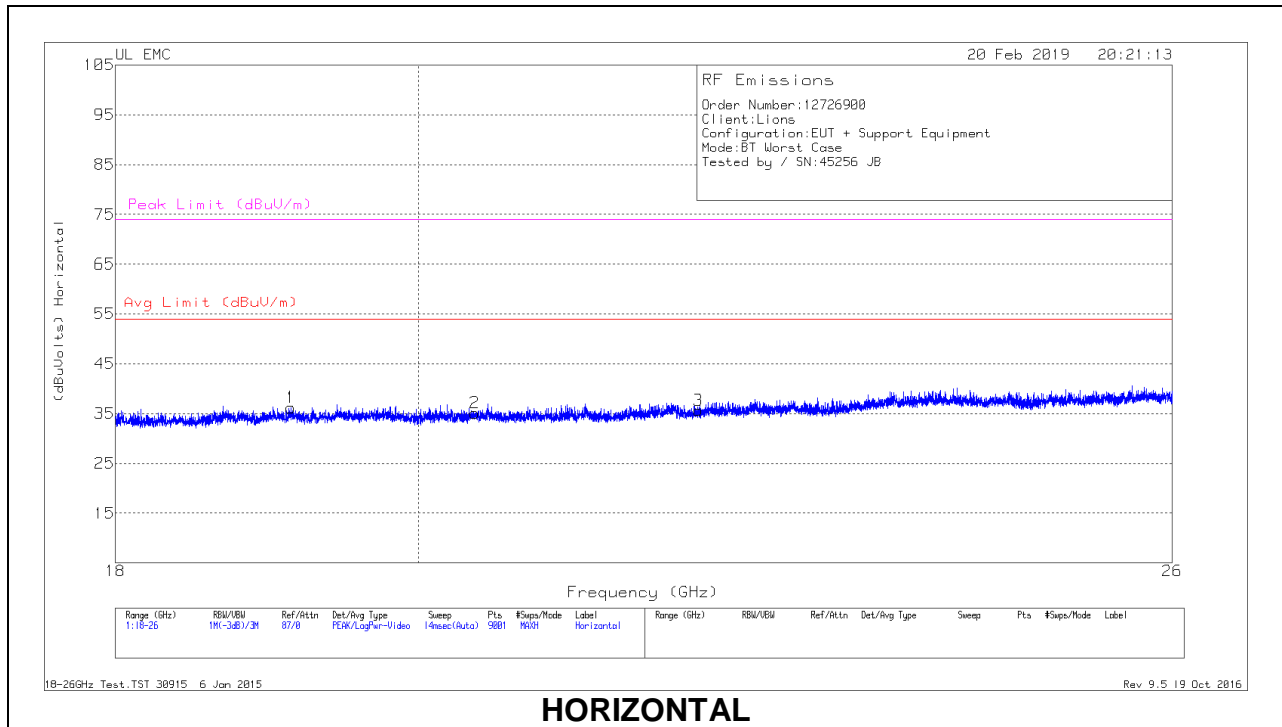

18 – 26GHz DATA

Marker	Frequency (GHz)	Meter Reading (dBuV)	Det	T447 AF (dB/m)	Amp/Cbl (dB)	Dist Corr (dB)	Corrected Reading (dBuVolts)	Avg Limit (dBuV/m)	Margin (dB)	Peak Limit (dBuV/m)	PK Margin (dB)
1	19.133	37.58	Pk	32.6	-24.5	-9.5	36.18	54	-17.82	74	-37.82
2	20.397	36.81	Pk	32.9	-25.1	-9.5	35.11	54	-18.89	74	-38.89
3	22.048	37.05	Pk	33.3	-25.2	-9.5	35.65	54	-18.35	74	-38.35
4	19.344	36.36	Pk	32.7	-24.7	-9.5	34.86	54	-19.14	74	-39.14
5	20.759	36.55	Pk	33	-25.4	-9.5	34.65	54	-19.35	74	-39.35
6	22.3	36.48	Pk	33.5	-25	-9.5	35.48	54	-18.52	74	-38.52

Pk - Peak detector

11. AC POWER LINE CONDUCTED EMISSIONS

LIMITS

FCC §15.207 (a)

Frequency of Emission (MHz)	Conducted Limit (dBuV)	
	Quasi-peak	Average
0.15-0.5	66 to 56*	56 to 46*
0.5-5	56	46
5-30	60	50

*Decreases with the logarithm of the frequency.

TEST PROCEDURE

The EUT is placed on a non-conducting table 40 cm from the vertical ground plane and 80 cm above the horizontal ground plane. The EUT is configured in accordance with ANSI C63.4.

The receiver is set to a resolution bandwidth of 9 kHz. Peak detection is used unless otherwise noted as quasi-peak or average.

Line conducted data is recorded for both NEUTRAL and HOT lines.

RESULTS

AC Power Line Norm

LINE 1 RESULTS

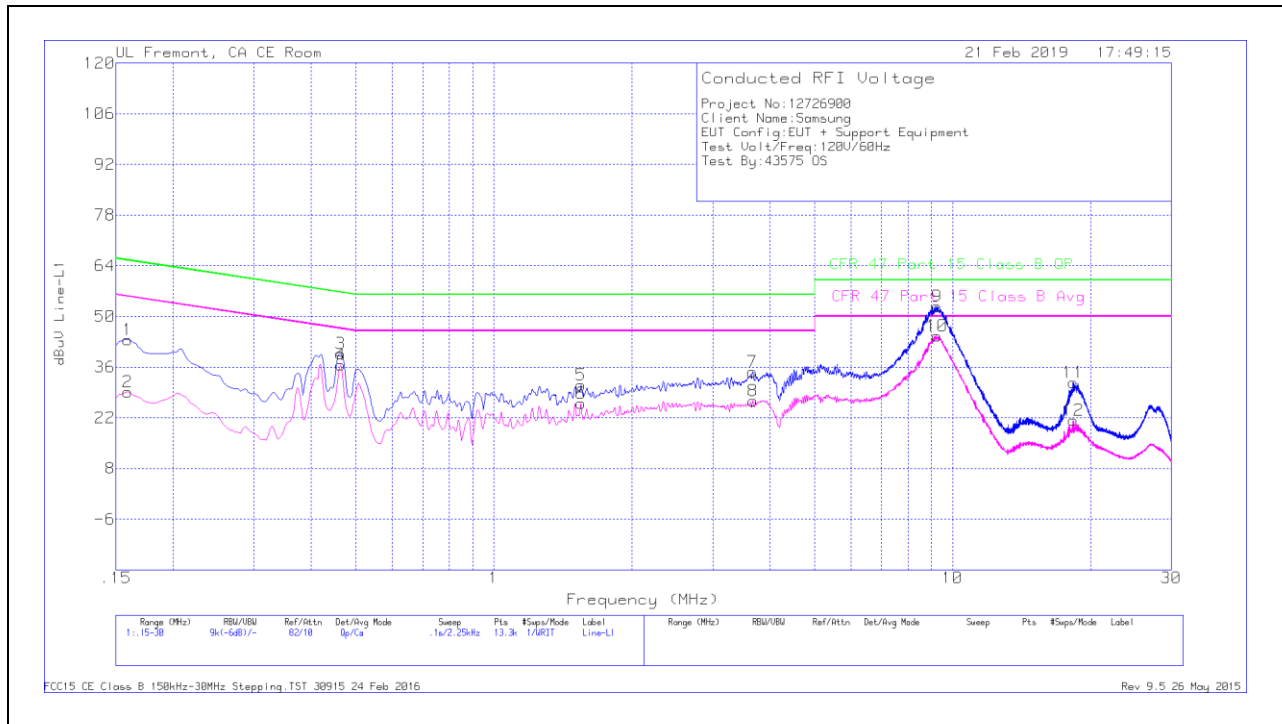

Trace Markers

Range 1: Line-L1 .15 - 30MHz											
Marker	Frequency (MHz)	Meter Reading (dBuV)	Det	LISN L1	LC Cables C1&C3	Limiter (dB)	Corrected Reading dBuV	CFR 47 Part 15 Class B QP	QP Margin (dB)	CFR 47 Part 15 Class B Avg	Av(CISPR) Margin (dB)
1	.159	33.4	Qp	.1	0	10.1	43.6	65.52	-21.92	-	-
2	.159	18.96	Ca	.1	0	10.1	29.16	-	-	55.52	-26.36
3	.46275	29.71	Qp	0	0	10.1	39.81	56.64	-16.83	-	-
4	.46275	26.54	Ca	0	0	10.1	36.64	-	-	46.64	-10
5	1.5495	20.89	Qp	0	.1	10.1	31.09	56	-24.91	-	-
6	1.54725	15.79	Ca	0	.1	10.1	25.99	-	-	46	-20.01
7	3.66675	24.49	Qp	0	.1	10.1	34.69	56	-21.31	-	-
8	3.67575	16.53	Ca	0	.1	10.1	26.73	-	-	46	-19.27
9	9.24675	42.39	Qp	0	.2	10.2	52.79	60	-7.21	-	-
10	9.249	34.26	Ca	0	.2	10.2	44.66	-	-	50	-5.34
11	18.35138	21.06	Qp	.1	.3	10.3	31.76	60	-28.24	-	-
12	18.3525	10.66	Ca	.1	.3	10.3	21.36	-	-	50	-28.64

Qp - Quasi-Peak detector
 Ca - CISPR average detection

LINE 2 RESULTS

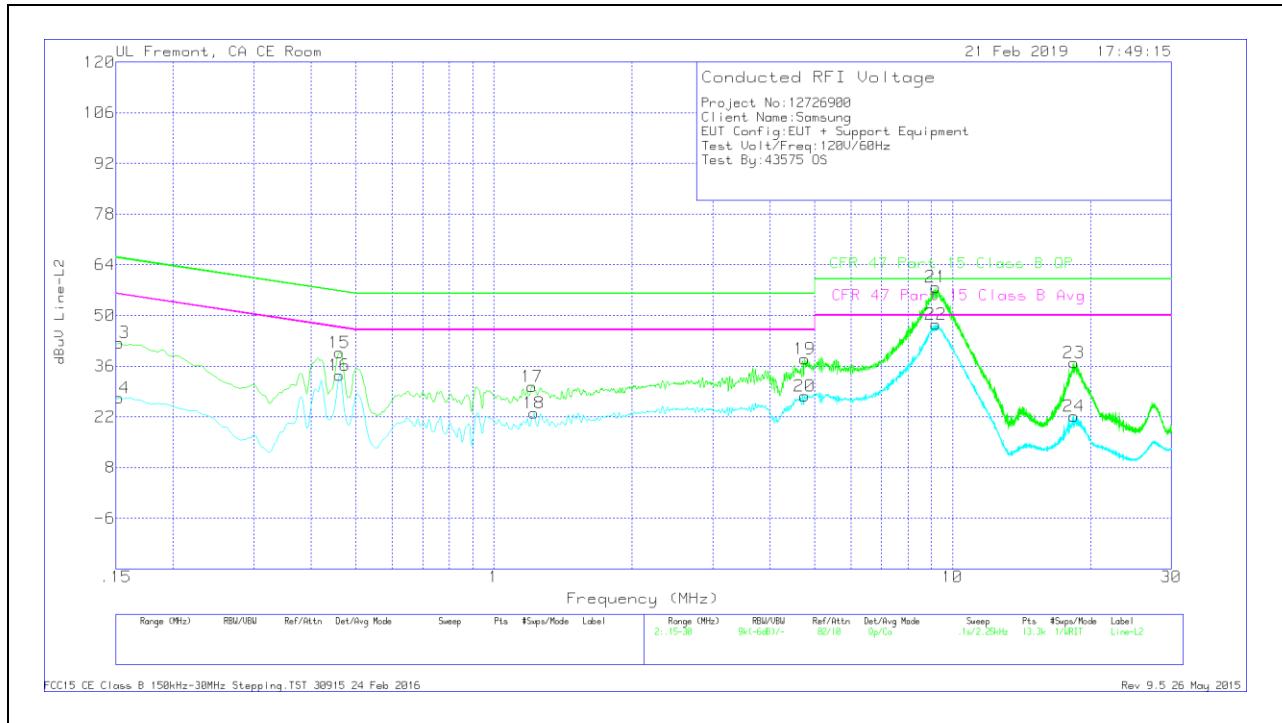

Trace Markers

Range 2: Line-L2 .15 - 30MHz											
Marker	Frequency (MHz)	Meter Reading (dBuV)	Det	LISN L2	LC Cables C2&C3	Limiter (dB)	Corrected Reading dBuV	CFR 47 Part 15 Class B QP	QP Margin (dB)	CFR 47 Part 15 Class B Avg	Av(CISPR) Margin (dB)
13	.15225	32.24	Qp	.1	0	10.1	42.44	65.88	-23.44	-	-
14	.15225	17.1	Ca	.1	0	10.1	27.3	-	-	55.88	-28.58
15	.4605	29.67	Qp	0	0	10.1	39.77	56.68	-16.91	-	-
16	.4605	23.4	Ca	0	0	10.1	33.5	-	-	46.68	-13.18
17	1.212	20.14	Qp	0	.1	10.1	30.34	56	-25.66	-	-
18	1.22325	12.79	Ca	0	.1	10.1	22.99	-	-	46	-23.01
19	4.76025	27.87	Qp	0	.1	10.1	38.07	56	-17.93	-	-
20	4.76025	17.58	Ca	0	.1	10.1	27.78	-	-	46	-18.22
21	9.19725	47.5	Qp	0	.2	10.2	57.9	60	-2.1	-	-
22	9.19725	37.09	Ca	0	.2	10.2	47.49	-	-	50	-2.51
23	18.39525	26.23	Qp	.1	.3	10.3	36.93	60	-23.07	-	-
24	18.39525	11.47	Ca	.1	.3	10.3	22.17	-	-	50	-27.83

Qp - Quasi-Peak detector
 Ca - CISPR average detection