



CERTIFICATION TEST REPORT

Report Number. : 12810836-E8V2

Applicant : Samsung Electronics Co., Ltd.
129 Samsung-Ro, Yeongtong-Gu,
Suwon-Si, Gyeonggi-Do, 16677, Korea

Model : SM-A705YN

FCC ID : A3LSMA705YN

EUT Description : GSM/WCDMA/LTE Phone with BT, DTS/UNII a/b/g/n/ac, ANT+,
and NFC

Test Standard(s) : FCC 47 CFR PART 15 SUBPART C

Date Of Issue:

April 29, 2019

Prepared by:

UL Verification Services Inc.
47173 Benicia Street
Fremont, CA 94538 U.S.A.
TEL: (510) 771-1000
FAX: (510) 661-0888



REPORT REVISION HISTORY

Rev.	Issue Date	Revisions	Revised By
V1	4/22/2019	Initial Issue	
V2	4/29/2019	Updated Section 12.1	K.Kedida

TABLE OF CONTENTS

REPORT REVISION HISTORY	2
TABLE OF CONTENTS	3
1. ATTESTATION OF TEST RESULTS	5
2. INTRODUCTION OF TEST DATA REUSE.....	6
2.1. INTRODUCTION	6
2.2. DIFFERENCES.....	6
2.3. SPOT CHECK VERIFICATION RESULTS SUMMARY.....	6
2.4. REFERENCE DETAIL	12
3. TEST METHODOLOGY	13
4. FACILITIES AND ACCREDITATION	13
5. CALIBRATION AND UNCERTAINTY	14
5.1. MEASURING INSTRUMENT CALIBRATION	14
5.2. SAMPLE CALCULATION	14
5.3. MEASUREMENT UNCERTAINTY.....	14
6. EQUIPMENT UNDER TEST	15
6.1. EUT DESCRIPTION	15
6.2. MAXIMUM FUNDAMENTAL FIELD STRENGTH.....	15
6.3. DESCRIPTION OF AVAILABLE ANTENNAS	15
6.4. SOFTWARE AND FIRMWARE.....	15
6.5. WORST-CASE CONFIGURATION AND MODE.....	15
6.6. DESCRIPTION OF TEST SETUP.....	16
7. TEST AND MEASUREMENT EQUIPMENT	19
8. MEASUREMENT METHODS	20
9. ANTENNA PORT TEST RESULTS	21
9.1. ON TIME AND DUTY CYCLE.....	21
9.2. 20dB BANDWIDTH.....	23
10. RADIATED TEST RESULTS	25
10.1. TRANSMITTER ABOVE 1 GHz.....	27
10.2. FUNDAMENTAL FREQUENCY RADIATED EMISSION	37
10.3. WORST CASE BELOW 30 MHz	38
10.4. WORST CASE BELOW 1 GHz	39

10.5.	WORST CASE 18-26 GHz	41
11.	AC POWER LINE CONDUCTED EMISSIONS	43
12.	SETUP PHOTOS	46
12.1.	SM-A705FN/DS (ORIGINAL)	46
12.2.	SM-A705YN (Spot Check).....	49

1. ATTESTATION OF TEST RESULTS

COMPANY NAME: Samsung Electronics Co., Ltd.
129 Samsung-Ro, Yeongtong-Gu,
Suwon-Si, Gyeonggi-Do, 16677, Korea

EUT DESCRIPTION: GSM/WCDMA/LTE Phone with BT, DTS/UNII a/b/g/n/ac, ANT+,
and NFC

MODEL: SM-A705YN

SERIAL NUMBER: Radiated (Original):R38M10NPF1Y, R38M10CSH8Z
Conducted (Original):R38M10CT1JE
Radiated (Spot Check): R38M4046MZN

DATE TESTED: February 21 – March 27, 2019 (Original)
April 11, 2019 (Spot Check)

APPLICABLE STANDARDS	
STANDARD	TEST RESULTS
CFR 47 Part 15 Subpart C	Complies

UL Verification Services Inc. tested the above equipment in accordance with the requirements set forth in the above standards. The test results show that the equipment tested is capable of demonstrating compliance with the requirements as documented in this report.

The results documented in this report apply only to the tested sample, under the conditions and modes of operation as described herein. It is the manufacturer's responsibility to assure that additional production units of this model are manufactured with identical electrical and mechanical components. All samples tested were in good operating condition throughout the entire test program. Measurement Uncertainties are published for informational purposes only and were not taken into account unless noted otherwise.

This document may not be altered or revised in any way unless done so by UL Verification Services Inc. and all revisions are duly noted in the revisions section. Any alteration of this document not carried out by UL Verification Services Inc. will constitute fraud and shall nullify the document. This report must not be used by the client to claim product certification, approval, or endorsement by NVLAP, NIST, any agency of the Federal Government, or any agency of the U.S. government.

Approved & Released For
UL Verification Services Inc. By:

Reviewed By:



Dan Coronio
Operations Leader
Consumer Technology Division
UL Verification Services Inc.

Kiya Kedida
Project Engineer
Consumer Technology Division
UL Verification Services Inc.

2. INTRODUCTION OF TEST DATA REUSE

2.1. INTRODUCTION

According to the manufacturer, FCC ID: A3LSMA705FN and FCC ID: A3LSMA705YN non-licensed radios are electrically identical. The FCC ID: A3LSMA705FN test data shall remain representative of FCC ID: A3LSMA705YN.

The applicant takes full responsibility that the test data as referenced in this section represents compliance for this FCC ID.

2.2. DIFFERENCES

The FCC ID: A3LSMA705FN, shares the same enclosure and circuit board as FCC ID: A3LSMA705YN. The ANT+ antennas and surrounding circuitry and layout are identical between two models.

After confirming through preliminary radiated emissions that the performance of the FCC ID: A3LSMG705FN remains representative of FCC ID: A3LSMA705YN. The test data of FCC ID: A3LSMG705FN being submitted for this application to cover ANT+ features.

2.3. SPOT CHECK VERIFICATION RESULTS SUMMARY

Spot check verification has been done on device A3LSMA705YN for radiated harmonic spurious and radiated band-edge. The data from the application has been verified through appropriate spot checks to demonstrate compliance for this device in accordance to FCC public KDB 484596 D01 as shown in the summary below.

A3LSMA705YN SPOT CHECK RESULTS									
Technology	Test Item	Channel	Measured Frequency	Original model		Spot check model		Delta (dB)	
				SM-A705FN/DS		SM-A705YN/DS			
				A3LSMA705FN		A3LSMA705YN		Peak	Ave
ANT+	Fundamental	80	2480MHz	89.41	55.72	87.59	53.9	-1.82	-1.82
	RBE	80	2507MHz	51.59	39.9	51.66	36.87	0.07	-3.03
	RSE	02	2764MHz	51.5	42.92	49.47	36.77	-2.03	-6.15

Comparison of the models, upper deviation is within 3dB range and all tests are under FCC Technical Limits.

SPOT CHECK DATA

FUNDAMENTAL FREQUENCY RADIATED EMISSION

Marker	Frequency (GHz)	Meter Reading (dBuV)	Det	AF T862 (dB/m)	Amp/Cb/Filtr/Pad (dB)	DC Corr (dB)	Corrected Reading (dBuV/m)	Avg Limit (dBuV/m)	Margin (dB)	Peak Limit (dBuV/m)	PK Margin (dB)	Azimuth (Degs)	Height (cm)	Polarity
1	2.48	80.09	PKFH	32.3	-24.8		87.59	-	-	114	-26.41	350	284	H
	2.48	80.09	AVG	32.3	-24.8	-33.69	53.9	94	-40.1	-	-	350	284	H
2	2.48	75.29	PKFH	32.3	-24.8		82.79	-	-	114	-31.21	301	345	V
	2.48	75.29	AVG	32.3	-24.8	-33.69	49.1	94	-44.9	-	-	301	345	V

PKFH - FHSS: RB=1MHz VB=3 x RB, Peak

AVG = Peak Reading + Duty Cycle Correction Factor

Duty Cycle Correction Factor = -33.69 dB

BANDEDGE (HIGH CHANNEL)

HORIZONTAL RESULT

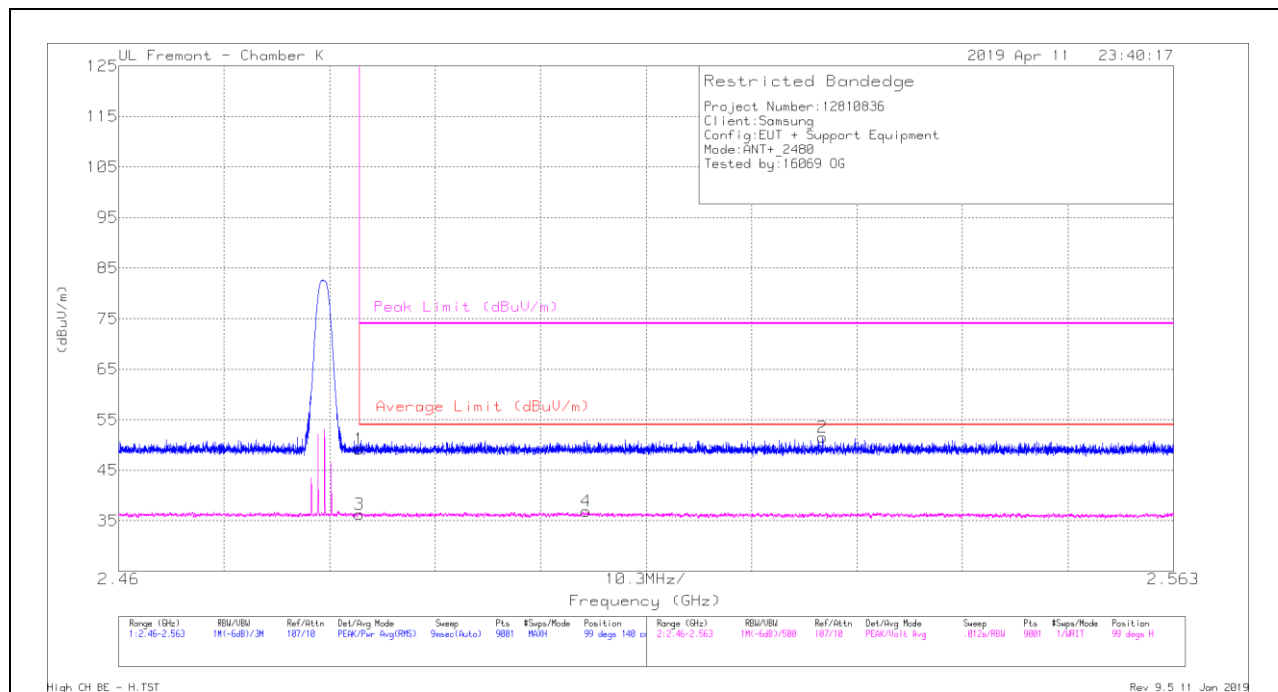

Trace Markers

Marker	Frequency (GHz)	Meter Reading (dBuV)	Det	AF T344 (dB/m)	Amp/Cbl/Fitr/Pad (dB)	Corrected Reading (dBuV/m)	Average Limit (dBuV/m)	Margin (dB)	Peak Limit (dBuV/m)	PK Margin (dB)	Azimuth (Degs)	Height (cm)	Polarity
1	* 2.484	41.71	Pk	32.3	-24.8	49.21	-	-	74	-24.79	99	140	H
2	2.529	44.04	Pk	32.3	-24.8	51.54	-	-	74	-22.46	99	140	H
3	* 2.484	28.81	VA1T	32.3	-24.8	36.31	54	-17.69	-	-	99	140	H
4	2.506	29.27	VA1T	32.3	-24.7	36.87	54	-17.13	-	-	99	140	H

* - indicates frequency in CFR47 Pt 15 / IC RSS-Restricted Band

Pk - Peak detector

VA1T - FHSS: Linear Voltage Average $V_B=1/T_{on}$ where: T_{on} is transmit duration

VERTICAL RESULT

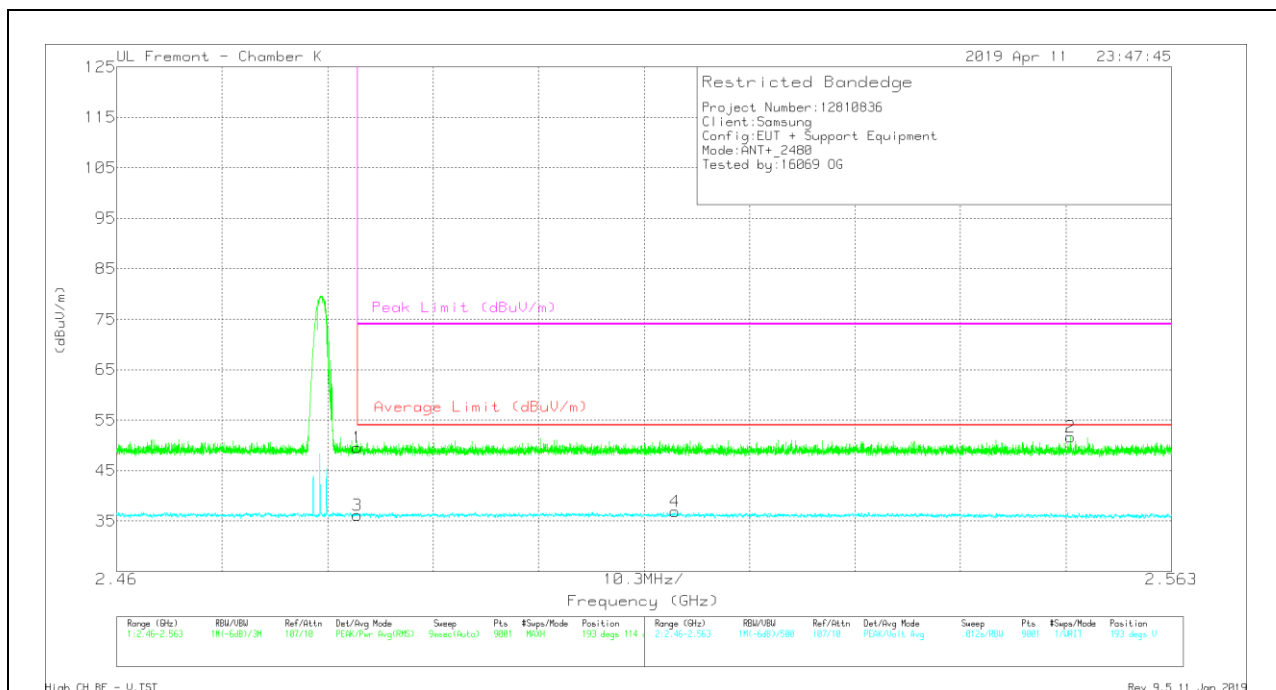

Trace Markers

Marker	Frequency (GHz)	Meter Reading (dBuV)	Det	AF T344 (dB/m)	Amp/Cbl/Filtr/Pad (dB)	Corrected Reading (dBuV/m)	Average Limit (dBuV/m)	Margin (dB)	Peak Limit (dBuV/m)	PK Margin (dB)	Azimuth (Degs)	Height (cm)	Polarity
1	* 2.484	42.08	Pk	32.3	-24.8	49.58	-	-	74	-24.42	193	114	V
2	2.553	44.16	Pk	32.3	-24.8	51.66	-	-	74	-22.34	193	114	V
3	* 2.484	28.68	VA1T	32.3	-24.8	36.18	54	-17.82	-	-	193	113	V
4	2.515	29.27	VA1T	32.3	-24.7	36.87	54	-17.13	-	-	193	113	V

* - indicates frequency in CFR47 Pt 15 / IC RSS-Restricted Band
 Pk - Peak detector
 VA1T - FHSS: Linear Voltage Average $V_B=1/T_{on}$ where: T_{on} is transmit duration

HARMONICS AND SPURIOUS EMISSIONS

LOW CHANNEL RESULTS

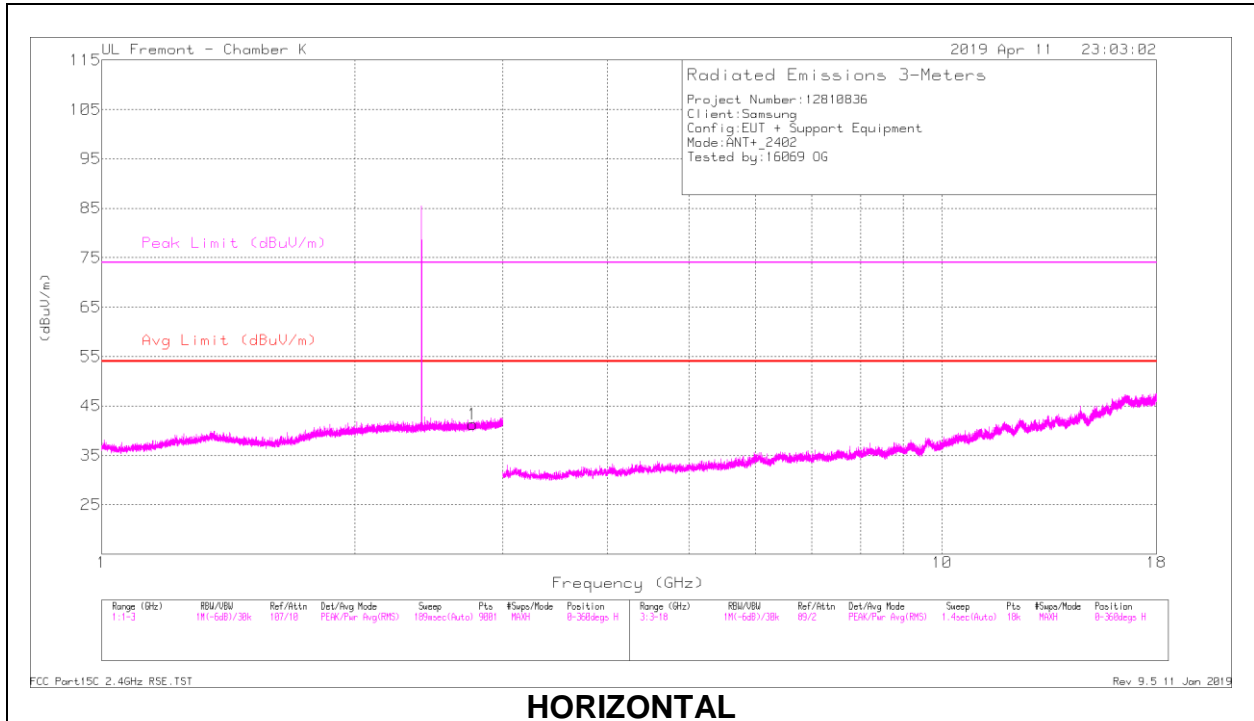

HORIZONTAL

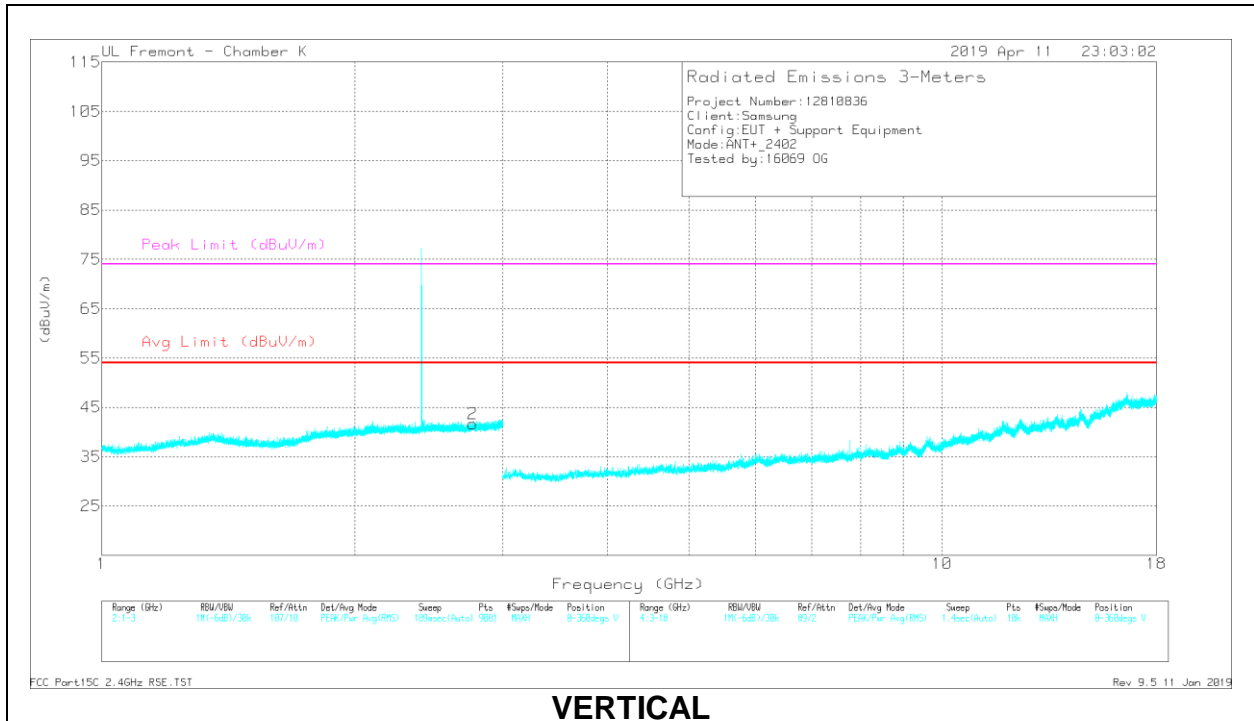

VERTICAL

RADIATED EMISSIONS

Marker	Frequency (GHz)	Meter Reading (dBuV)	Det	AF T344 (dB/m)	Amp/Cbl/Fitr/Pad (dB)	Corrected Reading (dBuV/m)	Avg Limit (dBuV/m)	Margin (dB)	Peak Limit (dBuV/m)	PK Margin (dB)	Azimuth (Degs)	Height (cm)	Polarity
1	* 2.763	42.03	PKFH	32.3	-24.5	49.83	-	-	74	-24.17	177	392	H
	* 2.763	29.05	VA1T	32.3	-24.5	36.85	54	-17.15	-	-	177	392	H
2	* 2.766	41.67	PKFH	32.3	-24.5	49.47	-	-	74	-24.53	85	260	V
	* 2.765	28.97	VA1T	32.3	-24.5	36.77	54	-17.23	-	-	85	260	V

* - indicates frequency in CFR47 Pt 15 / IC RSS-Restricted Band

PKFH FHSS/BT RB=100k for Frequencies<1GHz / RB=1MHz for Frequencies>1GHz, VB=3 x RB, Peak

VA1T - FHSS: Linear Voltage Average VB=1/Ton where: Ton is transmit duration

2.4. REFERENCE DETAIL

Reference application that contains the reused reference data

Equipment Class	Reference FCC ID	Type Grant/ Permissive Change	Reference Application	Folder Test/RF Exposure	Report Title/Section
DXX	A3LSMA705FN	Grant	12726900-E8	Test	FCC Report ANT+ / All sections

3. TEST METHODOLOGY

The tests documented in this report were performed in accordance with FCC CFR 47 Part 2, FCC CFR 47 Part 15, and ANSI C63.10-2013.

4. FACILITIES AND ACCREDITATION

The test sites and measurement facilities used to collect data are located at 47173 and 47266 Benicia Street, and 47658 Kato Road, Fremont, California, USA. Line conducted emissions are measured only at the 47173 address. The following table identifies which facilities were utilized for radiated emission measurements documented in this report. Specific facilities are also identified in the test results sections.

47173 Benicia Street	47266 Benicia Street	47658 Kato Rd
<input checked="" type="checkbox"/> Chamber A (ISED:2324B-1)	<input type="checkbox"/> Chamber D (ISED:22541-1)	<input type="checkbox"/> Chamber I (ISED:2324A-5)
<input type="checkbox"/> Chamber B (ISED:2324B-2)	<input type="checkbox"/> Chamber E (ISED:22541-2)	<input checked="" type="checkbox"/> Chamber J (ISED:2324A-6)
<input type="checkbox"/> Chamber C (ISED:2324B-3)	<input type="checkbox"/> Chamber F (ISED:22541-3)	<input checked="" type="checkbox"/> Chamber K (ISED:2324A-1)
	<input type="checkbox"/> Chamber G (ISED:22541-4)	<input type="checkbox"/> Chamber L (ISED:2324A-3)
	<input type="checkbox"/> Chamber H (ISED:22541-5)	

The above test sites and facilities are covered under FCC Test Firm Registration # 208313. Chambers above are covered under Industry Canada company address and respective code

UL Verification Services Inc. is accredited by NVLAP, Laboratory Code 200065-0

5. CALIBRATION AND UNCERTAINTY

5.1. MEASURING INSTRUMENT CALIBRATION

The measuring equipment utilized to perform the tests documented in this report has been calibrated in accordance with the manufacturer's recommendations, and is traceable to recognized national standards.

5.2. SAMPLE CALCULATION

RADIATED EMISSIONS

Where relevant, the following sample calculation is provided:

$$\text{Field Strength (dBuV/m)} = \text{Measured Voltage (dBuV)} + \text{Antenna Factor (dB/m)} + \text{Cable Loss (dB)} - \text{Preamp Gain (dB)}$$
$$36.5 \text{ dBuV} + 18.7 \text{ dB/m} + 0.6 \text{ dB} - 26.9 \text{ dB} = 28.9 \text{ dBuV/m}$$

MAINS CONDUCTED EMISSIONS

Where relevant, the following sample calculation is provided:

$$\text{Final Voltage (dBuV)} = \text{Measured Voltage (dBuV)} + \text{Cable Loss (dB)} + \text{Limiter Factor (dB)} + \text{LISN Insertion Loss.}$$
$$36.5 \text{ dBuV} + 0 \text{ dB} + 10.1 \text{ dB} + 0 \text{ dB} = 46.6 \text{ dBuV}$$

5.3. MEASUREMENT UNCERTAINTY

Where relevant, the following measurement uncertainty levels have been estimated for tests performed on the apparatus:

PARAMETER	UNCERTAINTY
Worst Case Conducted Disturbance, 9KHz to 0.15 MHz	3.84 dB
Worst Case Conducted Disturbance, 0.15 to 30 MHz	3.65 dB
Worst Case Radiated Disturbance, 9KHz to 30 MHz	3.15 dB
Worst Case Radiated Disturbance, 30 to 1000 MHz	5.36 dB
Worst Case Radiated Disturbance, 1000 to 18000 MHz	4.32 dB
Worst Case Radiated Disturbance, 18000 to 26000 MHz	4.45 dB
Worst Case Radiated Disturbance, 26000 to 40000 MHz	5.24 dB

Uncertainty figures are valid to a confidence level of 95%.

6. EQUIPMENT UNDER TEST

6.1. EUT DESCRIPTION

The EUT is a GSM/WCDMA/LTE Phone with BT, DTS/UNII a/b/g/n/ac, ANT+, and NFC. The model SM-A705FN/DS was used for final testing and is representative of the test results in this report

6.2. MAXIMUM FUNDAMENTAL FIELD STRENGTH

The transmitter has a maximum peak fundamental field strength as follows:

Frequency Range (MHz)	Mode	Peak E-field Strength (dBuV/m)	Avg E-field Strength (dBuV/m)	Distance (m)
2402 - 2480	ANT +	89.41	55.72	3.00

6.3. DESCRIPTION OF AVAILABLE ANTENNAS

The radio utilizes an FPCB antenna, with a maximum gain of -4.88 dBi.

6.4. SOFTWARE AND FIRMWARE

The test utility software used during testing was A705FN.001.

6.5. WORST-CASE CONFIGURATION AND MODE

WORST-CASE CONFIGURATION AND MODE FOR FINAL TEST

Radiated emissions below 1GHz, above 18GHz, and power line conducted emission were performed with the EUT set to transmit at the channel with highest output power as worst-case scenario.

Band edge and radiated emissions between 1GHz and 18GHz were performed with the EUT set to transmit at the highest power on low, middle and high channels.

The fundamental of the EUT was investigated in three orthogonal orientations X,Y,Z, it was determined that X orientation was worst-case orientation; therefore, all final radiated testing was performed with the EUT in X orientation.

All radios that can be transmitted simultaneously have been evaluated for radiated for all possible combinations of transmission and found to be in compliance.

6.6. DESCRIPTION OF TEST SETUP

SUPPORT EQUIPMENT

Support Equipment List				
Description	Manufacturer	Model	Serial Number	FCC ID
AC Adapter	Samsung	EP-TA50EWE	DW3J719AS/A-E	N/A
Earphone	Samsung	N/A	N/A	N/A

I/O CABLES (CONDUCTED TEST)

I/O Cable List						
Cable No	Port	# of identical ports	Connector Type	Cable Type	Cable Length (m)	Remarks
1	Antenna	1	RF	Shielded	0.2	To spectrum Analyzer
2	USB	1	USB	Un-shielded	1	EUT to AC Mains

I/O CABLES (RADIATED AND CONDUCTED EMISSIONS)

I/O Cable List						
Cable No	Port	# of identical ports	Connector Type	Cable Type	Cable Length (m)	Remarks
1	USB	1	USB	Shielded	1	N/A
2	Earphone	1	3.5mm	Un-shielded	1	N/A

TEST SETUP

The EUT is a stand alone unit. Test software exercised the radio card.

CONDUCTED TEST SETUP DIAGRAM

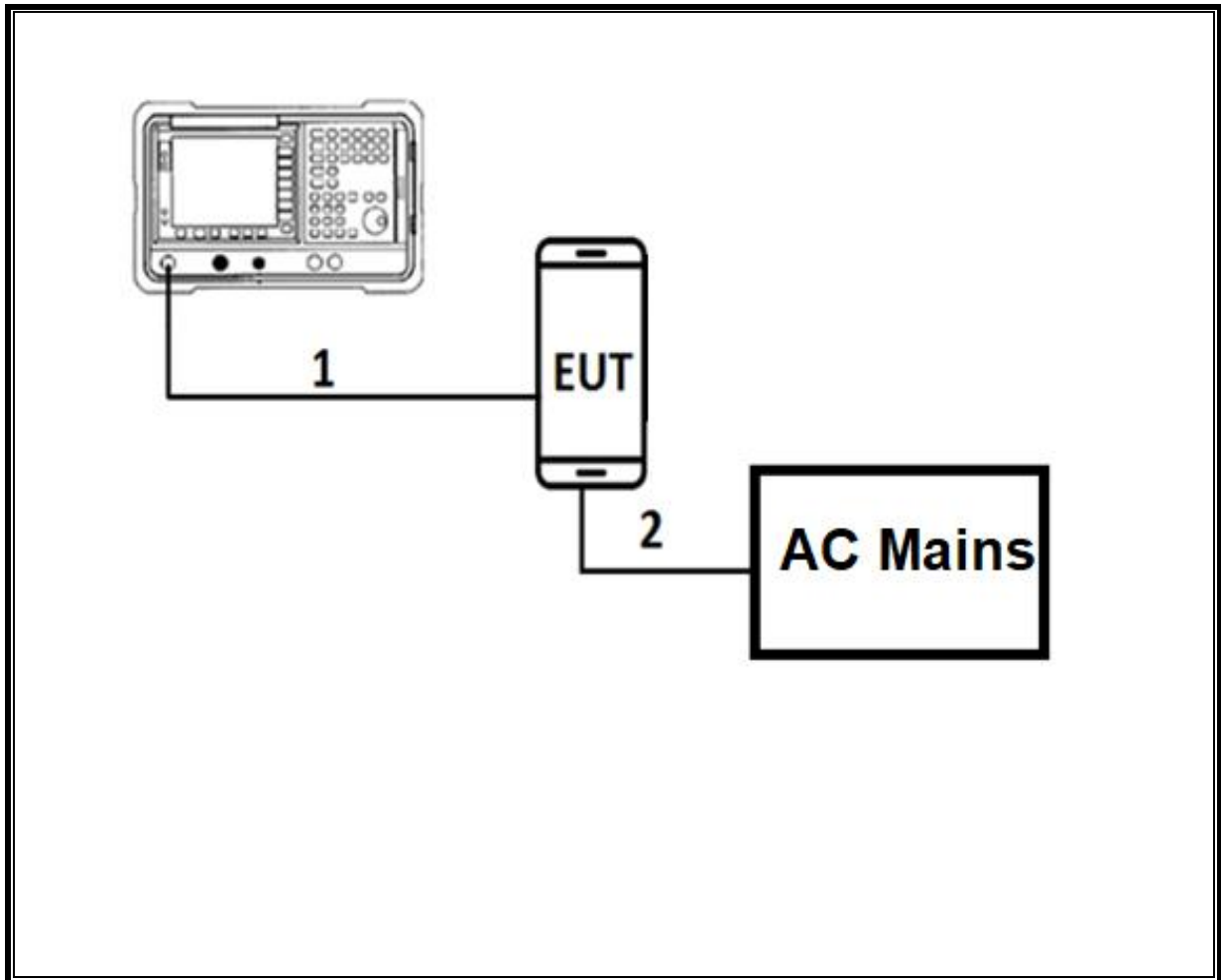

TEST SETUP

For conducted tests: the EUT was stand alone. The test software exercises the radio.

RADIATED AND AC LINE CONDUCTED EMISSIONS SETUP DIAGRAM

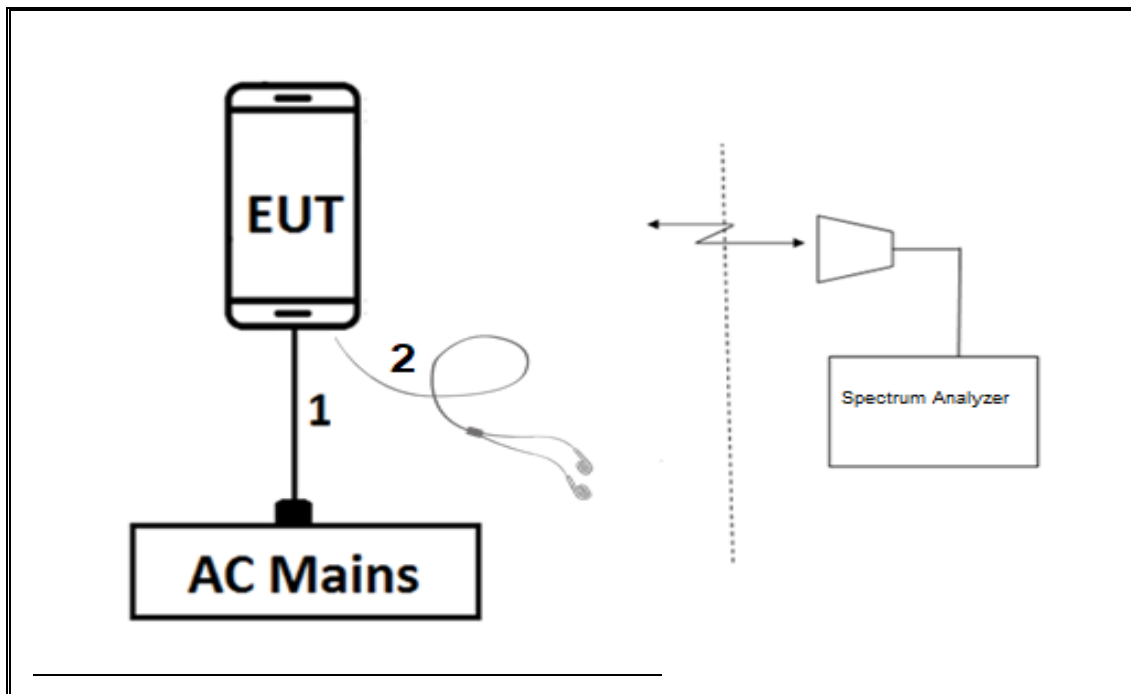

TEST SETUP

For radiated tests, the EUT is stand alone unit and the test software exercises the radio.

7. TEST AND MEASUREMENT EQUIPMENT

The following test and measurement equipment was utilized for the tests documented in this report:

TEST EQUIPMENT LIST					
Description	Manufacturer	Model	ID Num	Cal Due	Last Cal
6 port rf switch, 1-18GHz	Pasternack	PE7159	171455	08/01/2019	08/01/2018
Power Meter, P-series single channel	Agilent (Keysight) Technologies	N1911A	T1271	07/26/2019	07/26/2018
Power Sensor, P-series, 50MHz to 18GHz, Wideband	Agilent (Keysight) Technologies	N1921A	T1224	10/09/2019	10/09/2018
Antenna, Active Loop 9kHz-30MHz	ETS-Lindgren	6502	T757	09/25/2019	09/25/2018
Antenna, Horn 1-18GHz	ETS-Lindgren	3117	T344	04/30/2019	04/30/2018
Antenna, Horn 1-18GHz	ETS-Lindgren	3117	T862	05/25/2019	05/25/2018
EMI TEST RECEIVER	Rohde & Schwarz	ESW44	PRE0179372	05/04/2019	05/04/2018
EMI TEST RECEIVER	Rohde & Schwarz	ESW44	PRE0179375	05/08/2019	05/08/2018
Amplifier, 1-18GHz, 35 dB	AMPLICAL	AMP1G18-35	T1569	06/03/2019	06/23/2018
Amplifier, 1-18GHz, 35 dB	AMPLICAL	AMP1G18-35	T1571	07/30/2019	07/30/2018
Spectrum Analyzer, PXA, 3Hz to 44GHz	Agilent (Keysight) Technologies	N9030A	T908	01/23/2020	01/23/2019
Spectrum Analyzer, PXA, 3Hz to 44GHz	Agilent (Keysight) Technologies	N9030A	T341	09/26/2019	09/26/2018
Amplifier, 100kHz to 1GHz, 32 dB	Agilent (Keysight) Technologies	8447D	T15	10/20/2019	10/20/2018
Hybrid Antenna, 30MHz to 3GHz	SunAR rf motion	JB3	PRE0181574	08/21/2019	08/21/2018
Antenna, Horn 18 to 26.5GHz	ARA	MWH-1826/B	T447	06/16/2019	06/16/2018
Pre-Amp, 1-26.5GHz	Agilent	8449B	T404	03/09/2019	03/09/2018
AC Line Conducted					
EMI Receiver	Rohde & Schwarz	ESR	T1436	02/14/2020	02/14/2019
LISN for Conducted Emissions CISPR-16	FCC INC.	FCC LISN 50/250	T1310	06/15/2019	06/15/2018
Test Software List					
Radiated Software	UL	UL EMC		Ver 9.5, June 22, 2018	
Antenna Port Software	UL	UL RF		Ver 9.3.2, Jan. 07, 2019	
AC Line Conducted Software	UL	UL EMC		Ver 9.5, May 26, 2015	

NOTES:

1. Equipment listed above that calibrated during the testing period was set for test after the calibration.
2. Equipment listed above that has a calibration due date during the testing period, the testing is completed before equipment expiration date.

8. MEASUREMENT METHODS

On Time and Duty Cycle: ANSI C63.10-2013 Section 11.6

Occupied BW (20dB): ANSI C63.10-2013 Section 6.9.2

Radiated Spurious Emissions 30-1000MHz: ANSI C63.10-2013 Section 6.3 and 6.5

Radiated Spurious Emissions above 1GHz: ANSI C63.10-2013 Section 6.3 and 6.6

Radiated Band-edge: ANSI C63.10-2013 Section 6.10.5

AC Power-line conducted emissions: ANSI C63.10-2013, Section 6.2.

9. ANTENNA PORT TEST RESULTS

9.1. ON TIME AND DUTY CYCLE

LIMITS

None; for reporting purposes only.

PROCEDURE

ANSI C63.10, Section 11.6 : Zero-Span Spectrum Analyzer Method.

ON TIME AND DUTY CYCLE RESULTS

NOTE: For ON TIME measurement:

ON Time over 1msec period x No. of pulses over 100msec period = ON TIME

159us x 13 pulses = 2.067msec

Mode	ON Time B (msec)	Period (msec)	Duty Cycle x (linear)	Duty Cycle (%)	Duty Cycle Correction Factor for Average Measurements (dB)
2.4GHz Band					
ANT+	2.067	100.00	0.021	2.07%	-33.69

DUTY CYCLE PLOTS

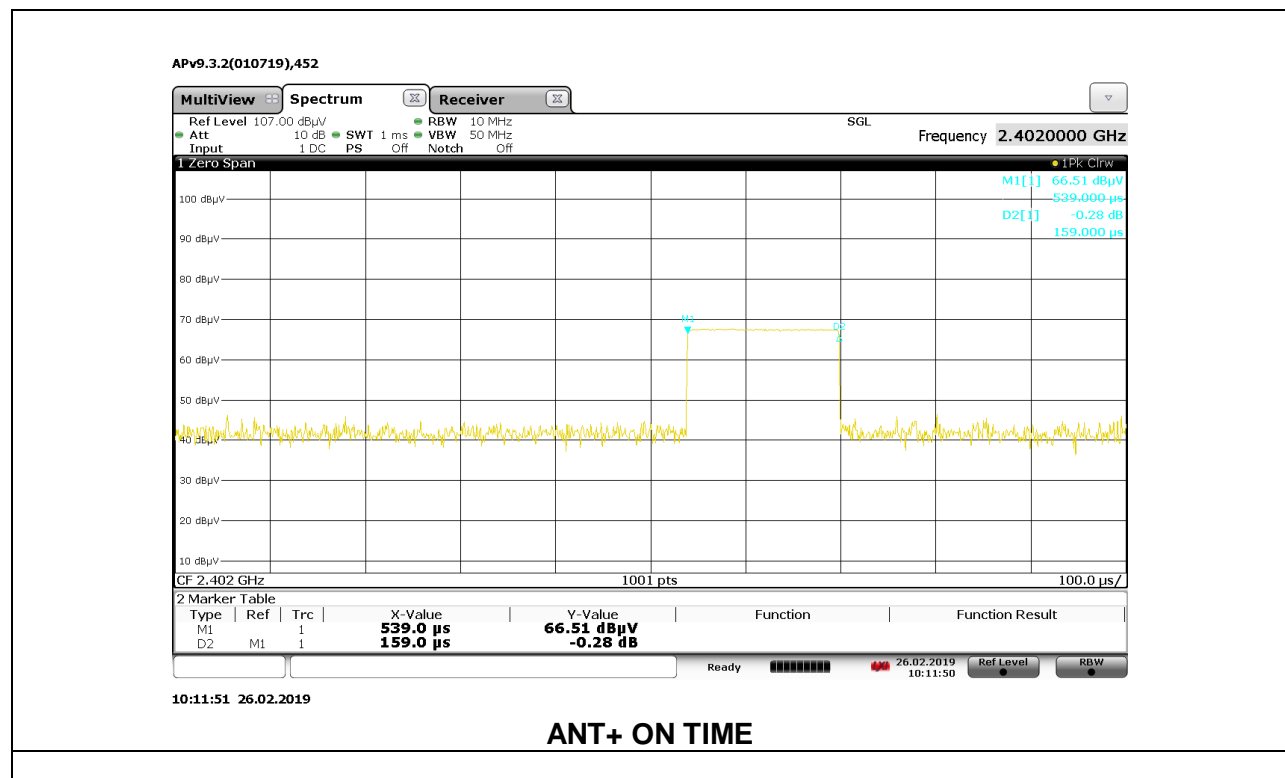

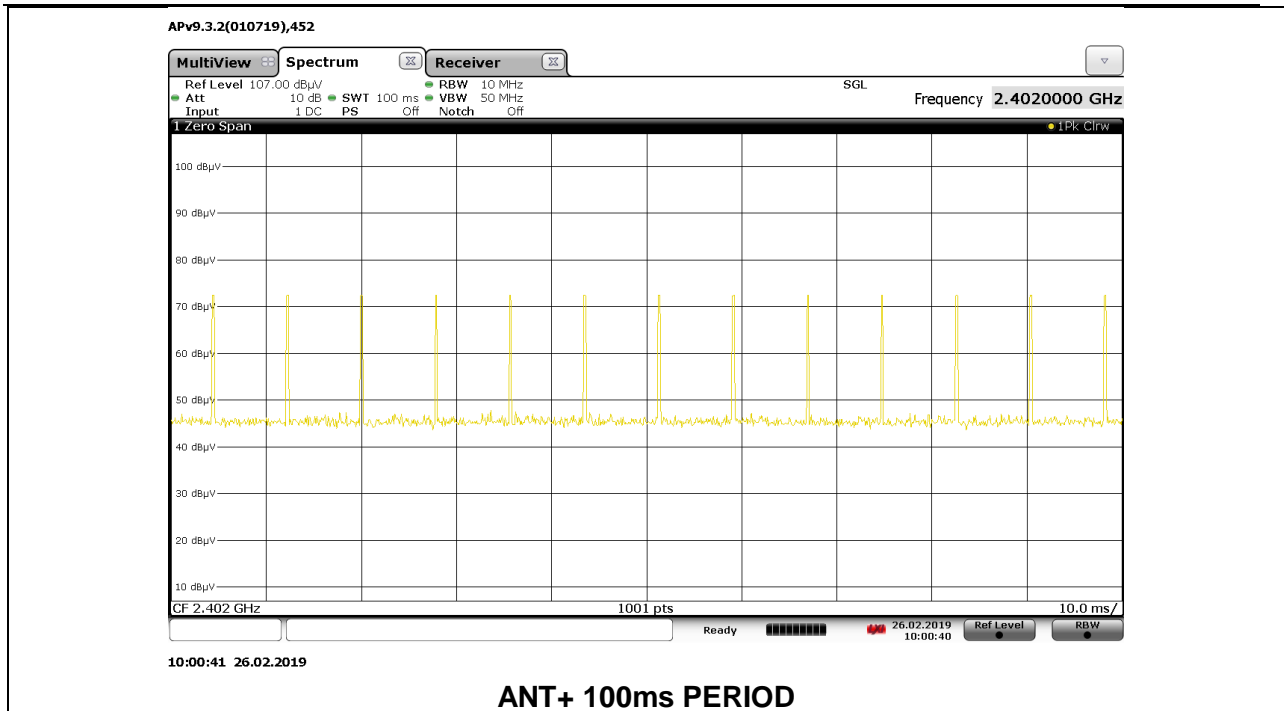

9.2. 20dB BANDWIDTH

LIMITS

None; for reporting purposes only.

TEST PROCEDURE

The transmitter output is connected to a spectrum analyzer. The RBW is set to 1% to 5% of the 20 dB bandwidth. The VBW is set to approximately three times RBW. The sweep time is coupled

RESULTS

Channel	Frequency (MHz)	20dB Bandwidth (MHz)	Frequency Edge (MHz)	Limit (MHz)	Margin (MHz)
Low	2402	0.765	2401.6175	2400	-1.62
Mid	2441	0.741	N/A	N/A	N/A
High	2480	0.747	2480.3735	2483.5	-3.13

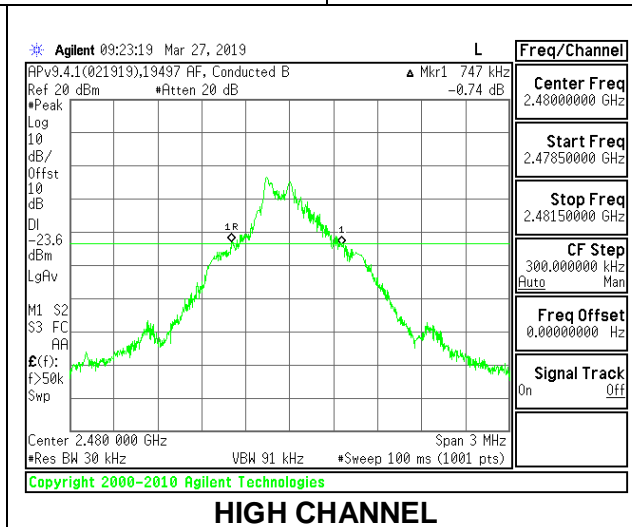
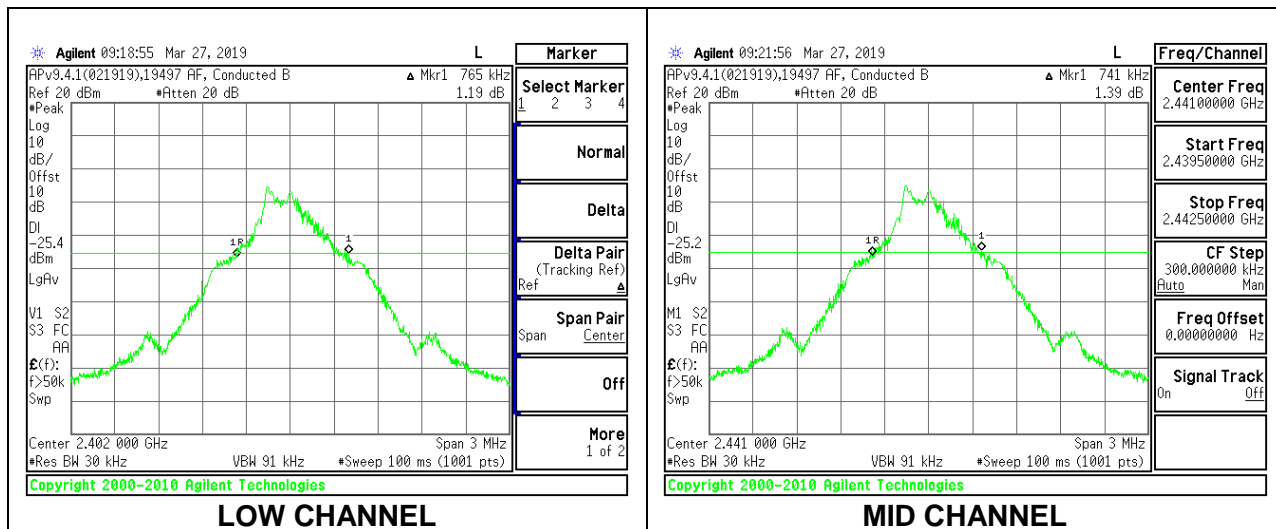

10. RADIATED TEST RESULTS

LIMITS

FCC §15.249
 FCC §15.205 and §15.209

Operation within the bands 902–928 MHz, 2400–2483.5 MHz, 5725–5875 MHz, and 24.0–24.25 GHz.

(a) Except as provided in paragraph (b) of this section, the field strength of emissions from intentional radiators operated within these frequency bands shall comply with the following:

Fundamental frequency	Field strength of fundamental (millivolts/ meter)	Field strength of harmonics (microvolts/ meter)
902–928 MHz	50	500
2400–2483.5 MHz	50	500
5725–5875 MHz	50	500
24.0–24.25 GHz	250	2500

(d) Emissions radiated outside of the specified frequency bands, except for harmonics, shall be attenuated by at least 50 dB below the level of the fundamental or to the general radiated emission limits in § 15.209, whichever is the lesser attenuation.

(e) As shown in Sec. 15.35(b), for frequencies above 1000 MHz, the field strength limits in paragraphs (a) and (b) of this section are based on average limits. However, the peak field strength of any emission shall not exceed the maximum permitted average limits specified above by more than 20 dB under any condition of modulation.

Frequency Range (MHz)	Field Strength Limit (uV/m) at 3 m	Field Strength Limit (dBuV/m) at 3 m
0.009-0.490	2400/F(kHz) @ 300 m	-
0.490-1.705	24000/F(kHz) @ 30 m	-
1.705 - 30	30 @ 30m	-
30 - 88	100	40
88 - 216	150	43.5
216 - 960	200	46
Above 960	500	54

TEST PROCEDURE

The EUT is placed on a non-conducting table 80 cm above the ground plane for measurement below 1GHz; 1.5 m above the ground plane for measurement above 1GHz. The antenna to EUT distance is 3 meters. The EUT is configured in accordance with ANSI C63.10. The EUT is set to transmit in a continuous mode.

For measurements below 1 GHz the resolution bandwidth is set to 100 kHz for peak detection measurements or 120 kHz for quasi-peak detection measurements. Peak detection is used unless otherwise noted as quasi-peak.

For pre-scans above 1 GHz the resolution bandwidth is set to 1 MHz; the video bandwidth is set to 30 KHz for peak measurements.

For final measurements above 1 GHz the resolution bandwidth is set to 1 MHz; the video bandwidth is set to 3 MHz for peak measurements and 1 MHz resolution bandwidth with 1/T (10 kHz) video bandwidth with peak detector for average measurements.

The spectrum from 1 GHz to 18 GHz is investigated with the transmitter set to the lowest, middle, and highest channels in each applicable band. Below 1GHz and above 18GHz emissions, the channel with the highest output power was tested.

The frequency range of interest is monitored at a fixed antenna height and EUT azimuth. The EUT is rotated through 360 degrees to maximize emissions received. The antenna is scanned from 1 to 4 meters above the ground plane to further maximize the emission. Measurements are made with the antenna polarized in both the vertical and the horizontal positions.

2D antenna use - For below 30MHz testing, investigation was done on three antenna orientations (parallel, perpendicular, and ground-parallel), parallel and perpendicular are the worst orientations, therefore testing was performed on these two orientations only.

KDB 414788 OFS and Chamber Correlation Justification

Base on FCC 15.31 (f) (2): measurements may be performed at a distance closer than that specified in the regulations; however, an attempt should be made to avoid making measurements in the near field.

OFS and chamber correlation testing had been performed and chamber measured test result is the worst case test result.

10.1. TRANSMITTER ABOVE 1 GHz

BANDEDGE (LOW CHANNEL)

HORIZONTAL RESULT

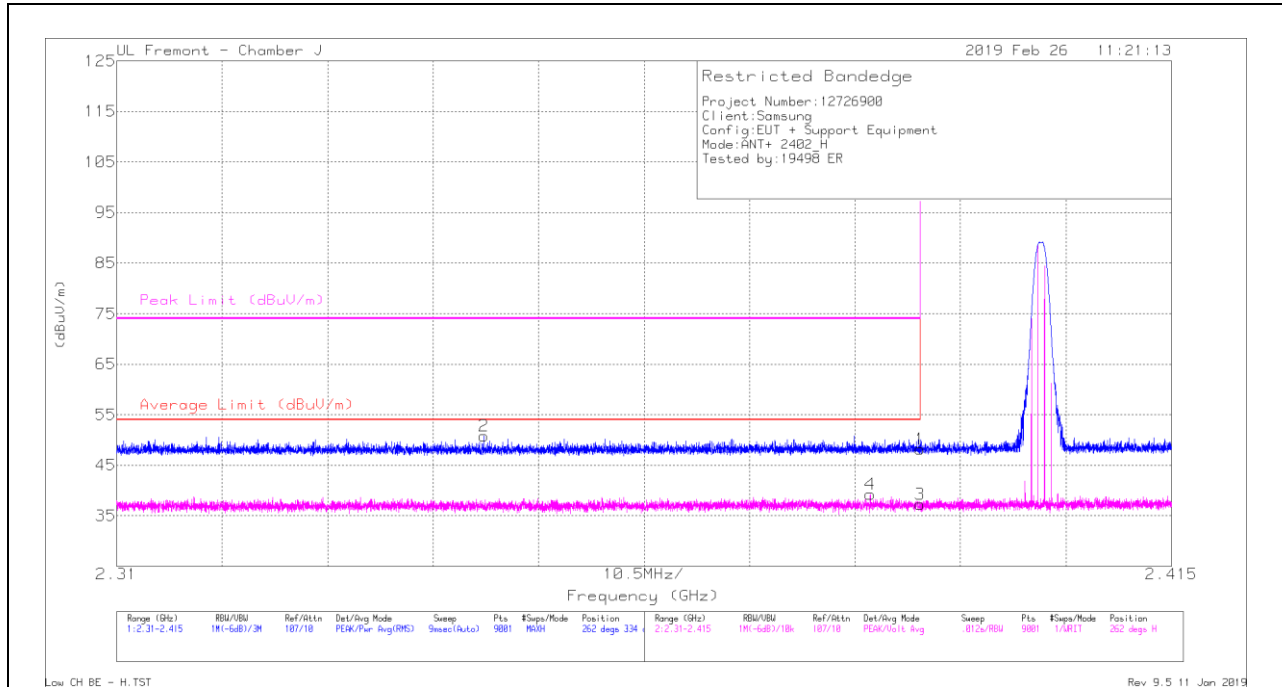

Trace Markers

Marker	Frequency (GHz)	Meter Reading (dBuV)	Det	AF AT0067 (dB/m)	Amp/Cbl/Filtr/Pad (dB)	Corrected Reading (dBuV/m)	Average Limit (dBuV/m)	Margin (dB)	Peak Limit (dBuV/m)	PK Margin (dB)	Azimuth (Degs)	Height (cm)	Polarity
1	* 2.39	41.97	Pk	32	-25.8	48.17	-	-	74	-25.83	262	334	H
2	* 2.347	44.72	Pk	31.9	-25.8	50.82	-	-	74	-23.18	262	334	H
3	* 2.39	31.07	VA1T	32	-25.8	37.27	54	-16.73	-	-	262	334	H
4	* 2.385	33.03	VA1T	32	-25.8	39.23	54	-14.77	-	-	262	334	H

* - indicates frequency in CFR47 Pt 15 / IC RSS-Restricted Band

Pk - Peak detector

VA1T - FHSS: Linear Voltage Average VB=1/Ton where: Ton is transmit duration

VERTICAL RESULT

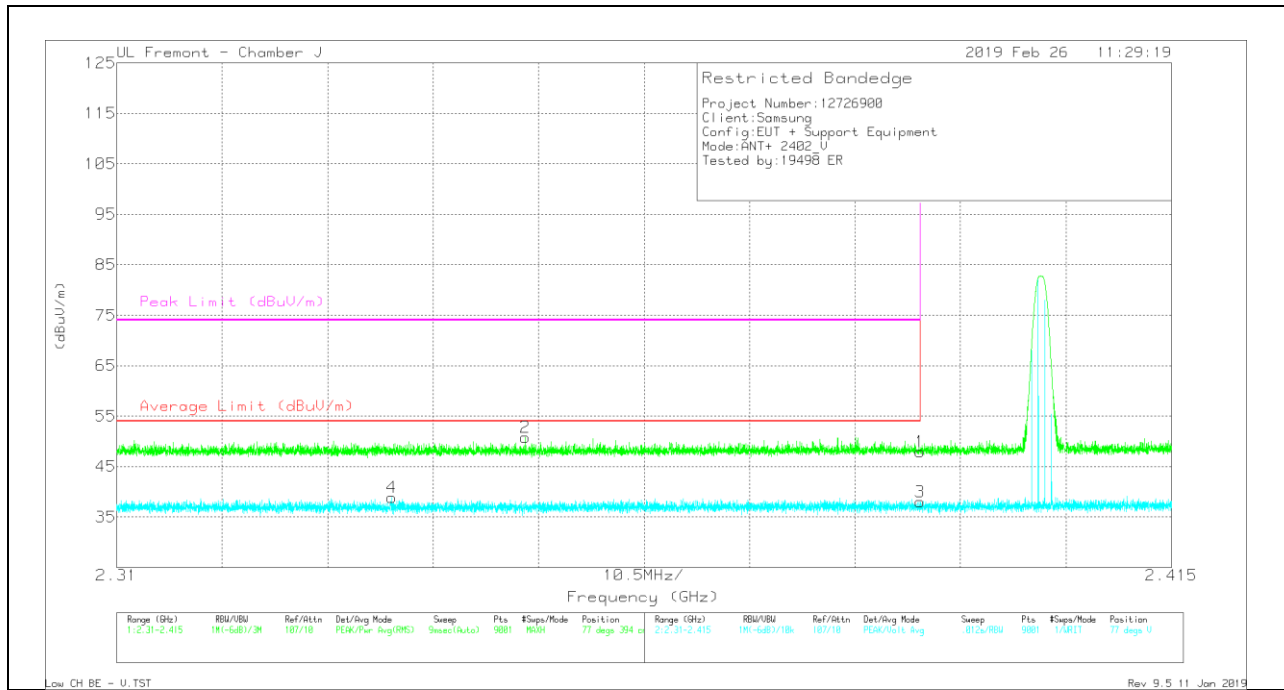

Trace Markers

Marker	Frequency (GHz)	Meter Reading (dBuV)	Det	AF AT0067 (dB/m)	Amp/Cbl/Fitr/Pad (dB)	Corrected Reading (dBuV/m)	Average Limit (dBuV/m)	Margin (dB)	Peak Limit (dBuV/m)	PK Margin (dB)	Azimuth (Degs)	Height (cm)	Polarity
1	* 2.39	41.76	Pk	32	-25.8	47.96	-	-	74	-26.04	77	394	V
2	* 2.351	44.71	Pk	31.9	-25.8	50.81	-	-	74	-23.19	77	394	V
3	* 2.39	31.79	VA1T	32	-25.8	37.99	54	-16.01	-	-	77	394	V
4	* 2.337	32.82	VA1T	31.9	-25.8	38.92	54	-15.08	-	-	77	394	V

* - indicates frequency in CFR47 Pt 15 / IC RSS-Restricted Band

Pk - Peak detector

VA1T - FHSS: Linear Voltage Average VB=1/Ton where: Ton is transmit duration

BANEDGE (HIGH CHANNEL)

HORIZONTAL RESULT

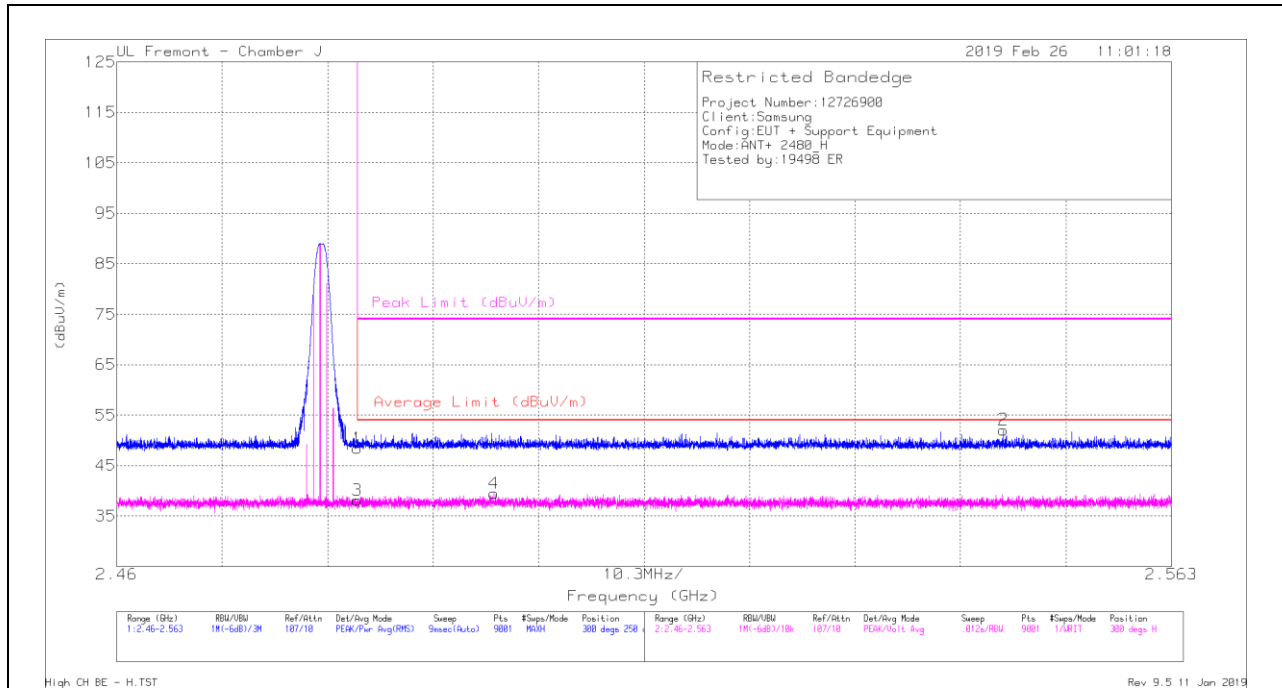

Trace Markers

Marker	Frequency (GHz)	Meter Reading (dBuV)	Det	AF AT0067 (dB/m)	Amp/Cb/Filtr/Pad (dB)	Corrected Reading (dBuV/m)	Average Limit (dBuV/m)	Margin (dB)	Peak Limit (dBuV/m)	PK Margin (dB)	Azimuth (Degs)	Height (cm)	Polarity
1	* 2.484	41.75	Pk	32.5	-25.8	48.45	-	-	74	-25.55	300	250	H
2	2.547	45.29	Pk	32.5	-25.7	52.09	-	-	74	-21.91	300	250	H
3	* 2.484	31.46	VA1T	32.5	-25.8	38.16	54	-15.84	-	-	300	250	H
4	* 2.497	32.65	VA1T	32.5	-25.7	39.45	54	-14.55	-	-	300	250	H

* - indicates frequency in CFR47 Pt 15 / IC RSS-Restricted Band
 Pk - Peak detector
 VA1T - FHSS: Linear Voltage Average $V_B=1/T_{on}$ where: T_{on} is transmit duration

VERTICAL RESULT

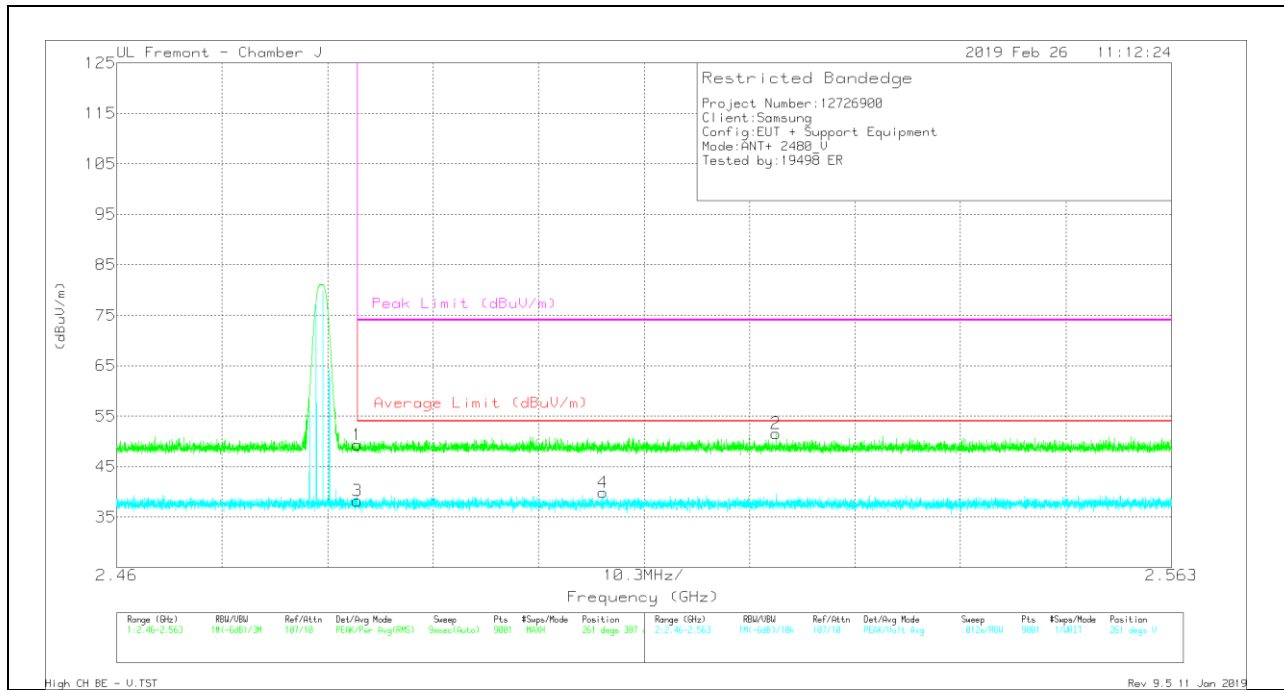

Trace Markers

Marker	Frequency (GHz)	Meter Reading (dBuV)	Det	AF AT0067 (dB/m)	Amp/Cb/Fitr/Pad (dB)	Corrected Reading (dBuV/m)	Average Limit (dBuV/m)	Margin (dB)	Peak Limit (dBuV/m)	PK Margin (dB)	Azimuth (Degs)	Height (cm)	Polarity
1	* 2.484	42.55	Pk	32.5	-25.8	49.25	-	-	74	-24.75	261	387	V
2	2.524	44.79	Pk	32.5	-25.7	51.59	-	-	74	-22.41	261	387	V
3	* 2.484	31.49	VA1T	32.5	-25.8	38.19	54	-15.81	-	-	261	387	V
4	2.507	33.1	VA1T	32.5	-25.7	39.9	54	-14.1	-	-	261	387	V

* - indicates frequency in CFR47 Pt 15 / IC RSS-Restricted Band

Pk - Peak detector

VA1T - FHSS: Linear Voltage Average $V_B = 1/T_{on}$ where: T_{on} is transmit duration

HARMONICS AND SPURIOUS EMISSIONS

LOW CHANNEL RESULTS

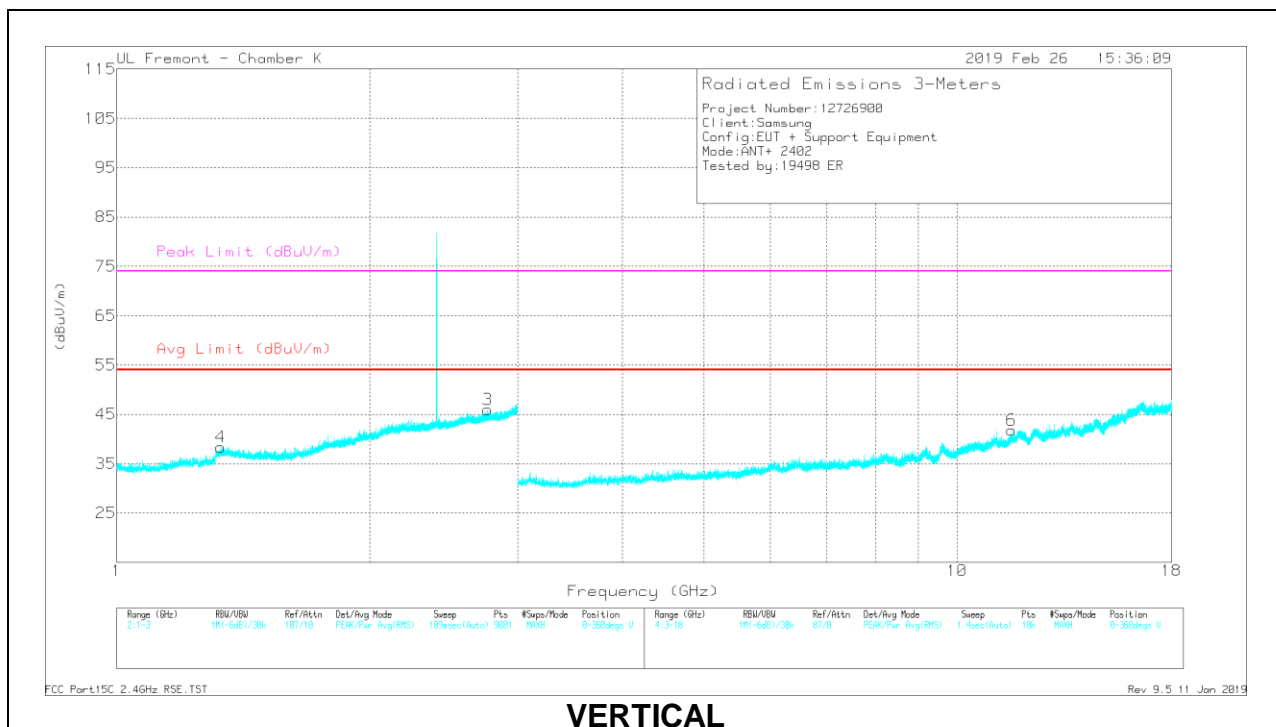
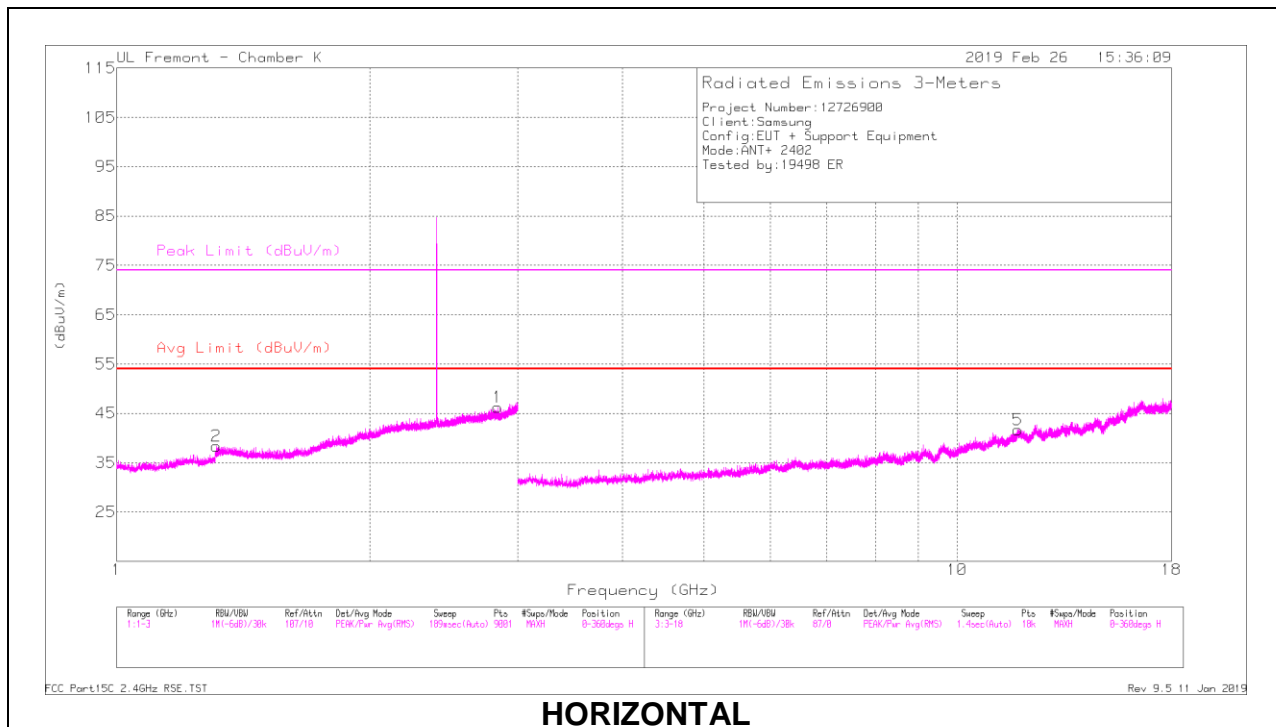

RADIATED EMISSIONS

Marker	Frequency (GHz)	Meter Reading (dBuV)	Det	AF T344 (dB/m)	Amp/Cbl/Filtr/Pad (dB)	Corrected Reading (dBuV/m)	Avg Limit (dBuV/m)	Margin (dB)	Peak Limit (dBuV/m)	PK Margin (dB)	Azimuth (Degs)	Height (cm)	Polarity
1	* 2.84	32.34	PKFH	32.3	-13.1	51.54	-	-	74	-22.46	287	212	H
	* 2.84	22.84	VA1T	32.3	-13.1	42.04	54	-11.96	-	-	287	212	H
2	* 1.314	32.26	PKFH	28.9	-17.1	44.06	-	-	74	-29.94	167	153	H
	* 1.314	23.32	VA1T	28.9	-17.1	35.12	54	-18.88	-	-	167	153	H
4	* 1.331	32.8	PKFH	29.2	-16.9	45.1	-	-	74	-28.9	312	110	V
	* 1.331	23.12	VA1T	29.2	-16.9	35.42	54	-18.58	-	-	312	110	V
3	* 2.764	32.3	PKFH	32.3	-13.1	51.5	-	-	74	-22.5	103	220	V
	* 2.764	23.72	VA1T	32.3	-13.1	42.92	54	-11.08	-	-	103	220	V
5	* 11.822	30.31	PKFH	38.4	-19.6	49.11	-	-	74	-24.89	147	211	H
	* 11.823	20.15	VA1T	38.4	-19.6	38.95	54	-15.05	-	-	147	211	H
6	* 11.616	30.72	PKFH	38.2	-20.4	48.52	-	-	74	-25.48	248	356	V
	* 11.614	20.25	VA1T	38.2	-20.4	38.05	54	-15.95	-	-	248	356	V

* - indicates frequency in CFR47 Pt 15 / IC RSS-Restricted Band
 PKFH FHSS/BT RB=100k for Frequencies<1GHz / RB=1MHz for Frequencies>1GHz, VB=3 x RB, Peak
 VA1T - FHSS: Linear Voltage Average VB=1/Ton where: Ton is transmit duration

MID CHANNEL RESULTS

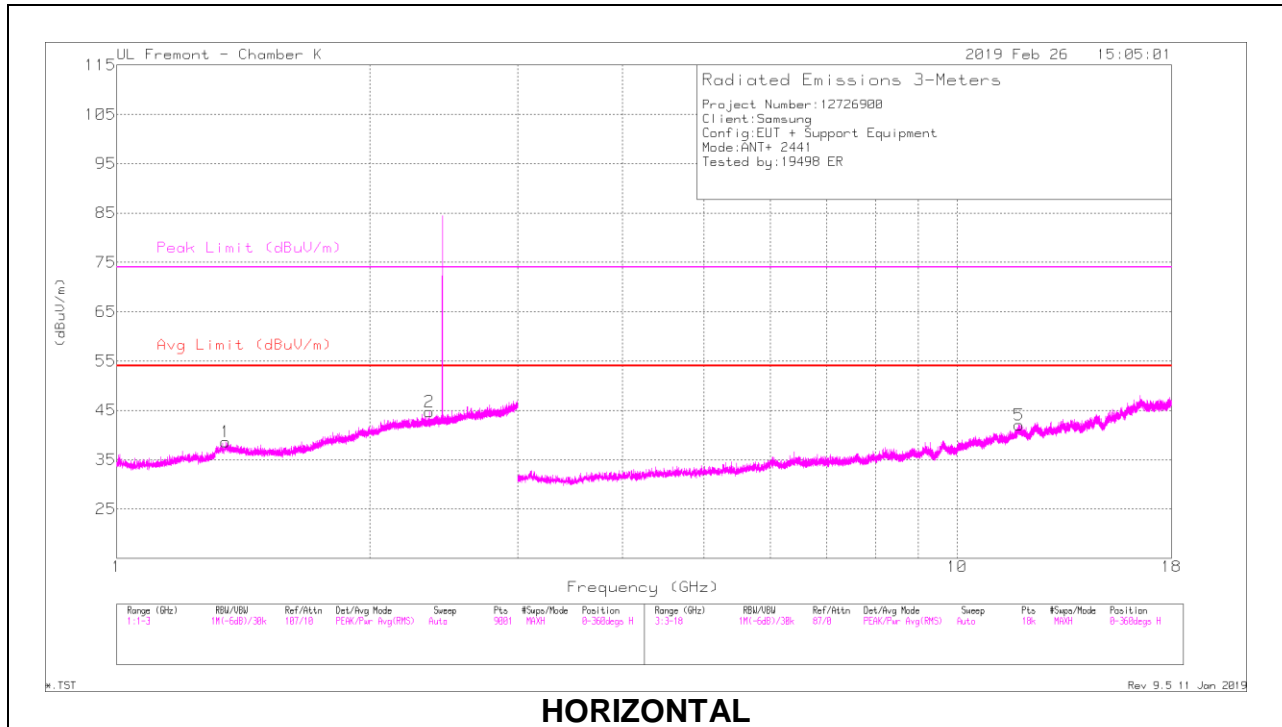

HORIZONTAL

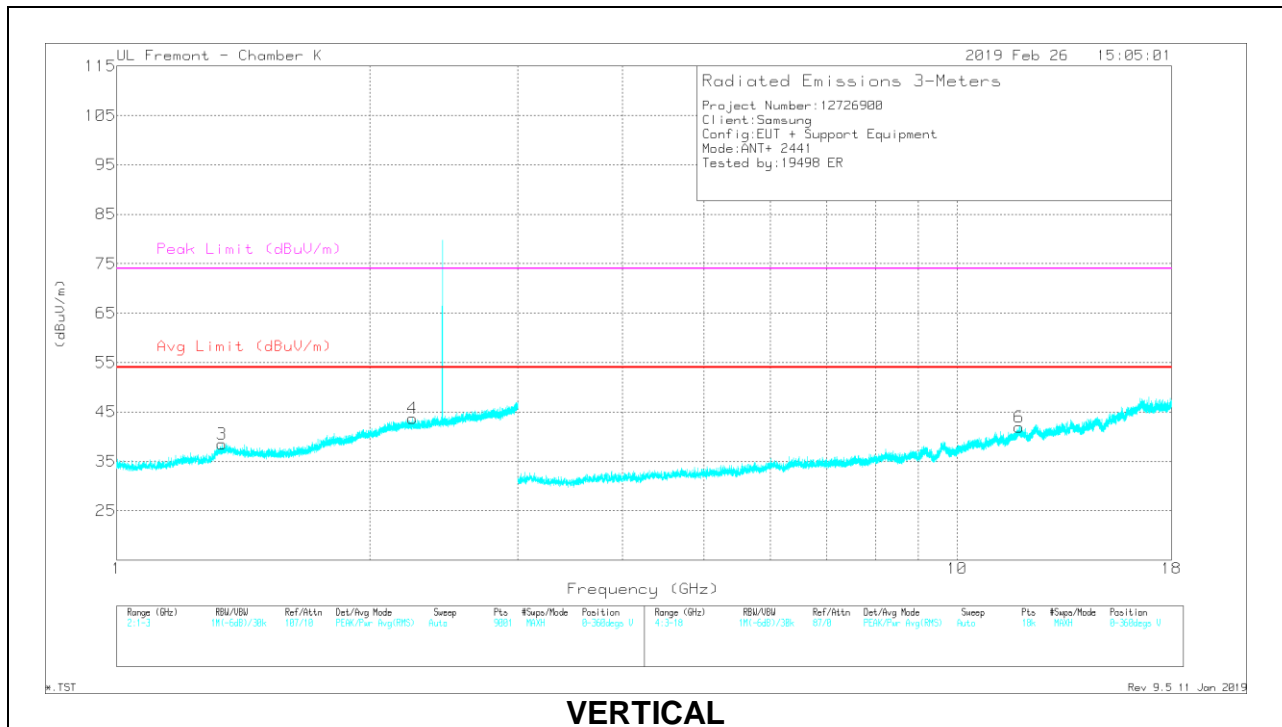

VERTICAL

RADIATED EMISSIONS

Marker	Frequency (GHz)	Meter Reading (dBuV)	Det	AF T344 (dB/m)	Amp/Cbl/Filtr/Pad (dB)	Corrected Reading (dBuV/m)	Avg Limit (dBuV/m)	Margin (dB)	Peak Limit (dBuV/m)	PK Margin (dB)	Azimuth (Degs)	Height (cm)	Polarity
1	* 1.349	32.82	PKFH	29.4	-16.9	45.32	-	-	74	-28.68	89	137	H
	* 1.35	22.84	VA1T	29.4	-16.9	35.34	54	-18.66	-	-	89	137	H
2	* 2.354	33.22	PKFH	31.7	-14.4	50.52	-	-	74	-23.48	228	170	H
	* 2.354	22.98	VA1T	31.7	-14.4	40.28	54	-13.72	-	-	228	170	H
3	* 1.336	33.68	PKFH	29.2	-16.9	45.98	-	-	74	-28.02	75	168	V
	* 1.333	22.87	VA1T	29.2	-16.9	35.17	54	-18.83	-	-	75	168	V
4	* 2.247	33.42	PKFH	31.9	-14.7	50.62	-	-	74	-23.38	222	194	V
	* 2.247	23.14	VA1T	31.9	-14.7	40.34	54	-13.66	-	-	222	194	V
5	* 11.851	29.89	PKFH	38.4	-19.8	48.49	-	-	74	-25.51	112	135	H
	* 11.852	20.31	VA1T	38.4	-19.8	38.91	54	-15.09	-	-	112	135	H
6	* 11.858	30.23	PKFH	38.4	-19.8	48.83	-	-	74	-25.17	14	165	V
	* 11.855	20.72	VA1T	38.4	-19.8	39.32	54	-14.68	-	-	14	165	V

* - indicates frequency in CFR47 Pt 15 / IC RSS-Restricted Band

PKFH FHSS/BT RB=100k for Frequencies<1GHz / RB=1MHz for Frequencies>1GHz, VB=3 x RB, Peak

VA1T - FHSS: Linear Voltage Average VB=1/Ton where: Ton is transmit duration

HIGH CHANNEL RESULTS

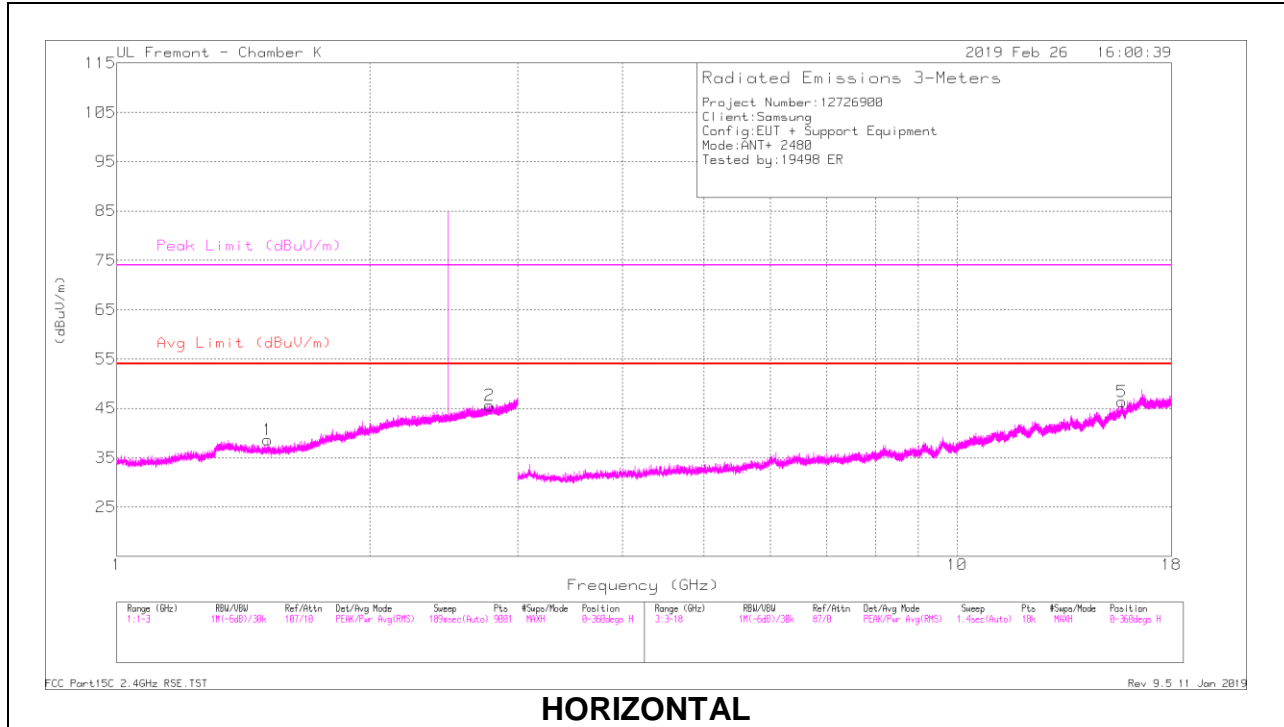

HORIZONTAL

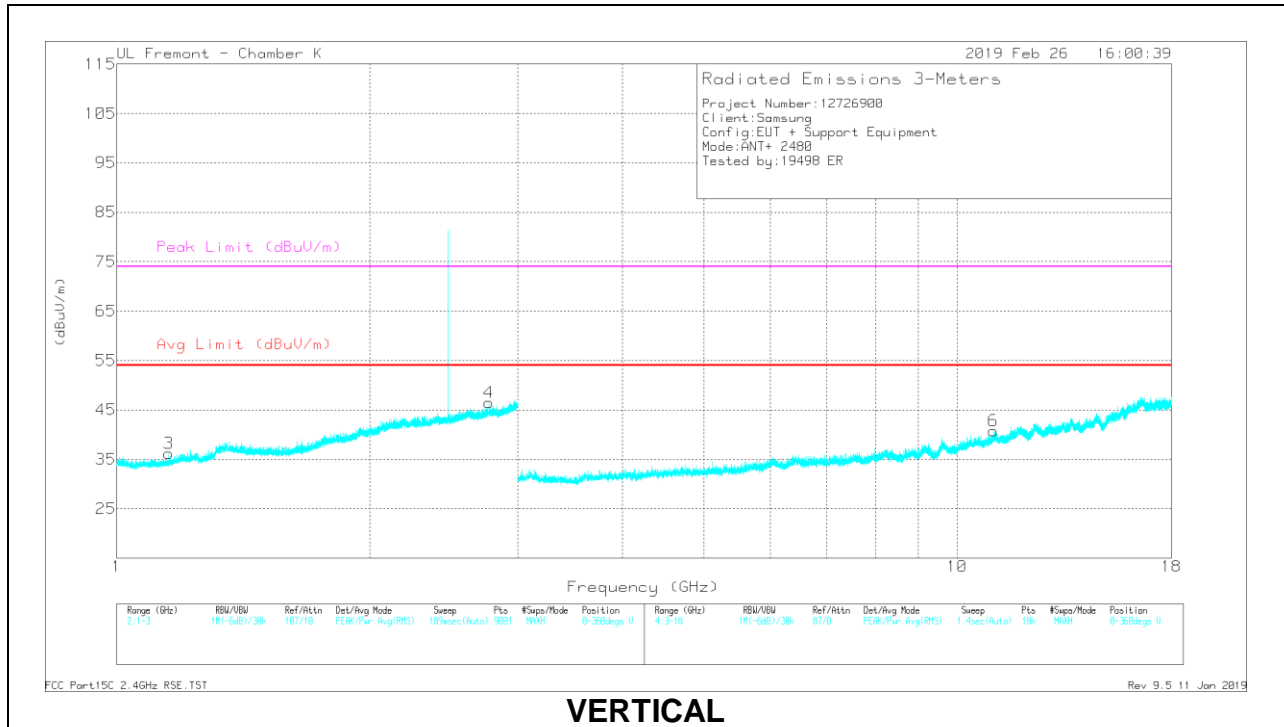

VERTICAL

RADIATED EMISSIONS

Marker	Frequency (GHz)	Meter Reading (dBuV)	Det	AF T344 (dB/m)	Amp/Cbl/Filtr/Pad (dB)	Corrected Reading (dBuV/m)	Avg Limit (dBuV/m)	Margin (dB)	Peak Limit (dBuV/m)	PK Margin (dB)	Azimuth (Degs)	Height (cm)	Polarity
1	* 1.514	33.42	PKFH	28.1	-16.4	45.12	-	-	74	-28.88	237	165	H
	* 1.514	23.05	VA1T	28.1	-16.4	34.75	54	-19.25	-	-	237	165	H
2	* 2.779	33.16	PKFH	32.3	-13.2	52.26	-	-	74	-21.74	258	256	H
	* 2.779	23.32	VA1T	32.3	-13.2	42.42	54	-11.58	-	-	258	256	H
3	* 1.155	33.21	PKFH	27.5	-17.5	43.21	-	-	74	-30.79	76	183	V
	* 1.152	22.81	VA1T	27.5	-17.4	32.91	54	-21.09	-	-	76	183	V
4	* 2.775	32.27	PKFH	32.3	-13.2	51.37	-	-	74	-22.63	58	317	V
	* 2.775	23.45	VA1T	32.3	-13.2	42.55	54	-11.45	-	-	58	317	V
5	* 15.702	28.81	PKFH	40.8	-17.5	52.11	-	-	74	-21.89	189	273	H
	* 15.703	18.61	VA1T	40.8	-17.5	41.91	54	-12.09	-	-	189	273	H
6	* 11.047	30.28	PKFH	37.9	-21.1	47.08	-	-	74	-26.92	353	214	V
	* 11.046	20.7	VA1T	37.9	-21.1	37.5	54	-16.5	-	-	353	214	V

* - indicates frequency in CFR47 Pt 15 / IC RSS-Restricted Band
 PKFH FHSS/BT RB=100k for Frequencies<1GHz / RB=1MHz for Frequencies>1GHz, VB=3 x RB, Peak
 VA1T - FHSS: Linear Voltage Average VB=1/Ton where: Ton is transmit duration

10.2. FUNDAMENTAL FREQUENCY RADIATED EMISSION

Frequency (GHz)	Meter Reading (dBuV)	Det	AF AT0067 (dB/m)	Amp/Cbl/Filtr/Pad (dB)	DC Corr (dB)	Corrected Reading (dBuV/m)	Avg Limit (dBuV/m)	Margin (dB)	Peak Limit (dBuV/m)	PK Margin (dB)	Azimuth (Degs)	Height (cm)	Polarity
2.402	72.06	PKFH	32.1	-14.8	0	89.36	-	-	114	-24.64	150	105	H
	72.06	AVG	32.1	-14.8	-33.69	55.67	94	-38.33	-	-	150	105	H
	67.3	PKFH	32.1	-14.8	0	84.6	-	-	114	-29.37	188	109	V
	67.3	AVG	32.1	-14.8	-33.69	50.91	94	-43.09	-	-	188	109	V
2.441	71.48	PKFH	32.4	-14.8	0	89.08	-	-	114	-24.92	301	183	H
	71.48	AVG	32.4	-14.8	-33.69	55.39	94	-38.61	-	-	301	183	H
	63.35	PKFH	32.4	-14.8	0	80.95	-	-	114	-33.05	243	108	V
	63.35	AVG	32.4	-14.8	-33.69	47.26	94	-46.74	-	-	243	108	V
2.480	71.61	PKFH	32.5	-14.7	0	89.41	-	-	114	-24.59	293	151	H
	71.61	AVG	32.5	-14.7	-33.69	55.72	94	-38.28	-	-	293	151	H
	66.5	PKFH	32.5	-14.7	0	84.3	-	-	114	-29.7	175	147	V
	66.5	AVG	32.5	-14.7	-33.69	50.61	94	-43.39	-	-	175	147	V

PKFH - FHSS: RB=1MHz VB=3 x RB, Peak
 AVG = Peak Reading + Duty Cycle Correction Factor
 Duty Cycle Correction Factor = -33.69 dB

10.3. WORST CASE BELOW 30 MHz

SPURIOUS EMISSIONS 9 kHz TO 30 MHz (WORST-CASE CONFIGURATION)

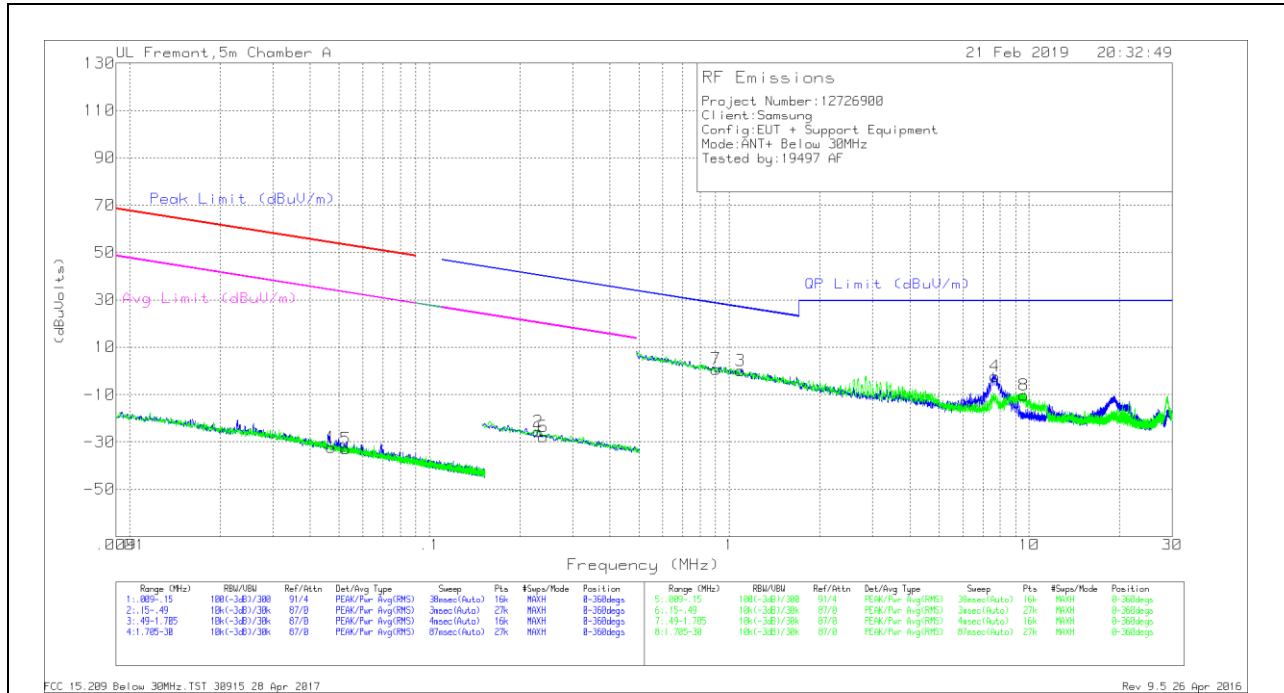

Below 30 MHz Data

Trace Markers

Marker	Frequency (MHz)	Meter Reading (dBuV)	Det	Loop Antenna (dBm)	Cables (dB)	Dist Corr 300m	Corrected Reading (dBuVolts)	Peak Limit (dBuV/m)	Margin (dB)	Avg Limit (dBuV/m)	Margin (dB)	Peak Limit (dBuV/m)	Margin (dB)	Avg Limit (dBuV/m)	Margin (dB)	Azimuth (Degs)
1	.04713	34.8	Pk	13	0	-80	-32.2	54.12	-86.32	34.12	-66.32	-	-	-	-	0-360
5	.05257	34.43	Pk	12.7	0	-80	-32.87	53.17	-86.04	33.17	-66.04	-	-	-	-	0-360
2	.23037	43.34	Pk	11	.1	-80	-25.56	-	-	-	-	40.37	-65.93	20.37	-45.93	0-360
6	.23945	41.15	Pk	11	.1	-80	-27.75	-	-	-	-	40.03	-67.78	20.03	-47.78	0-360

Pk - Peak detector

Marker	Frequency (MHz)	Meter Reading (dBuV)	Det	Loop Antenna (dBm)	Cables (dB)	Dist Corr 30m	Corrected Reading (dBuVolts)	QP Limit (dBuV/m)	Margin (dB)	Peak Limit (dBuV/m)	Margin (dB)	Avg Limit (dBuV/m)	Margin (dB)	Azimuth (Degs)
7	.902	29.57	Pk	11.1	.1	-40	.77	28.51	-27.74	-	-	-	-	0-360
3	1.08956	28.75	Pk	11.3	.1	-40	.15	26.88	-26.73	-	-	-	-	0-360
4	7.69222	26.53	Pk	10.9	.4	-40	-2.17	29.5	-31.67	-	-	-	-	0-360
8	9.59696	18.49	Pk	10.8	.4	-40	-10.31	29.5	-39.81	-	-	-	-	0-360

Pk - Peak detector

10.4. WORST CASE BELOW 1 GHz

SPURIOUS EMISSIONS 30 TO 1000 MHz (WORST-CASE CONFIGURATION)

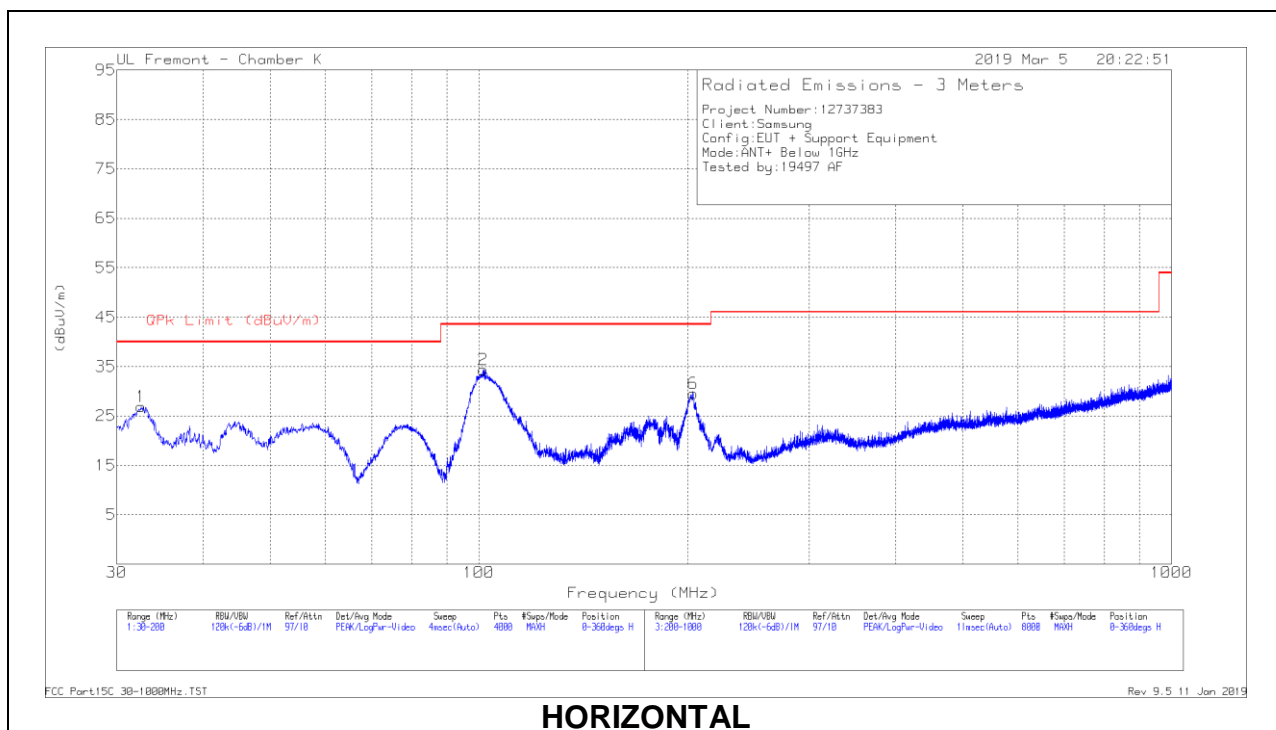

HORIZONTAL

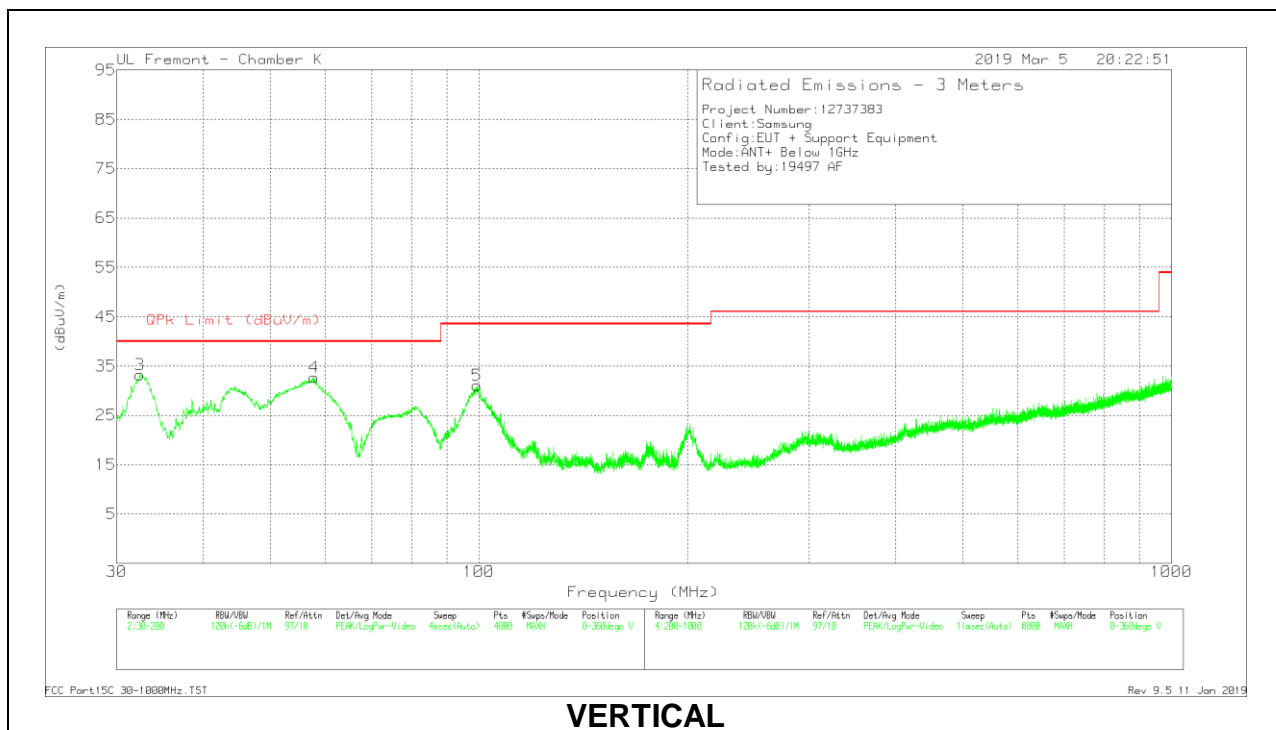

VERTICAL

Below 1GHz Data

Marker	Frequency (MHz)	Meter Reading (dBuV)	Det	AF PRE0184052 (dB/m)	Amp/Cbl (dB)	Corrected Reading (dBuV/m)	QPk Limit (dBuV/m)	Margin (dB)	Azimuth (Degs)	Height (cm)	Polarity
1	32.5081	33.47	Pk	25	-31.6	26.87	40	-13.13	0-360	199	H
2	101.546	48.67	Pk	16.6	-30.9	34.37	43.52	-9.15	0-360	299	H
3	32.4231	39.72	Pk	25.1	-31.6	33.22	40	-6.78	0-360	100	V
	32.3651	37.43	Qp	25.1	-31.6	30.93	40	-9.07	132	103	V
4	57.7597	50.8	Pk	13.2	-31.3	32.7	40	-7.3	0-360	100	V
5	99.4205	46.02	Pk	15.9	-30.9	31.02	43.52	-12.5	0-360	100	V
6	203.9005	42.39	Pk	17.3	-30.2	29.49	43.52	-14.03	0-360	100	H

* - indicates frequency in CFR47 Pt 15 / IC RSS-Restricted Band

Pk - Peak detector

Qp - Quasi-Peak detector

10.5. WORST CASE 18-26 GHz

SPURIOUS EMISSIONS 18-26 GHz (WORST-CASE CONFIGURATION)

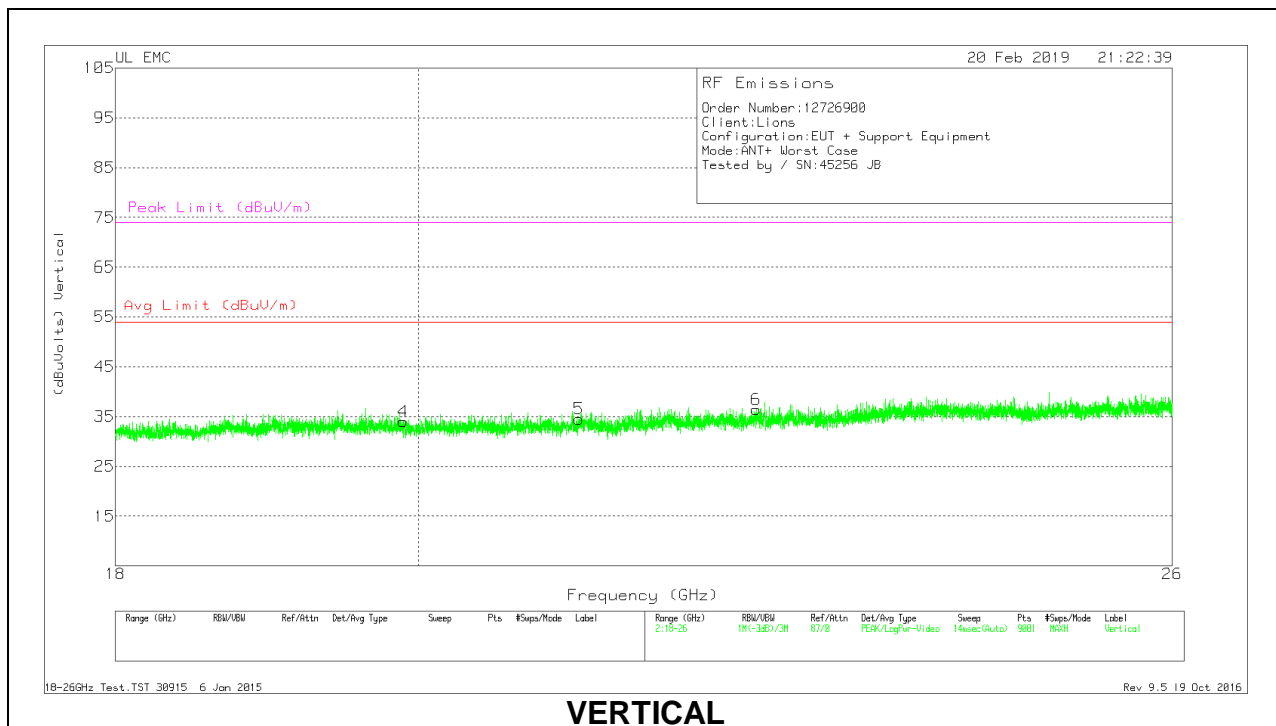
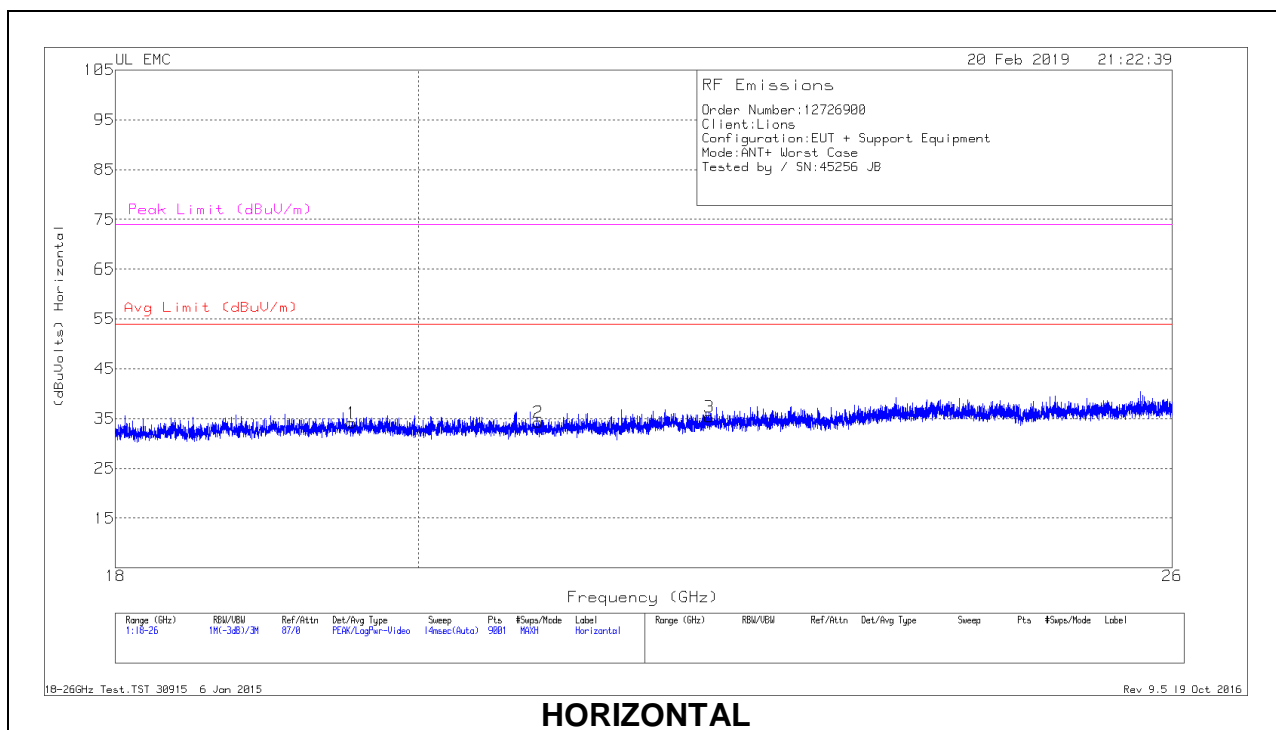

18 – 26GHz DATA

Marker	Frequency (GHz)	Meter Reading (dBuV)	Det	T447 AF (dB/m)	Amp/Cbl (dB)	Dist Corr (dB)	Corrected Reading (dBuVolts)	Avg Limit (dBuV/m)	Margin (dB)	Peak Limit (dBuV/m)	PK Margin (dB)
1	19.543	35.95	Pk	32.8	-25.1	-9.5	34.15	54	-19.85	74	-39.85
2	20.854	36.13	Pk	33	-25.4	-9.5	34.23	54	-19.77	74	-39.77
3	22.131	36.41	Pk	33.4	-25	-9.5	35.31	54	-18.69	74	-38.69
4	19.896	35.82	Pk	32.7	-25	-9.5	34.02	54	-19.98	74	-39.98
5	21.149	36.32	Pk	33	-25.3	-9.5	34.52	54	-19.48	74	-39.48
6	22.495	37.21	Pk	33.5	-24.8	-9.5	36.41	54	-17.59	74	-37.59

Pk - Peak detector

11. AC POWER LINE CONDUCTED EMISSIONS

LIMITS

FCC §15.207 (a)

Frequency of Emission (MHz)	Conducted Limit (dBuV)	
	Quasi-peak	Average
0.15-0.5	66 to 56*	56 to 46*
0.5-5	56	46
5-30	60	50

*Decreases with the logarithm of the frequency.

TEST PROCEDURE

The EUT is placed on a non-conducting table 40 cm from the vertical ground plane and 80 cm above the horizontal ground plane. The EUT is configured in accordance with ANSI C63.10.

The receiver is set to a resolution bandwidth of 9 kHz. Peak detection is used unless otherwise noted as quasi-peak or average.

Line conducted data is recorded for both NEUTRAL and HOT lines.

RESULTS

AC Power Line Norm

LINE 1 RESULTS

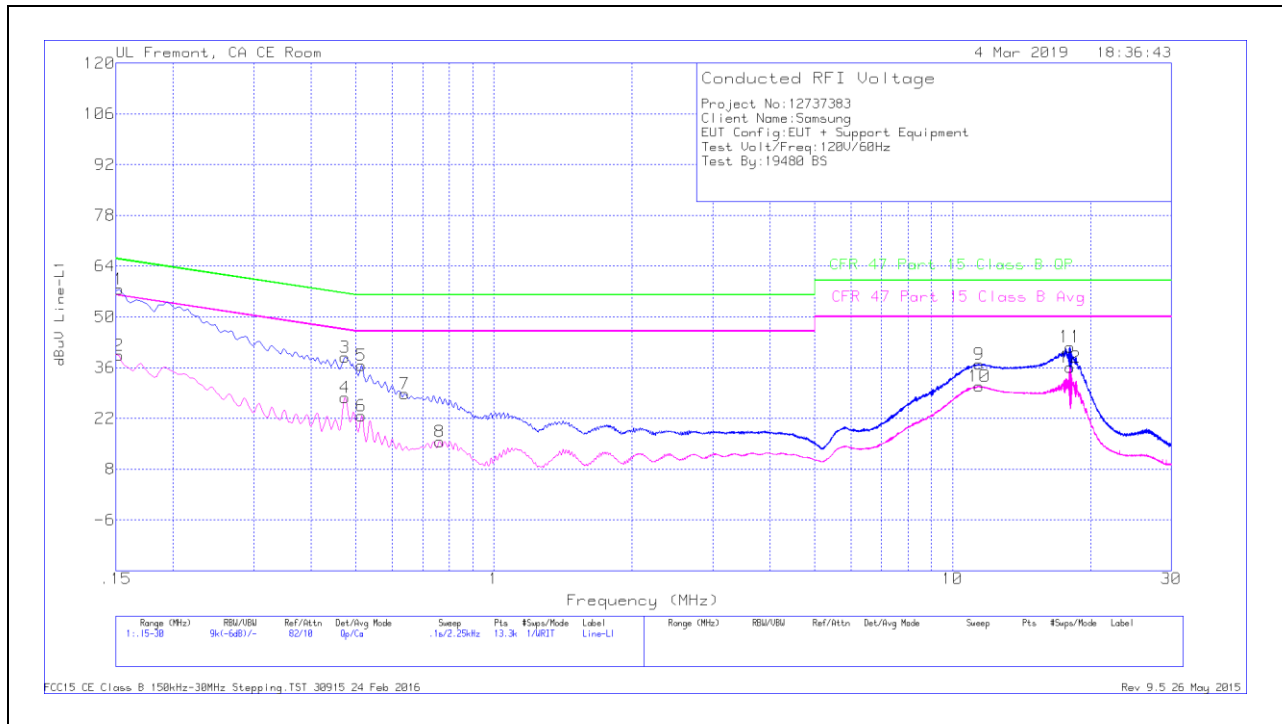

Trace Markers

Range 1: Line-L1 .15 - 30MHz											
Marker	Frequency (MHz)	Meter Reading (dBuV)	Det	LISN L1	LC Cables C1&C3	Limiter (dB)	Corrected Reading dBuV	CFR 47 Part 15 Class B QP	QP Margin (dB)	CFR 47 Part 15 Class B Avg	Av(CISPR) Margin (dB)
1	.15225	47.39	Qp	.1	0	10.1	57.59	65.88	-8.29	-	-
2	.15225	29.13	Ca	.1	0	10.1	39.33	-	-	55.88	-16.55
3	.474	28.78	Qp	0	0	10.1	38.88	56.44	-17.56	-	-
4	.474	17.72	Ca	0	0	10.1	27.82	-	-	46.44	-18.62
5	.5145	26.52	Qp	0	0	10.1	36.62	56	-19.38	-	-
6	.5145	12.59	Ca	0	0	10.1	22.69	-	-	46	-23.31
7	.63825	18.66	Qp	0	0	10.1	28.76	56	-27.24	-	-
8	.762	5.55	Ca	0	0	10.1	15.65	-	-	46	-30.35
9	11.43825	26.4	Qp	.1	.2	10.2	36.9	60	-23.1	-	-
10	11.44725	20.42	Ca	.1	.2	10.2	30.92	-	-	50	-19.08
11	18.02625	31.04	Qp	.1	.3	10.3	41.74	60	-18.26	-	-
12	18.0465	25.38	Ca	.1	.3	10.3	36.08	-	-	50	-13.92

Qp - Quasi-Peak detector
 Ca - CISPR average detection

LINE 2 RESULTS

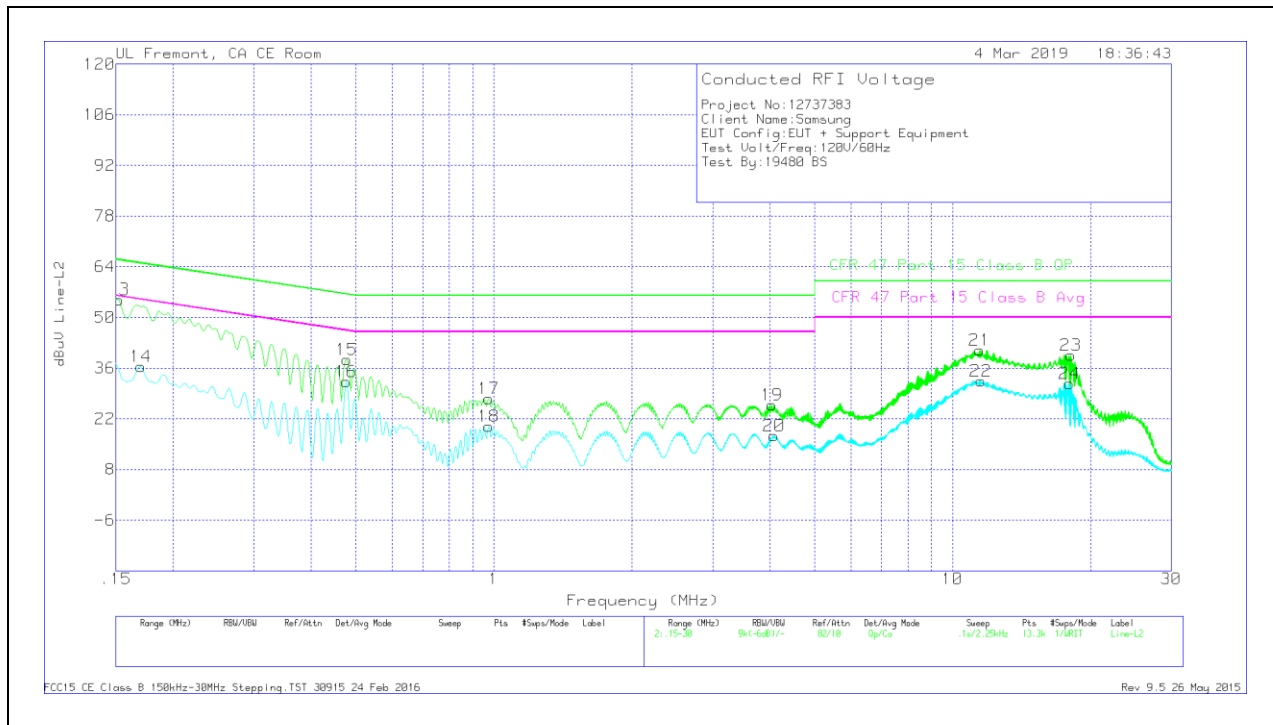

Trace Markers

Range 2: Line-L2 .15 - 30MHz											
Marker	Frequency (MHz)	Meter Reading (dBuV)	Det	LISN L2	LC Cables C2&C3	Limiter (dB)	Corrected Reading dBuV	CFR 47 Part 15 Class B QP	QP Margin (dB)	CFR 47 Part 15 Class B Avg	Av(CISPR) Margin (dB)
13	.15225	44.75	Qp	.1	0	10.1	54.95	65.88	-10.93	-	-
14	.17025	26.36	Ca	0	0	10.1	36.46	-	-	54.95	-18.49
15	.4785	28.29	Qp	0	0	10.1	38.39	56.37	-17.98	-	-
16	.47625	22.17	Ca	0	0	10.1	32.27	-	-	46.4	-14.13
17	.97575	17.3	Qp	0	.1	10.1	27.5	56	-28.5	-	-
18	.97575	9.69	Ca	0	.1	10.1	19.89	-	-	46	-26.11
19	4.0425	15.65	Qp	0	.1	10.1	25.85	56	-30.15	-	-
20	4.08413	7.05	Ca	0	.1	10.1	17.25	-	-	46	-28.75
21	11.4585	30.38	Qp	.1	.2	10.2	40.88	60	-19.12	-	-
22	11.5215	22.01	Ca	.1	.2	10.2	32.51	-	-	50	-17.49
23	18.08925	28.85	Qp	.1	.3	10.3	39.55	60	-20.45	-	-
24	17.9835	20.97	Ca	.1	.3	10.3	31.67	-	-	50	-18.33

Qp - Quasi-Peak detector
 Ca - CISPR average detection