



**FCC CFR47 PART 15 SUBPART C**

**DTS Wireless LAN**

**CERTIFICATION TEST REPORT**

**FOR**

**GSM/WCDMA/LTE Phone + BT/BLE, DTS/UNII a/b/g/n, ANT+ and NFC**

**MODEL NUMBER : SM-A605K**

**FCC ID: A3LSMA605K**

**REPORT NUMBER: 4788480738-E1V2**

**ISSUE DATE: MAY 30, 2018**

*Prepared for*  
**SAMSUNG ELECTRONICS CO., LTD.**  
**129 SAMSUNG-RO, YEONGTONG-GU, SUWON-SI,**  
**GYEONGGI-DO, 16677, KOREA**

*Prepared by*  
**UL Korea, Ltd.**  
**26th floor, 152, Teheran-ro, Gangnam-gu Seoul, 06236, Korea**

**Suwon Test Site: UL Korea, Ltd. Suwon Laboratory**  
**218 Maeyeong-ro, Yeongtong-gu,**  
**Suwon-si, Gyeonggi-do, 16675, Korea**  
**TEL: (031) 337-9902**  
**FAX: (031) 213-5433**



**ACCREDITED\***

Testing  
Laboratory

**TL-637**

Revision History

<u>Rev.</u>	<u>Issue Date</u>	<u>Revisions</u>	<u>Revised By</u>
V1	05/24/18	Initial issue	Junwhan Lee
V2	05/30/18	Updated to address TCB's question	Junwhan Lee

## TABLE OF CONTENTS

<b>1. ATTESTATION OF TEST RESULTS .....</b>	<b>5</b>
<b>2. TEST METHODOLOGY .....</b>	<b>6</b>
<b>3. FACILITIES AND ACCREDITATION .....</b>	<b>6</b>
<b>4. CALIBRATION AND UNCERTAINTY .....</b>	<b>6</b>
4.1. MEASURING INSTRUMENT CALIBRATION .....	6
4.2. SAMPLE CALCULATION .....	6
4.3. MEASUREMENT UNCERTAINTY.....	6
<b>5. EQUIPMENT UNDER TEST .....</b>	<b>7</b>
5.1. DESCRIPTION OF EUT .....	7
5.2. MAXIMUM OUTPUT POWER.....	7
5.3. DESCRIPTION OF AVAILABLE ANTENNAS .....	7
5.4. WORST-CASE CONFIGURATION AND MODE.....	7
5.5. DESCRIPTION OF TEST SETUP.....	8
<b>6. TEST AND MEASUREMENT EQUIPMENT .....</b>	<b>10</b>
<b>7. REFERENCE MEASUREMENT RESULTS.....</b>	<b>11</b>
7.1. ON TIME AND DUTY CYCLE RESULTS.....	11
<b>8. MEASUREMENT METHODS .....</b>	<b>12</b>
<b>9. SUMMARY TABLE .....</b>	<b>13</b>
<b>10. ANTENNA PORT TEST RESULTS .....</b>	<b>14</b>
10.1. 6 dB BANDWIDTH .....	14
10.1.1. 802.11b MODE IN THE 2.4 GHz BAND .....	15
10.1.1.1. 802.11g MODE IN THE 2.4 GHz BAND .....	15
10.1.2. 802.11n HT20 MODE IN THE 2.4 GHz BAND.....	15
10.1.3. dB BANDWIDTH PLOTS.....	16
10.2. OUTPUT POWER.....	21
10.2.1. 802.11b MODE IN THE 2.4 GHz BAND .....	22
10.2.2. 802.11g MODE IN THE 2.4 GHz BAND .....	23
10.2.3. 802.11n HT20 MODE IN THE 2.4 GHz BAND.....	24
10.3. PSD.....	25
10.3.1. 802.11b MODE IN THE 2.4 GHz BAND .....	26
10.3.2. 802.11g MODE IN THE 2.4 GHz BAND .....	26
10.3.3. 802.11n HT20 MODE IN THE 2.4 GHz BAND.....	26
10.3.4. PSD PLOTS.....	27
10.4. OUT-OF-BAND EMISSIONS.....	32

10.4.1.	802.11b MODE IN THE 2.4 GHz BAND .....	33
10.4.2.	802.11g MODE IN THE 2.4 GHz BAND .....	38
10.4.3.	802.11n HT20 MODE IN THE 2.4 GHz BAND.....	45
<b>11.</b>	<b>RADIATED TEST RESULTS .....</b>	<b>52</b>
11.1.	LIMITS AND PROCEDURE.....	52
11.2.	TRANSMITTER ABOVE 1 GHz.....	54
11.2.1.	TX ABOVE 1 GHz 802.11b MODE IN THE 2.4 GHz BAND.....	54
11.2.2.	TX ABOVE 1 GHz 802.11g MODE IN THE 2.4 GHz BAND.....	68
11.2.3.	TX ABOVE 1 GHz 802.11n HT20 MODE IN THE 2.4 GHz BAND .....	86
11.3.	WORST-CASE BELOW 1 GHz .....	104
<b>12.</b>	<b>AC POWER LINE CONDUCTED EMISSIONS .....</b>	<b>106</b>
<b>13.</b>	<b>SETUP PHOTOS .....</b>	<b>111</b>

# 1. ATTESTATION OF TEST RESULTS

**COMPANY NAME:** SAMSUNG ELECTRONICS CO., LTD.  
**EUT DESCRIPTION:** GSM/WCDMA/LTE Phone + BT/BLE, DTS/UNII a/b/g/n, ANT+ and NFC  
**MODEL NUMBER:** SM-A605K  
**SERIAL NUMBER:** R39K30GTZ6H (RADIATED);  
R39K30GTV6B (CONDUCTED)  
**DATE TESTED:** MAY 10, 2018 - MAY 23, 2018

APPLICABLE STANDARDS	
STANDARD	TEST RESULTS
CFR 47 Part 15 Subpart C	Pass

UL Korea, Ltd. tested the above equipment in accordance with the requirements set forth in the above standards. All indications of Pass/Fail in this report are opinions expressed by UL Korea, Ltd. based on interpretations and/or observations of test results. Measurement Uncertainties were not taken into account and are published for informational purposes only. The test results show that the equipment tested is capable of demonstrating compliance with the requirements as documented in this report.

**Note:** The results documented in this report apply only to the tested sample, under the conditions and modes of operation as described herein. This document may not be altered or revised in any way unless done so by UL Korea, Ltd. and all revisions are duly noted in the revisions section. Any alteration of this document not carried out by UL Korea, Ltd. will constitute fraud and shall nullify the document. This report must not be used by the client to claim product certification, approval, or endorsement by IAS, any agency of the Federal Government, or any agency of any government.

Approved & Released For  
UL Korea, Ltd. By:



---

SungGil Park  
Suwon Lab Engineer  
UL Korea, Ltd.

Tested By:



---

Junwhan Lee  
Suwon Lab Engineer  
UL Korea, Ltd.

## 2. TEST METHODOLOGY

The tests documented in this report were performed in accordance with following methods.

1. FCC CFR 47 Part 2.
2. FCC CFR 47 Part 15.
3. KDB 558074 D01 DTS Meas Guidance v04.
4. ANSI C63.10-2013.

## 3. FACILITIES AND ACCREDITATION

The test sites and measurement facilities used to collect data are located at 218 Maeyeong-ro, Yeongtong-gu, Suwon-si, Gyeonggi-do, 16675, Korea. Line conducted emissions are measured only at the 218 address. The following table identifies which facilities were utilized for radiated emission measurements documented in this report. Specific facilities are also identified in the test results sections.

218 Maeyeong-ro	
<input type="checkbox"/>	Chamber 1
<input checked="" type="checkbox"/>	Chamber 2
<input type="checkbox"/>	Chamber 3

UL Korea, Ltd. is accredited by IAS, Laboratory Code TL-637. The full scope of accreditation can be viewed at <http://www.iasonline.org/PDF/TL/TL-637.pdf>.

## 4. CALIBRATION AND UNCERTAINTY

### 4.1. MEASURING INSTRUMENT CALIBRATION

The measuring equipment utilized to perform the tests documented in this report has been calibrated in accordance with the manufacturer's recommendations, and is traceable to recognized national standards.

### 4.2. SAMPLE CALCULATION

Where relevant, the following sample calculation is provided:

$$\begin{aligned} \text{Field Strength (dBuV/m)} &= \text{Measured Voltage (dBuV)} + \text{Antenna Factor (dB/m)} + \\ &\text{Cable Loss (dB)} - \text{Preamp Gain (dB)} \\ 36.5 \text{ dBuV} + 18.7 \text{ dB/m} + 0.6 \text{ dB} - 26.9 \text{ dB} &= 28.9 \text{ dBuV/m} \end{aligned}$$

### 4.3. MEASUREMENT UNCERTAINTY

Where relevant, the following measurement uncertainty levels have been estimated for tests performed on the apparatus:

PARAMETER	UNCERTAINTY
Conducted Disturbance, 0.15 to 30 MHz	2.32 dB
Radiated Disturbance, Below 1GHz	3.86 dB
Radiated Disturbance, Above 1 GHz	5.97 dB

Uncertainty figures are valid to a confidence level of 95%.

## 5. EQUIPMENT UNDER TEST

### 5.1. DESCRIPTION OF EUT

The EUT is a GSM/WCDMA/LTE Tablet + BT/BLE, DTS/UNII a/b/g/n, ANT+ and NFC  
This test report addresses the DTS (WLAN) operational mode.

### 5.2. MAXIMUM OUTPUT POWER

The transmitter has a maximum total conducted average output power as follows:

Frequency Range [MHz]	Mode	Output Power [dBm]	Output Power [mW]
2412 - 2472	802.11b	18.47	70.31
	802.11g	17.22	52.72
	802.11n HT20	17.25	53.09

### 5.3. DESCRIPTION OF AVAILABLE ANTENNAS

The radio utilizes an internal antennas, with a antenna's maximum gain of -3.25 dBi.

### 5.4. WORST-CASE CONFIGURATION AND MODE

Radiated emission below 1GHz and power line conducted emission were performed with the EUT set to transmit at the channel with highest output power as worst-case scenario.

Radiated emission above 1GHz was performed with the EUT set to transmit low/mid/6 Channels.

The fundamental of the EUT was investigated in three orthogonal orientations X, Y and Z it was determined that Y orientation was worst-case orientation; therefore, all final radiated testing was performed with the EUT in Y orientation.

Based on the baseline scan, the worst-case data rates were:

802.11b mode: 1 Mbps  
802.11g mode: 6 Mbps  
802.11n HT20 mode: MCS0

Note : All radiated and power line conducted tests were performed connected with earphone and charger for evaluation of worst case mode.

## 5.5. DESCRIPTION OF TEST SETUP

### SUPPORT EQUIPMENT

Support Equipment List				
Description	Manufacturer	Model	Serial Number	FCC ID
Charger	SAMSUNG	EP-TA50KWK	DK4K207VS/A- E	N/A
Data Cable	SAMSUNG	ECB-DU68WE	N/A	N/A
Earphone	SAMSUNG	EHS64AVFWE	N/A	N/A

### I/O CABLES

I/O Cable List						
Cable No	Port	# of identical ports	Connector Type	Cable Type	Cable Length (m)	Remarks
1	DC Power	1	Mini-USB	Shielded	1.2m	N/A
2	Audio	2	Mini-Jack	Unshielded	1.2m	N/A

### TEST SETUP

The EUT is a stand-alone unit during the tests.  
 Test software in hidden menu exercised the EUT to enable DTS mode.



**SETUP DIAGRAM FOR TESTS (CONDUCTED TEST SETUP)**

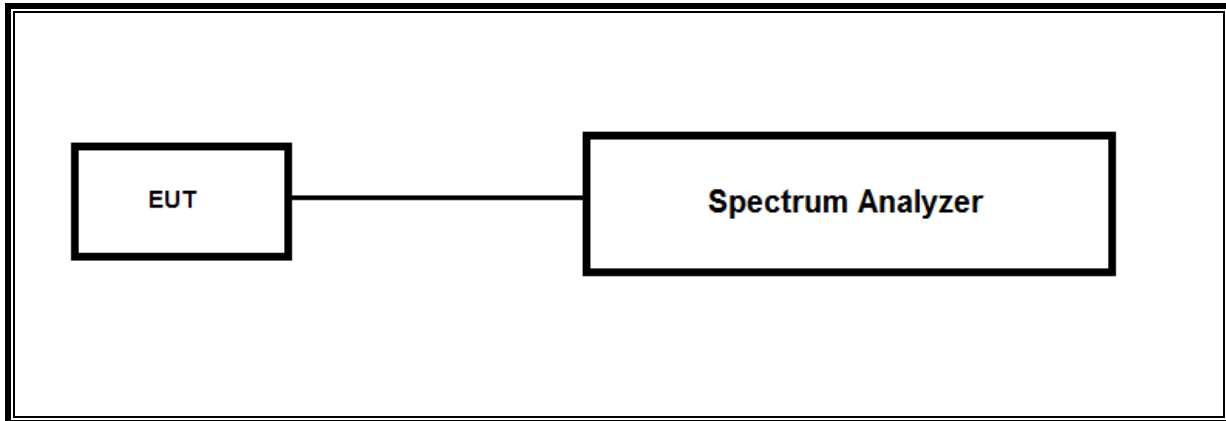

**SETUP DIAGRAM FOR TESTS (RADIATED TEST SETUP)**

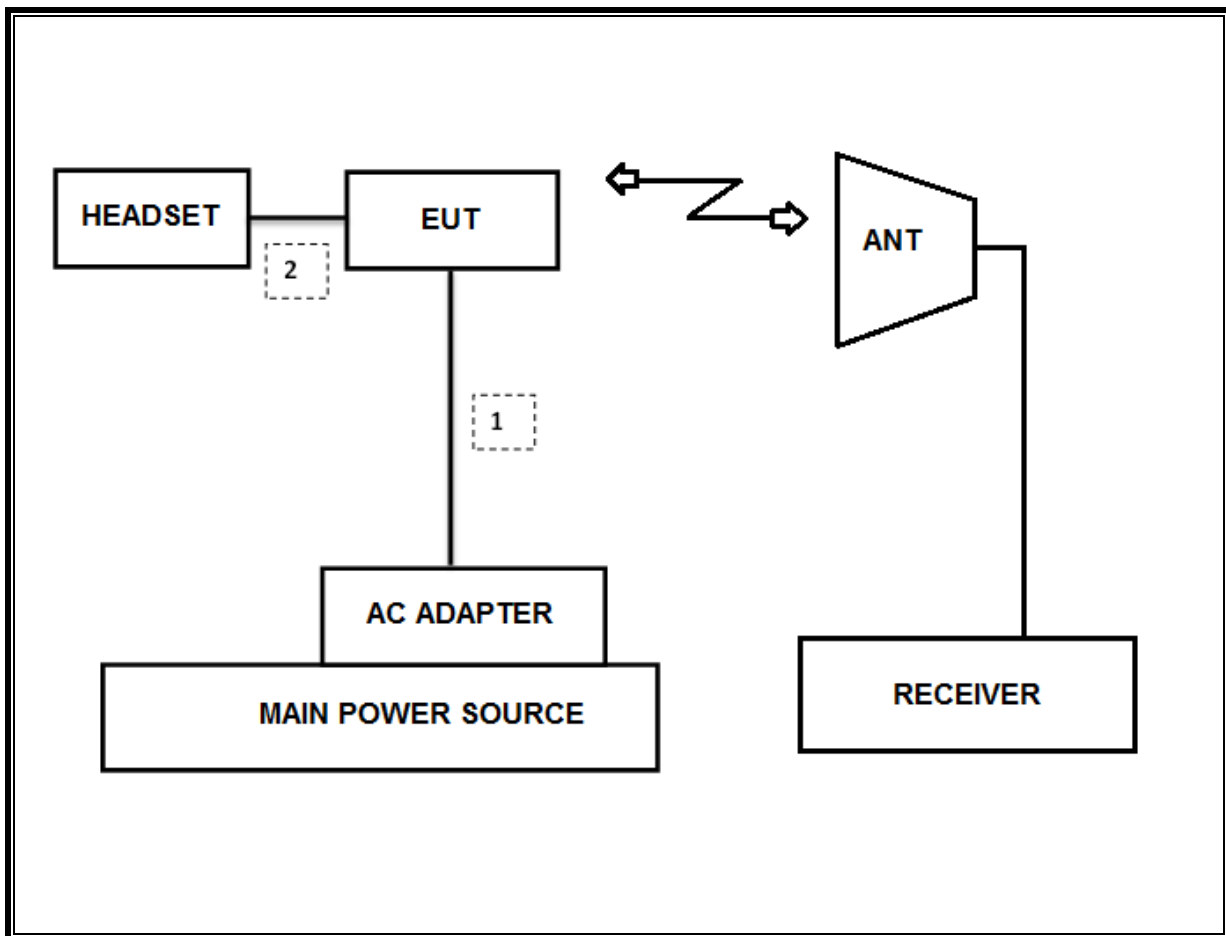

## 6. TEST AND MEASUREMENT EQUIPMENT

The following test and measurement equipment was utilized for the tests documented in this report:

Test Equipment List				
Description	Manufacturer	Model	S/N	Cal Due
Antenna, Bilog, 30MHz-1GHz	SCHWARZBECK	VULB9163	750	08-31-19
Antenna, Bilog, 30MHz-1GHz	SCHWARZBECK	VULB9163	749	09-14-19
Antenna, Bilog, 30MHz-1GHz	SCHWARZBECK	VULB9163	845	08-31-19
Antenna, Horn, 18 GHz	ETS	3115	00167211	10-14-18
Antenna, Horn, 18 GHz	ETS	3115	00161451	03-10-19
Antenna, Horn, 18 GHz	ETS	3117	00168724	05-31-19
Antenna, Horn, 18 GHz	ETS	3117	00168717	05-31-19
Antenna, Horn, 18 GHz	ETS	3117	00205959	11-29-18
Antenna, Horn, 40 GHz	ETS	3116C	00166155	12-04-19
Antenna, Horn, 40 GHz	ETS	3116C	00168645	12-04-19
Antenna, Horn, 40 GHz	ETS	3116C-PA	00168841	11-13-19
Preamplifier, 1000 MHz	Sonoma	310N	341282	08-09-18
Preamplifier, 1000 MHz	Sonoma	310N	351741	08-07-18
Preamplifier, 1000 MHz	Sonoma	310N	370599	08-10-18
Preamplifier, 18 GHz	Miteq	AFS42-00101800-25-S-42	1876511	08-08-18
Preamplifier, 18 GHz	Miteq	AFS42-00101800-25-S-42	1896138	08-08-18
Preamplifier, 18 GHz	Miteq	AFS42-00101800-25-S-42	2029169	08-11-18
Spectrum Analyzer, 44 GHz	Agilent / HP	N9030A	MY54170614	08-08-18
Spectrum Analyzer, 44 GHz	Agilent / HP	N9030A	MY54490312	08-08-18
Spectrum Analyzer, 43.5 GHz	R&S	FSW43	104089	08-11-18
Average Power Sensor	Agilent / HP	U2000	MY54270007	08-08-18
Attenuator	PASTERNAK	PE7087-10	A001	08-08-18
Attenuator	PASTERNAK	PE7087-10	A008	08-08-18
Attenuator	PASTERNAK	PE7087-10	2	08-10-18
Attenuator	PASTERNAK	PE7087-10	A009	08-08-18
EMI Test Receive, 40 GHz	R&S	ESU40	100439	08-08-18
EMI Test Receive, 40 GHz	R&S	ESU40	100457	08-08-18
EMI Test Receive, 44 GHz	R&S	ESW44	101590	08-09-18
EMI Test Receive, 3 GHz	R&S	ESR3	101832	08-07-18
Low Pass Filter 5GHz	Micro-Tronics	LPS17541	009	08-08-18
Low Pass Filter 5GHz	Micro-Tronics	LPS17541	015	08-08-18
Low Pass Filter 5GHz	Micro-Tronics	LPS17541	020	08-11-18
High Pass Filter 3GHz	Micro-Tronics	HPM17543	010	08-08-18
High Pass Filter 3GHz	Micro-Tronics	HPM17543	015	08-08-18
High Pass Filter 3GHz	Micro-Tronics	HPM17543	020	08-11-18
High Pass Filter 6GHz	Micro-Tronics	HPS17542	009	08-08-18
High Pass Filter 6GHz	Micro-Tronics	HPS17542	016	08-08-18
High Pass Filter 6GHz	Micro-Tronics	HPS17542	021	08-11-18
LISN	R&S	ENV-216	101837	08-09-18
UL Software				
Description	Manufacturer	Model	Version	
Radiated software	UL	UL EMC	Ver 9.5	

## 7. REFERENCE MEASUREMENT RESULTS

### 7.1. ON TIME AND DUTY CYCLE RESULTS

#### LIMITS

None; for reporting purposes only.

Mode	ON Time B [msec]	Period [msec]	Duty Cycle x [linear]	Duty Cycle [%]	Duty Cycle Correction Factor [dB]	1/T Minimum VBW [kHz]
<b>2400MHz Bands</b>						
802.11b	32.95	33.05	0.997	99.7%	0.00	0.010
802.11g	5.484	5.583	0.982	98.2%	0.00	0.010
802.11n HT20	5.068	5.166	0.981	98.1%	0.00	0.010

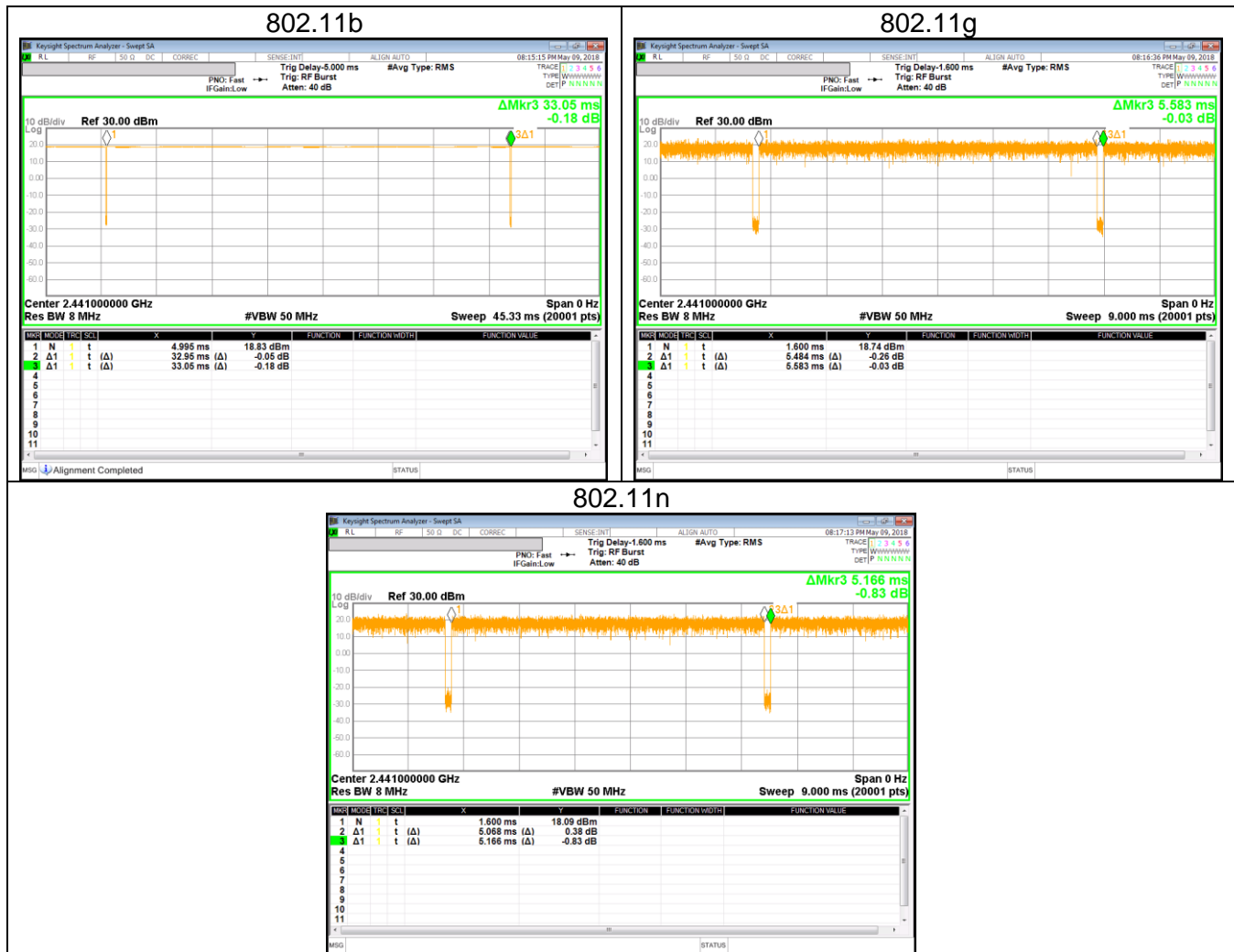

## 8. MEASUREMENT METHODS

6 dB BW : KDB 558074 D01 v04, Section 8.2.

OUTPUT POWER : KDB 558074 D01 v04, Section 9.2.3.1.

POWER SPECTRAL DENSITY : KDB 558074 D01 v04, Section 10.3./10.5.

Out-of-band EMISSIONS (Conducted) : KDB 558074 D01 v04, Section 11.1, 11.2.

Out-of-band EMISSIONS IN NON-RESTRICTED BANDS: KDB 558074 D01 v04, Section 11.0.

Out-of-band EMISSIONS IN RESTRICTED BANDS : KDB 558074 D01 v04, Section 12.1.

AC Power Line Conducted Emission : ANSI C63.10-2013, Section 6.2.

## 9. SUMMARY TABLE

FCC Part Section	Test Description	Test Limit	Test Condition	Test Result
15.247 (a)(2)	Occupied Band width (6dB)	>500KHz	Conducted	Pass
2.1051, 15.247 (d)	Band Edge / Conducted Spurious Emission	-30dBc		Pass
15.247 (b)(3)	TX conducted output power	<30dBm		Pass
15.247 (e)	PSD	<8dBm		Pass
15.207 (a)	AC Power Line conducted emissions	Section 10	Power Line conducted	Pass
15.205, 15.209	Radiated Spurious Emission	< 54dBuV/m	Radiated	Pass

## 10. ANTENNA PORT TEST RESULTS

### 10.1. 6 dB BANDWIDTH

#### LIMITS

FCC §15.247 (a) (2)

The minimum 6 dB bandwidth shall be at least 500 kHz.

#### TEST PROCEDURE

Reference to KDB 558074 D01 DTS Meas Guidance v04: The transmitter output is connected to a spectrum analyzer with the RBW set to 100KHz, the VBW  $\geq 3 \times$  RBW, peak detector and max hold.

**RESULTS****10.1.1.802.11b MODE IN THE 2.4 GHz BAND**

Channel	Frequency [MHz]	6 dB Bandwidth [MHz]	Minimum Limit [MHz]
1	2412	9.540	0.5
6	2437	9.038	0.5
11	2462	8.556	0.5
12	2467	9.037	0.5
13	2472	8.558	0.5
Worst		8.556	0.5

**10.1.1.1. 802.11g MODE IN THE 2.4 GHz BAND**

Channel	Frequency [MHz]	6 dB Bandwidth [MHz]	Minimum Limit [MHz]
1	2412	16.060	0.5
2	2417	16.290	0.5
6	2437	15.810	0.5
10	2457	15.400	0.5
11	2462	16.290	0.5
12	2467	16.300	0.5
13	2472	16.300	0.5
Worst		15.400	0.5

**10.1.2.802.11n HT20 MODE IN THE 2.4 GHz BAND**

Channel	Frequency [MHz]	6 dB Bandwidth [MHz]	Minimum Limit [MHz]
1	2412	16.630	0.5
2	2417	16.770	0.5
6	2437	17.260	0.5
10	2457	16.540	0.5
11	2462	17.060	0.5
12	2467	17.280	0.5
13	2472	17.140	0.5
Worst		16.540	0.5

### 10.1.3. dB BANDWIDTH PLOTS





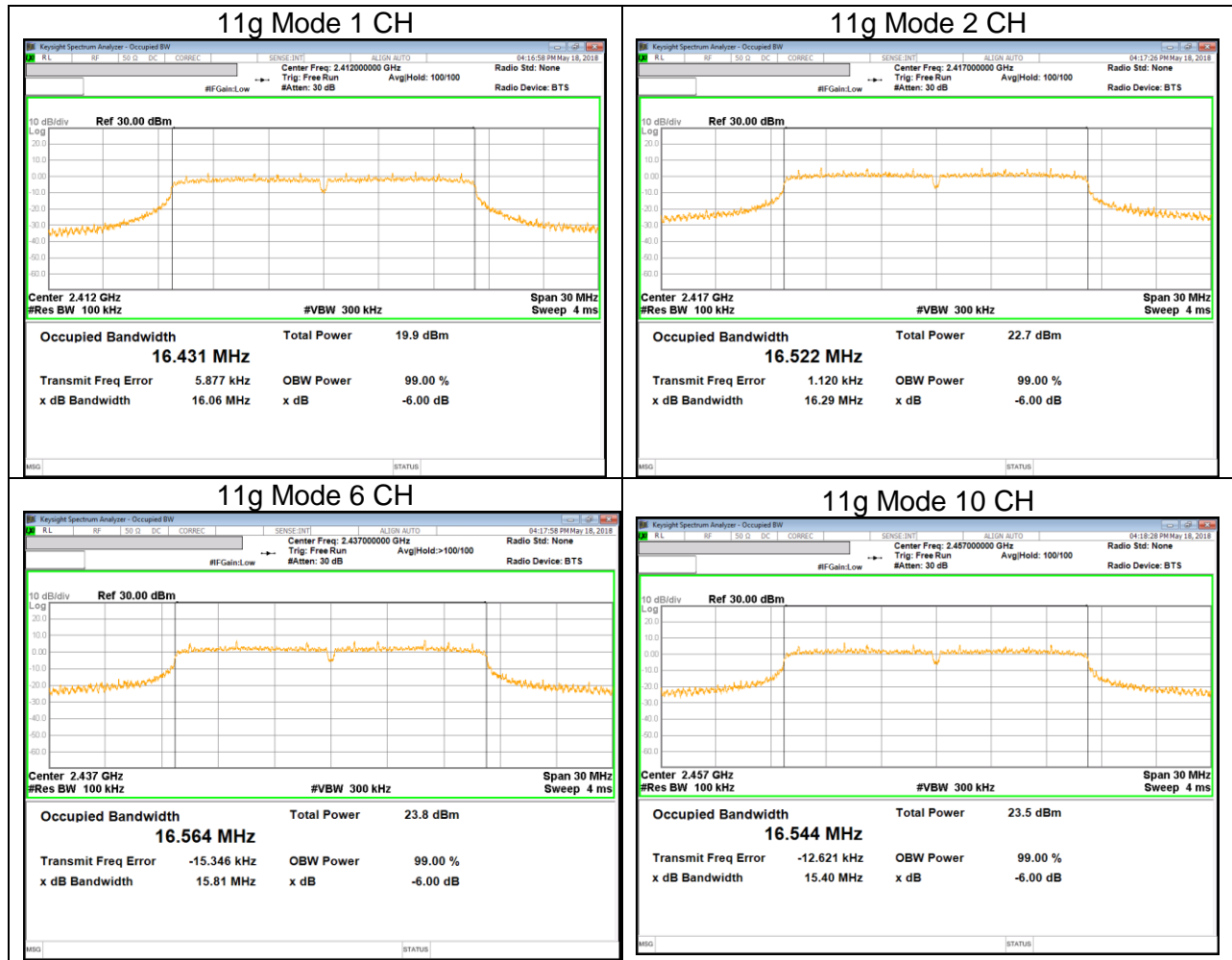

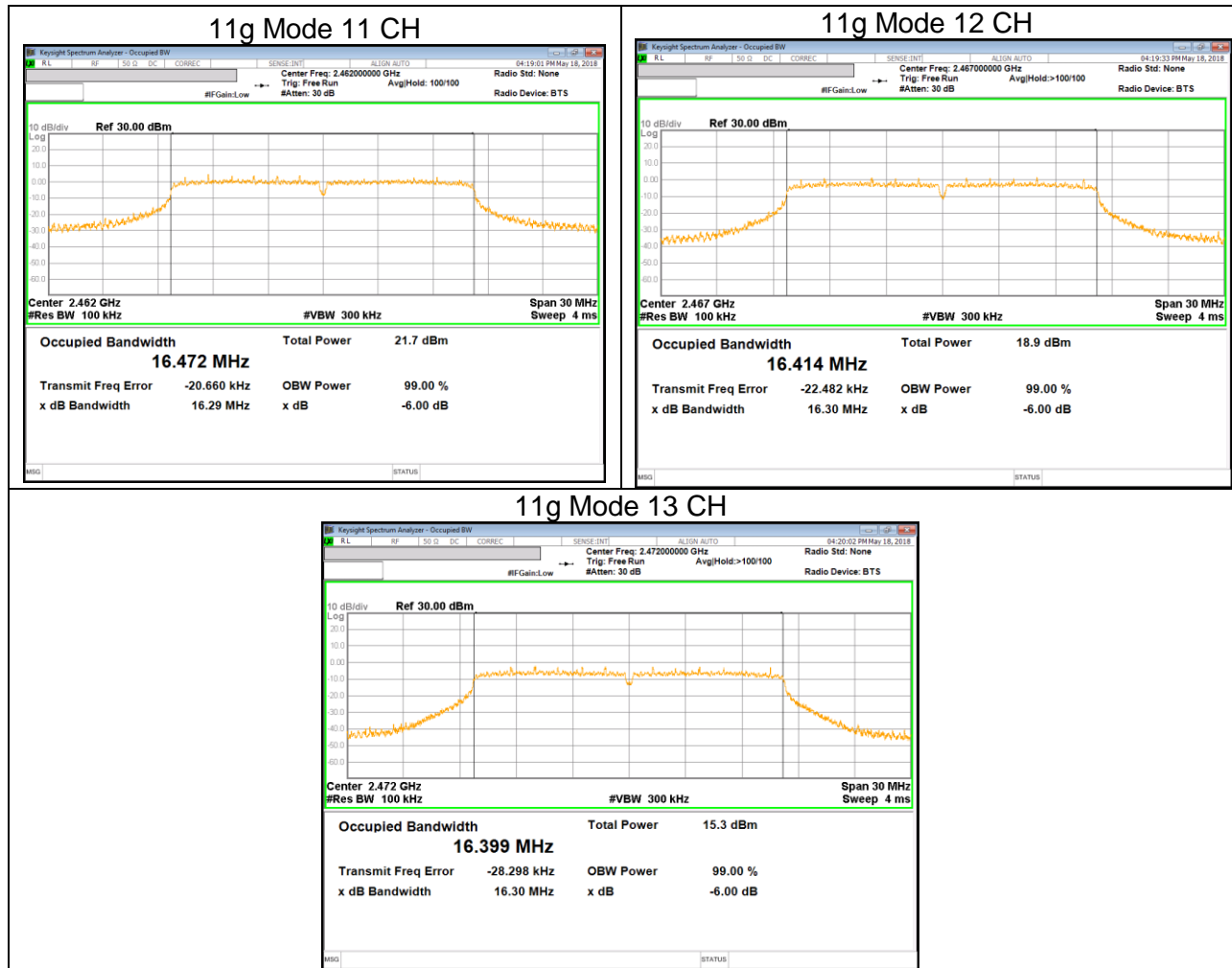



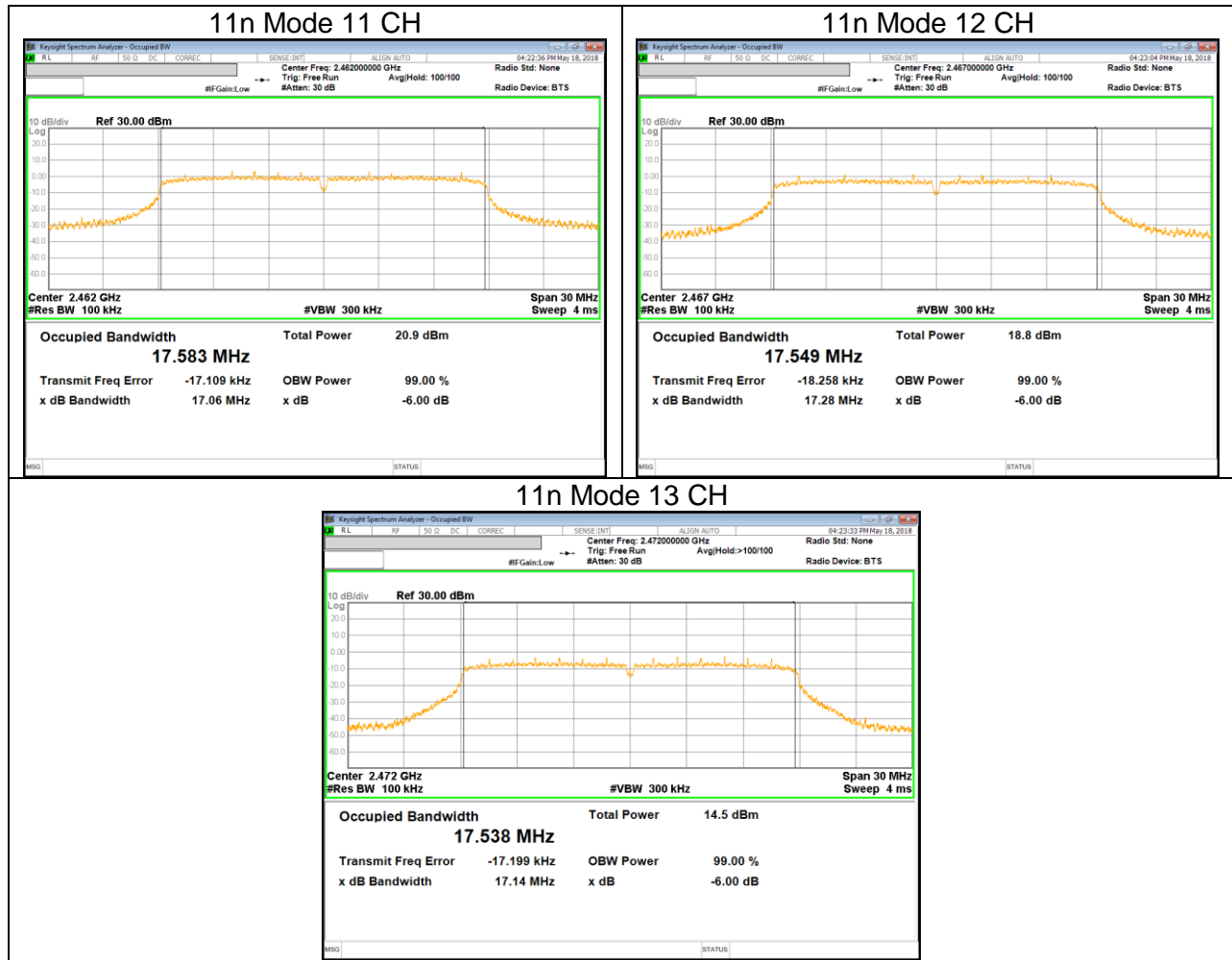

## 10.2. OUTPUT POWER

### LIMITS

FCC §15.247

For systems using digital modulation in the 902–928 MHz, 2400–2483.5 MHz, and 5725–5850 MHz bands: 1 Watt, based on the use of antennas with directional gains that do not exceed 6 dBi. If transmitting antennas of directional gain greater than 6 dBi are used, the conducted output power from the intentional radiator shall be reduced by the amount in dB that the directional gain of the antenna exceeds 6 dBi.

### DIRECTIONAL ANTENNA GAIN

There is only one transmitter output therefore the directional gain is equal to the antenna gain.

### TEST PROCEDURE

The transmitter output is connected to a power meter.

The cable assembly insertion loss was entered as an offset in the power meter to allow for direct reading of power.

Output power measurement was performed utilizing the “§9.2.3.1 AVGPM” under KDB558074 D01 DTS Meas Guidance v04.

Duty cycle correction factor is not added to the average output power results for duty cycle factor > 98%. (All mode)

**RESULTS****10.2.1.802.11b MODE IN THE 2.4 GHz BAND****Limits**

Channel	Frequency [MHz]	Directional Gain Primary [dBi]	FCC Power Limit [dBm]	Max Power [dBm]
1	2412	-3.25	30.00	30.00
6	2437	-3.25	30.00	30.00
11	2462	-3.25	30.00	30.00
12	2467	-3.25	30.00	30.00
13	2472	-3.25	30.00	30.00

**Results**

Channel	Frequency [MHz]	Meas Power [dBm]	Total Power [dBm]	Power Limit [dBm]	Margin [dB]
1	2412	18.47	18.47	30.00	-11.53
6	2437	18.46	18.46	30.00	-11.54
11	2462	18.44	18.44	30.00	-11.56
12	2467	17.45	17.45	30.00	-12.55
13	2472	14.43	14.43	30.00	-15.57
Worst			18.47	30.00	-11.53

**10.2.2.802.11g MODE IN THE 2.4 GHz BAND**

**Limits**

Channel	Frequency [MHz]	Directional Gain Primary [dBi]	FCC Power Limit [dBm]	Max Power [dBm]
1	2412	-3.25	30.00	30.00
2	2417	-3.25	30.00	30.00
6	2437	-3.25	30.00	30.00
10	2457	-3.25	30.00	30.00
11	2462	-3.25	30.00	30.00
12	2467	-3.25	30.00	30.00
13	2472	-3.25	30.00	30.00

**Results**

Channel	Frequency [MHz]	Meas Power [dBm]	Total Power [dBm]	Power Limit [dBm]	Margin [dB]
1	2412	13.53	13.53	30.00	-16.47
2	2417	16.30	16.30	30.00	-13.70
6	2437	17.22	17.22	30.00	-12.78
10	2457	17.06	17.06	30.00	-12.94
11	2462	15.28	15.28	30.00	-14.72
12	2467	12.42	12.42	30.00	-17.58
13	2472	8.84	8.84	30.00	-21.16
Worst			17.22	30.00	-12.78

**10.2.3.802.11n HT20 MODE IN THE 2.4 GHz BAND**

**Limits**

Channel	Frequency [MHz]	Directional Gain Primary [dBi]	FCC Power Limit [dBm]	Max Power [dBm]
1	2412	-3.25	30.00	30.00
2	2417	-3.25	30.00	30.00
6	2437	-3.25	30.00	30.00
10	2457	-3.25	30.00	30.00
11	2462	-3.25	30.00	30.00
12	2467	-3.25	30.00	30.00
13	2472	-3.25	30.00	30.00

**Results**

Channel	Frequency [MHz]	Meas Power [dBm]	Total Power [dBm]	Power Limit [dBm]	Margin [dB]
1	2412	13.38	13.38	30.00	-16.62
2	2417	16.28	16.28	30.00	-13.72
6	2437	17.25	17.25	30.00	-12.75
10	2457	17.14	17.14	30.00	-12.86
11	2462	14.42	14.42	30.00	-15.58
12	2467	12.34	12.34	30.00	-17.66
13	2472	8.07	8.07	30.00	-21.93
Worst			17.25	30.00	-12.75



### **10.3. PSD**

#### **LIMITS**

FCC §15.247

The power spectral density conducted from the transmitter to the antenna shall not be greater than 8 dBm in any 3 kHz band during any time interval of continuous transmission.

#### **TEST PROCEDURE**

Power Spectral Density was performed utilizing the "Method §10.3 AVGPSD-1 (802.11 b/g/n mode) under KDB558074 D01 DTS Meas Guidance v04.

**RESULTS**

**10.3.1.802.11b MODE IN THE 2.4 GHz BAND**

**PSD Results**

Channel	Frequency [MHz]	PSD Meas [dBm]	Duty Factor [dB]	Final PSD [dBm/3kHz]	Limit [dBm/3kHz]	Margin [dB]
1	2412	-13.019	0.00	-13.019	8.00	-21.019
6	2437	-12.904	0.00	-12.904	8.00	-20.904
11	2462	-12.632	0.00	-12.632	8.00	-20.632
12	2467	-14.312	0.00	-14.312	8.00	-22.312
13	2472	-16.688	0.00	-16.688	8.00	-24.688

**10.3.2.802.11g MODE IN THE 2.4 GHz BAND**

**PSD Results**

Channel	Frequency [MHz]	PSD Meas [dBm]	Duty Factor [dB]	Final PSD [dBm/3kHz]	Limit [dBm/3kHz]	Margin [dB]
1	2412	-20.296	0.00	-20.296	8.00	-28.296
2	2417	-17.734	0.00	-17.734	8.00	-25.734
6	2437	-16.771	0.00	-16.771	8.00	-24.771
10	2457	-16.728	0.00	-16.728	8.00	-24.728
11	2462	-18.685	0.00	-18.685	8.00	-26.685
12	2467	-21.585	0.00	-21.585	8.00	-29.585
13	2472	-22.585	0.00	-22.585	8.00	-30.585

**10.3.3.802.11n HT20 MODE IN THE 2.4 GHz BAND**

**PSD Results**

Channel	Frequency [MHz]	PSD Meas [dBm]	Duty Factor [dB]	Final PSD [dBm/3kHz]	Limit [dBm/3kHz]	Margin [dB]
1	2412	-20.544	0.00	-20.544	8.00	-28.544
2	2417	-17.875	0.00	-17.875	8.00	-25.875
6	2437	-16.760	0.00	-16.760	8.00	-24.760
10	2457	-16.880	0.00	-16.880	8.00	-24.880
11	2462	-19.711	0.00	-19.711	8.00	-27.711
12	2467	-21.541	0.00	-21.541	8.00	-29.541
13	2472	-22.519	0.00	-22.519	8.00	-30.519

### 10.3.4.PSD PLOTS

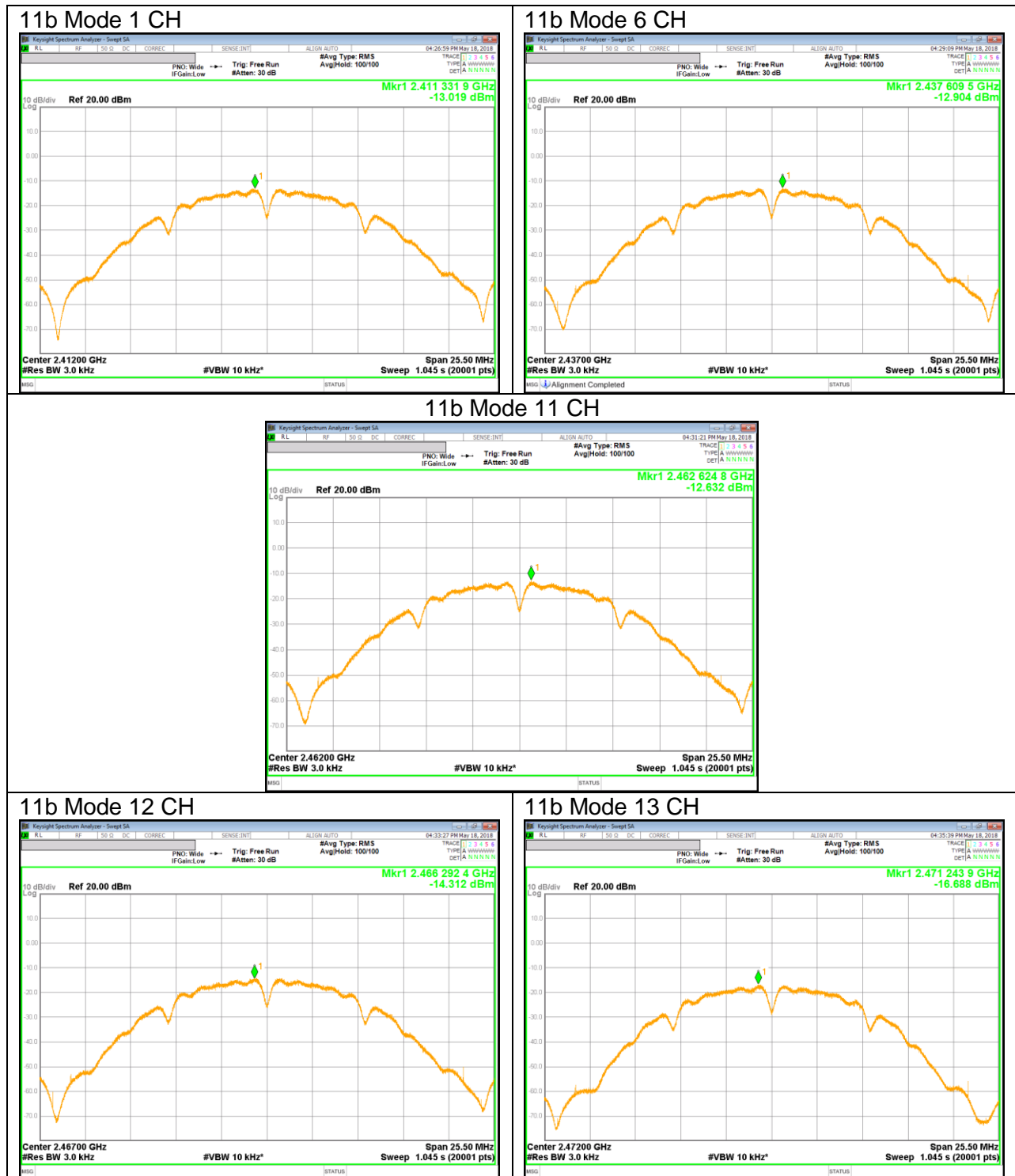

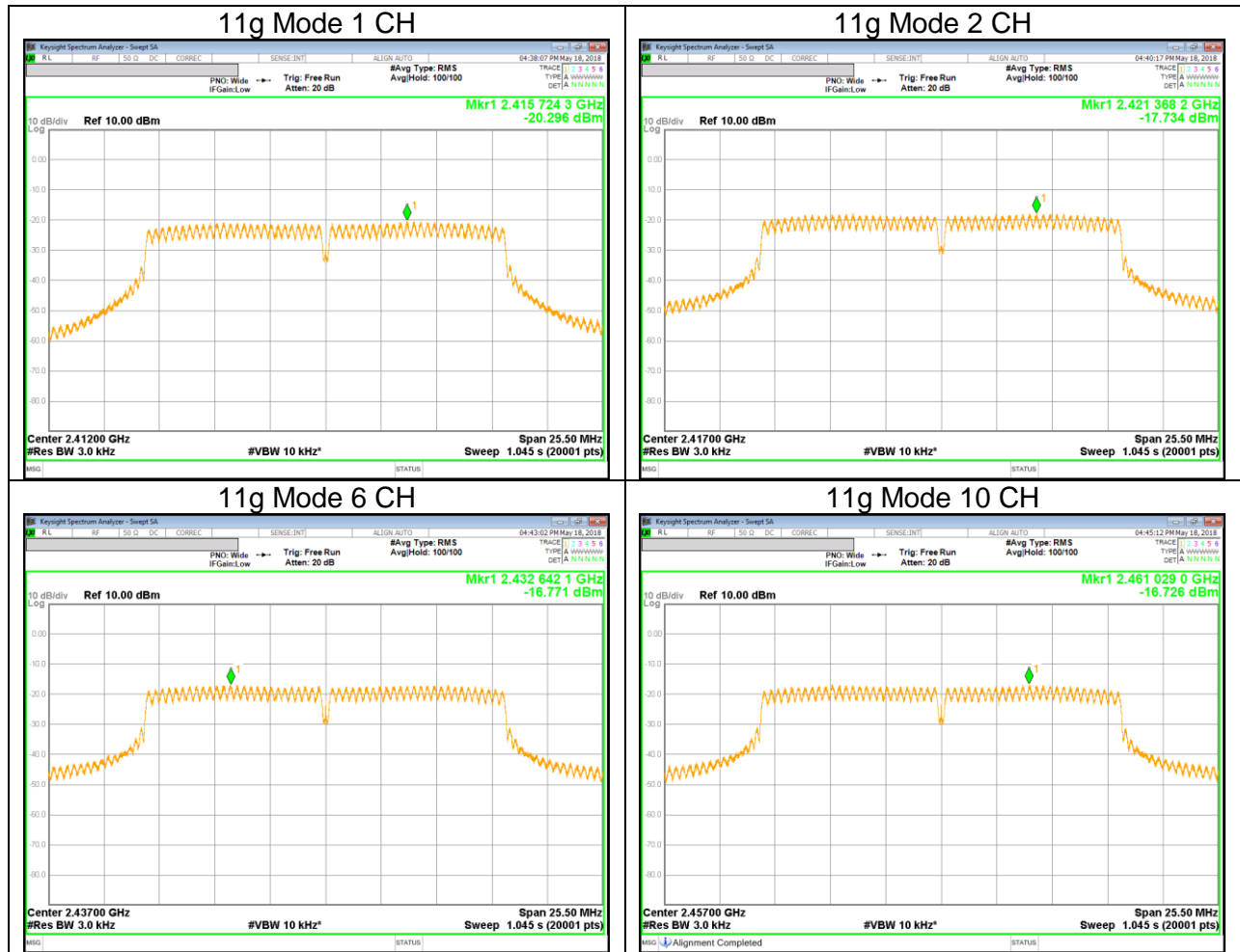

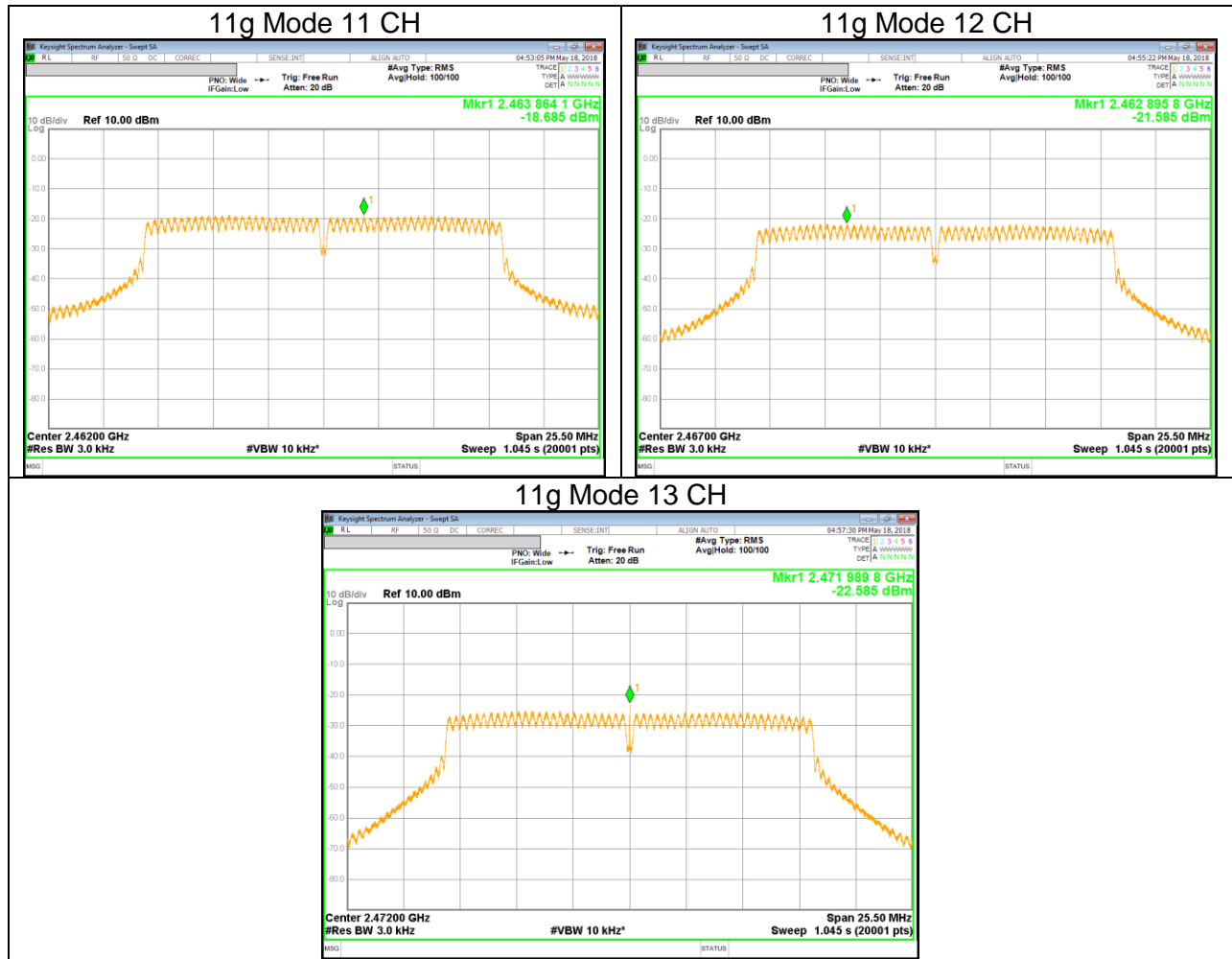

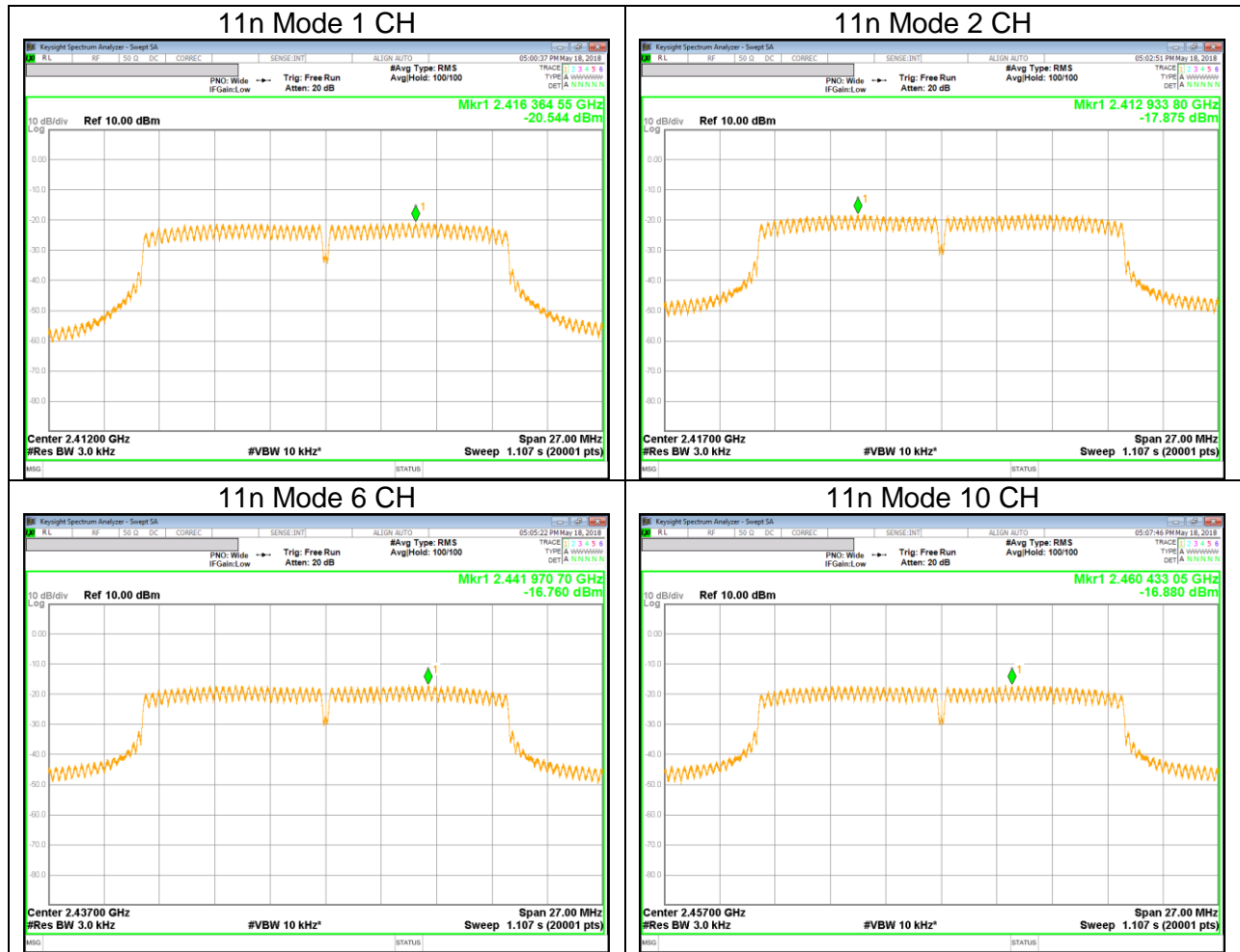

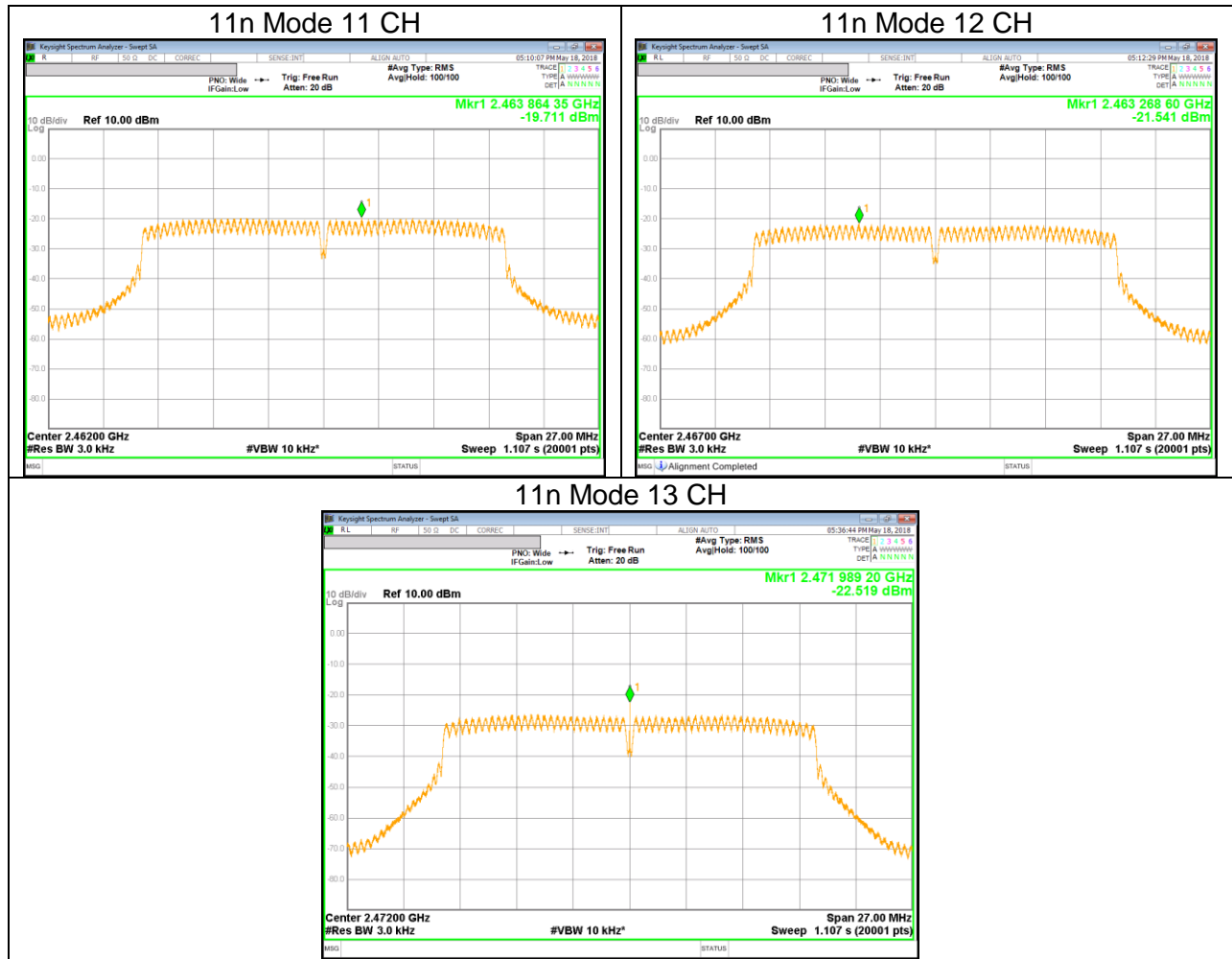

## 10.4. OUT-OF-BAND EMISSIONS

### LIMITS

FCC §15.247 (d)

In any 100 kHz bandwidth outside the frequency band in which the spread spectrum or digitally modulated intentional radiator is operating, the radio frequency power that is produced by the intentional radiator shall be at least 20 dB below that in the 100 kHz bandwidth within the band that contains the highest level of the desired power, based on either an RF conducted or a radiated measurement, provided the transmitter demonstrates compliance with the peak conducted power limits. If the transmitter complies with the conducted power limits based on the use of RMS averaging over a time interval, as permitted under paragraph (b)(3) of this section, the attenuation required under this paragraph shall be 30 dB instead of 20 dB. Attenuation below the general limits specified in §15.209(a) is not required.

### TEST PROCEDURE

The transmitter output is connected to a spectrum analyzer with RBW = 100 kHz, VBW = 300 kHz, peak detector, and max hold. Measurements utilizing these settings are made of the in-band reference level, bandedge, out-of-band emissions (where measurements to the general radiated limits will not be made)



**RESULTS**

**10.4.1.802.11b MODE IN THE 2.4 GHz BAND**

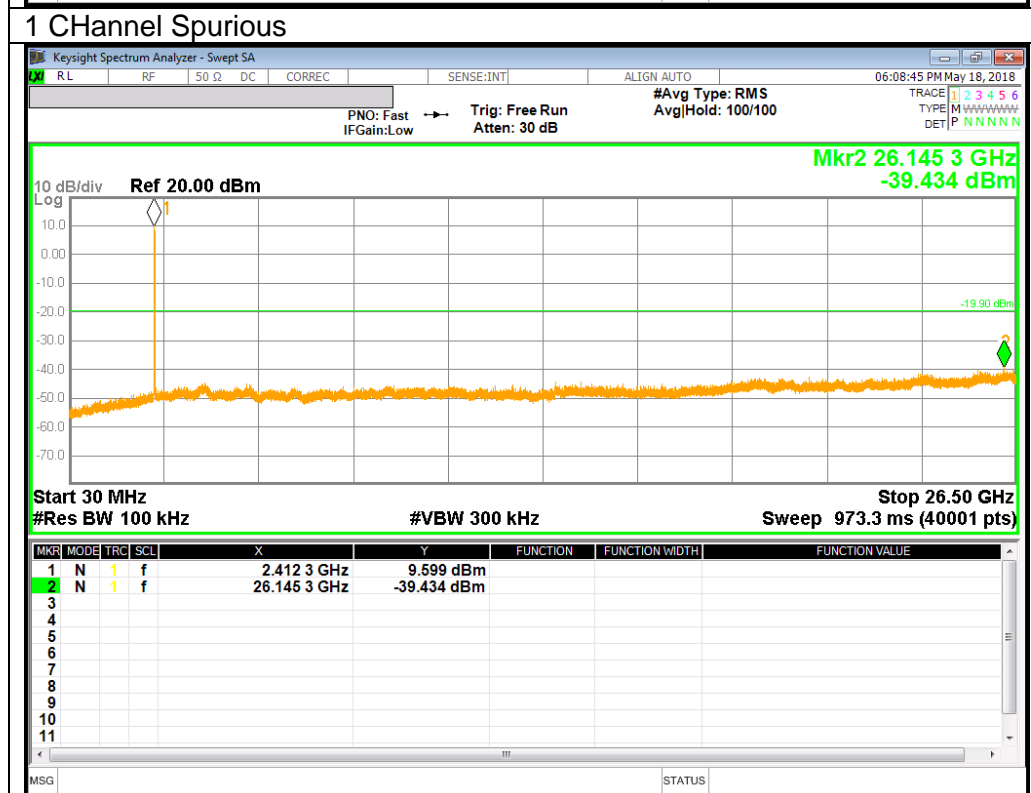
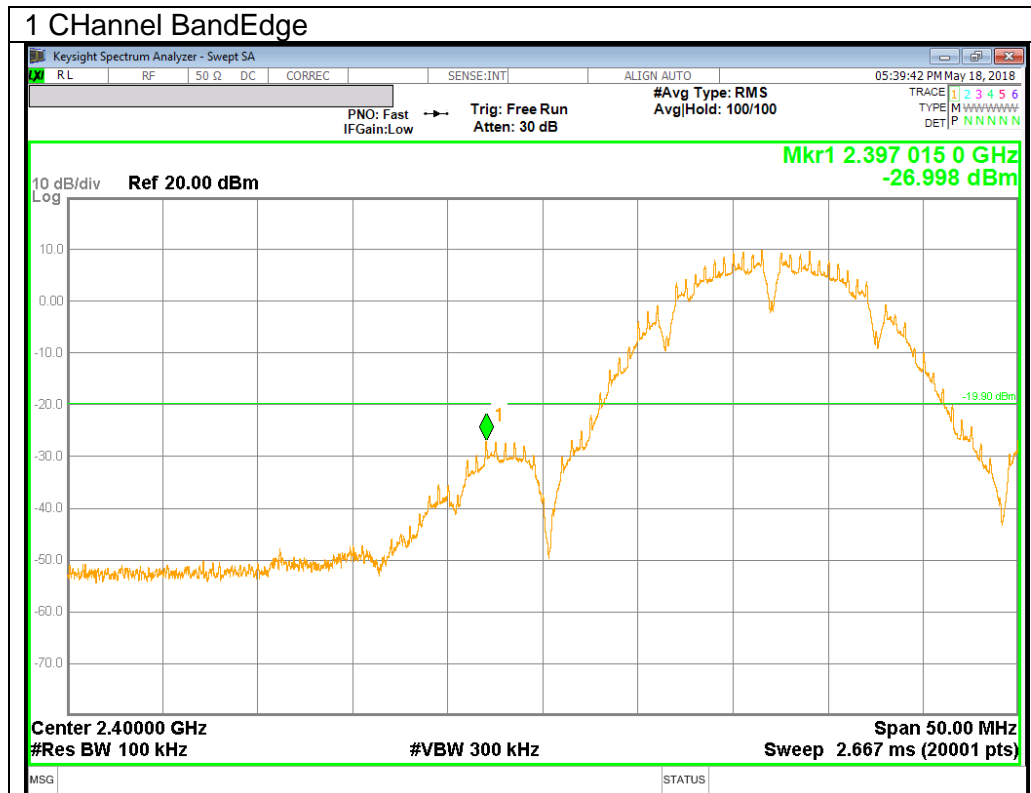

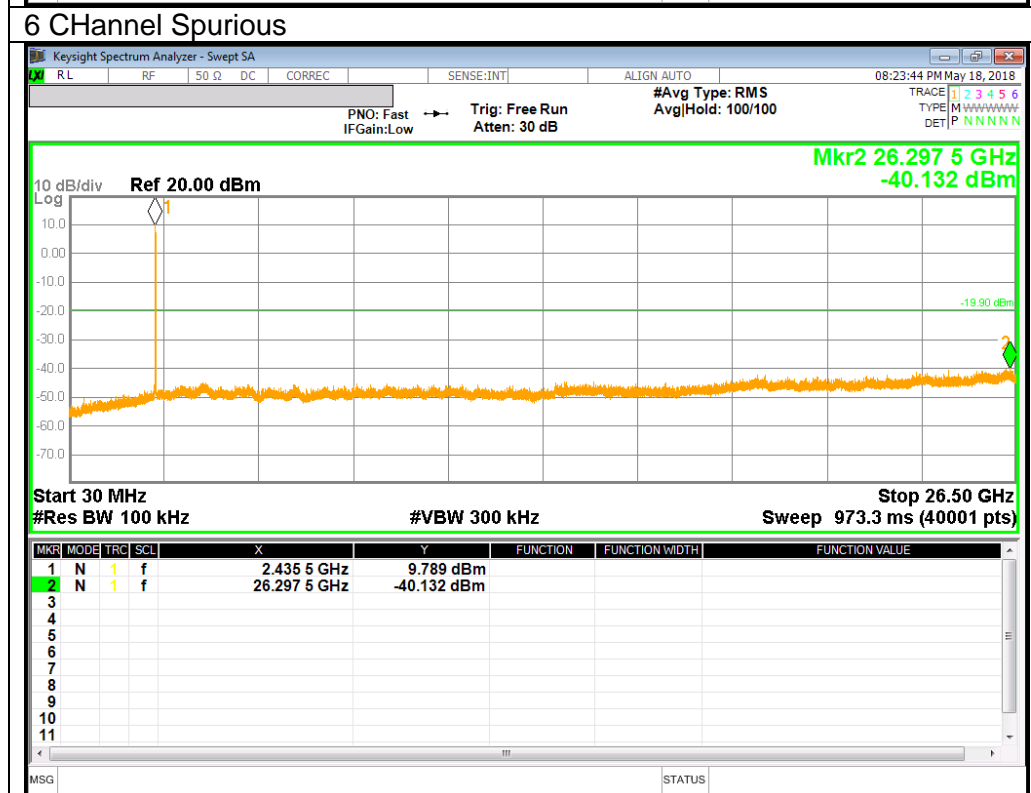
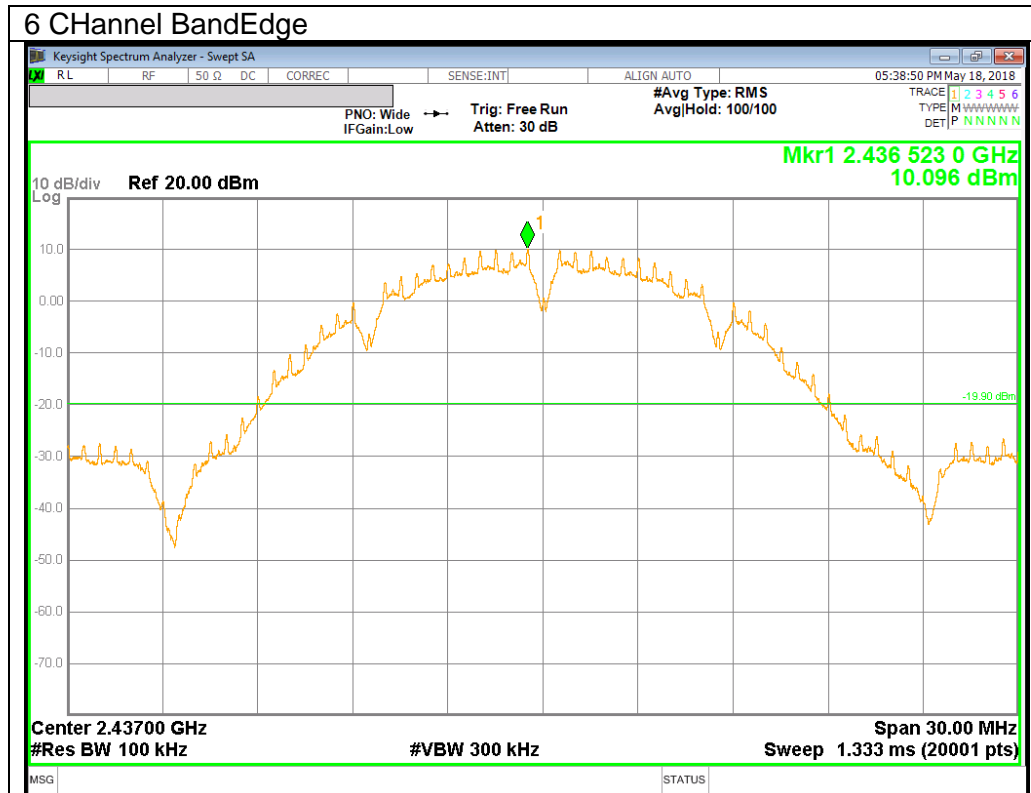

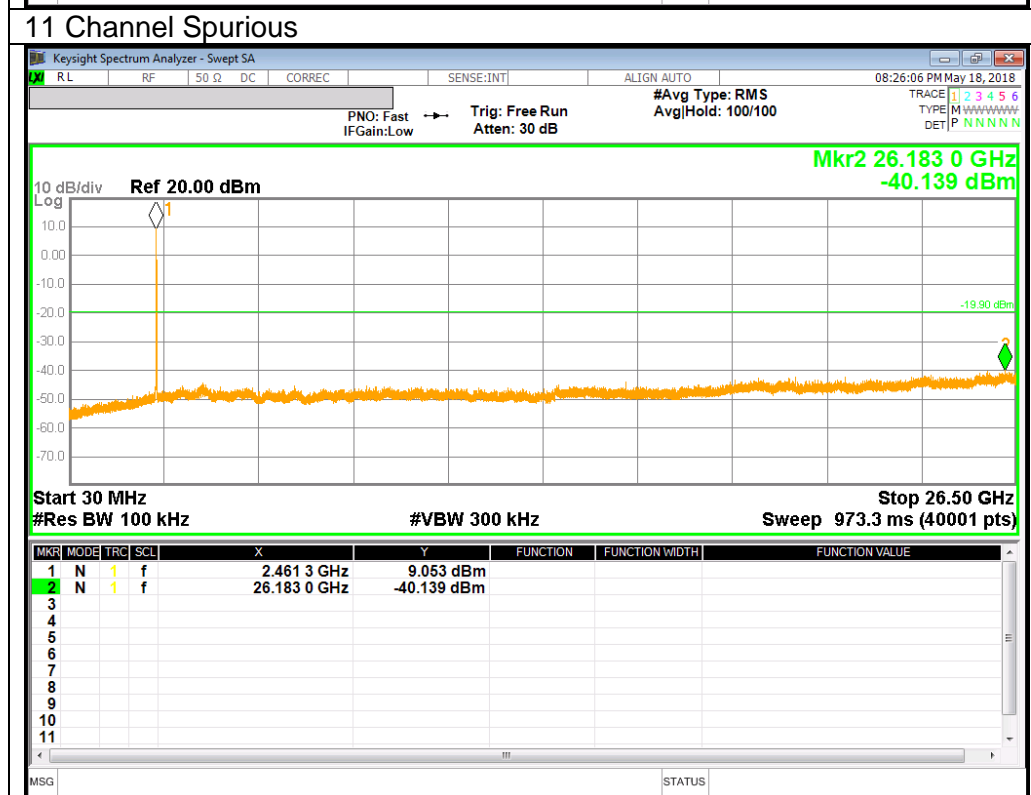
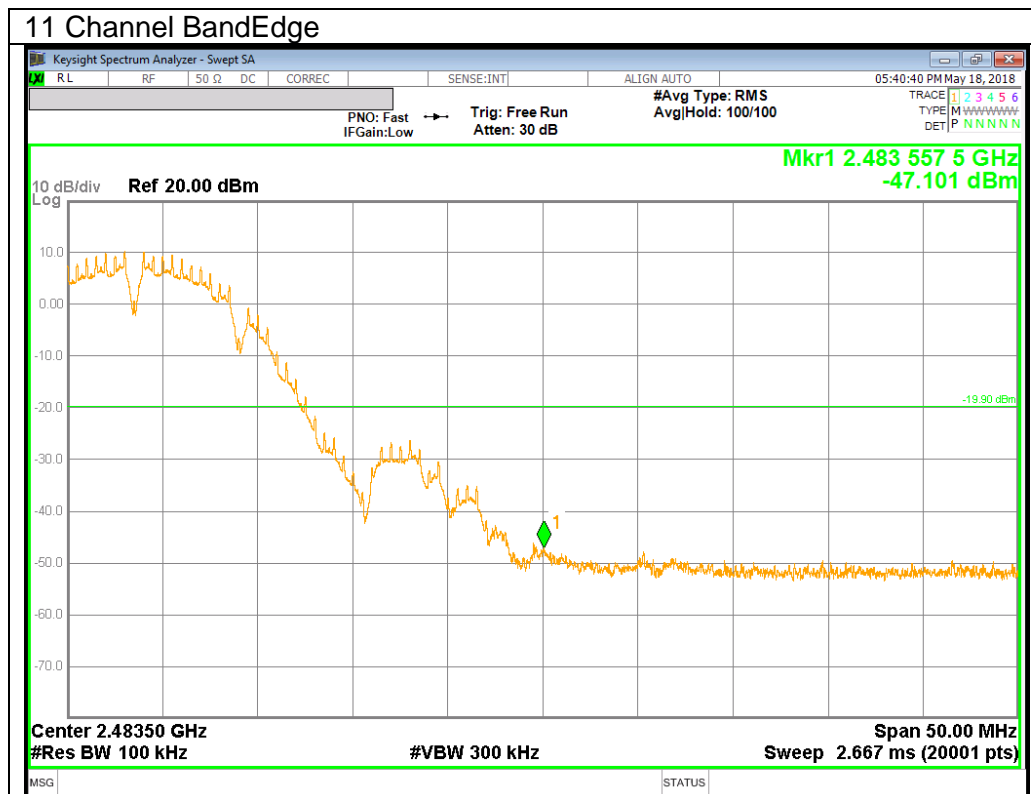

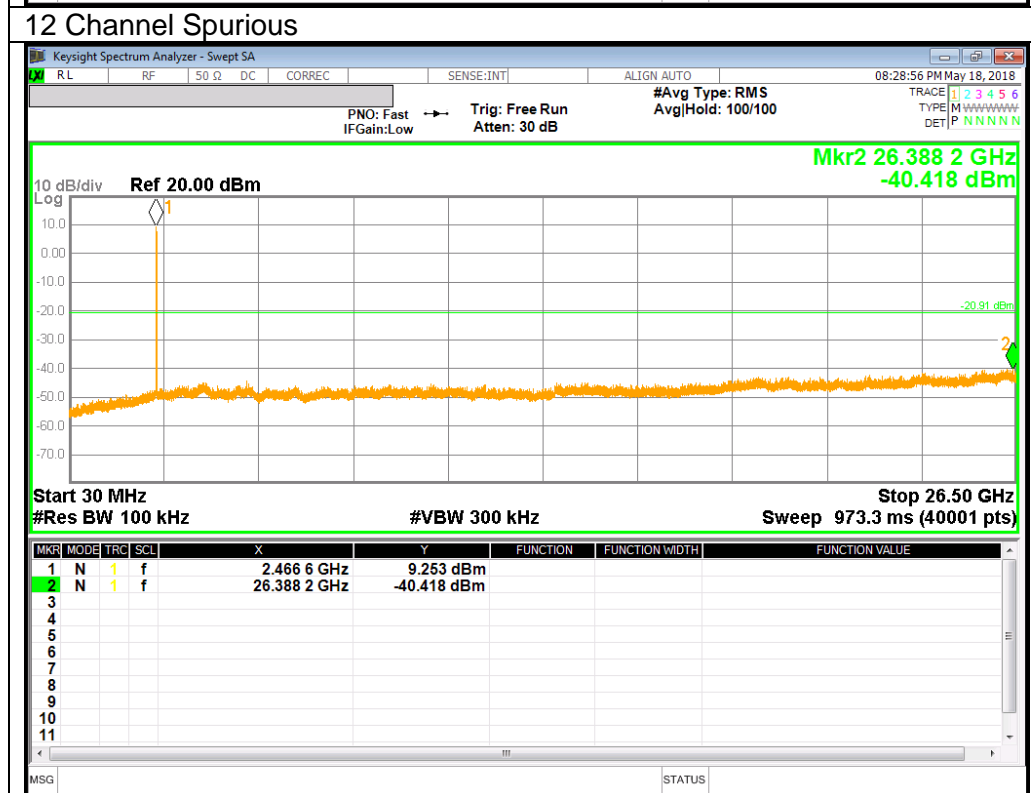
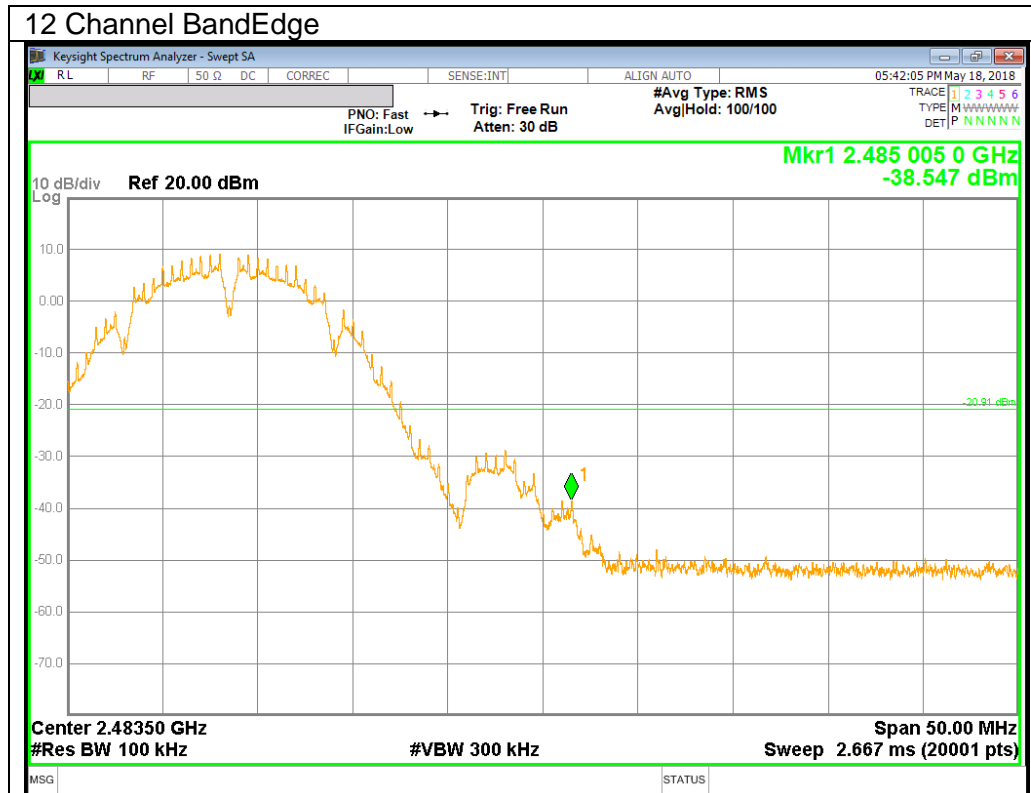

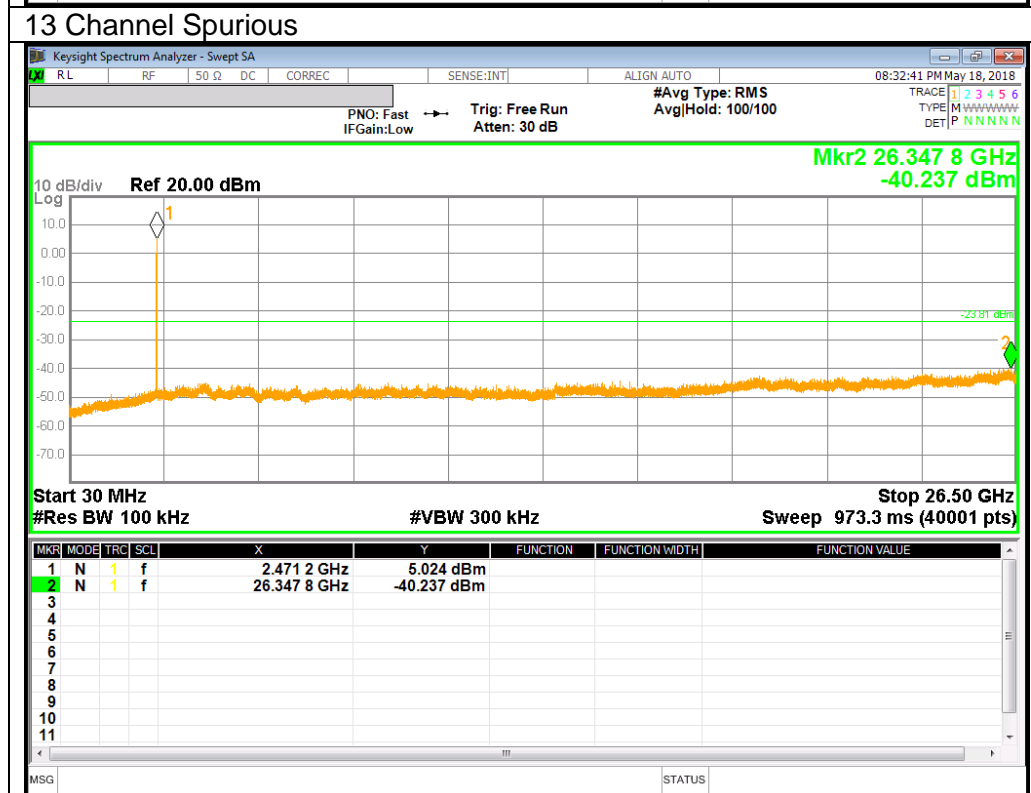
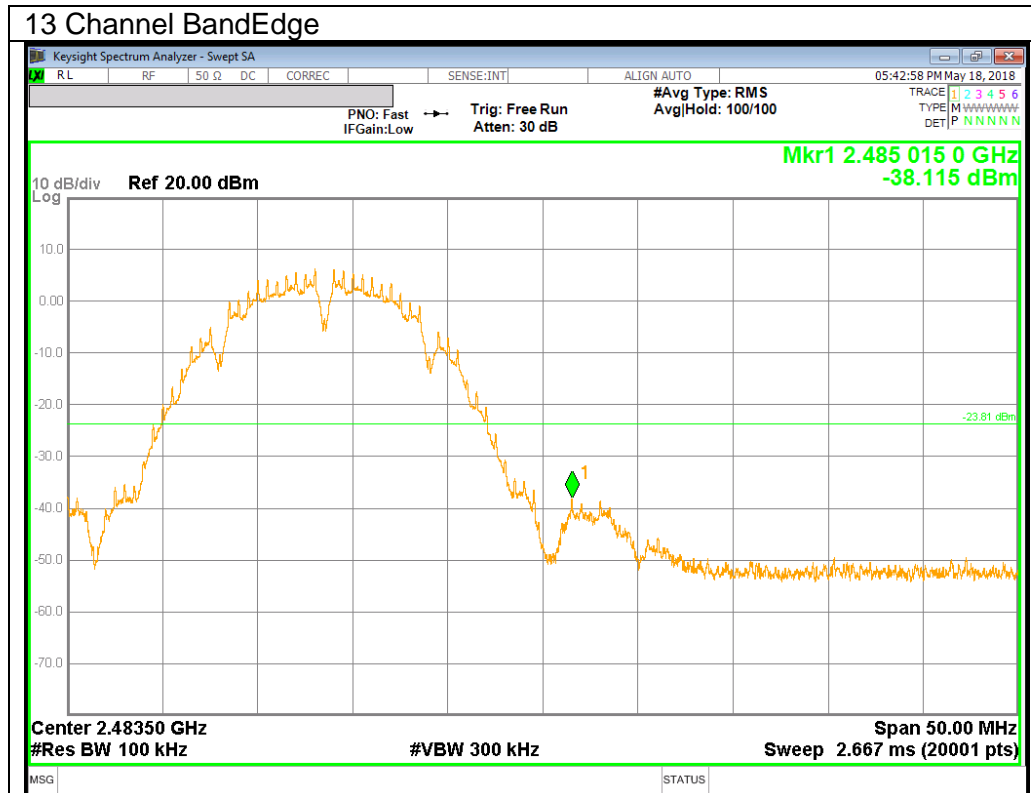

### 10.4.2.802.11g MODE IN THE 2.4 GHz BAND

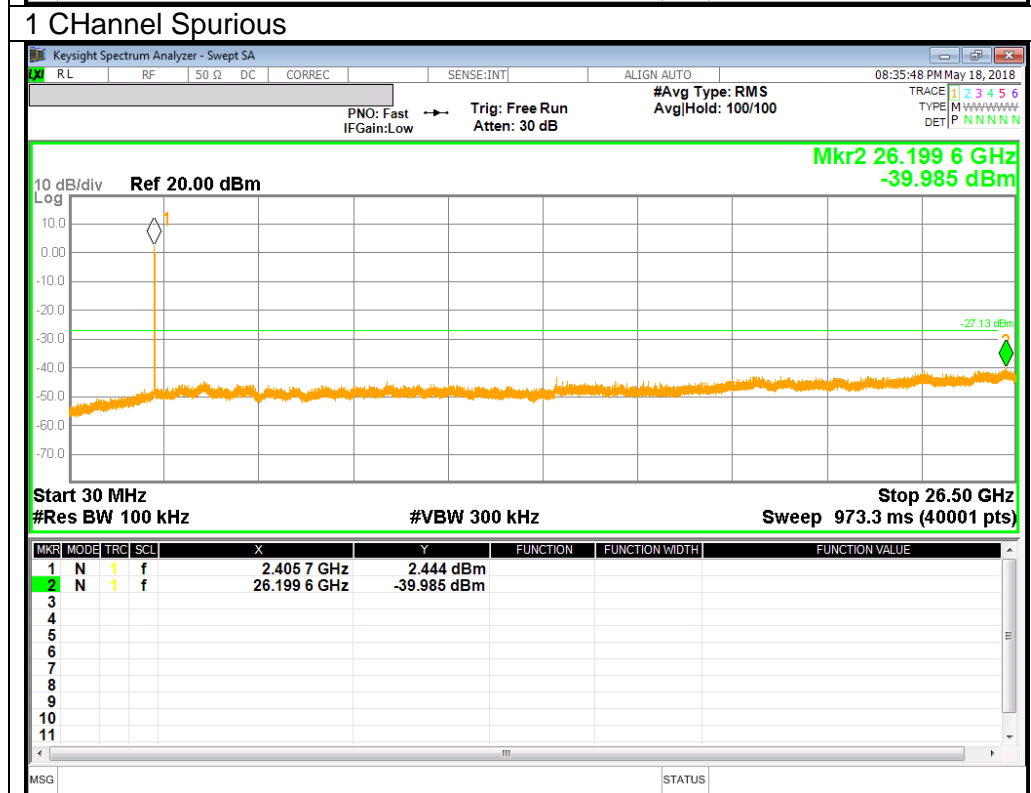
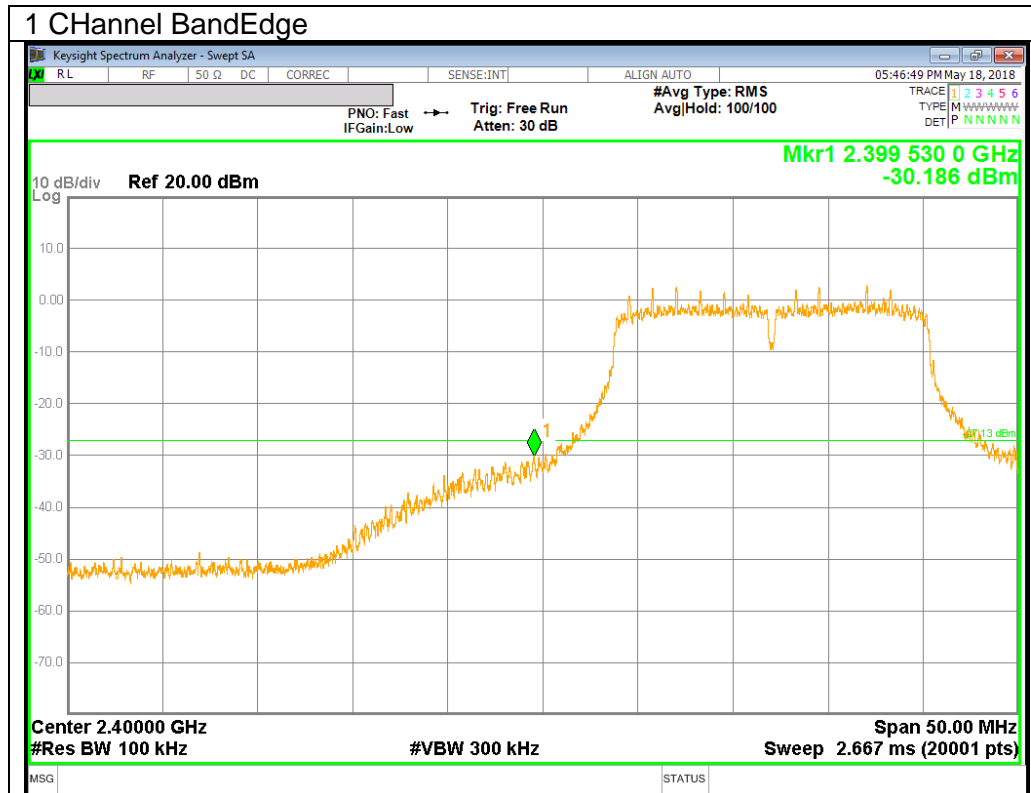

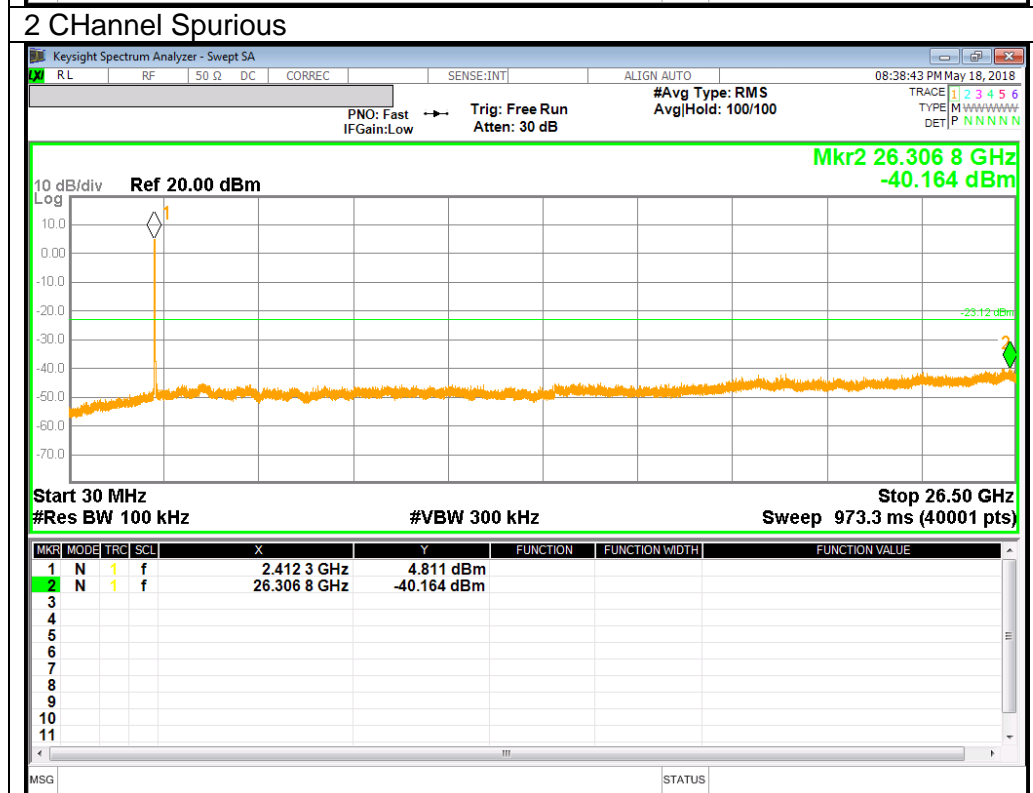
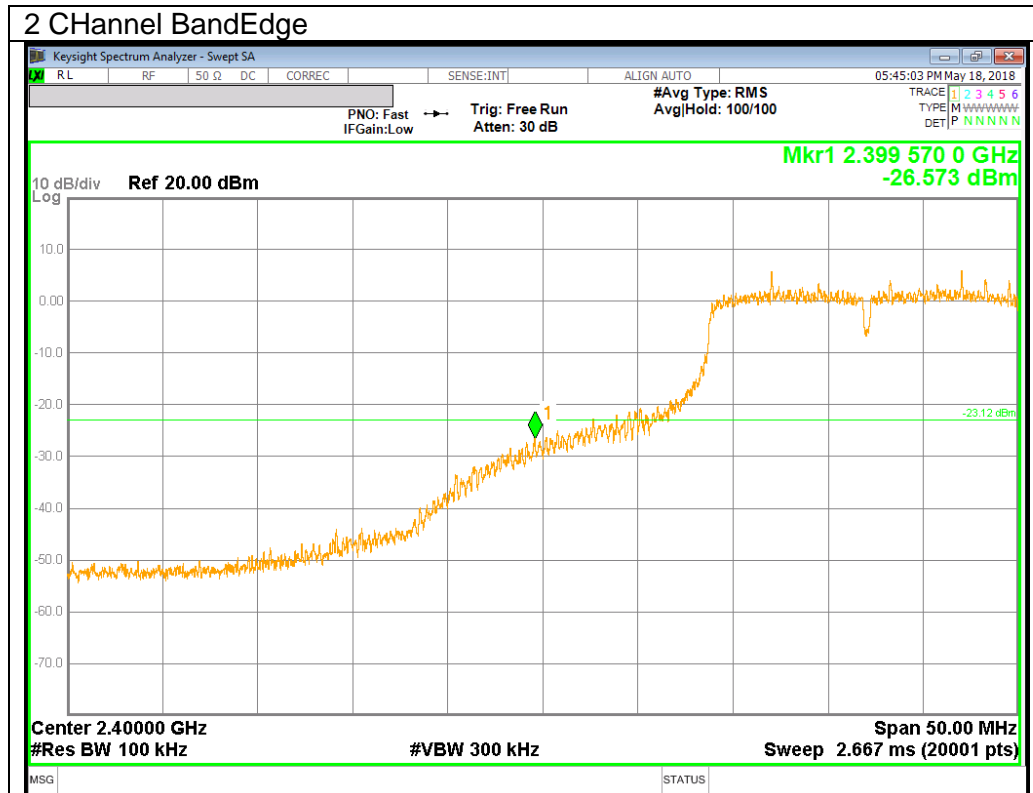

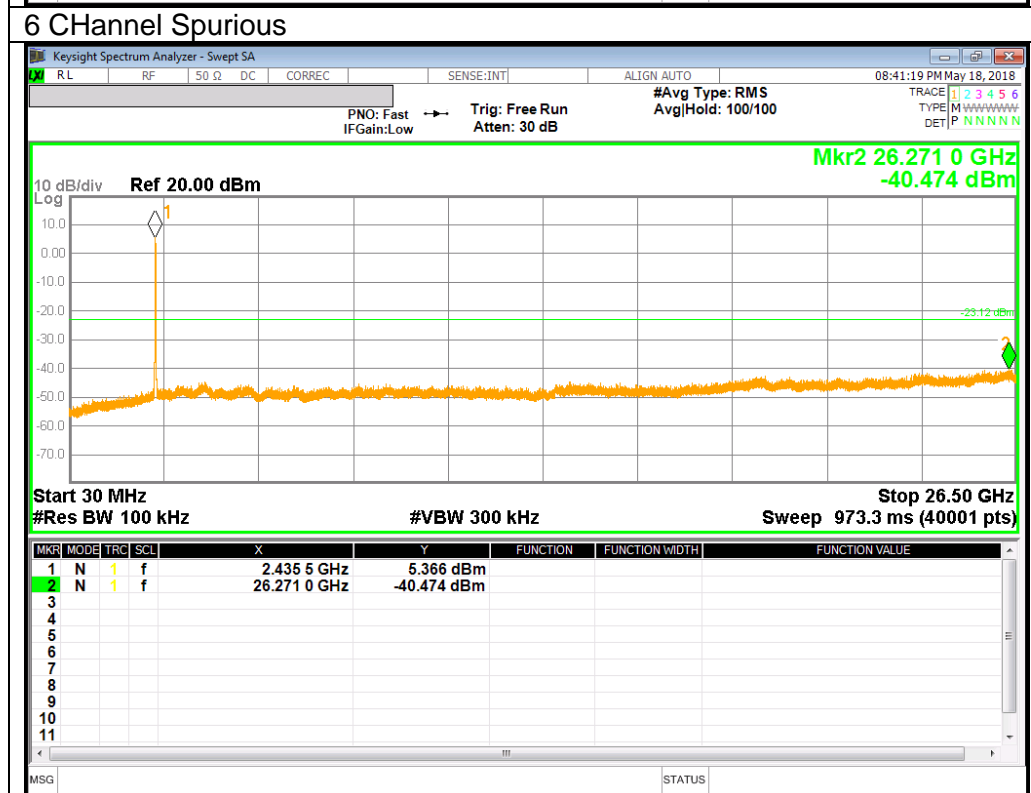
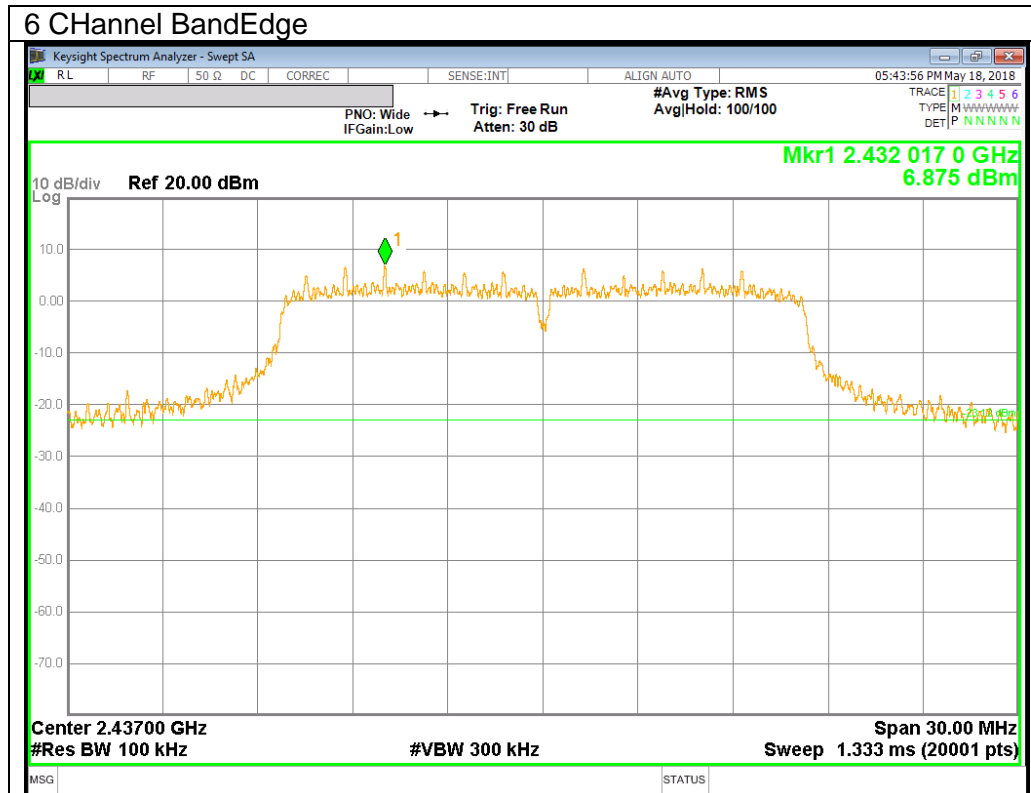



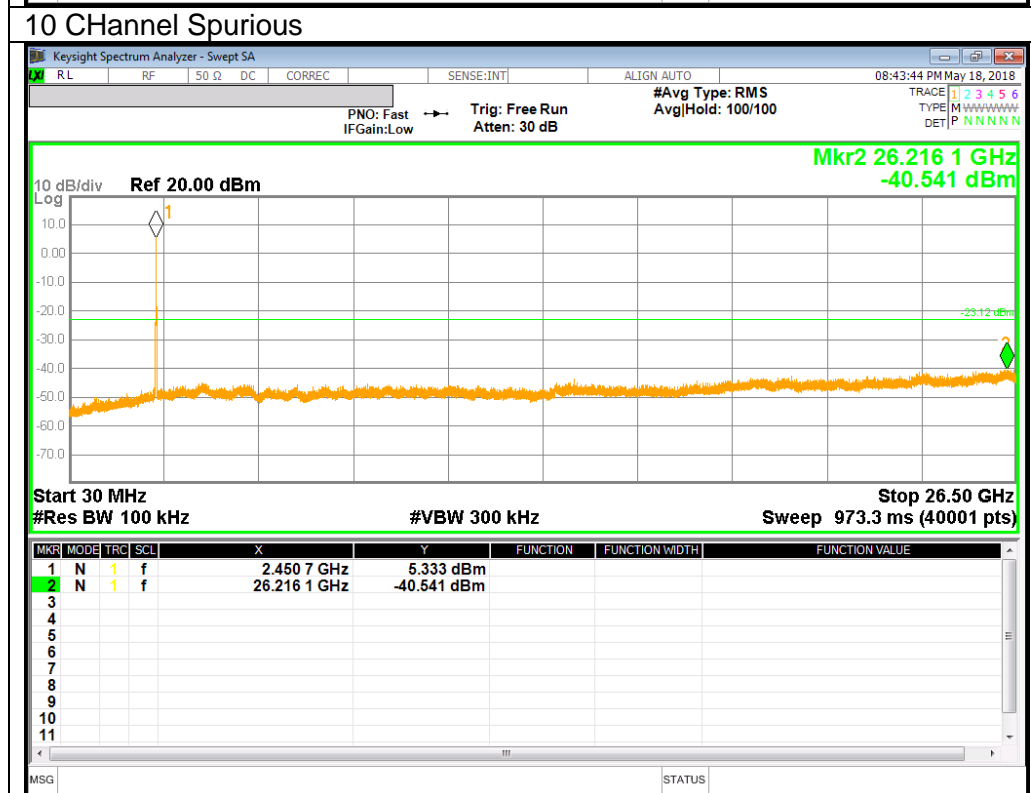
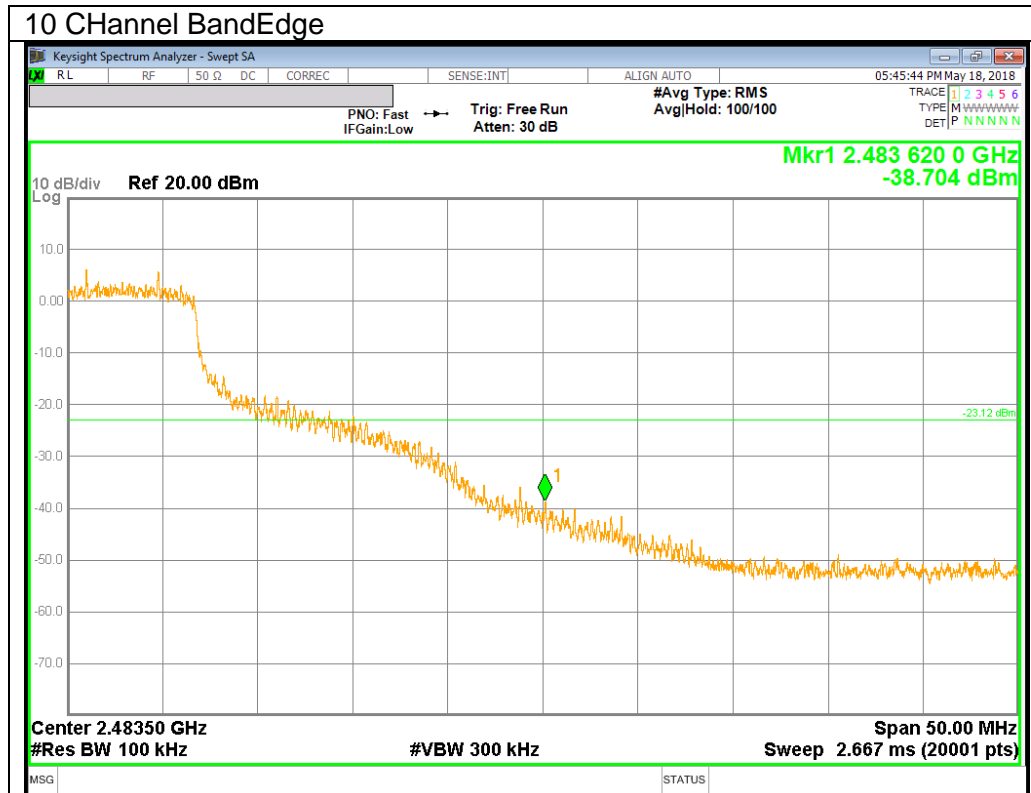

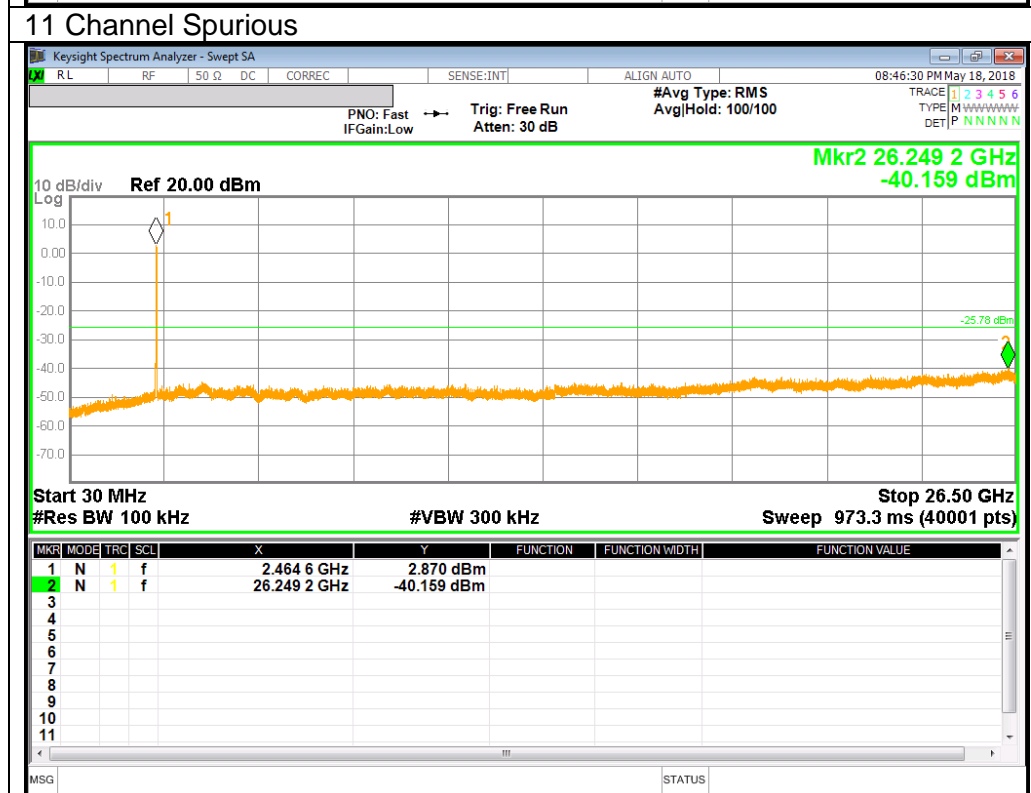
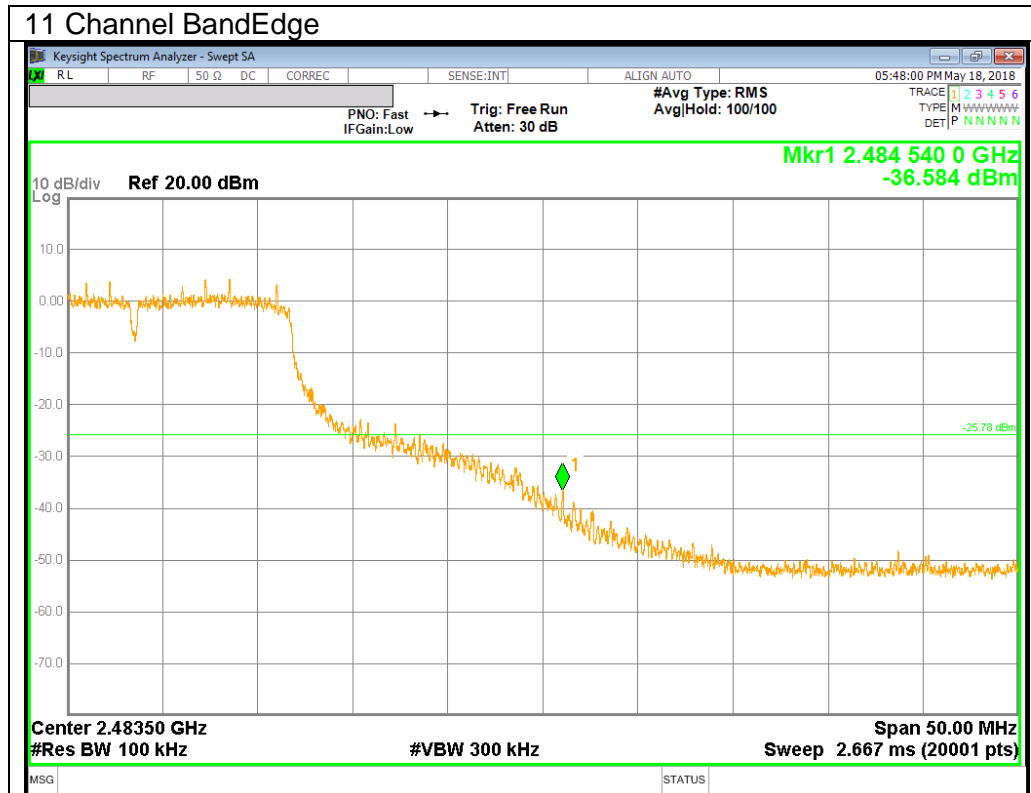

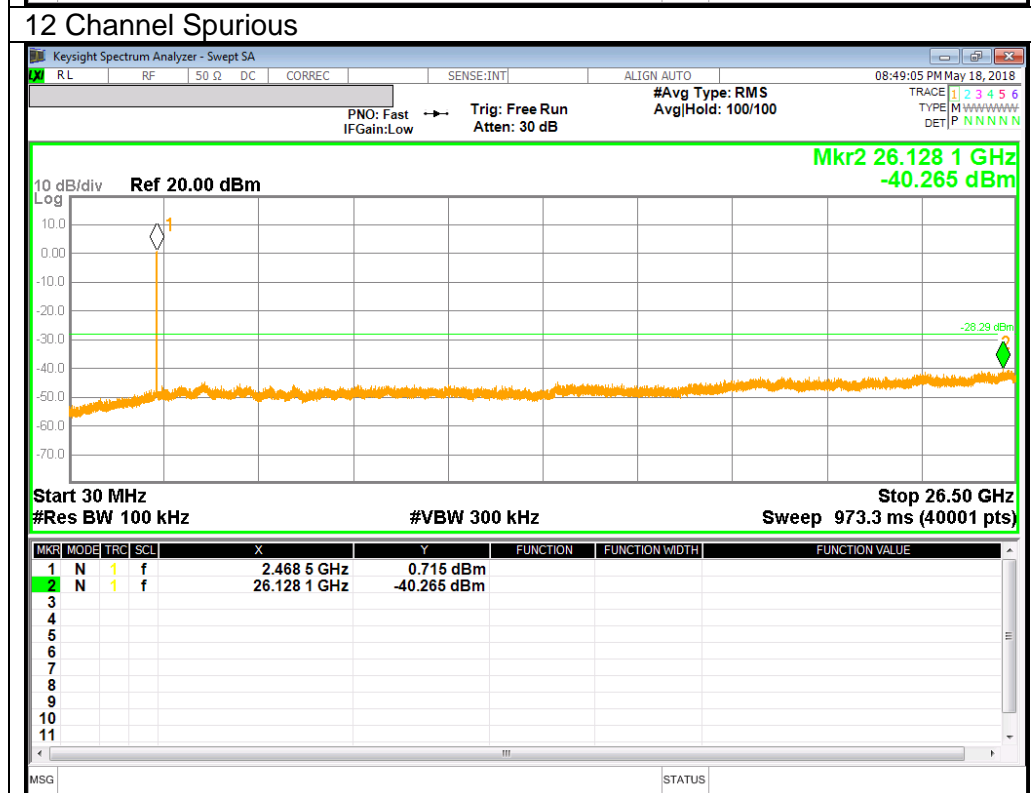
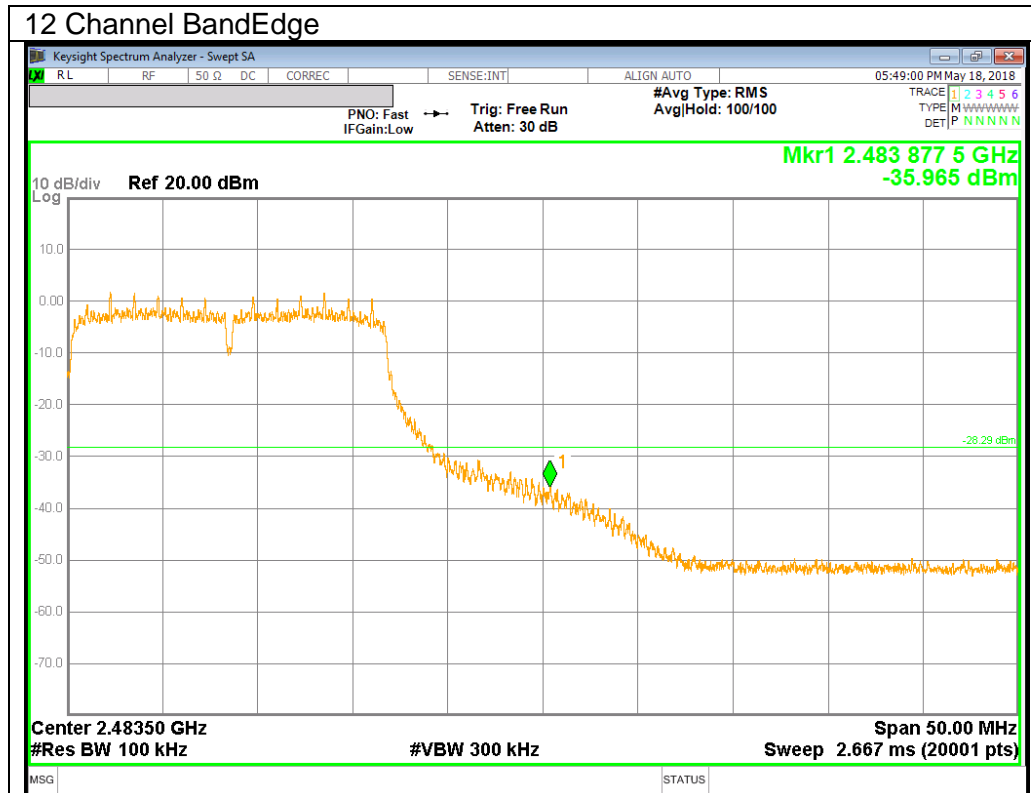

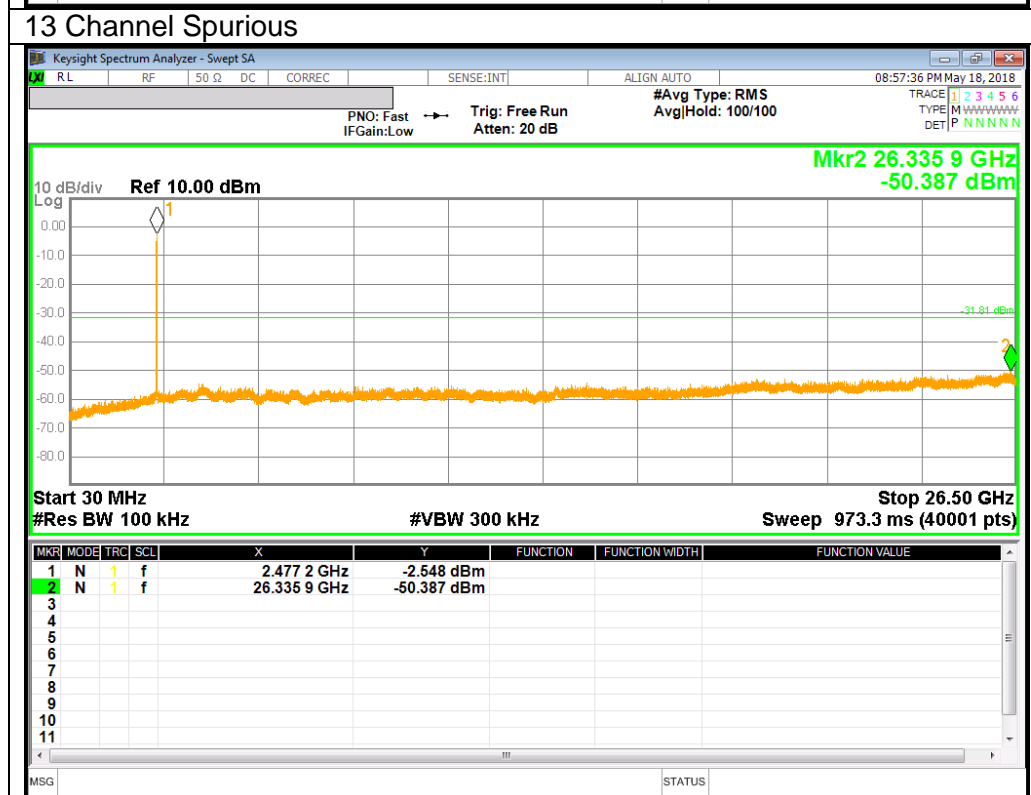
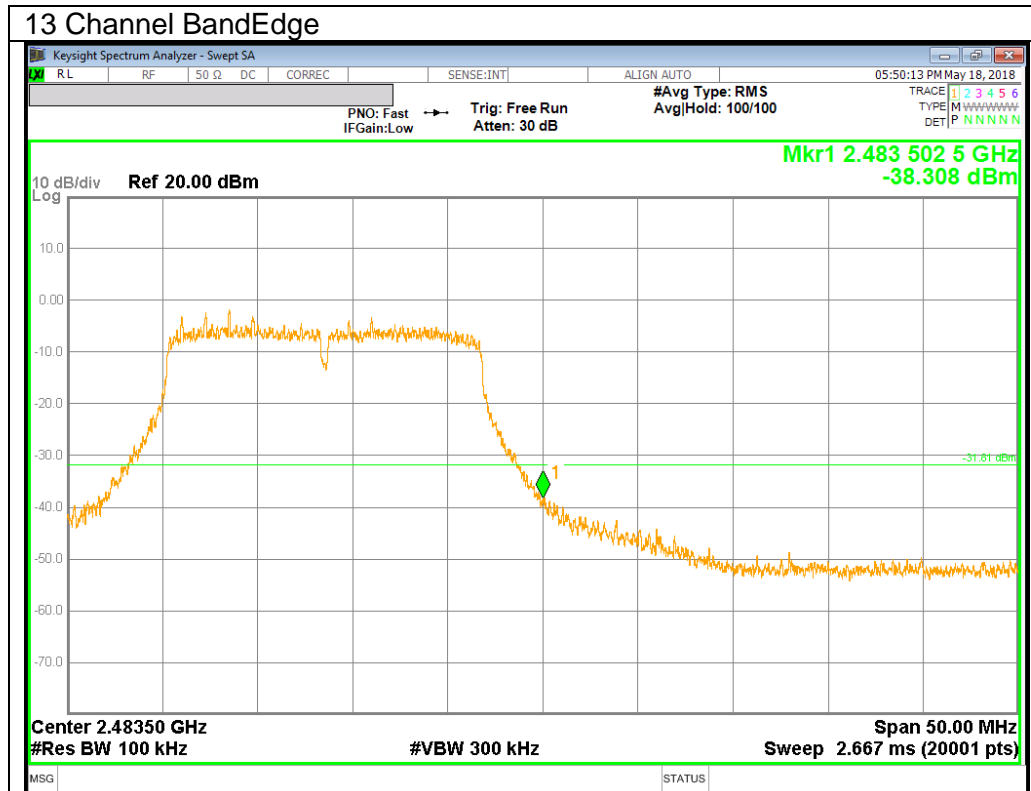

### 10.4.3.802.11n HT20 MODE IN THE 2.4 GHz BAND

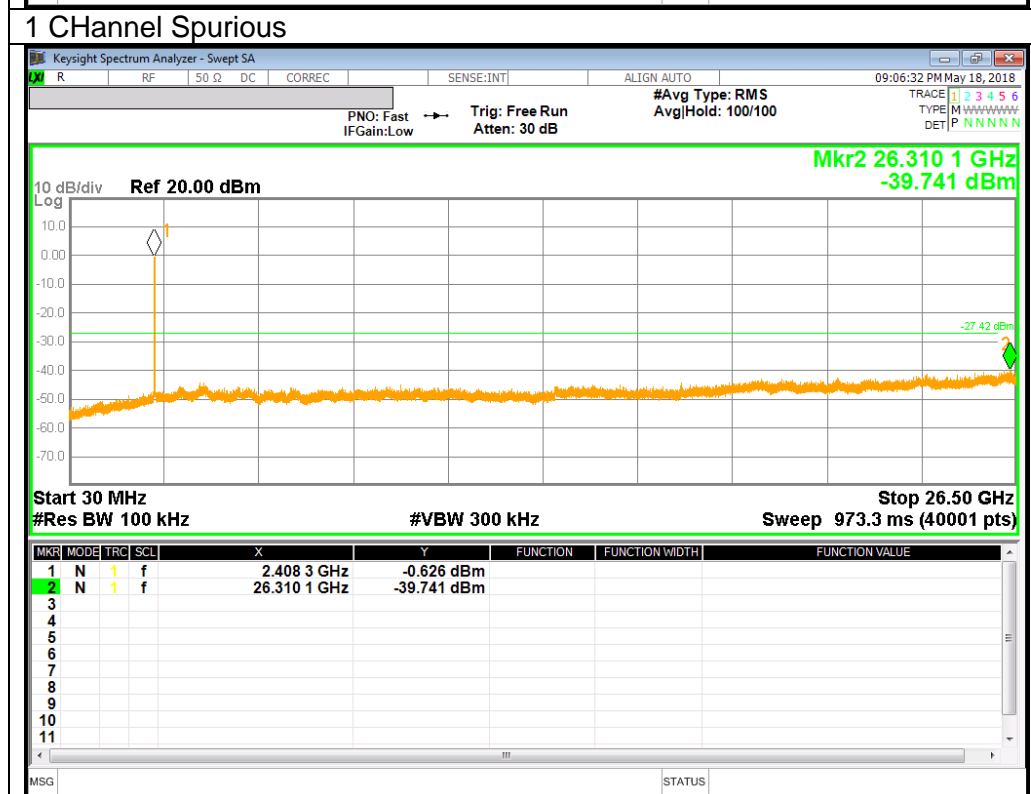
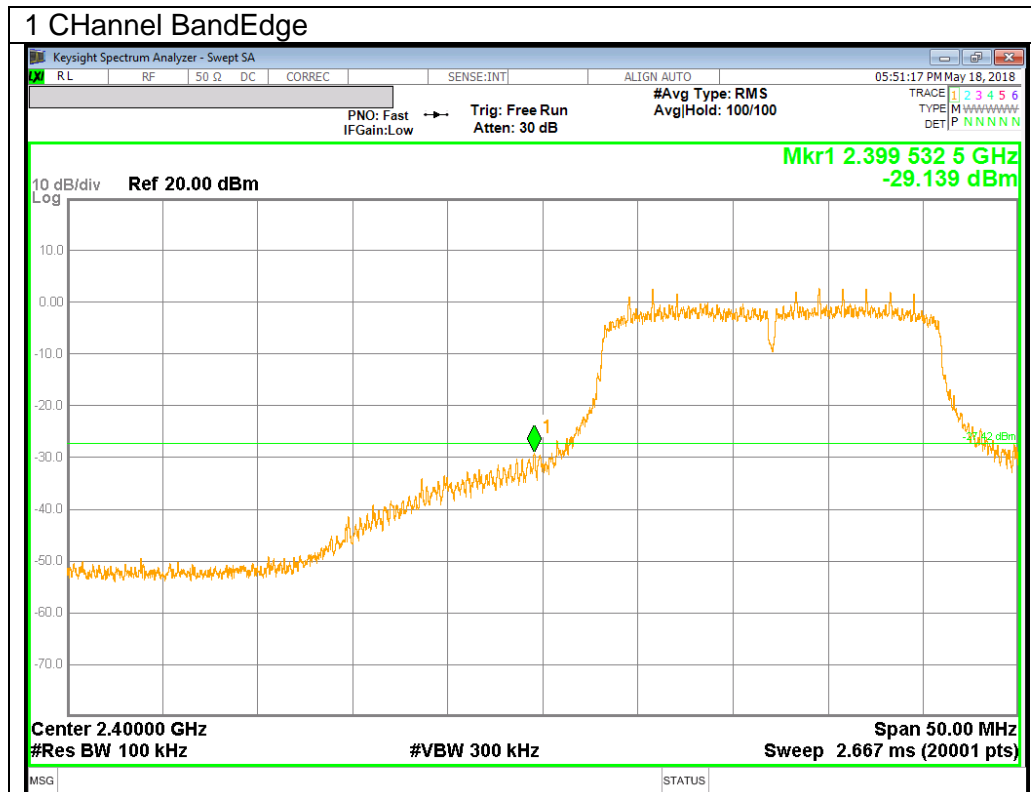

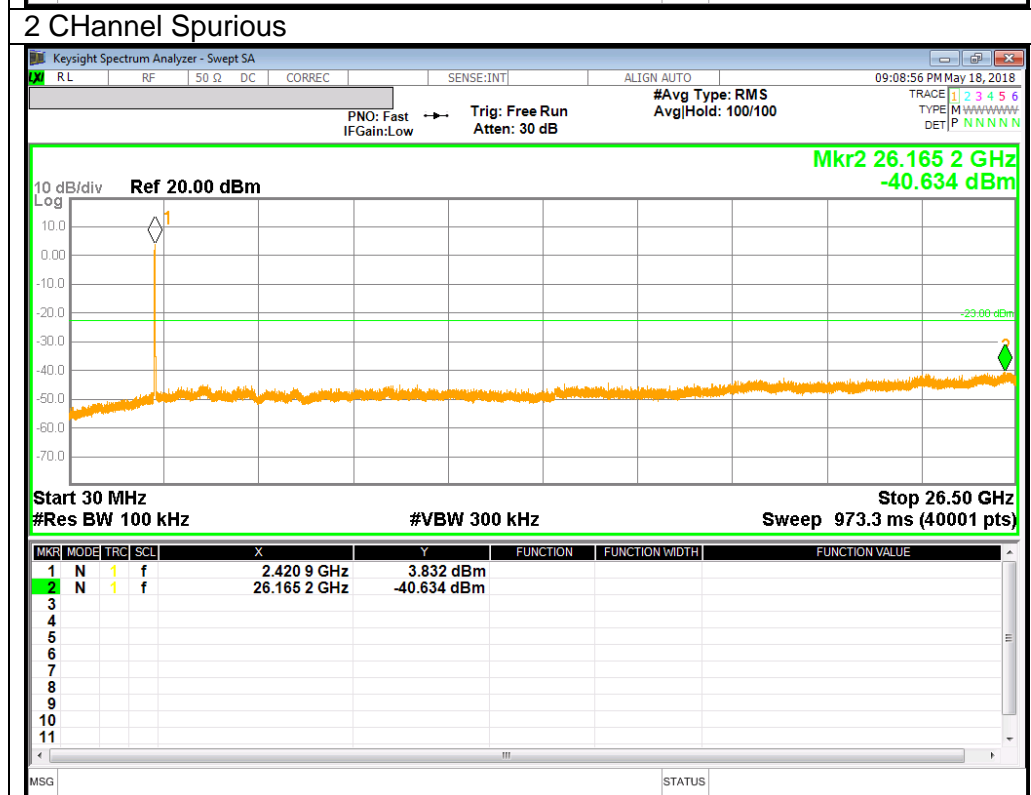
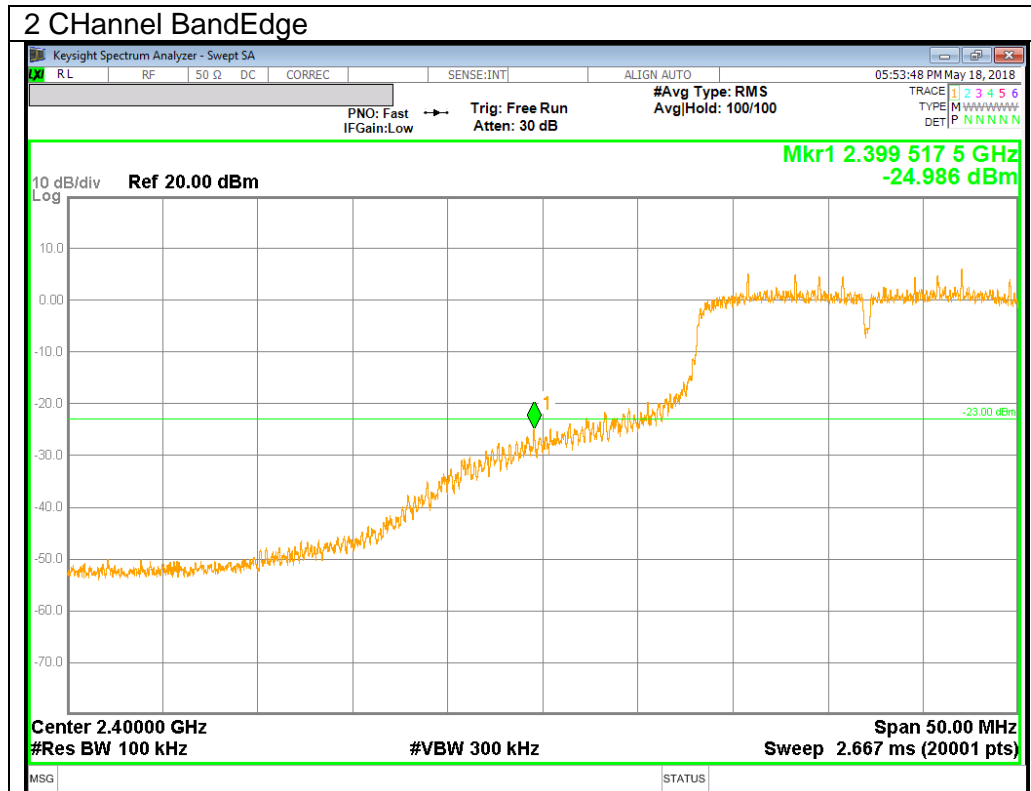

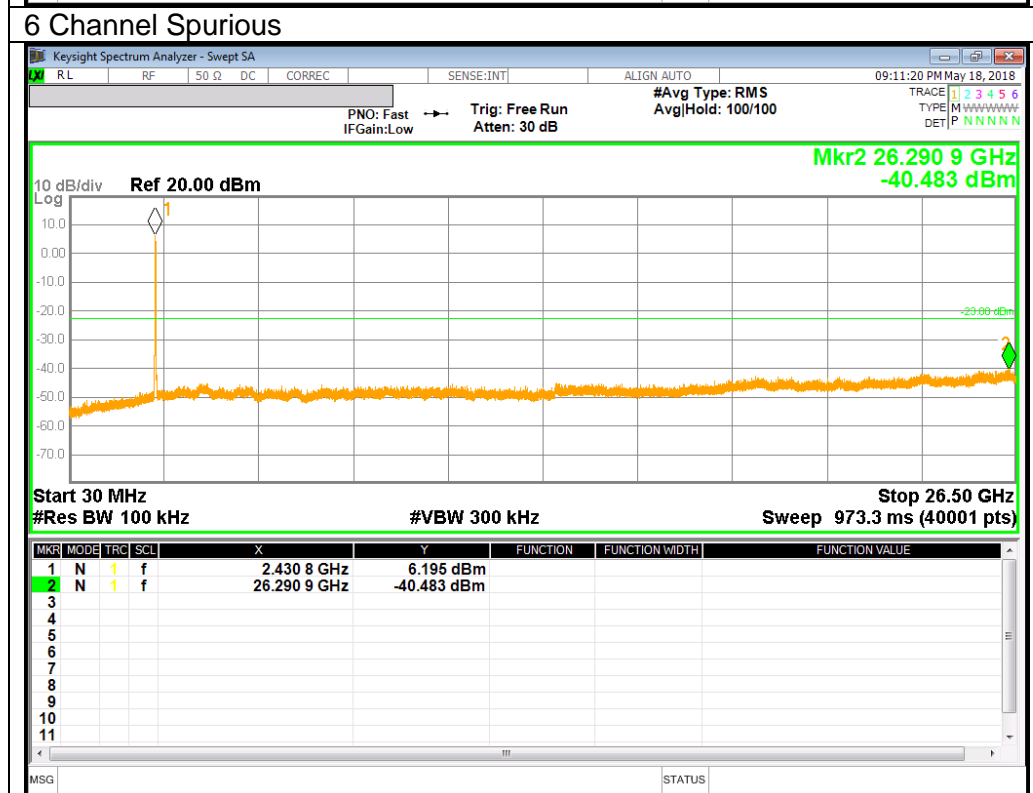
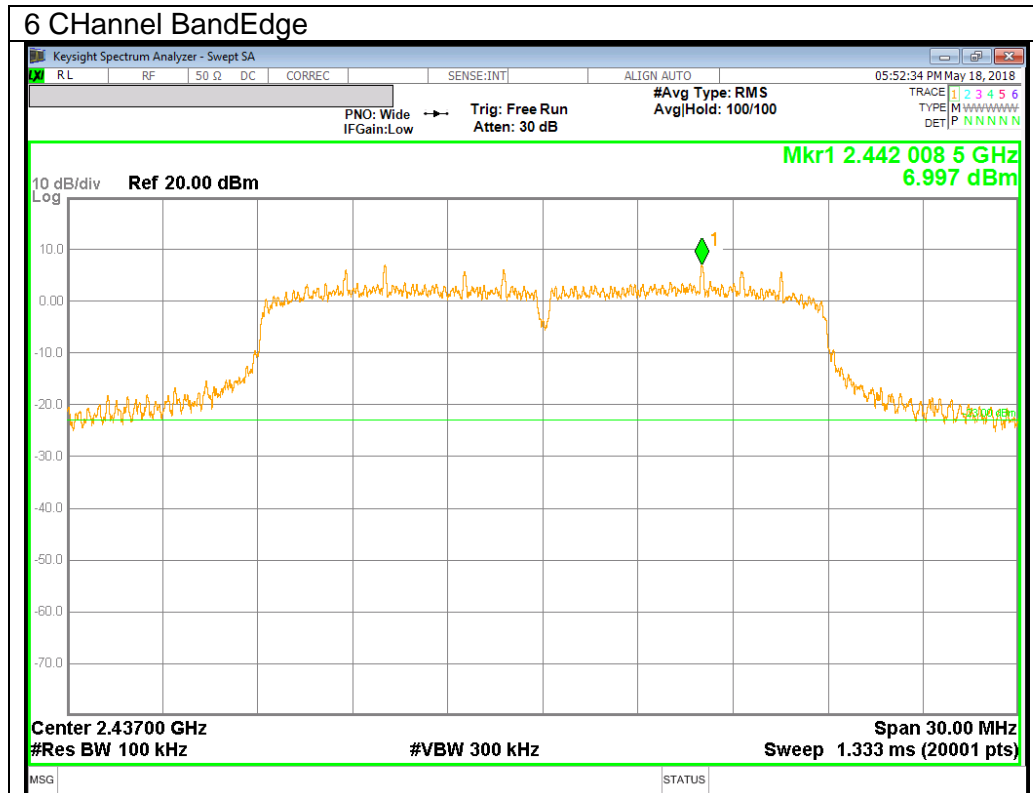

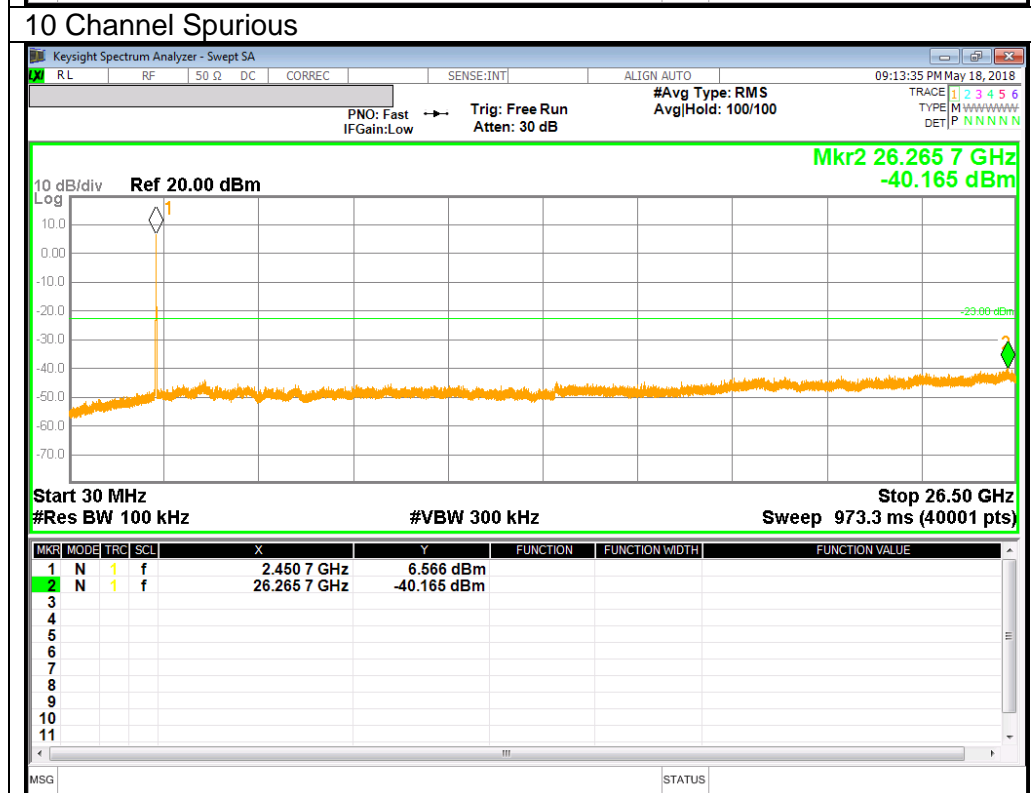
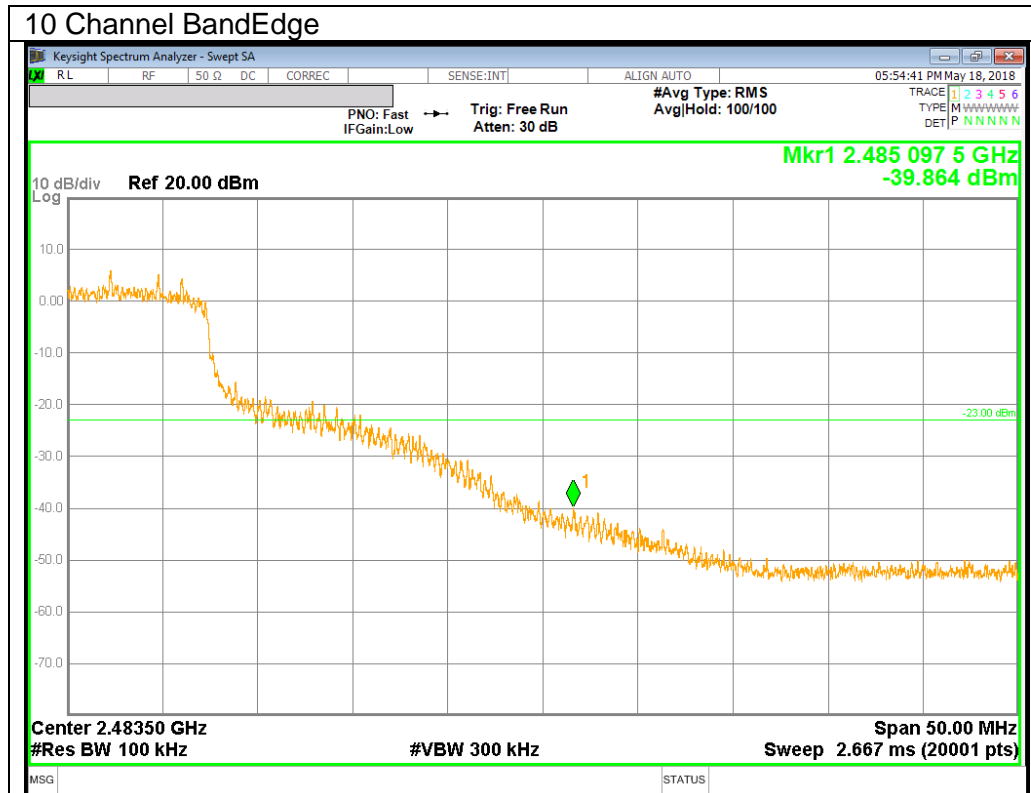



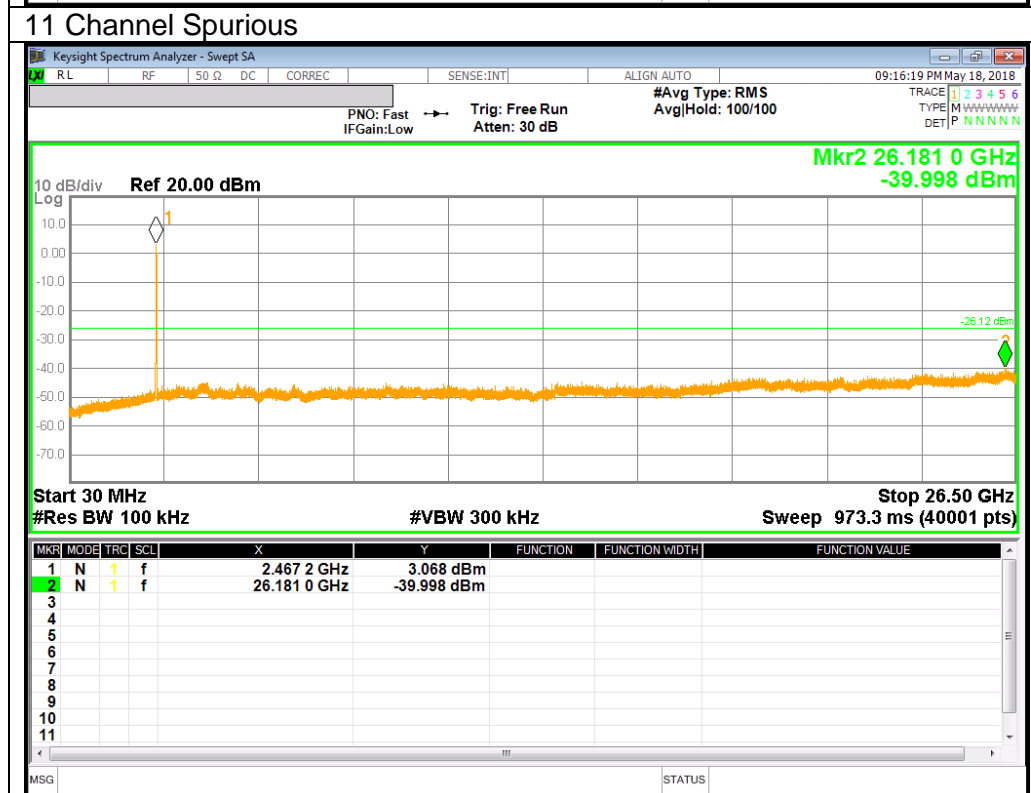
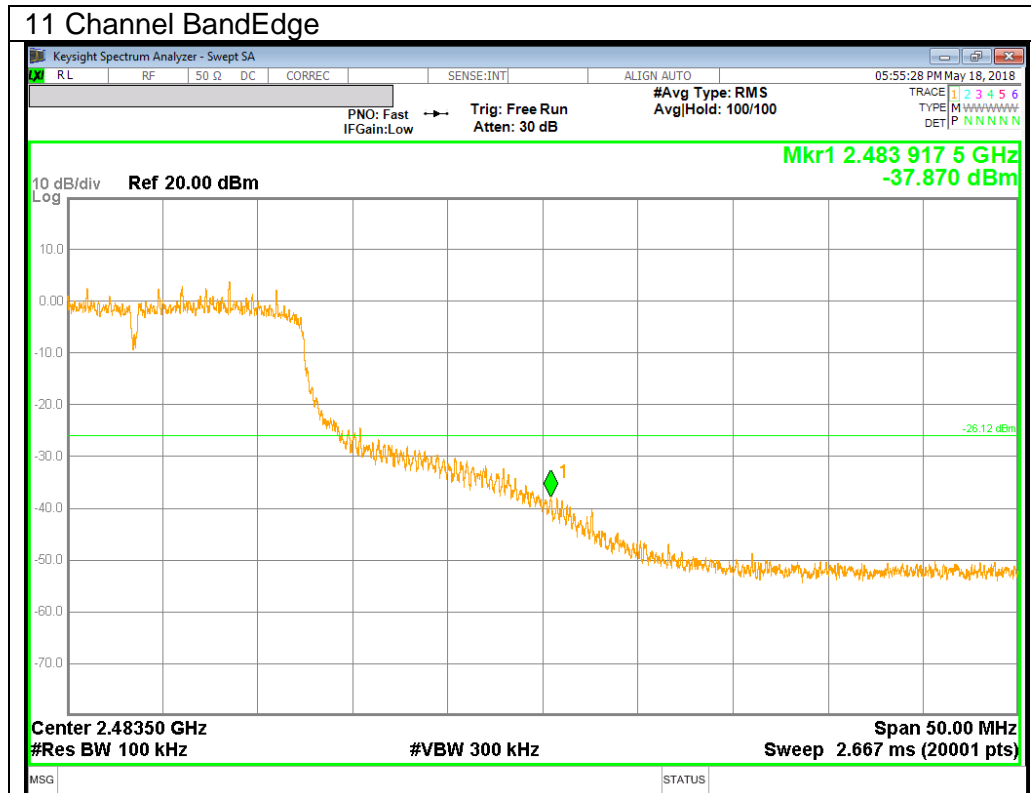

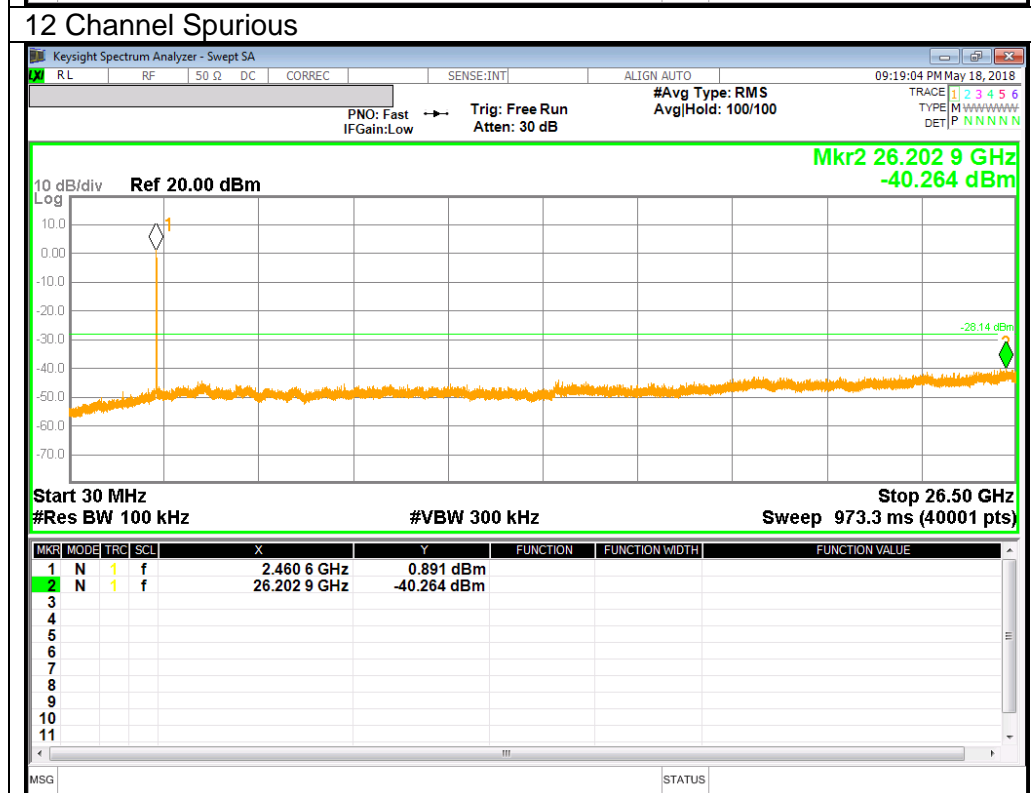
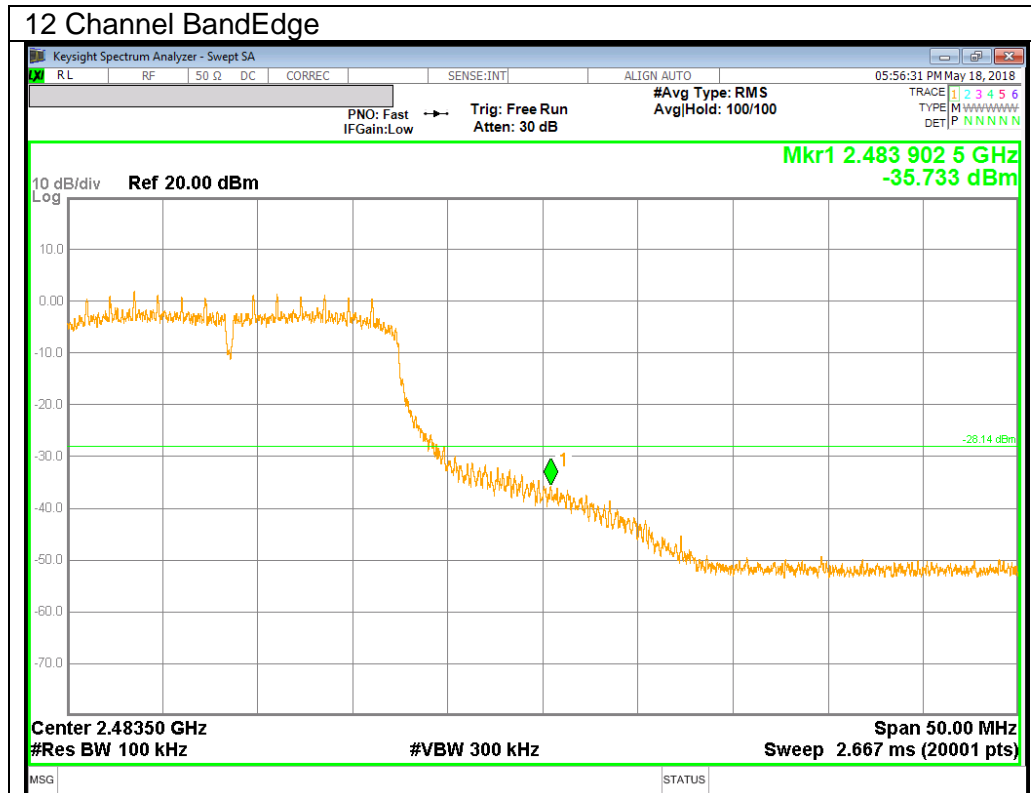

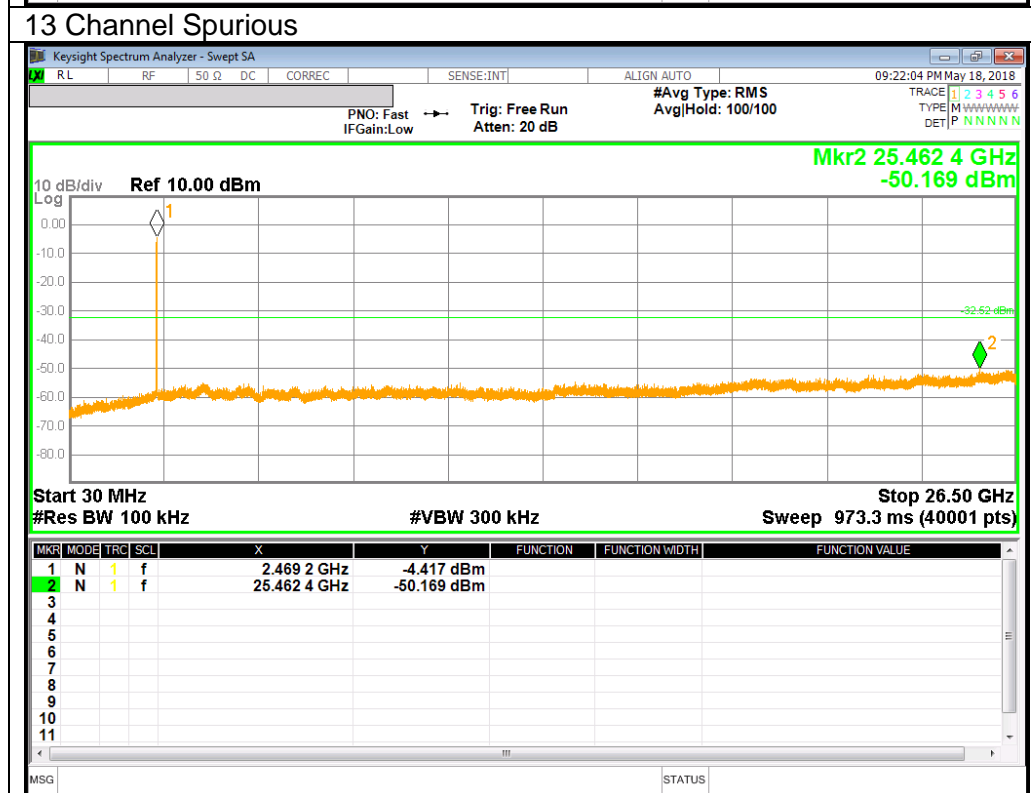
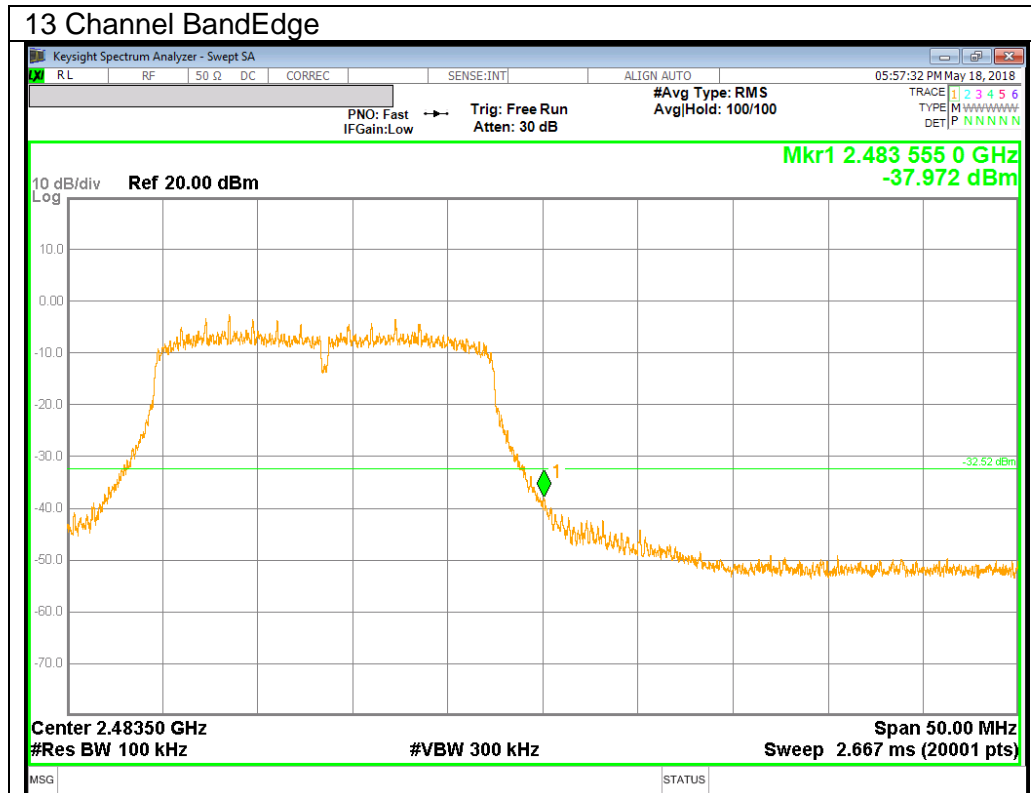

## 11. RADIATED TEST RESULTS

### 11.1. LIMITS AND PROCEDURE

#### LIMITS

FCC §15.205 and §15.209

Limits for radiated disturbance of an intentional radiator		
Frequency range (MHz)	Limits (µV/m)	Measurement Distance (m)
0.009 – 0.490	2400 / F (kHz)	300
0.490 – 1.705	24000 / F (kHz)	30
1.705 – 30.0	30	30
30 – 88	100**	3
88 - 216	150**	3
216 – 960	200**	3
Above 960	500	3

\*\* Except as provided in paragraph (g), fundamental emissions from intentional radiators operating under this section shall not be located in the frequency bands 54-72 MHz, 76-88 MHz, 174-216 MHz or 470-806 MHz. However, operation within these frequency bands is permitted under other sections of this part, e.g. §§ 15.231 and 15.241.

## **TEST PROCEDURE**

The EUT is placed on a non-conducting table 80 cm above the ground plane for below 1GHz and 150 cm for above 1GHz. The antenna to EUT distance is 3 meters. The EUT is configured in accordance with ANSI C63.10. The EUT is set to transmit in a continuous mode.

For measurements below 1 GHz the resolution bandwidth is set to 100 kHz for peak detection measurements or 120 kHz for quasi-peak detection measurements. Peak detection is used unless otherwise noted as quasi-peak.

For measurements above 1 GHz the resolution bandwidth is set to 1 MHz; the video bandwidth is set to 3 MHz for peak measurements and add duty cycle factor for average measurements. (Restricted bandedge, Final detection of spurious harmonic emissions)  
Duty cycle factor=  $10\log(1/x)$  For this sample B mode = 0dB (duty cycle >98%); G mode = 0dB (duty cycle >98%); N mode = 0dB (duty cycle >98%).

Pre-scans to detect harmonic and spurious emissions, the resolution bandwidth is set to 1 MHz; the video bandwidth is set to 30 KHz for peak measurements.

The spectrum from 1 GHz to 26 GHz is investigated with the transmitter set to the lowest, middle, and highest channels in each applicable band.  
(From 30MHz to 1GHz, test was performed with the EUT set to transmit at the channel with highest output power)

The frequency range of interest is monitored at a fixed antenna height and EUT azimuth. The EUT is rotated through 360 degrees to maximize emissions received. The antenna is scanned from 1 to 4 meters above the ground plane to further maximize the emission. Measurements are made with the antenna polarized in both the vertical and the horizontal positions.

## 11.2. TRANSMITTER ABOVE 1 GHz

### 11.2.1.TX ABOVE 1 GHz 802.11b MODE IN THE 2.4 GHz BAND

#### RESTRICTED BANDEDGE (1 CHANNEL)

#### HORIZONTAL PEAK AND AVERAGE PLOT

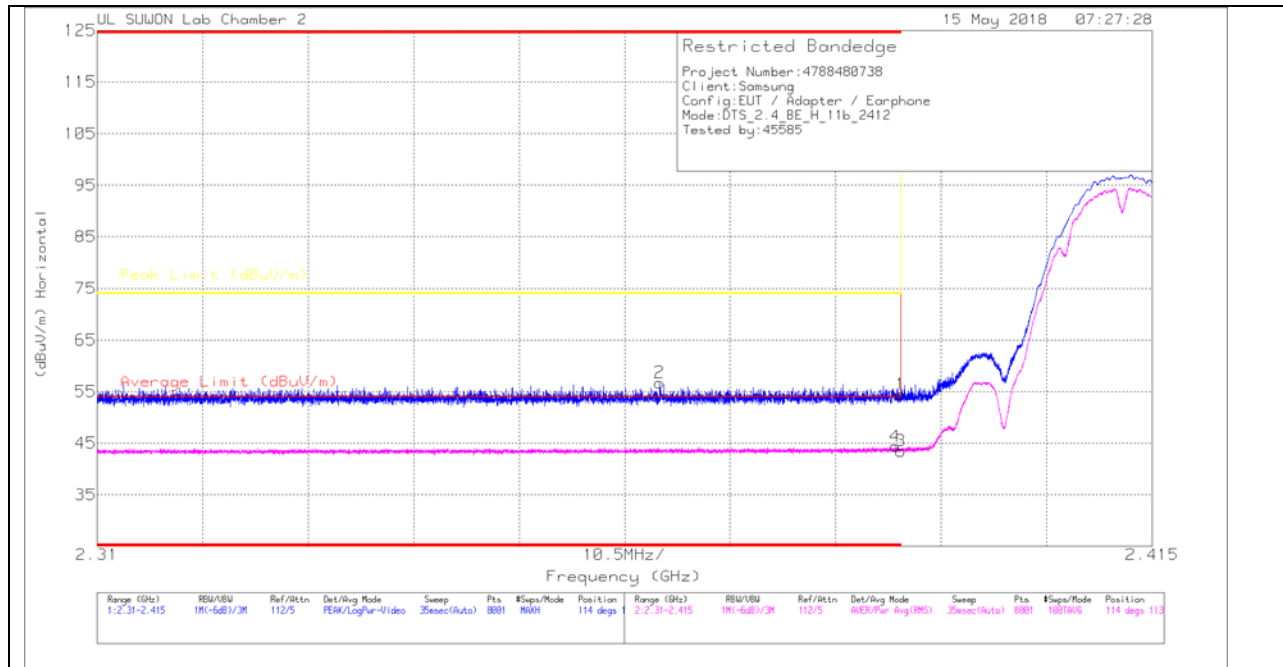

#### HORIZONTAL DATA

##### Trace Markers

Marker	Frequency (GHz)	Meter Reading (dBuV)	Det	1705311_3117(00168724)	10dB(dB)	DC Corr (dB)	Corrected Reading (dBuV/m)	Average Limit (dBuV/m)	Margin (dB)	Peak Limit (dBuV/m)	Pk Margin (dB)	Azimuth (Degs)	Height (cm)	Polarity
1	* 2.39	41.41	Pk	31.3	-18.2	0	54.51	-	-	74	-19.49	114	113	H
2	* 2.366	43.83	Pk	31.2	-18.3	0	56.73	-	-	74	-17.27	114	113	H
3	* 2.39	30.4	RMS	31.3	-18.2	0	43.5	54	-10.5	-	-	114	113	H
4	* 2.389	31.27	RMS	31.3	-18.2	0	44.37	54	-9.63	-	-	114	113	H

\* - indicates frequency in CFR47 Pt 15 / IC RSS-Restricted Band

Pk - Peak detector

RMS - RMS detection

**VERTICAL PEAK AND AVERAGE PLOT**

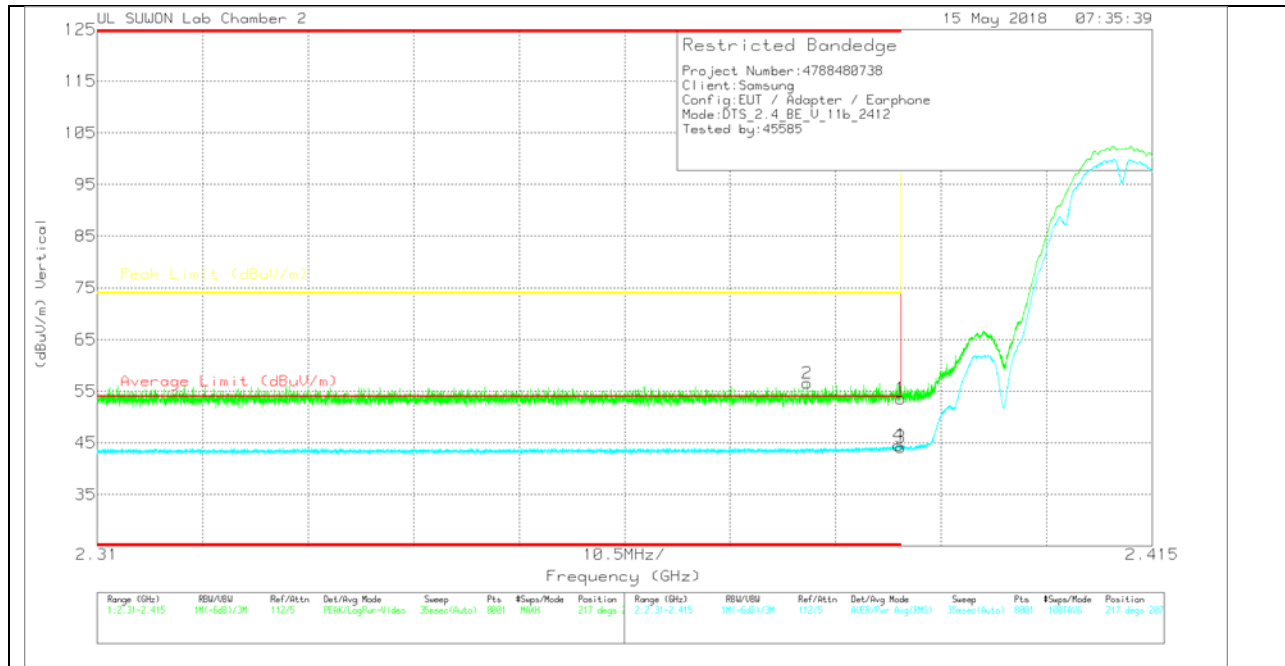

**VERTICAL DATA**

**Trace Markers**

Marker	Frequency (GHz)	Meter Reading (dBuV)	Det	170531_3117(00168724)	10dB(dB)	DC Corr (dB)	Corrected Reading (dBuV/m)	Average Limit (dBuV/m)	Margin (dB)	Peak Limit (dBuV/m)	Pk Margin (dB)	Azimuth (Degs)	Height (cm)	Polarity
1	* 2.39	40.5	Pk	31.3	-18.2	0	53.6	-	-	74	-20.4	217	207	V
2	* 2.381	43.54	Pk	31.3	-18.3	0	56.54	-	-	74	-17.46	217	207	V
3	* 2.39	31.07	RMS	31.3	-18.2	0	44.17	54	-9.83	-	-	217	207	V
4	* 2.39	31.45	RMS	31.3	-18.2	0	44.55	54	-9.45	-	-	217	207	V

\* - indicates frequency in CFR47 Pt 15 / IC RSS-Restricted Band

Pk - Peak detector

RMS - RMS detection

**AUTHORIZED BANDEDGE (11 CHANNEL)**

**HORIZONTAL PEAK AND AVERAGE PLOT**

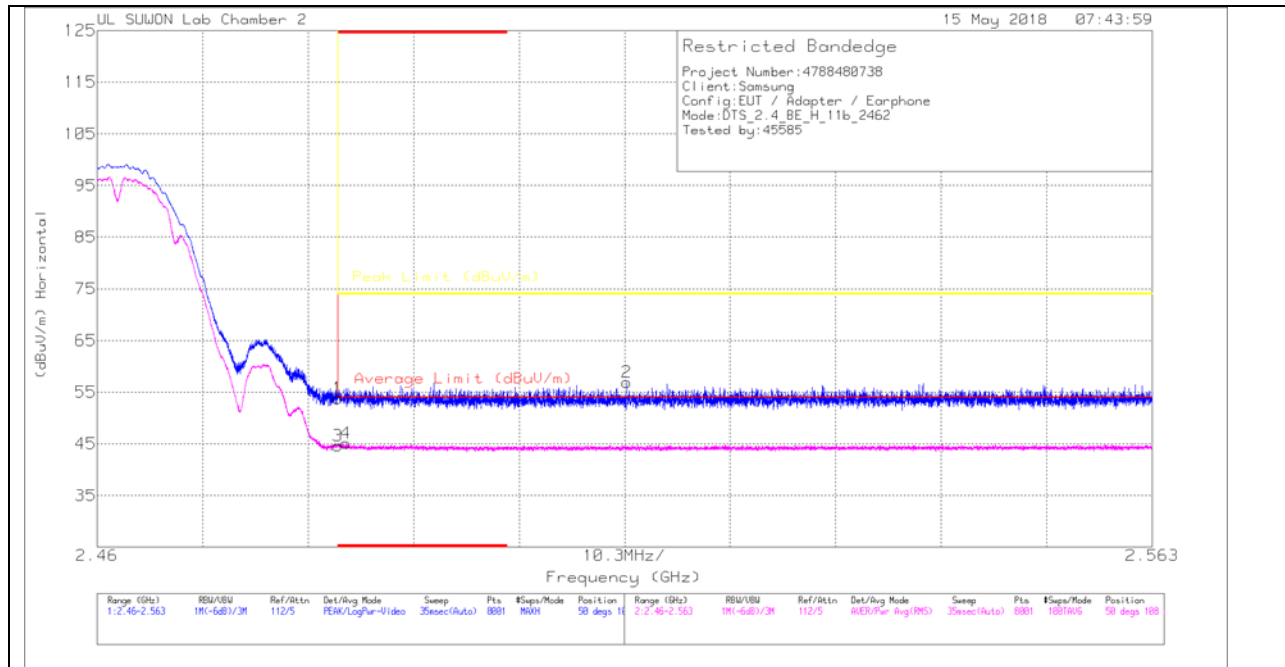

**HORIZONTAL DATA**

Trace Markers

Marker	Frequency (GHz)	Meter Reading (dBuV)	Det	170531_311700168724	10dB(dB)	DC Corr (dB)	Corrected Reading (dBuV/m)	Average Limit (dBuV/m)	Margin (dB)	Peak Limit (dBuV/m)	PK Margin (dB)	Azimuth (Degs)	Height (cm)	Polarity
1	* 2.484	40.24	Pk		31.6	-18	53.84	-	-	74	-20.16	50	108	H
2	2.512	43.3	Pk		31.6	-18	56.9	-	-	74	-17.1	50	108	H
3	* 2.484	31.01	RMS		31.6	-18	44.61	54	-9.39	-	-	50	108	H
4	* 2.484	31.51	RMS		31.6	-18	45.11	54	-8.89	-	-	50	108	H

\* - indicates frequency in CFR47 Pt 15 / IC RSS-Restricted Band

Pk - Peak detector

RMS - RMS detection



**VERTICAL PEAK AND AVERAGE PLOT**

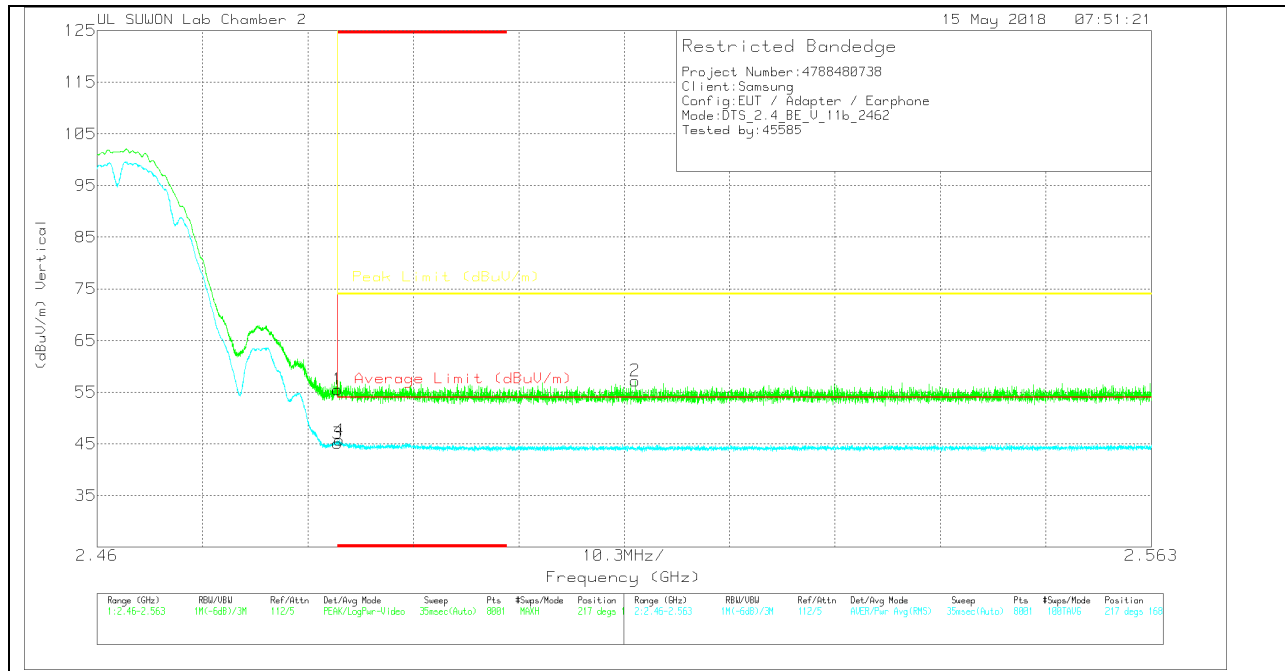

**VERTICAL DATA**

**Trace Markers**

Marker	Frequency (GHz)	Meter Reading (dBuV)	Det	170531_3117(00168724)	10dB(dB)	DC Corr (dB)	Corrected Reading (dBuV/m)	Average Limit (dBuV/m)	Margin (dB)	Peak Limit (dBuV/m)	PK Margin (dB)	Azimuth (Degs)	Height (cm)	Polarity
1	* 2.484	41.93	Pk		-18	0	55.53	-	-	74	-18.47	217	168	V
2	2.513	43.61	Pk		-18	0	57.21	-	-	74	-16.79	217	168	V
3	* 2.484	31.53	RMS		-18	0	45.13	54	-8.87	-	-	217	168	V
4	* 2.484	32.11	RMS		-18	0	45.71	54	-8.29	-	-	217	168	V

\* - indicates frequency in CFR47 Pt 15 / IC RSS-Restricted Band

Pk - Peak detector

RMS - RMS detection

**AUTHORIZED BANDEDGE (12 CHANNEL)**

**HORIZONTAL PEAK AND AVERAGE PLOT**

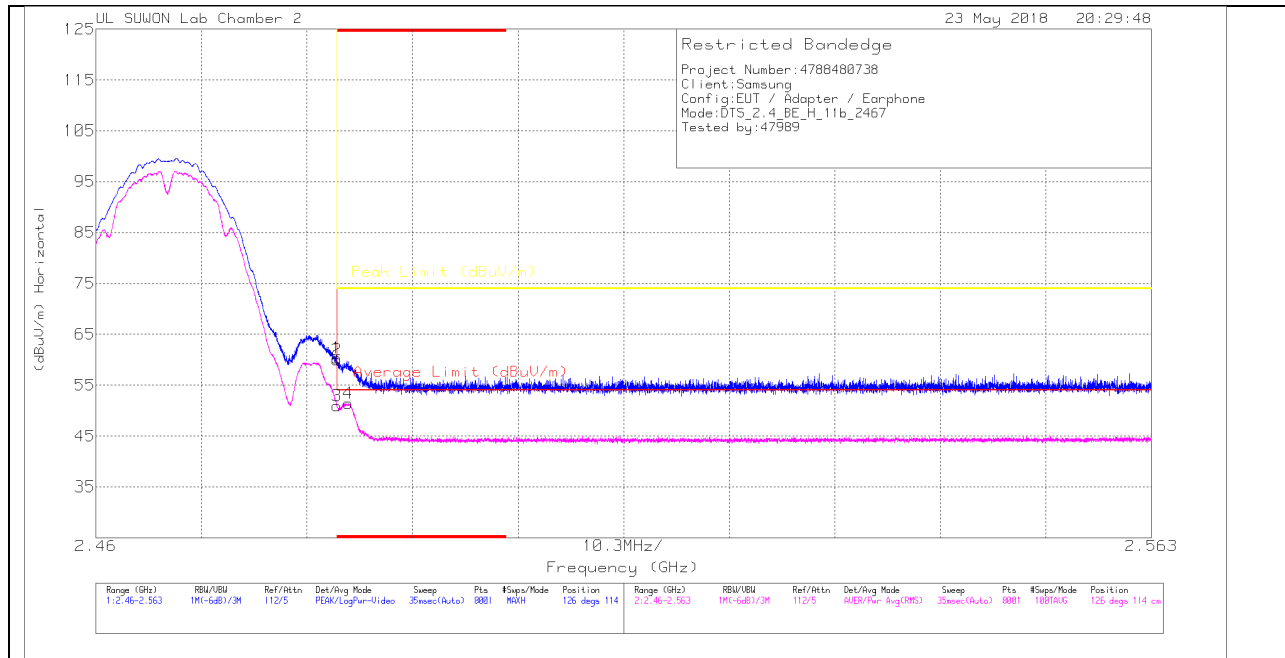

**HORIZONTAL DATA**

**Trace Markers**

Marker	Frequency (GHz)	Meter Reading (dBuV)	Det	170531_3117(00168724)	10dB(dB)	DC Corr (dB)	Corrected Reading (dBuV/m)	Average Limit (dBuV/m)	Margin (dB)	Peak Limit (dBuV/m)	PK Margin (dB)	Azimuth (Degs)	Height (cm)	Polarity
1	* 2.484	46.79	Pk	31.6	-18	0	60.39	-	-	74	-13.61	126	114	H
2	* 2.484	46.32	Pk	31.6	-18	0	59.92	-	-	74	-14.08	126	114	H
3	* 2.484	37.33	RMS	31.6	-18	0	50.93	54	-3.07	-	-	126	114	H
4	* 2.485	37.89	RMS	31.6	-18	0	51.49	54	-2.51	-	-	126	114	H

\* - indicates frequency in CFR47 Pt 15 / IC RSS-Restricted Band

Pk - Peak detector

RMS - RMS detection

**VERTICAL PEAK AND AVERAGE PLOT**

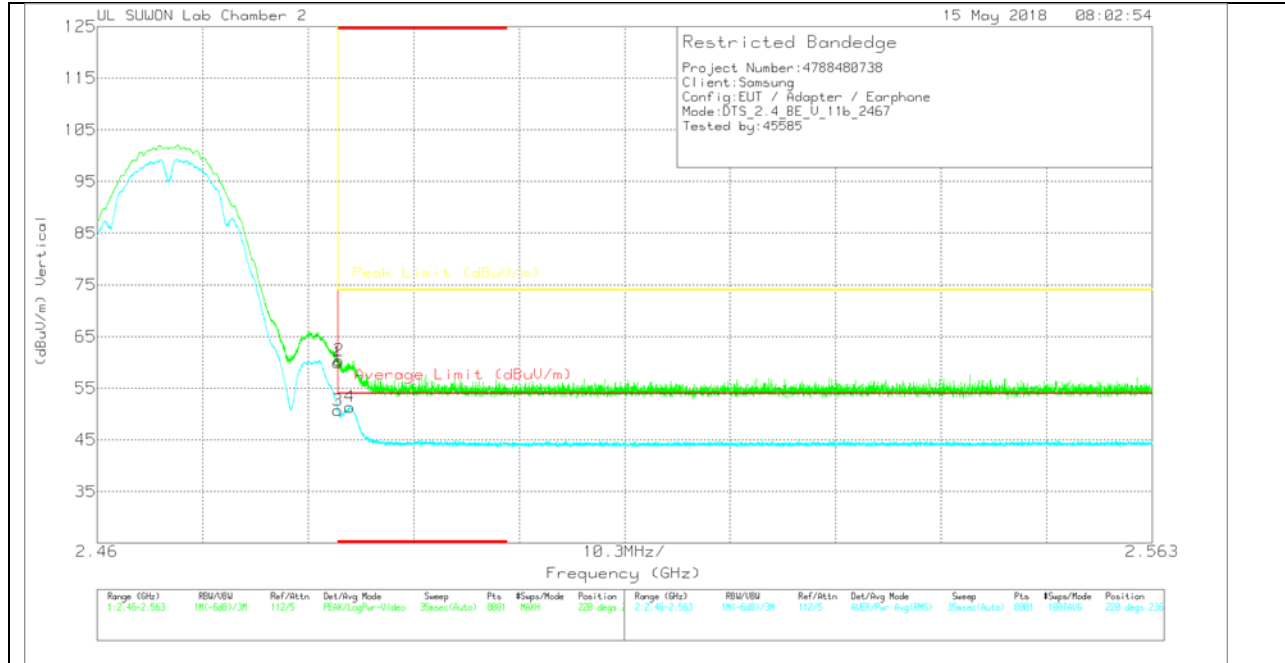

**VERTICAL DATA**

**Trace Markers**

Marker	Frequency (GHz)	Meter Reading (dBuV)	Det	170531_3117(00168724)	10dB(dB)	DC Corr (dB)	Corrected Reading (dBuV/m)	Average Limit (dBuV/m)	Margin (dB)	Peak Limit (dBuV/m)	Pk Margin (dB)	Azimuth (Degs)	Height (cm)	Polarity
1	* 2.484	46.38	Pk		-18	0	59.98	-	-	74	-14.02	220	236	V
2	* 2.484	46.77	Pk		-18	0	60.37	-	-	74	-13.63	220	236	V
3	* 2.484	37.12	RMS		-18	0	50.72	54	-3.28	-	-	220	236	V
4	* 2.485	37.79	RMS		-18	0	51.39	54	-2.61	-	-	220	236	V

\* - indicates frequency in CFR47 Pt 15 / IC RSS-Restricted Band

Pk - Peak detector

RMS - RMS detection

**AUTHORIZED BANDEDGE (13 CHANNEL)**

**HORIZONTAL PEAK AND AVERAGE PLOT**

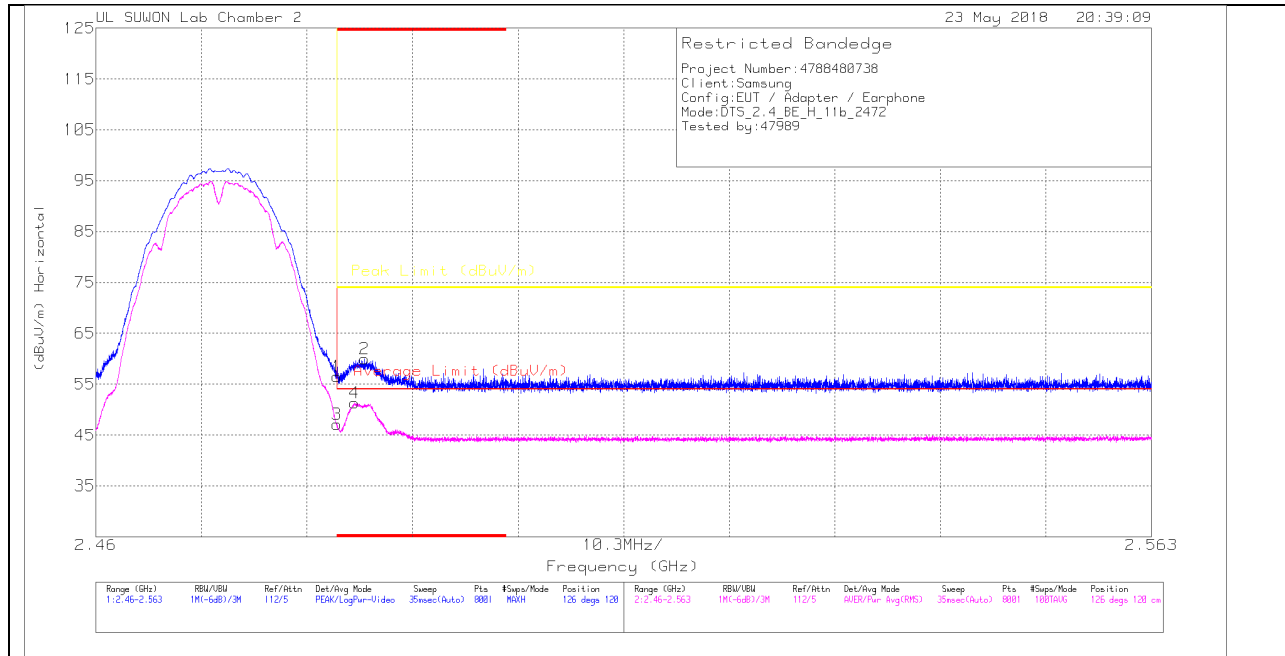

**HORIZONTAL DATA**

**Trace Markers**

Marker	Frequency (GHz)	Meter Reading (dBuV)	Det	170531_3117(00168724)	10dB(dB)	DC Corr (dB)	Corrected Reading (dBuV/m)	Average Limit (dBuV/m)	Margin (dB)	Peak Limit (dBuV/m)	PK Margin (dB)	Azimuth (Degs)	Height (cm)	Polarity	
1	* 2.484	42.86	Pk		31.6	-18	0	56.46	-	-	74	-17.54	126	120	H
2	* 2.486	46.35	Pk		31.6	-18	0	59.95	-	-	74	-14.05	126	120	H
3	* 2.484	33.46	RMS		31.6	-18	0	47.06	54	-6.94	-	-	126	120	H
4	* 2.485	37.75	RMS		31.6	-18	0	51.35	54	-2.65	-	-	126	120	H

\* - indicates frequency in CFR47 Pt 15 / IC RSS-Restricted Band

Pk - Peak detector

RMS - RMS detection

**VERTICAL PEAK AND AVERAGE PLOT**

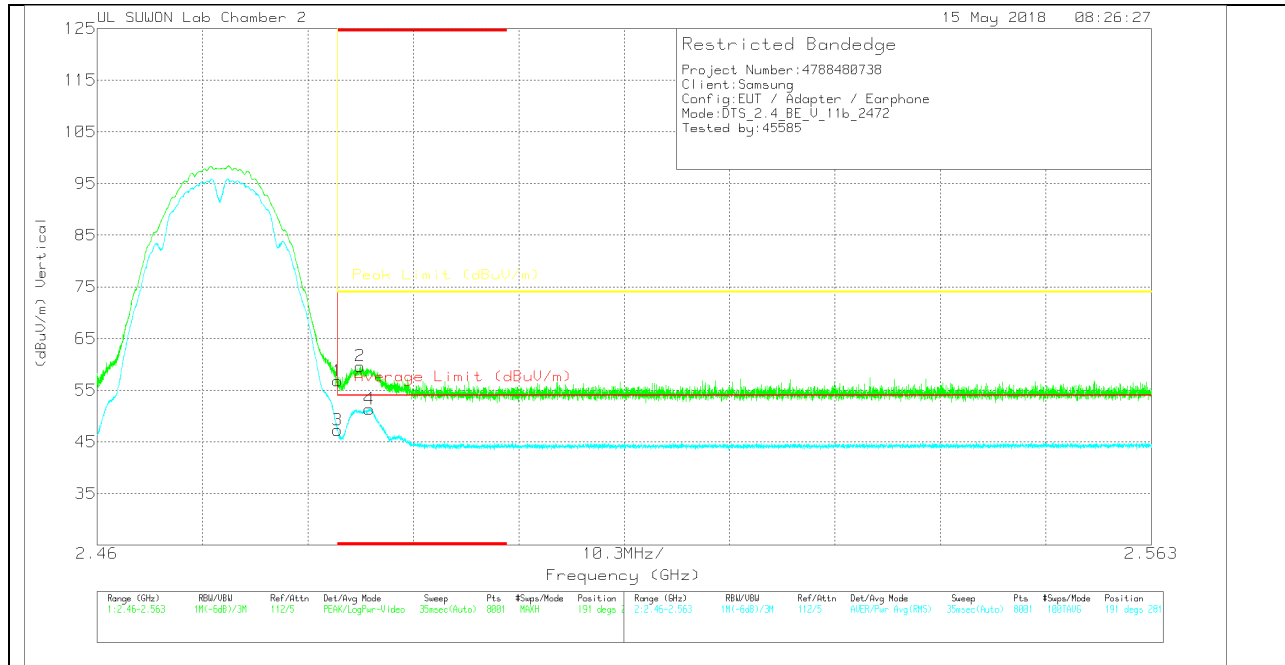

**VERTICAL DATA**

**Trace Markers**

Marker	Frequency (GHz)	Meter Reading (dBuV)	Det	170531_311700158724	10dB(dB)	DC Corr (dB)	Corrected Reading (dBuV/m)	Average Limit (dBuV/m)	Margin (dB)	Peak Limit (dBuV/m)	PK Margin (dB)	Azimuth (Degs)	Height (cm)	Polarity
1	* 2.484	43.22	Pk		31.6	-18	56.82	-	-	74	-17.18	191	281	V
2	* 2.486	46.07	Pk		31.6	-18	59.67	-	-	74	-14.33	191	281	V
3	* 2.484	33.68	RMS		31.6	-18	47.28	54	-6.72	-	-	191	281	V
4	* 2.487	37.77	RMS		31.6	-18	51.37	54	-2.63	-	-	191	281	V

\* - indicates frequency in CFR47 Pt 15 / IC RSS-Restricted Band

Pk - Peak detector

RMS - RMS detection

### HARMONICS AND SPURIOUS EMISSIONS

#### 1 CHANNEL HORIZONTAL

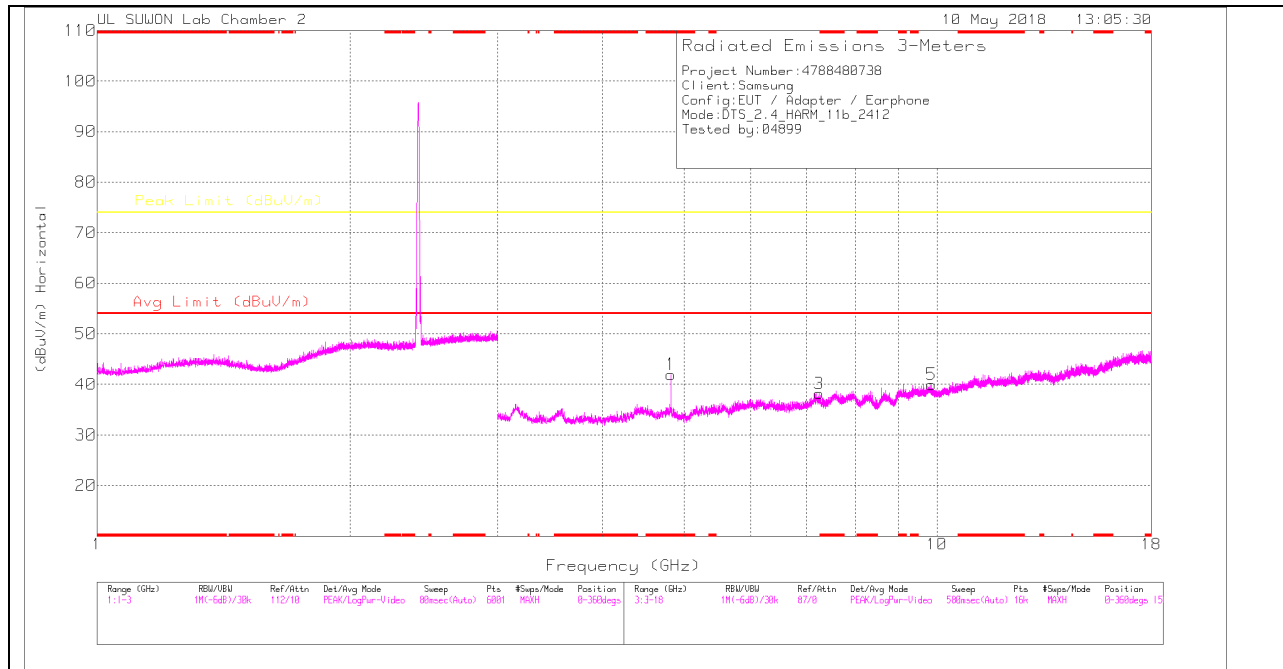

#### 1 CHANNEL VERTICAL

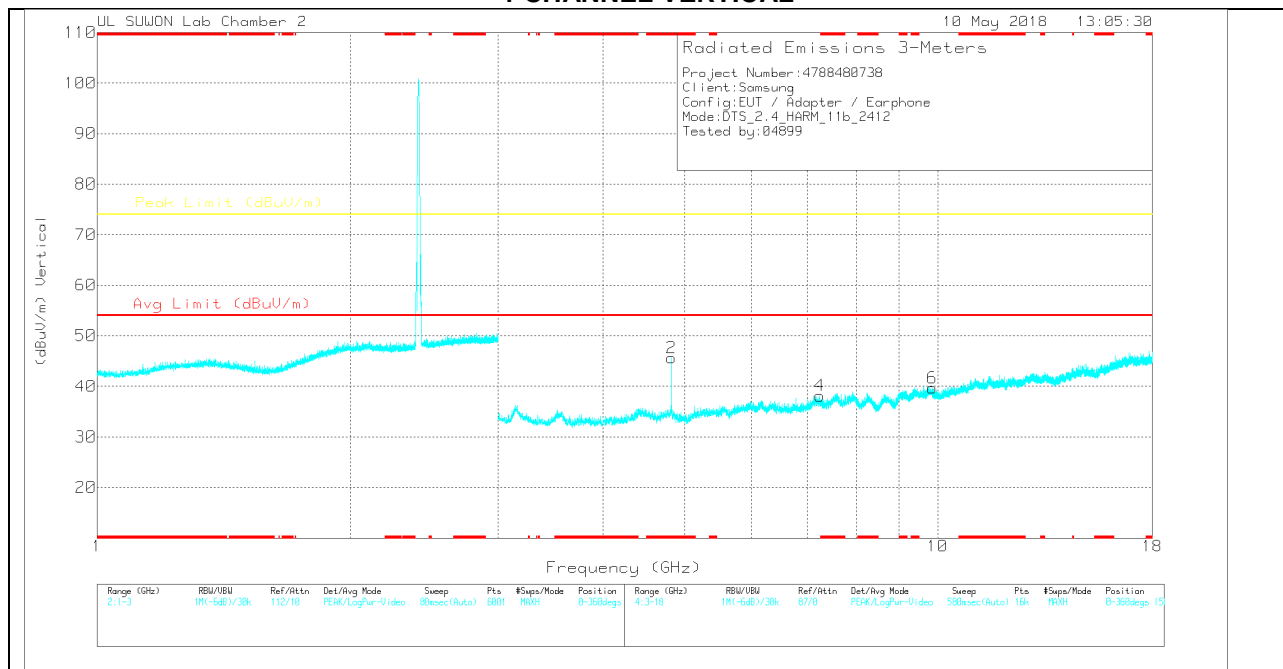

Note: Emission was scanned up to 26GHz; No emissions were detected above the noise floor which was at least 20dB below the specification limit.

**1 CHANNEL DATA**

Trace Markers

Marker	Frequency (GHz)	Meter Reading (dBuV)	Det	170531_3117[00168724]	3GHz_HP[dB]	DC Corr (dB)	Corrected Reading (dBuV/m)	Avg Limit (dBuV/m)	Margin (dB)	Peak Limit (dBuV/m)	Margin (dB)	Azimuth (Degs)	Height (cm)	Polarity	
1	* 4.823	32.45	PK		33.8	-24.3	0	41.95	-	-	74	-32.05	0-360	250	H
3	7.237	24.29	PK		35.9	-22	0	38.19	-	-	74	-35.81	0-360	250	H
5	9.848	20.84	PK		37	-17.9	0	39.94	-	-	74	-34.06	0-360	150	H
2	* 4.823	36.12	PK		33.8	-24.3	0	45.62	-	-	74	-28.38	0-360	250	V
4	7.237	24.24	PK		35.9	-22	0	38.14	-	-	74	-35.86	0-360	150	V
6	9.849	20.55	PK		37	-17.9	0	39.65	-	-	74	-34.35	0-360	150	V

\* - indicates frequency in CFR47 Pt 15 / IC RSS-Restricted Band  
 PK – Peak detector

Radiated Emissions

Frequency (GHz)	Meter Reading (dBuV)	Det	170531_3117[00168724]	3GHz_HP[dB]	DC Corr (dB)	Corrected Reading (dBuV/m)	Avg Limit (dBuV/m)	Margin (dB)	Peak Limit (dBuV/m)	Margin (dB)	Azimuth (Degs)	Height (cm)	Polarity	
* 4.824	37.63	PK2		33.8	-24.3	0	47.13	-	-	74	-26.87	29	109	H
* 4.824	31.63	MAv1		33.8	-24.3	0	41.13	54	-12.87	-	-	29	109	H
* 4.824	39.84	PK2		33.8	-24.3	0	49.34	-	-	74	-24.66	19	369	V
* 4.824	35.27	MAv1		33.8	-24.3	0	44.77	54	-9.23	-	-	19	369	V

\* - indicates frequency in CFR47 Pt 15 / IC RSS-Restricted Band  
 PK2 - KDB558074 Method: Maximum Peak  
 MAv1 - KDB558074 Option 1 Maximum RMS Average

6 CHANNEL HORIZONTAL

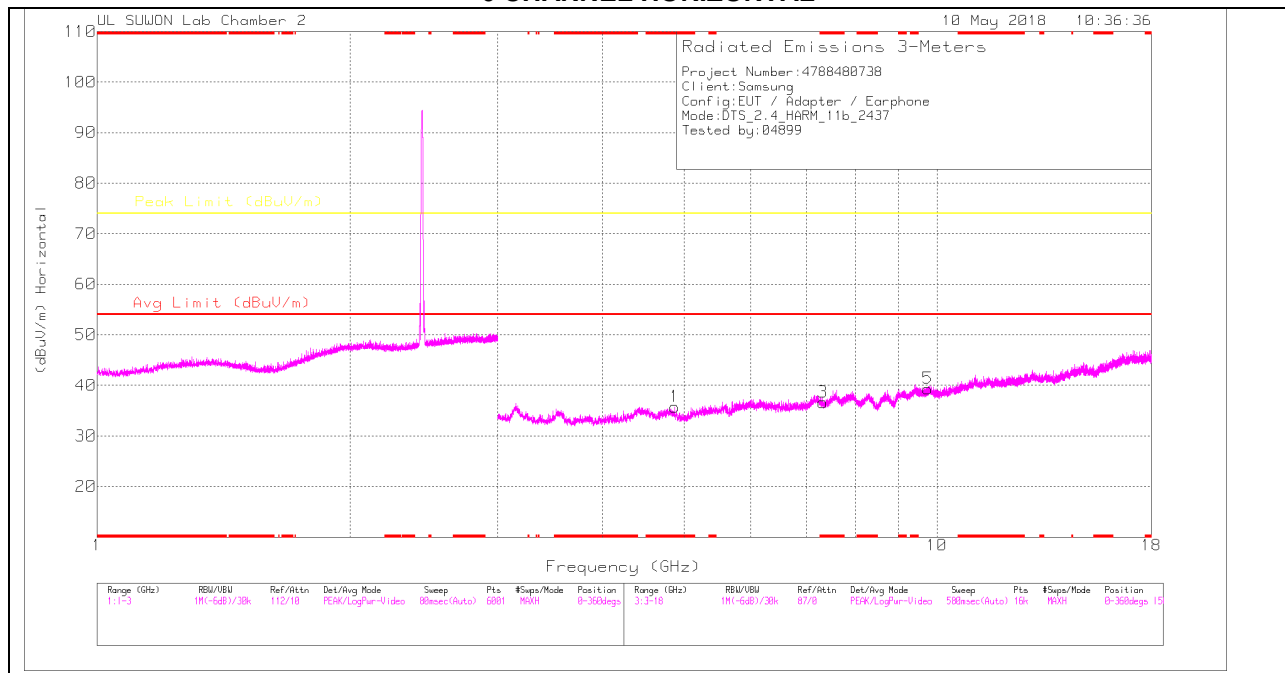

6 CHANNEL VERTICAL

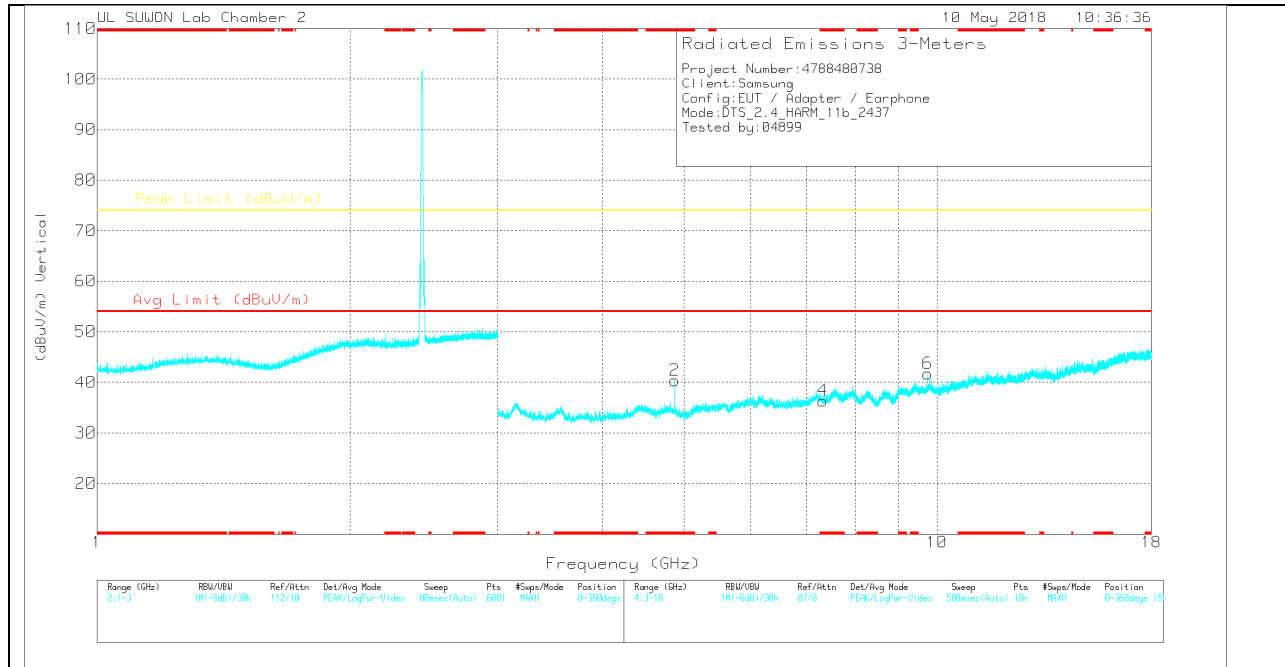

Note: Emission was scanned up to 26GHz; No emissions were detected above the noise floor which was at least 20dB below the specification limit.



**6 CHANNEL DATA**

Trace Markers

Marker	Frequency (GHz)	Meter Reading (dBuV)	Det	170531_3117[0168724]	3GHz_HP[dB]	DC Corr (dB)	Corrected Reading (dBuV/m)	Avg Limit (dBuV/m)	Margin (dB)	Peak Limit (dBuV/m)	Margin (dB)	Azimuth (Degs)	Height (cm)	Polarity	
1	* 4.874	26.46	PK		33.8	-24.5	0	35.76	-	-	74	-38.24	0-360	250	H
3	* 7.311	22.74	PK		35.9	-22	0	36.64	-	-	74	-37.36	0-360	250	H
5	9.748	20.56	PK		36.9	-18.1	0	39.36	-	-	74	-34.64	0-360	150	H
2	* 4.873	31.08	PK		33.8	-24.5	0	40.38	-	-	74	-33.62	0-360	250	V
4	* 7.311	22.46	PK		35.9	-22	0	36.36	-	-	74	-37.64	0-360	150	V
6	9.748	22.93	PK		36.9	-18.1	0	41.73	-	-	74	-32.27	0-360	250	V

\* - indicates frequency in CFR47 Pt 15 / IC RSS-Restricted Band  
 PK – Peak Detector

Radiated Emissions

Frequency (GHz)	Meter Reading (dBuV)	Det	170531_3117[0168724]	3GHz_HP[dB]	DC Corr (dB)	Corrected Reading (dBuV/m)	Avg Limit (dBuV/m)	Margin (dB)	Peak Limit (dBuV/m)	Margin (dB)	Azimuth (Degs)	Height (cm)	Polarity	
* 4.874	38.64	PK2		33.8	-24.5	0	47.94	-	-	74	-26.06	237	349	V
* 4.874	32.94	MAv1		33.8	-24.5	0	42.24	54	-11.76	-	-	237	349	V
9.748	29.15	PK2		36.9	-18.1	0	47.95	-	-	74	-26.05	171	123	V

\* - indicates frequency in CFR47 Pt 15 / IC RSS-Restricted Band  
 PK2 - KDB558074 Method: Maximum Peak  
 MAv1 - KDB558074 Option 1 Maximum RMS Average

11 CHANNEL HORIZONTAL

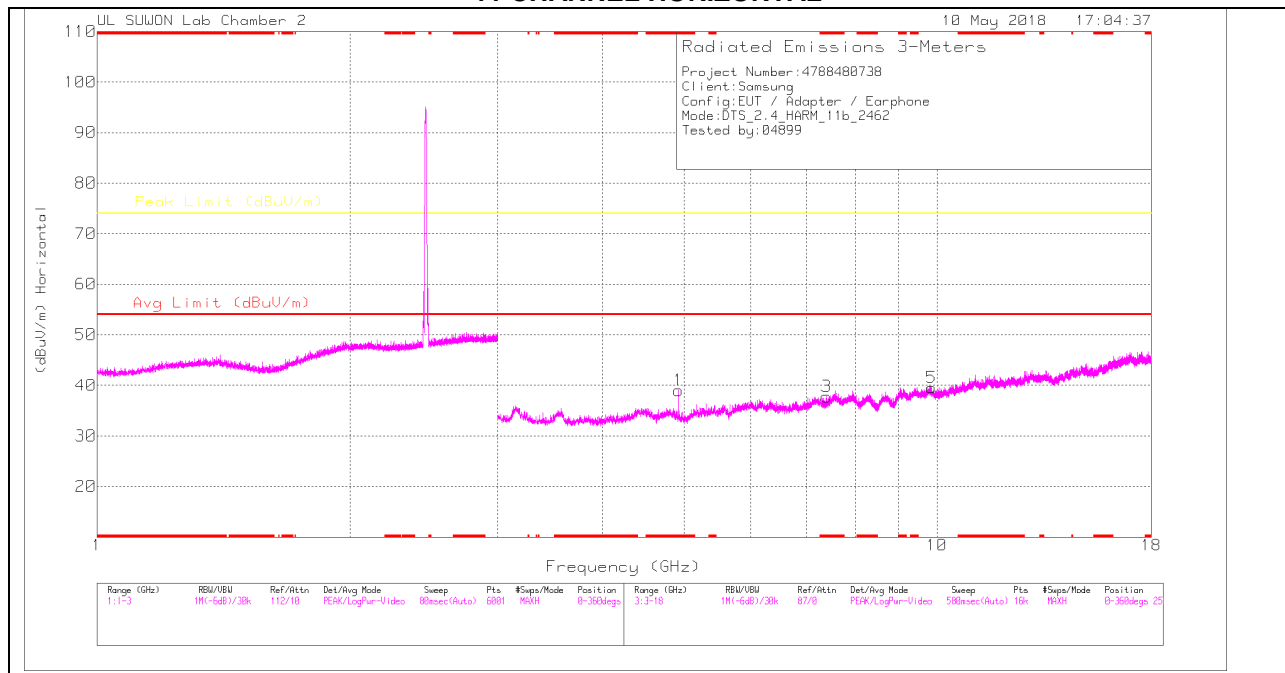

11 CHANNEL VERTICAL

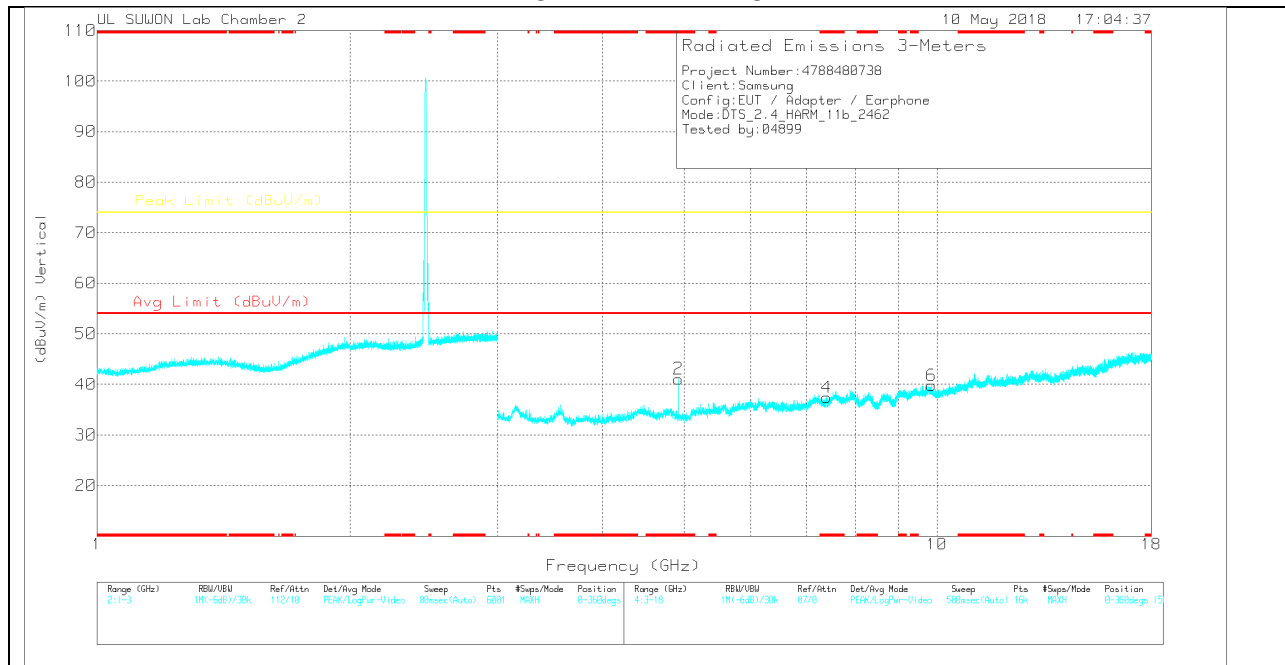

Note: Emission was scanned up to 26GHz; No emissions were detected above the noise floor which was at least 20dB below the specification limit.

**11 CHANNEL DATA**

**Trace Markers**

Marker	Frequency (GHz)	Meter Reading (dBuV)	Det	170531_3117[0168724]	3GHz_HP[dB]	DC Corr (dB)	Corrected Reading (dBuV/m)	Avg Limit (dBuV/m)	Margin (dB)	Peak Limit (dBuV/m)	Margin (dB)	Azimuth (Degs)	Height (cm)	Polarity
1	* 4.924	29.9	PK	33.8	-24.7	0	39	-	-	74	-35	0-360	150	H
3	* 7.386	23.26	PK	35.9	-21.4	0	37.76	-	-	74	-36.24	0-360	250	H
5	9.852	20.42	PK	37	-17.9	0	39.52	-	-	74	-34.48	0-360	150	H
2	* 4.924	31.98	PK	33.8	-24.7	0	41.08	-	-	74	-32.92	0-360	150	V
4	* 7.39	22.83	PK	35.9	-21.3	0	37.43	-	-	74	-36.57	0-360	150	V
6	9.848	20.69	PK	37	-17.9	0	39.79	-	-	74	-34.21	0-360	250	V

\* - indicates frequency in CFR47 Pt 15 / IC RSS-Restricted Band  
 PK – Peak detector

**Radiated Emissions**

Frequency (GHz)	Meter Reading (dBuV)	Det	170531_3117[0168724]	3GHz_HP[dB]	DC Corr (dB)	Corrected Reading (dBuV/m)	Avg Limit (dBuV/m)	Margin (dB)	Peak Limit (dBuV/m)	Margin (dB)	Azimuth (Degs)	Height (cm)	Polarity
* 4.924	36.94	PK2	33.8	-24.7	0	46.04	-	-	74	-27.96	30	100	H
* 4.924	30.52	MAv1	33.8	-24.7	0	39.62	54	-14.38	-	-	30	100	H
* 4.924	38.1	PK2	33.8	-24.7	0	47.2	-	-	74	-26.8	11	395	V
* 4.924	32.59	MAv1	33.8	-24.7	0	41.69	54	-12.31	-	-	11	395	V

\* - indicates frequency in CFR47 Pt 15 / IC RSS-Restricted Band  
 PK2 - KDB558074 Method: Maximum Peak  
 MAv1 - KDB558074 Option 1 Maximum RMS Average

### 11.2.2.TX ABOVE 1 GHz 802.11g MODE IN THE 2.4 GHz BAND

### RESTRICTED BANDEDGE (1 CHANNEL)

### HORIZONTAL PEAK AND AVERAGE PLOT

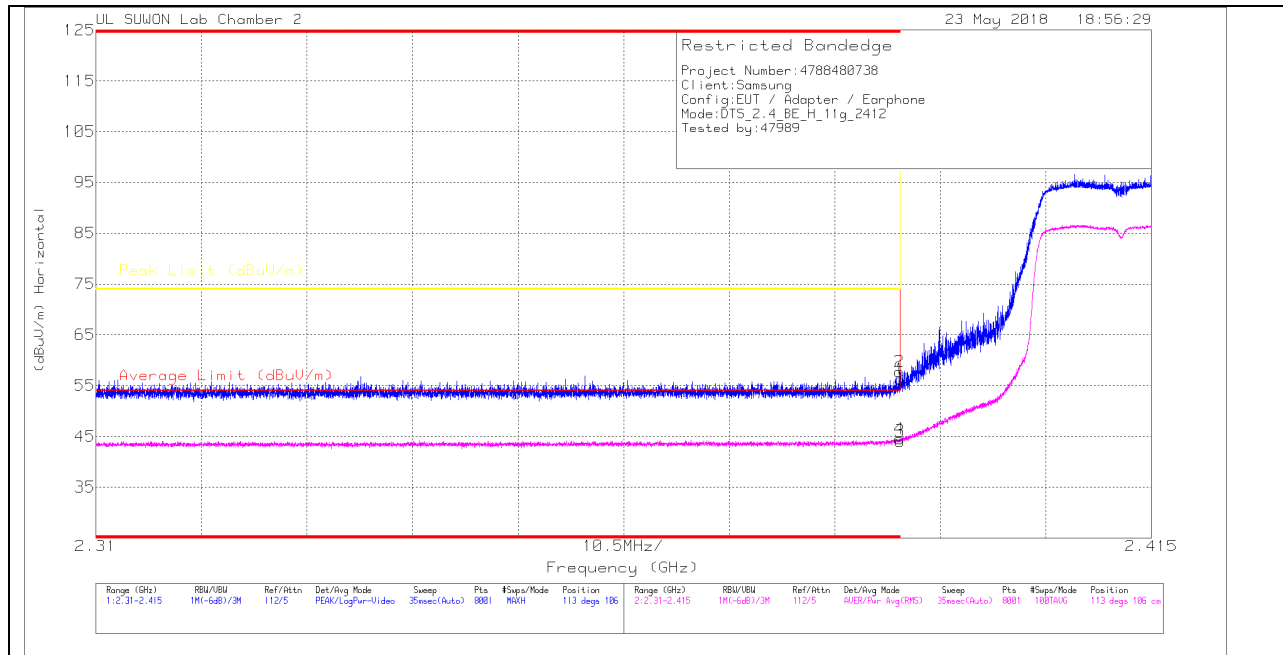

### HORIZONTAL DATA

#### Trace Markers

Marker	Frequency (GHz)	Meter Reading (dBuV)	Det	170531_3117(00168724)	10dB(dB)	DC Corr (dB)	Corrected Reading (dBuV/m)	Average Limit (dBuV/m)	Margin (dB)	Peak Limit (dBuV/m)	PK Margin (dB)	Azimuth (Degs)	Height (cm)	Polarity
1	* 2.39	43.19	PK	31.3	-18.2	0	56.29	-	-	74	-17.71	113	106	H
2	* 2.39	44.6	PK	31.3	-18.2	0	57.7	-	-	74	-16.3	113	106	H
3	* 2.39	30.98	RMS	31.3	-18.2	0	44.08	54	-9.92	-	-	113	106	H
4	* 2.39	31.37	RMS	31.3	-18.2	0	44.47	54	-9.53	-	-	113	106	H

\* - indicates frequency in CFR47 Pt 15 / IC RSS-Restricted Band

PK - Peak detector

RMS - RMS detection

**VERTICAL PEAK AND AVERAGE PLOT**

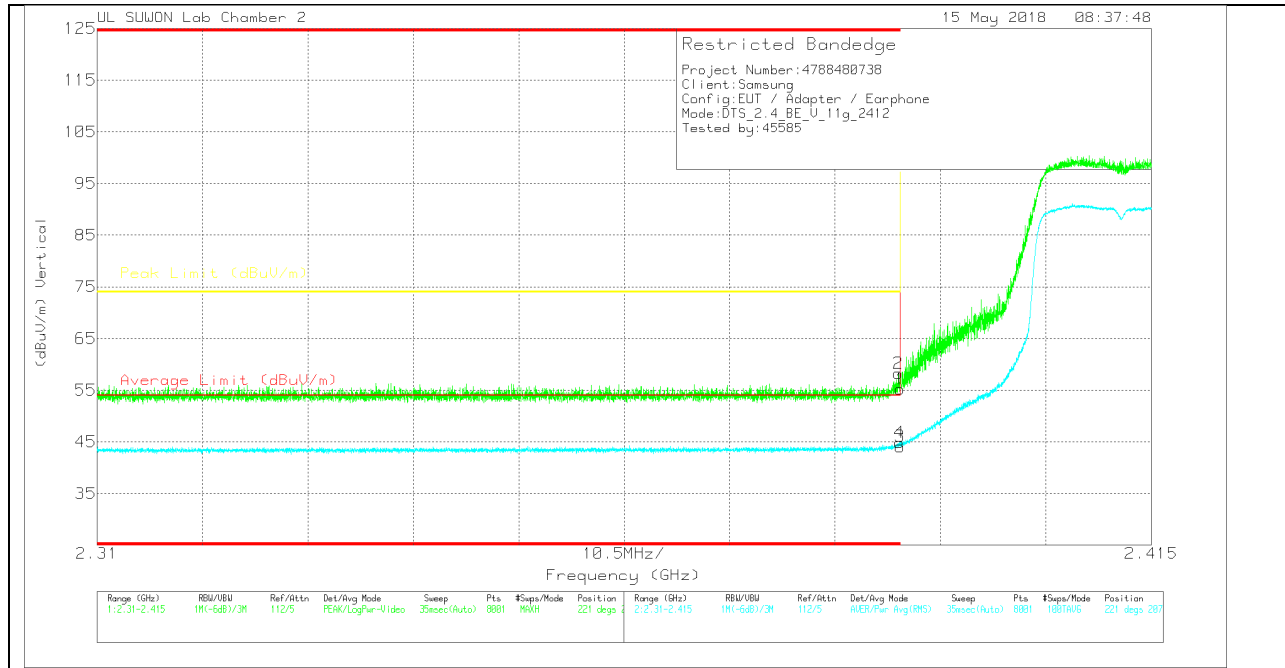

**VERTICAL DATA**

**Trace Markers**

Marker	Frequency (GHz)	Meter Reading (dBuV)	Det	170531_3117(00168724)	10dB(dB)	DC Corr (dB)	Corrected Reading (dBuV/m)	Average Limit (dBuV/m)	Margin (dB)	Peak Limit (dBuV/m)	PK Margin (dB)	Azimuth (Degs)	Height (cm)	Polarity
1	* 2.39	42.13	Pk	31.3	-18.2	0	55.23	-	-	74	-18.77	221	207	V
2	* 2.39	45.14	Pk	31.3	-18.2	0	58.24	-	-	74	-15.76	221	207	V
3	* 2.39	31.01	RMS	31.3	-18.2	0	44.11	54	-9.89	-	-	221	207	V
4	* 2.39	31.79	RMS	31.3	-18.2	0	44.89	54	-9.11	-	-	221	207	V

\* - indicates frequency in CFR47 Pt 15 / IC RSS-Restricted Band

Pk - Peak detector

RMS - RMS detection

**HORIZONTAL PEAK AND AVERAGE PLOT**

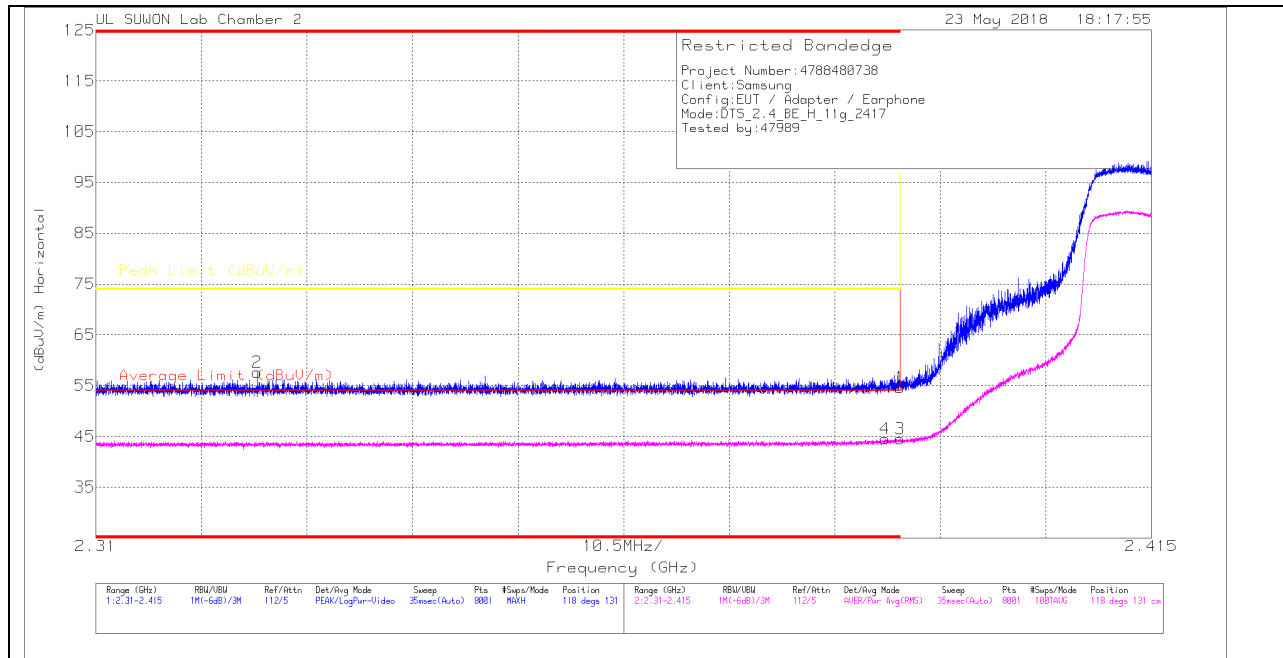

**HORIZONTAL DATA**

Trace Markers

Marker	Frequency (GHz)	Meter Reading (dBuV)	Det	170531_3117(00168724)	10dB(dB)	DC Corr (dB)	Corrected Reading (dBuV/m)	Average Limit (dBuV/m)	Margin (dB)	Peak Limit (dBuV/m)	PK Margin (dB)	Azimuth (Degs)	Height (cm)	Polarity
1	* 2.39	41.54	Pk	31.3	-18.2	0	54.64	-	-	74	-19.36	118	131	H
2	* 2.326	44.81	Pk	31.2	-18.4	0	57.61	-	-	74	-16.39	118	131	H
3	* 2.39	31.41	RMS	31.3	-18.2	0	44.51	54	-9.49	-	-	118	131	H
4	* 2.388	31.45	RMS	31.3	-18.2	0	44.55	54	-9.45	-	-	118	131	H

\* - indicates frequency in CFR47 Pt 15 / IC RSS-Restricted Band

Pk - Peak detector

RMS - RMS detection

**VERTICAL PEAK AND AVERAGE PLOT**

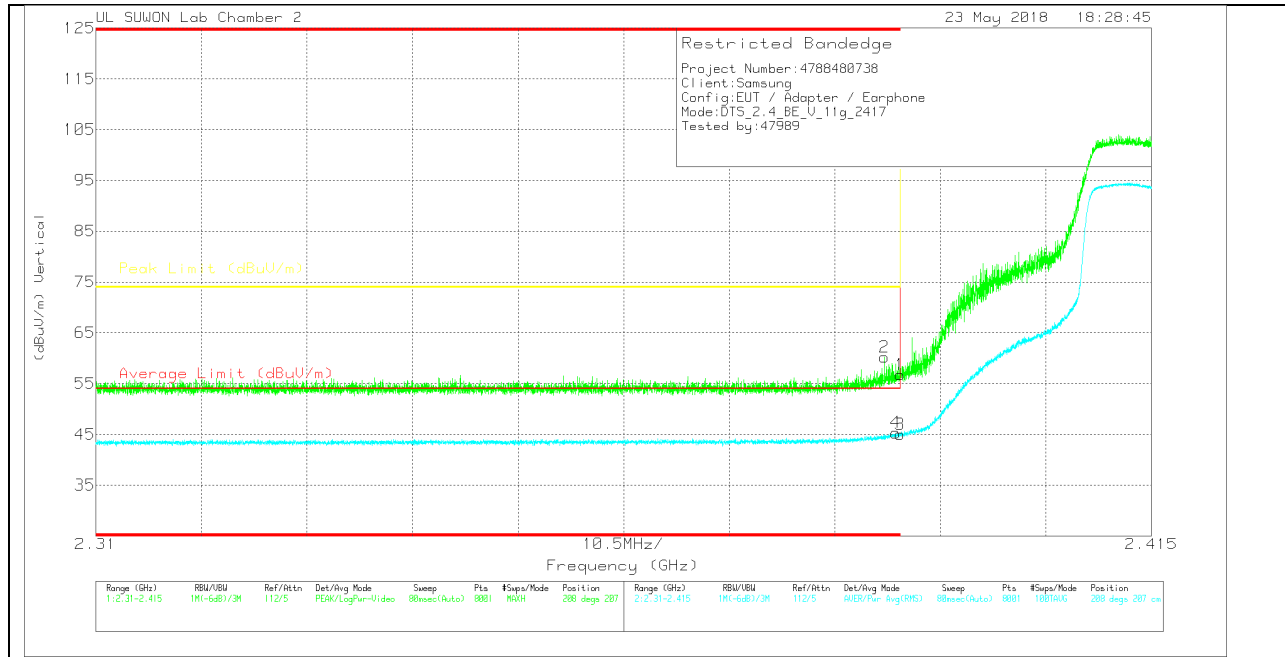

**VERTICAL DATA**

**Trace Markers**

Marker	Frequency (GHz)	Meter Reading (dBuV)	Det	170531_311700168724	10dB(dB)	DC Corr (dB)	Corrected Reading (dBuV/m)	Average Limit (dBuV/m)	Margin (dB)	Peak Limit (dBuV/m)	Pk Margin (dB)	Azimuth (Degs)	Height (cm)	Polarity
1	* 2.39	43.69	Pk	31.3	-18.2	0	56.79	-	-	74	-17.21	208	207	V
2	* 2.388	47.09	Pk	31.3	-18.2	0	60.19	-	-	74	-13.81	208	207	V
3	* 2.39	31.94	RMS	31.3	-18.2	0	45.04	54	-8.96	-	-	208	207	V
4	* 2.39	32.22	RMS	31.3	-18.2	0	45.32	54	-8.68	-	-	208	207	V

\* - indicates frequency in CFR47 Pt 15 / IC RSS-Restricted Band

Pk - Peak detector

RMS - RMS detection

**AUTHORIZED BANDEDGE (10 CHANNEL)**

**HORIZONTAL PEAK AND AVERAGE PLOT**

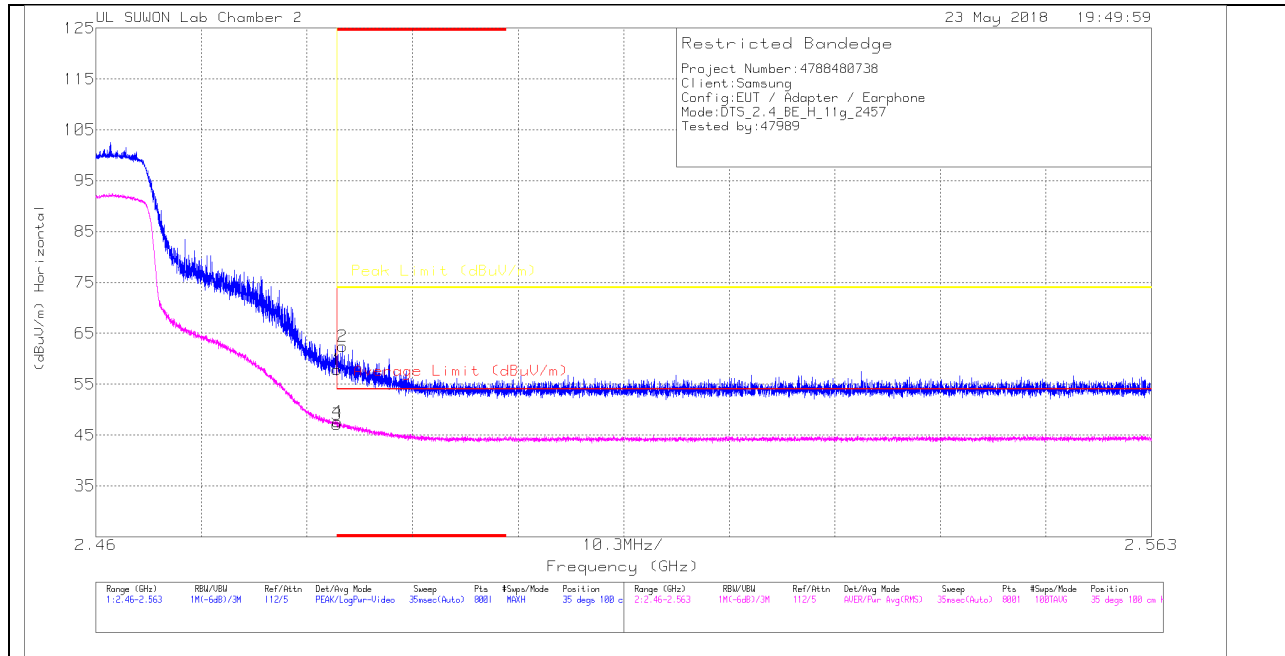

**HORIZONTAL DATA**

**Trace Markers**

Marker	Frequency (GHz)	Meter Reading (dBuV)	Det	170531_3117(00168724)	10dB(dB)	DC Corr (dB)	Corrected Reading (dBuV/m)	Average Limit (dBuV/m)	Margin (dB)	Peak Limit (dBuV/m)	Pk Margin (dB)	Azimuth (Degs)	Height (cm)	Polarity
1	* 2.484	44.25	Pk		31.6	-18	57.85	-	-	74	-16.15	35	100	H
2	* 2.484	48.81	Pk		31.6	-18	62.41	-	-	74	-11.59	35	100	H
3	* 2.484	33.53	RMS		31.6	-18	47.13	54	-6.87	-	-	35	100	H
4	* 2.484	33.97	RMS		31.6	-18	47.57	54	-6.43	-	-	35	100	H

\* - indicates frequency in CFR47 Pt 15 / IC RSS-Restricted Band

Pk - Peak detector

RMS - RMS detection



**VERTICAL PEAK AND AVERAGE PLOT**

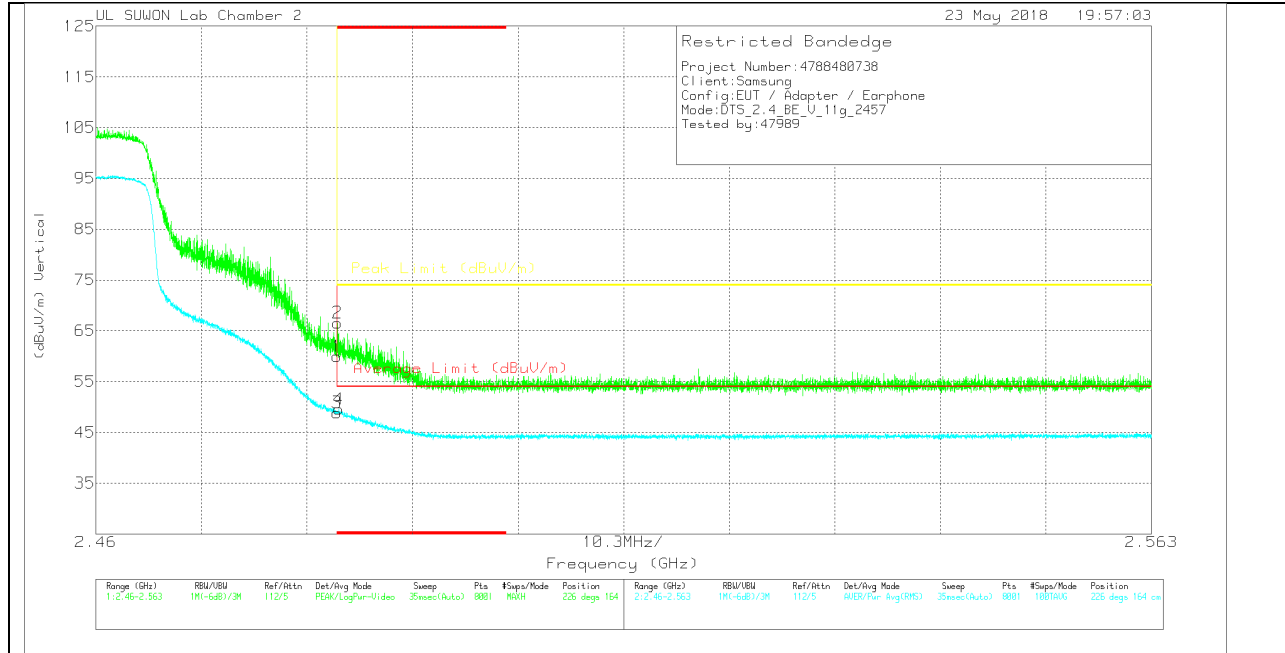

**VERTICAL DATA**

**Trace Markers**

Marker	Frequency (GHz)	Meter Reading (dBuV)	Det	170531_3117(00168724)	10dB(dB)	DC Corr (dB)	Corrected Reading (dBuV/m)	Average Limit (dBuV/m)	Margin (dB)	Peak Limit (dBuV/m)	PK Margin (dB)	Azimuth (Degs)	Height (cm)	Polarity
1	* 2.484	46.35	Pk		-18	0	59.95	-	-	74	-14.05	226	164	V
2	* 2.484	52.99	Pk		-18	0	66.59	-	-	74	-7.41	226	164	V
3	* 2.484	35.3	RMS		-18	0	48.9	54	-5.1	-	-	226	164	V
4	* 2.484	35.93	RMS		-18	0	49.53	54	-4.47	-	-	226	164	V

\* - indicates frequency in CFR47 Pt 15 / IC RSS-Restricted Band

Pk - Peak detector

RMS - RMS detection

**AUTHORIZED BANDEDGE (11 CHANNEL)**

**HORIZONTAL PEAK AND AVERAGE PLOT**

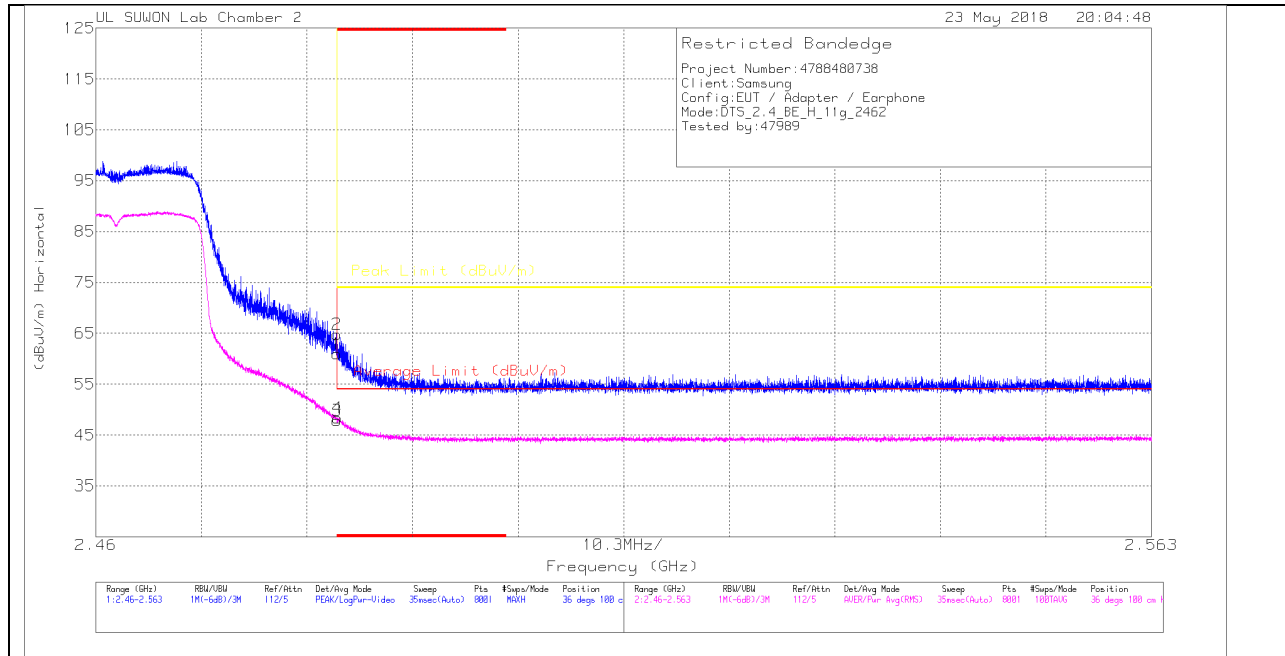

**HORIZONTAL DATA**

**Trace Markers**

Marker	Frequency (GHz)	Meter Reading (dBuV)	Det	170531_3117(00168724)	10dB(dB)	DC Corr (dB)	Corrected Reading (dBuV/m)	Average Limit (dBuV/m)	Margin (dB)	Peak Limit (dBuV/m)	PK Margin (dB)	Azimuth (Degs)	Height (cm)	Polarity
1	* 2.484	47.35	Pk		-18	0	60.95	-	-	74	-13.05	36	100	H
2	* 2.484	51.22	Pk		-18	0	64.82	-	-	74	-9.18	36	100	H
3	* 2.484	34.24	RMS		-18	0	47.84	54	-6.16	-	-	36	100	H
4	* 2.484	34.8	RMS		-18	0	48.4	54	-5.6	-	-	36	100	H

\* - indicates frequency in CFR47 Pt 15 / IC RSS-Restricted Band

Pk - Peak detector

RMS - RMS detection

**VERTICAL PEAK AND AVERAGE PLOT**

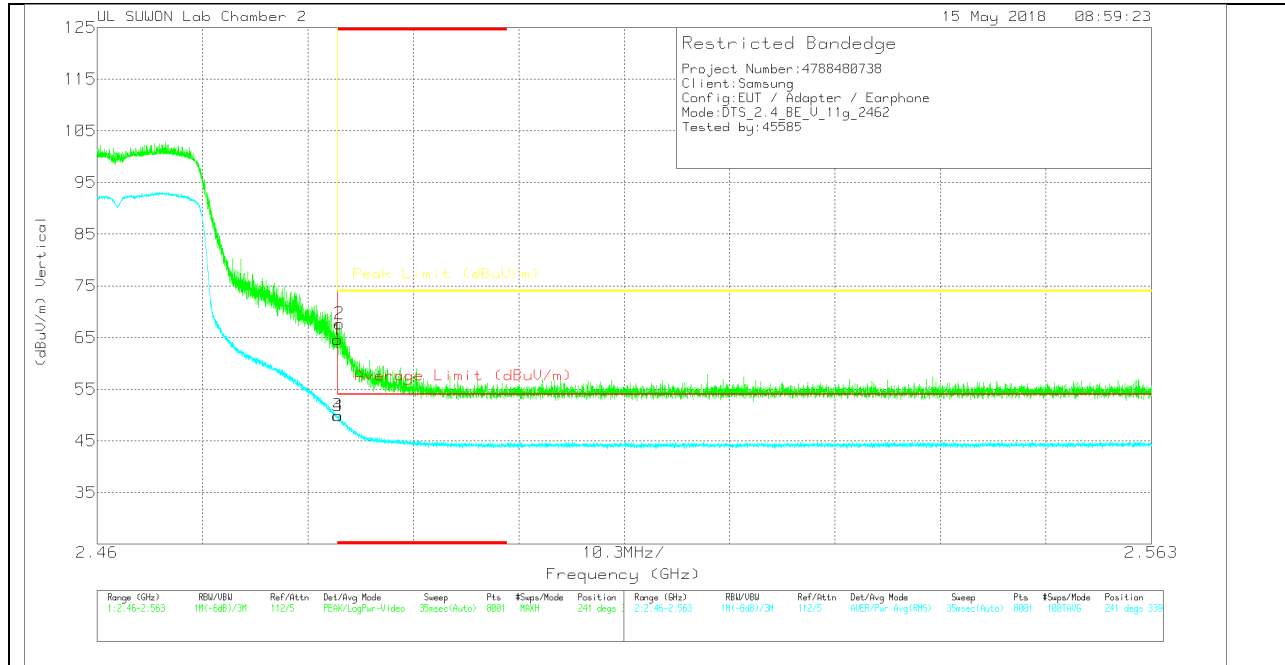

**VERTICAL DATA**

**Trace Markers**

Marker	Frequency (GHz)	Meter Reading (dBuV)	Det	170531_3117(00168724)	10dB(dB)	DC Corr (dB)	Corrected Reading (dBuV/m)	Average Limit (dBuV/m)	Margin (dB)	Peak Limit (dBuV/m)	PK Margin (dB)	Azimuth (Degs)	Height (cm)	Polarity
1	* 2.484	50.97	Pk		31.6	-18	64.57	-	-	74	-9.43	241	339	V
2	* 2.484	54.08	Pk		31.6	-18	67.68	-	-	74	-6.32	241	339	V
3	* 2.484	36.31	RMS		31.6	-18	49.91	54	-4.09	-	-	241	339	V
4	* 2.484	36.25	RMS		31.6	-18	49.85	54	-4.15	-	-	241	339	V

\* - indicates frequency in CFR47 Pt 15 / IC RSS-Restricted Band

Pk - Peak detector

RMS - RMS detection

**AUTHORIZED BANDEDGE (12 CHANNEL)**

**HORIZONTAL PEAK AND AVERAGE PLOT**

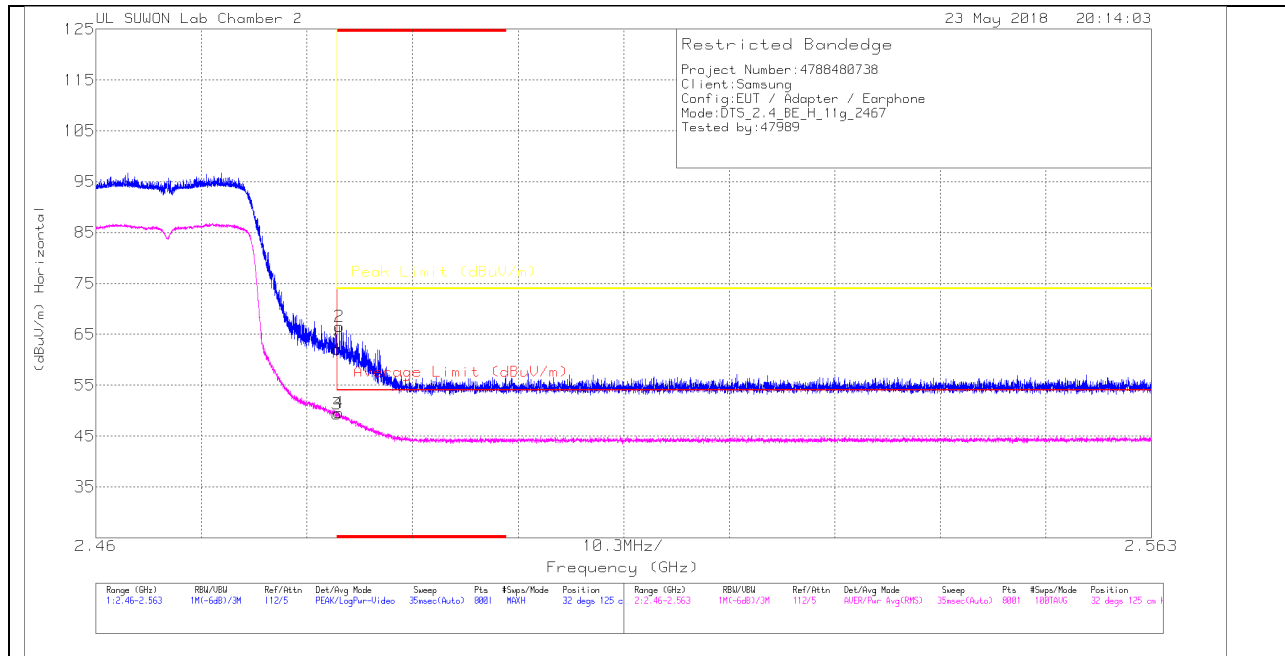

**HORIZONTAL DATA**

**Trace Markers**

Marker	Frequency (GHz)	Meter Reading (dBuV)	Det	170531_3117(00168724)	10dB(dB)	DC Corr (dB)	Corrected Reading (dBuV/m)	Average Limit (dBuV/m)	Margin (dB)	Peak Limit (dBuV/m)	PK Margin (dB)	Azimuth (Degs)	Height (cm)	Polarity
1	* 2.484	48.48	Pk	31.6	-18	0	62.08	-	-	74	-11.92	32	125	H
2	* 2.484	52.91	Pk	31.6	-18	0	66.51	-	-	74	-7.49	32	125	H
3	* 2.484	35.7	RMS	31.6	-18	0	49.3	54	-4.7	-	-	32	125	H
4	* 2.484	35.94	RMS	31.6	-18	0	49.54	54	-4.46	-	-	32	125	H

\* - indicates frequency in CFR47 Pt 15 / IC RSS-Restricted Band

Pk - Peak detector

RMS - RMS detection

**VERTICAL PEAK AND AVERAGE PLOT**

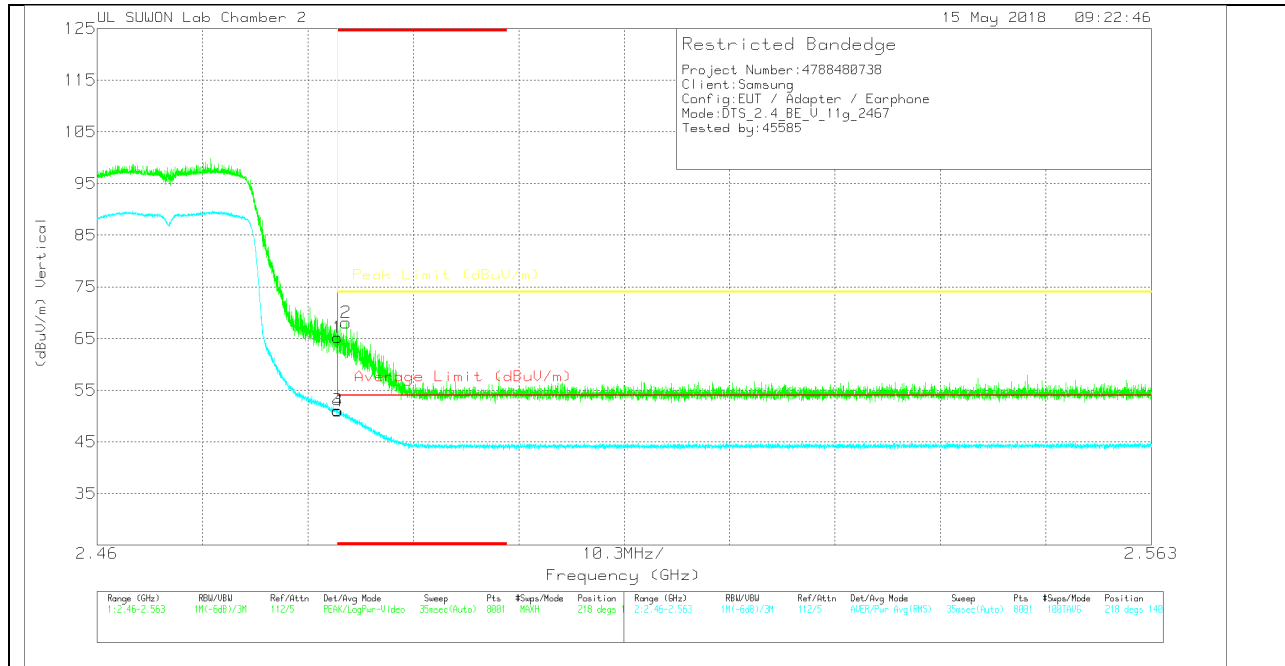

**VERTICAL DATA**

**Trace Markers**

Marker	Frequency (GHz)	Meter Reading (dBuV)	Det	170531_3117(00168724)	10dB(dB)	DC Corr (dB)	Corrected Reading (dBuV/m)	Average Limit (dBuV/m)	Margin (dB)	Peak Limit (dBuV/m)	PK Margin (dB)	Azimuth (Degs)	Height (cm)	Polarity
1	* 2.484	51.62	Pk		-18	0	65.22	-	-	74	-8.78	218	140	V
2	* 2.484	54.48	Pk		-18	0	68.08	-	-	74	-5.92	218	140	V
3	* 2.484	37.55	RMS		-18	0	51.15	54	-2.85	-	-	218	140	V
4	* 2.484	37.4	RMS		-18	0	51	54	-3	-	-	218	140	V

\* - indicates frequency in CFR47 Pt 15 / IC RSS-Restricted Band

Pk - Peak detector

RMS - RMS detection

**AUTHORIZED BANDEDGE (13 CHANNEL)**

**HORIZONTAL PEAK AND AVERAGE PLOT**

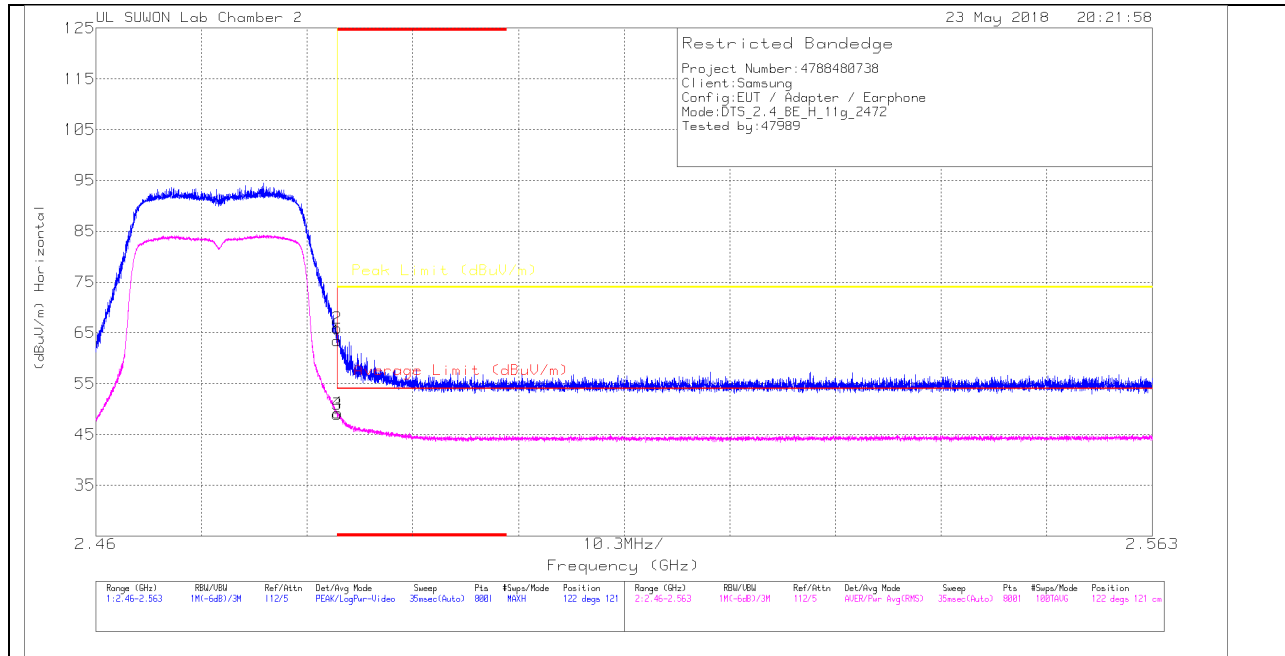

**HORIZONTAL DATA**

**Trace Markers**

Marker	Frequency (GHz)	Meter Reading (dBuV)	Det	170531_3117(00168724)	10dB(dB)	DC Corr (dB)	Corrected Reading (dBuV/m)	Average Limit (dBuV/m)	Margin (dB)	Peak Limit (dBuV/m)	PK Margin (dB)	Azimuth (Degs)	Height (cm)	Polarity
1	* 2.484	49.8	Pk	31.6	-18	0	63.4	-	-	74	-10.6	122	121	H
2	* 2.484	52.31	Pk	31.6	-18	0	65.91	-	-	74	-8.09	122	121	H
3	* 2.484	35.4	RMS	31.6	-18	0	49	54	-5	-	-	122	121	H
4	* 2.484	35.67	RMS	31.6	-18	0	49.27	54	-4.73	-	-	122	121	H

\* - indicates frequency in CFR47 Pt 15 / IC RSS-Restricted Band

Pk - Peak detector

RMS - RMS detection

**VERTICAL PEAK AND AVERAGE PLOT**

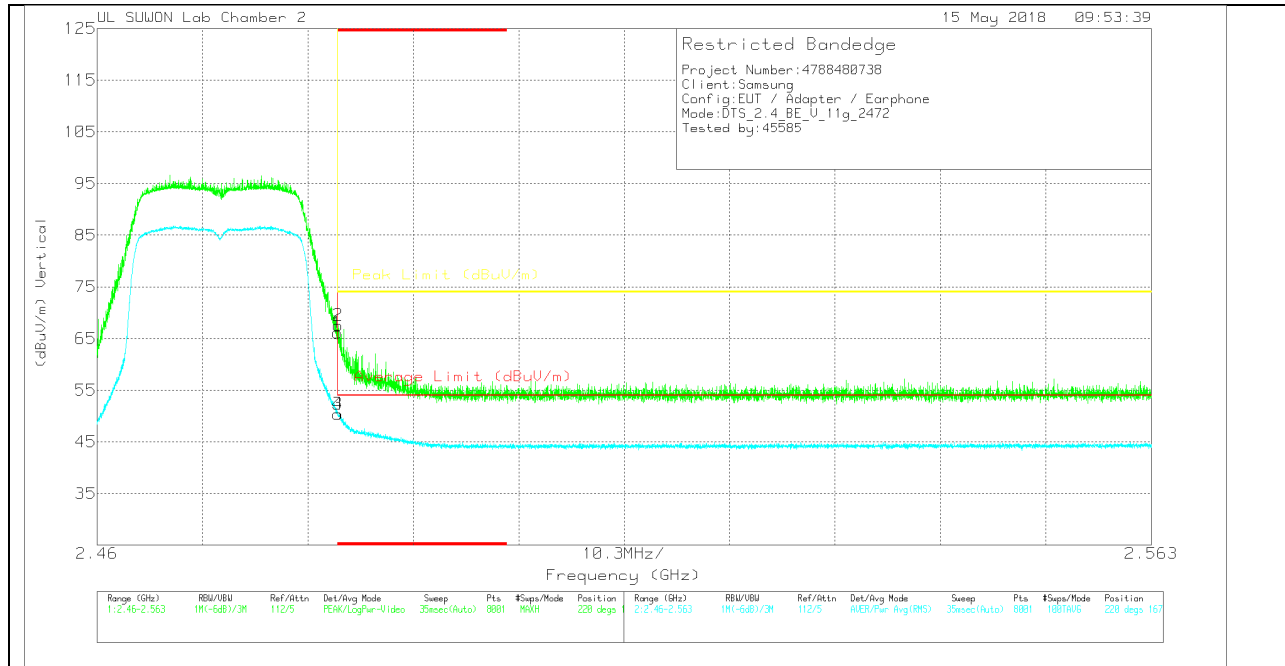

**VERTICAL DATA**

**Trace Markers**

Marker	Frequency (GHz)	Meter Reading (dBuV)	Det	170531_3117(00168724)	10dB(dB)	DC Corr (dB)	Corrected Reading (dBuV/m)	Average Limit (dBuV/m)	Margin (dB)	Peak Limit (dBuV/m)	PK Margin (dB)	Azimuth (Degs)	Height (cm)	Polarity
1	* 2.484	52.54	Pk		-18	0	66.14	-	-	74	-7.86	220	167	V
2	* 2.484	53.97	Pk		-18	0	67.57	-	-	74	-6.43	220	167	V
3	* 2.484	36.81	RMS		-18	0	50.41	54	-3.59	-	-	220	167	V
4	* 2.484	36.78	RMS		-18	0	50.38	54	-3.62	-	-	220	167	V

\* - indicates frequency in CFR47 Pt 15 / IC RSS-Restricted Band

Pk - Peak detector

RMS - RMS detection

### HARMONICS AND SPURIOUS EMISSIONS

#### 2 CHANNEL HORIZONTAL

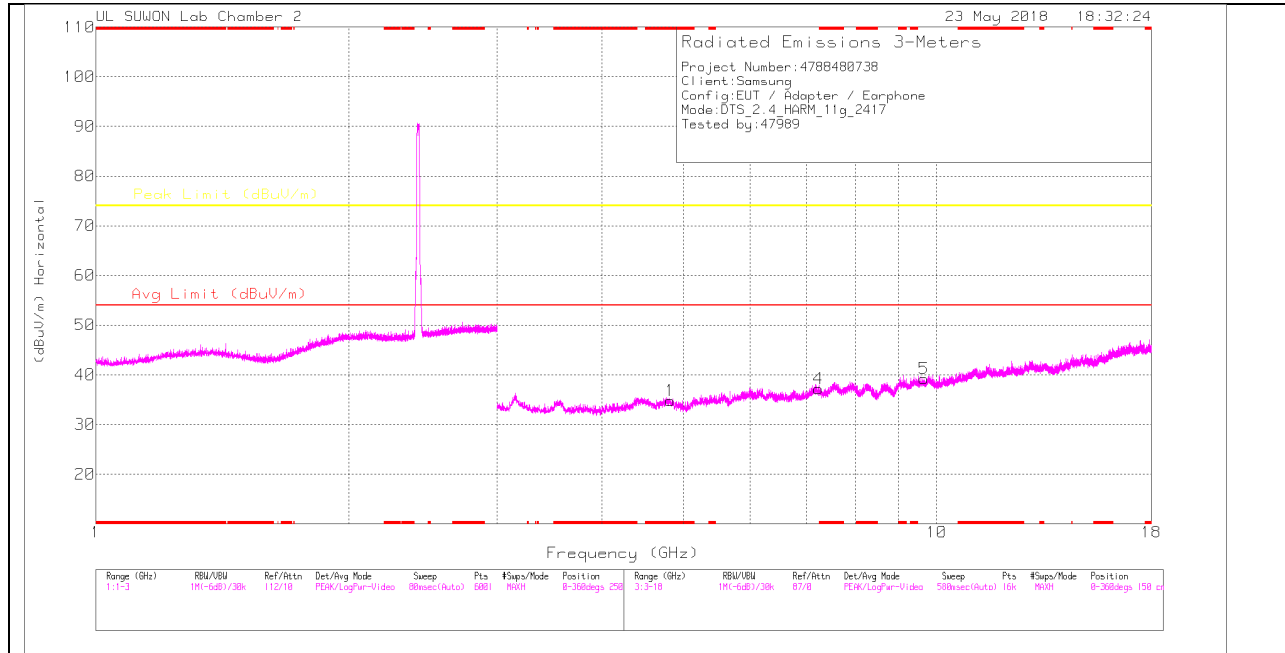

#### 2 CHANNEL VERTICAL

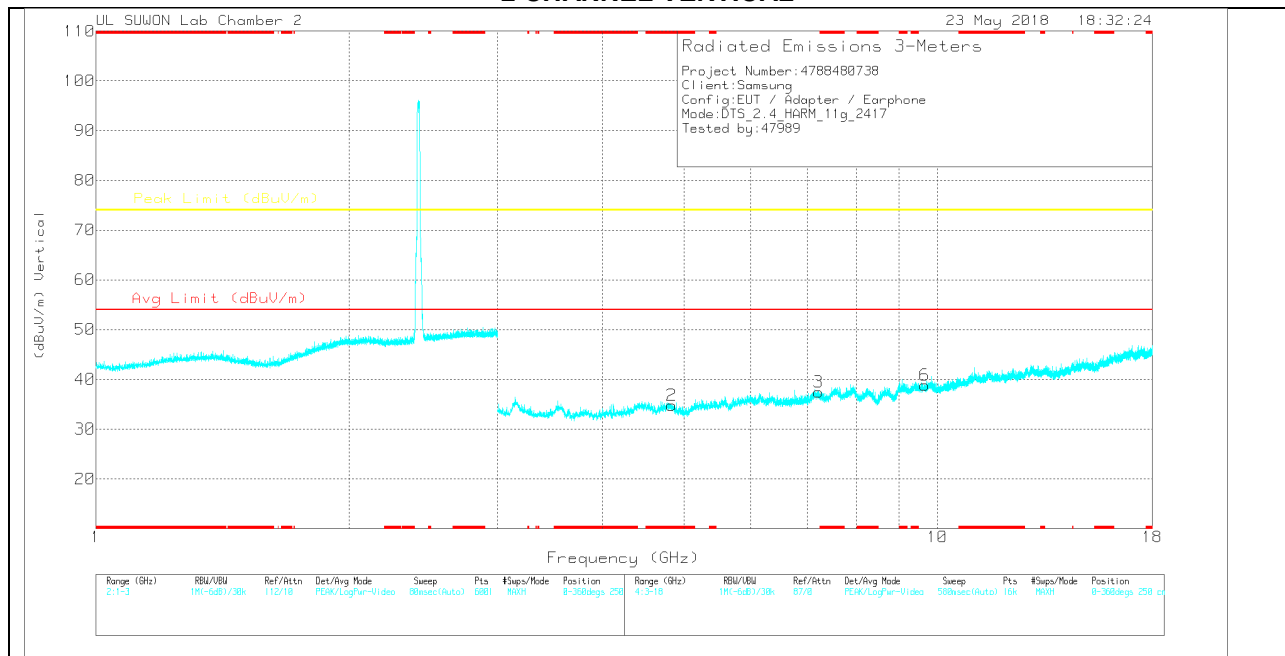

Note: Emission was scanned up to 26GHz; No emissions were detected above the noise floor which was at least 20dB below the specification limit.



**2 CHANNEL DATA**

Trace Markers

Marker	Frequency (GHz)	Meter Reading (dBuV)	Det	170531_3117[00168724]	3GHz_HP[dB]	DC Corr (dB)	Corrected Reading (dBuV/m)	Avg Limit (dBuV/m)	Margin (dB)	Peak Limit (dBuV/m)	Margin (dB)	Azimuth (Degs)	Height (cm)	Polarity
1	* 4.824	25.29	PK	33.8	-24.3	0	34.79	-	-	74	-39.21	0-360	150	H
4	7.229	23.18	PK	35.9	-21.9	0	37.18	-	-	74	-36.82	0-360	150	H
5	9.66	20.67	PK	36.8	-18.2	0	39.27	-	-	74	-34.73	0-360	250	H
2	* 4.834	25.28	PK	33.8	-24.3	0	34.78	-	-	74	-39.22	0-360	250	V
3	7.223	23.47	PK	35.9	-21.9	0	37.47	-	-	74	-36.53	0-360	150	V
6	9.656	20.33	PK	36.8	-18.3	0	38.83	-	-	74	-35.17	0-360	250	V

\* - indicates frequency in CFR47 Pt 15 / IC RSS-Restricted Band  
 PK – Peak detector

Note: Only peak measurement was performed. Because peak measurement result of unwanted emission is less than average limit (54dBuV/m).