



FCC CFR47 PART 15 SUBPART C

ANT+

CERTIFICATION TEST REPORT

FOR

GSM/WCDMA/LTE Phone + BT/BLE, DTS/UNII a/b/g/n, ANT+ and NFC

MODEL NUMBER : SM-A605K

FCC ID: A3LSMA605K

REPORT NUMBER: 4788480738-E5V2

ISSUE DATE: JUN 01, 2018

Prepared for
SAMSUNG ELECTRONICS CO., LTD.
129 SAMSUNG-RO, YEONGTONG-GU, SUWON-SI,
GYEONGGI-DO, 16677, KOREA

Prepared by
UL Korea, Ltd.
26th floor, 152, Teheran-ro, Gangnam-gu Seoul, 06236, Korea

Suwon Test Site: UL Korea, Ltd. Suwon Laboratory
218 Maeyeong-ro, Yeongtong-gu,
Suwon-si, Gyeonggi-do, 16675, Korea
TEL: (031) 337-9902
FAX: (031) 213-5433



ACCREDITED*

Testing
Laboratory

TL-637

Revision History

<u>Rev.</u>	<u>Issue Date</u>	<u>Revisions</u>	<u>Revised By</u>
V1	05/25/18	Initial issue	Junwhan Lee
V2	06/01/18	Updated to address TCB's question	Junwhan Lee

TABLE OF CONTENTS

1. ATTESTATION OF TEST RESULTS	4
2. TEST METHODOLOGY	5
3. FACILITIES AND ACCREDITATION	5
4. CALIBRATION AND UNCERTAINTY	5
4.1. <i>MEASURING INSTRUMENT CALIBRATION</i>	<i>5</i>
4.2. <i>SAMPLE CALCULATION</i>	<i>5</i>
4.3. <i>MEASUREMENT UNCERTAINTY.....</i>	<i>5</i>
5. EQUIPMENT UNDER TEST	6
5.1. <i>DESCRIPTION OF EUT</i>	<i>6</i>
5.2. <i>MAXIMUM E-FIELD STRENGTH</i>	<i>6</i>
5.3. <i>DESCRIPTION OF AVAILABLE ANTENNAS</i>	<i>6</i>
5.4. <i>WORST-CASE CONFIGURATION AND MODE.....</i>	<i>6</i>
5.5. <i>DESCRIPTION OF TEST SETUP.....</i>	<i>7</i>
6. TEST AND MEASUREMENT EQUIPMENT	9
7. LIMITS AND RESULTS.....	10
7.1. <i>99% BANDWIDTH.....</i>	<i>10</i>
7.2. <i>TRANSMITTER RADIATED EMISSIONS.....</i>	<i>12</i>
7.2.1. <i>DUTY CYCLE</i>	<i>15</i>
7.2.2. <i>FUNDAMENTAL FIELD STRENGTH LEVEL.....</i>	<i>16</i>
7.2.3. <i>TRANSMITTER BAND EDGES</i>	<i>22</i>
7.2.4. <i>HARMONICS AND SPURIOUS EMISSIONS</i>	<i>26</i>
7.2.5. <i>SPURIOUS BELOW 1 GHz</i>	<i>32</i>
8. AC POWER LINE CONDUCTED EMISSIONS	34
9. SETUP PHOTOS.....	39

1. ATTESTATION OF TEST RESULTS

COMPANY NAME: SAMSUNG ELECTRONICS CO., LTD.
EUT DESCRIPTION: GSM/WCDMA/LTE Phone + BT/BLE, DTS/UNII a/b/g/n, ANT+ and NFC
MODEL NUMBER: SM-A605K
SERIAL NUMBER: R39K30GTV6B (CONDUCTED)
R39K30GTZ6H (RADIATED);
DATE TESTED: MAR 31, 2018 - JUN 01, 2018;

APPLICABLE STANDARDS	
STANDARD	TEST RESULTS
CFR 47 Part 15 Subpart C	Pass

UL Korea, Ltd. tested the above equipment in accordance with the requirements set forth in the above standards. All indications of Pass/Fail in this report are opinions expressed by UL Korea, Ltd. based on interpretations and/or observations of test results. Measurement Uncertainties were not taken into account and are published for informational purposes only. The test results show that the equipment tested is capable of demonstrating compliance with the requirements as documented in this report.

Note: The results documented in this report apply only to the tested sample, under the conditions and modes of operation as described herein. This document may not be altered or revised in any way unless done so by UL Korea, Ltd. and all revisions are duly noted in the revisions section. Any alteration of this document not carried out by UL Korea, Ltd. will constitute fraud and shall nullify the document. This report must not be used by the client to claim product certification, approval, or endorsement by IAS, any agency of the Federal Government, or any agency of any government.

Approved & Released For
UL Korea, Ltd. By:

Tested By:



SungGil Park
Suwon Lab Engineer
UL Korea, Ltd.

Junwhan Lee
Suwon Lab Engineer
UL Korea, Ltd.

2. TEST METHODOLOGY

The tests documented in this report were performed in accordance with following methods.

1. FCC CFR 47 Part 2.
2. FCC CFR 47 Part 15.
3. ANSI C63.10-2013.

3. FACILITIES AND ACCREDITATION

The test sites and measurement facilities used to collect data are located at 218 Maeyeong-ro, Yeongtong-gu, Suwon-si, Gyeonggi-do, 16675, Korea. Line conducted emissions are measured only at the 218 address. The following table identifies which facilities were utilized for radiated emission measurements documented in this report. Specific facilities are also identified in the test results sections.

218 Maeyeong-ro	
<input type="checkbox"/>	Chamber 1
<input checked="" type="checkbox"/>	Chamber 2
<input type="checkbox"/>	Chamber 3

UL Korea, Ltd. is accredited by IAS, Laboratory Code TL-637. The full scope of accreditation can be viewed at <http://www.iasonline.org/PDF/TL/TL-637.pdf>.

4. CALIBRATION AND UNCERTAINTY

4.1. MEASURING INSTRUMENT CALIBRATION

The measuring equipment utilized to perform the tests documented in this report has been calibrated in accordance with the manufacturer's recommendations, and is traceable to recognized national standards.

4.2. SAMPLE CALCULATION

Where relevant, the following sample calculation is provided:

$$\begin{aligned} \text{Field Strength (dBuV/m)} &= \text{Measured Voltage (dBuV)} + \text{Antenna Factor (dB/m)} + \\ &\text{Cable Loss (dB)} - \text{Preamp Gain (dB)} \\ 36.5 \text{ dBuV} + 18.7 \text{ dB/m} + 0.6 \text{ dB} - 26.9 \text{ dB} &= 28.9 \text{ dBuV/m} \end{aligned}$$

4.3. MEASUREMENT UNCERTAINTY

Where relevant, the following measurement uncertainty levels have been estimated for tests performed on the apparatus:

PARAMETER	UNCERTAINTY
Conducted Disturbance, 0.15 to 30 MHz	2.32 dB
Radiated Disturbance, Below 1GHz	3.86 dB
Radiated Disturbance, Above 1 GHz	5.97 dB

Uncertainty figures are valid to a confidence level of 95%.

5. EQUIPMENT UNDER TEST

5.1. DESCRIPTION OF EUT

The EUT is a GSM/WCDMA/LTE Phone + BT/BLE, DTS/UNII a/b/g/n, ANT+ and NFC.
This test report addresses the ANT+ operational mode.

5.2. MAXIMUM E-FIELD STRENGTH

The ANT+ mode has maximum output fundamental field strength as follows:

Frequency Range [MHz]	Mode	Peak E-field Strength [dBuV/m]	Avg E-field Strength [dBuV/m]	Distance [m]
2402 - 2480	ANT +	95.79	71.78	3.00

5.3. DESCRIPTION OF AVAILABLE ANTENNAS

The radio utilizes an internal antenna, with a maximum gain of -3.25 dBi

5.4. WORST-CASE CONFIGURATION AND MODE

Radiated emission below 1GHz and power line conducted emission were performed with the EUT set to transmit at the channel with highest output power as worst-case scenario.

Radiated emission above 1GHz was performed with the EUT set to transmit low/mid/high channels.

The fundamental of the EUT was investigated in three orthogonal orientations X, Y and Z it was determined that Y orientation was worst-case orientation; therefore, all final radiated testing was performed with the EUT in Y orientation.

Note : All radiated and power line conducted tests were performed connected with earphone and charger for evaluation of worst case mode.

5.5. DESCRIPTION OF TEST SETUP

SUPPORT EQUIPMENT

Support Equipment List				
Description	Manufacturer	Model	Serial Number	FCC ID
Charger	SAMSUNG	EP-TA50KWK	DK4K207VS/A- E	N/A
Data Cable	SAMSUNG	ECB-DU68WE	N/A	N/A
Earphone	SAMSUNG	EHS64AVFWE	N/A	N/A

I/O CABLES

I/O Cable List						
Cable No	Port	# of identical ports	Connector Type	Cable Type	Cable Length (m)	Remarks
1	DC Power	1	Mini-USB	Shielded	1.2m	N/A
2	Audio	2	Mini-Jack	Unshielded	1.2m	N/A

TEST SETUP

The EUT is set to continuously transmit in ANT + test mode.
 Test software in hidden menu exercised the EUT to enable ANT+ mode.

SETUP DIAGRAM FOR TESTS (CONDUCTED TEST SETUP)

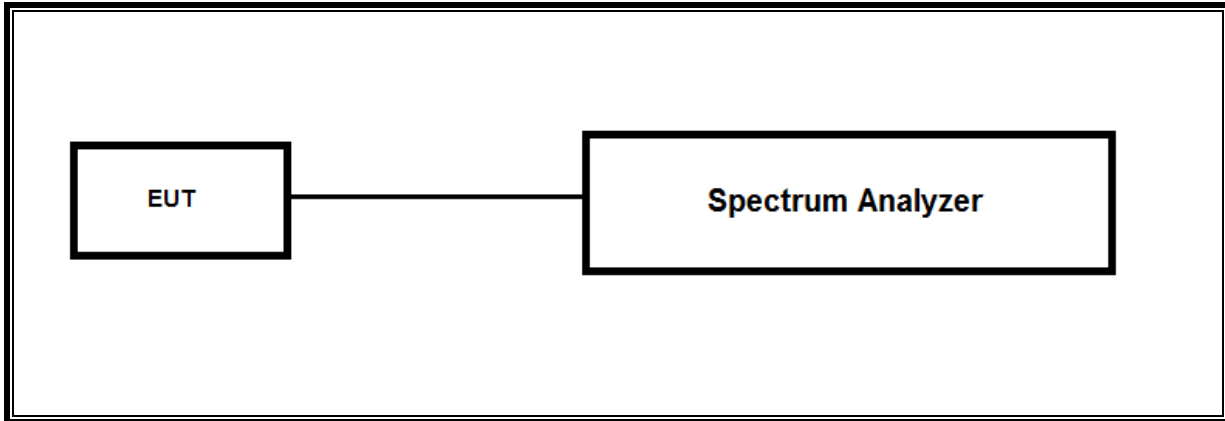

SETUP DIAGRAM FOR TESTS (RADIATED TEST SETUP)

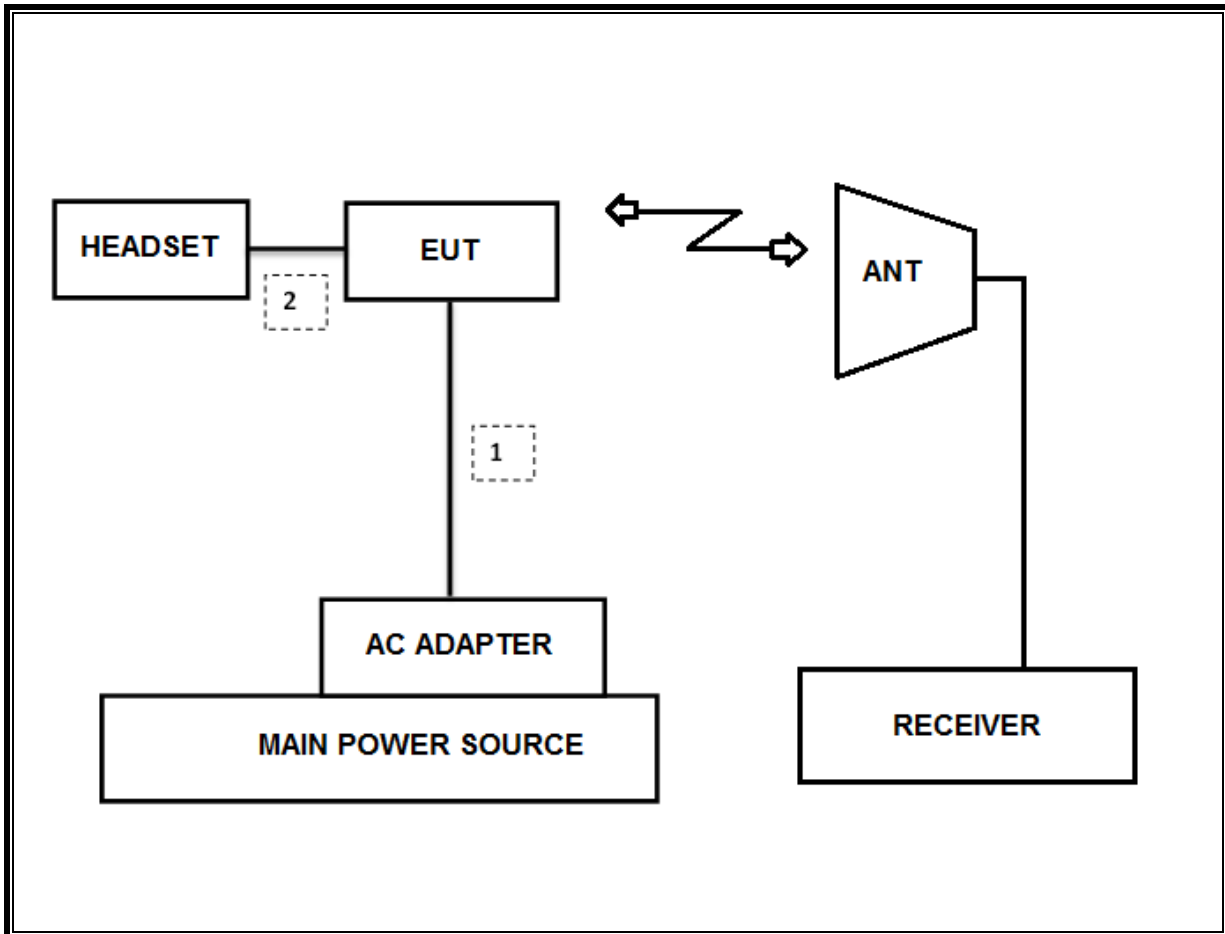

6. TEST AND MEASUREMENT EQUIPMENT

The following test and measurement equipment was utilized for the tests documented in this report:

Test Equipment List				
Description	Manufacturer	Model	S/N	Cal Due
Antenna, Bilog, 30MHz-1GHz	SCHWARZBECK	VULB9163	750	08-31-19
Antenna, Bilog, 30MHz-1GHz	SCHWARZBECK	VULB9163	749	09-14-19
Antenna, Bilog, 30MHz-1GHz	SCHWARZBECK	VULB9163	845	08-31-19
Antenna, Horn, 18 GHz	ETS	3115	00167211	10-14-18
Antenna, Horn, 18 GHz	ETS	3115	00161451	03-10-19
Antenna, Horn, 18 GHz	ETS	3117	00168724	05-31-19
Antenna, Horn, 18 GHz	ETS	3117	00168717	05-31-19
Antenna, Horn, 18 GHz	ETS	3117	00205959	11-29-18
Antenna, Horn, 40 GHz	ETS	3116C	00166155	12-04-19
Antenna, Horn, 40 GHz	ETS	3116C	00168645	12-04-19
Antenna, Horn, 40 GHz	ETS	3116C-PA	00168841	11-13-19
Preamplifier, 1000 MHz	Sonoma	310N	341282	08-09-18
Preamplifier, 1000 MHz	Sonoma	310N	351741	08-07-18
Preamplifier, 1000 MHz	Sonoma	310N	370599	08-10-18
Preamplifier, 18 GHz	Miteq	AFS42-00101800-25-S-42	1876511	08-08-18
Preamplifier, 18 GHz	Miteq	AFS42-00101800-25-S-42	1896138	08-08-18
Preamplifier, 18 GHz	Miteq	AFS42-00101800-25-S-42	2029169	08-11-18
Spectrum Analyzer, 44 GHz	Agilent / HP	N9030A	MY54170614	08-08-18
Spectrum Analyzer, 44 GHz	Agilent / HP	N9030A	MY54490312	08-08-18
Average Power Sensor	Agilent / HP	U2000	MY54270007	08-08-18
Attenuator	PASTERNAK	PE7087-10	A001	08-08-18
Attenuator	PASTERNAK	PE7087-10	A008	08-08-18
Attenuator	PASTERNAK	PE7087-10	2	08-10-18
EMI Test Receive, 40 GHz	R&S	ESU40	100439	08-08-18
EMI Test Receive, 40 GHz	R&S	ESU40	100457	08-08-18
EMI Test Receive, 44 GHz	R&S	ESW44	101590	08-09-18
EMI Test Receive, 3 GHz	R&S	ESR3	101832	08-07-18
Low Pass Filter 5GHz	Micro-Tronics	LPS17541	009	08-08-18
Low Pass Filter 5GHz	Micro-Tronics	LPS17541	015	08-08-18
Low Pass Filter 5GHz	Micro-Tronics	LPS17541	020	08-11-18
High Pass Filter 3GHz	Micro-Tronics	HPM17543	010	08-08-18
High Pass Filter 3GHz	Micro-Tronics	HPM17543	015	08-08-18
High Pass Filter 3GHz	Micro-Tronics	HPM17543	020	08-11-18
High Pass Filter 6GHz	Micro-Tronics	HPS17542	009	08-08-18
High Pass Filter 6GHz	Micro-Tronics	HPS17542	016	08-08-18
High Pass Filter 6GHz	Micro-Tronics	HPS17542	021	08-11-18
LISN	R&S	ENV-216	101837	08-09-18
UL Software				
Description	Manufacturer	Model	Version	
Radiated software	UL	UL EMC	Ver 9.5	
AC Line Conducted software	UL	UL EMC	Ver 9.5	

7. LIMITS AND RESULTS

7.1. 99% BANDWIDTH

LIMITS

None; for reporting purposes only.

TEST PROCEDURE

The transmitter output is connected to the spectrum analyzer. The RBW is set to 1% to 3% of the 99 % bandwidth. The VBW is set to 3 times the RBW. The sweep time is coupled. The spectrum analyzer internal 99% bandwidth function is utilized.

RESULTS

Channel	Frequency [MHz]	99% Bandwidth [kHz]	20 dB Bandwidth [kHz]
Low	2402	827.53	579.90
Mid	2441	810.88	638.30
High	2480	824.69	634.50
Worst		827.53	638.30

99% BANDWIDTH PLOTS

LOW CHANNEL

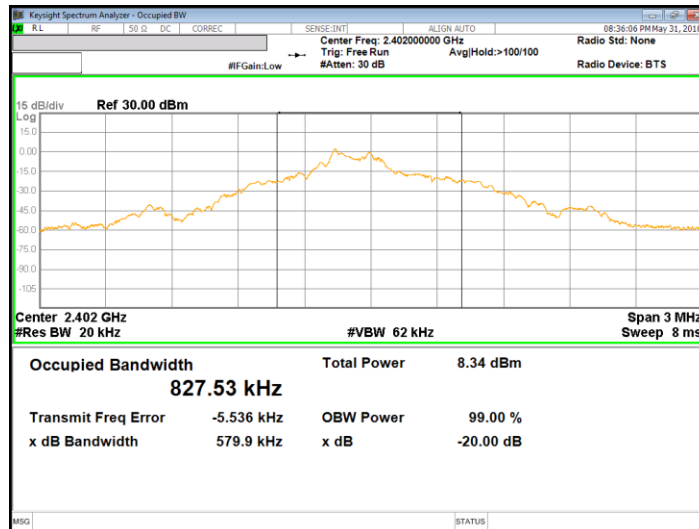

MID CHANNEL

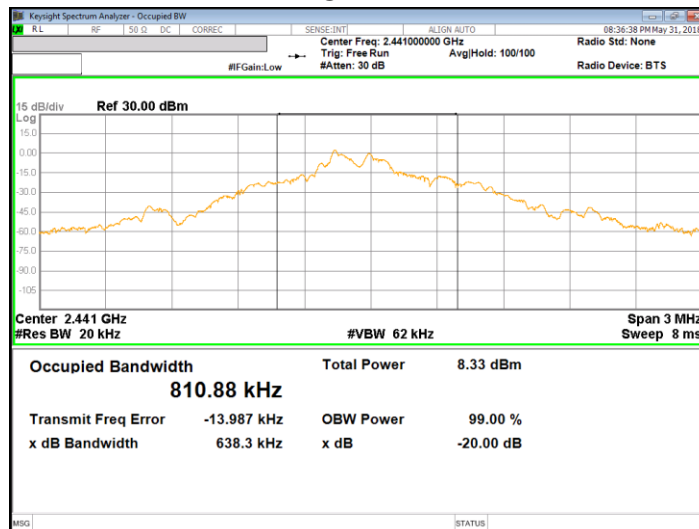

HIGH CHANNEL

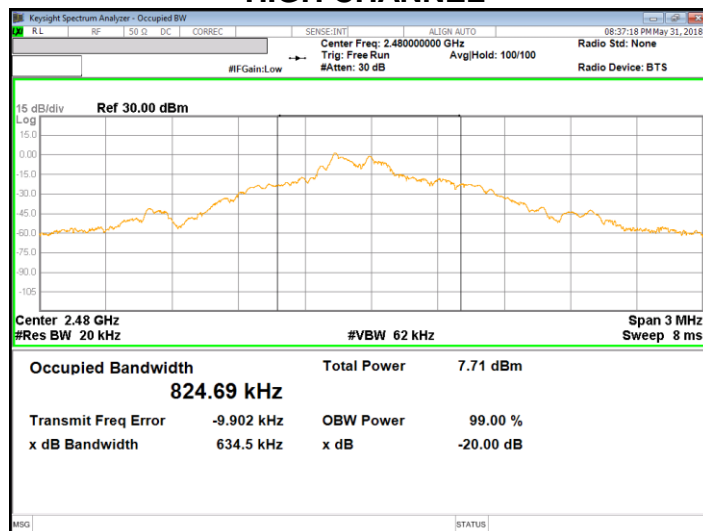

7.2. TRANSMITTER RADIATED EMISSIONS

TEST PROCEDURE

ANSI C63.10: 2013

The EUT is placed on a non-conducting table 80 cm above the ground plane for below 1GHz and 150 cm for above 1GHz. The antenna to EUT distance is 3 meters. The EUT is configured in accordance with ANSI C63.10. The EUT is set to transmit in a continuous mode.

For measurements below 1 GHz the resolution bandwidth is set to 100 kHz for peak detection measurements or 120 kHz for quasi-peak detection measurements. Peak detection is used unless otherwise noted as quasi-peak.

For measurements above 1 GHz the resolution bandwidth is set to 1 MHz, then the video bandwidth is set to 3 MHz for peak measurements and add duty cycle factor for average measurements.

Pre-scans to detect harmonic and spurious emissions, the resolution bandwidth is set to 1 MHz; the video bandwidth is set to 30 KHz for peak measurements.

LIMIT

FCC §15.249

Operation within the bands 902–928 MHz, 2400–2483.5 MHz, 5725–5875 MHz, and 24.0–24.25 GHz.

(a) Except as provided in paragraph (b) of this section, the field strength of emissions from intentional radiators operated within these frequency bands shall comply with the following:

Fundamental frequency	Field strength of fundamental (millivolts/meter)	Field strength of harmonics (microvolts/meter)
902-928 MHz	50	500
2400-2483.5 MHz	50	500
5725-5875 MHz	50	500
24.0-24.25 GHz	250	2500

(d) Emissions radiated outside of the specified frequency bands, except for harmonics, shall be attenuated by at least 50 dB below the level of the fundamental or to the general radiated emission limits in § 15.209, whichever is the lesser attenuation.

(e) As shown in Sec. 15.35(b), for frequencies above 1000 MHz, the field strength limits in paragraphs (a) and (b) of this section are based on average limits. However, the peak field strength of any emission shall not exceed the maximum permitted average limits specified above by more than 20 dB under any condition of modulation.

FCC §15.205 and §15.209

Limits for radiated disturbance of an intentional radiator		
Frequency range (MHz)	Limits ($\mu\text{V}/\text{m}$)	Measurement Distance (m)
0.009 – 0.490	2400 / F (kHz)	300
0.490 – 1.705	24000 / F (kHz)	30
1.705 – 30.0	30	30
30 – 88	100**	3
88 - 216	150**	3
216 – 960	200**	3
Above 960	500	3

** Except as provided in paragraph (g), fundamental emissions from intentional radiators operating under this section shall not be located in the frequency bands 54-72 MHz, 76-88 MHz, 174-216 MHz or 470-806 MHz. However, operation within these frequency bands is permitted under other sections of this part, e.g. §§ 15.231 and 15.241.

RESULTS

7.2.1. DUTY CYCLE

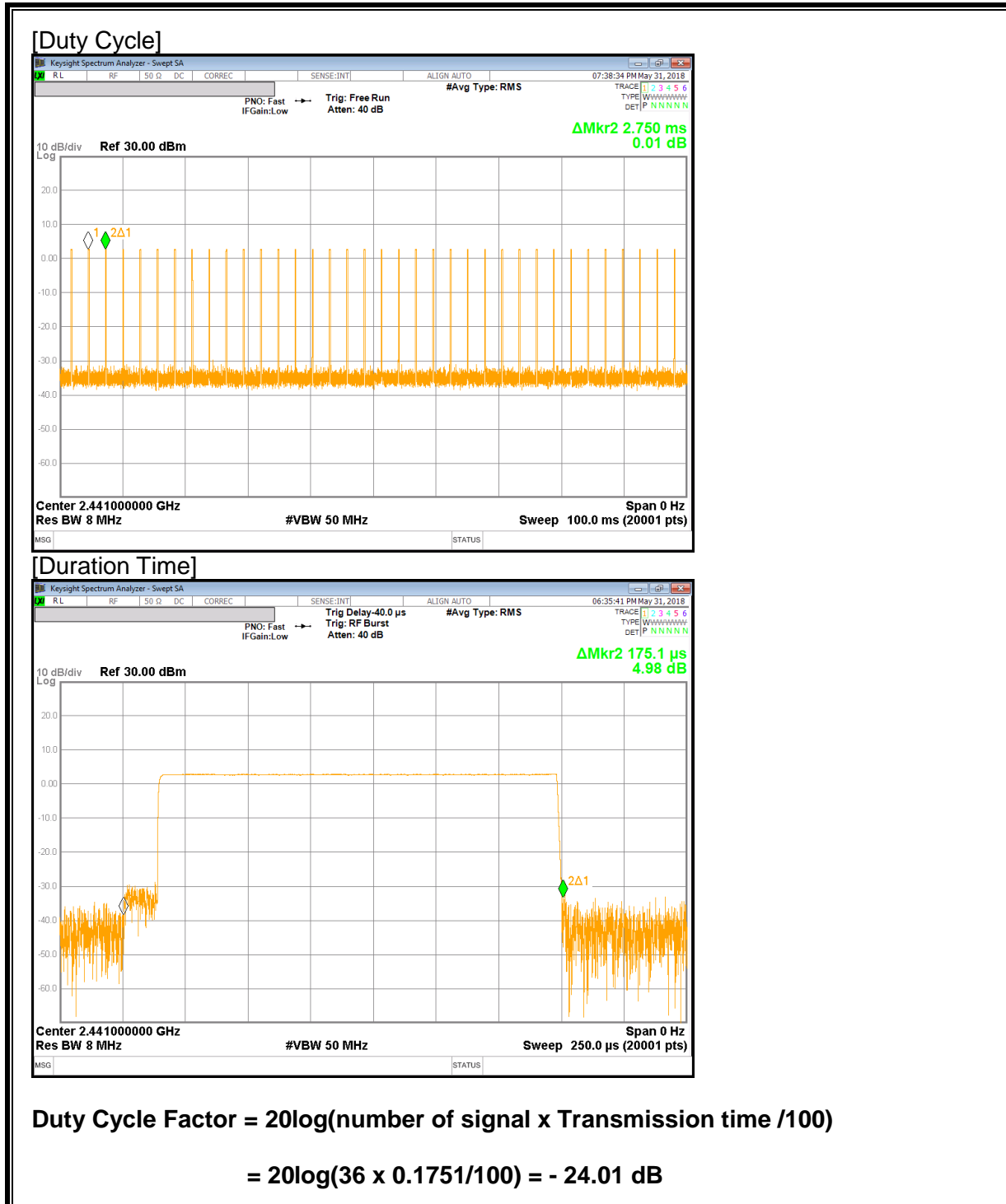

7.2.2. FUNDAMENTAL FIELD STRENGTH LEVEL

LOW CHANNEL, HORIZONTAL

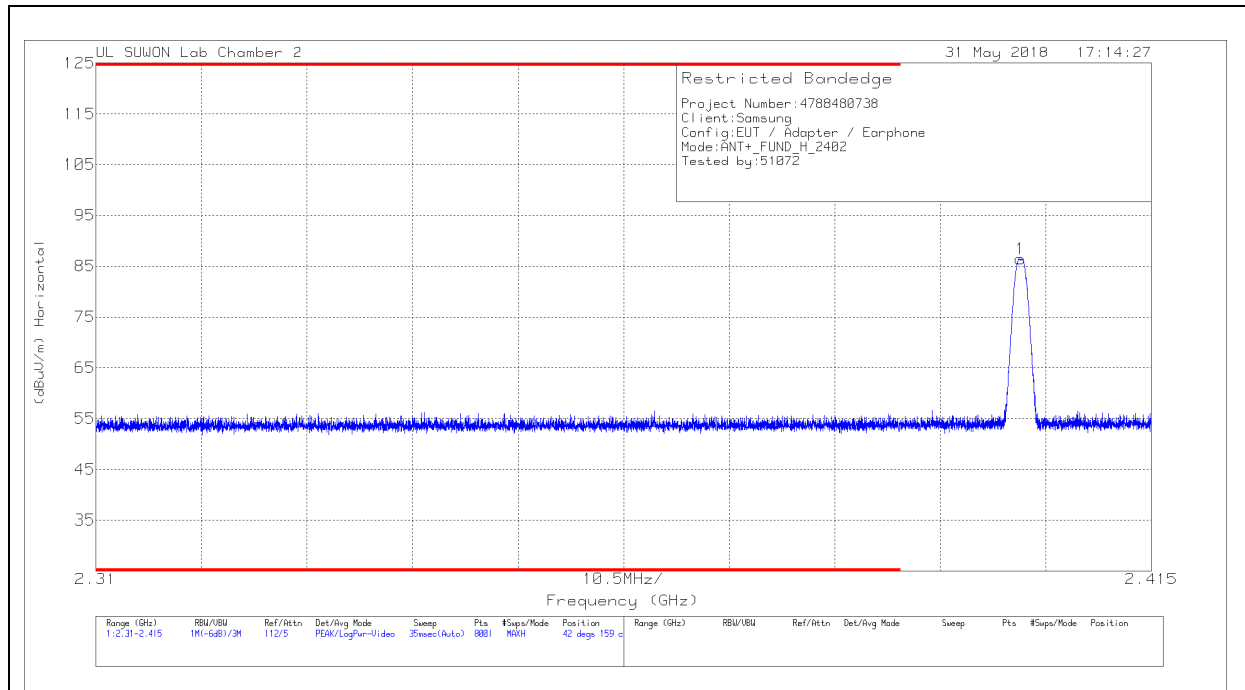

Trace Markers

Marker	Frequency (GHz)	Meter Reading (dBuV)	Det	170531_3117[00168724]	10dB[dB]	DC Corr (dB)	Corrected Reading (dBuV/m)	Azimuth (Degs)	Height (cm)	Polarity
1	2.402	73.29	Pk	31.3	-18.2	0	86.39	42	159	H

PK - Peak detector

Peak reading (dBuV/m)	Limit (dBuV/m)	Margin (dB)
86.39	114	27.61

** For marker 1 used the following method to do averaging:

DCCF = -24.01

Corrected AV reading = Peak Reading + DCCF

= 86.39 + -24.01 = 62.38 dBuV/m AVG Limit : 94 dBuV/m, Margin 31.62 dB

LOW CHANNEL, VERTICAL

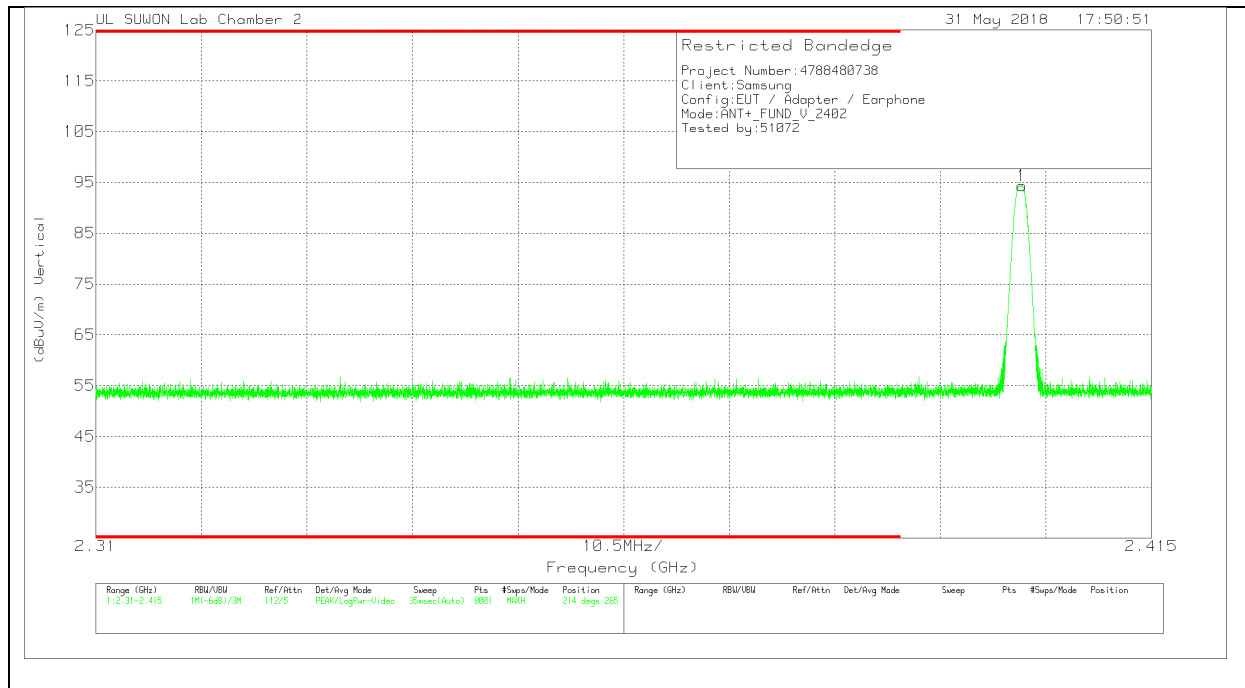

Trace Markers

Marker	Frequency (GHz)	Meter Reading (dBuV)	Det	170531_3117[00168724]	10dB[dB]	DC Corr (dB)	Corrected Reading (dBuV/m)	Azimuth (Degs)	Height (cm)	Polarity
1	2.402	81.25	Pk	31.3	-18.2	0	94.35	214	265	V

* - indicates frequency in CFR47 Pt 15 / IC RSS-Restricted Band
 Pk - Peak detector

Peak reading (dBuV/m)	Limit (dBuV/m)	Margin (dB)
94.35	114	19.65

** For marker 1 used the following method to do averaging:

DCCF = -24.01

Corrected AV reading = Peak Reading + DCCF

= 94.35 + -24.01 = 70.34 dBuV/m AVG Limit : 94 dBuV/m, Margin 23.66 dB

MID CHANNEL, HORIZONTAL

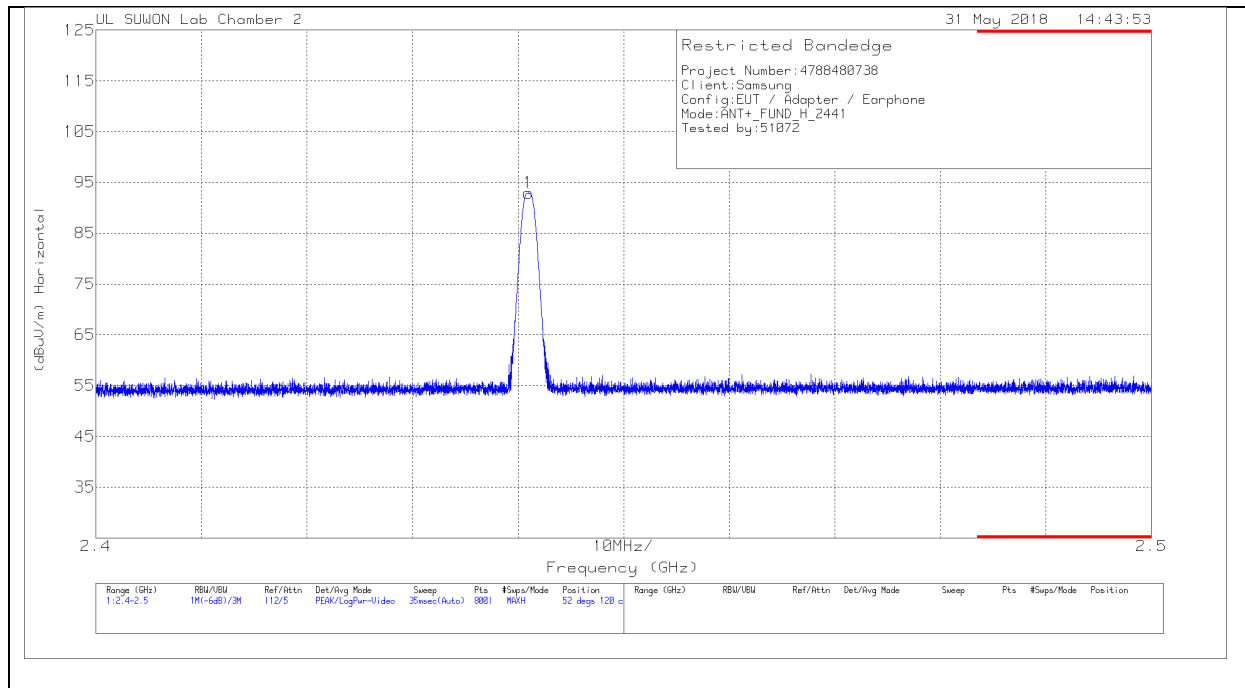

Trace Markers

Marker	Frequency (GHz)	Meter Reading (dBuV)	Det	170531_3117[00168724]	10dB[dB]	Corrected Reading (dBuV/m)	Azimuth (Degs)	Height (cm)	Polarity
1	2.441	79.54	Pk	31.5	-18.1	92.94	52	120	H

Pk - Peak detector

* Peak reading (dBuV/m)	Limit (dBuV/m)	Margin (dB)
92.94	114	21.06

** For marker 1 used the following method to do averaging:

DCCF = -24.01

Corrected AV reading = Peak Reading + DCCF

= 92.94 + -24.01 = 68.93 dBuV/m [AVG Limit : 94 dBuV/m, Margin 25.07 dB]

MID CHANNEL, VERTICAL

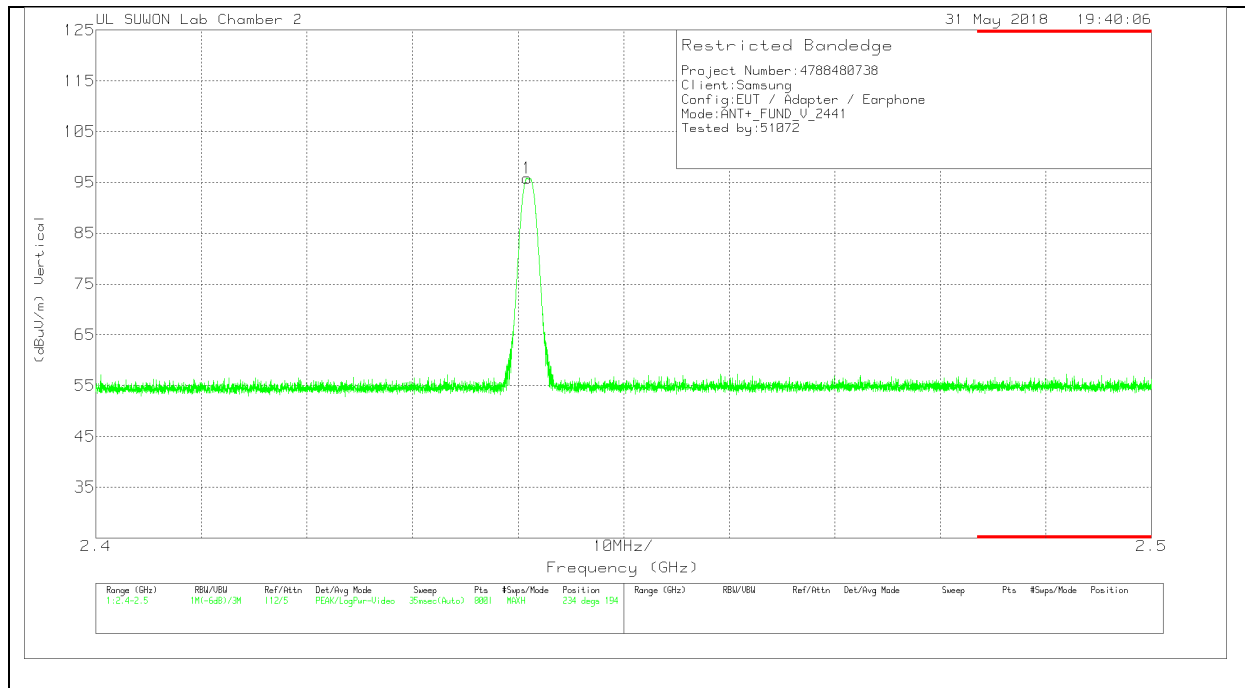

Trace Markers

Marker	Frequency (GHz)	Meter Reading (dBuV)	Det	170531_3117[00168724]	10dB[dB]	DC Corr (dB)	Corrected Reading (dBuV/m)	Azimuth (Degs)	Height (cm)	Polarity
1	2.441	82.39	Pk	31.5	-18.1	0	95.79	234	194	V

Pk - Peak detector

Peak reading (dBuV/m)	Limit (dBuV/m)	Margin (dB)
95.79	114	18.21

** For marker 1 used the following method to do averaging:

DCCF = -24.01

Corrected AV reading = Peak Reading + DCCF

= 95.79 + -24.01 = 71.78 dBuV/m ; AVG Limit : 94 dBuV/m, Margin 22.22 dB]

HIGH CHANNEL, HORIZONTAL

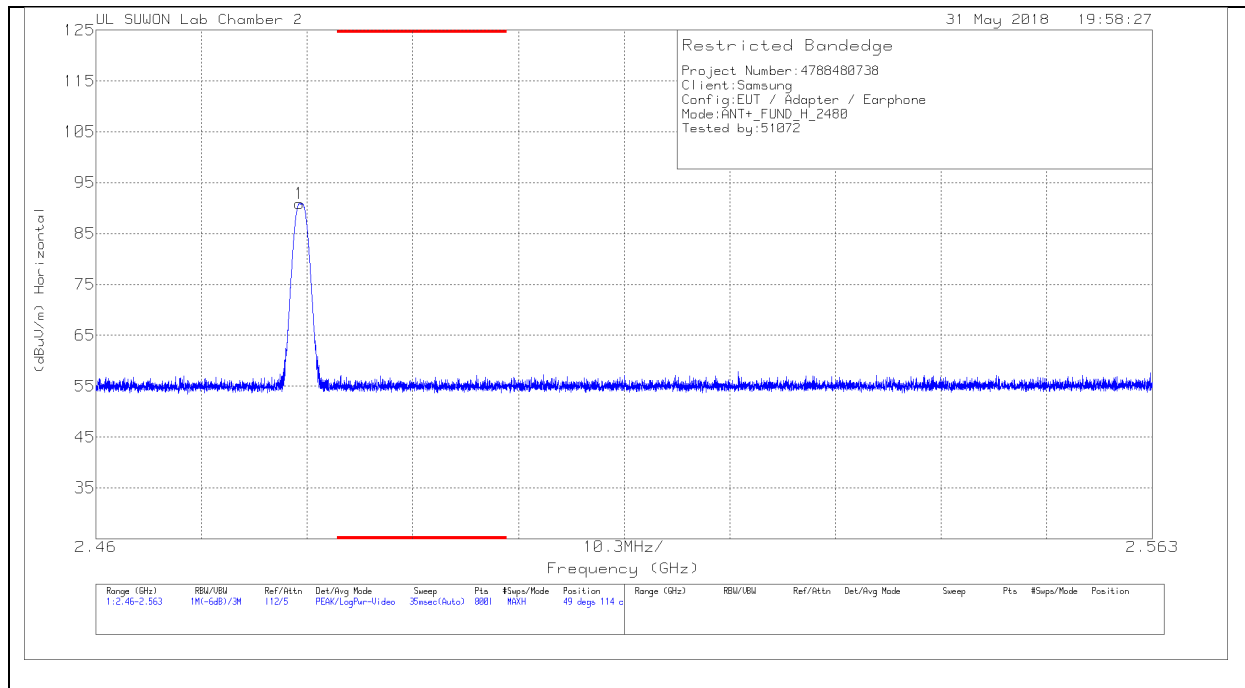

Trace Markers

Marker	Frequency (GHz)	Meter Reading (dBuV)	Det	170531_3117[00168724]	10dB[dB]	Corrected Reading (dBuV/m)	Azimuth (Degs)	Height (cm)	Polarity
1	2.48	77.3	Pk	31.6	-18	90.9	49	114	H

* - indicates frequency in CFR47 Pt 15 / IC RSS-Restricted Band
 Pk - Peak detector

Peak reading (dBuV/m)	Limit (dBuV/m)	Margin (dB)
90.9	114	23.1

** For marker 1 used the following method to do averaging:

DCCF = -24.01

Corrected AV reading = Peak Reading + DCCF

= 90.9 + -24.01 = 66.89 dBuV/m AVG Limit : 94 dBuV/m, Margin 27.11 dB]

HIGH CHANNEL, VERTICAL

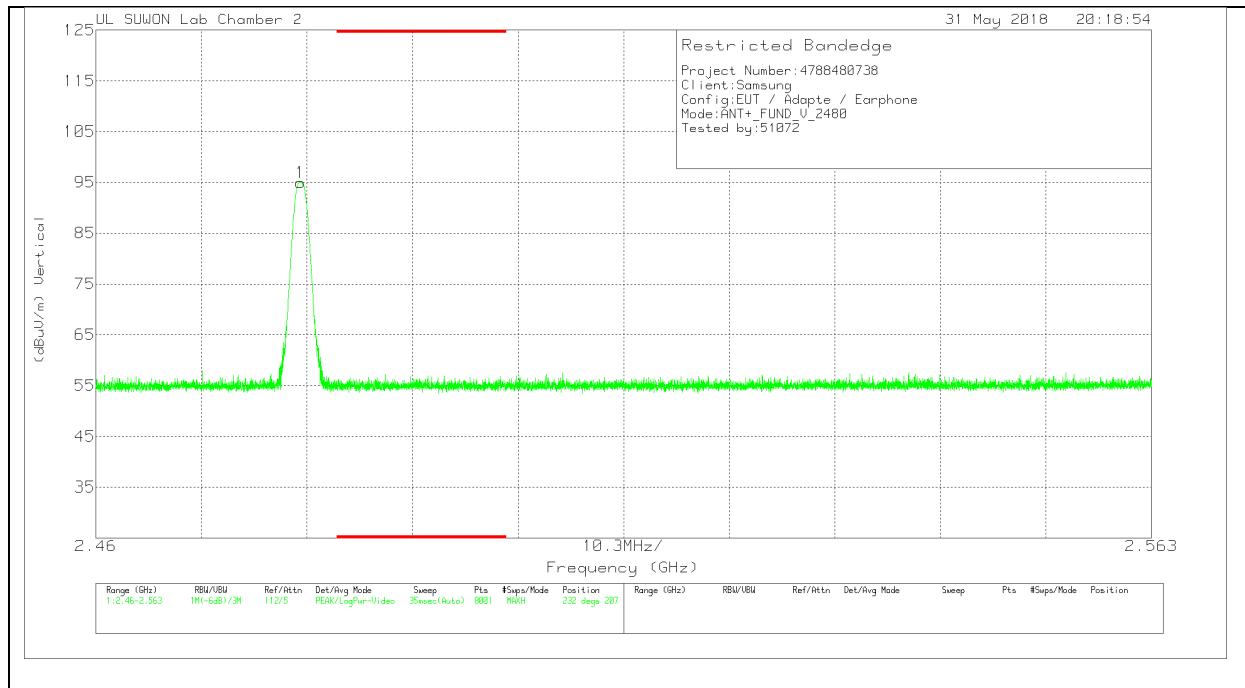

Trace Markers

Marker	Frequency (GHz)	Meter Reading (dBuV)	Det	170531_3117[00168724]	10dB[dB]	DC Corr (dB)	Corrected Reading (dBuV/m)	Azimuth (Degs)	Height (cm)	Polarity
1	2.48	81.43	Pk	31.6	-18	0	95.03	232	207	V

* - indicates frequency in CFR47 Pt 15 / IC RSS-Restricted Band
 Pk - Peak detector

Peak reading (dBuV/m)	Limit (dBuV/m)	Margin (dB)
95.03	114	18.97

** For marker 1 used the following method to do averaging:

DCCF = -24.01

Corrected AV reading = Peak Reading + DCCF

= 95.03 + -24.01 = 71.02 dBuV/m AVG Limit : 94 dBuV/m, Margin 22.98 dB

7.2.3. TRANSMITTER BAND EDGES

BANDEDGE (LOW CHANNEL, HORIZONTAL)

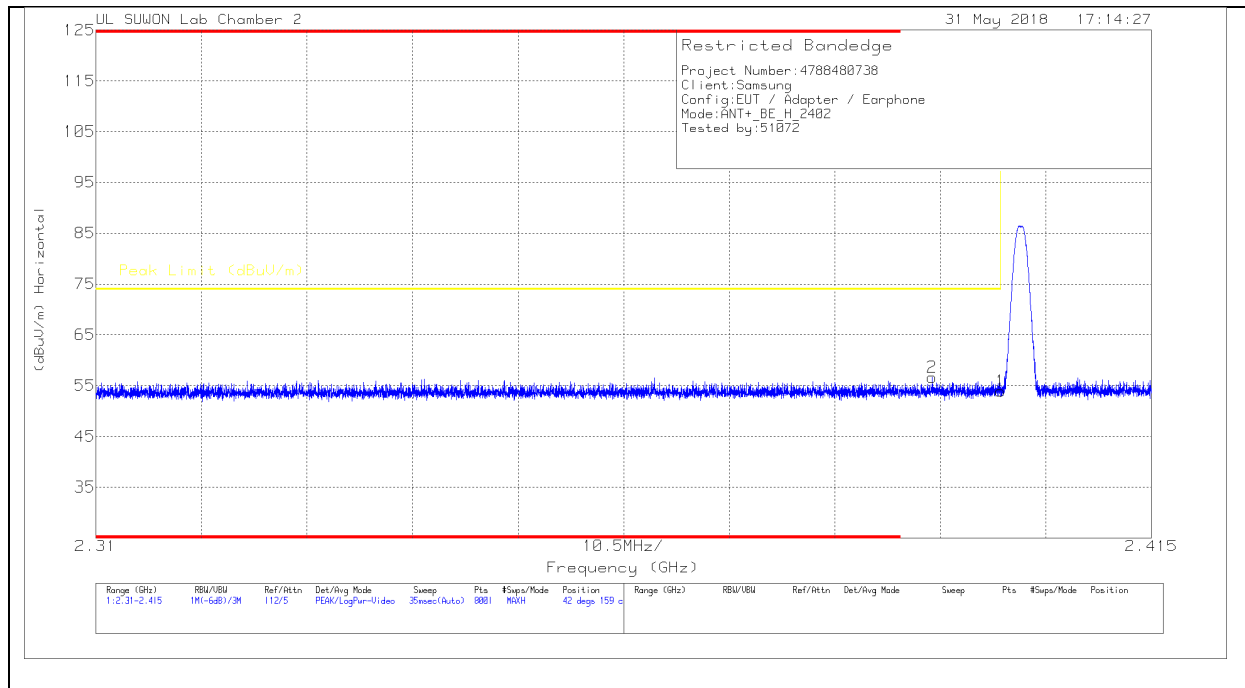

HORIZONTAL DATA

Trace Markers

Marker	Frequency (GHz)	Meter Reading (dBuV)	Det	170531_3117[001687 24]	10dB[dB]	DC Corr (dB)	Corrected Reading (dBuV/m)	Peak Limit (dBuV/m)	PK Margin (dB)	Azimuth (Degs)	Height (cm)	Polarity
1	2.4	40.86	Pk	31.3	-18.2	0	53.96	74	-20.04	42	159	H
2	2.393	43.48	Pk	31.3	-18.2	0	56.58	74	-17.42	42	159	H

Pk - Peak detector

* For marke 1 used the following method to do averaging:

$$DCCF = -24.01 \quad / \quad \text{Peak Reading} = \underline{53.96} \text{ dBu/Vm}$$

$$\text{Corrected AV reading} = \text{Peak Reading} + DCCF$$

$$= 53.96 + -24.01 = \underline{29.95} \text{ dBu/Vm} \quad \text{AVG Limit : 54 dBu/Vm, Margin } \underline{24.05} \text{ dB}$$

* For marke 2 used the following method to do averaging:

$$DCCF = -24.01 \quad / \quad \text{Peak Reading} = \underline{56.58} \text{ dBu/Vm}$$

$$\text{Corrected AV reading} = \text{Peak Reading} + DCCF$$

$$= 56.58 + -24.01 = \underline{32.57} \text{ dBu/Vm} \quad \text{AVG Limit : 54 dBu/Vm, Margin } \underline{21.43} \text{ dB}$$

VERTICAL PEAK AND AVERAGE PLOT

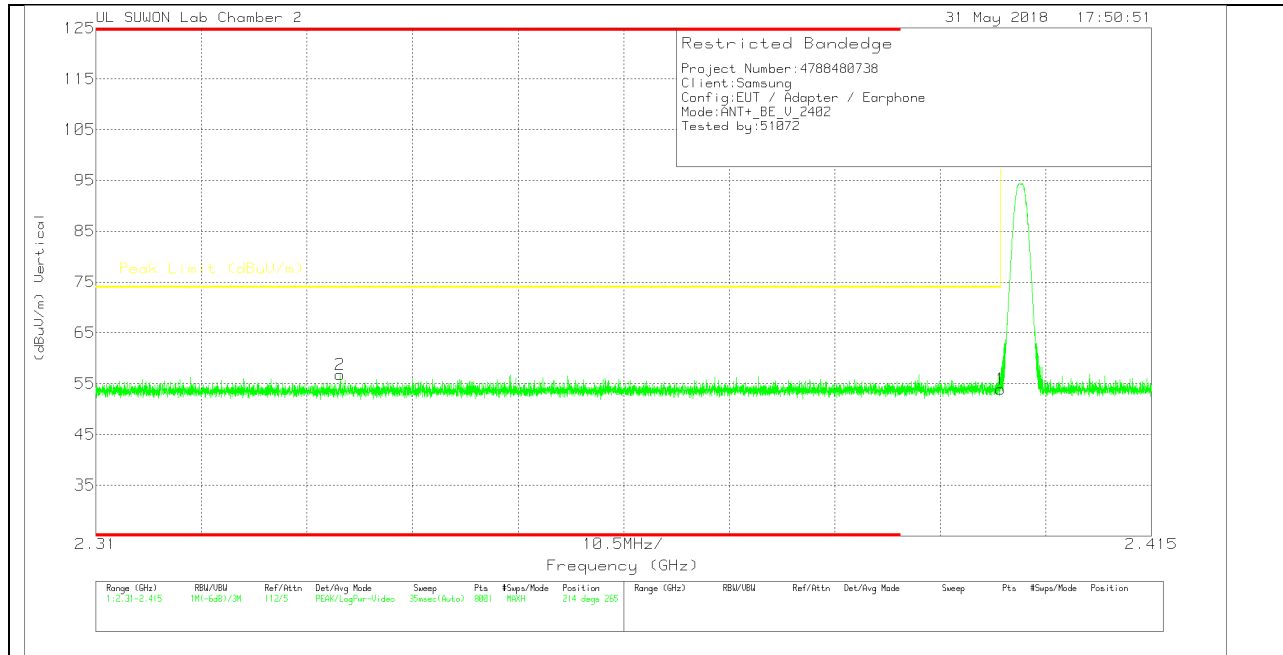

VERTICAL DATA

Trace Markers

Marker	Frequency (GHz)	Meter Reading (dBuV)	Det	170531_3117[001687_24]	10dB[dB]	DC Corr (dB)	Corrected Reading (dBuV/m)	Peak Limit (dBuV/m)	PK Margin (dB)	Azimuth (Degs)	Height (cm)	Polarity
1	2.4	40.78	Pk		-18.2	0	53.88	74	-20.12	214	265	V
2	* 2.334	43.96	Pk		-18.4	0	56.76	74	-17.24	214	265	V

Pk - Peak detector

* For marke 1 used the following method to do averaging:

$$DCCF = -24.01 \quad / \quad \text{Peak Reading} = \underline{53.88} \text{ dBuV/m}$$

$$\text{Corrected AV reading} = \text{Peak Reading} + DCCF$$

$$= 53.88 + -24.01 = \underline{29.87} \text{ dBuV/m} \quad \text{AVG Limit : 54 dBuV/m, Margin } \underline{24.13} \text{ dB}$$

* For marke 2 used the following method to do averaging:

$$DCCF = -24.01 \quad / \quad \text{Peak Reading} = \underline{56.76} \text{ dBuV/m}$$

$$\text{Corrected AV reading} = \text{Peak Reading} + DCCF$$

$$= 56.76 + -24.01 = \underline{32.75} \text{ dBuV/m} \quad \text{AVG Limit : 54 dBuV/m, Margin } \underline{21.25} \text{ dB}$$

AUTHORIZED BANDEDGE (HIGH CHANNEL)

HORIZONTAL PEAK AND AVERAGE PLOT

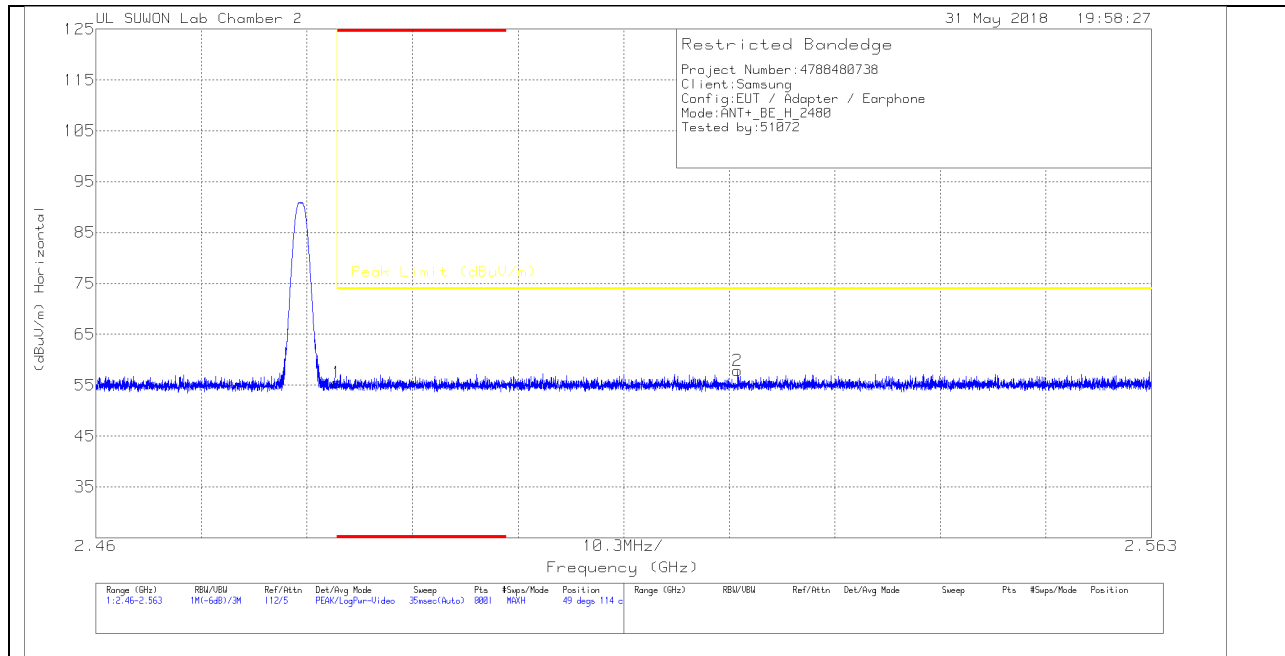

HORIZONTAL DATA

Trace Markers

Marker	Frequency (GHz)	Meter Reading (dBuV)	Det	170531_3117[00168724]	10dB[dB]	Corrected Reading (dBuV/m)	Peak Limit (dBuV/m)	PK Margin (dB)	Azimuth (Degs)	Height (cm)	Polarity
1	* 2.484	41.9	Pk		-18	55.5	74	-18.5	49	114	H
2	2.523	44.22	Pk		-18	57.82	74	-16.18	49	114	H

* - indicates frequency in CFR47 Pt 15 / IC RSS-Restricted Band
 Pk - Peak detector

* For marke 1 used the following method to do averaging:

$$\begin{aligned}
 \text{DCCF} &= -24.01 \quad / \quad \text{Peak Reading} = \underline{55.5} \text{ dBuV/m} \\
 \text{Corrected AV reading} &= \text{Peak Reading} + \text{DCCF} \\
 &= 55.5 + -24.01 = \underline{31.49} \text{ dBuV/m} \quad \text{AVG Limit : 54 dBuV/m, Margin } \underline{22.51} \text{ dB]
 \end{aligned}$$

* For marke 2 used the following method to do averaging:

$$\begin{aligned}
 \text{DCCF} &= -24.01 \quad / \quad \text{Peak Reading} = \underline{57.82} \text{ dBuV/m} \\
 \text{Corrected AV reading} &= \text{Peak Reading} + \text{DCCF} \\
 &= 57.82 + -24.01 = \underline{33.81} \text{ dBuV/m} \quad \text{AVG Limit : 54 dBuV/m, Margin } \underline{20.19} \text{ dB]
 \end{aligned}$$

VERTICAL PEAK AND AVERAGE PLOT

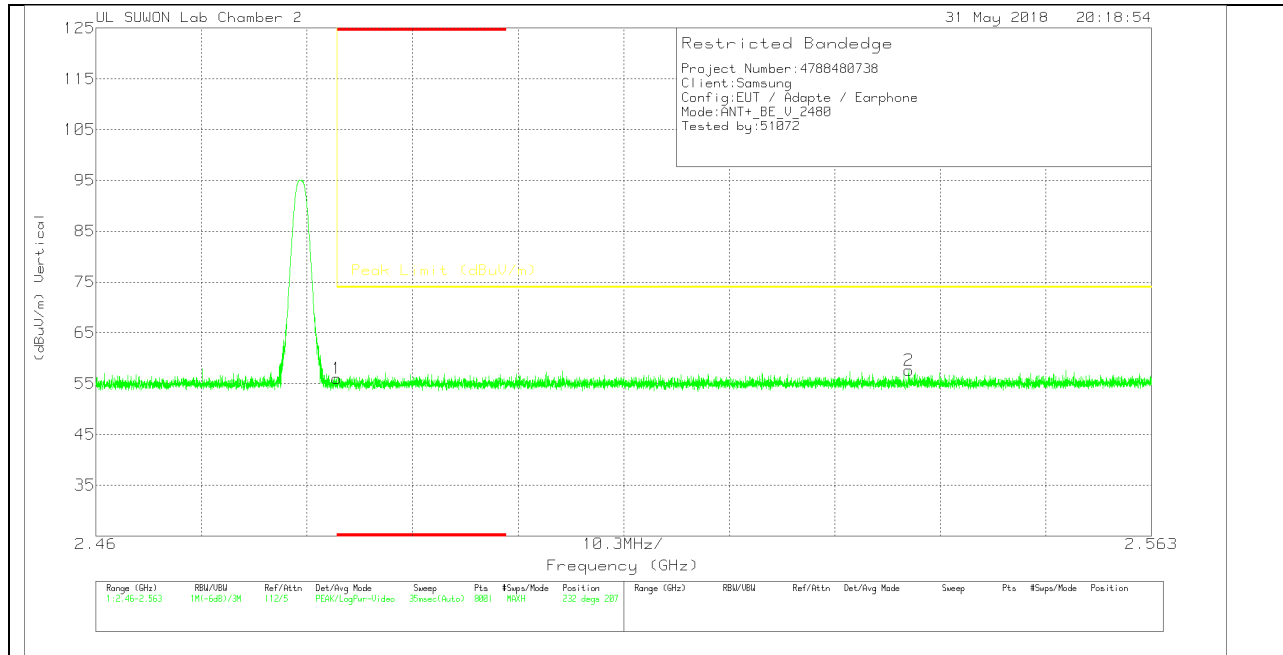

VERTICAL DATA

Trace Markers

Marker	Frequency (GHz)	Meter Reading (dBuV)	Det	170531_3117[001687 24]	10dB[dB]	DC Corr (dB)	Corrected Reading (dBuV/m)	Peak Limit (dBuV/m)	PK Margin (dB)	Azimuth (Degs)	Height (cm)	Polarity
1	* 2.484	42.4	Pk		-18	0	56	74	-18	232	207	V
2	2.539	43.88	Pk		-18	0	57.58	74	-16.42	232	207	V

* - indicates frequency in CFR47 Pt 15 / IC RSS-Restricted Band

Pk - Peak detector

* For marke 1 used the following method to do averaging:

$$DCCF = -24.01 \quad / \quad \text{Peak Reading} = \underline{56} \text{ dBuV/m}$$

$$\text{Corrected AV reading} = \text{Peak Reading} + DCCF$$

$$= 56 + -24.01 = 31.99 \text{ dBuV/m} \quad \text{AVG Limit : 54 dBuV/m, Margin } 22.01 \text{ dB}$$

* For marke 2 used the following method to do averaging:

$$DCCF = -24.01 \quad / \quad \text{Peak Reading} = \underline{57.58} \text{ dBuV/m}$$

$$\text{Corrected AV reading} = \text{Peak Reading} + DCCF$$

$$= 57.58 + -24.01 = 33.57 \text{ dBuV/m} \quad \text{AVG Limit : 54 dBuV/m, Margin } 20.43 \text{ dB}$$

7.2.4. HARMONICS AND SPURIOUS EMISSIONS

LOW CHANNEL HORIZONTAL

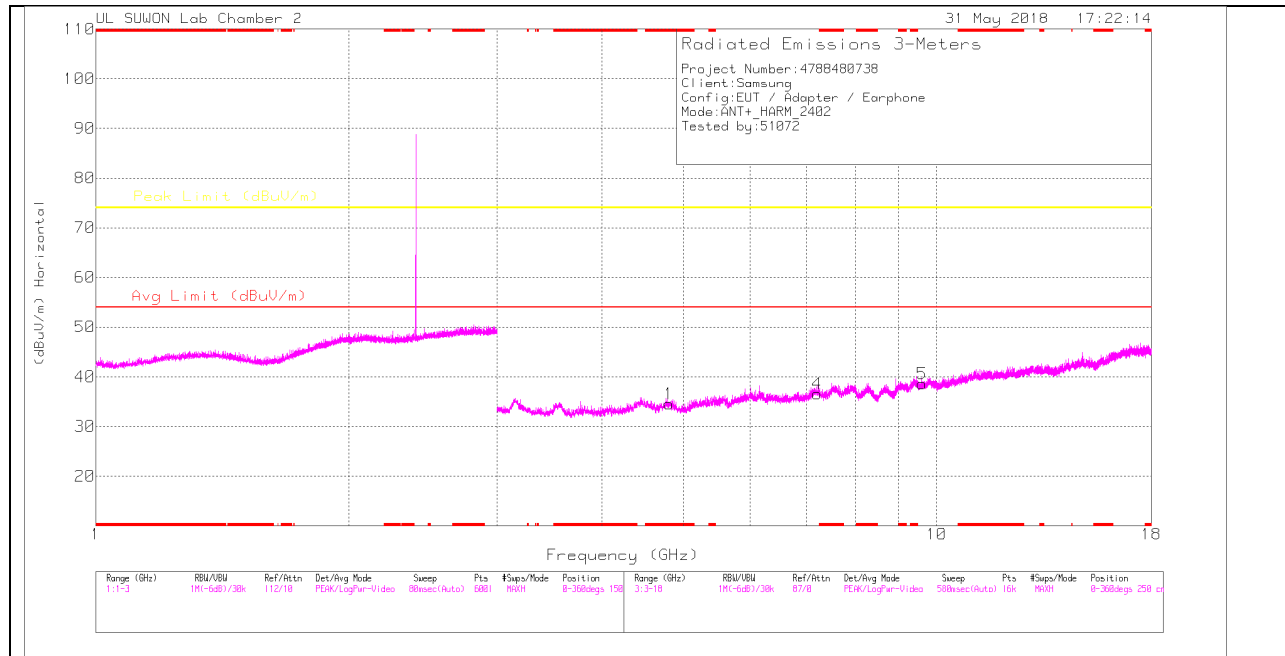

LOW CHANNEL VERTICAL

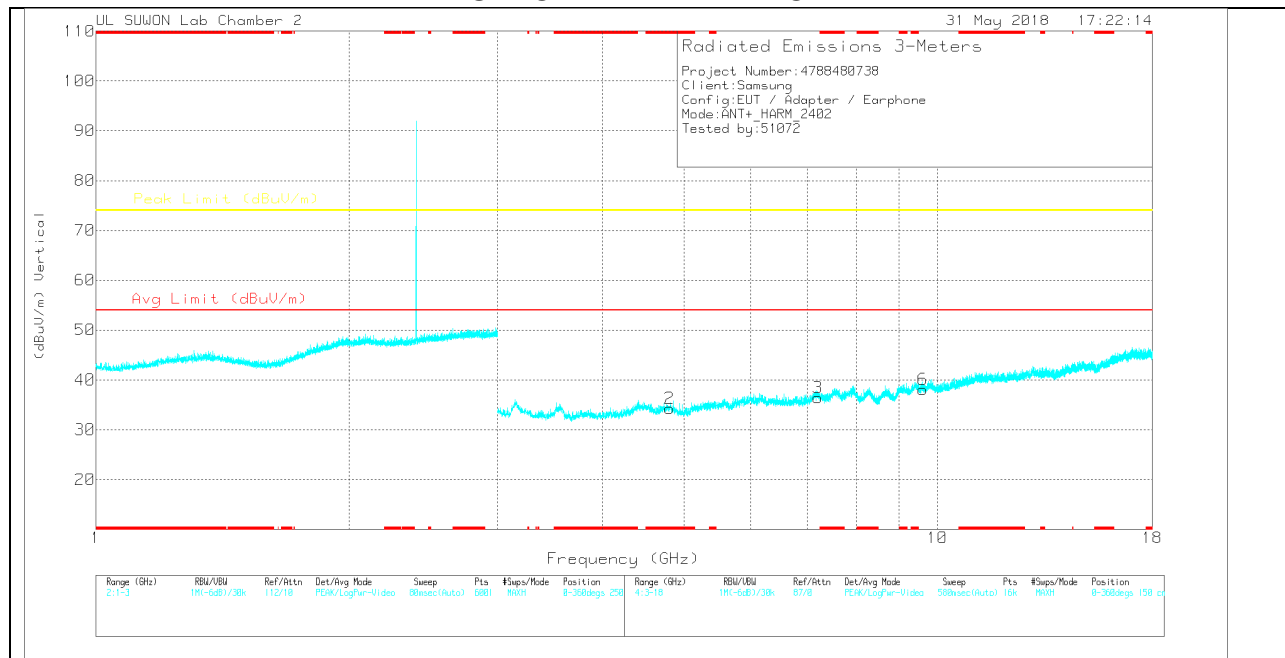

Note: Emission was scanned up to 26GHz; No emissions were detected above the noise floor which was at least 20dB below the specification limit.

LOW CHANNEL DATA

Trace Markers

Marker	Frequency (GHz)	Meter Reading (dBuV)	Det	170531_3117[00168724]	3GHz_HP(dB)	DC Corr (dB)	Corrected Reading (dBuV/m)	Avg Limit (dBuV/m)	Margin (dB)	Peak Limit (dBuV/m)	Margin (dB)	Azimuth (Degs)	Height (cm)	Polarity	
1	* 4.805	25.06	PK		33.8	-24.3	0	34.56	-	-	74	-39.44	0-360	250	H
4	7.206	22.34	PK		35.9	-21.7	0	36.54	-	-	74	-37.46	0-360	250	H
5	9.608	20.28	PK		36.7	-18.4	0	38.58	-	-	74	-35.42	0-360	250	H
2	* 4.805	24.77	PK		33.8	-24.3	0	34.27	-	-	74	-39.73	0-360	250	V
3	7.206	22.19	PK		35.9	-21.7	0	36.39	-	-	74	-37.61	0-360	150	V
6	9.608	19.8	PK		36.7	-18.4	0	38.1	-	-	74	-35.9	0-360	250	V

* - indicates frequency in CFR47 Pt 15 / IC RSS-Restricted Band

PK – Peak Detector

Note: Only peak measurement was performed. Because peak measurement result of unwanted emission is less than average limit (54dBuV/m).

MID CHANNEL HORIZONTAL

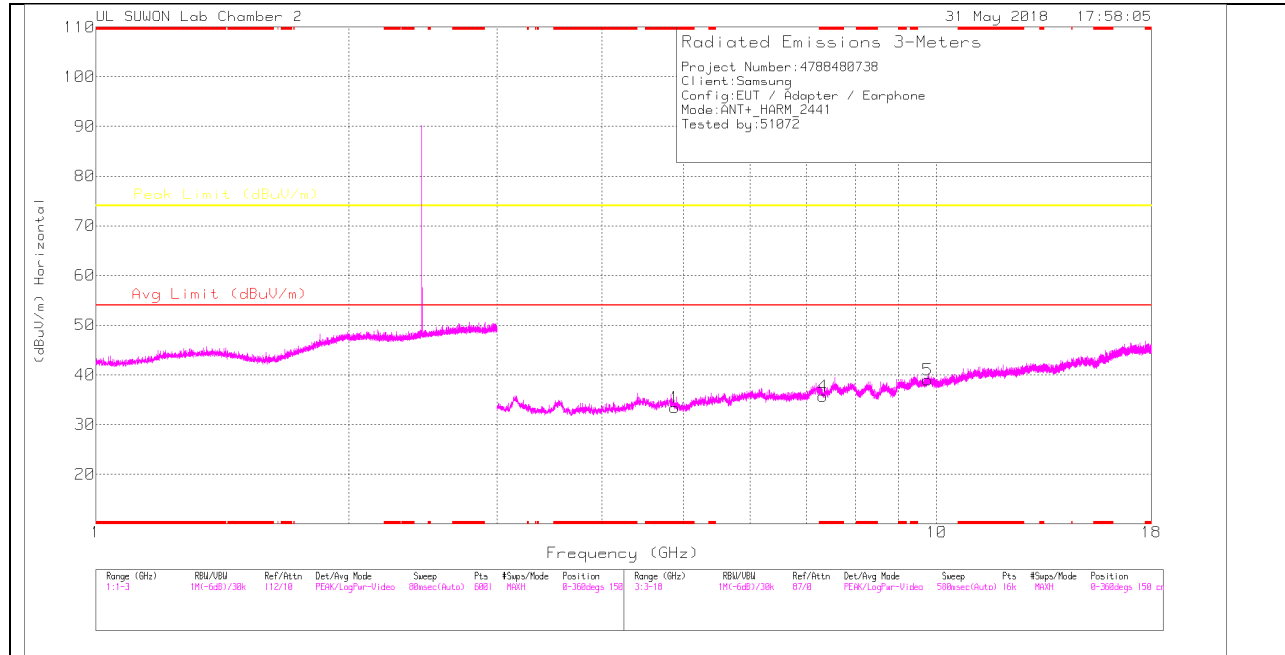

MID CHANNEL VERTICAL

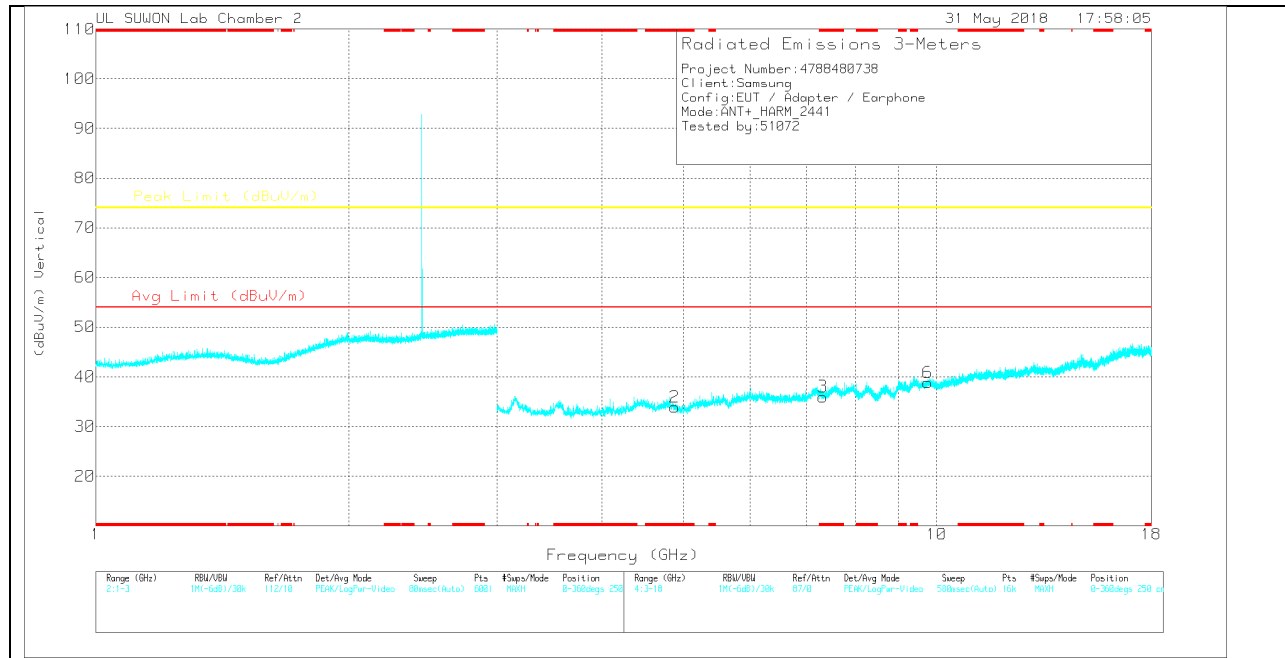

Note: Emission was scanned up to 26GHz; No emissions were detected above the noise floor which was at least 20dB below the specification limit.

MID CHANNEL DATA

Trace Markers

Marker	Frequency (GHz)	Meter Reading (dBuV)	Det	170531_3117(00168724)	3GHz_HP(dB)	DC Corr (dB)	Corrected Reading (dBuV/m)	Avg Limit (dBuV/m)	Margin (dB)	Peak Limit (dBuV/m)	Margin (dB)	Azimuth (Degs)	Height (cm)	Polarity	
1	* 4.882	24.25	PK		33.8	-24.6	0	33.45	-	-	74	-40.55	0-360	150	H
4	* 7.323	21.71	PK		35.9	-21.9	0	35.71	-	-	74	-38.29	0-360	250	H
5	9.765	20.03	PK		36.9	-18	0	38.93	-	-	74	-35.07	0-360	150	H
2	* 4.882	24.66	PK		33.8	-24.6	0	33.86	-	-	74	-40.14	0-360	150	V
3	* 7.323	22	PK		35.9	-21.9	0	36	-	-	74	-38	0-360	150	V
6	9.765	20	PK		36.9	-18	0	38.9	-	-	74	-35.1	0-360	150	V

* - indicates frequency in CFR47 Pt 15 / IC RSS-Restricted Band

PK – Peak Detector

Note: Only peak measurement was performed. Because peak measurement result of unwanted emission is less than average limit (54dBuV/m).

HIGH CHANNEL HORIZONTAL

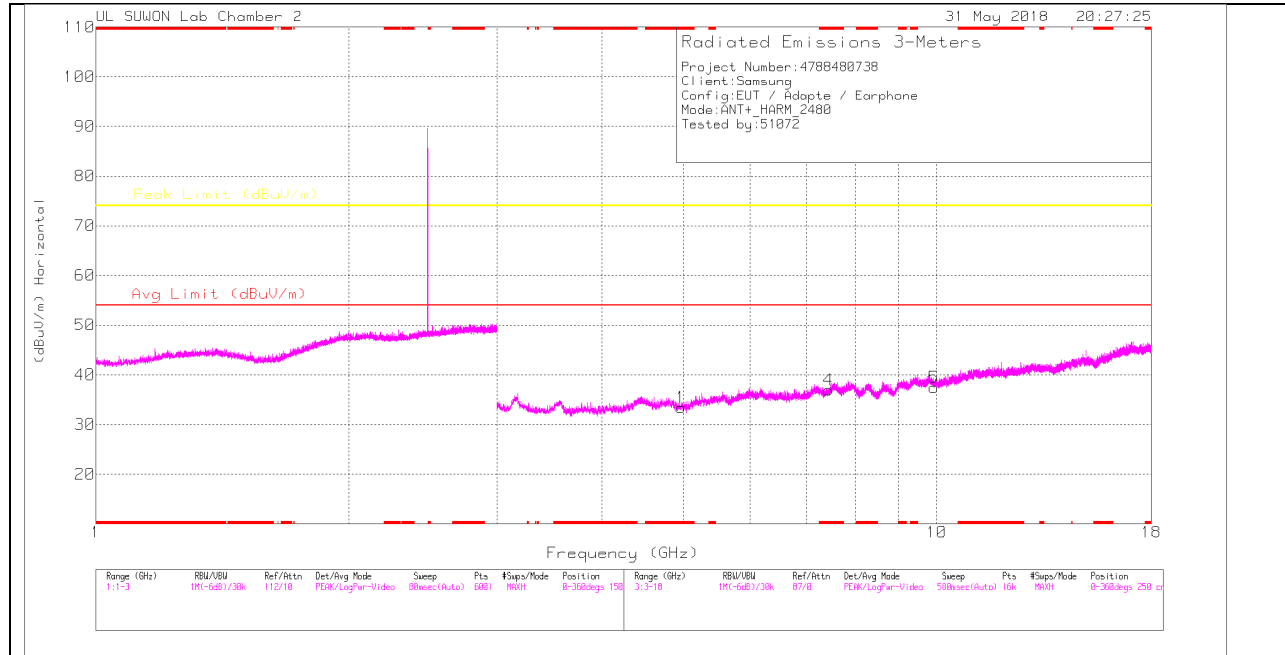

HIGH CHANNEL VERTICAL

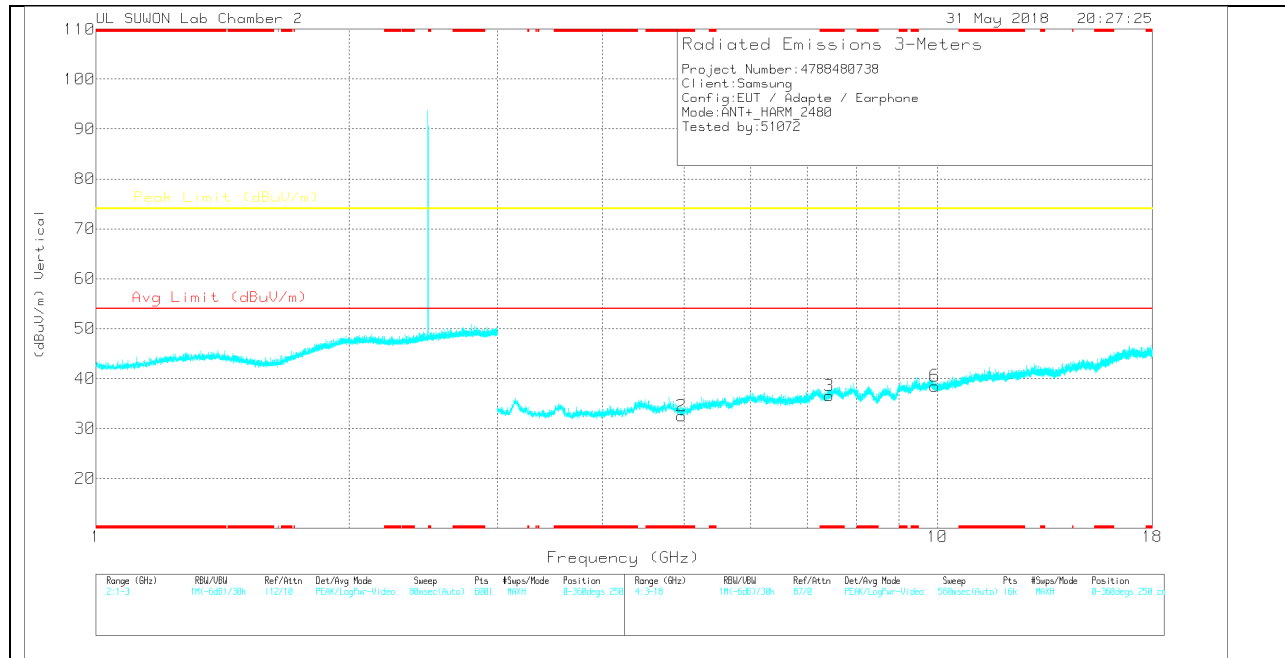

Note: Emission was scanned up to 26GHz; No emissions were detected above the noise floor which was at least 20dB below the specification limit.

HIGH CHANNEL DATA

Trace Markers

Marker	Frequency (GHz)	Meter Reading (dBuV)	Det	170531_3117(00168724)	3GHz_HP(dB)	DC Corr (dB)	Corrected Reading (dBuV/m)	Avg Limit (dBuV/m)	Margin (dB)	Peak Limit (dBuV/m)	Margin (dB)	Azimuth (Degs)	Height (cm)	Polarity	
1	* 4.96	24.33	PK		33.8	-24.7	0	33.43	-	-	74	-40.57	0-360	150	H
4	* 7.441	22.06	PK		35.9	-21	0	36.96	-	-	74	-37.04	0-360	150	H
5	9.92	18.39	PK		37.1	-18	0	37.49	-	-	74	-36.51	0-360	150	H
2	* 4.96	23.48	PK		33.8	-24.7	0	32.58	-	-	74	-41.42	0-360	150	V
3	* 7.441	21.64	PK		35.9	-21	0	36.54	-	-	74	-37.46	0-360	250	V
6	9.92	19.43	PK		37.1	-18	0	38.53	-	-	74	-35.47	0-360	250	V

* - indicates frequency in CFR47 Pt 15 / IC RSS-Restricted Band
 PK – Peak Detector

Note: Only peak measurement was performed. Because peak measurement result of unwanted emission is less than average limit (54dBuV/m).

7.2.5. SPURIOUS BELOW 1 GHz

SPURIOUS EMISSIONS 30 TO 1000 MHz (HORIZONTAL)

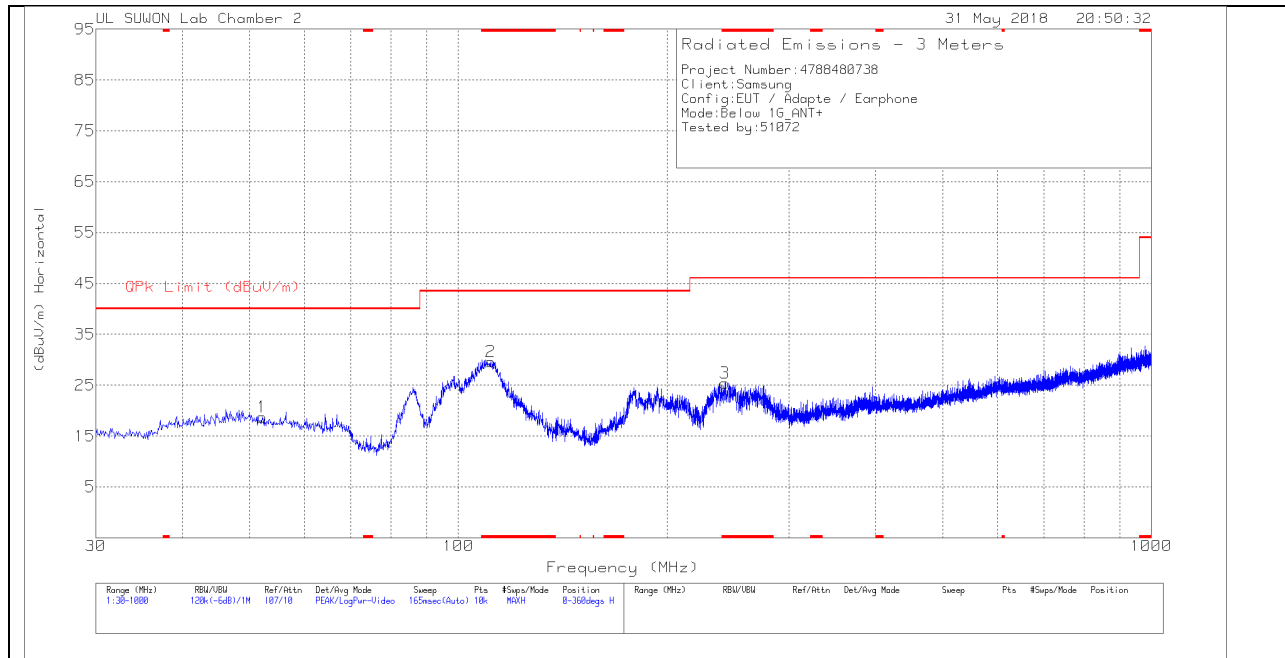

SPURIOUS EMISSIONS 30 TO 1000 MHz (VERTICAL)

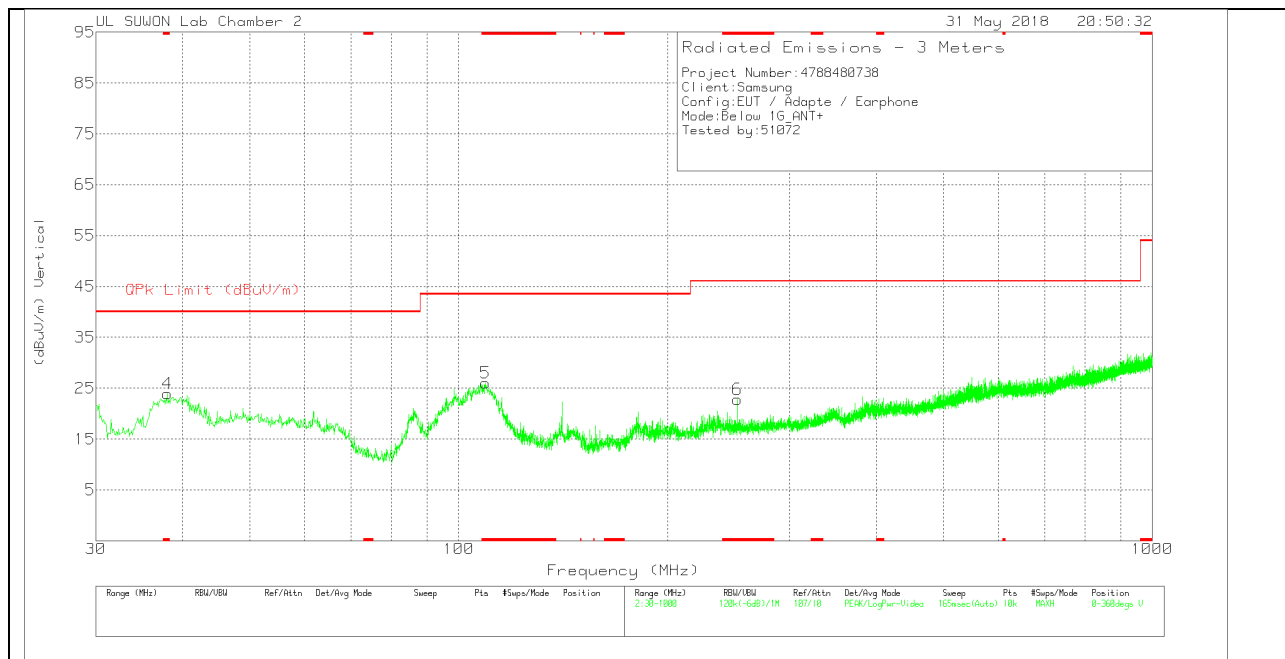

BELOW 1 GHz TABLE

Trace Markers

Marker	Frequency (MHz)	Meter Reading (dBuV)	Det	VULB9163-749	30-1000MHz[dB]	Corrected Reading (dBuV/m)	QPk Limit (dBuV/m)	Margin (dB)	Azimuth (Degs)	Height (cm)	Polarity
1	52.116	30.39	Pk	19.7	-31.4	18.69	40	-21.31	0-360	300	H
2	* 111.286	43.63	Pk	17	-31	29.63	43.52	-13.89	0-360	300	H
3	* 242.527	37.68	Pk	18	-30.3	25.38	46.02	-20.64	0-360	100	H
4	* 38.051	37.23	Pk	18.3	-31.6	23.93	40	-16.07	0-360	100	V
5	* 109.249	39.78	Pk	17.2	-31	25.98	43.52	-17.54	0-360	100	V
6	* 252.227	34.87	Pk	18.2	-30.3	22.77	46.02	-23.25	0-360	300	V

* - indicates frequency in CFR47 Pt 15 / IC RSS-Restricted Band
 Pk - Peak detector

8. AC POWER LINE CONDUCTED EMISSIONS

LIMITS

FCC §15.207 (a)

Frequency of emission (MHz)	Conducted limit (dB μ V)	
	Quasi-peak	Average
0.15-0.5	66 to 56*	56 to 46*
0.5-5	56	46
5-30	60	50

*Decreases with the logarithm of the frequency.

TEST PROCEDURE

The EUT is placed on a non-conducting table 40 cm from the vertical ground plane and 80 cm above the horizontal ground plane. The EUT is configured in accordance with ANSI C63.10.

The receiver is set to a resolution bandwidth of 9 kHz. Peak detection is used unless otherwise noted as quasi-peak or average.

Line conducted data is recorded for both NEUTRAL and HOT lines.

RESULTS

6 WORST EMISSIONS

LINE 1 PLOT

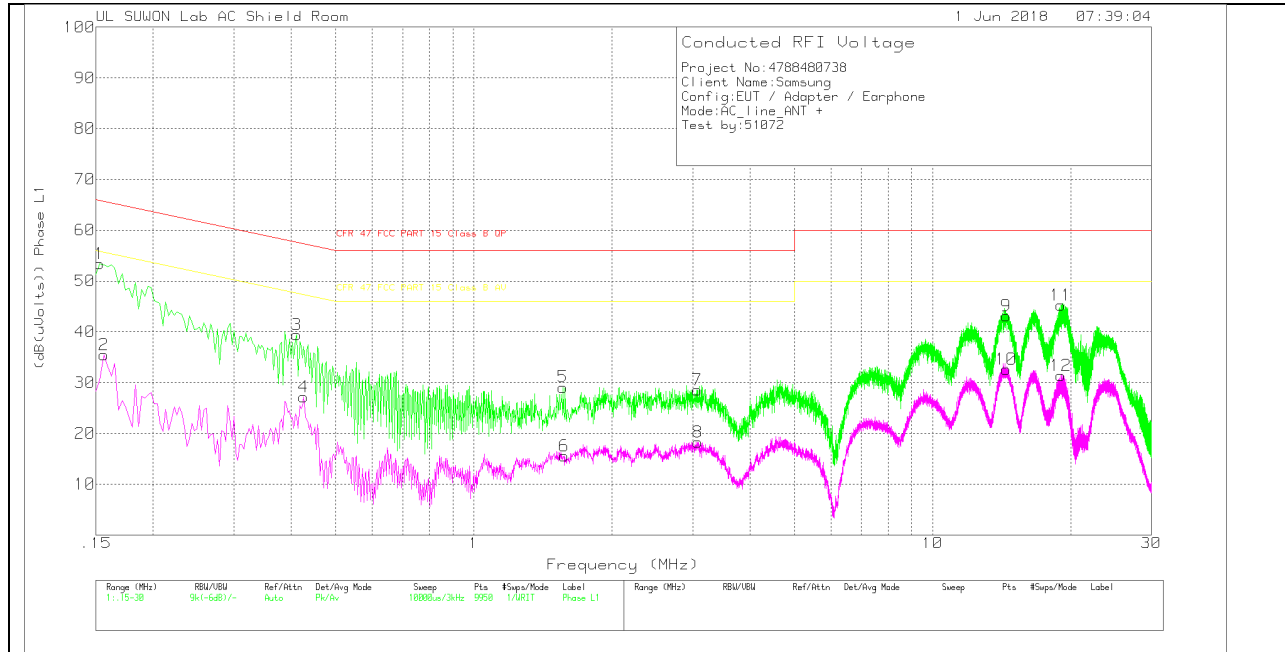

LINE 1 RESULTS

Trace Markers

Range 1: Phase L1 .15 - 30MHz

Marker	Frequency (MHz)	Meter Reading (dBuV)	Det	101837_L1_with extension	CABLELOSS(dB)	Corrected Reading (dB(uVolts))	CFR 47 FCC PART 15 Class B QP	Margin (dB)	CFR 47 FCC PART 15 Class B AV	Margin (dB)
1	.153	43.34	Pk	10	.1	53.44	65.84	-12.4	-	-
2	.156	25.42	Av	10	.1	35.52	-	-	55.67	-20.15
3	.411	29.47	Pk	9.8	.2	39.47	57.63	-18.16	-	-
4	.426	17.24	Av	9.7	.2	27.14	-	-	47.33	-20.19
5	1.566	18.9	Pk	9.9	.3	29.1	56	-26.9	-	-
6	1.572	5.32	Av	9.9	.3	15.52	-	-	46	-30.48
7	3.075	18.43	Pk	9.8	.3	28.53	56	-27.47	-	-
8	3.078	8.23	Av	9.8	.3	18.33	-	-	46	-27.67
9	14.481	32.97	Pk	9.8	.4	43.17	60	-16.83	-	-
10	14.487	22.44	Av	9.8	.4	32.64	-	-	50	-17.36
11	19.047	34.79	Pk	10	.4	45.19	60	-14.81	-	-
12	19.038	20.95	Av	10	.4	31.35	-	-	50	-18.65

Pk - Peak detector

Av - Average detection

Quasi-Peak Emissions

Range 1: Phase L1 .15 - 30MHz

Frequency (MHz)	Meter Reading (dBuV)	Det	101837_L1_with extension	CABLELOSS(dB)	Corrected Reading (dB(uVolts))	CFR 47 FCC PART 15 Class B QP	Margin (dB)	CFR 47 FCC PART 15 Class B AV	Margin (dB)
.15315	35.22	Qp	10	.1	45.32	65.83	-20.51	-	-
.15615	35	Qp	10	.1	45.1	65.67	-20.57	-	-
.41025	20.07	Qp	9.8	.2	30.07	57.64	-27.57	-	-
.42615	18.91	Qp	9.7	.2	28.81	57.33	-28.52	-	-
1.56675	12.1	Qp	9.9	.3	22.3	56	-33.7	-	-
1.57125	12.17	Qp	9.9	.3	22.37	56	-33.63	-	-
3.07515	14.07	Qp	9.8	.3	24.17	56	-31.83	-	-
3.07815	14	Qp	9.8	.3	24.1	56	-31.9	-	-
14.4812	30.6	Qp	9.8	.4	40.8	60	-19.2	-	-
14.4863	30.45	Qp	9.8	.4	40.65	60	-19.35	-	-
19.0463	30.2	Qp	10	.4	40.6	60	-19.4	-	-
19.0388	30.25	Qp	10	.4	40.65	60	-19.35	-	-

Qp - Quasi-Peak detector

LINE 2 PLOT

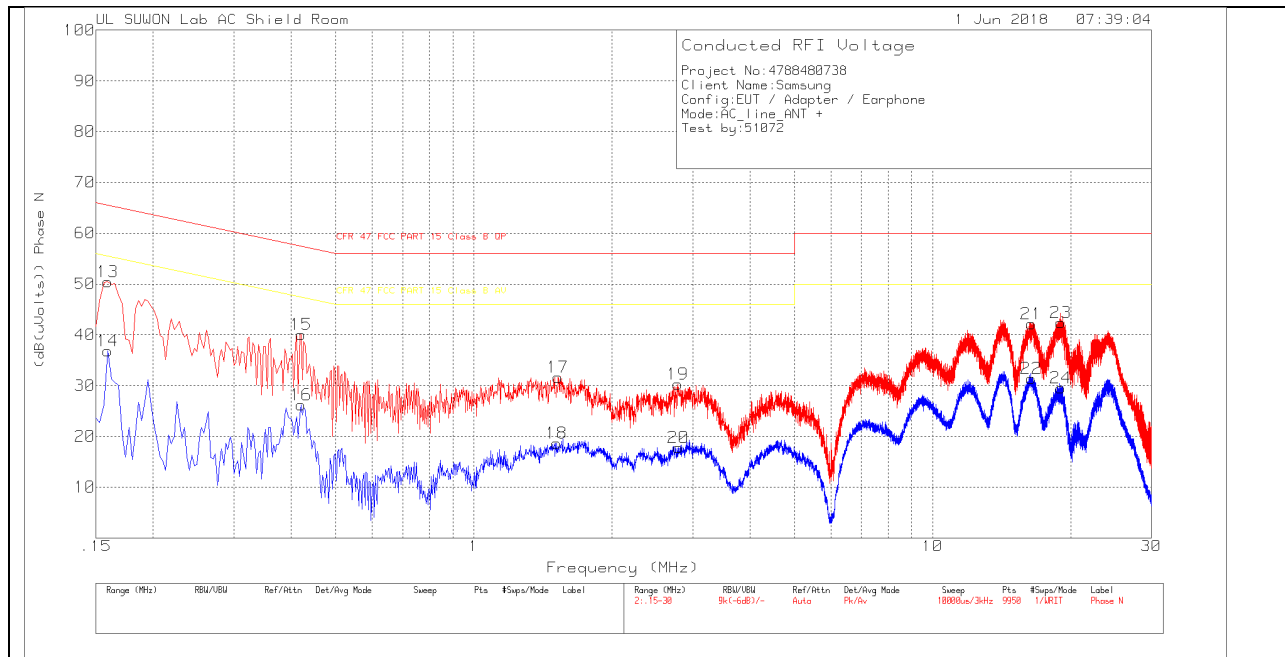

LINE 2 RESULTS

Trace Markers

Range 2: Phase N .15 - 30MHz

Marker	Frequency (MHz)	Meter Reading (dBuV)	Det	101837_N_with extension	CABLELOSS(dB)	Corrected Reading (dB(uVolts))	CFR 47 FCC PART 15 Class B QP	Margin (dB)	CFR 47 FCC PART 15 Class B AV	Margin (dB)
13	.159	40.32	Pk	10	.1	50.42	65.52	-15.1	-	-
14	.159	26.69	Av	10	.1	36.79	-	-	55.52	-18.73
15	.42	30.09	Pk	9.8	.2	40.09	57.45	-17.36	-	-
16	.42	16.15	Av	9.8	.2	26.15	-	-	47.45	-21.3
17	1.527	21.41	Pk	9.9	.3	31.61	56	-24.39	-	-
18	1.515	8.47	Av	9.9	.3	18.67	-	-	46	-27.33
19	2.784	20.03	Pk	9.9	.3	30.23	56	-25.77	-	-
20	2.79	7.54	Av	9.9	.3	17.74	-	-	46	-28.26
21	16.425	31.87	Pk	9.9	.4	42.17	60	-17.83	-	-
22	16.428	21.08	Av	9.9	.4	31.38	-	-	50	-18.62
23	19.035	32.01	Pk	10	.4	42.41	60	-17.59	-	-
24	19.032	19.14	Av	10	.4	29.54	-	-	50	-20.46

Pk - Peak detector

Av - Average detection

Quasi-Peak Emissions

Range 2: Phase N .15 - 30MHz

Frequency (MHz)	Meter Reading (dBuV)	Det	101837_N_with extension	CABLELOSS(dB)	Corrected Reading (dB(uVolts))	CFR 47 FCC PART 15 Class B QP	Margin (dB)	CFR 47 FCC PART 15 Class B AV	Margin (dB)
.15915	32	Qp	10	.1	42.1	65.51	-23.41	-	-
.41925	22.2	Qp	9.8	.2	32.2	57.46	-25.26	-	-
1.52715	19.25	Qp	9.9	.3	29.45	56	-26.55	-	-
1.51425	19.12	Qp	9.9	.3	29.32	56	-26.68	-	-
2.78325	14.9	Qp	9.9	.3	25.1	56	-30.9	-	-
2.79015	14.89	Qp	9.9	.3	25.09	56	-30.91	-	-
16.4258	28.6	Qp	9.9	.4	38.9	60	-21.1	-	-
16.4273	28.57	Qp	9.9	.4	38.87	60	-21.13	-	-
19.0352	28.42	Qp	10	.4	38.82	60	-21.18	-	-
19.0313	28.35	Qp	10	.4	38.75	60	-21.25	-	-

Qp - Quasi-Peak detector