



FCC CFR47 PART 15 SUBPART C

DTS Wireless LAN

CERTIFICATION TEST REPORT

FOR

GSM/WCDMA/LTE Phone + BT/BLE, DTS/UNII a/b/g/n and ANT+

MODEL NUMBER : SM-A605G/DS, SM-A605G

FCC ID: A3LSMA605G

REPORT NUMBER: 4788371693-E1V1

ISSUE DATE: MAR 27, 2018

Prepared for
SAMSUNG ELECTRONICS CO., LTD.
129 SAMSUNG-RO, YEONGTONG-GU, SUWON-SI,
GYEONGGI-DO, 16677, KOREA

Prepared by
UL Korea, Ltd.
26th floor, 152, Teheran-ro, Gangnam-gu Seoul, 06236, Korea

Suwon Test Site: UL Korea, Ltd. Suwon Laboratory
218 Maeyeong-ro, Yeongtong-gu,
Suwon-si, Gyeonggi-do, 16675, Korea
TEL: (031) 337-9902
FAX: (031) 213-5433



Testing
Laboratory

TL-637

Revision History

<u>Rev.</u>	<u>Issue Date</u>	<u>Revisions</u>	<u>Revised By</u>
V1	03/27/18	Initial issue	Junwhan Lee

TABLE OF CONTENTS

1. ATTESTATION OF TEST RESULTS	5
1.1. INTRODUCTION OF TEST DATA REUSE.....	6
1.2. DIFFERENCE.....	6
1.3. SPOT CHECK VERIFICATION DATA	6
1.4. REFERENCE DETAIL	7
2. TEST METHODOLOGY	8
3. FACILITIES AND ACCREDITATION	8
4. CALIBRATION AND UNCERTAINTY	8
4.1. MEASURING INSTRUMENT CALIBRATION	8
4.2. SAMPLE CALCULATION	8
4.3. MEASUREMENT UNCERTAINTY.....	8
5. EQUIPMENT UNDER TEST.....	9
5.1. DESCRIPTION OF EUT	9
5.2. MAXIMUM OUTPUT POWER.....	9
5.3. DESCRIPTION OF AVAILABLE ANTENNAS	9
5.4. WORST-CASE CONFIGURATION AND MODE.....	9
5.5. DESCRIPTION OF TEST SETUP.....	10
6. TEST AND MEASUREMENT EQUIPMENT	12
7. REFERENCE MEASUREMENT RESULTS.....	13
7.1. ON TIME AND DUTY CYCLE RESULTS.....	13
8. MEASUREMENT METHODS	14
9. SUMMARY TABLE	15
10. ANTENNA PORT TEST RESULTS	16
10.1. 6 dB BANDWIDTH.....	16
10.1.1. 802.11b MODE IN THE 2.4 GHz BAND	17
10.1.1.1. 802.11g MODE IN THE 2.4 GHz BAND	17
10.1.1.2. 802.11n HT20 MODE IN THE 2.4 GHz BAND.....	17
10.1.2. 802.11n HT20 MODE IN THE 2.4 GHz BAND.....	17
10.1.3. 6 dB BANDWIDTH PLOTS.....	18
10.2. OUTPUT POWER.....	21
10.2.1. 802.11b MODE IN THE 2.4 GHz BAND	22
10.2.2. 802.11g MODE IN THE 2.4 GHz BAND	23
10.2.3. 802.11n HT20 MODE IN THE 2.4 GHz BAND.....	24
10.3. PSD.....	25
10.3.1. 802.11b MODE IN THE 2.4 GHz BAND	26

10.3.2.	802.11g MODE IN THE 2.4 GHz BAND	26
10.3.3.	802.11n HT20 MODE IN THE 2.4 GHz BAND.....	26
10.3.4.	PSD PLOTS	27
10.4.	<i>OUT-OF-BAND EMISSIONS</i>	30
10.4.1.	802.11b MODE IN THE 2.4 GHz BAND	31
10.4.2.	802.11g MODE IN THE 2.4 GHz BAND	36
10.4.3.	802.11n HT20 MODE IN THE 2.4 GHz BAND.....	41
11.	RADIATED TEST RESULTS	46
11.1.	<i>LIMITS AND PROCEDURE</i>	46
11.2.	<i>TRANSMITTER ABOVE 1 GHz</i>	48
11.2.1.	TX ABOVE 1 GHz 802.11b MODE IN THE 2.4 GHz BAND	48
11.2.2.	TX ABOVE 1 GHz 802.11g MODE IN THE 2.4 GHz BAND.....	62
11.2.3.	TX ABOVE 1 GHz 802.11n HT20 MODE IN THE 2.4 GHz BAND	76
11.3.	<i>WORST-CASE BELOW 1 GHz</i>	90
12.	AC POWER LINE CONDUCTED EMISSIONS	92
13.	SETUP PHOTOS	97

1. ATTESTATION OF TEST RESULTS

COMPANY NAME: SAMSUNG ELECTRONICS CO., LTD.

EUT DESCRIPTION: GSM/WCDMA/LTE Phone + BT/BLE, DTS/UNII a/b/g/n and ANT+

MODEL NUMBER: SM-A605G/DS, SM-A605G

SERIAL NUMBER: R38K104PV9X (RADIATED, Original);
R38K104QEYH (CONDUCTED, Original);
R38K10D6MJN (RADIATED, Spot check)

DATE TESTED: FEB 22, 2018 - MAR 03, 2018 (Original)
MAR 15, 2018 (Spot check)

APPLICABLE STANDARDS	
STANDARD	TEST RESULTS
CFR 47 Part 15 Subpart C	Pass

UL Korea, Ltd. tested the above equipment in accordance with the requirements set forth in the above standards. All indications of Pass/Fail in this report are opinions expressed by UL Korea, Ltd. based on interpretations and/or observations of test results. Measurement Uncertainties were not taken into account and are published for informational purposes only. The test results show that the equipment tested is capable of demonstrating compliance with the requirements as documented in this report.

Note: The results documented in this report apply only to the tested sample, under the conditions and modes of operation as described herein. This document may not be altered or revised in any way unless done so by UL Korea, Ltd. and all revisions are duly noted in the revisions section. Any alteration of this document not carried out by UL Korea, Ltd. will constitute fraud and shall nullify the document. This report must not be used by the client to claim product certification, approval, or endorsement by IAS, any agency of the Federal Government, or any agency of any government.

Approved & Released For
UL Korea, Ltd. By:



SungGil Park
Suwon Lab Engineer
UL Korea, Ltd.

Tested By:



Junwhan Lee
Suwon Lab Engineer
UL Korea, Ltd.

1.1. INTRODUCTION OF TEST DATA REUSE

This report referenced from the FCC ID: A3LSMA605GN DTS WLAN(FCC CFR 47 Part 15C). And the applicant takes full responsibility that the test data as referenced in this report represent compliance for this FCC ID.

1.2. DIFFERENCE

The FCC ID: A3LSMA605G shares the same enclosure and circuit board as FCC ID: A3LSMA605GN. The WLAN antennas and surrounding circuitry and layout are identical between these two units.

After confirming through preliminary radiated emissions that the performance of the FCC ID: A3LSMA605GN remains representative of FCC ID: A3LSMA605G. The test data of FCC ID: A3LSMA605GN being submitted for this application to cover WLAN features.

1.3. SPOT CHECK VERIFICATION DATA

Band	Test Item	Mode	Frequency	Test Limit	Original model	Spot check model	Deviation	Remark
					SM-A605GN/DS Results	SM-A605G/DS Results		
					FCC ID : A3LSMA605GN	FCC ID : A3LSMA605G		
DTS WLAN (2.4GHz)	Band Edge	802.11b	2472 MHz	54 dBuV/m	49.77 dBuV/m	45.46 dBuV/m	-4.31 dB	
	RSE	802.11b	2412 MHz	54 dBuV/m	46.53 dBuV/m	42.06 dBuV/m	-4.47 dB	
	Band Edge	802.11g	2472 MHz	54 dBuV/m	49.92 dBuV/m	47.89 dBuV/m	-2.03 dB	
	RSE	802.11g	2412 MHz	74 dBuV/m	42.00 dBuV/m	40.84 dBuV/m	-1.16 dB	Noise floor level
	Band Edge	802.11n	2472 MHz	54 dBuV/m	49.91 dBuV/m	48.93 dBuV/m	-0.98 dB	
	RSE	802.11n	2462 MHz	74 dBuV/m	41.63 dBuV/m	39.78 dBuV/m	-1.85 dB	Noise floor level

Comparison of two models, higher deviation is within 3dB range and all test results are under FCC Technical Limits.

1.4. REFERENCE DETAIL

Reference application that contains the reused reference data.

Equipment Class	Reference FCC ID	Type Grant/Permissive Change	Reference Application	Folder Test/RF Exposure	Report Title / Section
DTS	A3LSMA605GN	Grant	4788371689-E1V1	Test	FCC Report DTS WLAN / All sections
			4788371689-E2V1	Test	FCC Report BLE / All sections
DSS	A3LSMA605GN	Grant	4788371689-E3V1	Test	FCC Report BT / All sections
NII	A3LSMA605GN	Grant	4788371689-E4V1	Test	FCC Report UNII WLAN / All sections
DXX	A3LSMA605GN	Grant	4788371689-E5V1	Test	FCC Report ANT+ / All sections
PCE	A3LSMA605GN	Grant	4788371689-E7V1	Test	FCC Report WWAN / All sections

2. TEST METHODOLOGY

The tests documented in this report were performed in accordance with following methods.

1. FCC CFR 47 Part 2.
2. FCC CFR 47 Part 15.
3. KDB 558074 D01 DTS Meas Guidance v04.
4. ANSI C63.10-2013.

3. FACILITIES AND ACCREDITATION

The test sites and measurement facilities used to collect data are located at 218 Maeyeong-ro, Yeongtong-gu, Suwon-si, Gyeonggi-do, 16675, Korea. Line conducted emissions are measured only at the 218 address. The following table identifies which facilities were utilized for radiated emission measurements documented in this report. Specific facilities are also identified in the test results sections.

218 Maeyeong-ro	
<input checked="" type="checkbox"/>	Chamber 1
<input checked="" type="checkbox"/>	Chamber 2
<input checked="" type="checkbox"/>	Chamber 3

UL Korea, Ltd. is accredited by IAS, Laboratory Code TL-637. The full scope of accreditation can be viewed at <http://www.iasonline.org/PDF/TL/TL-637.pdf>.

4. CALIBRATION AND UNCERTAINTY

4.1. MEASURING INSTRUMENT CALIBRATION

The measuring equipment utilized to perform the tests documented in this report has been calibrated in accordance with the manufacturer's recommendations, and is traceable to recognized national standards.

4.2. SAMPLE CALCULATION

Where relevant, the following sample calculation is provided:

$$\begin{aligned} \text{Field Strength (dBuV/m)} &= \text{Measured Voltage (dBuV)} + \text{Antenna Factor (dB/m)} + \\ &\text{Cable Loss (dB)} - \text{Preamp Gain (dB)} \\ 36.5 \text{ dBuV} + 18.7 \text{ dB/m} + 0.6 \text{ dB} - 26.9 \text{ dB} &= 28.9 \text{ dBuV/m} \end{aligned}$$

4.3. MEASUREMENT UNCERTAINTY

Where relevant, the following measurement uncertainty levels have been estimated for tests performed on the apparatus:

PARAMETER	UNCERTAINTY
Conducted Disturbance, 0.15 to 30 MHz	2.32 dB
Radiated Disturbance, Below 1GHz	3.86 dB
Radiated Disturbance, Above 1 GHz	5.97 dB

Uncertainty figures are valid to a confidence level of 95%.

5. EQUIPMENT UNDER TEST

5.1. DESCRIPTION OF EUT

The EUT is a GSM/WCDMA/LTE Phone + BT/BLE, DTS/UNII a/b/g/n and ANT+. This test report addresses the DTS (WLAN) operational mode.

5.2. MAXIMUM OUTPUT POWER

The transmitter has a maximum total conducted average output power as follows:

Frequency Range [MHz]	Mode	Output Power [dBm]	Output Power [mW]
2412 - 2472	802.11b	18.72	74.47
	802.11g	13.43	22.03
	802.11n HT20	12.68	18.54

5.3. DESCRIPTION OF AVAILABLE ANTENNAS

The radio utilizes an internal antennas, with a antenna's maximum gain of -3.25 dBi.

5.4. WORST-CASE CONFIGURATION AND MODE

Radiated emission below 1GHz and power line conducted emission were performed with the EUT set to transmit at the channel with highest output power as worst-case scenario.

Radiated emission above 1GHz was performed with the EUT set to transmit low/mid/high channels.

The fundamental of the EUT was investigated in three orthogonal orientations X, Y and Z it was determined that Y orientation was worst-case orientation; therefore, all final radiated testing was performed with the EUT in Y orientation.

Based on the baseline scan, the worst-case data rates were:

802.11b mode: 1 Mbps
802.11g mode: 6 Mbps
802.11n HT20 mode: MCS0

Note : All radiated and power line conducted tests were performed connected with earphone and charger for evaluation of worst case mode.

5.5. DESCRIPTION OF TEST SETUP

SUPPORT EQUIPMENT

Support Equipment List				
Description	Manufacturer	Model	Serial Number	FCC ID
Charger	SAMSUNG	EP-TA50EWE	DW3J719AS/A -E	N/A
Data Cable	SAMSUNG	ECB-DU68WE	N/A	N/A
Earphone	SAMSUNG	EHS61ASFWE	N/A	N/A

I/O CABLES

I/O Cable List						
Cable No	Port	# of identical ports	Connector Type	Cable Type	Cable Length (m)	Remarks
1	DC Power	1	Mini-USB	Shielded	1.2m	N/A
2	Audio	2	Mini-Jack	Unshielded	1.2m	N/A

TEST SETUP

The EUT is a stand-alone unit during the tests.
Test software in hidden menu exercised the EUT to enable DTS mode.

SETUP DIAGRAM FOR TESTS (CONDUCTED TEST SETUP)

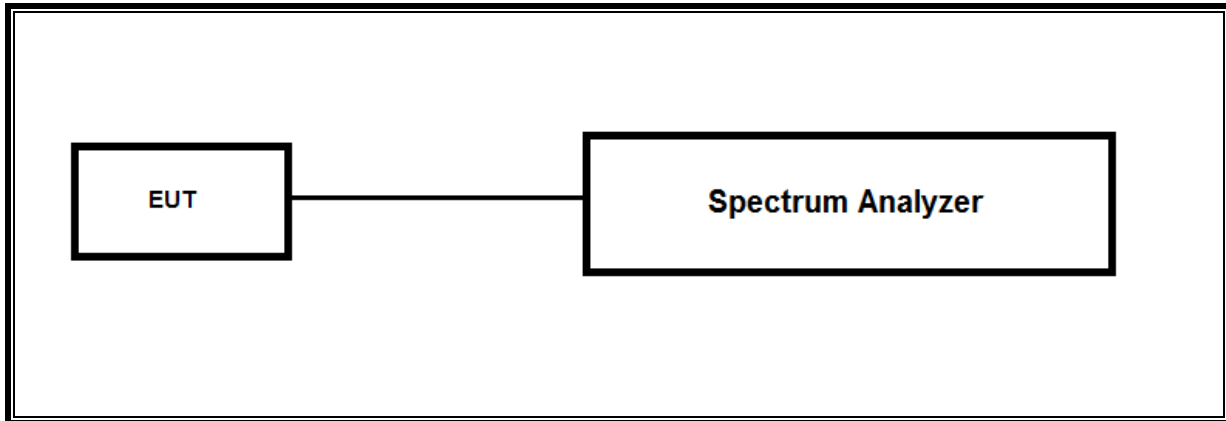

SETUP DIAGRAM FOR TESTS (RADIATED TEST SETUP)

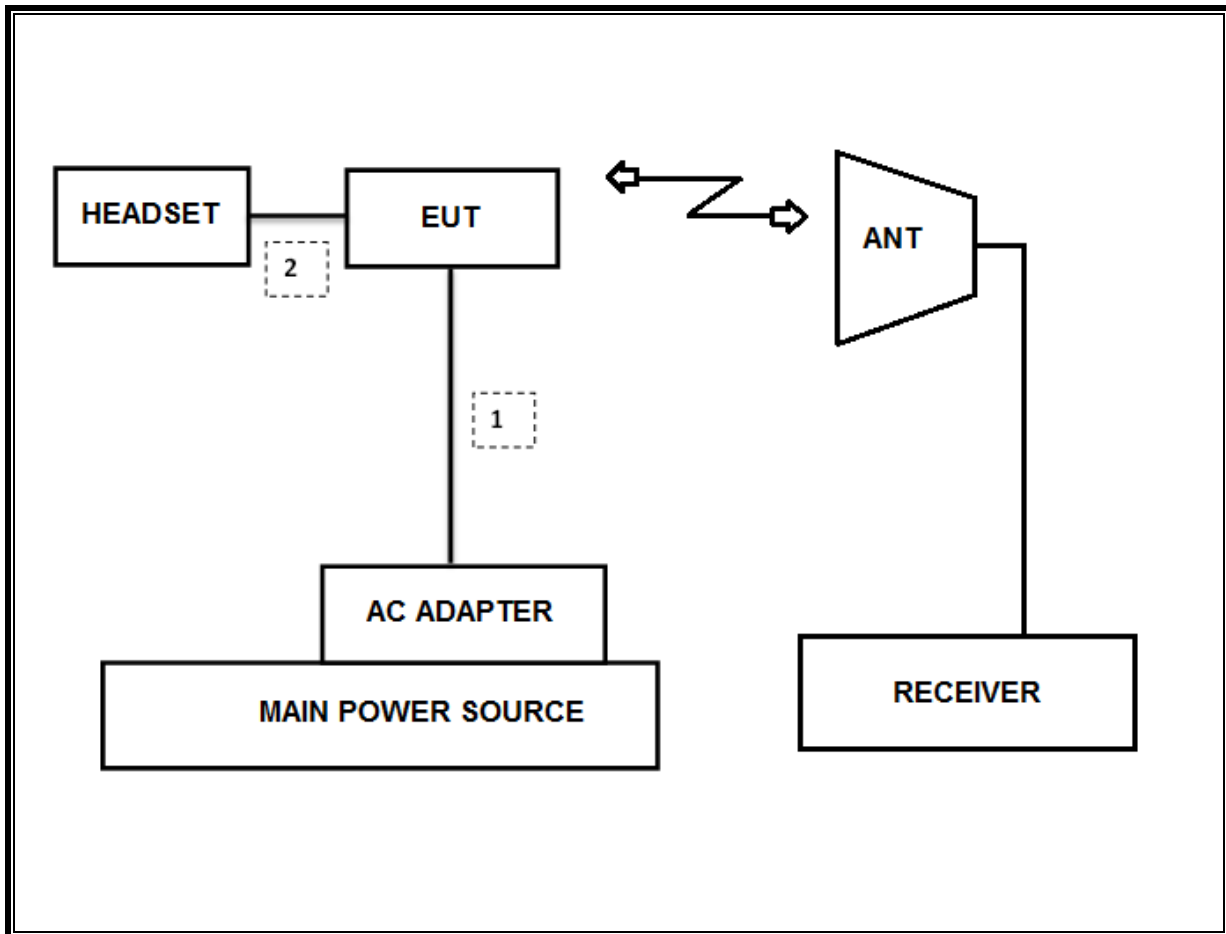

6. TEST AND MEASUREMENT EQUIPMENT

The following test and measurement equipment was utilized for the tests documented in this report:

Test Equipment List				
Description	Manufacturer	Model	S/N	Cal Due
Antenna, Bilog, 30MHz-1GHz	SCHWARZBECK	VULB9163	750	08-31-19
Antenna, Bilog, 30MHz-1GHz	SCHWARZBECK	VULB9163	749	09-14-19
Antenna, Bilog, 30MHz-1GHz	SCHWARZBECK	VULB9163	845	08-31-19
Antenna, Horn, 18 GHz	ETS	3115	00167211	10-14-18
Antenna, Horn, 18 GHz	ETS	3115	00161451	03-10-19
Antenna, Horn, 18 GHz	ETS	3117	00168724	05-31-19
Antenna, Horn, 18 GHz	ETS	3117	00168717	05-31-19
Antenna, Horn, 18 GHz	ETS	3117	00205959	11-29-18
Antenna, Horn, 40 GHz	ETS	3116C	00166155	12-04-19
Antenna, Horn, 40 GHz	ETS	3116C	00168645	12-04-19
Antenna, Horn, 40 GHz	ETS	3116C-PA	00168841	11-13-19
Preamplifier, 1000 MHz	Sonoma	310N	341282	08-09-18
Preamplifier, 1000 MHz	Sonoma	310N	351741	08-07-18
Preamplifier, 1000 MHz	Sonoma	310N	370599	08-10-18
Preamplifier, 18 GHz	Miteq	AFS42-00101800-25-S-42	1876511	08-08-18
Preamplifier, 18 GHz	Miteq	AFS42-00101800-25-S-42	1896138	08-08-18
Preamplifier, 18 GHz	Miteq	AFS42-00101800-25-S-42	2029169	08-11-18
Spectrum Analyzer, 44 GHz	Agilent / HP	N9030A	MY54170614	08-08-18
Spectrum Analyzer, 44 GHz	Agilent / HP	N9030A	MY54490312	08-08-18
Spectrum Analyzer, 43.5 GHz	R&S	FSW43	104089	08-11-18
Average Power Sensor	Agilent / HP	U2000	MY54270007	08-08-18
Attenuator	PASTERNAK	PE7087-10	A001	08-08-18
Attenuator	PASTERNAK	PE7087-10	A008	08-08-18
Attenuator	PASTERNAK	PE7087-10	2	08-10-18
Attenuator	PASTERNAK	PE7087-10	A009	08-08-18
EMI Test Receive, 40 GHz	R&S	ESU40	100439	08-08-18
EMI Test Receive, 40 GHz	R&S	ESU40	100457	08-08-18
EMI Test Receive, 44 GHz	R&S	ESW44	101590	08-09-18
EMI Test Receive, 3 GHz	R&S	ESR3	101832	08-07-18
Low Pass Filter 5GHz	Micro-Tronics	LPS17541	009	08-08-18
Low Pass Filter 5GHz	Micro-Tronics	LPS17541	015	08-08-18
Low Pass Filter 5GHz	Micro-Tronics	LPS17541	020	08-11-18
High Pass Filter 3GHz	Micro-Tronics	HPM17543	010	08-08-18
High Pass Filter 3GHz	Micro-Tronics	HPM17543	015	08-08-18
High Pass Filter 3GHz	Micro-Tronics	HPM17543	020	08-11-18
High Pass Filter 6GHz	Micro-Tronics	HPS17542	009	08-08-18
High Pass Filter 6GHz	Micro-Tronics	HPS17542	016	08-08-18
High Pass Filter 6GHz	Micro-Tronics	HPS17542	021	08-11-18
LISN	R&S	ENV-216	101837	08-09-18
UL Software				
Description	Manufacturer	Model	Version	
Radiated software	UL	UL EMC	Ver 9.5	

7. REFERENCE MEASUREMENT RESULTS

7.1. ON TIME AND DUTY CYCLE RESULTS

LIMITS

None; for reporting purposes only.

Mode	ON Time B [msec]	Period [msec]	Duty Cycle x [linear]	Duty Cycle [%]	Duty Cycle Correction Factor [dB]	1/T Minimum VBW [kHz]
2400MHz Bands						
802.11b	32.95	33.05	0.997	99.7%	0.00	0.010
802.11g	5.484	5.583	0.982	98.2%	0.00	0.010
802.11n HT20	5.068	5.166	0.981	98.1%	0.00	0.010

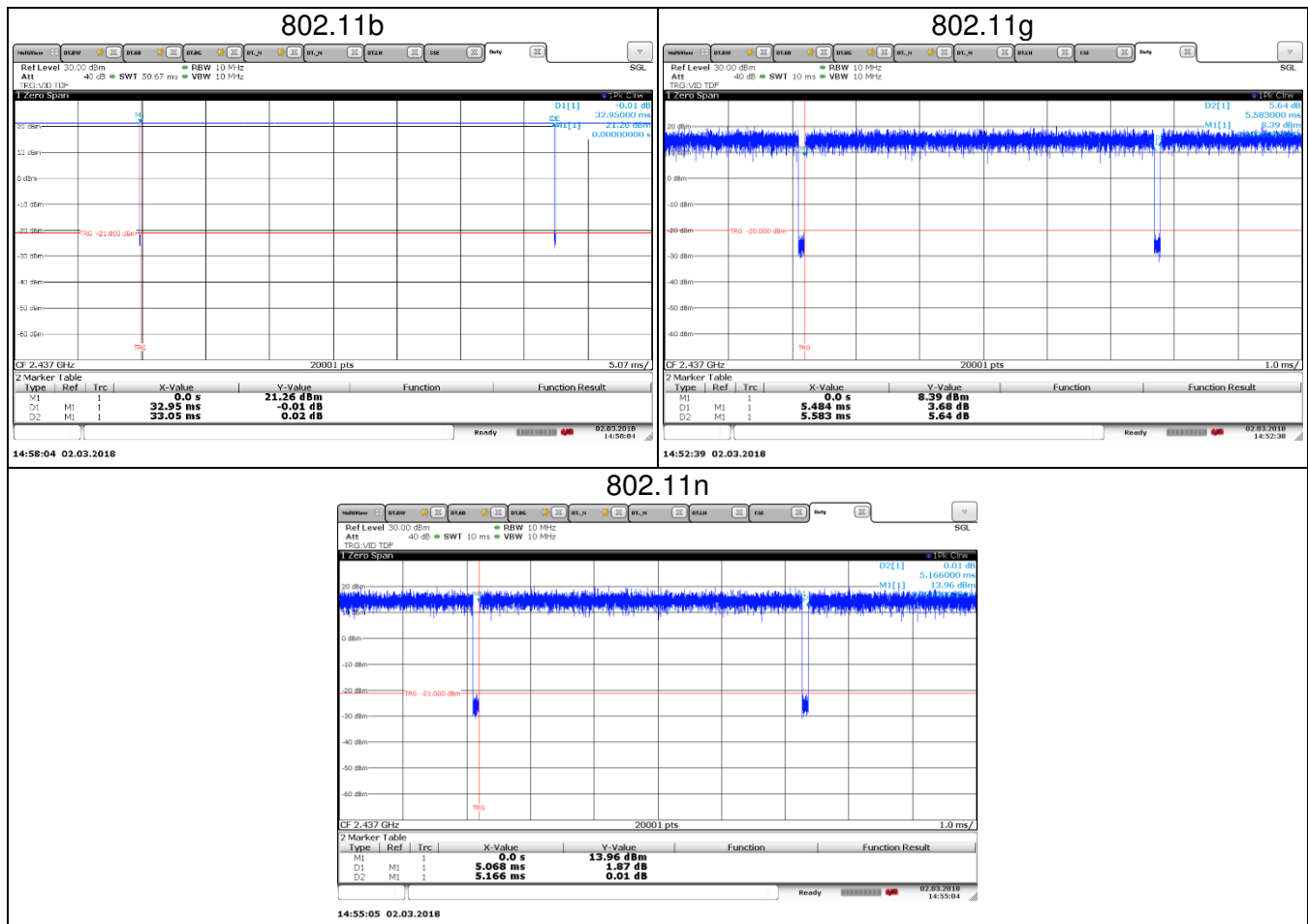

8. MEASUREMENT METHODS

6 dB BW : KDB 558074 D01 v04, Section 8.2.

OUTPUT POWER : KDB 558074 D01 v04, Section 9.2.3.1.

POWER SPECTRAL DENSITY : KDB 558074 D01 v04, Section 10.3./10.5.

Out-of-band EMISSIONS (Conducted) : KDB 558074 D01 v04, Section 11.1, 11.2.

Out-of-band EMISSIONS IN NON-RESTRICTED BANDS: KDB 558074 D01 v04, Section 11.0.

Out-of-band EMISSIONS IN RESTRICTED BANDS : KDB 558074 D01 v04, Section 12.1.

AC Power Line Conducted Emission : ANSI C63.10-2013, Section 6.2.

9. SUMMARY TABLE

FCC Part Section	Test Description	Test Limit	Test Condition	Test Result
15.247 (a)(2)	Occupied Band width (6dB)	>500KHz	Conducted	Pass
2.1051, 15.247 (d)	Band Edge / Conducted Spurious Emission	-30dBc		Pass
15.247 (b)(3)	TX conducted output power	<30dBm		Pass
15.247 (e)	PSD	<8dBm		Pass
15.207 (a)	AC Power Line conducted emissions	Section 10	Power Line conducted	Pass
15.205, 15.209	Radiated Spurious Emission	< 54dBuV/m	Radiated	Pass

10. ANTENNA PORT TEST RESULTS

10.1. 6 dB BANDWIDTH

LIMITS

FCC §15.247 (a) (2)

The minimum 6 dB bandwidth shall be at least 500 kHz.

TEST PROCEDURE

Reference to KDB 558074 D01 DTS Meas Guidance v04: The transmitter output is connected to a spectrum analyzer with the RBW set to 100kHz, the VBW $\geq 3 \times$ RBW, peak detector and max hold.

RESULTS**10.1.1.802.11b MODE IN THE 2.4 GHz BAND**

Channel	Frequency [MHz]	6 dB Bandwidth [MHz]	Minimum Limit [MHz]
Low	2412	9.367	0.5
Mid	2437	9.070	0.5
High	2462	9.043	0.5
12	2467	9.060	0.5
13	2472	8.132	0.5
Worst		8.132	0.5

10.1.1.1. 802.11g MODE IN THE 2.4 GHz BAND

Channel	Frequency [MHz]	6 dB Bandwidth [MHz]	Minimum Limit [MHz]
Low	2412	16.447	0.5
Mid	2437	16.394	0.5
High	2462	16.474	0.5
12	2467	16.451	0.5
13	2472	16.405	0.5
Worst		16.394	0.5

10.1.2.802.11n HT20 MODE IN THE 2.4 GHz BAND

Channel	Frequency [MHz]	6 dB Bandwidth [MHz]	Minimum Limit [MHz]
Low	2412	17.581	0.5
Mid	2437	17.587	0.5
High	2462	17.554	0.5
12	2467	17.597	0.5
13	2472	17.602	0.5
Worst		17.554	0.5

10.1.3.6 dB BANDWIDTH PLOTS

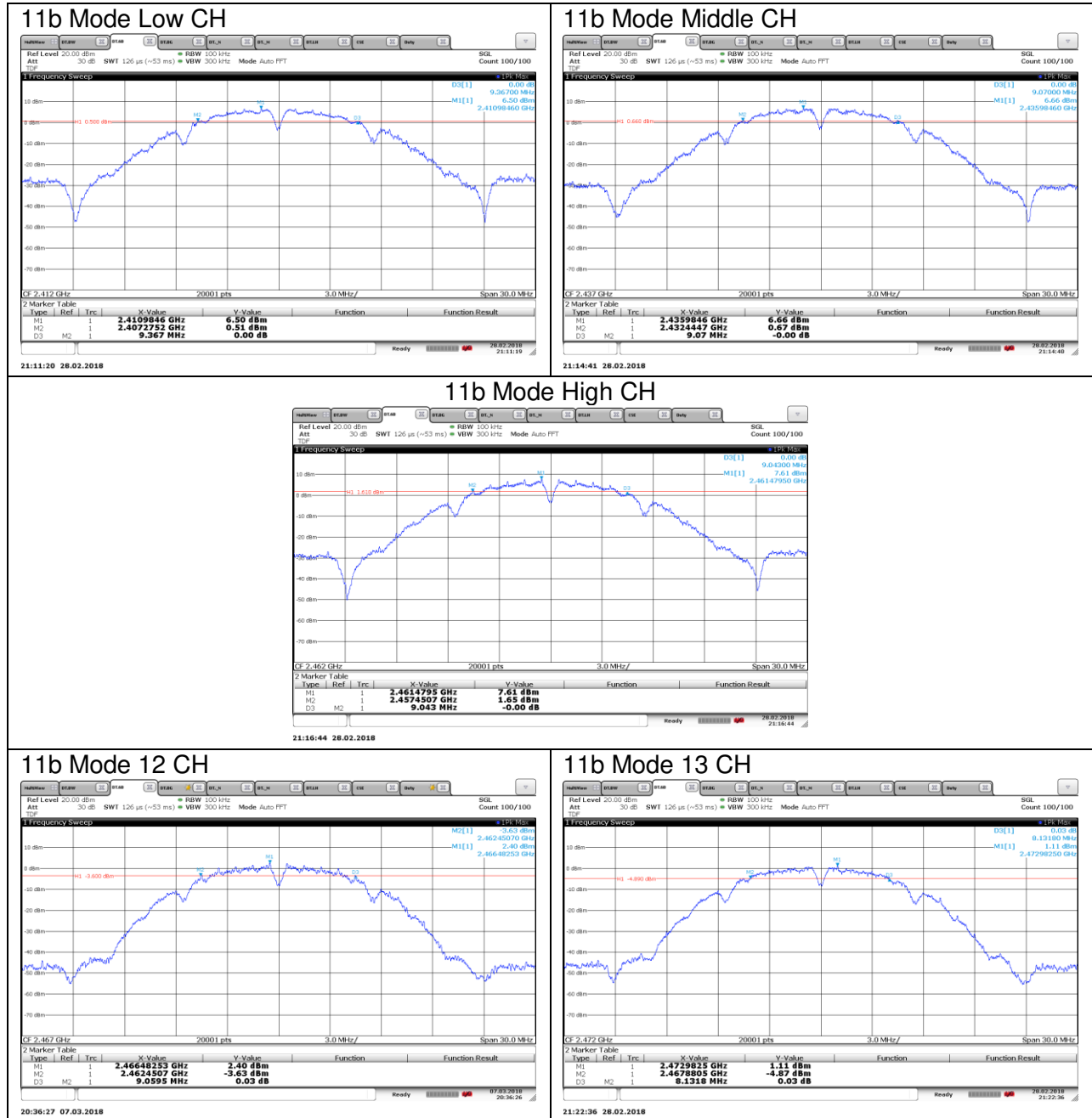

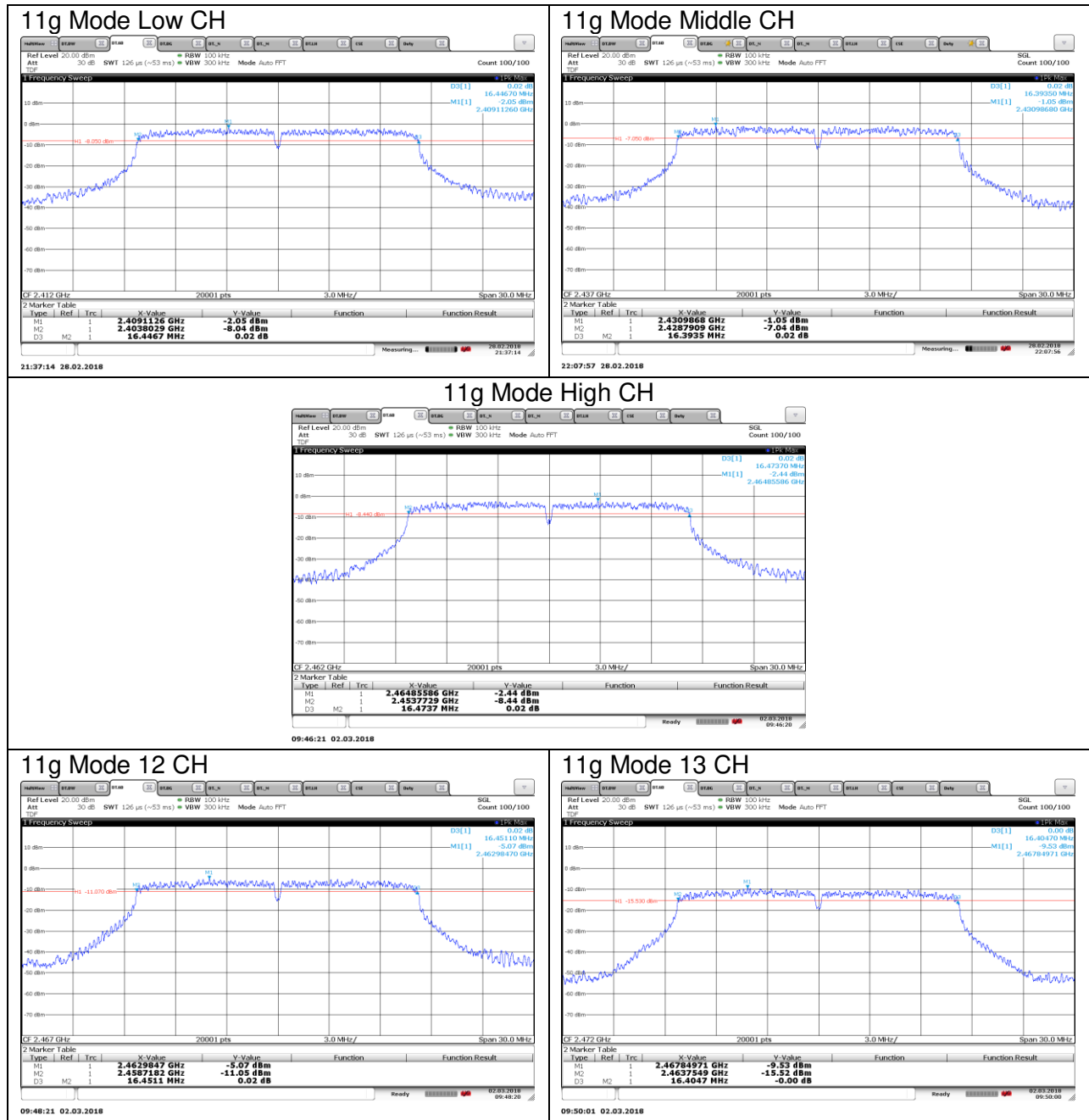

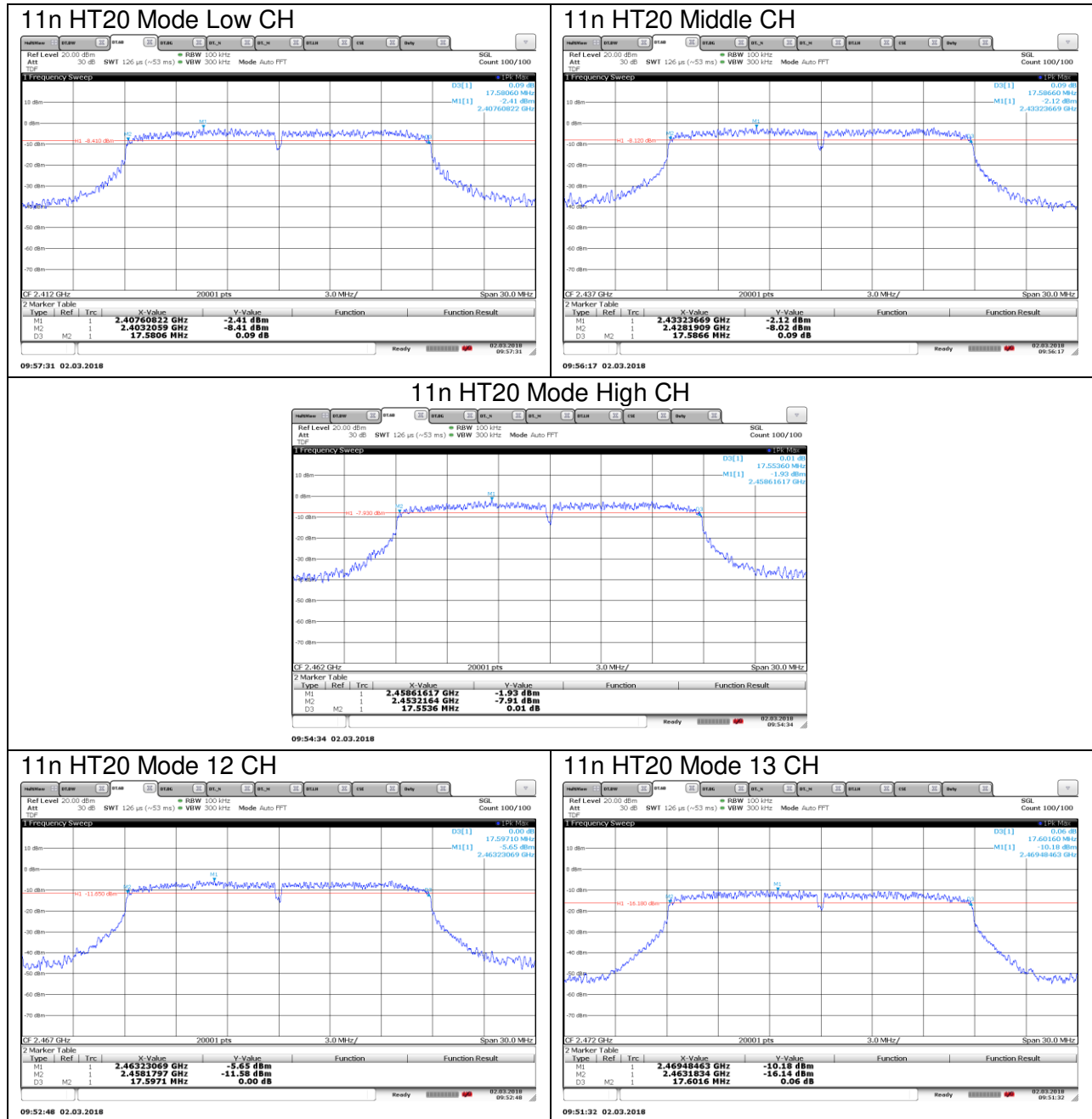

10.2. OUTPUT POWER

LIMITS

FCC §15.247

For systems using digital modulation in the 902–928 MHz, 2400–2483.5 MHz, and 5725–5850 MHz bands: 1 Watt, based on the use of antennas with directional gains that do not exceed 6 dBi. If transmitting antennas of directional gain greater than 6 dBi are used, the conducted output power from the intentional radiator shall be reduced by the amount in dB that the directional gain of the antenna exceeds 6 dBi.

DIRECTIONAL ANTENNA GAIN

There is only one transmitter output therefore the directional gain is equal to the antenna gain.

TEST PROCEDURE

The transmitter output is connected to a power meter.

The cable assembly insertion loss was entered as an offset in the power meter to allow for direct reading of power.

Output power measurement was performed utilizing the “§9.2.3.1 AVGPM” under KDB558074 D01 DTS Meas Guidance v04.

Duty cycle correction factor is not added to the average output power results for duty cycle factor > 98%. (All mode)

RESULTS**10.2.1.802.11b MODE IN THE 2.4 GHz BAND****Limits**

Channel	Frequency [MHz]	Directional Gain Primary [dBi]	FCC Power Limit [dBm]	Max Power [dBm]
Low	2412	-3.25	30.00	30.00
Mid	2437	-3.25	30.00	30.00
High	2462	-3.25	30.00	30.00
12	2467	-3.25	30.00	30.00
13	2472	-3.25	30.00	30.00

Results

Channel	Frequency [MHz]	Meas Power [dBm]	Total Power [dBm]	Power Limit [dBm]	Margin [dB]
Low	2412	18.51	18.51	30.00	-11.49
Mid	2437	18.72	18.72	30.00	-11.28
High	2462	18.66	18.66	30.00	-11.34
12	2467	12.36	12.36	30.00	-17.64
13	2472	12.54	12.54	30.00	-17.46
Worst			18.72	30.00	-11.28

10.2.2.802.11g MODE IN THE 2.4 GHz BAND

Limits

Channel	Frequency [MHz]	Directional Gain Primary [dBi]	FCC Power Limit [dBm]	Max Power [dBm]
Low	2412	-3.25	30.00	30.00
Mid	2437	-3.25	30.00	30.00
High	2462	-3.25	30.00	30.00
12	2467	-3.25	30.00	30.00
13	2472	-3.25	30.00	30.00

Results

Channel	Frequency [MHz]	Meas Power [dBm]	Total Power [dBm]	Power Limit [dBm]	Margin [dB]
Low	2412	12.41	12.41	30.00	-17.59
Mid	2437	12.67	12.67	30.00	-17.33
High	2462	13.43	13.43	30.00	-16.57
12	2467	9.64	9.64	30.00	-20.36
13	2472	4.93	4.93	30.00	-25.07
Worst			13.43	30.00	-16.57

10.2.3.802.11n HT20 MODE IN THE 2.4 GHz BAND

Limits

Channel	Frequency [MHz]	Directional Gain Primary [dBi]	FCC Power Limit [dBm]	Max Power [dBm]
Low	2412	-3.25	30.00	30.00
Mid	2437	-3.25	30.00	30.00
High	2462	-3.25	30.00	30.00
12	2467	-3.25	30.00	30.00
13	2472	-3.25	30.00	30.00

Results

Channel	Frequency [MHz]	Meas Power [dBm]	Total Power [dBm]	Power Limit [dBm]	Margin [dB]
Low	2412	12.32	12.32	30.00	-17.68
Mid	2437	12.68	12.68	30.00	-17.32
High	2462	12.40	12.40	30.00	-17.60
12	2467	9.59	9.59	30.00	-20.41
13	2472	4.89	4.89	30.00	-25.11
Worst			12.68	30.00	-17.32

10.3. PSD

LIMITS

FCC §15.247

The power spectral density conducted from the transmitter to the antenna shall not be greater than 8 dBm in any 3 kHz band during any time interval of continuous transmission.

TEST PROCEDURE

Power Spectral Density was performed utilizing the "Method §10.3 AVGPSD-1 (802.11 b/g/n mode) under KDB558074 D01 DTS Meas Guidance v04.

RESULTS

10.3.1.802.11b MODE IN THE 2.4 GHz BAND

PSD Results

Channel	Frequency [MHz]	PSD Meas [dBm]	Duty Factor [dB]	Final PSD [dBm/3kHz]	Limit [dBm/3kHz]	Margin [dB]
Low	2412	-15.190	0.00	-15.190	8.00	-23.190
Mid	2437	-14.610	0.00	-14.610	8.00	-22.610
High	2462	-15.290	0.00	-15.290	8.00	-23.290
12	2467	-20.240	0.00	-20.240	8.00	-28.240
13	2472	-21.470	0.00	-21.470	8.00	-29.470

10.3.2.802.11g MODE IN THE 2.4 GHz BAND

PSD Results

Channel	Frequency [MHz]	PSD Meas [dBm]	Duty Factor [dB]	Final PSD [dBm/3kHz]	Limit [dBm/3kHz]	Margin [dB]
Low	2412	-23.320	0.00	-23.320	8.00	-31.320
Mid	2437	-23.560	0.00	-23.560	8.00	-31.560
High	2462	-23.250	0.00	-23.250	8.00	-31.250
12	2467	-26.490	0.00	-26.490	8.00	-34.490
13	2472	-28.190	0.00	-28.190	8.00	-36.190

10.3.3.802.11n HT20 MODE IN THE 2.4 GHz BAND

PSD Results

Channel	Frequency [MHz]	PSD Meas [dBm]	Duty Factor [dB]	Final PSD [dBm/3kHz]	Limit [dBm/3kHz]	Margin [dB]
1	2412	-23.92	0.00	-23.920	8.00	-31.920
6	2437	-23.920	0.00	-23.920	8.00	-31.920
11	2462	-23.880	0.00	-23.880	8.00	-31.880
12	2467	-27.050	0.00	-27.050	8.00	-35.050
13	2472	-29.070	0.00	-29.070	8.00	-37.070

10.3.4.PSD PLOTS

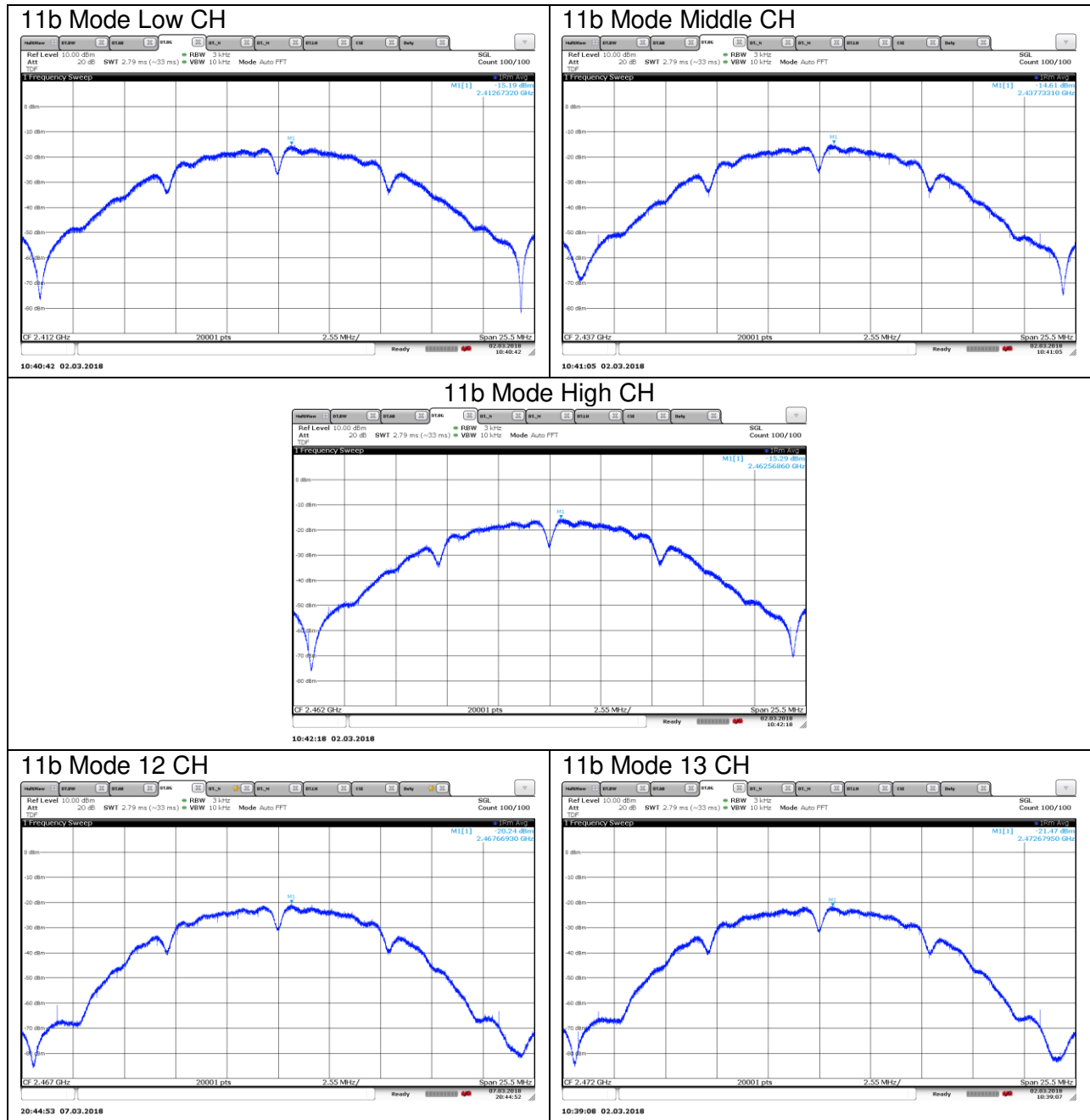

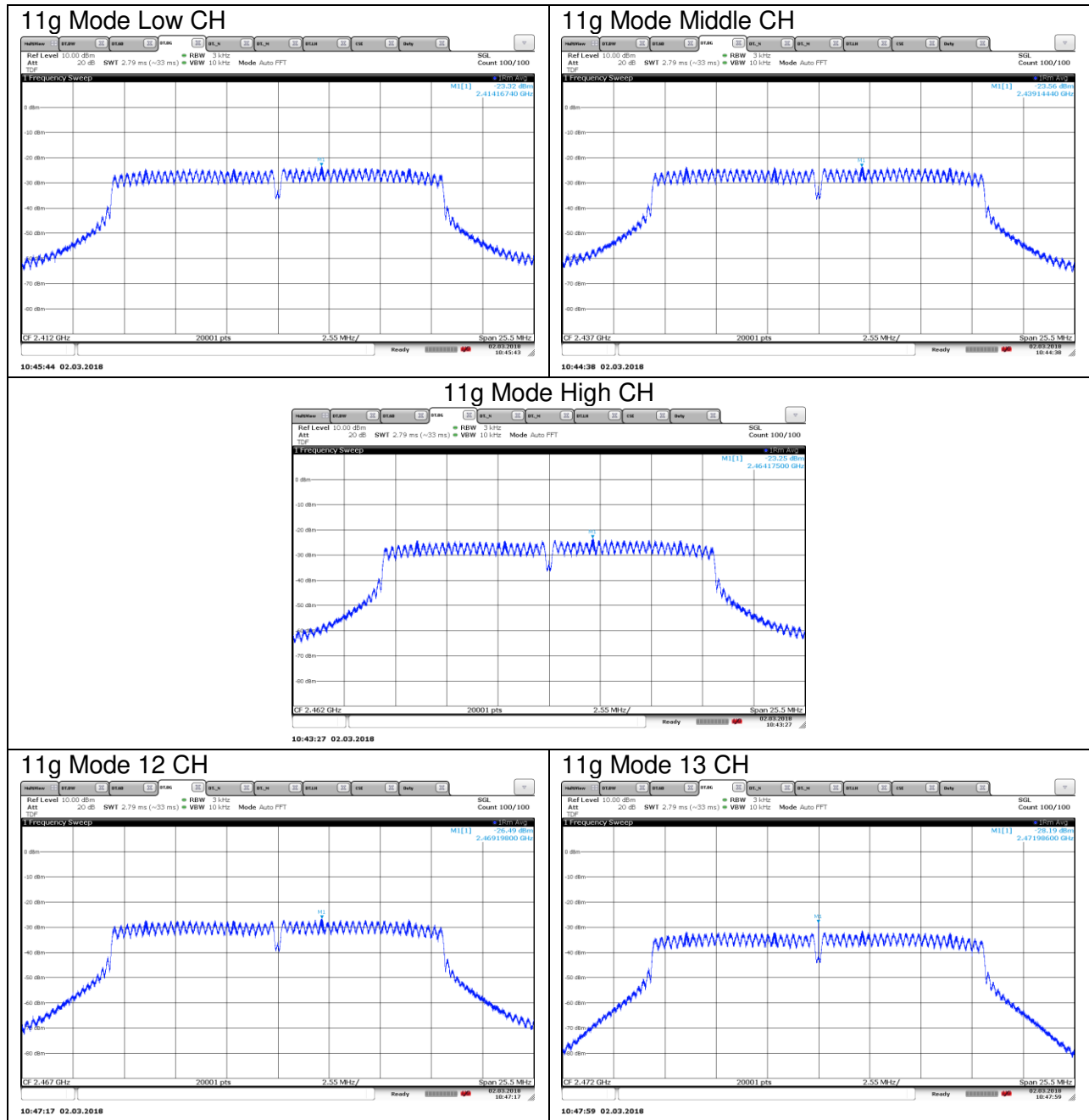

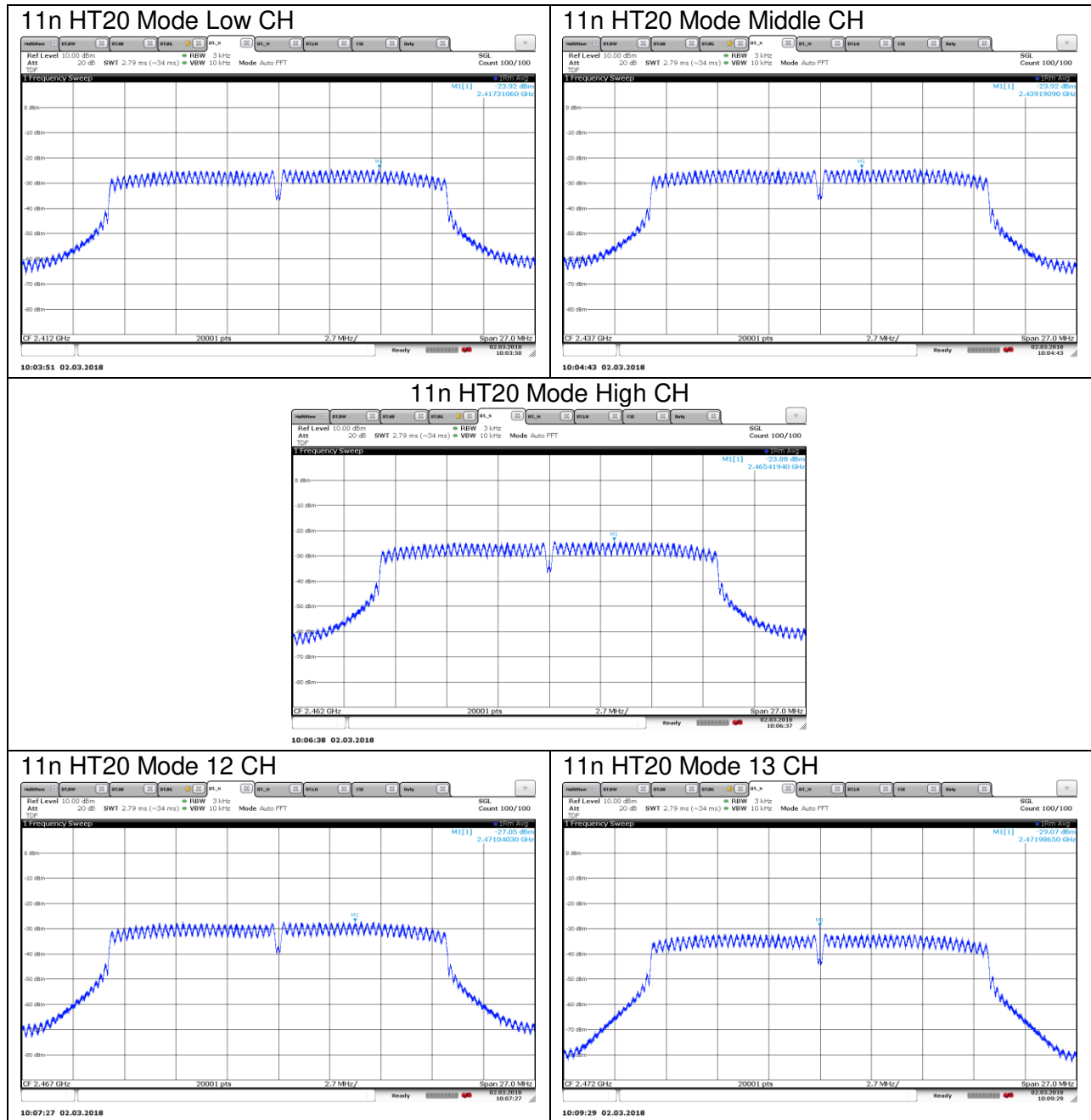

10.4. OUT-OF-BAND EMISSIONS

LIMITS

FCC §15.247 (d)

In any 100 kHz bandwidth outside the frequency band in which the spread spectrum or digitally modulated intentional radiator is operating, the radio frequency power that is produced by the intentional radiator shall be at least 20 dB below that in the 100 kHz bandwidth within the band that contains the highest level of the desired power, based on either an RF conducted or a radiated measurement, provided the transmitter demonstrates compliance with the peak conducted power limits. If the transmitter complies with the conducted power limits based on the use of RMS averaging over a time interval, as permitted under paragraph (b)(3) of this section, the attenuation required under this paragraph shall be 30 dB instead of 20 dB. Attenuation below the general limits specified in §15.209(a) is not required.

TEST PROCEDURE

The transmitter output is connected to a spectrum analyzer with RBW = 100 kHz, VBW = 300 kHz, peak detector, and max hold. Measurements utilizing these settings are made of the in-band reference level, bandedge (where measurements to the general radiated limits will not be made)

For out-of-band emissions, it was tested with RBW = 1 MHz, VBW = 3 MHz, peak detector, and max hold.

If the emission level with above setting was close to the limit (ie, less than 3 dB margin) then re-test is required using RBW = 100 kHz, VBW = 300 kHz, peak detector, and max hold to get accurate emission level within 100 kHz BW

RESULTS

10.4.1.802.11b MODE IN THE 2.4 GHz BAND

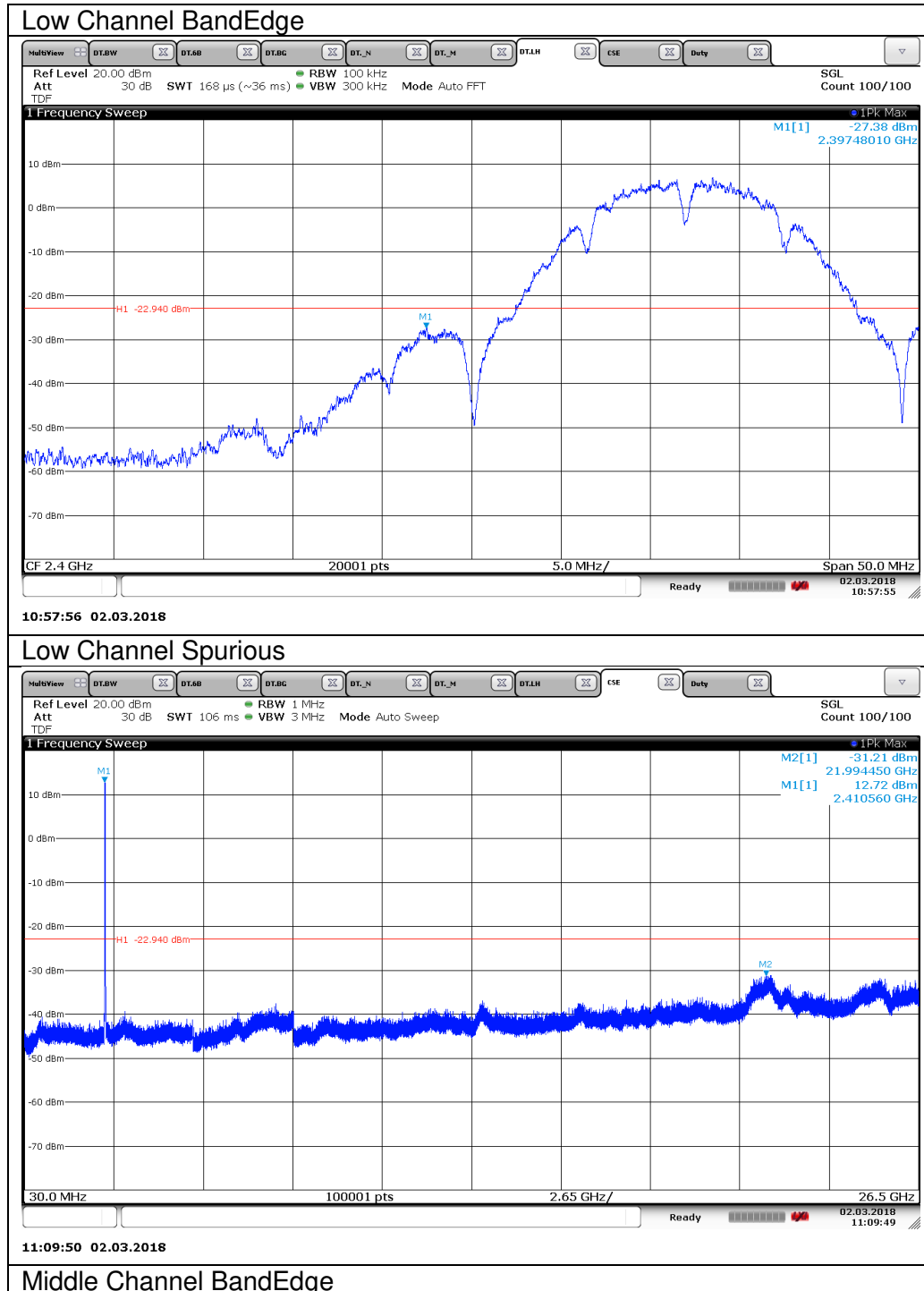

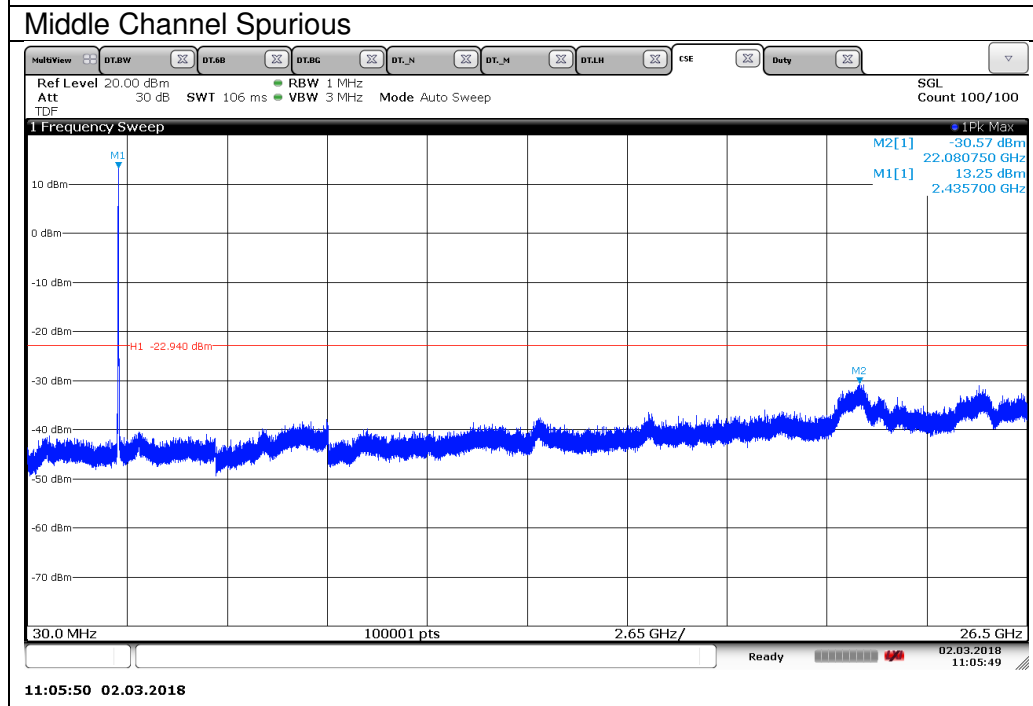
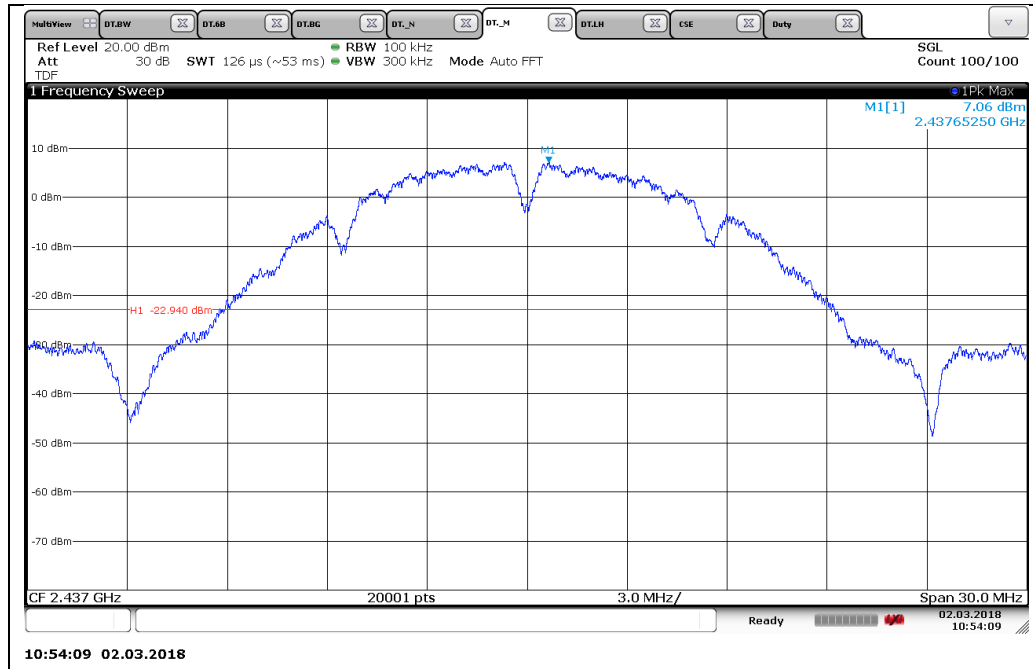

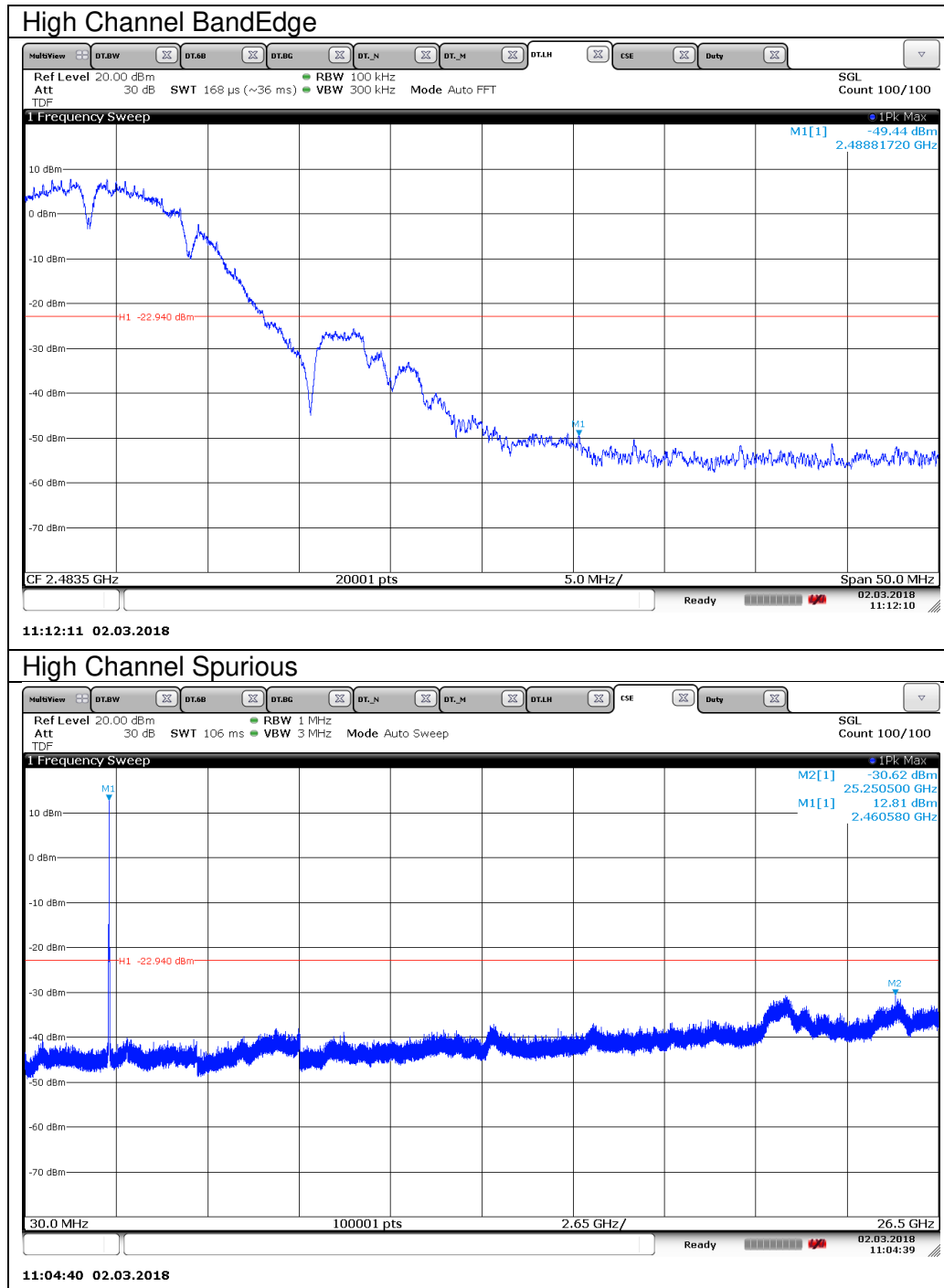

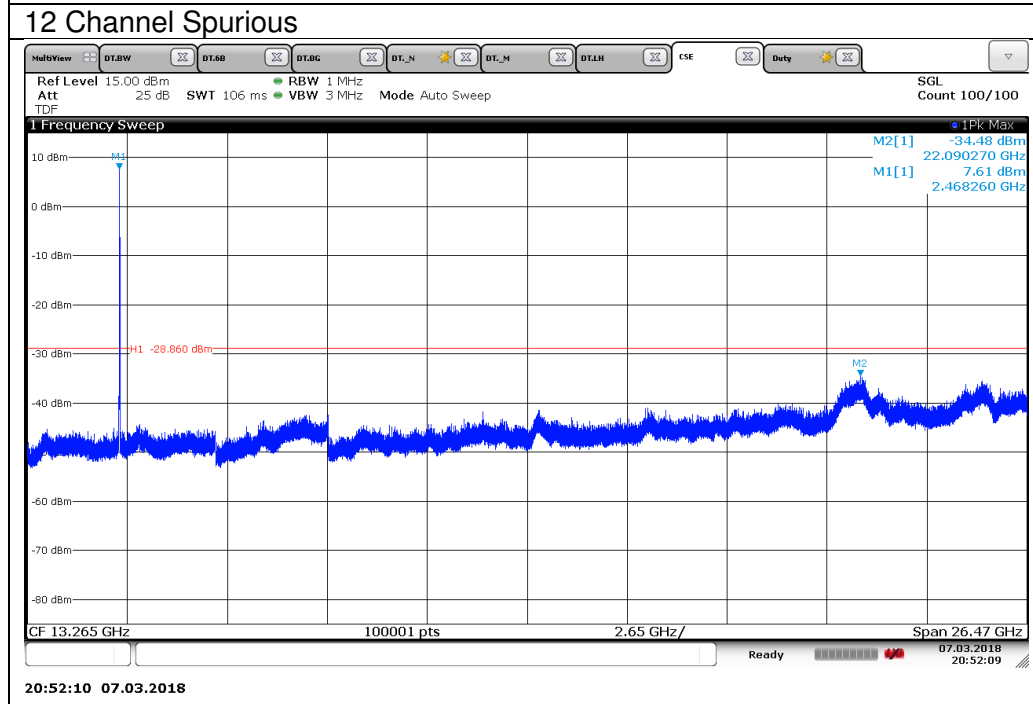
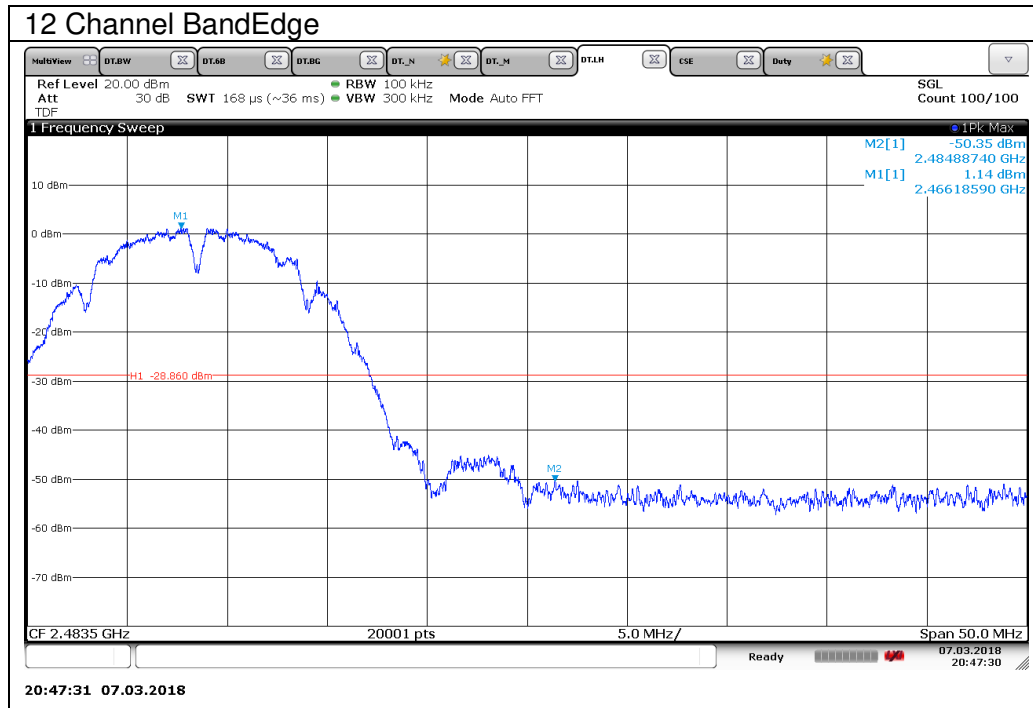

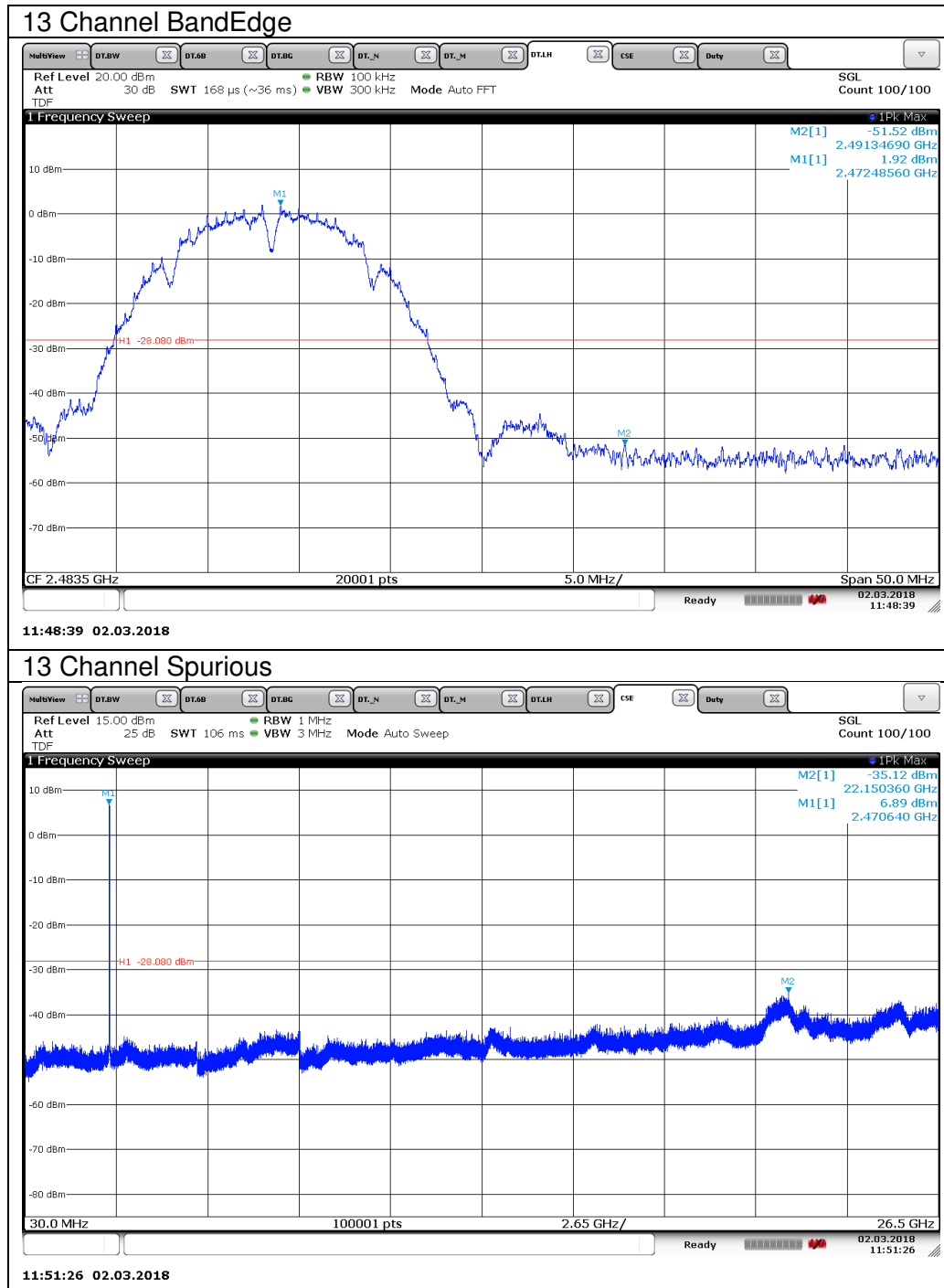

10.4.2.802.11g MODE IN THE 2.4 GHz BAND

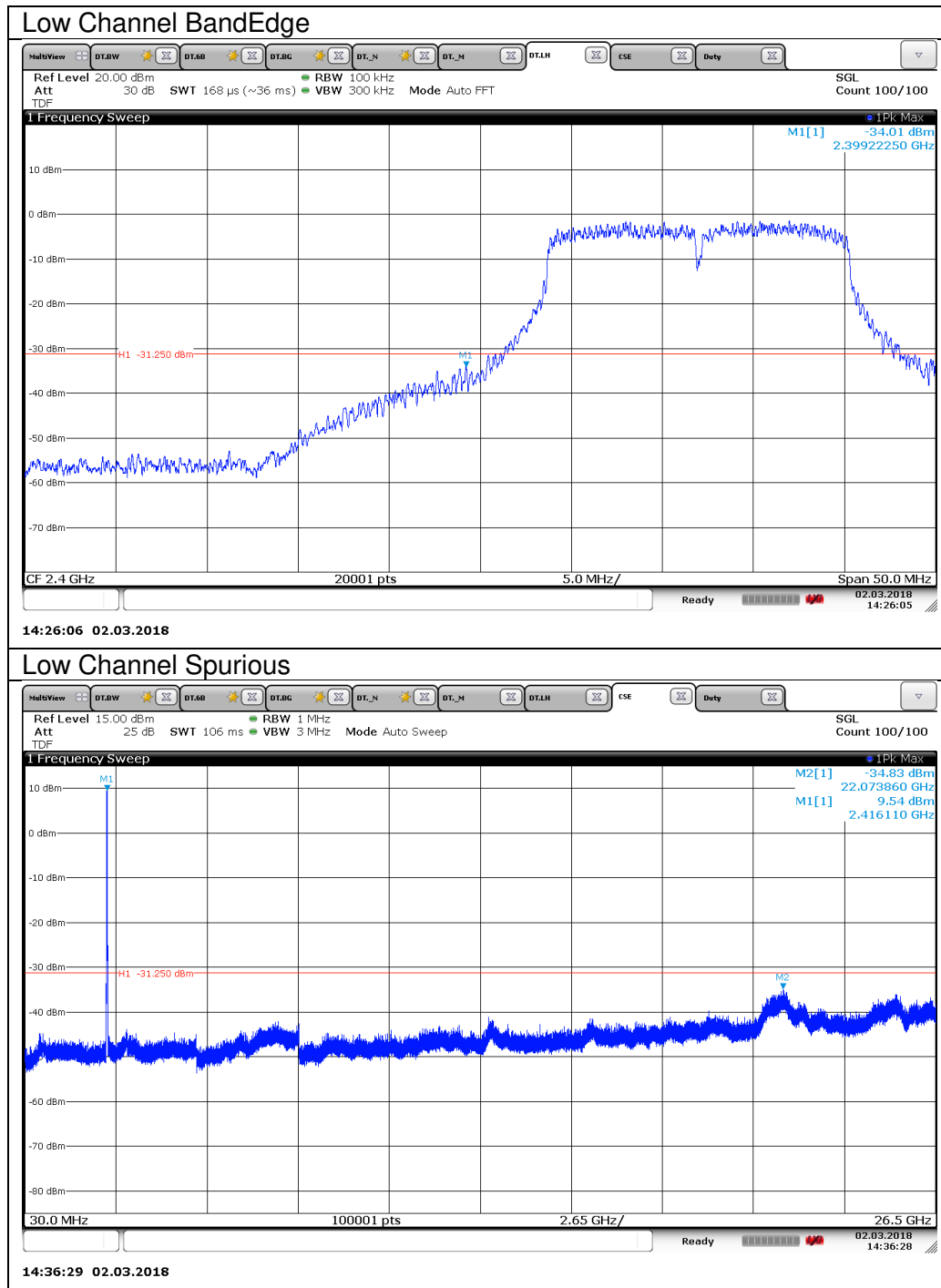

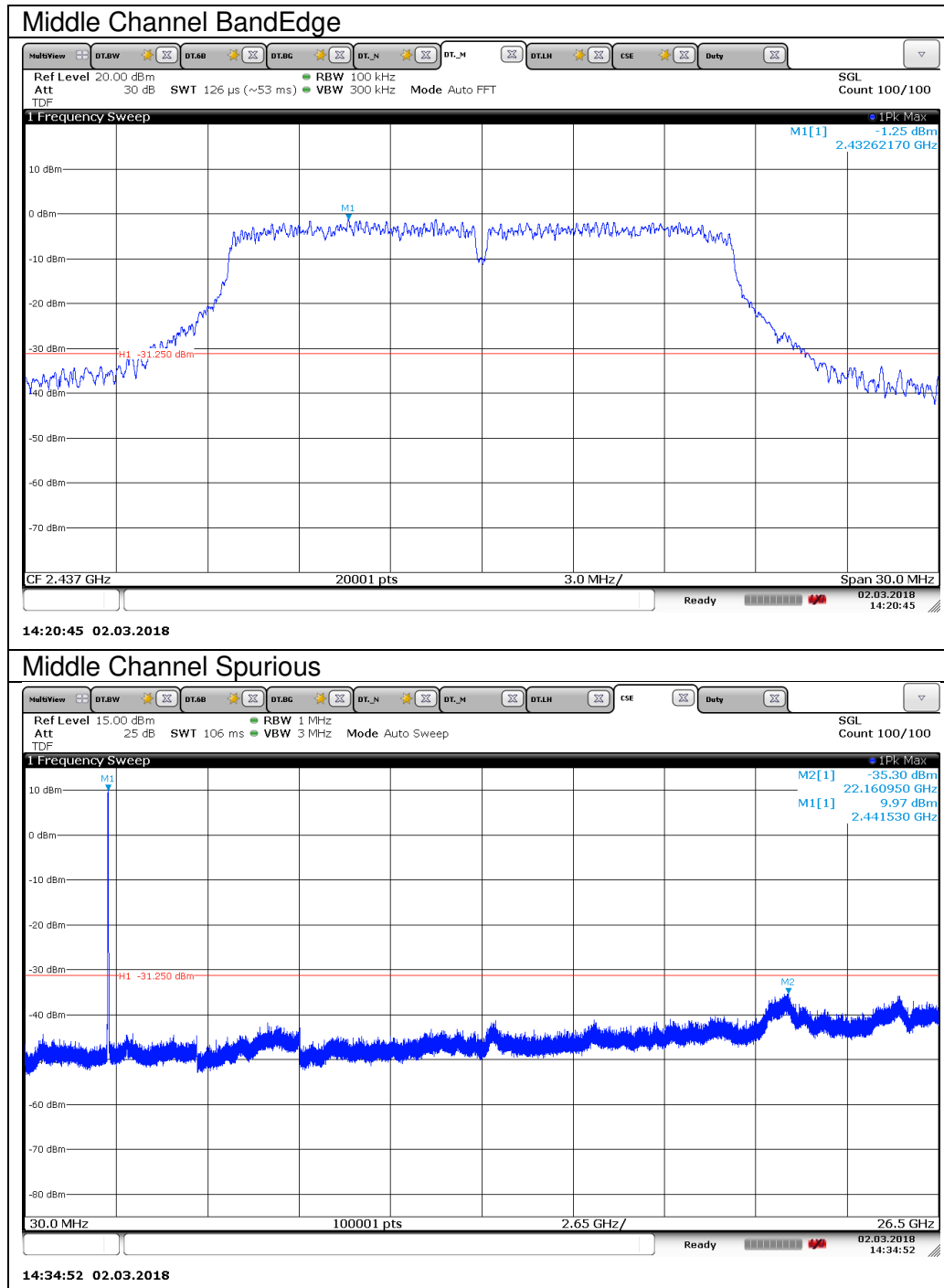

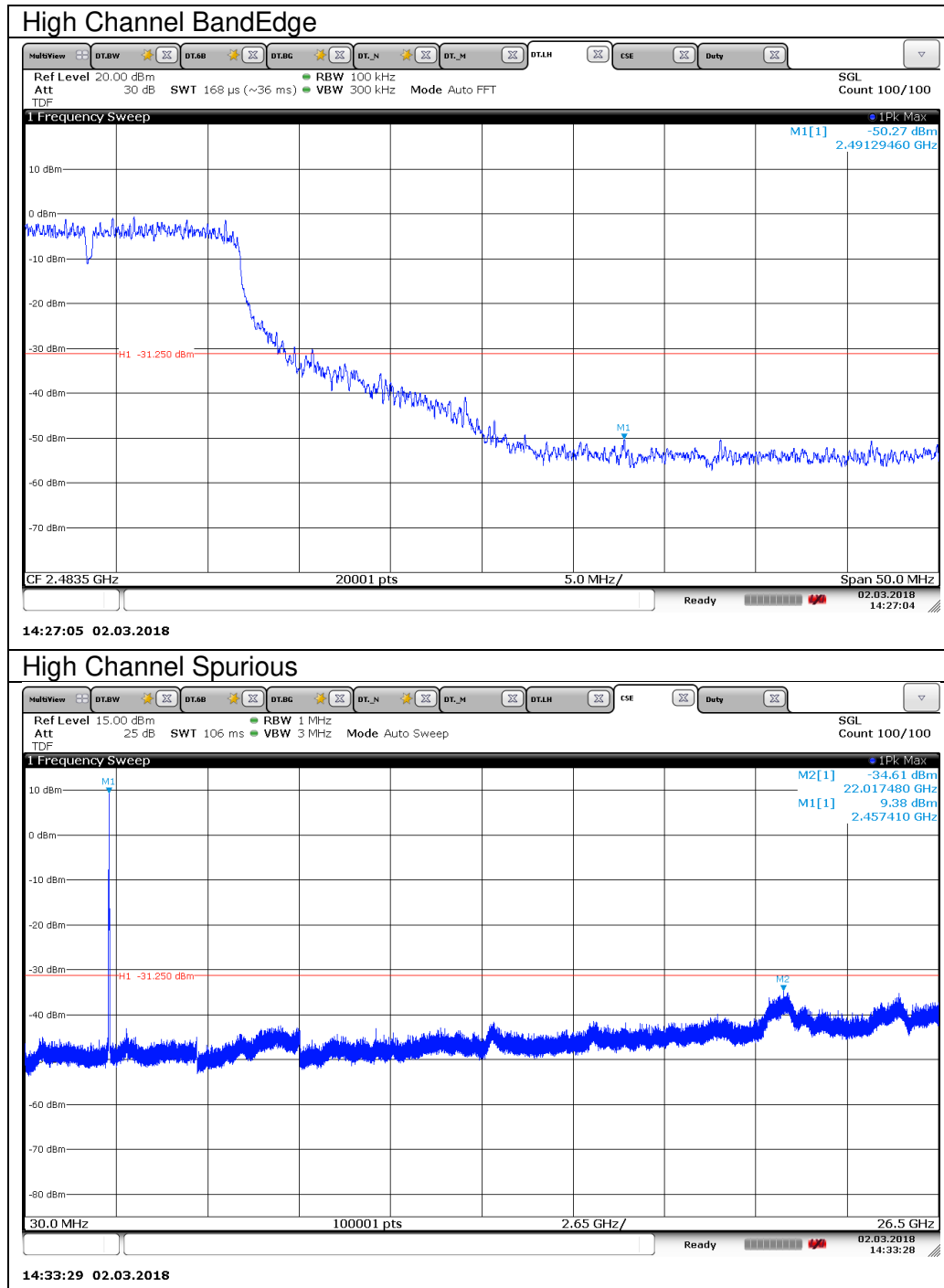

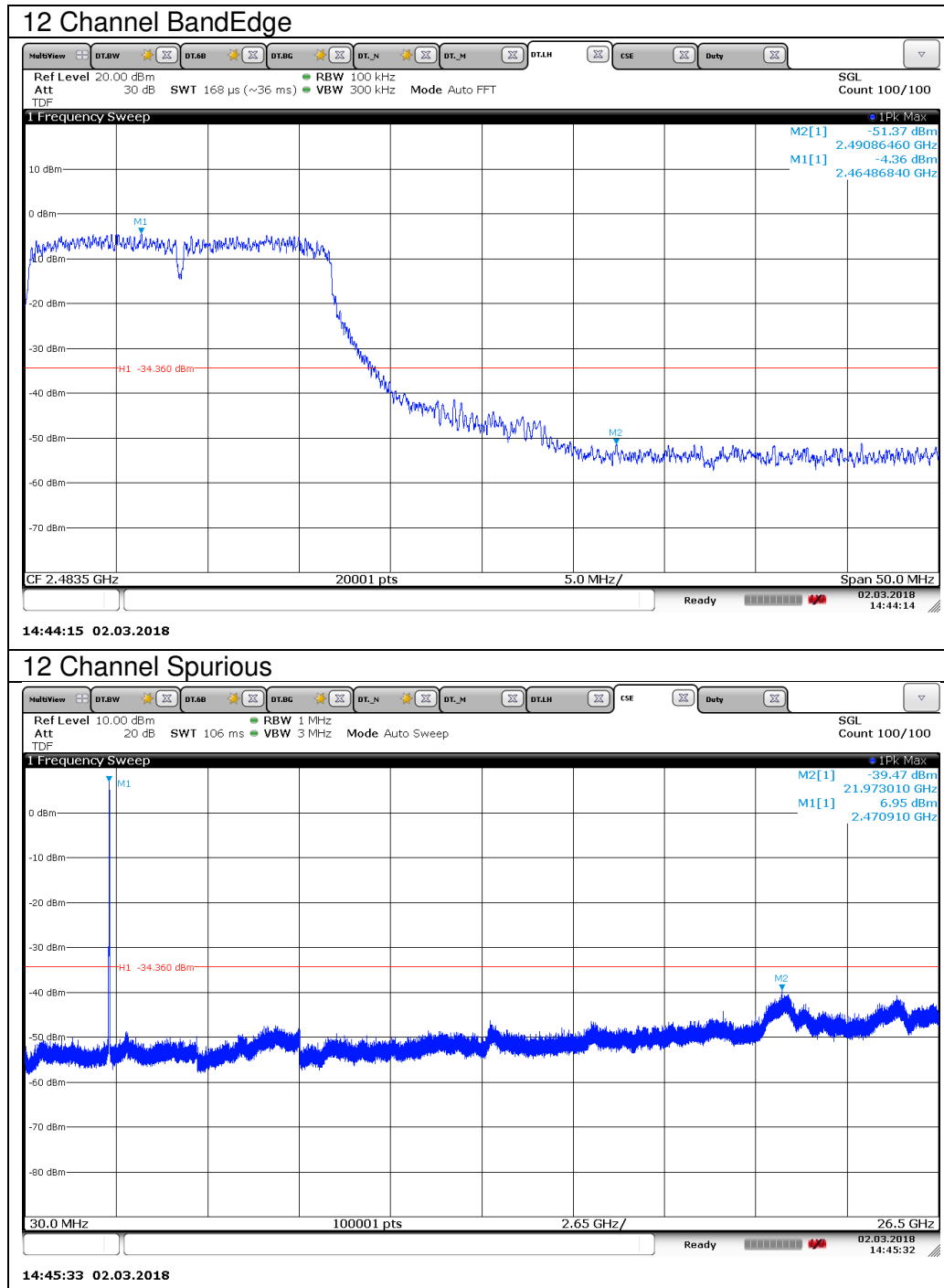

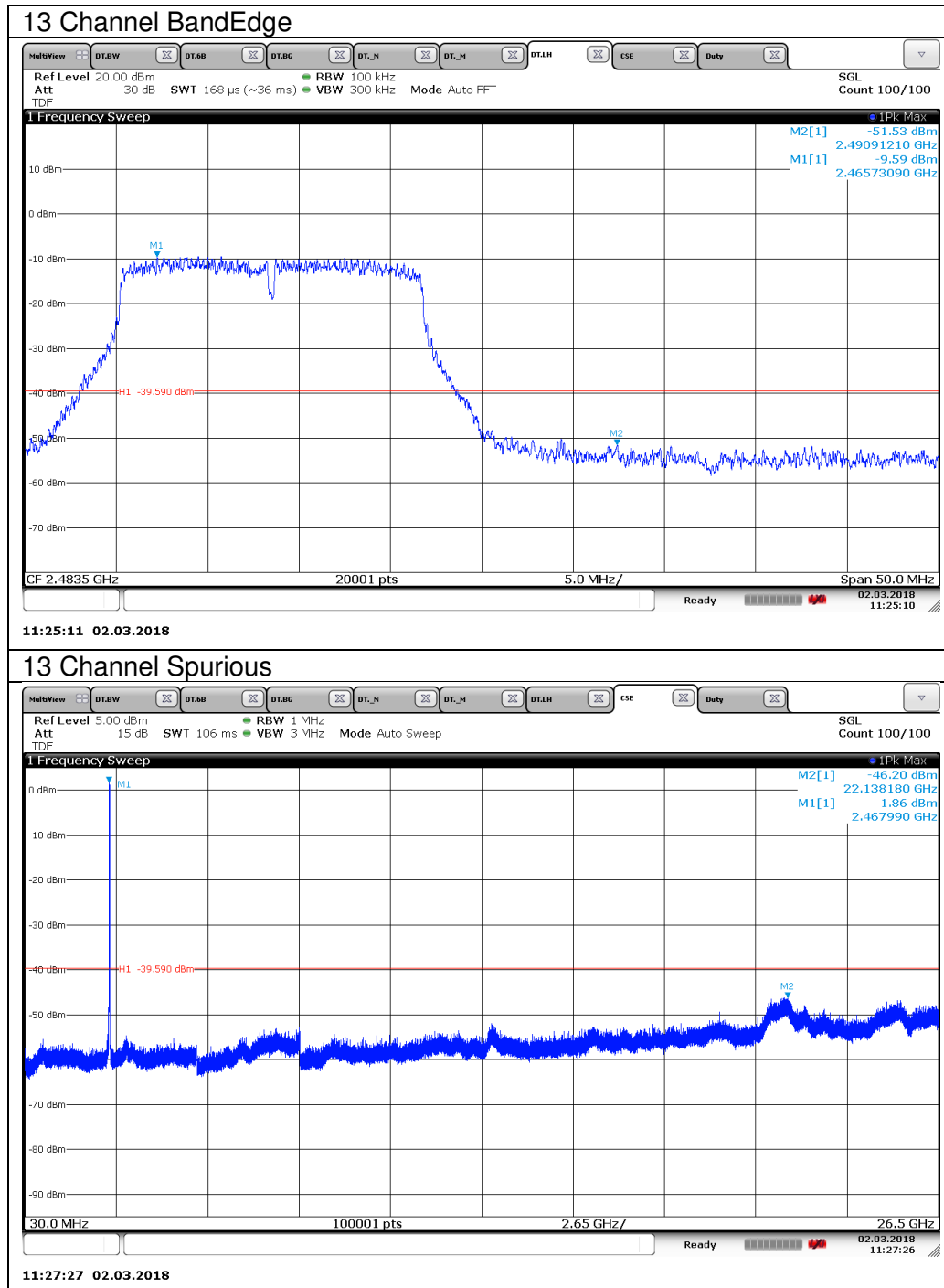

10.4.3.802.11n HT20 MODE IN THE 2.4 GHz BAND

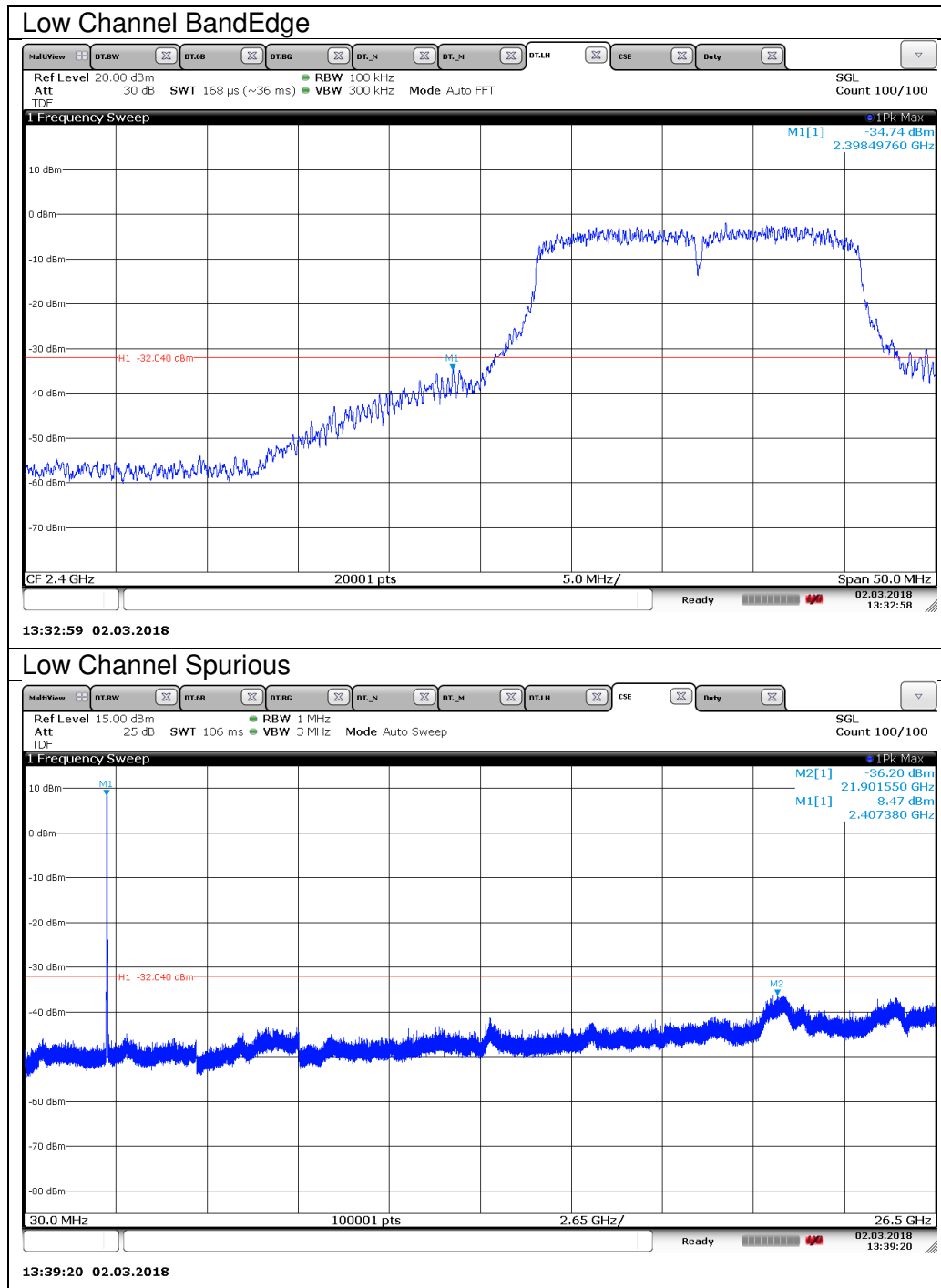

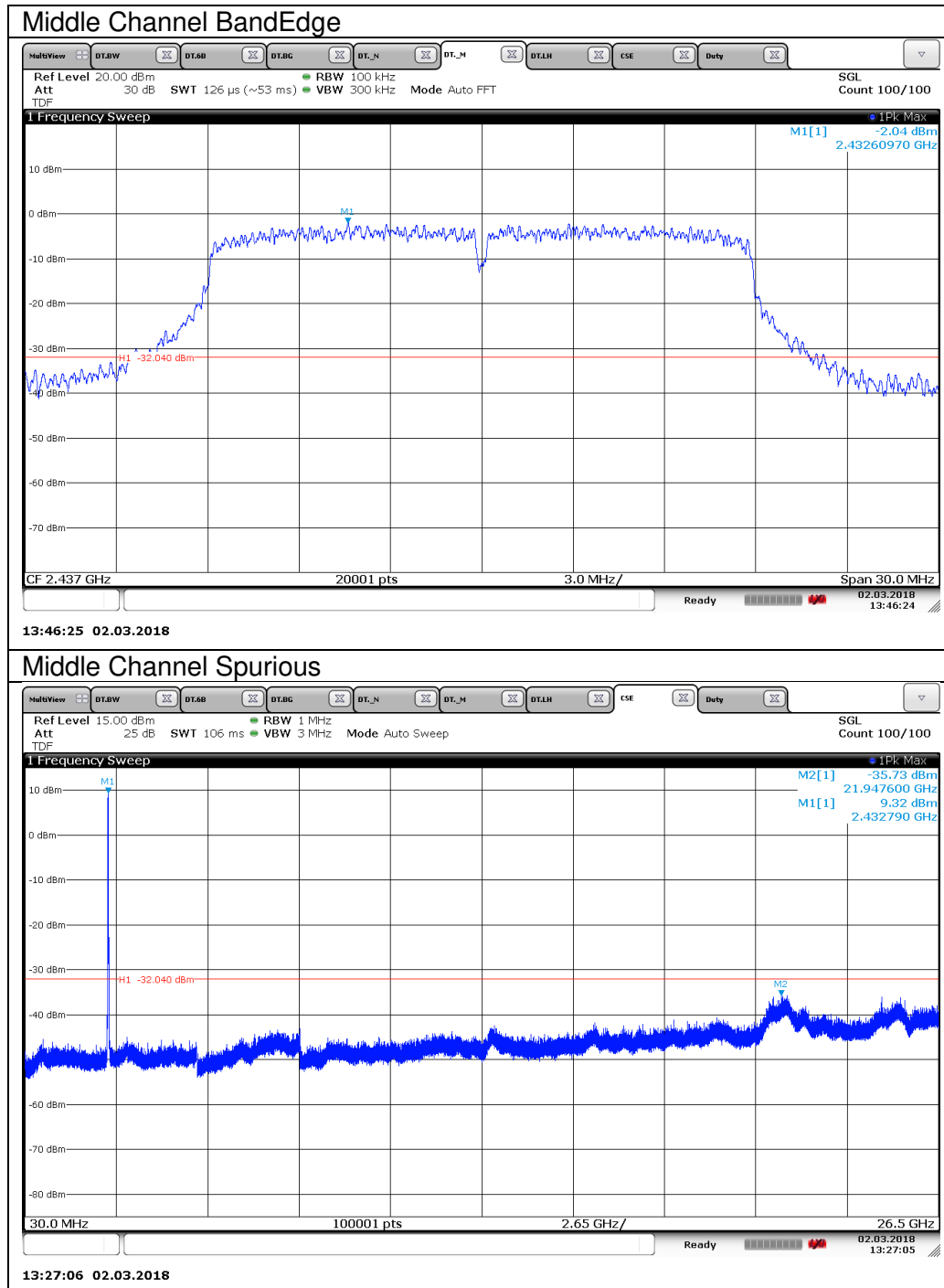

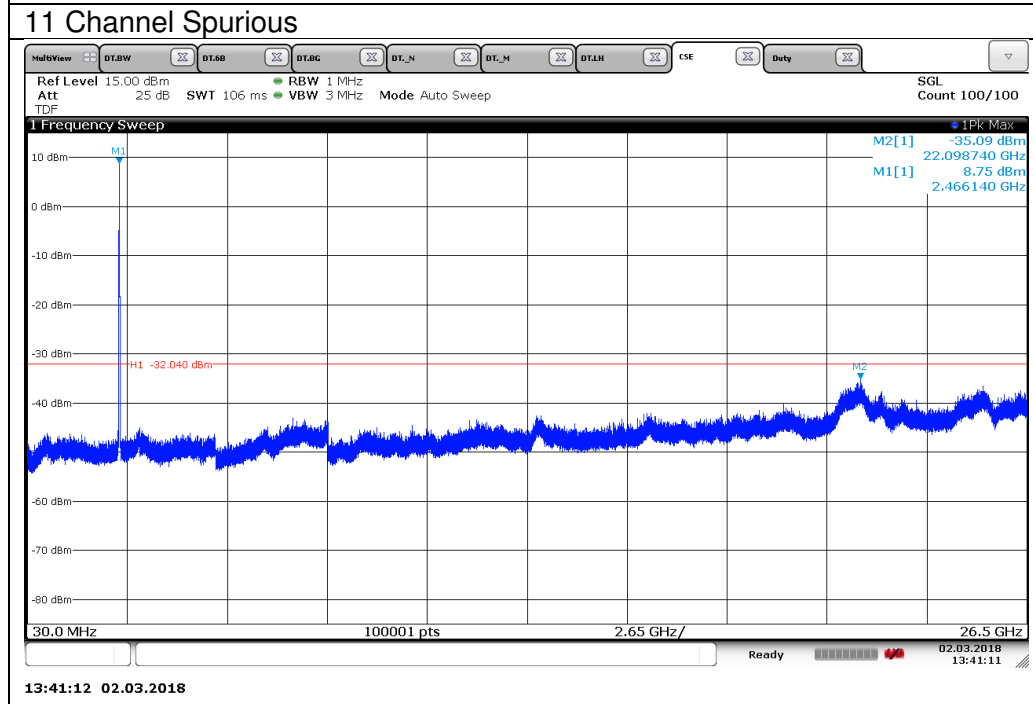
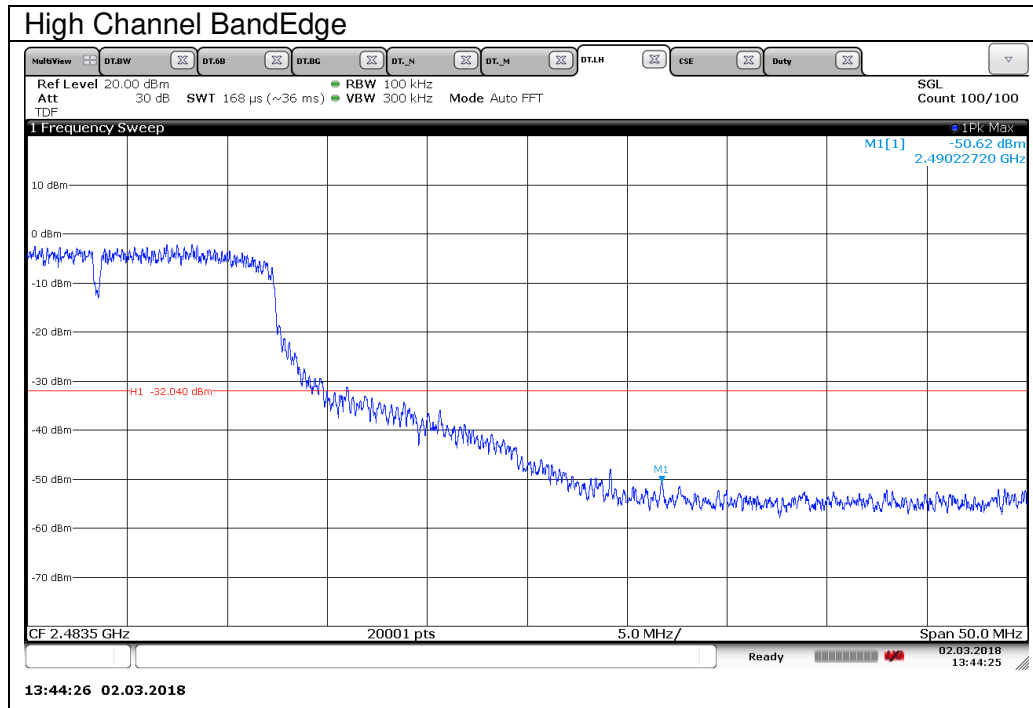

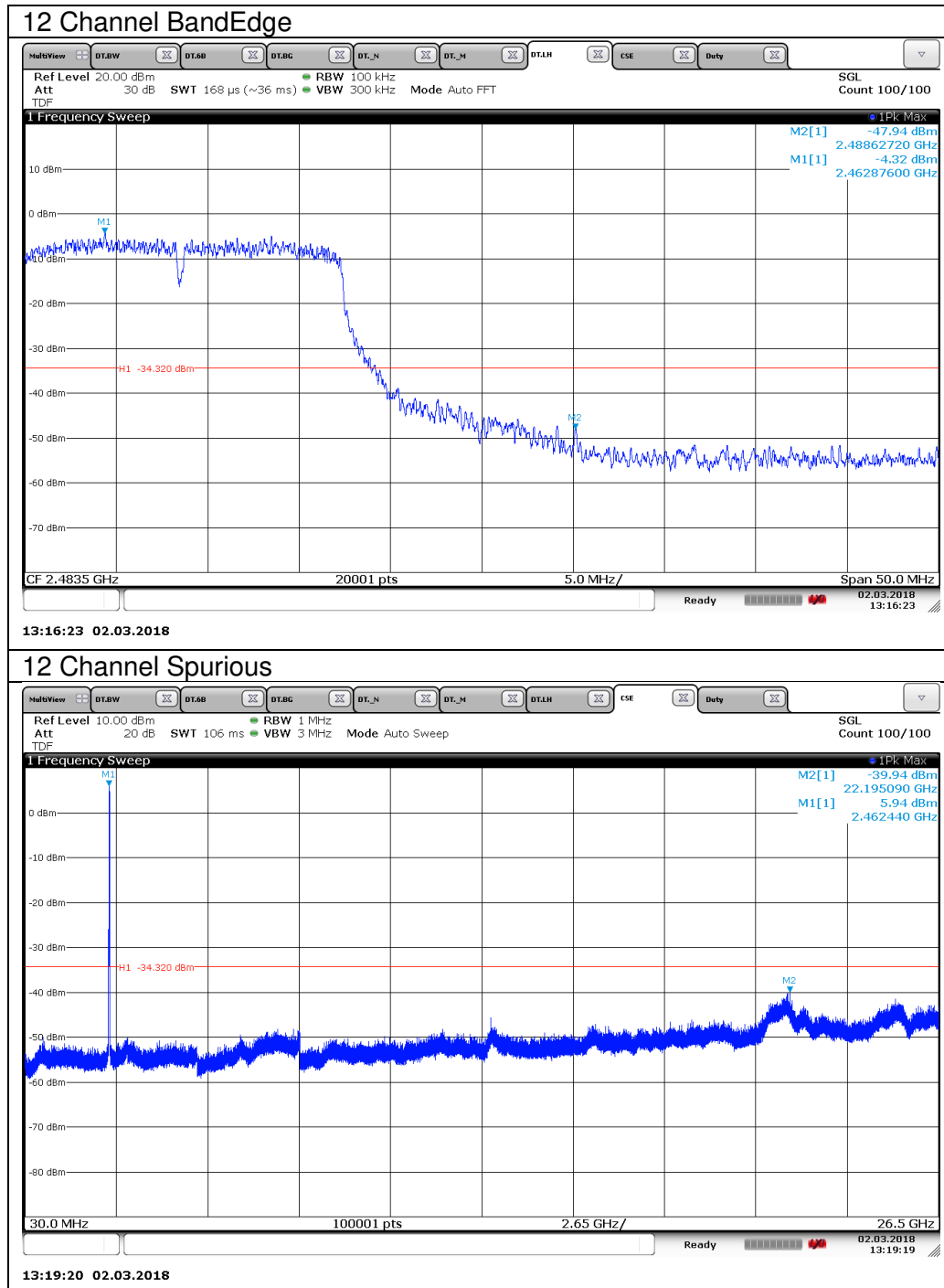

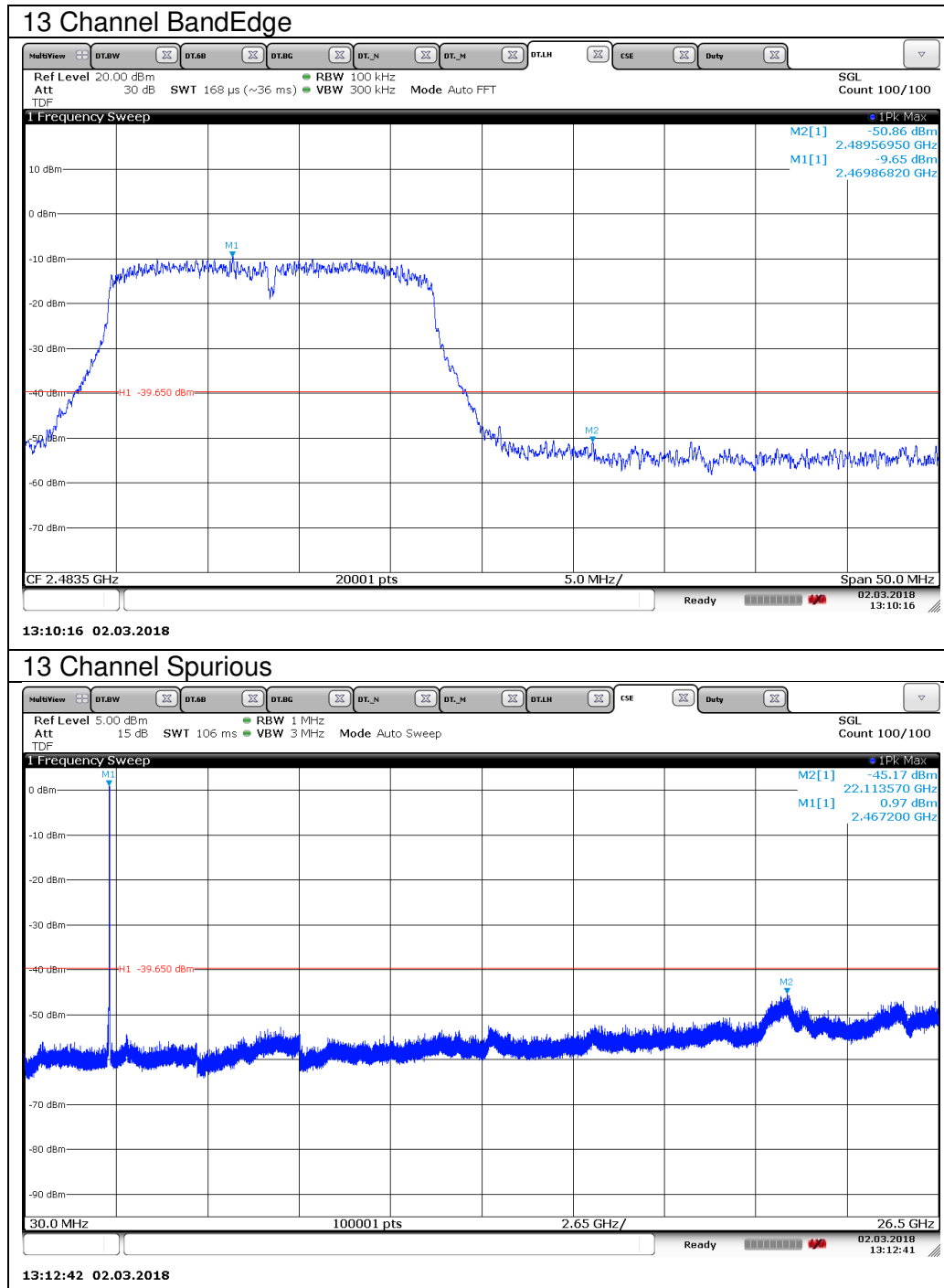

11. RADIATED TEST RESULTS

11.1. LIMITS AND PROCEDURE

LIMITS

FCC §15.205 and §15.209

Limits for radiated disturbance of an intentional radiator		
Frequency range (MHz)	Limits (µV/m)	Measurement Distance (m)
0.009 – 0.490	2400 / F (kHz)	300
0.490 – 1.705	24000 / F (kHz)	30
1.705 – 30.0	30	30
30 – 88	100**	3
88 - 216	150**	3
216 – 960	200**	3
Above 960	500	3

** Except as provided in paragraph (g), fundamental emissions from intentional radiators operating under this section shall not be located in the frequency bands 54-72 MHz, 76-88 MHz, 174-216 MHz or 470-806 MHz. However, operation within these frequency bands is permitted under other sections of this part, e.g. §§ 15.231 and 15.241.

TEST PROCEDURE

The EUT is placed on a non-conducting table 80 cm above the ground plane for below 1GHz and 150 cm for above 1GHz. The antenna to EUT distance is 3 meters. The EUT is configured in accordance with ANSI C63.10. The EUT is set to transmit in a continuous mode.

For measurements below 1 GHz the resolution bandwidth is set to 100 kHz for peak detection measurements or 120 kHz for quasi-peak detection measurements. Peak detection is used unless otherwise noted as quasi-peak.

For measurements above 1 GHz the resolution bandwidth is set to 1 MHz; the video bandwidth is set to 3 MHz for peak measurements and add duty cycle factor for average measurements. (Restricted bandedge, Final detection of spurious harmonic emissions)
Duty cycle factor= $10\log(1/x)$ For this sample B mode = 0dB (duty cycle >98%); G mode = 0dB (duty cycle >98%); N mode = 0dB (duty cycle >98%).

Pre-scans to detect harmonic and spurious emissions, the resolution bandwidth is set to 1 MHz; the video bandwidth is set to 30 KHz for peak measurements.

The spectrum from 1 GHz to 26 GHz is investigated with the transmitter set to the lowest, middle, and highest channels in each applicable band.
(From 30MHz to 1GHz, test was performed with the EUT set to transmit at the channel with highest output power)

The frequency range of interest is monitored at a fixed antenna height and EUT azimuth. The EUT is rotated through 360 degrees to maximize emissions received. The antenna is scanned from 1 to 4 meters above the ground plane to further maximize the emission. Measurements are made with the antenna polarized in both the vertical and the horizontal positions.

11.2. TRANSMITTER ABOVE 1 GHz

11.2.1.TX ABOVE 1 GHz 802.11b MODE IN THE 2.4 GHz BAND

RESTRICTED BANDEDGE (LOW CHANNEL)

HORIZONTAL PEAK AND AVERAGE PLOT

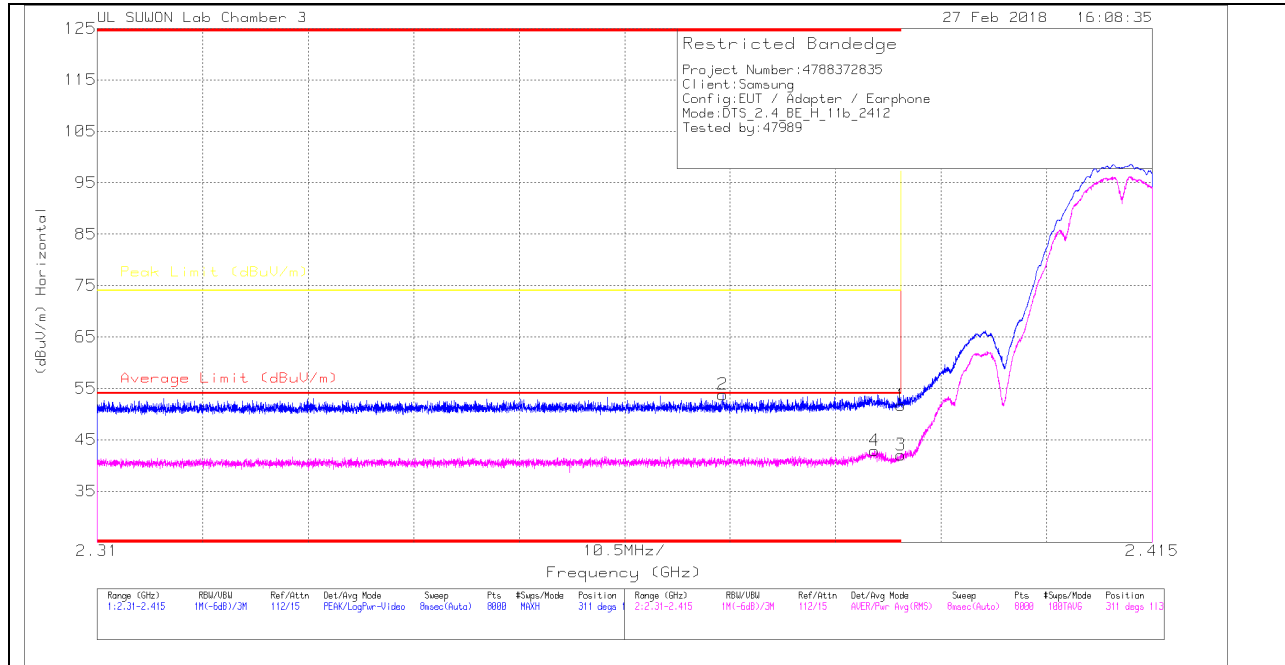

HORIZONTAL DATA

Trace Markers

Marker	Frequency (GHz)	Meter Reading (dBuV)	Det	3117(00205959)	10dB_ATT(dB)	DC Corr (dB)	Corrected Reading (dBuV/m)	Average Limit (dBuV/m)	Margin (dB)	Peak Limit (dBuV/m)	Pk Margin (dB)	Azimuth (Degs)	Height (cm)	Polarity
1	* 2.39	43.22	Pk	31.8	-23.3	0	51.72	-	-	74	-22.28	311	113	H
2	* 2.372	45.3	Pk	31.7	-23.2	0	53.8	-	-	74	-20.2	311	113	H
3	* 2.39	33.56	RMS	31.8	-23.3	0	42.06	54	-11.94	-	-	311	113	H
4	* 2.387	34.39	RMS	31.8	-23.3	0	42.89	54	-11.11	-	-	311	113	H

* - indicates frequency in CFR47 Pt 15 / IC RSS-Restricted Band

Pk - Peak detector

RMS - RMS detection

VERTICAL PEAK AND AVERAGE PLOT

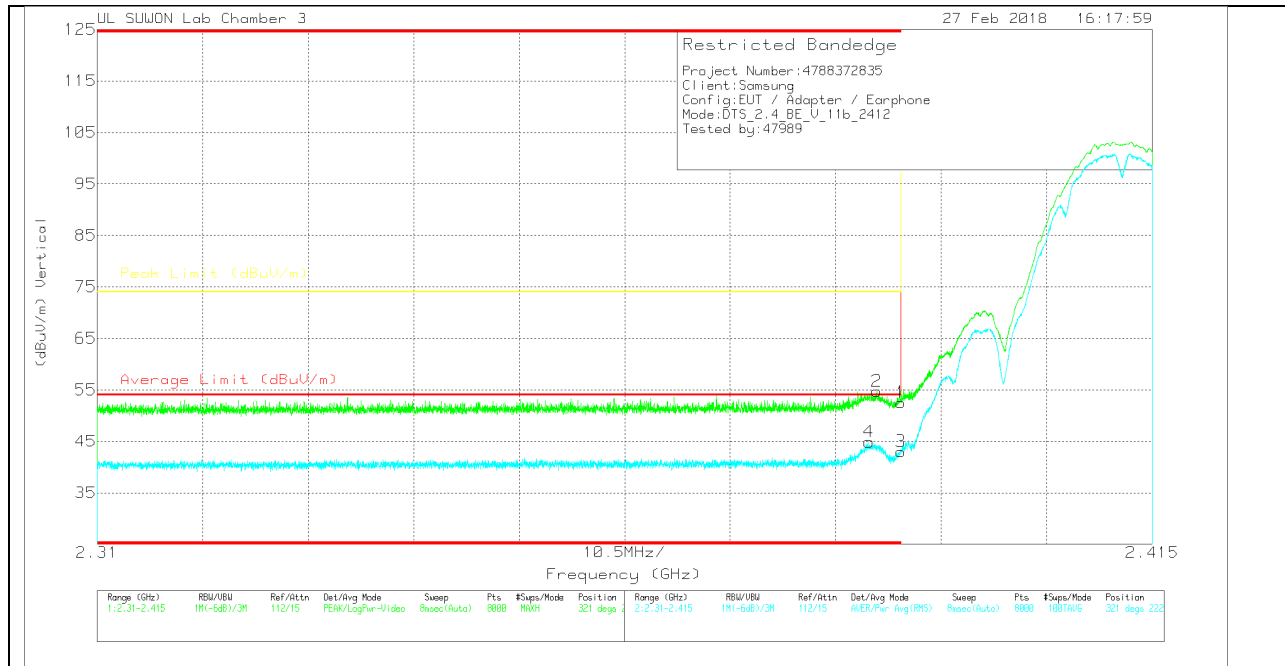

VERTICAL DATA

Trace Markers

Marker	Frequency (GHz)	Meter Reading (dBuV)	Det	3117(00205959)	10dB_ATT(dB)	DC Corr (dB)	Corrected Reading (dBuV/m)	Average Limit (dBuV/m)	Margin (dB)	Peak Limit (dBuV/m)	Pk Margin (dB)	Azimuth (Degs)	Height (cm)	Polarity
1	* 2.39	44.04	Pk	31.8	-23.3	0	52.54	-	-	74	-21.46	321	222	V
2	* 2.388	46.24	Pk	31.8	-23.3	0	54.74	-	-	74	-19.26	321	222	V
3	* 2.39	34.52	RMS	31.8	-23.3	0	43.02	54	-10.98	-	-	321	222	V
4	* 2.387	36.4	RMS	31.8	-23.3	0	44.9	54	-9.1	-	-	321	222	V

* - indicates frequency in CFR47 Pt 15 / IC RSS-Restricted Band

Pk - Peak detector

RMS - RMS detection

AUTHORIZED BANDEDGE (HIGH CHANNEL)

HORIZONTAL PEAK AND AVERAGE PLOT

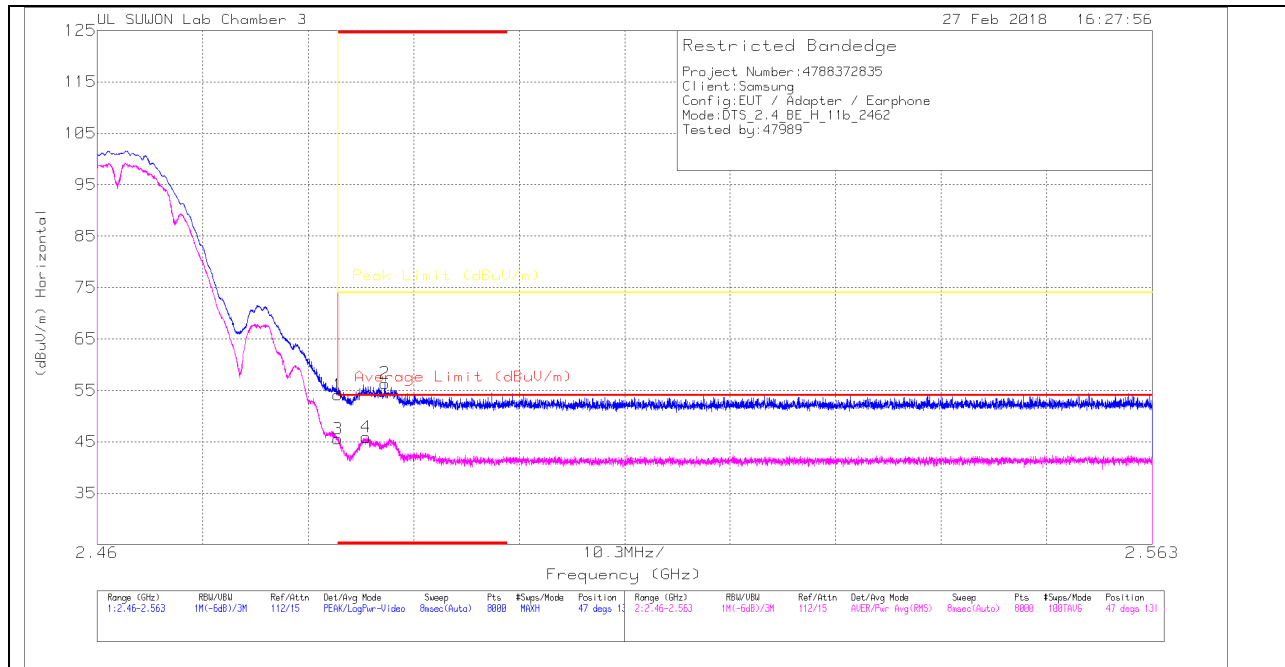

HORIZONTAL DATA

Trace Markers

Marker	Frequency (GHz)	Meter Reading (dBuV)	Det	311700205959	10dB_ATT(dB)	DC Corr (dB)	Corrected Reading (dBuV/m)	Average Limit (dBuV/m)	Margin (dB)	Peak Limit (dBuV/m)	PK Margin (dB)	Azimuth (Degs)	Height (cm)	Polarity
1	* 2.484	44.99	Pk		32.1	-23	54.09	-	-	74	-19.91	47	131	H
2	* 2.488	47.34	Pk		32.1	-23.1	56.34	-	-	74	-17.66	47	131	H
3	* 2.484	36.44	RMS		32.1	-23	45.54	54	-8.46	-	-	47	131	H
4	* 2.486	36.88	RMS		32.1	-23.1	45.88	54	-8.12	-	-	47	131	H

* - indicates frequency in CFR47 Pt 15 / IC RSS-Restricted Band

Pk - Peak detector

RMS - RMS detection

VERTICAL PEAK AND AVERAGE PLOT

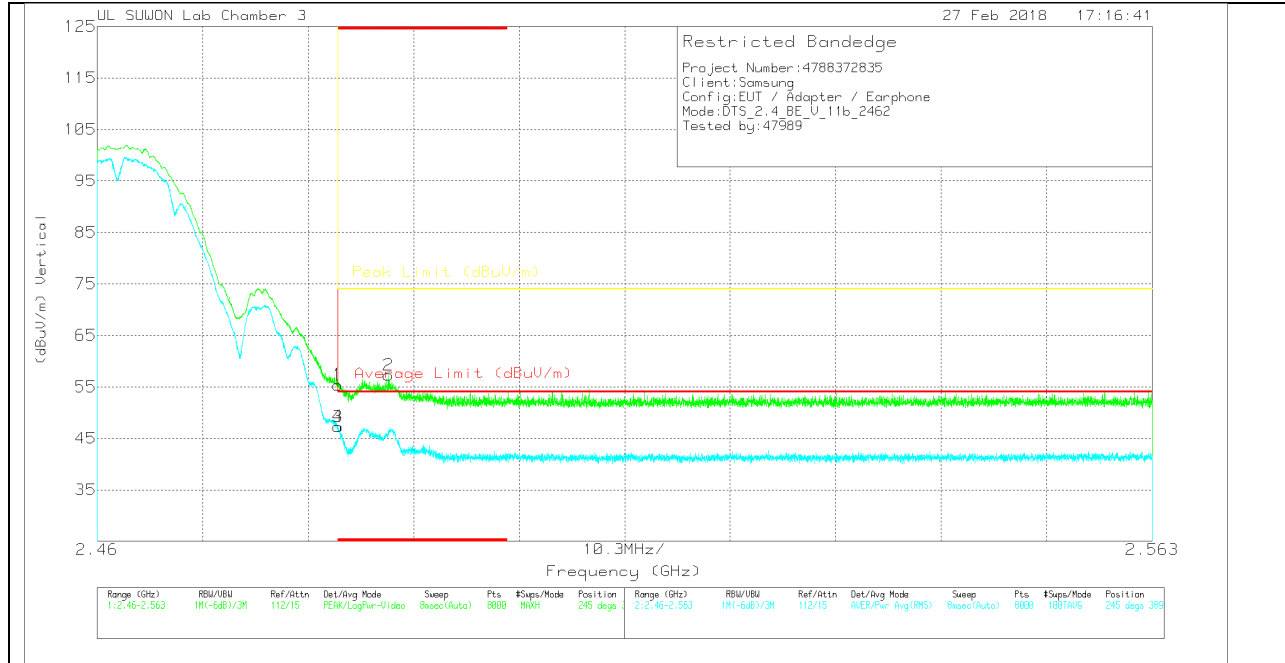

VERTICAL DATA

Trace Markers

Marker	Frequency (GHz)	Meter Reading (dBuV)	Det	3117(00205959)	10dB_ATT[dB]	DC Corr (dB)	Corrected Reading (dBuV/m)	Average Limit (dBuV/m)	Margin (dB)	Peak Limit (dBuV/m)	PK Margin (dB)	Azimuth (Degs)	Height (cm)	Polarity
1	* 2.484	46.27	Pk		-23	0	55.37	-	-	74	-18.63	245	389	V
2	* 2.488	48.26	Pk		-23.1	0	57.26	-	-	74	-16.74	245	389	V
3	* 2.484	38.16	RMS		-23	0	47.26	54	-6.74	-	-	245	389	V
4	* 2.484	38.19	RMS		-23	0	47.29	54	-6.71	-	-	245	389	V

* - indicates frequency in CFR47 Pt 15 / IC RSS-Restricted Band

Pk - Peak detector

RMS - RMS detection

AUTHORIZED BANDEDGE (12 CHANNEL)

HORIZONTAL PEAK AND AVERAGE PLOT

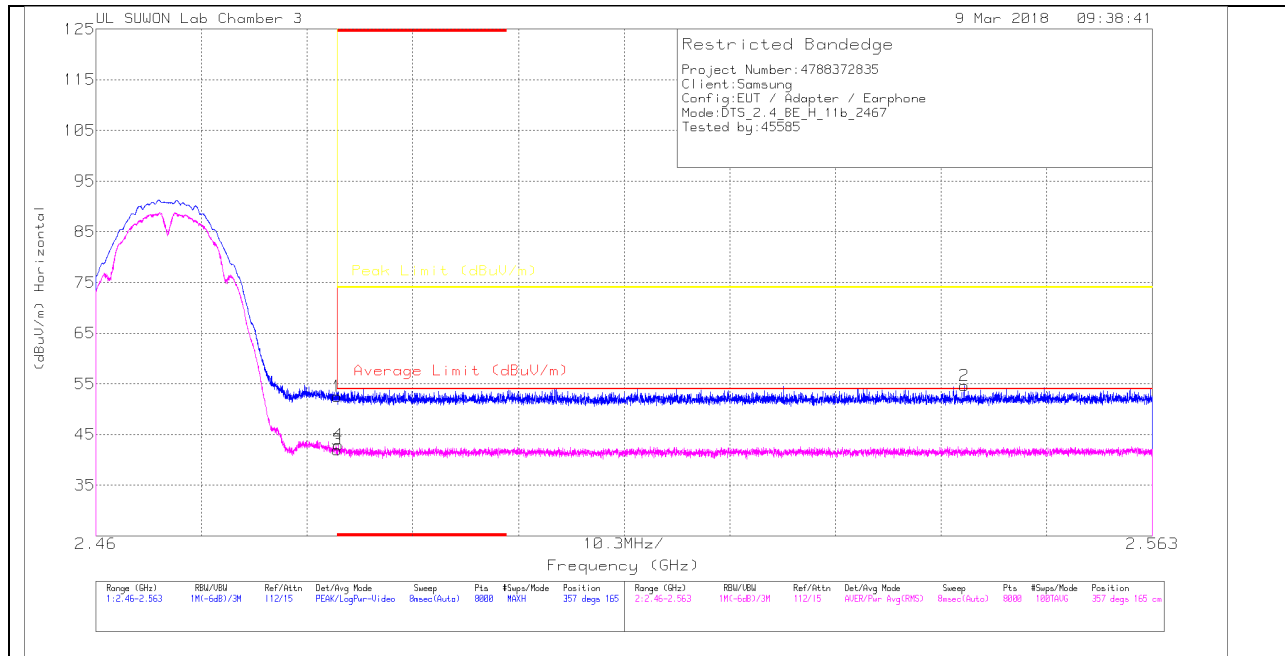

HORIZONTAL DATA

Trace Markers

Marker	Frequency (GHz)	Meter Reading (dBuV)	Det	3117(00205959)	10dB_ATT(dB)	DC Corr (dB)	Corrected Reading (dBuV/m)	Average Limit (dBuV/m)	Margin (dB)	Peak Limit (dBuV/m)	PK Margin (dB)	Azimuth (Degs)	Height (cm)	Polarity
1	* 2.484	43.43	Pk	32.1	-23	0	52.53	-	-	74	-21.47	357	165	H
2	2.545	45.44	Pk	32.1	-22.9	0	54.64	-	-	74	-19.36	357	165	H
3	* 2.484	32.82	RMS	32.1	-23	0	41.92	54	-12.08	-	-	357	165	H
4	* 2.484	33.87	RMS	32.1	-23	0	42.97	54	-11.03	-	-	357	165	H

* - indicates frequency in CFR47 Pt 15 / IC RSS-Restricted Band

Pk - Peak detector

RMS - RMS detection

VERTICAL PEAK AND AVERAGE PLOT

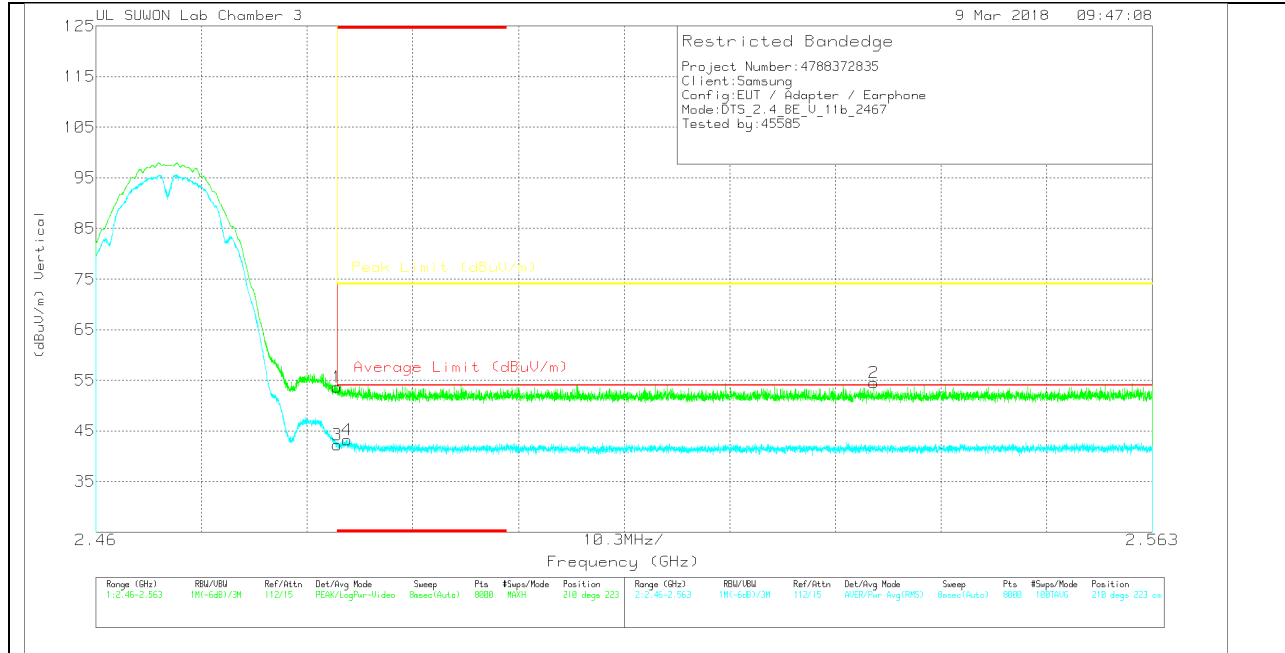

VERTICAL DATA

Trace Markers

Marker	Frequency (GHz)	Meter Reading (dBuV)	Det	3117(00209599)	10dB_ATT(dB)	DC Corr (dB)	Corrected Reading (dBuV/m)	Average Limit (dBuV/m)	Margin (dB)	Peak Limit (dBuV/m)	PK Margin (dB)	Azimuth (Degs)	Height (cm)	Polarity
1	* 2.484	44.51	PK	32.1	-23	0	53.61	-	-	74	-20.39	210	223	V
2	2.536	45.46	PK	32.1	-23	0	54.56	-	-	74	-19.44	210	223	V
3	* 2.484	33.11	RMS	32.1	-23	0	42.21	54	-11.79	-	-	210	223	V
4	* 2.484	34.21	RMS	32.1	-23.1	0	43.21	54	-10.79	-	-	210	223	V

* - indicates frequency in CFR47 Pt 15 / IC RSS-Restricted Band

PK - Peak detector

RMS - RMS detection

HORIZONTAL PEAK AND AVERAGE PLOT

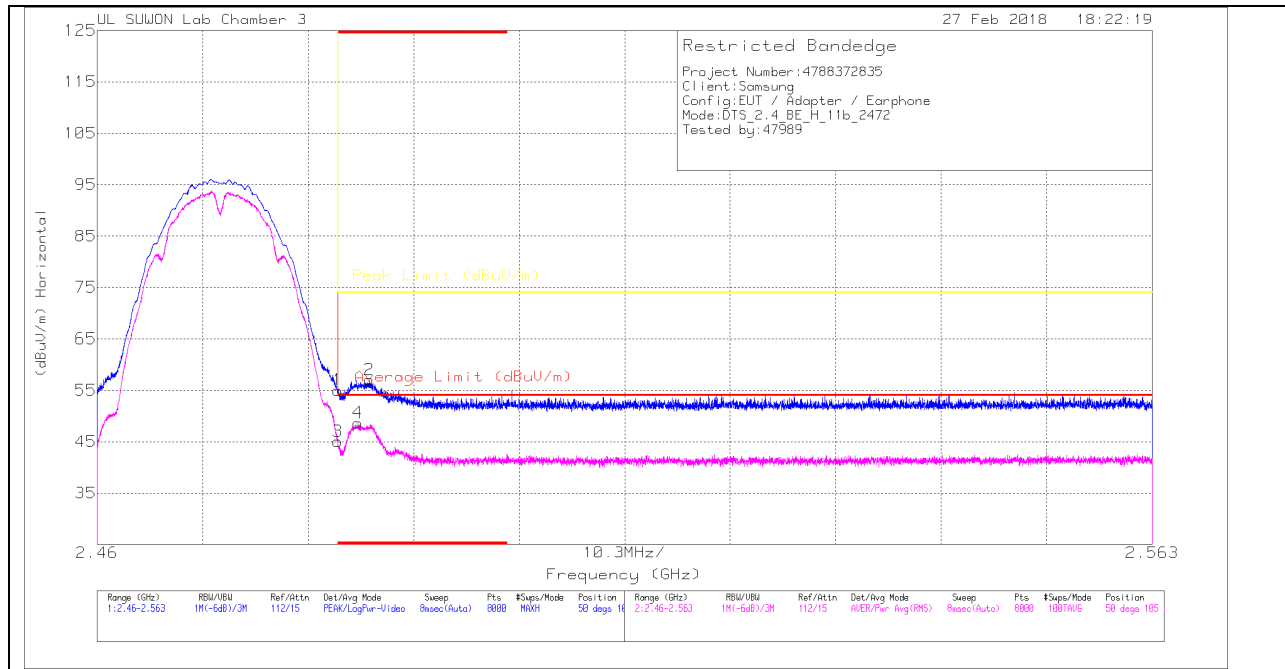

HORIZONTAL DATA

Trace Markers

Marker	Frequency (GHz)	Meter Reading (dBuV)	Det	311700205959	10dB_ATT(dB)	DC Corr (dB)	Corrected Reading (dBuV/m)	Average Limit (dBuV/m)	Margin (dB)	Peak Limit (dBuV/m)	PK Margin (dB)	Azimuth (Degs)	Height (cm)	Polarity
1	* 2.484	45.93	Pk	32.1	-23	0	55.03	-	-	74	-18.97	50	105	H
2	* 2.487	48.04	Pk	32.1	-23.1	0	57.04	-	-	74	-16.96	50	105	H
3	* 2.484	35.98	RMS	32.1	-23	0	45.08	54	-8.92	-	-	50	105	H
4	* 2.485	39.66	RMS	32.1	-23.1	0	48.66	54	-5.34	-	-	50	105	H

* - indicates frequency in CFR47 Pt 15 / IC RSS-Restricted Band

Pk - Peak detector

RMS - RMS detection

VERTICAL PEAK AND AVERAGE PLOT

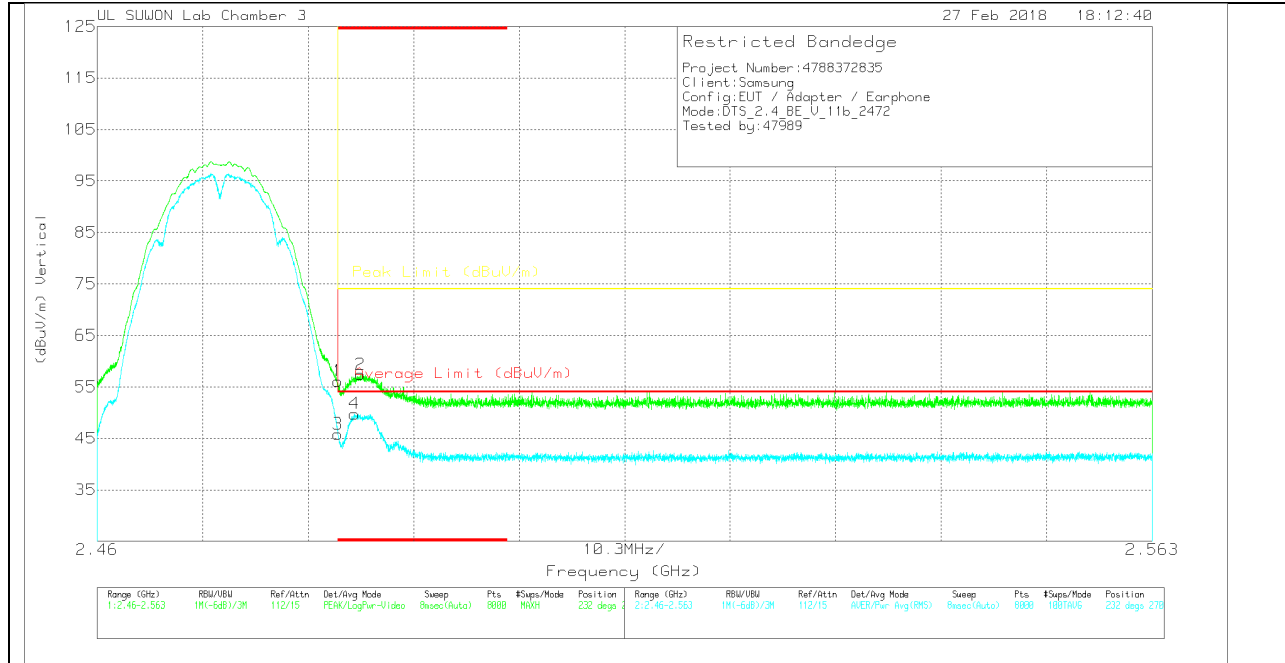

VERTICAL DATA

Trace Markers

Marker	Frequency (GHz)	Meter Reading (dBuV)	Det	3117(00205959)	10dB_ATT[dB]	DC Corr (dB)	Corrected Reading (dBuV/m)	Average Limit (dBuV/m)	Margin (dB)	Peak Limit (dBuV/m)	PK Margin (dB)	Azimuth (Degs)	Height (cm)	Polarity
1	* 2.484	47.03	Pk		-23	0	56.13	-	-	74	-17.87	232	270	V
2	* 2.486	48.41	Pk		-23.1	0	57.41	-	-	74	-16.59	232	270	V
3	* 2.484	36.72	RMS		-23	0	45.82	54	-8.18	-	-	232	270	V
4	* 2.485	40.77	RMS		-23.1	0	49.77	54	-4.23	-	-	232	270	V

* - indicates frequency in CFR47 Pt 15 / IC RSS-Restricted Band

Pk - Peak detector

RMS - RMS detection

HARMONICS AND SPURIOUS EMISSIONS

LOW CHANNEL HORIZONTAL

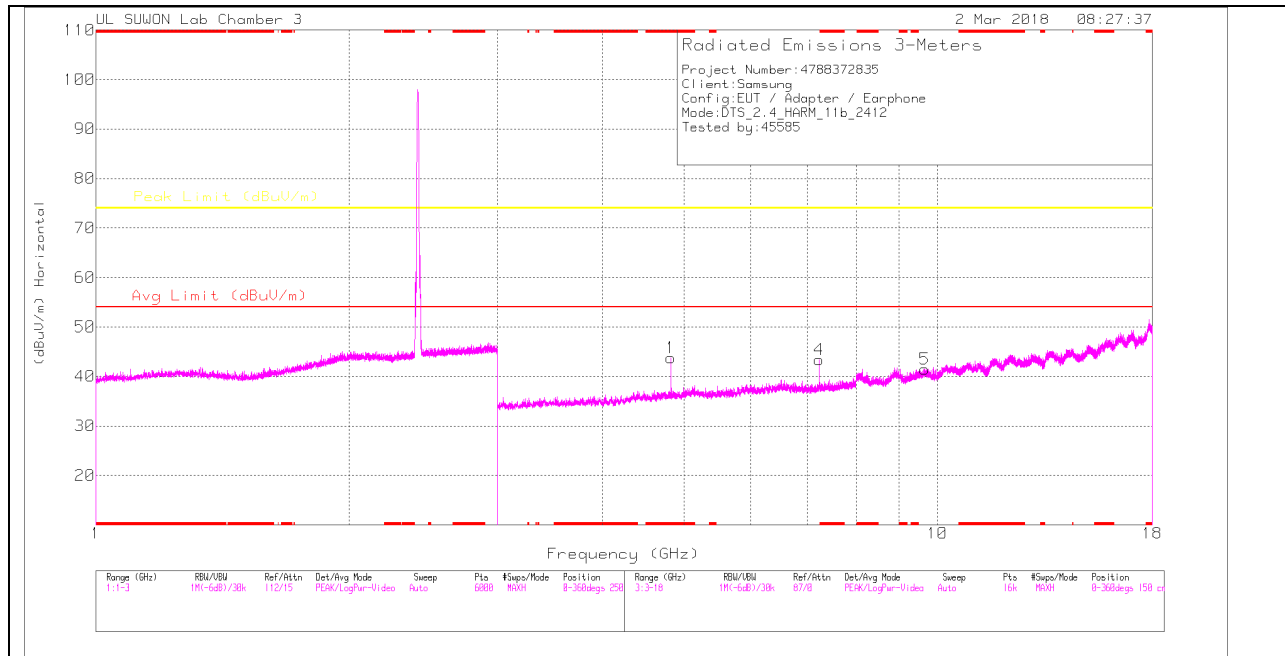

LOW CHANNEL VERTICAL

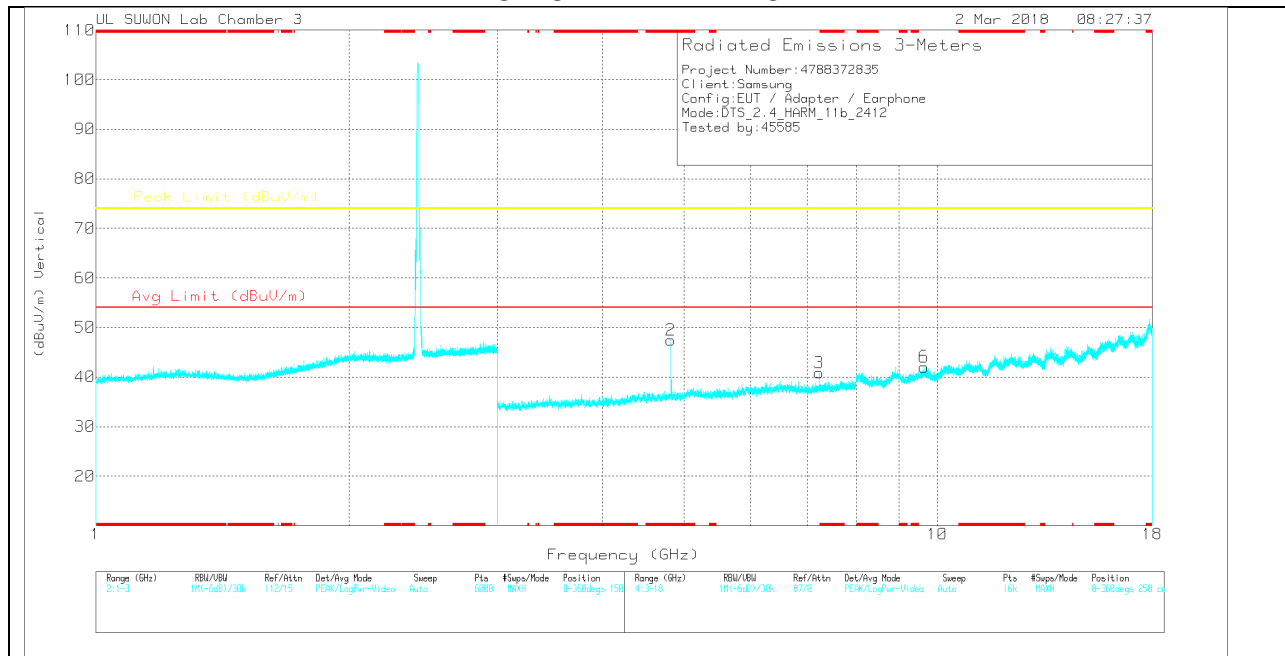

Note: Emission was scanned up to 26GHz; No emissions were detected above the noise floor which was at least 20dB below the specification limit.

LOW CHANNEL DATA

Trace Markers

Marker	Frequency (GHz)	Meter Reading (dBuV)	Det	3117[00205959]	3GHz_HP[dB]	DC Corr (dB)	Corrected Reading (dBuV/m)	Avg Limit (dBuV/m)	Margin (dB)	Peak Limit (dBuV/m)	Margin (dB)	Azimuth (Degs)	Height (cm)	Polarity
1	* 4.824	38.13	PK	34	-28.3	0	43.83	-	-	74	-30.17	0-360	250	H
4	7.234	31.74	PK	35.6	-23.9	0	43.44	-	-	74	-30.56	0-360	250	H
5	9.649	24.45	PK	36.7	-19.7	0	41.45	-	-	74	-32.55	0-360	250	H
2	* 4.824	41.77	PK	34	-28.3	0	47.47	-	-	74	-26.53	0-360	250	V
3	7.235	29.16	PK	35.6	-23.9	0	40.86	-	-	74	-33.14	0-360	150	V
6	9.648	25.06	PK	36.7	-19.7	0	42.06	-	-	74	-31.94	0-360	250	V

* - indicates frequency in CFR47 Pt 15 / IC RSS-Restricted Band
 PK – Peak Detector

Radiated Emissions

Frequency (GHz)	Meter Reading (dBuV)	Det	3117[00205959]	3GHz_HP[dB]	DC Corr (dB)	Corrected Reading (dBuV/m)	Avg Limit (dBuV/m)	Margin (dB)	Peak Limit (dBuV/m)	Margin (dB)	Azimuth (Degs)	Height (cm)	Polarity
* 4.824	43.83	PK2	34	-28.3	0	49.53	-	-	74	-24.47	60	324	H
* 4.824	38.68	MAv1	34	-28.3	0	44.38	54	-9.62	-	-	60	324	H
* 4.824	46.4	PK2	34	-28.3	0	52.1	-	-	74	-21.9	47	250	V
* 4.824	40.83	MAv1	34	-28.3	0	46.53	54	-7.47	-	-	47	250	V
7.235	38.44	PK2	35.6	-23.9	0	50.14	-	-	74	-23.86	333	179	V
7.237	38.84	PK2	35.6	-23.9	0	50.54	-	-	74	-23.46	212	128	H

* - indicates frequency in CFR47 Pt 15 / IC RSS-Restricted Band
 PK2 - KDB558074 Method: Maximum Peak
 MAv1 - KDB558074 Option 1 Maximum RMS Average

MID CHANNEL HORIZONTAL

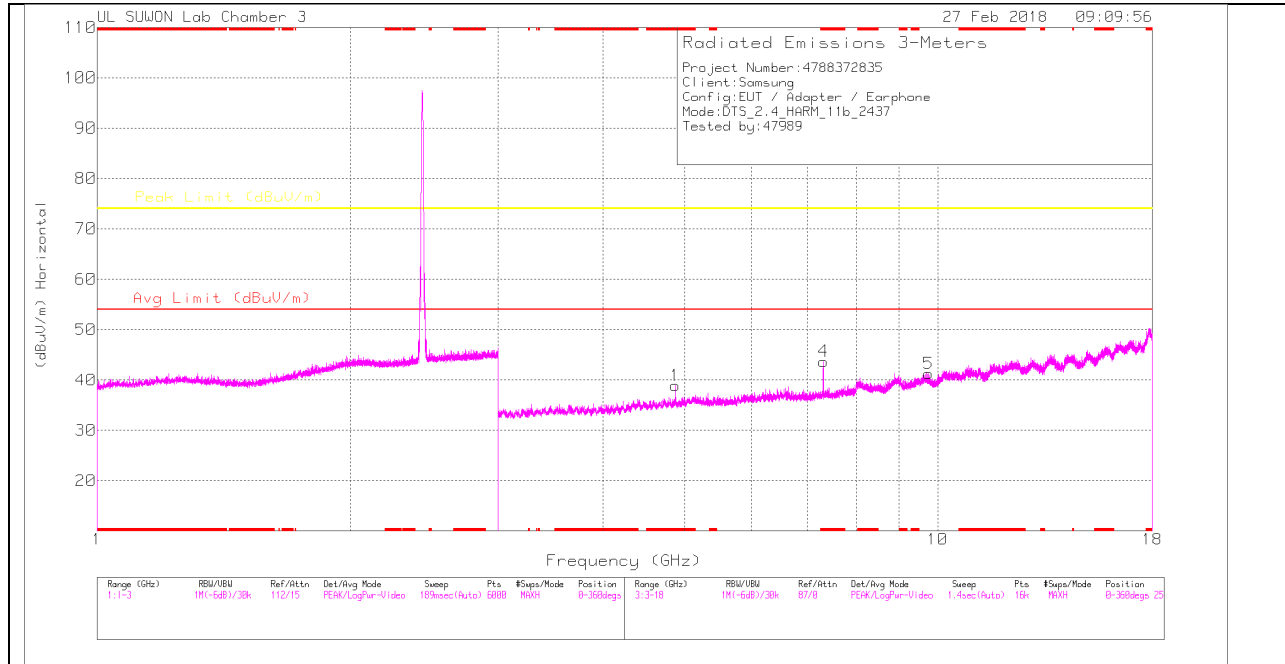

MID CHANNEL VERTICAL

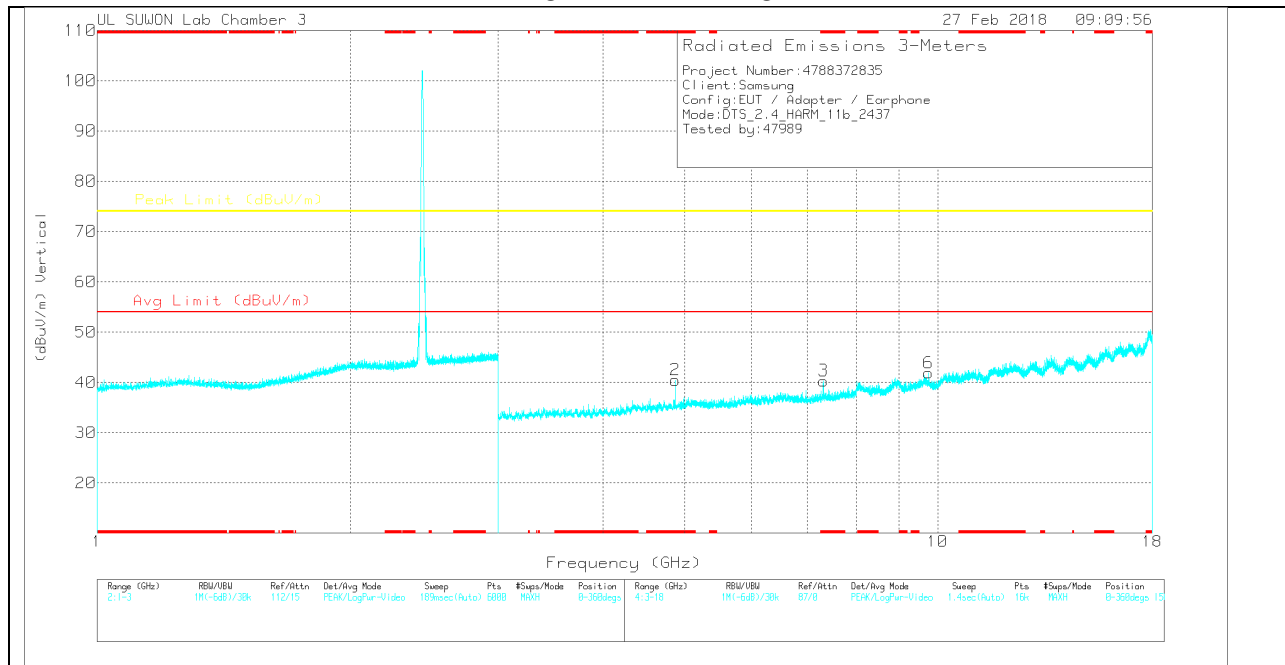

Note: Emission was scanned up to 26GHz; No emissions were detected above the noise floor which was at least 20dB below the specification limit.

MID CHANNEL DATA

Trace Markers

Marker	Frequency (GHz)	Meter Reading (dBuV)	Det	3117(00205959)	3GHz_HP[dB]	DC Corr (dB)	Corrected Reading (dBuV/m)	Avg Limit (dBuV/m)	Margin (dB)	Peak Limit (dBuV/m)	Margin (dB)	Azimuth (Degs)	Height (cm)	Polarity
1	* 4.873	33.69	PK	34	-28.8	0	38.89	-	-	74	-35.11	0-360	251	H
4	* 7.312	31.6	PK	35.6	-23.5	0	43.7	-	-	74	-30.3	0-360	251	H
5	9.748	23.87	PK	36.9	-19.5	0	41.27	-	-	74	-32.73	0-360	251	H
2	* 4.873	35.27	PK	34	-28.8	0	40.47	-	-	74	-33.53	0-360	150	V
3	* 7.311	28.23	PK	35.6	-23.5	0	40.33	-	-	74	-33.67	0-360	251	V
6	9.748	24.48	PK	36.9	-19.5	0	41.88	-	-	74	-32.12	0-360	150	V

* - indicates frequency in CFR47 Pt 15 / IC RSS-Restricted Band
 PK – Peak detector

Radiated Emissions

Frequency (GHz)	Meter Reading (dBuV)	Det	3117(00205959)	3GHz_HP[dB]	DC Corr (dB)	Corrected Reading (dBuV/m)	Avg Limit (dBuV/m)	Margin (dB)	Peak Limit (dBuV/m)	Margin (dB)	Azimuth (Degs)	Height (cm)	Polarity
* 4.874	41.68	PK	34	-28.9	0	46.78	-	-	74	-27.22	210	157	H
* 4.874	32.3	MAv1	34	-28.9	0	37.4	54	-16.6	-	-	210	157	H
* 4.874	42.55	PK2	34	-28.9	0	47.65	-	-	74	-26.35	296	383	V
* 4.874	35.4	MAv1	34	-28.9	0	40.5	54	-13.5	-	-	296	383	V
* 7.311	38.06	PK2	35.6	-23.5	0	50.16	-	-	74	-23.84	211	100	V
* 7.312	28.53	MAv1	35.6	-23.5	0	40.63	54	-13.37	-	-	211	100	V
* 7.312	36.99	PK2	35.6	-23.5	0	49.09	-	-	74	-24.91	146	198	H
* 7.312	27.57	MAv1	35.6	-23.5	0	39.67	54	-14.33	-	-	146	198	H

* - indicates frequency in CFR47 Pt 15 / IC RSS-Restricted Band
 PK - Peak detector
 PK2 - KDB558074 Method: Maximum Peak
 MAv1 - KDB558074 Option 1 Maximum RMS Average

HIGH CHANNEL HORIZONTAL

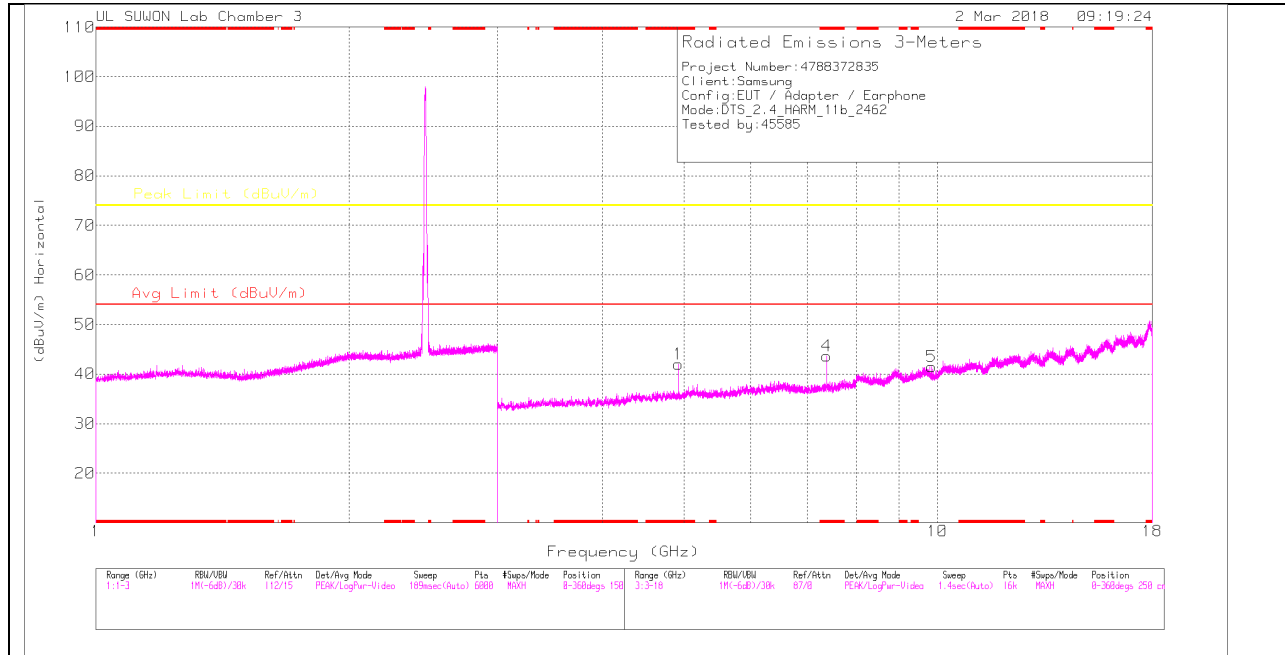

HIGH CHANNEL VERTICAL

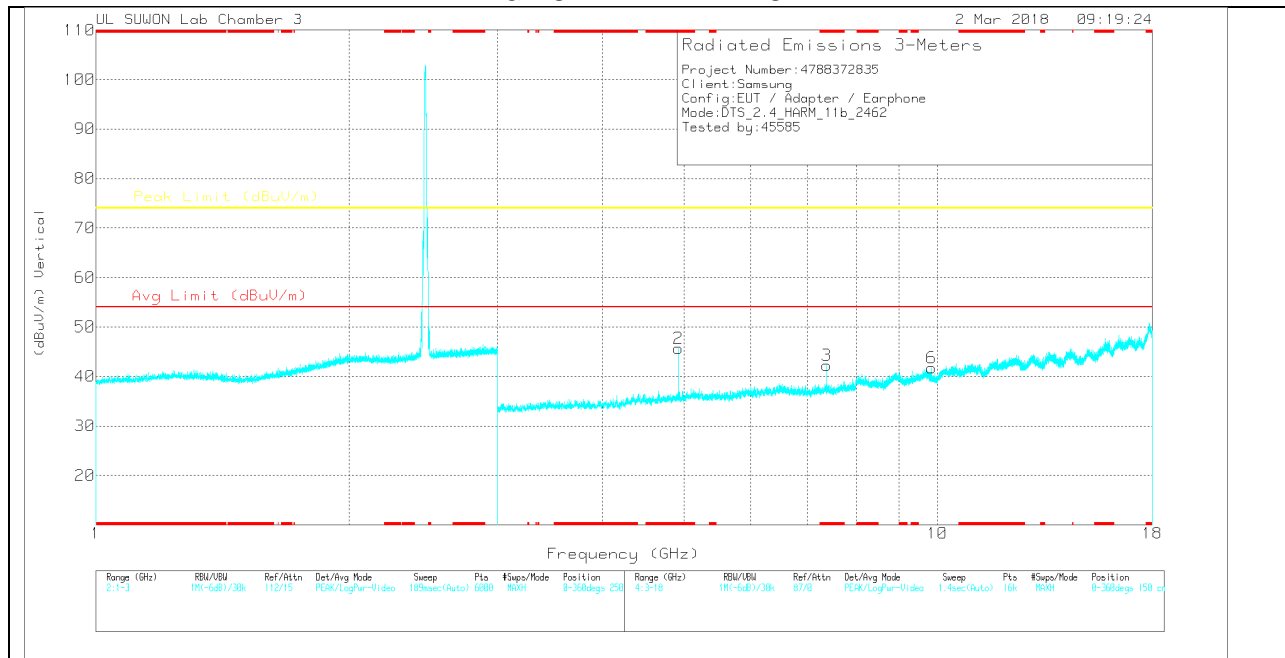

Note: Emission was scanned up to 26GHz; No emissions were detected above the noise floor which was at least 20dB below the specification limit.

HIGH CHANNEL DATA

Trace Markers

Marker	Frequency (GHz)	Meter Reading (dBuV)	Det	3117[00205959]	3GHz_HP[dB]	DC Corr (dB)	Corrected Reading (dBuV/m)	Avg Limit (dBuV/m)	Margin (dB)	Peak Limit (dBuV/m)	Margin (dB)	Azimuth (Degs)	Height (cm)	Polarity
1	* 4.924	36.85	PK	34	-28.9	0	41.95	-	-	74	-32.05	0-360	250	H
4	* 7.387	31.06	PK	35.6	-23	0	43.66	-	-	74	-30.34	0-360	250	H
5	9.848	24.21	PK	37	-19.7	0	41.51	-	-	74	-32.49	0-360	150	H
2	* 4.924	-40.6	PK	34	-28.9	0	45.7	-	-	74	-28.3	0-360	250	V
3	* 7.385	29.66	PK	35.6	-23	0	42.26	-	-	74	-31.74	0-360	250	V
6	9.848	24.39	PK	37	-19.7	0	41.69	-	-	74	-32.31	0-360	150	V

* - indicates frequency in CFR47 Pt 15 / IC RSS-Restricted Band
 PK – Peak Detector

Radiated Emissions

Frequency (GHz)	Meter Reading (dBuV)	Det	3117[00205959]	3GHz_HP[dB]	DC Corr (dB)	Corrected Reading (dBuV/m)	Avg Limit (dBuV/m)	Margin (dB)	Peak Limit (dBuV/m)	Margin (dB)	Azimuth (Degs)	Height (cm)	Polarity
* 4.924	44.3	PK2	34	-28.9	0	49.4	-	-	74	-24.6	69	373	H
* 4.924	38.18	MAv1	34	-28.9	0	43.28	54	-10.72	-	-	69	373	H
* 4.924	44.17	PK2	34	-28.9	0	49.27	-	-	74	-24.73	305	121	V
* 4.924	38.64	MAv1	34	-28.9	0	43.74	54	-10.26	-	-	305	121	V
* 7.385	38.13	PK2	35.6	-23	0	50.73	-	-	74	-23.27	210	114	V
* 7.387	29.83	MAv1	35.6	-23	0	42.43	54	-11.57	-	-	210	114	V
* 7.387	39.2	PK2	35.6	-23	0	51.8	-	-	74	-22.2	81	299	H
* 7.387	32.37	MAv1	35.6	-23	0	44.97	54	-9.03	-	-	81	299	H

* - indicates frequency in CFR47 Pt 15 / IC RSS-Restricted Band
 PK2 - KDB558074 Method: Maximum Peak
 MAv1 - KDB558074 Option 1 Maximum RMS Average

11.2.2.TX ABOVE 1 GHz 802.11g MODE IN THE 2.4 GHz BAND

RESTRICTED BANDEDGE (LOW CHANNEL)

HORIZONTAL PEAK AND AVERAGE PLOT

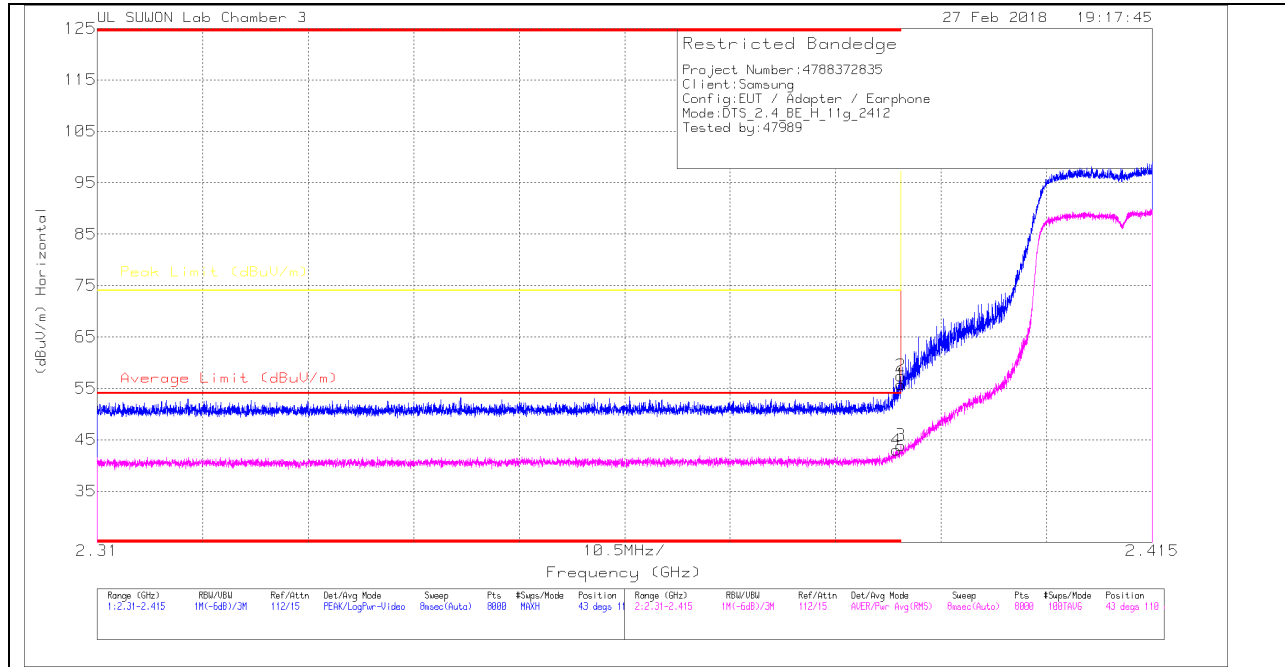

HORIZONTAL DATA

Trace Markers

Marker	Frequency (GHz)	Meter Reading (dBuV)	Det	3117(00205959)	10dB_ATT(dB)	DC Corr (dB)	Corrected Reading (dBuV/m)	Average Limit (dBuV/m)	Margin (dB)	Peak Limit (dBuV/m)	PK Margin (dB)	Azimuth (Degs)	Height (cm)	Polarity
1	* 2.39	47.23	Pk	31.8	-23.3	0	55.73	-	-	74	-18.27	43	110	H
2	* 2.39	48.93	Pk	31.8	-23.3	0	57.43	-	-	74	-16.57	43	110	H
3	* 2.39	35.39	RMS	31.8	-23.3	0	43.89	54	-10.11	-	-	43	110	H
4	* 2.39	34.47	RMS	31.8	-23.3	0	42.97	54	-11.03	-	-	43	110	H

* - indicates frequency in CFR47 Pt 15 / IC RSS-Restricted Band

Pk - Peak detector

RMS - RMS detection

VERTICAL PEAK AND AVERAGE PLOT

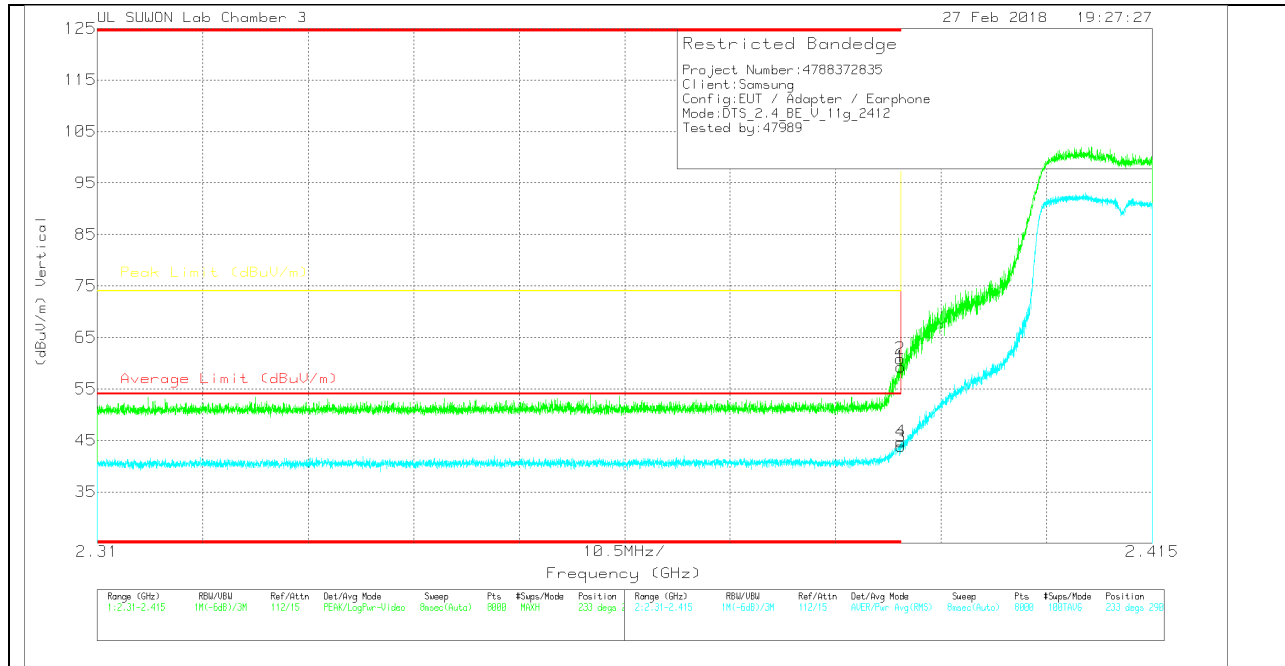

VERTICAL DATA

Trace Markers

Marker	Frequency (GHz)	Meter Reading (dBuV)	Det	3117(00205959)	10dB_ATT(dB)	DC Corr (dB)	Corrected Reading (dBuV/m)	Average Limit (dBuV/m)	Margin (dB)	Peak Limit (dBuV/m)	PK Margin (dB)	Altitude (Degs)	Height (cm)	Polarity
1	* 2.39	42.85	PK	31.8	-23.3	0	51.35	-	-	74	-22.65	38	209	V
2	* 2.388	45.23	PK	31.8	-23.3	0	53.73	-	-	74	-20.27	38	209	V
3	* 2.39	32.31	RMS	31.8	-23.3	.14	40.95	54	-13.05	-	-	38	209	V
4	* 2.389	33.6	RMS	31.8	-23.3	.14	42.24	54	-11.76	-	-	38	209	V

* - indicates frequency in CFR47 Pt 15 / IC RSS-Restricted Band

PK - Peak detector

RMS - RMS detection

HORIZONTAL PEAK AND AVERAGE PLOT

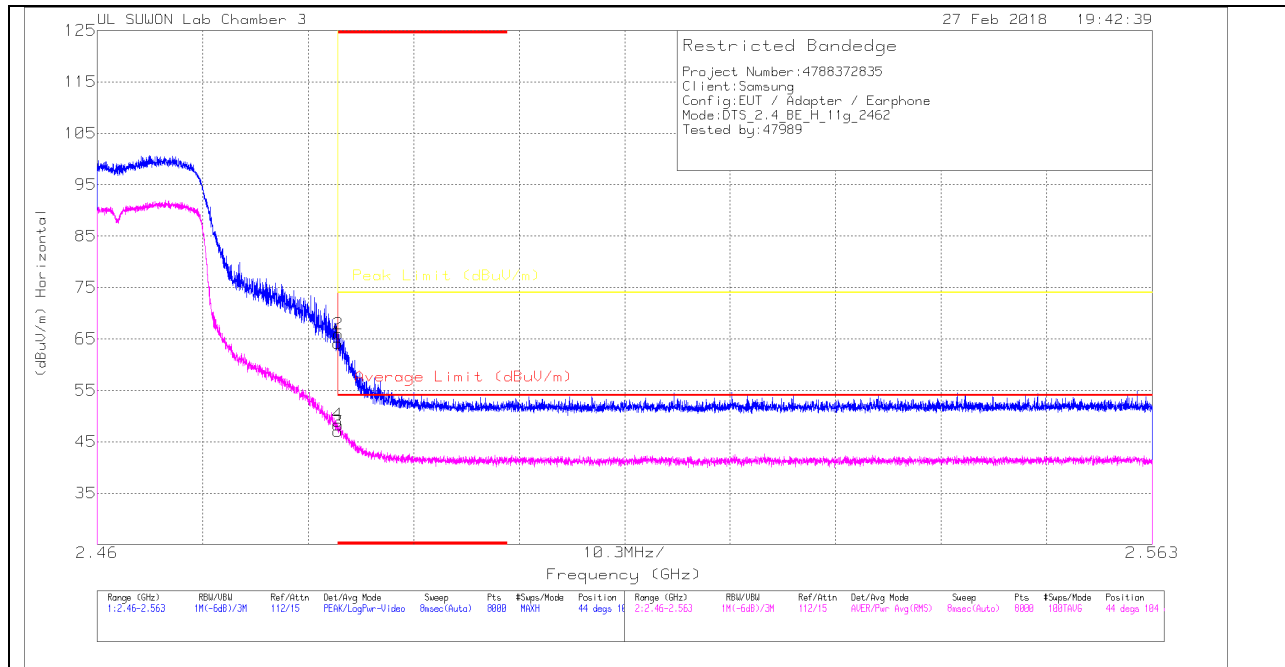

HORIZONTAL DATA

Trace Markers

Marker	Frequency (GHz)	Meter Reading (dBuV)	Det	311700205959	10dB_ATT(dB)	DC Corr (dB)	Corrected Reading (dBuV/m)	Average Limit (dBuV/m)	Margin (dB)	Peak Limit (dBuV/m)	PK Margin (dB)	Asimuth (Degs)	Height (cm)	Polarity
1	* 2.484	55.09	Pk	32.1	-23	0	64.19	-	-	74	-9.81	44	104	H
2	* 2.484	56.83	Pk	32.1	-23	0	65.93	-	-	74	-8.07	44	104	H
3	* 2.484	37.94	RMS	32.1	-23	0	47.04	54	-6.96	-	-	44	104	H
4	* 2.484	39.22	RMS	32.1	-23	0	48.32	54	-5.68	-	-	44	104	H

* - indicates frequency in CFR47 Pt 15 / IC RSS-Restricted Band

Pk - Peak detector

RMS - RMS detection

VERTICAL PEAK AND AVERAGE PLOT

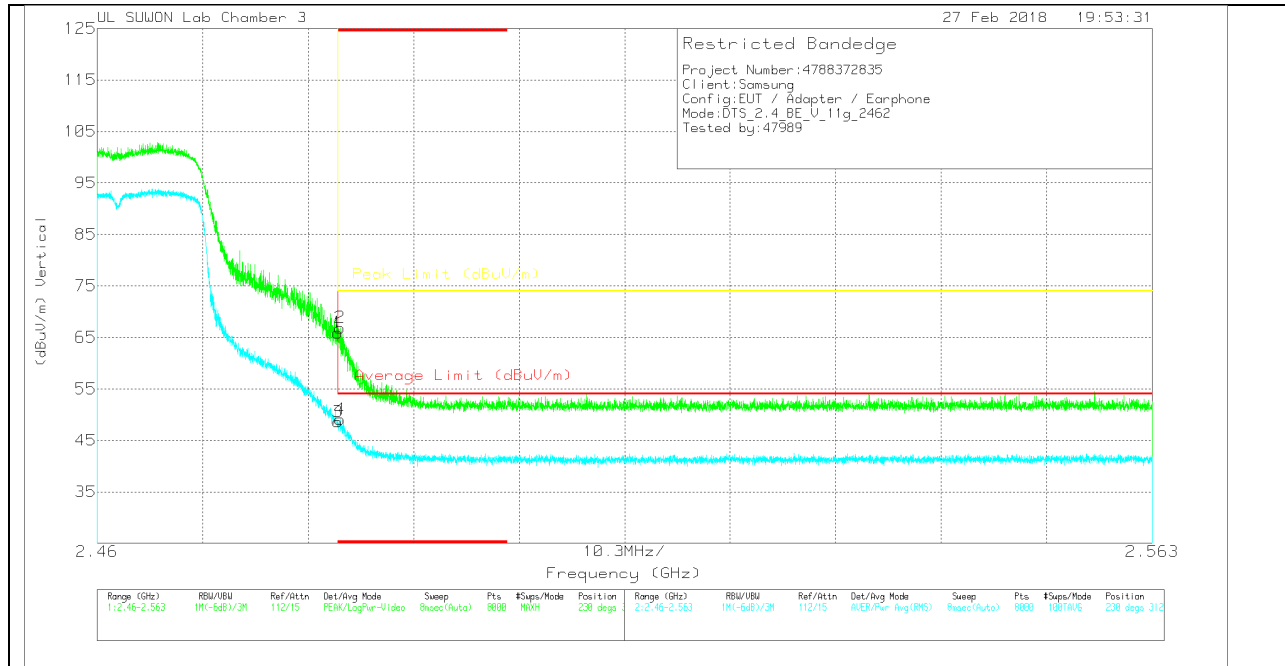

VERTICAL DATA

Trace Markers

Marker	Frequency (GHz)	Meter Reading (dBuV)	Det	3117(00205959)	10dB_ATT(dB)	DC Corr (dB)	Corrected Reading (dBuV/m)	Average Limit (dBuV/m)	Margin (dB)	Peak Limit (dBuV/m)	PK Margin (dB)	Azimuth (Degs)	Height (cm)	Polarity
1	* 2.484	56.82	Pk	32.1	-23	0	65.92	-	-	74	-8.08	230	312	V
2	* 2.484	57.78	Pk	32.1	-23	0	66.88	-	-	74	-7.12	230	312	V
3	* 2.484	39.52	RMS	32.1	-23	0	48.62	54	-5.38	-	-	230	312	V
4	* 2.484	39.98	RMS	32.1	-23	0	49.08	54	-4.92	-	-	230	312	V

* - indicates frequency in CFR47 Pt 15 / IC RSS-Restricted Band

Pk - Peak detector

RMS - RMS detection

AUTHORIZED BANDEDGE (12 CHANNEL)

HORIZONTAL PEAK AND AVERAGE PLOT

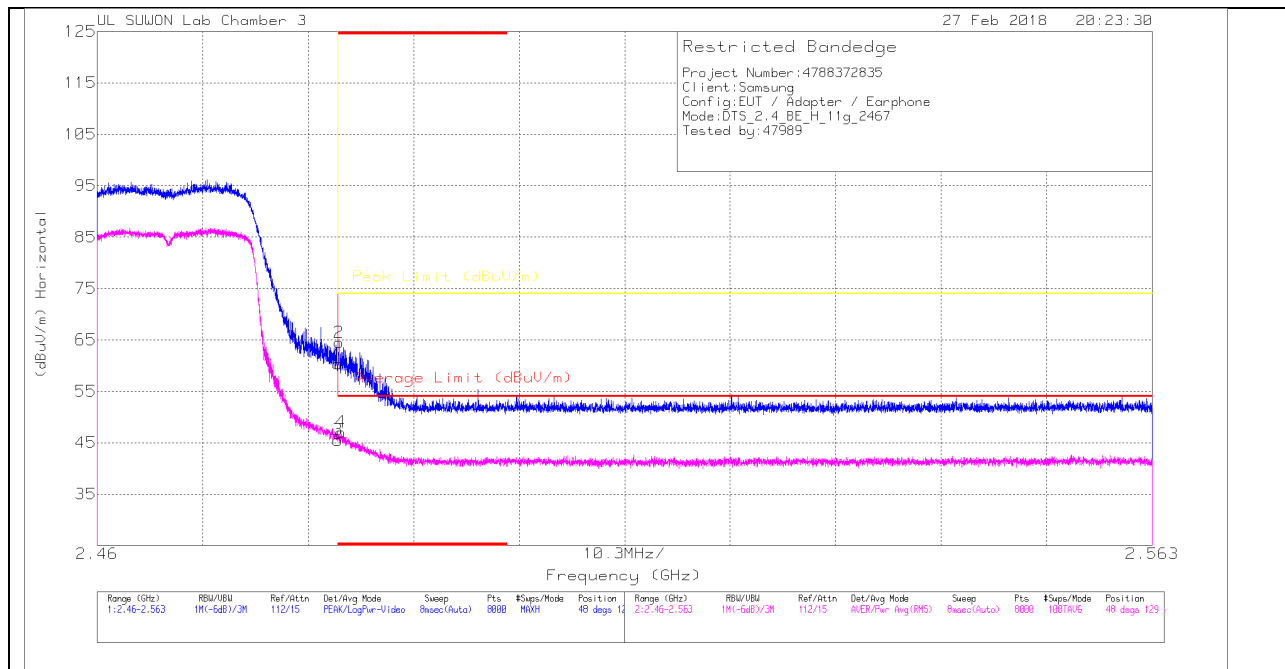

HORIZONTAL DATA

Trace Markers

Marker	Frequency (GHz)	Meter Reading (dBuV)	Det	3117(00205959)	10dB_ATT(dB)	DC Corr (dB)	Corrected Reading (dBuV/m)	Average Limit (dBuV/m)	Margin (dB)	Peak Limit (dBuV/m)	PK Margin (dB)	Azimuth (Degs)	Height (cm)	Polarity
1	* 2.484	51.25	Pk	32.1	-23	0	60.35	-	-	74	-13.65	48	129	H
2	* 2.484	55.37	Pk	32.1	-23	0	64.47	-	-	74	-9.53	48	129	H
3	* 2.484	36.42	RMS	32.1	-23	0	45.52	54	-8.48	-	-	48	129	H
4	* 2.484	38.05	RMS	32.1	-23.1	0	47.05	54	-6.95	-	-	48	129	H

* - indicates frequency in CFR47 Pt 15 / IC RSS-Restricted Band

Pk - Peak detector

RMS - RMS detection

VERTICAL PEAK AND AVERAGE PLOT

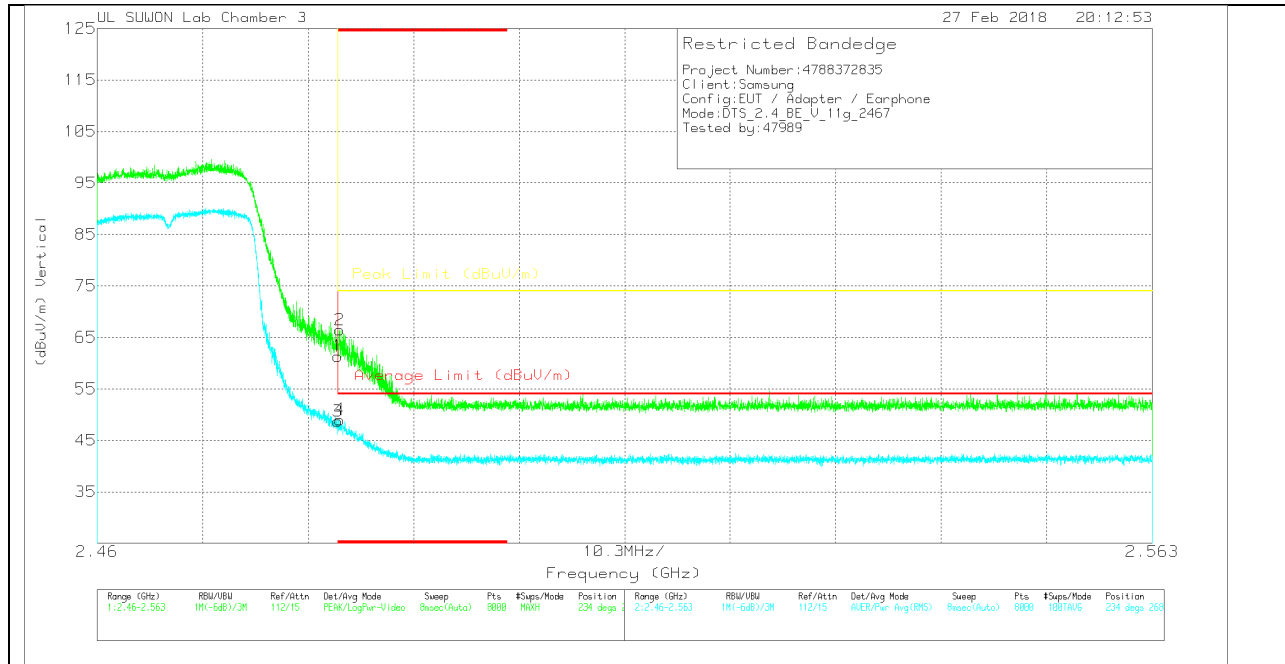

VERTICAL DATA

Trace Markers

Marker	Frequency (GHz)	Meter Reading (dBuV)	Det	311700005959	10dB_ATT[dB]	DC Corr (dB)	Corrected Reading (dBuV/m)	Average Limit (dBuV/m)	Margin (dB)	Peak Limit (dBuV/m)	PK Margin (dB)	Azimuth (Degs)	Height (cm)	Polarity
1	* 2.484	52.27	Pk	32.1	-23	0	61.37	-	-	74	-12.63	234	268	V
2	* 2.484	57.34	Pk	32.1	-23	0	66.44	-	-	74	-7.56	234	268	V
3	* 2.484	39.63	RMS	32.1	-23	0	48.73	54	-5.27	-	-	234	268	V
4	* 2.484	39.91	RMS	32.1	-23	0	49.01	54	-4.99	-	-	234	268	V

* - indicates frequency in CFR47 Pt 15 / IC RSS-Restricted Band

Pk - Peak detector

RMS - RMS detection

AUTHORIZED BANDEDGE (13 CHANNEL)

HORIZONTAL PEAK AND AVERAGE PLOT

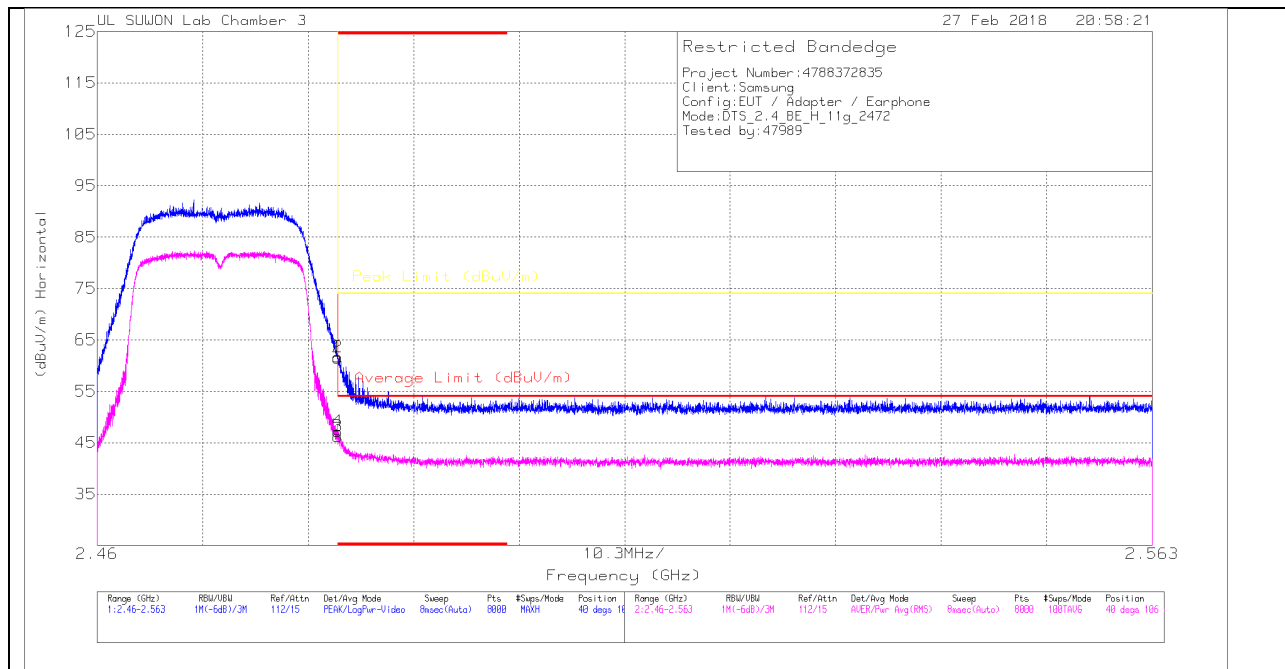

HORIZONTAL DATA

Trace Markers

Marker	Frequency (GHz)	Meter Reading (dBuV)	Det	3117000205959	10dB_ATT[dB]	DC Corr (dB)	Corrected Reading (dBuV/m)	Average Limit (dBuV/m)	Margin (dB)	Peak Limit (dBuV/m)	PK Margin (dB)	Asmuth (Degs)	Height (cm)	Polarity
1	* 2.484	52.41	Pk		-23	0	61.51	-	-	74	-12.49	40	106	H
2	* 2.484	52.6	Pk		-23	0	61.7	-	-	74	-12.3	40	106	H
3	* 2.484	37.14	RMS		-23	0	46.24	54	-7.76	-	-	40	106	H
4	* 2.484	38.11	RMS		-23	0	47.21	54	-6.79	-	-	40	106	H

* - indicates frequency in CFR47 Pt 15 / IC RSS-Restricted Band

Pk - Peak detector

RMS - RMS detection

VERTICAL PEAK AND AVERAGE PLOT

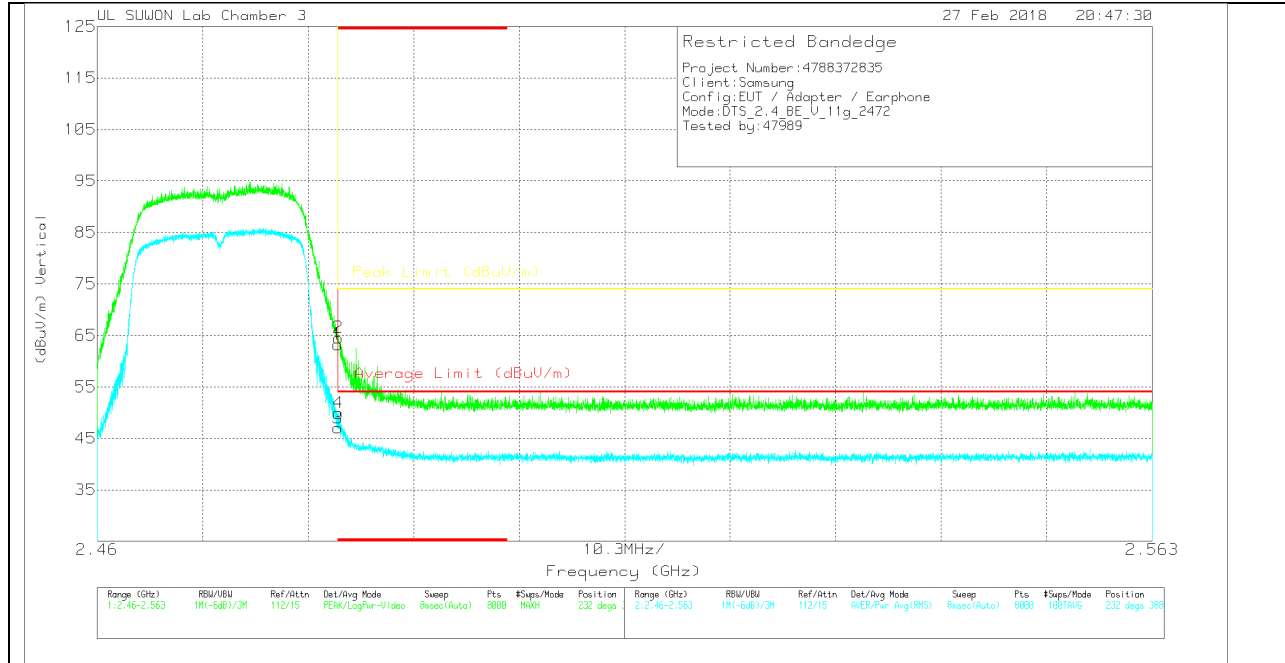

VERTICAL DATA

Trace Markers

Marker	Frequency (GHz)	Meter Reading (dBuV)	Det	3117(00205959)	10dB_ATT[dB]	DC Corr (dB)	Corrected Reading (dBuV/m)	Average Limit (dBuV/m)	Margin (dB)	Peak Limit (dBuV/m)	PK Margin (dB)	Azimuth (Degs)	Height (cm)	Polarity
1	* 2.484	54.13	Pk	32.1	-23	0	63.23	-	-	74	-10.77	232	388	V
2	* 2.484	55.46	Pk	32.1	-23	0	64.56	-	-	74	-9.44	232	388	V
3	* 2.484	37.92	RMS	32.1	-23	0	47.02	54	-6.98	-	-	232	388	V
4	* 2.484	40.82	RMS	32.1	-23	0	49.92	54	-4.08	-	-	232	388	V

* - indicates frequency in CFR47 Pt 15 / IC RSS-Restricted Band

Pk - Peak detector

RMS - RMS detection

HARMONICS AND SPURIOUS EMISSIONS

LOW CHANNEL HORIZONTAL

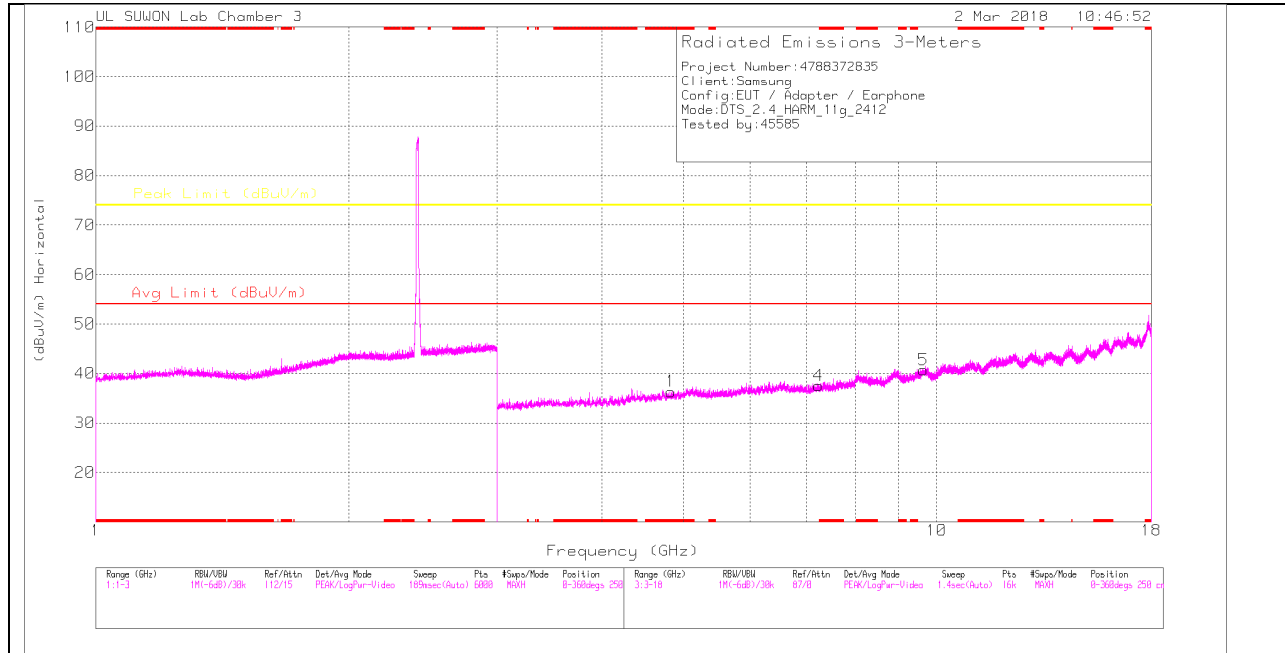

LOW CHANNEL VERTICAL

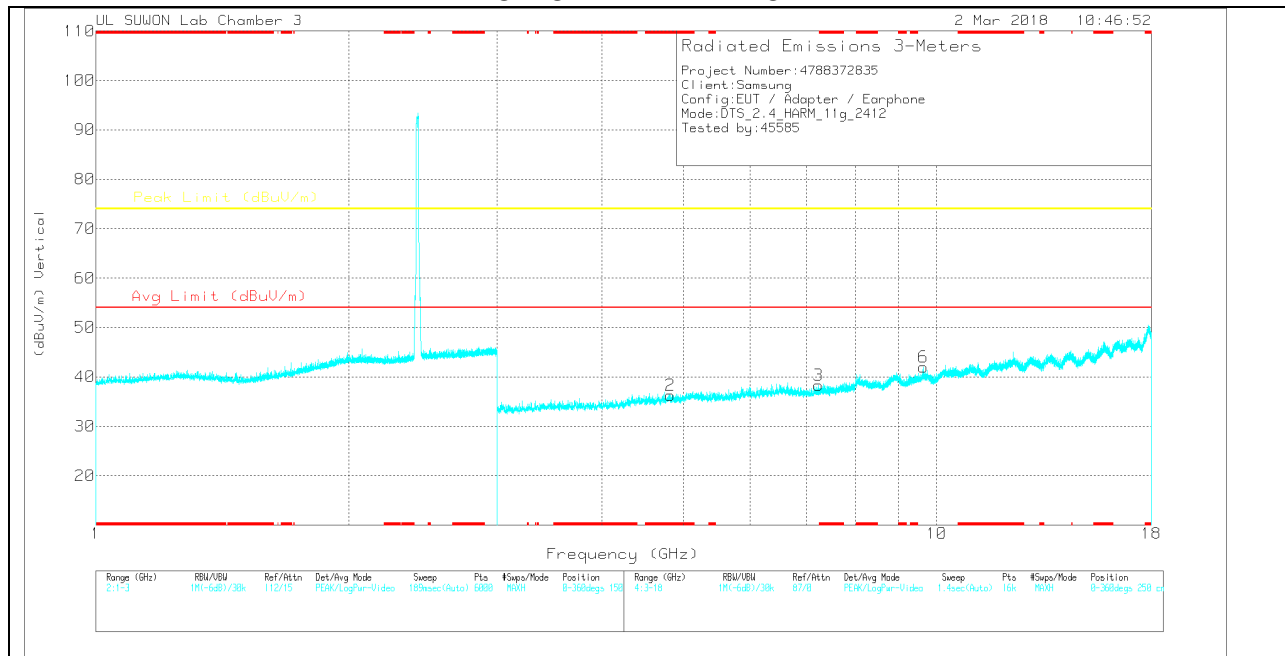

Note: Emission was scanned up to 26GHz; No emissions were detected above the noise floor which was at least 20dB below the specification limit.

LOW CHANNEL DATA

Trace Markers

Marker	Frequency (GHz)	Meter Reading (dBuV)	Det	3117[00205959]	3GHz_HP[dB]	DC Corr (dB)	Corrected Reading (dBuV/m)	Avg Limit (dBuV/m)	Margin (dB)	Peak Limit (dBuV/m)	Margin (dB)	Azimuth (Degs)	Height (cm)	Polarity
1	* 4.828	30.75	PK	34	-28.4	0	36.35	-	-	74	-37.65	0-360	250	H
4	7.235	25.82	PK	35.6	-23.9	0	37.52	-	-	74	-36.48	0-360	250	H
5	9.642	23.72	PK	36.7	-19.7	0	40.72	-	-	74	-33.28	0-360	250	H
2	* 4.819	30.61	PK	34	-28.3	0	36.31	-	-	74	-37.69	0-360	150	V
3	7.23	26.58	PK	35.6	-23.9	0	38.28	-	-	74	-35.72	0-360	150	V
6	9.648	25	PK	36.7	-19.7	0	42	-	-	74	-32	0-360	150	V

* - indicates frequency in CFR47 Pt 15 / IC RSS-Restricted Band
 PK – Peak Detector

Note: Only peak measurement was performed. Because peak measurement result of unwanted emission is less than average limit (54dBuV/m).

MID CHANNEL HORIZONTAL

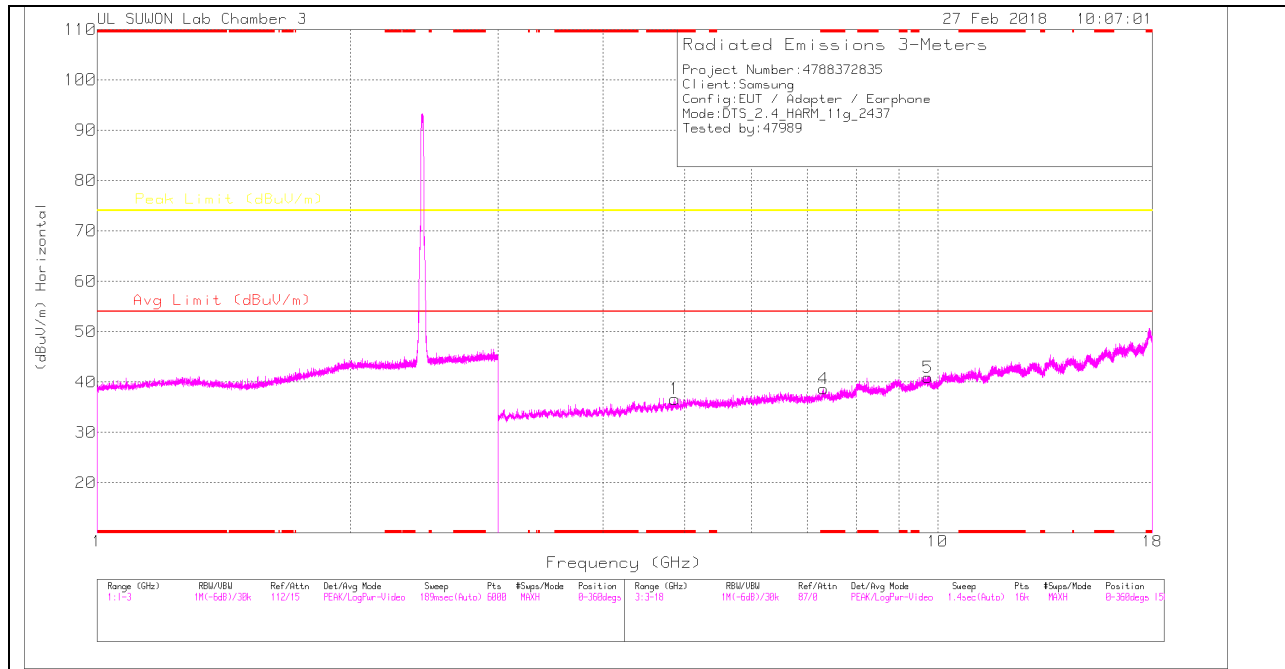

MID CHANNEL VERTICAL

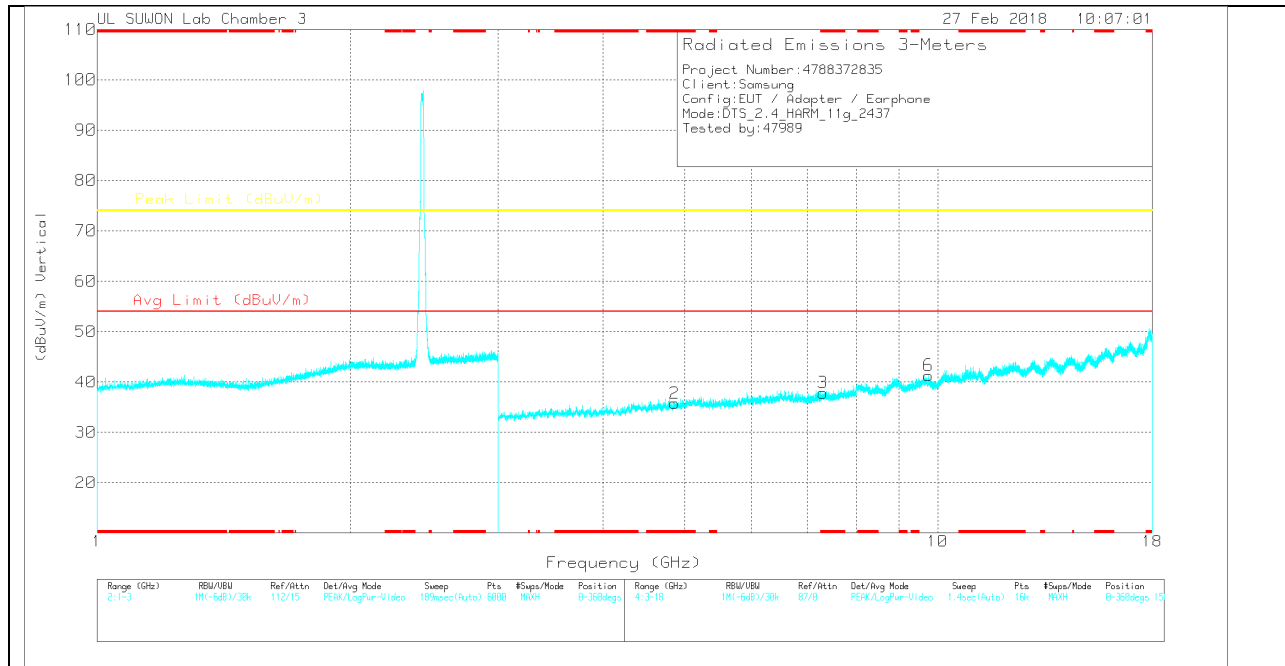

Note: Emission was scanned up to 26GHz; No emissions were detected above the noise floor which was at least 20dB below the specification limit.

MID CHANNEL DATA

Trace Markers

Marker	Frequency (GHz)	Meter Reading (dBuV)	Det	3117(00205959)	3GHz_HP[dB]	DC Corr (dB)	Corrected Reading (dBuV/m)	Avg Limit (dBuV/m)	Margin (dB)	Peak Limit (dBuV/m)	Margin (dB)	Azimuth (Degs)	Height (cm)	Polarity
1	* 4.869	31.41	PK	34	-28.8	0	36.61	-	-	74	-37.39	0-360	250	H
4	* 7.311	26.55	PK	35.6	-23.5	0	38.65	-	-	74	-35.35	0-360	250	H
5	9.741	23.51	PK	36.9	-19.5	0	40.91	-	-	74	-33.09	0-360	150	H
2	* 4.868	30.58	PK	34	-28.8	0	35.78	-	-	74	-38.22	0-360	150	V
3	* 7.302	25.96	PK	35.6	-23.7	0	37.86	-	-	74	-36.14	0-360	250	V
6	9.748	23.89	PK	36.9	-19.5	0	41.29	-	-	74	-32.71	0-360	150	V

* - indicates frequency in CFR47 Pt 15 / IC RSS-Restricted Band
 PK – Peak detector

Note: Only peak measurement was performed. Because peak measurement result of unwanted emission is less than average limit (54dBuV/m).

HIGH CHANNEL HORIZONTAL

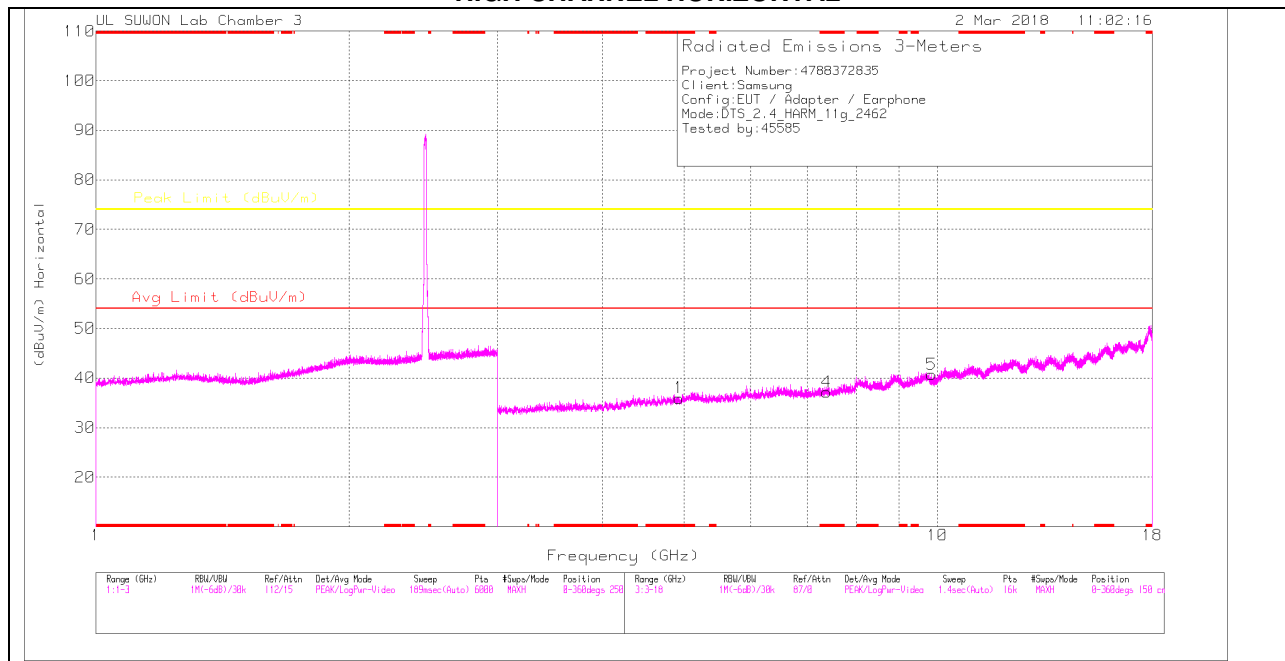

HIGH CHANNEL VERTICAL

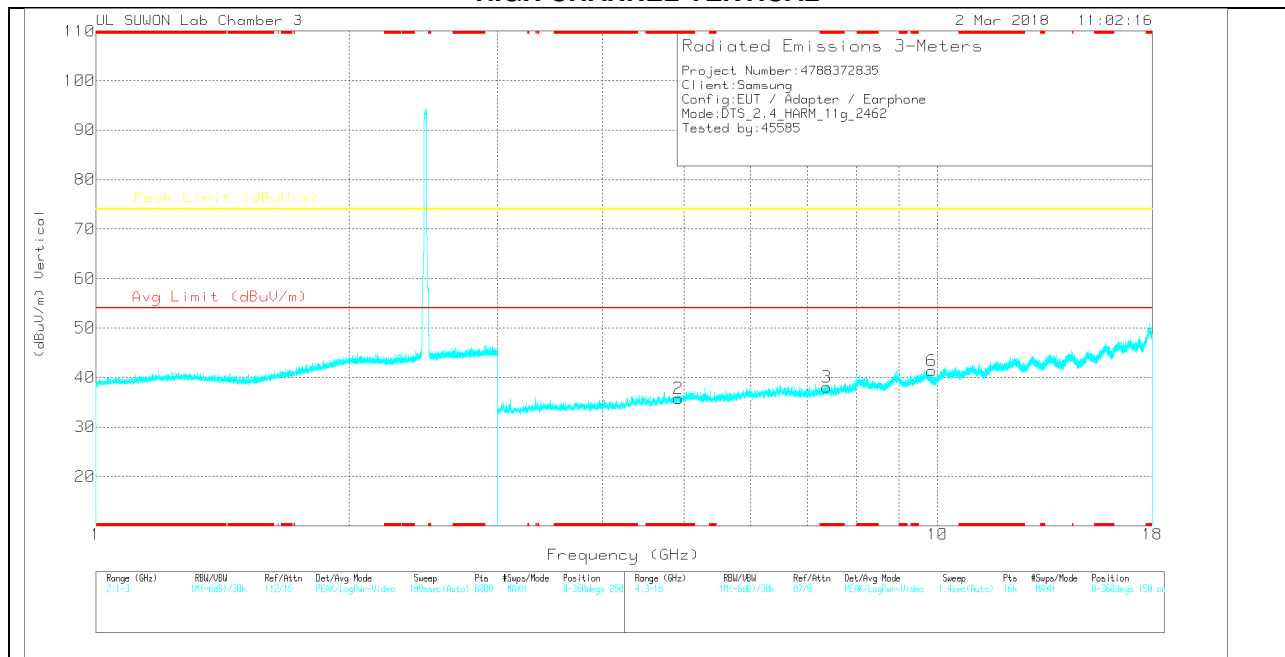

Note: Emission was scanned up to 26GHz; No emissions were detected above the noise floor which was at least 20dB below the specification limit.

HIGH CHANNEL DATA

Trace Markers

Marker	Frequency (GHz)	Meter Reading (dBuV)	Det	3117(00205959)	3GHz_HP[dB]	DC Corr (dB)	Corrected Reading (dBuV/m)	Avg Limit (dBuV/m)	Margin (dB)	Peak Limit (dBuV/m)	Margin (dB)	Azimuth (Degs)	Height (cm)	Polarity
1	* 4.927	30.87	PK	34	-28.9	0	35.97	-	-	74	-38.03	0-360	150	H
4	* 7.386	24.54	PK	35.6	-23	0	37.14	-	-	74	-36.86	0-360	250	H
5	9.848	23.44	PK	37	-19.7	0	40.74	-	-	74	-33.26	0-360	150	H
2	* 4.923	30.7	PK	34	-28.9	0	35.8	-	-	74	-38.2	0-360	150	V
3	* 7.385	25.45	PK	35.6	-23	0	38.05	-	-	74	-35.95	0-360	150	V
6	9.848	24.07	PK	37	-19.7	0	41.37	-	-	74	-32.63	0-360	150	V

* - indicates frequency in CFR47 Pt 15 / IC RSS-Restricted Band
 PK – Peak Detector

Note: Only peak measurement was performed. Because peak measurement result of unwanted emission is less than average limit (54dBuV/m).

11.2.3.TX ABOVE 1 GHz 802.11n HT20 MODE IN THE 2.4 GHz BAND

RESTRICTED BANDEDGE (LOW CHANNEL)

HORIZONTAL PEAK AND AVERAGE PLOT

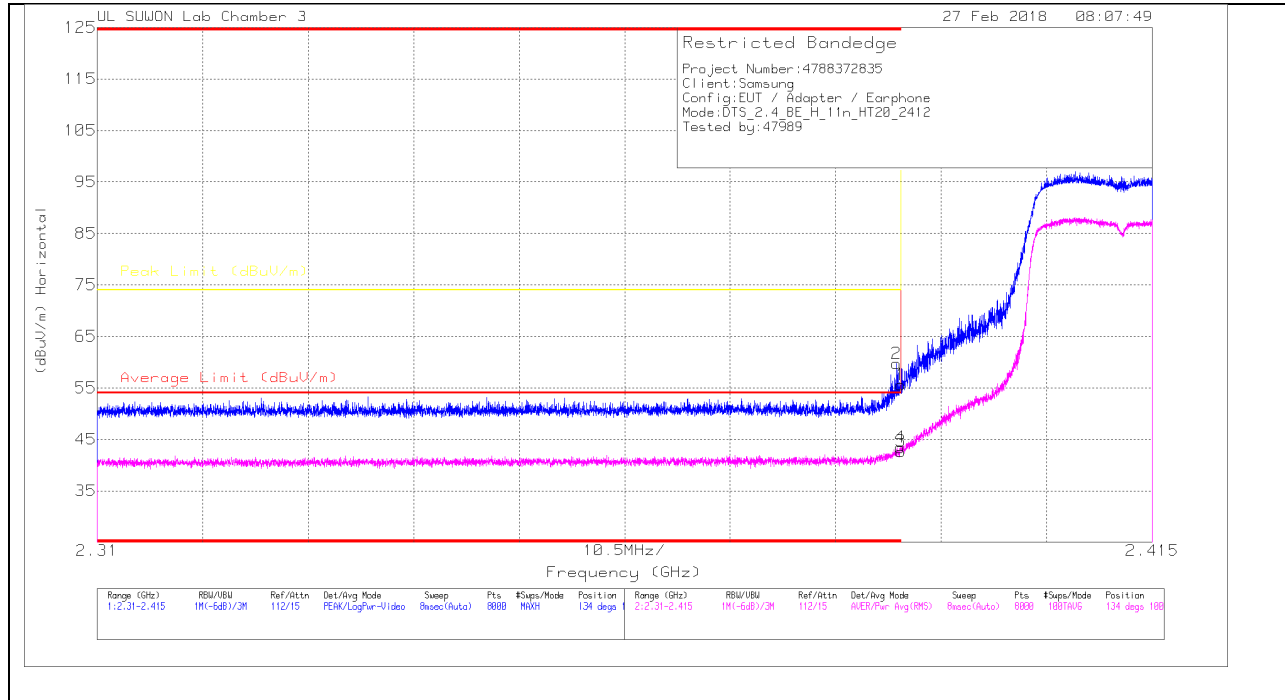

HORIZONTAL DATA

Trace Markers

Marker	Frequency (GHz)	Meter Reading (dBuV)	Det	3117(00205959)	10dB_ATT(dB)	DC Corr (dB)	Corrected Reading (dBuV/m)	Average Limit (dBuV/m)	Margin (dB)	Peak Limit (dBuV/m)	PK Margin (dB)	Azimuth (Degs)	Height (cm)	Polarity
1	* 2.39	47.11	Pk	31.8	-23.3	0	55.61	-	-	74	-18.39	134	100	H
2	* 2.39	51.23	Pk	31.8	-23.3	0	59.73	-	-	74	-14.27	134	100	H
3	* 2.39	34.18	RMS	31.8	-23.3	0	42.68	54	-11.32	-	-	134	100	H
4	* 2.39	34.94	RMS	31.8	-23.3	0	43.44	54	-10.56	-	-	134	100	H

* - indicates frequency in CFR47 Pt 15 / IC RSS-Restricted Band

Pk - Peak detector

RMS - RMS detection

VERTICAL PEAK AND AVERAGE PLOT

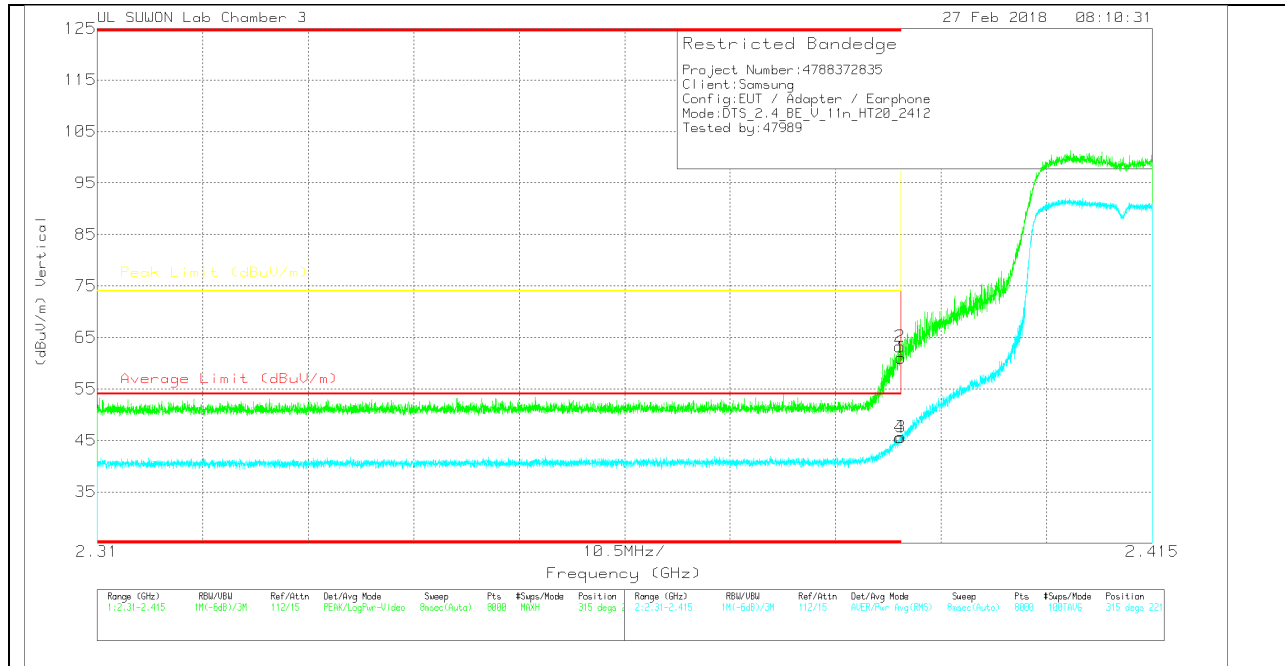

VERTICAL DATA

Trace Markers

Marker	Frequency (GHz)	Meter Reading (dBuV)	Det	3117(00205959)	10dB_ATT(dB)	DC Corr (dB)	Corrected Reading (dBuV/m)	Average Limit (dBuV/m)	Margin (dB)	Peak Limit (dBuV/m)	PK Margin (dB)	Azimuth (Degs)	Height (cm)	Polarity
1	* 2.39	52.53	Pk	31.8	-23.3	0	61.03	-	-	74	-12.97	315	221	V
2	* 2.39	54.73	Pk	31.8	-23.3	0	63.23	-	-	74	-10.77	315	221	V
3	* 2.39	37.14	RMS	31.8	-23.3	0	45.64	54	-8.36	-	-	315	221	V
4	* 2.39	37.08	RMS	31.8	-23.3	0	45.58	54	-8.42	-	-	315	221	V

* - indicates frequency in CFR47 Pt 15 / IC RSS-Restricted Band

Pk - Peak detector

RMS - RMS detection

AUTHORIZED BANDEDGE (HIGH CHANNEL)

HORIZONTAL PEAK AND AVERAGE PLOT

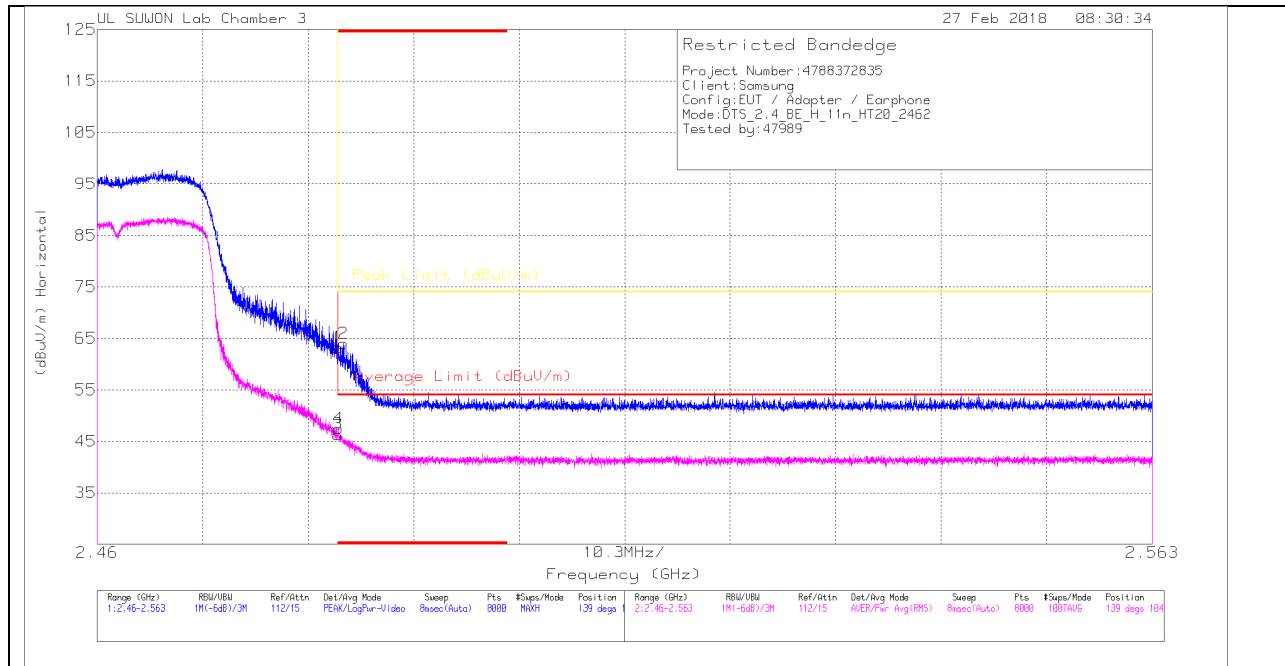

HORIZONTAL DATA

Trace Markers

Marker	Frequency (GHz)	Meter Reading (dBuV)	Det	3117(00205999)	10dB_ATT(dB)	DC Corr (dB)	Corrected Reading (dBuV/m)	Average Limit (dBuV/m)	Margin (dB)	Peak Limit (dBuV/m)	PK Margin (dB)	Azimuth (Degs)	Height (cm)	Polarity
1	* 2.484	54.13	Pk	32.1	-23	0	63.23	-	-	74	-10.77	139	104	H
2	* 2.484	54.99	Pk	32.1	-23.1	0	63.99	-	-	74	-10.01	139	104	H
3	* 2.484	37.25	RMS	32.1	-23	0	46.35	54	-7.65	-	-	139	104	H
4	* 2.484	38.42	RMS	32.1	-23	0	47.52	54	-6.48	-	-	139	104	H

* - indicates frequency in CFR47 Pt 15 / IC RSS-Restricted Band

Pk - Peak detector

RMS - RMS detection

VERTICAL PEAK AND AVERAGE PLOT

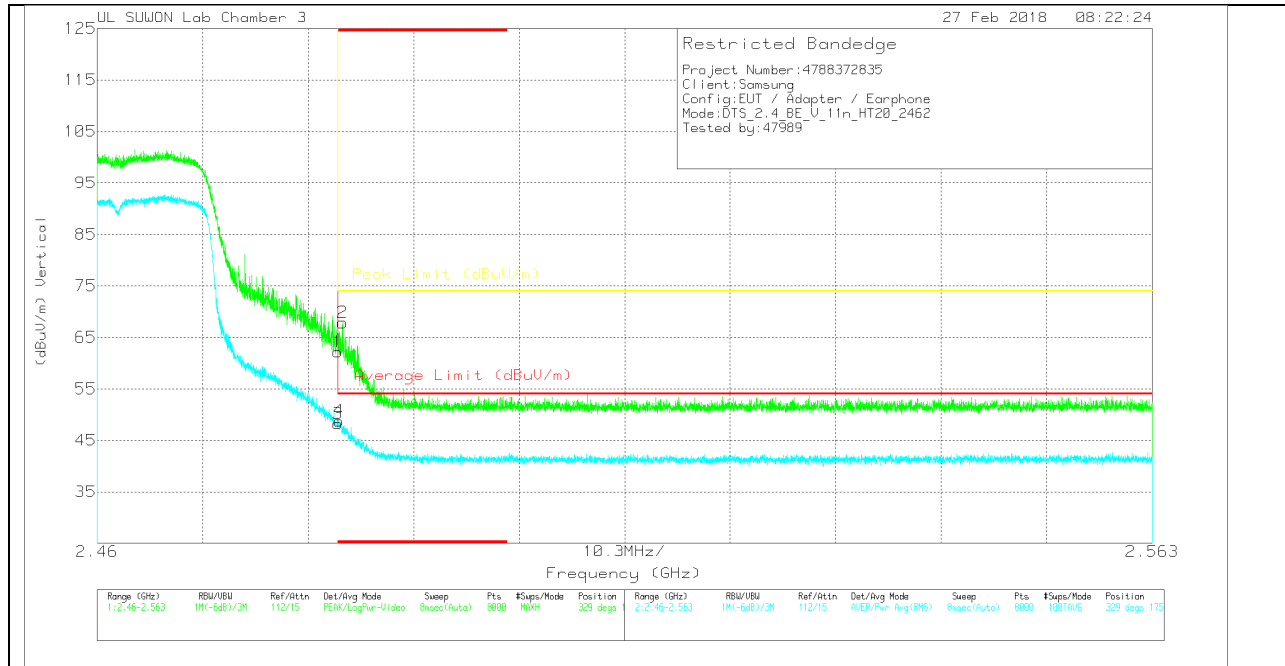

VERTICAL DATA

Trace Markers

Marker	Frequency (GHz)	Meter Reading (dBuV)	Det	3117(00205959)	10dB_ATT(dB)	DC Corr (dB)	Corrected Reading (dBuV/m)	Average Limit (dBuV/m)	Margin (dB)	Peak Limit (dBuV/m)	PK Margin (dB)	Azimuth (Degs)	Height (cm)	Polarity
1	* 2.484	53.09	PK	32.1	-23	0	62.19	-	-	74	-11.81	329	175	V
2	* 2.484	58.88	PK	32.1	-23.1	0	67.88	-	-	74	-6.12	329	175	V
3	* 2.484	39.15	RMS	32.1	-23	0	48.25	54	-5.75	-	-	329	175	V
4	* 2.484	39.69	RMS	32.1	-23	0	48.79	54	-5.21	-	-	329	175	V

* - indicates frequency in CFR47 Pt 15 / IC RSS-Restricted Band

PK - Peak detector

RMS - RMS detection

AUTHORIZED BANDEDGE (12 CHANNEL)

HORIZONTAL PEAK AND AVERAGE PLOT

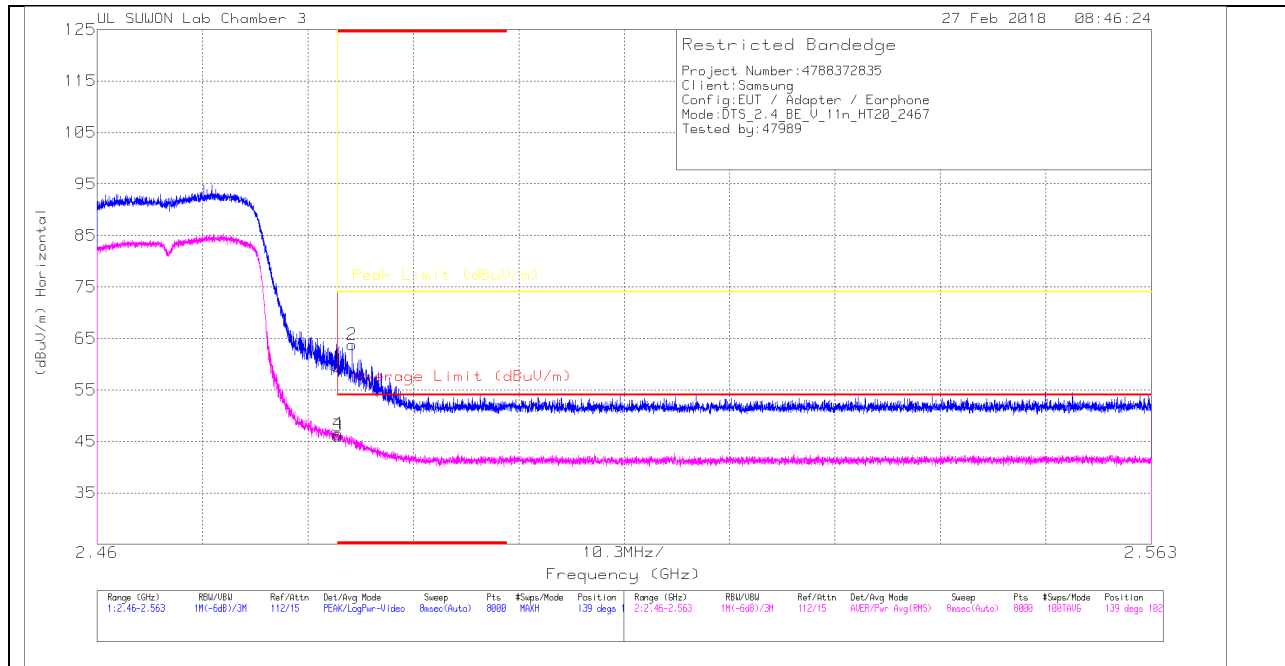

HORIZONTAL DATA

Trace Markers

Marker	Frequency (GHz)	Meter Reading (dBuV)	Det	3117(00209599)	10dB_ATT(dB)	DC Corr (dB)	Corrected Reading (dBuV/m)	Average Limit (dBuV/m)	Margin (dB)	Peak Limit (dBuV/m)	PK Margin (dB)	Azimuth (Degs)	Height (cm)	Polarity
1	* 2.484	50.49	Pk	32.1	-23	0	59.59	-	-	74	-14.41	139	102	H
2	* 2.485	54.78	Pk	32.1	-23.1	0	63.78	-	-	74	-10.22	139	102	H
3	* 2.484	36.97	RMS	32.1	-23	0	46.07	54	-7.93	-	-	139	102	H
4	* 2.484	37.4	RMS	32.1	-23	0	46.5	54	-7.5	-	-	139	102	H

* - indicates frequency in CFR47 Pt 15 / IC RSS-Restricted Band

Pk - Peak detector

RMS - RMS detection

VERTICAL PEAK AND AVERAGE PLOT

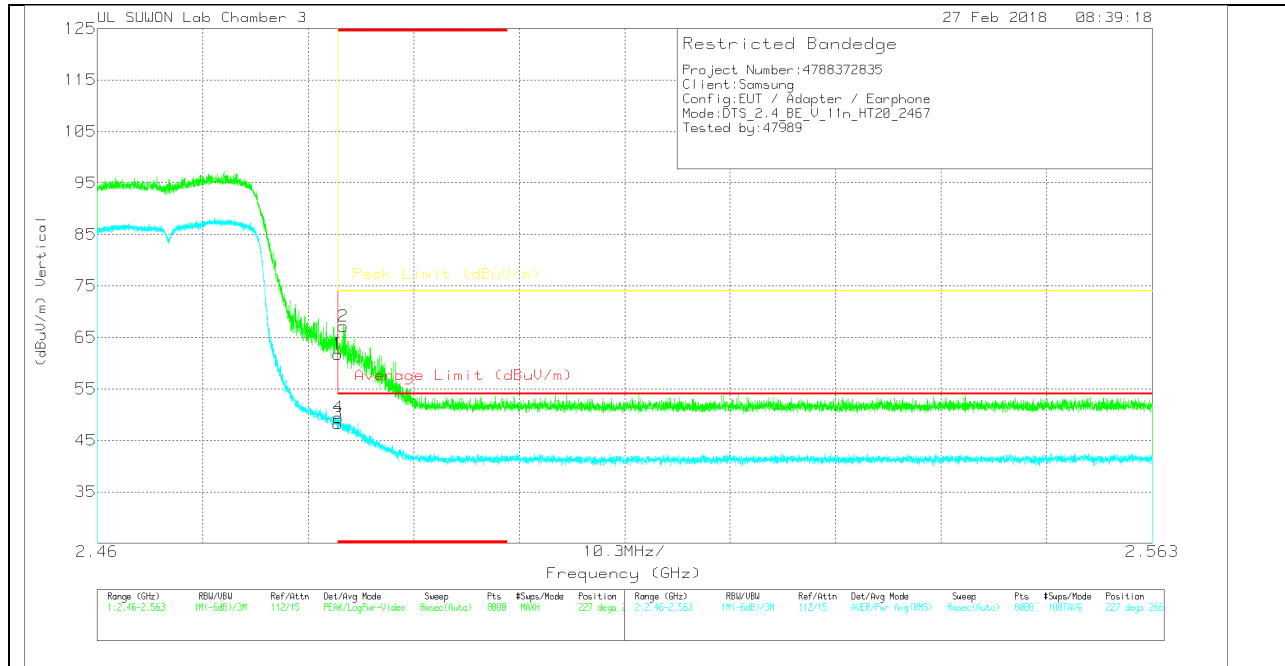

VERTICAL DATA

Trace Markers

Marker	Frequency (GHz)	Meter Reading (dBuV)	Det	3117(00205959)	10dB_ATT(dB)	DC Corr (dB)	Corrected Reading (dBuV/m)	Average Limit (dBuV/m)	Margin (dB)	Peak Limit (dBuV/m)	PK Margin (dB)	Azimuth (Degs)	Height (cm)	Polarity
1	* 2.484	52.64	Pk	32.1	-23	0	61.74	-	-	74	-12.26	227	266	V
2	* 2.484	58.15	Pk	32.1	-23.1	0	67.15	-	-	74	-6.85	227	266	V
3	* 2.484	39.2	RMS	32.1	-23	0	48.3	54	-5.7	-	-	227	266	V
4	* 2.484	40.33	RMS	32.1	-23	0	49.43	54	-4.57	-	-	227	266	V

* - indicates frequency in CFR47 Pt 15 / IC RSS-Restricted Band

Pk - Peak detector

RMS - RMS detection

AUTHORIZED BANDEDGE (13 CHANNEL)

HORIZONTAL PEAK AND AVERAGE PLOT

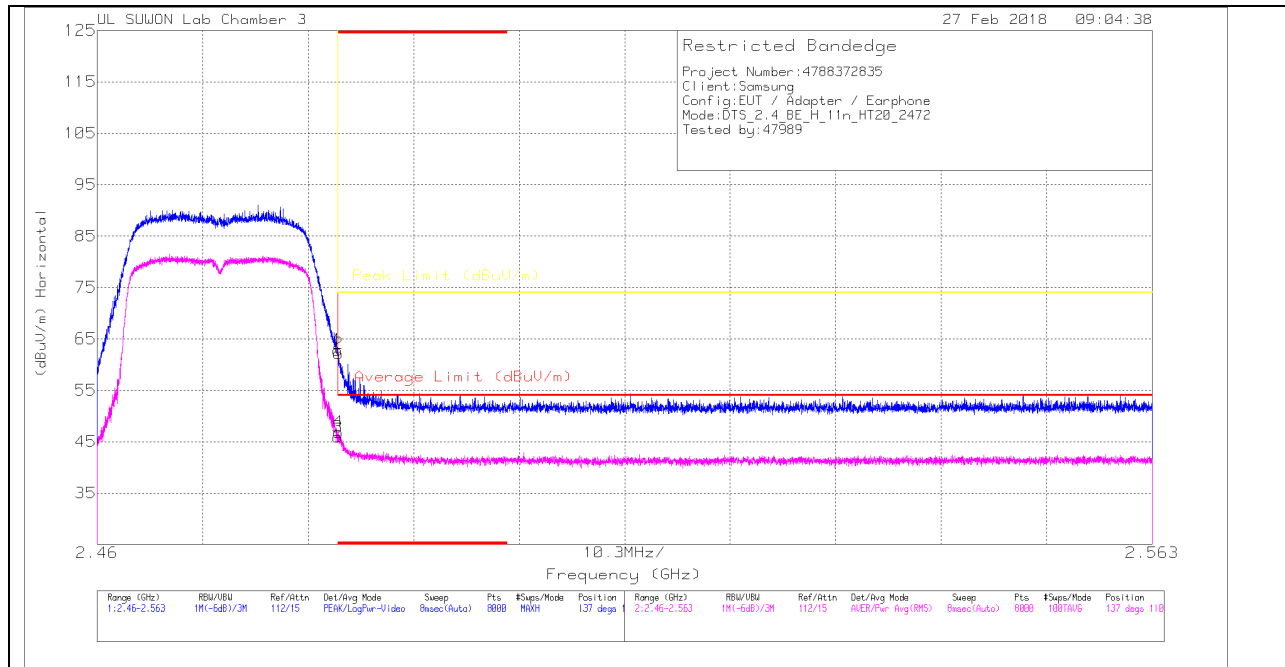

HORIZONTAL DATA

Trace Markers

Marker	Frequency (GHz)	Meter Reading (dBuV)	Det	311700205959	10dB_ATT(dB)	DC Corr (dB)	Corrected Reading (dBuV/m)	Average Limit (dBuV/m)	Margin (dB)	Peak Limit (dBuV/m)	PK Margin (dB)	Azimuth (Degs)	Height (cm)	Polarity
1	* 2.484	53.73	Pk	32.1	-23	0	62.83	-	-	74	-11.17	137	110	H
2	* 2.484	53.06	Pk	32.1	-23	0	62.16	-	-	74	-11.84	137	110	H
3	* 2.484	36.82	RMS	32.1	-23	0	45.92	54	-8.08	-	-	137	110	H
4	* 2.484	37.75	RMS	32.1	-23	0	46.85	54	-7.15	-	-	137	110	H

* - indicates frequency in CFR47 Pt 15 / IC RSS-Restricted Band

Pk - Peak detector

RMS - RMS detection

VERTICAL PEAK AND AVERAGE PLOT

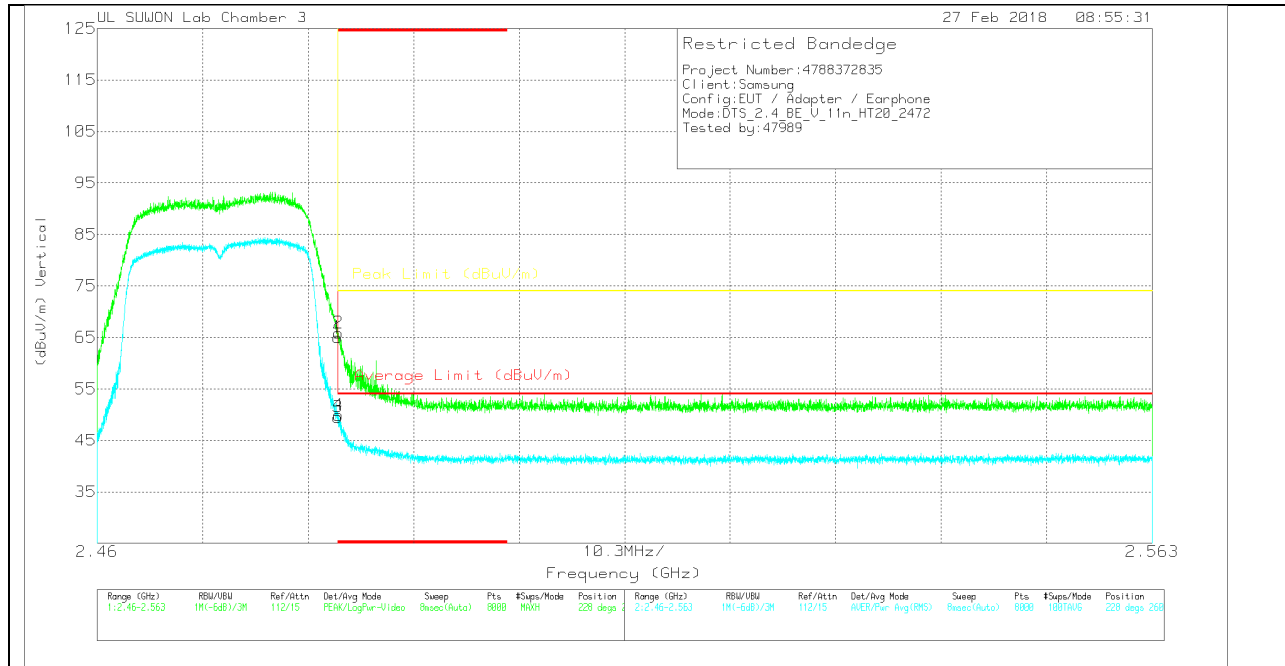

VERTICAL DATA

Trace Markers

Marker	Frequency (GHz)	Meter Reading (dBuV)	Det	3117(00205959)	10dB_ATT(dB)	DC Corr (dB)	Corrected Reading (dBuV/m)	Average Limit (dBuV/m)	Margin (dB)	Peak Limit (dBuV/m)	PK Margin (dB)	Azimuth (Degs)	Height (cm)	Polarity
1	* 2.484	55.91	Pk	32.1	-23	0	65.01	-	-	74	-8.99	228	260	V
2	* 2.484	56.78	Pk	32.1	-23	0	65.88	-	-	74	-8.12	228	260	V
3	* 2.484	40.44	RMS	32.1	-23	0	49.54	54	-4.46	-	-	228	260	V
4	* 2.484	40.81	RMS	32.1	-23	0	49.91	54	-4.09	-	-	228	260	V

* - indicates frequency in CFR47 Pt 15 / IC RSS-Restricted Band

Pk - Peak detector

RMS - RMS detection

HARMONICS AND SPURIOUS EMISSIONS

LOW CHANNEL HORIZONTAL

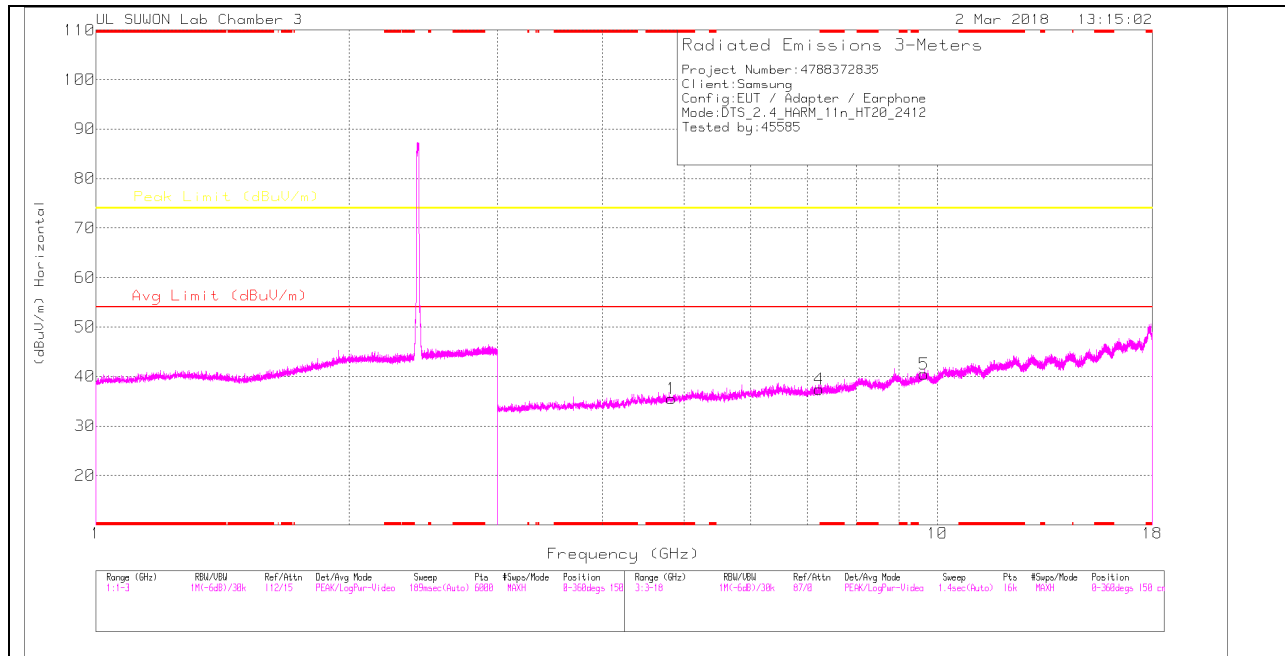

LOW CHANNEL VERTICAL

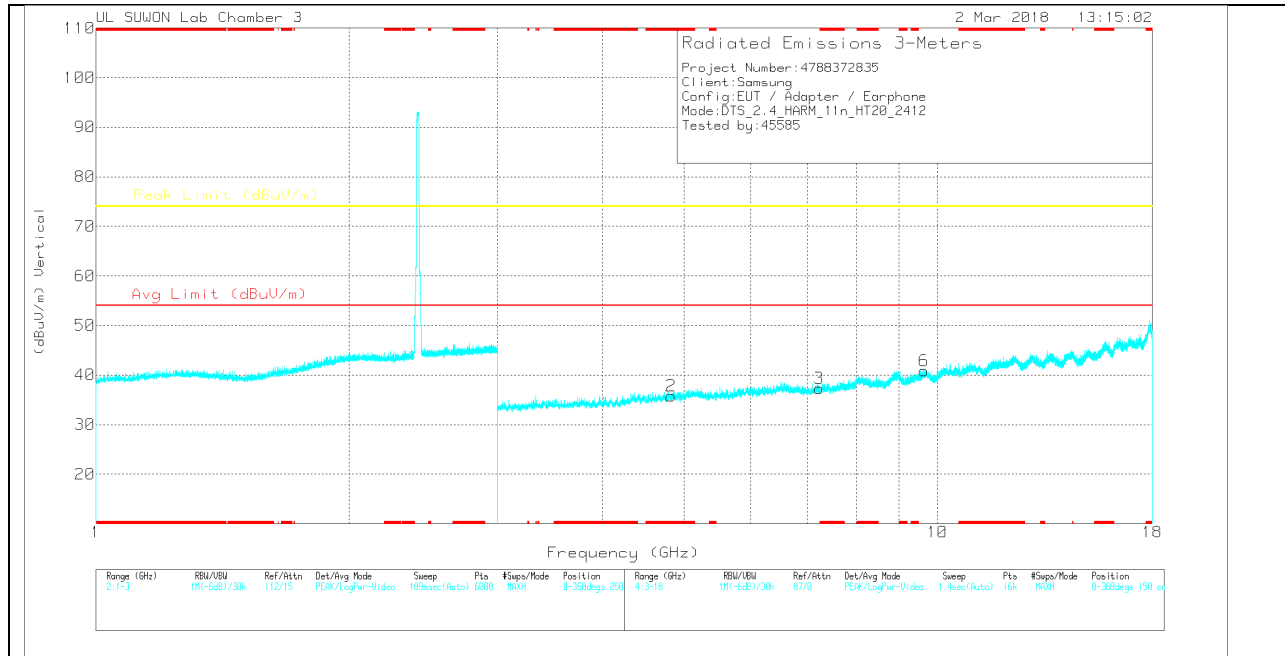

Note: Emission was scanned up to 26GHz; No emissions were detected above the noise floor which was at least 20dB below the specification limit.

LOW CHANNEL DATA

Trace Markers

Marker	Frequency (GHz)	Meter Reading (dBuV)	Det	3117(00205959)	3GHz_HP[dB]	DC Corr (dB)	Corrected Reading (dBuV/m)	Avg Limit (dBuV/m)	Margin (dB)	Peak Limit (dBuV/m)	Margin (dB)	Azimuth (Degs)	Height (cm)	Polarity
1	* 4.826	29.77	PK	34	-28.3	0	35.47	-	-	74	-38.53	0-360	250	H
4	7.237	25.74	PK	35.6	-23.9	0	37.44	-	-	74	-36.56	0-360	250	H
5	9.648	23.46	PK	36.7	-19.7	0	40.46	-	-	74	-33.54	0-360	250	H
2	* 4.825	30.15	PK	34	-28.4	0	35.75	-	-	74	-38.25	0-360	150	V
3	7.235	25.56	PK	35.6	-23.9	0	37.26	-	-	74	-36.74	0-360	250	V
6	9.648	23.83	PK	36.7	-19.7	0	40.83	-	-	74	-33.17	0-360	150	V

* - indicates frequency in CFR47 Pt 15 / IC RSS-Restricted Band
 PK – Peak Detector

Note: Only peak measurement was performed. Because peak measurement result of unwanted emission is less than average limit (54dBuV/m).

MID CHANNEL HORIZONTAL

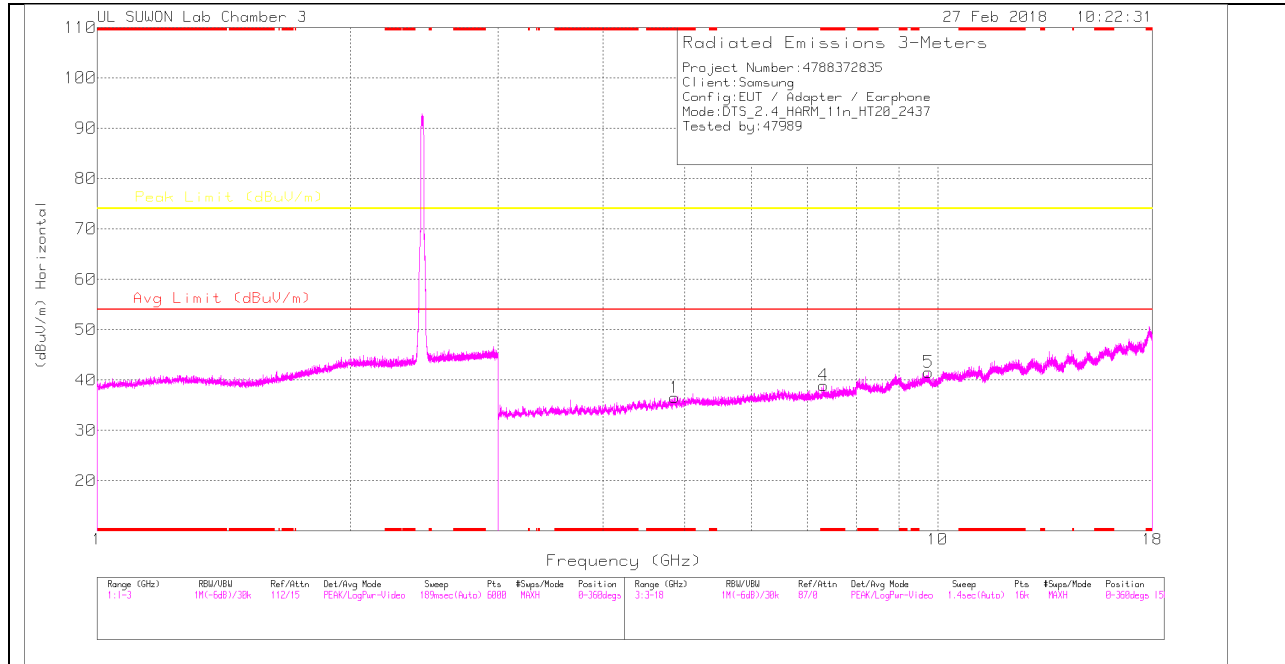

MID CHANNEL VERTICAL

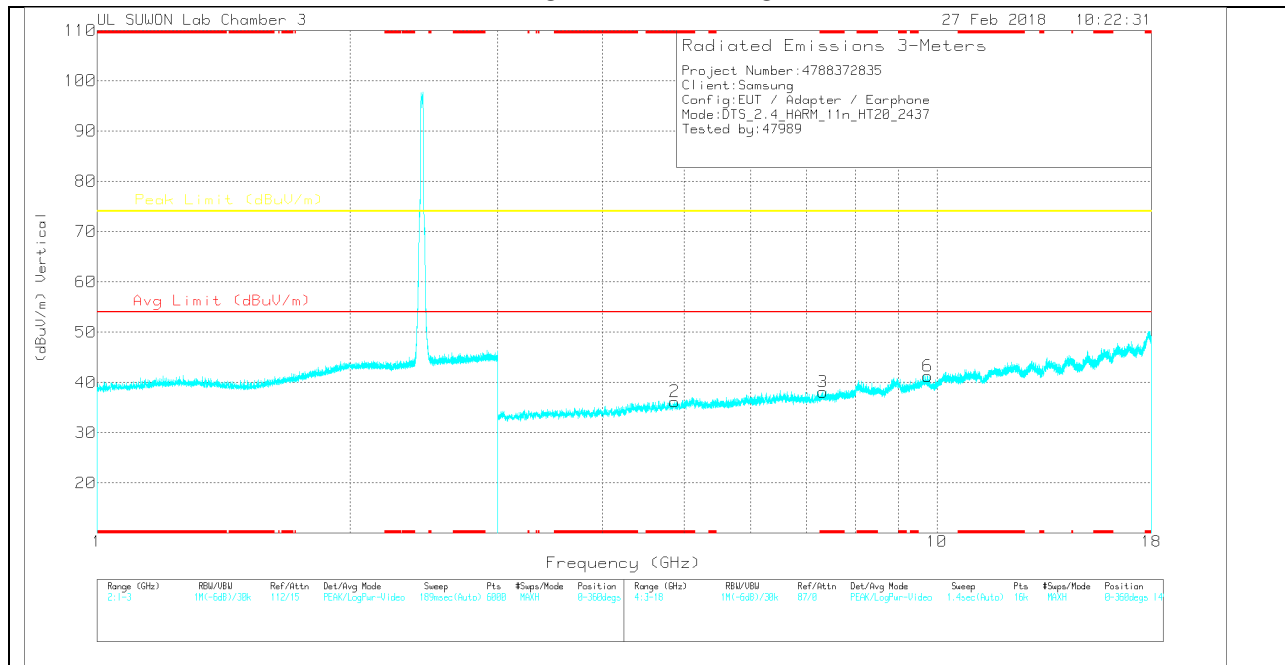

Note: Emission was scanned up to 26GHz; No emissions were detected above the noise floor which was at least 20dB below the specification limit.

MID CHANNEL DATA

Trace Markers

Marker	Frequency (GHz)	Meter Reading (dBuV)	Det	3117(00205959)	3GHz_HP[dB]	DC Corr (dB)	Corrected Reading (dBuV/m)	Avg Limit (dBuV/m)	Margin (dB)	Peak Limit (dBuV/m)	Margin (dB)	Azimuth (Degs)	Height (cm)	Polarity
1	* 4.867	31.34	PK	34	-28.8	0	36.54	-	-	74	-37.46	0-360	150	H
4	* 7.314	26.82	PK	35.6	-23.5	0	38.92	-	-	74	-35.08	0-360	250	H
5	9.748	24.17	PK	36.9	-19.5	0	41.57	-	-	74	-32.43	0-360	150	H
2	* 4.87	30.99	PK	34	-28.8	0	36.19	-	-	74	-37.81	0-360	149	V
3	* 7.311	26	PK	35.6	-23.5	0	38.1	-	-	74	-35.9	0-360	250	V
6	9.748	23.84	PK	36.9	-19.5	0	41.24	-	-	74	-32.76	0-360	250	V

* - indicates frequency in CFR47 Pt 15 / IC RSS-Restricted Band
 PK – Peak detector

Note: Only peak measurement was performed. Because peak measurement result of unwanted emission is less than average limit (54dBuV/m).

HIGH CHANNEL HORIZONTAL

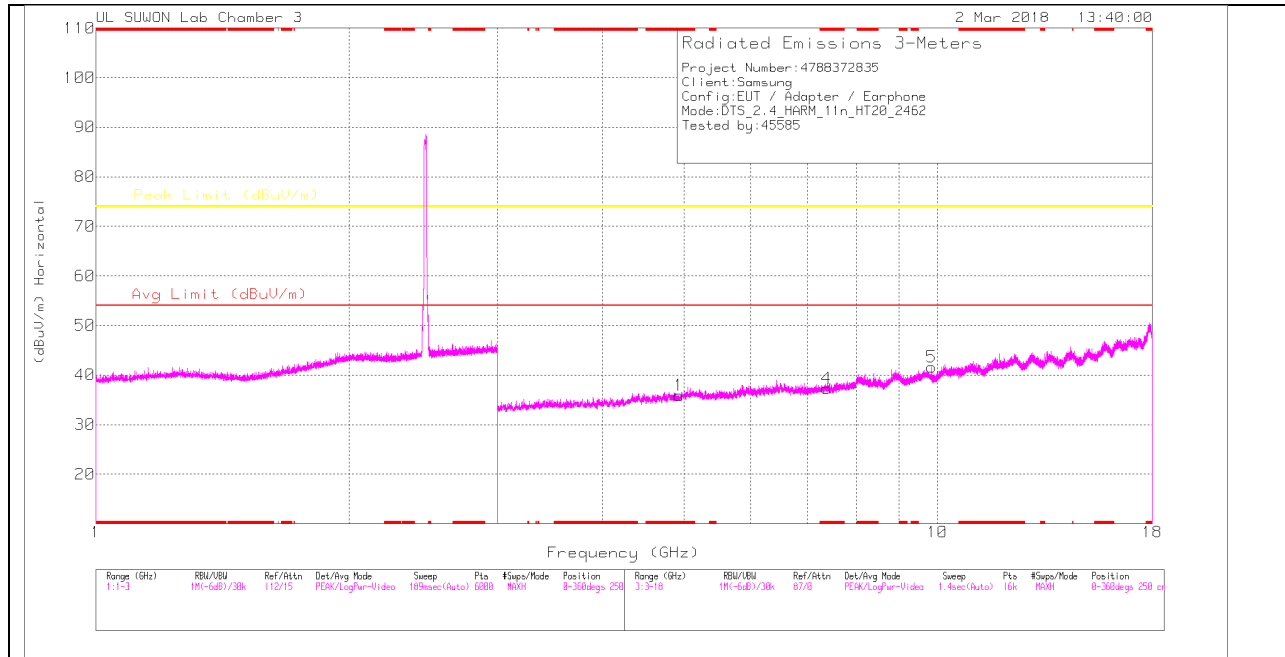

HIGH CHANNEL VERTICAL

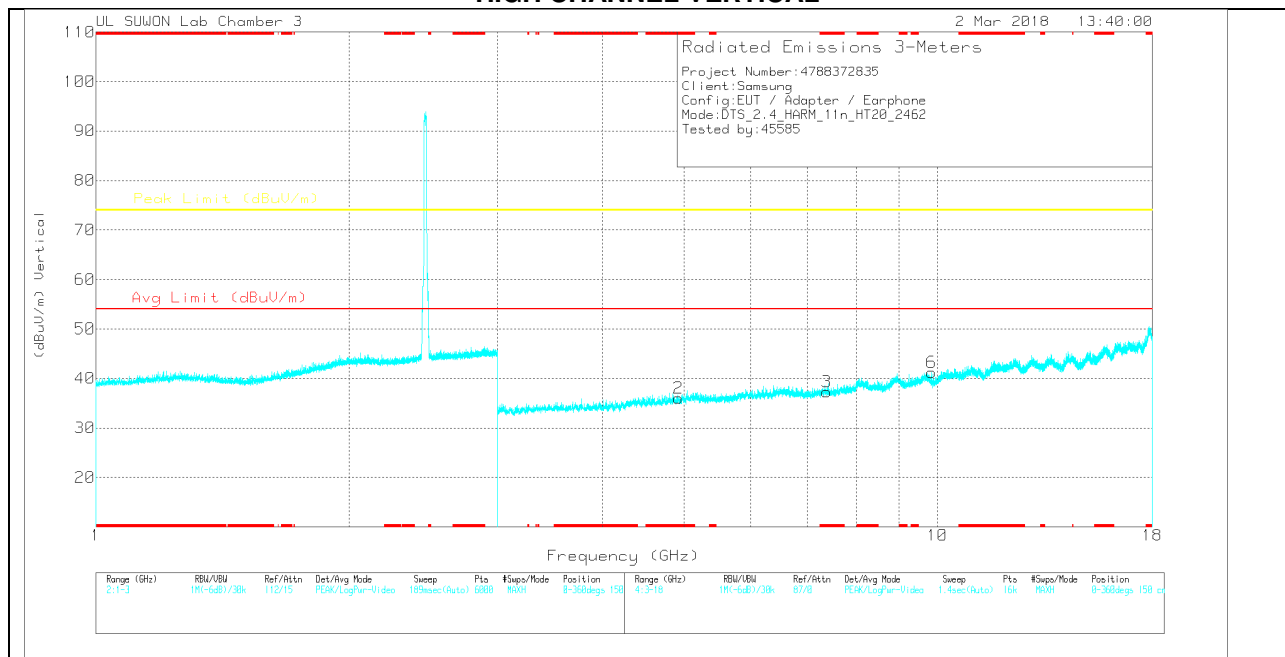

Note: Emission was scanned up to 26GHz; No emissions were detected above the noise floor which was at least 20dB below the specification limit.

HIGH CHANNEL DATA

Trace Markers

Marker	Frequency (GHz)	Meter Reading (dBuV)	Det	3117(00205959)	3GHz_HP[dB]	DC Corr (dB)	Corrected Reading (dBuV/m)	Avg Limit (dBuV/m)	Margin (dB)	Peak Limit (dBuV/m)	Margin (dB)	Azimuth (Degs)	Height (cm)	Polarity
1	* 4.927	30.84	PK	34	-28.9	0	35.94	-	-	74	-38.06	0-360	150	H
4	* 7.386	24.66	PK	35.6	-23	0	37.26	-	-	74	-36.74	0-360	150	H
5	9.848	24.33	PK	37	-19.7	0	41.63	-	-	74	-32.37	0-360	150	H
2	* 4.919	30.96	PK	34	-28.9	0	36.06	-	-	74	-37.94	0-360	250	V
3	* 7.387	24.69	PK	35.6	-23	0	37.29	-	-	74	-36.71	0-360	150	V
6	9.848	23.97	PK	37	-19.7	0	41.27	-	-	74	-32.73	0-360	150	V

* - indicates frequency in CFR47 Pt 15 / IC RSS-Restricted Band
 PK – Peak Detector

Note: Only peak measurement was performed. Because peak measurement result of unwanted emission is less than average limit (54dBuV/m).

11.3. WORST-CASE BELOW 1 GHz

SPURIOUS EMISSIONS 30 TO 1000 MHz (WORST-CASE CONFIGURATION, HORIZONTAL)

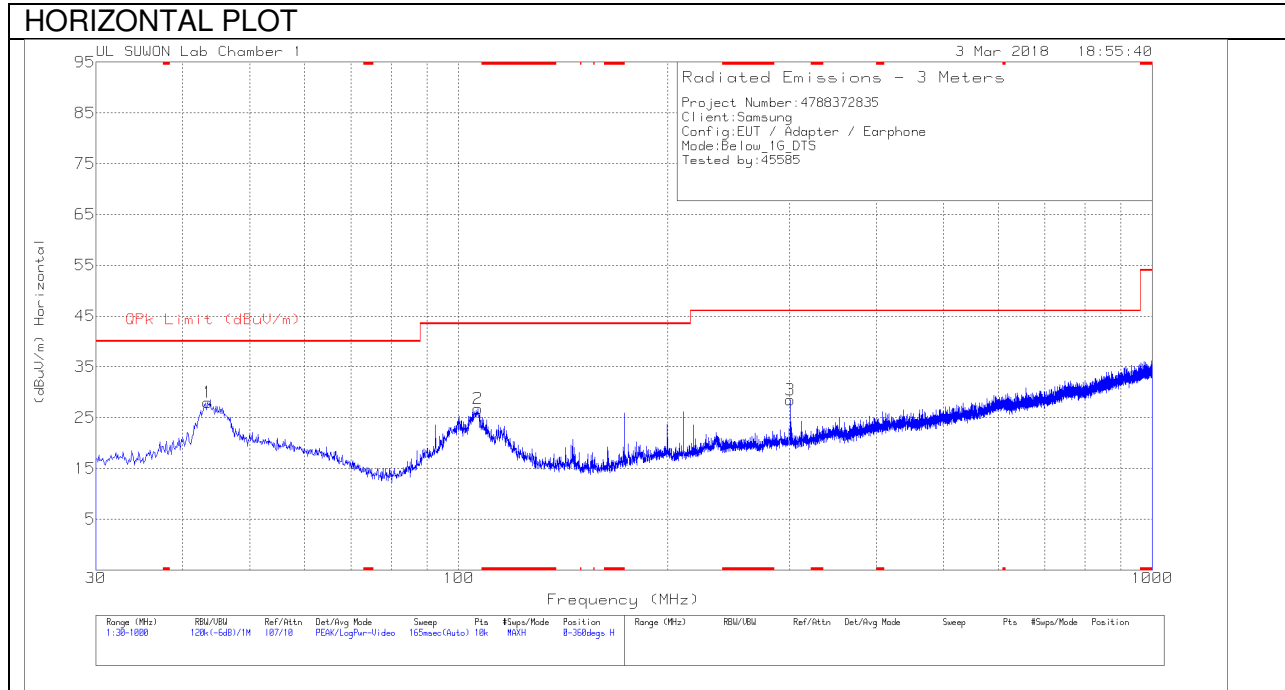

SPURIOUS EMISSIONS 30 TO 1000 MHz (WORST-CASE CONFIGURATION, VERTICAL)

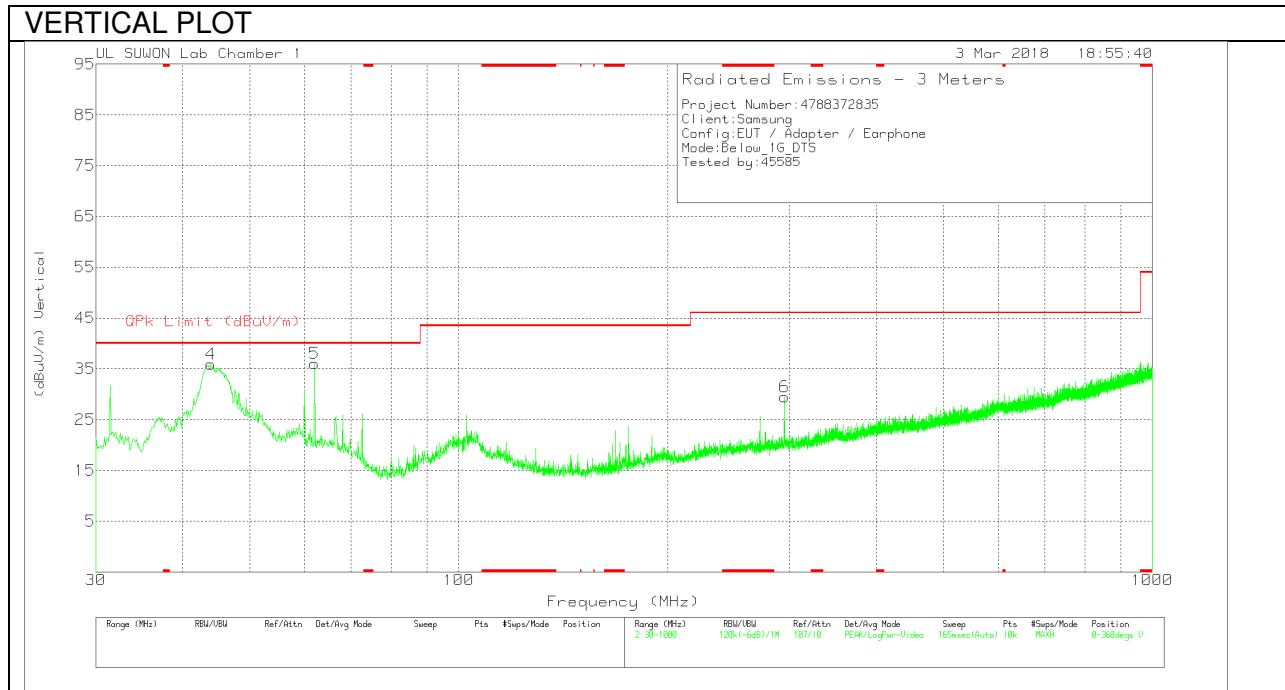

Below 1G Data

Trace Markers

Marker	Frequency (MHz)	Meter Reading (dBuV)	Det	750_20170831	30-1000MHz[dB]	Corrected Reading (dBuV/m)	QPk Limit (dBuV/m)	Margin (dB)	Azimuth (Degs)	Height (cm)	Polarity
1	43.483	37.94	Pk	19.4	-29.4	27.94	40	-12.06	0-360	400	H
2	106.533	37.6	Pk	17.4	-28.2	26.8	43.52	-16.72	0-360	300	H
3	300.921	36.06	Pk	19.3	-26.9	28.46	46.02	-17.56	0-360	100	H
4	43.968	45.76	Pk	19.5	-29.4	35.86	40	-4.14	0-360	100	V
5	62.01	47.49	Pk	17.8	-29.3	35.99	40	-4.01	0-360	200	V
6	294.81	37.41	Pk	19.1	-27	29.51	46.02	-16.51	0-360	200	V

* - indicates frequency in CFR47 Pt 15 / IC RSS-Restricted Band

Pk - Peak detector

12. AC POWER LINE CONDUCTED EMISSIONS

LIMITS

FCC §15.207 (a)
IC RSS-GEN Clause 8.8

Frequency of Emission (MHz)	Conducted Limit (dBuV)	
	Quasi-peak	Average
0.15-0.5	66 to 56 [*]	56 to 46 [*]
0.5-5	56	46
5-30	60	50

^{*}Decreases with the logarithm of the frequency.

TEST PROCEDURE

The EUT is placed on a non-conducting table 40 cm from the vertical ground plane and 80 cm above the horizontal ground plane. The EUT is configured in accordance with ANSI C63.10.

The receiver is set to a resolution bandwidth of 9 kHz. Peak detection is used unless otherwise noted as quasi-peak or average.

Line conducted data is recorded for both NEUTRAL and HOT lines.

WORST EMISSIONS

LINE 1 PLOT

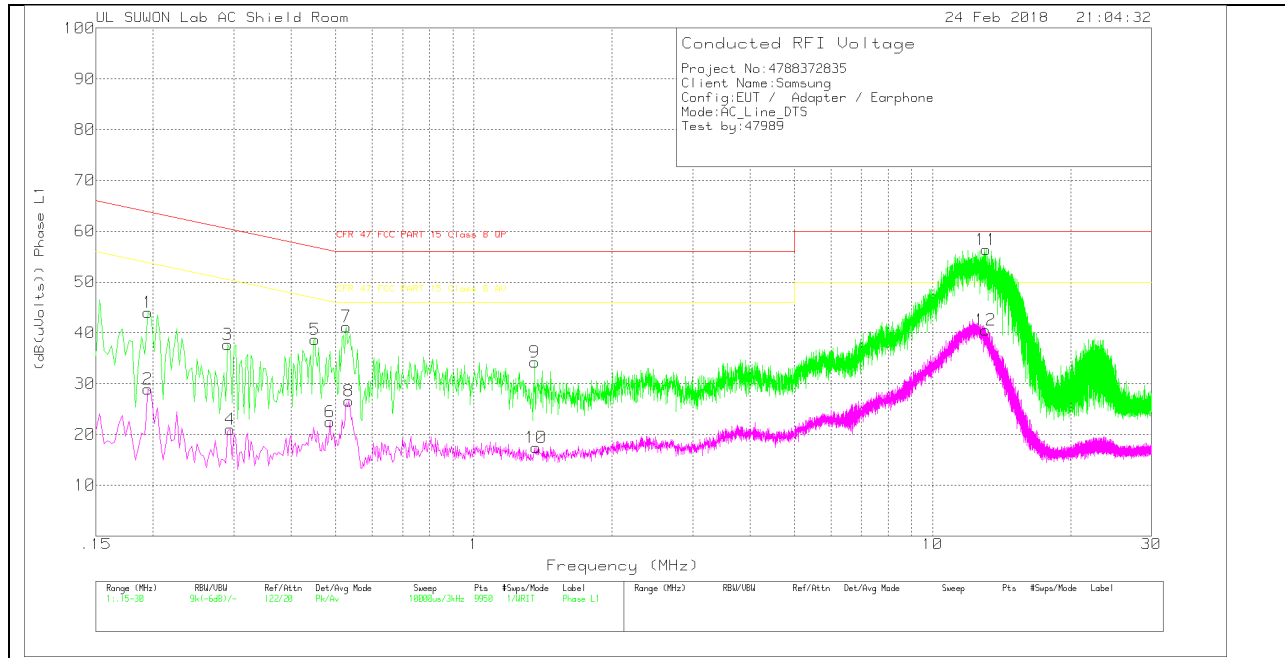

LINE 1 RESULTS

Trace Markers

Range 1: Phase L1 .15 - 30MHz

Marker	Frequency (MHz)	Meter Reading (dBuV)	Det	101837_L1_with extension	CABLELOSS(dB)	Corrected Reading (dB(uVolts))	CFR 47 FCC PART 15 Class B QP	Margin (dB)	CFR 47 FCC PART 15 Class B AV	Margin (dB)
1	.195	34.03	Pk	9.8	.2	44.03	63.82	-19.79	-	-
2	.195	18.88	Av	9.8	.2	28.88	-	-	53.82	-24.94
3	.291	27.88	Pk	9.6	.2	37.68	60.5	-22.82	-	-
4	.294	11.22	Av	9.6	.2	21.02	-	-	50.41	-29.39
5	.45	28.73	Pk	9.7	.2	38.63	56.88	-18.25	-	-
6	.486	12.63	Av	9.7	.2	22.53	-	-	46.24	-23.71
7	.528	31.32	Pk	9.7	.2	41.22	56	-14.78	-	-
8	.534	16.65	Av	9.7	.2	26.55	-	-	46	-19.45
9	1.359	24.08	Pk	9.9	.3	34.28	56	-21.72	-	-
10	1.368	7.26	Av	9.9	.3	17.46	-	-	46	-28.54
11	13.098	46.17	Pk	9.8	.4	56.37	60	-3.63	-	-
12	13.059	30.36	Av	9.8	.4	40.56	-	-	50	-9.44

Pk - Peak detector

Av - Average detection

Quasi-Peak Emissions

Range 1: Phase L1 .15 - 30MHz

Frequency (MHz)	Meter Reading (dBuV)	Det	101837_L1_with extension	CABLELOSS(dB)	Corrected Reading (dB(uVolts))	CFR 47 FCC PART 15 Class B QP	Margin (dB)	CFR 47 FCC PART 15 Class B AV	Margin (dB)
13.0982	39.32	Qp	9.8	.4	49.52	60	-10.48	-	-

Qp - Quasi-Peak detector

LINE 2 PLOT

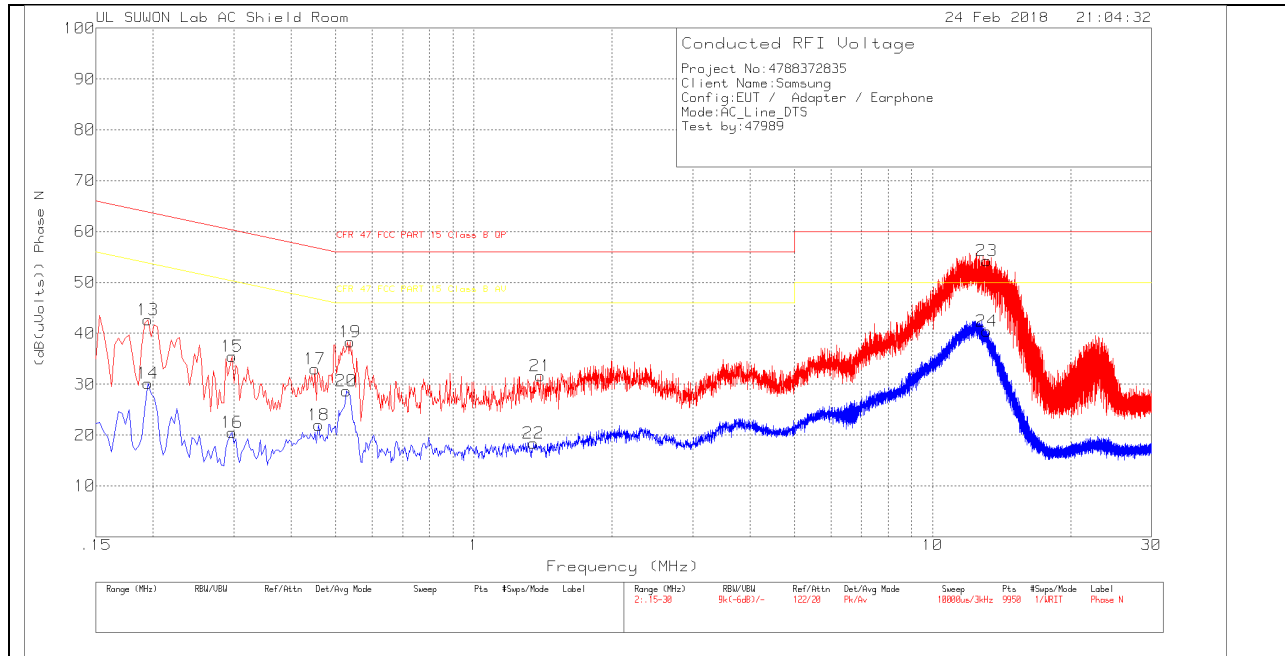

LINE 2 RESULTS

Trace Markers

Range 2: Phase N .15 - 30MHz

Marker	Frequency (MHz)	Meter Reading (dBuV)	Det	101837_N_with extension	CABLELOSS(dB)	Corrected Reading (dB(uVolts))	CFR 47 FCC PART 15 Class B QP	Margin (dB)	CFR 47 FCC PART 15 Class B AV	Margin (dB)
13	.195	32.49	Pk	9.9	.2	42.59	63.82	-21.23	-	-
14	.195	20.01	Av	9.9	.2	30.11	-	-	53.82	-23.71
15	.297	25.54	Pk	9.7	.2	35.44	60.33	-24.89	-	-
16	.297	10.55	Av	9.7	.2	20.45	-	-	50.33	-29.88
17	.45	22.95	Pk	9.8	.2	32.95	56.88	-23.93	-	-
18	.459	11.93	Av	9.8	.2	21.93	-	-	46.71	-24.78
19	.537	28.36	Pk	9.8	.2	38.36	56	-17.64	-	-
20	.528	18.64	Av	9.8	.2	28.64	-	-	46	-17.36
21	1.395	21.38	Pk	9.9	.3	31.58	56	-24.42	-	-
22	1.35	8.2	Av	9.9	.3	18.4	-	-	46	-27.6
23	13.146	44.03	Pk	9.8	.4	54.23	60	-5.77	-	-
24	13.131	30.25	Av	9.8	.4	40.45	-	-	50	-9.55

Pk - Peak detector

Av - Average detection

Quasi-Peak Emissions

Range 2: Phase N .15 - 30MHz

Frequency (MHz)	Meter Reading (dBuV)	Det	101837_N_with extension	CABLELOSS(dB)	Corrected Reading (dB(uVolts))	CFR 47 FCC PART 15 Class B QP	Margin (dB)	CFR 47 FCC PART 15 Class B AV	Margin (dB)
13.1468	38.01	Qp	9.8	.4	48.21	60	-11.79	-	-

Qp - Quasi-Peak detector