

## **Attachment 8.**

### **- DUT Antenna Information and SAR Test SETUP PHOTOGRAPHS**

## DUT Antenna Information

\* Placement of each antenna

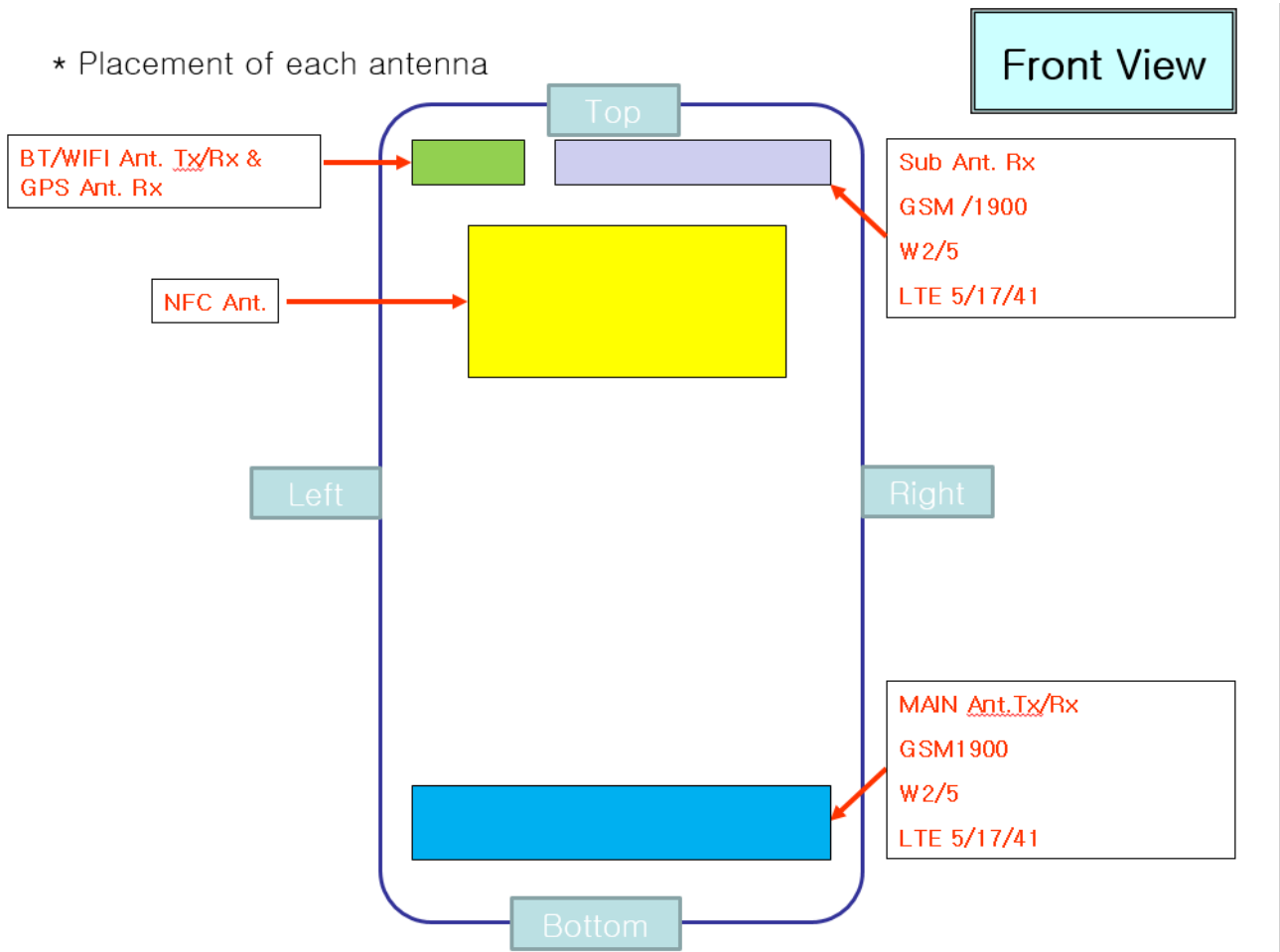

\* Distance between Main antenna and edge

Front View

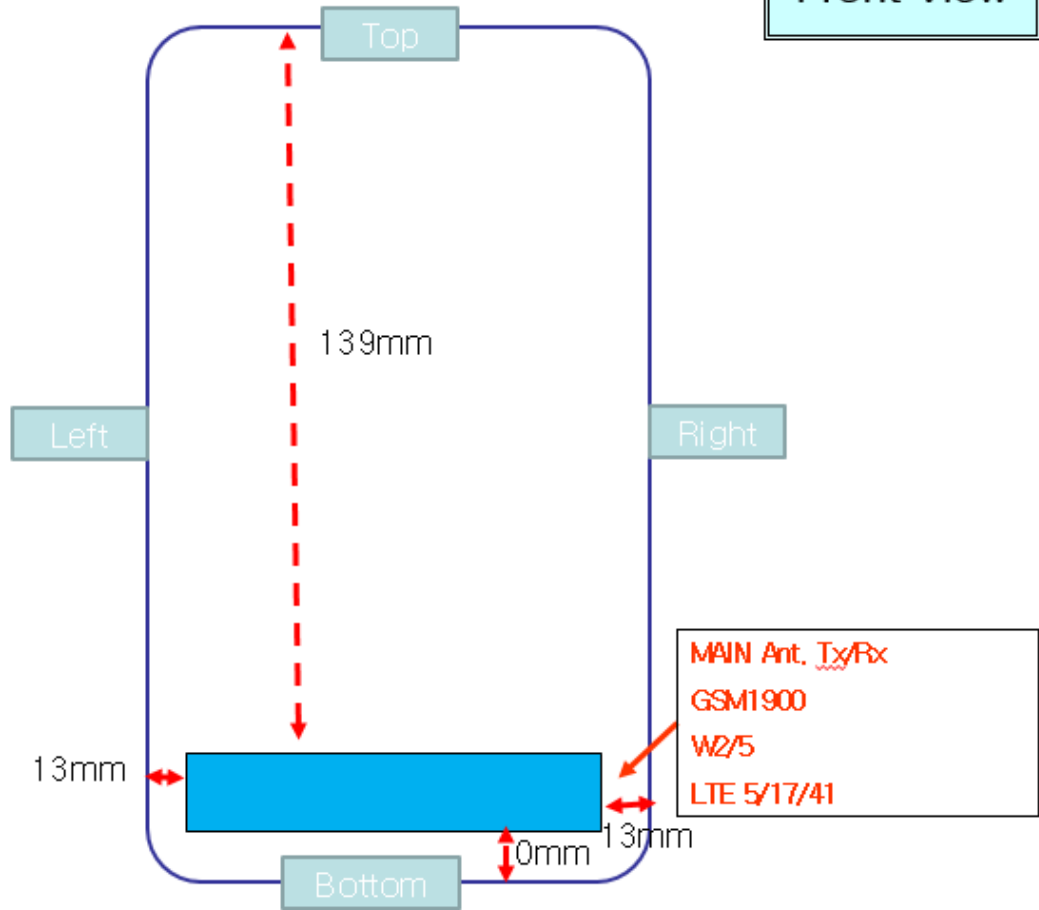

\* Distance between Bluetooth & WLAN antenna and edge

Front View

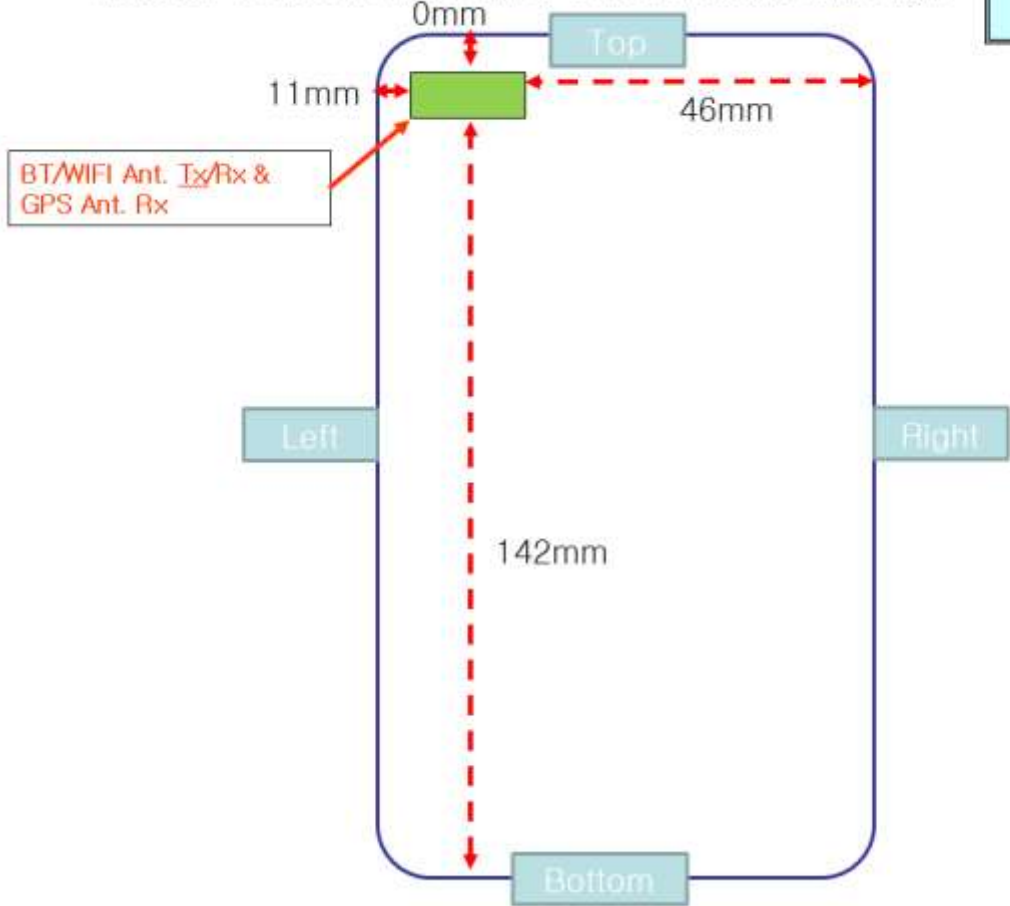

\* Diagonal dimension of LCD and device

Front View

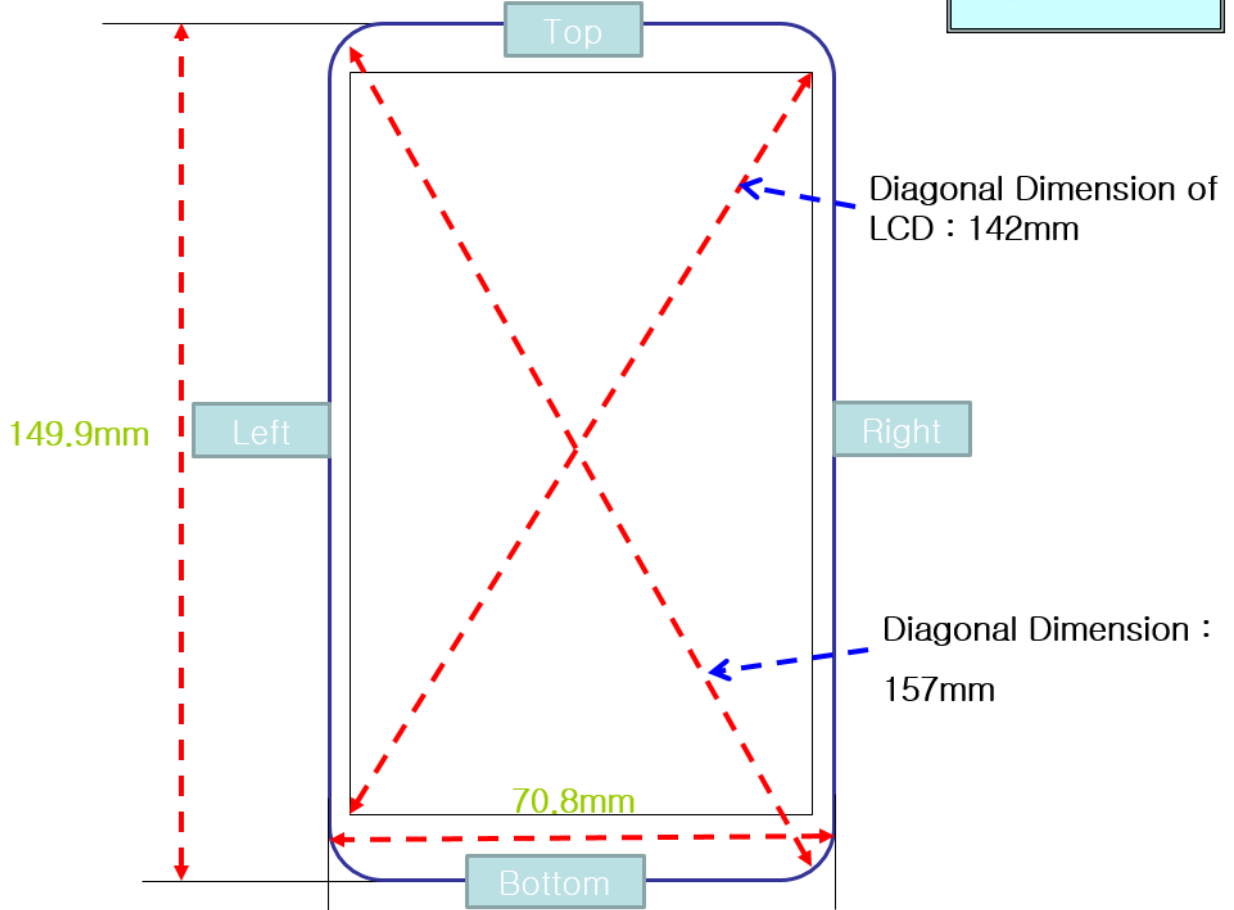

## SAR Test Setup Photographs

■ Test Setup Photo(Left All)



■ Test Setup Photo(Left Touch/Tilt)



■ **Test Setup Photo(Right All)**



■ **Test Setup Photo (Right Touch/Tilt)**



■ Test Setup Photo (Body All)



■ **Test Setup Photo (Rear)**

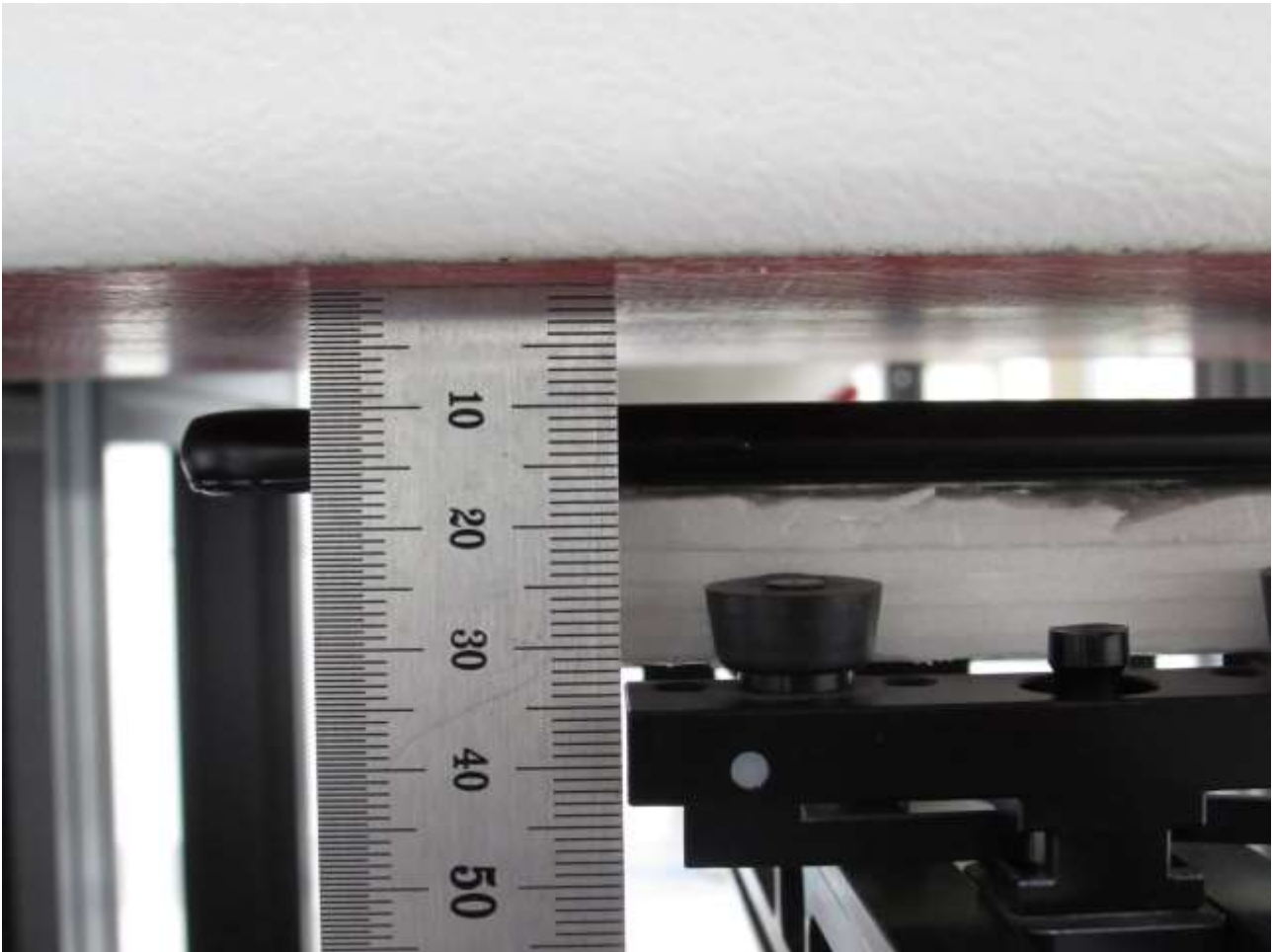

**[Distance of 1.0 cm from the EUT]**

■ **Test Setup Photo (Front)**

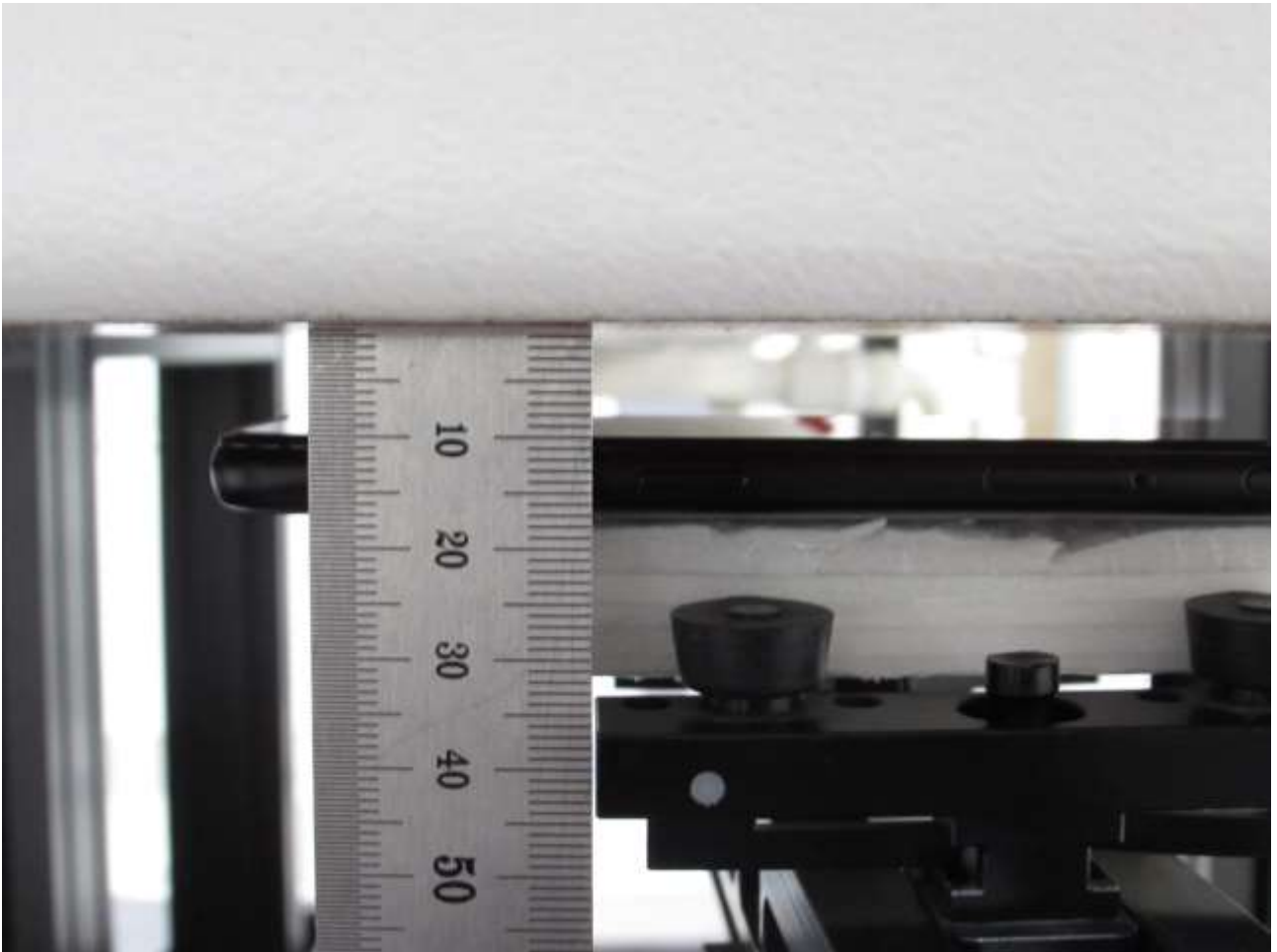

**[Distance of 1.0 cm from the EUT]**

■ **Test Setup Photo (Left)**

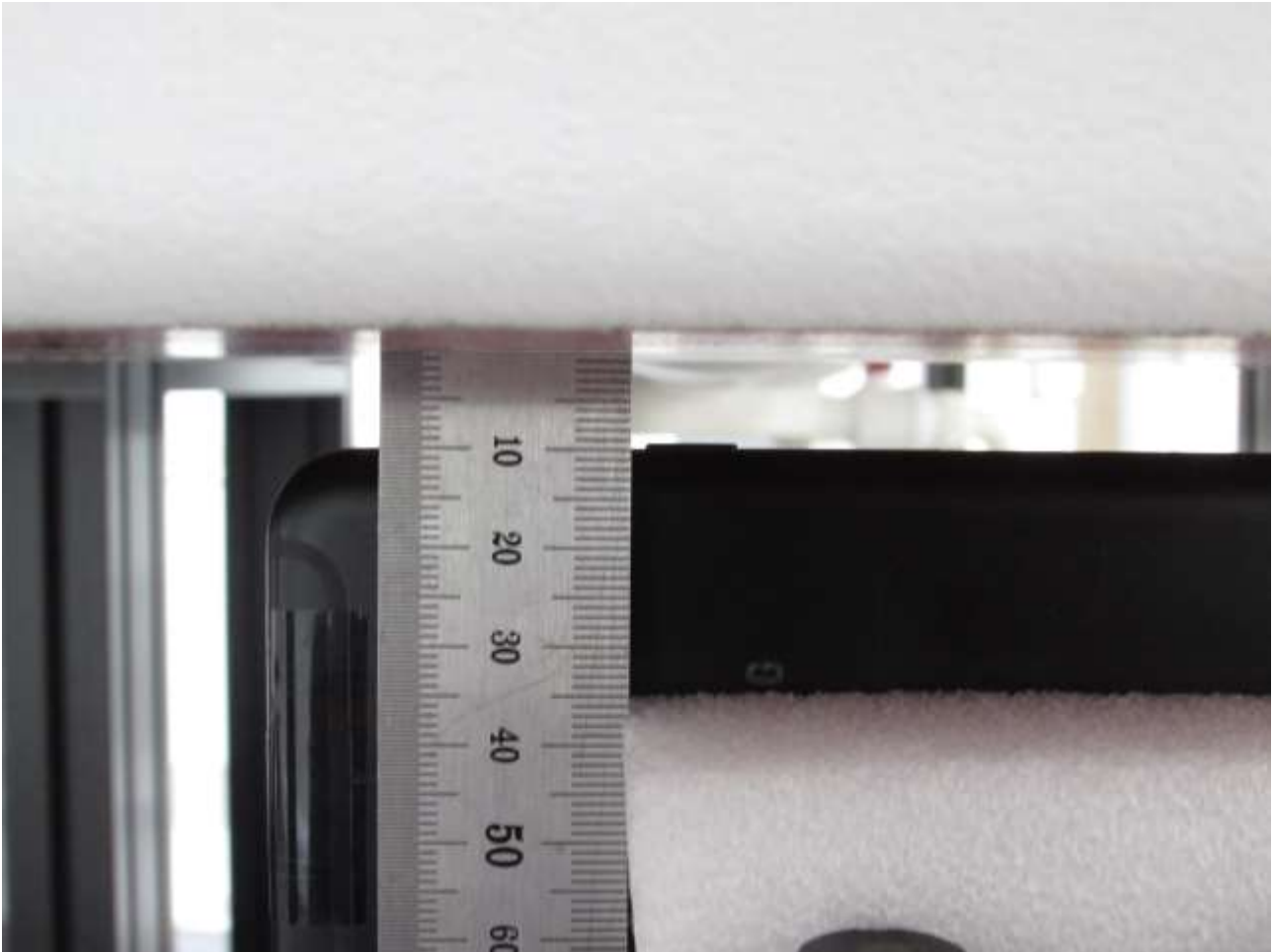

**[Distance of 1.0 cm from the EUT]**

■ **Test Setup Photo (Right)**



**[Distance of 1.0 cm from the EUT]**

■ **Test Setup Photo (Top)**



**[Distance of 1.0 cm from the EUT]**

■ **Test Setup Photo (Bottom)**

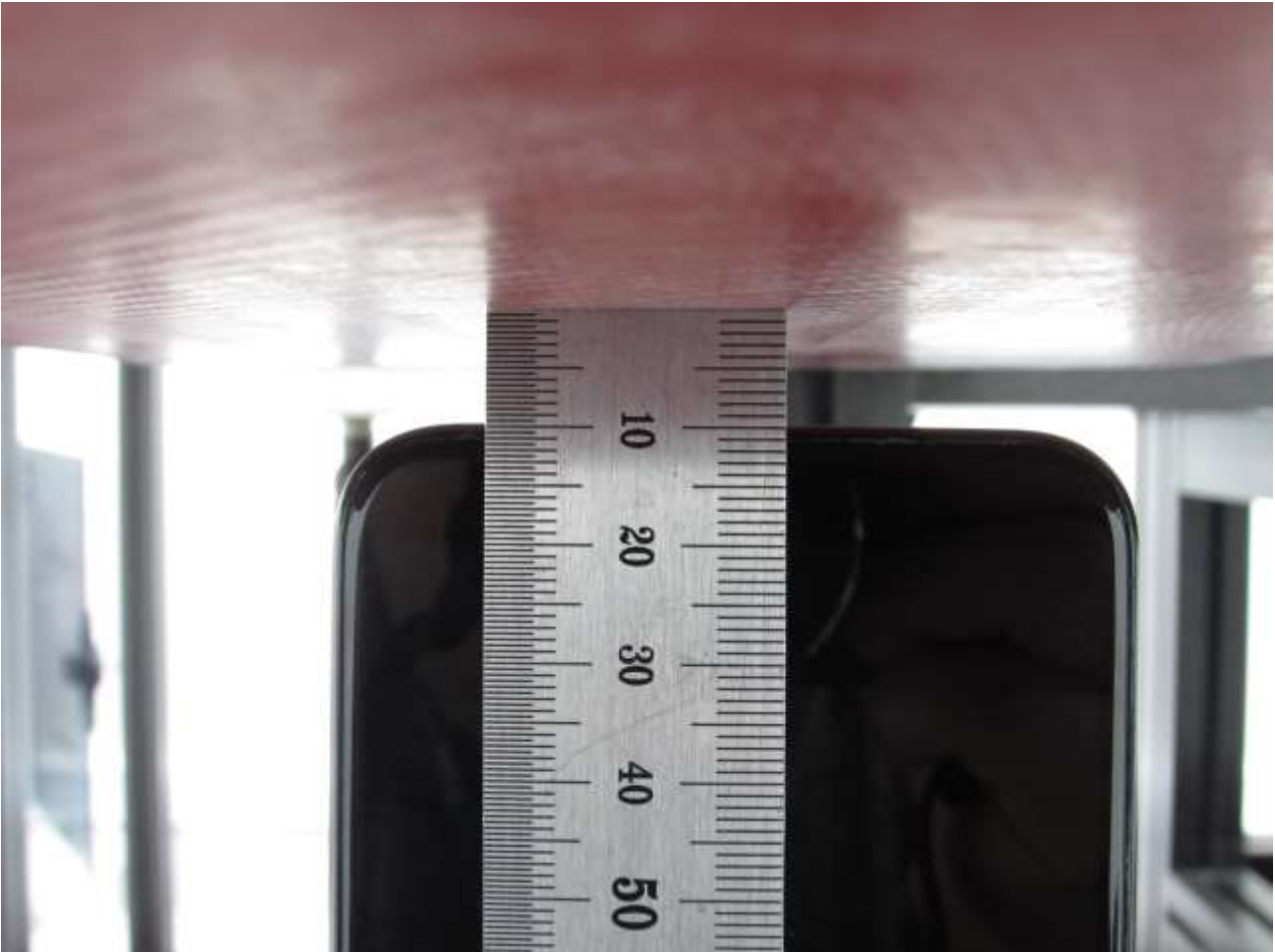

**[Distance of 1.0 cm from the EUT]**

■ **Test Setup Photo (Rear)**



**[Distance of 1.5 cm from the EUT]**

■ **Test Setup Photo (Front)**



**[Distance of 1.5 cm from the EUT]**