

HARMONICS AND SPURIOUS EMISSIONS

LOW CHANNEL HORIZONTAL

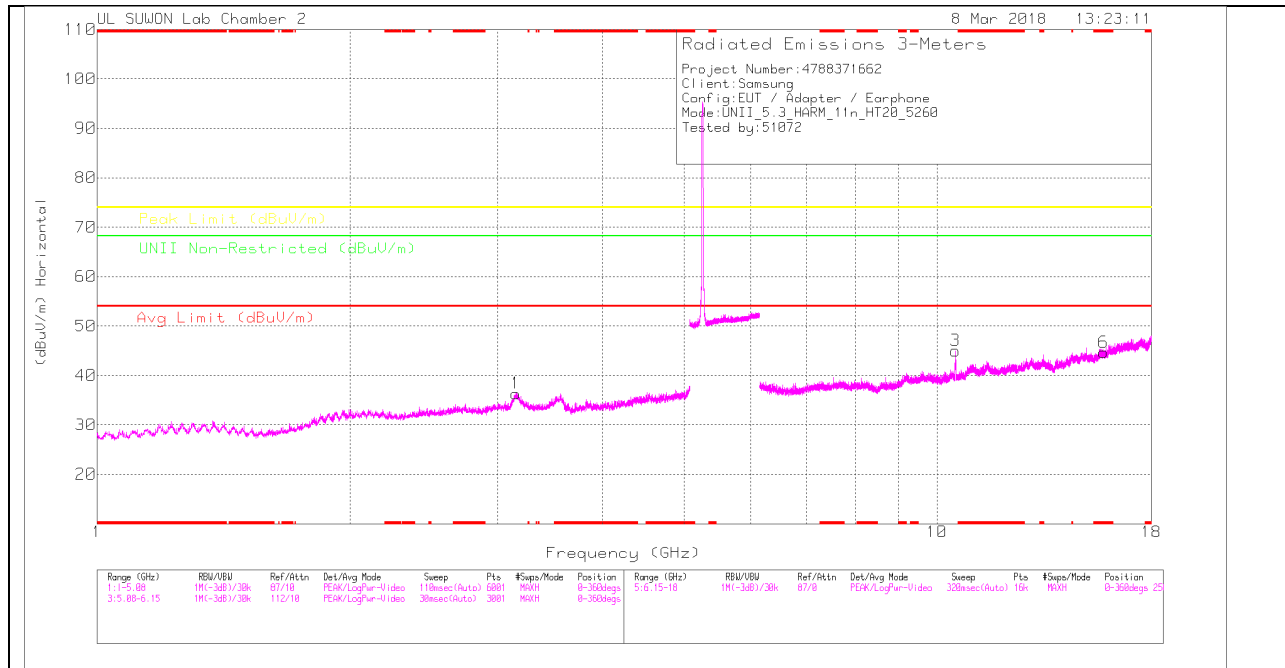

LOW CHANNEL VERTICAL

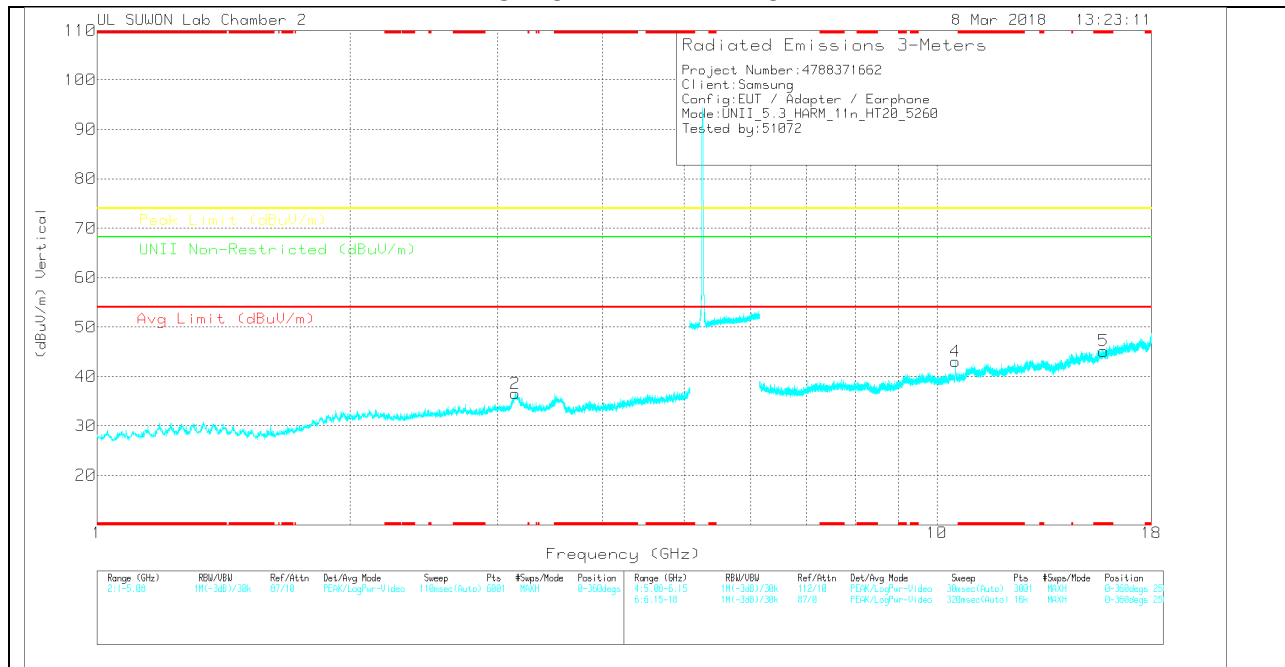

Note: Emission was scanned up to 40GHz; No emissions were detected above the noise floor which was at least 20dB below the specification limit.

LOW CHANNEL DATA

Trace Markers

Marker	Frequency (GHz)	Meter Reading (dBuV)	Det	170531_3117(001887 24)	5GHz_HF(dB)	DC Corr (dB)	Corrected Reading (dBuV/m)	Avg Limit (dBuV/m)	Margin (dB)	Peak Limit (dBuV/m)	Margin (dB)	UNII Non-Restricted (dBuV/m)	Margin (dB)	Azimuth (Degs)	Height (cm)	Polarity
1	3.151	27.55	PK	34.9	-26.1	0	36.35	-	-	-	-	68.2	-31.85	0-360	150	H
2	3.149	27.92	PK	34.8	-26.2	0	36.52	-	-	-	-	68.2	-31.68	0-360	250	V
3	10.521	24.11	PK	37.5	-16.6	0	45.01	-	-	-	-	68.2	-23.19	0-360	250	H
6	* 15.781	19.36	PK	40.1	-14.8	0	44.66	-	-	74	-29.34	-	-	0-360	150	H
4	10.517	22.1	PK	37.5	-16.6	0	43	-	-	-	-	68.2	-25.2	0-360	150	V
5	* 15.781	19.85	PK	40.1	-14.8	0	45.15	-	-	74	-28.85	-	-	0-360	250	V

* - indicates frequency in CFR47 Pt 15 / IC RSS-Restricted Band
 PK – Peak Detector

Radiated Emissions

Frequency (GHz)	Meter Reading (dBuV)	Det	170531_3117(00188724)	5GHz_HF(dB)	DC Corr (dB)	Corrected Reading (dBuV/m)	Avg Limit (dBuV/m)	Margin (dB)	Peak Limit (dBuV/m)	Margin (dB)	UNII Non-Restricted (dBuV/m)	Margin (dB)	Azimuth (Degs)	Height (cm)	Polarity
10.515	37.2	PK-U	37.5	-16.6	0	58.1	-	-	-	-	68.2	-10.1	24	134	H
10.523	34.94	PK-U	37.5	-16.6	0	55.84	-	-	-	-	68.2	-12.36	78	153	V

* - indicates frequency in CFR47 Pt 15 / IC RSS-Restricted Band
 PK-U - U-NII: Maximum Peak

MID CHANNEL HORIZONTAL

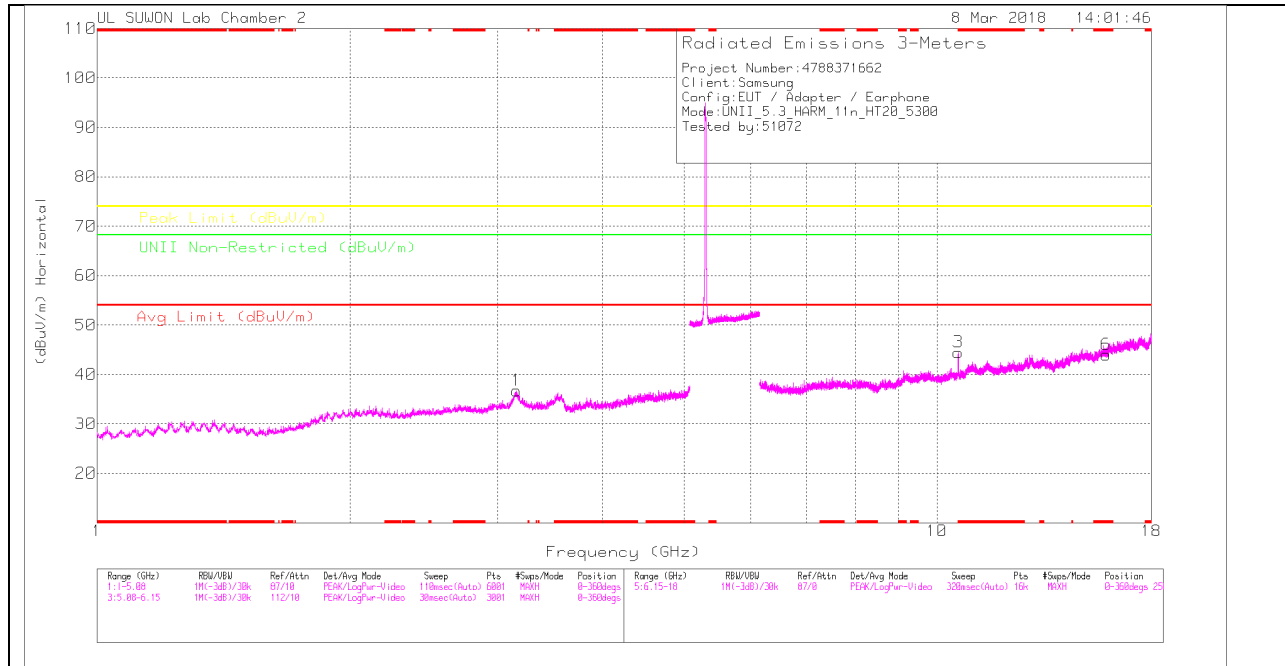

MID CHANNEL VERTICAL

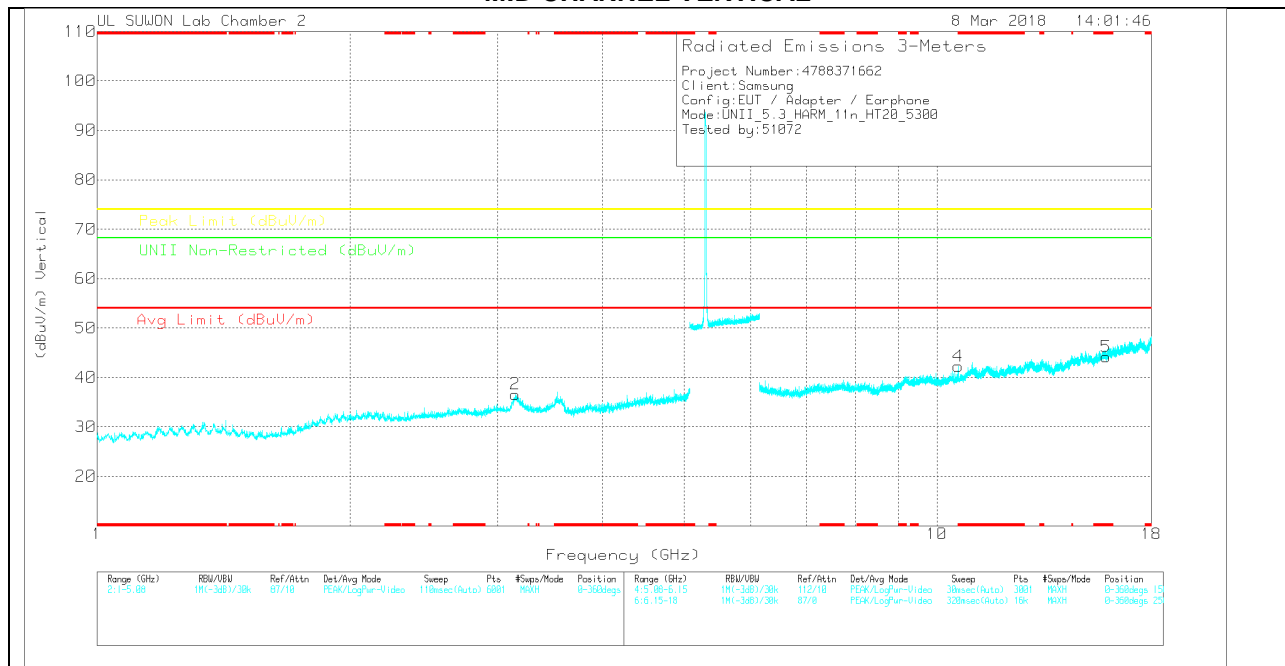

Note: Emission was scanned up to 40GHz; No emissions were detected above the noise floor which was at least 20dB below the specification limit.

MID CHANNEL DATA

Trace Markers

Marker	Frequency (GHz)	Meter Reading (dBuV)	Det	170531_3117(00168724)	5GHz_LF(dB)	DC Corr (dB)	Corrected Reading (dBuV/m)	Avg Limit (dBuV/m)	Margin (dB)	Peak Limit (dBuV/m)	Margin (dB)	UNII Non-Restricted (dBuV/m)	Margin (dB)	Asimuth (Degs)	Height (cm)	Polarity
1	3.158	28.04	PK	34.7	-26	0	36.74	-	-	-	-	68.2	-31.46	0-360	150	H
2	3.147	28.01	PK	34.8	-26.2	0	36.61	-	-	-	-	68.2	-31.59	0-360	250	V
3	* 10.601	23.49	PK	37.6	-16.6	0	44.49	-	-	74	-29.51	-	-	0-360	250	H
6	* 15.9	18.4	PK	40.3	-14.7	0	44	-	-	74	-30	-	-	0-360	150	H
4	* 10.6	21.27	PK	37.6	-16.6	0	42.27	-	-	74	-31.73	-	-	0-360	150	V
5	* 15.9	18.56	PK	40.3	-14.7	0	44.16	-	-	74	-29.84	-	-	0-360	150	V

* - indicates frequency in CFR47 Pt 15 / IC RSS-Restricted Band
 PK – Peak Detector

Radiated Emissions

Frequency (GHz)	Meter Reading (dBuV)	Det	170531_3117(00168724)	5GHz_LF(dB)	DC Corr (dB)	Corrected Reading (dBuV/m)	Avg Limit (dBuV/m)	Margin (dB)	Peak Limit (dBuV/m)	Margin (dB)	UNII Non-Restricted (dBuV/m)	Margin (dB)	Asimuth (Degs)	Height (cm)	Polarity
* 10.604	38.18	PK-U	37.6	-16.7	0	59.08	-	-	74	-14.92	-	-	345	233	H
* 10.601	22.58	ADR	37.6	-16.6	.15	43.73	54	-10.27	-	-	-	-	345	233	H
* 10.6	34.27	PK-U	37.6	-16.6	0	55.27	-	-	74	-18.73	-	-	81	149	V
* 10.6	19.84	ADR	37.6	-16.6	.15	40.99	54	-13.01	-	-	-	-	81	149	V

* - indicates frequency in CFR47 Pt 15 / IC RSS-Restricted Band
 PK-U - U-NII: Maximum Peak
 ADR - U-NII AD primary method, RMS average

HIGH CHANNEL HORIZONTAL

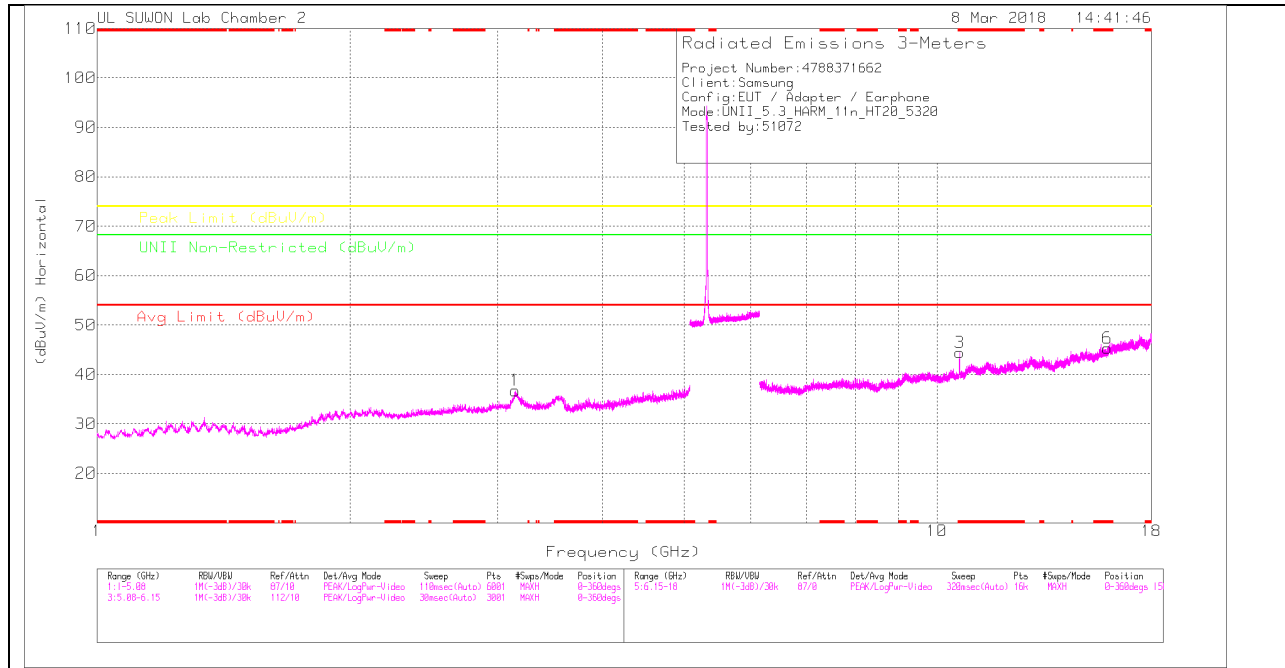

HIGH CHANNEL VERTICAL

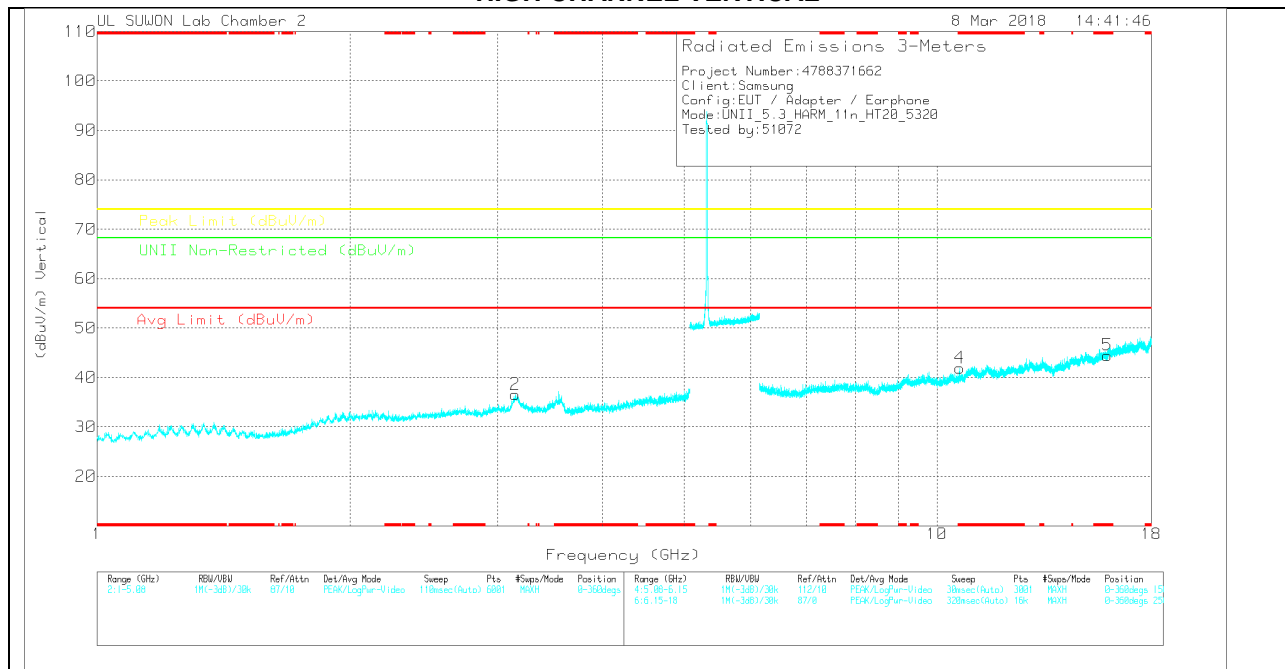

Note: Emission was scanned up to 40GHz; No emissions were detected above the noise floor which was at least 20dB below the specification limit.

HIGH CHANNEL DATA

Trace Markers

Marker	Frequency (GHz)	Meter Reading (dBuV)	Det	170531_3117001687 24)	5GHz_LF(dB)	DC Corr (dB)	Corrected Reading (dBuV/m)	Avg Limit (dBuV/m)	Margin (dB)	Peak Limit (dBuV/m)	Margin (dB)	UNII Non-Restricted (dBuV/m)	Margin (dB)	Asimuth (Degs)	Height (cm)	Polarity
1	3.146	28.24	PK	34.7	-26.2	0	36.74	-	-	-	-	68.2	-31.46	0-360	250	H
2	3.149	27.98	PK	34.8	-26.2	0	36.58	-	-	-	-	68.2	-31.62	0-360	150	V
3	* 10.639	23.34	PK	37.7	-16.6	0	44.44	-	-	74	-29.56	-	-	0-360	250	H
6	* 15.961	19.29	PK	40.4	-14.4	0	45.29	-	-	74	-28.71	-	-	0-360	150	H
4	* 10.642	20.83	PK	37.7	-16.6	0	41.93	-	-	74	-32.07	-	-	0-360	150	V
5	* 15.961	18.49	PK	40.4	-14.4	0	44.49	-	-	74	-29.51	-	-	0-360	250	V

* - indicates frequency in CFR47 Pt 15 / IC RSS-Restricted Band
 Avg - Video bandwidth < Resolution bandwidth

Radiated Emissions

Frequency (GHz)	Meter Reading (dBuV)	Det	170531_311700168724)	6GHz_HF(dB)	DC Corr (dB)	Corrected Reading (dBuV/m)	Avg Limit (dBuV/m)	Margin (dB)	Peak Limit (dBuV/m)	Margin (dB)	UNII Non-Restricted (dBuV/m)	Margin (dB)	Asimuth (Degs)	Height (cm)	Polarity
* 10.643	38.06	PK-U	37.7	-16.6	0	59.16	-	-	74	-14.84	-	-	353	232	H
* 10.64	21.93	ADR	37.7	-16.6	.15	43.18	54	-10.82	-	-	-	-	353	232	H
* 10.644	34.81	PK-U	37.7	-16.6	0	55.91	-	-	74	-18.09	-	-	87	100	V
* 10.641	19.39	ADR	37.7	-16.6	.15	40.64	54	-13.36	-	-	-	-	87	100	V

* - indicates frequency in CFR47 Pt 15 / IC RSS-Restricted Band
 PK-U - U-NII: Maximum Peak
 ADR - U-NII AD primary method, RMS average

11.2.3. TX ABOVE 1GHz 802.11n HT40 MODE IN THE 5.3GHz BAND AUTHORIZED BANDEDGE (HIGH CHANNEL)

HORIZONTAL PEAK AND AVERAGE PLOT

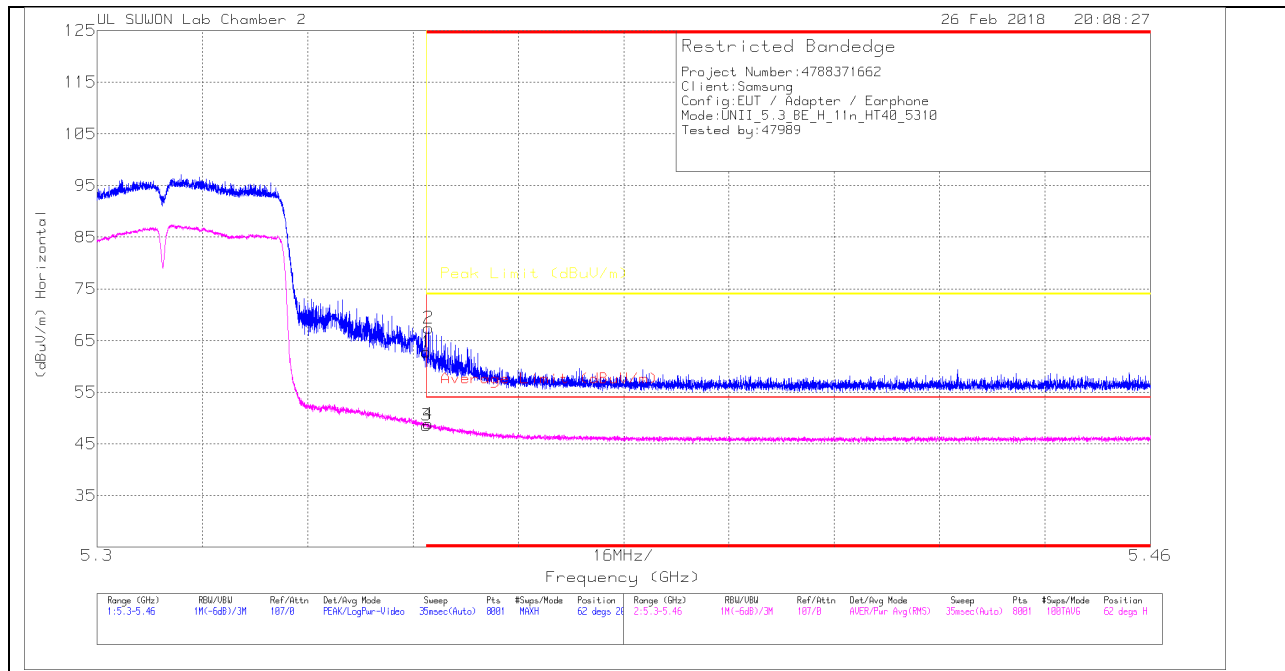

HORIZONTAL DATA

Trace Markers

Marker	Frequency (GHz)	Meter Reading (dBuV)	Det	170531_3117(00168724)	10dB(dB)	DC Corr (dB)	Corrected Reading (dBuV/m)	Average Limit (dBuV/m)	Margin (dB)	Peak Limit (dBuV/m)	PK Margin (dB)	Azimuth (Degs)	Height (cm)	Polarity
1	* 5.35	43.79	Pk	34.2	-15.2	0	62.79	-	-	74	-11.21	62	201	H
2	* 5.35	48.45	Pk	34.2	-15.2	0	67.45	-	-	74	-6.55	62	201	H
3	* 5.35	29.3	RMS	34.2	-15.2	.3	48.6	54	-5.4	-	-	62	201	H
4	* 5.35	29.6	RMS	34.2	-15.2	.3	48.9	54	-5.1	-	-	62	201	H

* - indicates frequency in CFR47 Pt 15 / IC RSS-Restricted Band

Pk - Peak detector

RMS - RMS detection

VERTICAL PEAK AND AVERAGE PLOT

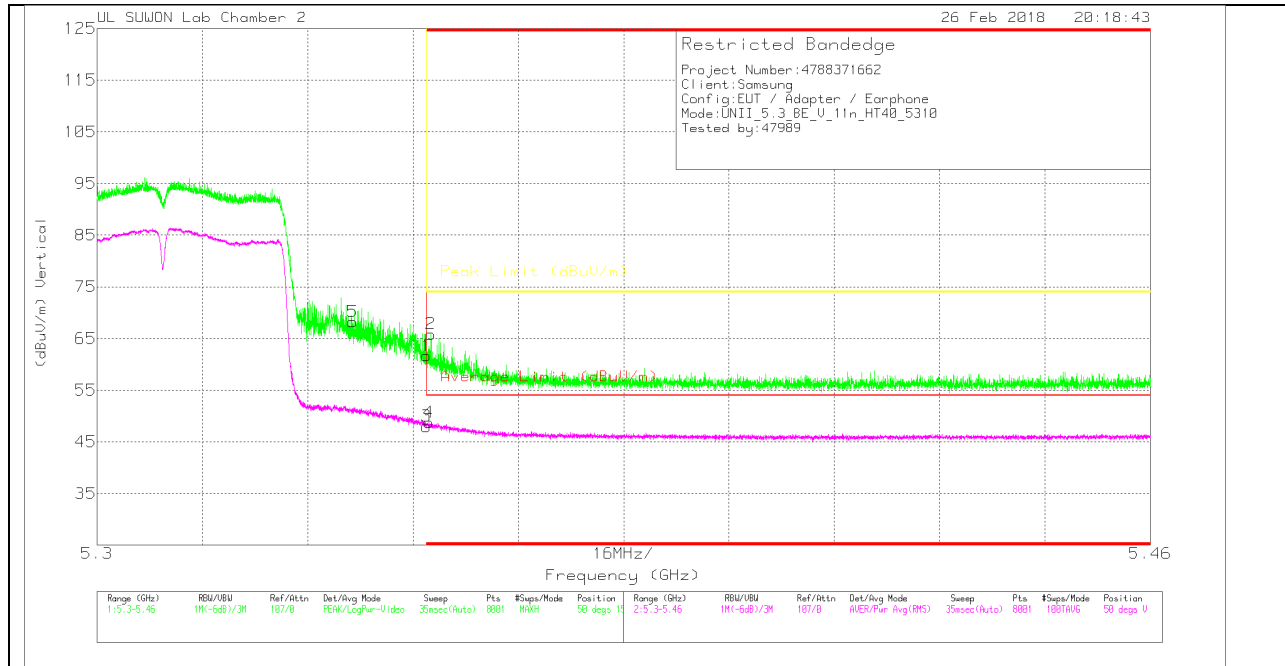

VERTICAL DATA

Trace Markers

Marker	Frequency (GHz)	Meter Reading (dBuV)	Det	170531_311700168724	10dB(dB)	DC Corr (dB)	Corrected Reading (dBuV/m)	Average Limit (dBuV/m)	Margin (dB)	Peak Limit (dBuV/m)	PK Margin (dB)	Azimuth (Degs)	Height (cm)	Polarity
1	* 5.35	42.69	Pk		34.2	-15.2	61.69	-	-	74	-12.31	50	152	V
2	* 5.351	46.88	Pk		34.2	-15.2	65.88	-	-	74	-8.12	50	152	V
3	* 5.35	28.7	RMS		34.2	-15.2	48	54	-6	-	-	50	152	V
4	* 5.35	29.48	RMS		34.2	-15.2	48.78	54	-5.22	-	-	50	152	V

* - indicates frequency in CFR47 Pt 15 / IC RSS-Restricted Band
 Pk - Peak detector
 RMS - RMS detection

HARMONICS AND SPURIOUS EMISSIONS

LOW CHANNEL HORIZONTAL

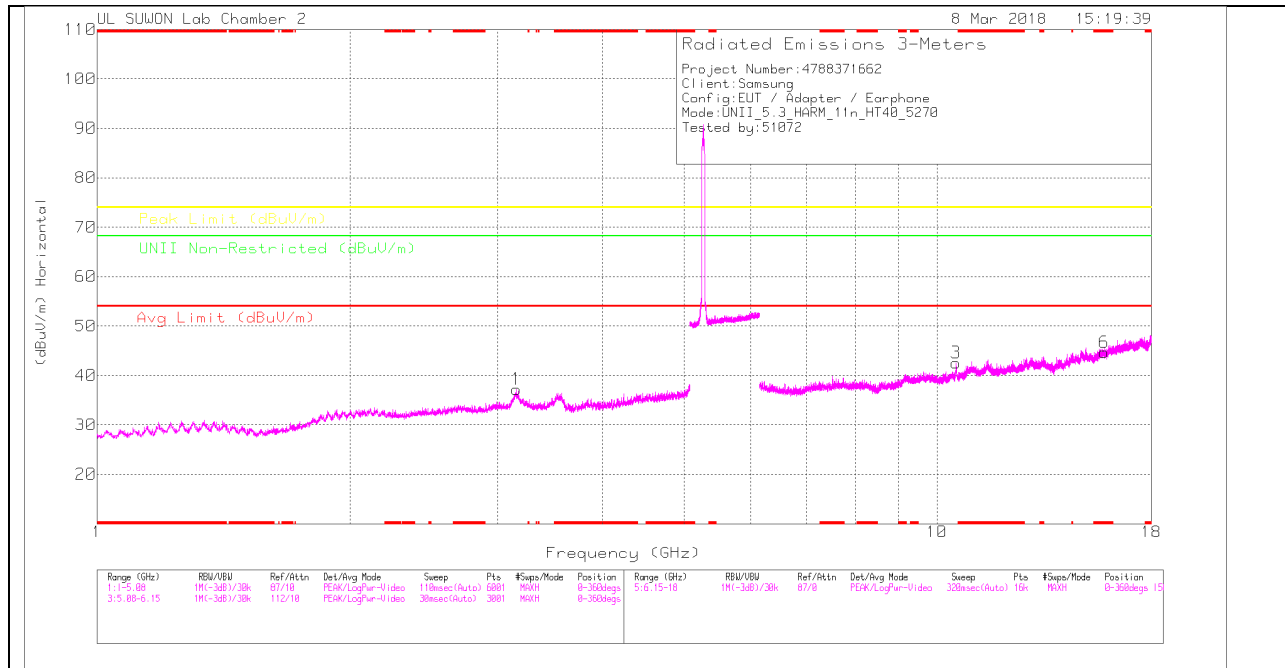

LOW CHANNEL VERTICAL

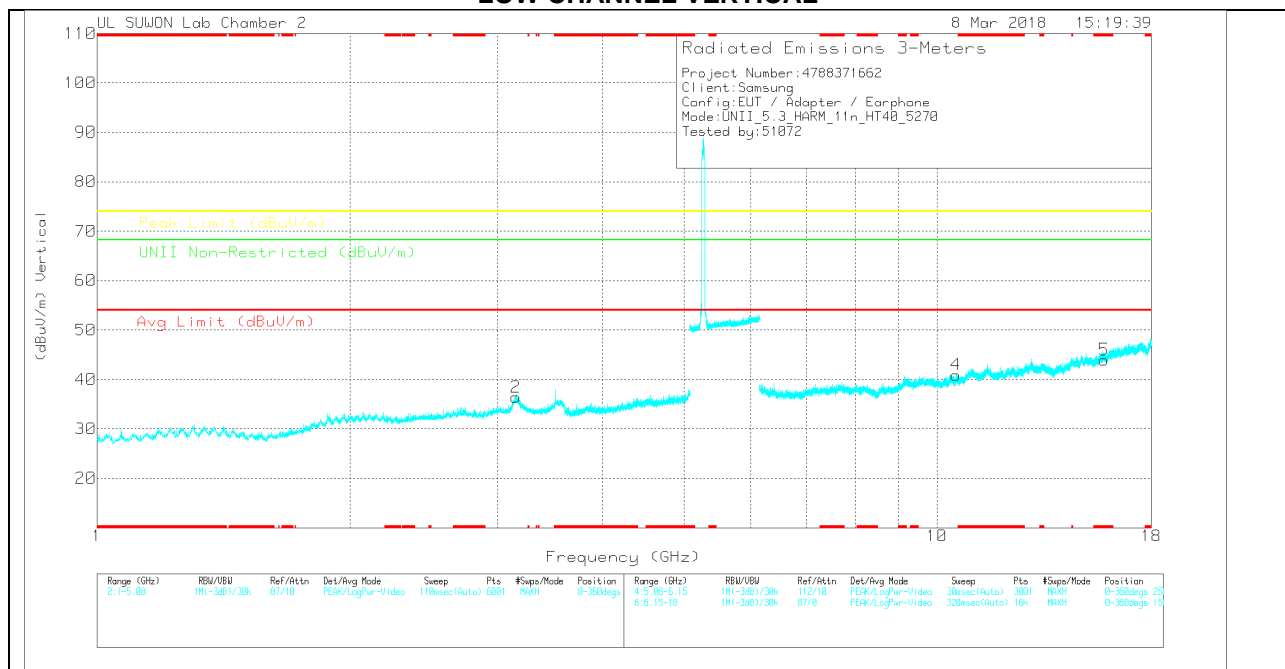

Note: Emission was scanned up to 40GHz; No emissions were detected above the noise floor which was at least 20dB below the specification limit.

LOW CHANNEL DATA

Trace Markers

Marker	Frequency (GHz)	Meter Reading (dBuV)	Det	170531_3117(001687 24)	5GHz_LF(dB)	DC Corr (dB)	Corrected Reading (dBuV/m)	Avg Limit (dBuV/m)	Margin (dB)	Peak Limit (dBuV/m)	Margin (dB)	U/NII Non-Restricted (dBuV/m)	Margin (dB)	Azimuth (Degs)	Height (cm)	Polarity
1	3.158	28.53	PK	34.7	-26	0	37.23	-	-	-	-	68.2	-30.97	0-360	150	H
2	3.151	27.58	PK	34.9	-26.1	0	36.38	-	-	-	-	68.2	-31.82	0-360	250	V
3	10.539	21.56	PK	37.6	-16.6	0	42.56	-	-	-	-	68.2	-25.64	0-360	250	H
6	* 15.81	19.28	PK	40.1	-14.7	0	44.68	-	-	74	-29.32	-	-	0-360	250	H
4	10.538	19.93	PK	37.6	-16.6	0	40.93	-	-	-	-	68.2	-27.27	0-360	250	V
5	* 15.81	18.55	PK	40.1	-14.7	0	43.95	-	-	74	-30.05	-	-	0-360	150	V

* - indicates frequency in CFR47 Pt 15 / IC RSS-Restricted Band
 PK – Peak Detector

Radiated Emissions

Frequency (GHz)	Meter Reading (dBuV)	Det	170531_3117(00168724)	5GHz_LF(dB)	DC Corr (dB)	Corrected Reading (dBuV/m)	Avg Limit (dBuV/m)	Margin (dB)	Peak Limit (dBuV/m)	Margin (dB)	U/NII Non-Restricted (dBuV/m)	Margin (dB)	Azimuth (Degs)	Height (cm)	Polarity
10.545	33.92	PK-U	37.6	-16.5	0	55.02	-	-	-	-	68.2	-13.18	348	240	H
10.539	30.86	PK-U	37.6	-16.6	0	51.86	-	-	-	-	68.2	-16.34	93	100	V

* - indicates frequency in CFR47 Pt 15 / IC RSS-Restricted Band
 PK-U - U-NII: Maximum Peak

HIGH CHANNEL HORIZONTAL

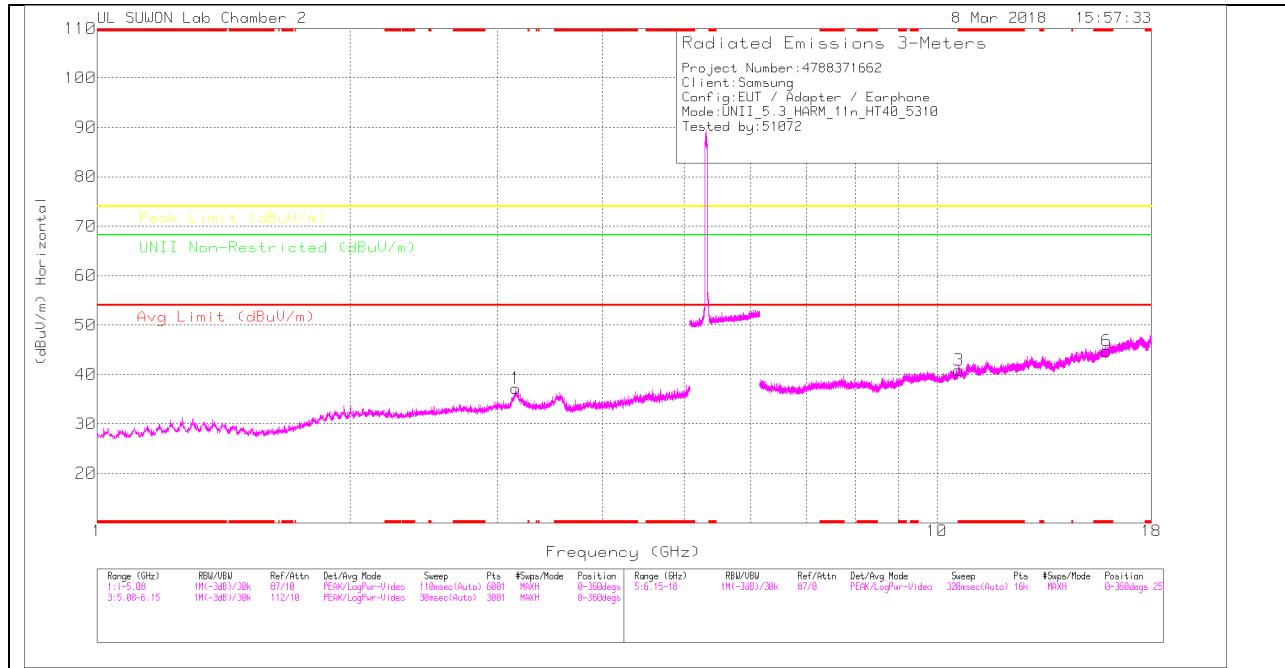

HIGH CHANNEL VERTICAL

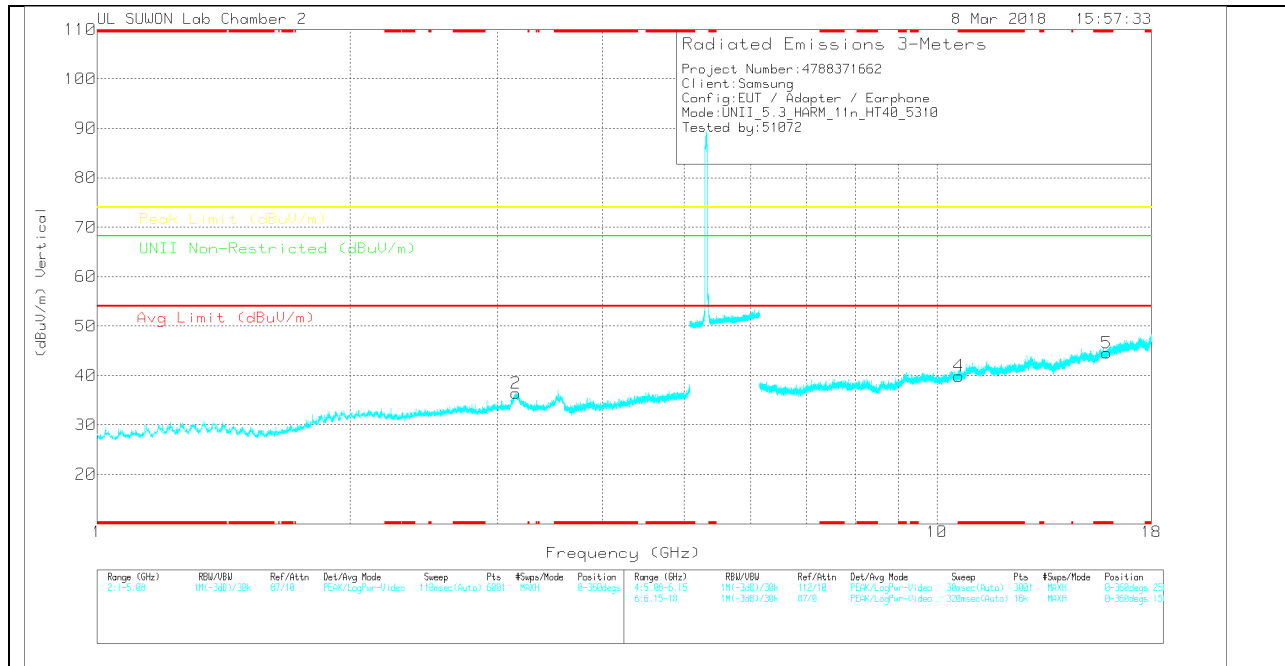

Note: Emission was scanned up to 40GHz; No emissions were detected above the noise floor which was at least 20dB below the specification limit.

HIGH CHANNEL DATA

Trace Markers

Marker	Frequency (GHz)	Marker Reading (dBuV)	Det	170531_3117001887 24	SGHz_LF(dB)	DC Corr (dB)	Corrected Reading (dBuV/m)	Avg Limit (dBuV/m)	Margin (dB)	Peak Limit (dBuV/m)	Margin (dB)	Unrestricted (dBuV/m)	Margin (dB)	Azimuth (Degs)	Height (cm)	Polarity
1	3.152	28.4	PK	34.9	-26.1	0	37.2	-	-	-	-	68.2	-31	0-360	251	H
2	3.152	27.59	PK	34.9	-26.1	0	36.39	-	-	-	-	68.2	-31.81	0-360	250	V
3	* 10.62	19.94	PK	37.6	-16.7	0	40.84	-	-	74	-33.16	-	-	0-360	250	H
6	* 15.93	19.06	PK	40.4	-14.7	0	44.76	-	-	74	-29.24	-	-	0-360	250	H
4	* 10.62	18.97	PK	37.6	-16.7	0	39.87	-	-	74	-34.13	-	-	0-360	150	V
5	* 15.93	18.86	PK	40.4	-14.7	0	44.56	-	-	74	-29.44	-	-	0-360	250	V

* - indicates frequency in CFR47 Pt 15 / IC RSS-Restricted Band
 PK – Peak Detector

Note: Only peak measurement was performed. Because peak measurement result of unwanted emission is less than average limit (54dBuV/m).

11.3. 5.5-5.6 GHz

11.3.1. TX ABOVE 1 GHz 802.11a MODE IN THE 5.5 GHz BAND

RESTRICTED BANDEDGE (LOW CHANNEL)

HORIZONTAL PEAK AND AVERAGE PLOT

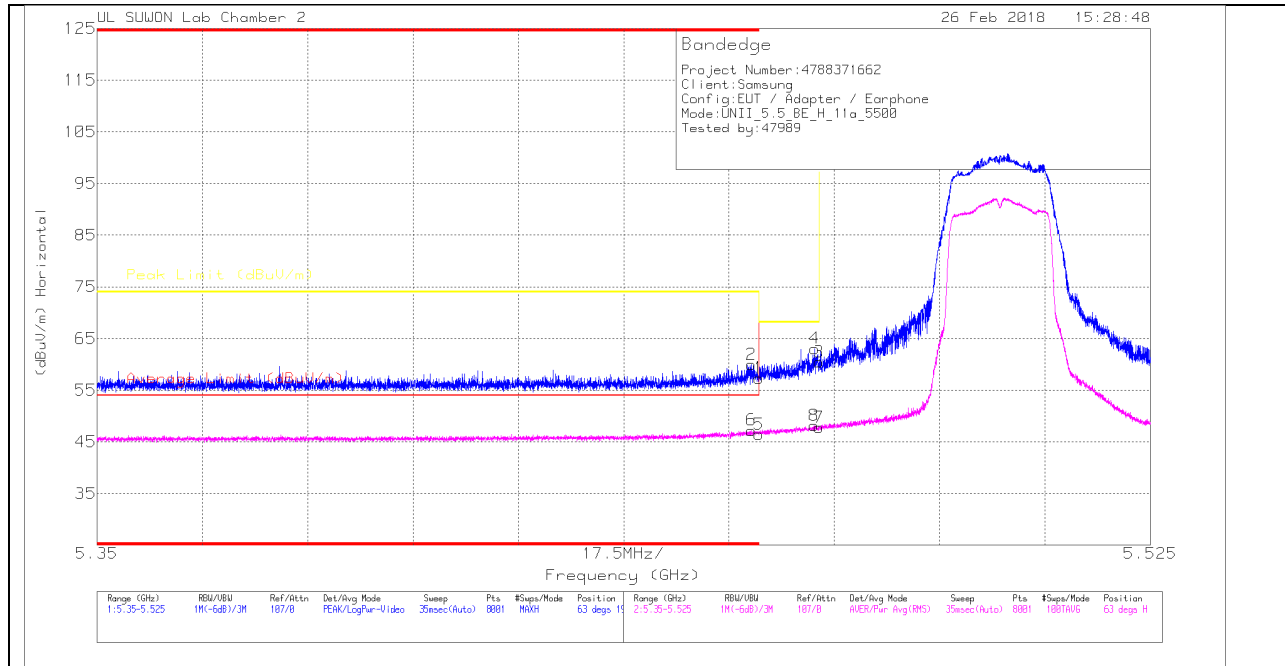

HORIZONTAL DATA

Trace Markers

Marker	Frequency (GHz)	Meter Reading (dBuV)	Det	170531_3117(00168724)	10dB(dB)	DC Corr (dB)	Corrected Reading (dBuV/m)	Average Limit (dBuV/m)	Margin (dB)	Peak Limit (dBuV/m)	PK Margin (dB)	Azimuth (Degs)	Height (cm)	Polarity
1	* 5.46	38.03	Pk	34.3	-15	0	57.33	-	-	74	-16.67	63	197	H
2	* 5.459	40.76	Pk	34.3	-15.1	0	59.96	-	-	74	-14.04	63	197	H
3	5.47	41.13	Pk	34.3	-15	0	60.43	-	-	68.2	-7.77	63	197	H
4	5.469	43.78	Pk	34.3	-15	0	63.08	-	-	68.2	-5.12	63	197	H
5	* 5.46	27.02	RMS	34.3	-15	-14	46.46	54	-7.54	-	-	63	197	H
6	* 5.459	27.91	RMS	34.3	-15.1	-14	47.25	54	-6.75	-	-	63	197	H

* - indicates frequency in CFR47 Pt 15 / IC RSS-Restricted Band

Pk - Peak detector

RMS - RMS detection

VERTICAL PEAK AND AVERAGE PLOT

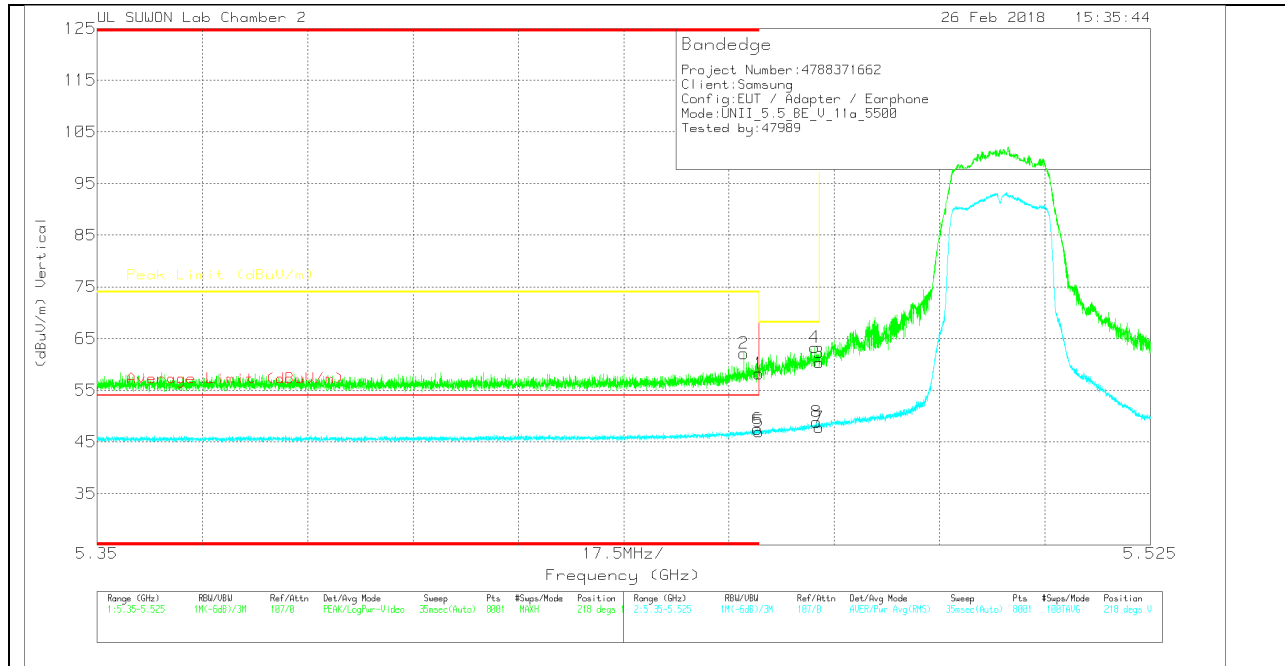

VERTICAL DATA

Trace Markers

Marker	Frequency (GHz)	Meter Reading (dBuV)	Det	170531_311700168724	10dB(dB)	DC Corr (dB)	Corrected Reading (dBuV/m)	Average Limit (dBuV/m)	Margin (dB)	Peak Limit (dBuV/m)	PK Margin (dB)	Azimuth (Degs)	Height (cm)	Polarity
1	* 5.46	38.93	Pk		34.3	-15	58.23	-	-	74	-15.77	218	108	V
2	* 5.457	42.92	Pk		34.3	-15.1	62.12	-	-	74	-11.88	218	108	V
3	5.47	41.05	Pk		34.3	-15	60.35	-	-	68.2	-7.85	218	108	V
4	5.469	43.98	Pk		34.3	-15	63.28	-	-	68.2	-4.92	218	108	V
5	* 5.46	27.53	RMS		34.3	-15	46.97	54	-7.03	-	-	218	108	V
6	* 5.46	28.07	RMS		34.3	-15	47.51	54	-6.49	-	-	218	108	V

* - indicates frequency in CFR47 Pt 15 / IC RSS-Restricted Band

Pk - Peak detector

RMS - RMS detection

AUTHORIZED BANDEDGE (HIGH CHANNEL)

HORIZONTAL PEAK AND AVERAGE PLOT

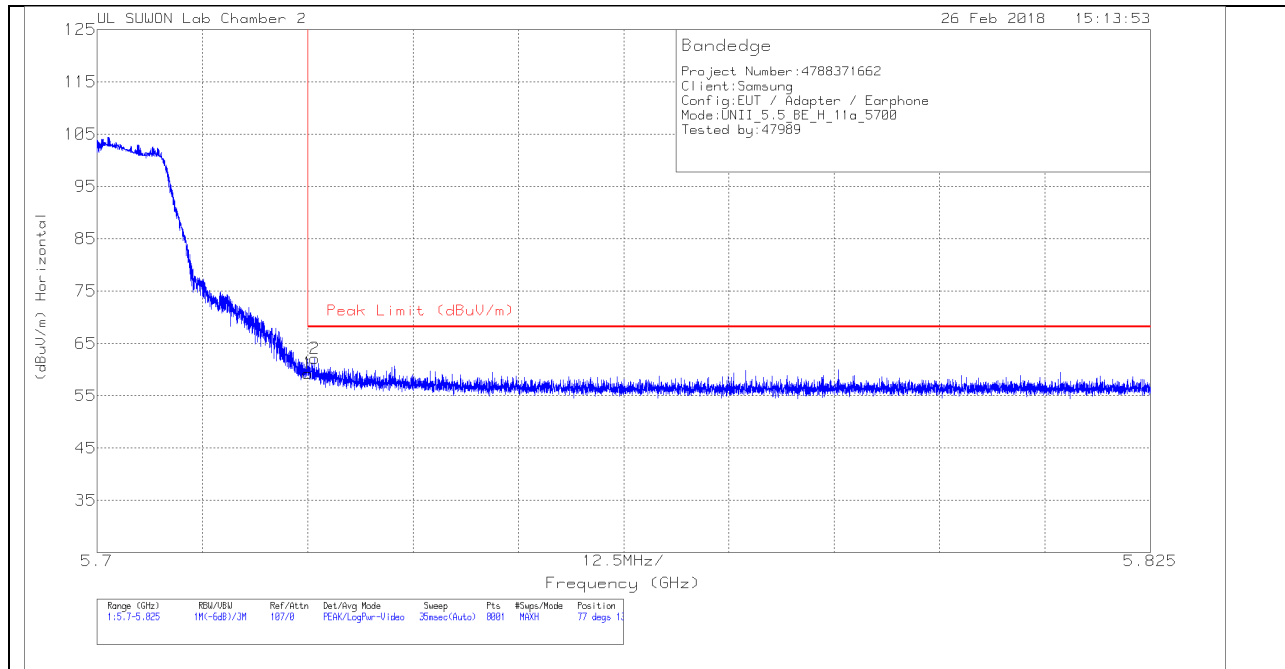

HORIZONTAL DATA

Trace Markers

Marker	Frequency (GHz)	Meter Reading (dBuV)	Det	170531_3117[001687 24]	10dB[dB]	DC Corr (dB)	Corrected Reading (dBuV/m)	Peak Limit (dBuV/m)	PK Margin (dB)	Azimuth (Degs)	Height (cm)	Polarity
1	5.725	39.37	Pk	34.4	-14.5	0	59.27	68.2	-8.93	77	130	H
2	5.726	42.19	Pk	34.4	-14.5	0	62.09	68.2	-6.11	77	130	H

Pk - Peak detector

VERTICAL PEAK AND AVERAGE PLOT

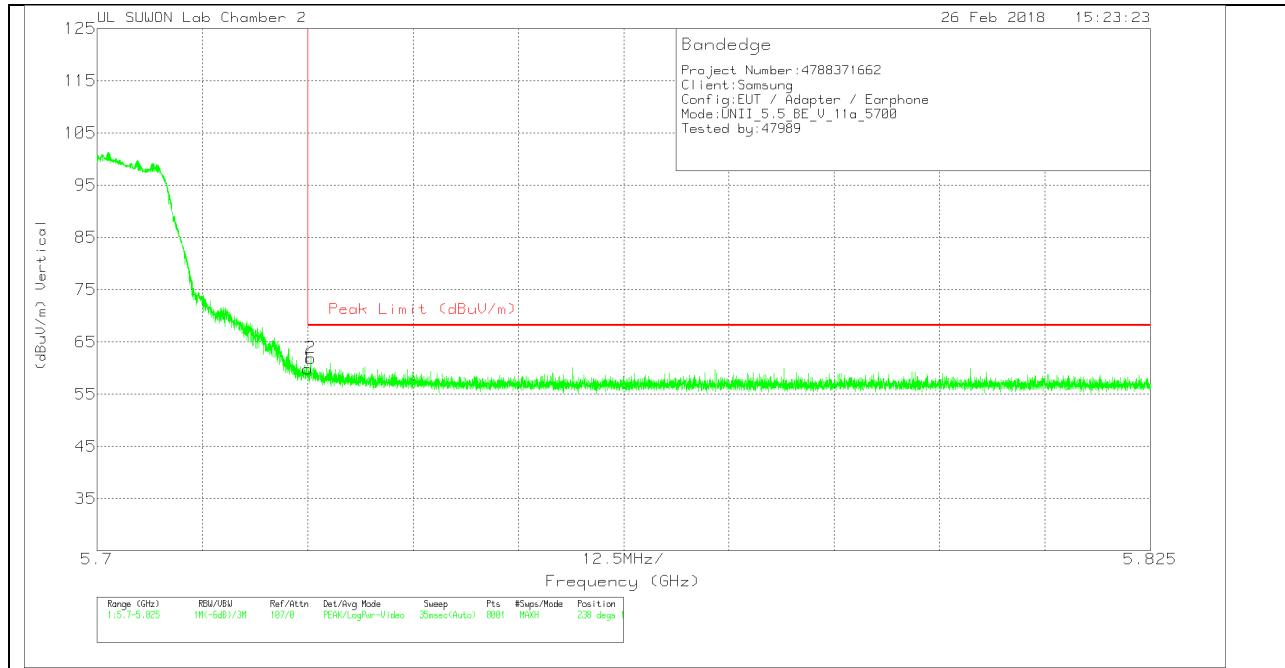

VERTICAL DATA

Trace Markers

Marker	Frequency (GHz)	Meter Reading (dBuV)	Det	170531_3117[001687 24]	10dB(dB)	DC Corr (dB)	Corrected Reading (dBuV/m)	Peak Limit (dBuV/m)	PK Margin (dB)	Azimuth (Degs)	Height (cm)	Polarity
1	5.725	39.99	Pk		34.4	-14.5	59.89	68.2	-8.31	238	113	V
2	5.725	42.04	Pk		34.4	-14.5	61.94	68.2	-6.26	238	113	V

* - indicates frequency in CFR47 Pt 15 / IC RSS-Restricted Band

Pk - Peak detector

HARMONICS AND SPURIOUS EMISSIONS

LOW CHANNEL HORIZONTAL

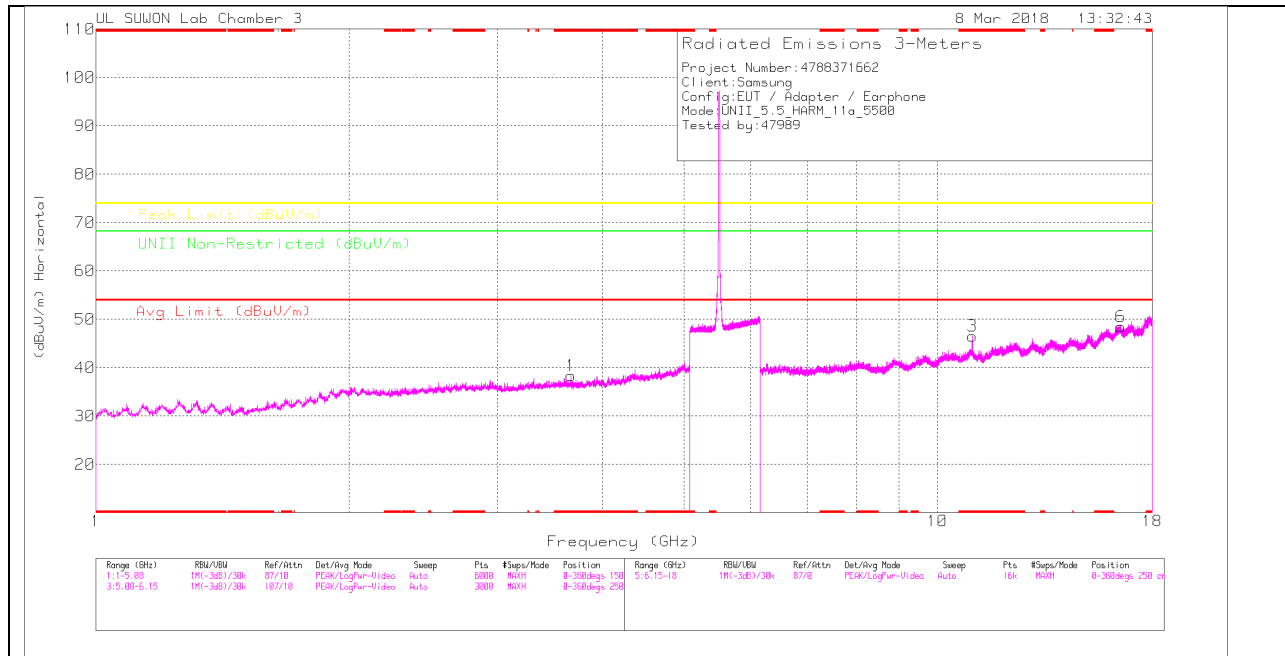

LOW CHANNEL VERTICAL

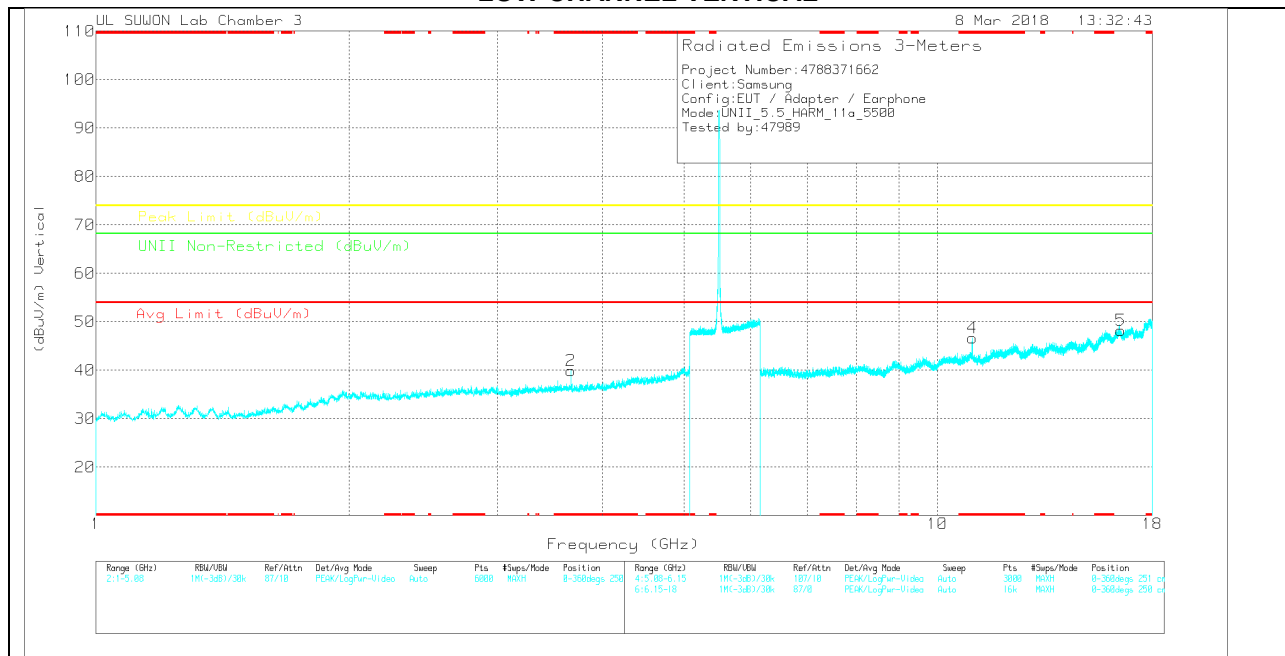

Note: Emission was scanned up to 40GHz; No emissions were detected above the noise floor which was at least 20dB below the specification limit.

LOW CHANNEL DATA

Trace Markers

Marker	Frequency (GHz)	Meter Reading (dBuV)	Det	3117(0020959)	5GHz_LF(dB)	DC Corr (dB)	Corrected Reading (dBuV/m)	Avg Limit (dBuV/m)	Margin (dB)	Peak Limit (dBuV/m)	Margin (dB)	Limit Non-Restricted (dBuV/m)	Margin (dB)	Altitude (Degs)	Height (cm)	Polarity
1	* 3.667	35.65	PK	33	-30.3	0	38.35	-	-	74	-35.65	-	-	0-360	250	H
2	* 3.667	37.2	PK	33	-30.3	0	39.9	-	-	74	-34.1	-	-	0-360	149	V
3	* 11.002	28.23	PK	37.8	-19.5	0	46.53	-	-	74	-27.47	-	-	0-360	250	H
6	16.517	24.44	PK	41.4	-17.4	0	48.44	-	-	-	-	68.2	-19.76	0-360	250	H
4	* 10.998	28.39	PK	37.8	-19.5	0	46.69	-	-	74	-27.31	-	-	0-360	250	V
5	16.513	24.19	PK	41.4	-17.4	0	48.19	-	-	-	-	68.2	-20.01	0-360	250	V

* - indicates frequency in CFR47 Pt 15 / IC RSS-Restricted Band
 PK – Peak detector

Radiated Emissions

Frequency (GHz)	Meter Reading (dBuV)	Det	3117(0020959)	5GHz_LF(dB)	DC Corr (dB)	Corrected Reading (dBuV/m)	Avg Limit (dBuV/m)	Margin (dB)	Peak Limit (dBuV/m)	Margin (dB)	Limit Non-Restricted (dBuV/m)	Margin (dB)	Altitude (Degs)	Height (cm)	Polarity
* 3.667	44.96	PK-U	33	-30.3	0	47.66	-	-	74	-26.34	-	-	9	179	H
* 3.667	34.95	ADR	33	-30.3	-14	37.79	54	-16.21	-	-	-	-	9	179	H
* 3.667	45.59	PK-U	33	-30.3	0	48.29	-	-	74	-25.71	-	-	23	181	V
* 3.667	36.99	ADR	33	-30.3	-14	39.83	54	-14.17	-	-	-	-	23	181	V
* 11.002	25.72	ADR	37.8	-19.5	-14	44.16	54	-9.84	-	-	-	-	330	236	V
* 10.999	25.57	ADR	37.8	-19.6	-14	43.91	54	-10.09	-	-	-	-	303	107	H
* 11.002	37.91	PK-U	37.8	-19.5	0	56.21	-	-	74	-17.79	-	-	330	236	V
* 10.997	37.63	PK-U	37.8	-19.6	0	55.83	-	-	74	-18.17	-	-	303	107	H

* - indicates frequency in CFR47 Pt 15 / IC RSS-Restricted Band
 PK-U - U-NII: Maximum Peak
 ADR - U-NII AD primary method, RMS average

MID CHANNEL HORIZONTAL

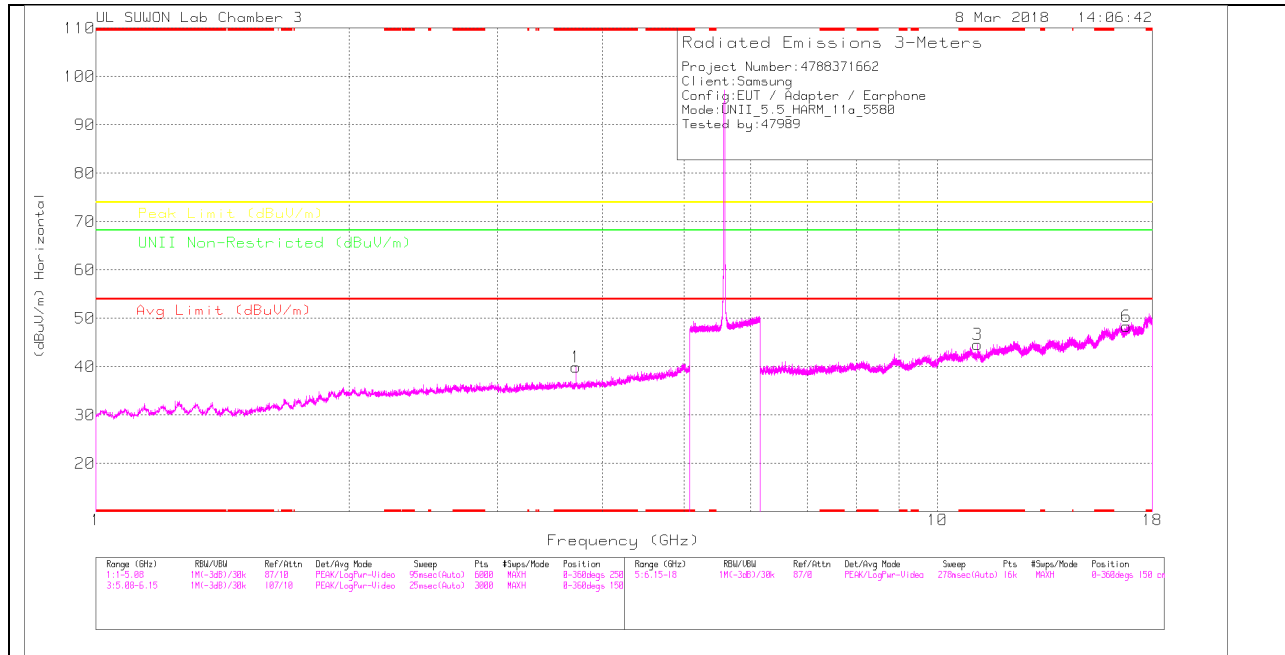

MID CHANNEL VERTICAL

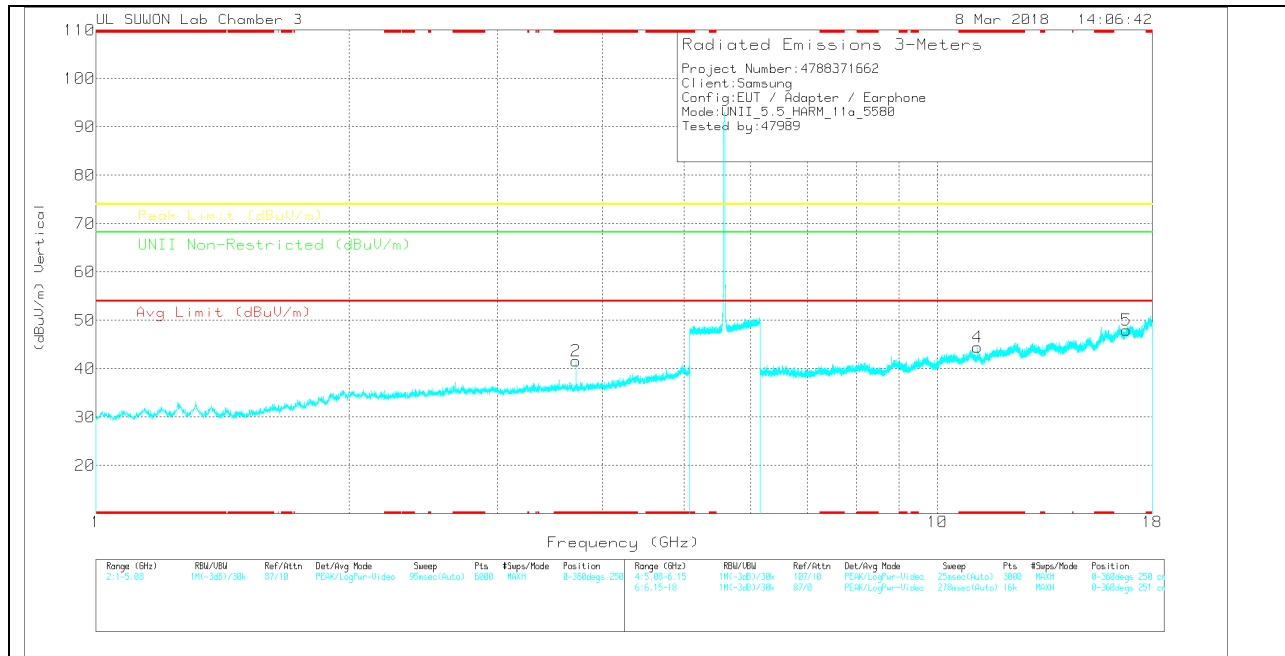

Note: Emission was scanned up to 40GHz; No emissions were detected above the noise floor which was at least 20dB below the specification limit.

MID CHANNEL DATA

Trace Markers

Marker	Frequency (GHz)	Meter Reading (dBuV)	Det	3117(0020959)	5GHz_LF(dB)	DC Corr (dB)	Corrected Reading (dBuV/m)	Avg Limit (dBuV/m)	Margin (dB)	Peak Limit (dBuV/m)	Margin (dB)	Limit Non-Restricted (dBuV/m)	Margin (dB)	Altitude (Degs)	Height (cm)	Polarity
1	* 3.72	37.31	PK	33	-30.4	0	39.91	-	-	74	-34.09	-	-	0-360	250	H
2	* 3.72	39.03	PK	33	-30.4	0	41.63	-	-	74	-32.37	-	-	0-360	149	V
3	* 11.16	26.45	PK	37.9	-19.8	0	44.55	-	-	74	-29.45	-	-	0-360	251	H
6	16.763	23.55	PK	41.5	-16.7	0	48.35	-	-	-	-	68.2	-19.85	0-360	251	H
4	* 11.157	26.32	PK	37.9	-19.7	0	44.52	-	-	74	-29.48	-	-	0-360	251	V
5	16.759	23.21	PK	41.5	-16.7	0	48.01	-	-	-	-	68.2	-20.19	0-360	251	V

* - indicates frequency in CFR47 Pt 15 / IC RSS-Restricted Band
 PK – Peak detector

Radiated Emissions

Frequency (GHz)	Meter Reading (dBuV)	Det	3117(0020959)	5GHz_LF(dB)	DC Corr (dB)	Corrected Reading (dBuV/m)	Avg Limit (dBuV/m)	Margin (dB)	Peak Limit (dBuV/m)	Margin (dB)	Limit Non-Restricted (dBuV/m)	Margin (dB)	Altitude (Degs)	Height (cm)	Polarity
* 3.72	45.57	PK-U	33	-30.4	0	48.17	-	-	74	-25.83	-	-	8	101	H
* 3.72	36.74	ADR	33	-30.4	-14	39.48	54	-14.52	-	-	-	-	8	101	H
* 3.72	46.04	PK-U	33	-30.4	0	48.64	-	-	74	-25.36	-	-	25	148	V
* 3.72	38.55	ADR	33	-30.4	-14	41.29	54	-12.71	-	-	-	-	25	148	V

* - indicates frequency in CFR47 Pt 15 / IC RSS-Restricted Band
 PK-U - U-NII: Maximum Peak
 ADR - U-NII AD primary method, RMS average

HIGH CHANNEL HORIZONTAL

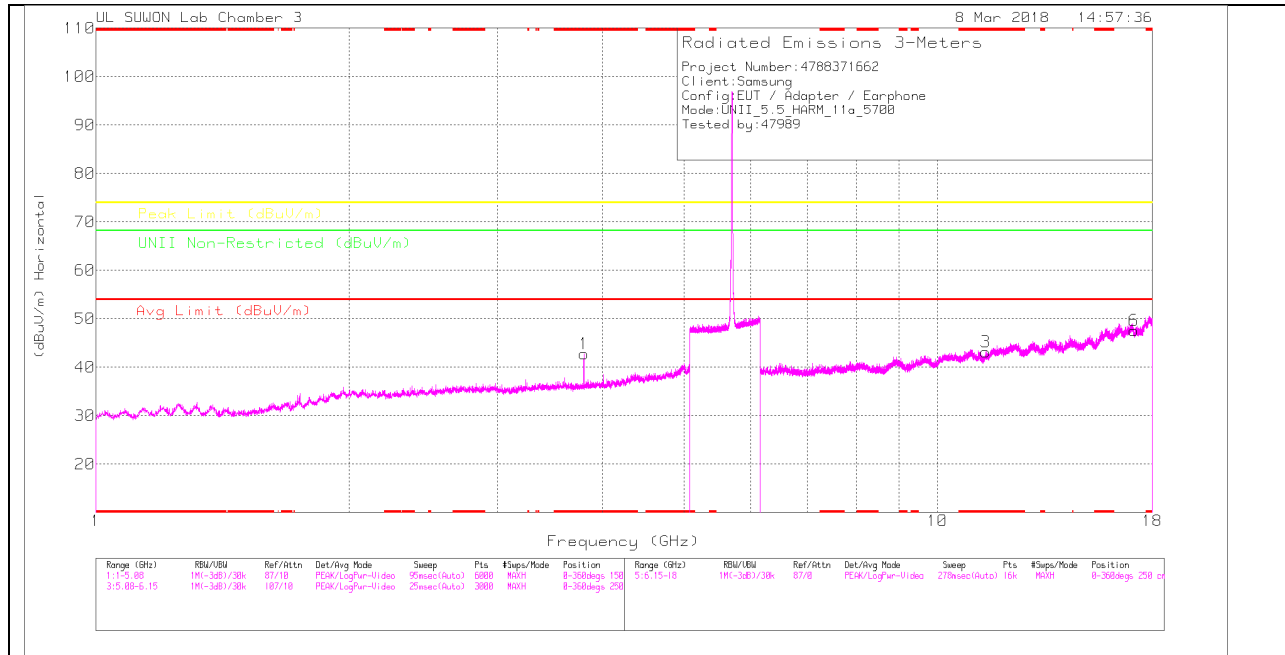

HIGH CHANNEL VERTICAL

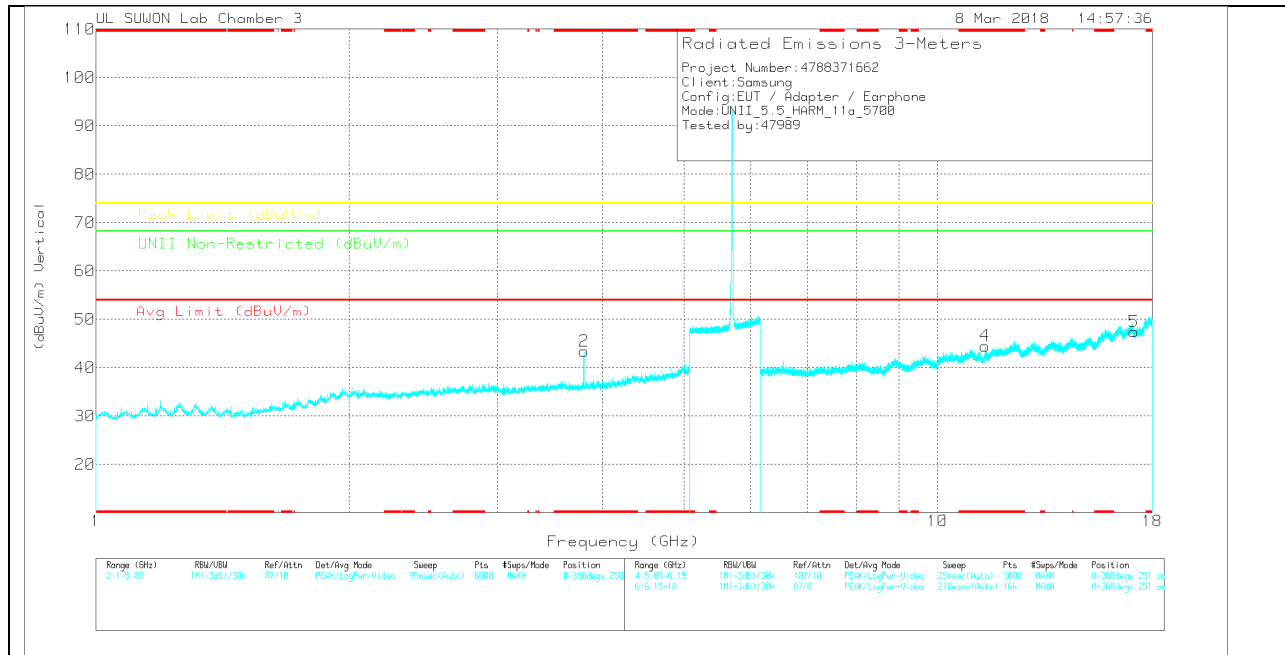

Note: Emission was scanned up to 40GHz; No emissions were detected above the noise floor which was at least 20dB below the specification limit.

HIGH CHANNEL DATA

Trace Markers

Marker	Frequency (GHz)	Meter Reading (dBuV)	Det	3117(0020959)	5GHz_LF(dB)	DC Corr (dB)	Corrected Reading (dBuV/m)	Avg Limit (dBuV/m)	Margin (dB)	Peak Limit (dBuV/m)	Margin (dB)	U/NII Non-Restricted (dBuV/m)	Margin (dB)	Azimuth (Degs)	Height (cm)	Polarity
1	* 3.8	39.98	PK	33	-30.2	0	42.78	-	-	74	-31.22	-	-	0-360	250	H
2	* 3.8	40.6	PK	33	-30.2	0	43.4	-	-	74	-30.6	-	-	0-360	149	V
3	* 11.404	24.73	PK	38	-19.6	0	43.13	-	-	74	-30.87	-	-	0-360	250	H
6	17.113	22.74	PK	41	-16.1	0	47.64	-	-	-	-	68.2	-20.56	0-360	150	H
4	* 11.398	26.23	PK	38	-19.7	0	44.53	-	-	74	-29.47	-	-	0-360	251	V
5	17.11	22.41	PK	41	-16	0	47.41	-	-	-	-	68.2	-20.79	0-360	251	V

* - indicates frequency in CFR47 Pt 15 / IC RSS-Restricted Band
 PK – Peak detector

Radiated Emissions

Frequency (GHz)	Meter Reading (dBuV)	Det	3117(0020959)	5GHz_LF(dB)	DC Corr (dB)	Corrected Reading (dBuV/m)	Avg Limit (dBuV/m)	Margin (dB)	Peak Limit (dBuV/m)	Margin (dB)	U/NII Non-Restricted (dBuV/m)	Margin (dB)	Azimuth (Degs)	Height (cm)	Polarity
* 3.8	46.57	PK-U	33	-30.2	0	49.37	-	-	74	-24.63	-	-	26	275	H
* 3.8	39.24	ADR	33	-30.2	.14	42.18	54	-11.82	-	-	-	-	26	275	H
* 3.8	46.81	PK-U	33	-30.2	0	49.61	-	-	74	-24.39	-	-	24	180	V
* 3.8	39.98	ADR	33	-30.2	.14	42.92	54	-11.08	-	-	-	-	24	180	V

* - indicates frequency in CFR47 Pt 15 / IC RSS-Restricted Band
 PK-U - U-NII: Maximum Peak
 ADR - U-NII AD primary method, RMS average

STRADDLE CHANNEL HORIZONTAL

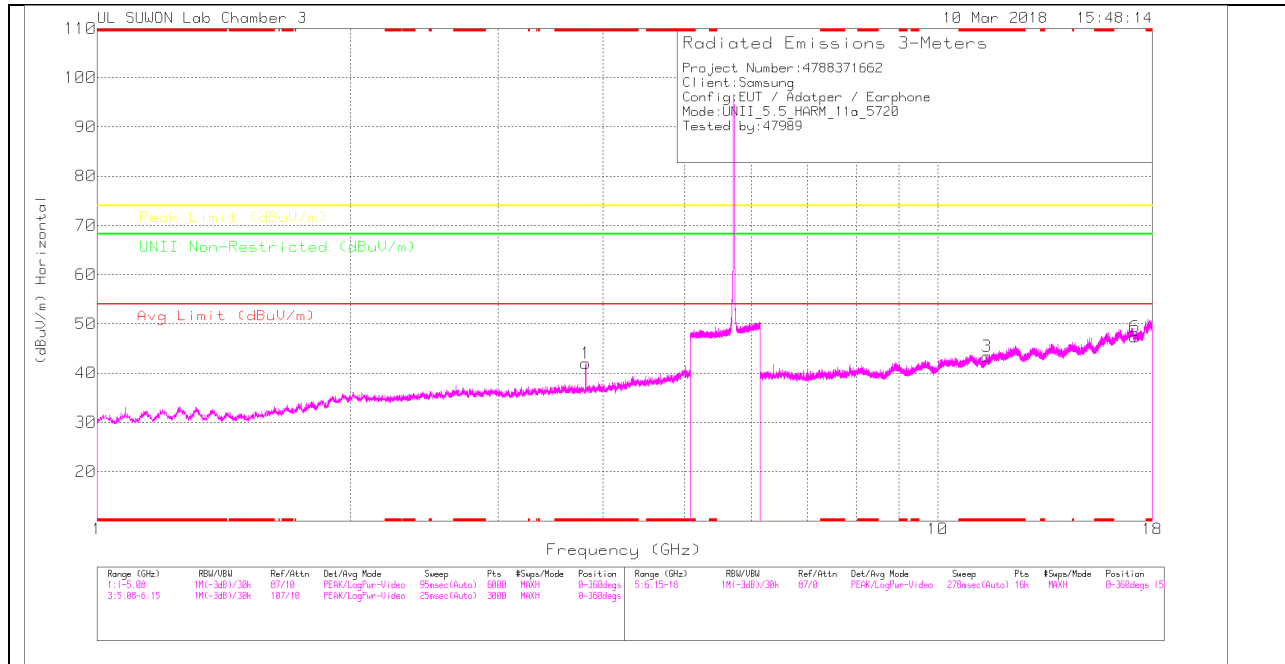

STRADDLE CHANNEL VERTICAL

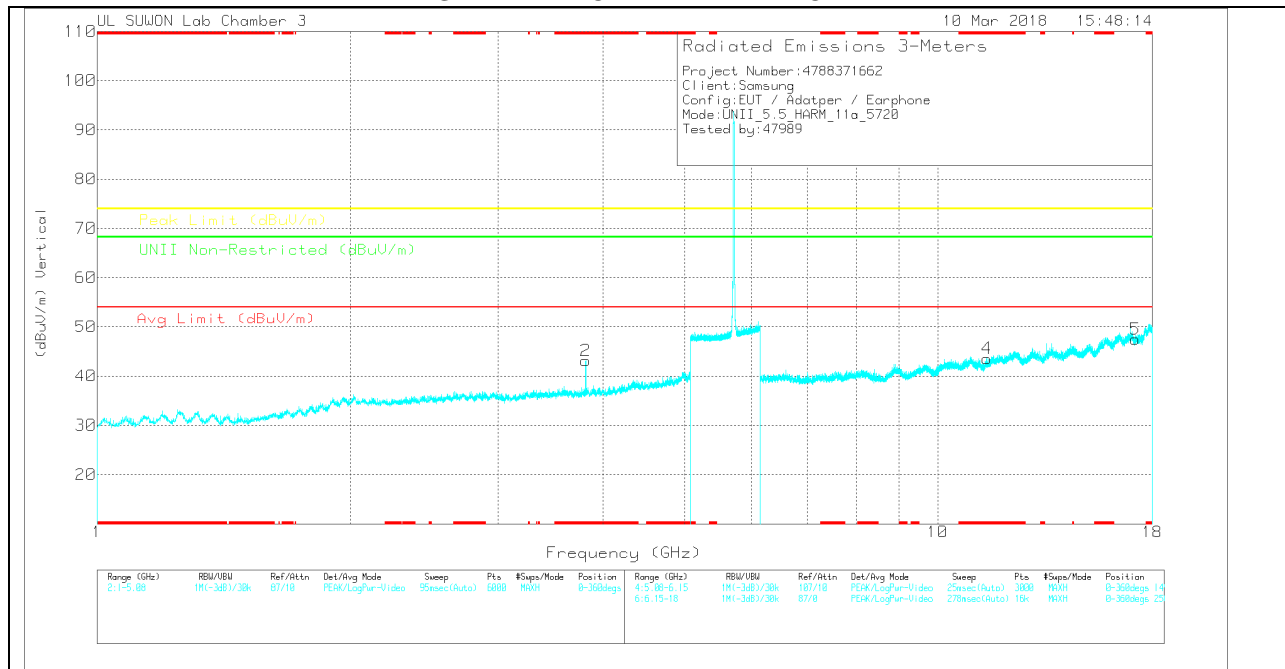

Note: Emission was scanned up to 40GHz; No emissions were detected above the noise floor which was at least 20dB below the specification limit.

STRADDLE CHANNEL DATA

Trace Markers

Marker	Frequency (GHz)	Meter Reading (dBuV)	Det	3117(0205959)	5GHz_LF(dB)	DC Corr (dB)	Corrected Reading (dBuV/m)	Ag Limit (dBuV/m)	Margin (dB)	Peak Limit (dBuV/m)	Margin (dB)	U-NII Non-Restricted (dBuV/m)	Margin (dB)	Azimuth (Degs)	Height (cm)	Polarity
1	* 3.814	39.09	PK	33.1	-30.2	0	41.99	-	-	74	-32.01	-	-	0-360	250	H
2	* 3.814	40.26	PK	33.1	-30.2	0	43.16	-	-	74	-30.84	-	-	0-360	250	V
3	* 11.444	24.9	PK	38	-19.5	0	43.4	-	-	74	-30.6	-	-	0-360	150	H
6	17.166	22.45	PK	40.9	-16	0	47.35	-	-	-	-	68.2	-20.85	0-360	250	H
4	* 11.446	25.06	PK	38	-19.5	0	43.56	-	-	74	-30.44	-	-	0-360	149	V
5	17.169	22.49	PK	40.9	-15.9	0	47.49	-	-	-	-	68.2	-20.71	0-360	250	V

* - indicates frequency in CFR47 Pt 15 / IC RSS-Restricted Band
 PK – Peak detector

Radiated Emissions

Frequency (GHz)	Meter Reading (dBuV)	Det	3117(0205959)	5GHz_LF(dB)	DC Corr (dB)	Corrected Reading (dBuV/m)	Ag Limit (dBuV/m)	Margin (dB)	Peak Limit (dBuV/m)	Margin (dB)	U-NII Non-Restricted (dBuV/m)	Margin (dB)	Azimuth (Degs)	Height (cm)	Polarity
* 3.814	46.22	PK-U	33.1	-30.2	0	49.12	-	-	74	-24.88	-	-	11	314	H
* 3.813	37.63	ADR	33.1	-30.2	.14	40.67	54	-13.33	-	-	-	-	11	314	H
* 3.813	48.15	PK-U	33.1	-30.2	0	51.05	-	-	74	-22.95	-	-	29	196	V
* 3.813	39.29	ADR	33.1	-30.2	.14	42.33	54	-11.67	-	-	-	-	29	195	V

* - indicates frequency in CFR47 Pt 15 / IC RSS-Restricted Band
 PK-U - U-NII: Maximum Peak
 ADR - U-NII AD primary method, RMS average

11.3.2. TX ABOVE 1GHz 802.11n HT20 MODE IN THE 5.5GHz BAND RESTRICTED BANDEDGE (LOW CHANNEL)

HORIZONTAL PEAK AND AVERAGE PLOT

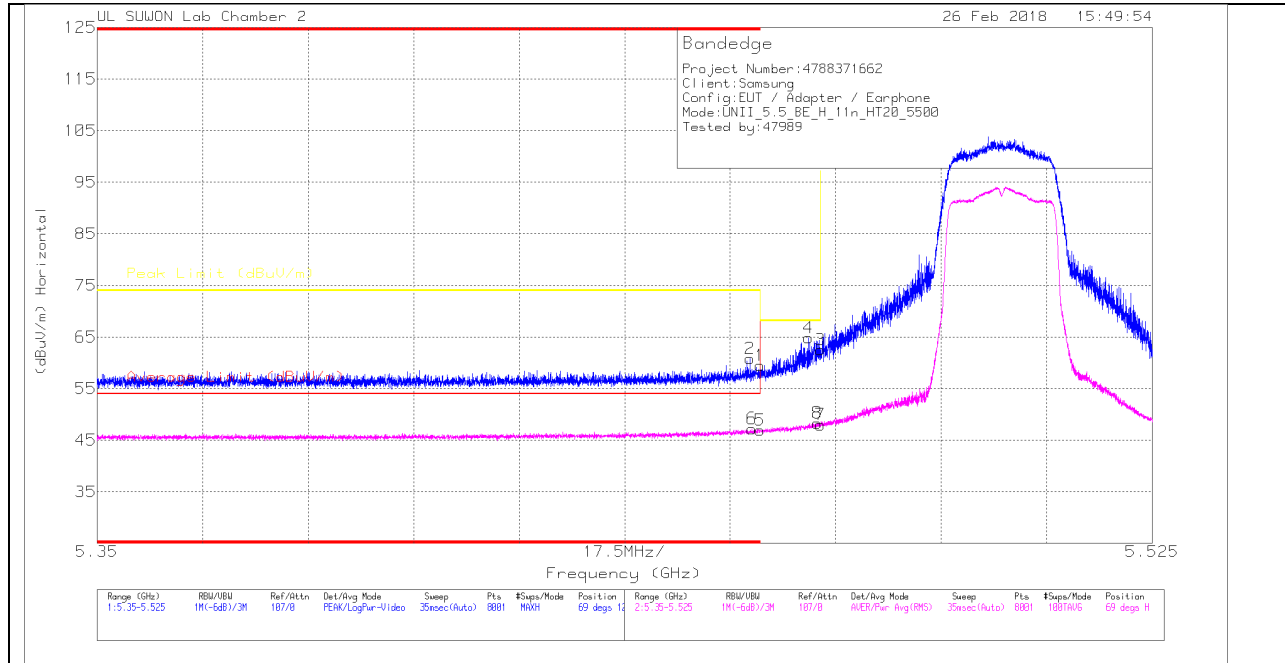

HORIZONTAL DATA

Trace Markers

Marker	Frequency (GHz)	Meter Reading (dBuV)	Det	170531_3117(00168724)	10dB(dB)	DC Corr (dB)	Corrected Reading (dBuV/m)	Average Limit (dBuV/m)	Margin (dB)	Peak Limit (dBuV/m)	PK Margin (dB)	Azimuth (Degs)	Height (cm)	Polarity
1	* 5.46	40.2	Pk	34.3	-15	0	59.5	-	-	74	-14.5	69	129	H
2	* 5.458	41.62	Pk	34.3	-15.1	0	60.82	-	-	74	-13.18	69	129	H
3	5.47	43.21	Pk	34.3	-15	0	62.51	-	-	68.2	-5.69	69	129	H
4	5.468	45.55	Pk	34.3	-15	0	64.85	-	-	68.2	-3.35	69	129	H
5	* 5.46	27.47	RMS	34.3	-15	-15	46.92	54	-7.08	-	-	69	129	H
6	* 5.459	27.88	RMS	34.3	-15.1	-15	47.23	54	-6.77	-	-	69	129	H

* - indicates frequency in CFR47 Pt 15 / IC RSS-Restricted Band

Pk - Peak detector

RMS - RMS detection

VERTICAL PEAK AND AVERAGE PLOT

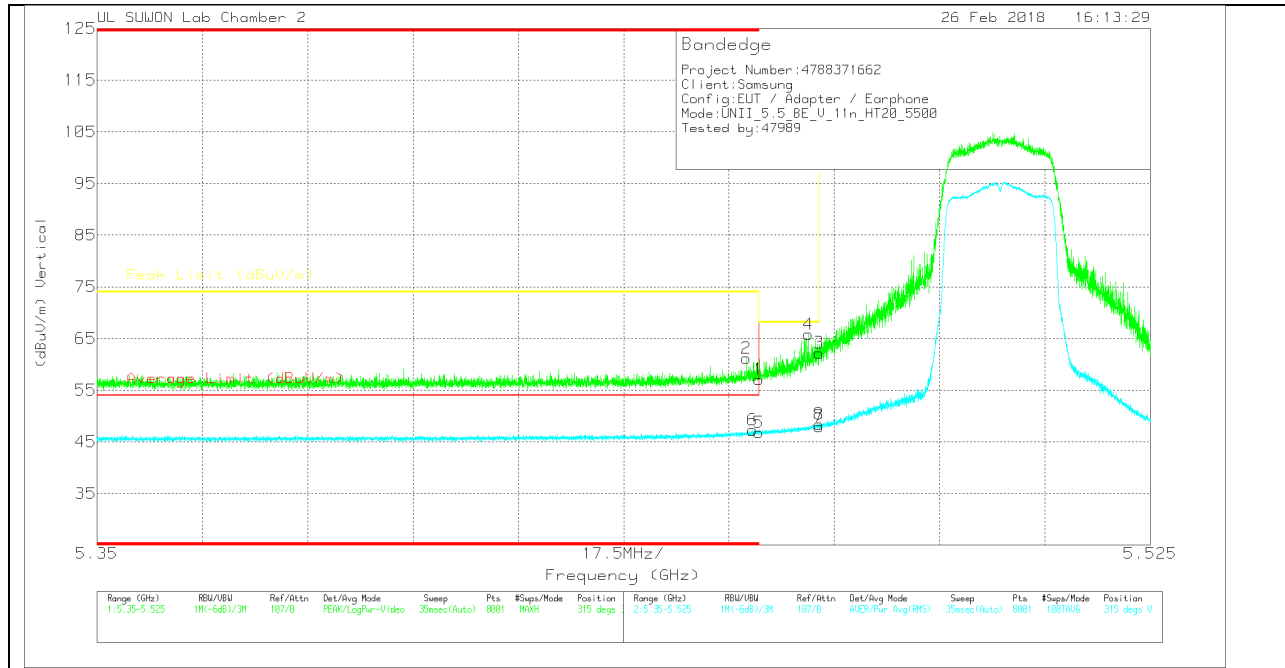

VERTICAL DATA

Trace Markers

Marker	Frequency (GHz)	Meter Reading (dBuV)	Det	170531_311700168724	10dB(dB)	DC Corr (dB)	Corrected Reading (dBuV/m)	Average Limit (dBuV/m)	Margin (dB)	Peak Limit (dBuV/m)	PK Margin (dB)	Azimuth (Degs)	Height (cm)	Polarity
1	* 5.46	37.79	Pk		34.3	-15	57.09	-	-	74	-16.91	315	384	V
2	* 5.458	41.99	Pk		34.3	-15.1	61.19	-	-	74	-12.81	315	384	V
3	5.47	42.91	Pk		34.3	-15	62.21	-	-	68.2	-5.99	315	384	V
4	5.468	46.53	Pk		34.3	-15	65.83	-	-	68.2	-2.37	315	384	V
5	* 5.46	27.35	RMS		34.3	-15	46.8	54	-7.2	-	-	315	384	V
6	* 5.459	27.83	RMS		34.3	-15	47.28	54	-6.72	-	-	315	384	V

* - indicates frequency in CFR47 Pt 15 / IC RSS-Restricted Band

Pk - Peak detector

RMS - RMS detection

AUTHORIZED BANDEDGE (HIGH CHANNEL)

HORIZONTAL PEAK AND AVERAGE PLOT

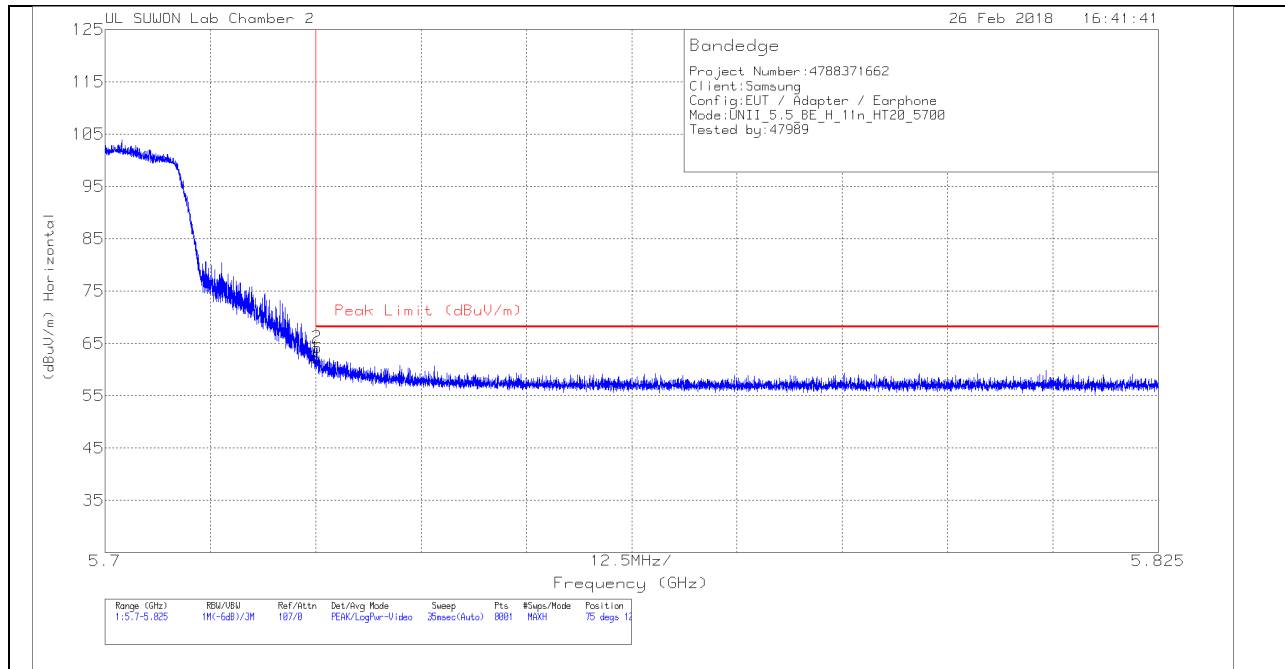

HORIZONTAL DATA

Trace Markers

Marker	Frequency (GHz)	Meter Reading (dBuV)	Det	170531_3117[001687_24]	10dB[dB]	DC Corr (dB)	Corrected Reading (dBuV/m)	Peak Limit (dBuV/m)	PK Margin (dB)	Azimuth (Degs)	Height (cm)	Polarity
1	5.725	42.32	Pk	34.4	-14.5	0	62.22	68.2	-5.98	75	128	H
2	5.725	44.31	Pk	34.4	-14.5	0	64.21	68.2	-3.99	75	128	H

Pk - Peak detector

VERTICAL PEAK AND AVERAGE PLOT

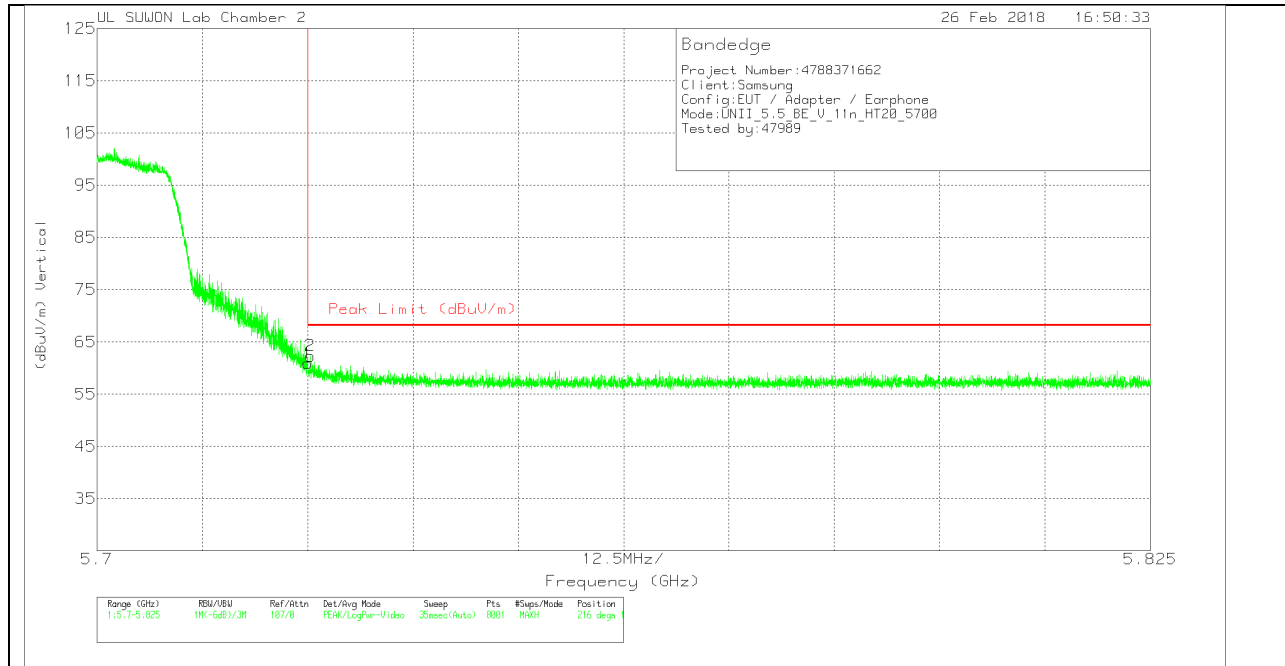

VERTICAL DATA

Trace Markers

Marker	Frequency (GHz)	Meter Reading (dBuV)	Det	170531_3117[001687 24]	10dB[dB]	DC Corr (dB)	Corrected Reading (dBuV/m)	Peak Limit (dBuV/m)	PK Margin (dB)	Azimuth (Degs)	Height (cm)	Polarity	
1	5.725	41	Pk		34.4	-14.5	0	60.9	68.2	-7.3	216	128	V
2	5.725	42.42	Pk		34.4	-14.5	0	62.32	68.2	-5.88	216	128	V

Pk - Peak detector

HARMONICS AND SPURIOUS EMISSIONS

LOW CHANNEL HORIZONTAL

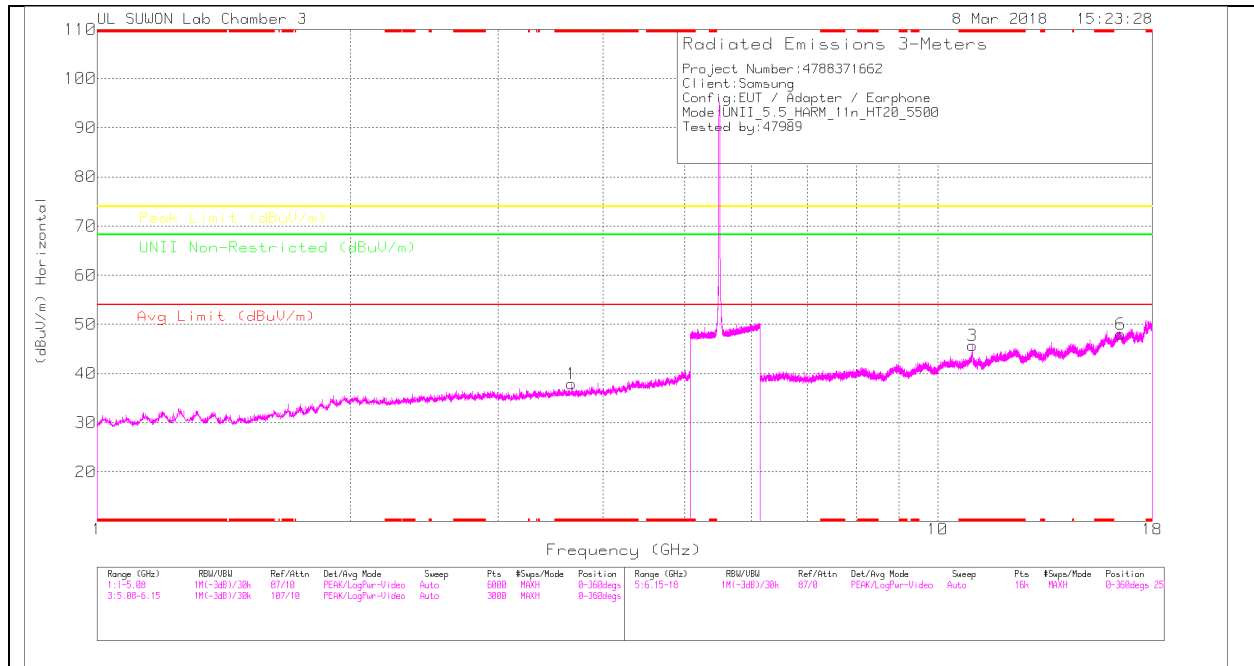

LOW CHANNEL VERTICAL

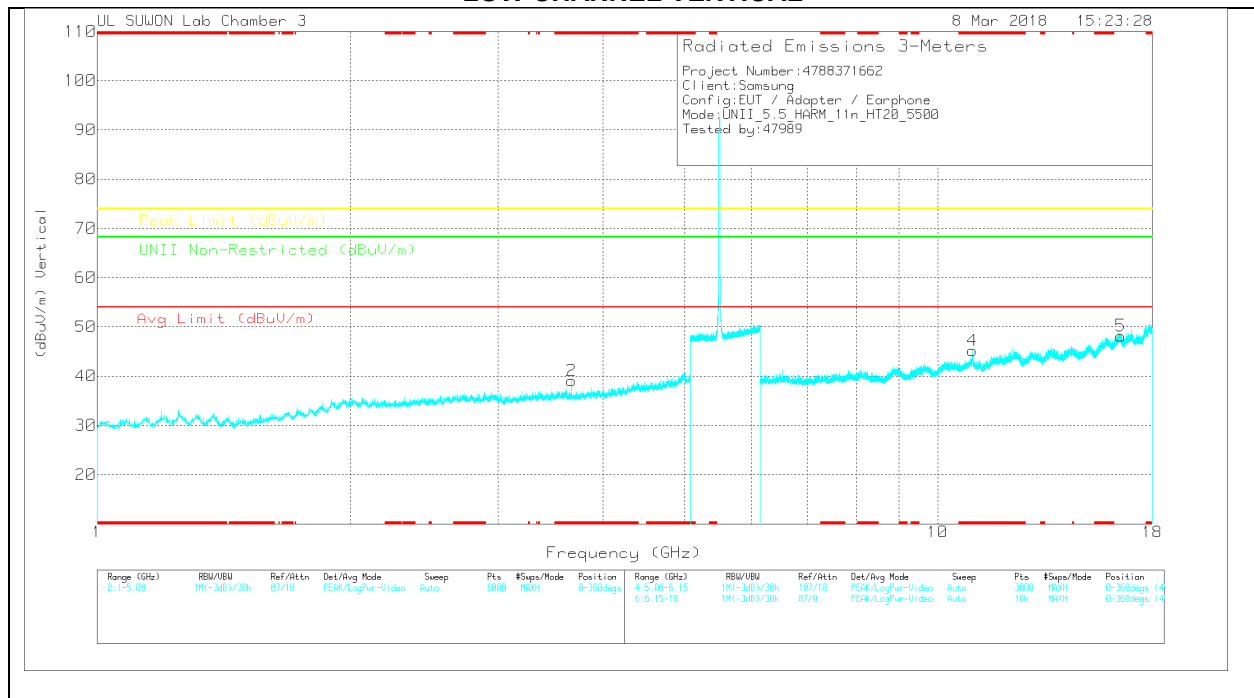

Note: Emission was scanned up to 40GHz; No emissions were detected above the noise floor which was at least 20dB below the specification limit.

LOW CHANNEL DATA

Trace Markers

Marker	Frequency (GHz)	Meter Reading (dBuV)	Det	3117(0020959)	5GHz_LF(dB)	DC Corr (dB)	Corrected Reading (dBuV/m)	Avg Limit (dBuV/m)	Margin (dB)	Peak Limit (dBuV/m)	Margin (dB)	U/NII Non-Restricted (dBuV/m)	Margin (dB)	Azimuth (Degs)	Height (cm)	Polarity
1	* 3.667	35.22	PK	33	-30.3	0	37.92	-	-	74	-36.08	-	-	0-360	150	H
2	* 3.667	36.36	PK	33	-30.3	0	39.06	-	-	74	-34.94	-	-	0-360	149	V
3	* 11.004	27.38	PK	37.8	-19.5	0	45.68	-	-	74	-28.32	-	-	0-360	250	H
6	16.511	24	PK	41.4	-17.4	0	48	-	-	-	-	68.2	-20.2	0-360	250	H
4	* 10.998	26.98	PK	37.8	-19.6	0	45.18	-	-	74	-28.82	-	-	0-360	250	V
5	16.508	24.16	PK	41.4	-17.4	0	48.16	-	-	-	-	68.2	-20.04	0-360	149	V

* - indicates frequency in CFR47 Pt 15 / IC RSS-Restricted Band
 PK – Peak detector

Radiated Emissions

Frequency (GHz)	Meter Reading (dBuV)	Det	3117(0020959)	5GHz_LF(dB)	DC Corr (dB)	Corrected Reading (dBuV/m)	Avg Limit (dBuV/m)	Margin (dB)	Peak Limit (dBuV/m)	Margin (dB)	U/NII Non-Restricted (dBuV/m)	Margin (dB)	Azimuth (Degs)	Height (cm)	Polarity
* 3.667	45.22	PK-U	33	-30.3	0	47.92	-	-	74	-26.08	-	-	169	258	V
* 3.667	34.53	ADR	33	-30.3	.15	37.38	54	-16.62	-	-	-	-	169	258	V
* 3.667	44.32	PK-U	33	-30.3	0	47.02	-	-	74	-26.98	-	-	330	393	H
* 3.667	33.98	ADR	33	-30.3	.15	36.83	54	-17.17	-	-	-	-	330	393	H
* 11.002	25.65	ADR	37.8	-19.5	.15	44.1	54	-9.9	-	-	-	-	247	220	H
* 11.002	24.54	ADR	37.8	-19.5	.15	42.99	54	-11.01	-	-	-	-	208	198	V
* 11.001	38.81	PK-U	37.8	-19.5	0	57.11	-	-	74	-16.89	-	-	247	220	H
* 11.002	37.08	PK-U	37.8	-19.5	0	55.38	-	-	74	-18.62	-	-	208	198	V

* - indicates frequency in CFR47 Pt 15 / IC RSS-Restricted Band
 PK-U - U-NII: Maximum Peak
 ADR - U-NII AD primary method, RMS average

MID CHANNEL HORIZONTAL

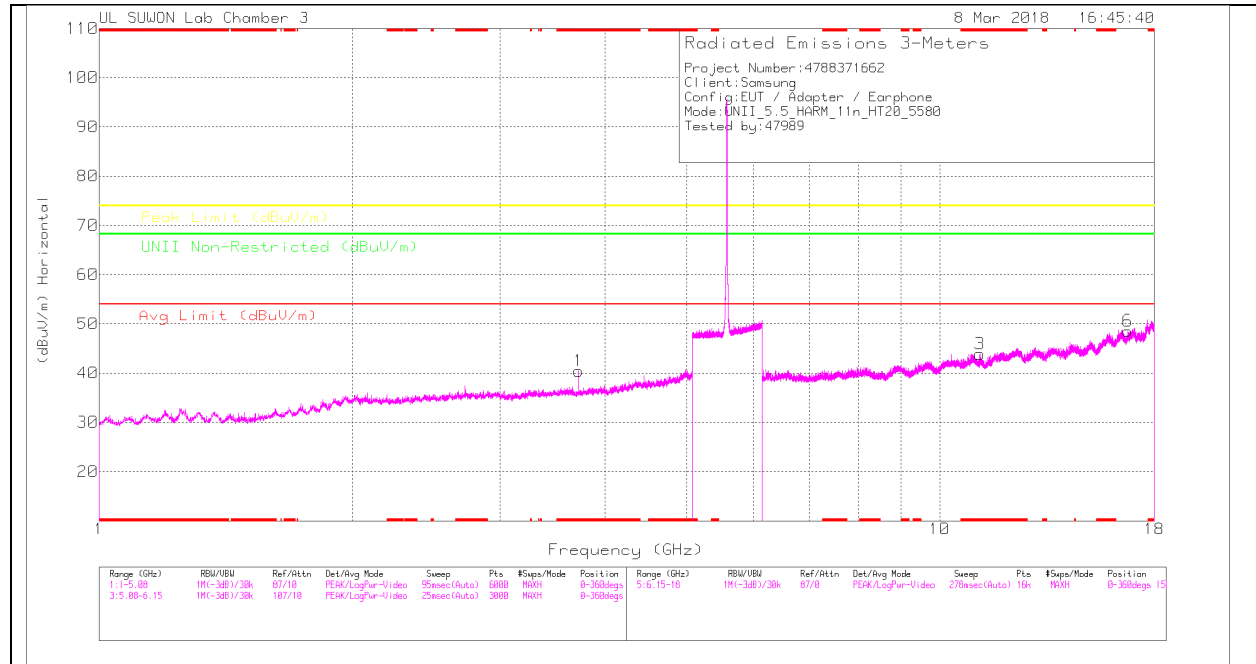

MID CHANNEL VERTICAL

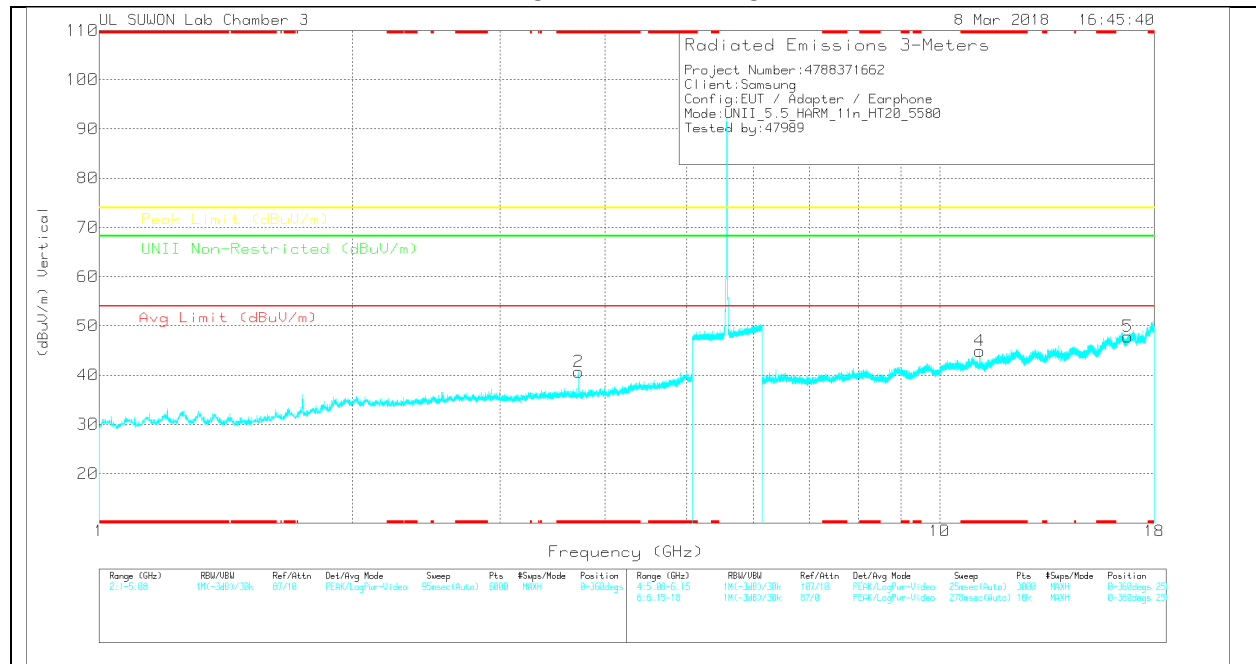

Note: Emission was scanned up to 40GHz; No emissions were detected above the noise floor which was at least 20dB below the specification limit.

MID CHANNEL DATA

Trace Markers

Marker	Frequency (GHz)	Meter Reading (dBuV)	Det	3117(0205959)	SGHz_LF[dB]	DC Corr (dB)	Corrected Reading (dBuV/m)	Aug Limit (dBuV/m)	Margin (dB)	Peak Limit (dBuV/m)	Margin (dB)	UNII Non-Restricted (dBuV/m)	Margin (dB)	Azimuth (Degs)	Height (cm)	Polarity
1	* 3.72	37.83	PK	33	-30.4	0	40.43	-	-	74	-33.57	-	-	0-360	250	H
2	* 3.72	38.08	PK	33	-30.4	0	40.68	-	-	74	-33.32	-	-	0-360	149	V
3	* 11.162	25.77	PK	37.9	-19.8	0	43.87	-	-	74	-30.13	-	-	0-360	250	H
6	16.745	23.95	PK	41.5	-16.9	0	48.55	-	-	-	-	68.2	-19.65	0-360	150	H
4	* 11.161	26.69	PK	37.9	-19.7	0	44.89	-	-	74	-29.11	-	-	0-360	250	V
5	16.739	23.23	PK	41.5	-16.9	0	47.83	-	-	-	-	68.2	-20.37	0-360	149	V

* - indicates frequency in CFR47 Pt 15 / IC RSS-Restricted Band
 PK – Peak detector

Radiated Emissions

Frequency (GHz)	Meter Reading (dBuV)	Det	3117(0205959)	SGHz_LF[dB]	DC Corr (dB)	Corrected Reading (dBuV/m)	Aug Limit (dBuV/m)	Margin (dB)	Peak Limit (dBuV/m)	Margin (dB)	UNII Non-Restricted (dBuV/m)	Margin (dB)	Azimuth (Degs)	Height (cm)	Polarity
* 3.72	45.43	PK-U	33	-30.4	0	48.03	-	-	74	-25.97	-	-	4	357	H
* 3.72	36.52	ADR	33	-30.4	.15	39.27	54	-14.73	-	-	-	-	4	357	H
* 3.72	46.09	PK-U	33	-30.4	0	48.69	-	-	74	-25.31	-	-	24	215	V
* 3.72	38.27	ADR	33	-30.4	.15	41.02	54	-12.98	-	-	-	-	24	215	V
* 11.16	24.3	ADR	37.9	-19.7	.15	42.65	54	-11.35	-	-	-	-	180	192	V
* 11.162	24.94	ADR	37.9	-19.8	.15	43.19	54	-10.81	-	-	-	-	249	211	H
* 11.159	36.3	PK-U	37.9	-19.8	0	54.4	-	-	74	-19.6	-	-	180	192	V
* 11.162	37.15	PK-U	37.9	-19.8	0	55.25	-	-	74	-18.75	-	-	249	211	H

* - indicates frequency in CFR47 Pt 15 / IC RSS-Restricted Band
 PK-U - U-NII: Maximum Peak
 ADR - U-NII AD primary method, RMS average

HIGH CHANNEL HORIZONTAL

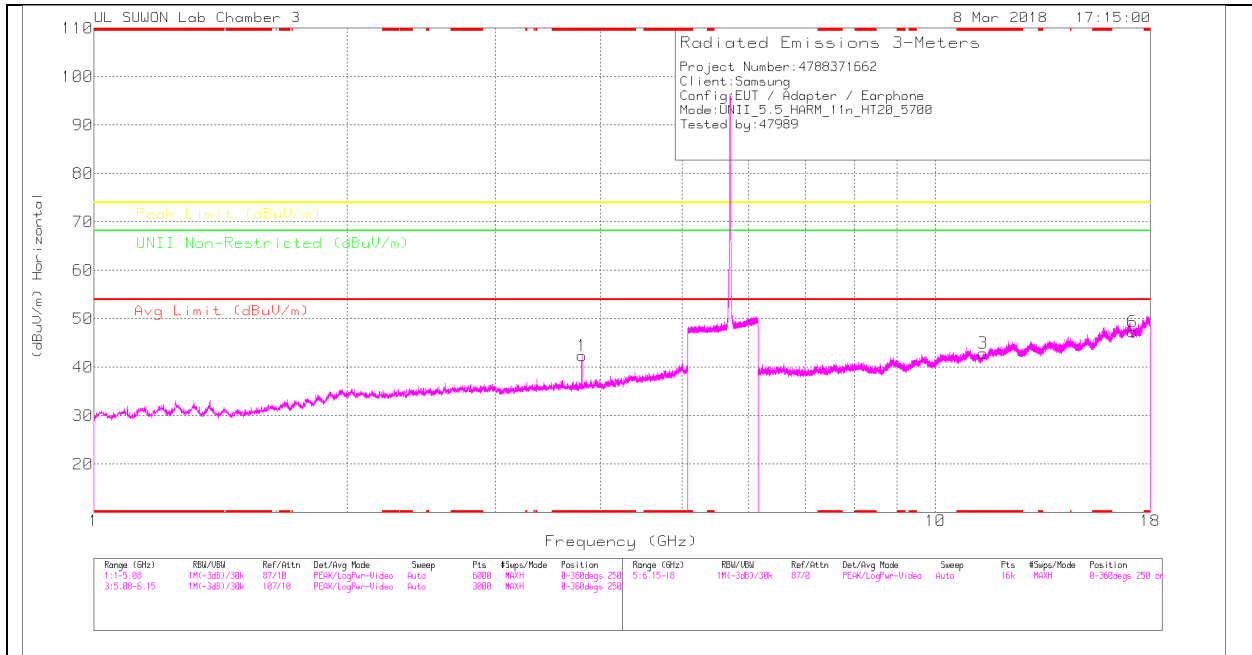

HIGH CHANNEL VERTICAL

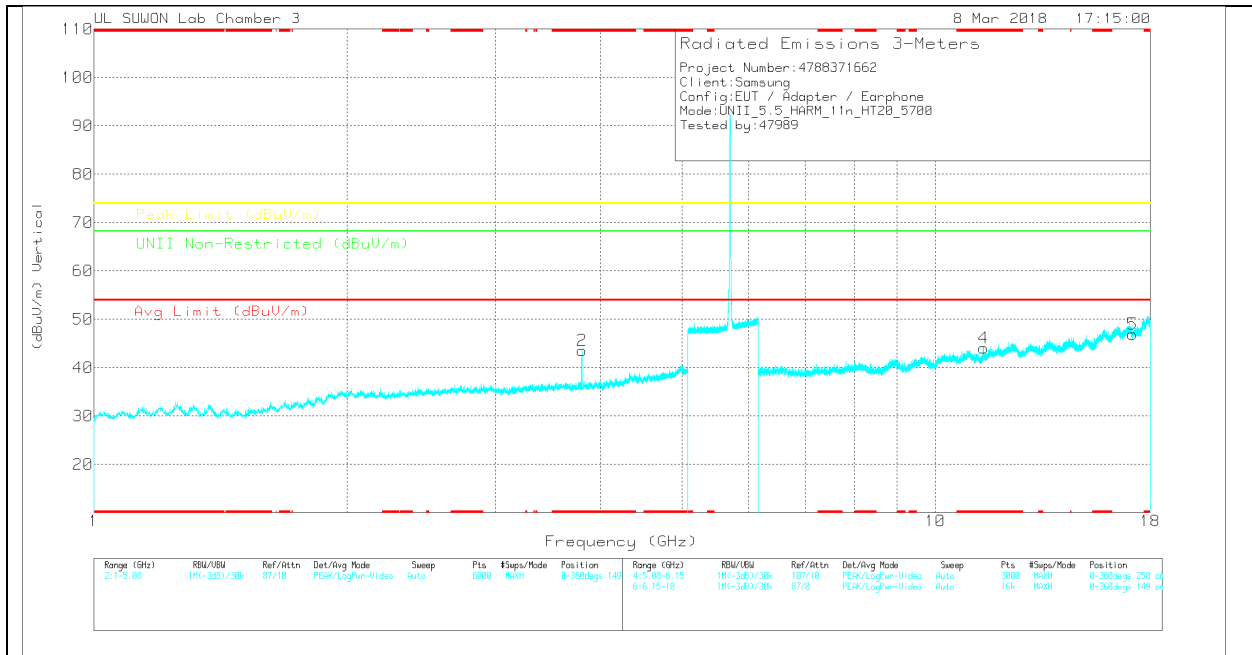

Note: Emission was scanned up to 40GHz; No emissions were detected above the noise floor which was at least 20dB below the specification limit.

HIGH CHANNEL DATA

Trace Markers

Marker	Frequency (GHz)	Meter Reading (dBuV)	Det	3117(02029959)	5GHz_LF(dB)	DC Corr (dB)	Corrected Reading (dBuV/m)	Avg Limit (dBuV/m)	Margin (dB)	Peak Limit (dBuV/m)	Margin (dB)	URL Non-Restricted (dBuV/m)	Margin (dB)	Azimuth (Degs)	Height (cm)	Polarity
1	* 3.8	39.53	PK	33	-30.2	0	42.33	-	-	74	-31.67	-	-	0-360	250	H
2	* 3.8	40.77	PK	33	-30.2	0	43.57	-	-	74	-30.43	-	-	0-360	250	V
3	* 11.398	24.59	PK	38	-19.7	0	42.89	-	-	74	-31.11	-	-	0-360	250	H
6	17.141	22.53	PK	40.9	-16.1	0	47.33	-	-	-	-	68.2	-20.87	0-360	150	H
4	* 11.404	25.65	PK	38	-19.6	0	44.05	-	-	74	-29.95	-	-	0-360	250	V
5	17.152	22.16	PK	40.9	-16.1	0	46.96	-	-	-	-	68.2	-21.24	0-360	149	V

* - indicates frequency in CFR47 Pt 15 / IC RSS-Restricted Band
 PK – Peak detector

Radiated Emissions

Frequency (GHz)	Meter Reading (dBuV)	Det	3117(02029959)	5GHz_LF(dB)	DC Corr (dB)	Corrected Reading (dBuV/m)	Avg Limit (dBuV/m)	Margin (dB)	Peak Limit (dBuV/m)	Margin (dB)	URL Non-Restricted (dBuV/m)	Margin (dB)	Azimuth (Degs)	Height (cm)	Polarity
* 3.8	46.81	PK-U	33	-30.2	0	49.61	-	-	74	-24.39	-	-	31	266	H
* 3.8	40.13	ADR	33	-30.2	.15	43.08	54	-10.92	-	-	-	-	31	266	H
* 3.8	47.44	PK-U	33	-30.2	0	50.24	-	-	74	-23.76	-	-	26	182	V
* 3.8	40.84	ADR	33	-30.2	.15	43.79	54	-10.21	-	-	-	-	26	182	V

* - indicates frequency in CFR47 Pt 15 / IC RSS-Restricted Band
 PK-U - U-NII: Maximum Peak
 ADR - U-NII AD primary method, RMS average

STRADDLE CHANNEL HORIZONTAL

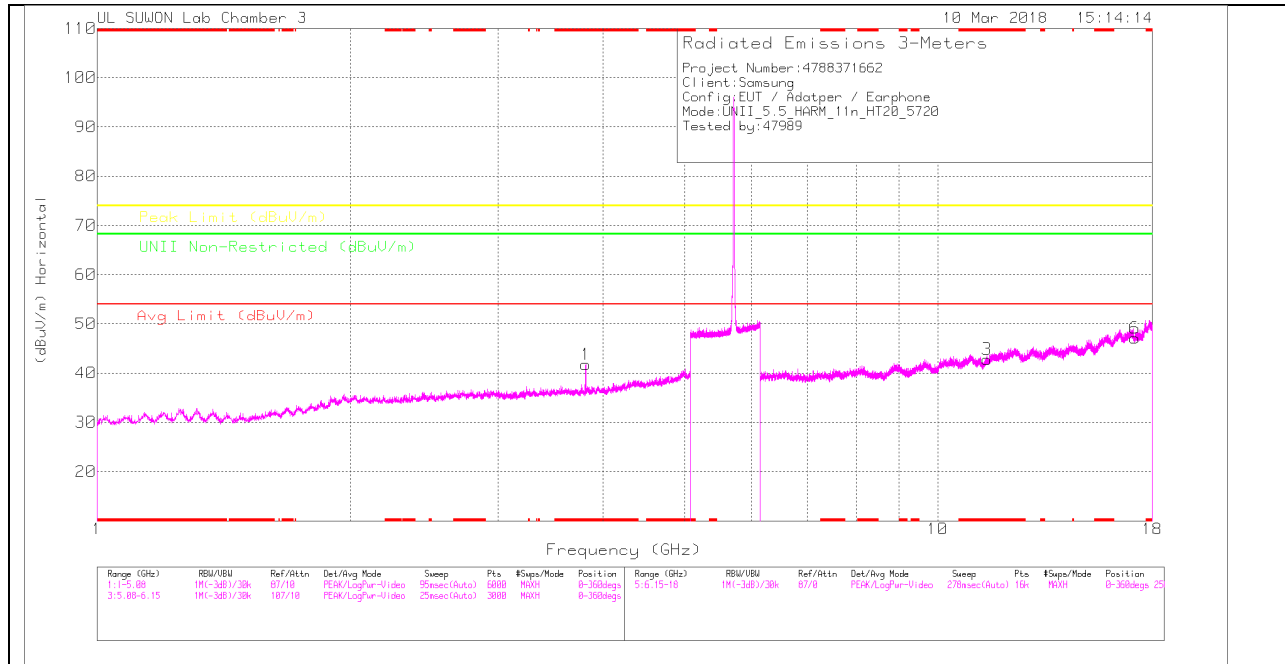

STRADDLE CHANNEL VERTICAL

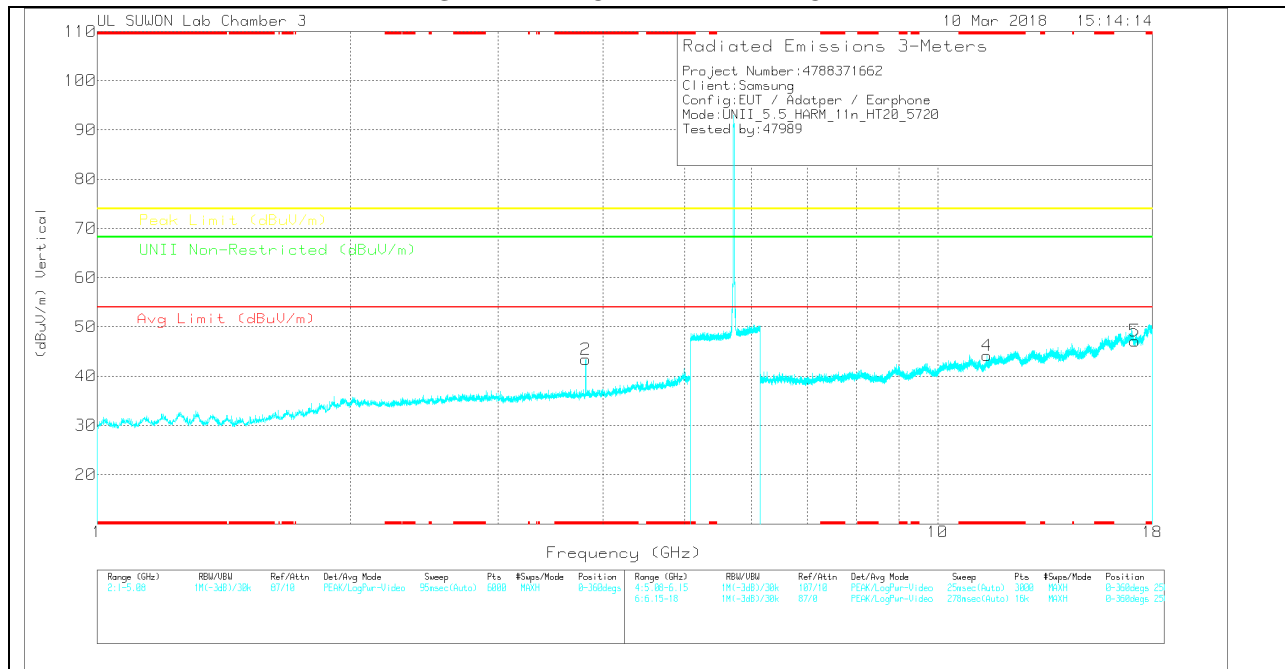

Note: Emission was scanned up to 40GHz; No emissions were detected above the noise floor which was at least 20dB below the specification limit.

STRADDLE CHANNEL DATA

Trace Markers

Marker	Frequency (GHz)	Meter Reading (dBuV)	Det	3117(02020959)	5GHz_LP(dB)	DC Corr (dB)	Corrected Reading (dBuV/m)	Avg Limit (dBuV/m)	Margin (dB)	Peak Limit (dBuV/m)	Margin (dB)	U/NII Non-Restricted (dBuV/m)	Margin (dB)	Azimuth (Degs)	Height (cm)	Polarity
1	* 3.814	38.82	PK	33.1	-30.2	0	41.72	-	-	74	-32.28	-	-	0-360	250	H
2	* 3.814	40.52	PK	33.1	-30.2	0	43.42	-	-	74	-30.58	-	-	0-360	149	V
3	* 11.442	24.29	PK	38	-19.5	0	42.79	-	-	74	-31.21	-	-	0-360	150	H
6	17.162	22.29	PK	40.9	-16.1	0	47.09	-	-	-	-	68.2	-21.11	0-360	150	H
4	* 11.44	25.74	PK	38	-19.6	0	44.14	-	-	74	-29.86	-	-	0-360	250	V
5	17.163	22.24	PK	40.9	-16	0	47.14	-	-	-	-	68.2	-21.06	0-360	250	V

* - indicates frequency in CFR47 Pt 15 / IC RSS-Restricted Band
 PK – Peak detector

Radiated Emissions

Frequency (GHz)	Meter Reading (dBuV)	Det	3117(02020959)	5GHz_LP(dB)	DC Corr (dB)	Corrected Reading (dBuV/m)	Avg Limit (dBuV/m)	Margin (dB)	Peak Limit (dBuV/m)	Margin (dB)	U/NII Non-Restricted (dBuV/m)	Margin (dB)	Azimuth (Degs)	Height (cm)	Polarity
* 3.814	46.13	PK-U	33.1	-30.2	0	49.03	-	-	74	-24.97	-	-	6	316	H
* 3.813	37.7	ADR	33.1	-30.2	.15	40.75	54	-13.25	-	-	-	-	6	316	H
* 3.813	46.84	PK-U	33.1	-30.2	0	49.74	-	-	74	-24.26	-	-	26	181	V
* 3.813	40.23	ADR	33.1	-30.2	.15	43.28	54	-10.72	-	-	-	-	26	181	V

* - indicates frequency in CFR47 Pt 15 / IC RSS-Restricted Band
 PK-U - U-NII: Maximum Peak
 ADR - U-NII AD primary method, RMS average

11.3.3. TX ABOVE 1GHz 802.11n HT40 MODE IN THE 5.5GHz BAND RESTRICTED BANDEDGE (LOW CHANNEL)

HORIZONTAL PEAK AND AVERAGE PLOT

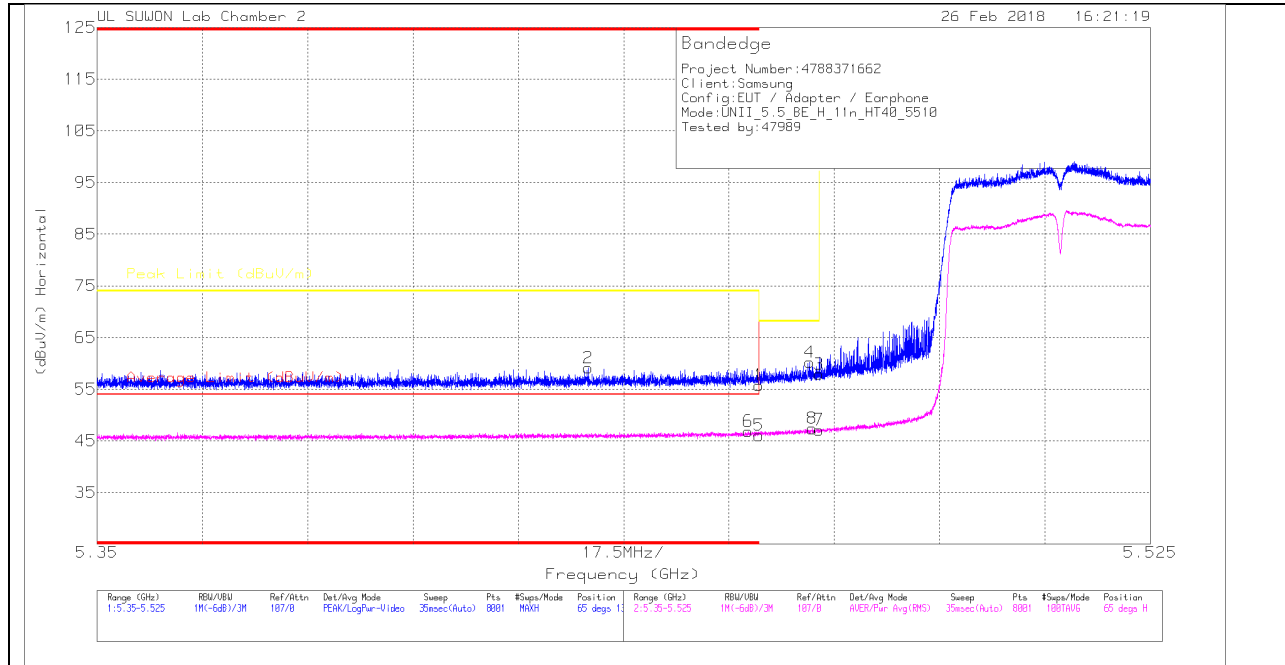

HORIZONTAL DATA

Trace Markers

Marker	Frequency (GHz)	Meter Reading (dBuV)	Det	170531_3117(00168724)	10dB(dB)	DC Corr (dB)	Corrected Reading (dBuV/m)	Average Limit (dBuV/m)	Margin (dB)	Peak Limit (dBuV/m)	PK Margin (dB)	Azimuth (Degs)	Height (cm)	Polarity
1	* 5.46	36.47	Pk	34.3	-15	0	55.77	-	-	74	-18.23	65	133	H
2	* 5.432	39.91	Pk	34.3	-15.1	0	59.11	-	-	74	-14.89	65	133	H
3	5.47	38.61	Pk	34.3	-15	0	57.91	-	-	68.2	-10.29	65	133	H
4	5.468	40.91	Pk	34.3	-15	0	60.21	-	-	68.2	-7.99	65	133	H
5	* 5.46	26.46	RMS	34.3	-15	.3	46.06	54	-7.94	-	-	65	133	H
6	* 5.458	27.35	RMS	34.3	-15.1	.3	46.85	54	-7.15	-	-	65	133	H

* - indicates frequency in CFR47 Pt 15 / IC RSS-Restricted Band

Pk - Peak detector

RMS - RMS detection

VERTICAL PEAK AND AVERAGE PLOT

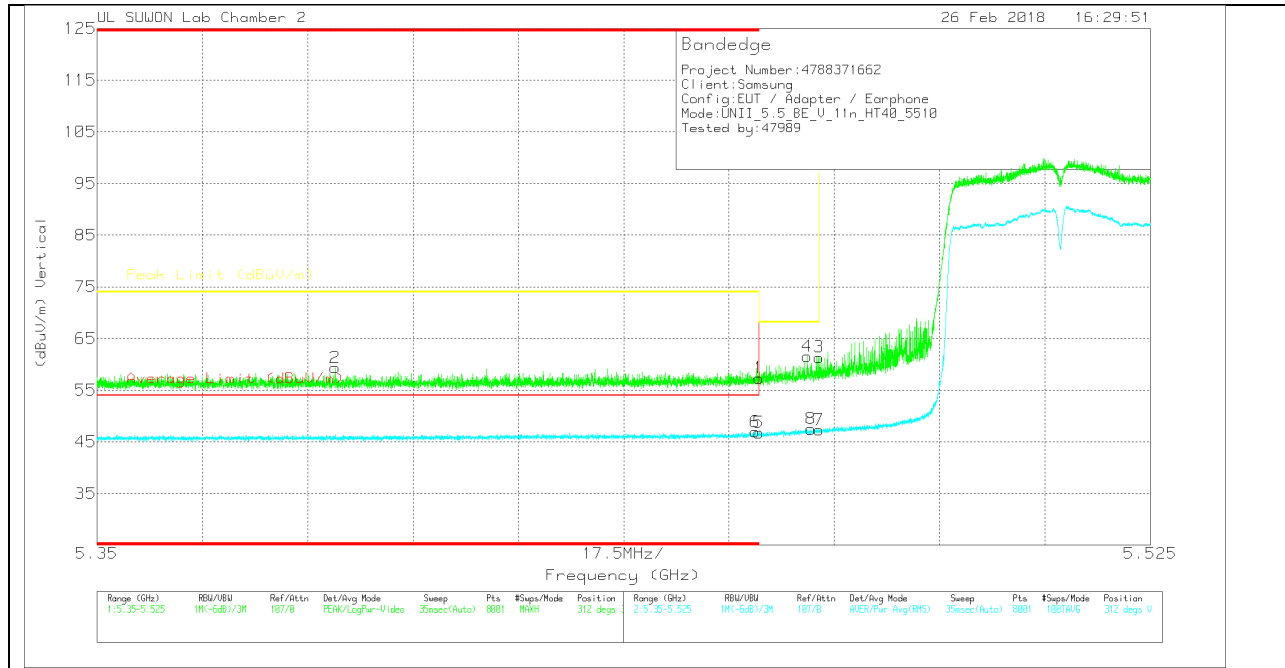

VERTICAL DATA

Trace Markers

Marker	Frequency (GHz)	Meter Reading (dBuV)	Det	170531_3117(00168724)	10dB(dB)	DC Corr (dB)	Corrected Reading (dBuV/m)	Average Limit (dBuV/m)	Margin (dB)	Peak Limit (dBuV/m)	PK Margin (dB)	Azimuth (Degs)	Height (cm)	Polarity
1	* 5.46	38.06	Pk	34.3	-15	0	57.36	-	-	74	-16.64	312	383	V
2	* 5.39	40.36	Pk	34.2	-15.2	0	59.36	-	-	74	-14.64	312	383	V
3	5.47	42.08	Pk	34.3	-15	0	61.38	-	-	68.2	-6.82	312	383	V
4	5.468	42.24	Pk	34.3	-15	0	61.54	-	-	68.2	-6.66	312	383	V
5	* 5.46	27.18	RMS	34.3	-15	.3	46.78	54	-7.22	-	-	312	383	V
6	* 5.459	27.32	RMS	34.3	-15	.3	46.92	54	-7.08	-	-	312	383	V

* - indicates frequency in CFR47 Pt 15 / IC RSS-Restricted Band

Pk - Peak detector

RMS - RMS detection

AUTHORIZED BANDEDGE (HIGH CHANNEL)

HORIZONTAL PEAK AND AVERAGE PLOT

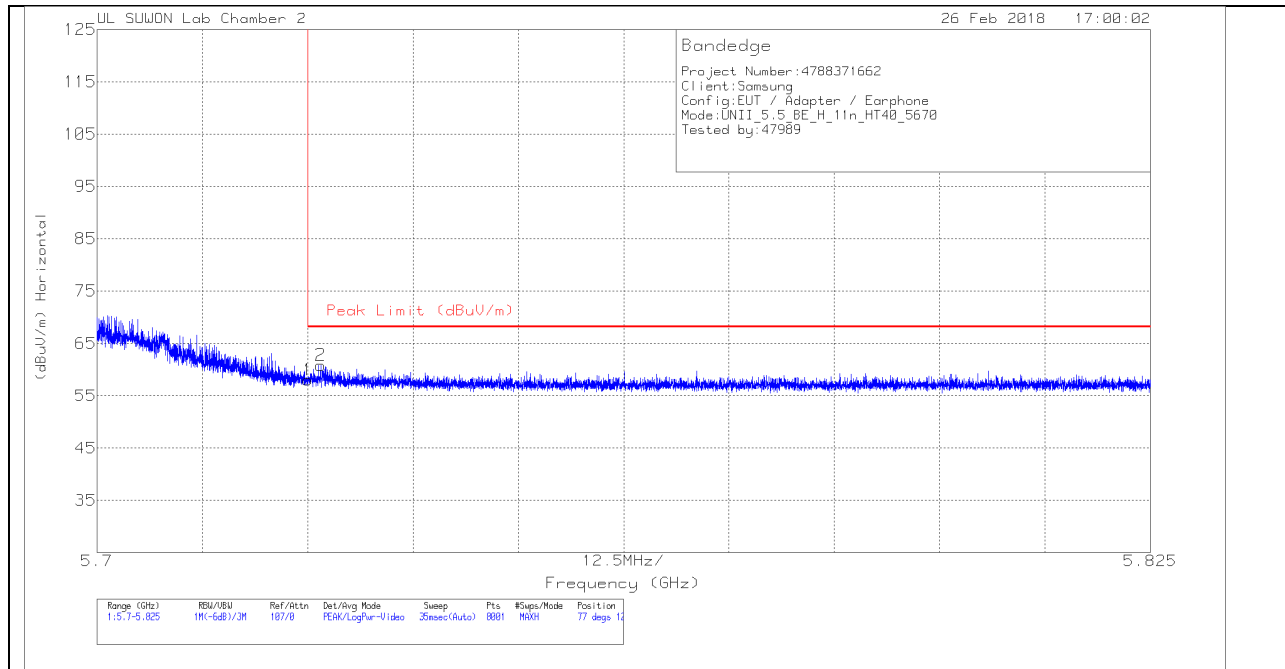

HORIZONTAL DATA

Trace Markers

Marker	Frequency (GHz)	Meter Reading (dBuV)	Det	170531_3117[001687 24]	10dB[dB]	DC Corr (dB)	Corrected Reading (dBuV/m)	Peak Limit (dBuV/m)	PK Margin (dB)	Azimuth (Degs)	Height (cm)	Polarity
1	5.725	38.12	Pk	34.4	-14.5	0	58.02	68.2	-10.18	77	120	H
2	5.727	40.93	Pk	34.4	-14.5	0	60.83	68.2	-7.37	77	120	H

Pk - Peak detector

VERTICAL PEAK AND AVERAGE PLOT

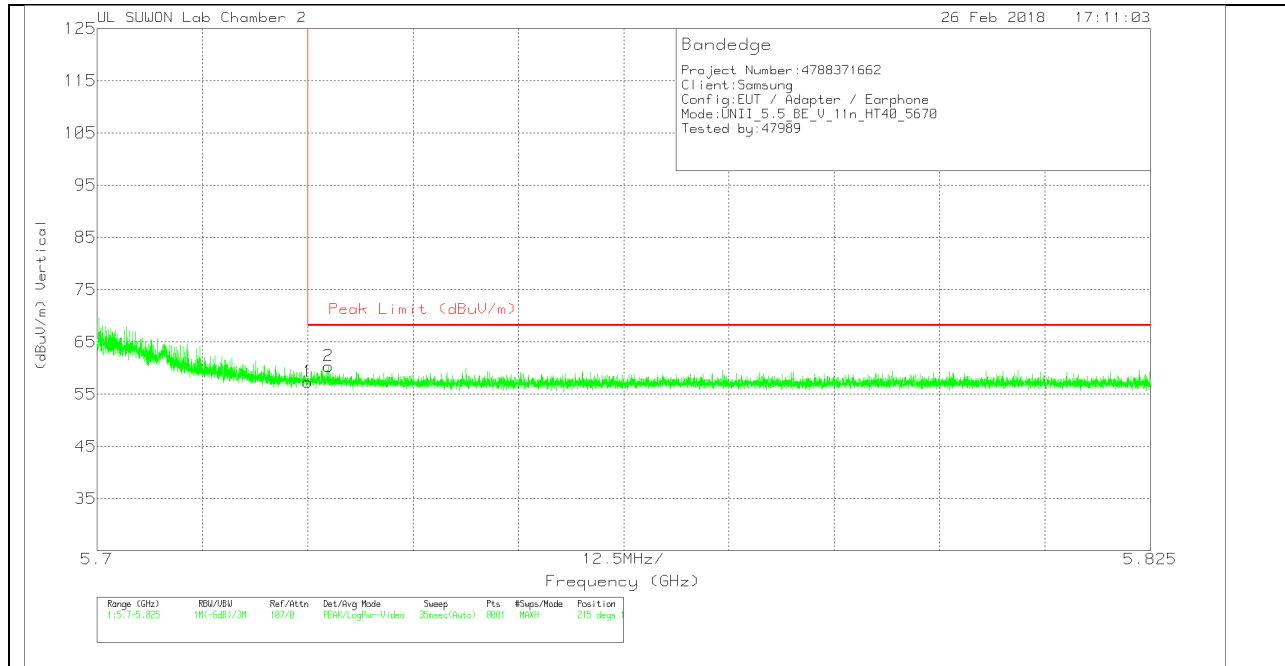

VERTICAL DATA

Trace Markers

Marker	Frequency (GHz)	Meter Reading (dBuV)	Det	170531_3117[001687 24]	10dB(dB)	DC Corr (dB)	Corrected Reading (dBuV/m)	Peak Limit (dBuV/m)	PK Margin (dB)	Azimuth (Degs)	Height (cm)	Polarity
1	5.725	37.47	Pk	34.4	-14.5	0	57.37	68.2	-10.83	215	107	V
2	5.728	40.48	Pk	34.4	-14.5	0	60.38	68.2	-7.82	215	107	V

Pk - Peak detector

HARMONICS AND SPURIOUS EMISSIONS

LOW CHANNEL HORIZONTAL

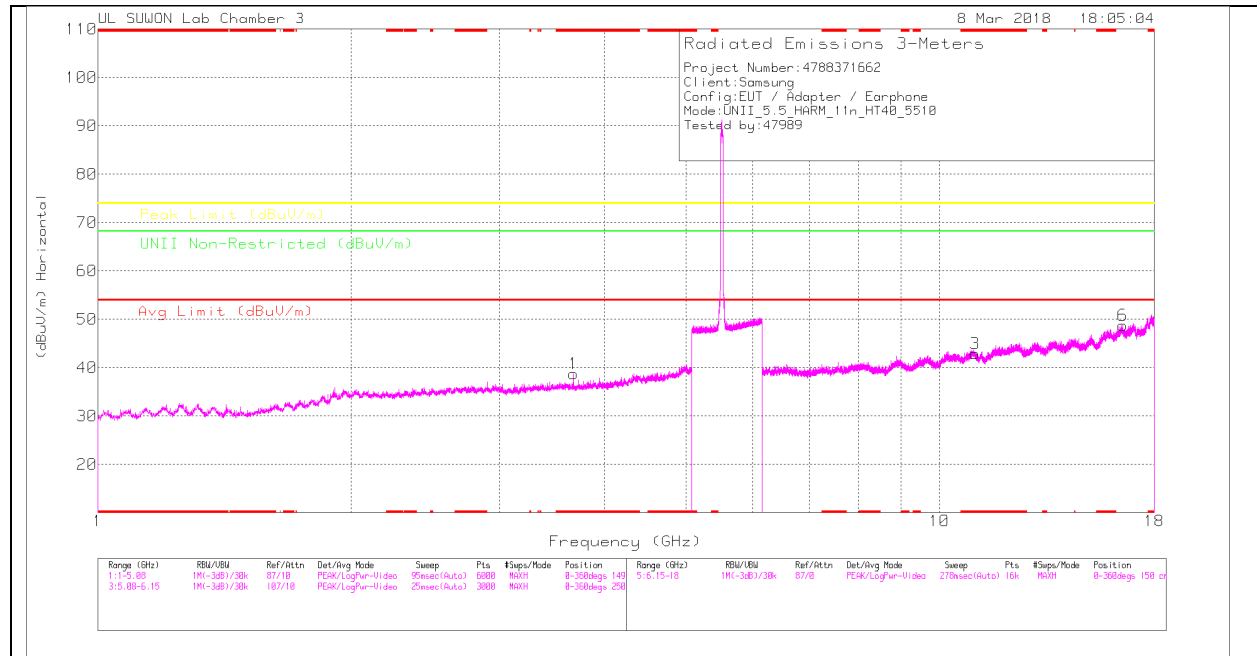

LOW CHANNEL VERTICAL

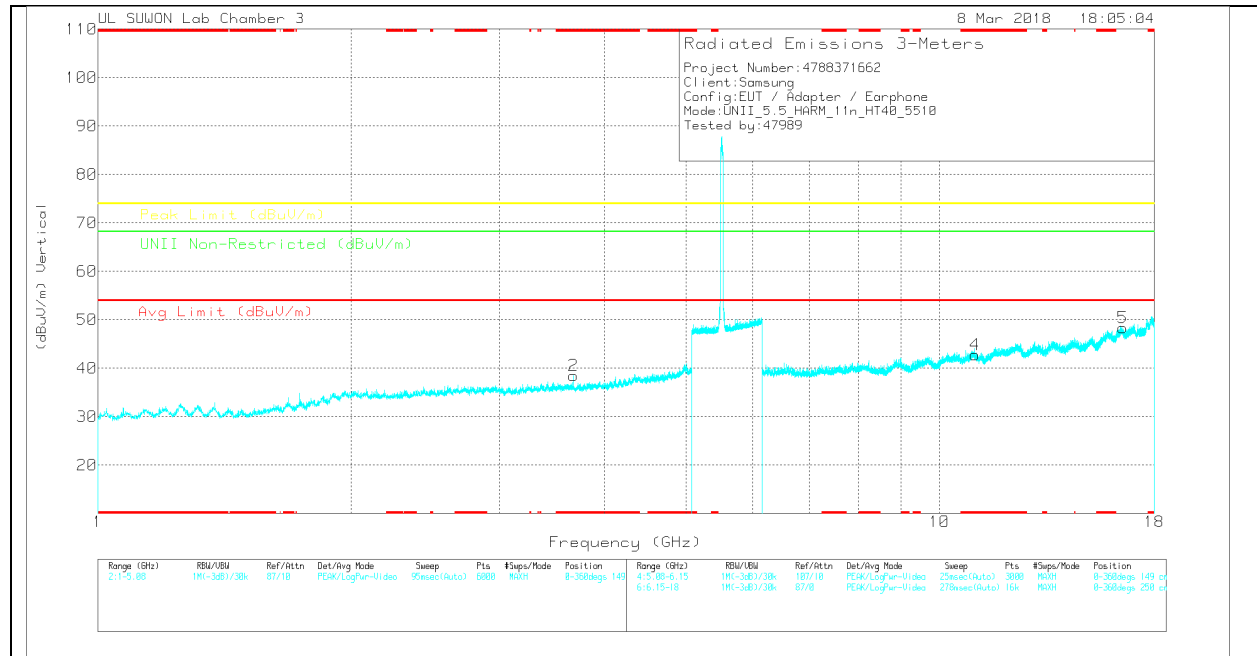

Note: Emission was scanned up to 40GHz; No emissions were detected above the noise floor which was at least 20dB below the specification limit.

LOW CHANNEL DATA

Trace Markers

Marker	Frequency (GHz)	Meter Reading (dBuV)	Det	3117(0209999)	SGM ₁ (dB)	DC Corr (dB)	Corrected Reading (dBuV/m)	Ag Limit (dBuV/m)	Margin (dB)	Peak Limit (dBuV/m)	Margin (dB)	UHF Non-Restricted (dBuV/m)	Margin (dB)	Azimuth (Degs)	Height (cm)	Polarity
1	* 3.674	36.1	PK	33	-30.4	0	38.7	-	-	74	-35.3	-	-	0-360	250	H
2	* 3.674	35.93	PK	33	-30.4	0	38.53	-	-	74	-35.47	-	-	0-360	149	V
3	* 11.021	24.76	PK	37.8	-19.6	0	42.96	-	-	74	-31.04	-	-	0-360	250	H
6	16.512	24.72	PK	41.4	-17.4	0	48.72	-	-	-	-	68.2	-19.48	0-360	250	H
4	* 11.023	24.56	PK	37.8	-19.6	0	42.76	-	-	74	-31.24	-	-	0-360	149	V
5	16.513	24.35	PK	41.4	-17.4	0	48.35	-	-	-	-	68.2	-19.85	0-360	149	V

* - indicates frequency in CFR47 Pt 15 / IC RSS-Restricted Band
 PK – Peak detector

Note: Only peak measurement was performed. Because peak measurement result of unwanted emission is less than average limit (54dBuV/m).

MID CHANNEL HORIZONTAL

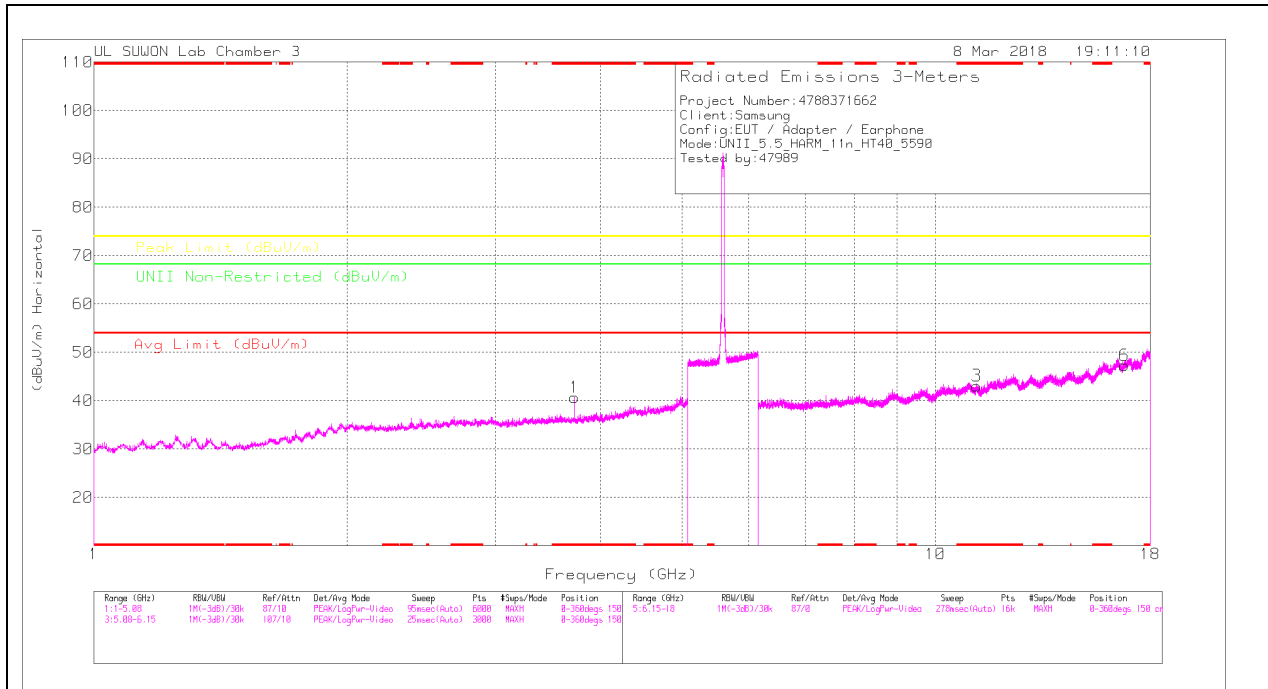

MID CHANNEL VERTICAL

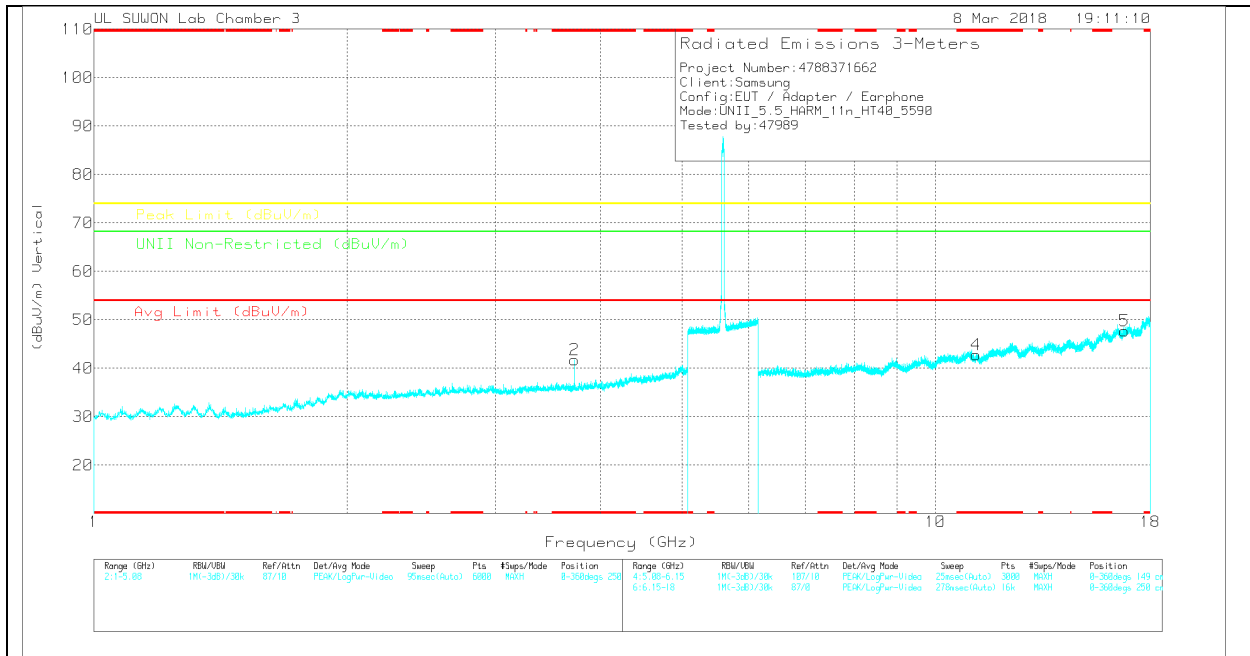

Note: Emission was scanned up to 40GHz; No emissions were detected above the noise floor which was at least 20dB below the specification limit.

MID CHANNEL DATA

Trace Markers

Marker	Frequency (GHz)	Marker Reading (dBuV)	Det	3117(0200959)	5GHz_LF(dB)	DC Corr (dB)	Corrected Reading (dBuV/m)	Ag Limit (dBuV/m)	Margin (dB)	Peak Limit (dBuV/m)	Margin (dB)	UNII Non-Restricted (dBuV/m)	Margin (dB)	Azimuth (Degs)	Height (cm)	Polarity
1	* 3.727	38.05	PK	33	-30.3	0	40.75	-	-	74	-33.25	-	-	0-360	250	H
2	* 3.727	39.06	PK	33	-30.3	0	41.76	-	-	74	-32.24	-	-	0-360	149	V
3	* 11.187	24.7	PK	37.9	-19.5	0	43.1	-	-	74	-30.9	-	-	0-360	150	H
6	16.771	22.56	PK	41.5	-16.7	0	47.36	-	-	-	-	68.2	-20.84	0-360	250	H
4	* 11.182	24.5	PK	37.9	-19.6	0	42.8	-	-	74	-31.2	-	-	0-360	250	V
5	16.777	22.86	PK	41.5	-16.6	0	47.76	-	-	-	-	68.2	-20.44	0-360	149	V

* - indicates frequency in CFR47 Pt 15 / IC RSS-Restricted Band
 PK – Peak detector

Radiated Emissions

Frequency (GHz)	Marker Reading (dBuV)	Det	3117(0200959)	5GHz_LF(dB)	DC Corr (dB)	Corrected Reading (dBuV/m)	Ag Limit (dBuV/m)	Margin (dB)	Peak Limit (dBuV/m)	Margin (dB)	UNII Non-Restricted (dBuV/m)	Margin (dB)	Azimuth (Degs)	Height (cm)	Polarity
* 3.727	46.11	PK-U	33	-30.3	0	48.81	-	-	74	-25.19	-	-	1	322	H
* 3.727	37.49	ADR	33	-30.3	.3	40.49	54	-13.51	-	-	-	-	1	322	H
* 3.727	46.31	PK-U	33	-30.3	0	49.01	-	-	74	-24.99	-	-	21	258	V
* 3.727	38.22	ADR	33	-30.3	.3	41.22	54	-12.78	-	-	-	-	21	258	V

* - indicates frequency in CFR47 Pt 15 / IC RSS-Restricted Band
 PK-U - U-NII: Maximum Peak
 ADR - U-NII AD primary method, RMS average

HIGH CHANNEL HORIZONTAL

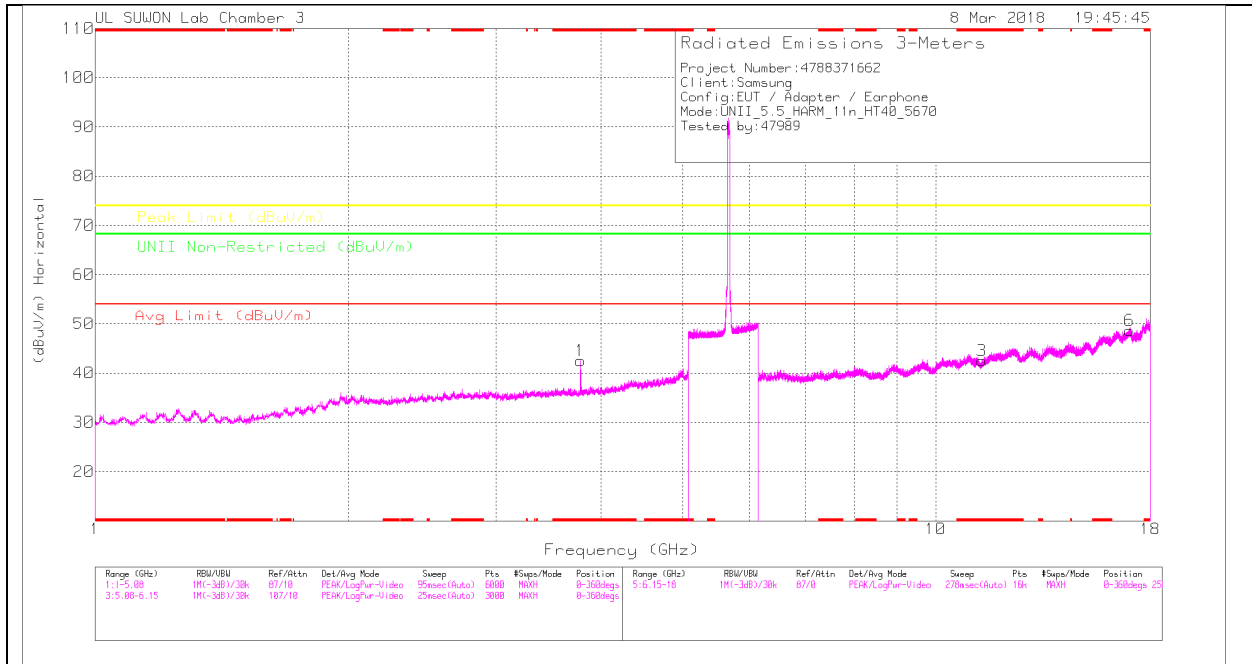

HIGH CHANNEL VERTICAL

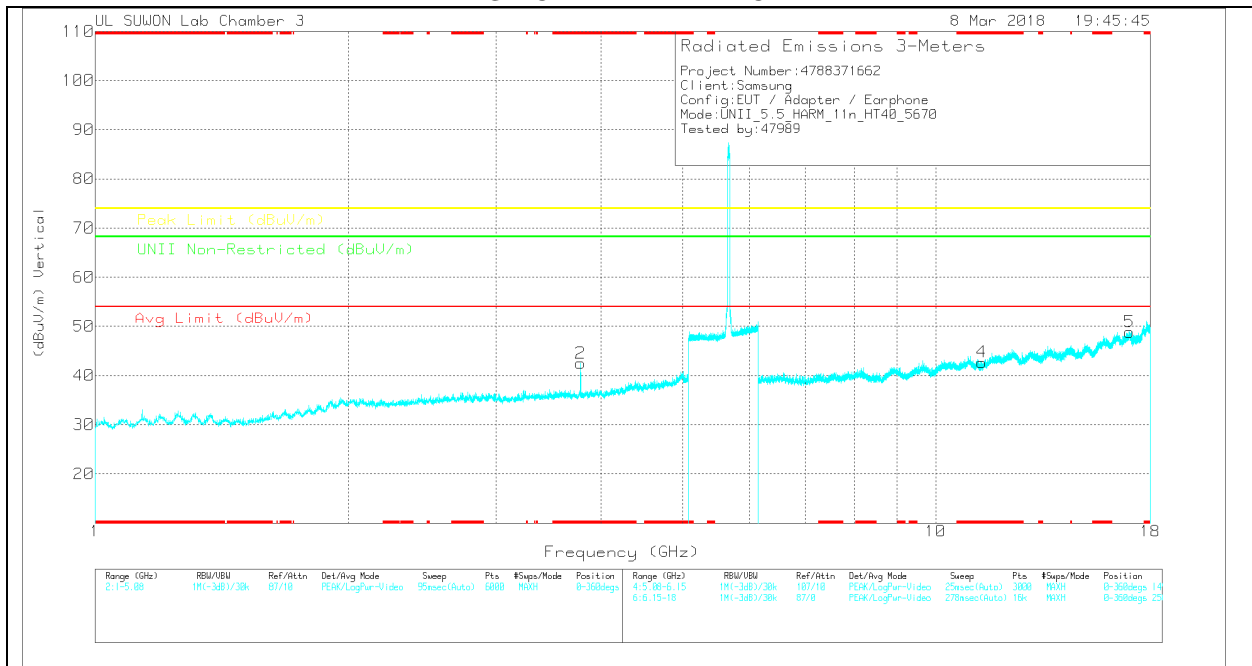

Note: Emission was scanned up to 40GHz; No emissions were detected above the noise floor which was at least 20dB below the specification limit.

HIGH CHANNEL DATA

Trace Markers

Marker	Frequency (GHz)	Meter Reading (dBuV)	Det	3117(0020959)	5GHz_LF5dB	DC Corr (dB)	Corrected Reading (dBuV/m)	Ag Limit (dBuV/m)	Margin (dB)	Peak Limit (dBuV/m)	Margin (dB)	U/NII Non-Restricted (dBuV/m)	Margin (dB)	Azimuth (Degs)	Height (cm)	Polarity
1	* 3.78	39.68	PK	33	-30.2	0	42.48	-	-	74	-31.52	-	-	0-360	250	H
2	* 3.78	39.69	PK	33	-30.2	0	42.49	-	-	74	-31.51	-	-	0-360	250	V
3	* 11.352	24.31	PK	37.9	-19.7	0	42.51	-	-	74	-31.49	-	-	0-360	250	H
6	17.01	23.45	PK	41.2	-16	0	48.65	-	-	-	-	68.2	-19.55	0-360	150	H
4	* 11.35	24.5	PK	37.9	-19.7	0	42.7	-	-	74	-31.3	-	-	0-360	250	V
5	17.006	23.65	PK	41.2	-16	0	48.85	-	-	-	-	68.2	-19.35	0-360	250	V

* - indicates frequency in CFR47 Pt 15 / IC RSS-Restricted Band
 PK – Peak detector

Radiated Emissions

Frequency (GHz)	Meter Reading (dBuV)	Det	3117(0020959)	5GHz_LF5dB	DC Corr (dB)	Corrected Reading (dBuV/m)	Ag Limit (dBuV/m)	Margin (dB)	Peak Limit (dBuV/m)	Margin (dB)	U/NII Non-Restricted (dBuV/m)	Margin (dB)	Azimuth (Degs)	Height (cm)	Polarity
* 3.78	46.93	PK-U	33	-30.2	0	49.73	-	-	74	-24.27	-	-	148	100	V
* 3.78	39.33	ADR	33	-30.3	.3	42.33	54	-11.67	-	-	-	-	148	100	V
* 3.78	46.65	PK-U	33	-30.3	0	49.35	-	-	74	-24.65	-	-	4	343	H
* 3.78	39.5	ADR	33	-30.2	.3	42.6	54	-11.4	-	-	-	-	4	343	H

* - indicates frequency in CFR47 Pt 15 / IC RSS-Restricted Band
 PK-U - U-NII: Maximum Peak
 ADR - U-NII AD primary method, RMS average

STRADDLE CHANNEL HORIZONTAL

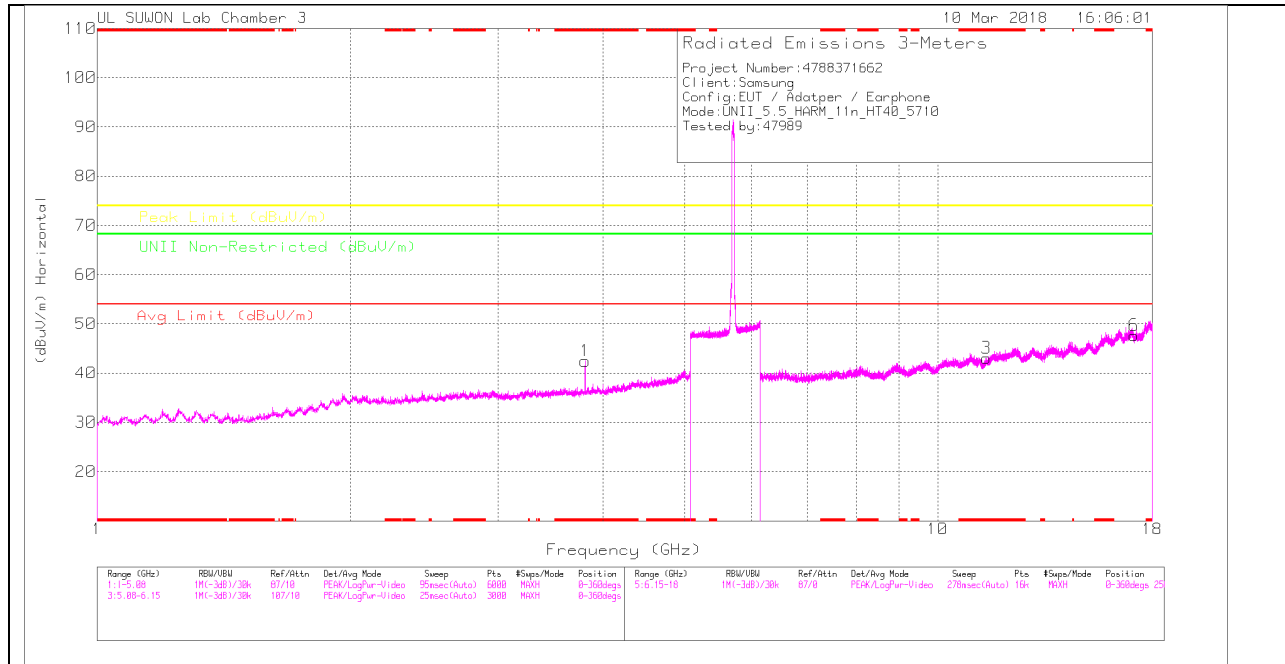

STRADDLE CHANNEL VERTICAL

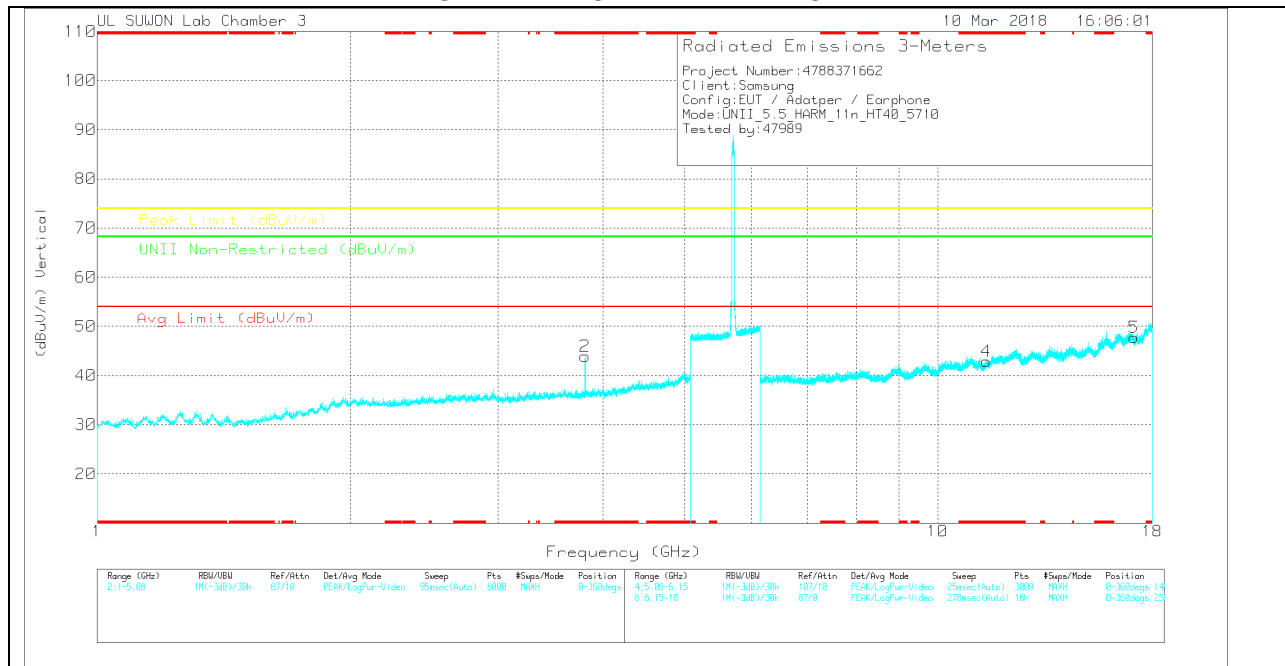

Note: Emission was scanned up to 40GHz; No emissions were detected above the noise floor which was at least 20dB below the specification limit.

STRADDLE CHANNEL DATA

Trace Markers

Marker	Frequency (GHz)	Meter Reading (dBuV)	Det	3117(0205959)	5GHz_LF(dB)	DC Corr (dB)	Corrected Reading (dBuV/m)	Ag Limit (dBuV/m)	Margin (dB)	Peak Limit (dBuV/m)	Margin (dB)	U-NII Non-Restricted (dBuV/m)	Margin (dB)	Azimuth (Degs)	Height (cm)	Polarity
1	* 3.807	39.67	PK	33	-30.2	0	42.47	-	-	74	-31.53	-	-	0-360	250	H
2	* 3.807	41.13	PK	33	-30.2	0	43.93	-	-	74	-30.07	-	-	0-360	149	V
3	* 11.431	24.66	PK	38	-19.6	0	43.06	-	-	74	-30.94	-	-	0-360	150	H
6	17.129	22.86	PK	40.9	-16.1	0	47.66	-	-	-	-	68.2	-20.54	0-360	150	H
4	* 11.431	24.48	PK	38	-19.6	0	42.88	-	-	74	-31.12	-	-	0-360	149	V
5	17.128	22.96	PK	40.9	-16.1	0	47.76	-	-	-	-	68.2	-20.44	0-360	149	V

* - indicates frequency in CFR47 Pt 15 / IC RSS-Restricted Band
 PK – Peak detector

Radiated Emissions

Frequency (GHz)	Meter Reading (dBuV)	Det	3117(0205959)	5GHz_LF(dB)	DC Corr (dB)	Corrected Reading (dBuV/m)	Ag Limit (dBuV/m)	Margin (dB)	Peak Limit (dBuV/m)	Margin (dB)	U-NII Non-Restricted (dBuV/m)	Margin (dB)	Azimuth (Degs)	Height (cm)	Polarity
* 3.807	45.77	PK-U	33	-30.2	0	48.57	-	-	74	-25.43	-	-	3	378	H
* 3.807	36.72	ADR	33	-30.2	.3	39.82	54	-14.18	-	-	-	-	0	378	H
* 3.807	47.64	PK-U	33	-30.2	0	50.44	-	-	74	-23.56	-	-	27	201	V
* 3.807	39.42	ADR	33	-30.2	.3	42.52	54	-11.48	-	-	-	-	27	200	V

* - indicates frequency in CFR47 Pt 15 / IC RSS-Restricted Band
 PK-U - U-NII: Maximum Peak
 ADR - U-NII AD primary method, RMS average

11.4. 5.8 GHz

11.4.1. TX ABOVE 1GHz 802.11a MODE IN THE 5.8GHz BAND BANDEDGE (LOW CHANNEL)

HORIZONTAL PEAK PLOT

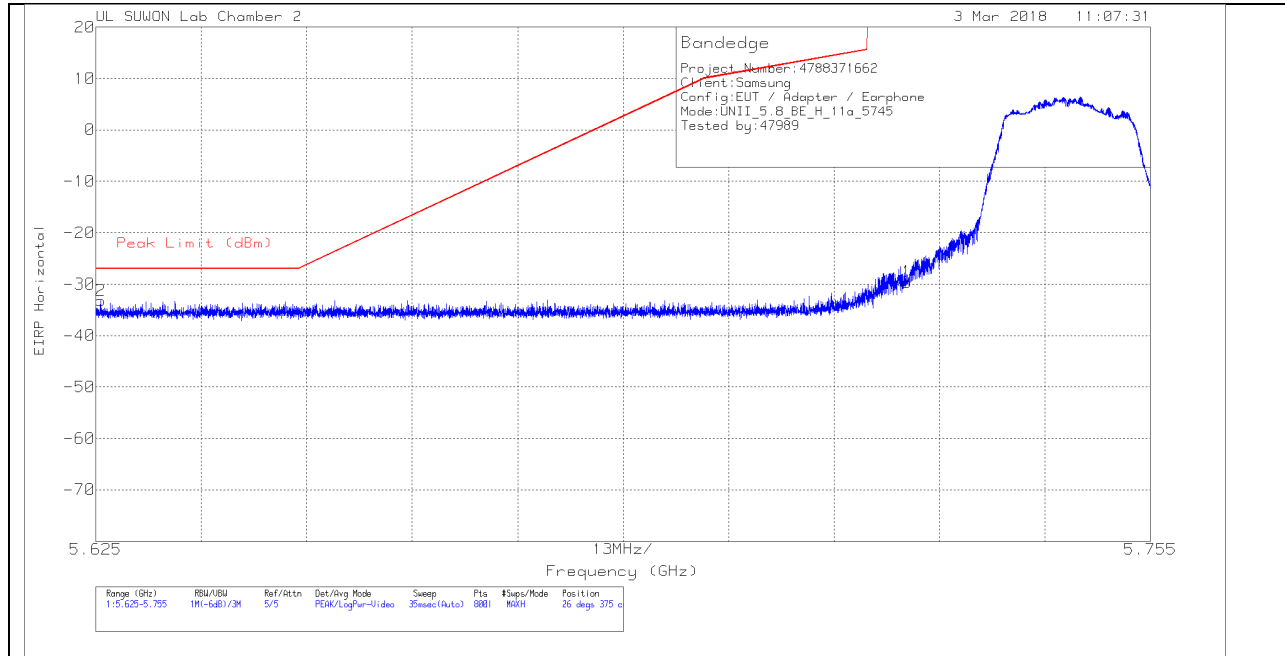

HORIZONTAL DATA

Trace Markers

Marker	Frequency (GHz)	Meter Reading (dBm)	Det	170531_3117[00 168724]	Path_2_10dB	Conversion Factor (dB)	DC Corr (dB)	Corrected Reading EIRP	Peak Limit (dBm)	PK Margin (dB)	Azimuth (Degs)	Height (cm)	Polarity
1	5.725	-60.28	Pk	34.5	-15.6	11.8	0	-29.58	278.26	-307.84	26	375	H
2	5.626	-63.7	Pk	34.4	-15.7	11.8	0	-33.2	-27	-6.2	26	375	H

Pk - Peak detector

VERTICAL PEAK PLOT

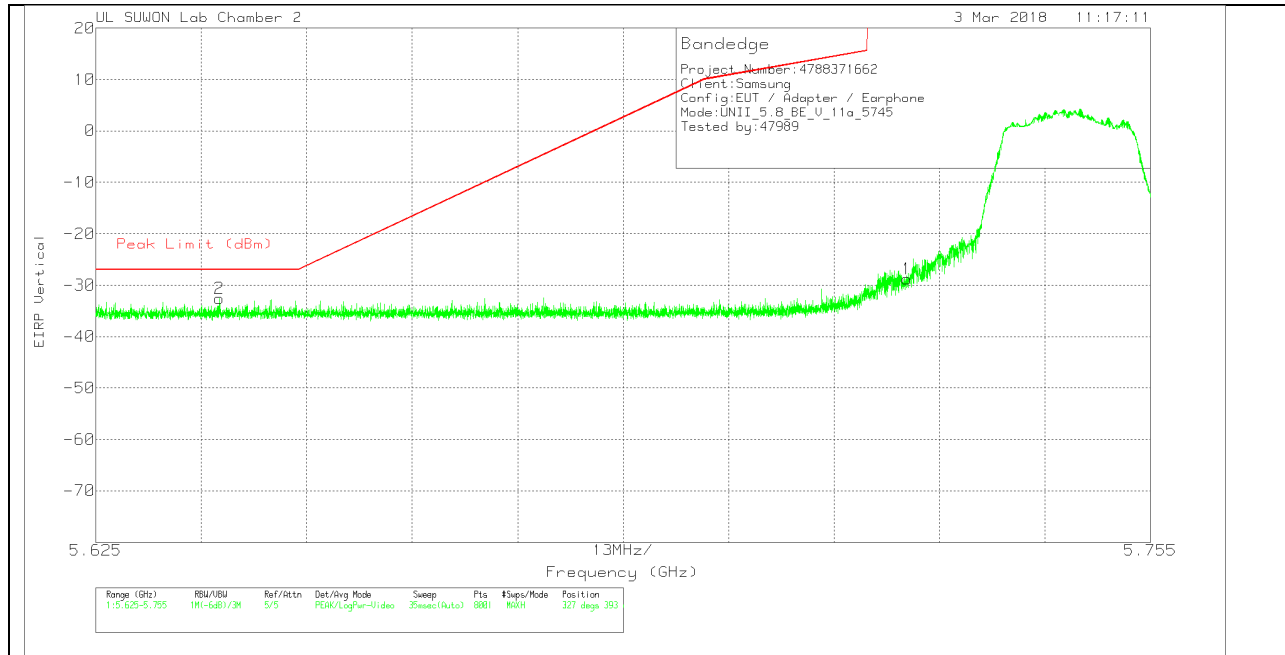

VERTICAL DATA

Trace Markers

Marker	Frequency (GHz)	Meter Reading (dBm)	Det	170531_3117[00 168724]	Path_2_10dB	Conversion Factor (dB)	DC Corr (dB)	Corrected Reading EIRP	Peak Limit (dBm)	PK Margin (dB)	Azimuth (Degs)	Height (cm)	Polarity
1	5.725	-59.45	Pk	34.5	-15.6	11.8	0	-28.75	278.26	-307.01	327	393	V
2	5.64	-63.06	Pk	34.4	-15.7	11.8	0	-32.56	-27	-5.56	327	393	V

Pk - Peak detector

BANDEDGE (HIGH CHANNEL)

HORIZONTAL PEAK PLOT

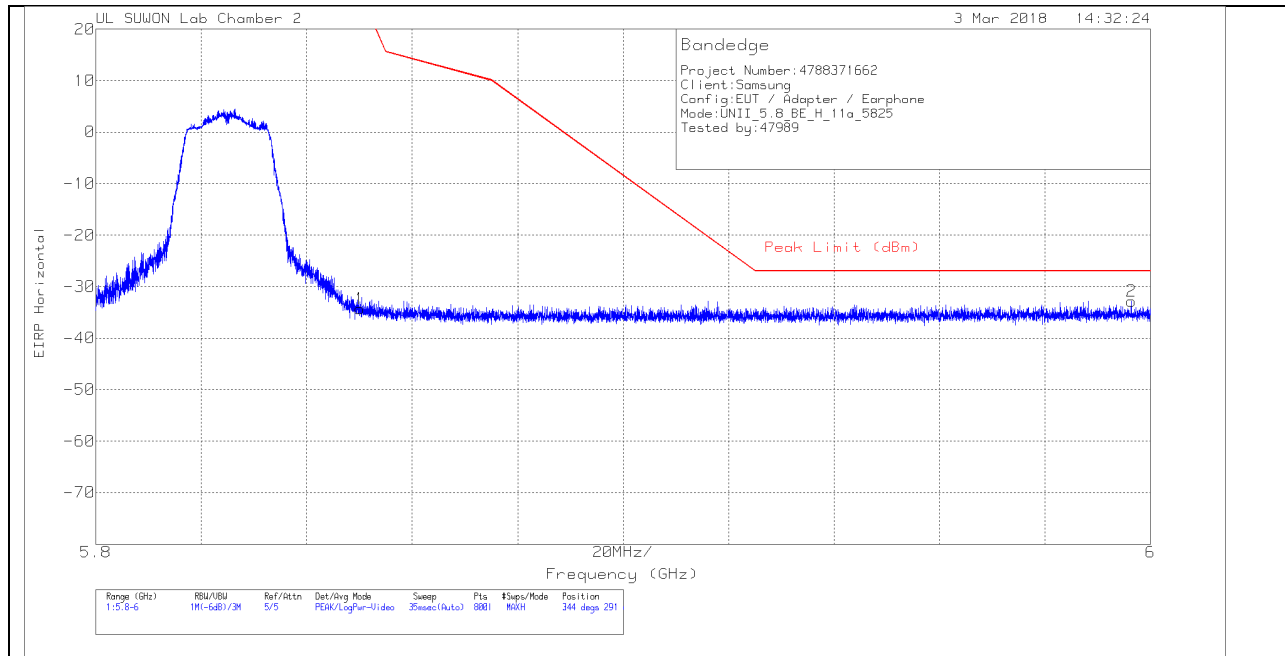

HORIZONTAL DATA

Trace Markers

Marker	Frequency (GHz)	Meter Reading (dBm)	Det	170531_3117[00 168724]	Path_2_10dB	Conversion Factor (dB)	DC Corr (dB)	Corrected Reading EIRP	Peak Limit (dBm)	PK Margin (dB)	Azimuth (Degs)	Height (cm)	Polarity
1	5.85	-65.06	Pk	34.5	-15.5	11.8	0	-34.26	26.94	-61.2	344	291	H
2	5.996	-63.97	Pk	34.8	-15.4	11.8	0	-32.77	-27	-5.77	344	291	H

Pk - Peak detector

VERTICAL PEAK PLOT

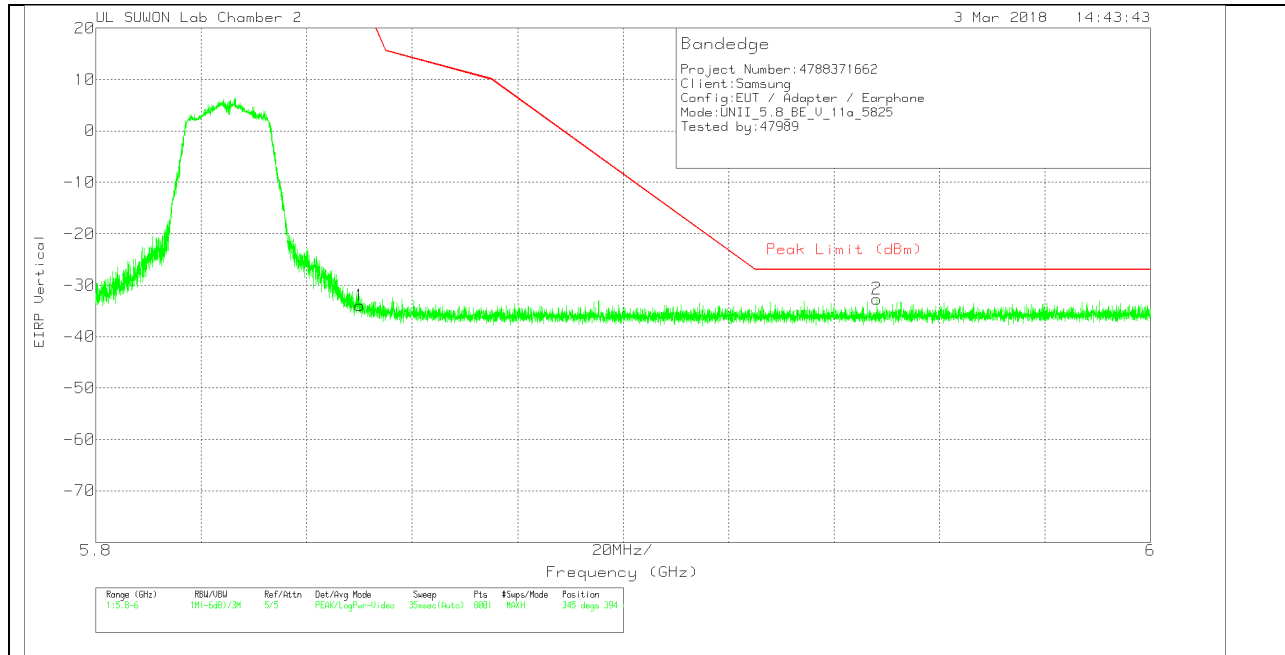

VERTICAL DATA

Trace Markers

Marker	Frequency (GHz)	Meter Reading (dBm)	Det	170531_3117[00 168724]	Path_2_10dB	Conversion Factor (dB)	DC Corr (dB)	Corrected Reading EIRP	Peak Limit (dBm)	PK Margin (dB)	Azimuth (Degs)	Height (cm)	Polarity
1	5.85	-64.77	Pk	34.5	-15.5	11.8	0	-33.97	26.94	-60.91	345	394	V
2	5.948	-63.54	Pk	34.6	-15.5	11.8	0	-32.64	-27	-5.64	345	394	V

Pk - Peak detector

LOW CHANNEL HORIZONTAL

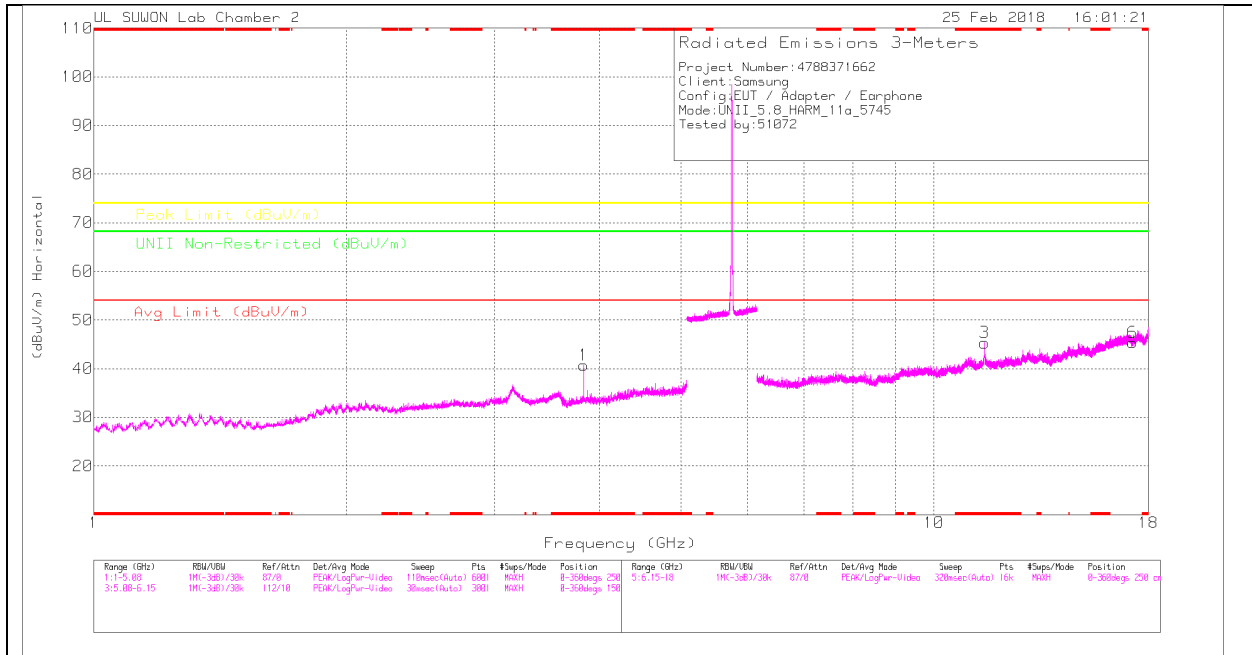

LOW CHANNEL VERTICAL

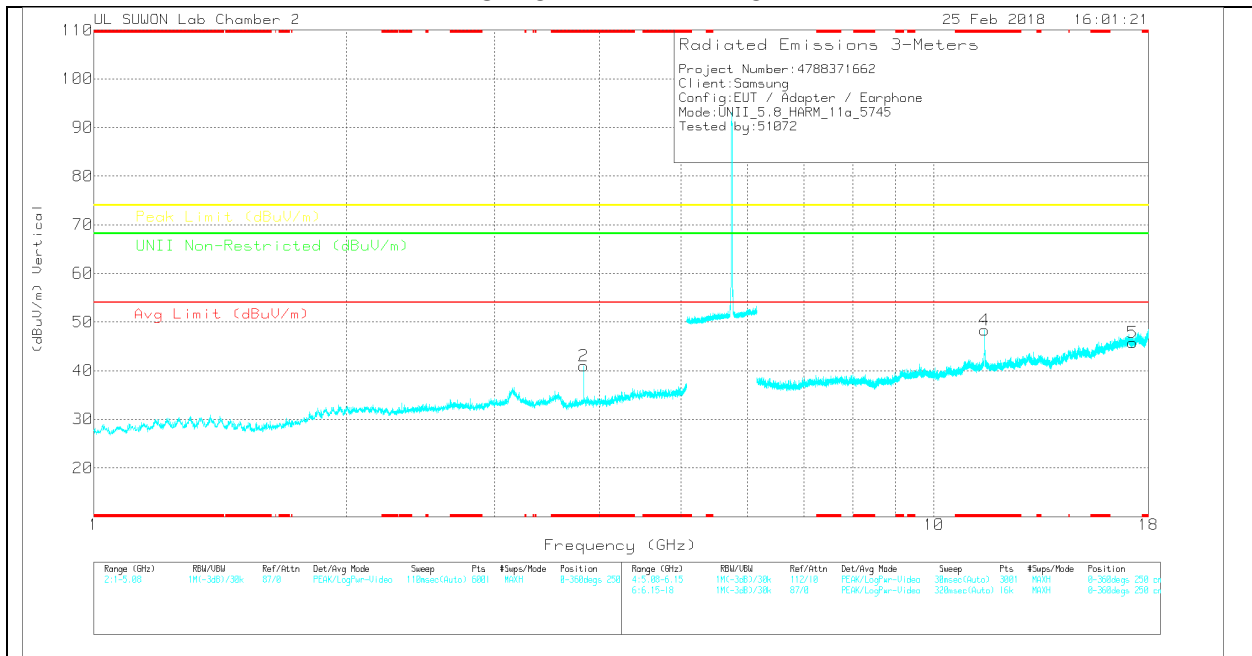

Note: Emission was scanned up to 40GHz; No emissions were detected above the noise floor which was at least 20dB below the specification limit.

LOW CHANNEL DATA

Trace Markers

Marker	Frequency (GHz)	Meter Reading (dBuV)	Det	170531_3117001687 24)	5GHz_LF(dB)	DC Corr (dB)	Corrected Reading (dBuV/m)	Avg Limit (dBuV/m)	Margin (dB)	Peak Limit (dBuV/m)	Margin (dB)	UNII Non-Restricted (dBuV/m)	Margin (dB)	Azimuth (Degs)	Height (cm)	Polarity
1	* 3.83	32.49	PK	33.1	-24.9	0	40.69	-	-	74	-33.31	-	-	0-360	250	H
2	* 3.83	32.81	PK	33.1	-24.9	0	41.01	-	-	74	-32.99	-	-	0-360	150	V
3	* 11.492	23.01	PK	38.2	-15.9	0	45.31	-	-	74	-28.69	-	-	0-360	250	H
6	17.236	17.25	PK	41.6	-13.5	0	45.35	-	-	-	-	68.2	-22.85	0-360	150	H
4	* 11.49	26	PK	38.2	-15.9	0	48.3	-	-	74	-25.7	-	-	0-360	250	V
5	17.236	17.66	PK	41.6	-13.5	0	45.76	-	-	-	-	68.2	-22.44	0-360	250	V

* - indicates frequency in CFR47 Pt 15 / IC RSS-Restricted Band
 PK – Peak Detector

Radiated Emissions

Frequency (GHz)	Meter Reading (dBuV)	Det	170531_311700168724)	5GHz_LF(dB)	DC Corr (dB)	Corrected Reading (dBuV/m)	Avg Limit (dBuV/m)	Margin (dB)	Peak Limit (dBuV/m)	Margin (dB)	UNII Non-Restricted (dBuV/m)	Margin (dB)	Azimuth (Degs)	Height (cm)	Polarity
* 3.83	39.53	PK-U	33.1	-25	0	47.63	-	-	74	-26.37	-	-	31	161	H
* 3.83	31.98	ADR	33.1	-25	.14	40.22	54	-13.78	-	-	-	-	31	161	H
* 3.83	40.17	PK-U	33.1	-25	0	48.27	-	-	74	-25.73	-	-	136	140	V
* 3.83	32.34	ADR	33.1	-24.9	.14	40.68	54	-13.32	-	-	-	-	136	140	V
* 11.486	20.62	ADR	38.2	-15.9	.14	43.06	54	-10.94	-	-	-	-	77	271	H
* 11.49	20.72	ADR	38.2	-15.9	.14	43.16	54	-10.84	-	-	-	-	1	118	V
* 11.489	33.81	PK-U	38.2	-15.9	0	56.11	-	-	74	-17.89	-	-	77	271	H
* 11.489	33.68	PK-U	38.2	-15.9	0	55.98	-	-	74	-18.02	-	-	1	118	V

* - indicates frequency in CFR47 Pt 15 / IC RSS-Restricted Band
 PK-U - U-NII: Maximum Peak
 ADR - U-NII AD primary method, RMS average

MID CHANNEL HORIZONTAL

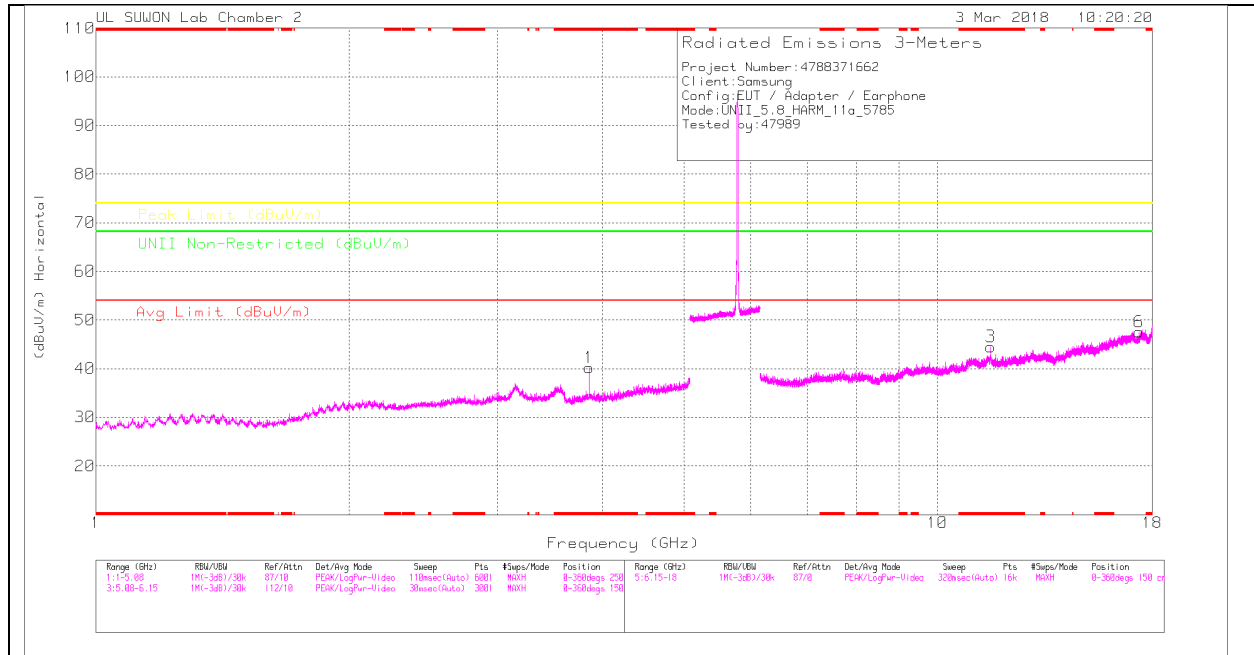

MID CHANNEL VERTICAL

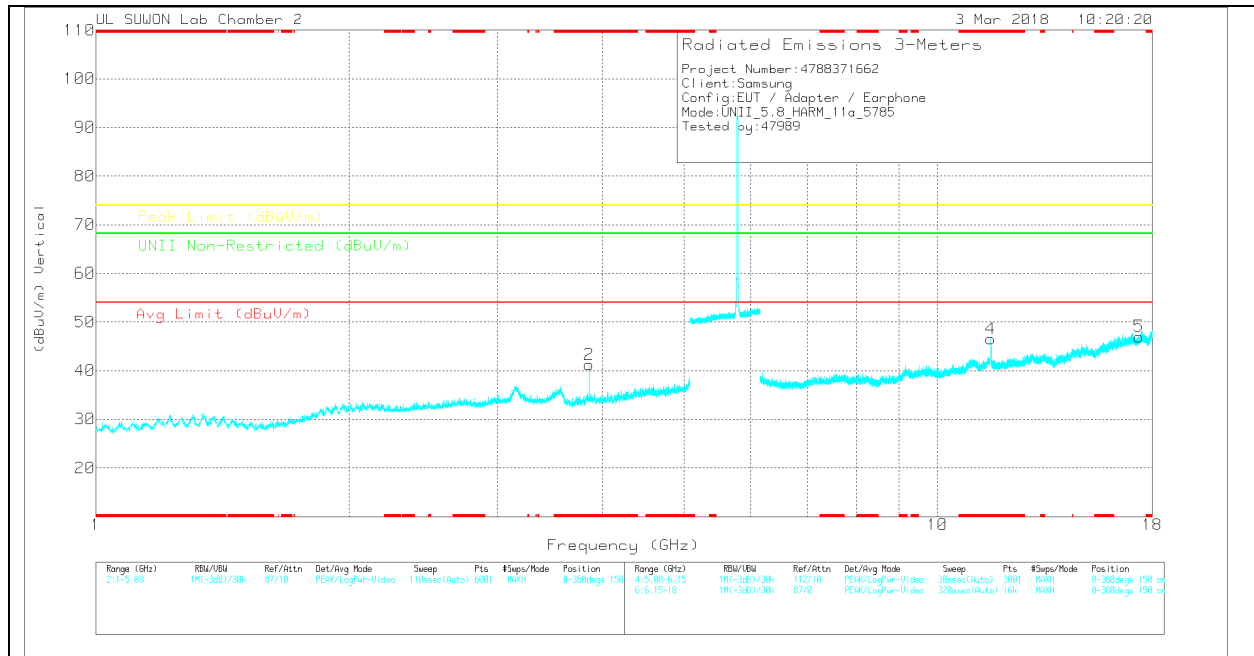

Note: Emission was scanned up to 40GHz; No emissions were detected above the noise floor which was at least 20dB below the specification limit.

MID CHANNEL DATA

Trace Markers

Marker	Frequency (GHz)	Marker Reading (dBuV)	Det	170531_3117(001887 24)	SGHz_LF(dB)	DC Corr (dB)	Corrected Reading (dBuV/m)	Avg Limit (dBuV/m)	Margin (dB)	Peak Limit (dBuV/m)	Margin (dB)	UNII Non-Restricted (dBuV/m)	Margin (dB)	Azimuth (Degs)	Height (cm)	Polarity
1	* 3.857	31.85	Avg	33.1	-24.7	0	40.25	-	-	74	-33.75	-	-	0-360	150	H
2	* 3.857	32.85	Avg	33.1	-24.7	0	41.25	-	-	74	-32.75	-	-	0-360	250	V
3	* 11.565	22.23	Avg	38.2	-15.9	0	44.53	-	-	74	-29.47	-	-	0-360	250	H
6	17.351	19.4	Avg	41.4	-13.2	0	47.6	-	-	-	-	68.2	-20.6	0-360	250	H
4	* 11.57	24.25	Avg	38.2	-15.9	0	46.55	-	-	74	-27.45	-	-	0-360	250	V
5	17.351	18.79	Avg	41.4	-13.2	0	46.99	-	-	-	-	68.2	-21.21	0-360	250	V

* - indicates frequency in CFR47 Pt 15 / IC RSS-Restricted Band
 PK – Peak detector

Radiated Emissions

Frequency (GHz)	Marker Reading (dBuV)	Det	170531_3117(0018724)	SGHz_LF(dB)	DC Corr (dB)	Corrected Reading (dBuV/m)	Avg Limit (dBuV/m)	Margin (dB)	Peak Limit (dBuV/m)	Margin (dB)	UNII Non-Restricted (dBuV/m)	Margin (dB)	Azimuth (Degs)	Height (cm)	Polarity
* 3.857	39.72	PK-U	33.1	-24.8	0	48.02	-	-	74	-25.98	-	-	53	275	H
* 3.857	31.46	ADR	33.1	-24.7	-14	40	54	-14	-	-	-	-	53	275	H
* 3.857	40.36	PK-U	33.1	-24.7	0	48.76	-	-	74	-25.24	-	-	24	201	V
* 3.857	33.38	ADR	33.1	-24.7	-14	41.92	54	-12.08	-	-	-	-	24	201	V
* 11.57	24.61	ADR	38.2	-15.9	-14	47.05	54	-6.95	-	-	-	-	357	100	V
* 11.57	19.75	ADR	38.2	-15.9	-14	42.19	54	-11.81	-	-	-	-	37	100	H
* 11.569	37.74	PK-U	38.2	-15.9	0	60.04	-	-	74	-13.96	-	-	357	100	V
* 11.569	32.95	PK-U	38.2	-15.9	0	55.25	-	-	74	-18.75	-	-	37	100	H

* - indicates frequency in CFR47 Pt 15 / IC RSS-Restricted Band
 PK-U - U-NII: Maximum Peak
 ADR - U-NII AD primary method, RMS average

HIGH CHANNEL HORIZONTAL

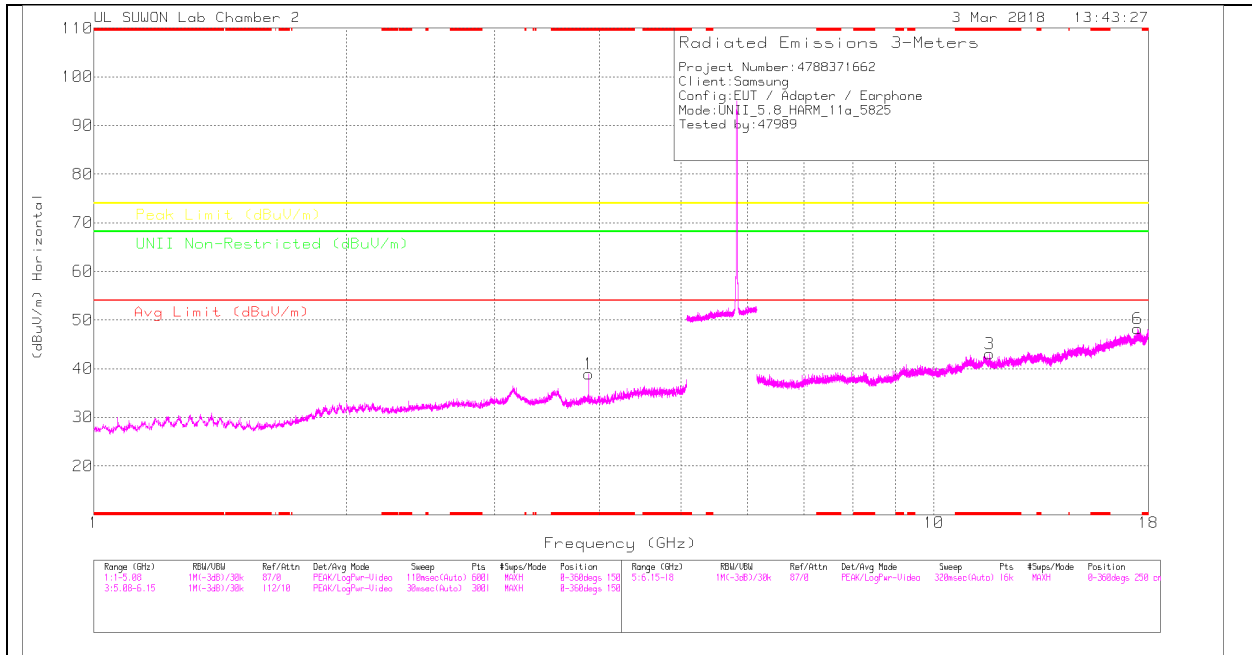

HIGH CHANNEL VERTICAL

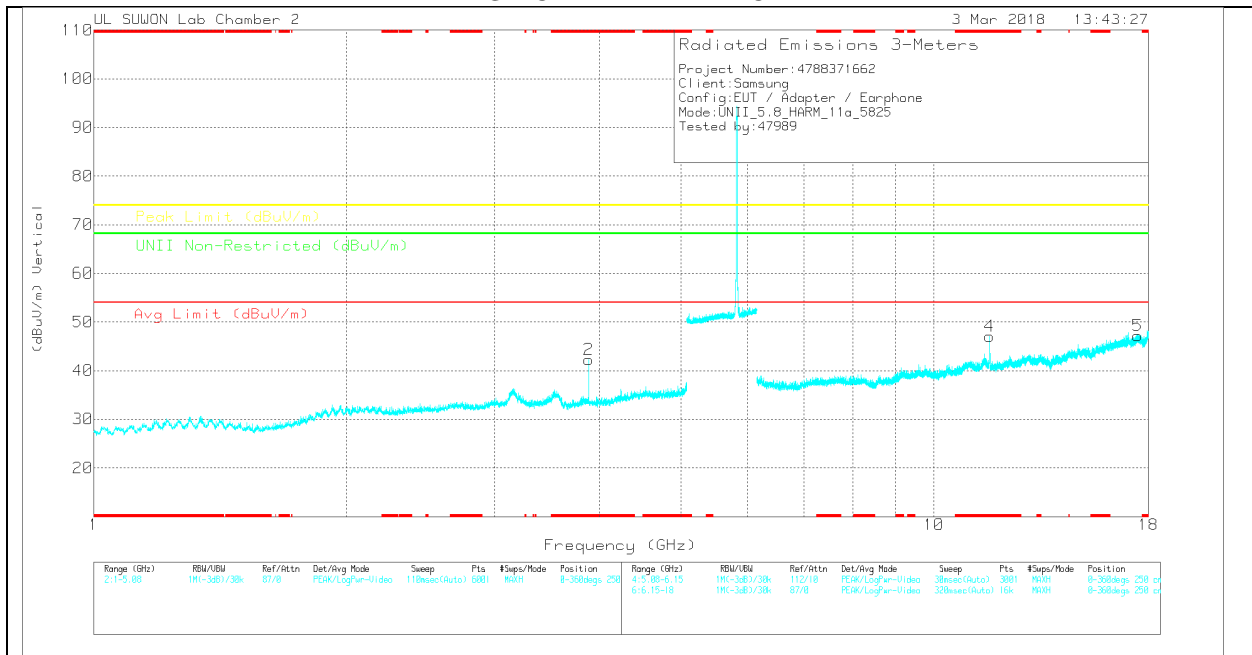

Note: Emission was scanned up to 40GHz; No emissions were detected above the noise floor which was at least 20dB below the specification limit.

HIGH CHANNEL DATA

Trace Markers

Marker	Frequency (GHz)	Meter Reading (dBuV)	Det	170531_3117(001687 24)	5GHz_LF(dB)	DC Corr (dB)	Corrected Reading (dBuV/m)	Avg Limit (dBuV/m)	Margin (dB)	Peak Limit (dBuV/m)	Margin (dB)	U/NII Non-Restricted (dBuV/m)	Margin (dB)	Azimuth (Degs)	Height (cm)	Polarity
1	* 3.884	30.45	PK	33.1	-24.7	0	38.85	-	-	74	-35.15	-	-	0-360	150	H
2	* 3.883	33.81	PK	33.1	-24.7	0	42.21	-	-	74	-31.79	-	-	0-360	150	V
3	* 11.649	20.66	PK	38.1	-15.7	0	43.06	-	-	74	-30.94	-	-	0-360	250	H
6	17.475	19.07	PK	41.3	-12.2	0	48.17	-	-	-	-	68.2	-20.03	0-360	150	H
4	* 11.653	24.78	PK	38.1	-15.8	0	47.08	-	-	74	-26.92	-	-	0-360	250	V
5	17.473	18.08	PK	41.3	-12.2	0	47.18	-	-	-	-	68.2	-21.02	0-360	150	V

* - indicates frequency in CFR47 Pt 15 / IC RSS-Restricted Band
 PK – Peak detector

Radiated Emissions

Frequency (GHz)	Meter Reading (dBuV)	Det	170531_3117(00168724)	5GHz_LF(dB)	DC Corr (dB)	Corrected Reading (dBuV/m)	Avg Limit (dBuV/m)	Margin (dB)	Peak Limit (dBuV/m)	Margin (dB)	U/NII Non-Restricted (dBuV/m)	Margin (dB)	Azimuth (Degs)	Height (cm)	Polarity
* 3.883	38.58	PK-U	33.1	-24.7	0	46.88	-	-	74	-27.02	-	-	14	173	H
* 3.883	30.86	ADR	33.1	-24.7	-14	39.4	54	-14.6	-	-	-	-	14	173	H
* 3.883	40.66	PK-U	33.1	-24.7	0	49.06	-	-	74	-24.94	-	-	35	134	V
* 3.883	34.06	ADR	33.1	-24.7	-14	42.6	54	-11.4	-	-	-	-	35	134	V
* 11.652	18.76	ADR	38.1	-15.7	-14	41.3	54	-12.7	-	-	-	-	271	117	V
* 11.652	19.2	ADR	38.1	-15.7	-14	41.74	54	-12.26	-	-	-	-	94	106	H
* 11.648	31.7	PK-U	38.1	-15.7	0	54.1	-	-	74	-19.9	-	-	271	117	V
* 11.649	32.5	PK-U	38.1	-15.7	0	54.9	-	-	74	-19.1	-	-	94	106	H

* - indicates frequency in CFR47 Pt 15 / IC RSS-Restricted Band
 PK-U - U-NII: Maximum Peak
 ADR - U-NII AD primary method, RMS average

11.4.2. TX ABOVE 1GHz 802.11n HT20 MODE IN THE 5.8GHz BAND BANDEDGE (LOW CHANNEL)

HORIZONTAL PEAK PLOT

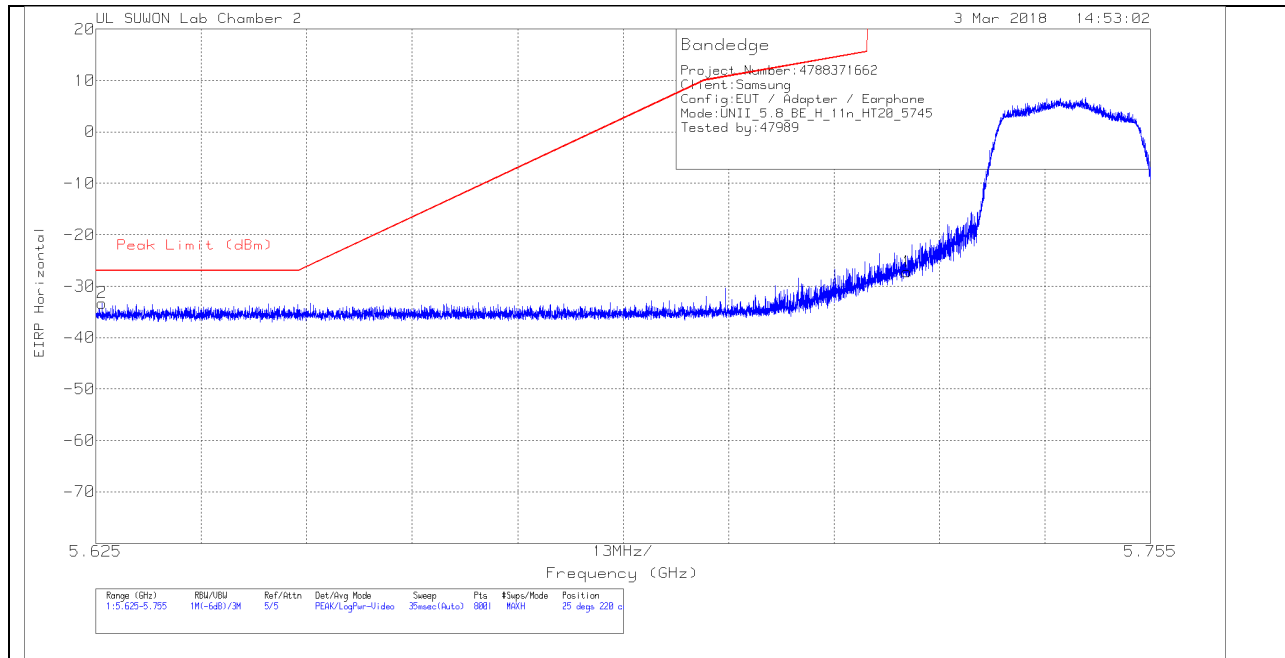

HORIZONTAL DATA

Trace Markers

Marker	Frequency (GHz)	Meter Reading (dBm)	Det	170531_3117[00 168724]	Path_2_10dB	Conversion Factor (dB)	DC Corr (dB)	Corrected Reading EIRP	Peak Limit (dBm)	PK Margin (dB)	Azimuth (Degs)	Height (cm)	Polarity
1	5.725	-57.88	Pk	34.5	-15.6	11.8	0	-27.18	278.26	-305.44	25	220	H
2	5.626	-63.75	Pk	34.4	-15.7	11.8	0	-33.25	-27	-6.25	25	220	H

Pk - Peak detector

VERTICAL PEAK PLOT

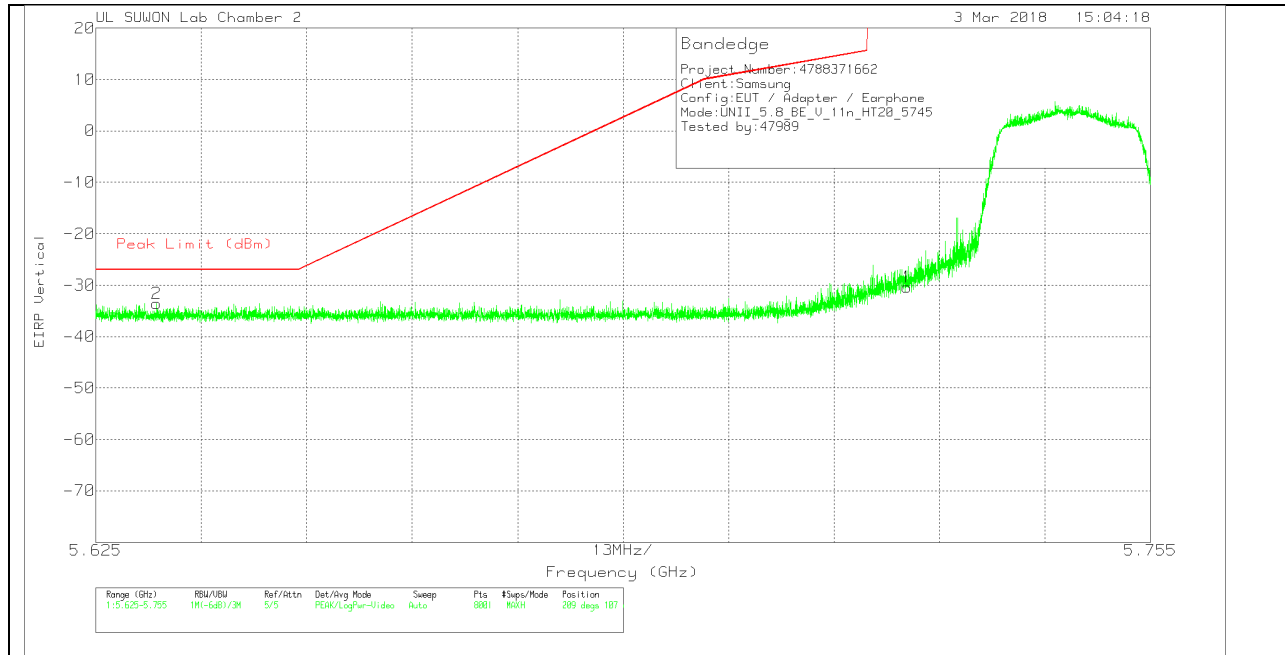

VERTICAL DATA

Trace Markers

Marker	Frequency (GHz)	Meter Reading (dBm)	Det	170531_3117[00 168724]	Path_2_10dB	Conversion Factor (dB)	DC Corr (dB)	Corrected Reading EIRP	Peak Limit (dBm)	PK Margin (dB)	Azimuth (Degs)	Height (cm)	Polarity
1	5.725	-61.03	Pk	34.5	-15.6	11.8	0	-30.33	278.26	-308.59	209	107	V
2	5.633	-64.01	Pk	34.4	-15.7	11.8	0	-33.51	-27	-6.51	209	107	V

Pk - Peak detector

BANDEDGE (HIGH CHANNEL)

HORIZONTAL PEAK AND AVERAGE PLOT

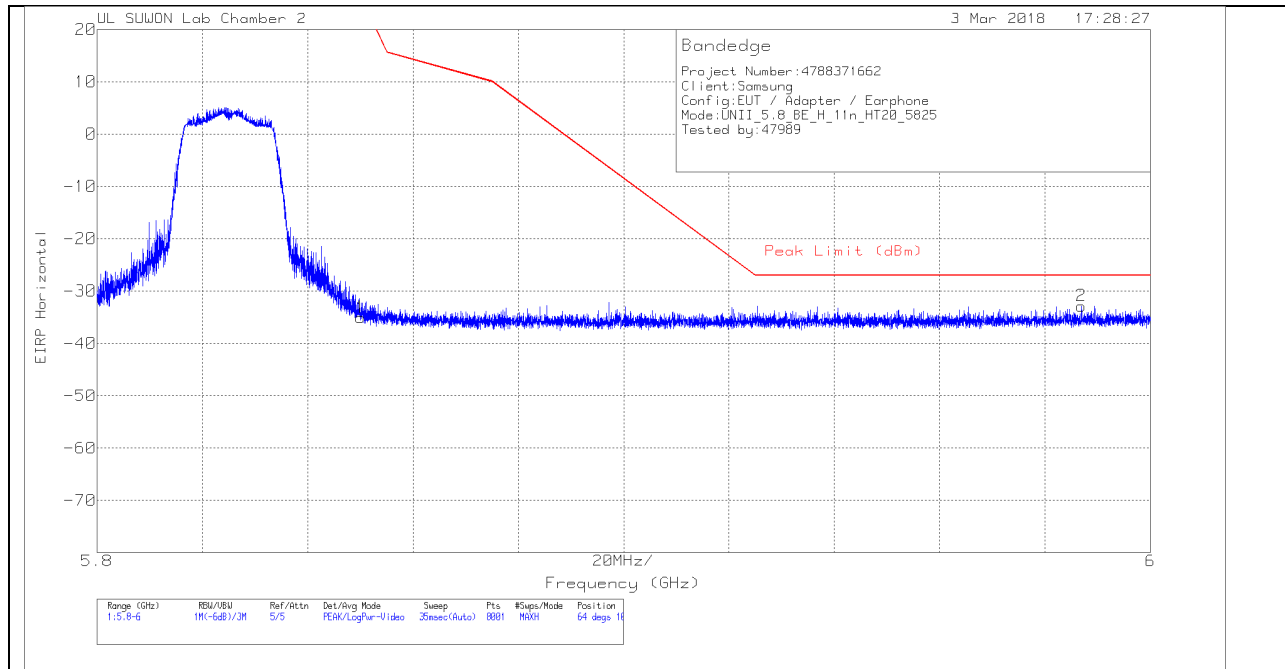

HORIZONTAL DATA

Trace Markers

Marker	Frequency (GHz)	Meter Reading (dBm)	Det	170531_3117[00 168724]	Path_2_10dB	Conversion Factor (dB)	DC Corr (dB)	Corrected Reading EIRP	Peak Limit (dBm)	PK Margin (dB)	Azimuth (Degs)	Height (cm)	Polarity
1	5.85	-65.83	Pk	34.5	-15.5	11.8	0	-35.03	26.94	-61.97	64	100	H
2	5.987	-63.93	Pk	34.7	-15.4	11.8	0	-32.83	-27	-5.83	64	100	H

Pk - Peak detector

VERTICAL PEAK PLOT

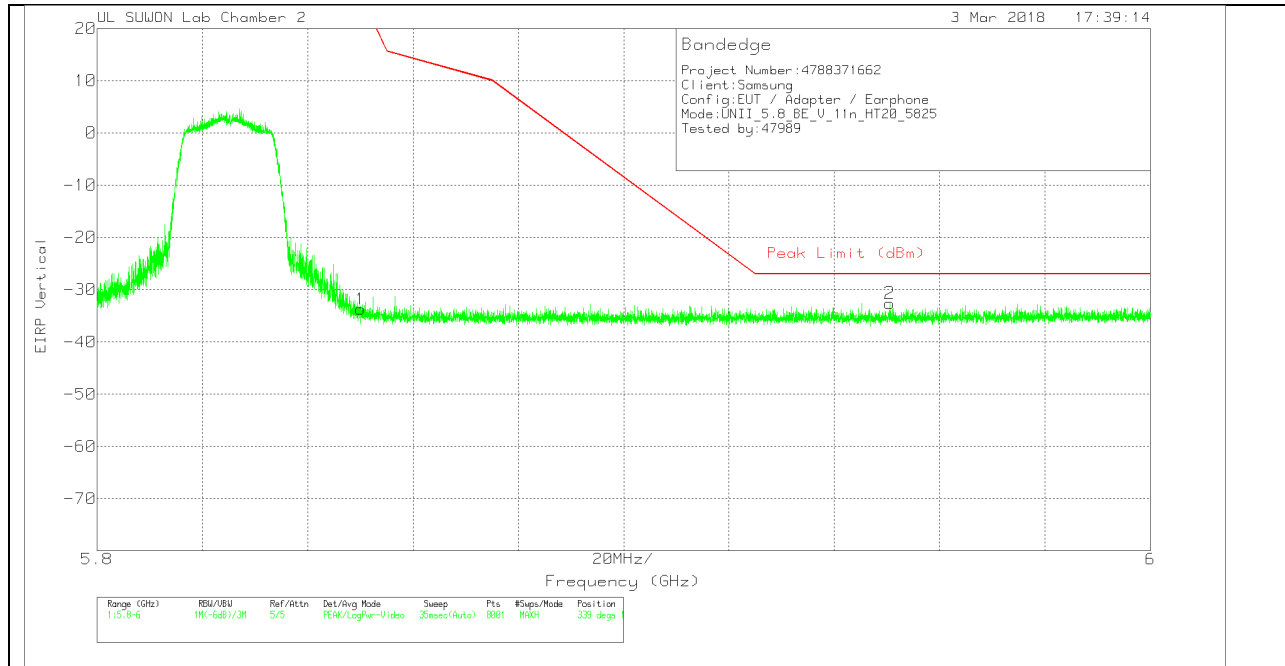

VERTICAL DATA

Trace Markers

Marker	Frequency (GHz)	Meter Reading (dBm)	Det	170531_3117[00 168724]	Path_2_10dB	Conversion Factor (dB)	DC Corr (dB)	Corrected Reading EIRP	Peak Limit (dBm)	PK Margin (dB)	Azimuth (Degs)	Height (cm)	Polarity
1	5.85	-64.55	Pk	34.5	-15.5	11.8	0	-33.75	26.94	-60.69	339	133	V
2	5.951	-63.52	Pk	34.6	-15.5	11.8	0	-32.62	-27	-5.62	339	133	V

Pk - Peak detector

LOW CHANNEL HORIZONTAL

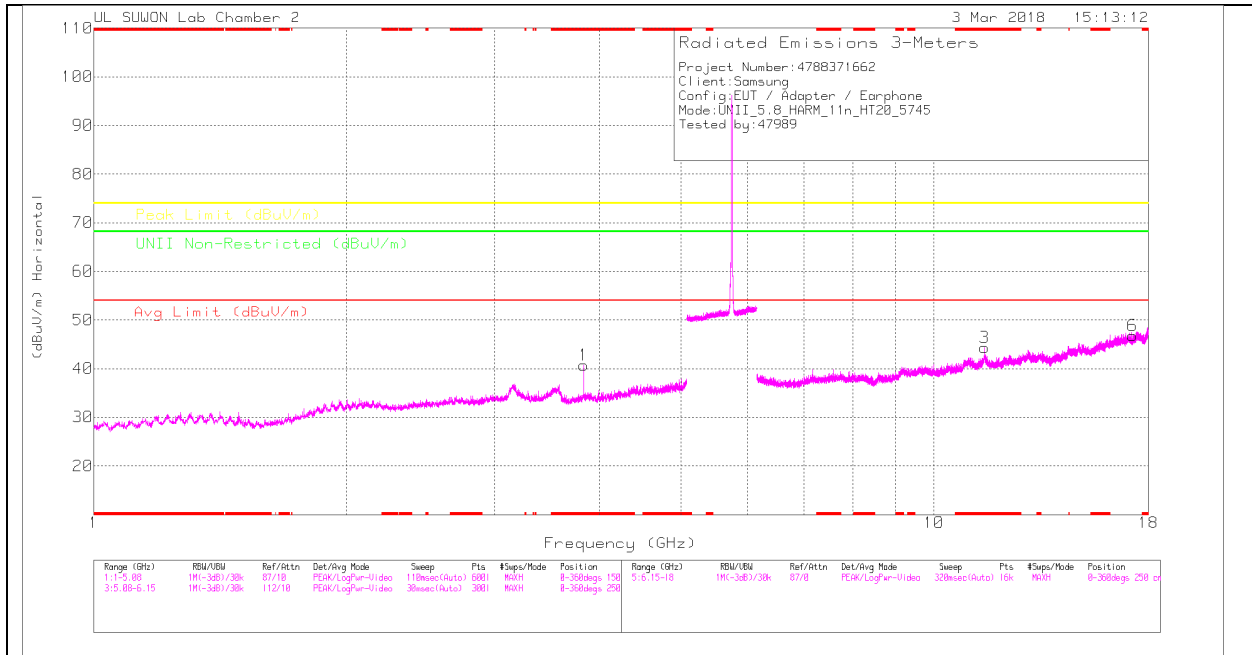

LOW CHANNEL VERTICAL

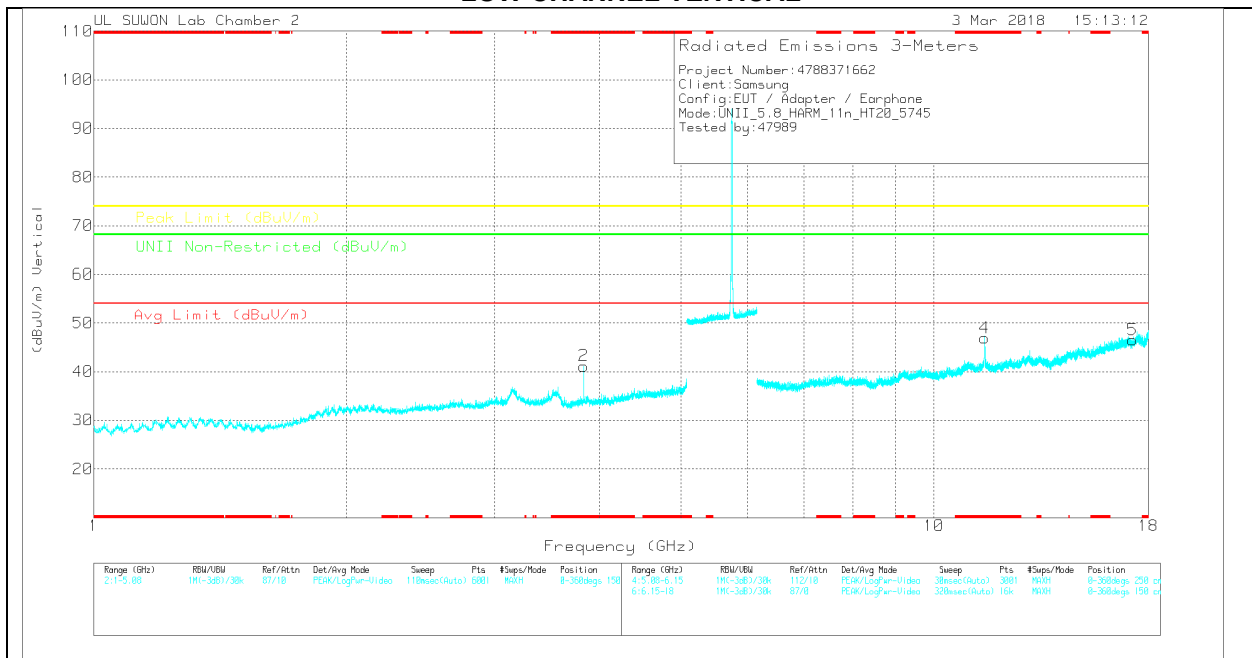

Note: Emission was scanned up to 40GHz; No emissions were detected above the noise floor which was at least 20dB below the specification limit.

LOW CHANNEL DATA

Trace Markers

Marker	Frequency (GHz)	Meter Reading (dBuV)	Det	170531_3117001687 24	SGHz_LF(dB)	DC Corr (dB)	Corrected Reading (dBuV/m)	Avg Limit (dBuV/m)	Margin (dB)	Peak Limit (dBuV/m)	Margin (dB)	U/NII Non-Restricted (dBuV/m)	Margin (dB)	Altitude (Degs)	Height (cm)	Polarity
1	* 3.83	32.56	PK	33.1	-24.9	0	40.76	-	-	74	-33.24	-	-	0-360	150	H
2	* 3.83	32.97	PK	33.1	-24.9	0	41.17	-	-	74	-32.83	-	-	0-360	150	V
3	* 11.491	22.03	PK	38.2	-15.9	0	44.33	-	-	74	-29.67	-	-	0-360	250	H
6	17.247	18.54	PK	41.6	-13.4	0	46.74	-	-	-	-	68.2	-21.46	0-360	250	H
4	* 11.489	24.66	PK	38.2	-15.9	0	46.96	-	-	74	-27.04	-	-	0-360	250	V
5	17.242	18.35	PK	41.6	-13.4	0	46.55	-	-	-	-	68.2	-21.65	0-360	150	V

* - indicates frequency in CFR47 Pt 15 / IC RSS-Restricted Band
 PK – Peak detector

Radiated Emissions

Frequency (GHz)	Meter Reading (dBuV)	Det	170531_311700168724	SGHz_LF(dB)	DC Corr (dB)	Corrected Reading (dBuV/m)	Avg Limit (dBuV/m)	Margin (dB)	Peak Limit (dBuV/m)	Margin (dB)	U/NII Non-Restricted (dBuV/m)	Margin (dB)	Altitude (Degs)	Height (cm)	Polarity
* 3.83	39.42	PK-U	33.1	-25	0	47.52	-	-	74	-26.48	-	-	11	115	H
* 3.83	31.52	ADR	33.1	-24.9	.15	39.87	54	-14.13	-	-	-	-	11	115	H
* 3.83	40.32	PK-U	33.1	-24.9	0	48.52	-	-	74	-25.48	-	-	24	159	V
* 3.83	33.33	ADR	33.1	-25	.15	41.58	54	-12.42	-	-	-	-	24	159	V
* 11.492	19.06	ADR	38.2	-15.9	.15	41.51	54	-12.49	-	-	-	-	270	123	V
* 11.489	20.25	ADR	38.2	-15.9	.15	42.7	54	-11.3	-	-	-	-	296	245	H
* 11.493	32.02	PK-U	38.2	-15.9	0	54.32	-	-	74	-19.68	-	-	270	123	V
* 11.489	33.37	PK-U	38.2	-15.9	0	55.67	-	-	74	-18.33	-	-	296	245	H

* - indicates frequency in CFR47 Pt 15 / IC RSS-Restricted Band
 PK-U - U-NII: Maximum Peak
 ADR - U-NII AD primary method, RMS average

MID CHANNEL HORIZONTAL

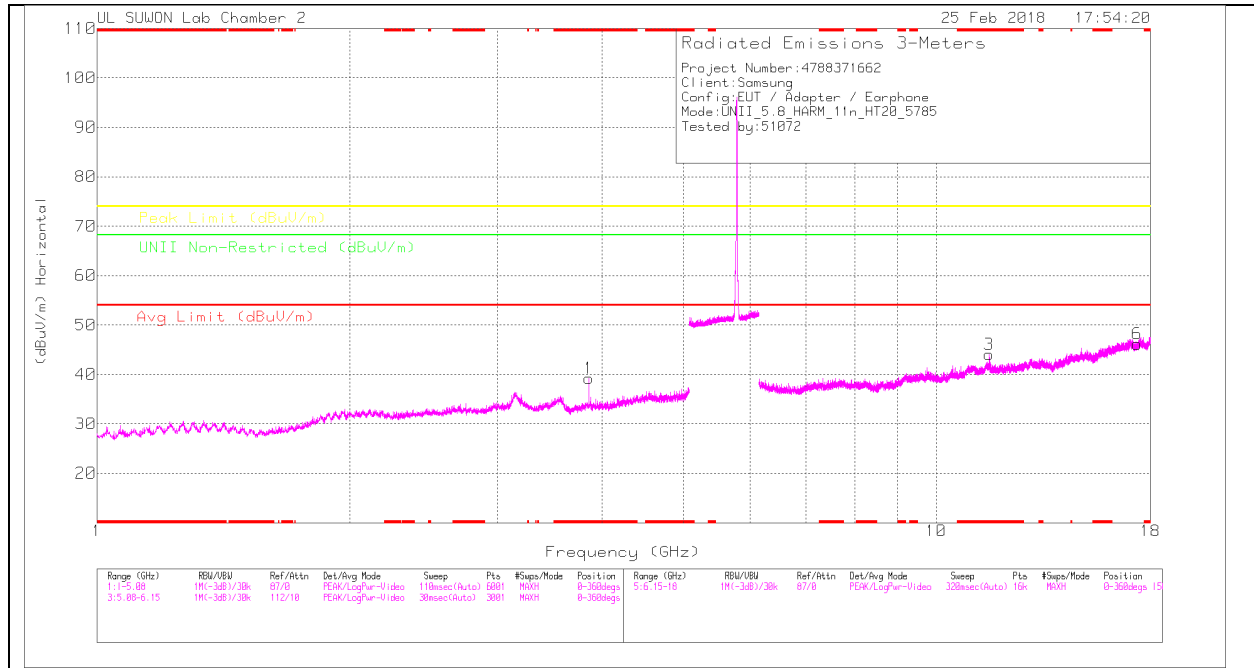

MID CHANNEL VERTICAL

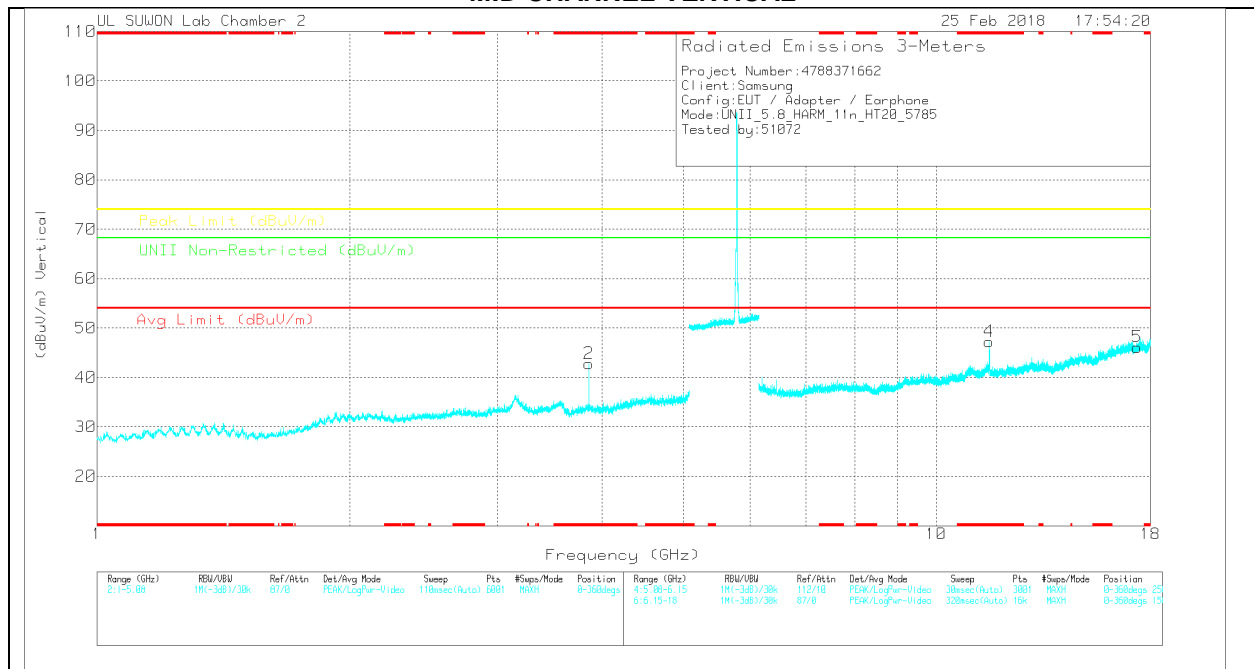

Note: Emission was scanned up to 40GHz; No emissions were detected above the noise floor which was at least 20dB below the specification limit.

MID CHANNEL DATA

Trace Markers

Marker	Frequency (GHz)	Marker Reading (dBuV)	Det	170531_3117(00188724)	SGHz_LF(dB)	DC Corr (dB)	Corrected Reading (dBuV/m)	Avg Limit (dBuV/m)	Margin (dB)	Peak Limit (dBuV/m)	Margin (dB)	U-NII Non-Restricted (dBuV/m)	Margin (dB)	Azimuth (Degs)	Height (cm)	Polarity
1	* 3.857	30.8	Avg	33.1	-24.7	0	39.2	-	-	74	-34.8	-	-	0-360	150	H
2	* 3.857	34.4	Avg	33.1	-24.7	0	42.8	-	-	74	-31.2	-	-	0-360	150	V
3	* 11.57	21.74	Avg	38.2	-15.9	0	44.04	-	-	74	-29.96	-	-	0-360	250	H
6	17.356	18.07	Avg	41.4	-13.3	0	46.17	-	-	-	-	68.2	-22.03	0-360	250	H
4	* 11.57	24.97	Avg	38.2	-15.9	0	47.27	-	-	74	-26.73	-	-	0-360	250	V
5	17.355	18.05	Avg	41.4	-13.3	0	46.15	-	-	-	-	68.2	-22.05	0-360	150	V

* - indicates frequency in CFR47 Pt 15 / IC RSS-Restricted Band
 PK – Peak Detector

Radiated Emissions

Frequency (GHz)	Marker Reading (dBuV)	Det	170531_3117(00188724)	SGHz_LF(dB)	DC Corr (dB)	Corrected Reading (dBuV/m)	Avg Limit (dBuV/m)	Margin (dB)	Peak Limit (dBuV/m)	Margin (dB)	U-NII Non-Restricted (dBuV/m)	Margin (dB)	Azimuth (Degs)	Height (cm)	Polarity
* 3.857	38.74	PK-U	33.1	-24.7	0	47.14	-	-	74	-26.86	-	-	251	343	H
* 3.857	29.69	ADR	33.1	-24.7	-15	38.24	54	-15.76	-	-	-	-	251	343	H
* 3.857	40.44	PK-U	33.1	-24.8	0	48.74	-	-	74	-25.26	-	-	210	115	V
* 3.857	34.09	ADR	33.1	-24.8	-15	42.54	54	-11.46	-	-	-	-	210	115	V
* 11.57	19.23	ADR	38.2	-15.9	-15	41.68	54	-12.32	-	-	-	-	158	277	H
* 11.569	20.04	ADR	38.2	-15.9	-15	42.49	54	-11.51	-	-	-	-	84	120	V
* 11.57	31.84	PK-U	38.2	-15.9	0	54.14	-	-	74	-19.86	-	-	158	277	H
* 11.574	33.05	PK-U	38.2	-15.9	0	55.35	-	-	74	-18.65	-	-	84	120	V

* - indicates frequency in CFR47 Pt 15 / IC RSS-Restricted Band
 PK-U - U-NII: Maximum Peak
 ADR - U-NII AD primary method, RMS average

HIGH CHANNEL HORIZONTAL

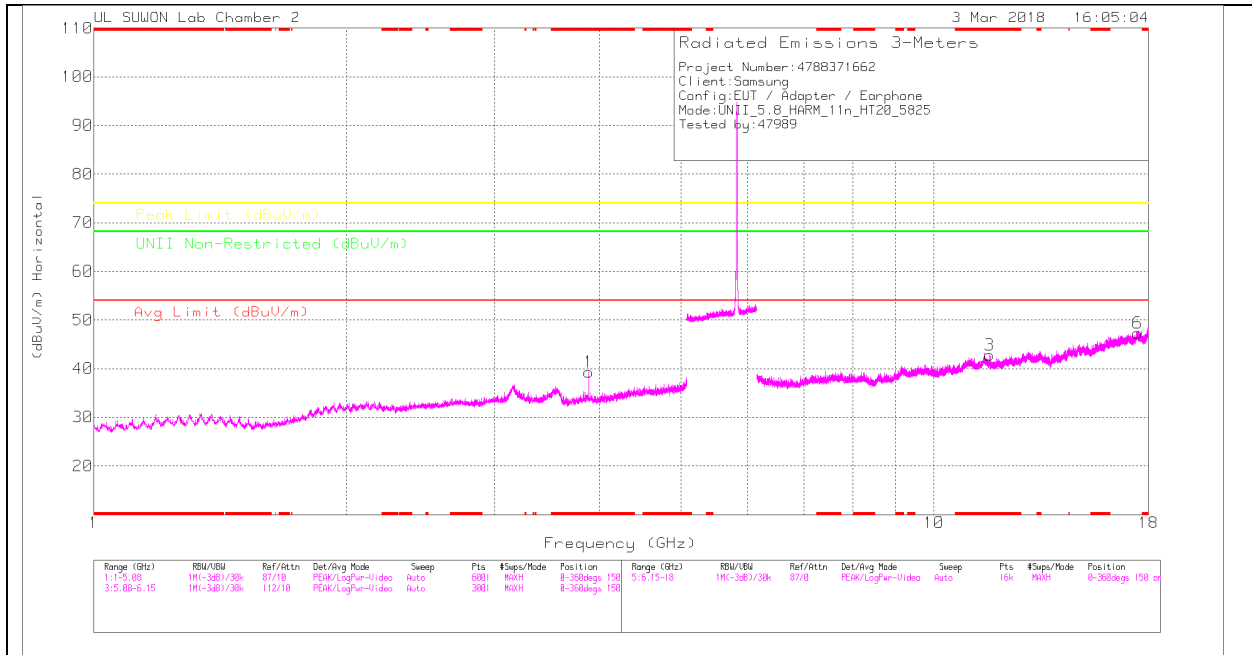

HIGH CHANNEL VERTICAL

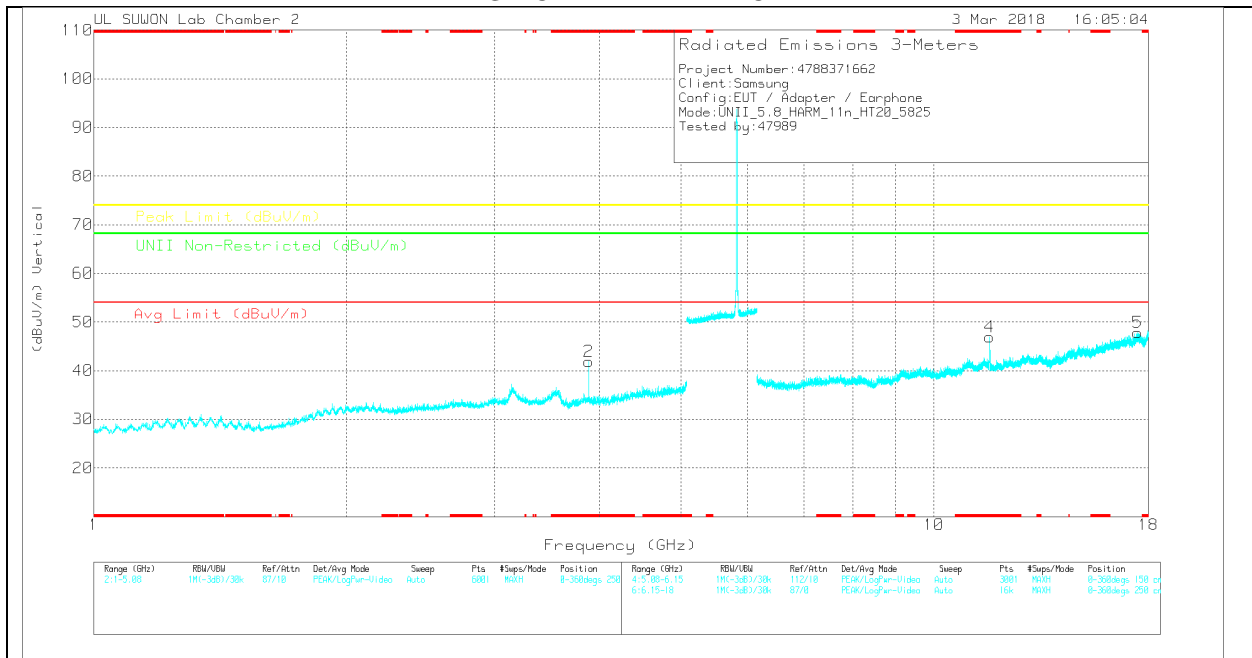

Note: Emission was scanned up to 40GHz; No emissions were detected above the noise floor which was at least 20dB below the specification limit.

HIGH CHANNEL DATA

Trace Markers

Marker	Frequency (GHz)	Meter Reading (dBuV)	Det	170511_3117001687 24)	5GHz_LF(dB)	DC Corr (dB)	Corrected Reading (dBuV/m)	Aug Limit (dBuV/m)	Margin (dB)	Peak Limit (dBuV/m)	Margin (dB)	UNII Non-Restricted (dBuV/m)	Margin (dB)	Azimuth (Degs)	Height (cm)	Polarity
1	* 3.883	30.9	PK	33.1	-24.7	0	39.3	-	-	74	-34.7	-	-	0-360	150	H
2	* 3.884	33.48	PK	33.1	-24.7	0	41.88	-	-	74	-32.12	-	-	0-360	150	V
3	* 11.65	20.4	PK	38.1	-15.7	0	42.8	-	-	74	-31.2	-	-	0-360	250	H
6	17.474	18.16	PK	41.3	-12.2	0	47.26	-	-	-	-	68.2	-20.94	0-360	250	H
4	* 11.65	24.57	PK	38.1	-15.7	0	46.97	-	-	74	-27.03	-	-	0-360	250	V
5	17.472	18.79	PK	41.3	-12.3	0	47.79	-	-	-	-	68.2	-20.41	0-360	250	V

* - indicates frequency in CFR47 Pt 15 / IC RSS-Restricted Band
 PK – Peak detector

Radiated Emissions

Frequency (GHz)	Meter Reading (dBuV)	Det	170511_311700168724)	5GHz_LF(dB)	DC Corr (dB)	Corrected Reading (dBuV/m)	Aug Limit (dBuV/m)	Margin (dB)	Peak Limit (dBuV/m)	Margin (dB)	UNII Non-Restricted (dBuV/m)	Margin (dB)	Azimuth (Degs)	Height (cm)	Polarity
* 3.883	39.24	PK-U	33.1	-24.7	0	47.54	-	-	74	-26.36	-	-	9	175	H
* 3.883	30.78	ADR	33.1	-24.7	15	39.33	54	-14.67	-	-	-	-	9	175	H
* 3.883	40.74	PK-U	33.1	-24.7	0	49.14	-	-	74	-24.86	-	-	23	188	V
* 3.883	33.71	ADR	33.1	-24.7	15	42.26	54	-11.74	-	-	-	-	23	188	V
* 11.648	18.82	ADR	38.1	-15.7	15	41.37	54	-12.63	-	-	-	-	270	113	V
* 11.651	18.19	ADR	38.1	-15.7	15	40.74	54	-13.26	-	-	-	-	44	180	H
* 11.648	31.31	PK-U	38.1	-15.7	0	53.71	-	-	74	-20.29	-	-	270	113	V
* 11.653	30.91	PK-U	38.1	-15.8	0	53.21	-	-	74	-20.79	-	-	44	180	H

* - indicates frequency in CFR47 Pt 15 / IC RSS-Restricted Band
 PK-U - U-NII: Maximum Peak
 ADR - U-NII AD primary method, RMS average

11.4.3. TX ABOVE 1GHz 802.11n HT40 MODE IN THE 5.8GHz BAND BANDEDGE (LOW CHANNEL)

HORIZONTAL PEAK PLOT

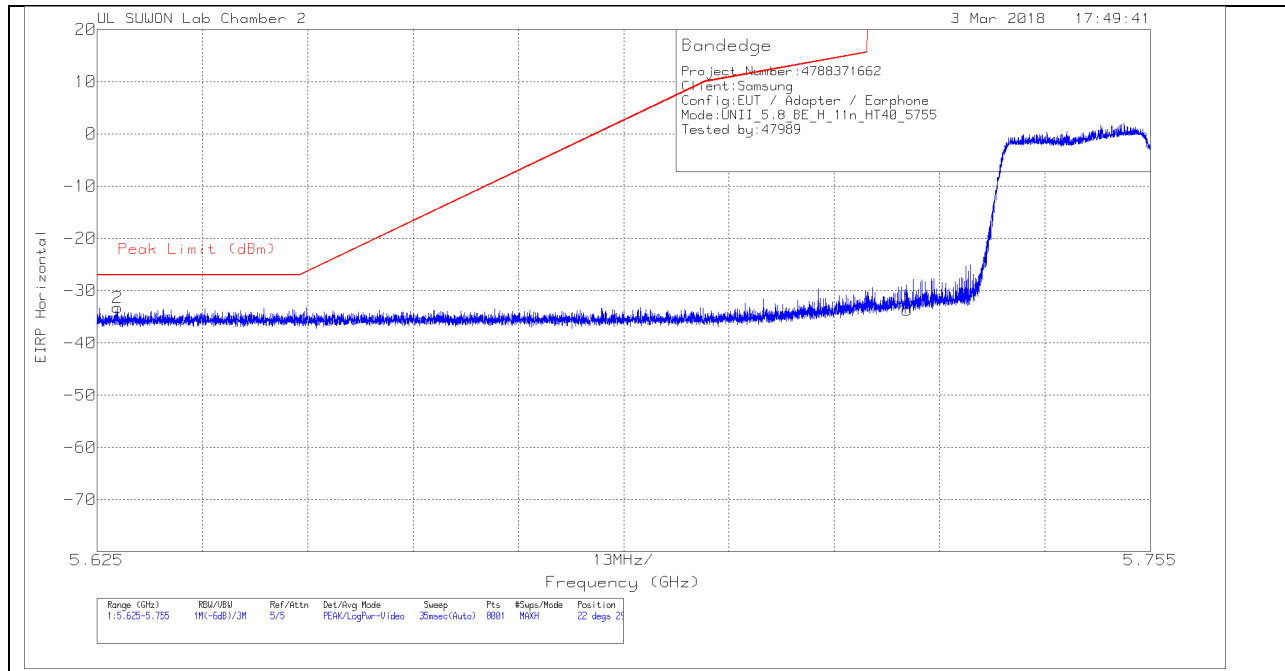

HORIZONTAL DATA

Trace Markers

Marker	Frequency (GHz)	Meter Reading (dBm)	Det	170531_3117[00 168724]	Path_2_10dB	Conversion Factor (dB)	DC Corr (dB)	Corrected Reading EIRP	Peak Limit (dBm)	PK Margin (dB)	Azimuth (Degs)	Height (cm)	Polarity
1	5.725	-64.35	Pk	34.5	-15.6	11.8	0	-33.65	278.26	-311.91	22	291	H
2	5.628	-63.76	Pk	34.4	-15.7	11.8	0	-33.26	-27	-6.26	22	291	H

Pk - Peak detector

VERTICAL PEAK PLOT

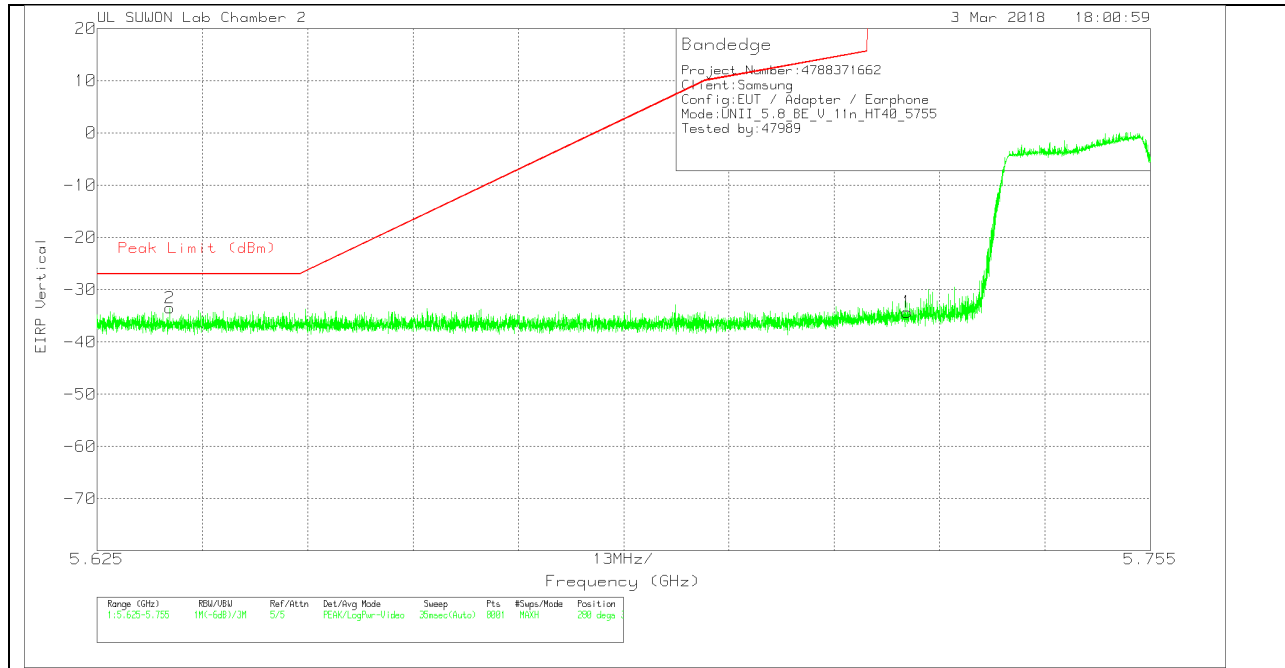

VERTICAL DATA

Trace Markers

Marker	Frequency (GHz)	Meter Reading (dBm)	Det	170531_3117[00 168724]	Path_2_10dB	Conversion Factor (dB)	DC Corr (dB)	Corrected Reading EIRP	Peak Limit (dBm)	PK Margin (dB)	Azimuth (Degs)	Height (cm)	Polarity
1	5.725	-64.99	Pk	34.5	-15.6	11.8	0	-34.29	278.26	-312.55	280	386	V
2	5.634	-63.99	Pk	34.4	-15.7	11.8	0	-33.49	-27	-6.49	280	386	V

Pk - Peak detector

BANDEDGE (HIGH CHANNEL)

HORIZONTAL PEAK PLOT

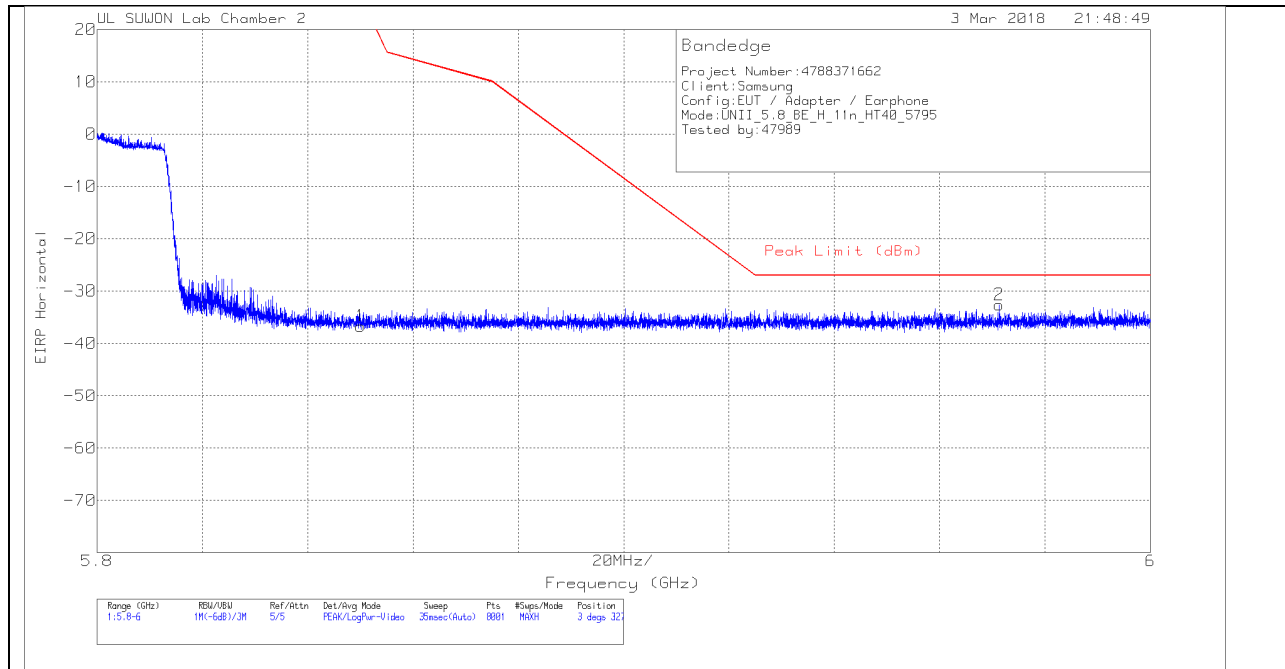

HORIZONTAL DATA

Trace Markers

Marker	Frequency (GHz)	Meter Reading (dBm)	Det	170531_3117[00 168724]	Path_2_10dB	Conversion Factor (dB)	DC Corr (dB)	Corrected Reading EIRP	Peak Limit (dBm)	PK Margin (dB)	Azimuth (Degs)	Height (cm)	Polarity
1	5.85	-67.48	Pk	34.5	-15.5	11.8	0	-36.68	26.94	-63.62	3	327	H
2	5.971	-63.71	Pk	34.7	-15.4	11.8	0	-32.61	-27	-5.61	3	327	H

Pk - Peak detector

VERTICAL PEAK PLOT

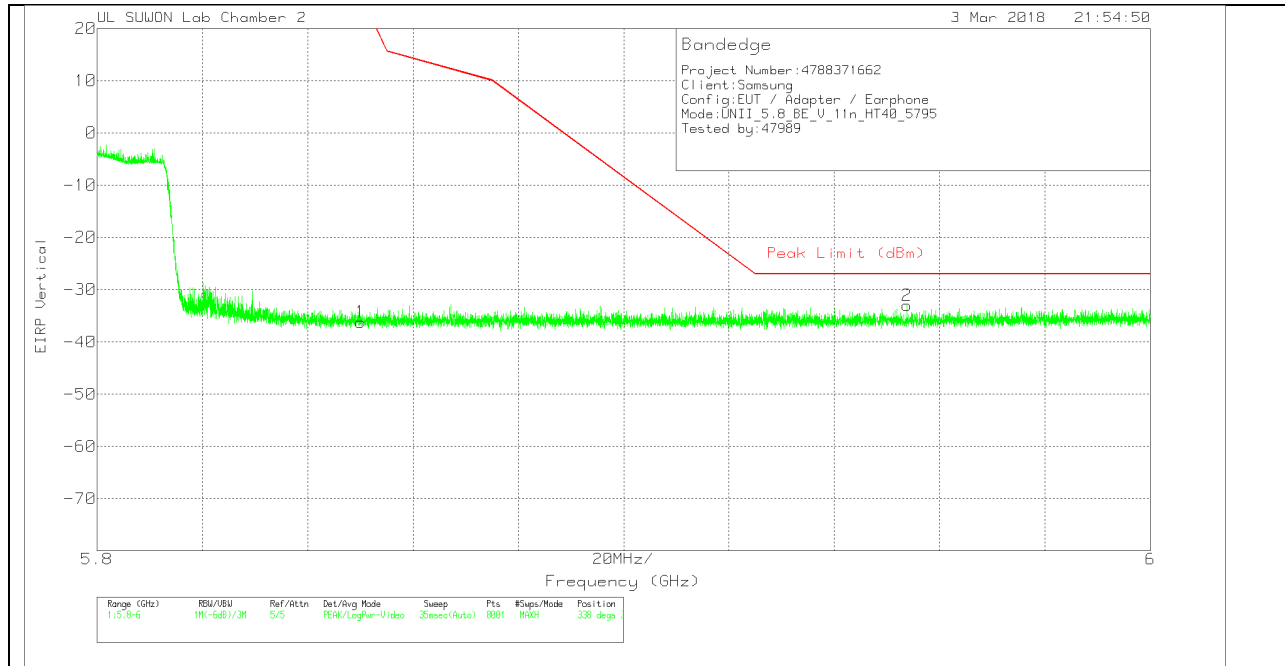

VERTICAL DATA

Trace Markers

Marker	Frequency (GHz)	Meter Reading (dBm)	Det	170531_3117[00 168724]	Path_2_10dB	Conversion Factor (dB)	DC Corr (dB)	Corrected Reading EIRP	Peak Limit (dBm)	PK Margin (dB)	Azimuth (Degs)	Height (cm)	Polarity
1	5.85	-67.02	Pk	34.5	-15.5	11.8	0	-36.22	26.94	-63.16	338	394	V
2	5.954	-63.93	Pk	34.6	-15.5	11.8	0	-33.03	-27	-6.03	338	394	V

Pk - Peak detector

LOW CHANNEL HORIZONTAL

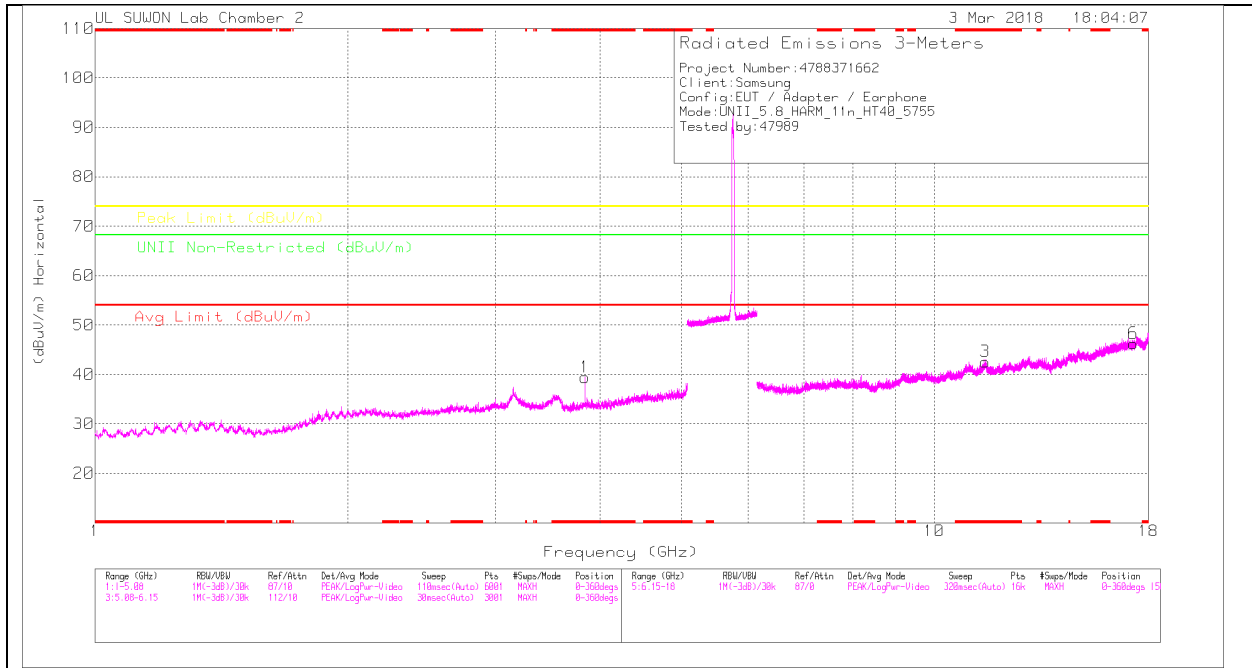

LOW CHANNEL VERTICAL

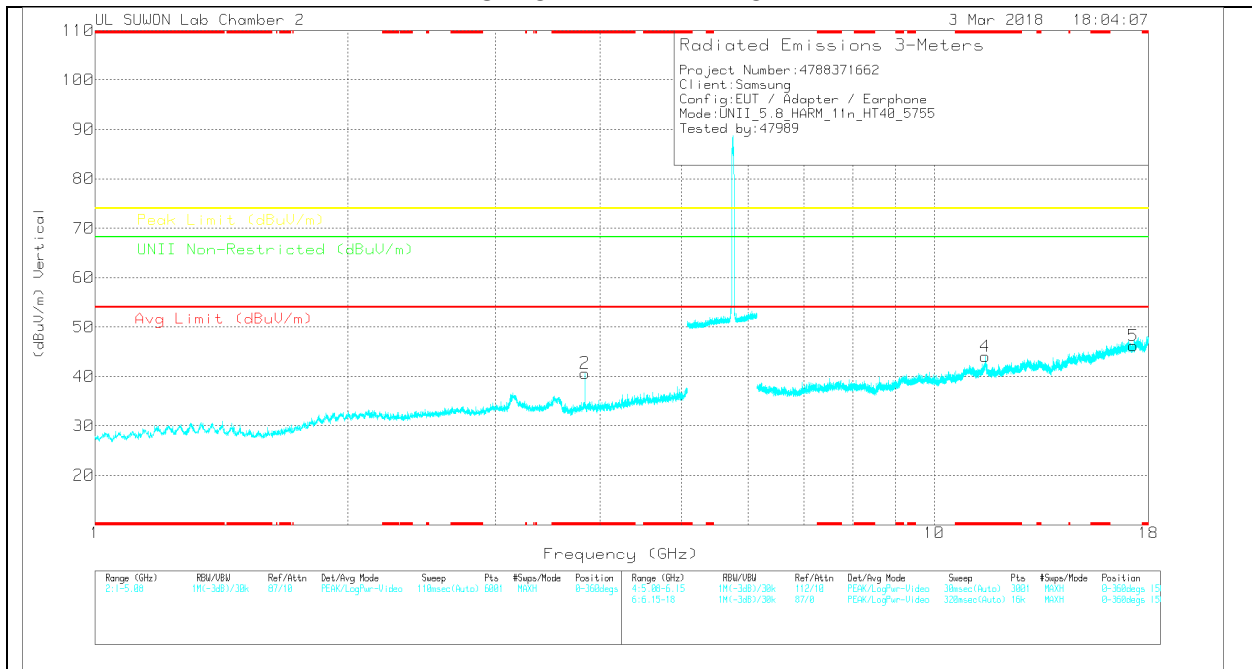

Note: Emission was scanned up to 40GHz; No emissions were detected above the noise floor which was at least 20dB below the specification limit.

LOW CHANNEL DATA

Trace Markers

Marker	Frequency (GHz)	Meter Reading (dBuV)	Det	170531_3117001687 24	SGHz_LF(dB)	DC Corr (dB)	Corrected Reading (dBuV/m)	Avg Limit (dBuV/m)	Margin (dB)	Peak Limit (dBuV/m)	Margin (dB)	UNI Non-Restricted (dBuV/m)	Margin (dB)	Altitude (Degs)	Height (cm)	Polarity
1	* 3.837	31.23	PK	33.1	-24.9	0	39.43	-	-	74	-34.57	-	-	0-360	150	H
2	* 3.837	32.45	PK	33.1	-24.9	0	40.65	-	-	74	-33.35	-	-	0-360	150	V
3	* 11.508	20.29	PK	38.2	-15.9	0	42.59	-	-	74	-31.41	-	-	0-360	250	H
6	17.265	18.15	PK	41.5	-13.4	0	46.25	-	-	-	-	68.2	-21.95	0-360	150	H
4	* 11.51	21.74	PK	38.2	-15.9	0	44.04	-	-	74	-29.96	-	-	0-360	250	V
5	17.262	17.99	PK	41.6	-13.4	0	46.19	-	-	-	-	68.2	-22.01	0-360	250	V

* - indicates frequency in CFR47 Pt 15 / IC RSS-Restricted Band
 PK – Peak detector

Radiated Emissions

Frequency (GHz)	Meter Reading (dBuV)	Det	170531_311700168724	SGHz_LF(dB)	DC Corr (dB)	Corrected Reading (dBuV/m)	Avg Limit (dBuV/m)	Margin (dB)	Peak Limit (dBuV/m)	Margin (dB)	UNI Non-Restricted (dBuV/m)	Margin (dB)	Altitude (Degs)	Height (cm)	Polarity
* 3.837	38.68	PK-U	33.1	-24.9	0	46.88	-	-	74	-27.12	-	-	51	195	H
* 3.837	29.56	ADR	33.1	-24.9	.3	38.06	54	-15.94	-	-	-	-	51	195	H
* 3.837	39.64	PK-U	33.1	-24.9	0	47.84	-	-	74	-26.16	-	-	24	155	V
* 3.837	32.56	ADR	33.1	-24.9	.3	41.06	54	-12.94	-	-	-	-	24	155	V
* 11.506	19.82	ADR	38.2	-15.8	.3	42.52	54	-11.48	-	-	-	-	349	100	V
* 11.506	18.52	ADR	38.2	-15.8	.3	41.22	54	-12.78	-	-	-	-	297	261	H
* 11.507	32.36	PK-U	38.2	-15.9	0	54.66	-	-	74	-19.34	-	-	349	100	V
* 11.507	30.68	PK-U	38.2	-15.9	0	52.98	-	-	74	-21.02	-	-	297	261	H

* - indicates frequency in CFR47 Pt 15 / IC RSS-Restricted Band
 PK-U - U-NII: Maximum Peak
 ADR - U-NII AD primary method, RMS average

HIGH CHANNEL HORIZONTAL

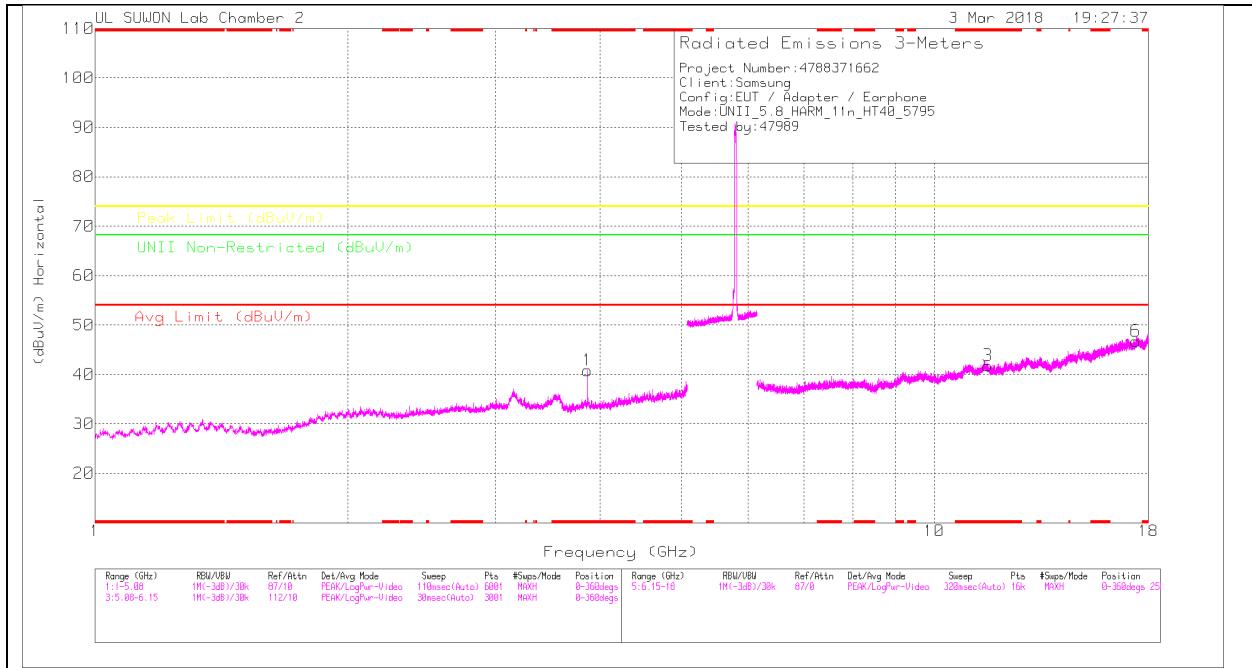

HIGH CHANNEL VERTICAL

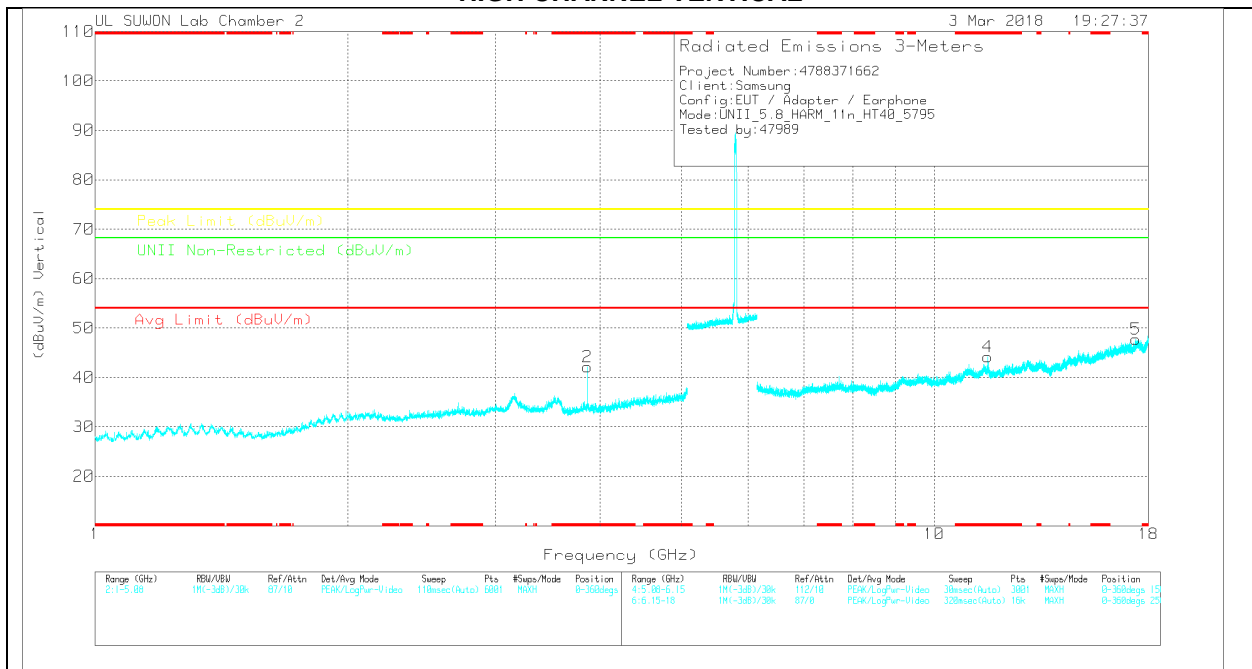

Note: Emission was scanned up to 40GHz; No emissions were detected above the noise floor which was at least 20dB below the specification limit.

HIGH CHANNEL DATA

Trace Markers

Marker	Frequency (GHz)	Meter Reading (dBuV)	Det	170931_3117(00188724)	5GHz_UF(dB)	DC Corr (dB)	Corrected Reading (dBuV/m)	Avg Limit (dBuV/m)	Margin (dB)	Peak Limit (dBuV/m)	Margin (dB)	UNII Non-Restricted (dBuV/m)	Margin (dB)	Altitude (Degs)	Height (cm)	Polarity
1	* 3.863	32.41	PK	33.1	-24.7	0	40.81	-	-	74	-33.19	-	-	0-360	150	H
2	* 3.863	33.75	PK	33.1	-24.7	0	42.15	-	-	74	-31.85	-	-	0-360	150	V
3	* 11.584	19.38	PK	38.2	-15.8	0	41.78	-	-	74	-32.22	-	-	0-360	250	H
6	17.389	18.47	PK	41.3	-13	0	46.77	-	-	-	-	68.2	-21.43	0-360	150	H
4	* 11.591	21.86	PK	38.2	-15.9	0	44.16	-	-	74	-29.84	-	-	0-360	250	V
5	17.393	19.41	PK	41.3	-13	0	47.71	-	-	-	-	68.2	-20.49	0-360	150	V

* - indicates frequency in CFR47 Pt 15 / IC RSS-Restricted Band
 PK – Peak detector

Radiated Emissions

Frequency (GHz)	Meter Reading (dBuV)	Det	170931_3117(00188724)	5GHz_UF(dB)	DC Corr (dB)	Corrected Reading (dBuV/m)	Avg Limit (dBuV/m)	Margin (dB)	Peak Limit (dBuV/m)	Margin (dB)	UNII Non-Restricted (dBuV/m)	Margin (dB)	Altitude (Degs)	Height (cm)	Polarity
* 3.863	39.84	PK-U	33.1	-24.7	0	48.24	-	-	74	-25.76	-	-	348	132	H
* 3.863	32.37	ADR	33.1	-24.7	.3	41.07	54	-12.93	-	-	-	-	348	132	H
* 3.863	40	PK-U	33.1	-24.7	0	48.4	-	-	74	-25.6	-	-	31	171	V
* 3.863	33.94	ADR	33.1	-24.7	.3	42.64	54	-11.36	-	-	-	-	31	171	V
* 11.589	20.65	ADR	38.2	-15.9	.3	43.25	54	-10.75	-	-	-	-	9	100	V
* 11.588	17.87	ADR	38.2	-15.9	.3	40.47	54	-13.53	-	-	-	-	53	181	H
* 11.584	33.4	PK-U	38.2	-15.8	0	55.8	-	-	74	-18.2	-	-	9	100	V
* 11.591	30.58	PK-U	38.2	-15.9	0	52.88	-	-	74	-21.12	-	-	53	181	H

* - indicates frequency in CFR47 Pt 15 / IC RSS-Restricted Band
 PK-U - U-NII: Maximum Peak
 ADR - U-NII AD primary method, RMS average

12. WORST-CASE BELOW 1 GHz

SPURIOUS EMISSIONS 30 TO 1000 MHz (WORST-CASE CONFIGURATION, HORIZONTAL)

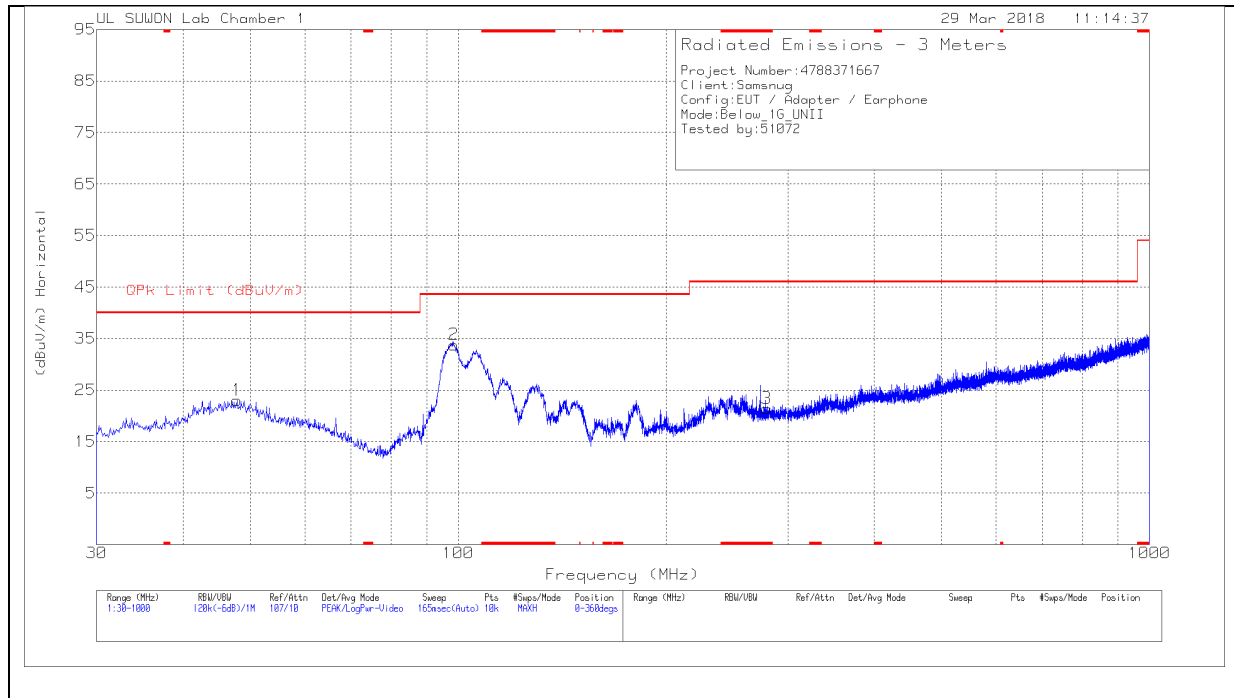

SPURIOUS EMISSIONS 30 TO 1000 MHz (WORST-CASE CONFIGURATION, VERTICAL)

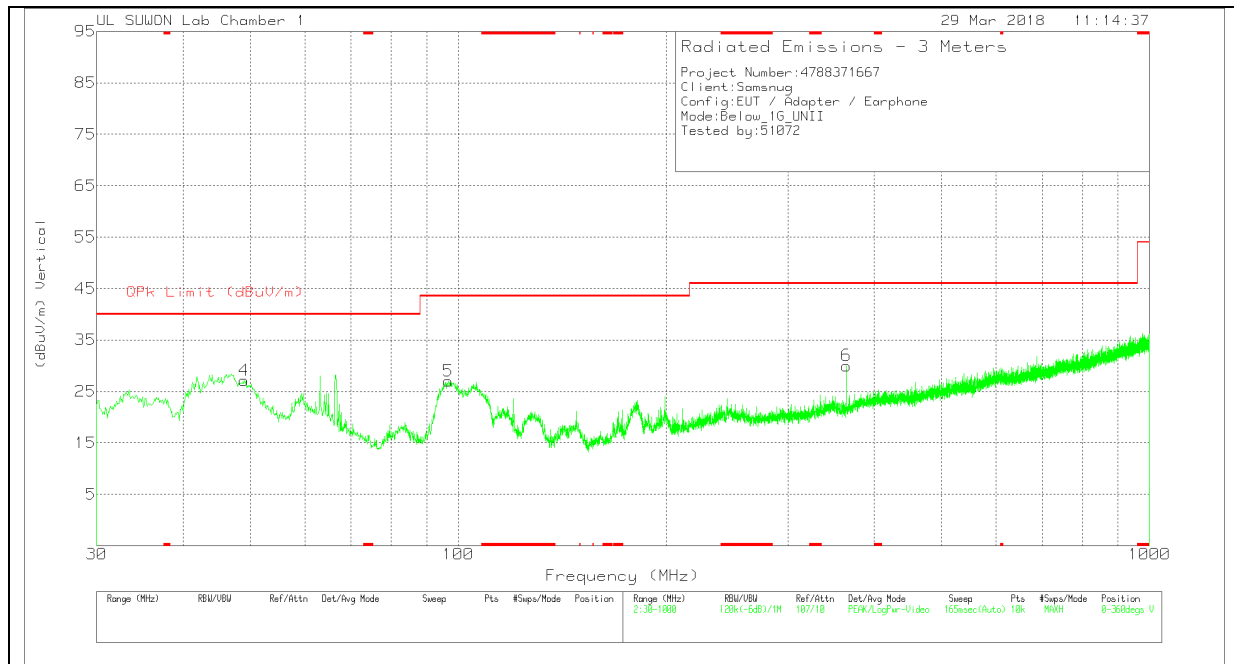

Below 1G Data

Trace Markers

Marker	Frequency (MHz)	Meter Reading (dBuV)	Det	750_20170831	30-1000MHz[dB]	DC Corr (dB)	Corrected Reading (dBuV/m)	QPk Limit (dBuV/m)	Margin (dB)	Azimuth (Degs)	Height (cm)	Polarity
1	47.848	32.82	Pk	19.8	-29.6	0	23.02	40	-16.98	0-360	400	H
2	98.579	45.09	Pk	17.2	-28.5	0	33.79	43.52	-9.73	0-360	300	H
3	* 279.193	29.82	Pk	18.7	-27.1	0	21.42	46.02	-24.6	0-360	100	H
4	49.012	36.85	Pk	19.9	-29.6	0	27.15	40	-12.85	0-360	100	V
5	96.736	38.53	Pk	17	-28.5	0	27.03	43.52	-16.49	0-360	100	V
6	364.747	36.21	Pk	20.3	-26.5	0	30.01	46.02	-16.01	0-360	100	V

* - indicates frequency in CFR47 Pt 15 / IC RSS-Restricted Band

Pk - Peak detector

13. AC POWER LINE CONDUCTED EMISSIONS

LIMITS

FCC §15.207 (a)

Frequency of Emission (MHz)	Conducted Limit (dBuV)	
	Quasi-peak	Average
0.15-0.5	66 to 56	56 to 46
0.5-5	56	46
5-30	60	50

*Decreases with the logarithm of the frequency.

TEST PROCEDURE

The EUT is placed on a non-conducting table 40 cm from the vertical ground plane and 80 cm above the horizontal ground plane. The EUT is configured in accordance with ANSI C63.10.

The receiver is set to a resolution bandwidth of 9 kHz. Peak detection is used unless otherwise noted as quasi-peak or average.

Line conducted data is recorded for both NEUTRAL and HOT lines.

RESULTS

6 WORST EMISSIONS

LINE 1 PLOT

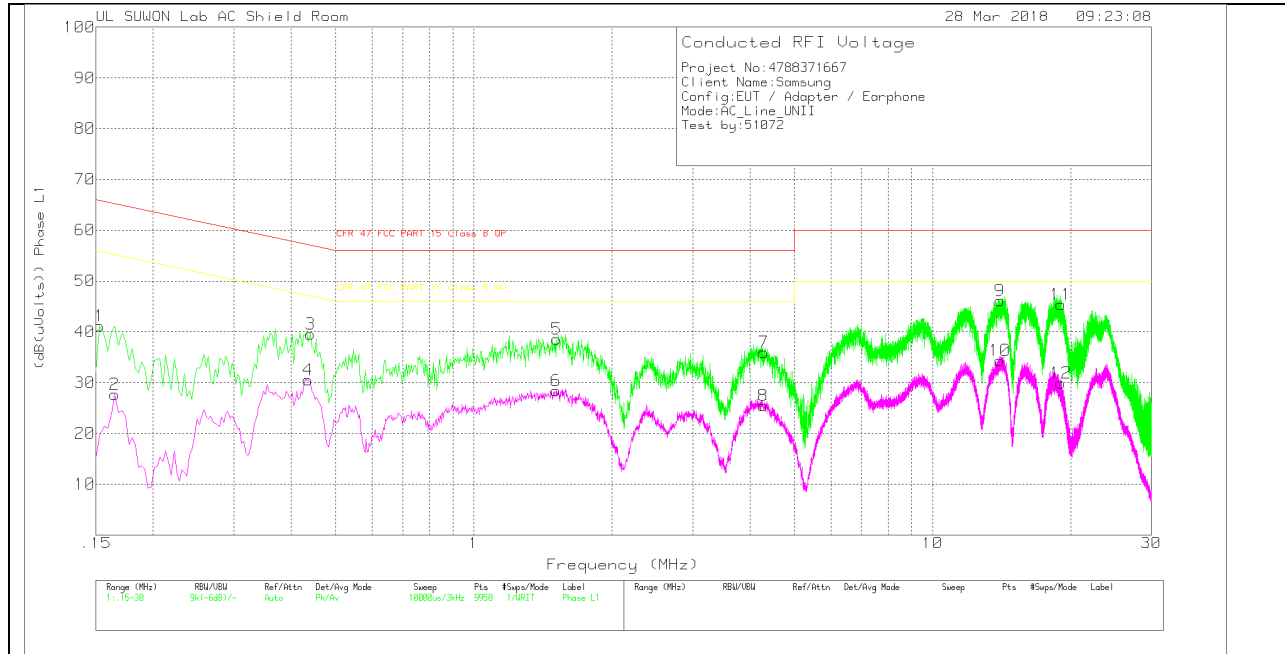

LINE 1 RESULTS

Trace Markers

Range 1: Phase L1 .15 - 30MHz

Marker	Frequency (MHz)	Meter Reading (dBuV)	Det	101837_L1_with extension	CABLELOSS(dB)	Corrected Reading (dB(uVolts))	CFR 47 FCC PART 15 Class B QP	Margin (dB)	CFR 47 FCC PART 15 Class B AV	Margin (dB)
1	.153	31.06	Pk	10	.1	41.16	65.84	-24.68	-	-
2	.165	17.59	Av	10	.1	27.69	-	-	55.21	-27.52
3	.441	29.68	Pk	9.7	.2	39.58	57.04	-17.46	-	-
4	.435	20.61	Av	9.7	.2	30.51	-	-	47.16	-16.65
5	1.518	28.37	Pk	9.9	.3	38.57	56	-17.43	-	-
6	1.512	18.25	Av	9.9	.3	28.45	-	-	46	-17.55
7	4.284	25.95	Pk	9.7	.3	35.95	56	-20.05	-	-
8	4.272	15.42	Av	9.7	.3	25.42	-	-	46	-20.58
9	14.013	35.92	Pk	9.8	.4	46.12	60	-13.88	-	-
10	14.028	24.15	Av	9.8	.4	34.35	-	-	50	-15.65
11	19.047	34.92	Pk	10	.4	45.32	60	-14.68	-	-
12	19.038	19.47	Av	10	.4	29.87	-	-	50	-20.13

Pk - Peak detector

Av - Average detection

Quasi-Peak Emissions

Range 1: Phase L1 .15 - 30MHz

Frequency (MHz)	Meter Reading (dBuV)	Det	101837_L1_with extension	CABLELOSS(dB)	Corrected Reading (dB(uVolts))	CFR 47 FCC PART 15 Class B QP	Margin (dB)	CFR 47 FCC PART 15 Class B AV	Margin (dB)
.15375	23.62	Qp	10	.1	33.72	65.79	-32.07	-	-
.16575	27.35	Qp	10	.1	37.45	65.17	-27.72	-	-
.44025	25.86	Qp	9.7	.2	35.76	57.06	-21.3	-	-
.43425	26.53	Qp	9.7	.2	36.43	57.17	-20.74	-	-
1.51725	24.3	Qp	9.9	.3	34.5	56	-21.5	-	-
1.51125	24.34	Qp	9.9	.3	34.54	56	-21.46	-	-
4.28475	22.37	Qp	9.7	.3	32.37	56	-23.63	-	-
4.27125	22.55	Qp	9.7	.3	32.55	56	-23.45	-	-
14.0138	31.37	Qp	9.8	.4	41.57	60	-18.43	-	-
14.0273	31.41	Qp	9.8	.4	41.61	60	-18.39	-	-
19.0463	30.08	Qp	10	.4	40.48	60	-19.52	-	-
19.0373	29.95	Qp	10	.4	40.35	60	-19.65	-	-

Qp - Quasi-Peak detector

LINE 2 PLOT

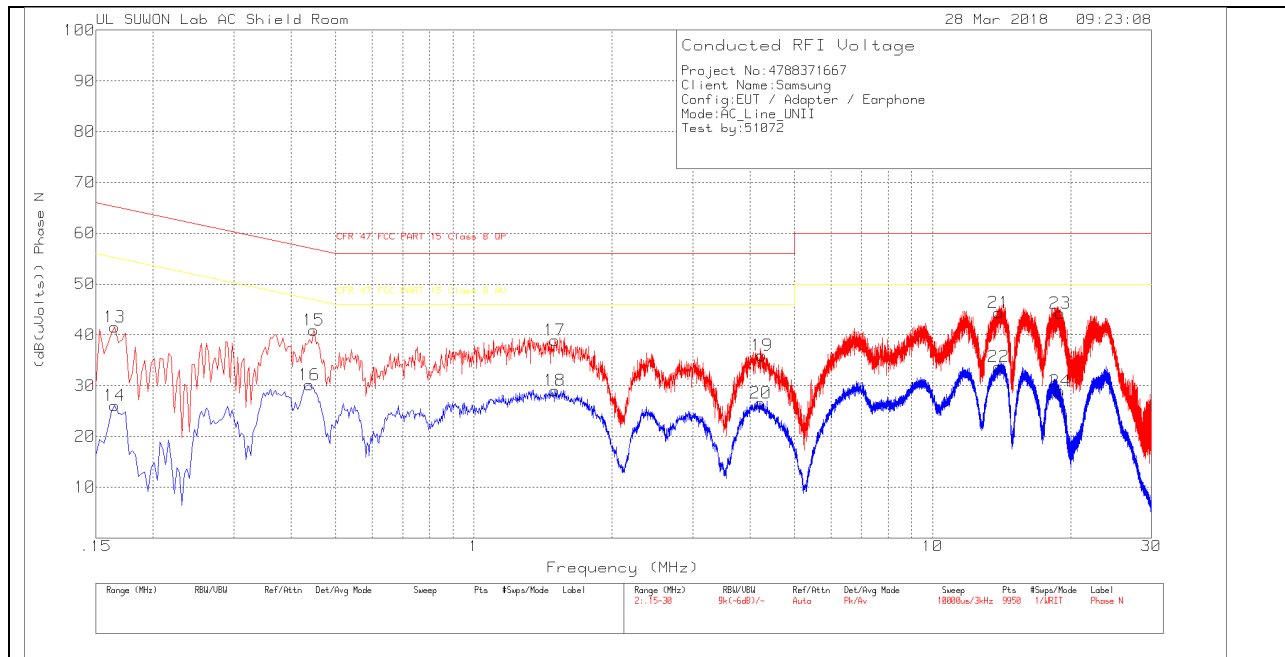

LINE 2 RESULTS

Trace Markers

Range 2: Phase N .15 - 30MHz

Marker	Frequency (MHz)	Meter Reading (dBuV)	Det	101837_N_with extension	CABLELOSS(dB)	Corrected Reading (dB(uVolts))	CFR 47 FCC PART 15 Class B QP	Margin (dB)	CFR 47 FCC PART 15 Class B AV	Margin (dB)
13	.165	31.42	Pk	10	.1	41.52	65.21	-23.69	-	-
14	.165	15.96	Av	10	.1	26.06	-	-	55.21	-29.15
15	.447	30.96	Pk	9.8	.2	40.96	56.93	-15.97	-	-
16	.438	20.15	Av	9.8	.2	30.15	-	-	47.1	-16.95
17	1.503	28.7	Pk	9.9	.3	38.9	56	-17.1	-	-
18	1.503	18.83	Av	9.9	.3	29.03	-	-	46	-16.97
19	4.245	25.84	Pk	9.8	.3	35.94	56	-20.06	-	-
20	4.227	16.42	Av	9.8	.3	26.52	-	-	46	-19.48
21	13.941	34.15	Pk	9.8	.4	44.35	60	-15.65	-	-
22	13.926	23.57	Av	9.8	.4	33.77	-	-	50	-16.23
23	18.987	33.89	Pk	10	.4	44.29	60	-15.71	-	-
24	18.969	18.52	Av	10	.4	28.92	-	-	50	-21.08

Pk - Peak detector
 Av - Average detection

Quasi-Peak Emissions

Range 2: Phase N .15 - 30MHz

Frequency (MHz)	Meter Reading (dBuV)	Det	101837_N_with extension	CABLELOSS(dB)	Corrected Reading (dB(uVolts))	CFR 47 FCC PART 15 Class B QP	Margin (dB)	CFR 47 FCC PART 15 Class B AV	Margin (dB)
.16575	27.28	Qp	10	.1	37.38	65.17	-27.79	-	-
.44625	26.26	Qp	9.8	.2	36.26	56.94	-20.68	-	-
.43875	26.99	Qp	9.8	.2	36.99	57.09	-20.1	-	-
1.50315	24.58	Qp	9.9	.3	34.78	56	-21.22	-	-
4.24515	21.83	Qp	9.8	.3	31.93	56	-24.07	-	-
4.22775	21.78	Qp	9.8	.3	31.88	56	-24.12	-	-
13.9403	30.21	Qp	9.8	.4	40.41	60	-19.59	-	-
13.9262	30.26	Qp	9.8	.4	40.46	60	-19.54	-	-
18.9878	28.75	Qp	10	.4	39.15	60	-20.85	-	-
18.9692	28.8	Qp	10	.4	39.2	60	-20.8	-	-

Qp - Quasi-Peak detector

14. DYNAMIC FREQUENCY SELECTION

14.1. OVERVIEW

14.1.1. LIMITS

FCC

§15.407 (h), FCC KDB 905462 D02 "COMPLIANCE MEASUREMENT PROCEDURES FOR UNLICENSED-NATIONAL INFORMATION INFRASTRUCTURE DEVICES OPERATING IN THE 5250-5350 MHz AND 5470-5725 MHz BANDS INCORPORATING DYNAMIC FREQUENCY SELECTION" and KDB 905462 D03 "U-NII CLIENT DEVICES WITHOUT RADAR DETECTION CAPABILITY".

Table 1: Applicability of DFS requirements prior to use of a channel

Requirement	Operational Mode		
	Master	Client (without radar detection)	Client (with radar detection)
Non-Occupancy Period	Yes	Not required	Yes
DFS Detection Threshold	Yes	Not required	Yes
Channel Availability Check Time	Yes	Not required	Not required
U-NII Detection Bandwidth	Yes	Not required	Yes

Table 2: Applicability of DFS requirements during normal operation

Requirement	Operational Mode		
	Master	Client (without DFS)	Client (with DFS)
DFS Detection Threshold	Yes	Not required	Yes
Channel Closing Transmission Time	Yes	Yes	Yes
Channel Move Time	Yes	Yes	Yes
U-NII Detection Bandwidth	Yes	Not required	Yes

Additional requirements for devices with multiple bandwidth modes	Master Device or Client with Radar DFS	Client (without DFS)
U-NII Detection Bandwidth and Statistical Performance Check	All BW modes must be tested	Not required
Channel Move Time and Channel Closing Transmission Time	Test using widest BW mode available	Test using the widest BW mode available for the link
All other tests	Any single BW mode	Not required
Note: Frequencies selected for statistical performance check (Section 7.8.4) should include several frequencies within the radar detection bandwidth and frequencies near the edge of the radar detection bandwidth. For 802.11 devices it is suggested to select frequencies in all 20 MHz channel blocks and a null frequency between the bonded 20 MHz channel blocks.		

Table 3: Interference Threshold values, Master or Client incorporating In-Service Monitoring

Maximum Transmit Power	Value (see notes)
E.I.R.P. \geq 200 mill watt	-64 dBm
E.I.R.P. < 200 mill watt and power spectral density < 10 dBm/MHz	-62 dBm
E.I.R.P. < 200 mill watt that do not meet power spectral density requirement	-64 dBm
<p>Note 1: This is the level at the input of the receiver assuming a 0 dBi receive antenna</p> <p>Note 2: Throughout these test procedures an additional 1 dB has been added to the amplitude of the test transmission waveforms to account for variations in measurement equipment. This will ensure that the test signal is at or above the detection threshold level to trigger a DFS response.</p> <p>Note 3: E.I.R.P. is based on the highest antenna gain. For MIMO devices refer to KDB publication 662911 D01.</p>	

Table 4: DFS Response requirement values

Parameter	Value
<i>Non-occupancy period</i>	30 minutes
<i>Channel Availability Check Time</i>	60 seconds
<i>Channel Move Time</i>	10 seconds (See Note 1)
<i>Channel Closing Transmission Time</i>	200 milliseconds + approx. 60 milliseconds over remaining 10 second period. (See Notes 1 and 2)
<i>U-NII Detection Bandwidth</i>	Minimum 100% of the U-NII 99% transmission power bandwidth. (See Note 3)
<p>Note 1: <i>Channel Move Time</i> and the <i>Channel Closing Transmission Time</i> should be performed with Radar Type 0. The measurement timing begins at the end of the Radar Type 0 burst.</p> <p>Note 2: The <i>Channel Closing Transmission Time</i> is comprised of 200 milliseconds starting at the beginning of the <i>Channel Move Time</i> plus any additional intermittent control signals required to facilitate a <i>Channel</i> move (an aggregate of 60 milliseconds) during the remainder of the 10 second period. The aggregate duration of control signals will not count quiet periods in between transmissions.</p> <p>Note 3: During the <i>U-NII Detection Bandwidth</i> detection test, radar type 0 should be used. For each frequency step the minimum percentage of detection is 90 percent. Measurements are performed with no data traffic.</p>	

Table 5 – Short Pulse Radar Test Waveforms

Radar Type	Pulse Width (usec)	PRI (usec)	Pulses	Minimum Percentage of Successful Detection	Minimum Trials
0	1	1428	18	See Note 1	See Note 1
1	1	Test A: 15 unique PRI values randomly selected from the list of 23 PRI values in table 5a	Roundup: $\{(1/360) \times (19 \times 10^6 \text{ PRI}_{\text{usec}})\}$	60%	30
		Test B: 15 unique PRI values randomly selected within the range of 518-3066 usec. With a minimum increment of 1 usec, excluding PRI values selected in Test A			
2	1-5	150-230	23-29	60%	30
3	6-10	200-500	16-18	60%	30
4	11-20	200-500	12-16	60%	30
Aggregate (Radar Types 1-4)				80%	120
Note 1: Short Pulse Radar Type 0 should be used for the <i>Detection Bandwidth</i> test, <i>Channel Move Time</i> , and <i>Channel Closing Time</i> tests.					

Table 6 – Long Pulse Radar Test Signal

Radar Waveform Type	Pulse Width (µsec)	Chirp Width (MHz)	PRI (µsec)	Pulses per Burst	Number of Bursts	Minimum Percentage of Successful Detection	Minimum Trials
5	50-100	5-20	1000-2000	1-3	8-20	80%	30

Table 7 – Frequency Hopping Radar Test Signal

Radar Waveform Type	Pulse Width (µsec)	PRI (µsec)	Pulses per Hop	Hopping Rate (kHz)	Hopping Sequence Length (msec)	Minimum Percentage of Successful Detection	Minimum Trials
6	1	333	9	0.333	300	70%	30

14.1.1. TEST AND MEASUREMENT SYSTEM

CONDUCTED METHOD SYSTEM BLOCK DIAGRAM

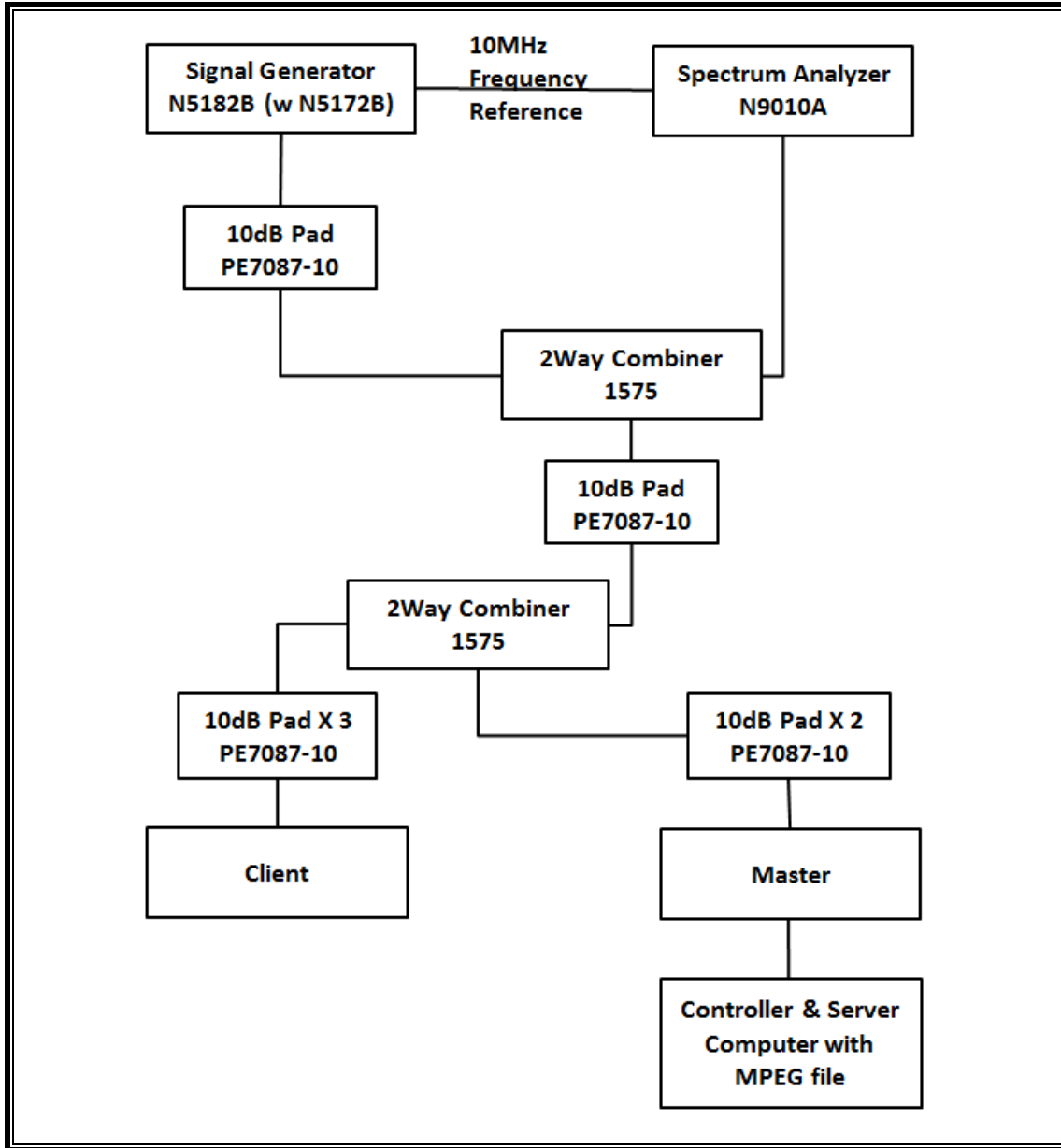

SYSTEM OVERVIEW

The short pulse and long pulse signal generating system utilizes the Keysite Signal Studio for Pulse Building as N5172B. The Vector Signal Generator has been validated by the NTIA. The hopping signal generating system utilizes the CCS simulated hopping method and system, which has been validated by the DoD, FCC and NTIA. The software selects waveform parameters from within the bounds of the signal type on a random basis using uniform distribution.

The short pulse types 1, 2, 3 and 4, and the long pulse type 5 parameters are randomized at run-time.

The hopping type 6 pulse parameters are fixed while the hopping sequence is based on the August 2005 NTIA Hopping Frequency List. The initial starting point randomized at run-time and each subsequent starting point is incremented by 475. Each frequency in the 100-length segment is compared to the boundaries of the EUT Detection Bandwidth and the software creates a hopping burst pattern in accordance with Section 7.4.1.3 Method #2 Simulated Frequency Hopping Radar Waveform Generating Subsystem of KDB 905462 D02. The frequency of the signal generator is incremented in 1 MHz steps from F_L to F_H for each successive trial. This incremental sequence is repeated as required to generate a minimum of 30 total trials and to maintain a uniform frequency distribution over the entire Detection Bandwidth.

The signal monitoring equipment consists of a spectrum analyzer. The aggregate ON time is calculated by multiplying the number of bins above a threshold during a particular observation period by the dwell time per bin, with the analyzer set to peak detection and max hold.

SYSTEM CALIBRATION

A 50-ohm load is connected in place of the spectrum analyzer, and the spectrum analyzer is connected to a horn antenna via a coaxial cable, with the reference level offset set to (horn antenna gain – coaxial cable loss). The signal generator is set to CW mode. The amplitude of the signal generator is adjusted to yield a level of –64 dBm as measured on the spectrum analyzer.

Without changing any of the instrument settings, the spectrum analyzer is reconnected to the Common port of the Spectrum Analyzer Combiner/Divider. The Reference Level Offset of the spectrum analyzer is adjusted so that the displayed amplitude of the signal is –64 dBm.

The spectrum analyzer displays the level of the signal generator as received at the antenna ports of the Master Device. The interference detection threshold may be varied from the calibrated value of –64 dBm and the spectrum analyzer will still indicate the level as received by the Master Device.

ADJUSTMENT OF DISPLAYED TRAFFIC LEVEL

A link is established between the Master and Slave and the distance between the units is adjusted as needed to provide a suitable received level at the Master and Slave devices. The video test file is streamed to generate WLAN traffic. The monitoring antenna is adjusted so that the WLAN traffic level, as displayed on the spectrum analyzer, is at lower amplitude than the radar detection threshold.

TEST AND MEASUREMENT EQUIPMENT

The following test and measurement equipment was utilized for the DFS tests documented in this report:

TEST EQUIPMENT LIST				
Description	Manufacturer	Model	S/N	Cal Due
Spectrum Analyzer, 7 GHz	Agilent / HP	N9010A	MY54200580	08-07-18
Vector Signal Generator, 6GHz	Agilent / HP	N5182B	MY53051241	08-07-18

14.1.2. SETUP OF EUT

CONDUCTED METHOD EUT TEST SETUP

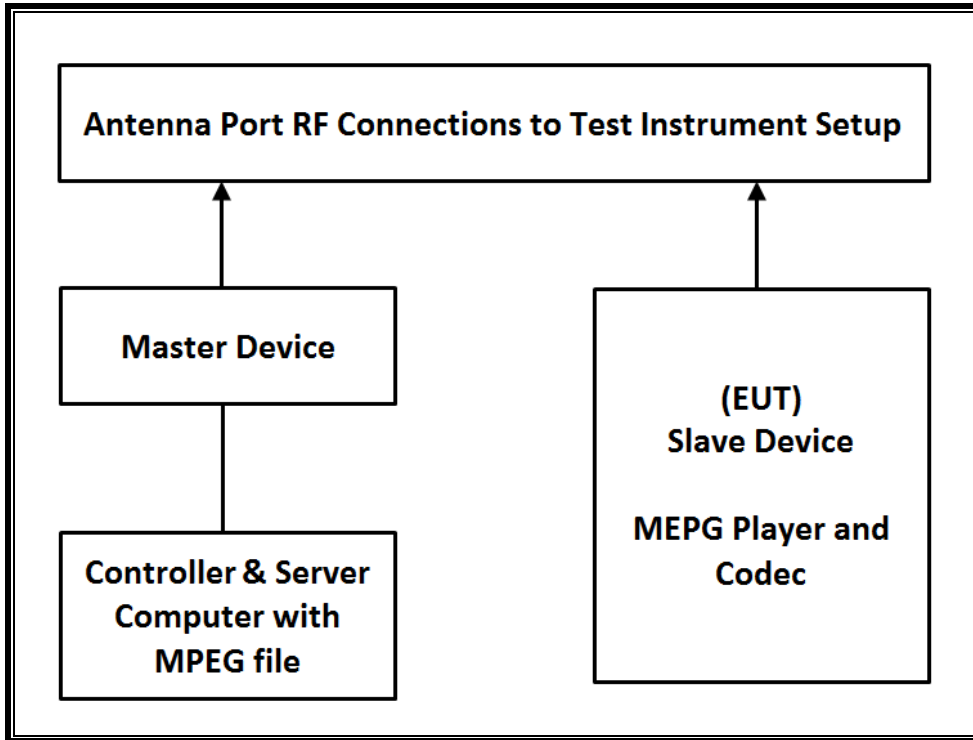

SUPPORT EQUIPMENT

The following support equipment was utilized for the DFS tests documented in this report:

PERIPHERAL SUPPORT EQUIPMENT LIST				
Description	Manufacturer	Model	Serial Number	FCC ID
Wireless Access Point	Cisco	AIR-CAP3702E-A-K9	FTX182276QX	LDK102087
PC (Controller/Server)	HP	HP EliteDesk 800 G1 TWR	CZC4125J25	DoC

14.1.3. DESCRIPTION OF EUT

The EUT operates over the 5250-5350 MHz and 5470-5725 MHz ranges.

The EUT is a Slave Device without Radar Detection.

The highest power level within these bands is 16.40 dBm in the 5250-5350 MHz band and 16.29 dBm in the 5470-5725 MHz band.

The antenna gain assembly utilized with the EUT are -1.74 dBi in the 5250-5350 MHz band and -1.74 dBi in the 5470-5725 MHz band.

The rated output power of the Master unit is > 23dBm (EIRP). Therefore the required interference threshold level is -64 dBm. After correction for procedural adjustments, the required conducted threshold at the antenna port is $-64 + 1 = -63$ dBm.

The calibrated radiated DFS Detection Threshold level is set to -64 dBm. The tested level is lower than the required level hence it provides a margin to the limit.

The EUT uses one transmitter/receiver chain connected to an antenna to perform radiated tests.

WLAN traffic that meets or exceeds the minimum required loading was generated by transferring a data stream from the controller/server PC to the EUT using iPerf version 2.0.5 software package.

TPC is not required since the maximum EIRP is less than 500 mW (27 dBm).

The EUT utilizes the 802.11a/n architecture. Two nominal channel bandwidths are implemented: 20 MHz and 40 MHz.

The software installed in the access point is 12.4(25d)JA1.

UNIFORM CHANNEL SPREADING

This requirement is not applicable to Slave radio devices.

OVERVIEW OF MASTER DEVICE WITH RESPECT TO §15.407 (h) REQUIREMENTS

The Master Device is a Cisco Access Point, FCC ID: LDK102087. The minimum antenna gain for the Master Device is 6 dBi.

The rated output power of the Master unit is > 23dBm (EIRP). Therefore the required interference threshold level is -64 dBm. After correction for procedural adjustments, the required radiated threshold at the antenna port is $-64 + 1 = -63$ dBm.

The calibrated radiated DFS Detection Threshold level is set to -64 dBm. The tested level is lower than the required level hence it provides a margin to the limit.

14.2. RESULTS FOR 20 MHz BANDWIDTH

14.2.1. TEST CHANNEL

All tests were performed at a channel center frequency of 5500 MHz.

14.2.2. RADAR WAVEFORM AND TRAFFIC

RADAR WAVEFORM

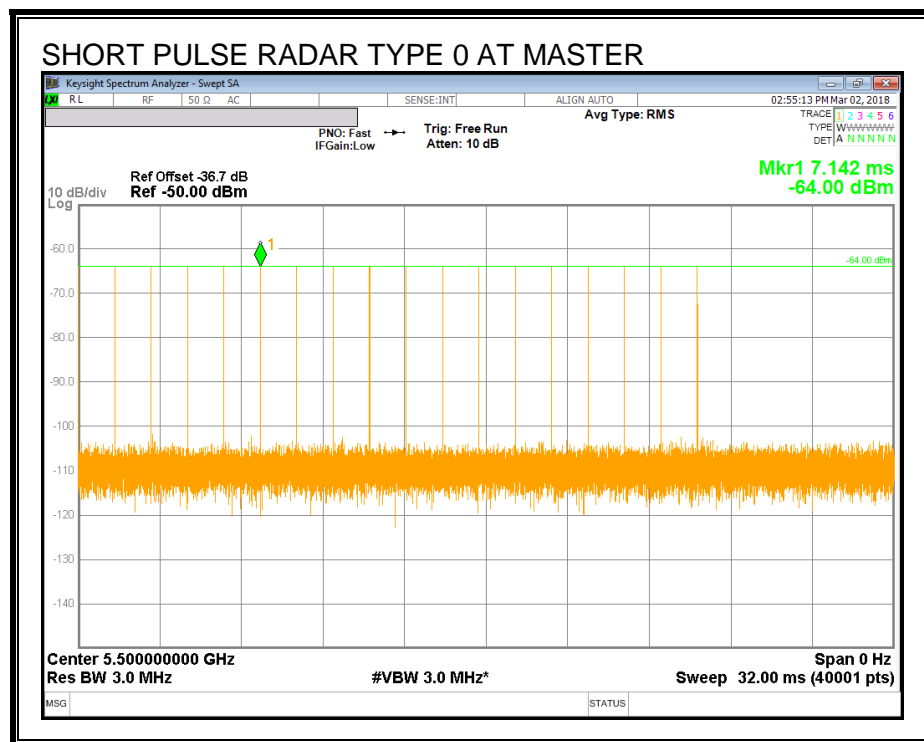

TRAFFIC

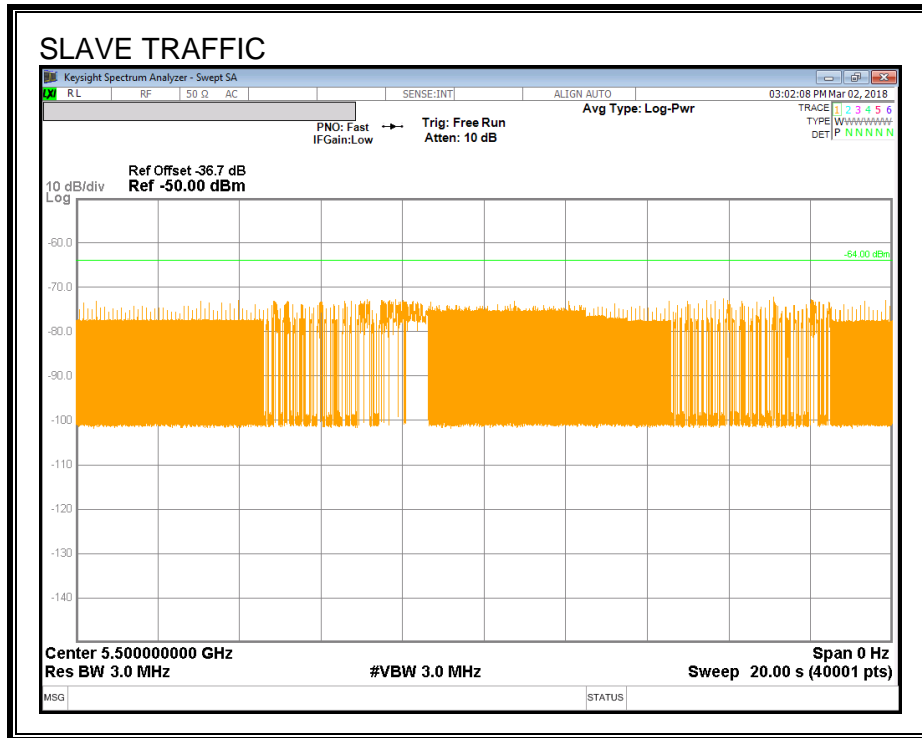

14.2.3. OVERLAPPING CHANNEL TESTS

RESULTS

These tests are not applicable.

14.2.4. MOVE AND CLOSING TIME

REPORTING NOTES

The reference marker is set at the end of last radar pulse.

The delta marker is set at the end of the last WLAN transmission following the radar pulse. This delta is the channel move time.

The aggregate channel closing transmission time is calculated as follows:

Aggregate Transmission Time =
(Number of analyzer bins showing transmission) * (dwell time per bin)

The observation period over which the aggregate time is calculated begins at (Reference Marker + 200 msec) and ends no earlier than (Reference Marker + 10 sec).

RESULTS

Channel Move Time (sec)	Limit (sec)
0.769	10

Aggregate Channel Closing Transmission Time (msec)	Limit (msec)
3.375	60

MOVE TIME & CHANNEL CLOSING TIME

AGGREGATE CHANNEL CLOSING TRANSMISSION TIME

No transmissions are observed during the aggregate monitoring period.

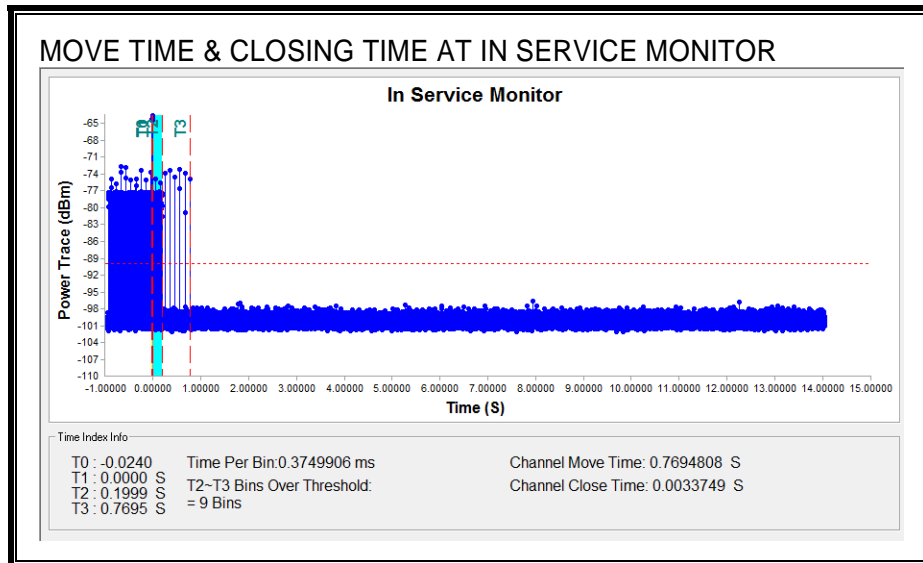
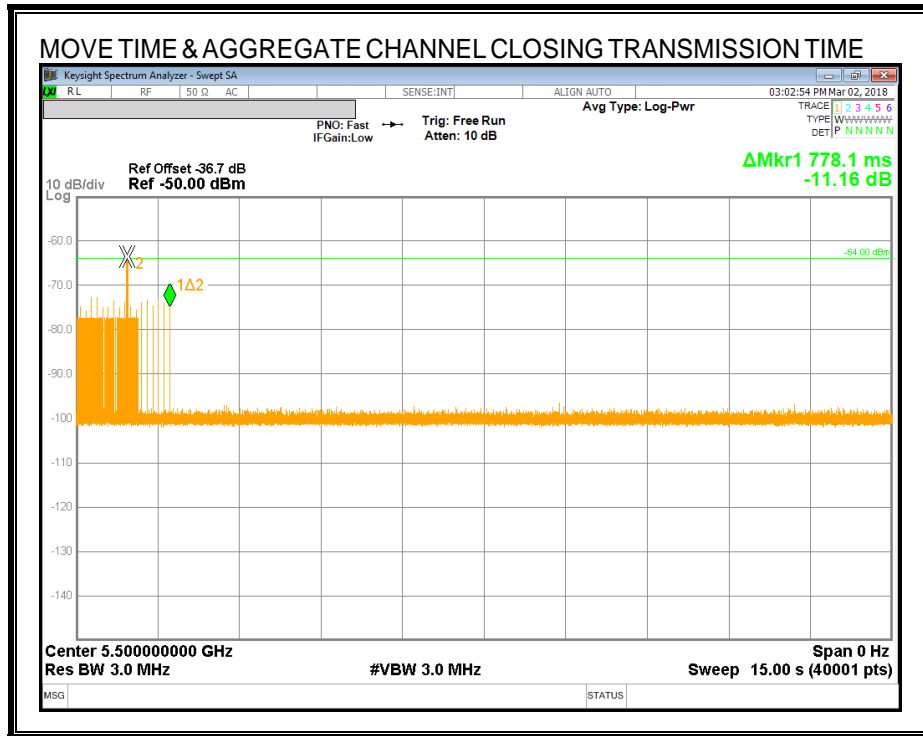

NON-OCCUPANCY PERIOD

RESULTS

No EUT transmissions were observed on the test channel during the 10-minute observation time.

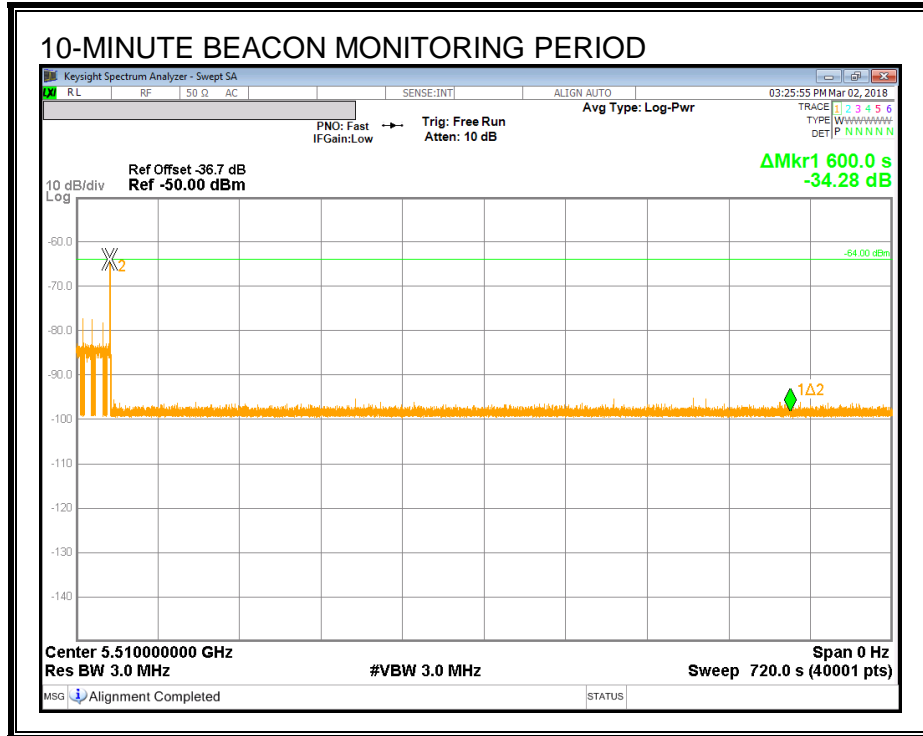

14.3. RESULTS FOR 40 MHz BANDWIDTH

14.3.1. TEST CHANNEL

All tests were performed at a channel center frequency of 5510 MHz.

14.3.2. RADAR WAVEFORM AND TRAFFIC

RADAR WAVEFORM

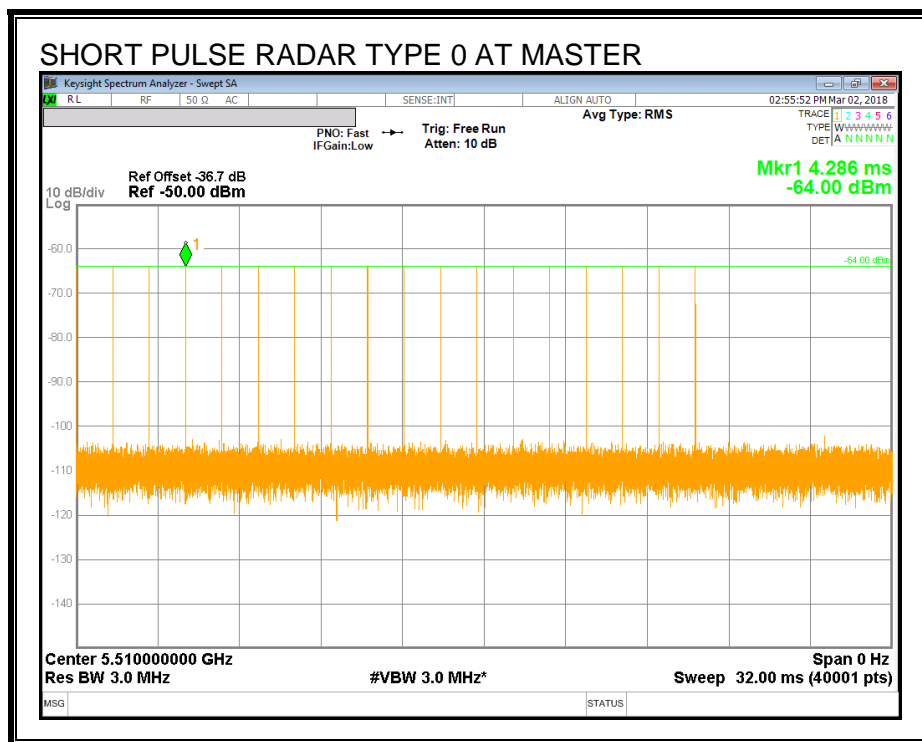

TRAFFIC

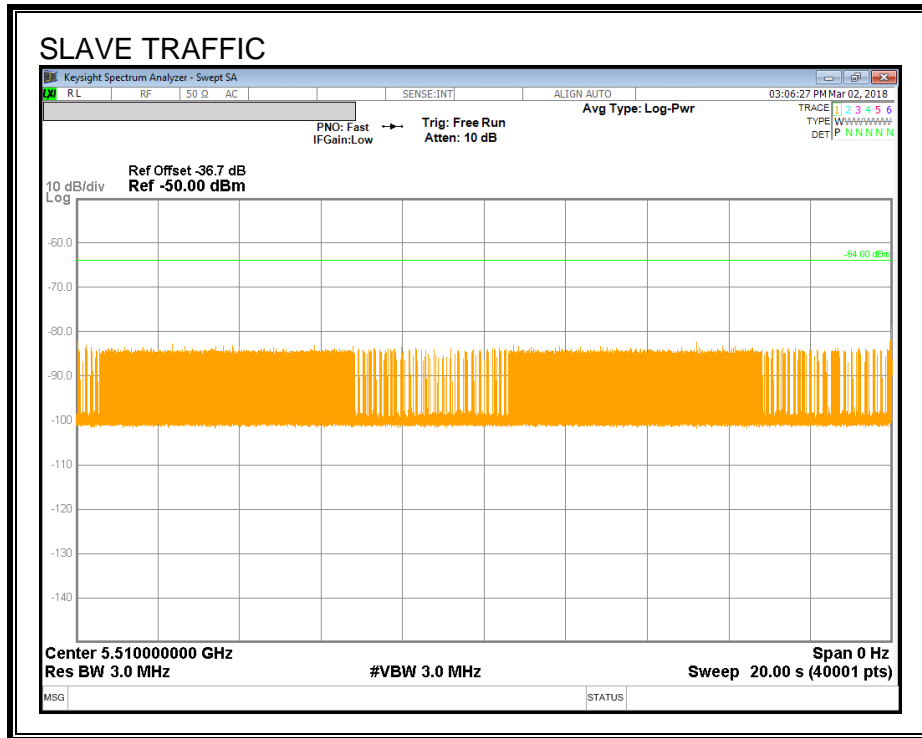

14.3.3. OVERLAPPING CHANNEL TESTS

RESULTS

These tests are not applicable.

14.3.4. MOVE AND CLOSING TIME

REPORTING NOTES

The reference marker is set at the end of last radar pulse.

The delta marker is set at the end of the last WLAN transmission following the radar pulse. This delta is the channel move time.

The aggregate channel closing transmission time is calculated as follows:

Aggregate Transmission Time =
(Number of analyzer bins showing transmission) * (dwell time per bin)

The observation period over which the aggregate time is calculated begins at (Reference Marker + 200 msec) and ends no earlier than (Reference Marker + 10 sec).

RESULTS

Channel Move Time (sec)	Limit (sec)
0.771	10
Aggregate Channel Closing Transmission Time (msec)	Limit (msec)
3.375	60

MOVE TIME & CHANNEL CLOSING TIME

AGGREGATE CHANNEL CLOSING TRANSMISSION TIME

No transmissions are observed during the aggregate monitoring period.

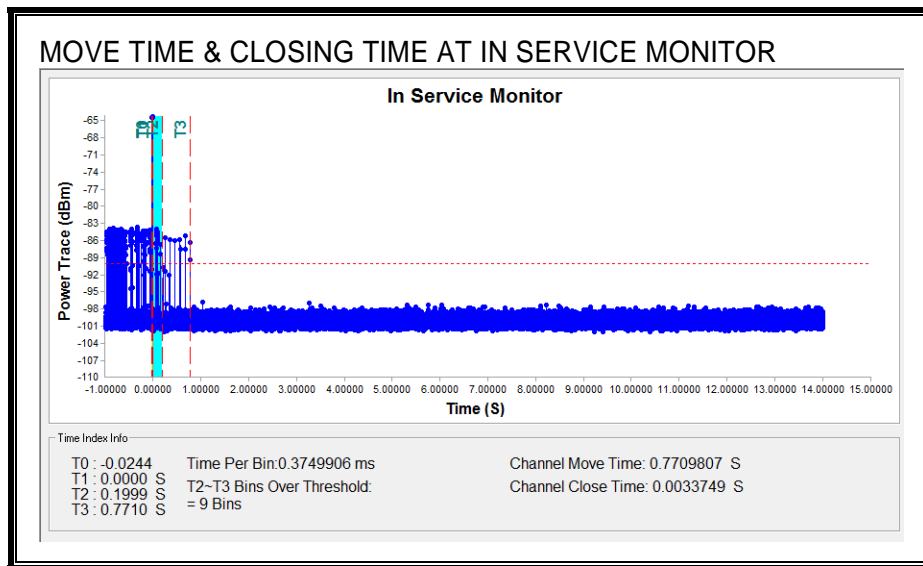
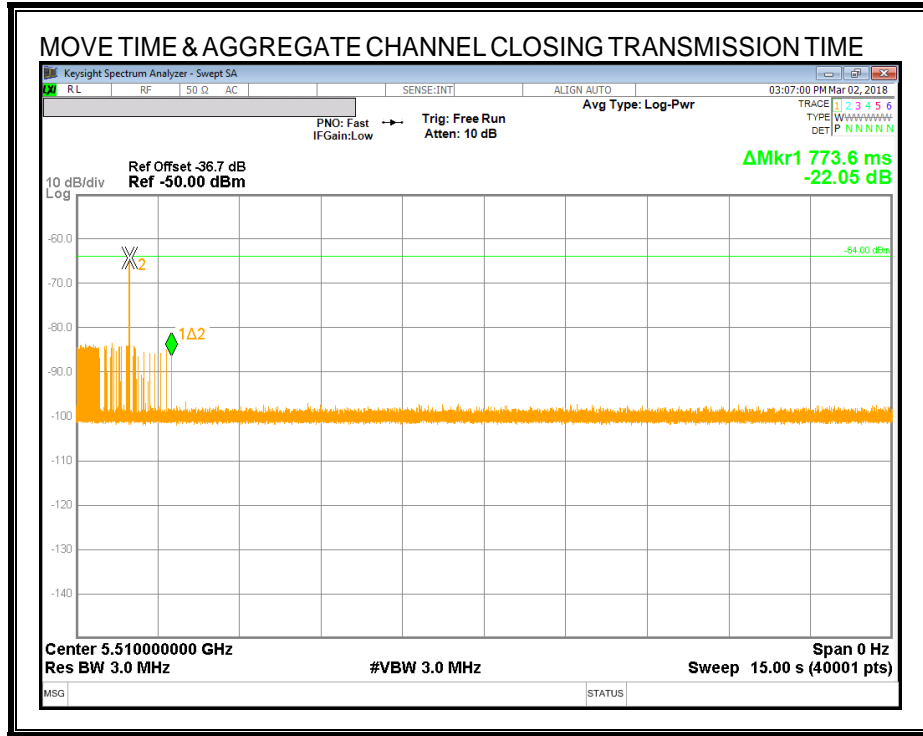

NON-OCCUPANCY PERIOD

RESULTS

No EUT transmissions were observed on the test channel during the 10-minute observation time.

