



HCT Co., Ltd.
74, Seoicheon-ro 578beon-gil, Majang-myeon, Icheon-si, Gyeonggi-do, 17383
KOREATel. +82 31 634 6300 Fax. +82 31 645 6401

FCC ID: A3LSMA546JPN

Appendix A.

- DUT Antenna Information and SAR Test SETUP PHOTOGRAPHS

REVISION HISTORY

The revision history for this document is shown in table.

Revision No.	Date of Issue	Description
0	February 27, 2023	Initial Release
1	March 3, 2023	Revised DUT Antenna Information

- DUT Antenna Information

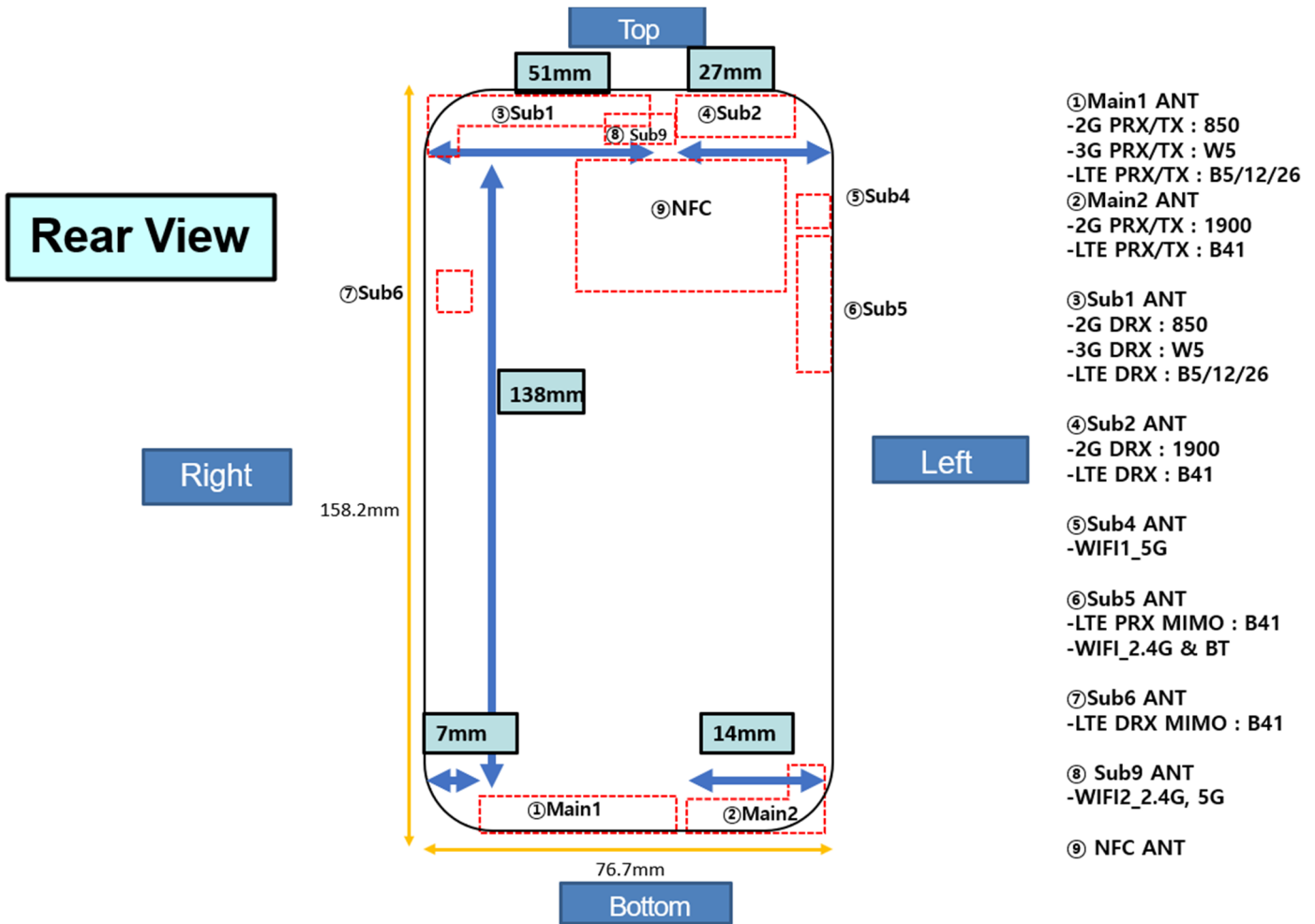

- SAR Test SETUP PHOTOGRAPHS

1. Head_SAM

1.1 Left All



1.2 Left Touch / Left Tilt

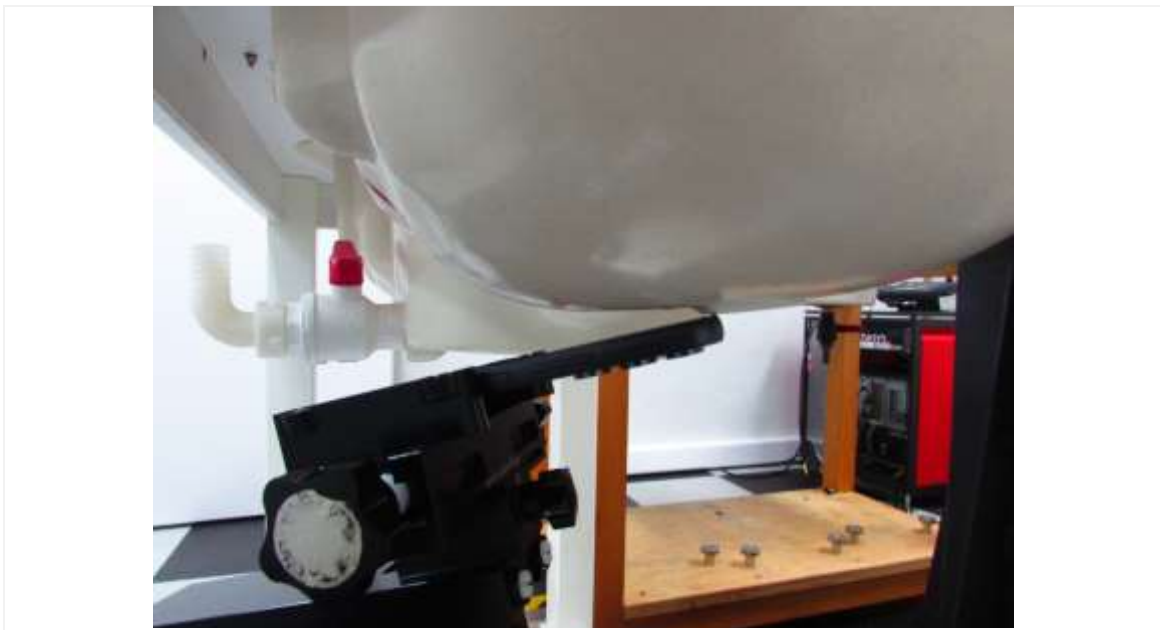
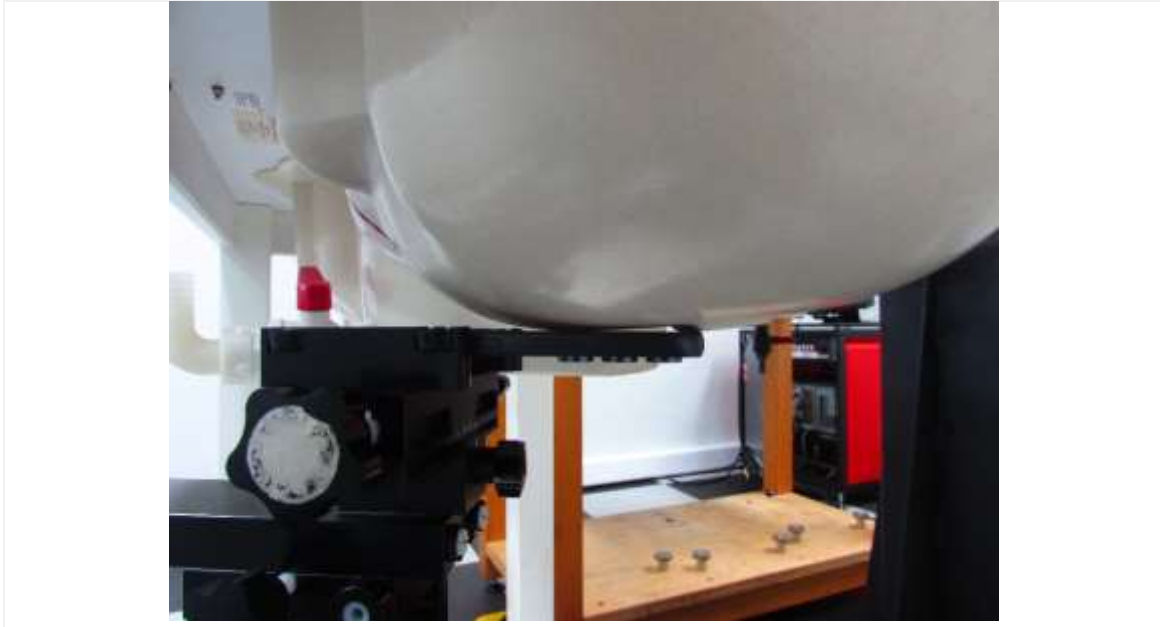

1.3 Right All

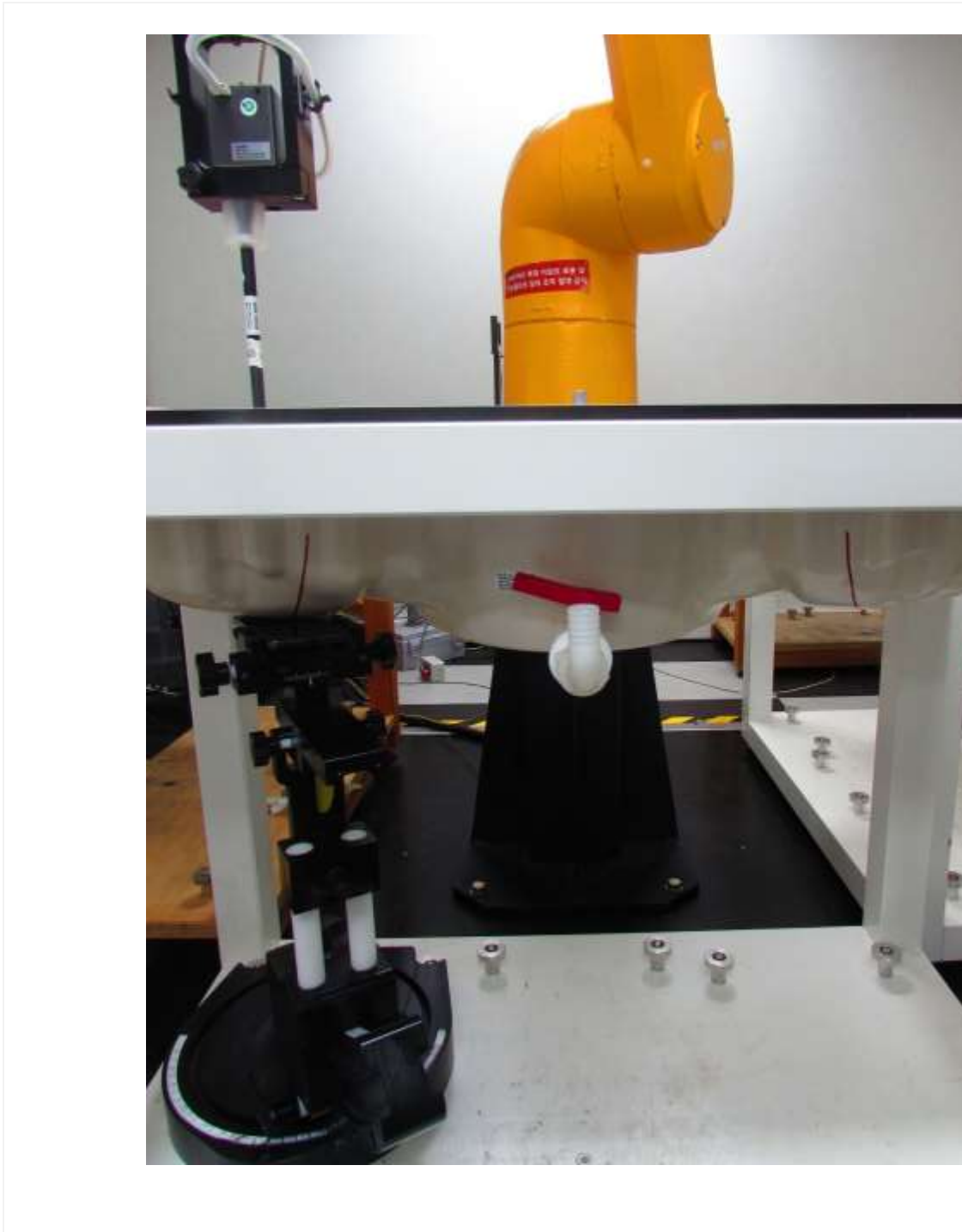

1.4 Right Touch / Right Tilt

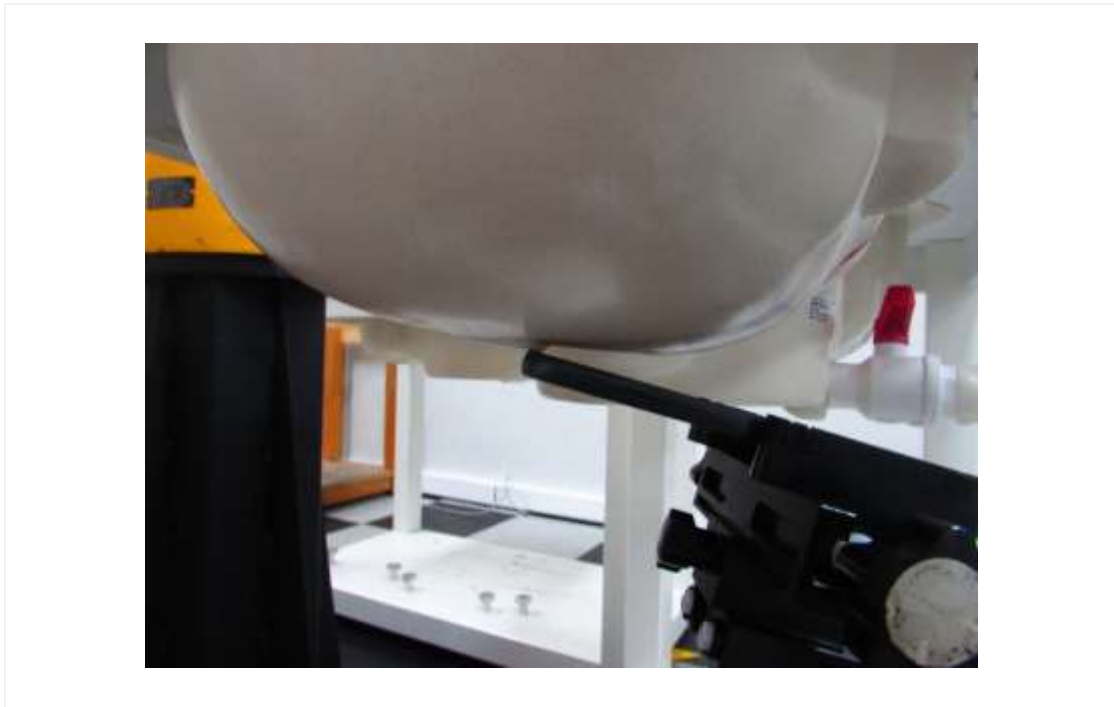
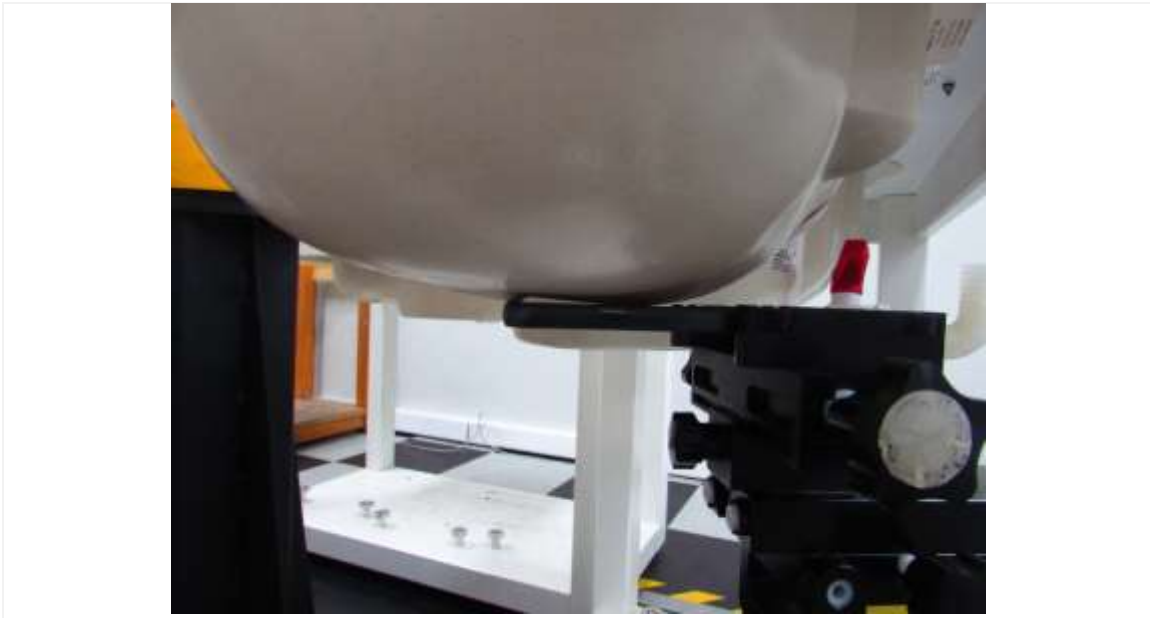

2. Body_SAM

2.1 Body All

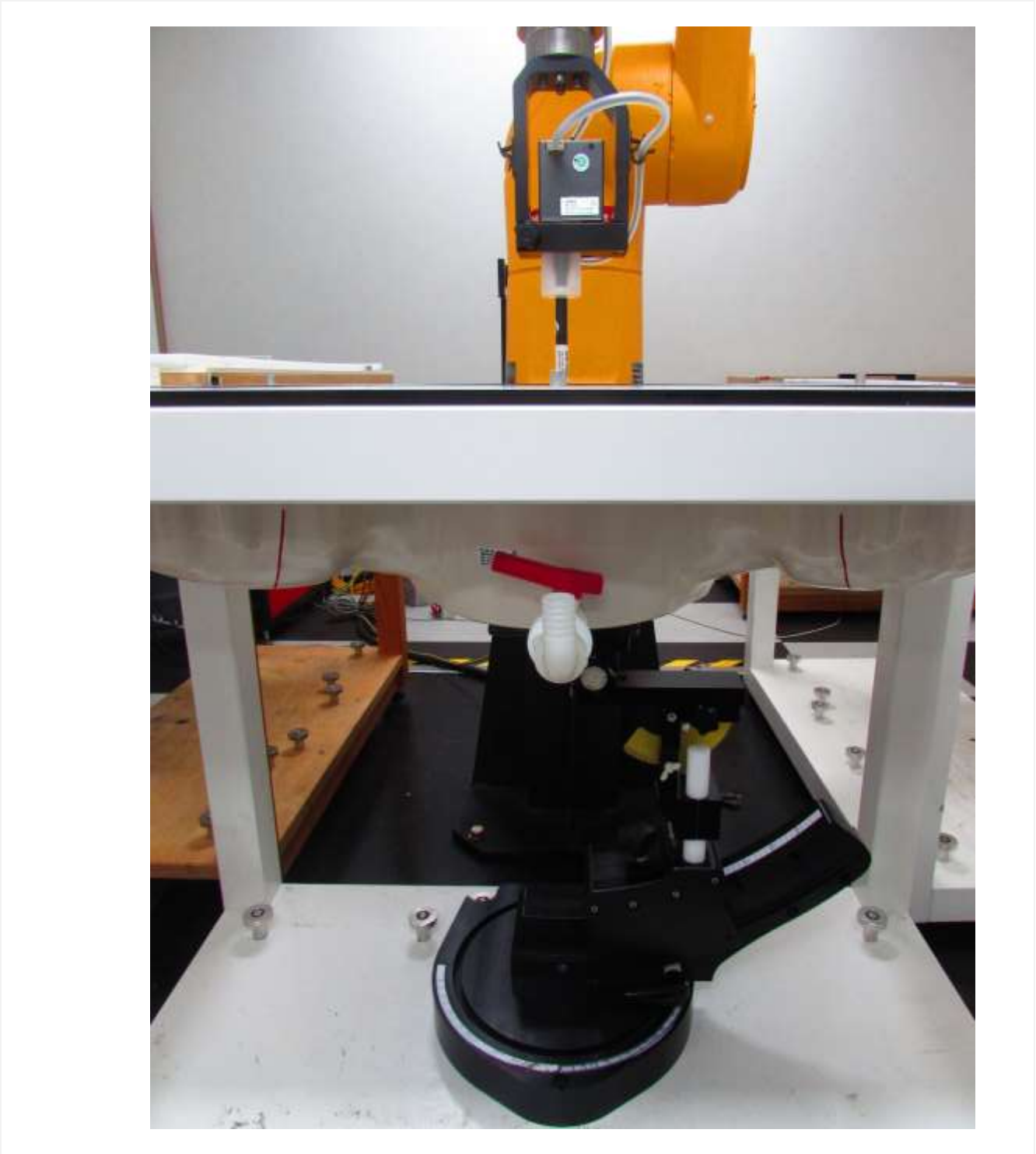

2.2 Body Rear



Distance of 10 mm from the EUT



Distance of 15 mm from the EUT

2.3 Body Front



Distance of 10 mm from the EUT



Distance of 15 mm from the EUT

2.4 Body Left



Distance of 10 mm from the EUT

2.5 Body Right



Distance of 10 mm from the EUT

2.6 Body Bottom



Distance of 10 mm from the EUT

2.7 Body Top



Distance of 10 mm from the EUT

3. Phablet_SAM

3.1 Phablet SAR Test Setup Rear



Distance of 0 mm from the EUT

3.2 Phablet SAR Test Setup Front



Distance of 0 mm from the EUT

3.3 Phablet SAR Test Setup Left



Distance of 0 mm from the EUT

3.5 Phablet SAR Test Setup Top



Distance of 0 mm from the EUT

4. Phablet_ELI

4.1 Body All



4.2 Phablet SAR Test Setup Rear



Distance of 0 mm from the EUT

4.3 Phablet SAR Test Setup Front



Distance of 0 mm from the EUT

4.4 Phablet SAR Test Setup Left



Distance of 0 mm from the EUT

4.5 Phablet SAR Test Setup Top



Distance of 0 mm from the EUT