

# EMI TEST REPORT

## FCC CERTIFICATION

**Applicant:**

**SAMSUNG Electronics Co., Ltd.**  
129, Samsung-ro, Yeongtong-gu, Suwon-si,  
Gyeonggi-do, 16677, Korea

**Date of Issue: February 24, 2023**

**Test Report No. HCT-EM-2302-FC009**

**Test Site: HCT CO., LTD.**

**FCC ID :**

**A3LSMA546JPN**

**Rule Part(s) / Standard(s) :** 47 CFR PART 15 Subpart B Class B  
ANSI C63.4-2014

**Product Name :** Mobile Phone

**Model Name :** SC-53D

**Series Model Name :** SCG21

**Date of Test :** February 06, 2023 to February 15, 2023

The device bearing the trade name and model specified above, has been shown to comply with the applicable technical standards as indicated in the measurement report and was tested in accordance with the measurement procedures specified in ANSI C63.4-2014. (See Test Report if any modifications were made for compliance)

I attest to the accuracy of data. All measurements reported herein were performed by me or were made under my supervision and are correct to the best of my knowledge and belief. I assume full responsibility for the completeness of these measurements and vouch for the qualifications of all persons taking them.

**Tested By**

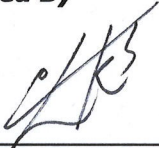

**Wook Yi**  
**Test Engineer**  
**EMC Team**  
**Certification Division**

**Reviewed**



**Jeong-Hyun Choi**  
**Technical Manager**  
**EMC Team**  
**Certification Division**

This report only responds to the tested sample and may not be reproduced, except in full, without written approval of the HCT Co., Ltd.



## REVISION HISTORY

*The revision history for this document is shown in table.*

<b>Rev No.</b>	<b>Issue Date</b>	<b>Information About Changes</b>
0	February 24, 2023	Initial Release

The above Test Report is not related to the accredited test result by (KS Q) ISO/IEC 17025 and KOLAS (Korea Laboratory Accreditation Scheme), which signed the ILAC-MRA.

If this report is required to confirmation of authenticity, please contact to [www.hct.co.kr](http://www.hct.co.kr)



## TABLE OF CONTENTS

	PAGE
1. GENERAL INFORMATION .....	4
1.1 Description of EUT .....	4
1.2 Tested System Details .....	4
1.3 Cable Description .....	5
1.4 Noise Suppression Parts on Cable. (I/O Cable).....	5
1.5 Test Facility .....	6
1.6 Calibration of Measuring Instrument .....	6
1.7 Measurement Uncertainty .....	6
2. LIST OF TEST EQUIPMENT .....	7
3. DESCRIPTION OF TEST .....	8
3.1 Measurement of Conducted Emission.....	8
3.2 Measurement of Radiated Emission.....	9
3.3 Configuration of Tested System .....	10
4. OPERATION OF THE EUT .....	10
4.1 Conducted Emission (Not Applicable).....	11
4.2 Radiated Emission.....	11
5. EMI TEST SUMMARY .....	12
5.1 Conducted Emission (Not Applicable).....	12
5.1.1 Test Condition .....	12
5.1.2 Measuring Data.....	12
5.2 Radiated Emission Below 1 GHz .....	12
5.2.1 Test Condition .....	13
5.2.2 Measuring Data.....	14
5.3 Radiated Emission Above 1 GHz .....	17
5.3.1 Test Condition .....	18
5.3.2 Measuring Data.....	19
6 APPENDIX A. TEST SETUP PHOTO.....	23



## 1. GENERAL INFORMATION

### 1.1 Description of EUT

<b>FCC ID</b>	A3LSMA546JPN
<b>Model Name</b>	SC-53D
<b>Series Model Name</b>	SCG21
<b>Product Name</b>	Mobile Phone
<b>Frequency Band</b>	GSM 850/1900, WCDMA B5, LTE 5/12/26/41, BT BDR/EDR/LE, WLAN a/b/g/n/ac/ax(MIMO), NFC, FM Receiver
<b>Power Supply</b>	Travel adapter: Input: 100~240 V, 50 ~ 60 Hz, 0.7 A Output: (PDO)5.0 V, 3.0 A or 9.0 V, 2.77 A (PPS)3.3~5.9 V, 3.0 A or 3.3~11.0 V, 2.25 A

### 1.2 Tested System Details

All equipment descriptions used in the tested system (including inserted cards) are:

Device Type	Model Name	Serial Number	Manufacturer
Mobile Phone	SC-53D	-	SAMSUNG
TA	EP-TA800	-	DONGYANG E&P
Data Cable	EP-DN980	-	RFTECH
Earphone	YBD-19HS	-	ALMUS



### 1.3 Cable Description

Product Name	Port	Power Cord Shielded (Y/N)	I/O Cable Shielded (Y/N)	Length (m)
EUT	Data Cable (USB Type C)	Y	N/A	(P) 1.0
	Earphone (USB Type C)	N/A	N	(D) 1.3

"(D)" Data Cable and "(P)" Power Cable.

### 1.4 Noise Suppression Parts on Cable. (I/O Cable)

Product Name	Port	Ferrite Bead (Y/N)	Location	Metal Hood (Y/N)	Location
EUT	Data Cable (USB Type C)	N	N/A	Y	Both End
	Earphone (USB Type C)	N	N/A	Y	EUT End



## 1.5 Test Facility

Test site is located at 74, Seoicheon-ro 578beon-gil, Majang-myeon, Icheon-si, Gyeonggi-do, Korea. Those measurement facilities are constructed in conformance with the requirements of ANSI C63.4-2014. The Normalized site attenuations (30 MHz to 1 GHz) and Site validation (1 GHz to 18 GHz) were performed in accordance with the standard in ANSI C63.4-2014 and ANSI C63.4a-2017. Our laboratories are accredited and designated in accordance with the provisions of Radio Waves ACT and International Standard ISO/IEC 17025:2017. (National Radio Research Agency, CABID No. KR0032)

## 1.6 Calibration of Measuring Instrument

The measuring equipment, which was utilized in performing the tests documented herein, has been calibrated in accordance with the manufacturers recommendations for utilizing calibration equipment, which is traceable to recognized national standards.

Especially, all antenna for measurement is calibrated in accordance with the requirements of C63.5:2017.

## 1.7 Measurement Uncertainty

The measurement uncertainties shown below were calculated in accordance with the requirements of ANSI C63.4-2014.

All measurement uncertainty values are shown with a coverage factor of  $k = 2$  to indicate a 95 % level of confidence. The measurement data shown herein meets or exceeds the  $U_{\text{CISPR}}$  measurement uncertainty values specified in CISPR 16-4-2 and, thus, can be compared directly to specified limits to determine compliance.

Test Item	Test Site (Chamber)	Expanded Uncertainty
Radiated Emission (30 MHz to 1 GHz)	3 m Semi Anechoic Chamber #1	5.9 dB
Radiated Emission (1 GHz to 18 GHz)	3 m Semi Anechoic Chamber #1	4.8 dB
Radiated Emission (18 GHz to 40 GHz)	3 m Semi Anechoic Chamber #1	5.8 dB



## 2. LIST OF TEST EQUIPMENT

<u>Type</u>	<u>Model Name</u>	<u>Manufacturer</u>	<u>Serial Number</u>	<u>Calibration Cycle</u>	<u>Next Calibration Date</u>
<b><u>Conducted Emission</u></b>					
<input type="checkbox"/> EMI Test Receiver	ESR7	Rohde & Schwarz	101910	1 year	06.07.2023
<input type="checkbox"/> LISN	ENV216	Rohde & Schwarz	102245	1 year	08.22.2023
<input type="checkbox"/> Antenna (for Communication)	HyperLOG7060	Aaronia	66450	-	-
<input type="checkbox"/> Antenna (for Communication)	HyperLOG7060	Aaronia	66451	-	-
<input type="checkbox"/> Software	EMC32	Rohde & Schwarz	-	-	-
<b><u>Radiated Emission</u></b>					
-For measurement below 1 GHz					
<input checked="" type="checkbox"/> EMI Test Receiver	ESU40	Rohde & Schwarz	100524	1 year	05.10.2023
<input checked="" type="checkbox"/> Bi-Log Antenna	VULB9168	Schwarzbeck	255	2 year	03.15.2023
<input checked="" type="checkbox"/> Antenna master	MA4640-XP-ET	INNCO SYSTEM	-	N/A	-
<input checked="" type="checkbox"/> Antenna master controller	CO3000	INNCO SYSTEM	CO3000/870/ 35990515/L	N/A	-
<input checked="" type="checkbox"/> Turn Table	1060	INNCO SYSTEM	-	N/A	-
<input checked="" type="checkbox"/> Turn Table controller	CO2000	INNCO SYSTEM	CO2000/095/ 7590304/L	N/A	-
<input type="checkbox"/> UNIVERSAL RADIO COMMUNICATION TESTER	CMU200	Rohde & Schwarz	107488	1 year	09.13.2023
<input checked="" type="checkbox"/> MOBILE COMMUNICATION TEST SET	CMW500	Rohde & Schwarz	103246	1 year	08.24.2023
<input checked="" type="checkbox"/> Radio communication analyzer	MT8821C	ANRITSU	6262192376	1 year	10.20.2023
<input checked="" type="checkbox"/> Antenna (for Communication)	HyperLOG7060	Aaronia	66450	-	-
<input type="checkbox"/> Radio communication analyzer	MT8000A	ANRITSU	6262208294	1 year	10.20.2023
<input type="checkbox"/> Antenna (for Communication)	HyperLOG7060	Aaronia	66451	-	-
<input checked="" type="checkbox"/> Software	EMC32	Rohde & Schwarz	-	-	-
-For measurement above 1 GHz					
<input checked="" type="checkbox"/> EMI Test Receiver	ESU40	Rohde & Schwarz	100524	1 year	05.10.2023
<input checked="" type="checkbox"/> Antenna master	MA4640-XP-ET	INNCO SYSTEM	-	N/A	-
<input checked="" type="checkbox"/> Antenna master controller	CO3000	INNCO SYSTEM	CO3000/870/ 35990515/L	N/A	-
<input checked="" type="checkbox"/> Turn Table	1060	INNCO SYSTEM	-	N/A	-
<input checked="" type="checkbox"/> Turn Table controller	CO2000	INNCO SYSTEM	CO2000/095/ 7590304/L	N/A	-
<input checked="" type="checkbox"/> Power Amplifier	TK-PA18H	TESTEK	170034-L	1 year	11.04.2023
<input type="checkbox"/> Low Noise Amplifier	TK-PA18H	TESTEK	170012-L	1 year	12.13.2023
<input checked="" type="checkbox"/> Low Noise Amplifier	TK-PA1840H	TESTEK	170030-L	1 year	02.22.2024
<input checked="" type="checkbox"/> Horn Antenna	BBHA 9120D	Schwarzbeck	01836	1 year	07.21.2023
<input checked="" type="checkbox"/> Horn Antenna	BBHA 9170	Schwarzbeck	BBHA 9170 #786	1 year	11.17.2023
<input checked="" type="checkbox"/> Radio communication analyzer	MT8821C	ANRITSU	6262192376	1 year	10.20.2023
<input checked="" type="checkbox"/> MOBILE COMMUNICATION TEST SET	CMW500	Rohde & Schwarz	103246	1 year	08.24.2023
<input checked="" type="checkbox"/> Antenna (for Communication)	HyperLOG7060	Aaronia	66450	-	-
<input type="checkbox"/> Radio communication analyzer	MT8000A	ANRITSU	6262208294	1 year	10.20.2023
<input type="checkbox"/> Antenna (for Communication)	HyperLOG7060	Aaronia	66451	-	-
<input checked="" type="checkbox"/> Software	EMC32	Rohde & Schwarz	-	-	-



### 3. DESCRIPTION OF TEST

#### 3.1 Measurement of Conducted Emission

The test procedure was in accordance with ANSI C63.4-2014, Clause 7.3

- a. The EUT was placed 0.4 meters from the conducting wall of the shielded room with EUT being connected to the power mains through a line impedance stabilization network (LISN).  
If the EUT is connected to the PC through USB, the AC power-line adapter of the PC is directly connected to a line impedance stabilization network (LISN).  
Other support units were connected to the power mains through another LISN. The two LISNs provide 50 Ohm/50uH of coupling impedance for the measuring instrument.
- b. Both conducted lines are measured in Quasi-Peak and Average mode, including the worst-case data points for each tested configuration.
- c. The frequency ranges from 150 kHz to 30 MHz was searched.

#### [ Conducted Emission Limits ]

Frequency (MHz)	Resolution Bandwidth (kHz)	Quasi-Peak (dB( $\mu$ V))	Average (dB( $\mu$ V))
0.15 to 0.5	9	66 to 56*	56 to 46*
0.5 to 5	9	56	46
5 to 30	9	60	50

*\*Decreases with the logarithm of the frequency.*





### 3.2 Measurement of Radiated Emission

The test procedure was in accordance with ANSI C63.4-2014, Clause 8.3

- The EUT was placed on the top of a turn table 0.8 meters above the ground at a semi-anechoic chamber. The table was rotated 360 degrees to determine the position of the highest radiation.
- The EUT was set 3 m away from the interference-receiving antenna, which was mounted on the top of a variable-height antenna tower.
- The antenna height is varied from 1 m to 4 m above the ground to determine the maximum value of the field strength. Both horizontal and vertical polarizations of the antenna are set to make the measurement.
- For each suspected emission, the EUT was arranged to its worst case and then the antenna was tuned to heights from 1 m to 4 m and the turn table was turned from 0 degrees to 360 degrees to find the maximum reading.
- The test-receiver system was set to Quasi-Peak detect function and specified bandwidth with maximum hold mode when the test frequency is below 1 GHz.
- The test-receiver system was set to Peak and Average detect function and specified bandwidth with maximum hold mode when the test frequency is above 1 GHz.
- Place the measurement antenna away from each area of the EUT determined to be a source of emissions at the specified measurement distance, while keeping the measurement antenna aimed at the source of emissions at each frequency of significant emissions, with polarization oriented for maximum response. (1 GHz to 40 GHz)

#### [ Radiated Emission Limits ]

Frequency (MHz)	Antenna Distance (m)	Field Strength ( $\mu\text{V}/\text{m}$ )	Quasi-Peak (dB $\mu\text{V}/\text{m}$ )
30 to 88	3	100	40.0
88 to 216	3	150	43.5
216 to 960	3	200	46.0
Above 960	3	500	54.0

Frequency (MHz)	Antenna Distance (m)	Peak (dB $\mu\text{V}/\text{m}$ )	Average (dB $\mu\text{V}/\text{m}$ )
Above 1 000	3	74	54



**3.2.1 Frequency Range of Radiated Measurements**

An unintentional radiator, including a digital device, the spectrum shall be investigated from the lowest radio frequency signal generated or used in the device, without going below the lowest frequency for which a Radiated Emission limit is specified, up to the frequency shown in the following table.

Highest frequency generated or used in the device or on which the device operates or tunes (MHz)	Upper frequency of measurement range (MHz)
Below 1.705	30
1.705 to 108	1 000
108 to 500	2 000
500 to 1 000	5 000
Above 1 000	5 <sup>th</sup> harmonic of the highest frequency or 40 GHz, whichever is lower

**3.3 Configuration of Tested System**

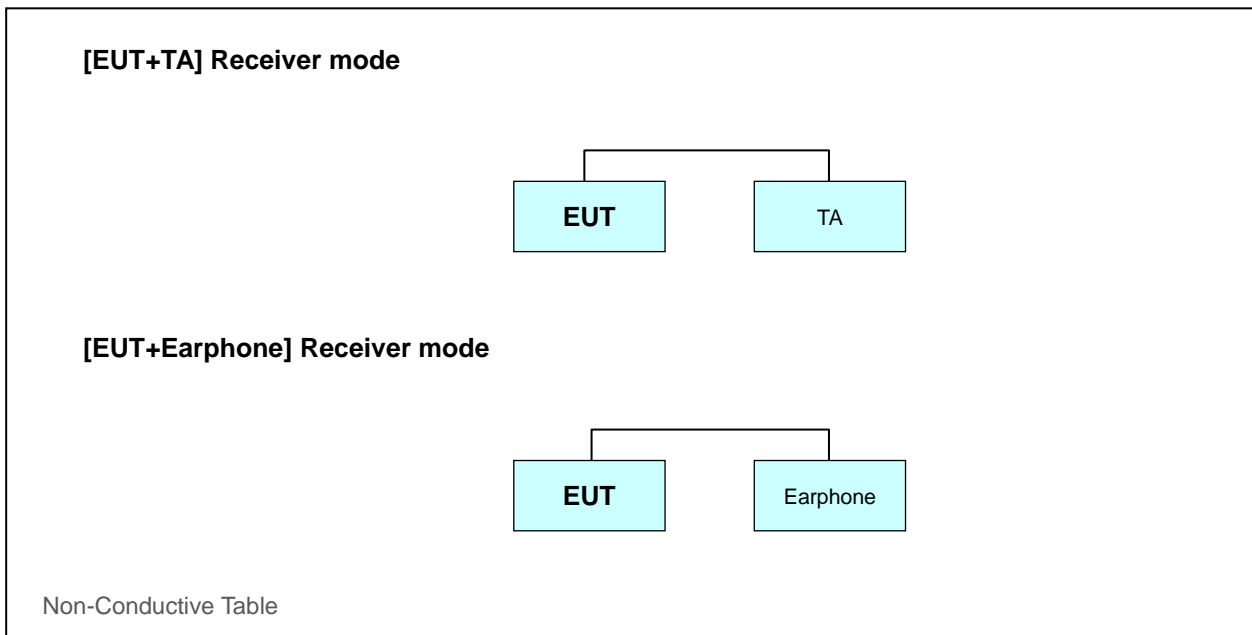



## 4. OPERATION OF THE EUT

During preliminary tests, the following operating mode was investigated.

Receiver mode(GSM 850 Low/Middle/High ch Idle)  
 Receiver mode(WCDMA B5 Low/Middle/High ch Idle)  
 Receiver mode(LTE B5\_Low/Middle/High ch)  
 Receiver mode(LTE B12\_Low/Middle/High ch)  
 Receiver mode(LTE B26\_Low/Middle/High ch)

NOTE. The worst case is tested.

### 4.1 Conducted Emission (Not Applicable)

**Operating Mode: Not applicable**

### 4.2 Radiated Emission

It was final tested the following operating mode, after connecting all peripheral devices.

**Operating Mode:**

**Radiated Emission below 1 GHz:**

**[EUT+TA]**

LTE B5 Low ch Idle\*  
 LTE B5 Middle ch Idle  
 LTE B5 High ch Idle  
 LTE B12 Low ch Idle  
 LTE B12 Middle ch Idle\*  
 LTE B12 High ch Idle  
 LTE B26 Low ch Idle  
 LTE B26 Middle ch Idle  
 LTE B26 High ch Idle\*

**[EUT+Earphone]**

LTE B5 Low ch Idle\*

**Radiated Emission above 1 GHz:**

**[EUT+TA]**

LTE B5 Low ch Idle\*  
 LTE B12 Middle ch Idle  
 LTE B26 High ch Idle

**[EUT+Earphone]**

LTE B5 Low ch Idle\*

NOTE.

1. Three orientations have been investigated and the worst case orientation (x-axis: The display of EUT placed on the table is facing upwards) is reported.
2. The worst case of operating mode is reported. [\*].



## 5. EMI TEST SUMMARY

### 5.1 Conducted Emission

#### 5.1.1 Test Condition

The test results of conducted emission at mains ports provide the following information:

<b>Used Test Standard</b>	47 CFR PART 15 Subpart B Class B ANSI C63.4-2014
<b>Frequency Range</b>	150 kHz to 30 MHz
<b>Detector</b>	Quasi-Peak, CISPR-Average
<b>Bandwidth</b>	9 kHz (6 dB)
<b>Operating Mode</b>	-
<b>Test Site</b>	EMI Shield Room
<b>Temperature</b>	min. - °C, max. - °C
<b>Humidity</b>	min. - % R.H., max. - % R.H.
<b>Test Date</b>	-

**Calculation Formula:**

1. Conductor L1 = Hot, Conductor N = Neutral
2. Corr. = LISN Factor+Cable Loss
3. QuasiPeak or CAverage= Receiver Reading+Corr.
4. Margin = Limit – QuasiPeak or CAverage

#### 5.1.2 Measuring Data

Not applicable



## 5.2 Radiated Emission Below 1 GHz

### 5.2.1 Test Condition

The test results of radiated emission provide the following information:

<b>Used Test Standard</b>	47 CFR PART 15 Subpart B Class B ANSI C63.4-2014
<b>Frequency Range</b>	30 MHz to 1 000 MHz
<b>Detector / Bandwidth</b>	Quasi-Peak / Bandwidth: 120 kHz (6 dB)
<b>Operating Mode of Worst case</b>	[EUT+TA] LTE B5 Low ch Idle LTE B12 Middle ch Idle LTE B26 High ch Idle  [EUT+Earphone] LTE B5 Low ch Idle
<b>Measurement Distance</b>	3 m
<b>Antenna Measurement Height</b>	1 m to 4 m
<b>Test Site</b>	3 m Semi Anechoic Chamber #1
<b>Temperature</b>	min. 19.1 °C, max. 21.1 °C
<b>Humidity</b>	min. 25.0 % R.H., max. 30.9 % R.H.
<b>Test Date</b>	February 06, 2023 – February 15, 2023

**Calculation Formula:**

1. POL. H = Horizontal, POL. V = Vertical
2. QuasiPeak = Reading (Receiver Reading)+Corr.
3. Corr. (Correction Factor) = Antenna Factor+Cable Loss
4. Margin = Limit - QuasiPeak



### 5.2.2 Measuring Data

Figure 1: Radiated Emission (30 to 1 000) MHz, [EUT+TA] LTE B5 Low ch Idle

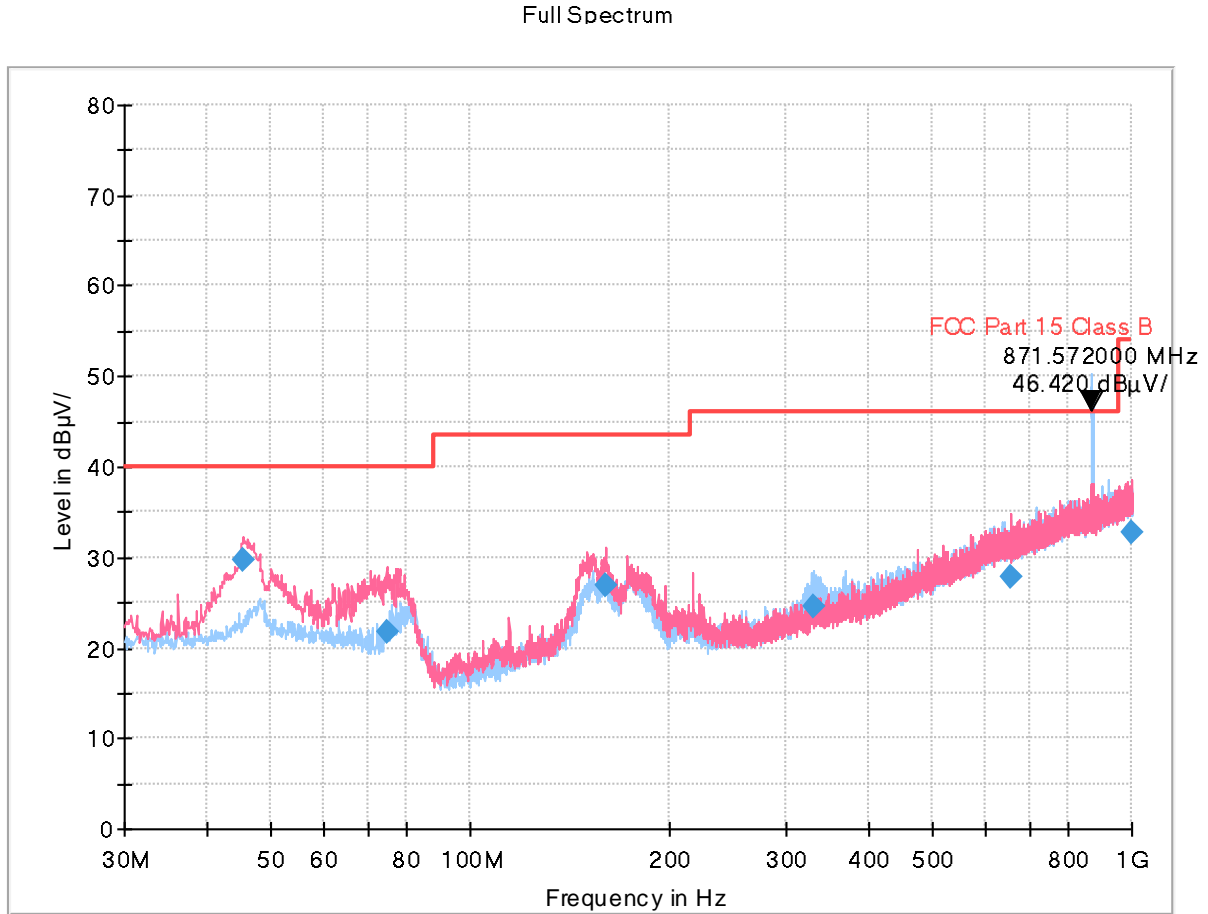

NOTE. 1. Carrier Frequency: Rx 871.572 MHz  
 2. These are signals for fundamental frequency from the base station

Frequency (MHz)	Quasi Peak (dBµV/m)	Limit (dBµV/m)	Margin (dB)	Antenna Height (cm)	POL. (H/V)	Azimuth (deg)	Corr. (dB)
45.2825	29.63	40.00	10.37	100.0	V	0.0	19.7
74.7483	21.85	40.00	18.15	100.0	V	316.0	17.0
160.4635	26.80	43.50	16.70	100.0	V	99.0	19.7
329.7311	24.56	46.00	21.44	100.0	H	200.0	21.3
658.1731	27.88	46.00	18.12	202.7	V	263.0	28.3
999.2438	32.76	54.00	21.24	125.1	V	124.0	32.6



Figure 2: Radiated Emission (30 to 1 000) MHz, [EUT+TA] LTE B12 Middle ch Idle

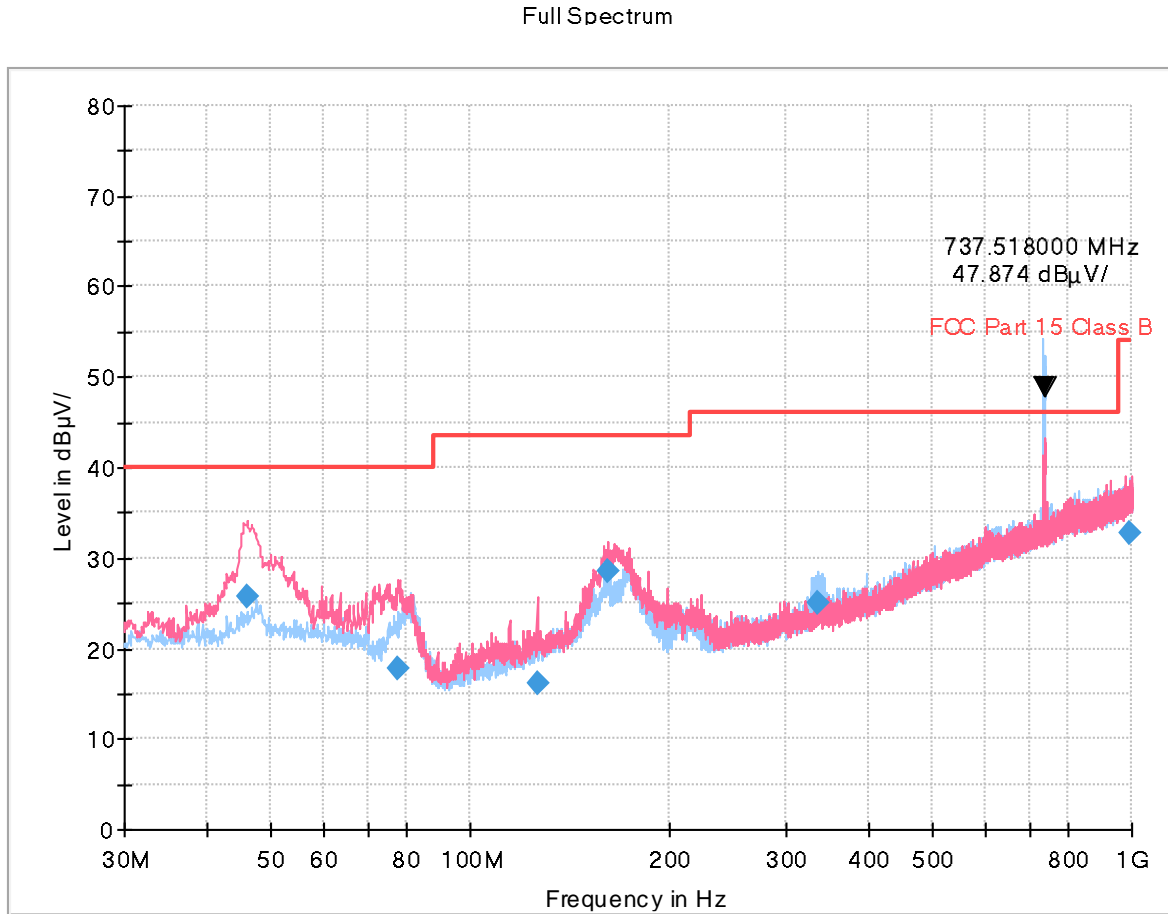

NOTE. 1. Carrier Frequency: Rx 737.518 MHz  
 2. These are signals for fundamental frequency from the base station

Frequency (MHz)	Quasi Peak (dBµV/m)	Limit (dBµV/m)	Margin (dB)	Antenna Height (cm)	POL. (H/V)	Azimuth (deg)	Corr. (dB)
46.0386	25.70	40.00	14.30	100.0	V	259.0	19.8
77.8885	17.85	40.00	22.15	100.0	V	345.0	16.2
126.1218	16.06	43.50	27.44	100.0	V	106.0	17.8
161.2533	28.45	43.50	15.05	100.0	V	98.0	19.6
334.9193	24.97	46.00	21.04	100.0	H	62.0	21.4
993.3425	32.71	54.00	21.29	400.0	H	135.0	32.5



Figure 3: Radiated Emission (30 to 1 000) MHz, [EUT+TA] LTE B26 High ch Idle

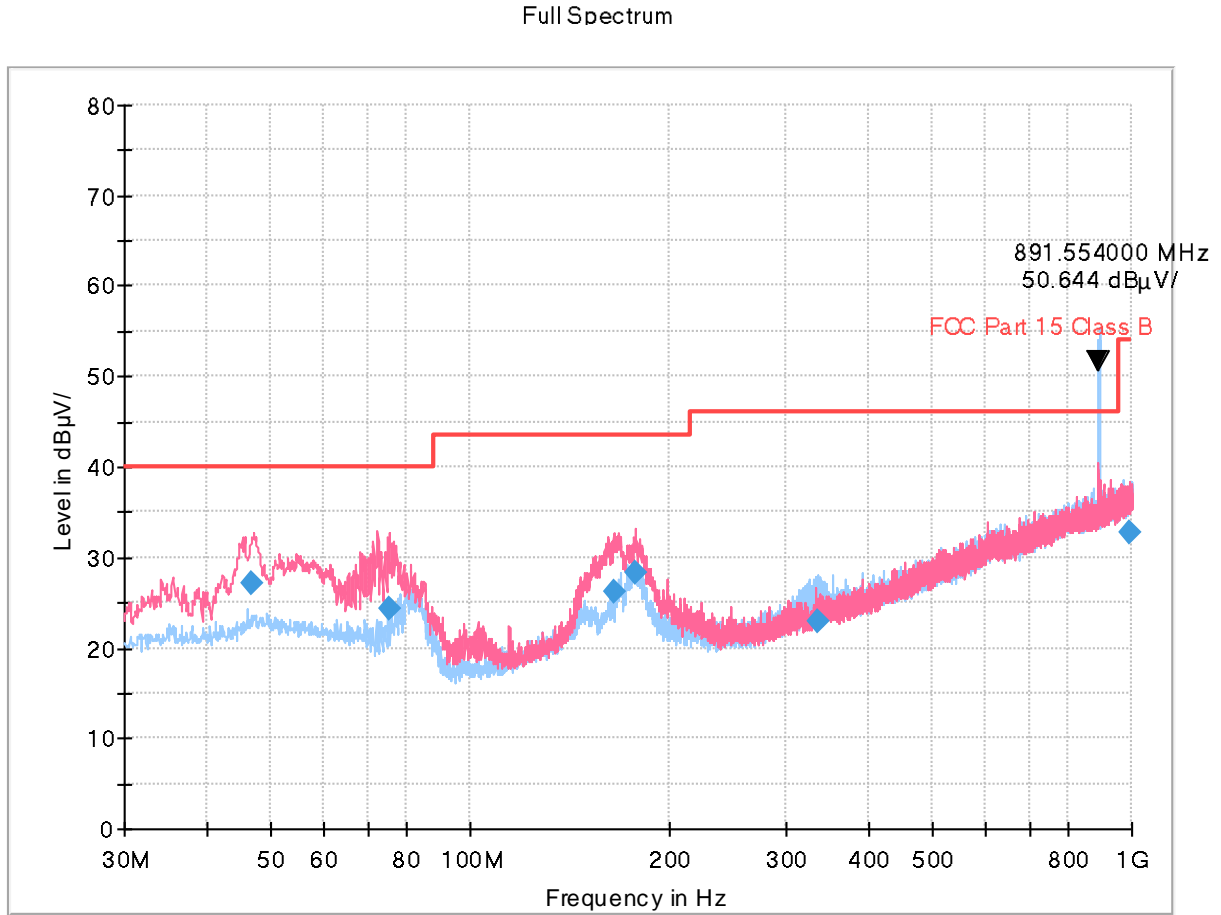

NOTE. 1. Carrier Frequency: Rx 891.554 MHz  
 2. These are signals for fundamental frequency from the base station

Frequency (MHz)	Quasi Peak (dBµV/m)	Limit (dBµV/m)	Margin (dB)	Antenna Height (cm)	POL. (H/V)	Azimuth (deg)	Corr. (dB)
46.8285	27.23	40.00	12.77	100.0	V	75.0	19.8
75.3509	24.38	40.00	15.62	100.0	V	30.0	16.9
164.5546	26.10	43.50	17.40	100.0	V	116.0	19.4
177.6426	28.38	43.50	15.12	100.0	V	142.0	18.5
334.3214	22.81	46.00	23.19	125.1	H	155.0	21.4
990.0395	32.75	54.00	21.25	325.1	H	206.0	32.5





Figure 4: Radiated Emission (30 to 1 000) MHz, [EUT+Earphone] LTE B5 Low ch Idle

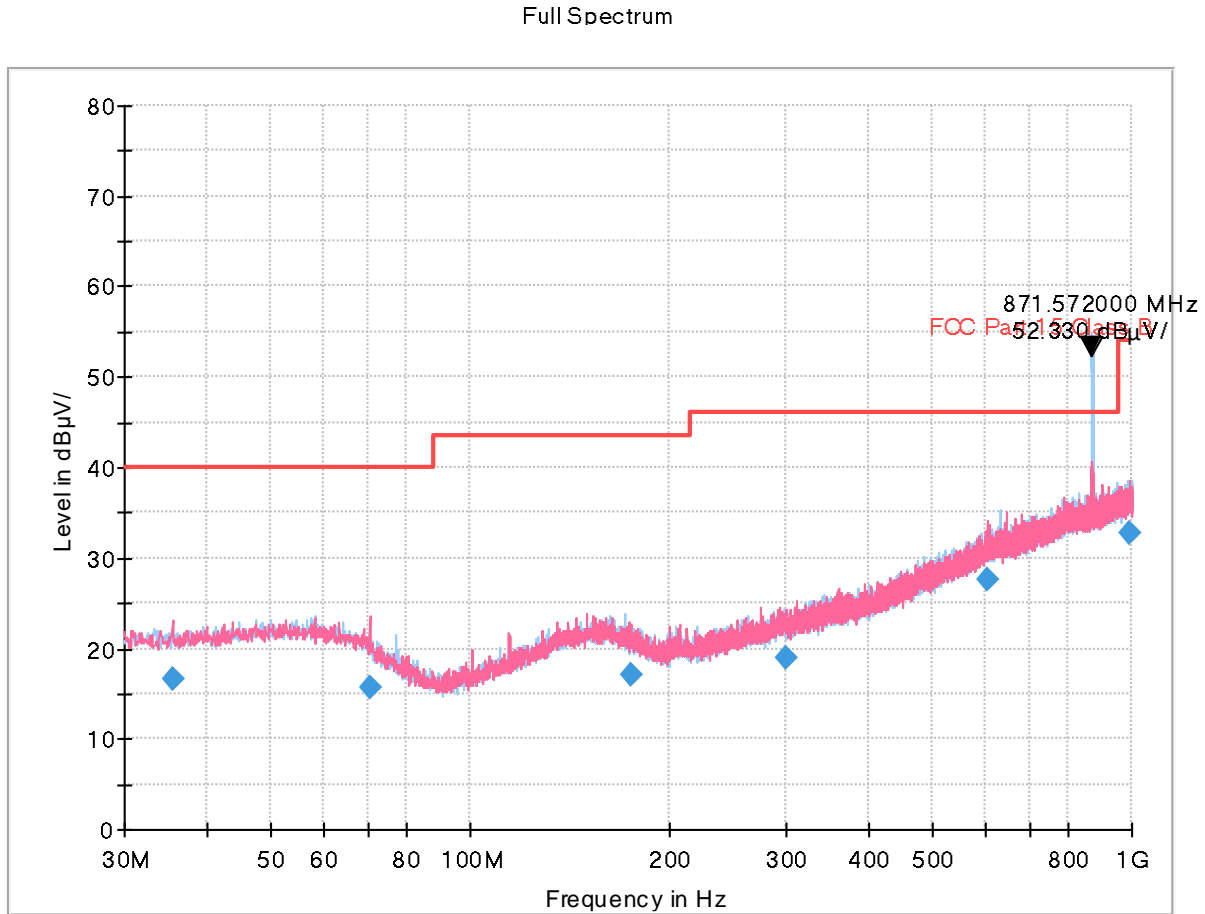

NOTE. 1. Carrier Frequency: Rx 871.572 MHz  
 2. These are signals for fundamental frequency from the base station

Frequency (MHz)	Quasi Peak (dBµV/m)	Limit (dBµV/m)	Margin (dB)	Antenna Height (cm)	POL. (H/V)	Azimuth (deg)	Corr. (dB)
35.4763	16.51	40.00	23.49	374.7	V	18.0	18.9
70.4580	15.78	40.00	24.22	112.7	V	58.0	18.2
174.5420	16.98	43.50	26.52	374.7	V	138.0	18.7
300.6311	19.05	46.00	26.95	174.9	V	26.0	20.6
603.5552	27.62	46.00	18.38	325.1	V	248.0	27.5
993.0254	32.78	54.00	21.22	109.8	V	246.0	32.5



### 5.3 Radiated Emission Above 1 GHz

#### 5.3.1 Test Condition

The test results of radiated emission provide the following information:

<b>Used Test Standard</b>	47 CFR PART 15 Subpart B Class B ANSI C63.4-2014
<b>Detector</b>	Peak, CISPR-Average
<b>Bandwidth</b>	1 MHz
<b>Highest Frequency</b>	5 825 MHz
<b>Tested Frequency Range</b>	1 GHz to 40 GHz
<b>Operating Mode of Worst case</b>	[EUT+TA] LTE B5 Low ch Idle  [EUT+Earphone] LTE B5 Low ch Idle
<b>Measurement Distance</b>	3 m
<b>Antenna Measurement Height</b>	1 m to 4 m
<b>Test Site</b>	3 m Semi Anechoic Chamber #1
<b>Temperature</b>	min. 19.4 °C, max. 21.1 °C
<b>Humidity</b>	min. 25.3 % R.H., max. 30.9 % R.H.
<b>Test Date</b>	February 08, 2023 - February 15, 2023

**Calculation Formula:**

1. POL. H = Horizontal, POL. V = Vertical
2. Peak or CAverage = Reading (Receiver Reading)+Corr.
3. Corr. (Correction Factor) = Antenna Factor+ Cable Loss –Amplifier Gain
4. Margin = Limit - Peak or CAverage



### 5.3.2 Measuring Data

Figure 5: Radiated Emission (1 to 40) GHz, [EUT+TA] LTE B5 Low ch Idle

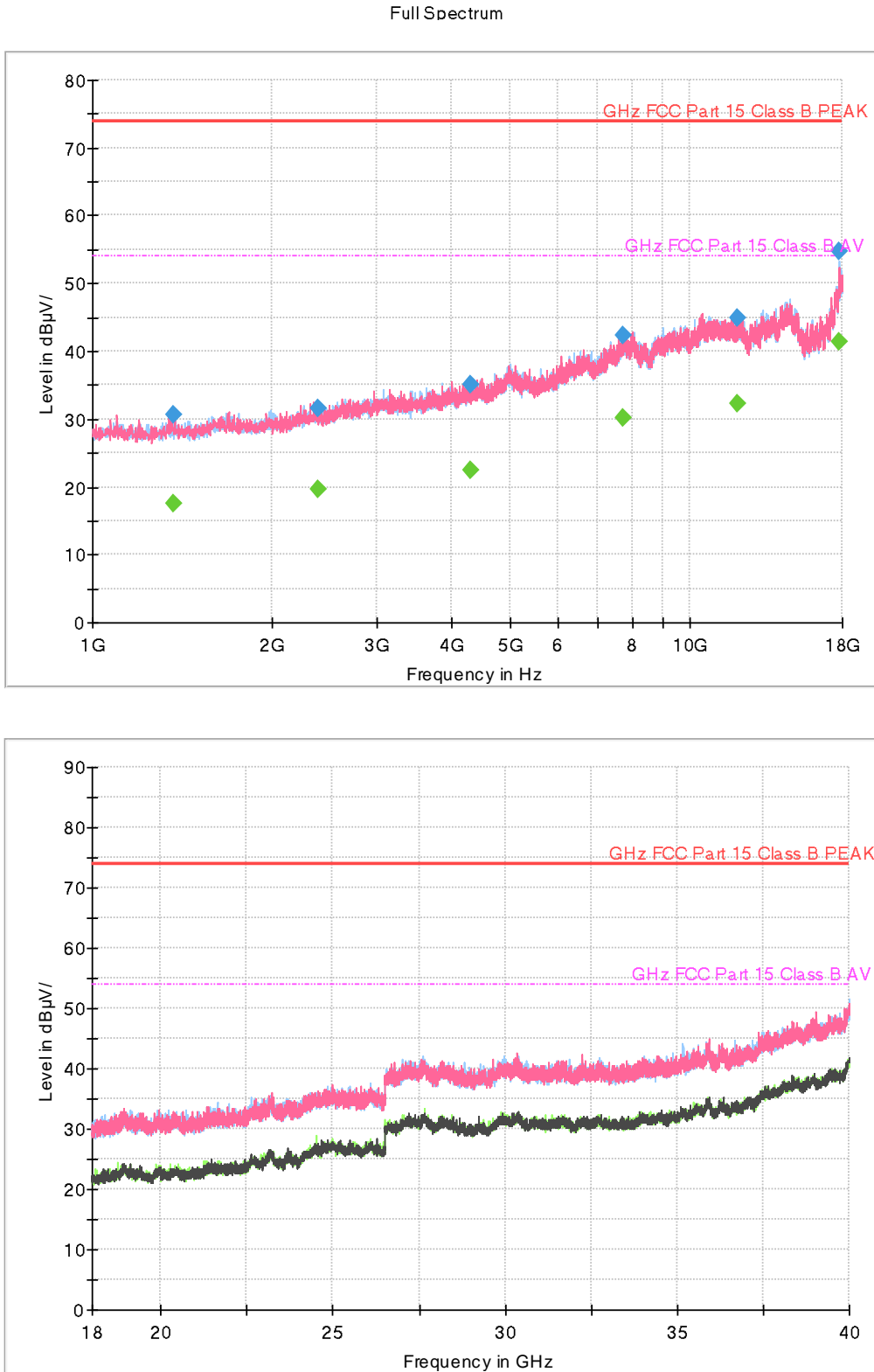



Frequency (MHz)	Peak (dB $\mu$ V/m)	Limit (dB $\mu$ V/m)	Margin (dB)	Antenna Height (cm)	POL. (H/V)	Azimuth (deg)	Corr. (dB)
1368.1250	30.75	74.00	43.25	302.6	V	287.0	-30.1
2383.1700	31.64	74.00	42.36	150.1	V	97.0	-26.4
4306.7400	35.03	74.00	38.97	249.8	V	227.0	-20.0
7728.2650	42.39	74.00	31.61	272.5	V	74.0	-10.0
12008.9900	44.92	74.00	29.08	173.5	H	300.0	-3.8
17810.9550	54.67	74.00	19.33	256.8	H	46.0	8.6

Frequency (MHz)	CAverage (dB $\mu$ V/m)	Limit (dB $\mu$ V/m)	Margin (dB)	Antenna Height (cm)	POL. (H/V)	Azimuth (deg)	Corr. (dB)
1368.1250	17.63	54.00	36.37	302.6	V	287.0	-30.1
2383.1700	19.65	54.00	34.35	150.1	V	97.0	-26.4
4306.7400	22.45	54.00	31.55	249.8	V	227.0	-20.0
7728.2650	30.19	54.00	23.81	272.5	V	74.0	-10.0
12008.9900	32.36	54.00	21.64	173.5	H	300.0	-3.8
17810.9550	41.29	54.00	12.71	256.8	H	46.0	8.6



Figure 6: Radiated Emission (1 to 40) GHz, [EUT+Earphone] LTE B5 Low ch Idle

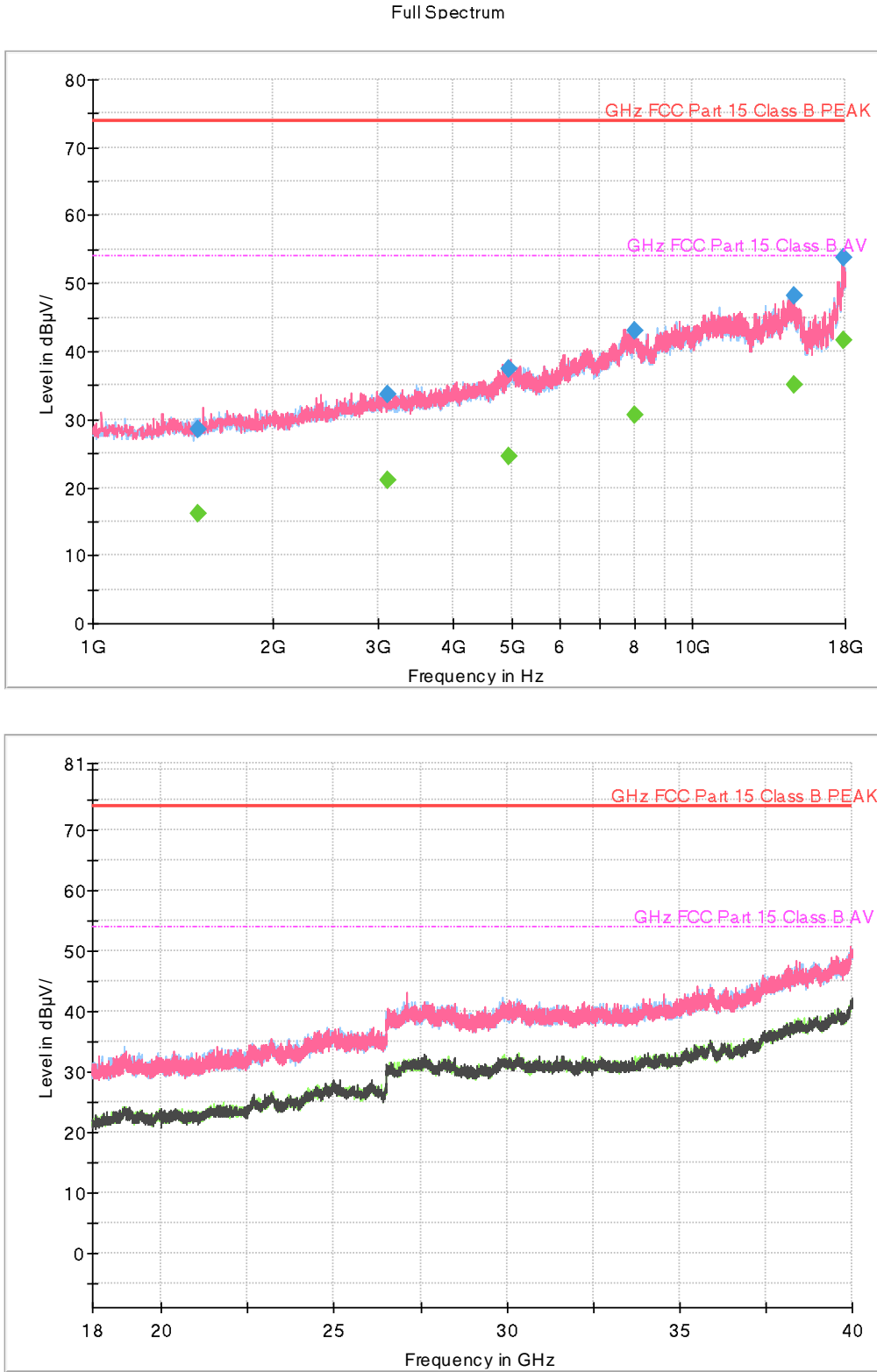



Frequency (MHz)	Peak (dB $\mu$ V/m)	Limit (dB $\mu$ V/m)	Margin (dB)	Antenna Height (cm)	POL. (H/V)	Azimuth (deg)	Corr. (dB)
1497.6650	28.51	74.00	45.49	100.0	H	67.0	-29.6
3096.8050	33.58	74.00	40.42	109.7	H	86.0	-23.6
4959.5250	37.47	74.00	36.53	133.6	V	335.0	-17.9
8025.0850	43.04	74.00	30.96	142.7	H	312.0	-9.5
14799.9650	48.12	74.00	25.88	134.7	V	213.0	-0.3
17852.1950	53.71	74.00	20.29	190.6	H	148.0	9.2

Frequency (MHz)	CAverage (dB $\mu$ V/m)	Limit (dB $\mu$ V/m)	Margin (dB)	Antenna Height (cm)	POL. (H/V)	Azimuth (deg)	Corr. (dB)
1497.6650	16.16	54.00	37.84	100.0	H	67.0	-29.6
3096.8050	21.03	54.00	32.97	109.7	H	86.0	-23.6
4959.5250	24.49	54.00	29.51	133.6	V	335.0	-17.9
8025.0850	30.62	54.00	23.38	142.7	H	312.0	-9.5
14799.9650	35.14	54.00	18.86	134.7	V	213.0	-0.3
17852.1950	41.73	54.00	12.27	190.6	H	148.0	9.2



## 6. APPENDIX A. TEST SETUP PHOTO

Please refer to EMI Test Setup Photo and test setup photo file no. as follows;

<b>Rev. No.</b>	<b>Issue Date</b>	<b>File No.</b>
0	February 24, 2023	HCT-EM-2302-FC009-P

End of report