



74, Seoicheon-ro 578beon-gil, Majang-myeon, Icheon-si, Gyeonggi-do, Korea  
 TEL: +82-31-645-6300 FAX: +82-31-645-6401

# HAC RF Emission Test Report

<b>Applicant Name:</b> <b>SAMSUNG Electronics Co., Ltd.</b> 129, Samsung-ro, Yeongtong-gu, Suwon-Si, Gyeonggi-do, 16677 Rep. of Korea	<b>Date of Issue:</b> Jul. 20, 2022 <b>Test Report No.:</b> HCT-SR-2207-FC023-R1 <b>Test Site:</b> HCT CO., LTD.
--	--

<b>FCC ID</b>	<b>A3LSMA536V</b>
---------------	-------------------

<b>Equipment Type:</b>	<b>Mobile Phone</b>
<b>Application Type</b>	<b>Class II Permissive Change</b>
<b>FCC Rule Part(s):</b>	<b>CFR §20.19 , ANSI C63.19-2011</b>
<b>Model Name:</b>	<b>SM-A536V</b>
<b>Date of Test:</b>	<b>Jan. 04, 2022</b>

<b>C63.19-2011 HAC Category</b>	<b>M3 (RF EMISSION CATEGORY)</b>
-------------------------------------	----------------------------------

This wireless portable device has been shown to be hearing-aid compatible under the above rated category, specified in ANSI/IEEE Std. C63.19-2011 and had been tested in accordance with the specified measurement procedures. Hearing-Aid Compatibility is based on the assumption that all production units will be designed electrically identical to the device tested in this report.

I attest to the accuracy of data. All measurements reported herein were performed by me or were made under my supervision and are correct to the best of my knowledge and belief. I assume full responsibility for the completeness of these measurements and vouch for the qualifications of all persons taking them.

**Tested by**



**Jee-Il, Lee**  
**Test Engineer**  
**SAR Team**  
**Certification Division**

**Technical Manager**



**Yun Jeang, Heo**  
**Technical Manager**  
**SAR Team**  
**Certification Division**

This report only responds to the tested sample and may not be reproduced, except in full, without written approval of the HCT Co., Ltd.

**REVISION HISTORY**

The revision history for this test report is shown in table.

<b>Revision No.</b>	<b>Date of Issue</b>	<b>Description</b>
0	Jul. 15, 2022	Initial Release
1	Jul. 20, 2022	Revised Page 20

This test results were applied only to the test methods required by the standard.

The above Test Report is not related to the accredited test result by (KS Q) ISO/IEC 17025 and KOLAS(Korea Laboratory Accreditation Scheme), which signed the ILAC-MRA.

## Table of Contents

1. Test Regulations .....	4
2. Attestation of test Result of Device Under Test.....	5
3. Device Under Test Description .....	6
4. HAC Measurement Set-Up .....	8
5. System Specifications.....	9
6. HAC RF Emmissions Test Procedure .....	11
7. System Specifications .....	13
8. System Validation .....	14
9. Modulation Interference Factor (MIF).....	16
10. Analysis of RF Air interface Technologies .....	18
11. Test Procedure .....	22
12. ANSI/IEEE C63.19 Performance Categories .....	24
13. Measurement Uncertainties .....	25
14. HAC Test Data Summary .....	26
15. HAC Test Equipment Chamber List .....	27
16. HAC Test Equipment List .....	28
17. CONCLUSION .....	29
18. Appendix A. TEST SETUP PHOTO .....	30
19. Appendix B. HAC RF Emission Test Plots.....	31
20. Appendix C. System Validation Plots.....	36
21. Appendix D. Probe Calibration Data .....	38
22. Appendix E. Dipole Calibration Data.....	61
23. Appendix F. UID Specifications .....	67

# 1. Test Regulations

The tests were performed according to the following regulations:

Test Standard	FCC 47 CFR §20.19 ANSI C63.19-2011
Test Method	<ul style="list-style-type: none"><li>• KDB 285076 D01 HAC Guidance v06</li><li>• KDB 285076 D03 HAC FAQ v01r05</li><li>• TCB workshop updates</li></ul>

## 2. Attestation of test Result of Device Under Test

Test Laboratory	
Company Name:	HCT Co., LTD
Address:	74, Seoicheon-ro 578beon-gil, Majang-myeon, Icheon-si, Gyeonggi-do, 17383, Rep. of Korea
Telephone:	+82 31 645 6300
Fax.:	+82 31 645 6401

Attestation of SAR test result	
Applicant Name:	SAMSUNG Electronics Co., Ltd.
Model Name	SM-A536V
EUT Type:	Mobile Phone
Application Type:	<b>Class II Permissive Change</b>

### 2.1 Test Methodology

The Tests document in this report were performed in accordance with ANSI C63.19-2011 method of Measurement of Compatibility between Wireless Communication Devices and Hearing Aids, FCC published KDB 285076 D01 HAC Guidance v06, FCC Published KDB285076 D03 HAC FAQ v01r05 and TCB Workshop updates .

### 3. Device Under Test Description

#### 3.1 DUT specification

Device Wireless specification overview		
Band & Mode	Operating Mode	Tx Frequency
GSM850	Voice / Data	824.2 MHz ~ 848.8 MHz
GSM1900	Voice / Data	1 850.2 MHz ~ 1 909.8 MHz
UMTS 850	Voice / Data	826.4 MHz ~ 846.6 MHz
UMTS 1900	Voice / Data	1 852.4 MHz ~ 1 907.6 MHz
LTE Band 2 (PCS)	Voice / Data	1 850.7 MHz ~ 1 909.3 MHz
LTE Band 4 (AWS)	Voice / Data	1 710.7 MHz ~ 1 754.3 MHz
LTE Band 5 (Cell)	Voice / Data	824.7 MHz ~ 848.3 MHz
LTE Band 7	Voice / Data	2 502.5 MHz ~ 2 567.5 MHz
LTE Band 12	Voice / Data	699.7 MHz ~ 715.3 MHz
LTE Band 13	Voice / Data	779.5 MHz ~ 784.5 MHz
LTE TDD Band 48	Voice / Data	3 552.5 MHz ~ 3 697.5 MHz
LTE Band 66 (AWS)	Voice / Data	1 710.7 MHz ~ 1 779.3 MHz
NR Band n2 (PCS)	Voice/ Data	1 852.5 MHz ~ 1 907.5 MHz
NR Band n5 (Cell)	Voice/ Data	826.5 MHz ~ 846.5 MHz
NR Band n66	Voice/ Data	1 712.5 MHz ~ 1 777.5 MHz
NR Band n48	Voice / Data	3 555 MHz ~ 3 694.98 MHz
NR Band n77	Voice/ Data	3 710 MHz ~ 3 969.99 MHz
NR Band 77(DoD)	Voice/ Data	3450 MHz ~ 3550 MHz
NR Band n260	Data	37 000 MHz ~ 40 000 MHz
NR Band n261	Data	27 500 MHz ~ 28 350 MHz
U-NII-1	Voice / Data	5 180 MHz ~ 5 240 MHz
U-NII-2A	Voice / Data	5 260 MHz ~ 5 320 MHz
U-NII-2C	Voice / Data	5 500 MHz ~ 5 720 MHz
U-NII-3	Voice / Data	5 745 MHz ~ 5 825 MHz
2.4 GHz WLAN	Voice / Data	2 412 MHz ~ 2 462 MHz
Bluetooth / LE 5.0	Data	2 402 MHz ~ 2 480 MHz
NFC	Data	13.56 MHz

### 3.2 Device Under Test

<b>Normal operation</b>	Held to head	
<b>Back Cover</b>	The Back Cover is not removable	
<b>Test sample information</b>	S/N UK10802M	Notes RF Emssion Test

## 4. HAC Measurement Set-Up

These measurements are performed using the DASY5 automated dosimetric assessment system. It is made by Schmid & Partner Engineering AG (SPEAG) in Zurich, Switzerland. It consists of high precision robotics system (Staubli), robot controller, Pentium IV computer, near-field probe, probe alignment sensor. The robot is a six-axis industrial robot performing precise movements.

A cell controller system contains the power supply, robot controller, teach pendant (Joystick), and remote control, is used to drive the robot motors. The PC consists of the HP Pentium IV 3.0 GHz computer with Windows XP system and HAC Measurement Software DASY5, A/D interface card, monitor, mouse, and keyboard. The Staubli Robot is connected to the cell controller to allow software manipulation of the robot. A data acquisition electronic (DAE) circuit performs the signal amplification, signal multiplexing, AD-conversion, offset measurements, mechanical surface detection, collision detection, etc. is connected to the Electro-optical coupler (EOC). The EOC performs the conversion from the optical into digital electric signal of the DAE and transfers data to the PC plug-in card.

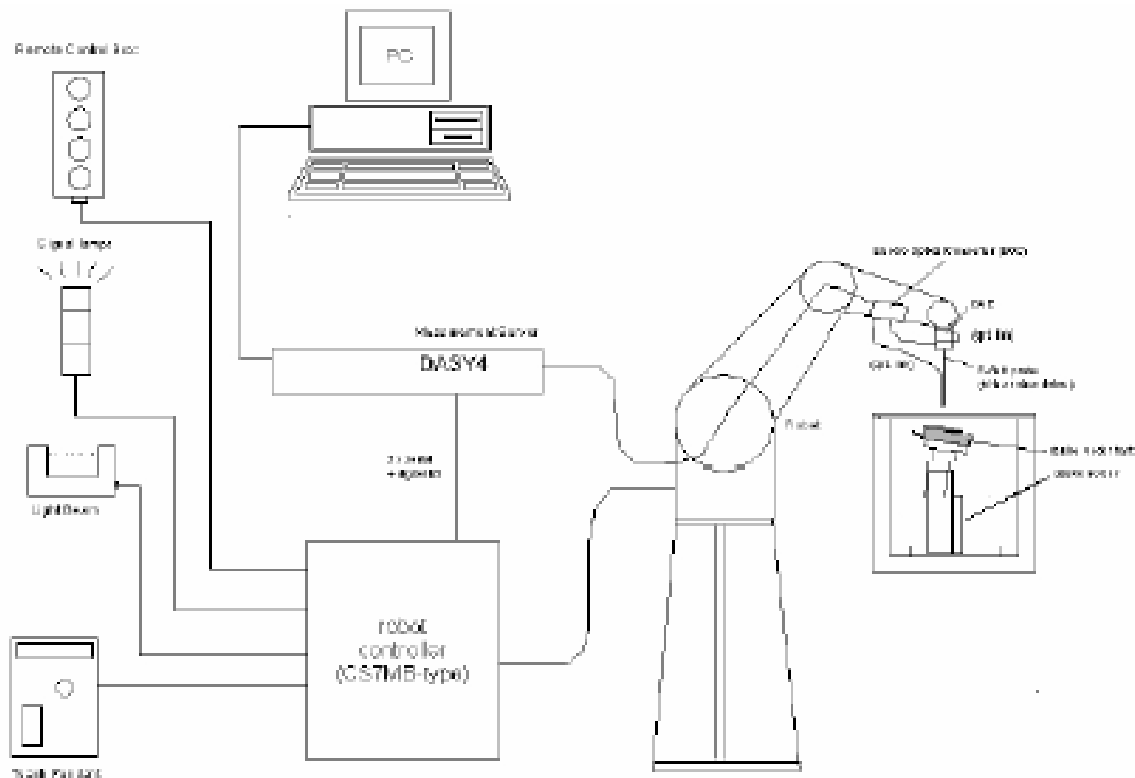

Figure 1. HAC Test Measurement Set-up

The DAE4 consists of a highly sensitive electrometer-grade preamplifier with auto-zeroing, a channel and gain-switching multiplexer, a fast 16 bit AD-converter and a command decoder and control logic unit. Transmission to the PC-card is accomplished through an optical downlink for data and status information and an optical uplink for commands and clock lines.

The mechanical probe mounting device includes two different sensor systems for frontal and sidewise probe contacts. They are also used for mechanical surface detection and probe collision detection.

The robot uses its own controller with a built in VME-bus computer.



## 5. System Specifications

### 5.1 Probe

#### E-Field Probe Description

Construction	One dipole parallel, two dipoles normal to probe axis Built-in shielding against static charges	 <p>[ E-Field Probe ]</p>
Calibration	In air from 100 MHz to 3.0 GHz (absolute accuracy $\pm 6.0\%$ , $k = 2$ )	
Frequency	100 MHz to > 6 GHz; Linearity: $\pm 0.2$ dB (100 MHz to 3 GHz)	
Directivity	$\pm 0.2$ dB in air (rotation around probe axis) $\pm 0.4$ dB in air (rotation normal to probe axis)	
Dynamic Range	2 V/m to > 1000 V/m (M3 or better device readings fall well below diode compression point)	
Linearity	$\pm 0.2$ dB	
Dimensions	Overall length: 337 mm (Tip: 20 mm) Tip diameter: 3.9 mm (Body: 12 mm) Distance from probe tip to dipole centers: 1.5 mm	

## 5.2 Phantom & Device Holder



Figure 2. HAC Phantom & Device Holder

The Test Arch phantom should be positioned horizontally on a stable surface. Reference markings on the Phantom allow the complete setup of all predefined phantom positions and measurement grids by manually teaching three points in the robot.

The devices can be easily, accurately, and repeatable positioned according to the FCC specifications.

## 5.3 Robotic System Specifications

### Specifications

**POSITIONER:** Stäubli Unimation Corp. Robot Model: TX90 XLspeag  
**Repeatability:** 0.02 mm  
**No. of axis:** 6

### Data Acquisition Electronic (DAE) System

#### Cell Controller

**Processor:** Core i7  
**Clock Speed:** 3.0 GHz  
**Operating System:** Windows 7  
**Data Card:** DASY5 PC-Board

#### Data Converter

**Features:** Signal Amplifier, multiplexer, A/D converter, and control logic  
**Software:** DASY5 software  
**Connecting Lines:** Optical downlink for data and status info.  
 Optical uplink for commands and clock

### PC Interface Card

**Function:** 24 bit (64 MHz) DSP for real time processing  
 Link to DAE  
 16 bit A/D converter for surface detection system  
 serial link to robot  
 direct emergency stop output for robot

## 6. HAC RF Emissions Test Procedure

The following are step-by-step test procedures.

- a) Confirm proper operation of the field probe, probe measurement system and other instrumentation and the positioning system.
  - b) Position the WD in its intended test position.
  - c) Set the WD to transmit a fixed and repeatable combination of signal power and modulation characteristic that is representative of the worst case (highest interference potential) encountered in normal use. Transiently occurring start-up, changeover, or termination conditions, or other operations likely to occur less than 1% of the time during normal operation, may be excluded from consideration.
  - d) The center sub-grid shall be centered on the T-Coil mode perpendicular measurement point or the acoustic output, as appropriate. Locate the field probe at the initial test position in the 50 mm by 50 mm grid, which is contained in the measurement plane, refer to illustrated in Figure 1. If the field alignment method is used, align the probe for maximum field reception.
  - e) Record the reading at the output of the measurement system.
  - f) Scan the entire 50 mm by 50 mm region in equally spaced increments and record the reading at each measurement point. The distance between measurement points shall be sufficient to assure the identification of the maximum reading.
  - g) Identify the five contiguous sub-grids around the center sub-grid whose maximum reading is the lowest of all available choices. This eliminates the three sub-grids with the maximum readings. Thus, the six areas to be used to determine the WD's highest emissions are identified.
  - h) Identify the maximum reading within the non-excluded sub-grids identified in step g).
  - i) Convert the highest field reading within identified in step h) to RF audio interference level, in V/m, by taking the square root of the reading and then dividing it by the measurement system transfer function, established in 5.5.1.1 Convert this result to dB(V/m) by taking the base-10 logarithm and multiplying by 20. Indirect measurement method Replacing step i), the RF audio interference level in dB (V/m) is obtained by adding the MIF (in dB) to the maximum steady-state rms field-strength reading, in dB (V/m), from step h). Use this result to determine the category rating.
  - j) Compare this RF audio interference level with the categories in Clause 8 (ANSI C63.19) and record the resulting WD category rating.
- Otherwise, repeat step a) through step i), with the grid shifted so that it is centered on the perpendicular measurement point. Record the WD category rating.



Figure 3. WD reference and plane for RF emission measurements

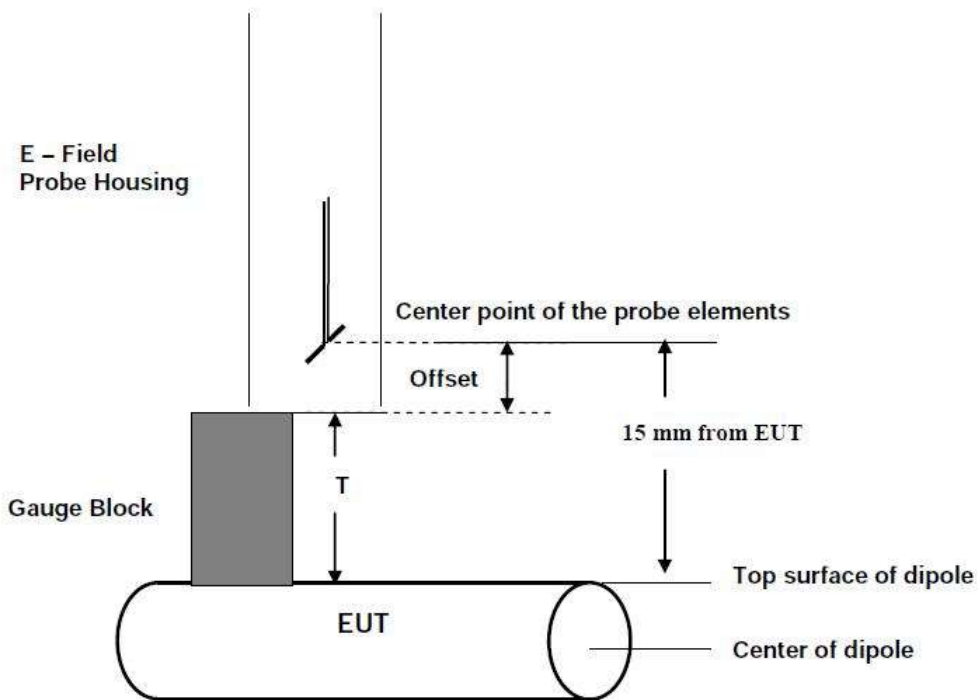

Figure 4. Gauge Block with E-Field Probe

## 7. System Specifications

E-field measurements are performed using the DASY52 automated dosimetric assessment system. The DASY52 is made by Schmid & Partner Engineering AG (SPEAG) in Zurich, Switzerland.

The DASY52 HAC Extension consists of the following parts:

### Test Arch Phantom

The specially designed Test Arch allows high precision positioning of both the device and any of the validation dipoles.

### EF3DV3 Isotropic E-Field Probe

Construction:	One dipole parallel, two dipoles normal to probe axis Interleaved sensors Built-in shielding against static charges PEEK enclosure material
Calibration:	In air from 100 MHz to 3.0 GHz (absolute accuracy $\pm 6.0\%$ , $k=2$ ) ISO/IEC 17025 <a href="#">calibration service</a> available.
Frequency:	40 MHz – >6 GHz (can be extended to < 20 MHz); Linearity: $\pm 0.2$ dB (100 MHz – 3 GHz)
Directivity:	$\pm 0.2$ dB in air (rotation around probe axis) $\pm 0.4$ dB in air (rotation normal to probe axis)
Dynamic Range:	2 V/m to > 1000 V/m; Linearity: $\pm 0.2$ dB
Dimensions:	Overall length: 337 mm (Tip: 20 mm) Tip diameter: 3.9 mm (Body: 12 mm) Distance from probe tip to dipole centers: 1.5 mm Sensor displacement to probe's calibration point: <0.7 mm
Application:	General near-field measurements up to 6 GHz  HAC measurements up to 6 GHz  Field component measurements  Fast automatic scanning in phantoms

## 8. System Validation

The test setup was validated when first configured and verified periodically thereafter to ensure proper function. The procedure provided in this section is a validation procedure using dipole antennas for which the field levels were computed by numeric modeling.

Procedure:

Place a dipole antenna meeting the requirements given in ANSI C63.19 in the normally occupied by the WD.

The dipole antenna serves as a known source for an electrical and magnetic output. Position the E-field probe so that the following occurs:

- The probes and their cables are parallel to the coaxial feed of the dipole antenna
- The probe cables and the coaxial feed of the dipole antenna approach the measurement area from opposite directions
- The center point of the probe element(s) is 15 mm from the closest surface of the dipole elements.

Scan the length of the dipole with the E-field probe and record the two maximum values found near the dipole ends. Average the two readings and compare the reading to the expected value in the calibration certificate or the expected value in this standard.

**Setup diagram**

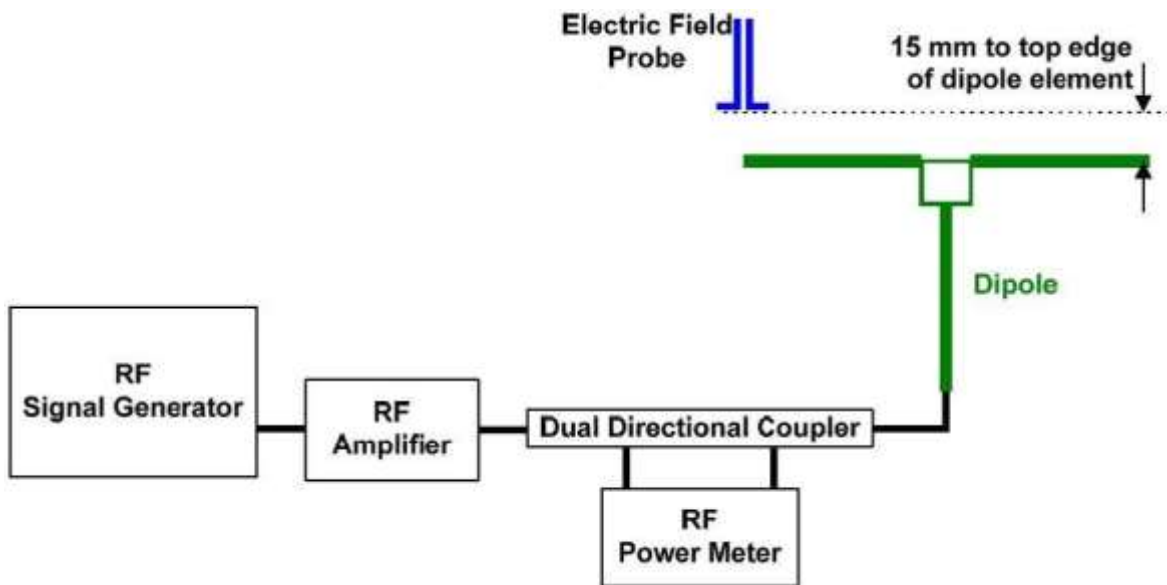

## 8.1 SYSTEM Validation Result

Mode	Date	Dipole Type_Seria_ Freq.	Input Power	MAX. Measured from		Average max. above arm	Target Value SPEAG	Dev.	Dipole Calib. Date
			Above high end	Above low end					
			[dBm]	[V/m]	[V/m]	[V/m]	[V/m]	[%]	
CW	01/04/2022	CD3500V3_SN:1012_(3500 MHz)	20	87.30	84.72	86.01	83.5	3.01	11/22/2022

### Notes:

- 1) Deviation (%) =  $100 * (\text{Measured value} - \text{Target value}) / \text{Target value}$ . ANSI-C63.19 requires values to be within 25% of their targets. 12% is deviation and 13% is measurement uncertainty.
- 2) The maximum E-field was evaluated and compared to the target values provided by SPEAG in the calibration certificate of specific dipoles.
- 3) Please refer to the attachment for detailed measurement data and plot.

## 9. Modulation Interference Factor (MIF)

The HAC Standard ANSI C63.19 defines a new scaling using the Modulation Interference Factor (MIF) which replaces the need for the Articulation Weighting Factor (AWF) during the evaluation and is applicable to any modulation scheme.

The Modulation Interference factor (MIF, in dB) is added to the measured average E-field (in dBV/m) and converts it to the RF Audio Interference level (in dBV/m). This level considers the audible amplitude modulation components in the RF E-field. CW fields without amplitude modulation are assumed to not interfere with the hearing aid electronics. Modulations without time slots and low fluctuations at low frequencies have low MIF values, TDMA modulations with narrow transmission and repetition rates of few 100 Hz have high MIF values and give similar classifications as ANSI C63.19.

### Definitions

E-field probes have a bandwidth <10 kHz and can therefore not evaluate the RF envelope in the full audio band. DASY52 is therefore using the "indirect" measurement method according to ANSI C63.19 which is the primary method. These near field probes read the averaged E-field measurement. Especially for the new high peak-to-average (PAR) signal types, the probes shall be linearized by probe modulation response (PMR) calibration in order to not overestimate the field reading.

The evaluation method of the MIF is defined in ANSI C63.19 section D.7. An RMS demodulated RF signal is fed to a spectral filter (similar to an A weighting filter) and forwarded to a temporal filter acting as a quasi-peak detector. The averaged output of these filtering is called to a 1 kHz 80% AM signal as reference. MIF measurement requires additional instrumentation and is not well suited for evaluation by the end user with reasonable uncertainty. It may alternatively be determined through analysis and simulation, because it is constraint and characteristic for a communication signal. DASY52 uses well defined signals for PMR calibration. The MIF of these signals has been determined by simulation and is automatically applied.

MIF values were not tested by a probe or as specified in the standards but are based on analysis provided by SPEAG for all the air interfaces (CDMA, GSM, WCDMA, LTE, and Wi-Fi). The data included in this report are for the worst case operating modes. The UIDs used are listed below:

A PMR calibrated probe is linearized for the selected waveform over the full dynamic range within the uncertainty specified in its calibration certificate. E-field probes have a bandwidth <10 kHz and can therefore not evaluate the RF envelope in the full audio band. DASY52 is therefore using the "indirect" measurement method according to ANSI C63.19 which is the primary method. These near field probes read the averaged E-field measurement. Especially for the new high peak-to-average (PAR) signal types, the probes shall be linearized by PMR calibration in order to not overestimate the field reading.



The MIF measurement uncertainty is estimated as follows, for modulation frequencies from slotted waveforms with fundamental frequency and at least 2 harmonics within 10 kHz:

- 0.2 dB for MIF -7 to +5 dB,
- 0.5 dB for MIF -13 to +11 dB
- 1 dB for MIF > -20 dB

**SPEAG test files**

UID	Communication System Name	MIF (dB)
10021-DAC	GSM-FDD (TDMA, GMSK)	3.63
10460-AAA	UMTS-FDD (WCDMA,AMR)	-25.43
10170-CAE	LTE-FDD (SC-FDMA, 1 RB, 20 MHz, 16QAM)	-9.76
10182-CAE	LTE-FDD (SC-FDMA, 1 RB, 15 MHz, 16QAM)	-9.76
10176-CAG	LTE-FDD (SC-FDMA, 1 RB, 10 MHz, 16QAM)	-9.76
10173-CAG	LTE-TDD (SC-FDMA, 1 RB, 10 MHz, 16QAM)	-1.44
10061-CAB	IEEE 802.11b WiFi 2.4 GHz (DSSS, 11 Mbps)	-2.02
10077-CAB	IEEE 802.11g WiFi 2.4 GHz (DSSS/OFDM, 54 Mbps)	0.12
10591-AAB	IEEE 802.11n (HT Mixed, 20MHz, MCS0, 90pc duty cycle)	-5.59
10069-CAC	IEEE 802.11a/n WiFi 5 GHz (OFDM, 54 Mbps)	-3.15
10616-AAB	IEEE 802.11ac WiFi (40MHz, MCS0, 90pc duty cycle)	-5.57
10030-CAA	IEEE 802.15.1 Bluetooth (GFSK, DH1)	1.02
10933-AAC	5G NR-FDD (DFT-s-OFDM, 1RB, 20 MHz, QPSK, 15 kHz)	-15.06
10972-AAB	5G NR TDD (CP-OFDM, 1 RB, 20 MHz, QPSK, 15 kHz)	-1.65
10973-AAB	5G NR TDD (DFT-s-OFDM, 1 RB, 100 MHz, QPSK, 30 kHz)	-1.64
10974-AAB	5G NR TDD (CP-OFDM, 100% RB, 100 MHz, 256-QAM, 30 kHz)	-3.48

## 10. Analysis of RF Air interface Technologies

An analysis was performed, following the guidance of 4.3 and 4.4 of the ANSI standard, of the RF air interface technologies being evaluated. The factors that will affect the RF interference Potential were evaluated, and the worst case operating modes were identified and used in the evaluation. A WD's interference potential is a function both of the WD's average near-field field strength and of the signal's audio-frequency amplitude modulation characteristics. Per 4.4, RF air interface technologies that have low power have been found to produce sufficiently low RF interference potential, so it is possible to exempt them from the product testing specified in Clause 5 of the ANSI standard. An RF air interface technology of a device is exempt from testing

When its average antenna input power plus its MIF is  $\leq 17\text{dBm}$  for all of its operating modes.

The worst case MIF plus the worst case average antenna input power for all modes are investigated below to determine the testing requirements for this device.

### 10.1 Air Interfaces and Operating Mode

Air-Interface	Band (MHz)	Type	HAC Tested	Simultaneous Transmissions Note: Not to be tested	Name of Voice service	Power Reduction
GSM	850	VO	Yes	Yes: BT, WLAN	CMRS Voice	N/A
	1900					
	GPRS/EDGE	VD	N/A	Yes: BT, WLAN	google Duo	N/A
WCDMA	850	VO	No <sup>1</sup>	Yes: BT, WLAN	CMRS Voice	N/A
	1900					
	HSPA	VD	N/A	Yes: BT, WLAN	google Duo	N/A
LTE (FDD)	700 (B12)	VD	No <sup>1</sup>	Yes: NR, BT, WLAN	VoLTE,google Duo	N/A
	780 (B13)					
	850 (B5)					
	1700 (B4,B66)					
	1900 (B2)					
	2500(B7)					
LTE (TDD)	3500 (B48)	VD	Yes	Yes: NR, BT, WLAN	VoLTE,google Duo	Yes
NR(FDD)	850(B5)	VD	No <sup>1</sup>	Yes: LTE, BT, WLAN	VoNR,google Duo	N/A
	1700(B66)					
	1900(B2)					
NR(TDD)	3500(B48)	VD	Yes	Yes: LTE, BT, WLAN	VoNR,google Duo	Yes
	3800(B77)	VD	No <sup>1</sup>			
WLAN	2450	VD	No <sup>1</sup>	Yes: WWAN, Wifi 5GHz	VoWIFI, google Duo	Yes
	5200(UNII 1)		No <sup>1</sup>	Yes: WWAN and BT		
	5300(UNII 2A)		No <sup>1</sup>			
	5500(UNII 2C)		No <sup>1</sup>			
	5800(UNII 3)		No <sup>1</sup>			
BT	2450	DT	N/A	Yes: WWAN and Wifi 5GHz	N/A	Yes
Type Transport VO = CMRS Voice Service DT = Digital Transport VD = CMRS IP Voice Service and Digital Transport				Note: <sup>1</sup> . Evaluated for MIF and low power exemption. This report pertains to NR n48 only. For full data, please refer to original test report.(Test Report : HCT-SR-2201-FC004-R1)		

## 10.2 Individual Mode Evaluations

Max. Average Power + MIF calculations for Low Power Exemptions

Air Interface	Maximum Average Power	Worst case MIF	Total (Power + MIF)	C63.19 Testing Required
	[dBm]	[dBm]	[dBm]	
NR Band 48	19.5*	-1.65	17.85	Yes

**Note(s):**

1. Max tune-up limit.

\*. ANSI C63.19-2011 Sec. 4.4 footnot 20 indicates the use of a long averaging time for measuring the antenna input power when using this method of exclusion. Therefore, the frame averaged power was calculated for these modes in this investigation.

### **10.3 Low-Power Exemption Conclusions**

Per ANSI C63.19-2011, RF Emissions testing for this device is required only for NR TDD Band 48 data mode voice. All other applicable air interfaces are exempt.

## 11. Test Procedure

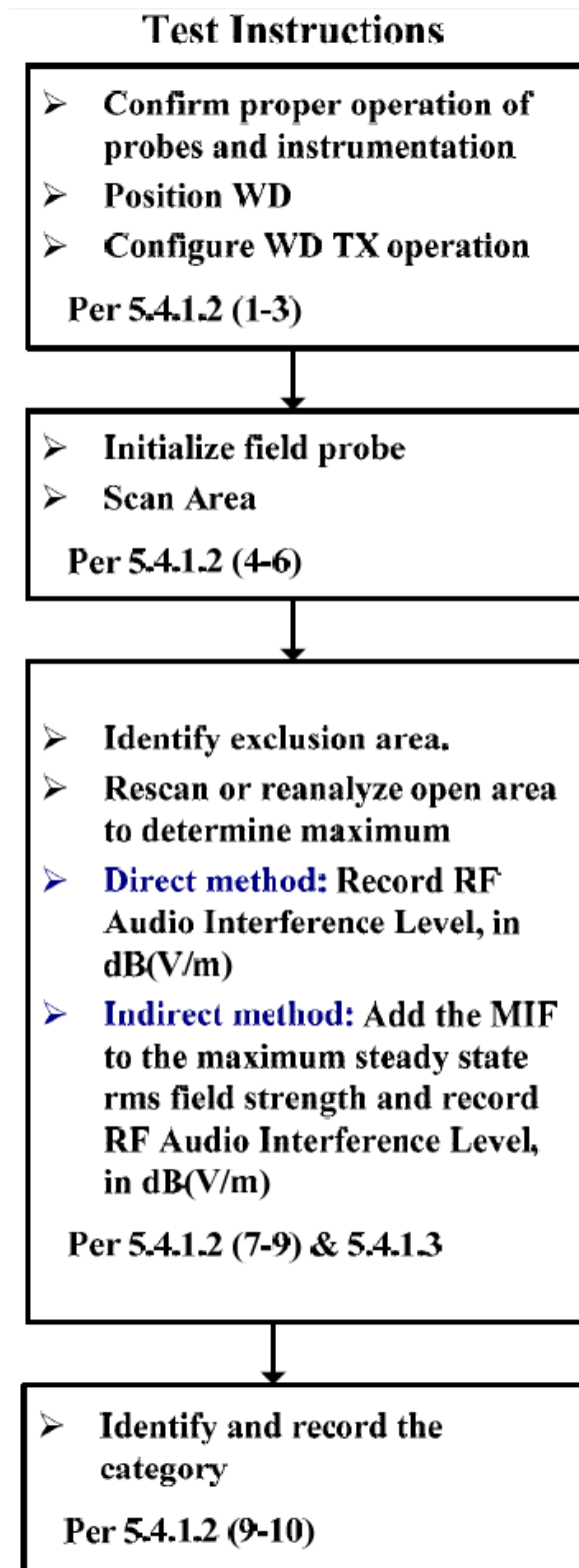

Figure 6. WD near-field emission automated test flowchart

**The evaluation was performed with the following procedure:**

1. Confirm proper operation of the field probe, probe measurement system and other instrumentation and the positioning system.
2. Position the WD in its intended test position. The measurement should be performed at a distance 1.5 cm from the probe elements so the gauge block can simplify this positioning.
3. Configure the WD normal operation for maximum rated RF output power, at the desired channel and other operating parameters, as intended for the test.
4. The center sub-grid shall be centered on the center of the WD output (acoustic or T-Coil output), as appropriate.
5. A Surface calibration was performed before each setup change to ensure repeatable spacing and proper maintenance of the measurement plane using the HAC Phantom.
6. Locate the field probe at reference location and measure the field strength.
7. Scan the entire 5 cm by 5 cm region at 5 mm increments and record the reading at each measurement point.
8. Identify the maximum field reading within the non-excluded sub-grids identified in Step 7.
9. Move the probe to the location of maximum scan measurement and then 360° rotating the probe to align it for the maximum reading at that position.
10. Locate the field probe at the reference location and measure the field strength for drift evaluation. If conducted power deviations of more than 5 % occurred, the tests were repeated.
11. Convert the maximum field strength reading identified in Step 8 to V/m or A/m, as appropriate. For probes which require a probe modulation factor, this conversion shall be done using the appropriate probe modulation.
12. Repeat Step 1 through Step 11 for both the E-field measurements.

## 12. ANSI/IEEE C63.19 Performance Categories

The EUT must meet the following M3 or M4 category:

Emission Categories	E-field emissions dB [V/m]	
	< 960 MHz	> 960 MHz
Category M1	50 to 55	40 to 45
Category M2	45 to 50	35 to 40
Category M3	40 to 45	30 to 35
Category M4	< 40	< 30

Telephone near-field categories in linear units



### 13. Measurement Uncertainties

Error Description	Uncertainty value [±%]	Probe Dist.	Div.	(Ci) E	(Ci) H	Std. Unc. E [±%]
<b>Measurement System</b>						
Probe Calibration	5.1	N	1	1	1	5.1
Axial Isotropy	4.7	R	√3	1	1	2.7
Sensor Displacement	16.5	R	√3	1	0.145	9.5
Boundary Effects	2.4	R	√3	1	1	1.4
Phantom Boundary Effect	7.2	R	√3	1	0	4.1
Linearity	4.7	R	√3	1	1	2.7
Scaling with PMR calibration	10.0	R	√3	1	1	5.8
System Detection Limit	1.0	R	√3	1	1	0.6
Readout Electronics	0.3	N	1	1	1	0.3
Response Time	0.8	R	√3	1	1	0.5
Integration Time	2.6	R	√3	1	1	1.5
RF Ambient Conditions	3.0	R	√3	1	1	1.7
RF Reflections	12	R	√3	1	1	6.9
Probe Positioner	1.2	R	√3	1	0.67	0.7
Probe Positioning	4.7	R	√3	1	0.67	2.7
Extrap. and Interpolation	1.0	R	√3	1	1	0.6
<b>Test Sample Related</b>						
Device Positioning Vertical	4.7	R	√3	1	0.67	2.7
Device Positioning Lateral	1.0	R	√3	1	1	0.6
Device Holder and Phantom	2.4	R	√3	1	1	1.4
Power Drift	5.0	R	√3	1	1	2.9
<b>Phantom and Setup Related</b>						
Phantom Thickness	2.4	R	√3	1	0.67	1.4
Combined Std. Uncertainty	(k=1)					16.3
Expanded Std. Uncertainty on Power	(Coverage Factor for 95%, k =2)					<b>32.6</b>
Expanded Std. Uncertainty on Field	(Coverage Factor for 95%)					<b>16.3</b>

## 14. HAC Test Data Summary

### E-Field Measurement Result (NR)

Mode	Channel	Mod.	BW	RB Size	RB offset	Time Avg. Filed [V/m]	Audio Inteference Level [dBV/m]	FCC Limit [dBV/m]	FCC Margin [dB]	MIF	Result	Exclu-sion Block	Plot No.
NR Band 48	637334	CP-OFDM	20	1	1	46.51	31.70	35	3.30	-1.65	M3	none	1
	640222	CP-OFDM	20	1	1	44.31	31.28	35	3.72	-1.65	M3	none	2
	643112	CP-OFDM	20	1	1	43.05	31.03	35	3.97	-1.65	M3	none	3
	646000	CP-OFDM	20	1	1	43.80	31.18	35	3.82	-1.65	M3	none	4

## 15. HAC Test Equipment Chamber List

The test sites and measurement facilities used to collect data are located at  
SAR 1 Room(HAC)

## 16. HAC Test Equipment List

Manufacturer	Type / Model	S/N	Calib. Date	Calib.Interval	Calib.Due
SPEAG	HAC Phantom	-	N/A	N/A	N/A
HP	SAR System Control PC	-	N/A	N/A	N/A
Staubli	TX90 XIspeag	F11/5K3RA1/C/01	N/A	N/A	N/A
Staubli	CS8Cspeag-TX90	F11/5K3RA1/A/01	N/A	N/A	N/A
Staubli	Teach Pendant (Joystick)	S-1203 0309	N/A	N/A	N/A
Staubli	Light Alignment Sensor	SE UKS 030 AA	N/A	N/A	N/A
SPEAG	DAE4	466	04/23/2021	Annual	04/23/2022
SPEAG	E-Field Probe EF3DV3*	4034	02/25/2021	Annual	02/25/2022
SPEAG	Dipole CD835V3	1024	02/19/2021	Annual	02/19/2022
SPEAG	Dipole CD1880V3	1019	02/19/2021	Annual	02/19/2022
SPEAG	Dipole CD3500V3	1012	11/22/2021	Annual	11/22/2022
HP	Power Meter E4419B	MY40511244	04/15/2021	Annual	04/15/2022
Agilent	Power Sensor 8481A	SG1091286	10/06/2021	Annual	10/06/2022
Agilent	Power Sensor 8481A	MY41090675	10/06/2021	Annual	10/06/2022
Agilent	Power Meter N1911A	MY45101406	07/08/2021	Annual	07/08/2022
Agilent	Power Sensor N1921A	MY55220026	08/25/2021	Annual	08/25/2022
Agilent	Signal Generator N5182A	MY47070230	05/10/2021	Annual	05/10/2022
Agilent	11636B/Power Divider	58698	02/26/2021	Annual	02/26/2022
TESTO	175-H1/Thermometer	2183499992	12/09/2021	Annual	12/09/2022
EMPOWER	RF Power Amplifier / 2135DEFAAXLXX	1084	06/25/2021	Annual	06/25/2022
Agilent	Directional Bridge 86205A	3140A03878	05/28/2021	Annual	05/28/2022
MICRO LAB	LP Filter / LA-60N	32011	10/06/2021	Annual	10/06/2022
MICRO LAB	LP Filter / LA-30N	-	10/06/2021	Annual	10/06/2022
MICRO LAB	LP Filter / LA-15N	10453	10/06/2021	Annual	10/06/2022
HP	Attenuator (3dB) 333340A	02427	09/06/2021	Annual	09/06/2022
Agilent	Attenuator (20dB) 33340C	18128	02/09/2021	Annual	02/09/2022
WEINSCHTEL	Attenuator (10dB) 3M-10	z6226	11/11/2021	Annual	11/11/2022
HP	Attenuator (20dB) 8493C	09271	09/06/2021	Annual	09/17/2022
R & S	Radio Communication Tester	167918	04/15/2021	Annual	04/15/2022
Agilent	MXA Signal Analyzer N9020A	MY50510407	10/22/2021	Annual	10/22/2022
Anritsu	Radio Communication Tester MT8821C	6262044720	12/20/2021	Annual	12/20/2022
Anritsu	Radio Communication Tester MT8000A	6262036812	12/20/2021	Annual	12/20/2022

\*: According to SPEAG's Technical Report, "MIF Verification", Doc # TR-FB-12.09.04-1, issued date: 9/4/2012. E-field probes are calibrated with specified uncertainty according to ISO 17025 as described in their calibration certificate. The MIF according to the definition in ANSI C63.19 is specific for a modulation and can therefore be used as a constant value if the probe has been PMR calibrated.

## 17. CONCLUSION

The HAC measurement indicates that the EUT complies with the HAC limits of the ANSI-C63.19-2011. These measurements are taken to simulate the RF effects exposure under worst-case conditions. Precise Laboratory measures were taken to assure repeatability of the tests.

## 18. Appendix A. TEST SETUP PHOTO

Please refer to test Setup Photo file no. as follows;

Rev. No.	File No.
0	HCT-SR-2201-FC004-P

## 19. Appendix B. HAC RF Emission Test Plots

**Plot No.1**

**Date : 2022-01-04**

Communication System: UID 10972 - AAB, 5G NR (CP-OFDM, 1 RB, 20 MHz, QPSK, 15 kHz);  
 Frequency: 3560.01 MHz; Duty Cycle: 1:14.4311  
 Medium parameters used:  $\sigma = 0$  S/m,  $\epsilon_r = 1$ ;  $\rho = 0$  kg/m<sup>3</sup>  
 Phantom section: RF Section

**DASY5 Configuration:**

- Probe: EF3DV3 - SN4034; ConvF(1, 1, 1) @ 3560.01 MHz; Calibrated: 2021-02-25
- Sensor-Surface: (Fix Surface)
- Electronics: DAE4 Sn466; Calibrated: 2021-04-23
- Phantom: HAC Test Arch with AMCC
- Measurement SW: DASY52, Version 52.10 (4)

**Device E-Field measurement (E-field scan for ANSI C63.19-2007 & -2011 compliance)/E Scan - ER3D: 15 mm from Probe Center to the Device/Hearing Aid Compatibility Test (101x101x1):**

Interpolated grid: dx=0.5000 mm, dy=0.5000 mm  
 Device Reference Point: 0, 0, -6.3 mm  
 Reference Value = 36.95 V/m; Power Drift = -0.17 dB  
 Applied MIF = -1.65 dB  
 RF audio interference level = 31.70 dBV/m  
**Emission category: M3**

MIF scaled E-field

<b>M3</b> 31.26 dBV/m	Grid 2 <b>M3</b> 31.7 dBV/m	Grid 3 <b>M3</b> 30.87 dBV/m
Grid 4 <b>M4</b> 27.52 dBV/m	<b>Grid 5 M4</b> 29.39 dBV/m	Grid 6 <b>M4</b> 29.23 dBV/m
Grid 7 <b>M4</b> 22.88 dBV/m	Grid 8 <b>M4</b> 23.67 dBV/m	Grid 9 <b>M4</b> 23.76 dBV/m

**Cursor:**

Total = 31.70 dBV/m  
 E Category: M3  
 Location: 0.5, -25, 7.7 mm

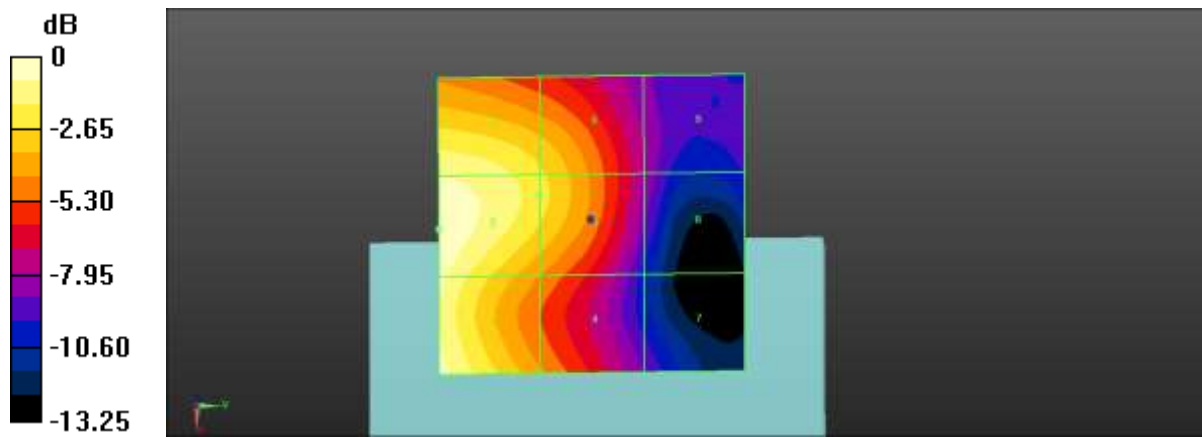

0 dB = 38.50 V/m = 31.71 dBV/m



**Plot No.2**

**Date : 2022-01-04**

Communication System: UID 10972 - AAB, 5G NR (CP-OFDM, 1 RB, 20 MHz, QPSK, 15 kHz);  
 Frequency: 3603.33 MHz; Duty Cycle: 1:14.4311  
 Medium parameters used:  $\sigma = 0$  S/m,  $\epsilon_r = 1$ ;  $\rho = 0$  kg/m<sup>3</sup>  
 Phantom section: RF Section

DASY5 Configuration:

- Probe: EF3DV3 - SN4034; ConvF(1, 1, 1) @ 3603.33 MHz; Calibrated: 2021-02-25
- Sensor-Surface: (Fix Surface)
- Electronics: DAE4 Sn466; Calibrated: 2021-04-23
- Phantom: HAC Test Arch with AMCC
- Measurement SW: DASY52, Version 52.10 (4)

**Device E-Field measurement (E-field scan for ANSI C63.19-2007 & -2011 compliance)/E Scan - ER3D: 15 mm from Probe Center to the Device/Hearing Aid Compatibility Test (101x101x1):**

Interpolated grid: dx=0.5000 mm, dy=0.5000 mm  
 Device Reference Point: 0, 0, -6.3 mm  
 Reference Value = 34.64 V/m; Power Drift = 0.05 dB  
 Applied MIF = -1.65 dB  
 RF audio interference level = 31.28 dBV/m  
**Emission category: M3**

MIF scaled E-field

Grid 1 <b>M3</b> <b>31.21 dBV/m</b>	Grid 2 <b>M3</b> <b>31.28 dBV/m</b>	Grid 3 <b>M3</b> <b>30.34 dBV/m</b>
Grid 4 <b>M4</b> <b>28.02 dBV/m</b>	Grid 5 <b>M4</b> <b>29.07 dBV/m</b>	Grid 6 <b>M4</b> <b>28.92 dBV/m</b>
Grid 7 <b>M4</b> <b>24 dBV/m</b>	Grid 8 <b>M4</b> <b>24.32 dBV/m</b>	Grid 9 <b>M4</b> <b>24.38 dBV/m</b>

**Cursor:**

Total = 31.28 dBV/m  
 E Category: M3  
 Location: 1.5, -25, 7.7 mm

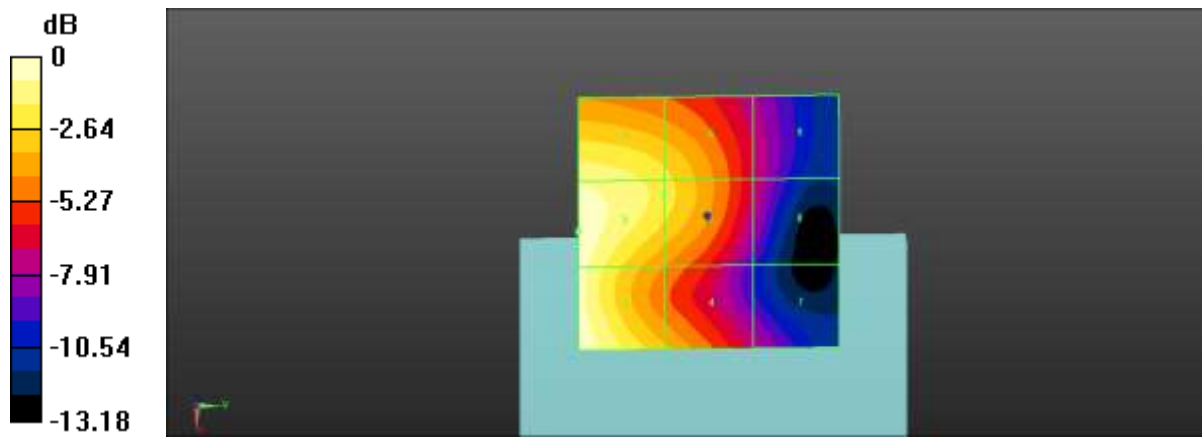

0 dB = 36.68 V/m = 31.29 dBV/m

**Plot No.3**

**Date : 2022-01-04**

Communication System: UID 10972 - AAB, 5G NR (CP-OFDM, 1 RB, 20 MHz, QPSK, 15 kHz);  
 Frequency: 3646.68 MHz; Duty Cycle: 1:14.4311  
 Medium parameters used:  $\sigma = 0$  S/m,  $\epsilon_r = 1$ ;  $\rho = 0$  kg/m<sup>3</sup>  
 Phantom section: RF Section

**DASY5 Configuration:**

- Probe: EF3DV3 - SN4034; ConvF(1, 1, 1) @ 3646.68 MHz; Calibrated: 2021-02-25
- Sensor-Surface: (Fix Surface)
- Electronics: DAE4 Sn466; Calibrated: 2021-04-23
- Phantom: HAC Test Arch with AMCC
- Measurement SW: DASY52, Version 52.10 (4)

**Device E-Field measurement (E-field scan for ANSI C63.19-2007 & -2011 compliance)/E Scan - ER3D: 15 mm from Probe Center to the Device/Hearing Aid Compatibility Test (101x101x1):**

Interpolated grid: dx=0.5000 mm, dy=0.5000 mm  
 Device Reference Point: 0, 0, -6.3 mm  
 Reference Value = 33.40 V/m; Power Drift = 0.01 dB  
 Applied MIF = -1.65 dB  
 RF audio interference level = 31.03 dBV/m  
**Emission category: M3**

MIF scaled E-field

Grid 1 <b>M3</b> <b>30.84 dBV/m</b>	Grid 2 <b>M3</b> <b>31.03 dBV/m</b>	Grid 3 <b>M4</b> <b>29.91 dBV/m</b>
Grid 4 <b>M4</b> <b>27.42 dBV/m</b>	Grid 5 <b>M4</b> <b>28.69 dBV/m</b>	Grid 6 <b>M4</b> <b>28.63 dBV/m</b>
Grid 7 <b>M4</b> <b>24.13 dBV/m</b>	Grid 8 <b>M4</b> <b>24.33 dBV/m</b>	Grid 9 <b>M4</b> <b>24.29 dBV/m</b>

**Cursor:**

Total = 31.03 dBV/m  
 E Category: M3  
 Location: 2.5, -25, 7.7 mm

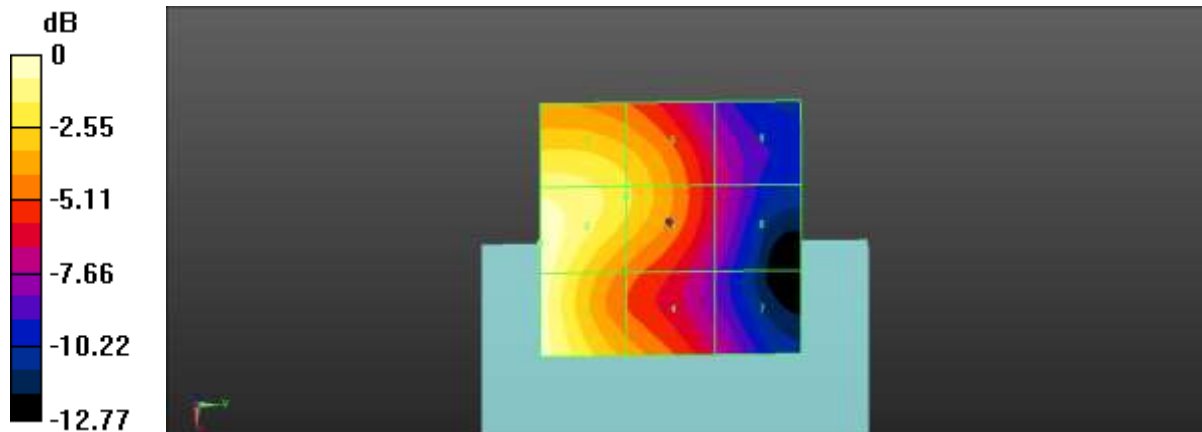

0 dB = 35.63 V/m = 31.04 dBV/m

**Plot No.4**

**Date : 2022-01-04**

Communication System: UID 10972 - AAB, 5G NR (CP-OFDM, 1 RB, 20 MHz, QPSK, 15 kHz);  
 Frequency: 3690 MHz; Duty Cycle: 1:14.4311  
 Medium parameters used:  $\sigma = 0$  S/m,  $\epsilon_r = 1$ ;  $\rho = 0$  kg/m<sup>3</sup>  
 Phantom section: RF Section

**DASY5 Configuration:**

- Probe: EF3DV3 - SN4034; ConvF(1, 1, 1) @ 3690 MHz; Calibrated: 2021-02-25
- Sensor-Surface: (Fix Surface)
- Electronics: DAE4 Sn466; Calibrated: 2021-04-23
- Phantom: HAC Test Arch with AMCC
- Measurement SW: DASY52, Version 52.10 (4)

**Device E-Field measurement (E-field scan for ANSI C63.19-2007 & -2011 compliance)/E Scan - ER3D: 15 mm from Probe Center to the Device/Hearing Aid Compatibility Test (101x101x1):**

Interpolated grid: dx=0.5000 mm, dy=0.5000 mm  
 Device Reference Point: 0, 0, -6.3 mm  
 Reference Value = 38.10 V/m; Power Drift = 0.06 dB  
 Applied MIF = -1.65 dB  
 RF audio interference level = 31.18 dBV/m  
**Emission category: M3**

MIF scaled E-field

Grid 1 <b>M3</b> 30.98 dBV/m	Grid 2 <b>M3</b> 31.18 dBV/m	Grid 3 <b>M4</b> 29.93 dBV/m
Grid 4 <b>M4</b> 27.36 dBV/m	Grid 5 <b>M4</b> 28.86 dBV/m	Grid 6 <b>M4</b> 28.63 dBV/m
Grid 7 <b>M4</b> 23.78 dBV/m	Grid 8 <b>M4</b> 24.79 dBV/m	Grid 9 <b>M4</b> 24.62 dBV/m

**Cursor:**

Total = 31.18 dBV/m  
 E Category: M3  
 Location: 2, -25, 7.7 mm

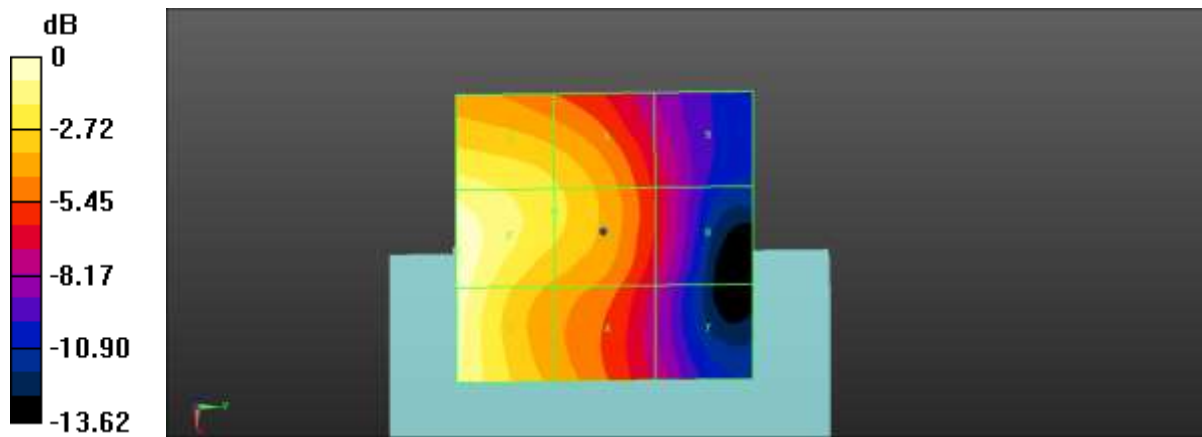

0 dB = 36.25 V/m = 31.19 dBV/m

## 20. Appendix C. System Validation Plots

**3500MHz Verification**

Date : 2022-01-04

**DUT: HAC Dipole 3500 MHz; Type: CD3500V3;**

Communication System: UID 0, CW (0); Frequency: 3500 MHz;Duty Cycle: 1:1  
 Medium parameters used:  $\sigma = 0$  S/m,  $\epsilon_r = 1$ ;  $\rho = 0$  kg/m<sup>3</sup>  
 Phantom section: RF Section

**DASY5 Configuration:**

- Probe: EF3DV3 - SN4034; ConvF(1, 1, 1) @ 3500 MHz; Calibrated: 2021-02-25
- Sensor-Surface: (Fix Surface)
- Electronics: DAE4 Sn466; Calibrated: 2021-04-23
- Phantom: HAC Test Arch with AMCC
- Measurement SW: DASY52, Version 52.10 (4)

**Device E-Field measurement (E-field scan for ANSI C63.19-2007 & -2011 compliance)/E Scan - ER3D: 15 mm from Probe Center to the Device/Hearing Aid Compatibility Test (41x101x1):**

Interpolated grid: dx=0.5000 mm, dy=0.5000 mm  
 Device Reference Point: 0, 0, -6.3 mm  
 Reference Value = 90.16 V/m; Power Drift = 0.11 dB  
 Applied MIF = 0.00 dB  
 RF audio interference level = 38.82 dBV/m  
**Emission category: M2**

MIF scaled E-field

Grid 1 M2 38.74 dBV/m	Grid 2 M2 38.82 dBV/m	Grid 3 M2 38.58 dBV/m
Grid 4 M2 38.31 dBV/m	Grid 5 M2 38.41 dBV/m	Grid 6 M2 38.26 dBV/m
Grid 7 M2 38.47 dBV/m	Grid 8 M2 38.56 dBV/m	Grid 9 M2 38.44 dBV/m

**Cursor:**

Total = 38.82 dBV/m  
 E Category: M2  
 Location: 0.5, -14.5, 9.7 mm

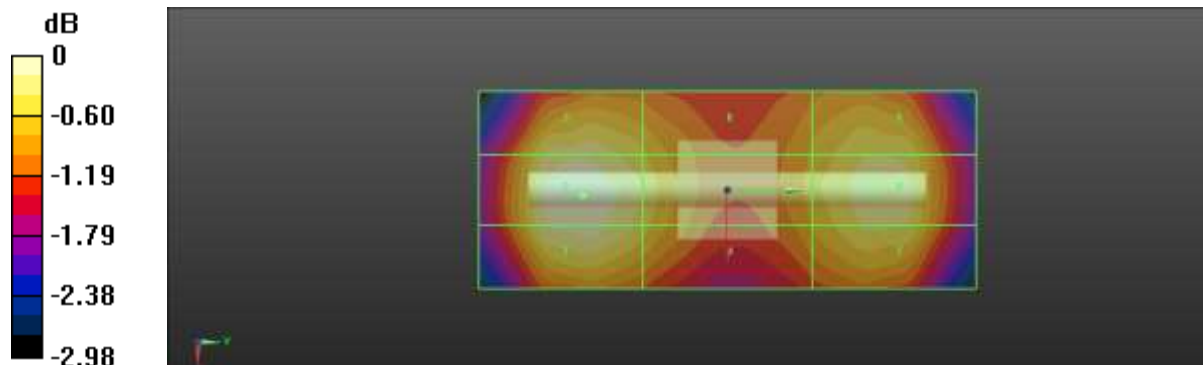

0 dB = 87.31 V/m = 38.82 dBV/m

## 21. Appendix D. Probe Calibration Data

**Calibration Laboratory of  
Schmid & Partner  
Engineering AG**  
Zeughausstrasse 43, 8004 Zurich, Switzerland



**S** Schweizerischer Kalibrierdienst  
**C** Service suisse d'étalonnage  
**S** Servizio svizzero di taratura  
**S** Swiss Calibration Service

Accredited by the Swiss Accreditation Service (SAS)  
The Swiss Accreditation Service is one of the signatories to the EA  
Multilateral Agreement for the recognition of calibration certificates

Accreditation No.: **SCS 0108**

Client **HCT (Dymstec)**

Certificate No: **EF3-4034\_Feb21**

**CALIBRATION CERTIFICATE**

	실	담당자	확인자
Object	EF3DV3- SN:4034	<i>[Handwritten Signature]</i>	<i>[Handwritten Signature]</i>
Calibration procedure(s)	QA CAL-02.v9, QA CAL-25.v7 Calibration procedure for E-field probes optimized for close near field evaluations in air	BL 카스트라 2021.02.09	이영성 2021.02.09
Calibration date:	February 25, 2021		

This calibration certificate documents the traceability to national standards, which realize the physical units of measurements (SI). The measurements and the uncertainties with confidence probability are given on the following pages and are part of the certificate.

All calibrations have been conducted in the closed laboratory facility: environment temperature (22 ± 3)°C and humidity < 70%.

Calibration Equipment used (M&TE critical for calibration)

Primary Standards	ID	Cal Date (Certificate No.)	Scheduled Calibration
Power meter NRP	SN: 104778	01-Apr-20 (No. 217-03100/03101)	Apr-21
Power sensor NRP-Z91	SN: 103244	01-Apr-20 (No. 217-03100)	Apr-21
Power sensor NRP-Z91	SN: 103245	01-Apr-20 (No. 217-03101)	Apr-21
Reference 20 dB Attenuator	SN: CC2552 (20x)	31-Mar-20 (No. 217-03106)	Apr-21
DAE4	SN: 789	23-Dec-20 (No. DAE4-789 Dec20)	Dec-21
Reference Probe ER3DV6	SN: 2328	05-Oct-20 (No. ER3-2328_Oct20)	Oct-21
Secondary Standards	ID	Check Date (in house)	Scheduled Check
Power meter E4419B	SN: GB41293874	06-Apr-16 (in house check Jun-20)	In house check: Jun-22
Power sensor E4412A	SN: MY41498087	06-Apr-16 (in house check Jun-20)	In house check: Jun-22
Power sensor E4412A	SN: 000110210	06-Apr-16 (in house check Jun-20)	In house check: Jun-22
RF generator HP 8648C	SN: US3642U01700	04-Aug-99 (in house check Jun-20)	In house check: Jun-22
Network Analyzer E8358A	SN: US41080477	31-Mar-14 (in house check Oct-20)	In house check: Oct-21

	Name	Function	Signature
Calibrated by:	Jelon Kastrati	Laboratory Technician	<i>[Handwritten Signature]</i>
Approved by:	Katja Pokovic	Technical Manager	<i>[Handwritten Signature]</i>

issued: February 25, 2021

This calibration certificate shall not be reproduced except in full without written approval of the laboratory.



**Calibration Laboratory of  
Schmid & Partner  
Engineering AG**  
Zeughausstrasse 43, 8004 Zurich, Switzerland



**S** Schweizerischer Kalibrierdienst  
**C** Service suisse d'étalonnage  
**S** Servizio svizzero di taratura  
Swiss Calibration Service

Accredited by the Swiss Accreditation Service (SAS)  
The Swiss Accreditation Service is one of the signatories to the EA  
Multilateral Agreement for the recognition of calibration certificates

Accreditation No.: **SCS 0108**

**Glossary:**

NORM <sub>x,y,z</sub>	sensitivity in free space
DCP	diode compression point
CF	crest factor (1/duty_cycle) of the RF signal
A, B, C, D	modulation dependent linearization parameters
En	incident E-field orientation normal to probe axis
Ep	incident E-field orientation parallel to probe axis
Polarization $\varphi$	$\varphi$ rotation around probe axis
Polarization $\vartheta$	$\vartheta$ rotation around an axis that is in the plane normal to probe axis (at measurement center), i.e., $\vartheta = 0$ is normal to probe axis
Connector Angle	information used in DASY system to align probe sensor X to the robot coordinate system

**Calibration is Performed According to the Following Standards:**

- a) IEEE Std 1309-2005, "IEEE Standard for calibration of electromagnetic field sensors and probes, excluding antennas, from 9 kHz to 40 GHz", December 2005
- b) CTIA Test Plan for Hearing Aid Compatibility, Rev 3.1.1, May 2017

**Methods Applied and Interpretation of Parameters:**

- **NORM<sub>x,y,z</sub>**: Assessed for E-field polarization  $\vartheta = 0$  for XY sensors and  $\vartheta = 90$  for Z sensor ( $f \leq 900$  MHz in TEM-cell;  $f > 1800$  MHz: R22 waveguide).
- **NORM(f)<sub>x,y,z</sub>** = NORM<sub>x,y,z</sub> \* frequency\_response (see Frequency Response Chart).
- **DCP<sub>x,y,z</sub>**: DCP are numerical linearization parameters assessed based on the data of power sweep with CW signal (no uncertainty required). DCP does not depend on frequency nor media.
- **PAR**: PAR is the Peak to Average Ratio that is not calibrated but determined based on the signal characteristics
- **A<sub>x,y,z</sub>; B<sub>x,y,z</sub>; C<sub>x,y,z</sub>; D<sub>x,y,z</sub>; VR<sub>x,y,z</sub>**: A, B, C, D are numerical linearization parameters assessed based on the data of power sweep for specific modulation signal. The parameters do not depend on frequency nor media. VR is the maximum calibration range expressed in RMS voltage across the diode.
- **Spherical isotropy (3D deviation from isotropy)**: in a locally homogeneous field realized using an open waveguide setup.
- **Sensor Offset**: The sensor offset corresponds to the offset of virtual measurement center from the probe tip (on probe axis). No tolerance required.
- **Connector Angle**: The angle is assessed using the information gained by determining the NORM<sub>x</sub> (no uncertainty required).



EF3DV3 – SN:4034

February 25, 2021

### DASY/EASY - Parameters of Probe: EF3DV3 - SN:4034

#### Basic Calibration Parameters

	Sensor X	Sensor Y	Sensor Z	Unc (k=2)
Norm ( $\mu\text{V}/(\text{V}/\text{m})^2$ )	0.90	0.75	1.32	$\pm 10.1\%$
DCP (mV) <sup>a</sup>	97.8	97.9	98.0	

#### Calibration results for Frequency Response (30 MHz – 6 GHz)

Frequency MHz	Target E-Field V/m	Measured E-field (E <sub>n</sub> ) V/m	Deviation E-normal in %	Measured E-field (E <sub>p</sub> ) V/m	Deviation E-normal in %	Unc (k=2) %
30	77.2	77.0	-0.2%	77.3	0.2%	$\pm 5.1\%$
100	77.2	78.3	1.4%	77.8	0.8%	$\pm 5.1\%$
450	77.2	78.4	1.5%	78.0	1.0%	$\pm 5.1\%$
600	77.1	77.9	1.0%	77.5	0.5%	$\pm 5.1\%$
750	77.0	77.7	0.8%	77.4	0.4%	$\pm 5.1\%$
1800	143.2	139.2	-2.8%	139.6	-2.5%	$\pm 5.1\%$
2000	136.0	132.2	-2.8%	132.0	-2.9%	$\pm 5.1\%$
2200	127.6	123.3	-3.3%	124.4	-2.5%	$\pm 5.1\%$
2500	124.9	121.6	-2.6%	122.8	-1.6%	$\pm 5.1\%$
3000	79.7	75.7	-4.9%	76.7	-3.7%	$\pm 5.1\%$
3500	256.9	246.9	-3.9%	244.9	-4.7%	$\pm 5.1\%$
3700	249.4	239.2	-4.1%	238.3	-4.5%	$\pm 5.1\%$
5200	50.7	51.3	1.2%	51.7	1.9%	$\pm 5.1\%$
5500	47.0	46.7	-0.6%	48.2	2.6%	$\pm 5.1\%$
5800	48.8	48.5	-0.7%	47.0	-3.8%	$\pm 5.1\%$

The reported uncertainty of measurement is stated as the standard uncertainty of measurement multiplied by the coverage factor k=2, which for a normal distribution corresponds to a coverage probability of approximately 95%.

<sup>a</sup> Numerical linearization parameter; uncertainty not required.  
<sup>b</sup> Uncertainty is determined using the max. deviation from linear response applying rectangular distribution and is expressed for the square of the field value.

EF3DV3 – SN:4034

February 25, 2021

### DASY/EASY - Parameters of Probe: EF3DV3 - SN:4034

#### Calibration Results for Modulation Response

UID	Communication System Name		A dB	B dB $\mu$ V	C	D dB	VR mV	Max dev.	Max Unc <sup>E</sup> (k=2)
0	CW	X	0.00	0.00	1.00	0.00	145.8	± 3.3 %	± 4.7 %
		Y	0.00	0.00	1.00		128.8		
		Z	0.00	0.00	1.00		129.4		
10352-AAA	Pulse Waveform (200Hz, 10%)	X	5.08	73.01	13.67	10.00	60.0	± 2.4 %	± 9.6 %
		Y	5.86	74.96	14.88		60.0		
		Z	3.88	69.83	12.48		60.0		
10353-AAA	Pulse Waveform (200Hz, 20%)	X	6.12	77.42	14.38	6.99	80.0	± 0.9 %	± 9.6 %
		Y	10.57	83.16	16.51		80.0		
		Z	3.24	70.95	11.90		80.0		
10354-AAA	Pulse Waveform (200Hz, 40%)	X	20.00	89.99	16.82	3.98	95.0	± 0.8 %	± 9.6 %
		Y	20.00	91.16	17.64		95.0		
		Z	12.69	84.73	15.00		95.0		
10355-AAA	Pulse Waveform (200Hz, 60%)	X	20.00	93.74	17.44	2.22	120.0	± 0.8 %	± 9.6 %
		Y	20.00	95.32	18.46		120.0		
		Z	20.00	89.48	15.36		120.0		
10387-AAA	QPSK Waveform, 1 MHz	X	1.90	68.62	16.40	1.00	150.0	± 1.9 %	± 9.6 %
		Y	1.97	70.23	17.09		150.0		
		Z	1.92	69.98	16.81		150.0		
10388-AAA	QPSK Waveform, 10 MHz	X	2.56	70.38	17.12	0.00	150.0	± 1.0 %	± 9.6 %
		Y	2.58	71.06	17.59		150.0		
		Z	2.40	70.00	17.03		150.0		
10396-AAA	64-QAM Waveform, 100 kHz	X	3.12	73.09	20.31	3.01	150.0	± 0.7 %	± 9.6 %
		Y	2.80	71.56	19.82		150.0		
		Z	2.50	69.71	18.66		150.0		
10399-AAA	64-QAM Waveform, 40 MHz	X	3.64	67.78	16.31	0.00	150.0	± 1.1 %	± 9.6 %
		Y	3.53	67.47	16.25		150.0		
		Z	3.49	67.37	16.14		150.0		
10414-AAA	WLAN CCDF, 64-QAM, 40MHz	X	4.78	65.40	15.57	0.00	150.0	± 2.1 %	± 9.6 %
		Y	4.76	65.65	15.76		150.0		
		Z	4.74	65.64	15.71		150.0		

Note: For details on UID parameters see Appendix

The reported uncertainty of measurement is stated as the standard uncertainty of measurement multiplied by the coverage factor k=2, which for a normal distribution corresponds to a coverage probability of approximately 95%.

<sup>a</sup> Numerical linearization parameter: uncertainty not required.  
<sup>c</sup> Uncertainty is determined using the max. deviation from linear response applying rectangular distribution and is expressed for the square of the field value.

EF3DV3 – SN:4034

February 25, 2021

## DASY/EASY - Parameters of Probe: EF3DV3 - SN:4034

### Sensor Frequency Model Parameters

	Sensor X	Sensor Y	Sensor Z
Frequency Corr. (LF)	0.94	0.78	1.22
Frequency Corr. (HF)	2.82	2.82	2.82

### Sensor Model Parameters

	C1 fF	C2 fF	$\alpha$ V <sup>-1</sup>	T1 ms.V <sup>-2</sup>	T2 ms.V <sup>-1</sup>	T3 ms	T4 V <sup>-2</sup>	T5 V <sup>-1</sup>	T6
X	48.8	320.22	36.46	6.68	0.29	4.99	1.32	0.11	1.01
Y	42.4	278.18	36.50	8.22	0.39	4.99	0.83	0.14	1.00
Z	41.4	270.93	36.24	6.57	0.36	4.98	0.57	0.16	1.00

### Other Probe Parameters

Sensor Arrangement	Rectangular
Connector Angle (°)	-171.5
Mechanical Surface Detection Mode	enabled
Optical Surface Detection Mode	disabled
Probe Overall Length	337 mm
Probe Body Diameter	12 mm
Tip Length	25 mm
Tip Diameter	4 mm
Probe Tip to Sensor X Calibration Point	1.5 mm
Probe Tip to Sensor Y Calibration Point	1.5 mm
Probe Tip to Sensor Z Calibration Point	1.5 mm

EF3DV3 – SN:4034

February 25, 2021

Receiving Pattern ( $\phi$ ),  $\theta = 0^\circ$

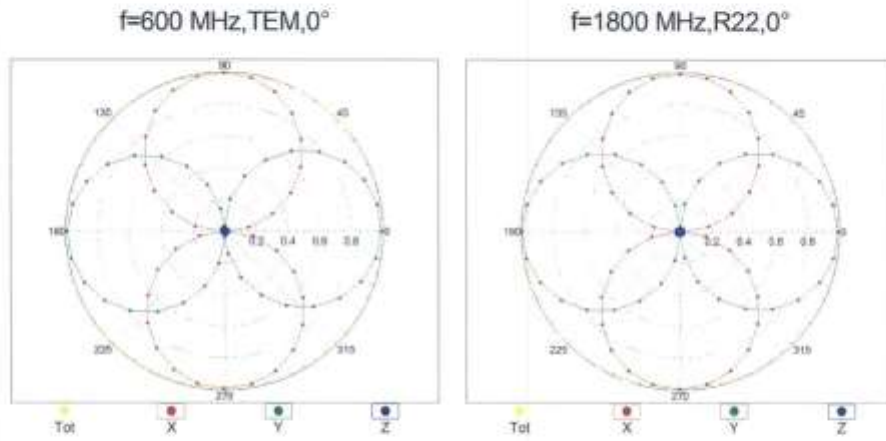

Receiving Pattern ( $\phi$ ),  $\theta = 90^\circ$

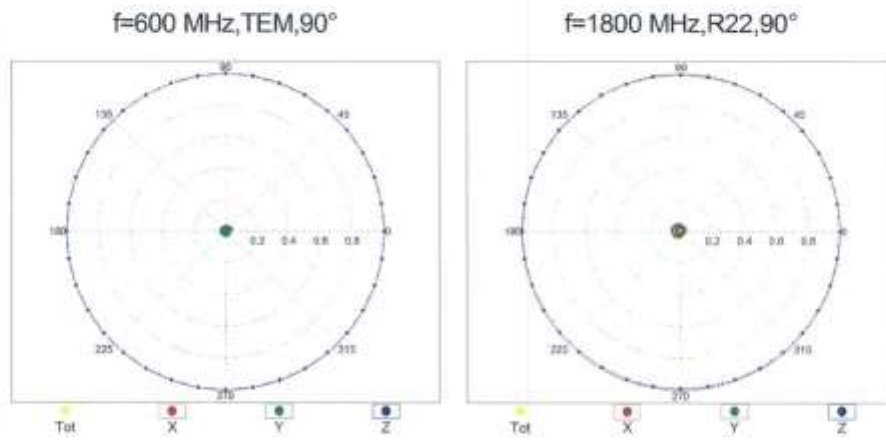

EF30V3 – SN:4034

February 25, 2021

### Receiving Pattern ( $\phi$ ), $\vartheta = 0^\circ$

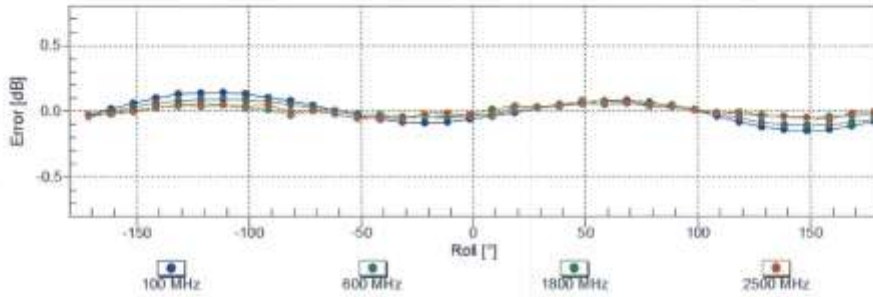

Uncertainty of Axial Isotropy Assessment:  $\pm 0.5\%$  (k=2)

### Receiving Pattern ( $\phi$ ), $\vartheta = 90^\circ$

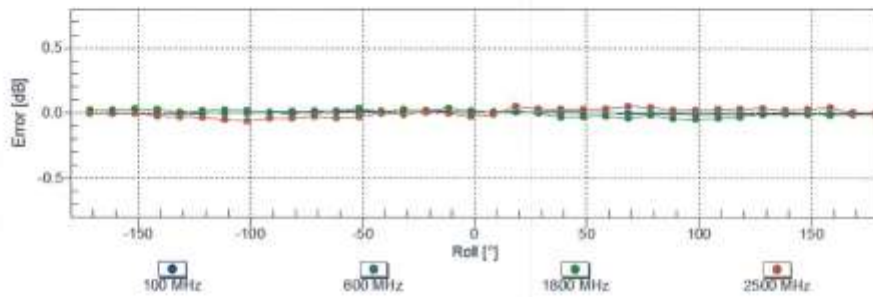

Uncertainty of Axial Isotropy Assessment:  $\pm 0.5\%$  (k=2)

EF3DV3 – SN:4034

February 25, 2021

### Dynamic Range f(E-field) (TEM cell, f = 900 MHz)

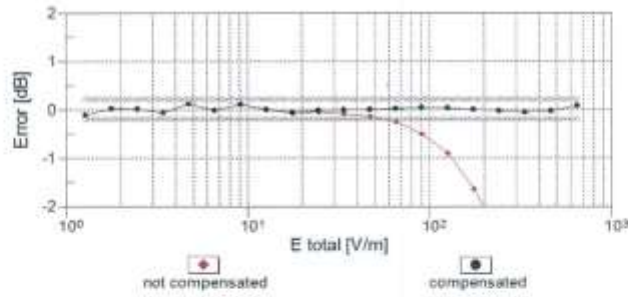
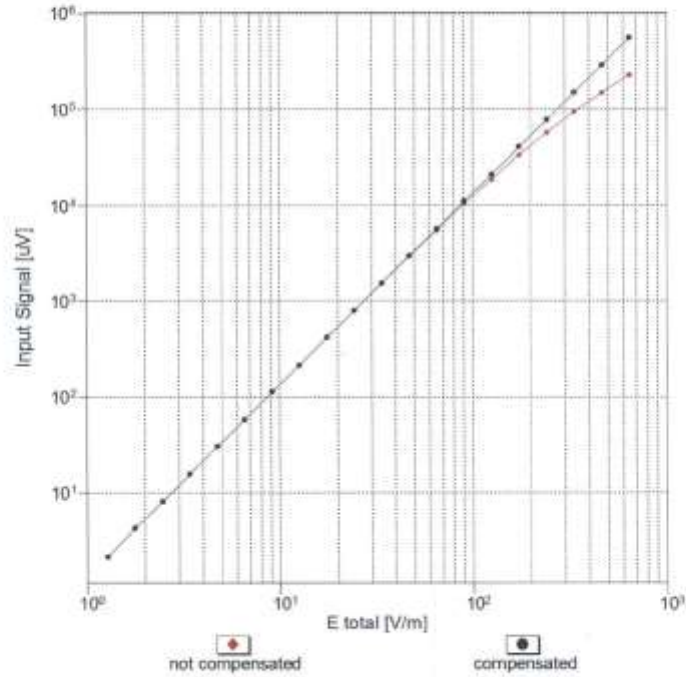

Uncertainty of Linearity Assessment:  $\pm 0.6\%$  (k=2)



EF3DV3 – SN:4034

February 25, 2021

### Deviation from Isotropy in Air Error ( $\phi$ , $\theta$ ), $f = 900$ MHz

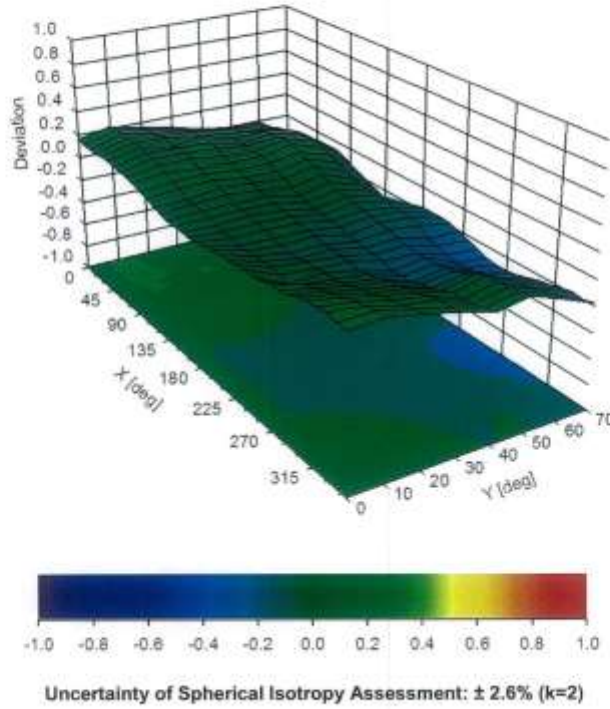

EF3DV3 – SN:4034

February 25, 2021

**Appendix: Modulation Calibration Parameters**

UID	Rev	Communication System Name	Group	PAR (dB)	Unc <sup>2</sup> (k=2)
0		CW	CW	0.00	± 4.7 %
10010	CAA	SAR Validation (Square, 100ms, 10ms)	Test	10.00	± 9.6 %
10011	CAB	UMTS-FDD (WCDMA)	WCDMA	2.91	± 9.6 %
10012	CAB	IEEE 802.11b WiFi 2.4 GHz (DSSS, 1 Mbps)	WLAN	1.87	± 9.6 %
10013	CAB	IEEE 802.11g WiFi 2.4 GHz (DSSS-OFDM, 6 Mbps)	WLAN	9.46	± 9.6 %
10021	DAC	GSM-FDD (TDMA, GMSK)	GSM	9.39	± 9.6 %
10023	DAC	GPRS-FDD (TDMA, GMSK, TN 0)	GSM	9.57	± 9.6 %
10024	DAC	GPRS-FDD (TDMA, GMSK, TN 0-1)	GSM	6.56	± 9.6 %
10025	DAC	EDGE-FDD (TDMA, 8PSK, TN 0)	GSM	12.62	± 9.6 %
10026	DAC	EDGE-FDD (TDMA, 8PSK, TN 0-1)	GSM	9.55	± 9.6 %
10027	DAC	GPRS-FDD (TDMA, GMSK, TN 0-1-2)	GSM	4.80	± 9.6 %
10028	DAC	GPRS-FDD (TDMA, GMSK, TN 0-1-2-3)	GSM	3.55	± 9.6 %
10029	DAC	EDGE-FDD (TDMA, 8PSK, TN 0-1-2)	GSM	7.78	± 9.6 %
10030	CAA	IEEE 802.15.1 Bluetooth (GFSK, DH1)	Bluetooth	5.30	± 9.6 %
10031	CAA	IEEE 802.15.1 Bluetooth (GFSK, DH3)	Bluetooth	1.87	± 9.6 %
10032	CAA	IEEE 802.15.1 Bluetooth (GFSK, DH5)	Bluetooth	1.16	± 9.6 %
10033	CAA	IEEE 802.15.1 Bluetooth (PI/4-DQPSK, DH1)	Bluetooth	7.74	± 9.6 %
10034	CAA	IEEE 802.15.1 Bluetooth (PI/4-DQPSK, DH3)	Bluetooth	4.53	± 9.6 %
10035	CAA	IEEE 802.15.1 Bluetooth (PI/4-DQPSK, DH5)	Bluetooth	3.83	± 9.6 %
10036	CAA	IEEE 802.15.1 Bluetooth (8-DPSK, DH1)	Bluetooth	8.01	± 9.6 %
10037	CAA	IEEE 802.15.1 Bluetooth (8-DPSK, DH3)	Bluetooth	4.77	± 9.6 %
10038	CAA	IEEE 802.15.1 Bluetooth (8-DPSK, DH5)	Bluetooth	4.10	± 9.6 %
10039	CAB	CDMA2000 (1xRTT, RC1)	CDMA2000	4.57	± 9.6 %
10042	CAB	IS-54 / IS-136 FDD (TDMA/FDM, PI/4-DQPSK, Halfrate)	AMPS	7.78	± 9.6 %
10044	CAA	IS-91/EIA/TIA-553 FDD (FDMA, FM)	AMPS	0.00	± 9.6 %
10048	CAA	DECT (TDD, TDMA/FDM, GFSK, Full Slot, 24)	DECT	13.80	± 9.6 %
10049	CAA	DECT (TDD, TDMA/FDM, GFSK, Double Slot, 12)	DECT	10.79	± 9.6 %
10056	CAA	UMTS-TDD (TD-SCDMA, 1.28 Mcps)	TD-SCDMA	11.01	± 9.6 %
10058	DAC	EDGE-FDD (TDMA, 8PSK, TN 0-1-2-3)	GSM	6.52	± 9.6 %
10059	CAB	IEEE 802.11b WiFi 2.4 GHz (DSSS, 2 Mbps)	WLAN	2.12	± 9.6 %
10060	CAB	IEEE 802.11b WiFi 2.4 GHz (DSSS, 5.5 Mbps)	WLAN	2.83	± 9.6 %
10061	CAB	IEEE 802.11b WiFi 2.4 GHz (DSSS, 11 Mbps)	WLAN	3.60	± 9.6 %
10062	CAD	IEEE 802.11a/h WiFi 5 GHz (OFDM, 6 Mbps)	WLAN	8.68	± 9.6 %
10063	CAD	IEEE 802.11a/h WiFi 5 GHz (OFDM, 9 Mbps)	WLAN	8.63	± 9.6 %
10064	CAD	IEEE 802.11a/h WiFi 5 GHz (OFDM, 12 Mbps)	WLAN	9.09	± 9.6 %
10065	CAD	IEEE 802.11a/h WiFi 5 GHz (OFDM, 18 Mbps)	WLAN	9.00	± 9.6 %
10066	CAD	IEEE 802.11a/h WiFi 5 GHz (OFDM, 24 Mbps)	WLAN	9.38	± 9.6 %
10067	CAD	IEEE 802.11a/h WiFi 5 GHz (OFDM, 36 Mbps)	WLAN	10.12	± 9.6 %
10068	CAD	IEEE 802.11a/h WiFi 5 GHz (OFDM, 48 Mbps)	WLAN	10.24	± 9.6 %
10069	CAD	IEEE 802.11a/h WiFi 5 GHz (OFDM, 54 Mbps)	WLAN	10.56	± 9.6 %
10071	CAB	IEEE 802.11g WiFi 2.4 GHz (DSSS/OFDM, 9 Mbps)	WLAN	9.83	± 9.6 %
10072	CAB	IEEE 802.11g WiFi 2.4 GHz (DSSS/OFDM, 12 Mbps)	WLAN	9.62	± 9.6 %
10073	CAB	IEEE 802.11g WiFi 2.4 GHz (DSSS/OFDM, 18 Mbps)	WLAN	9.94	± 9.6 %
10074	CAB	IEEE 802.11g WiFi 2.4 GHz (DSSS/OFDM, 24 Mbps)	WLAN	10.30	± 9.6 %
10075	CAB	IEEE 802.11g WiFi 2.4 GHz (DSSS/OFDM, 36 Mbps)	WLAN	10.77	± 9.6 %
10076	CAB	IEEE 802.11g WiFi 2.4 GHz (DSSS/OFDM, 48 Mbps)	WLAN	10.94	± 9.6 %
10077	CAB	IEEE 802.11g WiFi 2.4 GHz (DSSS/OFDM, 54 Mbps)	WLAN	11.00	± 9.6 %
10081	CAB	CDMA2000 (1xRTT, RC3)	CDMA2000	3.97	± 9.6 %
10082	CAB	IS-54 / IS-136 FDD (TDMA/FDM, PI/4-DQPSK, Fullrate)	AMPS	4.77	± 9.6 %
10090	DAC	GPRS-FDD (TDMA, GMSK, TN 0-4)	GSM	6.56	± 9.6 %
10097	CAC	UMTS-FDD (HSDPA)	WCDMA	3.98	± 9.6 %
10098	DAC	UMTS-FDD (HSUPA, Sublest 2)	WCDMA	3.98	± 9.6 %



EF3DV3 – SN:4034

February 25, 2021

10089	CAC	EDGE-FDD (TDMA, 8PSK, TN 0-4)	GSM	9.55	± 9.6 %
10100	CAC	LTE-FDD (SC-FDMA, 100% RB, 20 MHz, QPSK)	LTE-FDD	5.67	± 9.6 %
10101	CAB	LTE-FDD (SC-FDMA, 100% RB, 20 MHz, 16-QAM)	LTE-FDD	6.42	± 9.6 %
10102	CAB	LTE-FDD (SC-FDMA, 100% RB, 20 MHz, 64-QAM)	LTE-FDD	6.60	± 9.6 %
10103	DAC	LTE-TDD (SC-FDMA, 100% RB, 20 MHz, QPSK)	LTE-TDD	9.29	± 9.6 %
10104	CAE	LTE-TDD (SC-FDMA, 100% RB, 20 MHz, 16-QAM)	LTE-TDD	9.97	± 9.6 %
10105	CAE	LTE-TDD (SC-FDMA, 100% RB, 20 MHz, 64-QAM)	LTE-TDD	10.01	± 9.6 %
10108	CAE	LTE-FDD (SC-FDMA, 100% RB, 10 MHz, QPSK)	LTE-FDD	5.80	± 9.6 %
10109	CAG	LTE-FDD (SC-FDMA, 100% RB, 10 MHz, 16-QAM)	LTE-FDD	6.43	± 9.6 %
10110	CAG	LTE-FDD (SC-FDMA, 100% RB, 5 MHz, QPSK)	LTE-FDD	5.75	± 9.6 %
10111	CAG	LTE-FDD (SC-FDMA, 100% RB, 5 MHz, 16-QAM)	LTE-FDD	6.44	± 9.6 %
10112	CAG	LTE-FDD (SC-FDMA, 100% RB, 10 MHz, 64-QAM)	LTE-FDD	6.59	± 9.6 %
10113	CAG	LTE-FDD (SC-FDMA, 100% RB, 5 MHz, 64-QAM)	LTE-FDD	6.62	± 9.6 %
10114	CAG	IEEE 802.11n (HT Greenfield, 13.5 Mbps, BPSK)	WLAN	8.10	± 9.6 %
10115	CAG	IEEE 802.11n (HT Greenfield, 81 Mbps, 16-QAM)	WLAN	8.46	± 9.6 %
10116	CAG	IEEE 802.11n (HT Greenfield, 135 Mbps, 64-QAM)	WLAN	8.15	± 9.6 %
10117	CAG	IEEE 802.11n (HT Mixed, 13.5 Mbps, BPSK)	WLAN	8.07	± 9.6 %
10118	CAD	IEEE 802.11n (HT Mixed, 81 Mbps, 16-QAM)	WLAN	8.59	± 9.6 %
10119	CAD	IEEE 802.11n (HT Mixed, 135 Mbps, 64-QAM)	WLAN	8.13	± 9.6 %
10140	CAD	LTE-FDD (SC-FDMA, 100% RB, 15 MHz, 16-QAM)	LTE-FDD	6.49	± 9.6 %
10141	CAD	LTE-FDD (SC-FDMA, 100% RB, 15 MHz, 64-QAM)	LTE-FDD	6.53	± 9.6 %
10142	CAD	LTE-FDD (SC-FDMA, 100% RB, 3 MHz, QPSK)	LTE-FDD	5.73	± 9.6 %
10143	CAD	LTE-FDD (SC-FDMA, 100% RB, 3 MHz, 16-QAM)	LTE-FDD	6.35	± 9.6 %
10144	CAC	LTE-FDD (SC-FDMA, 100% RB, 3 MHz, 64-QAM)	LTE-FDD	6.65	± 9.6 %
10145	CAC	LTE-FDD (SC-FDMA, 100% RB, 1.4 MHz, QPSK)	LTE-FDD	5.76	± 9.6 %
10146	CAC	LTE-FDD (SC-FDMA, 100% RB, 1.4 MHz, 16-QAM)	LTE-FDD	6.41	± 9.6 %
10147	CAC	LTE-FDD (SC-FDMA, 100% RB, 1.4 MHz, 64-QAM)	LTE-FDD	6.72	± 9.6 %
10149	CAE	LTE-FDD (SC-FDMA, 50% RB, 20 MHz, 16-QAM)	LTE-FDD	6.42	± 9.6 %
10150	CAE	LTE-FDD (SC-FDMA, 50% RB, 20 MHz, 64-QAM)	LTE-FDD	6.60	± 9.6 %
10151	CAE	LTE-TDD (SC-FDMA, 50% RB, 20 MHz, QPSK)	LTE-TDD	9.28	± 9.6 %
10152	CAE	LTE-TDD (SC-FDMA, 50% RB, 20 MHz, 16-QAM)	LTE-TDD	9.92	± 9.6 %
10153	CAE	LTE-TDD (SC-FDMA, 50% RB, 20 MHz, 64-QAM)	LTE-TDD	10.05	± 9.6 %
10154	CAF	LTE-FDD (SC-FDMA, 50% RB, 10 MHz, QPSK)	LTE-FDD	5.75	± 9.6 %
10155	CAF	LTE-FDD (SC-FDMA, 50% RB, 10 MHz, 16-QAM)	LTE-FDD	6.43	± 9.6 %
10156	CAF	LTE-FDD (SC-FDMA, 50% RB, 5 MHz, QPSK)	LTE-FDD	5.79	± 9.6 %
10157	CAE	LTE-FDD (SC-FDMA, 50% RB, 5 MHz, 16-QAM)	LTE-FDD	6.49	± 9.6 %
10158	CAE	LTE-FDD (SC-FDMA, 50% RB, 10 MHz, 64-QAM)	LTE-FDD	6.62	± 9.6 %
10159	CAG	LTE-FDD (SC-FDMA, 50% RB, 5 MHz, 64-QAM)	LTE-FDD	6.56	± 9.6 %
10160	CAG	LTE-FDD (SC-FDMA, 50% RB, 15 MHz, QPSK)	LTE-FDD	5.82	± 9.6 %
10161	CAG	LTE-FDD (SC-FDMA, 50% RB, 15 MHz, 16-QAM)	LTE-FDD	6.43	± 9.6 %
10162	CAG	LTE-FDD (SC-FDMA, 50% RB, 15 MHz, 64-QAM)	LTE-FDD	6.58	± 9.6 %
10166	CAG	LTE-FDD (SC-FDMA, 50% RB, 1.4 MHz, QPSK)	LTE-FDD	5.46	± 9.6 %
10167	CAG	LTE-FDD (SC-FDMA, 50% RB, 1.4 MHz, 16-QAM)	LTE-FDD	6.21	± 9.6 %
10168	CAG	LTE-FDD (SC-FDMA, 50% RB, 1.4 MHz, 64-QAM)	LTE-FDD	6.79	± 9.6 %
10169	CAG	LTE-FDD (SC-FDMA, 1 RB, 20 MHz, QPSK)	LTE-FDD	5.73	± 9.6 %
10170	CAG	LTE-FDD (SC-FDMA, 1 RB, 20 MHz, 16-QAM)	LTE-FDD	6.52	± 9.6 %
10171	CAE	LTE-FDD (SC-FDMA, 1 RB, 20 MHz, 64-QAM)	LTE-FDD	6.49	± 9.6 %
10172	CAE	LTE-TDD (SC-FDMA, 1 RB, 20 MHz, QPSK)	LTE-TDD	9.21	± 9.6 %
10173	CAE	LTE-TDD (SC-FDMA, 1 RB, 20 MHz, 16-QAM)	LTE-TDD	9.48	± 9.6 %
10174	CAF	LTE-TDD (SC-FDMA, 1 RB, 20 MHz, 64-QAM)	LTE-TDD	10.25	± 9.6 %
10175	CAF	LTE-FDD (SC-FDMA, 1 RB, 10 MHz, QPSK)	LTE-FDD	5.72	± 9.6 %
10176	CAF	LTE-FDD (SC-FDMA, 1 RB, 10 MHz, 16-QAM)	LTE-FDD	6.52	± 9.6 %
10177	CAE	LTE-FDD (SC-FDMA, 1 RB, 5 MHz, QPSK)	LTE-FDD	5.73	± 9.6 %
10178	CAE	LTE-FDD (SC-FDMA, 1 RB, 5 MHz, 16-QAM)	LTE-FDD	6.52	± 9.6 %
10179	AAE	LTE-FDD (SC-FDMA, 1 RB, 10 MHz, 64-QAM)	LTE-FDD	6.50	± 9.6 %
10180	CAG	LTE-FDD (SC-FDMA, 1 RB, 5 MHz, 64-QAM)	LTE-FDD	6.50	± 9.6 %

Certificate No: EF3-4034\_Feb21

Page 11 of 22

EF3DV3 – SN:4034

February 25, 2021

10181	CAG	LTE-FDD (SC-FDMA, 1 RB, 15 MHz, QPSK)	LTE-FDD	5.72	± 9.6 %
10182	CAG	LTE-FDD (SC-FDMA, 1 RB, 15 MHz, 16-QAM)	LTE-FDD	6.52	± 9.6 %
10183	CAG	LTE-FDD (SC-FDMA, 1 RB, 15 MHz, 64-QAM)	LTE-FDD	6.50	± 9.6 %
10184	CAG	LTE-FDD (SC-FDMA, 1 RB, 3 MHz, QPSK)	LTE-FDD	5.73	± 9.6 %
10185	CAI	LTE-FDD (SC-FDMA, 1 RB, 3 MHz, 16-QAM)	LTE-FDD	6.51	± 9.6 %
10186	CAG	LTE-FDD (SC-FDMA, 1 RB, 3 MHz, 64-QAM)	LTE-FDD	6.50	± 9.6 %
10187	CAG	LTE-FDD (SC-FDMA, 1 RB, 1.4 MHz, QPSK)	LTE-FDD	5.73	± 9.6 %
10188	CAG	LTE-FDD (SC-FDMA, 1 RB, 1.4 MHz, 16-QAM)	LTE-FDD	6.52	± 9.6 %
10189	CAE	LTE-FDD (SC-FDMA, 1 RB, 1.4 MHz, 64-QAM)	LTE-FDD	6.50	± 9.6 %
10193	CAE	IEEE 802.11n (HT Greenfield, 8.5 Mbps, BPSK)	WLAN	8.09	± 9.6 %
10194	AAD	IEEE 802.11n (HT Greenfield, 39 Mbps, 16-QAM)	WLAN	8.12	± 9.6 %
10195	CAE	IEEE 802.11n (HT Greenfield, 65 Mbps, 64-QAM)	WLAN	8.21	± 9.6 %
10196	CAE	IEEE 802.11n (HT Mixed, 6.5 Mbps, BPSK)	WLAN	8.10	± 9.6 %
10197	AAE	IEEE 802.11n (HT Mixed, 39 Mbps, 16-QAM)	WLAN	8.13	± 9.6 %
10198	CAF	IEEE 802.11n (HT Mixed, 65 Mbps, 64-QAM)	WLAN	8.27	± 9.6 %
10219	CAF	IEEE 802.11n (HT Mixed, 7.2 Mbps, BPSK)	WLAN	8.03	± 9.6 %
10220	AAF	IEEE 802.11n (HT Mixed, 43.3 Mbps, 16-QAM)	WLAN	8.13	± 9.6 %
10221	CAC	IEEE 802.11n (HT Mixed, 72.2 Mbps, 64-QAM)	WLAN	8.27	± 9.6 %
10222	CAC	IEEE 802.11n (HT Mixed, 15 Mbps, BPSK)	WLAN	8.06	± 9.6 %
10223	CAD	IEEE 802.11n (HT Mixed, 90 Mbps, 16-QAM)	WLAN	8.48	± 9.6 %
10224	CAD	IEEE 802.11n (HT Mixed, 150 Mbps, 64-QAM)	WLAN	8.08	± 9.6 %
10225	CAD	UMTS-FDD (HSPA+)	WCDMA	5.97	± 9.6 %
10226	CAD	LTE-TDD (SC-FDMA, 1 RB, 1.4 MHz, 16-QAM)	LTE-TDD	9.49	± 9.6 %
10227	CAD	LTE-TDD (SC-FDMA, 1 RB, 1.4 MHz, 64-QAM)	LTE-TDD	10.26	± 9.6 %
10228	CAD	LTE-TDD (SC-FDMA, 1 RB, 1.4 MHz, QPSK)	LTE-TDD	9.22	± 9.6 %
10229	DAC	LTE-TDD (SC-FDMA, 1 RB, 3 MHz, 16-QAM)	LTE-TDD	9.48	± 9.6 %
10230	CAC	LTE-TDD (SC-FDMA, 1 RB, 3 MHz, 64-QAM)	LTE-TDD	10.25	± 9.6 %
10231	CAC	LTE-TDD (SC-FDMA, 1 RB, 3 MHz, QPSK)	LTE-TDD	9.19	± 9.6 %
10232	CAD	LTE-TDD (SC-FDMA, 1 RB, 5 MHz, 16-QAM)	LTE-TDD	9.48	± 9.6 %
10233	CAD	LTE-TDD (SC-FDMA, 1 RB, 5 MHz, 64-QAM)	LTE-TDD	10.25	± 9.6 %
10234	CAD	LTE-TDD (SC-FDMA, 1 RB, 5 MHz, QPSK)	LTE-TDD	9.21	± 9.6 %
10235	CAD	LTE-TDD (SC-FDMA, 1 RB, 10 MHz, 16-QAM)	LTE-TDD	9.48	± 9.6 %
10236	CAD	LTE-TDD (SC-FDMA, 1 RB, 10 MHz, 64-QAM)	LTE-TDD	10.25	± 9.6 %
10237	CAD	LTE-TDD (SC-FDMA, 1 RB, 10 MHz, QPSK)	LTE-TDD	9.21	± 9.6 %
10238	CAB	LTE-TDD (SC-FDMA, 1 RB, 15 MHz, 16-QAM)	LTE-TDD	9.48	± 9.6 %
10239	CAB	LTE-TDD (SC-FDMA, 1 RB, 15 MHz, 64-QAM)	LTE-TDD	10.25	± 9.6 %
10240	CAB	LTE-TDD (SC-FDMA, 1 RB, 15 MHz, QPSK)	LTE-TDD	9.21	± 9.6 %
10241	CAB	LTE-TDD (SC-FDMA, 50% RB, 1.4 MHz, 16-QAM)	LTE-TDD	9.82	± 9.6 %
10242	CAD	LTE-TDD (SC-FDMA, 50% RB, 1.4 MHz, 64-QAM)	LTE-TDD	9.86	± 9.6 %
10243	CAD	LTE-TDD (SC-FDMA, 50% RB, 1.4 MHz, QPSK)	LTE-TDD	9.46	± 9.6 %
10244	CAD	LTE-TDD (SC-FDMA, 50% RB, 3 MHz, 16-QAM)	LTE-TDD	10.06	± 9.6 %
10245	CAG	LTE-TDD (SC-FDMA, 50% RB, 3 MHz, 64-QAM)	LTE-TDD	10.06	± 9.6 %
10246	CAG	LTE-TDD (SC-FDMA, 50% RB, 3 MHz, QPSK)	LTE-TDD	9.30	± 9.6 %
10247	CAG	LTE-TDD (SC-FDMA, 50% RB, 5 MHz, 16-QAM)	LTE-TDD	9.91	± 9.6 %
10248	CAG	LTE-TDD (SC-FDMA, 50% RB, 5 MHz, 64-QAM)	LTE-TDD	10.09	± 9.6 %
10249	CAG	LTE-TDD (SC-FDMA, 50% RB, 5 MHz, QPSK)	LTE-TDD	9.29	± 9.6 %
10250	CAG	LTE-TDD (SC-FDMA, 50% RB, 10 MHz, 16-QAM)	LTE-TDD	9.81	± 9.6 %
10251	CAF	LTE-TDD (SC-FDMA, 50% RB, 10 MHz, 64-QAM)	LTE-TDD	10.17	± 9.6 %
10252	CAF	LTE-TDD (SC-FDMA, 50% RB, 10 MHz, QPSK)	LTE-TDD	9.24	± 9.6 %
10253	CAF	LTE-TDD (SC-FDMA, 50% RB, 15 MHz, 16-QAM)	LTE-TDD	9.90	± 9.6 %
10254	CAB	LTE-TDD (SC-FDMA, 50% RB, 15 MHz, 64-QAM)	LTE-TDD	10.14	± 9.6 %
10255	CAB	LTE-TDD (SC-FDMA, 50% RB, 15 MHz, QPSK)	LTE-TDD	9.20	± 9.6 %
10256	CAB	LTE-TDD (SC-FDMA, 100% RB, 1.4 MHz, 16-QAM)	LTE-TDD	9.96	± 9.6 %
10257	CAD	LTE-TDD (SC-FDMA, 100% RB, 1.4 MHz, 64-QAM)	LTE-TDD	10.08	± 9.6 %
10258	CAD	LTE-TDD (SC-FDMA, 100% RB, 1.4 MHz, QPSK)	LTE-TDD	9.34	± 9.6 %
10259	CAD	LTE-TDD (SC-FDMA, 100% RB, 3 MHz, 16-QAM)	LTE-TDD	9.98	± 9.6 %



EF3DV3 – SN:4034

February 25, 2021

10260	CAG	LTE-TDD (SC-FDMA, 100% RB, 3 MHz, 64-QAM)	LTE-TDD	9.97	± 9.6 %
10261	CAG	LTE-TDD (SC-FDMA, 100% RB, 3 MHz, QPSK)	LTE-TDD	9.24	± 9.6 %
10262	CAG	LTE-TDD (SC-FDMA, 100% RB, 5 MHz, 16-QAM)	LTE-TDD	9.83	± 9.6 %
10263	CAG	LTE-TDD (SC-FDMA, 100% RB, 5 MHz, 64-QAM)	LTE-TDD	10.16	± 9.6 %
10264	CAG	LTE-TDD (SC-FDMA, 100% RB, 5 MHz, QPSK)	LTE-TDD	9.23	± 9.6 %
10265	CAG	LTE-TDD (SC-FDMA, 100% RB, 10 MHz, 16-QAM)	LTE-TDD	9.92	± 9.6 %
10266	CAF	LTE-TDD (SC-FDMA, 100% RB, 10 MHz, 64-QAM)	LTE-TDD	10.07	± 9.6 %
10267	CAF	LTE-TDD (SC-FDMA, 100% RB, 10 MHz, QPSK)	LTE-TDD	9.30	± 9.6 %
10268	CAF	LTE-TDD (SC-FDMA, 100% RB, 15 MHz, 16-QAM)	LTE-TDD	10.06	± 9.6 %
10269	CAB	LTE-TDD (SC-FDMA, 100% RB, 15 MHz, 64-QAM)	LTE-TDD	10.13	± 9.6 %
10270	CAB	LTE-TDD (SC-FDMA, 100% RB, 15 MHz, QPSK)	LTE-TDD	9.58	± 9.6 %
10274	CAB	UMTS-FDD (HSUPA, Subtest 5, 3GPP Rel8.10)	WCDMA	4.87	± 9.6 %
10275	CAD	UMTS-FDD (HSUPA, Subtest 5, 3GPP Rel8.4)	WCDMA	3.96	± 9.6 %
10277	CAD	PHS (QPSK)	PHS	11.81	± 9.6 %
10278	CAD	PHS (QPSK, BW 884MHz, Roll-off 0.5)	PHS	11.81	± 9.6 %
10279	CAG	PHS (QPSK, BW 884MHz, Roll-off 0.38)	PHS	12.18	± 9.6 %
10290	CAG	CDMA2000, RC1, SO55, Full Rate	CDMA2000	3.91	± 9.6 %
10291	CAG	CDMA2000, RC3, SO55, Full Rate	CDMA2000	3.46	± 9.6 %
10292	CAG	CDMA2000, RC3, SO32, Full Rate	CDMA2000	3.39	± 9.6 %
10293	CAG	CDMA2000, RC3, SO3, Full Rate	CDMA2000	3.50	± 9.6 %
10295	CAG	CDMA2000, RC1, SO3, 1/8th Rate 25 fr.	CDMA2000	12.49	± 9.6 %
10297	CAF	LTE-FDD (SC-FDMA, 50% RB, 20 MHz, QPSK)	LTE-FDD	5.81	± 9.6 %
10298	CAF	LTE-FDD (SC-FDMA, 50% RB, 3 MHz, QPSK)	LTE-FDD	5.72	± 9.6 %
10299	CAF	LTE-FDD (SC-FDMA, 50% RB, 3 MHz, 16-QAM)	LTE-FDD	6.39	± 9.6 %
10300	CAC	LTE-FDD (SC-FDMA, 50% RB, 3 MHz, 64-QAM)	LTE-FDD	6.60	± 9.6 %
10301	CAC	IEEE 802.16e WIMAX (29:18, 5ms, 10MHz, QPSK, PUSC)	WIMAX	12.03	± 9.6 %
10302	CAB	IEEE 802.16e WIMAX (29:18, 5ms, 10MHz, QPSK, PUSC, 3CTRL)	WIMAX	12.57	± 9.6 %
10303	CAB	IEEE 802.16e WIMAX (31:15, 5ms, 10MHz, 64QAM, PUSC)	WIMAX	12.52	± 9.6 %
10304	CAA	IEEE 802.16e WIMAX (29:18, 5ms, 10MHz, 64QAM, PUSC)	WIMAX	11.86	± 9.6 %
10305	CAA	IEEE 802.16e WIMAX (31:15, 10ms, 10MHz, 64QAM, PUSC)	WIMAX	15.24	± 9.6 %
10306	CAA	IEEE 802.16e WIMAX (29:18, 10ms, 10MHz, 64QAM, PUSC)	WIMAX	14.67	± 9.6 %
10307	AAB	IEEE 802.16e WIMAX (29:18, 10ms, 10MHz, QPSK, PUSC)	WIMAX	14.49	± 9.6 %
10308	AAB	IEEE 802.16e WIMAX (29:18, 10ms, 10MHz, 16QAM, PUSC)	WIMAX	14.46	± 9.6 %
10309	AAB	IEEE 802.16e WIMAX (29:18, 10ms, 10MHz, 16QAM, AMC 2x3)	WIMAX	14.58	± 9.6 %
10310	AAB	IEEE 802.16e WIMAX (29:18, 10ms, 10MHz, QPSK, AMC 2x3)	WIMAX	14.57	± 9.6 %
10311	AAB	LTE-FDD (SC-FDMA, 100% RB, 15 MHz, QPSK)	LTE-FDD	6.06	± 9.6 %
10313	AAD	IDEN 1:3	IDEN	10.51	± 9.6 %
10314	AAD	IDEN 1:6	IDEN	13.48	± 9.6 %
10315	AAD	IEEE 802.11b WiFi 2.4 GHz (DSSS, 1 Mbps, 96pc dc)	WLAN	1.71	± 9.6 %
10316	AAD	IEEE 802.11g WiFi 2.4 GHz (ERP-OFDM, 6 Mbps, 96pc dc)	WLAN	8.36	± 9.6 %
10317	AAA	IEEE 802.11a WiFi 5 GHz (OFDM, 6 Mbps, 96pc dc)	WLAN	8.36	± 9.6 %
10352	AAA	Pulse Waveform (200Hz, 10%)	Generic	10.00	± 9.6 %
10353	AAA	Pulse Waveform (200Hz, 20%)	Generic	6.99	± 9.6 %
10354	AAA	Pulse Waveform (200Hz, 40%)	Generic	3.98	± 9.6 %
10355	AAA	Pulse Waveform (200Hz, 60%)	Generic	2.22	± 9.6 %
10356	AAA	Pulse Waveform (200Hz, 80%)	Generic	0.97	± 9.6 %
10367	AAA	QPSK Waveform, 1 MHz	Generic	5.10	± 9.6 %
10388	AAA	QPSK Waveform, 10 MHz	Generic	5.22	± 9.6 %
10396	AAA	64-QAM Waveform, 100 kHz	Generic	6.27	± 9.6 %
10399	AAA	64-QAM Waveform, 40 MHz	Generic	6.27	± 9.6 %
10400	AAD	IEEE 802.11ac WiFi (20MHz, 64-QAM, 99pc dc)	WLAN	8.37	± 9.6 %
10401	AAA	IEEE 802.11ac WiFi (40MHz, 64-QAM, 99pc dc)	WLAN	8.60	± 9.6 %
10402	AAA	IEEE 802.11ac WiFi (80MHz, 64-QAM, 99pc dc)	WLAN	8.53	± 9.6 %
10403	AAB	CDMA2000 (1xEV-DO, Rev. 0)	CDMA2000	3.76	± 9.6 %
10404	AAB	CDMA2000 (1xEV-DO, Rev. A)	CDMA2000	3.77	± 9.6 %
10406	AAD	CDMA2000, RC3, SO32, SCH0, Full Rate	CDMA2000	5.22	± 9.6 %

EF3DV3 – SN:4034

February 25, 2021

10410	AAA	LTE-TDD (SC-FDMA, 1 RB, 10 MHz, QPSK, UL Sub=2,3,4,7,8,9)	LTE-TDD	7.82	± 9.6 %
10414	AAA	WLAN CCDF, 64-QAM, 40MHz	Generic	8.54	± 9.6 %
10415	AAA	IEEE 802.11b WiFi 2.4 GHz (DSSS, 1 Mbps, 99pc dc)	WLAN	1.54	± 9.6 %
10416	AAA	IEEE 802.11g WiFi 2.4 GHz (ERP-OFDM, 6 Mbps, 99pc dc)	WLAN	8.23	± 9.6 %
10417	AAA	IEEE 802.11a/h WiFi 5 GHz (OFDM, 8 Mbps, 99pc dc)	WLAN	8.23	± 9.6 %
10418	AAA	IEEE 802.11g WiFi 2.4 GHz (DSSS-OFDM, 6 Mbps, 99pc, Long)	WLAN	8.14	± 9.6 %
10419	AAA	IEEE 802.11g WiFi 2.4 GHz (DSSS-OFDM, 6 Mbps, 99pc, Short)	WLAN	8.19	± 9.6 %
10422	AAA	IEEE 802.11n (HT Greenfield, 7.2 Mbps, BPSK)	WLAN	8.32	± 9.6 %
10423	AAA	IEEE 802.11n (HT Greenfield, 43.3 Mbps, 16-QAM)	WLAN	8.47	± 9.6 %
10424	AAE	IEEE 802.11n (HT Greenfield, 72.2 Mbps, 64-QAM)	WLAN	8.40	± 9.6 %
10425	AAE	IEEE 802.11n (HT Greenfield, 15 Mbps, BPSK)	WLAN	8.41	± 9.6 %
10426	AAE	IEEE 802.11n (HT Greenfield, 90 Mbps, 16-QAM)	WLAN	8.45	± 9.6 %
10427	AAB	IEEE 802.11n (HT Greenfield, 150 Mbps, 64-QAM)	WLAN	8.41	± 9.6 %
10430	AAB	LTE-FDD (OFDMA, 5 MHz, E-TM 3.1)	LTE-FDD	8.28	± 9.6 %
10431	AAC	LTE-FDD (OFDMA, 10 MHz, E-TM 3.1)	LTE-FDD	8.38	± 9.6 %
10432	AAB	LTE-FDD (OFDMA, 15 MHz, E-TM 3.1)	LTE-FDD	8.34	± 9.6 %
10433	AAC	LTE-FDD (OFDMA, 20 MHz, E-TM 3.1)	LTE-FDD	8.34	± 9.6 %
10434	AAG	W-CDMA (BS Test Model 1, 64 DPCH)	WCDMA	8.60	± 9.6 %
10435	AAA	LTE-TDD (SC-FDMA, 1 RB, 20 MHz, QPSK, UL Sub)	LTE-TDD	7.82	± 9.6 %
10447	AAA	LTE-FDD (OFDMA, 5 MHz, E-TM 3.1, Clipping 44%)	LTE-FDD	7.56	± 9.6 %
10448	AAA	LTE-FDD (OFDMA, 10 MHz, E-TM 3.1, Clipping 44%)	LTE-FDD	7.53	± 9.6 %
10449	AAC	LTE-FDD (OFDMA, 15 MHz, E-TM 3.1, Clipping 44%)	LTE-FDD	7.51	± 9.6 %
10450	AAA	LTE-FDD (OFDMA, 20 MHz, E-TM 3.1, Clipping 44%)	LTE-FDD	7.48	± 9.6 %
10451	AAA	W-CDMA (BS Test Model 1, 64 DPCH, Clipping 44%)	WCDMA	7.59	± 9.6 %
10453	AAC	Validation (Square, 10ms, 1ms)	Test	10.00	± 9.6 %
10456	AAC	IEEE 802.11ac WiFi (160MHz, 64-QAM, 99pc dc)	WLAN	8.63	± 9.6 %
10457	AAC	UMTS-FDD (DC-HSDPA)	WCDMA	6.62	± 9.6 %
10458	AAC	CDMA2000 (1xEV-DO, Rev. B, 2 carriers)	CDMA2000	6.55	± 9.6 %
10459	AAC	CDMA2000 (1xEV-DO, Rev. B, 3 carriers)	CDMA2000	8.25	± 9.6 %
10460	AAC	UMTS-FDD (WCDMA, AMR)	WCDMA	2.39	± 9.6 %
10461	AAC	LTE-TDD (SC-FDMA, 1 RB, 1.4 MHz, QPSK, UL Sub)	LTE-TDD	7.82	± 9.6 %
10462	AAC	LTE-TDD (SC-FDMA, 1 RB, 1.4 MHz, 16-QAM, UL Sub)	LTE-TDD	8.30	± 9.6 %
10463	AAD	LTE-TDD (SC-FDMA, 1 RB, 1.4 MHz, 64-QAM, UL Sub)	LTE-TDD	8.56	± 9.6 %
10464	AAD	LTE-TDD (SC-FDMA, 1 RB, 3 MHz, QPSK, UL Sub)	LTE-TDD	7.82	± 9.6 %
10465	AAC	LTE-TDD (SC-FDMA, 1 RB, 3 MHz, 16-QAM, UL Sub)	LTE-TDD	8.32	± 9.6 %
10466	AAC	LTE-TDD (SC-FDMA, 1 RB, 3 MHz, 64-QAM, UL Sub)	LTE-TDD	8.57	± 9.6 %
10467	AAA	LTE-TDD (SC-FDMA, 1 RB, 5 MHz, QPSK, UL Sub)	LTE-TDD	7.82	± 9.6 %
10468	AAF	LTE-TDD (SC-FDMA, 1 RB, 5 MHz, 16-QAM, UL Sub)	LTE-TDD	8.32	± 9.6 %
10469	AAD	LTE-TDD (SC-FDMA, 1 RB, 5 MHz, 64-QAM, UL Sub)	LTE-TDD	8.56	± 9.6 %
10470	AAD	LTE-TDD (SC-FDMA, 1 RB, 10 MHz, QPSK, UL Sub)	LTE-TDD	7.82	± 9.6 %
10471	AAC	LTE-TDD (SC-FDMA, 1 RB, 10 MHz, 16-QAM, UL Sub)	LTE-TDD	8.32	± 9.6 %
10472	AAC	LTE-TDD (SC-FDMA, 1 RB, 10 MHz, 64-QAM, UL Sub)	LTE-TDD	8.57	± 9.6 %
10473	AAA	LTE-TDD (SC-FDMA, 1 RB, 15 MHz, QPSK, UL Sub)	LTE-TDD	7.82	± 9.6 %
10474	AAC	LTE-TDD (SC-FDMA, 1 RB, 15 MHz, 16-QAM, UL Sub)	LTE-TDD	8.32	± 9.6 %
10475	AAD	LTE-TDD (SC-FDMA, 1 RB, 15 MHz, 64-QAM, UL Sub)	LTE-TDD	8.57	± 9.6 %
10477	AAC	LTE-TDD (SC-FDMA, 1 RB, 20 MHz, 16-QAM, UL Sub)	LTE-TDD	8.32	± 9.6 %
10478	AAC	LTE-TDD (SC-FDMA, 1 RB, 20 MHz, 64-QAM, UL Sub)	LTE-TDD	8.57	± 9.6 %
10479	AAC	LTE-TDD (SC-FDMA, 50% RB, 1.4 MHz, QPSK, UL Sub)	LTE-TDD	7.74	± 9.6 %
10480	AAA	LTE-TDD (SC-FDMA, 50% RB, 1.4 MHz, 16-QAM, UL Sub)	LTE-TDD	8.18	± 9.6 %
10481	AAA	LTE-TDD (SC-FDMA, 50% RB, 1.4 MHz, 64-QAM, UL Sub)	LTE-TDD	8.45	± 9.6 %
10482	AAA	LTE-TDD (SC-FDMA, 50% RB, 3 MHz, QPSK, UL Sub)	LTE-TDD	7.71	± 9.6 %
10483	AAA	LTE-TDD (SC-FDMA, 50% RB, 3 MHz, 16-QAM, Sub)	LTE-TDD	8.39	± 9.6 %
10484	AAB	LTE-TDD (SC-FDMA, 50% RB, 3 MHz, 64-QAM, UL Sub)	LTE-TDD	8.47	± 9.6 %
10485	AAB	LTE-TDD (SC-FDMA, 50% RB, 5 MHz, QPSK, UL Sub)	LTE-TDD	7.59	± 9.6 %
10486	AAB	LTE-TDD (SC-FDMA, 50% RB, 5 MHz, 16-QAM, UL Sub)	LTE-TDD	8.38	± 9.6 %
10487	AAC	LTE-TDD (SC-FDMA, 50% RB, 5 MHz, 64-QAM, UL Sub)	LTE-TDD	8.60	± 9.6 %



EF3DV3 – SN:4034

February 25, 2021

10488	AAC	LTE-TDD (SC-FDMA, 50% RB, 10 MHz, QPSK, UL Sub)	LTE-TDD	7.70	± 9.6 %
10489	AAC	LTE-TDD (SC-FDMA, 50% RB, 10 MHz, 16-QAM, UL Sub)	LTE-TDD	8.31	± 9.6 %
10490	AAF	LTE-TDD (SC-FDMA, 50% RB, 10 MHz, 64-QAM, UL Sub)	LTE-TDD	8.54	± 9.6 %
10491	AAF	LTE-TDD (SC-FDMA, 50% RB, 15 MHz, QPSK, UL Sub)	LTE-TDD	7.74	± 9.6 %
10492	AAF	LTE-TDD (SC-FDMA, 50% RB, 15 MHz, 16-QAM, UL Sub)	LTE-TDD	8.41	± 9.6 %
10493	AAF	LTE-TDD (SC-FDMA, 50% RB, 15 MHz, 64-QAM, UL Sub)	LTE-TDD	8.55	± 9.6 %
10494	AAF	LTE-TDD (SC-FDMA, 50% RB, 20 MHz, QPSK, UL Sub)	LTE-TDD	7.74	± 9.6 %
10495	AAF	LTE-TDD (SC-FDMA, 50% RB, 20 MHz, 16-QAM, UL Sub)	LTE-TDD	8.37	± 9.6 %
10496	AAE	LTE-TDD (SC-FDMA, 50% RB, 20 MHz, 64-QAM, UL Sub)	LTE-TDD	8.54	± 9.6 %
10497	AAE	LTE-TDD (SC-FDMA, 100% RB, 1.4 MHz, QPSK, UL Sub)	LTE-TDD	7.67	± 9.6 %
10498	AAE	LTE-TDD (SC-FDMA, 100% RB, 1.4 MHz, 16-QAM, UL Sub)	LTE-TDD	8.40	± 9.6 %
10499	AAC	LTE-TDD (SC-FDMA, 100% RB, 1.4 MHz, 64-QAM, UL Sub)	LTE-TDD	8.68	± 9.6 %
10500	AAF	LTE-TDD (SC-FDMA, 100% RB, 3 MHz, QPSK, UL Sub)	LTE-TDD	7.67	± 9.6 %
10501	AAF	LTE-TDD (SC-FDMA, 100% RB, 3 MHz, 16-QAM, UL Sub)	LTE-TDD	8.44	± 9.6 %
10502	AAB	LTE-TDD (SC-FDMA, 100% RB, 3 MHz, 64-QAM, UL Sub)	LTE-TDD	8.52	± 9.6 %
10503	AAB	LTE-TDD (SC-FDMA, 100% RB, 5 MHz, QPSK, UL Sub)	LTE-TDD	7.72	± 9.6 %
10504	AAB	LTE-TDD (SC-FDMA, 100% RB, 5 MHz, 16-QAM, UL Sub)	LTE-TDD	8.31	± 9.6 %
10505	AAC	LTE-TDD (SC-FDMA, 100% RB, 5 MHz, 64-QAM, UL Sub)	LTE-TDD	8.54	± 9.6 %
10506	AAC	LTE-TDD (SC-FDMA, 100% RB, 10 MHz, QPSK, UL Sub)	LTE-TDD	7.74	± 9.6 %
10507	AAC	LTE-TDD (SC-FDMA, 100% RB, 10 MHz, 16-QAM, UL Sub)	LTE-TDD	8.36	± 9.6 %
10508	AAF	LTE-TDD (SC-FDMA, 100% RB, 10 MHz, 64-QAM, UL Sub)	LTE-TDD	8.55	± 9.6 %
10509	AAF	LTE-TDD (SC-FDMA, 100% RB, 15 MHz, QPSK, UL Sub)	LTE-TDD	7.99	± 9.6 %
10510	AAF	LTE-TDD (SC-FDMA, 100% RB, 15 MHz, 16-QAM, UL Sub)	LTE-TDD	8.49	± 9.6 %
10511	AAF	LTE-TDD (SC-FDMA, 100% RB, 15 MHz, 64-QAM, UL Sub)	LTE-TDD	8.51	± 9.6 %
10512	AAF	LTE-TDD (SC-FDMA, 100% RB, 20 MHz, QPSK, UL Sub)	LTE-TDD	7.74	± 9.6 %
10513	AAF	LTE-TDD (SC-FDMA, 100% RB, 20 MHz, 16-QAM, UL Sub)	LTE-TDD	8.42	± 9.6 %
10514	AAE	LTE-TDD (SC-FDMA, 100% RB, 20 MHz, 64-QAM, UL Sub)	LTE-TDD	8.45	± 9.6 %
10515	AAE	IEEE 802.11b WiFi 2.4 GHz (DSSS, 2 Mbps, 99pc dc)	WLAN	1.58	± 9.6 %
10516	AAE	IEEE 802.11b WiFi 2.4 GHz (DSSS, 5.5 Mbps, 99pc dc)	WLAN	1.57	± 9.6 %
10517	AAF	IEEE 802.11b WiFi 2.4 GHz (DSSS, 11 Mbps, 99pc dc)	WLAN	1.58	± 9.6 %
10518	AAF	IEEE 802.11a/h WiFi 5 GHz (OFDM, 9 Mbps, 99pc dc)	WLAN	8.23	± 9.6 %
10519	AAF	IEEE 802.11a/h WiFi 5 GHz (OFDM, 12 Mbps, 99pc dc)	WLAN	8.39	± 9.6 %
10520	AAB	IEEE 802.11a/h WiFi 5 GHz (OFDM, 18 Mbps, 99pc dc)	WLAN	8.12	± 9.6 %
10521	AAB	IEEE 802.11a/h WiFi 5 GHz (OFDM, 24 Mbps, 99pc dc)	WLAN	7.97	± 9.6 %
10522	AAB	IEEE 802.11a/h WiFi 5 GHz (OFDM, 36 Mbps, 99pc dc)	WLAN	8.45	± 9.6 %
10523	AAC	IEEE 802.11a/h WiFi 5 GHz (OFDM, 48 Mbps, 99pc dc)	WLAN	8.08	± 9.6 %
10524	AAC	IEEE 802.11a/h WiFi 5 GHz (OFDM, 54 Mbps, 99pc dc)	WLAN	8.27	± 9.6 %
10525	AAC	IEEE 802.11ac WiFi (20MHz, MCS0, 99pc dc)	WLAN	8.36	± 9.6 %
10526	AAF	IEEE 802.11ac WiFi (20MHz, MCS1, 99pc dc)	WLAN	8.42	± 9.6 %
10527	AAF	IEEE 802.11ac WiFi (20MHz, MCS2, 99pc dc)	WLAN	8.21	± 9.6 %
10528	AAF	IEEE 802.11ac WiFi (20MHz, MCS3, 99pc dc)	WLAN	8.36	± 9.6 %
10529	AAF	IEEE 802.11ac WiFi (20MHz, MCS4, 99pc dc)	WLAN	8.36	± 9.6 %
10531	AAF	IEEE 802.11ac WiFi (20MHz, MCS6, 99pc dc)	WLAN	8.43	± 9.6 %
10532	AAF	IEEE 802.11ac WiFi (20MHz, MCS7, 99pc dc)	WLAN	8.29	± 9.6 %
10533	AAE	IEEE 802.11ac WiFi (20MHz, MCS8, 99pc dc)	WLAN	8.38	± 9.6 %
10534	AAE	IEEE 802.11ac WiFi (40MHz, MCS0, 99pc dc)	WLAN	8.45	± 9.6 %
10535	AAE	IEEE 802.11ac WiFi (40MHz, MCS1, 99pc dc)	WLAN	8.45	± 9.6 %
10536	AAF	IEEE 802.11ac WiFi (40MHz, MCS2, 99pc dc)	WLAN	8.32	± 9.6 %
10537	AAF	IEEE 802.11ac WiFi (40MHz, MCS3, 99pc dc)	WLAN	8.44	± 9.6 %
10538	AAF	IEEE 802.11ac WiFi (40MHz, MCS4, 99pc dc)	WLAN	8.54	± 9.6 %
10540	AAA	IEEE 802.11ac WiFi (40MHz, MCS6, 99pc dc)	WLAN	8.39	± 9.6 %
10541	AAA	IEEE 802.11ac WiFi (40MHz, MCS7, 99pc dc)	WLAN	8.46	± 9.6 %
10542	AAA	IEEE 802.11ac WiFi (40MHz, MCS8, 99pc dc)	WLAN	8.65	± 9.6 %
10543	AAC	IEEE 802.11ac WiFi (40MHz, MCS9, 99pc dc)	WLAN	8.65	± 9.6 %
10544	AAC	IEEE 802.11ac WiFi (80MHz, MCS0, 99pc dc)	WLAN	8.47	± 9.6 %
10545	AAC	IEEE 802.11ac WiFi (80MHz, MCS1, 99pc dc)	WLAN	8.55	± 9.6 %

EF3DV3 – SN:4034

February 25, 2021

10546	AAC	IEEE 802.11ac WiFi (80MHz, MCS2, 99pc dc)	WLAN	8.35	± 9.6 %
10547	AAC	IEEE 802.11ac WiFi (80MHz, MCS3, 99pc dc)	WLAN	8.49	± 9.6 %
10548	AAC	IEEE 802.11ac WiFi (80MHz, MCS4, 99pc dc)	WLAN	8.37	± 9.6 %
10550	AAC	IEEE 802.11ac WiFi (80MHz, MCS6, 99pc dc)	WLAN	8.38	± 9.6 %
10551	AAC	IEEE 802.11ac WiFi (80MHz, MCS7, 99pc dc)	WLAN	8.50	± 9.6 %
10552	AAC	IEEE 802.11ac WiFi (80MHz, MCS8, 99pc dc)	WLAN	8.42	± 9.6 %
10553	AAC	IEEE 802.11ac WiFi (80MHz, MCS9, 99pc dc)	WLAN	8.45	± 9.6 %
10554	AAC	IEEE 802.11ac WiFi (160MHz, MCS0, 99pc dc)	WLAN	8.48	± 9.6 %
10555	AAC	IEEE 802.11ac WiFi (160MHz, MCS1, 99pc dc)	WLAN	8.47	± 9.6 %
10556	AAC	IEEE 802.11ac WiFi (160MHz, MCS2, 99pc dc)	WLAN	8.50	± 9.6 %
10557	AAC	IEEE 802.11ac WiFi (160MHz, MCS3, 99pc dc)	WLAN	8.52	± 9.6 %
10558	AAC	IEEE 802.11ac WiFi (160MHz, MCS4, 99pc dc)	WLAN	8.61	± 9.6 %
10560	AAC	IEEE 802.11ac WiFi (160MHz, MCS6, 99pc dc)	WLAN	8.73	± 9.6 %
10561	AAC	IEEE 802.11ac WiFi (160MHz, MCS7, 99pc dc)	WLAN	8.56	± 9.6 %
10562	AAC	IEEE 802.11ac WiFi (160MHz, MCS8, 99pc dc)	WLAN	8.69	± 9.6 %
10563	AAC	IEEE 802.11ac WiFi (160MHz, MCS9, 99pc dc)	WLAN	8.77	± 9.6 %
10564	AAC	IEEE 802.11g WiFi 2.4 GHz (DSSS-OFDM, 9 Mbps, 99pc dc)	WLAN	8.25	± 9.6 %
10565	AAC	IEEE 802.11g WiFi 2.4 GHz (DSSS-OFDM, 12 Mbps, 99pc dc)	WLAN	8.45	± 9.6 %
10566	AAC	IEEE 802.11g WiFi 2.4 GHz (DSSS-OFDM, 18 Mbps, 99pc dc)	WLAN	8.13	± 9.6 %
10567	AAC	IEEE 802.11g WiFi 2.4 GHz (DSSS-OFDM, 24 Mbps, 99pc dc)	WLAN	8.00	± 9.6 %
10568	AAC	IEEE 802.11g WiFi 2.4 GHz (DSSS-OFDM, 36 Mbps, 99pc dc)	WLAN	8.37	± 9.6 %
10569	AAC	IEEE 802.11g WiFi 2.4 GHz (DSSS-OFDM, 48 Mbps, 99pc dc)	WLAN	8.10	± 9.6 %
10570	AAC	IEEE 802.11g WiFi 2.4 GHz (DSSS-OFDM, 54 Mbps, 99pc dc)	WLAN	8.30	± 9.6 %
10571	AAC	IEEE 802.11b WiFi 2.4 GHz (DSSS, 1 Mbps, 90pc dc)	WLAN	1.99	± 9.6 %
10572	AAC	IEEE 802.11b WiFi 2.4 GHz (DSSS, 2 Mbps, 90pc dc)	WLAN	1.99	± 9.6 %
10573	AAC	IEEE 802.11b WiFi 2.4 GHz (DSSS, 5.5 Mbps, 90pc dc)	WLAN	1.98	± 9.6 %
10574	AAC	IEEE 802.11b WiFi 2.4 GHz (DSSS, 11 Mbps, 90pc dc)	WLAN	1.98	± 9.6 %
10575	AAC	IEEE 802.11g WiFi 2.4 GHz (DSSS-OFDM, 6 Mbps, 90pc dc)	WLAN	8.59	± 9.6 %
10576	AAC	IEEE 802.11g WiFi 2.4 GHz (DSSS-OFDM, 9 Mbps, 90pc dc)	WLAN	8.60	± 9.6 %
10577	AAC	IEEE 802.11g WiFi 2.4 GHz (DSSS-OFDM, 12 Mbps, 90pc dc)	WLAN	8.70	± 9.6 %
10578	AAD	IEEE 802.11g WiFi 2.4 GHz (DSSS-OFDM, 18 Mbps, 90pc dc)	WLAN	8.49	± 9.6 %
10579	AAD	IEEE 802.11g WiFi 2.4 GHz (DSSS-OFDM, 24 Mbps, 90pc dc)	WLAN	8.36	± 9.6 %
10580	AAD	IEEE 802.11g WiFi 2.4 GHz (DSSS-OFDM, 36 Mbps, 90pc dc)	WLAN	8.76	± 9.6 %
10581	AAD	IEEE 802.11g WiFi 2.4 GHz (DSSS-OFDM, 48 Mbps, 90pc dc)	WLAN	8.35	± 9.6 %
10582	AAD	IEEE 802.11g WiFi 2.4 GHz (DSSS-OFDM, 54 Mbps, 90pc dc)	WLAN	8.67	± 9.6 %
10583	AAD	IEEE 802.11a/h WiFi 5 GHz (OFDM, 6 Mbps, 90pc dc)	WLAN	8.59	± 9.6 %
10584	AAD	IEEE 802.11a/h WiFi 5 GHz (OFDM, 9 Mbps, 90pc dc)	WLAN	8.60	± 9.6 %
10585	AAD	IEEE 802.11a/h WiFi 5 GHz (OFDM, 12 Mbps, 90pc dc)	WLAN	8.70	± 9.6 %
10586	AAD	IEEE 802.11a/h WiFi 5 GHz (OFDM, 18 Mbps, 90pc dc)	WLAN	8.49	± 9.6 %
10587	AAA	IEEE 802.11a/h WiFi 5 GHz (OFDM, 24 Mbps, 90pc dc)	WLAN	8.36	± 9.6 %
10588	AAA	IEEE 802.11a/h WiFi 5 GHz (OFDM, 36 Mbps, 90pc dc)	WLAN	8.76	± 9.6 %
10589	AAA	IEEE 802.11a/h WiFi 5 GHz (OFDM, 48 Mbps, 90pc dc)	WLAN	8.35	± 9.6 %
10590	AAA	IEEE 802.11a/h WiFi 5 GHz (OFDM, 54 Mbps, 90pc dc)	WLAN	8.67	± 9.6 %
10591	AAA	IEEE 802.11n (HT Mixed, 20MHz, MCS0, 90pc dc)	WLAN	8.63	± 9.6 %
10592	AAA	IEEE 802.11n (HT Mixed, 20MHz, MCS1, 90pc dc)	WLAN	8.79	± 9.6 %
10593	AAA	IEEE 802.11n (HT Mixed, 20MHz, MCS2, 90pc dc)	WLAN	8.64	± 9.6 %
10594	AAA	IEEE 802.11n (HT Mixed, 20MHz, MCS3, 90pc dc)	WLAN	8.74	± 9.6 %
10595	AAA	IEEE 802.11n (HT Mixed, 20MHz, MCS4, 90pc dc)	WLAN	8.74	± 9.6 %
10596	AAA	IEEE 802.11n (HT Mixed, 20MHz, MCS5, 90pc dc)	WLAN	8.71	± 9.6 %
10597	AAA	IEEE 802.11n (HT Mixed, 20MHz, MCS6, 90pc dc)	WLAN	8.72	± 9.6 %
10598	AAA	IEEE 802.11n (HT Mixed, 20MHz, MCS7, 90pc dc)	WLAN	8.50	± 9.6 %
10599	AAA	IEEE 802.11n (HT Mixed, 40MHz, MCS0, 90pc dc)	WLAN	8.79	± 9.6 %
10600	AAA	IEEE 802.11n (HT Mixed, 40MHz, MCS1, 90pc dc)	WLAN	8.88	± 9.6 %
10601	AAA	IEEE 802.11n (HT Mixed, 40MHz, MCS2, 90pc dc)	WLAN	8.82	± 9.6 %
10602	AAA	IEEE 802.11n (HT Mixed, 40MHz, MCS3, 90pc dc)	WLAN	8.94	± 9.6 %
10603	AAA	IEEE 802.11n (HT Mixed, 40MHz, MCS4, 90pc dc)	WLAN	9.03	± 9.6 %

Certificate No: EF3-4034\_Feb21

Page 16 of 22



EF3DV3 – SN:4034

February 25, 2021

10604	AAA	IEEE 802.11n (HT Mixed, 40MHz, MCS5, 90pc dc)	WLAN	8.76	± 9.6 %
10605	AAA	IEEE 802.11n (HT Mixed, 40MHz, MCS6, 90pc dc)	WLAN	8.97	± 9.6 %
10606	AAC	IEEE 802.11n (HT Mixed, 40MHz, MCS7, 90pc dc)	WLAN	8.82	± 9.6 %
10607	AAC	IEEE 802.11ac WiFi (20MHz, MCS0, 90pc dc)	WLAN	8.64	± 9.6 %
10608	AAC	IEEE 802.11ac WiFi (20MHz, MCS1, 90pc dc)	WLAN	8.77	± 9.6 %
10609	AAC	IEEE 802.11ac WiFi (20MHz, MCS2, 90pc dc)	WLAN	8.57	± 9.6 %
10610	AAC	IEEE 802.11ac WiFi (20MHz, MCS3, 90pc dc)	WLAN	8.78	± 9.6 %
10611	AAC	IEEE 802.11ac WiFi (20MHz, MCS4, 90pc dc)	WLAN	8.70	± 9.6 %
10612	AAC	IEEE 802.11ac WiFi (20MHz, MCS5, 90pc dc)	WLAN	8.77	± 9.6 %
10613	AAC	IEEE 802.11ac WiFi (20MHz, MCS6, 90pc dc)	WLAN	8.94	± 9.6 %
10614	AAC	IEEE 802.11ac WiFi (20MHz, MCS7, 90pc dc)	WLAN	8.59	± 9.6 %
10615	AAC	IEEE 802.11ac WiFi (20MHz, MCS8, 90pc dc)	WLAN	8.82	± 9.6 %
10616	AAC	IEEE 802.11ac WiFi (40MHz, MCS0, 90pc dc)	WLAN	8.82	± 9.6 %
10617	AAC	IEEE 802.11ac WiFi (40MHz, MCS1, 90pc dc)	WLAN	8.81	± 9.6 %
10618	AAC	IEEE 802.11ac WiFi (40MHz, MCS2, 90pc dc)	WLAN	8.58	± 9.6 %
10619	AAC	IEEE 802.11ac WiFi (40MHz, MCS3, 90pc dc)	WLAN	8.86	± 9.6 %
10620	AAC	IEEE 802.11ac WiFi (40MHz, MCS4, 90pc dc)	WLAN	8.87	± 9.6 %
10621	AAC	IEEE 802.11ac WiFi (40MHz, MCS5, 90pc dc)	WLAN	8.77	± 9.6 %
10622	AAC	IEEE 802.11ac WiFi (40MHz, MCS6, 90pc dc)	WLAN	8.68	± 9.6 %
10623	AAC	IEEE 802.11ac WiFi (40MHz, MCS7, 90pc dc)	WLAN	8.82	± 9.6 %
10624	AAC	IEEE 802.11ac WiFi (40MHz, MCS8, 90pc dc)	WLAN	8.96	± 9.6 %
10625	AAC	IEEE 802.11ac WiFi (40MHz, MCS9, 90pc dc)	WLAN	8.96	± 9.6 %
10626	AAC	IEEE 802.11ac WiFi (80MHz, MCS0, 90pc dc)	WLAN	8.83	± 9.6 %
10627	AAC	IEEE 802.11ac WiFi (80MHz, MCS1, 90pc dc)	WLAN	8.88	± 9.6 %
10628	AAC	IEEE 802.11ac WiFi (80MHz, MCS2, 90pc dc)	WLAN	8.71	± 9.6 %
10629	AAC	IEEE 802.11ac WiFi (80MHz, MCS3, 90pc dc)	WLAN	8.85	± 9.6 %
10630	AAC	IEEE 802.11ac WiFi (80MHz, MCS4, 90pc dc)	WLAN	8.72	± 9.6 %
10631	AAC	IEEE 802.11ac WiFi (80MHz, MCS5, 90pc dc)	WLAN	8.81	± 9.6 %
10632	AAC	IEEE 802.11ac WiFi (80MHz, MCS6, 90pc dc)	WLAN	8.74	± 9.6 %
10633	AAC	IEEE 802.11ac WiFi (80MHz, MCS7, 90pc dc)	WLAN	8.83	± 9.6 %
10634	AAC	IEEE 802.11ac WiFi (80MHz, MCS8, 90pc dc)	WLAN	8.80	± 9.6 %
10635	AAC	IEEE 802.11ac WiFi (80MHz, MCS9, 90pc dc)	WLAN	8.81	± 9.6 %
10636	AAC	IEEE 802.11ac WiFi (160MHz, MCS0, 90pc dc)	WLAN	8.83	± 9.6 %
10637	AAC	IEEE 802.11ac WiFi (160MHz, MCS1, 90pc dc)	WLAN	8.79	± 9.6 %
10638	AAC	IEEE 802.11ac WiFi (160MHz, MCS2, 90pc dc)	WLAN	8.86	± 9.6 %
10639	AAC	IEEE 802.11ac WiFi (160MHz, MCS3, 90pc dc)	WLAN	8.85	± 9.6 %
10640	AAC	IEEE 802.11ac WiFi (160MHz, MCS4, 90pc dc)	WLAN	8.98	± 9.6 %
10641	AAC	IEEE 802.11ac WiFi (160MHz, MCS5, 90pc dc)	WLAN	9.06	± 9.6 %
10642	AAC	IEEE 802.11ac WiFi (160MHz, MCS6, 90pc dc)	WLAN	9.06	± 9.6 %
10643	AAC	IEEE 802.11ac WiFi (160MHz, MCS7, 90pc dc)	WLAN	8.89	± 9.6 %
10644	AAC	IEEE 802.11ac WiFi (160MHz, MCS8, 90pc dc)	WLAN	9.05	± 9.6 %
10645	AAC	IEEE 802.11ac WiFi (160MHz, MCS9, 90pc dc)	WLAN	9.11	± 9.6 %
10646	AAC	LTE-TDD (SC-FDMA, 1 RB, 5 MHz, QPSK, UL Sub=2,7)	LTE-TDD	11.96	± 9.6 %
10647	AAC	LTE-TDD (SC-FDMA, 1 RB, 20 MHz, QPSK, UL Sub=2,7)	LTE-TDD	11.96	± 9.6 %
10648	AAC	CDMA2000 (1x Advanced)	CDMA2000	3.45	± 9.6 %
10652	AAC	LTE-TDD (OFDMA, 5 MHz, E-TM 3.1, Clipping 44%)	LTE-TDD	6.91	± 9.6 %
10653	AAC	LTE-TDD (OFDMA, 10 MHz, E-TM 3.1, Clipping 44%)	LTE-TDD	7.42	± 9.6 %
10654	AAC	LTE-TDD (OFDMA, 15 MHz, E-TM 3.1, Clipping 44%)	LTE-TDD	6.96	± 9.6 %
10655	AAC	LTE-TDD (OFDMA, 20 MHz, E-TM 3.1, Clipping 44%)	LTE-TDD	7.21	± 9.6 %
10658	AAC	Pulse Waveform (200Hz, 10%)	Test	10.00	± 9.6 %
10659	AAC	Pulse Waveform (200Hz, 20%)	Test	6.99	± 9.6 %
10660	AAC	Pulse Waveform (200Hz, 40%)	Test	3.98	± 9.6 %
10661	AAC	Pulse Waveform (200Hz, 60%)	Test	2.22	± 9.6 %
10662	AAC	Pulse Waveform (200Hz, 80%)	Test	0.97	± 9.6 %
10670	AAC	Bluetooth Low Energy	Bluetooth	2.19	± 9.6 %
10671	AAD	IEEE 802.11ax (20MHz, MCS0, 90pc dc)	WLAN	9.09	± 9.6 %

EF3DV3 – SN:4034

February 25, 2021

10672	AAD	IEEE 802.11ax (20MHz, MCS1, 90pc dc)	WLAN	8.57	± 9.6 %
10673	AAD	IEEE 802.11ax (20MHz, MCS2, 90pc dc)	WLAN	8.78	± 9.6 %
10674	AAD	IEEE 802.11ax (20MHz, MCS3, 90pc dc)	WLAN	8.74	± 9.6 %
10675	AAD	IEEE 802.11ax (20MHz, MCS4, 90pc dc)	WLAN	8.90	± 9.6 %
10676	AAD	IEEE 802.11ax (20MHz, MCS5, 90pc dc)	WLAN	8.77	± 9.6 %
10677	AAD	IEEE 802.11ax (20MHz, MCS6, 90pc dc)	WLAN	8.73	± 9.6 %
10678	AAD	IEEE 802.11ax (20MHz, MCS7, 90pc dc)	WLAN	8.78	± 9.6 %
10679	AAD	IEEE 802.11ax (20MHz, MCS8, 90pc dc)	WLAN	8.89	± 9.6 %
10680	AAD	IEEE 802.11ax (20MHz, MCS9, 90pc dc)	WLAN	8.80	± 9.6 %
10681	AAG	IEEE 802.11ax (20MHz, MCS10, 90pc dc)	WLAN	8.62	± 9.6 %
10682	AAF	IEEE 802.11ax (20MHz, MCS11, 90pc dc)	WLAN	8.83	± 9.6 %
10683	AAA	IEEE 802.11ax (20MHz, MCS0, 99pc dc)	WLAN	8.42	± 9.6 %
10684	AAC	IEEE 802.11ax (20MHz, MCS1, 99pc dc)	WLAN	8.26	± 9.6 %
10685	AAC	IEEE 802.11ax (20MHz, MCS2, 99pc dc)	WLAN	8.33	± 9.6 %
10686	AAC	IEEE 802.11ax (20MHz, MCS3, 99pc dc)	WLAN	8.28	± 9.6 %
10687	AAE	IEEE 802.11ax (20MHz, MCS4, 99pc dc)	WLAN	8.45	± 9.6 %
10688	AAE	IEEE 802.11ax (20MHz, MCS5, 99pc dc)	WLAN	8.29	± 9.6 %
10689	AAD	IEEE 802.11ax (20MHz, MCS6, 99pc dc)	WLAN	8.55	± 9.6 %
10690	AAE	IEEE 802.11ax (20MHz, MCS7, 99pc dc)	WLAN	8.29	± 9.6 %
10691	AAB	IEEE 802.11ax (20MHz, MCS8, 99pc dc)	WLAN	8.25	± 9.6 %
10692	AAA	IEEE 802.11ax (20MHz, MCS9, 99pc dc)	WLAN	8.29	± 9.6 %
10693	AAA	IEEE 802.11ax (20MHz, MCS10, 99pc dc)	WLAN	8.25	± 9.6 %
10694	AAA	IEEE 802.11ax (20MHz, MCS11, 99pc dc)	WLAN	8.57	± 9.6 %
10695	AAA	IEEE 802.11ax (40MHz, MCS0, 90pc dc)	WLAN	8.78	± 9.6 %
10696	AAA	IEEE 802.11ax (40MHz, MCS1, 90pc dc)	WLAN	8.91	± 9.6 %
10697	AAA	IEEE 802.11ax (40MHz, MCS2, 90pc dc)	WLAN	8.61	± 9.6 %
10698	AAA	IEEE 802.11ax (40MHz, MCS3, 90pc dc)	WLAN	8.89	± 9.6 %
10699	AAA	IEEE 802.11ax (40MHz, MCS4, 90pc dc)	WLAN	8.82	± 9.6 %
10700	AAA	IEEE 802.11ax (40MHz, MCS5, 90pc dc)	WLAN	8.73	± 9.6 %
10701	AAA	IEEE 802.11ax (40MHz, MCS6, 90pc dc)	WLAN	8.86	± 9.6 %
10702	AAA	IEEE 802.11ax (40MHz, MCS7, 90pc dc)	WLAN	8.70	± 9.6 %
10703	AAA	IEEE 802.11ax (40MHz, MCS8, 90pc dc)	WLAN	8.82	± 9.6 %
10704	AAA	IEEE 802.11ax (40MHz, MCS9, 90pc dc)	WLAN	8.56	± 9.6 %
10705	AAA	IEEE 802.11ax (40MHz, MCS10, 90pc dc)	WLAN	8.69	± 9.6 %
10706	AAC	IEEE 802.11ax (40MHz, MCS11, 90pc dc)	WLAN	8.66	± 9.6 %
10707	AAC	IEEE 802.11ax (40MHz, MCS0, 99pc dc)	WLAN	8.32	± 9.6 %
10708	AAC	IEEE 802.11ax (40MHz, MCS1, 99pc dc)	WLAN	8.55	± 9.6 %
10709	AAC	IEEE 802.11ax (40MHz, MCS2, 99pc dc)	WLAN	8.33	± 9.6 %
10710	AAC	IEEE 802.11ax (40MHz, MCS3, 99pc dc)	WLAN	8.29	± 9.6 %
10711	AAC	IEEE 802.11ax (40MHz, MCS4, 99pc dc)	WLAN	8.39	± 9.6 %
10712	AAC	IEEE 802.11ax (40MHz, MCS5, 99pc dc)	WLAN	8.67	± 9.6 %
10713	AAC	IEEE 802.11ax (40MHz, MCS6, 99pc dc)	WLAN	8.33	± 9.6 %
10714	AAC	IEEE 802.11ax (40MHz, MCS7, 99pc dc)	WLAN	8.26	± 9.6 %
10715	AAC	IEEE 802.11ax (40MHz, MCS8, 99pc dc)	WLAN	8.45	± 9.6 %
10716	AAC	IEEE 802.11ax (40MHz, MCS9, 99pc dc)	WLAN	8.30	± 9.6 %
10717	AAC	IEEE 802.11ax (40MHz, MCS10, 99pc dc)	WLAN	8.48	± 9.6 %
10718	AAC	IEEE 802.11ax (40MHz, MCS11, 99pc dc)	WLAN	8.24	± 9.6 %
10719	AAC	IEEE 802.11ax (80MHz, MCS0, 90pc dc)	WLAN	8.81	± 9.6 %
10720	AAC	IEEE 802.11ax (80MHz, MCS1, 90pc dc)	WLAN	8.87	± 9.6 %
10721	AAC	IEEE 802.11ax (80MHz, MCS2, 90pc dc)	WLAN	8.76	± 9.6 %
10722	AAC	IEEE 802.11ax (80MHz, MCS3, 90pc dc)	WLAN	8.55	± 9.6 %
10723	AAC	IEEE 802.11ax (80MHz, MCS4, 90pc dc)	WLAN	8.70	± 9.6 %
10724	AAC	IEEE 802.11ax (80MHz, MCS5, 90pc dc)	WLAN	8.90	± 9.6 %
10725	AAC	IEEE 802.11ax (80MHz, MCS6, 90pc dc)	WLAN	8.74	± 9.6 %
10726	AAC	IEEE 802.11ax (80MHz, MCS7, 90pc dc)	WLAN	8.72	± 9.6 %
10727	AAC	IEEE 802.11ax (80MHz, MCS8, 90pc dc)	WLAN	8.66	± 9.6 %



EF3DV3 – SN:4034

February 25, 2021

10728	AAC	IEEE 802.11ax (80MHz, MCS9, 90pc dc)	WLAN	8.65	± 9.6 %
10729	AAC	IEEE 802.11ax (80MHz, MCS10, 90pc dc)	WLAN	8.64	± 9.6 %
10730	AAC	IEEE 802.11ax (80MHz, MCS11, 90pc dc)	WLAN	8.67	± 9.6 %
10731	AAC	IEEE 802.11ax (80MHz, MCS0, 99pc dc)	WLAN	8.42	± 9.6 %
10732	AAC	IEEE 802.11ax (80MHz, MCS1, 99pc dc)	WLAN	8.46	± 9.6 %
10733	AAC	IEEE 802.11ax (80MHz, MCS2, 99pc dc)	WLAN	8.40	± 9.6 %
10734	AAC	IEEE 802.11ax (80MHz, MCS3, 99pc dc)	WLAN	8.25	± 9.6 %
10735	AAC	IEEE 802.11ax (80MHz, MCS4, 99pc dc)	WLAN	8.33	± 9.6 %
10736	AAC	IEEE 802.11ax (80MHz, MCS5, 99pc dc)	WLAN	8.27	± 9.6 %
10737	AAC	IEEE 802.11ax (80MHz, MCS6, 99pc dc)	WLAN	8.36	± 9.6 %
10738	AAC	IEEE 802.11ax (80MHz, MCS7, 99pc dc)	WLAN	8.42	± 9.6 %
10739	AAC	IEEE 802.11ax (80MHz, MCS8, 99pc dc)	WLAN	8.29	± 9.6 %
10740	AAC	IEEE 802.11ax (80MHz, MCS9, 99pc dc)	WLAN	8.48	± 9.6 %
10741	AAC	IEEE 802.11ax (80MHz, MCS10, 99pc dc)	WLAN	8.40	± 9.6 %
10742	AAC	IEEE 802.11ax (80MHz, MCS11, 99pc dc)	WLAN	8.43	± 9.6 %
10743	AAC	IEEE 802.11ax (160MHz, MCS0, 90pc dc)	WLAN	8.94	± 9.6 %
10744	AAC	IEEE 802.11ax (160MHz, MCS1, 90pc dc)	WLAN	9.16	± 9.6 %
10745	AAC	IEEE 802.11ax (160MHz, MCS2, 90pc dc)	WLAN	8.93	± 9.6 %
10746	AAC	IEEE 802.11ax (160MHz, MCS3, 90pc dc)	WLAN	9.11	± 9.6 %
10747	AAC	IEEE 802.11ax (160MHz, MCS4, 90pc dc)	WLAN	9.04	± 9.6 %
10748	AAC	IEEE 802.11ax (160MHz, MCS5, 90pc dc)	WLAN	8.93	± 9.6 %
10749	AAC	IEEE 802.11ax (160MHz, MCS6, 90pc dc)	WLAN	8.90	± 9.6 %
10750	AAC	IEEE 802.11ax (160MHz, MCS7, 90pc dc)	WLAN	8.79	± 9.6 %
10751	AAC	IEEE 802.11ax (160MHz, MCS8, 90pc dc)	WLAN	8.82	± 9.6 %
10752	AAC	IEEE 802.11ax (160MHz, MCS9, 90pc dc)	WLAN	8.81	± 9.6 %
10753	AAC	IEEE 802.11ax (160MHz, MCS10, 90pc dc)	WLAN	9.00	± 9.6 %
10754	AAC	IEEE 802.11ax (160MHz, MCS11, 90pc dc)	WLAN	8.94	± 9.6 %
10755	AAC	IEEE 802.11ax (160MHz, MCS0, 99pc dc)	WLAN	8.64	± 9.6 %
10756	AAC	IEEE 802.11ax (160MHz, MCS1, 99pc dc)	WLAN	8.77	± 9.6 %
10757	AAC	IEEE 802.11ax (160MHz, MCS2, 99pc dc)	WLAN	8.77	± 9.6 %
10758	AAC	IEEE 802.11ax (160MHz, MCS3, 99pc dc)	WLAN	8.69	± 9.6 %
10759	AAC	IEEE 802.11ax (160MHz, MCS4, 99pc dc)	WLAN	8.58	± 9.6 %
10760	AAC	IEEE 802.11ax (160MHz, MCS5, 99pc dc)	WLAN	8.49	± 9.6 %
10761	AAC	IEEE 802.11ax (160MHz, MCS6, 99pc dc)	WLAN	8.58	± 9.6 %
10762	AAC	IEEE 802.11ax (160MHz, MCS7, 99pc dc)	WLAN	8.49	± 9.6 %
10763	AAC	IEEE 802.11ax (160MHz, MCS8, 99pc dc)	WLAN	8.53	± 9.6 %
10764	AAC	IEEE 802.11ax (160MHz, MCS9, 99pc dc)	WLAN	8.54	± 9.6 %
10765	AAC	IEEE 802.11ax (160MHz, MCS10, 99pc dc)	WLAN	8.54	± 9.6 %
10766	AAC	IEEE 802.11ax (160MHz, MCS11, 99pc dc)	WLAN	8.51	± 9.6 %
10767	AAC	5G NR (CP-OFDM, 1 RB, 5 MHz, QPSK, 15 kHz)	5G NR FR1 TDD	7.99	± 9.6 %
10768	AAC	5G NR (CP-OFDM, 1 RB, 10 MHz, QPSK, 15 kHz)	5G NR FR1 TDD	8.01	± 9.6 %
10769	AAC	5G NR (CP-OFDM, 1 RB, 15 MHz, QPSK, 15 kHz)	5G NR FR1 TDD	8.01	± 9.6 %
10770	AAC	5G NR (CP-OFDM, 1 RB, 20 MHz, QPSK, 15 kHz)	5G NR FR1 TDD	8.02	± 9.6 %
10771	AAC	5G NR (CP-OFDM, 1 RB, 25 MHz, QPSK, 15 kHz)	5G NR FR1 TDD	8.02	± 9.6 %
10772	AAC	5G NR (CP-OFDM, 1 RB, 30 MHz, QPSK, 15 kHz)	5G NR FR1 TDD	8.23	± 9.6 %
10773	AAC	5G NR (CP-OFDM, 1 RB, 40 MHz, QPSK, 15 kHz)	5G NR FR1 TDD	8.03	± 9.6 %
10774	AAC	5G NR (CP-OFDM, 1 RB, 50 MHz, QPSK, 15 kHz)	5G NR FR1 TDD	8.02	± 9.6 %
10775	AAC	5G NR (CP-OFDM, 50% RB, 5 MHz, QPSK, 15 kHz)	5G NR FR1 TDD	8.31	± 9.6 %
10776	AAC	5G NR (CP-OFDM, 50% RB, 10 MHz, QPSK, 15 kHz)	5G NR FR1 TDD	8.30	± 9.6 %
10777	AAC	5G NR (CP-OFDM, 50% RB, 15 MHz, QPSK, 15 kHz)	5G NR FR1 TDD	8.30	± 9.6 %
10778	AAC	5G NR (CP-OFDM, 50% RB, 20 MHz, QPSK, 15 kHz)	5G NR FR1 TDD	8.34	± 9.6 %
10779	AAC	5G NR (CP-OFDM, 50% RB, 25 MHz, QPSK, 15 kHz)	5G NR FR1 TDD	8.42	± 9.6 %
10780	AAC	5G NR (CP-OFDM, 50% RB, 30 MHz, QPSK, 15 kHz)	5G NR FR1 TDD	8.38	± 9.6 %
10781	AAC	5G NR (CP-OFDM, 50% RB, 40 MHz, QPSK, 15 kHz)	5G NR FR1 TDD	8.38	± 9.6 %
10782	AAC	5G NR (CP-OFDM, 50% RB, 50 MHz, QPSK, 15 kHz)	5G NR FR1 TDD	8.43	± 9.6 %
10783	AAC	5G NR (CP-OFDM, 100% RB, 5 MHz, QPSK, 15 kHz)	5G NR FR1 TDD	8.31	± 9.6 %

EF3DV3 – SN:4034

February 25, 2021

10784	AAC	5G NR (CP-OFDM, 100% RB, 10 MHz, QPSK, 15 kHz)	5G NR FR1 TDD	8.29	± 9.6 %
10785	AAC	5G NR (CP-OFDM, 100% RB, 15 MHz, QPSK, 15 kHz)	5G NR FR1 TDD	8.40	± 9.6 %
10786	AAC	5G NR (CP-OFDM, 100% RB, 20 MHz, QPSK, 15 kHz)	5G NR FR1 TDD	8.35	± 9.6 %
10787	AAC	5G NR (CP-OFDM, 100% RB, 25 MHz, QPSK, 15 kHz)	5G NR FR1 TDD	8.44	± 9.6 %
10788	AAC	5G NR (CP-OFDM, 100% RB, 30 MHz, QPSK, 15 kHz)	5G NR FR1 TDD	8.39	± 9.6 %
10789	AAC	5G NR (CP-OFDM, 100% RB, 40 MHz, QPSK, 15 kHz)	5G NR FR1 TDD	8.37	± 9.6 %
10790	AAC	5G NR (CP-OFDM, 100% RB, 50 MHz, QPSK, 15 kHz)	5G NR FR1 TDD	8.39	± 9.6 %
10791	AAC	5G NR (CP-OFDM, 1 RB, 5 MHz, QPSK, 30 kHz)	5G NR FR1 TDD	7.83	± 9.6 %
10792	AAC	5G NR (CP-OFDM, 1 RB, 10 MHz, QPSK, 30 kHz)	5G NR FR1 TDD	7.92	± 9.6 %
10793	AAC	5G NR (CP-OFDM, 1 RB, 15 MHz, QPSK, 30 kHz)	5G NR FR1 TDD	7.95	± 9.6 %
10794	AAC	5G NR (CP-OFDM, 1 RB, 20 MHz, QPSK, 30 kHz)	5G NR FR1 TDD	7.82	± 9.6 %
10795	AAC	5G NR (CP-OFDM, 1 RB, 25 MHz, QPSK, 30 kHz)	5G NR FR1 TDD	7.84	± 9.6 %
10796	AAC	5G NR (CP-OFDM, 1 RB, 30 MHz, QPSK, 30 kHz)	5G NR FR1 TDD	7.82	± 9.6 %
10797	AAC	5G NR (CP-OFDM, 1 RB, 40 MHz, QPSK, 30 kHz)	5G NR FR1 TDD	8.01	± 9.6 %
10798	AAC	5G NR (CP-OFDM, 1 RB, 50 MHz, QPSK, 30 kHz)	5G NR FR1 TDD	7.89	± 9.6 %
10799	AAC	5G NR (CP-OFDM, 1 RB, 60 MHz, QPSK, 30 kHz)	5G NR FR1 TDD	7.93	± 9.6 %
10801	AAC	5G NR (CP-OFDM, 1 RB, 80 MHz, QPSK, 30 kHz)	5G NR FR1 TDD	7.89	± 9.6 %
10802	AAC	5G NR (CP-OFDM, 1 RB, 90 MHz, QPSK, 30 kHz)	5G NR FR1 TDD	7.87	± 9.6 %
10803	AAE	5G NR (CP-OFDM, 1 RB, 100 MHz, QPSK, 30 kHz)	5G NR FR1 TDD	7.93	± 9.6 %
10805	AAD	5G NR (CP-OFDM, 50% RB, 10 MHz, QPSK, 30 kHz)	5G NR FR1 TDD	8.34	± 9.6 %
10806	AAD	5G NR (CP-OFDM, 50% RB, 15 MHz, QPSK, 30 kHz)	5G NR FR1 TDD	8.37	± 9.6 %
10809	AAD	5G NR (CP-OFDM, 50% RB, 30 MHz, QPSK, 30 kHz)	5G NR FR1 TDD	8.34	± 9.6 %
10810	AAD	5G NR (CP-OFDM, 50% RB, 40 MHz, QPSK, 30 kHz)	5G NR FR1 TDD	8.34	± 9.6 %
10812	AAD	5G NR (CP-OFDM, 50% RB, 60 MHz, QPSK, 30 kHz)	5G NR FR1 TDD	8.35	± 9.6 %
10817	AAD	5G NR (CP-OFDM, 100% RB, 5 MHz, QPSK, 30 kHz)	5G NR FR1 TDD	8.35	± 9.6 %
10818	AAD	5G NR (CP-OFDM, 100% RB, 10 MHz, QPSK, 30 kHz)	5G NR FR1 TDD	8.34	± 9.6 %
10819	AAD	5G NR (CP-OFDM, 100% RB, 15 MHz, QPSK, 30 kHz)	5G NR FR1 TDD	8.33	± 9.6 %
10820	AAD	5G NR (CP-OFDM, 100% RB, 20 MHz, QPSK, 30 kHz)	5G NR FR1 TDD	8.30	± 9.6 %
10821	AAC	5G NR (CP-OFDM, 100% RB, 25 MHz, QPSK, 30 kHz)	5G NR FR1 TDD	8.41	± 9.6 %
10822	AAD	5G NR (CP-OFDM, 100% RB, 30 MHz, QPSK, 30 kHz)	5G NR FR1 TDD	8.41	± 9.6 %
10823	AAC	5G NR (CP-OFDM, 100% RB, 40 MHz, QPSK, 30 kHz)	5G NR FR1 TDD	8.36	± 9.6 %
10824	AAD	5G NR (CP-OFDM, 100% RB, 50 MHz, QPSK, 30 kHz)	5G NR FR1 TDD	8.39	± 9.6 %
10825	AAD	5G NR (CP-OFDM, 100% RB, 60 MHz, QPSK, 30 kHz)	5G NR FR1 TDD	8.41	± 9.6 %
10827	AAD	5G NR (CP-OFDM, 100% RB, 80 MHz, QPSK, 30 kHz)	5G NR FR1 TDD	8.42	± 9.6 %
10828	AAE	5G NR (CP-OFDM, 100% RB, 90 MHz, QPSK, 30 kHz)	5G NR FR1 TDD	8.43	± 9.6 %
10829	AAD	5G NR (CP-OFDM, 100% RB, 100 MHz, QPSK, 30 kHz)	5G NR FR1 TDD	8.40	± 9.6 %
10830	AAD	5G NR (CP-OFDM, 1 RB, 10 MHz, QPSK, 60 kHz)	5G NR FR1 TDD	7.63	± 9.6 %
10831	AAD	5G NR (CP-OFDM, 1 RB, 15 MHz, QPSK, 60 kHz)	5G NR FR1 TDD	7.73	± 9.6 %
10832	AAD	5G NR (CP-OFDM, 1 RB, 20 MHz, QPSK, 60 kHz)	5G NR FR1 TDD	7.74	± 9.6 %
10833	AAD	5G NR (CP-OFDM, 1 RB, 25 MHz, QPSK, 60 kHz)	5G NR FR1 TDD	7.70	± 9.6 %
10834	AAD	5G NR (CP-OFDM, 1 RB, 30 MHz, QPSK, 60 kHz)	5G NR FR1 TDD	7.75	± 9.6 %
10835	AAD	5G NR (CP-OFDM, 1 RB, 40 MHz, QPSK, 60 kHz)	5G NR FR1 TDD	7.70	± 9.6 %
10836	AAE	5G NR (CP-OFDM, 1 RB, 50 MHz, QPSK, 60 kHz)	5G NR FR1 TDD	7.66	± 9.6 %
10837	AAD	5G NR (CP-OFDM, 1 RB, 60 MHz, QPSK, 60 kHz)	5G NR FR1 TDD	7.68	± 9.6 %
10839	AAD	5G NR (CP-OFDM, 1 RB, 80 MHz, QPSK, 60 kHz)	5G NR FR1 TDD	7.70	± 9.6 %
10840	AAD	5G NR (CP-OFDM, 1 RB, 90 MHz, QPSK, 60 kHz)	5G NR FR1 TDD	7.67	± 9.6 %
10841	AAD	5G NR (CP-OFDM, 1 RB, 100 MHz, QPSK, 60 kHz)	5G NR FR1 TDD	7.71	± 9.6 %
10843	AAD	5G NR (CP-OFDM, 50% RB, 15 MHz, QPSK, 60 kHz)	5G NR FR1 TDD	8.49	± 9.6 %
10844	AAD	5G NR (CP-OFDM, 50% RB, 20 MHz, QPSK, 60 kHz)	5G NR FR1 TDD	8.34	± 9.6 %
10846	AAD	5G NR (CP-OFDM, 50% RB, 30 MHz, QPSK, 60 kHz)	5G NR FR1 TDD	8.41	± 9.6 %
10854	AAD	5G NR (CP-OFDM, 100% RB, 10 MHz, QPSK, 60 kHz)	5G NR FR1 TDD	8.34	± 9.6 %
10855	AAD	5G NR (CP-OFDM, 100% RB, 15 MHz, QPSK, 60 kHz)	5G NR FR1 TDD	8.36	± 9.6 %
10856	AAD	5G NR (CP-OFDM, 100% RB, 20 MHz, QPSK, 60 kHz)	5G NR FR1 TDD	8.37	± 9.6 %
10857	AAD	5G NR (CP-OFDM, 100% RB, 25 MHz, QPSK, 60 kHz)	5G NR FR1 TDD	8.35	± 9.6 %
10858	AAD	5G NR (CP-OFDM, 100% RB, 30 MHz, QPSK, 60 kHz)	5G NR FR1 TDD	8.36	± 9.6 %
10859	AAD	5G NR (CP-OFDM, 100% RB, 40 MHz, QPSK, 60 kHz)	5G NR FR1 TDD	8.34	± 9.6 %



EF3DV3 – SN:4034

February 25, 2021

10860	AAD	5G NR (CP-OFDM, 100% RB, 50 MHz, QPSK, 60 kHz)	5G NR FR1 TDD	8.41	± 9.6 %
10861	AAD	5G NR (CP-OFDM, 100% RB, 60 MHz, QPSK, 60 kHz)	5G NR FR1 TDD	8.40	± 9.6 %
10863	AAD	5G NR (CP-OFDM, 100% RB, 80 MHz, QPSK, 60 kHz)	5G NR FR1 TDD	8.41	± 9.6 %
10864	AAE	5G NR (CP-OFDM, 100% RB, 90 MHz, QPSK, 60 kHz)	5G NR FR1 TDD	8.37	± 9.6 %
10865	AAD	5G NR (CP-OFDM, 100% RB, 100 MHz, QPSK, 60 kHz)	5G NR FR1 TDD	8.41	± 9.6 %
10866	AAD	5G NR (DFT-s-OFDM, 1 RB, 100 MHz, QPSK, 30 kHz)	5G NR FR1 TDD	5.68	± 9.6 %
10868	AAD	5G NR (DFT-s-OFDM, 100% RB, 100 MHz, QPSK, 30 kHz)	5G NR FR1 TDD	5.89	± 9.6 %
10869	AAD	5G NR (DFT-s-OFDM, 1 RB, 100 MHz, QPSK, 120 kHz)	5G NR FR2 TDD	5.75	± 9.6 %
10870	AAD	5G NR (DFT-s-OFDM, 100% RB, 100 MHz, QPSK, 120 kHz)	5G NR FR2 TDD	5.86	± 9.6 %
10871	AAD	5G NR (DFT-s-OFDM, 1 RB, 100 MHz, 16QAM, 120 kHz)	5G NR FR2 TDD	5.75	± 9.6 %
10872	AAD	5G NR (DFT-s-OFDM, 100% RB, 100 MHz, 16QAM, 120 kHz)	5G NR FR2 TDD	6.52	± 9.6 %
10873	AAD	5G NR (DFT-s-OFDM, 1 RB, 100 MHz, 64QAM, 120 kHz)	5G NR FR2 TDD	6.61	± 9.6 %
10874	AAD	5G NR (DFT-s-OFDM, 100% RB, 100 MHz, 64QAM, 120 kHz)	5G NR FR2 TDD	6.65	± 9.6 %
10875	AAD	5G NR (CP-OFDM, 1 RB, 100 MHz, QPSK, 120 kHz)	5G NR FR2 TDD	7.78	± 9.6 %
10876	AAD	5G NR (CP-OFDM, 100% RB, 100 MHz, QPSK, 120 kHz)	5G NR FR2 TDD	8.39	± 9.6 %
10877	AAD	5G NR (CP-OFDM, 1 RB, 100 MHz, 16QAM, 120 kHz)	5G NR FR2 TDD	7.95	± 9.6 %
10878	AAD	5G NR (CP-OFDM, 100% RB, 100 MHz, 16QAM, 120 kHz)	5G NR FR2 TDD	8.41	± 9.6 %
10879	AAD	5G NR (CP-OFDM, 1 RB, 100 MHz, 64QAM, 120 kHz)	5G NR FR2 TDD	8.12	± 9.6 %
10880	AAD	5G NR (CP-OFDM, 100% RB, 100 MHz, 64QAM, 120 kHz)	5G NR FR2 TDD	8.38	± 9.6 %
10881	AAD	5G NR (DFT-s-OFDM, 1 RB, 50 MHz, QPSK, 120 kHz)	5G NR FR2 TDD	5.75	± 9.6 %
10882	AAD	5G NR (DFT-s-OFDM, 100% RB, 50 MHz, QPSK, 120 kHz)	5G NR FR2 TDD	5.96	± 9.6 %
10883	AAD	5G NR (DFT-s-OFDM, 1 RB, 50 MHz, 16QAM, 120 kHz)	5G NR FR2 TDD	6.57	± 9.6 %
10884	AAD	5G NR (DFT-s-OFDM, 100% RB, 50 MHz, 16QAM, 120 kHz)	5G NR FR2 TDD	6.53	± 9.6 %
10885	AAD	5G NR (DFT-s-OFDM, 1 RB, 50 MHz, 64QAM, 120 kHz)	5G NR FR2 TDD	6.61	± 9.6 %
10886	AAD	5G NR (DFT-s-OFDM, 100% RB, 50 MHz, 64QAM, 120 kHz)	5G NR FR2 TDD	6.65	± 9.6 %
10887	AAD	5G NR (CP-OFDM, 1 RB, 50 MHz, QPSK, 120 kHz)	5G NR FR2 TDD	7.78	± 9.6 %
10888	AAD	5G NR (CP-OFDM, 100% RB, 50 MHz, QPSK, 120 kHz)	5G NR FR2 TDD	8.35	± 9.6 %
10889	AAD	5G NR (CP-OFDM, 1 RB, 50 MHz, 16QAM, 120 kHz)	5G NR FR2 TDD	8.02	± 9.6 %
10890	AAD	5G NR (CP-OFDM, 100% RB, 50 MHz, 16QAM, 120 kHz)	5G NR FR2 TDD	8.40	± 9.6 %
10891	AAD	5G NR (CP-OFDM, 1 RB, 50 MHz, 64QAM, 120 kHz)	5G NR FR2 TDD	8.13	± 9.6 %
10892	AAD	5G NR (CP-OFDM, 100% RB, 50 MHz, 64QAM, 120 kHz)	5G NR FR2 TDD	8.41	± 9.6 %
10897	AAD	5G NR (DFT-s-OFDM, 1 RB, 5 MHz, QPSK, 30 kHz)	5G NR FR1 TDD	5.66	± 9.6 %
10898	AAD	5G NR (DFT-s-OFDM, 1 RB, 10 MHz, QPSK, 30 kHz)	5G NR FR1 TDD	5.67	± 9.6 %
10899	AAD	5G NR (DFT-s-OFDM, 1 RB, 15 MHz, QPSK, 30 kHz)	5G NR FR1 TDD	5.67	± 9.6 %
10900	AAD	5G NR (DFT-s-OFDM, 1 RB, 20 MHz, QPSK, 30 kHz)	5G NR FR1 TDD	5.68	± 9.6 %
10901	AAD	5G NR (DFT-s-OFDM, 1 RB, 25 MHz, QPSK, 30 kHz)	5G NR FR1 TDD	5.68	± 9.6 %
10902	AAD	5G NR (DFT-s-OFDM, 1 RB, 30 MHz, QPSK, 30 kHz)	5G NR FR1 TDD	5.68	± 9.6 %
10903	AAD	5G NR (DFT-s-OFDM, 1 RB, 40 MHz, QPSK, 30 kHz)	5G NR FR1 TDD	5.68	± 9.6 %
10904	AAD	5G NR (DFT-s-OFDM, 1 RB, 50 MHz, QPSK, 30 kHz)	5G NR FR1 TDD	5.68	± 9.6 %
10905	AAD	5G NR (DFT-s-OFDM, 1 RB, 60 MHz, QPSK, 30 kHz)	5G NR FR1 TDD	5.68	± 9.6 %
10906	AAD	5G NR (DFT-s-OFDM, 1 RB, 80 MHz, QPSK, 30 kHz)	5G NR FR1 TDD	5.68	± 9.6 %
10907	AAD	5G NR (DFT-s-OFDM, 50% RB, 5 MHz, QPSK, 30 kHz)	5G NR FR1 TDD	5.78	± 9.6 %
10908	AAD	5G NR (DFT-s-OFDM, 50% RB, 10 MHz, QPSK, 30 kHz)	5G NR FR1 TDD	5.93	± 9.6 %
10909	AAD	5G NR (DFT-s-OFDM, 50% RB, 15 MHz, QPSK, 30 kHz)	5G NR FR1 TDD	5.96	± 9.6 %
10910	AAD	5G NR (DFT-s-OFDM, 50% RB, 20 MHz, QPSK, 30 kHz)	5G NR FR1 TDD	5.83	± 9.6 %
10911	AAD	5G NR (DFT-s-OFDM, 50% RB, 25 MHz, QPSK, 30 kHz)	5G NR FR1 TDD	5.93	± 9.6 %
10912	AAD	5G NR (DFT-s-OFDM, 50% RB, 30 MHz, QPSK, 30 kHz)	5G NR FR1 TDD	5.84	± 9.6 %
10913	AAD	5G NR (DFT-s-OFDM, 50% RB, 40 MHz, QPSK, 30 kHz)	5G NR FR1 TDD	5.84	± 9.6 %
10914	AAD	5G NR (DFT-s-OFDM, 50% RB, 50 MHz, QPSK, 30 kHz)	5G NR FR1 TDD	5.85	± 9.6 %
10915	AAD	5G NR (DFT-s-OFDM, 50% RB, 60 MHz, QPSK, 30 kHz)	5G NR FR1 TDD	5.83	± 9.6 %
10916	AAD	5G NR (DFT-s-OFDM, 50% RB, 80 MHz, QPSK, 30 kHz)	5G NR FR1 TDD	5.87	± 9.6 %
10917	AAD	5G NR (DFT-s-OFDM, 50% RB, 100 MHz, QPSK, 30 kHz)	5G NR FR1 TDD	5.94	± 9.6 %
10918	AAD	5G NR (DFT-s-OFDM, 100% RB, 5 MHz, QPSK, 30 kHz)	5G NR FR1 TDD	5.86	± 9.6 %
10919	AAD	5G NR (DFT-s-OFDM, 100% RB, 10 MHz, QPSK, 30 kHz)	5G NR FR1 TDD	5.86	± 9.6 %
10920	AAD	5G NR (DFT-s-OFDM, 100% RB, 15 MHz, QPSK, 30 kHz)	5G NR FR1 TDD	5.87	± 9.6 %
10921	AAD	5G NR (DFT-s-OFDM, 100% RB, 20 MHz, QPSK, 30 kHz)	5G NR FR1 TDD	5.84	± 9.6 %

EF3DV3 – SN:4034

February 25, 2021

10922	AAD	5G NR (DFT-s-OFDM, 100% RB, 25 MHz, QPSK, 30 kHz)	5G NR FR1 TDD	5.82	± 9.6 %
10923	AAD	5G NR (DFT-s-OFDM, 100% RB, 30 MHz, QPSK, 30 kHz)	5G NR FR1 TDD	5.84	± 9.6 %
10924	AAD	5G NR (DFT-s-OFDM, 100% RB, 40 MHz, QPSK, 30 kHz)	5G NR FR1 TDD	5.84	± 9.6 %
10925	AAD	5G NR (DFT-s-OFDM, 100% RB, 50 MHz, QPSK, 30 kHz)	5G NR FR1 TDD	5.95	± 9.6 %
10926	AAD	5G NR (DFT-s-OFDM, 100% RB, 60 MHz, QPSK, 30 kHz)	5G NR FR1 TDD	5.84	± 9.6 %
10927	AAD	5G NR (DFT-s-OFDM, 100% RB, 80 MHz, QPSK, 30 kHz)	5G NR FR1 TDD	5.94	± 9.6 %
10928	AAD	5G NR (DFT-s-OFDM, 1 RB, 5 MHz, QPSK, 15 kHz)	5G NR FR1 FDD	5.52	± 9.6 %
10929	AAD	5G NR (DFT-s-OFDM, 1 RB, 10 MHz, QPSK, 15 kHz)	5G NR FR1 FDD	5.52	± 9.6 %
10930	AAD	5G NR (DFT-s-OFDM, 1 RB, 15 MHz, QPSK, 15 kHz)	5G NR FR1 FDD	5.52	± 9.6 %
10931	AAD	5G NR (DFT-s-OFDM, 1 RB, 20 MHz, QPSK, 15 kHz)	5G NR FR1 FDD	5.51	± 9.6 %
10932	AAB	5G NR (DFT-s-OFDM, 1 RB, 25 MHz, QPSK, 15 kHz)	5G NR FR1 FDD	5.51	± 9.6 %
10933	AAA	5G NR (DFT-s-OFDM, 1 RB, 30 MHz, QPSK, 15 kHz)	5G NR FR1 FDD	5.51	± 9.6 %
10934	AAA	5G NR (DFT-s-OFDM, 1 RB, 40 MHz, QPSK, 15 kHz)	5G NR FR1 FDD	5.51	± 9.6 %
10935	AAA	5G NR (DFT-s-OFDM, 1 RB, 50 MHz, QPSK, 15 kHz)	5G NR FR1 FDD	5.51	± 9.6 %
10936	AAC	5G NR (DFT-s-OFDM, 50% RB, 5 MHz, QPSK, 15 kHz)	5G NR FR1 FDD	5.90	± 9.6 %
10937	AAB	5G NR (DFT-s-OFDM, 50% RB, 10 MHz, QPSK, 15 kHz)	5G NR FR1 FDD	5.77	± 9.6 %
10938	AAB	5G NR (DFT-s-OFDM, 50% RB, 15 MHz, QPSK, 15 kHz)	5G NR FR1 FDD	5.90	± 9.6 %
10939	AAB	5G NR (DFT-s-OFDM, 50% RB, 20 MHz, QPSK, 15 kHz)	5G NR FR1 FDD	5.82	± 9.6 %
10940	AAB	5G NR (DFT-s-OFDM, 50% RB, 25 MHz, QPSK, 15 kHz)	5G NR FR1 FDD	5.89	± 9.6 %
10941	AAB	5G NR (DFT-s-OFDM, 50% RB, 30 MHz, QPSK, 15 kHz)	5G NR FR1 FDD	5.83	± 9.6 %
10942	AAB	5G NR (DFT-s-OFDM, 50% RB, 40 MHz, QPSK, 15 kHz)	5G NR FR1 FDD	5.85	± 9.6 %
10943	AAB	5G NR (DFT-s-OFDM, 50% RB, 50 MHz, QPSK, 15 kHz)	5G NR FR1 FDD	5.95	± 9.6 %
10944	AAB	5G NR (DFT-s-OFDM, 100% RB, 5 MHz, QPSK, 15 kHz)	5G NR FR1 FDD	5.81	± 9.6 %
10945	AAB	5G NR (DFT-s-OFDM, 100% RB, 10 MHz, QPSK, 15 kHz)	5G NR FR1 FDD	5.85	± 9.6 %
10946	AAC	5G NR (DFT-s-OFDM, 100% RB, 15 MHz, QPSK, 15 kHz)	5G NR FR1 FDD	5.83	± 9.6 %
10947	AAB	5G NR (DFT-s-OFDM, 100% RB, 20 MHz, QPSK, 15 kHz)	5G NR FR1 FDD	5.87	± 9.6 %
10948	AAB	5G NR (DFT-s-OFDM, 100% RB, 25 MHz, QPSK, 15 kHz)	5G NR FR1 FDD	5.94	± 9.6 %
10949	AAB	5G NR (DFT-s-OFDM, 100% RB, 30 MHz, QPSK, 15 kHz)	5G NR FR1 FDD	5.87	± 9.6 %
10950	AAB	5G NR (DFT-s-OFDM, 100% RB, 40 MHz, QPSK, 15 kHz)	5G NR FR1 FDD	5.94	± 9.6 %
10951	AAB	5G NR (DFT-s-OFDM, 100% RB, 50 MHz, QPSK, 15 kHz)	5G NR FR1 FDD	5.92	± 9.6 %
10952	AAB	5G NR DL (CP-OFDM, TM 3.1, 5 MHz, 64-QAM, 15 kHz)	5G NR FR1 FDD	8.25	± 9.6 %
10953	AAB	5G NR DL (CP-OFDM, TM 3.1, 10 MHz, 64-QAM, 15 kHz)	5G NR FR1 FDD	8.15	± 9.6 %
10954	AAB	5G NR DL (CP-OFDM, TM 3.1, 15 MHz, 64-QAM, 15 kHz)	5G NR FR1 FDD	8.23	± 9.6 %
10955	AAB	5G NR DL (CP-OFDM, TM 3.1, 20 MHz, 64-QAM, 15 kHz)	5G NR FR1 FDD	8.42	± 9.6 %
10956	AAB	5G NR DL (CP-OFDM, TM 3.1, 5 MHz, 64-QAM, 30 kHz)	5G NR FR1 FDD	8.14	± 9.6 %
10957	AAC	5G NR DL (CP-OFDM, TM 3.1, 10 MHz, 64-QAM, 30 kHz)	5G NR FR1 FDD	8.31	± 9.6 %
10958	AAB	5G NR DL (CP-OFDM, TM 3.1, 15 MHz, 64-QAM, 30 kHz)	5G NR FR1 FDD	8.61	± 9.6 %
10959	AAB	5G NR DL (CP-OFDM, TM 3.1, 20 MHz, 64-QAM, 30 kHz)	5G NR FR1 FDD	8.33	± 9.6 %
10960	AAB	5G NR DL (CP-OFDM, TM 3.1, 5 MHz, 64-QAM, 15 kHz)	5G NR FR1 TDD	9.32	± 9.6 %
10961	AAB	5G NR DL (CP-OFDM, TM 3.1, 10 MHz, 64-QAM, 15 kHz)	5G NR FR1 TDD	9.36	± 9.6 %
10962	AAB	5G NR DL (CP-OFDM, TM 3.1, 15 MHz, 64-QAM, 15 kHz)	5G NR FR1 TDD	9.40	± 9.6 %
10963	AAB	5G NR DL (CP-OFDM, TM 3.1, 20 MHz, 64-QAM, 15 kHz)	5G NR FR1 TDD	9.55	± 9.6 %
10964	AAB	5G NR DL (CP-OFDM, TM 3.1, 5 MHz, 64-QAM, 30 kHz)	5G NR FR1 TDD	9.29	± 9.6 %
10965	AAB	5G NR DL (CP-OFDM, TM 3.1, 10 MHz, 64-QAM, 30 kHz)	5G NR FR1 TDD	9.37	± 9.6 %
10966	AAB	5G NR DL (CP-OFDM, TM 3.1, 15 MHz, 64-QAM, 30 kHz)	5G NR FR1 TDD	9.55	± 9.6 %
10967	AAB	5G NR DL (CP-OFDM, TM 3.1, 20 MHz, 64-QAM, 30 kHz)	5G NR FR1 TDD	9.42	± 9.6 %
10968	AAB	5G NR DL (CP-OFDM, TM 3.1, 100 MHz, 64-QAM, 30 kHz)	5G NR FR1 TDD	9.49	± 9.6 %
10972	AAB	5G NR (CP-OFDM, 1 RB, 20 MHz, QPSK, 15 kHz)	5G NR FR1 TDD	11.59	± 9.6 %
10973	AAB	5G NR (DFT-s-OFDM, 1 RB, 100 MHz, QPSK, 30 kHz)	5G NR FR1 TDD	9.06	± 9.6 %
10974	AAB	5G NR (CP-OFDM, 100% RB, 100 MHz, 256-QAM, 30 kHz)	5G NR FR1 TDD	10.28	± 9.6 %

<sup>2</sup> Uncertainty is determined using the max. deviation from linear response applying rectangular distribution and is expressed for the square of the field value.

## 22. Appendix E. Dipole Calibration Data



**Calibration Laboratory of Schmid & Partner Engineering AG**  
 Zeughausstrasse 43, 8004 Zurich, Switzerland



**S** Schweizerischer Kalibrierdienst  
**C** Service suisse d'étalonnage  
**S** Servizio svizzero di taratura  
**S** Swiss Calibration Service

Accredited by the Swiss Accreditation Service (SAS)  
 The Swiss Accreditation Service is one of the signatories to the EA Multilateral Agreement for the recognition of calibration certificates

Accreditation No.: **SCS 0108**

Client **HCT (Dymstec)**

Certificate No: **CD3500V3-1012\_Nov21**

**CALIBRATION CERTIFICATE**

Object: **CD3500V3 - SN: 1012**

Calibration procedure(s): **QA CAL-20.v7  
 Calibration Procedure for Validation Sources in air**

Calibration date: **November 22, 2021**

This calibration certificate documents the traceability to national standards, which realize the physical units of measurements (SI). The measurements and the uncertainties with confidence probability are given on the following pages and are part of the certificate.

All calibrations have been conducted in the closed laboratory facility; environment temperature (22 ± 3)°C and humidity < 70%.

Calibration Equipment used (M&TE critical for calibration)

Primary Standards	ID #	Cal Date (Certificate No.)	Scheduled Calibration
Power meter NRP	SN: 104778	09-Apr-21 (No. 217-03291/03292)	Apr-22
Power sensor NRP-Z91	SN: 103244	09-Apr-21 (No. 217-03291)	Apr-22
Power sensor NRP-Z91	SN: 103245	09-Apr-21 (No. 217-03292)	Apr-22
Reference 20 dB Attenuator	SN: BH9394 (20k)	09-Apr-21 (No. 217-03343)	Apr-22
Type-N mismatch combination	SN: 310982 / 06327	09-Apr-21 (No. 217-03344)	Apr-22
Probe EF3DV3	SN: 4013	28-Dec-20 (No. EF3-4013_Dec20)	Dec-21
DAE4	SN: 781	23-Dec-20 (No. DAE4-781_Dec20)	Dec-21

Secondary Standards	ID #	Check Date (in house)	Scheduled Check
Power meter Agilent 4419B	SN: GB42420191	09-Oct-09 (in house check Oct-20)	In house check: Oct-23
Power sensor HP E4412A	SN: US39485102	05-Jan-10 (in house check Oct-20)	In house check: Oct-23
Power sensor HP 8482A	SN: US37295597	09-Oct-09 (in house check Oct-20)	In house check: Oct-23
RF generator R&S SMT-06	SN: 837633/005	10-Jan-19 (in house check Oct-20)	In house check: Oct-23
Network Analyzer Agilent E8358A	SN: US41080477	31-Mar-14 (in house check Oct-20)	In house check: Oct-22

Calibrated by:	Name	Function	Signature
	Leif Klysner	Laboratory Technician	

Approved by:	Name	Function	Signature
	Niels Kustor	Quality Manager	

Issued: November 22, 2021

This calibration certificate shall not be reproduced except in full without written approval of the laboratory.

Certificate No: CD3500V3-1012\_Nov21

Page 1 of 5

결	담당자	확인자
재		
	02 박정효 2021.11.09	05 허준성 2021.12.09

**Calibration Laboratory of  
Schmid & Partner  
Engineering AG**  
Zeughausstrasse 43, 8004 Zurich, Switzerland



**S** Schweizerischer Kalibrierdienst  
**C** Service suisse d'étalonnage  
**S** Servizio svizzero di taratura  
**S** Swiss Calibration Service

Accredited by the Swiss Accreditation Service (SAS)  
The Swiss Accreditation Service is one of the signatories to the EA  
Multilateral Agreement for the recognition of calibration certificates

Accreditation No.: **SCS 0108**

#### References

- [1] ANSI-C63.19-2019 (ANSI-C63.19-2011)  
American National Standard, Methods of Measurement of Compatibility between Wireless Communications Devices and Hearing Aids.

#### Methods Applied and Interpretation of Parameters:

- **Coordinate System:** y-axis is in the direction of the dipole arms. z-axis is from the basis of the antenna (mounted on the table) towards its feed point between the two dipole arms. x-axis is normal to the other axes. In coincidence with the standards [1], the measurement planes (probe sensor center) are selected to be at a distance of 15 mm above the top metal edge of the dipole arms.
- **Measurement Conditions:** Further details are available from the hardcopies at the end of the certificate. All figures stated in the certificate are valid at the frequency indicated. The forward power to the dipole connector is set with a calibrated power meter connected and monitored with an auxiliary power meter connected to a directional coupler. While the dipole under test is connected, the forward power is adjusted to the same level.
- **Antenna Positioning:** The dipole is mounted on a HAC Test Arch phantom using the matching dipole positioner with the arms horizontal and the feeding cable coming from the floor. The measurements are performed in a shielded room with absorbers around the setup to reduce the reflections. It is verified before the mounting of the dipole under the Test Arch phantom, that its arms are perfectly in a line. It is installed on the HAC dipole positioner with its arms parallel below the dielectric reference wire and able to move elastically in vertical direction without changing its relative position to the top center of the Test Arch phantom. The vertical distance to the probe is adjusted after dipole mounting with a DASY5 Surface Check job. Before the measurement, the distance between phantom surface and probe tip is verified. The proper measurement distance is selected by choosing the matching section of the HAC Test Arch phantom with the proper device reference point (upper surface of the dipole) and the matching grid reference point (tip of the probe) considering the probe sensor offset. The vertical distance to the probe is essential for the accuracy.
- **Feed Point Impedance and Return Loss:** These parameters are measured using a Vector Network Analyzer. The impedance is specified at the SMA connector of the dipole. The influence of reflections was eliminating by applying the averaging function while moving the dipole in the air, at least 70cm away from any obstacles.
- **E-field distribution:** E field is measured in the x-y-plane with an isotropic E-field probe with 100 mW forward power to the antenna feed point. In accordance with [1], the scan area is 20mm wide, its length exceeds the dipole arm length (180 or 90mm). The sensor center is 15 mm (in z) above the metal top of the dipole arms. Two 3D maxima are available near the end of the dipole arms. Assuming the dipole arms are perfectly in one line, the average of these two maxima (in subgrid 2 and subgrid 8) is determined to compensate for any non-parallelity to the measurement plane as well as the sensor displacement. The E-field value stated as calibration value represents the maximum of the interpolated 3D-E-field, in the plane above the dipole surface.

The reported uncertainty of measurement is stated as the standard uncertainty of measurement multiplied by the coverage factor  $k=2$ , which for a normal distribution corresponds to a coverage probability of approximately 95%.

**Measurement Conditions**

DASY system configuration, as far as not given on page 1.

DASY Version	DASY5	V52.10.4
Phantom	HAC Test Arch	
Distance Dipole Top - Probe Center	15 mm	
Scan resolution	dx, dy = 5 mm	
Frequency	3500 MHz ± 1 MHz	
Input power drift	< 0.05 dB	

**Maximum Field values at 3500 MHz**

E-field 15 mm above dipole surface	condition	Interpolated maximum
Maximum measured above high end	100 mW input power	84.0 V/m = 38.48 dBV/m
Maximum measured above low end	100 mW input power	83.1 V/m = 38.39 dBV/m
Averaged maximum above arm	100 mW input power	<b>83.5 V/m ± 12.8 % (k=2)</b>

**Appendix (Additional assessments outside the scope of SCS 0108)**

**Antenna Parameters**

Frequency	Return Loss	Impedance
3300 MHz	17.8 dB	64.5 Ω - 2.8 jΩ
3400 MHz	23.4 dB	51.9 Ω - 6.6 jΩ
3500 MHz	27.0 dB	49.3 Ω - 4.4 jΩ
3600 MHz	25.1 dB	46.0 Ω - 3.5 jΩ
3700 MHz	22.9 dB	43.5 Ω + 1.3 jΩ

**3.2 Antenna Design and Handling**

The calibration dipole has a symmetric geometry with a built-in two stub matching network, which leads to the enhanced bandwidth.

The dipole is built of standard semirigid coaxial cable. The internal matching line is open ended. The antenna is therefore open for DC signals.

Do not apply force to dipole arms, as they are liable to bend. The soldered connections near the feedpoint may be damaged. After excessive mechanical stress or overheating, check the impedance characteristics to ensure that the internal matching network is not affected.

After long term use with 40W radiated power, only a slight warming of the dipole near the feedpoint can be measured.



**Impedance Measurement Plot**

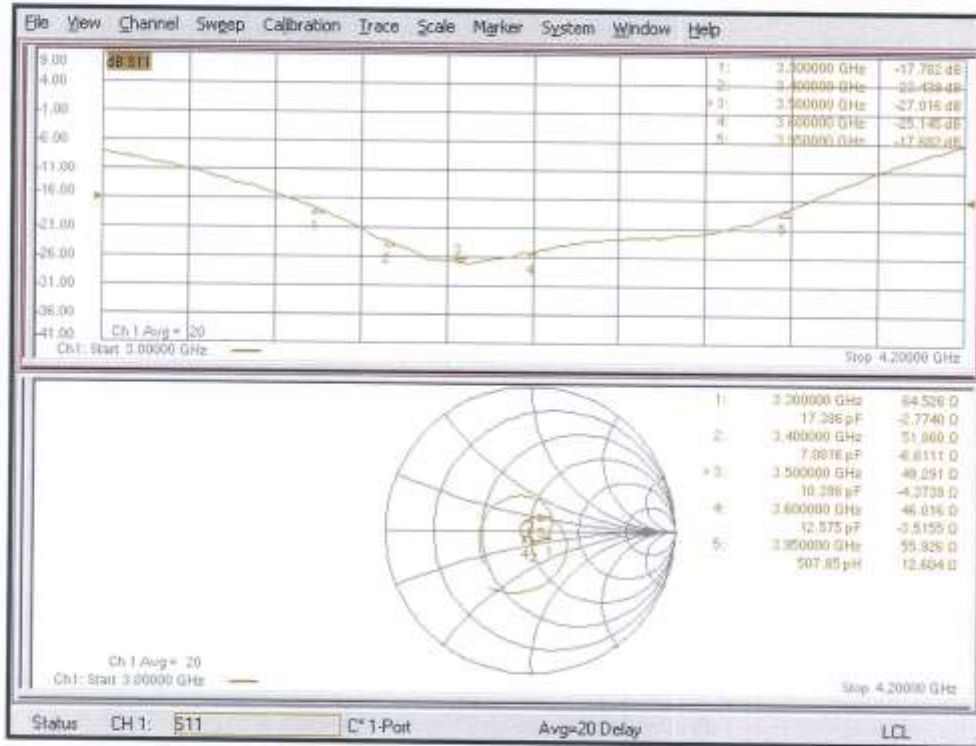

**DASY5 E-field Result**

Date: 22.11.2021

Test Laboratory: SPEAG Lab2

**DUT: HAC Dipole 3500 MHz; Type: CD3500V3; Serial: CD3500V3 - SN: 1012**

Communication System: UID 0 - CW ; Frequency: 3500 MHz  
 Medium parameters used:  $\sigma = 0$  S/m,  $\epsilon_r = 1$ ;  $\rho = 0$  kg/m<sup>3</sup>  
 Phantom section: RF Section  
 Measurement Standard: DASY5 (IEEE/IEC/ANSI C63.19-2011)

DASY52 Configuration:

- Probe: EF3DV3 - SN4013; ConvF(1, 1, 1) @ 3500 MHz; Calibrated: 28.12.2020
- Sensor-Surface: (Fix Surface)
- Electronics: DAE4 Sn781; Calibrated: 23.12.2020
- Phantom: HAC Test Arch with AMCC; Type: SD HAC P01 BA; Serial: 1070
- DASY52 52.10.4(1535); SEMCAD X 14.6.14(7501)

**Dipole E-Field measurement @ 3500MHz/E-Scan - 3500MHz d=15mm/Hearing Aid Compatibility Test (41x121x1):**

Interpolated grid: dx=0.5000 mm, dy=0.5000 mm  
 Device Reference Point: 0, 0, -6.3 mm  
 Reference Value = 35.57 V/m; Power Drift = 0.02 dB  
 Applied MIF = 0.00 dB  
 RF audio interference level = 38.48 dBV/m  
**Emission category: M2**

MIF scaled E-field

Grid 1 M2	Grid 2 M2	Grid 3 M2
38.39 dBV/m	38.48 dBV/m	38.24 dBV/m
Grid 4 M2	Grid 5 M2	Grid 6 M2
38.06 dBV/m	38.14 dBV/m	37.95 dBV/m
Grid 7 M2	Grid 8 M2	Grid 9 M2
38.3 dBV/m	38.39 dBV/m	38.15 dBV/m

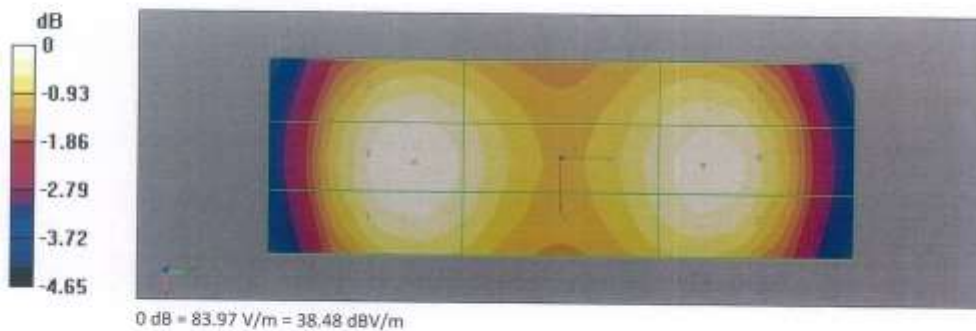

## 23. Appendix F. UID Specifications

**Calibration Laboratory of  
Schmid & Partner  
Engineering AG**  
Zeughausstrasse 43, 8004 Zurich, Switzerland

Name:	GSM-FDD (TDMA, GMSK)
Group:	GSM
UID:	10021-DAC
PAR: <sup>1</sup>	9.39 dB
MIF: <sup>2</sup>	3.63 dB
Standard Reference:	ETSI TS 100 909 V8.9.0 (2005-01) FCC OET KDB 941225, D03 and D04
Category:	Periodic pulsed modulation
Modulation:	GMSK
Frequency Band:	GSM 450 (450.4 - 457.6 MHz) GSM 480 (478.8 - 486.0 MHz) GSM 710 (698.0 - 716.0 MHz) GSM 750 (747.0 - 763.0 MHz) GSM 850 (824.0 - 849.0 MHz) P-GSM 900 (890.0 - 915.0 MHz) E-GSM 900 (880.0 - 915.0 MHz) R-GSM 900 (876.0 - 915.0 MHz) DCS 1800 (1710.0 - 1785.0 MHz) PCS 1900 (1850.0 - 1910.0 MHz) ER-GSM 900 (873.0 - 915.0 MHz) Validation band (0.0 - 6000.0 MHz)
Detailed Specification:	Active Slot: TN0 Data: PMS continuous Frame: composed out of 8 Slots Multiframe: 26th (IDLE) Frame set blank Slottype & -timing: Normal burst for GMSK
Bandwidth:	0.2 MHz
Integration Time:	120.0 ms

<sup>1</sup> PAR (0.1%) in accordance with FCC KDB 971168, Section 6.0 "Measurement of the Peak-to-Average Power Ratio (PAPR)"  
<sup>2</sup> Modulation Interference Factor (MIF) value valid only in conjunction with advanced probe response linearization calibration for the same communication system (same UID and version).

**Calibration Laboratory of  
Schmid & Partner  
Engineering AG**  
Zeughausstrasse 43, 8004 Zurich, Switzerland

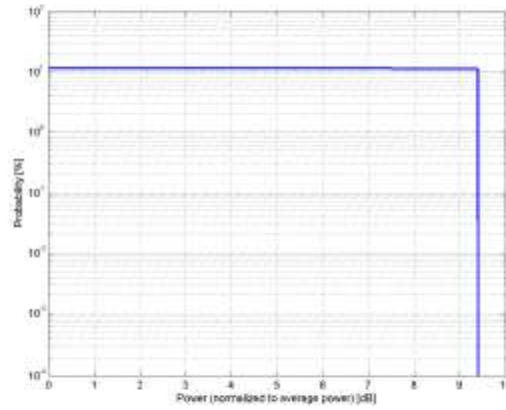

**Complementary Cumulative Distribution Function (CCDF)**

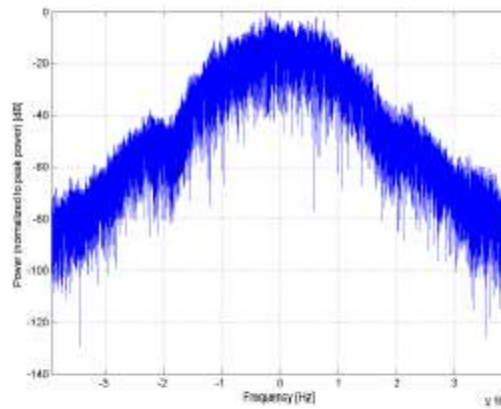

**Frequency Domain**

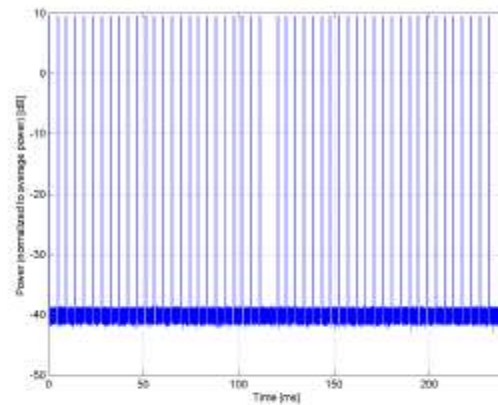

**Time Domain**

**Calibration Laboratory of  
Schmid & Partner  
Engineering AG**  
Zeughausstrasse 43, 8004 Zurich, Switzerland

Name:	UMTS-FDD (WCDMA, AMR)
Group:	WCDMA
UID:	10460-AAA
PAR: <sup>1</sup>	2.39 dB
MIF: <sup>2</sup>	-25.43 dB
Standard Reference:	FCC OET KDB 941225 D01 SAR test for 3G devices v03
Category:	Random amplitude modulation
Modulation:	QPSK
Frequency Band:	Band 1, UTRA/FDD (1920.0-1980.0 MHz, 20000) Band 2, UTRA/FDD (1850.0-1910.0 MHz, 20001) Band 3, UTRA/FDD (1710.0-1785.0 MHz, 20002) Band 4, UTRA/FDD (1710.0-1755.0 MHz, 20003) Band 5, UTRA/FDD (824.0-849.0 MHz, 20004) Band 6, UTRA/FDD (830.0-840.0 MHz, 20005) Band 7, UTRA/FDD (2500.0-2570.0 MHz, 20006) Band 8, UTRA/FDD (880.0-915.0 MHz, 20007) Band 9, UTRA/FDD (1749.9-1784.9 MHz, 20008) Band 10, UTRA/FDD (1710.0-1770.0 MHz, 20009) Band 11, UTRA/FDD (1427.9-1452.9 MHz, 20010) Band 12, UTRA/FDD (698.0-716.0 MHz, 20011) Band 13, UTRA/FDD (777.0-787.0 MHz, 20012) Band 14, UTRA/FDD (788.0-798.0 MHz, 20013) Band 19, UTRA/FDD (830.0-845.0 MHz, 20130) Band 20, UTRA/FDD (832.0-862.0 MHz, 20131) Band 21, UTRA/FDD (1447.9-1462.9 MHz, 20132) Band 22, UTRA/FDD (3410.0-3490.0 MHz, 20217) Band 25, UTRA/FDD (1850.0-1915.0 MHz, 20218) Band 26, UTRA/FDD (814.0-849.0 MHz, 20219)
Detailed Specification:	Dedicated Channel Type: 12.2 kbps AMR 3.4 kbps SRB
Bandwidth:	5.0 MHz
Integration Time:	100.0 ms

<sup>1</sup> PAR (0.1%) in accordance with FCC KDB 971168, Section 6.0 "Measurement of the Peak-to-Average Power Ratio (PAPR)"

<sup>2</sup> Modulation Interference Factor (MIF) value valid only in conjunction with advanced probe response linearization calibration for the same communication system (same UID and version).

**Calibration Laboratory of  
Schmid & Partner  
Engineering AG**  
Zeughausstrasse 43, 8004 Zurich, Switzerland

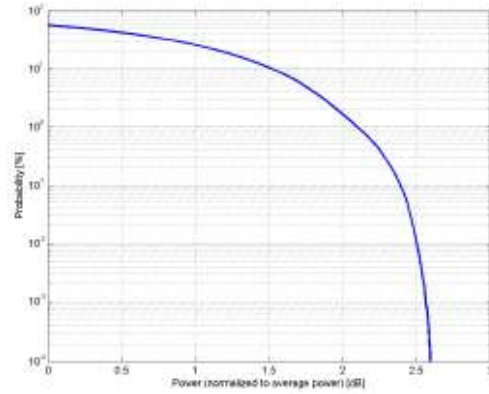

**Complementary Cumulative Distribution Function (CCDF)**

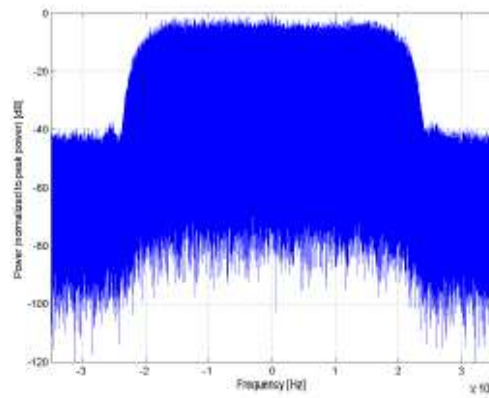

**Frequency Domain**

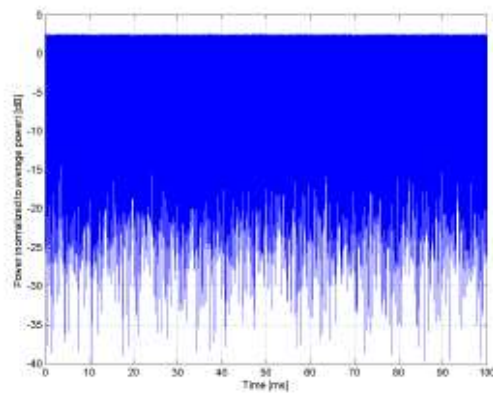

**Time Domain**



**Calibration Laboratory of  
Schmid & Partner  
Engineering AG**  
Zeughausstrasse 43, 8004 Zurich, Switzerland

Name:	LTE-FDD (SC-FDMA, 1 RB, 20 MHz, 16-QAM)
Group:	LTE-FDD
UID:	10170-CAE
PAP: <sup>1</sup>	6.52 dB
MIF: <sup>2</sup>	-9.76 dB
Standard Reference:	3GPP / ETSI TS 136.101 V8.4.0 3GPP / ETSI TS 136.213 V8.4.0 FCC OET KDB 941225 D05 SAR for LTE Devices v01 Random amplitude modulation
Category:	16-QAM
Modulation:	
Frequency Band:	Band 1, E-UTRA/FDD (1920.0 - 1980.0 MHz) Band 2, E-UTRA/FDD (1850.0 - 1910.0 MHz) Band 3, E-UTRA/FDD (1710.0 - 1785.0 MHz) Band 4, E-UTRA/FDD (1710.0 - 1755.0 MHz) Band 7, E-UTRA/FDD (2500.0 - 2570.0 MHz) Band 9, E-UTRA/FDD (1749.9 - 1784.9 MHz) Band 10, E-UTRA/FDD (1710.0 - 1770.0 MHz) Band 20, E-UTRA/FDD (832.0 - 862.0 MHz) Band 22, E-UTRA/FDD (3410.0 - 3490.0 MHz) Band 23, E-UTRA/FDD (2000.0 - 2020.0 MHz) Band 25, E-UTRA/FDD (1850.0 - 1915.0 MHz) Band 28 E-UTRA/FDD (703.0 - 748.0 MHz) Band 65, E-UTRA/FDD (1920.0 - 2010.0 MHz) Band 66, E-UTRA/FDD (1710.0 - 1780.0 MHz) Band 70, E-UTRA/FDD (1695.0 - 1710.0 MHz) Band 71, E-UTRA/FDD (663.0 - 698.0 MHz) Band 74, E-UTRA/FDD (1427.0 - 1470.0 MHz) Validation band (0.0 - 6000.0 MHz)
Detailed Specification:	Modulation Scheme: SC-FDMA Number of PUSCHs: 1 Settings for Subframe #0 to #9: Modulation Scheme: 16QAM Data Type: UL-SCH Number RB: 1 Transport Block Size: 256 TBS Index: 14 MCS Index: 15 Data Type: PNG
Bandwidth:	20.0 MHz
Integration Time:	10.0 ms

<sup>1</sup> PAP (0.1%) in accordance with FCC KDB 971168, Section 6.0 "Measurement of the Peak-to-Average Power Ratio (PAPR)"  
<sup>2</sup> Modulation Interference Factor (MIF) value valid only in conjunction with advanced probe response linearization calibration for the same communication system (same UID and version).



**Calibration Laboratory of  
Schmid & Partner  
Engineering AG**  
Zeughausstrasse 43, 8004 Zurich, Switzerland

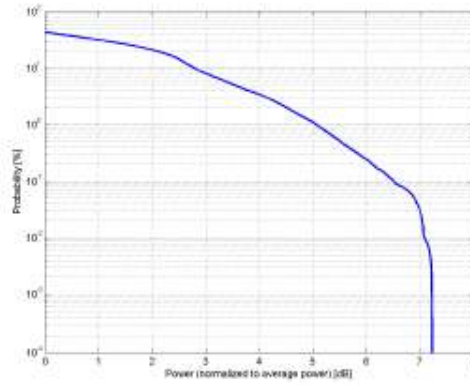

**Complementary Cumulative Distribution Function (CCDF)**

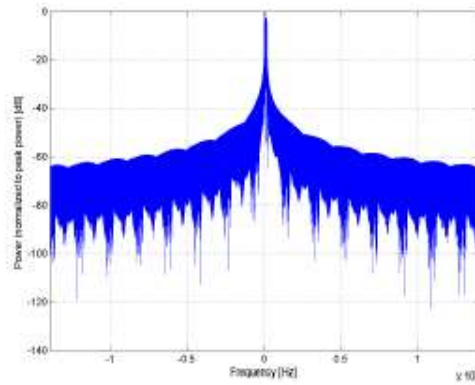

**Frequency Domain**

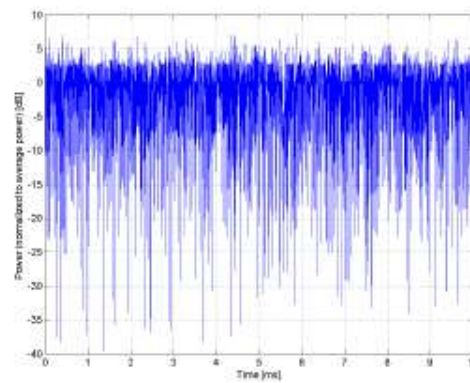

**Time Domain**

### Calibration Laboratory of

Schmid & Partner

Engineering AG

Zeughausstrasse 43, 8004 Zurich, Switzerland

Name:	LTE-FDD (SC-FDMA, 1 RB, 15 MHz, 16-QAM)
Group:	LTE-FDD
UID:	10182-CAE
PAR: <sup>1</sup>	6.52 dB
MIF: <sup>2</sup>	-9.76 dB
Standard Reference:	3GPP / ETSI TS 136.101 V8.4.0 3GPP / ETSI TS 136.213 V8.4.0 FCC OET KDB 941225 D05 SAR for LTE Devices v01 Random amplitude modulation
Category:	16-QAM
Modulation:	
Frequency Band:	Band 1, E-UTRA/FDD (1920.0 - 1980.0 MHz) Band 2, E-UTRA/FDD (1850.0 - 1910.0 MHz) Band 3, E-UTRA/FDD (1710.0 - 1785.0 MHz) Band 4, E-UTRA/FDD (1710.0 - 1755.0 MHz) Band 7, E-UTRA/FDD (2500.0 - 2570.0 MHz) Band 9, E-UTRA/FDD (1749.9 - 1784.9 MHz) Band 10, E-UTRA/FDD (1710.0 - 1770.0 MHz) Band 18, E-UTRA/FDD (815.0 - 830.0 MHz) Band 19, E-UTRA/FDD (830.0 - 845.0 MHz) Band 20, E-UTRA/FDD (832.0 - 862.0 MHz) Band 21, E-UTRA/FDD (1447.9 - 1462.9 MHz) Band 22, E-UTRA/FDD (3410.0 - 3490.0 MHz) Band 23, E-UTRA/FDD (2000.0 - 2020.0 MHz) Band 25, E-UTRA/FDD (1850.0 - 1915.0 MHz) Band 28 E-UTRA/FDD (814.0 - 849.0 MHz) Band 29 E-UTRA/FDD (703.0 - 748.0 MHz) Band 65, E-UTRA/FDD (1920.0 - 2010.0 MHz) Band 66, E-UTRA/FDD (1710.0 - 1790.0 MHz) Band 68, E-UTRA/FDD (898.0 - 728.0 MHz) Band 70, E-UTRA/FDD (1695.0 - 1710.0 MHz) Band 71, E-UTRA/FDD (863.0 - 898.0 MHz) Band 74, E-UTRA/FDD (1427.0 - 1470.0 MHz) Validation band (0.0 - 6000.0 MHz)
Detailed Specification:	Modulation Scheme: SC-FDMA Number of PUSCHs: 1 Settings for Subframe #0 to #9: Modulation Scheme: 16QAM Data Type: UL-SCH Number RB: 1 Transport Block Size: 256 TBS Index: 14 MCS Index: 15 Data Type: PUS
Bandwidth:	15.0 MHz
Integration Time:	10.0 ms

<sup>1</sup> PAR (0.1%) in accordance with FCC KDB 971168, Section 6.0 "Measurement of the Peak-to-Average Power Ratio (PAPR)"  
<sup>2</sup> Modulation Interference Factor (MIF) value valid only in conjunction with advanced probe response linearization calibration for the same communication system (same UID and version).

**Calibration Laboratory of  
Schmid & Partner  
Engineering AG**  
Zeughausstrasse 43, 8004 Zurich, Switzerland

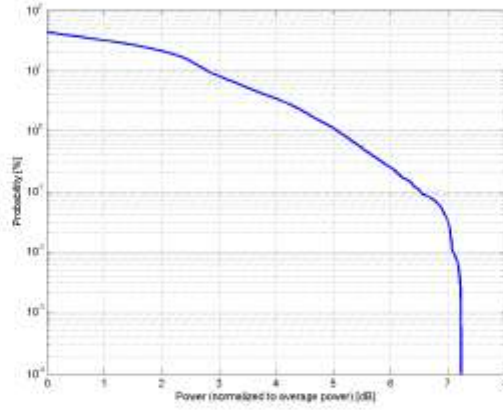

**Complementary Cumulative Distribution Function (CCDF)**

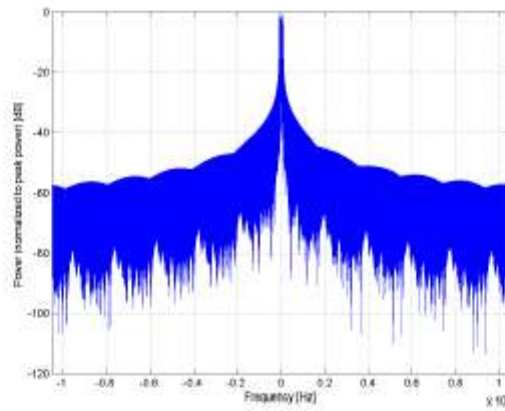

**Frequency Domain**

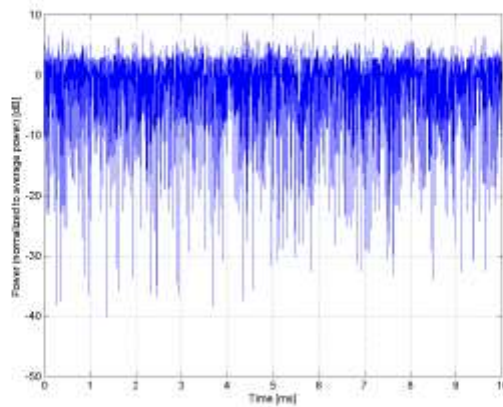

**Time Domain**

**Calibration Laboratory of  
Schmid & Partner  
Engineering AG**  
Zeughausstrasse 43, 8004 Zurich, Switzerland

Name:	LTE-FDD (SC-FDMA, 1 RB, 10 MHz, 16-QAM)
Group:	LTE-FDD
UID:	10176-CAG
PAR: <sup>1</sup>	6.52 dB
MIF: <sup>2</sup>	-9.76 dB
Standard Reference:	3GPP / ETSI TS 136.101 V8.4.0 3GPP / ETSI TS 136.213 V8.4.0 FCC OET KDB 941225 D05 SAR for LTE Devices v01 Random amplitude modulation
Category:	16-QAM
Modulation:	
Frequency Band:	Band 1, E-UTRA/FDD (1920.0 - 1980.0 MHz) Band 2, E-UTRA/FDD (1850.0 - 1910.0 MHz) Band 3, E-UTRA/FDD (1710.0 - 1785.0 MHz) Band 4, E-UTRA/FDD (1710.0 - 1755.0 MHz) Band 5, E-UTRA/FDD (824.0 - 849.0 MHz) Band 6, E-UTRA/FDD (830.0 - 840.0 MHz) Band 7, E-UTRA/FDD (2500.0 - 2570.0 MHz) Band 8, E-UTRA/FDD (880.0 - 915.0 MHz) Band 9, E-UTRA/FDD (1749.9 - 1784.9 MHz) Band 10, E-UTRA/FDD (1710.0 - 1770.0 MHz) Band 11, E-UTRA/FDD (1427.9 - 1447.9 MHz) Band 12, E-UTRA/FDD (699.0 - 716.0 MHz) Band 13, E-UTRA/FDD (777.0 - 787.0 MHz) Band 14, E-UTRA/FDD (788.0 - 798.0 MHz) Band 17, E-UTRA/FDD (704.0 - 716.0 MHz) Band 18, E-UTRA/FDD (815.0 - 830.0 MHz) Band 19, E-UTRA/FDD (830.0 - 845.0 MHz) Band 20, E-UTRA/FDD (832.0 - 862.0 MHz) Band 21, E-UTRA/FDD (1447.9 - 1462.9 MHz) Band 22, E-UTRA/FDD (3410.0 - 3490.0 MHz) Band 23, E-UTRA/FDD (2000.0 - 2020.0 MHz) Band 24, E-UTRA/FDD (1626.5 - 1660.5 MHz) Band 25, E-UTRA/FDD (1850.0 - 1915.0 MHz) Band 26 E-UTRA/FDD (814.0 - 849.0 MHz) Band 27 E-UTRA/FDD (807.0 - 824.0 MHz) Band 28 E-UTRA/FDD (703.0 - 748.0 MHz) Band 30, E-UTRA/FDD (2305.0 - 2315.0 MHz) Band 65, E-UTRA/FDD (1920.0 - 2010.0 MHz) Band 66, E-UTRA/FDD (1710.0 - 1780.0 MHz) Band 68, E-UTRA/FDD (698.0 - 728.0 MHz) Band 70, E-UTRA/FDD (1695.0 - 1710.0 MHz) Band 71, E-UTRA/FDD (663.0 - 698.0 MHz) Band 74, E-UTRA/FDD (1427.0 - 1470.0 MHz) Band 85, E-UTRA/FDD (898.0 - 716.0 MHz) Validation band (0.0 - 6000.0 MHz)
Detailed Specification:	Modulation Scheme: SC-FDMA Number of PUSCHs: 1 Settings for Subframe #0 to #9: Modulation Scheme: QPSK Data Type: UL-SCH Number RB: 1 Transport Block Size: 256 TBS Index: 14 MCS Index: 15 Data Type: PUS
Bandwidth:	10.0 MHz
Integration Time:	10.0 ms

<sup>1</sup> PAR (0.1%) in accordance with FCC KDB 971168, Section 6.0 "Measurement of the Peak-to-Average Power Ratio (PAPR)"  
<sup>2</sup> Modulation Interference Factor (MIF) value valid only in conjunction with advanced probe response linearization calibration for the same communication system (same UID and version).

**Calibration Laboratory of  
Schmid & Partner  
Engineering AG**  
Zeughausstrasse 43, 8004 Zurich, Switzerland

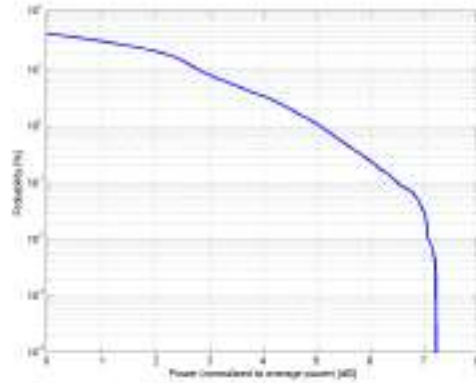

**Complementary Cumulative Distribution Function (CCDF)**

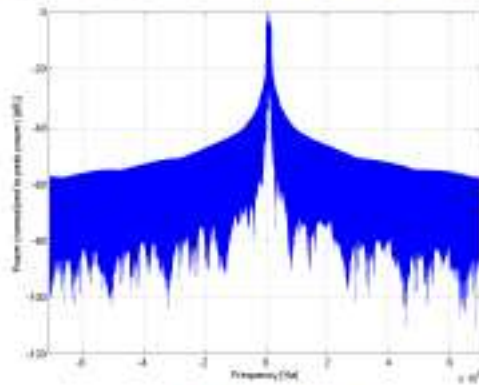

**Frequency Domain**

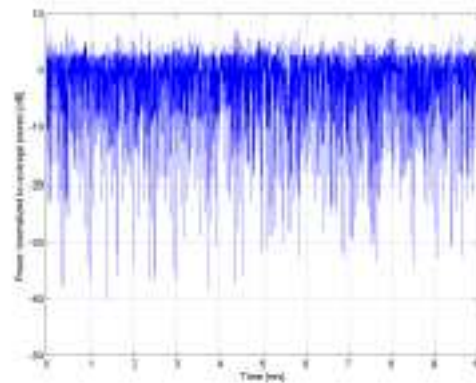

**Time Domain**



**Calibration Laboratory of  
Schmid & Partner  
Engineering AG**  
Zeughausstrasse 43, 8004 Zurich, Switzerland

Name:	LTE-TDD (SC-FDMA, 1 RB, 20 MHz, 16-QAM)
Group: UID:	LTE-TDD 10173-CAG
PAR: <sup>1</sup> MIF: <sup>2</sup>	9.48 dB -1.44 dB
Standard Reference:	3GPP / ETSI TS 136.101 V8.4.0 3GPP / ETSI TS 136.213 V8.4.0 FCC OET KDB 941225 D05 SAR for LTE Devices v02 Random amplitude modulation
Category: Modulation: Frequency Band:	16-QAM Band 33, E-UTRA/TDD (1900.0 - 1920.0 MHz) Band 35, E-UTRA/TDD (1850.0 - 1910.0 MHz) Band 36, E-UTRA/TDD (1930.0 - 1990.0 MHz) Band 37, E-UTRA/TDD (1910.0 - 1930.0 MHz) Band 38, E-UTRA/TDD (2570.0 - 2620.0 MHz) Band 39, E-UTRA/TDD (1880.0 - 1920.0 MHz) Band 40, E-UTRA/TDD (2300.0 - 2400.0 MHz) Band 41, E-UTRA/TDD (2496.0 - 2690.0 MHz) Band 42, E-UTRA/TDD (3400.0 - 3600.0 MHz) Band 43, E-UTRA/TDD (3600.0 - 3800.0 MHz) Band 44, E-UTRA/TDD (703.0 - 803.0 MHz) Band 45, E-UTRA/FDD (1447.0 - 1467.0 MHz) Band 46, E-UTRA/FDD (5150.0 - 5925.0 MHz) Band 47, E-UTRA/TDD (5855.0 - 5925.0 MHz) Band 48, E-UTRA/TDD (3550.0 - 3700.0 MHz) Band 49, E-UTRA/TDD (3550.0 - 3700.0 MHz) Band 50, E-UTRA/TDD (1432.0 - 1517.0 MHz) Band 78, E-UTRA/FDD (3300.0 - 3400.0 MHz) Validation band (0.0 - 6000.0 MHz)
Detailed Specification:	Modulation Scheme: SC-FDMA Uplink-downlink configuration: 1 Special Subframe configuration: 4 Number of Frames: 1 Settings for UL Subframe 2,3,7,8: Number of PUSCHs: 1 Modulation Scheme: 16QAM Allocated RB: 1 Start Number of RB: 50 Data Type: PNGfx
Bandwidth: Integration Time:	20.0 MHz 6.0 ms

<sup>1</sup> PAR (0.1%) in accordance with FCC KDB 971168, Section 6.0 "Measurement of the Peak-to-Average Power Ratio (PAR)"  
<sup>2</sup> Modulation Interference Factor (MIF) value valid only in conjunction with advanced probe response linearization calibration for the same communication system (same UID and version).

**Calibration Laboratory of  
Schmid & Partner  
Engineering AG**  
Zeughausstrasse 43, 8004 Zurich, Switzerland

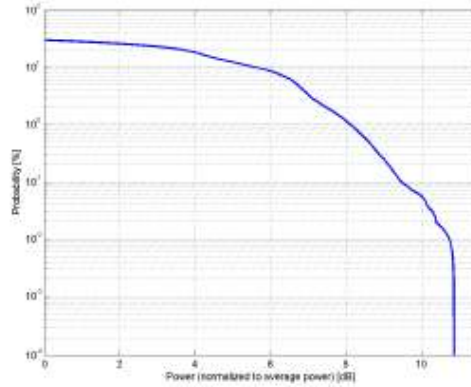

**Complementary Cumulative Distribution Function (CCDF)**

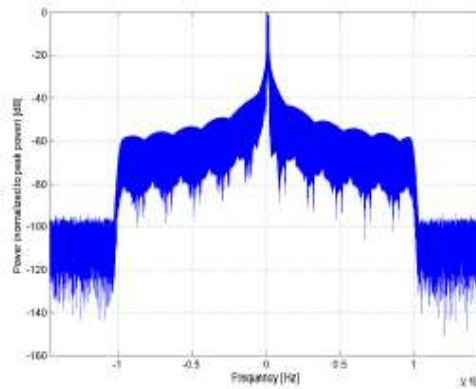

**Frequency Domain**

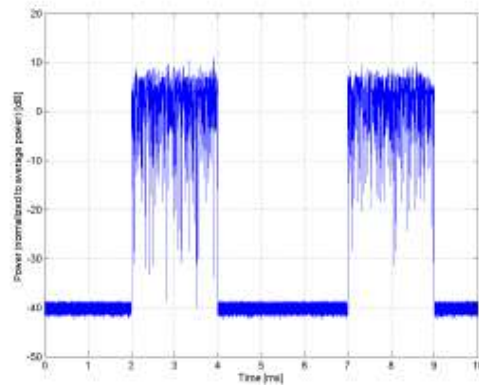

**Time Domain**

**Calibration Laboratory of**

Schmid &amp; Partner

Engineering AG

Zeughausstrasse 43, 8004 Zurich, Switzerland

Name:	IEEE 802.11b WiFi 2.4 GHz (DSSS, 11 Mbps)
Group:	WLAN
UID:	10061-CAB
PAR: <sup>1</sup>	3.60 dB
MIF: <sup>2</sup>	-2.02 dB
Standard Reference:	IEEE 802.11b-1999, Part 11, FCC SAR meas for 802 11 a b g v01r02 (248227 D01)
Category:	Random amplitude modulation
Modulation:	DQPSK
Frequency Band:	WLAN 2.4GHz (2412.0-2484.0 MHz, 20230)
Detailed Specification:	Data Rate: 11 Mbps Spreading, Coding: CCK PPDU format: Long Preamble & Heading PSDU Length: 1024
Bandwidth:	PSDU Data: PN9 20.0 MHz
Integration Time:	1.5 ms

<sup>1</sup> PAR (0.1%) in accordance with FCC KDB 971168, Section 6.0 "Measurement of the Peak-to-Average Power Ratio (PAPR)"

<sup>2</sup> Modulation Interference Factor (MIF) value valid only in conjunction with advanced probe response linearization calibration for the same communication system (same UID and version).

**Calibration Laboratory of  
Schmid & Partner  
Engineering AG**  
Zeughausstrasse 43, 8004 Zurich, Switzerland

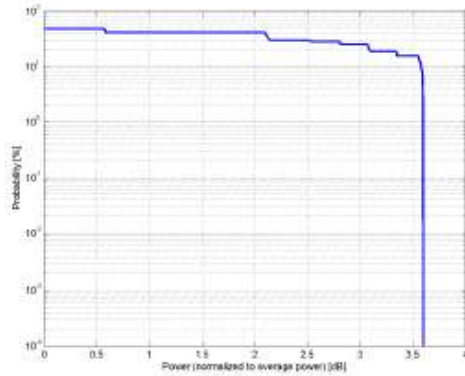

**Complementary Cumulative Distribution Function (CCDF)**

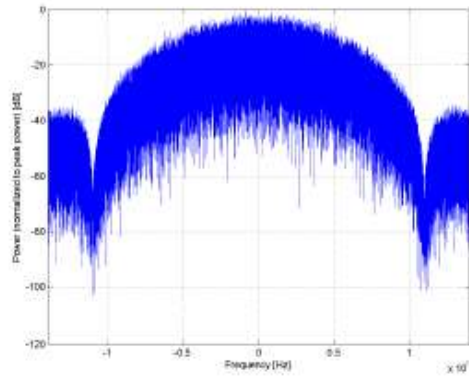

**Frequency Domain**

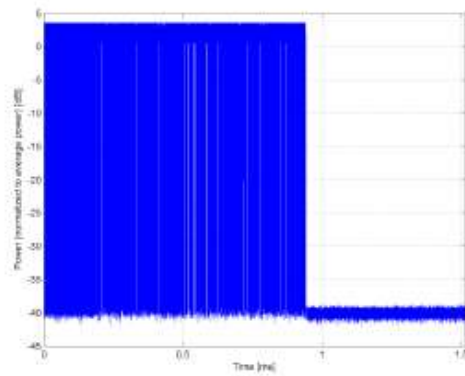

**Time Domain**

**Calibration Laboratory of  
Schmid & Partner  
Engineering AG**  
Zeughausstrasse 43, 8004 Zurich, Switzerland

Name:	IEEE 802.11g WiFi 2.4 GHz (DSSS/OFDM, 54 Mbps)
Group:	WLAN
UID:	10077-CAB
PAR: <sup>1</sup>	11.00 dB
MIF: <sup>2</sup>	0.12 dB
Standard Reference:	IEEE 802.11g-2003 , Part 11
Category:	FCC SAR meas for 802 11 a b g v01r02 (248227 D01)
Modulation:	Random amplitude modulation
Modulation:	64-QAM
Frequency Band:	WLAN 2.4GHz (2412.0-2484.0 MHz, 20230)
Detailed Specification:	Data Rate: 54 Mbps
	Coding Rate: 3/4
	Coded bits per subcarrier: 6
	Coded bits per OFDM symbol: 288
	Data bits per OFDM symbol: 216
	PSDU Length: 1000 Bytes
	PSDU Data: PN9
Bandwidth:	20.0 MHz
Integration Time:	0.9 ms

<sup>1</sup> PAR (0.1%) in accordance with FCC KDB 971168, Section 6.0 "Measurement of the Peak-to-Average Power Ratio (PAPR)"

<sup>2</sup> Modulation Interference Factor (MIF) value valid only in conjunction with advanced probe response linearization calibration for the same communication system (same UID and version).

**Calibration Laboratory of  
Schmid & Partner  
Engineering AG**  
Zeughausstrasse 43, 8004 Zurich, Switzerland

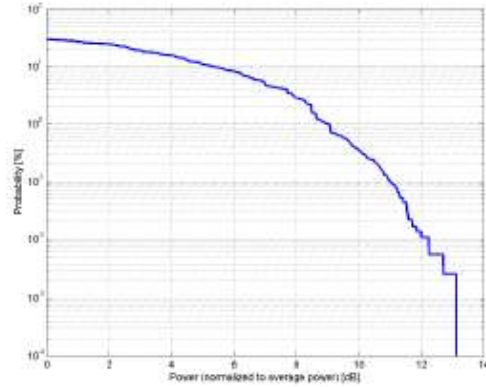

**Complementary Cumulative Distribution Function (CCDF)**

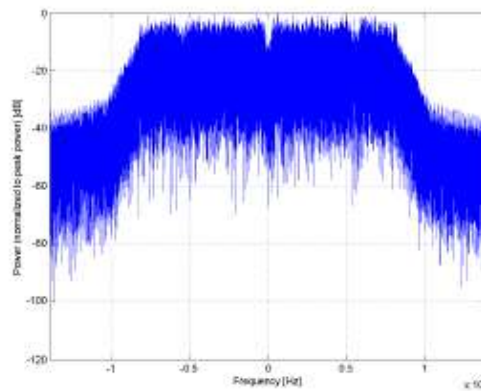

**Frequency Domain**

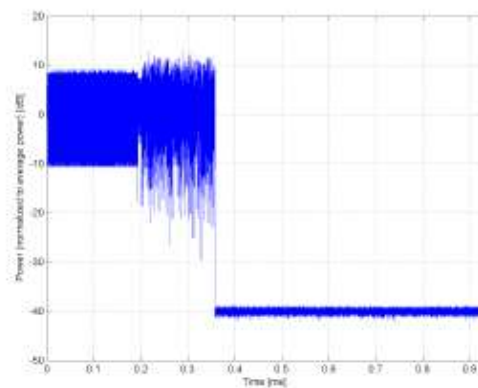

**Time Domain**



**Calibration Laboratory of  
Schmid & Partner  
Engineering AG**  
Zeughausstrasse 43, 8004 Zurich, Switzerland

Name:	IEEE 802.11n (HT Mibed, 20MHz, MCS0, 90pc duty cycle)
Group:	WLAN
UID:	10591-AAC
PAR: <sup>1</sup>	8.63 dB
MIF: <sup>2</sup>	-5.59 dB
Standard Reference:	IEEE 802.11-2012 FCC OET KDB 248227 D01 802.11 W-Fi SAR v02r01
Category:	Random amplitude modulation
Modulation:	BPSK
Frequency Band:	WLAN 2.4GHz (2412.0 - 2484.0 MHz) WLAN 5GHz (4915.0 - 5825.0 MHz) U-NII-1, U-NII-2A (5170 - 5330 MHz) U-NII-2C Standalone (5490 - 5710 MHz) U-NII-2C <5.65 GHz (5490 - 5650 MHz) U-NII-3 Standalone (5735 - 5835 MHz) U-NII-2C, U-NII-3 (5650 - 5835 MHz) U-NII-4 (5825 - 5925 MHz) Validation band (0.0 - 6000.0 MHz)
Detailed Specification:	Duty cycle: 90% MPDU length: 4096 bytes MCS: 0 Guard interval: long
Bandwidth:	20.0MHz
Integration Time:	5.6 ms

<sup>1</sup> PAR (0.1%) in accordance with FCC KDB 971168, Section 6.0 "Measurement of the Peak-to-Average Power Ratio (PAPR)"  
<sup>2</sup> Modulation Interference Factor (MIF) value valid only in conjunction with advanced probe response linearization calibration for the same communication system (same UID and version).

**Calibration Laboratory of  
Schmid & Partner  
Engineering AG**  
Zeughausstrasse 43, 8004 Zurich, Switzerland

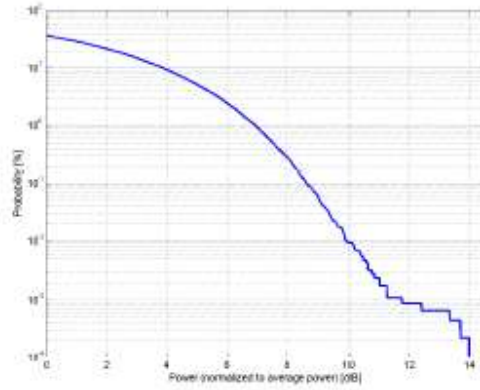

**Complementary Cumulative Distribution Function (CCDF)**

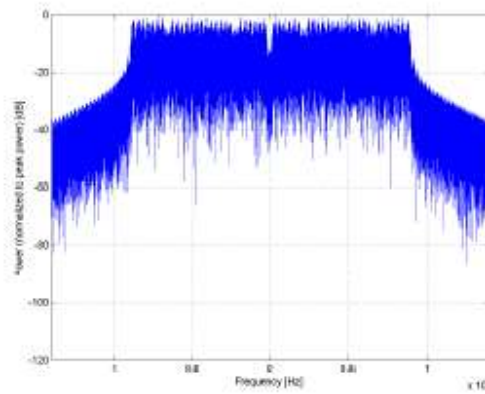

**Frequency Domain**

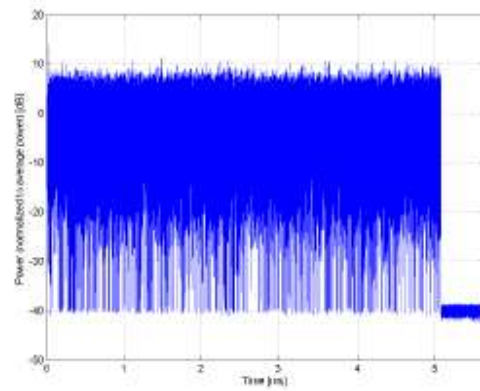

**Time Domain**

**Calibration Laboratory of  
Schmid & Partner  
Engineering AG**  
Zeughausstrasse 43, 8004 Zurich, Switzerland

Name:	IEEE 802.11a/h WiFi 5 GHz (OFDM, 54 Mbps)
Group: UID:	WLAN 10069-CAD
PAR: <sup>1</sup> MIF: <sup>2</sup>	10.56 dB -3.15 dB
Standard Reference:	IEEE 802.11a-1999 (R2003), Part 11 IEEE 802.11h-2003, Part 11 FCC SAR meas for 802.11 a b g v01r02 (248227 D01)
Category: Modulation: Frequency Band:	Random amplitude modulation 64-QAM WLAN 5GHz (4915.0 - 5825.0 MHz) U-NII-1, U-NII-2A (5170 - 5330 MHz) U-NII-2C Standalone (5490 - 5710 MHz) U-NII-2C <5.65 GHz (5490 - 5650 MHz) U-NII-3 Standalone (5735 - 5835 MHz) U-NII-2C, U-NII-3 (5650 - 5835 MHz) U-NII-4 (5.825 - 5.925 MHz) Validation band (0.0 - 6000.0 MHz)
Detailed Specification:	Data Rate: 54 Mbps Coding Rate: 3/4 Coded bits per subcarrier: 6 Coded bits per OFDM symbol: 288 Data bits per OFDM symbol: 216 PSDU Length: 1000 Bytes PSDU Data: PNB
Bandwidth: Integration Time:	20.0 MHz 0.3 ms

<sup>1</sup> PAR (0.1%) in accordance with FCC KDB 971168, Section 6.0 "Measurement of the Peak-to-Average Power Ratio (PARP)"  
<sup>2</sup> Modulation Interference Factor (MIF) value valid only in conjunction with advanced probe response linearization calibration for the same communication system (same UID and version).

**Calibration Laboratory of  
Schmid & Partner  
Engineering AG**  
Zeughausstrasse 43, 8004 Zurich, Switzerland

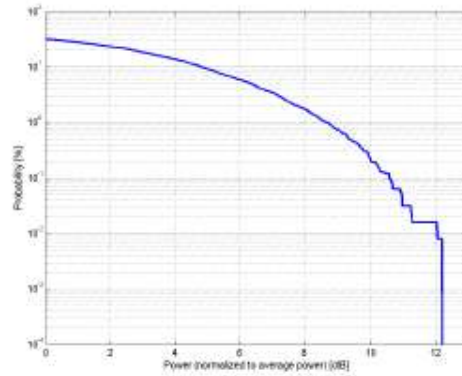

**Complementary Cumulative Distribution Function (CCDF)**

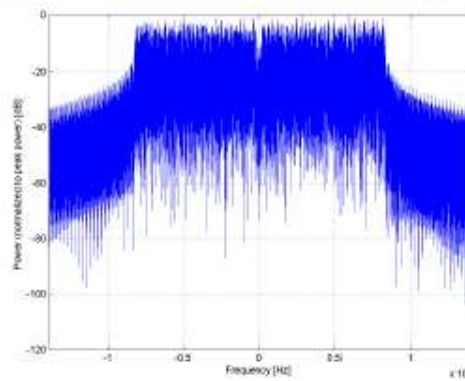

**Frequency Domain**

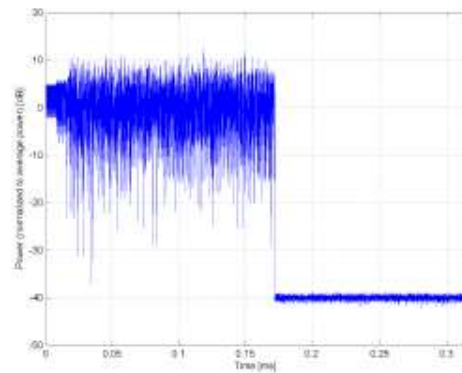

**Calibration Laboratory of  
Schmid & Partner  
Engineering AG**  
Zeughausstrasse 43, 8004 Zurich, Switzerland

Name:	IEEE 802.11ac WiFi (40MHz, MCS0, 90pc duty cycle)
Group:	WLAN
UID:	10616-AAC
PAR: <sup>1</sup>	8.82 dB
MIF: <sup>2</sup>	-5.57 dB
Standard Reference:	IEEE 802.11-2013 FCC OET KDB 248227 D01 802.11 Wi-Fi SAR v02r01
Category:	Random amplitude modulation
Modulation:	BPSK
Frequency Band:	WLAN 2.4GHz (2412.0 - 2484.0 MHz) WLAN 5GHz (4915.0 - 5825.0 MHz) U-NII-1, U-NII-2A (5170 - 5330 MHz) U-NII-2C Standalone (5490 - 5710 MHz) U-NII-2C <5.65 GHz (5490 - 5650 MHz) U-NII-3 Standalone (5735 - 5835 MHz) U-NII-2C, U-NII-3 (5650 - 5835 MHz) U-NII-4 (5.825 - 5.925 MHz) Validation band (0.0 - 6000.0 MHz)
Detailed Specification:	Bandwidth: 40MHz Duty cycle: 90% MCS: 0 Number of spatial streams: 1 MPDU length: 8192
Bandwidth:	40.0MHz
Integration Time:	5.4 ms

<sup>1</sup> PAR (0.1%) in accordance with FCC KDB 971168, Section 6.0 "Measurement of the Peak-to-Average Power Ratio (PAPR)"  
<sup>2</sup> Modulation Interference Factor (MIF) value valid only in conjunction with advanced probe response linearization calibration for the same communication system (same UID and version).

**Calibration Laboratory of  
Schmid & Partner  
Engineering AG**  
Zeughausstrasse 43, 8004 Zurich, Switzerland

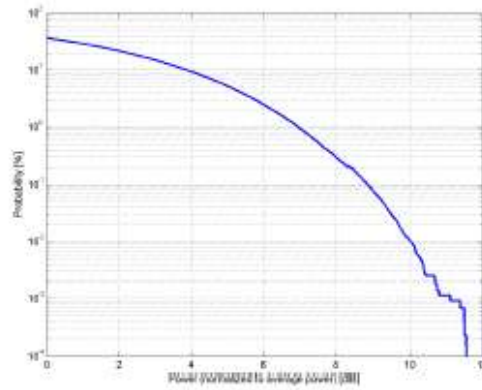

**Complementary Cumulative Distribution Function (CCDF)**

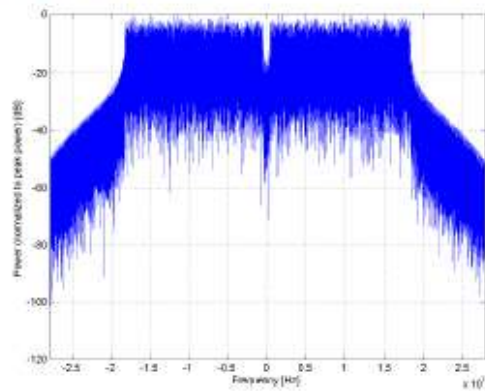

**Frequency Domain**

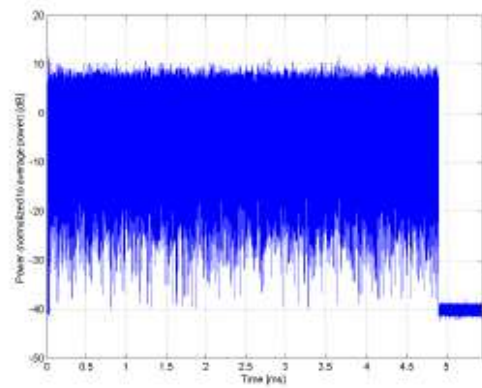

**Time Domain**



**Calibration Laboratory of  
Schmid & Partner  
Engineering AG**  
Zeughausstrasse 43, 8004 Zurich, Switzerland

Name:	IEEE 802.11ax (20MHz, MCS0, 90pc duty cycle)
Group:	WLAN
UID:	10671-AAC
PAR: <sup>1</sup>	9.09 dB
MIF: <sup>2</sup>	-5.59 dB
Standard Reference:	SPEAG
Category:	Random amplitude modulation
Modulation:	BPSK
Frequency Band:	WLAN 2.4GHz (2412.0 - 2484.0 MHz) WLAN 5GHz (4915.0 - 5825.0 MHz) U-NII-1, U-NII-2A (5170 - 5330 MHz) U-NII-2C Standalone (5490 - 5710 MHz) U-NII-2C <5.65 GHz (5490 - 5650 MHz) U-NII-3 Standalone (5735 - 5835 MHz) U-NII-2C, U-NII-3 (5650 - 5835 MHz) U-NII-5 (5925 - 6425 MHz) U-NII-6 (6425 - 6525 MHz) U-NII-7 (6525 - 6875 MHz) U-NII-8 (6875 - 7125 MHz) U-NII-4 (5.825 - 5.925 MHz) Validation band (0.0 - 6000.0 MHz)
Detailed Specification:	Bandwidth: 20MHz Duty Cycle: 90% Number of spatial stream: 1
Bandwidth:	20.0MHz
Integration Time:	5.0 ms

<sup>1</sup> PAR (0.1%) in accordance with FCC KDB 971168, Section 6.0 "Measurement of the Peak-to-Average Power Ratio (PAPR)"

<sup>2</sup> Modulation Interference Factor (MIF) value valid only in conjunction with advanced probe response linearization calibration for the same communication system (same UID and version).

**Calibration Laboratory of  
Schmid & Partner  
Engineering AG**  
Zeughausstrasse 43, 8004 Zurich, Switzerland

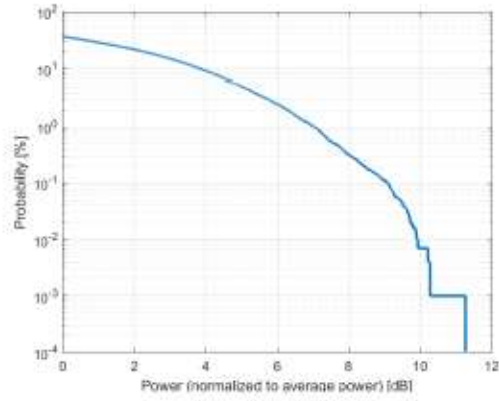

**Complementary Cumulative Distribution Function (CCDF)**

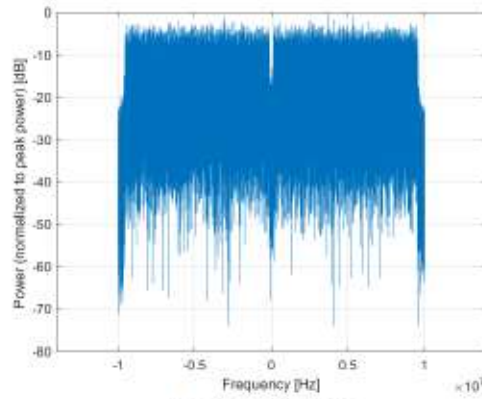

**Frequency Domain**

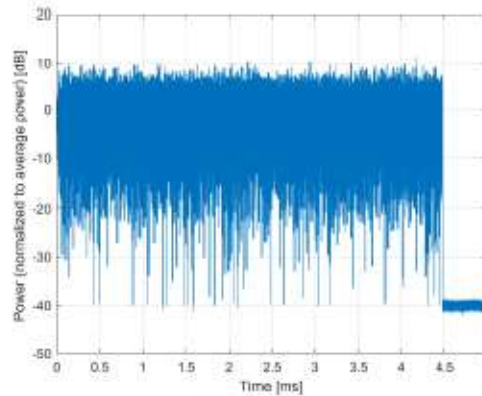

**Time Domain**

**Calibration Laboratory of  
Schmid & Partner  
Engineering AG**  
Zeughausstrasse 43, 8004 Zurich, Switzerland

Name:	IEEE 802.11ax (160MHz, MCS0, 90pc duty cycle)
Group:	WLAN
UID:	10743-AAC
PAR: <sup>1</sup>	8.94 dB
MIF: <sup>2</sup>	-6.50 dB
Standard Reference:	SPEAG
Category:	Random amplitude modulation
Modulation:	BPSK
Frequency Band:	WLAN 2.4GHz (2412.0 - 2484.0 MHz) WLAN 5GHz (4915.0 - 5825.0 MHz) U-NII-1, U-NII-2A (5170 - 5330 MHz) U-NII-2C Standalone (5490 - 5710 MHz) U-NII-2C < 5.65 GHz (5490 - 5650 MHz) U-NII-3 Standalone (5735 - 5835 MHz) U-NII-2C, U-NII-3 (5650 - 5835 MHz) U-NII-5 (5925 - 6425 MHz) U-NII-6 (6425 - 6525 MHz) U-NII-7 (6525 - 6875 MHz) U-NII-8 (6875 - 7125 MHz) U-NII-4 (5.925 - 5.925 MHz) Validation band (0.0 - 6000.0 MHz)
Detailed Specification:	Bandwidth: 160MHz Duty Cycle: 90% Number of spatial stream: 1
Bandwidth:	160.0 MHz
Integration Time:	0.9 ms

<sup>1</sup> PAR (0.1%) in accordance with FCC KDB 971168, Section 6.0 "Measurement of the Peak-to-Average Power Ratio (PAPR)"  
<sup>2</sup> Modulation Interference Factor (MIF) value valid only in conjunction with advanced probe response linearization calibration for the same communication system (same UID and version).

**Calibration Laboratory of  
Schmid & Partner  
Engineering AG**  
Zeughausstrasse 43, 8004 Zurich, Switzerland

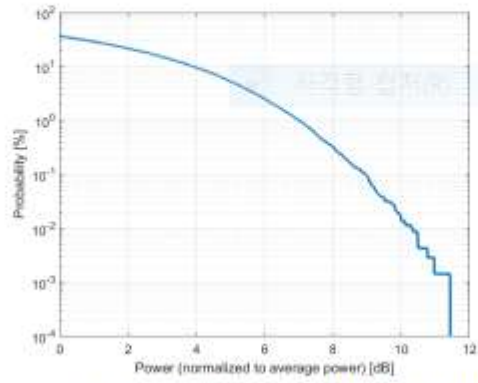

**Complementary Cumulative Distribution Function (CCDF)**

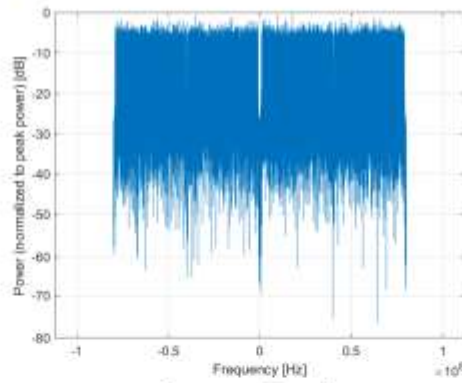

**Frequency Domain**

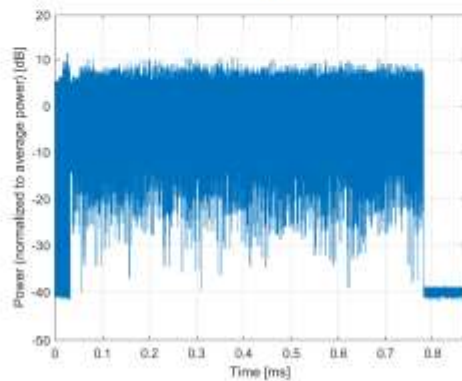

**Time Domain**

**Calibration Laboratory of  
Schmid & Partner  
Engineering AG**  
Zeughausstrasse 43, 8004 Zurich, Switzerland

Name:	IEEE 802.15.1 Bluetooth (GFSK, DH1)
Group:	Bluetooth
UID:	10030-CAA
PAR: <sup>1</sup>	5.30 dB
MIF: <sup>2</sup>	1.02 dB
Standard Reference:	Bluetooth 1.2 (IEEE Standard 802.15.1-2005)
Category:	Periodic pulsed modulation
Modulation:	GFSK
Frequency Band:	ISM 2.4 GHz Band (2400.0-2483.5 MHz, 20052)
Detailed Specification:	Basic Rate, 1 Slot active Data Rate: 1 Mbps Packet Type: DH1 Payload Body: 27 Bytes PN9 data is inserted into the payload body Modulation for Payload: GFSK Modulation Index: 0.32
Bandwidth:	1.4 MHz
Integration Time:	2.5 ms

<sup>1</sup> PAR (0.1%) in accordance with FCC KDB 971168, Section 6.0 "Measurement of the Peak-to-Average Power Ratio (PAPR)"  
<sup>2</sup> Modulation Interference Factor (MIF) value valid only in conjunction with advanced probe response linearization calibration for the same communication system (same UID and version).

**Calibration Laboratory of  
Schmid & Partner  
Engineering AG**  
Zeughausstrasse 43, 8004 Zurich, Switzerland

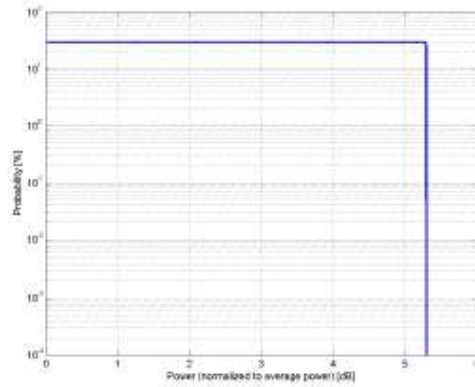

**Complementary Cumulative Distribution Function (CCDF)**

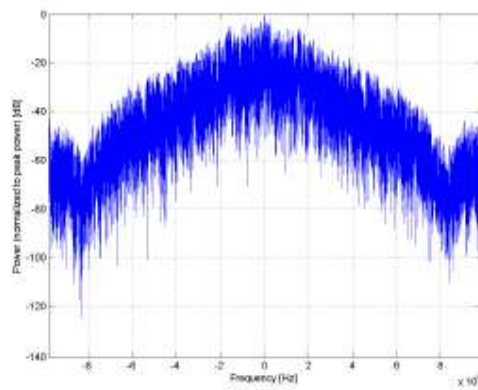

**Frequency Domain**

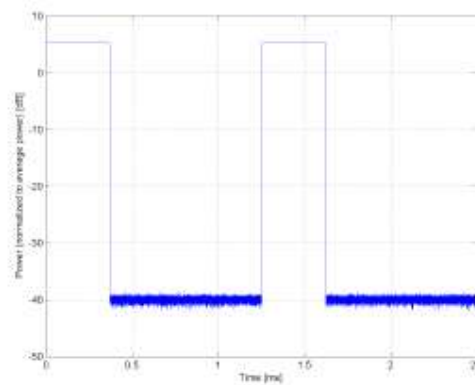

**Time Domain**



**Calibration Laboratory of  
Schmid & Partner  
Engineering AG**  
Zeughausstrasse 43, 8004 Zurich, Switzerland

Name:	5G NR (DFT-s-OFDM, 1 RB, 30 MHz, QPSK, 15 kHz)
Group:	5G NR FR1 FDD
UID:	10933-AAC
PAR: <sup>1</sup>	5.51 dB
MIF: <sup>2</sup>	-15.06 dB
Standard Reference:	SPEAG
Category:	Random amplitude modulation
Modulation:	QPSK
Frequency Band:	Band n25 (1850 - 1915 MHz) Band n66 (1710 - 1780 MHz) Band n1 (1920 - 1980 MHz) Band n3 (1710 - 1785 MHz) Band n7 (2500 - 2570 MHz) Band n28 (703 - 748 MHz) Band n80 (1710 - 1785 MHz) Band n97 (2300 - 2400 MHz) Band n98 (1880 - 1920 MHz) Validation band (0.0 - 6000.0 MHz)
Detailed Specification:	Multiplexing Scheme: DFT-s-OFDM Modulation Scheme: QPSK Subcarrier Spacing: 15 kHz Number RBs: 1 Data Type: PNB
Bandwidth:	30.0 MHz
Integration Time:	10.0 ms

<sup>1</sup> PAR (0.1%) in accordance with FCC KDB 971168, Section 6.0 "Measurement of the Peak-to-Average Power Ratio (PAR)"  
<sup>2</sup> Modulation Interference Factor (MIF) value valid only in conjunction with advanced probe response linearization calibration for the same communication system (same UID and version).

**Calibration Laboratory of  
Schmid & Partner  
Engineering AG**  
Zeughausstrasse 43, 8004 Zurich, Switzerland

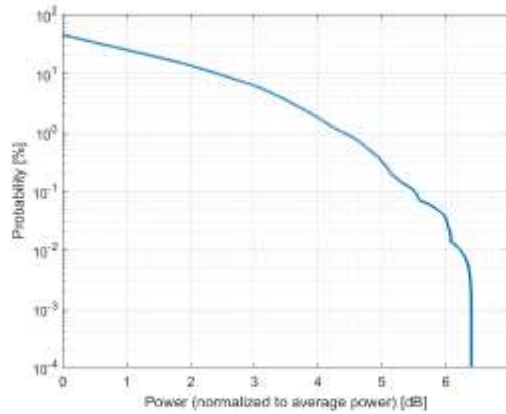

**Complementary Cumulative Distribution Function (CCDF)**

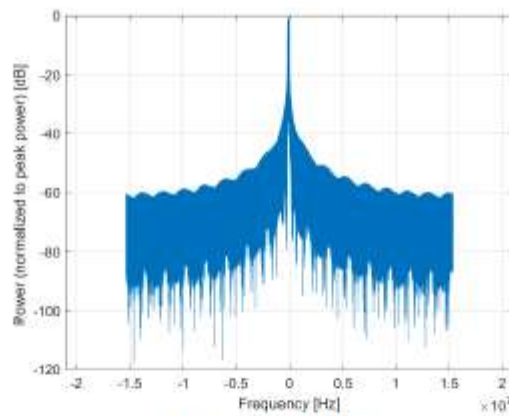

**Frequency Domain**

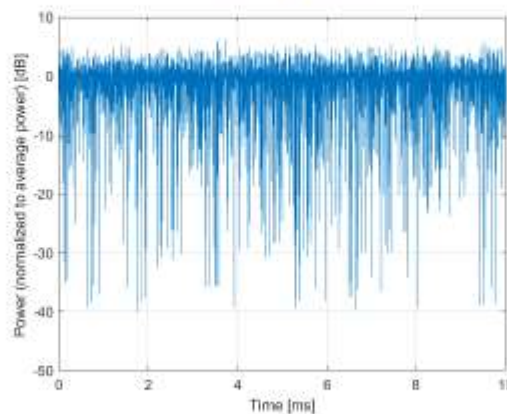

**Time Domain**

**Calibration Laboratory of  
Schmid & Partner  
Engineering AG**  
Zeughausstrasse 43, 8004 Zurich, Switzerland

Name:	5G NR (CP-OFDM, 1 RB, 20 MHz, QPSK, 15 kHz)
Group:	5G NR FR1 TDD
UID:	10972-AAB
PAR: <sup>1</sup>	11.59 dB
MIF: <sup>2</sup>	-1.65 dB
Standard Reference:	SPEAG
Category:	Random amplitude modulation
Modulation:	QPSK
Frequency Band:	Band n38 (2570 - 2620 MHz) Band n39 (1880 - 1920 MHz) Band n40 (2300 - 2400 MHz) Band n41 (2496 - 2690 MHz) Band n48 (3550 - 3700 MHz) Band n60 (1432 - 1517 MHz) Band n77 (3300 - 4200 MHz) Band n78 (3300 - 3800 MHz) Band n90 (2496 - 2690 MHz) Band n47 (5855 - 5925 MHz) Validation band (0.0 - 6000.0 MHz)
Detailed Specification:	Multiplexing Scheme: CP-OFDM Modulation Scheme: QPSK Subcarrier Spacing: 15 kHz Number RBs: 1 Slot Format Index: - Data Type: PUSCH
Bandwidth:	20.0 MHz
Integration Time:	10.0 ms

<sup>1</sup> PAR (0.1%) in accordance with FCC KDB 971160, Section 6.0 "Measurement of the Peak-to-Average Power Ratio (PAPR)"  
<sup>2</sup> Modulation Interference Factor (MIF) value valid only in conjunction with advanced probe response linearization calibration for the same communication system (same UID and version).

**Calibration Laboratory of  
Schmid & Partner  
Engineering AG**  
Zeughausstrasse 43, 8004 Zurich, Switzerland

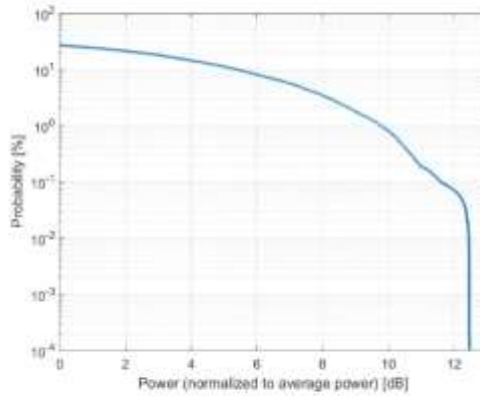

**Complementary Cumulative Distribution Function (CCDF)**

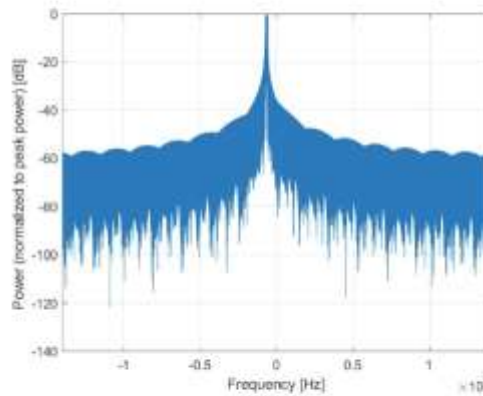

**Frequency Domain**

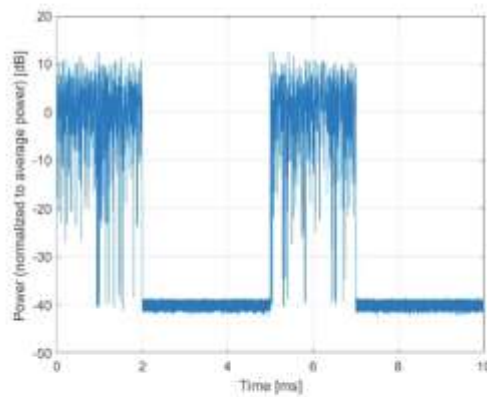

**Time Domain**

**Calibration Laboratory of  
Schmid & Partner  
Engineering AG**  
Zeughausstrasse 43, 8004 Zurich, Switzerland

Name:	5G NR (DFT-s-OFDM, 1 RB, 100 MHz, QPSK, 30 kHz)
Group:	5G NR FR1 TDD
UID:	10973-AAB
PAR: <sup>1</sup>	9.06 dB
MIF: <sup>2</sup>	-1.64 dB
Standard Reference:	SPEAG
Category:	Random amplitude modulation
Modulation:	QPSK
Frequency Band:	Band n41 (2496 - 2690 MHz) Band n48 (3550 - 3700 MHz) Band n77 (3300 - 4200 MHz) Band n78 (3300 - 3800 MHz) Band n79 (4400 - 5000 MHz) Band n90 (2496 - 2690 MHz) Validation band (0.0 - 6000.0 MHz)
Detailed Specification:	Multiplexing Scheme: DFT-s-OFDM Modulation Scheme: QPSK Subcarrier Spacing: 30 kHz Number RBs: 1 Slot Format Index: - Data Type: PUSCH
Bandwidth:	100.0 MHz
Integration Time:	10.0 ms

<sup>1</sup> PAR (0.1%) in accordance with FCC KDB 971168, Section 5.0 "Measurement of the Peak-to-Average Power Ratio (PAPR)"  
<sup>2</sup> Modulation Interference Factor (MIF) value valid only in conjunction with advanced probe response linearization calibration for the same communication system (same UID and version).

**Calibration Laboratory of  
Schmid & Partner  
Engineering AG**  
Zeughausstrasse 43, 8004 Zurich, Switzerland

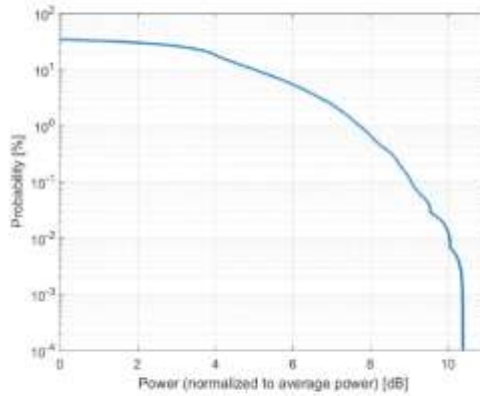

**Complementary Cumulative Distribution Function (CCDF)**

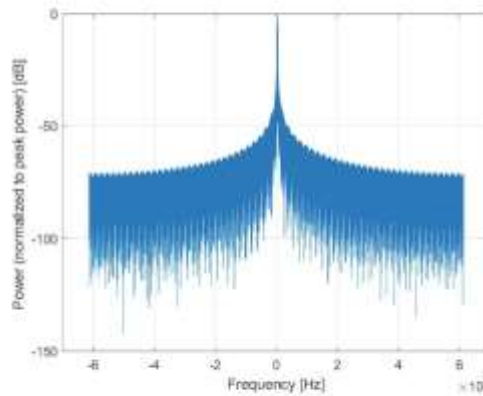

**Frequency Domain**

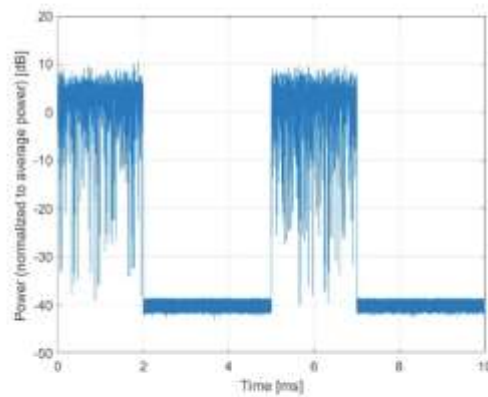

**Time Domain**



**Calibration Laboratory of  
Schmid & Partner  
Engineering AG**  
Zeughausstrasse 43, 8004 Zurich, Switzerland

Name:	5G NR (CP-OFDM, 100% RB, 100 MHz, 256-QAM, 30 kHz)
Group:	5G NR FR1 TDD
UID:	10974-AAB
PAR: <sup>1</sup>	10.28 dB
MIF: <sup>2</sup>	-3.48 dB
Standard Reference:	SPEAG
Category:	Random amplitude modulation
Modulation:	256-QAM
Frequency Band:	Band n41 (2496 - 2690 MHz) Band n48 (3550 - 3700 MHz) Band n77 (3300 - 4200 MHz) Band n78 (3300 - 3800 MHz) Band n79 (4400 - 5000 MHz) Band n90 (2496 - 2690 MHz) Validation band (0.0 - 6000.0 MHz)
Detailed Specification:	Multiplexing Scheme: CP-OFDM Modulation Scheme: 256-QAM Subcarrier Spacing: 30 kHz Number RBs: 273 Slot Format Index: - Data Type: PUSCH
Bandwidth:	100.0 MHz
Integration Time:	10.0 ms

<sup>1</sup> PAR (0.1%) in accordance with FCC KDB 971168, Section 6.0 "Measurement of the Peak-to-Average Power Ratio (PAPR)"  
<sup>2</sup> Modulation Interference Factor (MIF) value valid only in conjunction with advanced probe response linearization calibration for the same communication system (same UID and version).

**Calibration Laboratory of  
Schmid & Partner  
Engineering AG**  
Zeughausstrasse 43, 8004 Zurich, Switzerland

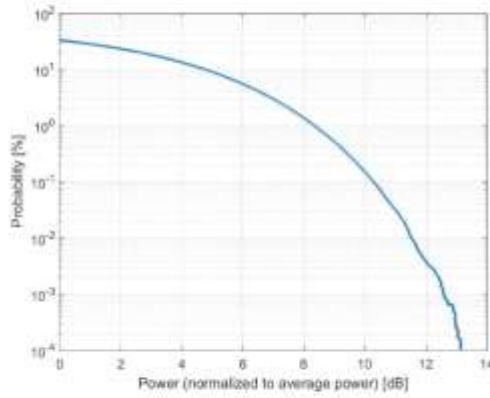

**Complementary Cumulative Distribution Function (CCDF)**

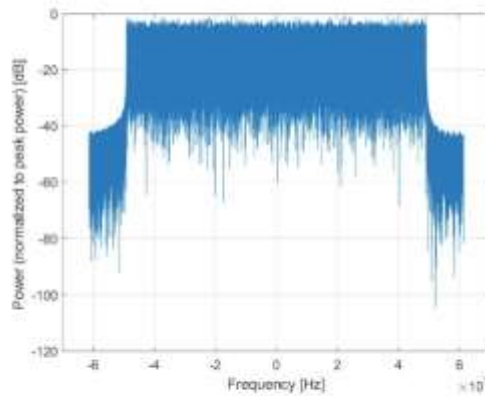

**Frequency Domain**

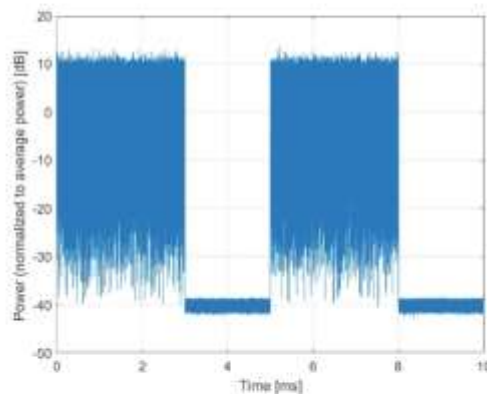

**Time Domain**