



74, Seoicheon-ro 578beon-gil, Majang-myeon, Icheon-si, Gyeonggi-do, Korea
TEL: +82-31-645-6300 FAX: +82-31-645-6401

HAC T-COIL Test Report

Applicant Name:
SAMSUNG Electronics Co., Ltd.
129, Samsung-ro, Yeongtong-gu, Suwon-Si, Gyeonggi-do,
16677 Rep. of Korea

Date of Issue: Jan. 14, 2022
Test Report No.: HCT-SR-2201-FC003-R1
Test Site: HCT CO., LTD.

FCC ID

A3LSMA536V

Equipment Type:	Mobile Phone
Application Type	Certification
FCC Rule Part(s):	CFR §20.19 , ANSI C63.19-2011
Model Name:	SM-A536V
Date of Test:	11/17/2021 ~ 12/28/2021

C63.19-2011
HAC Category

T3 (T-COIL CATEGORY)

This wireless portable device has been shown to be hearing-aid compatible under the above rated category, specified in ANSI/IEEE Std. C63.19-2011 and had been tested in accordance with the specified measurement procedures. Hearing-Aid Compatibility is based on the assumption that all production units will be designed electrically identical to the device tested in this report.

I attest to the accuracy of data. All measurements reported herein were performed by me or were made under my supervision and are correct to the best of my knowledge and belief. I assume full responsibility for the completeness of these measurements and vouch for the qualifications of all persons taking them.

Tested By

Jee-lii, Lee
Test Engineer
SAR Team
Certification Division

Reviewed By

Yun-jeang, Heo
Technical Manager
SAR Team
Certification Division

This report only responds to the tested sample and may not be reproduced, except in full, without written approval of the HCT Co., Ltd.

REVISION HISTORY

The revision history for this test report is shown in table.

Revision No.	Date of Issue	Description
0	Jan. 05, 2022	Initial Release
1	Jan. 14, 2022	Removed blue highlight background 7.2 & 7.3

This test results were applied only to the test methods required by the standard.

The above Test Report is not related to the accredited test result by (KS Q) ISO/IEC 17025 and KOLAS(Korea Laboratory Accreditation Scheme), which signed the ILAC-MRA.

Table of Contents

1. Test Regulations	4
2. ATTESTATION OF TEST RESULT OF DEVICE UNDER TEST	5
3. DEVICE UNDER TEST DESCRIPTION.....	6
4. Test Methodology	7
5. Measuring Instrument Calibraion	8
6. Measurement Uncertainty.....	9
7. Test Procedures for all Technologies	10
8. Audio Level and Gain Measurements.....	14
9 T-coil Measurement Criteria	17
10. Device Under Test.....	19
11. Air Interfaces and Operating Mode	20
12. HAC (T-coil) Test Results	20
Appendix A. HAC T-COIL Test Plots	45
Appendix B. HAC T-Coil Probe Certificates	166
Appendix C. HAC T-COIL Setup Photo	

1. Test Regulations

The tests were performed according to the following regulations:

Test Standard	FCC 47 CFR §20.19
Test Method	<ul style="list-style-type: none">• ANSI C63.19-2011FCC KDB 285076 D01 HAC Guidance v05r01• FCC KDB 285076 D02 T Coil testing v03r01• FCC KDB 285076 D03 HAC FAQ v01r04

2. ATTESTATION OF TEST RESULT OF DEVICE UNDER TEST

Test Laboratory	
Company Name:	HCT Co., LTD
Address:	74, Seoicheon-ro 578beon-gil, Majang-myeon, Icheon-si, Gyeonggi-do, 17383, Rep. of Korea
Telephone:	+82 31 645 6300
Fax.:	+82 31 645 6401

Attestation of SAR test result	
Applicant Name:	SAMSUNG Electronics Co., Ltd.
Model:	SM-A536V
EUT Type:	Mobile Phone
Application Type:	Certification

2.1 Test Methodology

The Tests document in this report were performed in accordance with ANSI C63.19-2011 method of Measurement of Compatibility between Wireless Communication Devices and Hearing Aids, FCC published KDB 285076 D01 HAC Guidance v05r01, FCC published KDB 285076 D02 HAC T-Coil Testing v03r01, FCC Published KDB285076 D03 HAC FAQ v01r04 and TCB Workshop updates .

3. DEVICE UNDER TEST DESCRIPTION

3.1 DUT specification

Device Wireless specification overview		
Band & Mode	Operating Mode	Tx Frequency
GSM850	Voice / Data	824.2 MHz ~ 848.8 MHz
GSM1900	Voice / Data	1 850.2 MHz ~ 1 909.8 MHz
UMTS 850	Voice / Data	826.4 MHz ~ 846.6 MHz
UMTS 1900	Voice / Data	1 852.4 MHz ~ 1 907.6 MHz
LTE Band 2 (PCS)	Voice / Data	1 850.7 MHz ~ 1 909.3 MHz
LTE Band 4 (AWS)	Voice / Data	1 710.7 MHz ~ 1 754.3 MHz
LTE Band 5 (Cell)	Voice / Data	824.7 MHz ~ 848.3 MHz
LTE Band 7	Voice / Data	2 502.5 MHz ~ 2 567.5 MHz
LTE Band 12	Voice / Data	699.7 MHz ~ 715.3 MHz
LTE Band 13	Voice / Data	779.5 MHz ~ 784.5 MHz
LTE TDD Band 48	Voice / Data	3 552.5 MHz ~ 3 697.5 MHz
LTE Band 66 (AWS)	Voice / Data	1 710.7 MHz ~ 1 779.3 MHz
NR Band n2 (PCS)	Voice / Data	1 852.5 MHz ~ 1 907.5 MHz
NR Band n5 (Cell)	Voice / Data	826.5 MHz ~ 846.5 MHz
NR Band n66	Voice / Data	1 712.5 MHz ~ 1 777.5 MHz
NR Band n77	Voice / Data	3 710 MHz ~ 3 969.99 MHz
NR Band 77(DoD)	Voice/ Data	3 450 MHz ~ 3 550 MHz
NR Band n260	Data	37 000 MHz ~ 40 000 MHz
NR Band n261	Data	27 500 MHz ~ 28 350 MHz
U-NII-1	Voice / Data	5 180 MHz ~ 5 240 MHz
U-NII-2A	Voice / Data	5 260 MHz ~ 5 320 MHz
U-NII-2C	Voice / Data	5 500 MHz ~ 5 720 MHz
U-NII-3	Voice / Data	5 745 MHz ~ 5 825 MHz
2.4 GHz WLAN	Voice / Data	2 412 MHz ~ 2 462 MHz
Bluetooth / LE 5.0	Data	2 402 MHz ~ 2 480 MHz
NFC	Data	13.56 MHz

4. Test Methodology

The tests documented in this report were performed in accordance with ANSI C63.19-2011 Methods of Measurement of Compatibility between Wireless Communications Devices and Hearing Aids and FCC published procedure

KDB 285076 D01 HAC Guidance v05r01

KDB 285076 D03 HAC FAQ v01r04

TCB workshop updates

KDB 285076 D02 T-Coil testing v03r01

5. Measuring Instrument Calibraion

The measuring equipment used to perform the tests documented in this report has been calibrated in accordance with the manufacturers' recommendations and is traceable to recognized national standards.

Name of Equipment	Manufacturer	Type/Model	Serial No.	Cal. Due Date
ABM Probe	SPEAG	AM1DV3	3050	11/23/2022
ABM Probe	SPEAG	AM1DV3	3049	06/01/2022
Data Acquisition Electronics	SPEAG	DAE4	466	04/23/2022
Data Acquisition Electronics	SPEAG	DAE4	1686	06/21/2022
DAC	Sound Devices	USBPre 2	HB1318341009	N/A
DAC	Sound Devices	USBPre 2	HB1319212059	N/A
Radio Communication Tester	R & S	CMW 500	167916	10/22/2022
Radio Communication Tester	R & S	CMW 500	167918	04/15/2022
USB Audio Module	KEYSIGHT	U8903B-UAM	101006	N/A
UXM 5G Wireless Test Set	KEYSIGHT	E7515B	MY58460166	08/11/2022

6. Measurement Uncertainty

Measurement Uncertainty for Audio Band Magnetic Measurement

Error Description	Uncertainty values (±%)	Probe Dist.	Div.	C _i ABM1	C _i ABM2	Std. Unc.	
						ABM1 (±%)	ABM2 (±%)
Probe Sensitivity							
ReFereNce Level	3.00	N	1	1	1	3.00	3.00
AMCC Geometry	0.40	R	1.73	1	1	0.23	0.23
AMCC Current	1.00	R	1.73	1	1	0.58	0.58
Porbe Positioning during Calibr.	0.10	R	1.73	1	1	0.06	0.06
Noise Contribution	0.70	R	1.73	0.0143	1	0.01	0.40
Frequency Slope	5.90	R	1.73	0.1	1	0.34	3.41
Probe System							
Repeatability / Drift	1.00	R	1.73	1	1	0.58	0.58
Linearity / Dynamic Range	0.60	R	1.73	1	1	0.35	0.35
Acoustic Noise	1.00	R	1.73	0.1	1	0.06	0.58
Probe Angle	2.30	R	1.73	1	1	1.33	1.33
Spectral Processing	0.90	R	1.73	1	1	0.52	0.52
Integration Time	0.60	N	1.00	1	5	0.60	3.00
Field Disturbation	0.20	R	1.73	1	1	0.12	0.12
Test Signal							
Ref. Signal Spectral Response	0.60	R	1.73	0	1	0.00	0.35
Positioning							
Probe Positioning	1.90	R	1.73	1	1	1.10	1.10
Phantom Thickness	0.90	R	1.73	1	1	0.52	0.52
DUT Positioning	1.90	R	1.73	1	1	1.10	1.10
External Contributions							
RF Interference	0.00	R	1.73	1	0.3	0.00	0.00
Test Signal Variation	2.00	R	1.73	1	1	1.2	1.2
Combined Std. Uncertainty (ABM field)						4.1	6.1
Expanded Std. Uncertainty (%)						8.1	12.3
Notes for table N - Nomal R - Rectangular Div. - Divisor used to obtain standard uncertainty							

7. Test Procedures for all Technologies

7.1 General Procedures C63.19-2011, Section 7

ANSI C63.19-2011, Section 7

This document describes the procedures used to measure the ABM (T-Coil) performance of the WD.

In addition to measuring the absolute signal levels, the A-weighted magnitude of the unintended signal shall also be determined. In order to assure that the required signal quality is measured, the measurement of the intended signal and the measurement of the unintended signal must be made at the same location for all measurement positions. In addition, the RF field strength at each measurement location must be at or below that required for the assigned category.

Measurements shall not include undesired properties from the WD's RF field; therefore, use of a coaxial connection to a base station simulator or non-radiating load may be necessary. However, even then with a coaxial connection to a base station simulator or non-radiating load there may still be RF leakage from the WD, which may interfere with the desired measurement. Pre-measurement checks should be made to avoid this possibility. All measurements shall be done with the WD operating on battery power with an appropriate normal speech audio signal input level given in Table 7.1. If the device display can be turned off during a phone call then that may be done during the measurement as well.

Measurements shall be performed at two locations specified in A.3, with the correct probe orientation for a particular location, in a multistage sequence by first measuring the field intensity of the desired T-Coil signal (ABM1) that is useful to a hearing aid T-Coil. The undesired magnetic components (ABM2) must be measured at the same location as the desired ABM or T-Coil signal (ABM1), and the ratio of desired to undesired ABM signals must be calculated. For the perpendicular field location, only the ABM1 frequency response shall be determined in a third measurement stage. The flow chart in Figure 7.3 illustrates this three-stage, two orientation process.

The following steps summarize the basic test flow for determining ABM1 and ABM2. These steps assume that a sine wave or narrowband 1/3 octave signal can be used for the measurement of ABM1.

A validation of the test setup and instrumentation may be performed using a TMFS or Helmholtz coil. Measure the emissions and confirm that they are within the specified tolerance.

Position the WD in the test setup and connect the WD RF connector to a base station simulator or a non- radiating load as shown in Figure 7.1 or Figure 7.2. Confirm that equipment that requires calibration has been calibrated, and that the noise level meets the requirements given in 7.3.1.

The drive level to the WD is set such that the reference input level specified in Table 7.1 is input to the base station simulator (or manufacturer's test mode equivalent) in the 1 kHz, 1/3 octave band. This drive level shall be used for the T-Coil signal test (ABM1) at $f = 1$ kHz. Either a sine wave at 1025 Hz or a voice- like signal, band-limited to the 1 kHz 1/3 octave, as defined in 7.4.2, shall be used for the reference audio signal.

If interference is found at 1025 Hz an alternative nearby reference audio signal frequency may be used.

The same drive level will be used for the ABM1 frequency response measurements at each 1/3 octave band center frequency. The WD volume control may be set at any level up to maximum, provided that a signal at any frequency at maximum modulation would not result in clipping or signal overload.

Determine the magnetic measurement locations for the WD device (A.3), if not already specified by the manufacturer, as described in 7.4.4.1.1 and 7.4.4.2.

At each measurement location, measure and record the desired T-Coil magnetic signals (ABM1 at f_i) as described in 7.4.4.2 in each individual ISO 266-1975 R10 standard 1/3 octave band. The desired audio band input frequency (f_i) shall be centered in each 1/3 octave band maintaining the same drive level as determined in item c) and the reading taken for that band.

Equivalent methods of determining the frequency response may also be employed, such as fast Fourier transform (FFT) analysis using noise excitation or input-output comparison using simulated speech.

The full-band integrated or half-band integrated probe output, as specified in D.9, may be used, as long as the appropriate calibration curve is applied to the measured result, so as to yield an accurate measurement of the field magnitude. (The resulting measurement shall be an accurate measurement in dB A/m.)

All measurements of the desired signal shall be shown to be of the desired signal and not of an undesired signal. This may be shown by turning the desired signal ON and OFF with the probe measuring the same location. If the scanning method is used the scans shall show that all measurement points selected for the ABM1 measurement meet the ambient and test system noise criteria in 7.3.1.

At the measurement location for each orientation, measure and record the undesired broadband audio magnetic signal (ABM2) as specified in 7.4.4.4 with no audio signal applied (or digital zero applied, if appropriate) using A-weighting and the half-band integrator. Calculate the ratio of the desired to undesired signal strength (i.e., signal quality).

Obtain the data from the postprocessor, SEMCAD, and determine the category that properly classifies the signal quality based on Table 8.5.

Test Setup Diagram

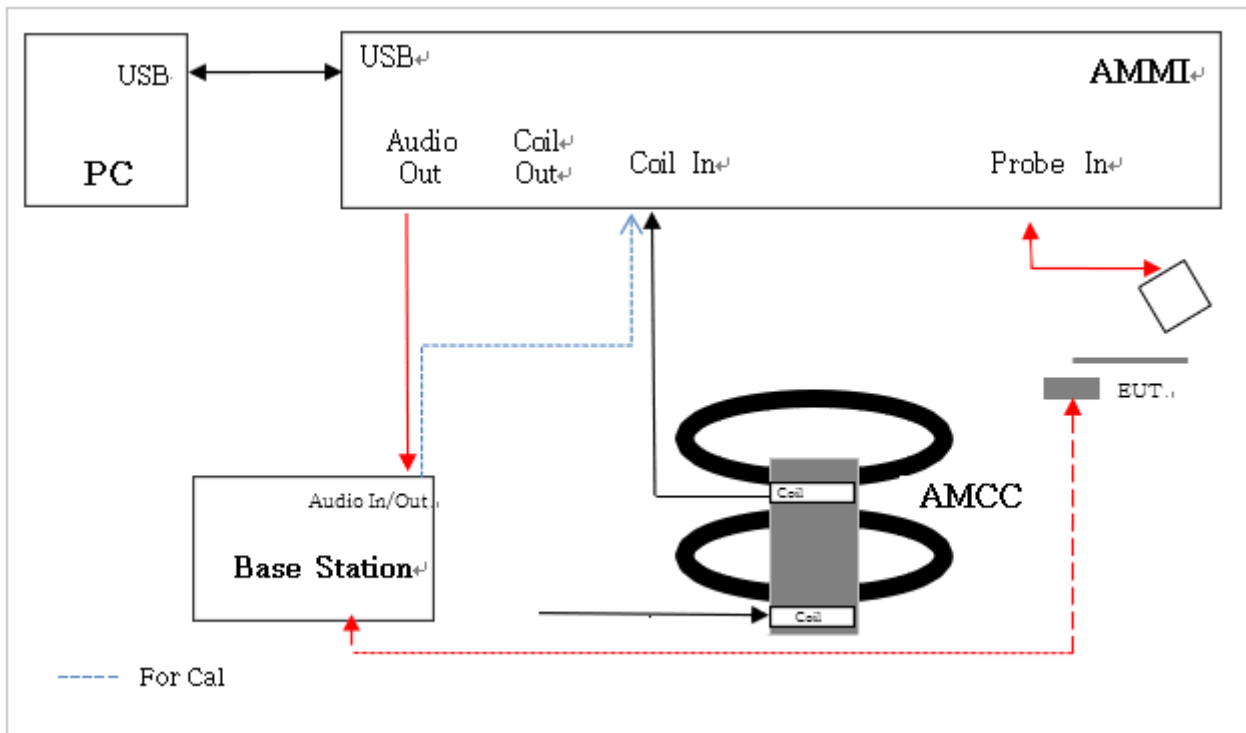

7.2 VoWiFi PAG-Reuse

This device supports Wi-Fi calling (aka Voice over Wi-Fi or VoWiFi) which is an extended feature of the carriers CMRS service to offload VoLTE calls onto local area networks over WI-FI via the internet and subject to HAC assessment for phones with a HAC rating. HAC assessment for this feature is subject to Pre Approval Guidance.

The set up for VoWiFi uses the Base station as described in section 7.1 with the exception that the reference audio level is set at -20dBm0. The reference level is calibrated using the standard call box calibration procedures with the exception of the -20dBm0 reference level being used (refer to section 8.4).

An investigation was performed to determine worst case codec, bit rate and air interface configuration (refer to sections 12.5 and 12.6).

7.3 Over the Top(OTT)

This device supports VoIP via a preinstalled application that uses the Google Duo service, using OPUS as its only codec (refer to §11 for air interface details and §12.7 for codec bit rates). VoIP capabilities require HAC assessment when voice calls are supported over the cellular data connection via pre-installed VoIP applications and the assessment is subject to Pre-Approval Guidance procedures.

The equipment is set up as shown below with a support device used to originate the call using the IP transport. The support device connects to the cloud-based Google Duo service via Wi-Fi access point and router, or RJ45. The DUT connects to the VoIP service via a cellular/unlicensed air interface to the call box and an Ethernet connection from call box to Internet. The various codec bit rate and air interface configurations are evaluated to determine the worst-case configuration (refer to §12.7).

Test Setup configuration for OTT calls

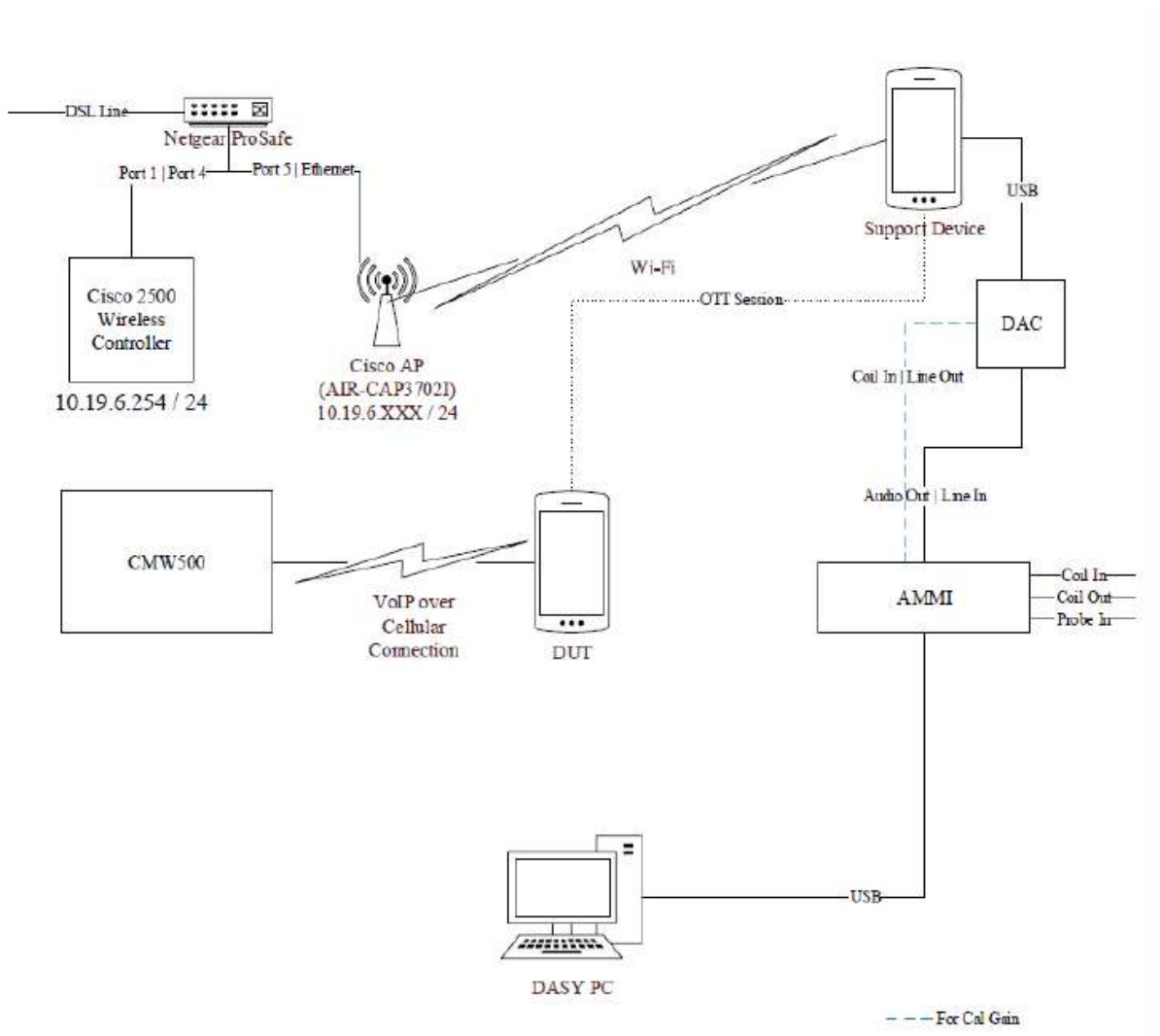

For the OTT call, the calibrated audio card within the CMW500 cannot be used so the AMMI is connected to an external Digital-Analog Converter (DAC) and the DAC is connected to the Support Device via USB. The test signal is sent from the DASY PC to the AMMI, from the AMMI to the DAC, from the DAC to the Support Device, and, via the VoIP call, to the DUT.

As this test set up uses an external DAC between the AMMI's audio output and support device, the appropriate gain factor for the OTT call needs be determined. This is done by connecting the DAC between the AMMI Audio output and Coil input as shown below.

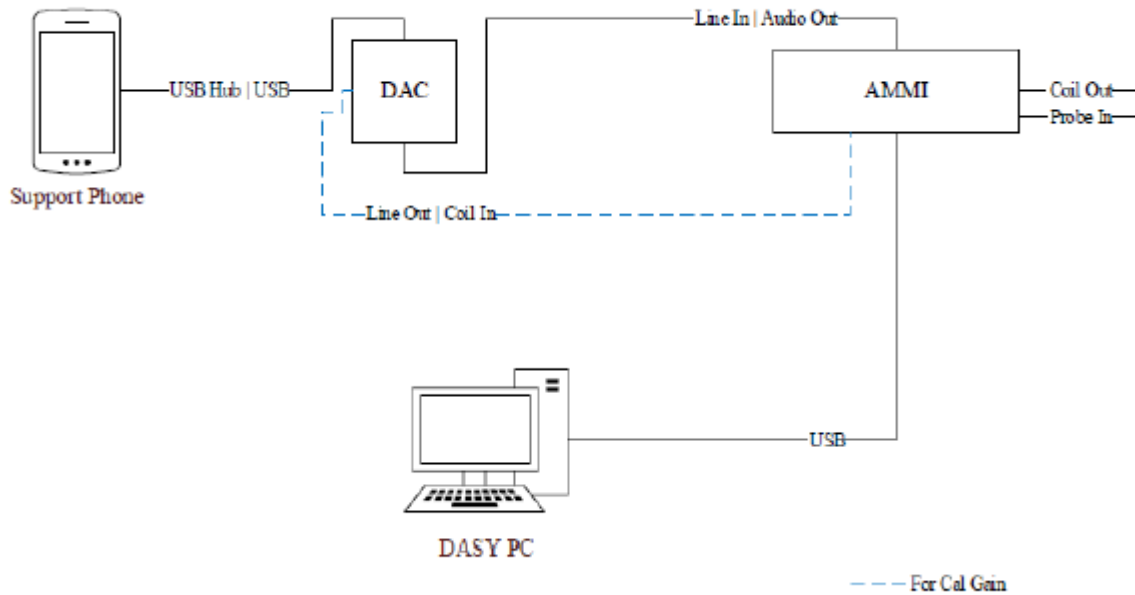

Using the metering function on the DAC, the DAC gain is adjusted until the volume reaches 0 dBFS (3.14 dBm0 based on TIA/EIA 810-A). SPEAG's "TN-LK-05042018-C-T-Coil_Levels" document (Appendix E) steps E through H are then followed to determine the adjusted gain values as detailed in §8.5 so that the reference level is set to 23.14dB below full scale, i.e. at -20dBm0. A verification of the DAC's output is performed prior to testing

8. Audio Level and Gain Measurements

8.1 GSM

Refer to the below table for the gains used to measure GSM.

Signal Type	Audio Level [dBm]	Gain [dB]	Gain [linear]
Voice 1 kHz	-16	27.82	24.55
Voice 300 - 3 kHz	-19	34.53	52.75

8.2 WCDMA

Refer to the below table for the gains used to measure WCDMA.

Signal Type	Audio Level [dBm]	Gain [dB]	Gain [linear]
Voice 1 kHz	-16	27.82	24.55
Voice 300 - 3 kHz	-19	34.53	52.75

8.3 VOLTE

Refer to the below table for the gains used to measure VoLTE.

The following software/firmware was used to simulate the VoLTE server for testing:

Firmware	License Keys	Software Name
V3.7.30 for LTE	KS500 KS550	LTE FDD R8 SIG BASIC LTE TDD R8 SIG BASIC
V3.7.20 for Audio	KA100 KA150 KAA20 KM050 KS104	IP APPL ENABLING IPv4 IP APPL ENABLING IPv6 IP APPL IMS BASIC DATA APPL MEAS EVS SPEECH CODEC

Signal Type	Audio Level [dBm]	Gain [dB]	Gain [linear]
Voice 1 kHz	-16	27.83	24.61
Voice 300 - 3 kHz	-19	34.54	52.93

8.4 VoNR

Refer to the below table for the gains used to measure VoNR of Call Box(E7515B)

The following software/firmware was used to simulate the VoNR server for testing:

Firmware	License Model	Software Name
5G NR	C8700200A	Test Applicaton Framework
Audio	C8700201A	IMS-SIP Emulation
	C87300P1A	LTE IP data
	C87350P1A	5G NR IP data

5G NR FDD, TDD

Signal Type	Audio Level [dBm]	Gain [dB]	Gain [linear]
Voice 1 kHz	-16	33.58	43.90
Voice 300 - 3 kHz	-19	40.29	93.49

8.5 VoWi-Fi

Refer to the below table for the gains used to measure VoWi-Fi.

Firmware	License Keys	Software Name
V3.7.40 for WLAN	KS650	WLAN A/B/G SIG BASIC
	KS651	WLAN N SIG BASIC
	KS656	WLAN IEEE 802.11ac
	KS657	WLAN IEEE 802.11ax
V3.7.20 for Audio	KA100	IP APPL ENABLING IPv4
	KA150	IP APPL ENABLING IPv4
	KAA20	IP APPL IMS BASIC
	KM050	DATA APPL MEAS
	KS104	EVS SPEECH CODEC

Signal Type	Audio Level [dBm]	Gain [dB]	Gain [linear]
Voice 1 kHz	-20	23.84	15.51
Voice 300 - 3 kHz	-20	33.55	47.17

8.6 Over the Top(OTT)

For EDGE, HSPA, LTE, NR and Wi-Fi the linear gain levels listed below were used. The results below are based on a reference input level of -20 dBm.

To calibrate the DAC (refer §7.3), three. Way audio files (sine wave, 1 kHz voice, and 300 to 3 kHz voice) are sent from the DASY5 PC to the AMMI, then to the DAC. The Helmholtz resonator measures the field strength, which represents the AMMI to DAC input sensitivity. After determining the input sensitivity, the adjusted linear gain values can then be calculated.

#11 Chamber Test Band : EDGE, HSPA, LTE, Wifi

Signal Type	Audio Level [dBm]	Gain [dB]	Gain [linear]
Voice 1 kHz	-20	25.65	19.05
Voice 300-3 kHz	-20	35.36	58.00

#9 Chamber Test Band : NR

Signal Type	Audio Level [dBm]	Gain [dB]	Gain [linear]
Voice 1 kHz	-20	25.97	19.84
Voice 300-3 kHz	-20	35.68	60.33

9 T-coil Measurement Criteria

9.1 Frequency Responses

The frequency response of the axial component of the magnetic field, measured in 1/3 octave bands, shall follow the response curve, over the frequency range 300 Hz to 3000 Hz.

Figure 8.1 and Figure 8.2 provide the boundaries for the specified frequency. These response curves are for true field strength measurements of the T-Coil signal. Thus the 6 dB/octave probe response has been **corrected from the raw readings.**

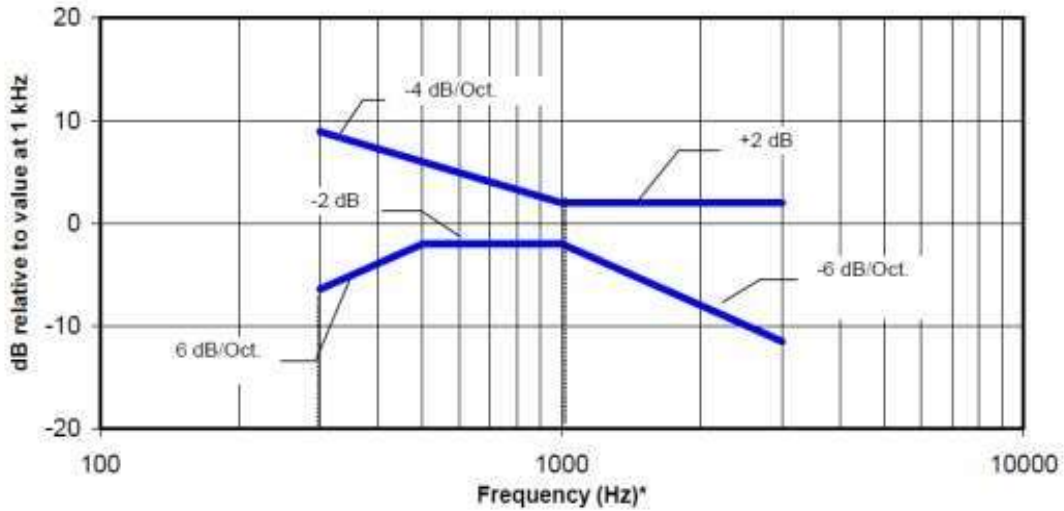

NOTE—The frequency response is between 300 Hz and 3000 Hz.

Figure 8.1—Magnetic field frequency response for WDs with field strength ≤ -15 dB (A/m) at 1 kHz

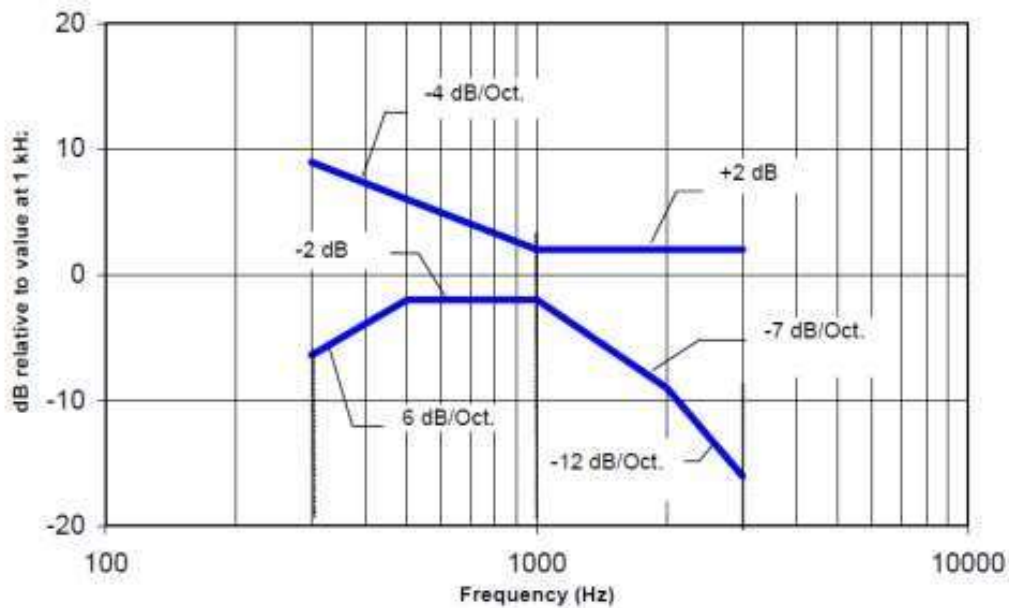

NOTE—The frequency response is between 300 Hz and 3000 Hz.

Figure 8.2—Magnetic field frequency response for WDs with a field that exceeds -15 dB(A/m) at 1 kHz

9.2 Signal to Noise

This specifies the signal-to-noise quality requirement for the intended T-Coil signal from a WD. The worst signal to noise of the two T-Coil signal measurements, as determined in Clause 7, shall be used to determine the T-Coil mode category per Table 8.5.

Only the RF immunity of the hearing aid is measured in T-Coil mode. It is assumed that a hearing aid can have no immunity to an interference signal in the audio band, which is the intended reception band for this mode. So, the only criterion that can be measured is the RF immunity in T-Coil Mode. This is measured using the same procedure as for the audio coupling mode and at the same levels as specified in 6.4.

Category	Telephone parameters WD signal quality [(signal+noise)-to-noise ratio in decibels]
Category T1	0 dB to 10 dB
Category T2	10 dB to 20 dB
Category T3	20 dB to 30 dB
Category T4	> 30 dB

Table 8.5- T-Coil signal-to-noise categories

Measurement locations and reference plane to be used for the T-coil measurements.

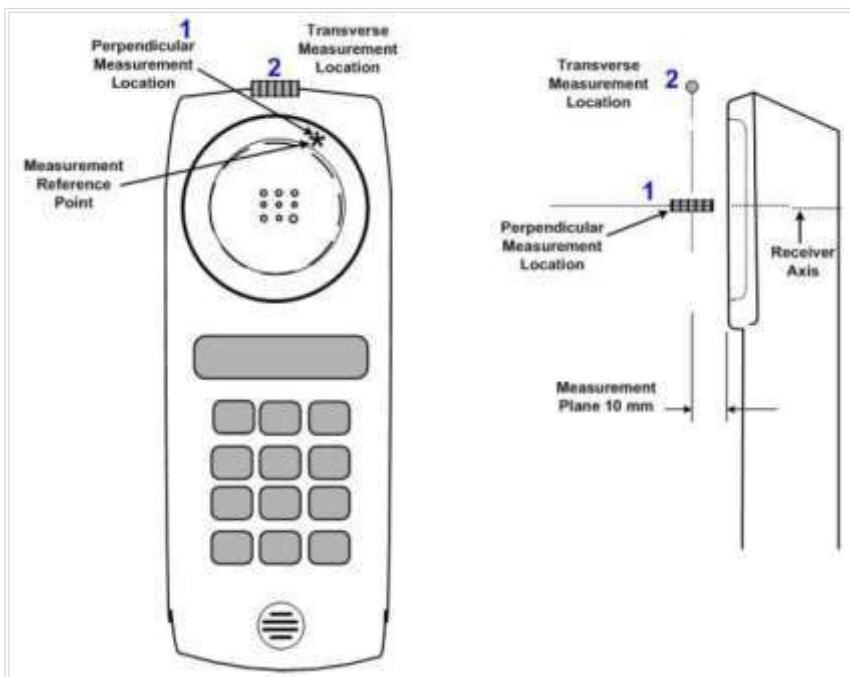

10. Device Under Test

Normal operation	Held to head	
Back Cover	The Back Cover is not removable	
Test sample information	S/N	Notes
	UK10827M	T-coil Test
	UK10802M	T-coil Test

11. Air Interfaces and Operating Mode

Air Interface	Bands (MHz)	Type	C63.19 Tested	Simultaneous Transmitter	Audio Codecs Evaluated
GSM	850	VO	Yes	Wi-Fi, BT	EFR
	1900				
	GPRS/EDGE	VD	Yes	Wi-Fi, BT	OPUS ²
WCDMA (UMTS)	850	VO	Yes	Wi-Fi, BT	AMR-NB & AMR-WB
	1900				
	HSPA	VD	Yes	Wi-Fi, BT	OPUS ²
LTE - FDD	700 (B12/13)	VD	Yes	NR,Wi-Fi, BT	(AMR-NB, AMR- WB, EVS-NB, EVS-WB) ¹ & OPUS ²
	850 (B5)				
	1700 (B4/66)				
	1900 (B2)				
	2500 (B7)				
LTE – TDD	3600 (B48)	VD	Yes	NR,Wi-Fi, BT	(AMR-NB, AMR- WB, EVS-NB, EVS-WB) ¹ & OPUS ²
NR -FDD	850(B5)	VD	Yes	LTE,Wi-Fi, BT	(AMR-NB, AMR- WB, EVS-NB, EVS-WB) ¹ & OPUS ^{2,3}
	1700(B66)				
	1900(B2)				
NR -TDD	3800(B77)	VD	Yes	LTE,Wi-Fi, BT	(AMR-NB, AMR- WB, EVS-NB, EVS-WB) ¹ & OPUS ^{2,3}
	28000 (n261)		No ⁴		
	39000 (n260)		No ⁴		
Wi-Fi	2450	VD	Yes	WWAN	AMR-NB, AMR- WB, EVS-NB, EVS-WB & OPUS ²
	5200 (U-NII-1)			WWAN and BT	
	5300 (U-NII-2A)				
	5500 (U-NII-2C)				
	5800 (U-NII-3)				
BT	2450	DT	NA	WWAN and Wifi 5GHz	N/A
Type: VO: Legacy Cellular Voice Service DT: Digital Transport only (no voice) CMRS: Commercial Mobile Radio Service VD: IP Voice service over Digital Transport				Note: 1. Ref Lev in accordance with the July 2012 VoLTE interpretation 2. Ref Lev -20 dBm0 3.PAG Reuse 4. For n260,n261 are currently outside the scope of ANSI C63.19 and FCC HAC regulations. This DUT dose not support VOmmWave for n260,n261	

12. HAC (T-coil) Test Results

12.1 Codec Investigation

An investigation between the various codec configurations (Low/High bit rates for Narrowband, Wideband) and specific parameters are documented (ABM1, ABM2, S+N/N, frequency response) to determine the worst-case bit rates for each voice service type. The table below compares the varying codec configurations.

A codec investigation was performed on one band of each GSM, WCDMA, LTE FDD/TDD , NR FDD/TDD..

The highlighted results below were determined to be the worst case codec configuration(s) for GSM, WCDMA and LTE FDD/TDD, NR FDD/TDD.

Codec Investigation				
Codec State	AMR-NB (kbit/s)		Orientation	Band/ Channel
	FR V1	HR V1		
ABM1 (dB/m)	3.32	4.16	z (Axial)	GSM 850 CH.190
ABM2 (dBA/m)	-34.62	-36.98		
S+N/N (dB)	37.94	41.13		
Freq. Resposne (dB)	2	2		
ABM1 (dB/m)	4.19	5.79	y (Transversal)	
ABM2 (dBA/m)	-29.7	-24.71		
S+N/N (dB)	33.89	30.5		

Codec Investigation								
Codec State	AMR-NB (kbit/s)			AMR-WB (kbit/s)			Orientation	Band/ Bandwidth/ Channel
	4.75	7.4	12.2	6.6	15.85	23.85		
ABM1 (dB/m)	11.18	11.5	11.76	14.93	11.23	11.34	z (Axial)	WCDMA Band II Rel.99 CH.9400
ABM2 (dBA/m)	-38.08	-38.68	-37.78	-19.57	-22.94	-22.9		
S+N/N (dB)	49.25	50.18	49.54	34.5	34.17	34.24		
Freq. Resposne (dB)	2	1.97	2	2	2	2		
ABM1 (dB/m)	1.34	4.38	1.63	3.43	2.73	7.1	y (Transversal)	
ABM2 (dBA/m)	-47.43	-45.28	-48.48	-31.05	-31.47	-27.08		
S+N/N (dB)	48.77	49.66	50.11	34.49	34.19	34.18		

Codec Investigation											
Codec State	AMR-NB (kbit/s)			AMR-WB (kbit/s)			Orientation	Band/ Bandwidth/ Channel			
	4.75	7.4	12.2	6.6	15.85	23.85					
ABM1 (dB/m)	17.31	17.56	17.48	18.64	19.12	10.05	z (Axial)	LTE Band 66 CH.132322 20 Mhz BW QPSK 1RB 0offset			
ABM2 (dBA/m)	-33.77	-32.15	-31.26	-13.51	-12.92	-21.62					
S+N/N (dB)	51.07	49.71	48.74	32.16	32.03	31.67					
Freq. Resposne(dB)	1.21	1.25	1.27	1.88	1.08	1.09					
ABM1 (dB/m)	-1.9	6.3	7.5	7.57	5.04	10.68	y (Transversal)			LTE Band 66 CH.132322 20 Mhz BW QPSK 1RB 0offset	
ABM2 (dBA/m)	-48.76	-39.66	-39.14	-24.86	-26.91	-20.88					
S+N/N (dB)	46.86	45.96	46.64	32.43	31.94	31.55					

Codec Investigation														
Codec State	EVS-NB (kbit/s)			EVS-WB (kbit/s)			EVS-SWB (kbit/s)			Orientation	Band/ BandWidth/ Channel			
	5.9	13.2	24.4	5.9	24.4	128	9.6	24.4	128					
ABM1 (dB/m)	3.75	18	17.34	15.6	15.47	19.86	16.3	20.55	16.54	z (Axial))	LTE Band 66 CH.132322 20 Mhz BW QPSK 1RB 0offset			
ABM2 (dBA/m)	-35.69	-31.55	-31.19	-12.72	-16.67	-12.98	-16.23	-11.34	-16.75					
S+N/N (dB)	39.45	49.55	48.52	28.31	32.15	32.84	32.53	31.89	33.29					
Freq.Resposne(dB)	1.82	2	1.83	1.49	1.05	1.06	2	2	2					
ABM1 (dB/m)	4.97	7.77	7.57	5.26	5.27	9.64	5.25	10.67	6.12	y (Transversal)			LTE Band 66 CH.132322 20 Mhz BW QPSK 1RB 0offset	
ABM2 (dBA/m)	-26.8	-39.27	-38.93	-24.01	-26.9	-23.04	-27.35	-21.12	-27.01					
S+N/N (dB)	31.78	47.04	46.5	29.26	32.17	32.68	32.6	31.79	33.14					

Codec Investigation											
Codec State	AMR-NB (kbit/s)			AMR-WB (kbit/s)			Orientation	Band/ Bandwidth/ Channel			
	4.75	7.4	12.2	6.6	15.85	23.85					
ABM1 (dB/m)	5.84	17.37	5.67	7.59	7.41	7.23	z (Axial)	LTE Band 48 CH.55990 20 Mhz BW QPSK 1RB 0offset			
ABM2 (dBA/m)	-35.5	-33.28	-36.67	-24.27	-24.38	-24.11					
S+N/N (dB)	41.34	50.65	42.34	31.86	31.79	31.34					
Freq. Resposne(dB)	1.49	1.28	1.3	1.91	1.13	1.01					
ABM1 (dB/m)	8.83	8.88	9.12	10.44	10.91	11.01	y (Transversal)			LTE Band 48 CH.55990 20 Mhz BW QPSK 1RB 0offset	
ABM2 (dBA/m)	-24	-27.7	-24.15	-20.01	-19.31	-19.15					
S+N/N (dB)	32.83	36.58	33.27	30.46	30.22	30.16					

Codec Investigation														
Codec State	EVS-NB (kbit/s)			EVS-WB (kbit/s)			EVS-SWB (kbit/s)			Orientation	Band/ BandWidth/ Channel			
	5.9	13.2	24.4	5.9	24.4	128	9.6	24.4	128					
ABM1 (dB/m)	5.71	5.41	5.41	6.88	8.12	7.29	9.09	14.74	18.06	z (Axial))	LTE Band 48 CH.55990 20 Mhz BW QPSK 1RB 0offset			
ABM2 (dBA/m)	-36.19	-36.85	-36.54	-23.26	-23.85	-25.19	-22.61	-16.7	-15.28					
S+N/N (dB)	41.89	42.26	41.95	30.13	31.96	32.48	31.71	31.45	33.34					
Freq.Resposne(dB)	1.66	1.97	1.91	1.6	1.08	1.11	2	2	2					
ABM1 (dB/m)	6.99	9.19	9.32	6.66	11.35	11.32	12.32	12.2	12.37	y (Transversal)			LTE Band 48 CH.55990 20 Mhz BW QPSK 1RB 0offset	
ABM2 (dBA/m)	-24.55	-24.01	-24.01	-21.47	-19.08	-19.53	-18.14	-18.17	-20.08					
S+N/N (dB)	31.55	33.21	33.33	28.13	30.44	30.85	30.45	30.38	32.45					

12.2 TDD Configuration

LTE TDD Uplink-Downlink Configuration Investigation for VoLTE over IMS

An investigation was performed to determine the worst-case Uplink-Downlink configuration for VoLTE over IMS T-Coil testing. The effects of UL-DL configuration were found to be independent of band and bandwidth; therefore, only one band and bandwidth were used for this investigation.

Per 3GPP TS 36.211, the total frame length for each TDD radio frame of length $T_f = 307200 \cdot T_s = 10$ ms, where T_s is a number of time units equal to $1/(15000 \times 2048)$ seconds. Additionally, each radio frame consists of 10 subframes, each of length $30720 \cdot T_s = 1$ ms, and subframes can be designated as uplink (U), downlink (D), or special subframe (S), depending on the Uplink-Downlink configuration as indicated in Table 4.2-2 of 3GPP TS 36.211. In the transmission duty factor calculation, the special subframe configuration with the shortest UpPTS duration within the special subframe is used and will be applied for measurement. From 3GPP TS 36.211 Table 4.2-1, the shortest UpPTS is $2192 \cdot T_s$ which occurs in the normal cyclic prefix and special subframe configuration 4.

See table below outlining the calculated transmission duty cycles for each Uplink-Downlink configuration:

Uplink-Downlink Configurations for Type 2 Frame Structures

Uplink-downlink configuration	Downlink-to-Uplink Switch-point periodicity	Subframe number										Calculated Transmission Duty Cycle (%)
		0	1	2	3	4	5	6	7	8	9	
0	5 ms	D	S	U	U	U	D	S	U	U	U	61.4%
1	5 ms	D	S	U	U	D	D	S	U	U	D	41.4%
2	5 ms	D	S	U	D	D	D	S	U	D	D	21.4%
3	10 ms	D	S	U	U	U	D	D	D	D	D	30.7%
4	10 ms	D	S	U	U	D	D	D	D	D	D	20.7%
5	10 ms	D	S	U	D	D	D	D	D	D	D	10.7%
6	5 ms	D	S	U	U	U	D	S	U	U	D	51.4%

Power Class 3 Uplink-Downlink Configuration Investigation

VoLTE over IMS was evaluated with the following radio configuration → channel 40620, 20MHz BW, QPSK, 1RB, 0Offset. all configurations (0-6) are supported. The configuration which resulted in the worst z (Axial), y(Transversal) SNR was used for full testing. Uplink-Downlink configuration 1 was used as the worst-case configuration for VoLTE over IMS T-Coil testing. See table below for the SNR comparison between each Uplink-Downlink configuration:

VoLTE over IMS SNNR by UL-DL Configuration

Frequency [MHz]	Channel	Bandwidth [MHz]	Modulation	RB Size	RB Offset	UL-DL Configuration	ABM1 [dB(A/m)]	ABM2 [dB(A/m)]	Orientation	Freq. Response (dB)	SNR [dB]
3625.0	55990	20	QPSK	1	0	0	6.88	-23.26	z (Axial)	1.6	30.13
3625.0	55990	20	QPSK	1	0	1	9.56	-18.21		1.38	27.77
3625.0	55990	20	QPSK	1	0	2	17.8	-12.19		1	29.99
3625.0	55990	20	QPSK	1	0	3	5.42	-24.95		1.52	30.37
3625.0	55990	20	QPSK	1	0	4	12.81	-18.75		1.29	31.56
3625.0	55990	20	QPSK	1	0	5	16.22	-15.45		1.63	31.67
3625.0	55990	20	QPSK	1	0	6	16.14	-15.17		1.11	31.31
3625.0	55990	20	QPSK	1	0	0	6.66	-21.47	y (Transversal)		28.13
3625.0	55990	20	QPSK	1	0	1	6.15	-23.15			29.3
3625.0	55990	20	QPSK	1	0	2	4.19	-23.68			27.87
3625.0	55990	20	QPSK	1	0	3	7.09	-23.3			30.39
3625.0	55990	20	QPSK	1	0	4	9.38	-20.38			29.76
3625.0	55990	20	QPSK	1	0	5	5.92	-23.58			29.5
3625.0	55990	20	QPSK	1	0	6	7.08	-21.46		28.55	

Per the investigations above, UL-DL Configuration 1 was used to evaluate VoLTE over IMS

NR FDD

Codec Investigation								
Codec State	AMR-NB (kbit/s)			AMR-WB (kbit/s)			Orientation	Band/ Bandwidth/ Channel
	4.75	7.4	12.2	6.6	15.85	23.85		
ABM1 (dB/m)	6.97	-5.69	-5.14	-3.07	-2.25	-2.55	z (Axial)	NR Band 66 CH.349000 DFT-s OFDM QPSK 20 MHz BW 1 RB/ 1 Offset
ABM2 (dBA/m)	-37.2	-39.78	-40.56	-38.41	-37.58	-37.73		
S+N/N (dB)	44.17	34.09	35.42	35.33	35.33	35.17		
Freq. Resposne(dB)	2	2	2	2	2	2	y (Transversal)	
ABM1 (dB/m)	4.46	2.99	3.46	6.92	7.13	6.15		
ABM2 (dBA/m)	-28.31	-29.92	-30.84	-27.70	-28.80	-28.35		
S+N/N (dB)	32.77	32.91	34.3	34.62	35.93	34.51		

Codec Investigation											
Codec State	EVS-NB (kbit/s)			EVS-WB (kbit/s)			EVS-SWB (kbit/s)			Orientation	Band/ BandWidth/ Channel
	5.9	13.2	24.4	5.9	24.4	128	9.6	24.4	128		
ABM1 (dB/m)	-6.86	-5.23	-5.25	-1.46	6.3	6.56	-2.19	5.35	5.89	z (Axial)	NR Band 66 CH.349000 DFT-s OFDM QPSK 20 MHz BW 1 RB/ 1 Offset
ABM2 (dBA/m)	-40.12	-40.68	-40.96	-33.91	-30.91	-30.77	-38.99	-33.23	-33.03		
S+N/N (dB)	33.26	35.45	35.72	32.45	37.21	37.33	36.8	38.58	38.92		
Freq.Resposne(dB)	2	2	1.84	2	2	2	1.66	1.79	1.78	y (Transversal)	
ABM1 (dB/m)	2.25	4.00	3.56	0.17	7.48	7.49	6.89	7.62	8.26		
ABM2 (dBA/m)	-30.20	-28.72	-30.35	-31.09	-28.42	-28.28	-28.98	-29.49	-29.35		
S+N/N (dB)	32.45	32.72	33.91	31.26	35.91	35.77	35.87	37.11	37.61		

NR TDD

Codec Investigation								
Codec State	AMR-NB (kbit/s)			AMR-WB (kbit/s)			Orientation	Band/ Bandwidth/ Channel
	4.75	7.4	12.2	6.6	15.85	23.85		
ABM1 (dB/m)	7.84	8.08	8.46	10.18	11.36	11.4	z (Axial)	NR Band 77 CH.656000 DFT-s OFDM QPSK 100 MHz BW 270 RB/ 0 Offset
ABM2 (dBA/m)	-25.48	-25.53	-25.56	-25.52	-23.74	-23.18		
S+N/N (dB)	33.32	33.61	34.02	35.7	35.1	34.58		
Freq. Resposne(dB)	2	2	2	2	2	2		
ABM1 (dB/m)	2.28	2.61	2.81	5.02	5.74	5.83	y (Transversal)	
ABM2 (dBA/m)	-24.34	-24.26	-24.30	-24.17	-23.77	-23.64		
S+N/N (dB)	26.62	26.87	27.11	29.19	29.51	29.47		

Codec Investigation											
Codec State	EVS-NB (kbit/s)			EVS-WB (kbit/s)			EVS-SWB (kbit/s)			Orientation	Band/ BandWidth/ Channel
	5.9	13.2	24.4	5.9	24.4	128	9.6	24.4	128		
ABM1 (dB/m)	7.61	8.73	10.13	1.36	6.57	6.39	7.26	6.76	7.27	z (Axial)	NR Band 77 CH.656000 DFT-s OFDM QPSK 100 MHz BW 270 RB/ 0 Offset
ABM2 (dBA/m)	-25.53	-25.45	-24.56	-36.09	-34.05	-35.16	-34.21	-34.9	-34.3		
S+N/N (dB)	33.15	34.19	34.69	37.45	40.62	41.56	41.47	41.62	41.61		
Freq.Resposne(dB)	1.63	2	1.76	2	1.37	2	1.78	1.26	1.98		
ABM1 (dB/m)	6.19	2.86	-3.58	1.28	6.45	9.88	8.01	10.64	10.36	y (Transversal)	
ABM2 (dBA/m)	-20.23	-24.23	-31.38	-21.78	-21.51	-18.19	-21.22	-19.43	-19.32		
S+N/N (dB)	26.42	27.09	27.8	23.06	27.96	28.07	29.23	30.07	29.68		

12.3 Air Interface Investigation

Use the worst-case codec test and document a limited set of bands/modulations/channels/bandwidth.

Observe the effect of changing the band and bandwidth to ensure that there are no unexpected variations.

GSM / WCDMA (UMTS)

Mode	Ch. Freq.	Orientation	ABM1 dB (A/m)	ABM2 dB (A/m)	Ambient Noise dB(A/m)	Freq. Response (dB)	ABMSNR (dB)	T-Rating	Plot No.
GSM 850 Voice Coder Speech Codec: HR V1	CH.190 836.6 MHz	z(Axial)	4.16	-36.98	-55.52	2	41.13	T4	1/ 2
		y(Transversal)	5.79	-24.71	-55.82		30.50	T4	3
GSM 1900 Voice Coder Speech Codec: HR V1	CH.512 1850.2 MHz	z(Axial)	6.99	-36.67	-55.52	2	43.66	T4	
		y(Transversal)	-7.92	-38.44	-55.82		30.52	T4	
	CH.661 1880.0 MHz	z(Axial)	3.99	-36.84	-55.52	2	40.84	T4	
		y(Transversal)	5.65	-24.6	-55.82		30.25	T4	
CH.810 1909.8 MHz	z(Axial)	3.63	-38.17	-55.52	2	41.8	T4	4/ 5	
	y(Transversal)	-8.06	-37.43	-55.82		29.37	T3	6	
WCDMA Band II Voice AMR WB Codec:15.85 kbit/s	CH.9400 1880.0 MHz	z(Axial)	11.23	-22.94	-55.69	2	34.17	T4	7/ 8
		y(Transversal)	2.73	-31.47	-55.9		34.19	T4	9
WCDMA Band V Voice AMR WB Codec: 15.85 kbit/s	CH.4132 826.4 MHz	z(Axial)	13.79	-20.30	-55.69	2	34.10	T4	10/11
		y(Transversal)	2.01	-31.94	-55.9		33.95	T4	12
	CH.4183 836.6 MHz	z(Axial)	11.09	-22.93	-55.69	2	34.02	T4	
		y(Transversal)	2.84	-31.14	-55.9		33.98	T4	
CH.4233 846.6 MHz	z(Axial)	13.7	-20.36	-55.69	2	34.06	T4		
	y(Transversal)	2.52	-31.45	-55.9		33.97	T4		

Air Interface Investigation(Contiued)

LTE-FDD

Mode:	Ch. Freq.	BW	BW/ Modulation	RB Config.	Orientation	ABM1 dB(A/m)	ABM2 dB(A/m)	Ambient Noise dB(A/m)	Freq. Response (dB)	ABM SNR (dB)	T-Rating	Plot No.		
LTE Band 66 Voice EVS WB Codec: 5.9 kbit/s	CH.132322 1745 MHz	20 MHz	QPSK	1/0	z(Axial)	15.6	-12.72	-55.8	1.49	28.31	T3			
					y(Transversal)	5.26	-24.01	-55.87		29.26	T3			
				1/49	z(Axial)	4.76	-24.4	-55.8	1.05	29.17	T3			
					y(Transversal)	8.43	-21.16	-55.87		29.59	T3			
				1/99	z(Axial)	9.02	-21.6	-55.8	1.44	30.62	T4			
					y(Transversal)	-6.55	-35.44	-55.87		28.89	T3			
				50/0	z(Axial)	15.35	-12.51	-55.8	1.24	27.85	T3	13/14		
					y(Transversal)	8.18	-21.8	-55.87		29.98	T3	15		
				50/25	z(Axial)	10.8	-18.2	-55.8	1.13	29	T3			
					y(Transversal)	4.66	-24.13	-55.87		28.79	T3			
				50/49	z(Axial)	6.37	-25.03	-55.8	1.2	31.4	T4			
					y(Transversal)	0.47	-31.65	-55.87		32.12	T4			
				100/0	z(Axial)	18.7	-13.22	-55.8	1.43	31.92	T4			
					y(Transversal)	-2.37	-34.08	-55.87		31.71	T4			
				16QAM	50/0	z(Axial)	6.57	-25.03	-55.8	1.13	31.6	T4		
						y(Transversal)	8.54	-23.4	-55.87		31.94	T4		
				64QAM	50/0	z(Axial)	4.54	-28.25	-55.8	1.43	32.78	T4		
						y(Transversal)	3.14	-29.96	-55.87		33.1	T4		
				256QAM	50/0	z(Axial)	1	-28.98	-55.8	1.24	29.98	T3		
						y(Transversal)	-0.35	-30.59	-55.87		30.24	T4		
				15 MHz	QPSK	36/0	z(Axial)	0.12	-29.48	-55.32	1.35	29.61	T3	
							y(Transversal)	0.65	-29.33	-55.83		29.98	T3	
						25/0	z(Axial)	4.88	-29.09	-55.32	1.25	33.97	T4	
							y(Transversal)	-1.15	-34.56	-55.83		33.4	T4	
		12/0	z(Axial)			3.8	-29.8	-55.32	1.29	33.61	T4			
			y(Transversal)			0.1	-32.57	-55.83		32.67	T4			
		8/0	z(Axial)	4.39	-26.83	-55.32	1.41	31.22	T4					
			y(Transversal)	3.56	-26.66	-55.83		30.21	T4					
		1.4 MHz	3/0	z(Axial)	9.82	1.34	-28.04	1.41	29.38	T3				
				y(Transversal)	2.12	-29.91	-55.83		32.03	T4				

Air Interface Investigation(Contiued)

LTE-FDD

Mode	Ch. Freq.	Band width	BW/ Mode	RB Config.	Orientation	ABM1 dB(A/m)	ABM2 dB(A/m)	Ambient Noise dB(A/m)	Freq. Response (dB)	ABM SNR (dB)	T-Rating	Plot No.
LTE Band 2 Voice EVS WB Codec: 5.9 kbit/s	CH.18900 1880 MHz	20 MHz	QPSK	50/0	z(Axial)	16.65	-13.91	-55.32	1.49	30.56	T4	16/17
					y(Transversal)	-13.69	-45.61	-55.83		31.92	T4	18
LTE Band 5 Voice EVS WB Codec: 5.9 kbit/s	CH.20525 836.5 MHz	10 MHz	QPSK	25/0	z(Axial)	18.71	-35.78	-55.32	1.07	54.49	T4	19/20
					y(Transversal)	5.11	-39.16	-55.83		44.28	T4	21
LTE Band 7 Voice EVS WB Codec: 5.9 kbit/s	CH.21100 2535 MHz	20 MHz	QPSK	50/0	z(Axial)	13.13	-18.19	-55.32	1.48	31.32	T4	22/23
					y(Transversal)	-3.32	-34.32	-55.83		31.00	T4	24
LTE Band 12 Voice EVS WB Codec: 5.9 kbit/s	CH.23095 707.5 MHz	10 MHz	QPSK	25/0	z(Axial)	14.43	-15.36	-55.32	1.46	29.79	T3	25/ 26
					y(Transversal)	8.72	-22.30	-55.83		31.03	T4	27
LTE Band 13 Voice EVS WB Codec: 5.9 kbit/s	CH.23230 782 MHz	10 MHz	QPSK	25/0	z(Axial)	16.33	-14.88	-55.32	1.31	31.2	T4	28/ 29
					y(Transversal)	3.73	-27.26	-55.83		30.99	T4	30
LTE Band 66 Voice EVS WB Codec: 5.9 kbit/s	CH.132072 1720 MHz	20 MHz	QPSK	50/0	z(Axial)	4.69	-25.68	-55.32	1.51	30.37	T4	
					y(Transversal)	5.52	-25.79	-55.83		31.32	T4	
	CH.132572 1770 MHz	20 MHz	QPSK	50/0	z(Axial)	-1.31	-31.03	-55.32	1.3	29.72	T3	
					y(Transversal)	-9.82	-40.53	-55.83		30.71	T4	

Air Interface Investigation(Contiued)

LTE-TDD

Mode	Ch. Freq.	BW	BW/ Modulation	RB Config.	Orientation	ABM1 dB(A/m)	ABM2 dB(A/m)	Ambient Noise dB(A/m)	Freq. Response (dB)	ABM SNR (dB)	T-Rating	Plot No.
LTE Band 48 Voice EVS-WB Codec: 5.9kbit/s	CH.55990 3625 Mhz	20 Mhz	QPSK	1/0	z(Axial)	9.56	-18.21	-55.43	1.38	27.77	T3	
					y(Transversal)	6.15	-23.15	-55.74		29.30	T3	
				1/49	z(Axial)	18.01	-12.62	-55.43	1.61	30.64	T4	
					y(Transversal)	7.97	-21.87	-55.74		29.84	T3	
				1/99	z(Axial)	14.63	-15.94	-55.43	1.35	30.57	T4	
					y(Transversal)	6.21	-20.25	-55.74		26.46	T3	
				50/0	z(Axial)	14.95	-15.23	-55.43	1.72	30.18	T4	
					y(Transversal)	9.77	-19.81	-55.74		29.58	T3	
				50/25	z(Axial)	17.23	-13.05	-55.43	1.45	30.28	T4	
					y(Transversal)	8.58	-20.59	-55.74		29.17	T3	
				50/49	z(Axial)	8.69	-22.42	-55.43	1.65	31.11	T4	
					y(Transversal)	6.53	-23.1	-55.74		29.63	T3	
		100/0	z(Axial)	5.29	-24.95	-55.43	1.19	30.25	T4			
			y(Transversal)	5.46	-24.33	-55.74		29.80	T3			
		16QAM	1/99	z(Axial)	5.3	-26.66	-55.43	1.26	31.95	T4		
				y(Transversal)	5.83	-24.93	-55.74		30.76	T4		
		64QAM	1/99	z(Axial)	15.16	-15.48	-55.43	1.4	30.65	T4		
				y(Transversal)	-5.03	-33.8	-55.74		28.77	T3		
		256QAM	1/99	z(Axial)	14.71	-14.95	-55.43	1.31	29.66	T3		
				y(Transversal)	7.11	-22.15	-55.74		29.26	T3		
		15 Mhz	QPSK	1/74	z(Axial)	9.17	-21.08	-55.43	1.37	30.26	T4	
					y(Transversal)	3.98	-27.08	-55.74		31.06	T4	
		10 Mhz	QPSK	1/49	z(Axial)	2.47	-35.38	-55.43	1.67	37.85	T4	
					y(Transversal)	7.93	-24.56	-55.74		32.49	T4	
5 Mhz	QPSK	1/24	z(Axial)	15.45	-12.22	-55.43	1.54	27.66	T3			
			y(Transversal)	-13.89	-39.77	-55.74		25.88	T3			

Mode	Ch. Freq.	BW	BW/ Modulation	RB Config.	Orientation	ABM1 dB(A/m)	ABM2 dB(A/m)	Ambient Noise dB(A/m)	Freq. Response (dB)	ABM SNR (dB)	T-Rating	Plot No.
LTE Band 48 Voice EVS-WB Codec: 5.9kbit/s	CH.55265 3552.5 MHz	5 MHz	QPSK	1/24	z(Axial)	15.37	-14.87	-55.43	1.17	30.23	T4	31/32
					y(Transversal)	-6.67	-32.20	-55.74		25.52	T3	33
	z(Axial)				1.66	-36.30	-55.43	1.43	37.95	T4		
	y(Transversal)				8.26	-24.53	-55.74		32.79	T4		
	z(Axial)				16.00	-15.92	-55.43	1.35	31.92	T4		
	y(Transversal)				5.06	-23.45	-55.74		28.51	T3		
	z(Axial)				10.60	-18.14	-55.43	1.16	28.75	T3		
	CH.56232 3649.2 MHz				y(Transversal)	3.14	-25.00	-55.74		28.15	T3	
	CH.56715 3697.5 MHz											

NR-FDD RB/ Modulation configuration

Mode	Ch. Freq.	BW	Waveform	BW/ Modulation	RB Config.	Orientation	ABM1 dB(A/m)	ABM2 dB(A/m)	Ambient Noise dB(A/m)	Freq. Response (dB)	ABM SNR (dB)	T-Rating	Plot No.	
NR Band 66 Voice EVS-WB Codec: 5.9 kbit/s	CH.349000 1745 MHz	20 MHz	CP-OFDM	QPSK	1/1	z(Axial)	6.6	-39.23	-55.67	1.89	45.82	T4		
						y(Transversal)	-1.77	-34.99	-55.89		33.22	T4		
					1/53	z(Axial)	6.61	-38.75	-55.67	1.62	45.36	T4		
						y(Transversal)	-0.12	-35.31	-55.89		35.19	T4		
					1/104	z(Axial)	5.63	-38.95	-55.67	1.56	44.57	T4		
						y(Transversal)	-2.15	-34.89	-55.89		32.75	T4		
					53/0	z(Axial)	9.73	-38.52	-55.67	1.64	48.26	T4		
						y(Transversal)	-2.72	-46.83	-55.89		44.12	T4		
					53/27	z(Axial)	-1.58	-31.75	-55.42	2	30.17	T4		
						y(Transversal)	2.15	-29.71	-55.95		31.86	T4		
					53/53	z(Axial)	-0.26	-31.04	-55.42	2	30.78	T4		
						y(Transversal)	0.48	-26.99	-55.95		27.47	T3		
				106/0	z(Axial)	-0.88	-35.84	-55.42	2	34.96	T4			
					y(Transversal)	0.08	-28.63	-55.95		28.71	T3			
				16QAM	53/53	z(Axial)	4.83	-28.49	-55.42	2	33.32	T4		
						y(Transversal)	0.34	-29.38	-55.95		29.72	T3		
				64QAM	53/53	z(Axial)	0.25	-36.72	-55.42	2	36.97	T4		
						y(Transversal)	0.55	-29.57	-55.95		30.12	T4		
				256QAM	53/53	z(Axial)	13.05	-21.87	-55.42	2	34.92	T4		
						y(Transversal)	0.05	-30.97	-55.95		31.02	T4		
				DFTs-OFDM	1/1	z(Axial)	-1.46	-33.91	-55.67	2	32.45	T4		
						y(Transversal)	0.17	-31.09	-55.89		31.26	T4		
					1/53	z(Axial)	3.8	-30.63	-55.67	1.57	34.43	T4		
						y(Transversal)	1.77	-34.3	-55.89		36.07	T4		
		1/105	z(Axial)		2.63	-32.92	-55.67	1.92	35.54	T4				
			y(Transversal)		3.57	-29.77	-55.89		33.34	T4				
		50/0	z(Axial)		2.82	-35.35	-55.67	2	38.17	T4				
			y(Transversal)		6.32	-29.33	-55.89		35.65	T4				
		50/28	z(Axial)		2.65	-34.02	-55.67	2	36.67	T4				
			y(Transversal)		6.17	-28.6	-55.89		34.77	T4				
		50/56	z(Axial)		2.76	-34.92	-55.67	1.96	37.68	T4				
			y(Transversal)		6.37	-28.44	-55.89		34.8	T4				
		100/0	z(Axial)		2.93	-35.45	-55.67	2	38.38	T4				
			y(Transversal)		6.44	-29.01	-55.89		35.45	T4				
		BPSK	1/1		z(Axial)	9.51	-38.63	-55.67	1.72	48.14	T4			
					y(Transversal)	-0.1	-45.23	-55.89		45.13	T4			
		16QAM	1/1		z(Axial)	6.73	-38.47	-55.67	1.75	45.21	T4			
					y(Transversal)	-1.79	-34.6	-55.89		32.81	T4			
		64QAM	1/1		z(Axial)	3.25	-38.57	-55.67	1.93	41.82	T4			
					y(Transversal)	-2.25	-35.14	-55.89		32.89	T4			
		256QAM	1/1		z(Axial)	8.37	-38.83	-55.67	1.91	47.2	T4			
					y(Transversal)	0.19	-35.05	-55.89		35.24	T4			
		15 MHz	CP-OFDM		QPSK	39/40	z(Axial)	0.51	-34.83	-55.42	2	35.34	T4	
							y(Transversal)	-0.5	-27.85	-55.95		27.35	T3	
				26/26		z(Axial)	0.25	-35.82	-55.42	2	36.07	T4		
						y(Transversal)	1.31	-28.63	-55.95		29.93	T3		
				13/12		z(Axial)	0.8	-30.79	-55.42	2	31.58	T4		
						y(Transversal)	-1.46	-29.27	-55.95		27.8	T3		
10 MHz	CP-OFDM	QPSK	39/40	z(Axial)	0.51	-34.83	-55.42	2	35.34	T4				
				y(Transversal)	-0.5	-27.85	-55.95		27.35	T3				
			26/26	z(Axial)	0.25	-35.82	-55.42	2	36.07	T4				
				y(Transversal)	1.31	-28.63	-55.95		29.93	T3				
			13/12	z(Axial)	0.8	-30.79	-55.42	2	31.58	T4				
				y(Transversal)	-1.46	-29.27	-55.95		27.8	T3				
5 MHz	CP-OFDM	QPSK	39/40	z(Axial)	0.51	-34.83	-55.42	2	35.34	T4				
				y(Transversal)	-0.5	-27.85	-55.95		27.35	T3				
			26/26	z(Axial)	0.25	-35.82	-55.42	2	36.07	T4				
				y(Transversal)	1.31	-28.63	-55.95		29.93	T3				
			13/12	z(Axial)	0.8	-30.79	-55.42	2	31.58	T4				
				y(Transversal)	-1.46	-29.27	-55.95		27.8	T3				

Mode	Ch. Freq.	BW	Waveform	BW/Modulation	RB Config.	Orientation	ABM1 dB(A/m)	ABM2 dB(A/m)	Ambient Noise dB(A/m)	Freq. Response (dB)	ABM SNR (dB)	T-Rating	Plot No.
NR Band n2 Voice EVS-WB Codec: 5.9 kbit/s	CH.376000 1880 MHz	15 MHz	CP-OFDM	QPSK	39/40	z(Axial)	-2.70	-36.89	-55.42	2	34.20	T4	34/35
						y(Transversal)	1.65	-28.72	-55.95		30.37	T4	36
NR Band n5 Voice EVS-WB Codec: 5.9 kbit/s	CH.167300 836.5 MHz	15 MHz	CP-OFDM	QPSK	39/40	z(Axial)	9.57	-27.64	-55.42	2	37.20	T4	37/38
						y(Transversal)	0.12	-36.38	-55.95		36.50	T4	39
NR Band n66 Voice EVS-WB Codec: 5.9 kbit/s	CH.343500 1717.5 MHz	15 MHz	CP-OFDM	QPSK	39/40	z(Axial)	-2.41	-35.22	-55.42	2	32.81	T4	
						y(Transversal)	0.58	-27.34	-55.95		27.92	T3	
NR Band n66 Voice EVS-WB Codec: 5.9 kbit/s	CH.354500 1772.5 MHz	15 MHz	CP-OFDM	QPSK	39/40	z(Axial)	-0.68	-32.79	-55.42	2	32.11	T4	40/41
						y(Transversal)	0.51	-26.54	-55.95		27.05	T3	42

NR-TDD RB/ Modulation configuration

Mode	Ch. Freq.	BW	Waceform	BW/ Modulation	RB Config.	Orientation	ABM1 dB(A/m)	ABM2 dB(A/m)	Ambient Noise dB(A/m)	Freq. Response (dB)	ABM SNR (dB)	T- Rating	Plot No.	
NR Band 77 Voice EVS-WB Codec: 5.9 kbit/s	CH.656000 3840 MHz	100 MHz	CP-OFDM	QPSK	1/1	z(Axial)	6.25	-26.25	-55.73	2	32.5	T4		
						y(Transversal)	3.2	-21.56	-55.88		24.76	T3		
					1/137	z(Axial)	2.81	-31.4	-55.73	2	34.21	T4		
						y(Transversal)	5.51	-19.42	-55.88		24.93	T3		
					1/271	z(Axial)	8.02	-26.43	-55.73	2	34.45	T4		
						y(Transversal)	2.2	-23.51	-55.88		25.71	T3		
					137/0	z(Axial)	11.68	-22.52	-55.73	2	34.2	T4		
						y(Transversal)	0.23	-23.6	-55.88		23.83	T3		
					137/68	z(Axial)	2.9	-29.48	-55.73	2	32.38	T4		
						y(Transversal)	4.34	-20.28	-55.88		24.62	T3		
					137/136	z(Axial)	10.54	-22.16	-55.73	2	32.7	T4		
						y(Transversal)	2.02	-23.55	-55.88		25.57	T3		
					273/0	z(Axial)	5.65	-26.32	-55.73	2	31.98	T4		
						y(Transversal)	1.5	-21.59	-55.88		23.1	T3		
					16QAM	273/0	z(Axial)	10.41	-22.22	-55.73	2	32.63	T4	
							y(Transversal)	6.36	-19.49	-55.88		25.85	T3	
					64QAM	273/0	z(Axial)	7.48	-26.52	-55.73	2	34	T4	
							y(Transversal)	3.04	-23.78	-55.88		26.82	T3	
					256QAM	273/0	z(Axial)	5.94	-26.52	-55.73	2	32.46	T4	
							y(Transversal)	-0.33	-23.82	-55.88		23.49	T3	
			DFTs-OFDM	QPSK	1/1	z(Axial)	1.62	-31.85	-55.67	2	33.47	T4		
						y(Transversal)	2.53	-21.5	-55.89		24.03	T3		
					1/137	z(Axial)	2.58	-36.17	-55.67	2	38.75	T4		
						y(Transversal)	3.65	-20.07	-55.89		23.72	T3		
					1/271	z(Axial)	6.62	-24.58	-55.67	2	31.2	T4		
						y(Transversal)	4.53	-18.86	-55.89		23.39	T3		
					135/0	z(Axial)	1.85	-36.11	-55.67	2	37.96	T4		
						y(Transversal)	-6.57	-29.99	-55.89		23.42	T3		
					135/69	z(Axial)	2.82	-36.14	-55.67	2	38.96	T4		
						y(Transversal)	-5.44	-29.96	-55.89		24.52	T3		
					135/138	z(Axial)	2.38	-35.87	-55.67	2	38.25	T4		
						y(Transversal)	-7.18	-31.02	-55.89		23.84	T3		
					270/0	z(Axial)	1.36	-36.09	-55.67	2	37.45	T4	43/44	
						y(Transversal)	1.28	-21.78	-55.89		23.06	T3	45	
					BPSK	270/0	z(Axial)	3.32	-31.41	-55.67	2	34.73	T4	
							y(Transversal)	44.19	-20.51	-55.89		24.71	T3	
					16QAM	270/0	z(Axial)	5.94	-25.29	-55.67	2	31.23	T4	
							y(Transversal)	3.4	-20.53	-55.89		23.94	T3	
					64QAM	270/0	z(Axial)	0.15	-31.34	-55.67	2	31.49	T4	
							y(Transversal)	2.44	-22.82	-55.89		25.26	T3	
256QAM	270/0	z(Axial)	5.64	-25.65	-55.67	2	31.29	T4						
		y(Transversal)	3.77	-20.87	-55.89		24.65	T3						

Mode	Ch. Freq.	BW	Waveform	BW/ Modulation	RB Config.	Orientation	ABM1 dB(A/m)	ABM2 dB(A/m)	Ambient Noise dB(A/m)	Freq. Response (dB)	ABM SNR (dB)	T-Rating	Plot No.
NR Band 77 Voice EVS-WB Codec: 5.9 kbit/s	CH.656000 3840 MHz	90 MHz	DFTs-OFDM	QPSK	243/0	z(Axial)	7.11	-25.21	-55.67	2	32.32	T4	
						y(Transversal)	4.37	-20.82	-55.89		25.19	T3	
		80 MHz			216/0	z(Axial)	1.35	-35.58	-55.67	2	36.93	T4	
						y(Transversal)	5.55	-19.1	-55.89		24.65	T3	
		70 MHz			180/0	z(Axial)	0.48	-35.53	-55.75	2	36.01	T4	
						y(Transversal)	2.81	-23.03	-55.89		25.84	T3	
		60 MHz			162/0	z(Axial)	-0.8	-36.66	-55.75	2	35.86	T4	
						y(Transversal)	2.65	-20.81	-55.89		23.47	T3	
		50 MHz			128/0	z(Axial)	0.56	-33.48	-55.75	2	34.04	T4	
						y(Transversal)	5.82	-20.83	-55.89		26.64	T3	
		40 MHz			100/0	z(Axial)	-0.07	-36.9	-55.75	2	36.83	T4	
						y(Transversal)	0.37	-24.2	-55.89		24.57	T3	
		30 MHz			75/0	z(Axial)	-0.005	-37.27	-55.75	2	37.26	T4	
						y(Transversal)	2.54	-24.2	-55.89		26.74	T3	
		25 MHz			64/0	z(Axial)	-1.03	-37.29	-55.75	2	36.27	T4	
						y(Transversal)	3.04	-20.87	-55.89		23.91	T3	
		20 MHz			50/0	z(Axial)	-0.85	-31.16	-55.75	2	30.31	T4	
						y(Transversal)	5.5	-19.79	-55.89		25.29	T3	
		15 MHz			36/0	z(Axial)	1.39	-34.79	-55.75	2	36.18	T4	
						y(Transversal)	-1.61	-31.94	-55.89		30.33	T3	
10 MHz	24/0	z(Axial)	-0.06	-32.3	-55.75	2	32.24	T4					
		y(Transversal)	7.06	-22.1	-55.75		29.16	T3					
CH.633334 3500.01 MHz	100 MHz	270/0	z(Axial)	0.05	-34.95	-55.75	2	35	T4				
			y(Transversal)	4.32	-21.08	-55.89		25.4	T3				
NR Band n77 Voice EVS-WB Codec: 5.9 kbit/s	CH.650000 3750 MHz CH.662000 3930 MHz	100 MHz	DFTs-OFDM	QPSK	270/0	z(Axial)	3.29	-31.63	-55.75	2	34.92	T4	
						y(Transversal)	1.64	-22.16	-55.89		23.81	T3	
					270/0	z(Axial)	11.2	-20.06	-55.75	2	31.26	T4	
						y(Transversal)	4.3	-21.02	-55.89		25.32	T3	

12.4 VoWi-Fi Codec Investigation

An investigation between the various codec configurations (Low/High bit rates for Narrowband, Wideband) and specific parameters are documented (ABM1, ABM2, S+N/N, frequency response) to determine the worst-case bit rates for each voice service type. The table below compares the varying codec configurations. A codec investigation was performed for each Wi-Fi 2.4 GHz and 5 GHz.

The highlighted results below were determined to be the worst case codec configuration(s) for Wi-Fi 2.4 GHz and 5 GHz.

Codec Investigation								
Codec State	AMR-NB (kbit/s)			AMR-WB (kbit/s)			Orientation	Band/ Bandwidth/ Channel
	4.75	7.4	12.2	6.6	15.85	23.85		
ABM1 (dB/m)	13.3	10.64	14.38	10.07	17.64	17.73	z (Axial)	802.11b CH.6 2437 MHz DSSS 1 Mbps
ABM2 (dBA/m)	-30.63	-33.72	-30.49	-19.04	-17.78	-16.77		
S+N/N (dB)	43.93	44.36	44.87	29.11	35.42	34.5		
Freq. Resposne(dB)	2	2	2	1.73	1.17	1.03		
ABM1 (dB/m)	-11.75	-11.32	-10.64	-8.91	-7.32	-7.22	y (Transversal)	
ABM2 (dBA/m)	-44.11	-43.83	-43.95	-37.06	-40.36	-39.63		
S+N/N (dB)	32.36	32.5	33.31	28.15	33.04	32.41		

Codec Investigation											
Codec State	EVS-NB (kbit/s)			EVS-WB (kbit/s)			EVS-SWB (kbit/s)			Orientation	Band/ BandWidth/ Channel
	5.9	13.2	24.4	5.9	24.4	128	9.6	24.4	128		
ABM1 (dB/m)	10.12	14.06	13.96	4.14	17.28	11.93	12.78	15.93	19.17	z (Axial)	802.11b CH.6 2437 MHz DSSS 1 Mbps
ABM2 (dBA/m)	-24.55	-31.3	-31.84	-22.59	-20.51	-19.01	-18.46	-16	-11.75		
S+N/N (dB)	34.67	45.35	45.8	26.73	37.79	30.94	31.24	31.93	30.92		
Freq.Resposne(dB)	1.92	1.99	1.91	1.24	1.06	1.04	2	2	2		
ABM1 (dB/m)	-7.76	-10.73	-11.27	-11.32	-7.03	-6.68	5.98	-14.04	-5.17	y (Transversal)	
ABM2 (dBA/m)	-41.96	-45.68	-45.37	-37.07	-42.55	-31.07	-25.76	-44.37	-35.57		
S+N/N (dB)	34.2	34..95	34.11	25.75	35.52	29.98	31.74	30.33	30.39		

Codec Investigation								
Codec State	AMR-NB (kbit/s)			AMR-WB (kbit/s)			Orientation	Band/ Bandwidth/ Channel
	4.75	7.4	12.2	6.6	15.85	23.85		
ABM1 (dB/m)	12.46	13.57	14.13	9.81	14.56	17.58	z (Axial)	802.11a CH.40 5200 MHz BPSK 6 Mbps
ABM2 (dBA/m)	-32.73	-31.87	-32.42	-19.98	-20.32	-17.06		
S+N/N (dB)	45.19	45.45	46.55	29.78	34.88	34.63		
Freq. Resposne(dB)	2	2	2	2	1.05	1.02		
ABM1 (dB/m)	2.43	3.16	3.91	5.93	7.16	4.81	y (Transversal)	
ABM2 (dBA/m)	-35.36	-34.86	-35.1	-23.3	-27.3	-29.05		
S+N/N (dB)	37.79	38.02	39.01	29.23	34.45	33.86		

Codec Investigation											
Codec State	EVS-NB (kbit/s)			EVS-WB (kbit/s)			EVS-SWB (kbit/s)			Orientation	Band/ BandWidth/ Channel
	5.9	13.2	24.4	5.9	24.4	128	9.6	24.4	128		
ABM1 (dB/m)	11.65	14.41	11.43	10.3	14.96	18.24	7.36	19.39	19.57	z (Axial))	802.11a CH.40 5200 MHz BPSK 6 Mbps
ABM2 (dBA/m)	-29.38	-29.59	-34	-19.8	-22.69	-14.14	-23.59	-11.51	-11.25		
S+N/N (dB)	41.04	44	45.42	30.1	37.65	32.38	30.95	30.9	30.82		
Freq.Resposne(dB)	1.64	2	1.86	1.09	1.06	1.07	2	2	2		
ABM1 (dB/m)	0.93	3.81	3.8	3.19	7.03	7.76	6.68	8.98	9.25	y (Transversal)	
ABM2 (dBA/m)	-36.8	-34.62	-34.98	-26.83	-29.13	-24.2	-24.13	-21.7	-21.59		
S+N/N (dB)	37.73	38.42	38.79	30.03	36.17	31.96	30.8	30.68	30.84		

12.5 VoWi-Fi Air Interface Investigation

Using the data from §9.4, further testing was performed on the remaining 802.11 modes. The objective of these measurements is to ensure that changing the modulation, bandwidth, and data rate, whilst using the worst case codec configuration measured in §9.4, yields no unexpected variations.

Moe	Ch. Freq.	BW	BW/ Modulation	Orientation	ABM1 dB(A/m)	ABM2 dB(A/m)	Ambient Noise dB(A/m)	Freq. Response (dB)	ABM SNR (dB)	T-Rating	Plot No.
802.11b Voice EVS-WB Codec: 5.9 kbit/s	CH.6 2437 MHz	20 MHz	DSSS 1 Mbps	z(Axial)	4.14	-22.59	-55.33	1.24	26.73	T4	
				y(Transversal)	-11.32	-37.07	-55.89	___	25.75	T3	
			CCK 5.5 Mbps	z(Axial)	3.28	-26.16	-55.33	1.78	29.44	T4	
				y(Transversal)	-9.22	-35.61	-55.89	___	26.39	T3	
	CCK 11 Mbps		z(Axial)	13.73	-12.10	-55.33	1.26	25.82	T4	46/47	
			y(Transversal)	-11.80	-36.25	-55.89	___	24.45	T3	48	
	CH.1 2412 MHz		CCK 11 Mbps	z(Axial)	4.57	-21.36	-55.33	1.25	25.94	T4	
				y(Transversal)	-7.26	-32.71	-55.89	___	25.45	T3	
CH.11 2462 MHz	CCK 11 Mbps	z(Axial)	4.08	-20.99	-55.33	1.59	25.06	T4			
		y(Transversal)	-3.46	-28.12	-55.89	___	24.67	T4			
802.11g Voice EVS-WB Codec: 5.9 kbit/s	CH.6 2437 MHz	20 MHz	BPSK 6 Mbps	z(Axial)	13.04	-16.13	-55.33	1.21	29.17	T4	
				y(Transversal)	5.55	-19.52	-55.89	___	25.07	T4	
802.11n HT20 Voice EVS-WB Codec: 5.9 kbit/s	CH.6 2437 MHz	20 MHz	MCS 0 6.5 Mbps	z(Axial)	11.94	-14.71	-55.33	1.36	26.64	T4	
				y(Transversal)	1.29	-25.13	-55.89	___	26.41	T4	

VoWi-Fi Air Interface Investigation (Continued)

Mode	Ch. Freq.	BW	BW /Modulation	Orientation	ABM1 dB(A/m)	ABM2 dB(A/m)	Ambient Noise dB(A/m)	Freq. Response (dB)	ABM SNR (dB)	T-Rating	Plot No.
802.11a Voice AMR-WB Codec: 6.6kbit/s	CH.40 5200 MHz	20 MHz	BPSK 6 Mbps	z(Axial)	9.81	-19.98	-55.59	2	29.78	T3	
				y(Transversal)	5.93	-23.3	-55.85		29.23	T3	
			QPSK 18 Mbps	z(Axial)	4.08	-25.54	-55.59	1.89	29.63	T3	
				y(Transversal)	0.93	-28.48	-55.85		29.42	T3	
64QAM 54 Mbps	z(Axial)	13.39	-16.01	-55.59	1.99	29.4	T3				
	y(Transversal)	2.48	-26.78	-55.85		29.26	T3				
802.11n HT20 Voice AMR-WB Codec: 6.6kbit/s	CH.40 5200 MHz	20 MHz	MCS 0 6.5 Mbps	z(Axial)	13.27	-15.85	-55.59	1.80	29.12	T3	49/ 50
				y(Transversal)	3.78	-24.88	-55.85		28.66	T3	51
			MCS 3 26 Mbps	z(Axial)	12.94	-15.92	-55.59	1.83	28.86	T3	
				y(Transversal)	5.8	-22.94	-55.85		28.74	T3	
MCS 7 65 Mbps	z(Axial)	16.09	-13.83	-55.59	1.57	29.92	T3				
	y(Transversal)	1.73	-27.66	-55.85		29.39	T3				
802.11n HT40 Voice AMR-WB Codec: 6.6kbit/s	CH.38 5190 MHz	40 MHz	MCS 0 13.5 Mbps	z(Axial)	9.47	-20.65	-55.25	1.86	30.11	T4	
				y(Transversal)	-3.52	-33.12	-55.72		29.59	T3	
			MCS 3 54 Mbps	z(Axial)	15.7	-24.44	-55.25	1.68	40.14	T4	
				y(Transversal)	3.6	-33.83	-55.72		37.43	T4	
MCS 7 135 Mbps	z(Axial)	13.57	-21.93	-55.25	1.69	35.5	T4				
	y(Transversal)	2.7	-34.28	-55.72		36.99	T4				
802.11ac VHT20 Voice AMR-WB Codec: 6.6kbit/s	CH.40 5200 MHz	20 MHz	MCS 0 6.5 Mbps	z(Axial)	7.11	-21.97	-55.25	1.6	29.08	T3	
				y(Transversal)	-0.17	-29.35	-55.72		29.18	T3	
			MCS 4 39 Mbps	z(Axial)	9.96	-19.22	-55.25	1.9	29.18	T3	
				y(Transversal)	5.78	-23.08	-55.72		28.87	T3	
MCS 8 78 Mbps	z(Axial)	15.52	-13.5	-55.25	1.62	29.02	T3				
	y(Transversal)	7.18	-21.56	-55.72		28.74	T3				
802.11ac VHT40 Voice AMR-WB Codec: 6.6kbit/s	CH.38 5190 MHz	40 MHz	MCS 0 13.5 Mbps	z(Axial)	13.54	-15.31	-55.25	1.93	28.85	T3	
				y(Transversal)	3.93	-25.45	-55.72		29.38	T3	
			MCS 4 81 Mbps	z(Axial)	12.83	-16.36	-55.25	1.71	28.93	T3	
				y(Transversal)	0.68	-28.25	-55.72		28.93	T3	
MCS 9 180 Mbps	z(Axial)	16.2	-12.79	-55.25	1.82	28.98	T3				
	y(Transversal)	7.76	-20.96	-55.72		28.72	T3				
802.11ac VHT80 Voice AMR-WB Codec: 6.6kbit/s	CH.42 5210 MHz	80 MHz	MCS 0 29.3 Mbps	z(Axial)	16.04	-12.99	-55.25	1.93	29.03	T3	
				y(Transversal)	-1.18	-30.17	-55.72		28.99	T3	
			MCS 4 175.5Mbps	z(Axial)	7.53	-23.02	-55.25	1.66	30.55	T4	
				y(Transversal)	5	-25.59	-55.72		30.59	T4	
MCS 9 390 Mbps	z(Axial)	12.66	-16.99	-55.25	1.83	29.66	T3				
	y(Transversal)	1.33	-28.98	-55.72		30.31	T4				

Mode	Ch. Freq.	BW	BW /Modulation	Orientation	ABM1 dB(A/m)	ABM2 dB(A/m)	Ambient Noise dB(A/m)	Freq. Response (dB)	ABM SNR (dB)	T-Rating	Plot No.
802.11n20 Voice AMR-WB Codec: 6.6kbit/s	CH.56 5280 MHz	20 MHz	MCS 0 6.5 Mbps	z(Axial)	15.46	-14.13	-55.59	1.90	29.59	T3	52/53
				y(Transversal)	5.90	-23.91	-55.85		29.81	T3	54
802.11n20 Voice AMR-WB Codec: 6.6kbit/s	CH.120 5600 MHz	20 MHz	MCS 0 6.5Mbps	z(Axial)	9.94	-19.58	-55.59	1.69	29.52	T3	55/56
				y(Transversal)	3.65	-25.47	-55.85		29.12	T3	57
802.11n20 Voice AMR-WB Codec: 6.6kbit/s	CH.157 5785 MHz	20 MHz	MCS 0 6.5Mbps	z(Axial)	11.98	-17.34	-55.59	1.86	29.31	T3	58/59
				y(Transversal)	-4.83	-33.91	-55.85		29.08	T3	60
802.11n20 Voice AMR-WB Codec: 6.6kbit/s	CH.36 5180 MHz	20 MHz	MCS 0 6.5Mbps	z(Axial)	16.51	-13.37	-55.59	1.81	29.88	T3	
				y(Transversal)	7.36	-21.67	-55.85		29.03	T3	
802.11n20 Voice AMR-WB Codec: 6.6kbit/s	CH.48 5240 MHz	20 MHz	MCS 0 6.5Mbps	z(Axial)	15.99	-13.69	-55.59	1.77	29.68	T3	
				y(Transversal)	-0.54	-29.94	-55.85		29.4	T3	

12.6 OTT Codec Investigation

The DUT's nested OTT application supports range of codec bit rate 6 – 75 kbit/s, thus an investigation between the various codec configurations (6/75 as Low/High bit rates) and specific parameters are documented (ABM1, ABM2, S+N/N, frequency response) to determine the worst-case bit rates for each service type.

The table below compares the varying codec configurations.

Codec Investigation					
Codec State	codec bit rate (kbit/s)			Orientation	Band/ BandWidth/ Channel
	6	40	75		
ABM1 (dB/m)	16.94	9.46	6	z (Axial)	GSM 1900 EDGE 2 slots CH.810 1909.8 MHz
ABM2 (dBA/m)	-30.81	-34.64	-32.99		
S+N/N (dB)	47.75	44.1	38.99		
Freq.Resposne (dB)	1.29	1.79	1.6		
ABM1 (dB/m)	7.52	-10.7	7.62	y(Transversal)	
ABM2 (dBA/m)	-32.48	-43.83	-26.66		
S+N/N (dB)	40	33.13	34.28		
ABM1 (dB/m)	16.9	18.28	18.34	z (Axial)	
ABM2 (dBA/m)	-36.96	-37.07	-38.01		
S+N/N (dB)	53.86	55.35	56.36		
Freq.Resposne (dB)	1.8	2	1.84		
ABM1 (dB/m)	7.22	7.76	7.71	y(Transversal)	
ABM2 (dBA/m)	-47	-46.98	-47.21		
S+N/N (dB)	54.23	54.74	54.92		
ABM1 (dB/m)	19.48	17.73	17.87	z (Axial)	LTE Band 66 20 MHz QPSK 50RB0offset CH.132322 1745 MHz
ABM2 (dBA/m)	-34.43	-37.01	-36.41		
S+N/N (dB)	53.91	54.74	54.28		
Freq.Resposne (dB)	1.8	1.84	1.82		
ABM1 (dB/m)	10.79	10.89	6.99	y(Transversal)	
ABM2 (dBA/m)	-39.35	-38.86	-43.11		
S+N/N (dB)	50.15	49.75	50.1		

Codec Investigation					
Codec State	codec bit rate (kbit/s)			Orientation	Band/ BandWidth/ Channel
	6	40	75		
ABM1 (dB/m)	17.9	19.88	18.11	z (Axial)	LTE Band 48 5 MHz QPSK 1RB 24offset CH.55265 3625 MHz
ABM2 (dBA/m)	-34.3	-32.2	-33.79		
S+N/N (dB)	52.2	52.08	51.91		
Freq.Resposne (dB)	1.72	1.93	1.87		
ABM1 (dB/m)	8.81	9.18	9.08	y(Transversal)	
ABM2 (dBA/m)	-36.5	-36.37	-36.45		
S+N/N (dB)	45.3	45.55	45.53		
ABM1 (dB/m)	18.25	18.72	18.6	z (Axial)	
ABM2 (dBA/m)	-37.2	-37.5	-35.69		
S+N/N (dB)	55.45	56.21	54.29		
Freq.Resposne (dB)	1.74	2	1.91		
ABM1 (dB/m)	11.96	0.3	0.3	y(Transversal)	
ABM2 (dBA/m)	-29.92	-42.24	-42.21		
S+N/N (dB)	41.88	42.54	42.51		
ABM1 (dB/m)	18.29	18.75	18.78	z (Axial)	802.11n20 CH.40 5200 MHz MCS 0
ABM2 (dBA/m)	-36.98	-36.56	-36.28		
S+N/N (dB)	55.27	55.32	55.06		
Freq.Resposne (dB)	2	2	1.85		
ABM1 (dB/m)	11.8	12	10.13	y(Transversal)	
ABM2 (dBA/m)	-36.34	-35.85	-37.94		
S+N/N (dB)	48.14	47.84	48.07		

Codec Investigation					
Codec State	codec bit rate (kbit/s)			Orientation	Band/ BandWidth/ Channel
	6	40	75		
ABM1 (dB/m)	9.12	17.49	9.18	z (Axial)	n66 CP 15MHz 40RB 39offset ch.354500 1772.5 MHz
ABM2 (dBA/m)	-32.89	-29.81	-33		
S+N/N (dB)	42.01	47.3	42.18		
Freq.Resposne (dB)	1.55	1.99	1.98		
ABM1 (dB/m)	10	10.22	10.09	y(Transversal)	
ABM2 (dBA/m)	-30.56	-30.73	-30.67		
S+N/N (dB)	40.56	40.95	40.76		
ABM1 (dB/m)	8.97	9.38	9.23	z (Axial)	
ABM2 (dBA/m)	-34.11	-33.99	-33.75		
S+N/N (dB)	43.07	43.38	42.98		
Freq.Resposne (dB)	1.81	2	2		
ABM1 (dB/m)	11.46	8.84	8.6	y(Transversal)	
ABM2 (dBA/m)	-20.37	-23.94	-23.93		
S+N/N (dB)	31.83	32.77	32.52		

12.7 OTT Air Interface Investigation

Mode	Ch. Freq.	BW	BW/ Mode	RB Config.	Orientation	ABM1 dB(A/m)	ABM2 dB(A/m)	Ambient Noise dB(A/m)	Freq. Response (dB)	ABM SNR (dB)	T-Rating	Plot No.
GSM850 EDGE 2 slots Duo Codec: 40 kbit/s	CH.190 836.6 MHz				z(Axial)	15.76	-29.86	-54.29	1.29	45.62	T4	61/62
					y(Transversal)	9.69	-29.13	-54.79		38.82	T4	63
GSM1900 EDGE 2 slots Duo Codec: 40 kbit/s	CH.810 1909.8 MHz				z(Axial)	9.46	-34.64	-54.29	1.79	44.10	T4	64/65
					y(Transversal)	-10.70	-43.83	-54.79		33.13	T4	66
WCDMA Band II HSUPA subtest1 Duo Codec: 6 kbit/s	CH.9400 1880.0 MHz				z(Axial)	19.13	-33.76	-54.29	1.63	52.89	T4	67/68
					y(Transversal)	7.36	-45.81	-54.79		53.17	T4	69
WCDMA Band V HSUPA subtest1 Duo Codec: 6 kbit/s	CH.4132 826.4 MHz				z(Axial)	16.90	-36.96	-54.29	1.80	53.86	T4	70/71
					y(Transversal)	7.22	-47.00	-54.79		54.23	T4	72
LTE Band 2 Google Duo Codec: 40 kbit/s	CH.18900 1880 MHz	20 MHz	QPSK	50/0	z(Axial)	18.03	-32.92	-54.09	1.87	50.95	T4	73/74
					y(Transversal)	11.10	-40.53	-54.52		51.63	T4	75
LTE Band 5 Google Duo Codec: 40 kbit/s	CH.20525 836.5 MHz	10 MHz	QPSK	25/0	z(Axial)	17.98	-33.86	-54.09	1.92	51.84	T4	76/77
					y(Transversal)	11.42	-40.75	-54.52		52.16	T4	78
LTE Band 7 Google Duo Codec: 40 kbit/s	CH.21100 2535 MHz	20 MHz	QPSK	50/0	z(Axial)	17.71	-35.09	-54.09	1.93	52.81	T4	79/80
					y(Transversal)	10.99	-40.80	-54.52		51.78	T4	81
LTE Band 12 Google Duo Codec: 40 kbit/s	CH.23095 707.5 MHz	10 MHz	QPSK	25/0	z(Axial)	18.61	-33.03	-54.09	1.95	51.64	T4	82/83
					y(Transversal)	11.66	-39.40	-54.52		51.06	T4	84
LTE Band 13 Google Duo Codec: 40 kbit/s	CH.23230 782 MHz	10 MHz	QPSK	25/0	z(Axial)	18.26	-32.43	-54.09	1.89	50.70	T4	85/86
					y(Transversal)	11.59	-39.18	-54.52		50.77	T4	87
LTE Band 66 Google Duo Codec: 40 kbit/s	CH.132322 1745 MHz	20 MHz	QPSK	50/0	z(Axial)	17.73	-37.01	-54.09	1.84	54.74	T4	88/89
					y(Transversal)	10.89	-38.86	-54.52		49.75	T4	90

Mode:	Ch./ Freq.	BW/ Data Rate	BW/ Modulation	RB Config	Orientation	ABM1 dB(A/m)	ABM2 dB(A/m)	Ambient Noise dB(A/m)	Freq. Response (dB)	ABM SNR(dB)	T-Rating	Plot No.
LTE Band 48 Google Duo Codec: 6 kbit/s	CH.55265 3552.5 MHz	20 MHz	QPSK	1/24	z(Axial)	17.90	-34.30	-54.09	1.72	52.20	T4	91/92
					y(Transversal)	8.81	-36.50	-54.52		45.31	T4	93
Wi-Fi 2.4 GHz 802.11b Google Duo Codec: 6 kbit/s	CH.6 2437 MHz	20 MHz	DSSS 11 Mbps		z(Axial)	18.25	-37.20	-53.25	1.74	55.45	T4	94/95
					y(Transversal)	11.96	-29.92	-54.66		41.88	T4	96
U-NII 5.2 GHz 802.11n20 Google Duo Codec: 40 kbit/s	CH.40 5200 MHz	20 MHz	MCS 0 6.5 Mbps		z(Axial)	18.75	-36.56	-53.25	2	55.32	T4	97/98
					y(Transversal)	12.00	-35.85	-54.66		47.84	T4	99
U-NII 5.3 GHz 802.11n20 Google Duo Codec: 40 kbit/s	CH.56 5280 MHz	20 MHz	MCS 0 6.5 Mbps		z(Axial)	18.43	-36.93	-53.25	2	55.36	T4	100/101
					y(Transversal)	12.07	-33.25	-54.66		45.33	T4	102
U-NII 5.6 GHz 802.11n20 Google Duo Codec: 40 kbit/s	CH.120 5600 MHz	20 MHz	MCS 0 6.5 Mbps		z(Axial)	18.57	-36.12	-53.25	2	54.68	T4	103/104
					y(Transversal)	9.83	-35.39	-54.66		45.21	T4	105
U-NII 5.8 GHz 802.11n20 Google Duo Codec: 40 kbit/s	CH.157 5785 MHz	20 MHz	MCS 0 6.5 Mbps		z(Axial)	15.84	-33.27	-53.25	2	49.11	T4	106/107
					y(Transversal)	9.72	-33.65	-54.66		43.38	T4	108
NR Band 2 Google Duo Codec: 6 kbit/s	CH. 376000 1880 MHz	15 MHz	CP QPSK	39/40	z(Axial)	9.56	-32.22	-55.10	1.88	41.78	T4	109/110
					y(Transversal)	10.06	-30.58	-55.75		40.64	T4	111
NR Band 5 Google Duo Codec: 6 kbit/s	CH. 167300 836.5 MHz	15 MHz	CP QPSK	39/40	z(Axial)	17.54	-26.36	-55.10	1.81	43.90	T4	112/113
					y(Transversal)	10.17	-36.98	-55.75		47.15	T4	114
NR Band 66 Google Duo Codec: 6 kbit/s	CH.354500 1772.5 MHz	15 MHz	CP QPSK	39/40	z(Axial)	9.12	-32.89	-55.10	1.55	42.01	T4	115/116
					y(Transversal)	10.00	-30.56	-55.75		40.56	T4	117
NR Band 77 Google Duo Codec: 6 kbit/s	CH. 633334 3500.01 MHz	100 MHz	DFTs QPSK	270/0	z(Axial)	9.2	-33.81	-55.10	2	43.01	T4	
					y(Transversal)	8.45	-24.44	-55.75		32.89	T4	
NR Band 77 Google Duo Codec: 6 kbit/s	CH. 656000 3840 MHz	100 MHz	DFTs QPSK	270/0	z(Axial)	9.43	-31.36	-55.10	1.84	40.79	T4	118/119
					y(Transversal)	9.53	-21.44	-55.75		30.97	T4	120
NR Band 77 Google Duo Codec: 6 kbit/s	CH. 650000 3750 MHz	100 MHz	DFTs QPSK	270/0	z(Axial)	8.89	-34.76	-55.10	1.57	43.65	T4	
					y(Transversal)	11.71	-21	-55.75		32.72	T4	
NR Band 77 Google Duo Codec: 6 kbit/s	CH. 662000 3930 MHz	100 MHz	DFTs QPSK	270/0	z(Axial)	8.8	-34.44	-55.10	1.95	43.23	T4	
					y(Transversal)	10.62	-22.58	-55.75		33.19	T4	

Appendix A. HAC T-COIL Test Plots

Plot No.1

GSM850 FR V1 190ch z(axial)

Communication System: UID 0, GSM 850 (0); Frequency: 836.6 MHz;Duty Cycle: 1:8.30042
Medium parameters used: $\sigma = 0$ S/m, $\epsilon_r = 1$; $\rho = 0$ kg/m³
Phantom section: TCoil Section

DASY5 Configuration:

- Probe: AM1DV3 - 3049; ; Calibrated: 2021-06-01
- Sensor-Surface: 0mm (Fix Surface)
- Electronics: DAE4 Sn1686; Calibrated: 2021-06-21
- Phantom: HAC Test Arch with AMCC
- Measurement SW: DASY52, Version 52.10 (4)

T-Coil scan (scan for ANSI C63.19-2007 & 2011 compliance)/General Scans/z (axial) 4.2mm 50 x 50/ABM Signal(x,y,z) (13x13x1): Measurement grid: dx=10mm, dy=10mm

Signal Type: Audio File (.wav) 48k_voice_1kHz_1s.wav
Output Gain: 24.55
Measure Window Start: 300ms
Measure Window Length: 1000ms
BWC applied: 0.16 dB
Device Reference Point: 0, 0, -6.3 mm

Cursor:

ABM1 comp = 4.16 dBA/m
BWC Factor = 0.16 dB
Location: 8.3, 0, 3.7 mm

Cursor:

ABM2 = -36.98 dBA/m
Location: 8.3, 0, 3.7 mm

Cursor:

ABM1/ABM2 = 41.13 dB
ABM1 comp = 4.16 dBA/m
BWC Factor = 0.16 dB
Location: 8.3, 0, 3.7 mm

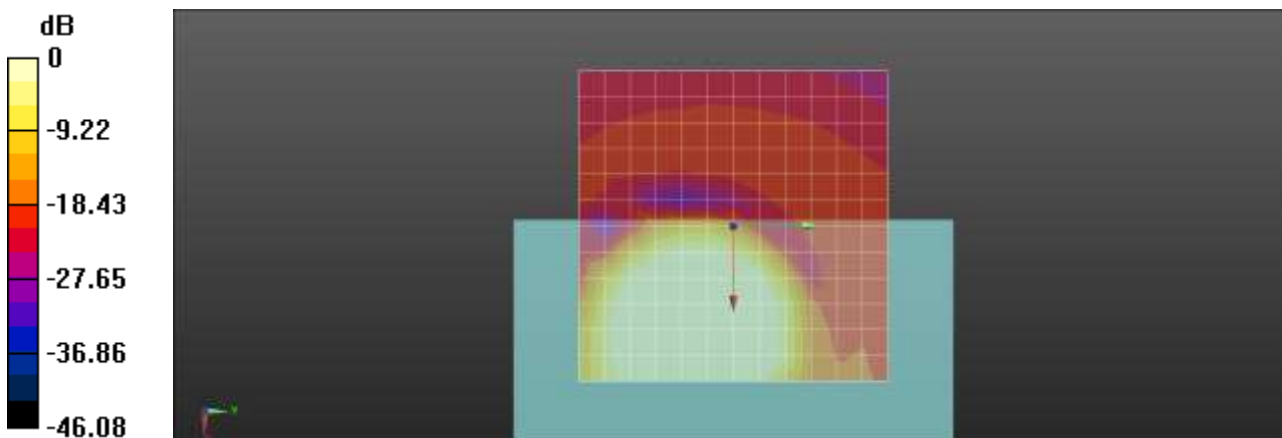

0 dB = 1.000 A/m = 0.00 dBA/m

Plot No.2

GSM850 FR V1 190ch Freq. Response

Communication System: UID 0, GSM 850 (0); Frequency: 836.6 MHz;Duty Cycle: 1:8.30042
 Medium parameters used: $\sigma = 0$ S/m, $\epsilon_r = 1$; $\rho = 0$ kg/m³
 Phantom section: TCoil Section

DASY5 Configuration:

- Probe: AM1DV3 - 3049; ; Calibrated: 2021-06-01
- Sensor-Surface: 0mm (Fix Surface)
- Electronics: DAE4 Sn1686; Calibrated: 2021-06-21
- Phantom: HAC Test Arch with AMCC
- Measurement SW: DASY52, Version 52.10 (4)

T-Coil scan (scan for ANSI C63.19-2007 & 2011 compliance)/General Scans/z (axial) wideband at best

S/N/ABM Freq Resp(x,y,z,f) (1x1x1): Measurement grid: dx=10mm, dy=10mm
 Signal Type: Audio File (.wav) 48k_Normal_51s new.wav
 Output Gain: 52.75
 Measure Window Start: 300ms
 Measure Window Length: 51000ms
 BWC applied: 9.48 dB
 Device Reference Point: 0, 0, -6.3 mm

Category	Telephone parameters WD signal quality [(signal+noise)-to-noise ratio in decibels]
Category T1	0 dB to 10 dB
Category T2	10 dB to 20 dB
Category T3	20 dB to 30 dB
Category T4	> 30 dB

Cursor:

Diff = 2.00 dB
 BWC Factor = 9.48 dB
 Location: 8.5, 0, 3.7 mm

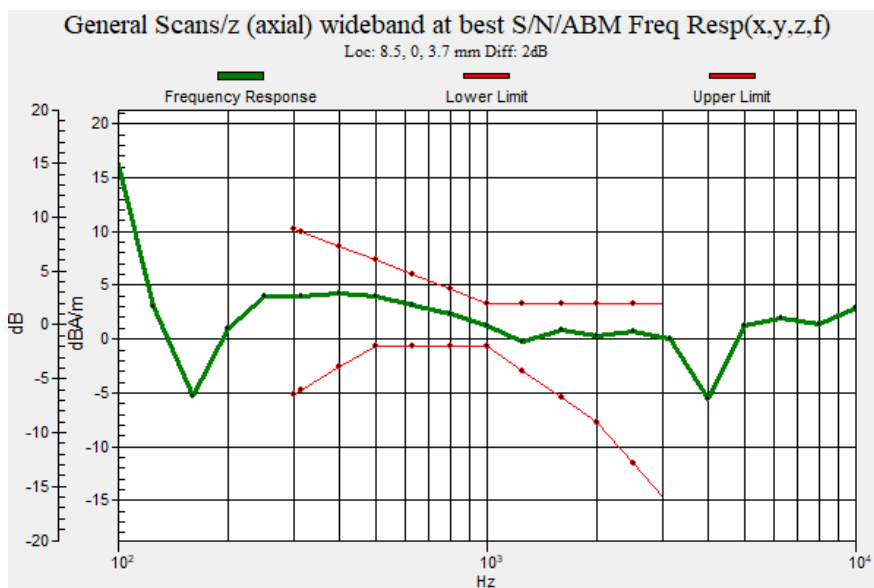

Plot No.3

GSM850 FR V1 190ch y(transversal)

Communication System: UID 0, GSM 850 (0); Frequency: 836.6 MHz;Duty Cycle: 1:8.30042
Medium parameters used: $\sigma = 0$ S/m, $\epsilon_r = 1$; $\rho = 0$ kg/m³
Phantom section: TCoil Section

DASY5 Configuration:

- Probe: AM1DV3 - 3049; ; Calibrated: 2021-06-01
- Sensor-Surface: 0mm (Fix Surface)
- Electronics: DAE4 Sn1686; Calibrated: 2021-06-21
- Phantom: HAC Test Arch with AMCC
- Measurement SW: DASY52, Version 52.10 (4)

T-Coil scan (scan for ANSI C63.19-2007 & 2011 compliance)/General Scans/y (transversal) 4.2mm 50

x 50/ABM Signal(x,y,z) (13x13x1): Measurement grid: dx=10mm, dy=10mm

Signal Type: Audio File (.wav) 48k_voice_1kHz_1s.wav

Output Gain: 24.55

Measure Window Start: 300ms

Measure Window Length: 1000ms

BWC applied: 0.16 dB

Device Reference Point: 0, 0, -6.3 mm

Cursor:

ABM1 comp = 5.79 dBA/m

BWC Factor = 0.16 dB

Location: 16.7, -12.5, 3.7 mm

Cursor:

ABM2 = -24.71 dBA/m

Location: 16.7, -12.5, 3.7 mm

Cursor:

ABM1/ABM2 = 30.50 dB

ABM1 comp = 5.79 dBA/m

BWC Factor = 0.16 dB

Location: 16.7, -12.5, 3.7 mm

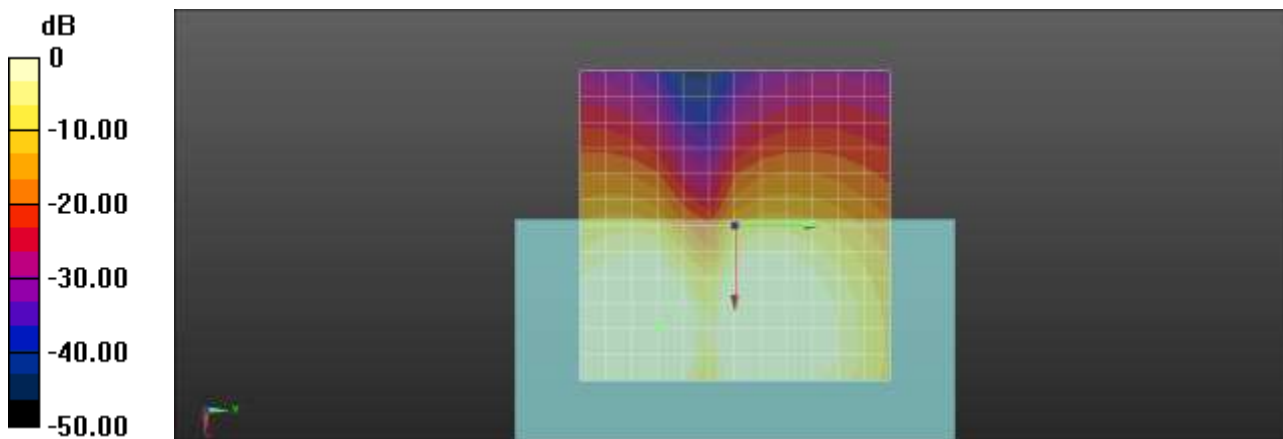

0 dB = 1.000 A/m = 0.00 dBA/m

Plot No.4

GSM1900 FR V1 810ch z(axial)

Communication System: UID 0, GSM 1900 (0); Frequency: 1909.8 MHz;Duty Cycle: 1:8.30042
Medium parameters used: $\sigma = 0$ S/m, $\epsilon_r = 1$; $\rho = 0$ kg/m³
Phantom section: TCoil Section

DASY5 Configuration:

- Probe: AM1DV3 - 3049; ; Calibrated: 2021-06-01
- Sensor-Surface: 0mm (Fix Surface)
- Electronics: DAE4 Sn1686; Calibrated: 2021-06-21
- Phantom: HAC Test Arch with AMCC
- Measurement SW: DASY52, Version 52.10 (4)

T-Coil scan (scan for ANSI C63.19-2007 & 2011 compliance)/General Scans/z (axial) 4.2mm 50 x 50/ABM Signal(x,y,z) (13x13x1): Measurement grid: dx=10mm, dy=10mm

Signal Type: Audio File (.wav) 48k_voice_1kHz_1s.wav
Output Gain: 24.55
Measure Window Start: 300ms
Measure Window Length: 1000ms
BWC applied: 0.16 dB
Device Reference Point: 0, 0, -6.3 mm

Cursor:

ABM1 comp = 3.63 dBA/m
BWC Factor = 0.16 dB
Location: 8.3, 0, 3.7 mm

Cursor:

ABM2 = -38.17 dBA/m
Location: 8.3, 0, 3.7 mm

Cursor:

ABM1/ABM2 = 41.80 dB
ABM1 comp = 3.63 dBA/m
BWC Factor = 0.16 dB
Location: 8.3, 0, 3.7 mm

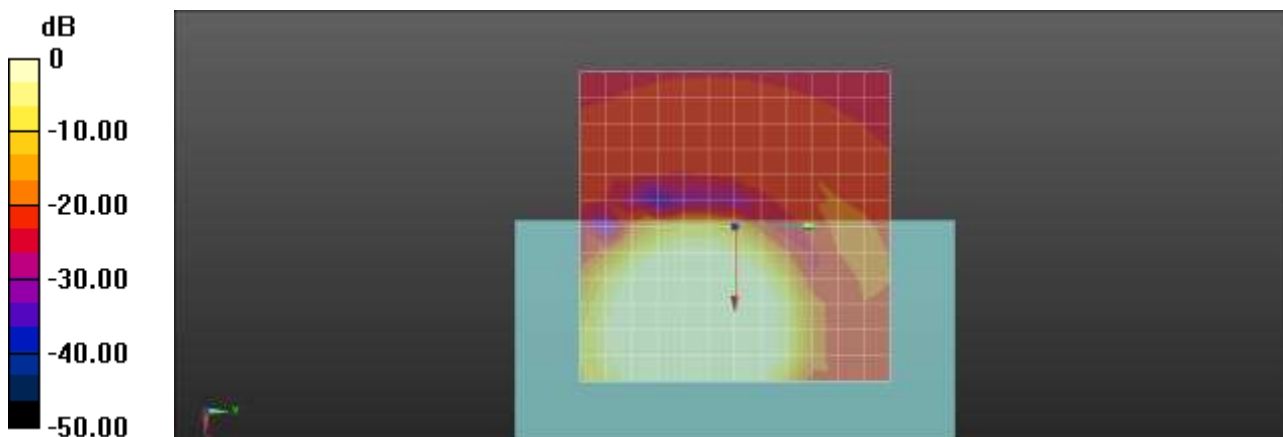

0 dB = 1.000 A/m = 0.00 dBA/m

Plot No.5

GSM1900 FR V1 810ch Freq. Response

Communication System: UID 0, GSM 1900 (0); Frequency: 1909.8 MHz;Duty Cycle: 1:8.30042
 Medium parameters used: $\sigma = 0$ S/m, $\epsilon_r = 1$; $\rho = 0$ kg/m³
 Phantom section: TCoil Section

DASY5 Configuration:

- Probe: AM1DV3 - 3049; ; Calibrated: 2021-06-01
- Sensor-Surface: 0mm (Fix Surface)
- Electronics: DAE4 Sn1686; Calibrated: 2021-06-21
- Phantom: HAC Test Arch with AMCC
- Measurement SW: DASY52, Version 52.10 (4)

T-Coil scan (scan for ANSI C63.19-2007 & 2011 compliance)/General Scans/z (axial) wideband at best

S/N/ABM Freq Resp(x,y,z,f) (1x1x1): Measurement grid: dx=10mm, dy=10mm
 Signal Type: Audio File (.wav) 48k_Normal_51s new.wav
 Output Gain: 52.75
 Measure Window Start: 300ms
 Measure Window Length: 51000ms
 BWC applied: 9.48 dB
 Device Reference Point: 0, 0, -6.3 mm

Category	Telephone parameters WD signal quality [(signal+noise)-to-noise ratio in decibels]
Category T1	0 dB to 10 dB
Category T2	10 dB to 20 dB
Category T3	20 dB to 30 dB
Category T4	> 30 dB

Cursor:

Diff = 2.00 dB
 BWC Factor = 9.48 dB
 Location: 8.7, -1.8, 3.7 mm

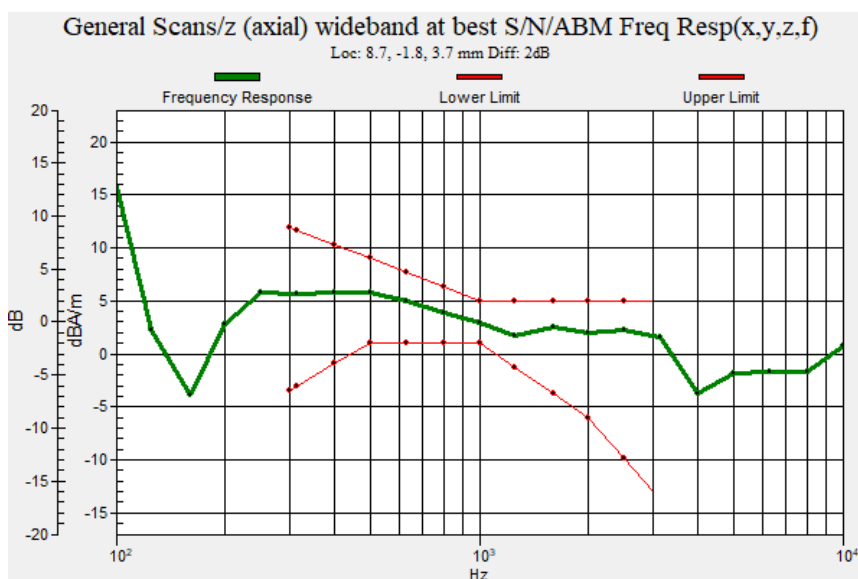

Plot No.6

GSM1900 FR V1 810ch y(transversal)

Communication System: UID 0, GSM 1900 (0); Frequency: 1909.8 MHz;Duty Cycle: 1:8.30042
 Medium parameters used: $\sigma = 0$ S/m, $\epsilon_r = 1$; $\rho = 0$ kg/m³
 Phantom section: TCoil Section

DASY5 Configuration:

- Probe: AM1DV3 - 3049; ; Calibrated: 2021-06-01
- Sensor-Surface: 0mm (Fix Surface)
- Electronics: DAE4 Sn1686; Calibrated: 2021-06-21
- Phantom: HAC Test Arch with AMCC
- Measurement SW: DASY52, Version 52.10 (4)

T-Coil scan (scan for ANSI C63.19-2007 & 2011 compliance)/General Scans/y (transversal) 4.2mm 50

x 50/ABM Signal(x,y,z) (13x13x1): Measurement grid: dx=10mm, dy=10mm

Signal Type: Audio File (.wav) 48k_voice_1kHz_1s.wav

Output Gain: 24.55

Measure Window Start: 300ms

Measure Window Length: 1000ms

BWC applied: 0.16 dB

Device Reference Point: 0, 0, -6.3 mm

Cursor:

ABM1 comp = -8.06 dBA/m

BWC Factor = 0.16 dB

Location: 0, -20.8, 3.7 mm

Cursor:

ABM2 = -37.43 dBA/m

Location: 0, -20.8, 3.7 mm

Cursor:

ABM1/ABM2 = 29.37 dB

ABM1 comp = -8.06 dBA/m

BWC Factor = 0.16 dB

Location: 0, -20.8, 3.7 mm

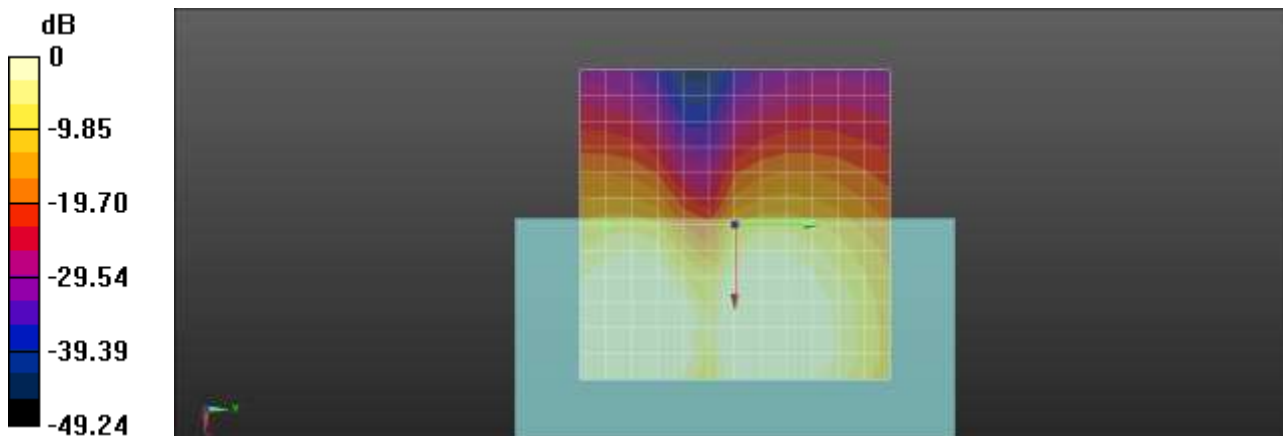

0 dB = 1.000 A/m = 0.00 dBA/m

Plot No.7

WCDMA1900 AMR WB 15.85 kbit/s 9400ch z(axial)

Communication System: UID 0, WCDMA1900 (0); Frequency: 1880 MHz;Duty Cycle: 1:1
 Medium parameters used: $\sigma = 0$ S/m, $\epsilon_r = 1$; $\rho = 0$ kg/m³
 Phantom section: TCoil Section

DASY5 Configuration:

- Probe: AM1DV3 - 3049; ; Calibrated: 2021-06-01
- Sensor-Surface: 0mm (Fix Surface)
- Electronics: DAE4 Sn1686; Calibrated: 2021-06-21
- Phantom: HAC Test Arch with AMCC
- Measurement SW: DASY52, Version 52.10 (4)

T-Coil scan (scan for ANSI C63.19-2007 & 2011 compliance)/General Scans/z (axial) 4.2mm 50 x

50/ABM Signal(x,y,z) (13x13x1): Measurement grid: dx=10mm, dy=10mm

Signal Type: Audio File (.wav) 48k_voice_1kHz_1s.wav

Output Gain: 24.55

Measure Window Start: 300ms

Measure Window Length: 1000ms

BWC applied: 0.16 dB

Device Reference Point: 0, 0, -6.3 mm

Cursor:

ABM1 comp = 11.23 dBA/m

BWC Factor = 0.16 dB

Location: 12.5, 0, 3.7 mm

Cursor:

ABM2 = -22.94 dBA/m

Location: 12.5, 0, 3.7 mm

Cursor:

ABM1/ABM2 = 34.17 dB

ABM1 comp = 11.23 dBA/m

BWC Factor = 0.16 dB

Location: 12.5, 0, 3.7 mm

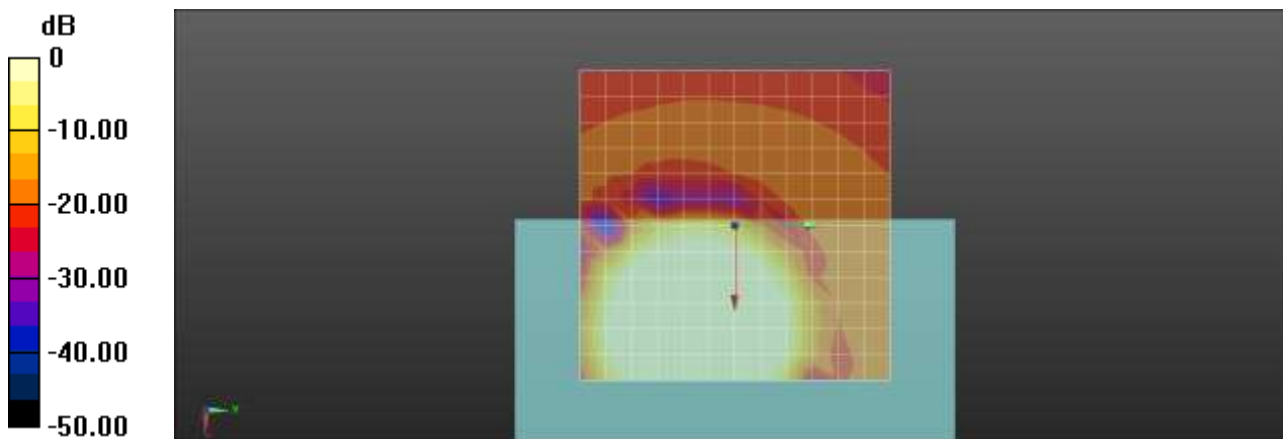

0 dB = 1.000 A/m = 0.00 dBA/m

Plot No.8

WCDMA1900 AMR WB 15.85 kbit/s 9400ch Freq. Response

Communication System: UID 0, WCDMA1900 (0); Frequency: 1880 MHz;Duty Cycle: 1:1
 Medium parameters used: $\sigma = 0$ S/m, $\epsilon_r = 1$; $\rho = 0$ kg/m³
 Phantom section: TCoil Section

DASY5 Configuration:

- Probe: AM1DV3 - 3049; ; Calibrated: 2021-06-01
- Sensor-Surface: 0mm (Fix Surface)
- Electronics: DAE4 Sn1686; Calibrated: 2021-06-21
- Phantom: HAC Test Arch with AMCC
- Measurement SW: DASY52, Version 52.10 (4)

T-Coil scan (scan for ANSI C63.19-2007 & 2011 compliance)/General Scans/z (axial) wideband at best

S/N/ABM Freq Resp(x,y,z,f) (1x1x1): Measurement grid: dx=10mm, dy=10mm
 Signal Type: Audio File (.wav) 48k_Normal_51s new.wav
 Output Gain: 52.75
 Measure Window Start: 300ms
 Measure Window Length: 51000ms
 BWC applied: 9.48 dB
 Device Reference Point: 0, 0, -6.3 mm

Category	Telephone parameters WD signal quality [(signal+noise)-to-noise ratio in decibels]
Category T1	0 dB to 10 dB
Category T2	10 dB to 20 dB
Category T3	20 dB to 30 dB
Category T4	> 30 dB

Cursor:

Diff = 2.00 dB
 BWC Factor = 9.48 dB
 Location: 5.6, 2.2, 3.7 mm

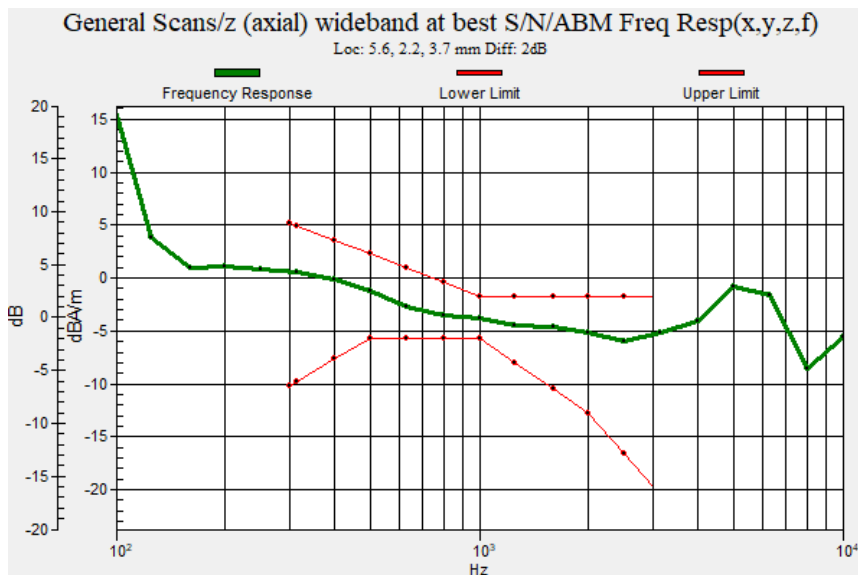

Plot No.9

WCDMA1900 AMR WB 15.85 kbit/s 9400ch y(transversal)

Communication System: UID 0, WCDMA1900 (0); Frequency: 1880 MHz;Duty Cycle: 1:1
Medium parameters used: $\sigma = 0$ S/m, $\epsilon_r = 1$; $\rho = 0$ kg/m³
Phantom section: TCoil Section

DASY5 Configuration:

- Probe: AM1DV3 - 3049; ; Calibrated: 2021-06-01
- Sensor-Surface: 0mm (Fix Surface)
- Electronics: DAE4 Sn1686; Calibrated: 2021-06-21
- Phantom: HAC Test Arch with AMCC
- Measurement SW: DASY52, Version 52.10 (4)

T-Coil scan (scan for ANSI C63.19-2007 & 2011 compliance)/General Scans/y (transversal) 4.2mm 50

x 50/ABM Signal(x,y,z) (13x13x1): Measurement grid: dx=10mm, dy=10mm

Signal Type: Audio File (.wav) 48k_voice_1kHz_1s.wav

Output Gain: 24.55

Measure Window Start: 300ms

Measure Window Length: 1000ms

BWC applied: 0.16 dB

Device Reference Point: 0, 0, -6.3 mm

Cursor:

ABM1 comp = 2.73 dBA/m

BWC Factor = 0.16 dB

Location: 8.3, 8.3, 3.7 mm

Cursor:

ABM2 = -31.47 dBA/m

Location: 8.3, 8.3, 3.7 mm

Cursor:

ABM1/ABM2 = 34.19 dB

ABM1 comp = 2.73 dBA/m

BWC Factor = 0.16 dB

Location: 8.3, 8.3, 3.7 mm

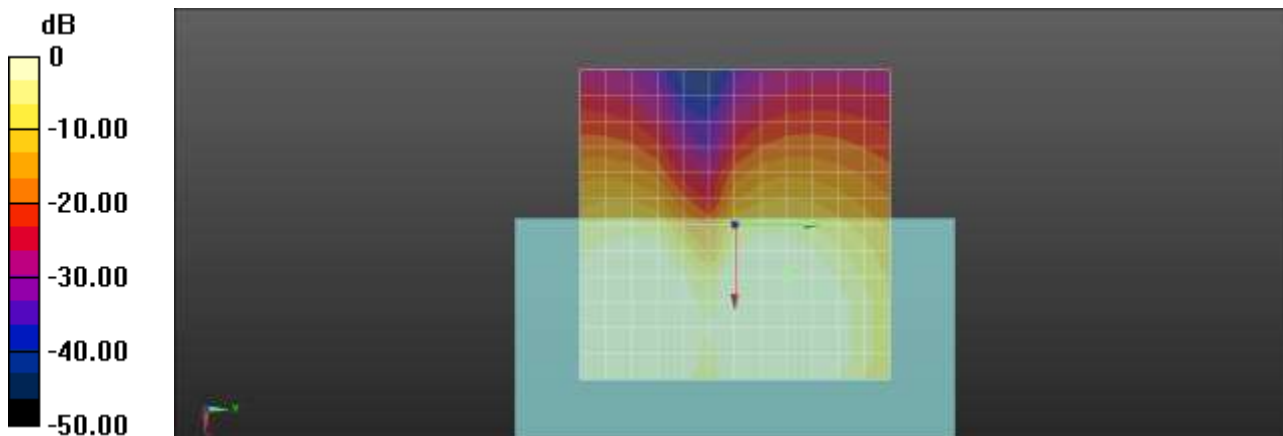

0 dB = 1.000 A/m = 0.00 dBA/m

Plot No.10
WCDMA1700 AMR WB 15.85 kbit/s 4132ch z(axial)

Communication System: UID 0, WCDMA850 (0); Frequency: 826.4 MHz;Duty Cycle: 1:1
Medium parameters used: $\sigma = 0$ S/m, $\epsilon_r = 1$; $\rho = 0$ kg/m³
Phantom section: TCoil Section

DASY5 Configuration:

- Probe: AM1DV3 - 3049; ; Calibrated: 2021-06-01
- Sensor-Surface: 0mm (Fix Surface)
- Electronics: DAE4 Sn1686; Calibrated: 2021-06-21
- Phantom: HAC Test Arch with AMCC
- Measurement SW: DASY52, Version 52.10 (4)

T-Coil scan (scan for ANSI C63.19-2007 & 2011 compliance)/General Scans/z (axial) 4.2mm 50 x 50/ABM Signal(x,y,z) (13x13x1): Measurement grid: dx=10mm, dy=10mm
Signal Type: Audio File (.wav) 48k_voice_1kHz_1s.wav
Output Gain: 24.55
Measure Window Start: 300ms
Measure Window Length: 1000ms
BWC applied: 0.16 dB
Device Reference Point: 0, 0, -6.3 mm

Cursor:

ABM1 comp = 13.79 dBA/m
BWC Factor = 0.16 dB
Location: 12.5, -4.2, 3.7 mm

Cursor:

ABM2 = -20.30 dBA/m
Location: 12.5, -4.2, 3.7 mm

Cursor:

ABM1/ABM2 = 34.10 dB
ABM1 comp = 13.79 dBA/m
BWC Factor = 0.16 dB
Location: 12.5, -4.2, 3.7 mm

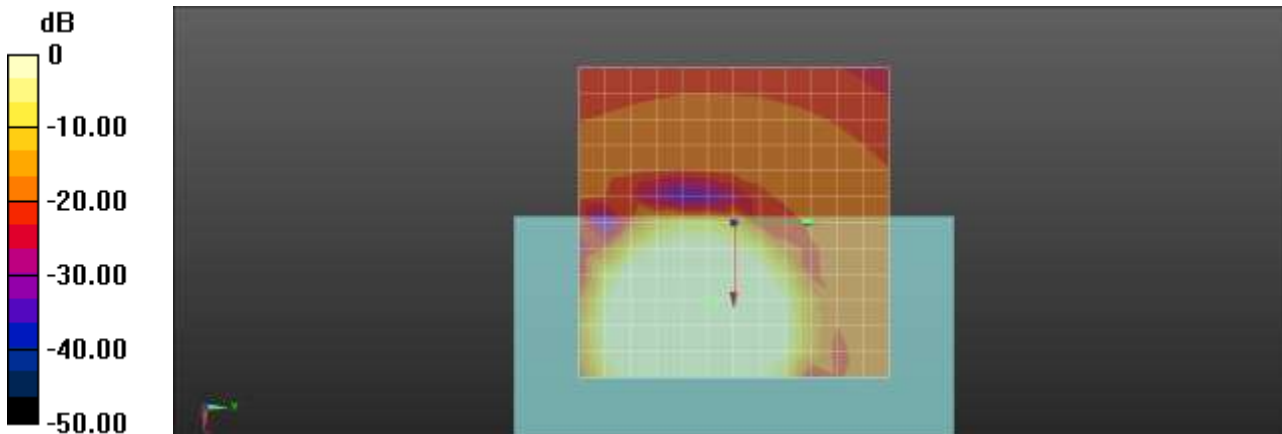

0 dB = 1.000 A/m = 0.00 dBA/m

Plot No.11

WCDMA1700 AMR WB 15.85 kbit/s 4132ch Freq. Response

Communication System: UID 0, WCDMA850 (0); Frequency: 826.4 MHz;Duty Cycle: 1:1
 Medium parameters used: $\sigma = 0$ S/m, $\epsilon_r = 1$; $\rho = 0$ kg/m³
 Phantom section: TCoil Section

DASY5 Configuration:

- Probe: AM1DV3 - 3049; ; Calibrated: 2021-06-01
- Sensor-Surface: 0mm (Fix Surface)
- Electronics: DAE4 Sn1686; Calibrated: 2021-06-21
- Phantom: HAC Test Arch with AMCC
- Measurement SW: DASY52, Version 52.10 (4)

T-Coil scan (scan for ANSI C63.19-2007 & 2011 compliance)/General Scans/z (axial) wideband at best

S/N/ABM Freq Resp(x,y,z,f) (1x1x1): Measurement grid: dx=10mm, dy=10mm

Signal Type: Audio File (.wav) 48k_Normal_51s new.wav

Output Gain: 52.75

Measure Window Start: 300ms

Measure Window Length: 51000ms

BWC applied: 9.48 dB

Device Reference Point: 0, 0, -6.3 mm

Category	Telephone parameters WD signal quality [(signal+noise)-to-noise ratio in decibels]
Category T1	0 dB to 10 dB
Category T2	10 dB to 20 dB
Category T3	20 dB to 30 dB
Category T4	> 30 dB

Cursor:

Diff = 2.00 dB

BWC Factor = 9.48 dB

Location: 11.9, 3, 3.7 mm

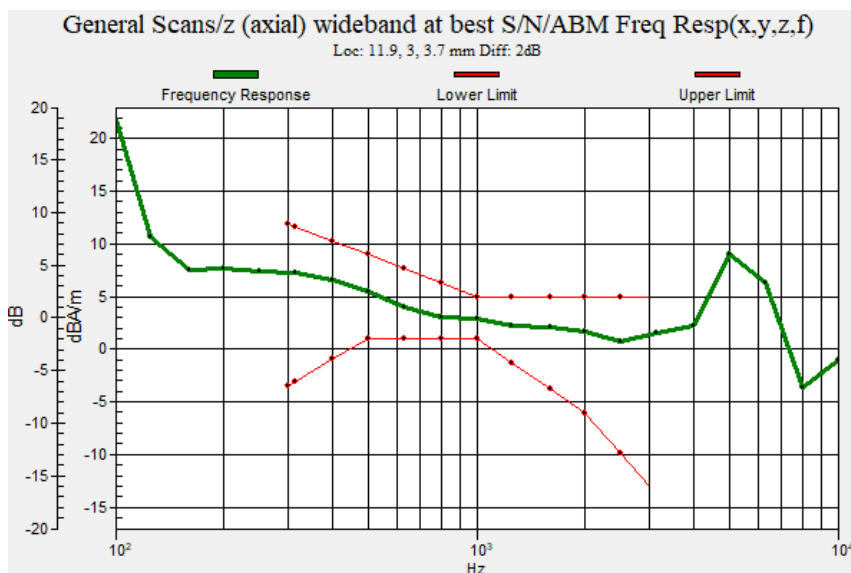

Plot No.12

WCDMA1700 AMR WB 15.85 kbit/s 4132ch y(transversal)

Communication System: UID 0, WCDMA850 (0); Frequency: 826.4 MHz;Duty Cycle: 1:1
Medium parameters used: $\sigma = 0$ S/m, $\epsilon_r = 1$; $\rho = 0$ kg/m³
Phantom section: TCoil Section

DASY5 Configuration:

- Probe: AM1DV3 - 3049; ; Calibrated: 2021-06-01
- Sensor-Surface: 0mm (Fix Surface)
- Electronics: DAE4 Sn1686; Calibrated: 2021-06-21
- Phantom: HAC Test Arch with AMCC
- Measurement SW: DASY52, Version 52.10 (4)

T-Coil scan (scan for ANSI C63.19-2007 & 2011 compliance)/General Scans/y (transversal) 4.2mm 50

x 50/ABM Signal(x,y,z) (13x13x1): Measurement grid: dx=10mm, dy=10mm

Signal Type: Audio File (.wav) 48k_voice_1kHz_1s.wav

Output Gain: 24.55

Measure Window Start: 300ms

Measure Window Length: 1000ms

BWC applied: 0.16 dB

Device Reference Point: 0, 0, -6.3 mm

Cursor:

ABM1 comp = 2.01 dBA/m

BWC Factor = 0.16 dB

Location: 16.7, -8.3, 3.7 mm

Cursor:

ABM2 = -31.94 dBA/m

Location: 16.7, -8.3, 3.7 mm

Cursor:

ABM1/ABM2 = 33.95 dB

ABM1 comp = 2.01 dBA/m

BWC Factor = 0.16 dB

Location: 16.7, -8.3, 3.7 mm

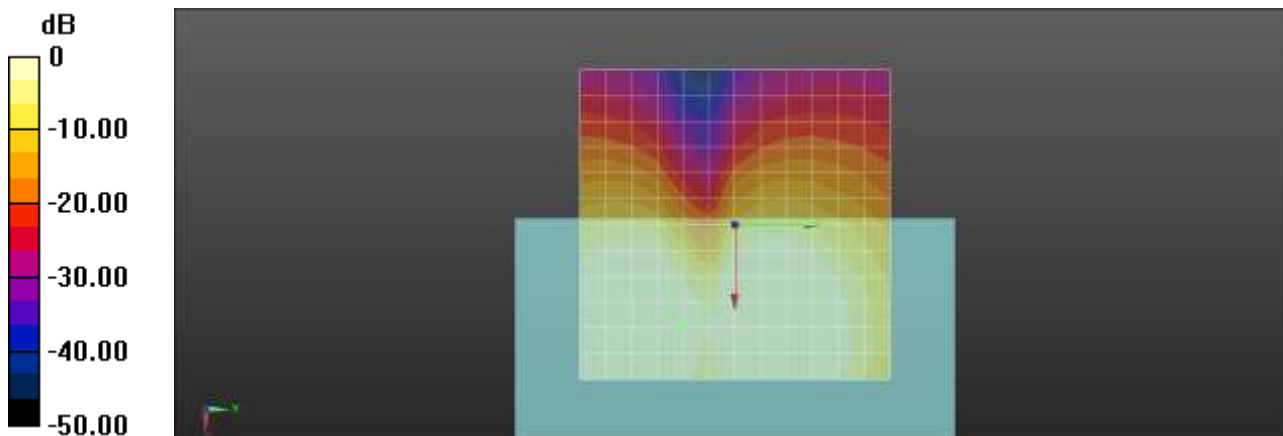

0 dB = 1.000 A/m = 0.00 dBA/m

Plot No.13

LTE Band 66 QPSK 20MHz 50RB 0offset EVS WB 5.9 kbit/s 132322ch z(axial)

Communication System: UID 0, LTE Band66 (0); Frequency: 1745 MHz;Duty Cycle: 1:1
 Medium parameters used: $\sigma = 0$ S/m, $\epsilon_r = 1$; $\rho = 0$ kg/m³
 Phantom section: TCoil Section

DASY5 Configuration:

- Probe: AM1DV3 - 3049; ; Calibrated: 2021-06-01
- Sensor-Surface: 0mm (Fix Surface)
- Electronics: DAE4 Sn1686; Calibrated: 2021-06-21
- Phantom: HAC Test Arch with AMCC
- Measurement SW: DASY52, Version 52.10 (4)

T-Coil scan (scan for ANSI C63.19-2007 & 2011 compliance)/General Scans/z (axial) 4.2mm 50 x

50/ABM Signal(x,y,z) (13x13x1): Measurement grid: dx=10mm, dy=10mm

Signal Type: Audio File (.wav) 48k_voice_1kHz_1s.wav

Output Gain: 24.61

Measure Window Start: 300ms

Measure Window Length: 1000ms

BWC applied: 0.14 dB

Device Reference Point: 0, 0, -6.3 mm

Cursor:

ABM1 comp = 15.35 dBA/m

BWC Factor = 0.14 dB

Location: 16.7, -8.3, 3.7 mm

Cursor:

ABM2 = -12.51 dBA/m

Location: 16.7, -8.3, 3.7 mm

Cursor:

ABM1/ABM2 = 27.85 dB

ABM1 comp = 15.35 dBA/m

BWC Factor = 0.14 dB

Location: 16.7, -8.3, 3.7 mm

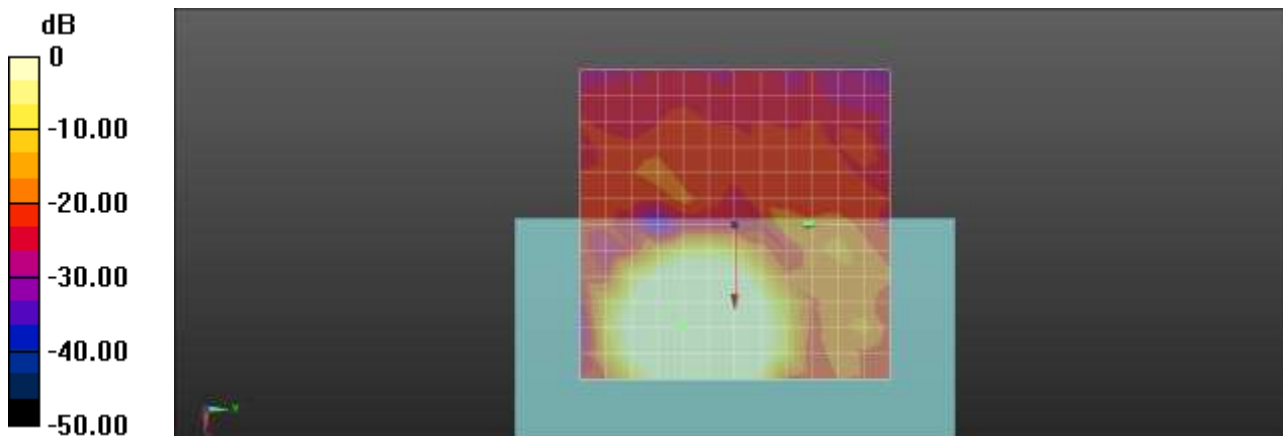

0 dB = 1.000 A/m = 0.00 dBA/m

Plot No.14

LTE Band 66 QPSK 20MHz 50RB 0offset EVS WB 5.9 kbit/s 132322ch Freq. Response

Communication System: UID 0, LTE Band66 (0); Frequency: 1745 MHz;Duty Cycle: 1:1
 Medium parameters used: $\sigma = 0$ S/m, $\epsilon_r = 1$; $\rho = 0$ kg/m³
 Phantom section: TCoil Section

DASY5 Configuration:

- Probe: AM1DV3 - 3049; ; Calibrated: 2021-06-01
- Sensor-Surface: 0mm (Fix Surface)
- Electronics: DAE4 Sn1686; Calibrated: 2021-06-21
- Phantom: HAC Test Arch with AMCC
- Measurement SW: DASY52, Version 52.10 (4)

T-Coil scan (scan for ANSI C63.19-2007 & 2011 compliance)/General Scans/z (axial) wideband at best

S/N/ABM Freq Resp(x,y,z,f) (1x1x1): Measurement grid: dx=10mm, dy=10mm
 Signal Type: Audio File (.wav) 48k_Normal_51s new.wav
 Output Gain: 52.93
 Measure Window Start: 300ms
 Measure Window Length: 51000ms
 BWC applied: 9.46 dB
 Device Reference Point: 0, 0, -6.3 mm

Category	Telephone parameters WD signal quality [(signal+noise)-to-noise ratio in decibels]
Category T1	0 dB to 10 dB
Category T2	10 dB to 20 dB
Category T3	20 dB to 30 dB
Category T4	> 30 dB

Cursor:

Diff = 1.24 dB
 BWC Factor = 9.46 dB
 Location: 16.7, -8.4, 3.7 mm

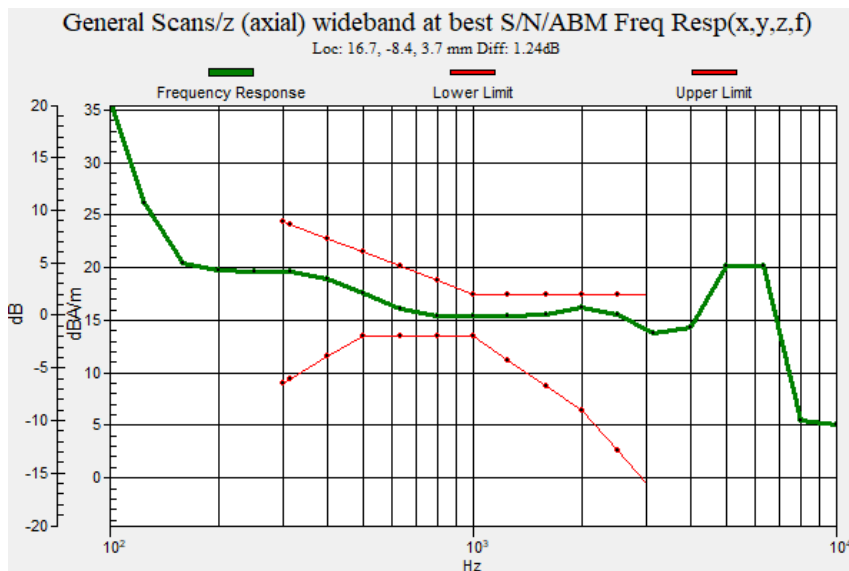

Plot No.15

LTE Band 66 QPSK 20MHz 50RB 0offset EVS WB 5.9 kbit/s 132322ch y(transversal)

Communication System: UID 0, LTE Band66 (0); Frequency: 1745 MHz;Duty Cycle: 1:1
Medium parameters used: $\sigma = 0$ S/m, $\epsilon_r = 1$; $\rho = 0$ kg/m³
Phantom section: TCoil Section

DASY5 Configuration:

- Probe: AM1DV3 - 3049; ; Calibrated: 2021-06-01
- Sensor-Surface: 0mm (Fix Surface)
- Electronics: DAE4 Sn1686; Calibrated: 2021-06-21
- Phantom: HAC Test Arch with AMCC
- Measurement SW: DASY52, Version 52.10 (4)

T-Coil scan (scan for ANSI C63.19-2007 & 2011 compliance)/General Scans/y (transversal) 4.2mm 50

x 50/ABM Signal(x,y,z) (13x13x1): Measurement grid: dx=10mm, dy=10mm

Signal Type: Audio File (.wav) 48k_voice_1kHz_1s.wav

Output Gain: 24.61

Measure Window Start: 300ms

Measure Window Length: 1000ms

BWC applied: 0.14 dB

Device Reference Point: 0, 0, -6.3 mm

Cursor:

ABM1 comp = 8.18 dBA/m

BWC Factor = 0.14 dB

Location: 16.7, -16.7, 3.7 mm

Cursor:

ABM2 = -21.80 dBA/m

Location: 16.7, -16.7, 3.7 mm

Cursor:

ABM1/ABM2 = 29.98 dB

ABM1 comp = 8.18 dBA/m

BWC Factor = 0.14 dB

Location: 16.7, -16.7, 3.7 mm

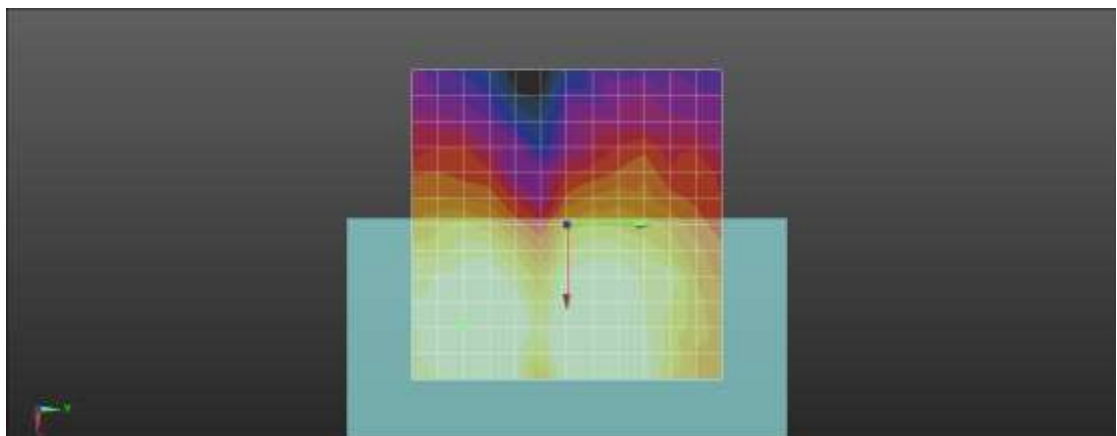
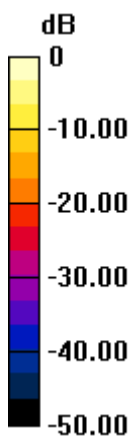

0 dB = 1.000 A/m = 0.00 dBA/m

Plot No.16

LTE Band 2 QPSK 20MHz 50RB 0offset EVS WB 5.9 kbit/s 18900ch z(axial)

Communication System: UID 0, LTE Band 2 (0); Frequency: 1880 MHz;Duty Cycle: 1:1
Medium parameters used: $\sigma = 0$ S/m, $\epsilon_r = 1$; $\rho = 0$ kg/m³
Phantom section: TCoil Section

DASY5 Configuration:

- Probe: AM1DV3 - 3049; ; Calibrated: 2021-06-01
- Sensor-Surface: 0mm (Fix Surface)
- Electronics: DAE4 Sn1686; Calibrated: 2021-06-21
- Phantom: HAC Test Arch with AMCC
- Measurement SW: DASY52, Version 52.10 (4)

T-Coil scan (scan for ANSI C63.19-2007 & 2011 compliance)/General Scans/z (axial) 4.2mm 50 x

50/ABM Signal(x,y,z) (13x13x1): Measurement grid: dx=10mm, dy=10mm

Signal Type: Audio File (.wav) 48k_voice_1kHz_1s.wav

Output Gain: 24.61

Measure Window Start: 300ms

Measure Window Length: 1000ms

BWC applied: 0.15 dB

Device Reference Point: 0, 0, -6.3 mm

Cursor:

ABM1 comp = 16.65 dBA/m

BWC Factor = 0.15 dB

Location: 16.7, -4.2, 3.7 mm

Cursor:

ABM2 = -13.91 dBA/m

Location: 16.7, -4.2, 3.7 mm

Cursor:

ABM1/ABM2 = 30.56 dB

ABM1 comp = 16.65 dBA/m

BWC Factor = 0.15 dB

Location: 16.7, -4.2, 3.7 mm

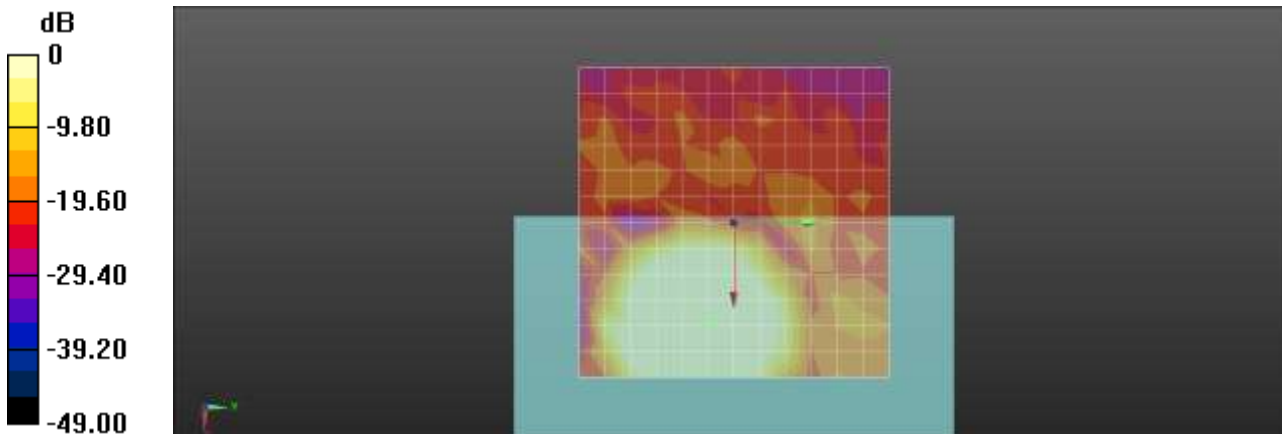

0 dB = 1.000 A/m = 0.00 dBA/m

Plot No.17

LTE Band 2 QPSK 20MHz 50RB 0offset EVS WB 5.9 kbit/s 18900ch Freq. Response

Communication System: UID 0, LTE Band 2 (0); Frequency: 1880 MHz;Duty Cycle: 1:1
 Medium parameters used: $\sigma = 0$ S/m, $\epsilon_r = 1$; $\rho = 0$ kg/m³
 Phantom section: TCoil Section

DASY5 Configuration:

- Probe: AM1DV3 - 3049; ; Calibrated: 2021-06-01
- Sensor-Surface: 0mm (Fix Surface)
- Electronics: DAE4 Sn1686; Calibrated: 2021-06-21
- Phantom: HAC Test Arch with AMCC
- Measurement SW: DASY52, Version 52.10 (4)

T-Coil scan (scan for ANSI C63.19-2007 & 2011 compliance)/General Scans/z (axial) wideband at best

S/N/ABM Freq Resp(x,y,z,f) (1x1x1): Measurement grid: dx=10mm, dy=10mm
 Signal Type: Audio File (.wav) 48k_Normal_51s new.wav
 Output Gain: 52.93
 Measure Window Start: 300ms
 Measure Window Length: 51000ms
 BWC applied: 9.47 dB
 Device Reference Point: 0, 0, -6.3 mm

Category	Telephone parameters WD signal quality [(signal+noise)-to-noise ratio in decibels]
Category T1	0 dB to 10 dB
Category T2	10 dB to 20 dB
Category T3	20 dB to 30 dB
Category T4	> 30 dB

Cursor:

Diff = 1.49 dB
 BWC Factor = 9.47 dB
 Location: 16.3, -4.4, 3.7 mm

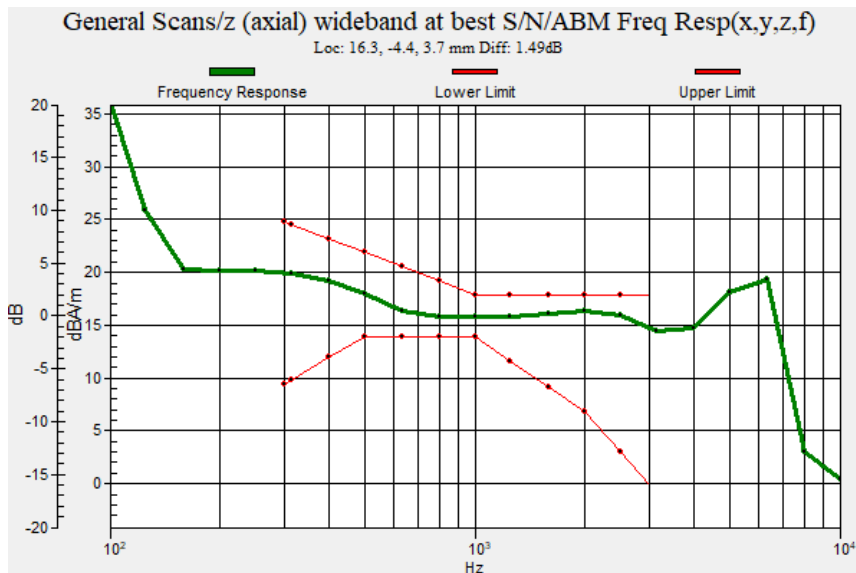

Plot No.18

LTE Band 2 QPSK 20MHz 50RB 0offset EVS WB 5.9 kbit/s 18900ch y(transversal)

Communication System: UID 0, LTE Band 2 (0); Frequency: 1880 MHz;Duty Cycle: 1:1
Medium parameters used: $\sigma = 0$ S/m, $\epsilon_r = 1$; $\rho = 0$ kg/m³
Phantom section: TCoil Section

DASY5 Configuration:

- Probe: AM1DV3 - 3049; ; Calibrated: 2021-06-01
- Sensor-Surface: 0mm (Fix Surface)
- Electronics: DAE4 Sn1686; Calibrated: 2021-06-21
- Phantom: HAC Test Arch with AMCC
- Measurement SW: DASY52, Version 52.10 (4)

T-Coil scan (scan for ANSI C63.19-2007 & 2011 compliance)/General Scans/y (transversal) 4.2mm 50

x 50/ABM Signal(x,y,z) (13x13x1): Measurement grid: dx=10mm, dy=10mm

Signal Type: Audio File (.wav) 48k_voice_1kHz_1s.wav

Output Gain: 24.61

Measure Window Start: 300ms

Measure Window Length: 1000ms

BWC applied: 0.15 dB

Device Reference Point: 0, 0, -6.3 mm

Cursor:

ABM1 comp = -13.69 dBA/m

BWC Factor = 0.15 dB

Location: -8.3, -20.8, 3.7 mm

Cursor:

ABM2 = -45.61 dBA/m

Location: -8.3, -20.8, 3.7 mm

Cursor:

ABM1/ABM2 = 31.92 dB

ABM1 comp = -13.69 dBA/m

BWC Factor = 0.15 dB

Location: -8.3, -20.8, 3.7 mm

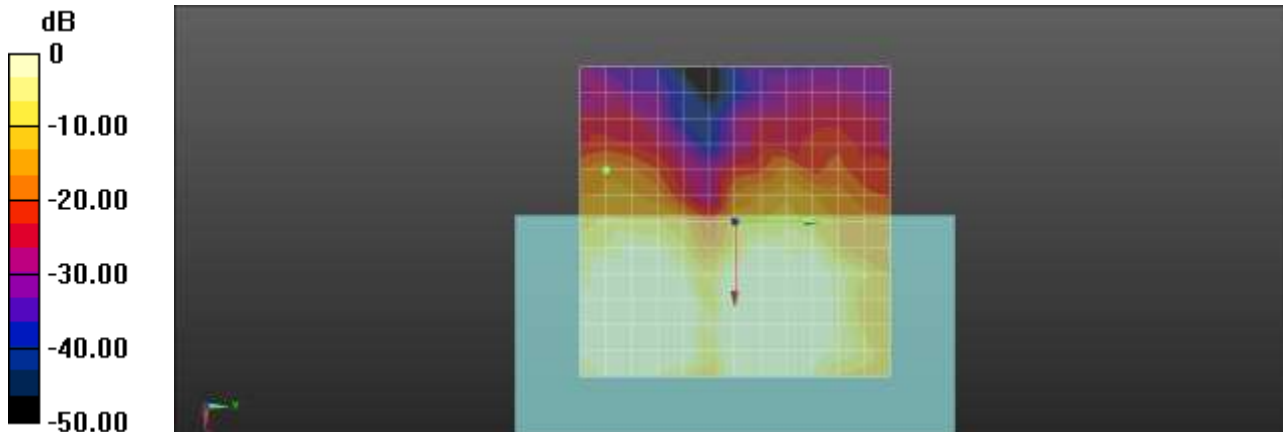

0 dB = 1.000 A/m = 0.00 dBA/m

Plot No.19

LTE Band 5 QPSK 10MHz 25RB 0offset EVS WB 5.9 kbit/s 20525ch z(axial)

Communication System: UID 0, LTE Band 5 (0); Frequency: 836.5 MHz;Duty Cycle: 1:1
Medium parameters used: $\sigma = 0$ S/m, $\epsilon_r = 1$; $\rho = 0$ kg/m³
Phantom section: TCoil Section

DASY5 Configuration:

- Probe: AM1DV3 - 3049; ; Calibrated: 2021-06-01
- Sensor-Surface: 0mm (Fix Surface)
- Electronics: DAE4 Sn1686; Calibrated: 2021-06-21
- Phantom: HAC Test Arch with AMCC
- Measurement SW: DASY52, Version 52.10 (4)

T-Coil scan (scan for ANSI C63.19-2007 & 2011 compliance)/General Scans/z (axial) 4.2mm 50 x

50/ABM Signal(x,y,z) (13x13x1): Measurement grid: dx=10mm, dy=10mm

Signal Type: Audio File (.wav) 48k_voice_1kHz_1s.wav

Output Gain: 24.61

Measure Window Start: 300ms

Measure Window Length: 1000ms

BWC applied: 0.15 dB

Device Reference Point: 0, 0, -6.3 mm

Cursor:

ABM1 comp = 3.48 dBA/m

BWC Factor = 0.15 dB

Location: 16.7, -16.7, 3.7 mm

Cursor:

ABM2 = -29.17 dBA/m

Location: 16.7, -16.7, 3.7 mm

Cursor:

ABM1/ABM2 = 32.65 dB

ABM1 comp = 18.71 dBA/m

BWC Factor = 0.15 dB

Location: 16.7, -16.7, 3.7 mm

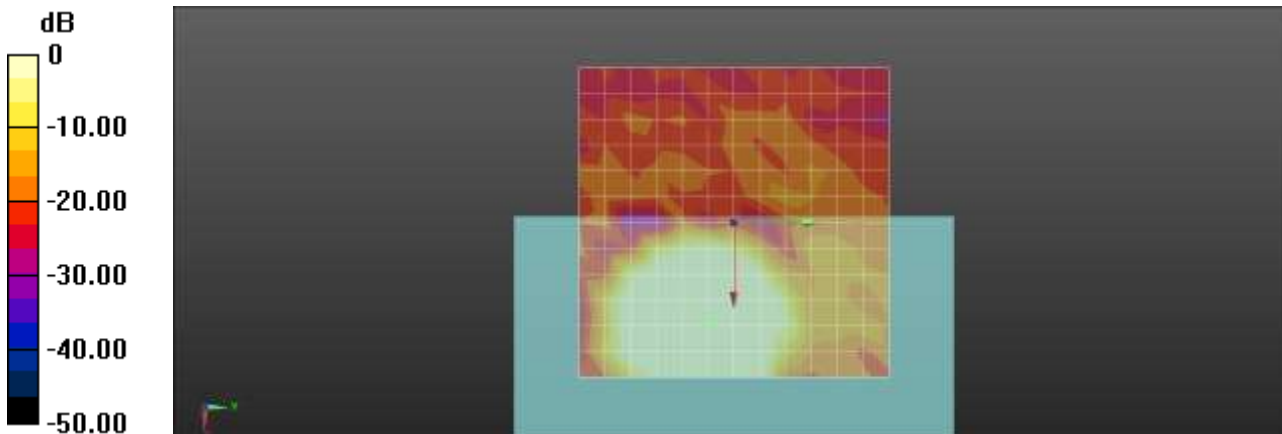

0 dB = 1.000 A/m = 0.00 dBA/m

Plot No.20

LTE Band 5 QPSK 10MHz 25RB 0offset EVS WB 5.9 kbit/s 20525ch Freq. Response

Communication System: UID 0, LTE Band 5 (0); Frequency: 836.5 MHz;Duty Cycle: 1:1
 Medium parameters used: $\sigma = 0$ S/m, $\epsilon_r = 1$; $\rho = 0$ kg/m³
 Phantom section: TCoil Section

DASY5 Configuration:

- Probe: AM1DV3 - 3049; ; Calibrated: 2021-06-01
- Sensor-Surface: 0mm (Fix Surface)
- Electronics: DAE4 Sn1686; Calibrated: 2021-06-21
- Phantom: HAC Test Arch with AMCC
- Measurement SW: DASY52, Version 52.10 (4)

T-Coil scan (scan for ANSI C63.19-2007 & 2011 compliance)/General Scans/z (axial) wideband at best

S/N/ABM Freq Resp(x,y,z,f) (1x1x1): Measurement grid: dx=10mm, dy=10mm
 Signal Type: Audio File (.wav) 48k_Normal_51s new.wav
 Output Gain: 52.93
 Measure Window Start: 300ms
 Measure Window Length: 51000ms
 BWC applied: 9.47 dB
 Device Reference Point: 0, 0, -6.3 mm

Category	Telephone parameters WD signal quality [(signal+noise)-to-noise ratio in decibels]
Category T1	0 dB to 10 dB
Category T2	10 dB to 20 dB
Category T3	20 dB to 30 dB
Category T4	> 30 dB

Cursor:

Diff = 1.07 dB
 BWC Factor = 9.47 dB
 Location: 16.4, -4.5, 3.7 mm

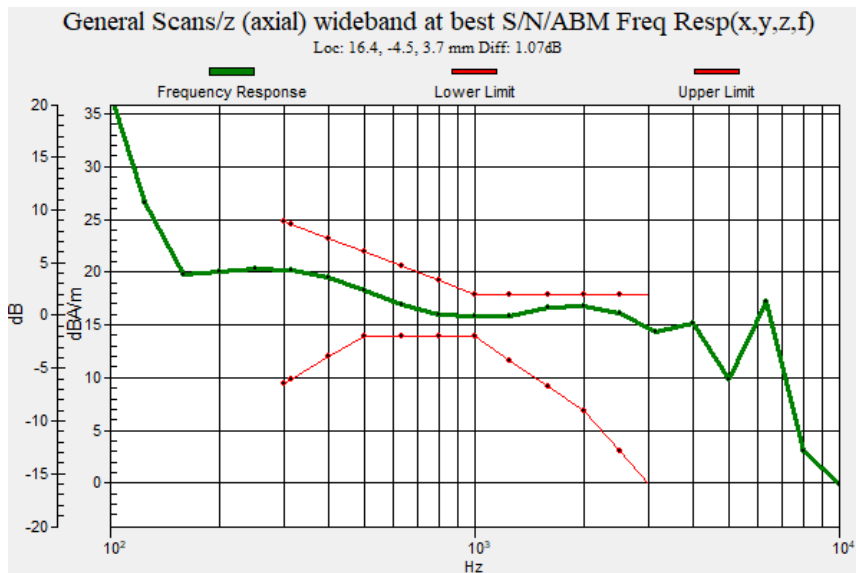

Plot No.21

LTE Band 5 QPSK 10MHz 25RB 0offset EVS WB 5.9 kbit/s 20525ch y(transversal)

Communication System: UID 0, LTE Band 5 (0); Frequency: 836.5 MHz;Duty Cycle: 1:1
 Medium parameters used: $\sigma = 0$ S/m, $\epsilon_r = 1$; $\rho = 0$ kg/m³
 Phantom section: TCoil Section

DASY5 Configuration:

- Probe: AM1DV3 - 3049; ; Calibrated: 2021-06-01
- Sensor-Surface: 0mm (Fix Surface)
- Electronics: DAE4 Sn1686; Calibrated: 2021-06-21
- Phantom: HAC Test Arch with AMCC
- Measurement SW: DASY52, Version 52.10 (4)

T-Coil scan (scan for ANSI C63.19-2007 & 2011 compliance)/General Scans/y (transversal) 4.2mm 50

x 50/ABM Signal(x,y,z) (13x13x1): Measurement grid: dx=10mm, dy=10mm

Signal Type: Audio File (.wav) 48k_voice_1kHz_1s.wav

Output Gain: 24.61

Measure Window Start: 300ms

Measure Window Length: 1000ms

BWC applied: 0.15 dB

Device Reference Point: 0, 0, -6.3 mm

Cursor:

ABM1 comp = -7.03 dBA/m

BWC Factor = 0.15 dB

Location: 4.2, -16.7, 3.7 mm

Cursor:

ABM2 = -44.85 dBA/m

Location: 4.2, -16.7, 3.7 mm

Cursor:

ABM1/ABM2 = 37.82 dB

ABM1 comp = 5.11 dBA/m

BWC Factor = 0.15 dB

Location: 4.2, -16.7, 3.7 mm

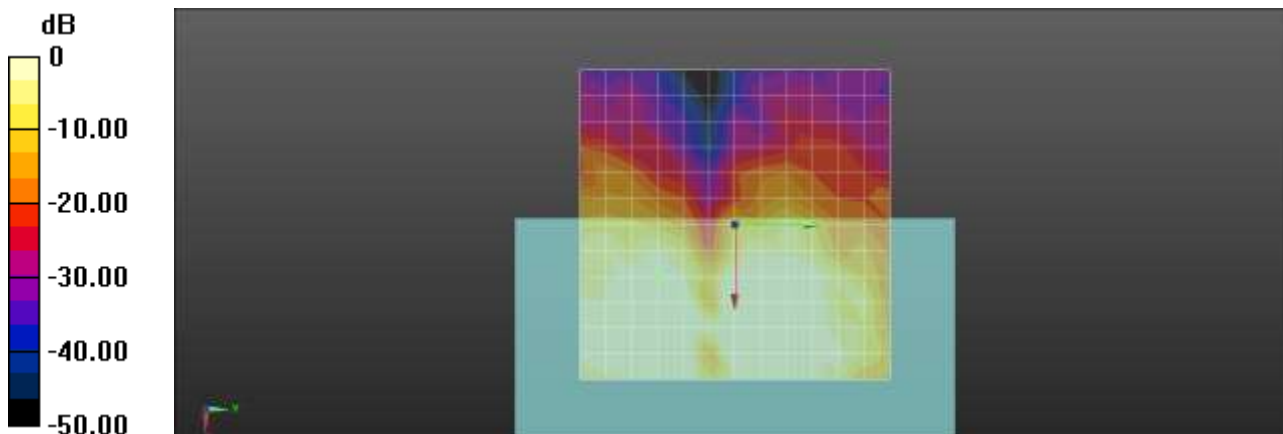

0 dB = 1.000 A/m = 0.00 dBA/m

Plot No.22

LTE Band 7 QPSK 20MHz 50RB 0offset EVS WB 5.9 kbit/s 21100ch z(axial)

Communication System: UID 0, LTE Band 7 (0); Frequency: 2535 MHz;Duty Cycle: 1:1
 Medium parameters used: $\sigma = 0$ S/m, $\epsilon_r = 1$; $\rho = 0$ kg/m³
 Phantom section: TCoil Section

DASY5 Configuration:

- Probe: AM1DV3 - 3049; ; Calibrated: 2021-06-01
- Sensor-Surface: 0mm (Fix Surface)
- Electronics: DAE4 Sn1686; Calibrated: 2021-06-21
- Phantom: HAC Test Arch with AMCC
- Measurement SW: DASY52, Version 52.10 (4)

T-Coil scan (scan for ANSI C63.19-2007 & 2011 compliance)/General Scans/z (axial) 4.2mm 50 x

50/ABM Signal(x,y,z) (13x13x1): Measurement grid: dx=10mm, dy=10mm

Signal Type: Audio File (.wav) 48k_voice_1kHz_1s.wav

Output Gain: 24.61

Measure Window Start: 300ms

Measure Window Length: 1000ms

BWC applied: 0.15 dB

Device Reference Point: 0, 0, -6.3 mm

Cursor:

ABM1 comp = 13.13 dBA/m

BWC Factor = 0.15 dB

Location: 12.5, 0, 3.7 mm

Cursor:

ABM2 = -18.19 dBA/m

Location: 12.5, 0, 3.7 mm

Cursor:

ABM1/ABM2 = 31.32 dB

ABM1 comp = 13.13 dBA/m

BWC Factor = 0.15 dB

Location: 12.5, 0, 3.7 mm

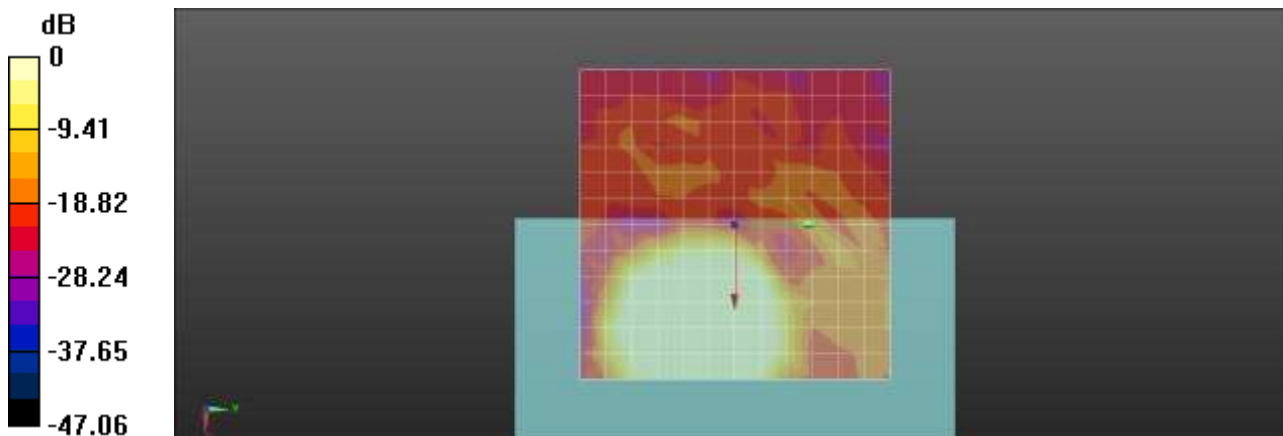

0 dB = 1.000 A/m = 0.00 dBA/m

Plot No.23

LTE Band 7 QPSK 20MHz 50RB 0offset EVS WB 5.9 kbit/s 21100ch Freq. Response

Communication System: UID 0, LTE Band 7 (0); Frequency: 2535 MHz;Duty Cycle: 1:1
 Medium parameters used: $\sigma = 0$ S/m, $\epsilon_r = 1$; $\rho = 0$ kg/m³
 Phantom section: TCoil Section

DASY5 Configuration:

- Probe: AM1DV3 - 3049; ; Calibrated: 2021-06-01
- Sensor-Surface: 0mm (Fix Surface)
- Electronics: DAE4 Sn1686; Calibrated: 2021-06-21
- Phantom: HAC Test Arch with AMCC
- Measurement SW: DASY52, Version 52.10 (4)

T-Coil scan (scan for ANSI C63.19-2007 & 2011 compliance)/General Scans/z (axial) wideband at best

S/N/ABM Freq Resp(x,y,z,f) (1x1x1): Measurement grid: dx=10mm, dy=10mm
 Signal Type: Audio File (.wav) 48k_Normal_51s new.wav
 Output Gain: 52.93
 Measure Window Start: 300ms
 Measure Window Length: 51000ms
 BWC applied: 9.47 dB
 Device Reference Point: 0, 0, -6.3 mm

Category	Telephone parameters WD signal quality [(signal+noise)-to-noise ratio in decibels]
Category T1	0 dB to 10 dB
Category T2	10 dB to 20 dB
Category T3	20 dB to 30 dB
Category T4	> 30 dB

Cursor:

Diff = 1.48 dB
 BWC Factor = 9.47 dB
 Location: 12.5, -2, 3.7 mm

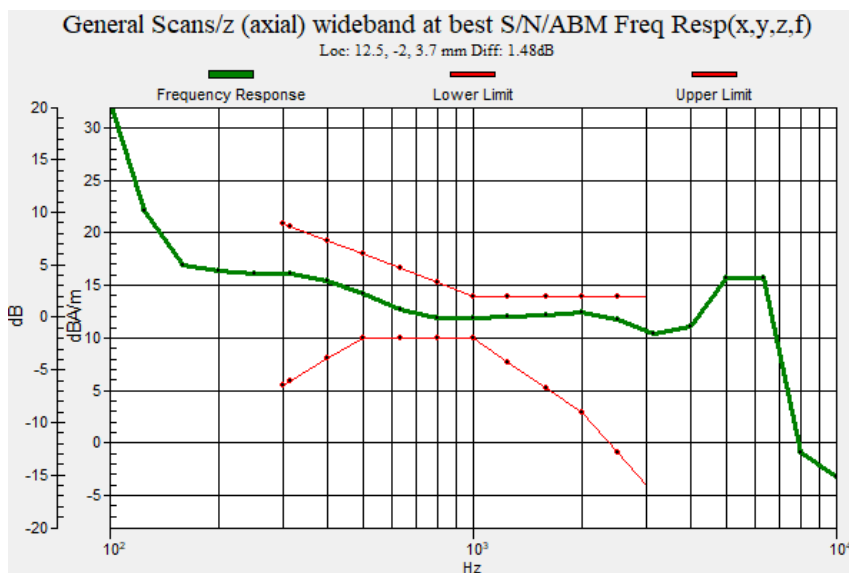

Plot No.24

LTE Band 7 QPSK 20MHz 50RB 0offset EVS WB 5.9 kbit/s 21100ch y(transversal)

Communication System: UID 0, LTE Band 7 (0); Frequency: 2535 MHz;Duty Cycle: 1:1
Medium parameters used: $\sigma = 0$ S/m, $\epsilon_r = 1$; $\rho = 0$ kg/m³
Phantom section: TCoil Section

DASY5 Configuration:

- Probe: AM1DV3 - 3049; ; Calibrated: 2021-06-01
- Sensor-Surface: 0mm (Fix Surface)
- Electronics: DAE4 Sn1686; Calibrated: 2021-06-21
- Phantom: HAC Test Arch with AMCC
- Measurement SW: DASY52, Version 52.10 (4)

T-Coil scan (scan for ANSI C63.19-2007 & 2011 compliance)/General Scans/y (transversal) 4.2mm 50

x 50/ABM Signal(x,y,z) (13x13x1): Measurement grid: dx=10mm, dy=10mm

Signal Type: Audio File (.wav) 48k_voice_1kHz_1s.wav

Output Gain: 24.61

Measure Window Start: 300ms

Measure Window Length: 1000ms

BWC applied: 0.15 dB

Device Reference Point: 0, 0, -6.3 mm

Cursor:

ABM1 comp = -3.32 dBA/m

BWC Factor = 0.15 dB

Location: 8.3, 16.7, 3.7 mm

Cursor:

ABM2 = -34.32 dBA/m

Location: 8.3, 16.7, 3.7 mm

Cursor:

ABM1/ABM2 = 31.00 dB

ABM1 comp = -3.32 dBA/m

BWC Factor = 0.15 dB

Location: 8.3, 16.7, 3.7 mm

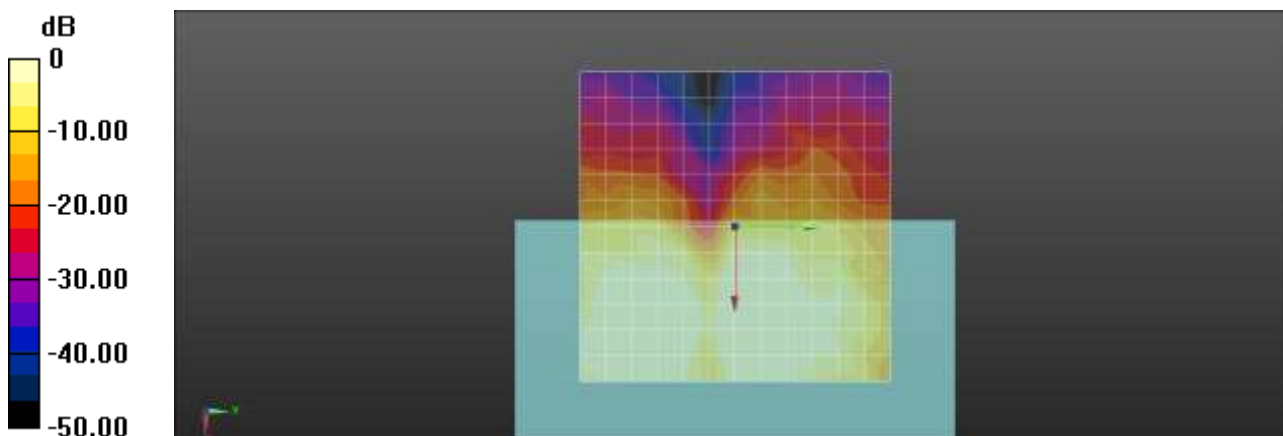

0 dB = 1.000 A/m = 0.00 dBA/m

Plot No.25

LTE Band 12 QPSK 10MHz 25RB 0offset EVS WB 5.9 kbit/s 23095ch z(axial)

Communication System: UID 0, LTE Band12 (0); Frequency: 707.5 MHz;Duty Cycle: 1:1
 Medium parameters used: $\sigma = 0$ S/m, $\epsilon_r = 1$; $\rho = 0$ kg/m³
 Phantom section: TCoil Section

DASY5 Configuration:

- Probe: AM1DV3 - 3049; ; Calibrated: 2021-06-01
- Sensor-Surface: 0mm (Fix Surface)
- Electronics: DAE4 Sn1686; Calibrated: 2021-06-21
- Phantom: HAC Test Arch with AMCC
- Measurement SW: DASY52, Version 52.10 (4)

T-Coil scan (scan for ANSI C63.19-2007 & 2011 compliance)/General Scans/z (axial) 4.2mm 50 x

50/ABM Signal(x,y,z) (13x13x1): Measurement grid: dx=10mm, dy=10mm

Signal Type: Audio File (.wav) 48k_voice_1kHz_1s.wav

Output Gain: 24.61

Measure Window Start: 300ms

Measure Window Length: 1000ms

BWC applied: 0.15 dB

Device Reference Point: 0, 0, -6.3 mm

Cursor:

ABM1 comp = 14.43 dBA/m

BWC Factor = 0.15 dB

Location: 12.5, -4.2, 3.7 mm

Cursor:

ABM2 = -15.36 dBA/m

Location: 12.5, -4.2, 3.7 mm

Cursor:

ABM1/ABM2 = 29.79 dB

ABM1 comp = 14.43 dBA/m

BWC Factor = 0.15 dB

Location: 12.5, -4.2, 3.7 mm

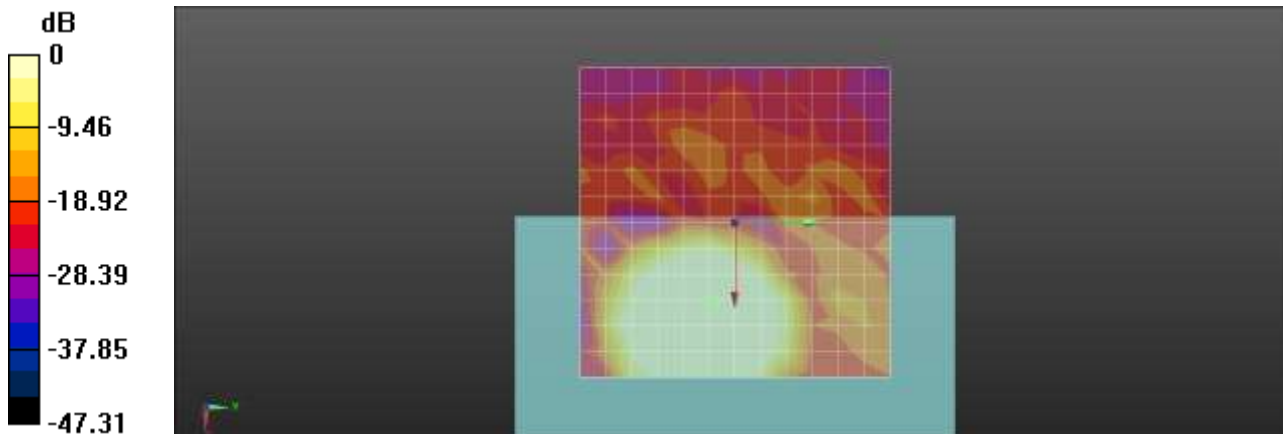

0 dB = 1.000 A/m = 0.00 dBA/m

Plot No.26

LTE Band 12 QPSK 10MHz 25RB 0offset EVS WB 5.9 kbit/s 23095ch Freq. Response

Communication System: UID 0, LTE Band12 (0); Frequency: 707.5 MHz;Duty Cycle: 1:1
 Medium parameters used: $\sigma = 0$ S/m, $\epsilon_r = 1$; $\rho = 0$ kg/m³
 Phantom section: TCoil Section

DASY5 Configuration:

- Probe: AM1DV3 - 3049; ; Calibrated: 2021-06-01
- Sensor-Surface: 0mm (Fix Surface)
- Electronics: DAE4 Sn1686; Calibrated: 2021-06-21
- Phantom: HAC Test Arch with AMCC
- Measurement SW: DASY52, Version 52.10 (4)

T-Coil scan (scan for ANSI C63.19-2007 & 2011 compliance)/General Scans/z (axial) wideband at best

S/N/ABM Freq Resp(x,y,z,f) (1x1x1): Measurement grid: dx=10mm, dy=10mm
 Signal Type: Audio File (.wav) 48k_Normal_51s new.wav
 Output Gain: 52.93
 Measure Window Start: 300ms
 Measure Window Length: 51000ms
 BWC applied: 9.47 dB
 Device Reference Point: 0, 0, -6.3 mm

Category	Telephone parameters WD signal quality [(signal+noise)-to-noise ratio in decibels]
Category T1	0 dB to 10 dB
Category T2	10 dB to 20 dB
Category T3	20 dB to 30 dB
Category T4	> 30 dB

Cursor:

Diff = 1.46 dB
 BWC Factor = 9.47 dB
 Location: 12.3, -2.9, 3.7 mm

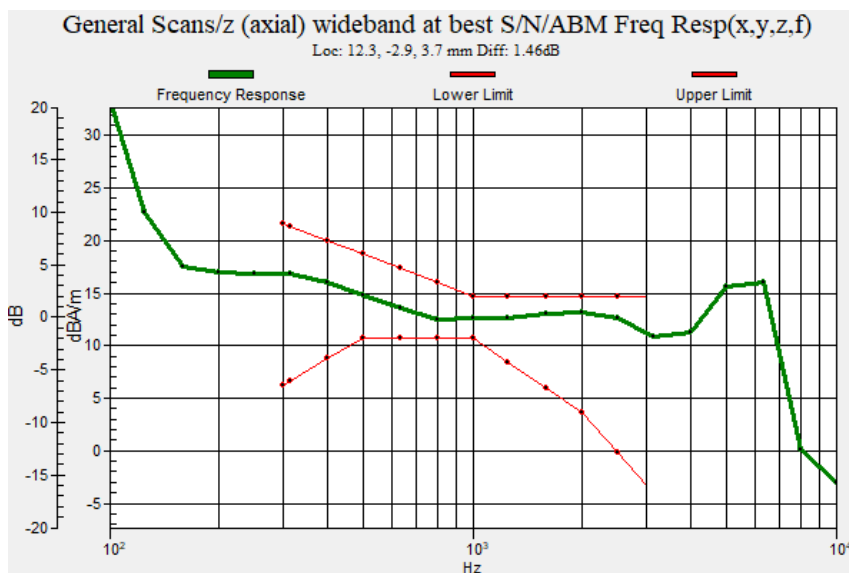

Plot No.27

LTE Band 12 QPSK 10MHz 25RB 0offset EVS WB 5.9 kbit/s 23095ch y(transversal)

Communication System: UID 0, LTE Band12 (0); Frequency: 707.5 MHz;Duty Cycle: 1:1
 Medium parameters used: $\sigma = 0$ S/m, $\epsilon_r = 1$; $\rho = 0$ kg/m³
 Phantom section: TCoil Section

DASY5 Configuration:

- Probe: AM1DV3 - 3049; ; Calibrated: 2021-06-01
- Sensor-Surface: 0mm (Fix Surface)
- Electronics: DAE4 Sn1686; Calibrated: 2021-06-21
- Phantom: HAC Test Arch with AMCC
- Measurement SW: DASY52, Version 52.10 (4)

T-Coil scan (scan for ANSI C63.19-2007 & 2011 compliance)/General Scans/y (transversal) 4.2mm 50

x 50/ABM Signal(x,y,z) (13x13x1): Measurement grid: dx=10mm, dy=10mm

Signal Type: Audio File (.wav) 48k_voice_1kHz_1s.wav

Output Gain: 24.61

Measure Window Start: 300ms

Measure Window Length: 1000ms

BWC applied: 0.15 dB

Device Reference Point: 0, 0, -6.3 mm

Cursor:

ABM1 comp = 8.72 dBA/m

BWC Factor = 0.15 dB

Location: 20.8, -12.5, 3.7 mm

Cursor:

ABM2 = -22.30 dBA/m

Location: 20.8, -12.5, 3.7 mm

Cursor:

ABM1/ABM2 = 31.03 dB

ABM1 comp = 8.72 dBA/m

BWC Factor = 0.15 dB

Location: 20.8, -12.5, 3.7 mm

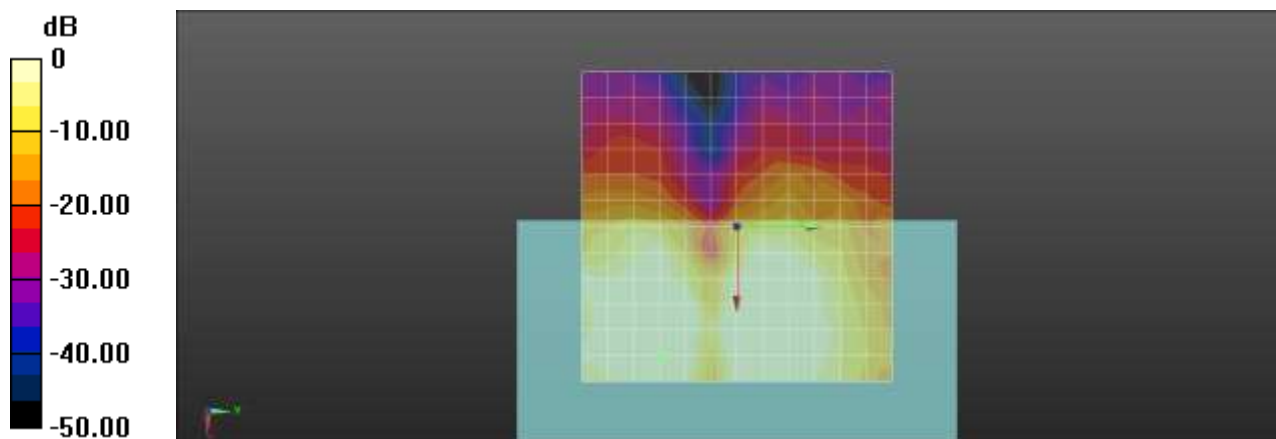

0 dB = 1.000 A/m = 0.00 dBA/m

Plot No.28

LTE Band 13 QPSK 10MHz 25RB 0offset EVS WB 5.9 kbit/s 23230ch z(axial)

Communication System: UID 0, LTE Band 13 (0); Frequency: 782 MHz;Duty Cycle: 1:1
 Medium parameters used: $\sigma = 0$ S/m, $\epsilon_r = 1$; $\rho = 0$ kg/m³
 Phantom section: TCoil Section

DASY5 Configuration:

- Probe: AM1DV3 - 3049; ; Calibrated: 2021-06-01
- Sensor-Surface: 0mm (Fix Surface)
- Electronics: DAE4 Sn1686; Calibrated: 2021-06-21
- Phantom: HAC Test Arch with AMCC
- Measurement SW: DASY52, Version 52.10 (4)

T-Coil scan (scan for ANSI C63.19-2007 & 2011 compliance)/General Scans/z (axial) 4.2mm 50 x

50/ABM Signal(x,y,z) (13x13x1): Measurement grid: dx=10mm, dy=10mm

Signal Type: Audio File (.wav) 48k_voice_1kHz_1s.wav

Output Gain: 24.61

Measure Window Start: 300ms

Measure Window Length: 1000ms

BWC applied: 0.15 dB

Device Reference Point: 0, 0, -6.3 mm

Cursor:

ABM1 comp = 16.33 dBA/m

BWC Factor = 0.15 dB

Location: 12.5, -4.2, 3.7 mm

Cursor:

ABM2 = -14.88 dBA/m

Location: 12.5, -4.2, 3.7 mm

Cursor:

ABM1/ABM2 = 31.20 dB

ABM1 comp = 16.33 dBA/m

BWC Factor = 0.15 dB

Location: 12.5, -4.2, 3.7 mm

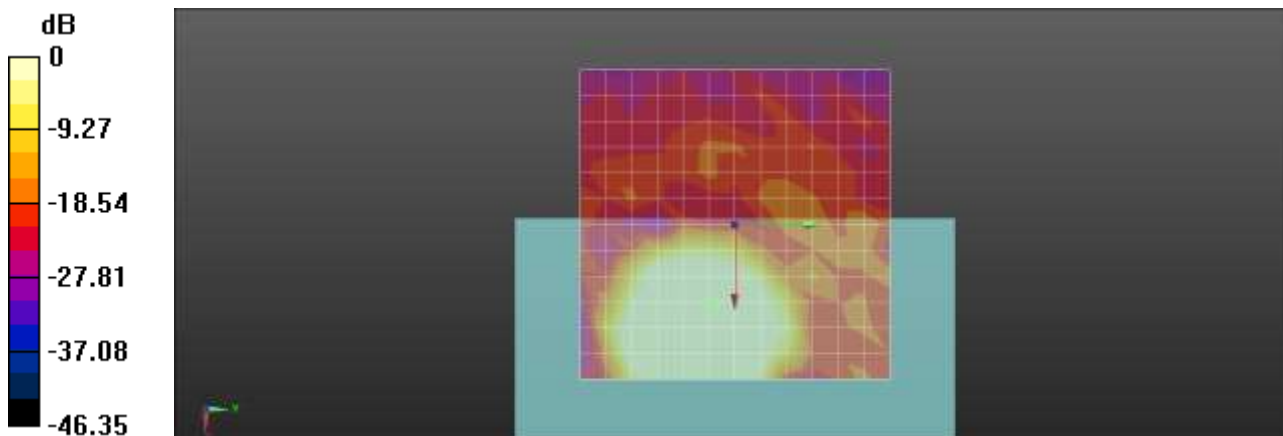

0 dB = 1.000 A/m = 0.00 dBA/m

Plot No.29

LTE Band 13 QPSK 10MHz 25RB 0offset EVS WB 5.9 kbit/s 23230ch Freq. Response

Communication System: UID 0, LTE Band 13 (0); Frequency: 782 MHz;Duty Cycle: 1:1
 Medium parameters used: $\sigma = 0$ S/m, $\epsilon_r = 1$; $\rho = 0$ kg/m³
 Phantom section: TCoil Section

DASY5 Configuration:

- Probe: AM1DV3 - 3049; ; Calibrated: 2021-06-01
- Sensor-Surface: 0mm (Fix Surface)
- Electronics: DAE4 Sn1686; Calibrated: 2021-06-21
- Phantom: HAC Test Arch with AMCC
- Measurement SW: DASY52, Version 52.10 (4)

T-Coil scan (scan for ANSI C63.19-2007 & 2011 compliance)/General Scans/z (axial) wideband at best

S/N/ABM Freq Resp(x,y,z,f) (1x1x1): Measurement grid: dx=10mm, dy=10mm
 Signal Type: Audio File (.wav) 48k_Normal_51s new.wav
 Output Gain: 52.93
 Measure Window Start: 300ms
 Measure Window Length: 51000ms
 BWC applied: 9.47 dB
 Device Reference Point: 0, 0, -6.3 mm

Category	Telephone parameters WD signal quality [(signal+noise)-to-noise ratio in decibels]
Category T1	0 dB to 10 dB
Category T2	10 dB to 20 dB
Category T3	20 dB to 30 dB
Category T4	> 30 dB

Cursor:

Diff = 1.31 dB
 BWC Factor = 9.47 dB
 Location: 12.1, -4.8, 3.7 mm

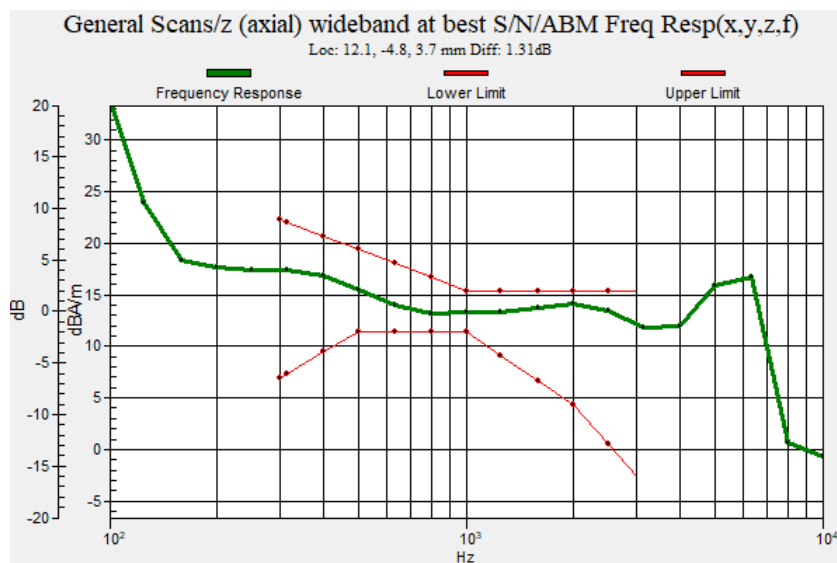

Plot No.30

LTE Band 13 QPSK 10MHz 25RB 0offset EVS WB 5.9 kbit/s 23230ch y(transversal)

Communication System: UID 0, LTE Band 13 (0); Frequency: 782 MHz;Duty Cycle: 1:1
 Medium parameters used: $\sigma = 0$ S/m, $\epsilon_r = 1$; $\rho = 0$ kg/m³
 Phantom section: TCoil Section

DASY5 Configuration:

- Probe: AM1DV3 - 3049; ; Calibrated: 2021-06-01
- Sensor-Surface: 0mm (Fix Surface)
- Electronics: DAE4 Sn1686; Calibrated: 2021-06-21
- Phantom: HAC Test Arch with AMCC
- Measurement SW: DASY52, Version 52.10 (4)

T-Coil scan (scan for ANSI C63.19-2007 & 2011 compliance)/General Scans/y (transversal) 4.2mm 50

x 50/ABM Signal(x,y,z) (13x13x1): Measurement grid: dx=10mm, dy=10mm

Signal Type: Audio File (.wav) 48k_voice_1kHz_1s.wav

Output Gain: 24.61

Measure Window Start: 300ms

Measure Window Length: 1000ms

BWC applied: 0.15 dB

Device Reference Point: 0, 0, -6.3 mm

Cursor:

ABM1 comp = 3.73 dBA/m

BWC Factor = 0.15 dB

Location: 8.3, 8.3, 3.7 mm

Cursor:

ABM2 = -27.26 dBA/m

Location: 8.3, 8.3, 3.7 mm

Cursor:

ABM1/ABM2 = 30.99 dB

ABM1 comp = 3.73 dBA/m

BWC Factor = 0.15 dB

Location: 8.3, 8.3, 3.7 mm

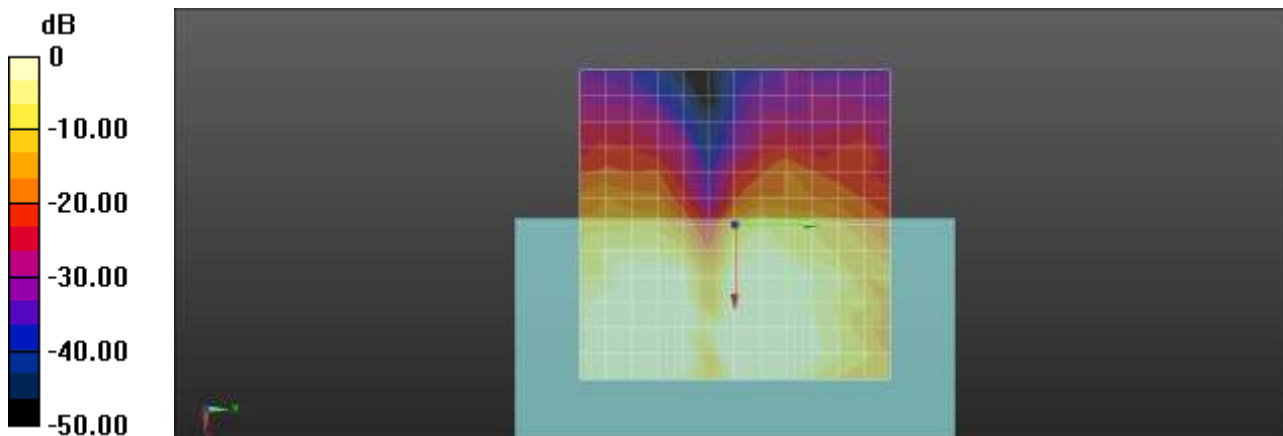

0 dB = 1.000 A/m = 0.00 dBA/m

Plot No.31

LTE Band 48 QPSK 5MHz 1RB 24offset EVR WB 5.9 kbit/s 55265ch z(axial)

Communication System: UID 0, LTE 48 (0); Frequency: 3552.5 MHz;Duty Cycle: 1:2.30728

Medium parameters used: $\sigma = 0$ S/m, $\epsilon_r = 1$; $\rho = 0$ kg/m³

Phantom section: TCoil Section

DASY5 Configuration:

- Probe: AM1DV3 - 3049; ; Calibrated: 2021-06-01
- Sensor-Surface: 0mm (Fix Surface)
- Electronics: DAE4 Sn1686; Calibrated: 2021-06-21
- Phantom: HAC Test Arch with AMCC
- Measurement SW: DASY52, Version 52.10 (4)

T-Coil scan (scan for ANSI C63.19-2007 & 2011 compliance)/General Scans/z (axial) 4.2mm 50 x

50/ABM Signal(x,y,z) (13x13x1): Measurement grid: dx=10mm, dy=10mm

Signal Type: Audio File (.wav) 48k_voice_1kHz_1s.wav

Output Gain: 24.61

Measure Window Start: 300ms

Measure Window Length: 1000ms

BWC applied: 0.15 dB

Device Reference Point: 0, 0, -6.3 mm

Cursor:

ABM1 comp = 15.37 dBA/m

BWC Factor = 0.15 dB

Location: 12.5, -4.2, 3.7 mm

Cursor:

ABM2 = -14.87 dBA/m

Location: 12.5, -4.2, 3.7 mm

Cursor:

ABM1/ABM2 = 30.23 dB

ABM1 comp = 15.37 dBA/m

BWC Factor = 0.15 dB

Location: 12.5, -4.2, 3.7 mm

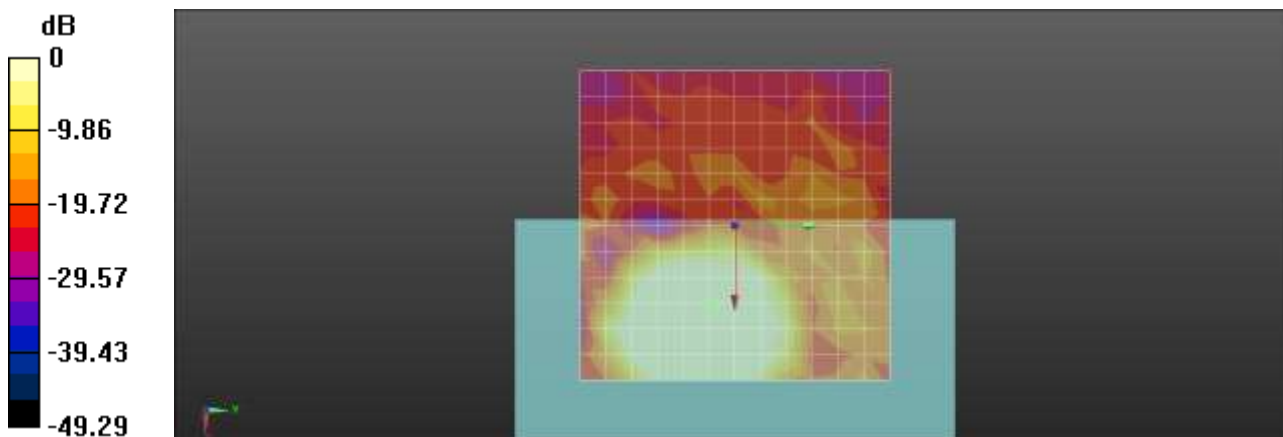

0 dB = 1.000 A/m = 0.00 dBA/m

Plot No.32

LTE Band 48 QPSK 5MHz 1RB 24offset EVR WB 5.9 kbit/s 55265ch Freq. Response

Communication System: UID 0, LTE 48 (0); Frequency: 3552.5 MHz;Duty Cycle: 1:2.30728
 Medium parameters used: $\sigma = 0$ S/m, $\epsilon_r = 1$; $\rho = 0$ kg/m³
 Phantom section: TCoil Section

DASY5 Configuration:

- Probe: AM1DV3 - 3049; ; Calibrated: 2021-06-01
- Sensor-Surface: 0mm (Fix Surface)
- Electronics: DAE4 Sn1686; Calibrated: 2021-06-21
- Phantom: HAC Test Arch with AMCC
- Measurement SW: DASY52, Version 52.10 (4)

T-Coil scan (scan for ANSI C63.19-2007 & 2011 compliance)/General Scans/z (axial) wideband at best

S/N/ABM Freq Resp(x,y,z,f) (1x1x1): Measurement grid: dx=10mm, dy=10mm
 Signal Type: Audio File (.wav) 48k_Normal_51s new.wav
 Output Gain: 52.93
 Measure Window Start: 300ms
 Measure Window Length: 51000ms
 BWC applied: 9.47 dB
 Device Reference Point: 0, 0, -6.3 mm

Category	Telephone parameters WD signal quality [(signal+noise)-to-noise ratio in decibels]
Category T1	0 dB to 10 dB
Category T2	10 dB to 20 dB
Category T3	20 dB to 30 dB
Category T4	> 30 dB

Cursor:

Diff = 1.17 dB
 BWC Factor = 9.47 dB
 Location: 12.5, -4, 3.7 mm

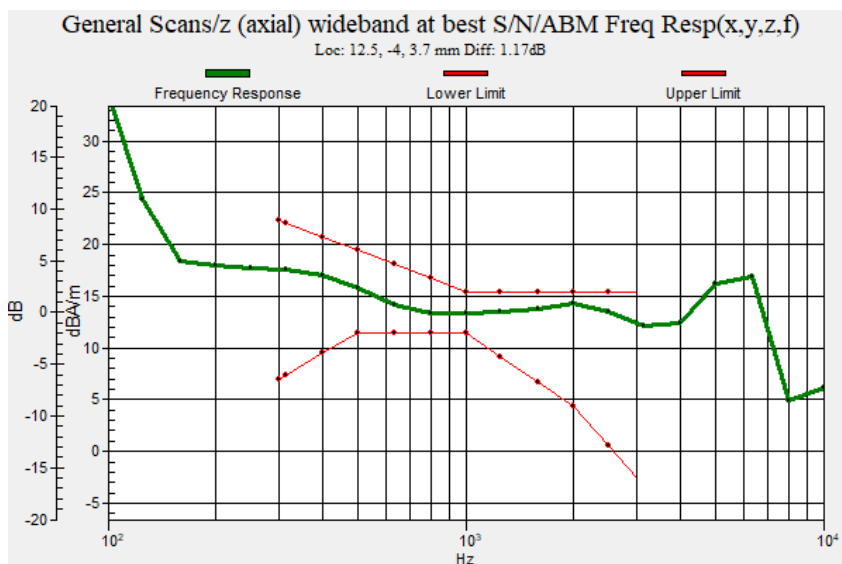

Plot No.33

LTE Band 48 QPSK 5MHz 1RB 24offset EVR WB 5.9 kbit/s 55265ch y(transversal)

Communication System: UID 0, LTE 48 (0); Frequency: 3552.5 MHz;Duty Cycle: 1:2.30728
 Medium parameters used: $\sigma = 0$ S/m, $\epsilon_r = 1$; $\rho = 0$ kg/m³
 Phantom section: TCoil Section

DASY5 Configuration:

- Probe: AM1DV3 - 3049; ; Calibrated: 2021-06-01
- Sensor-Surface: 0mm (Fix Surface)
- Electronics: DAE4 Sn1686; Calibrated: 2021-06-21
- Phantom: HAC Test Arch with AMCC
- Measurement SW: DASY52, Version 52.10 (4)

T-Coil scan (scan for ANSI C63.19-2007 & 2011 compliance)/General Scans/y (transversal) 4.2mm 50

x 50/ABM Signal(x,y,z) (13x13x1): Measurement grid: dx=10mm, dy=10mm

Signal Type: Audio File (.wav) 48k_voice_1kHz_1s.wav

Output Gain: 24.61

Measure Window Start: 300ms

Measure Window Length: 1000ms

BWC applied: 0.15 dB

Device Reference Point: 0, 0, -6.3 mm

Cursor:

ABM1 comp = -6.67 dBA/m

BWC Factor = 0.15 dB

Location: 0, -16.7, 3.7 mm

Cursor:

ABM2 = -32.20 dBA/m

Location: 0, -16.7, 3.7 mm

Cursor:

ABM1/ABM2 = 25.52 dB

ABM1 comp = -6.67 dBA/m

BWC Factor = 0.15 dB

Location: 0, -16.7, 3.7 mm

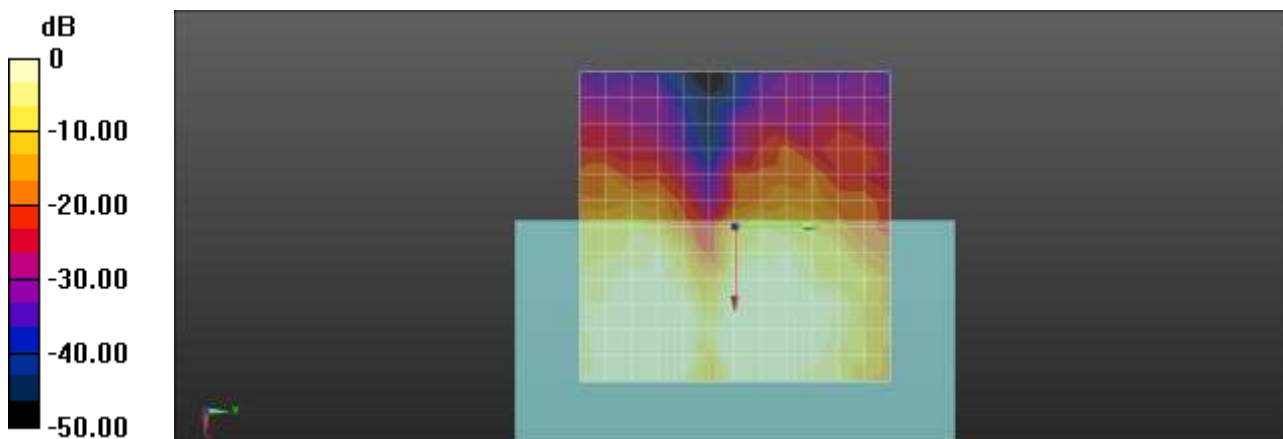

0 dB = 1.000 A/m = 0.00 dBA/m

Plot No.34

NR Band 2 QPSK 15MHz 39RB 40offset EVS WB 5.9 kbit/s 376000ch z(axial)

Communication System: UID 0, NR Band 2 (0); Frequency: 1880 MHz;Duty Cycle: 1:1
 Medium parameters used: $\sigma = 0$ S/m, $\epsilon_r = 1$; $\rho = 0$ kg/m³
 Phantom section: TCoil Section

DASY5 Configuration:

- Probe: AM1DV3 - 3049; ; Calibrated: 2021-06-01
- Sensor-Surface: 0mm (Fix Surface)
- Electronics: DAE4 Sn1686; Calibrated: 2021-06-21
- Phantom: HAC Test Arch with AMCC
- Measurement SW: DASY52, Version 52.10 (4)

T-Coil scan (scan for ANSI C63.19-2007 & 2011 compliance)/General Scans/z (axial) 4.2mm 50 x 50/ABM Signal(x,y,z) (13x13x1): Measurement grid: dx=10mm, dy=10mm

Signal Type: Audio File (.wav) 48k_voice_1kHz_1s.wav
 Output Gain: 43.9
 Measure Window Start: 300ms
 Measure Window Length: 3000ms
 BWC applied: 0.16 dB
 Device Reference Point: 0, 0, -6.3 mm

Cursor:

ABM1 comp = -2.70 dBA/m
 BWC Factor = 0.16 dB
 Location: 8.3, 0, 3.7 mm

Cursor:

ABM2 = -36.89 dBA/m
 Location: 8.3, 0, 3.7 mm

Cursor:

ABM1/ABM2 = 34.20 dB
 ABM1 comp = -2.70 dBA/m
 BWC Factor = 0.16 dB
 Location: 8.3, 0, 3.7 mm

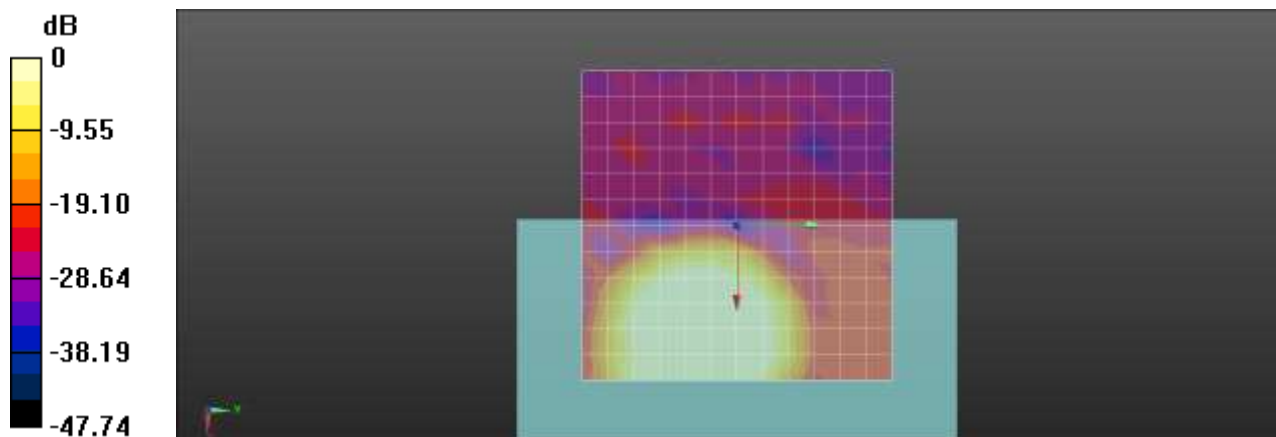

0 dB = 1.000 A/m = 0.00 dBA/m

Plot No.35

NR Band 2 QPSK 15MHz 40RB 39offset EVS WB 5.9 kbit/s 376000ch Freq. Response

Communication System: UID 0, NR Band 2 (0); Frequency: 1880 MHz;Duty Cycle: 1:1
 Medium parameters used: $\sigma = 0$ S/m, $\epsilon_r = 1$; $\rho = 0$ kg/m³
 Phantom section: TCoil Section

DASY5 Configuration:

- Probe: AM1DV3 - 3049; ; Calibrated: 2021-06-01
- Sensor-Surface: 0mm (Fix Surface)
- Electronics: DAE4 Sn1686; Calibrated: 2021-06-21
- Phantom: HAC Test Arch with AMCC
- Measurement SW: DASY52, Version 52.10 (4)

T-Coil scan (scan for ANSI C63.19-2007 & 2011 compliance)/General Scans/z (axial) wideband at best

S/N/ABM Freq Resp(x,y,z,f) (1x1x1): Measurement grid: dx=10mm, dy=10mm
 Signal Type: Audio File (.wav) 48k_Normal_51s new.wav
 Output Gain: 93.49
 Measure Window Start: 300ms
 Measure Window Length: 51000ms
 BWC applied: 9.48 dB
 Device Reference Point: 0, 0, -6.3 mm

Category	Telephone parameters WD signal quality [(signal+noise)-to-noise ratio in decibels]
Category T1	0 dB to 10 dB
Category T2	10 dB to 20 dB
Category T3	20 dB to 30 dB
Category T4	> 30 dB

Cursor:

Diff = 2.00 dB
 BWC Factor = 9.48 dB
 Location: 8.8, -0.3, 3.7 mm

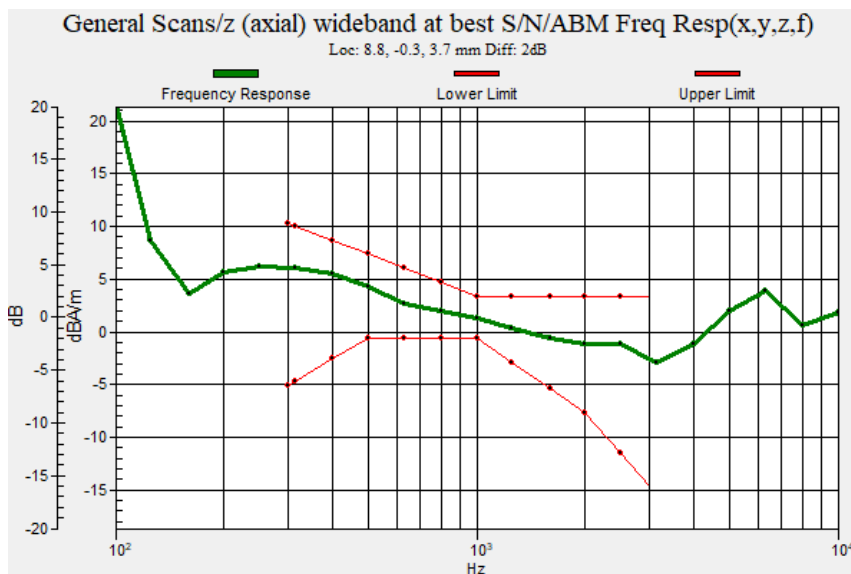

Plot No.36

NR Band 2 QPSK 15MHz 39RB 40offset EVS WB 5.9 kbit/s 376000ch y(transversal)

Communication System: UID 0, NR Band 2 (0); Frequency: 1880 MHz;Duty Cycle: 1:1
 Medium parameters used: $\sigma = 0$ S/m, $\epsilon_r = 1$; $\rho = 0$ kg/m³
 Phantom section: TCoil Section

DASY5 Configuration:

- Probe: AM1DV3 - 3049; ; Calibrated: 2021-06-01
- Sensor-Surface: 0mm (Fix Surface)
- Electronics: DAE4 Sn1686; Calibrated: 2021-06-21
- Phantom: HAC Test Arch with AMCC
- Measurement SW: DASY52, Version 52.10 (4)

T-Coil scan (scan for ANSI C63.19-2007 & 2011 compliance)/General Scans/y (transversal) 4.2mm 50 x 50/ABM Signal(x,y,z) (13x13x1): Measurement grid: dx=10mm, dy=10mm

Signal Type: Audio File (.wav) 48k_voice_1kHz_1s.wav
 Output Gain: 43.9
 Measure Window Start: 300ms
 Measure Window Length: 3000ms
 BWC applied: 0.16 dB
 Device Reference Point: 0, 0, -6.3 mm

Cursor:

ABM1 comp = 1.65 dBA/m
 BWC Factor = 0.16 dB
 Location: 16.7, -12.5, 3.7 mm

Cursor:

ABM2 = -28.72 dBA/m
 Location: 16.7, -12.5, 3.7 mm

Cursor:

ABM1/ABM2 = 30.37 dB
 ABM1 comp = 1.65 dBA/m
 BWC Factor = 0.16 dB
 Location: 16.7, -12.5, 3.7 mm

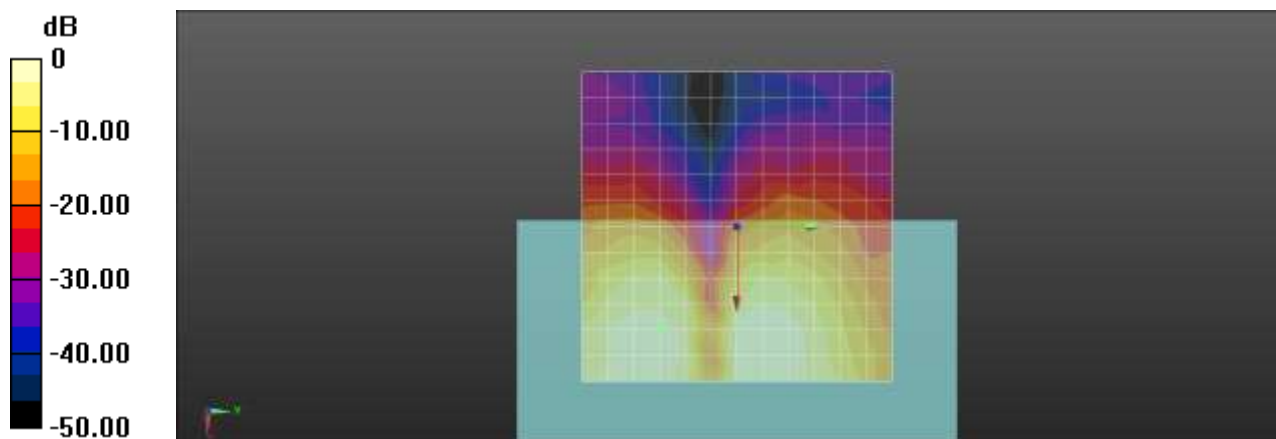

0 dB = 1.000 A/m = 0.00 dBA/m

Plot No.37

NR Band 5 QPSK 15MHz 39RB 40offset EVS WB 5.9 kbit/s 167300ch z(axial)

Communication System: UID 0, NR Band 5 (0); Frequency: 836.5 MHz;Duty Cycle: 1:1
 Medium parameters used: $\sigma = 0$ S/m, $\epsilon_r = 1$; $\rho = 0$ kg/m³
 Phantom section: TCoil Section

DASY5 Configuration:

- Probe: AM1DV3 - 3049; ; Calibrated: 2021-06-01
- Sensor-Surface: 0mm (Fix Surface)
- Electronics: DAE4 Sn1686; Calibrated: 2021-06-21
- Phantom: HAC Test Arch with AMCC
- Measurement SW: DASY52, Version 52.10 (4)

T-Coil scan (scan for ANSI C63.19-2007 & 2011 compliance)/General Scans/z (axial) 4.2mm 50 x

50/ABM Signal(x,y,z) (13x13x1): Measurement grid: dx=10mm, dy=10mm

Signal Type: Audio File (.wav) 48k_voice_1kHz_1s.wav

Output Gain: 43.9

Measure Window Start: 300ms

Measure Window Length: 3000ms

BWC applied: 0.16 dB

Device Reference Point: 0, 0, -6.3 mm

Cursor:

ABM1 comp = 9.57 dBA/m

BWC Factor = 0.16 dB

Location: 12.5, -4.2, 3.7 mm

Cursor:

ABM2 = -27.64 dBA/m

Location: 12.5, -4.2, 3.7 mm

Cursor:

ABM1/ABM2 = 37.20 dB

ABM1 comp = 9.57 dBA/m

BWC Factor = 0.16 dB

Location: 12.5, -4.2, 3.7 mm

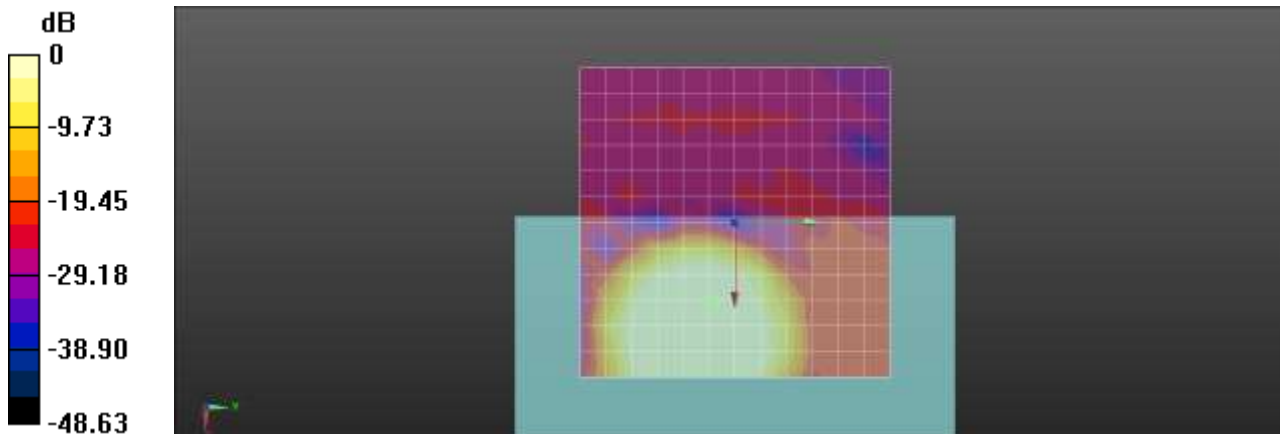

0 dB = 1.000 A/m = 0.00 dBA/m

Plot No.38

NR Band 5 QPSK 15MHz 39RB 40offset EVS WB 5.9 kbit/s 167300ch Freq. Response

Communication System: UID 0, NR Band 5 (0); Frequency: 836.5 MHz;Duty Cycle: 1:1
 Medium parameters used: $\sigma = 0$ S/m, $\epsilon_r = 1$; $\rho = 0$ kg/m³
 Phantom section: TCoil Section

DASY5 Configuration:

- Probe: AM1DV3 - 3049; ; Calibrated: 2021-06-01
- Sensor-Surface: 0mm (Fix Surface)
- Electronics: DAE4 Sn1686; Calibrated: 2021-06-21
- Phantom: HAC Test Arch with AMCC
- Measurement SW: DASY52, Version 52.10 (4)

T-Coil scan (scan for ANSI C63.19-2007 & 2011 compliance)/General Scans/z (axial) wideband at best S/N/ABM Freq Resp(x,y,z,f) (1x1x1): Measurement grid: dx=10mm, dy=10mm

Signal Type: Audio File (.wav) 48k_Normal_51s new.wav
 Output Gain: 93.49
 Measure Window Start: 300ms
 Measure Window Length: 51000ms
 BWC applied: 9.48 dB
 Device Reference Point: 0, 0, -6.3 mm

Category	Telephone parameters WD signal quality [(signal+noise)-to-noise ratio in decibels]
Category T1	0 dB to 10 dB
Category T2	10 dB to 20 dB
Category T3	20 dB to 30 dB
Category T4	> 30 dB

Cursor:

Diff = 2.00 dB
 BWC Factor = 9.48 dB
 Location: 13, -3.6, 3.7 mm

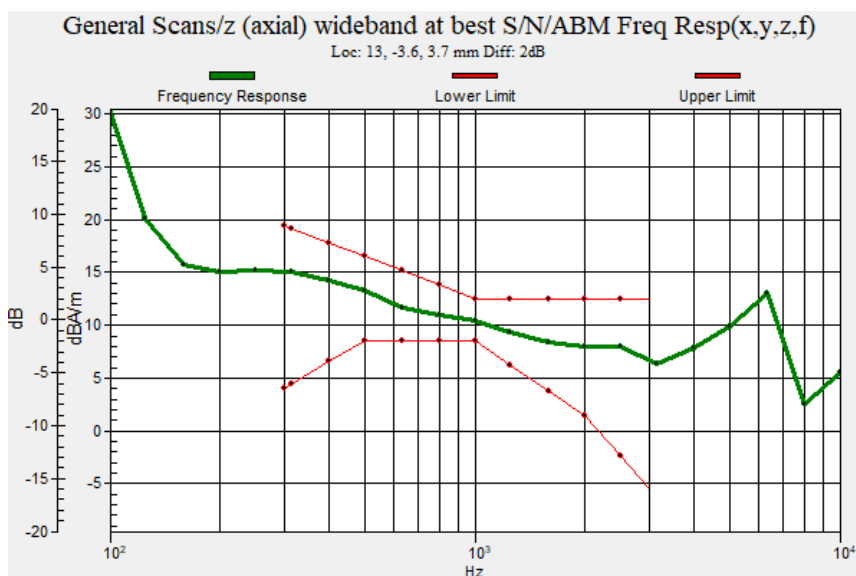

Plot No.39

NR Band 5 QPSK 15MHz 39RB 40offset EVS WB 5.9 kbit/s 167300ch y(transversal)

Communication System: UID 0, NR Band 5 (0); Frequency: 836.5 MHz;Duty Cycle: 1:1
 Medium parameters used: $\sigma = 0$ S/m, $\epsilon_r = 1$; $\rho = 0$ kg/m³
 Phantom section: TCoil Section

DASY5 Configuration:

- Probe: AM1DV3 - 3049; ; Calibrated: 2021-06-01
- Sensor-Surface: 0mm (Fix Surface)
- Electronics: DAE4 Sn1686; Calibrated: 2021-06-21
- Phantom: HAC Test Arch with AMCC
- Measurement SW: DASY52, Version 52.10 (4)

T-Coil scan (scan for ANSI C63.19-2007 & 2011 compliance)/General Scans/y (transversal) 4.2mm 50

x 50/ABM Signal(x,y,z) (13x13x1): Measurement grid: dx=10mm, dy=10mm

Signal Type: Audio File (.wav) 48k_voice_1kHz_1s.wav

Output Gain: 43.9

Measure Window Start: 300ms

Measure Window Length: 3000ms

BWC applied: 0.16 dB

Device Reference Point: 0, 0, -6.3 mm

Cursor:

ABM1 comp = 0.12 dBA/m

BWC Factor = 0.16 dB

Location: 16.7, 4.2, 3.7 mm

Cursor:

ABM2 = -36.38 dBA/m

Location: 16.7, 4.2, 3.7 mm

Cursor:

ABM1/ABM2 = 36.50 dB

ABM1 comp = 0.12 dBA/m

BWC Factor = 0.16 dB

Location: 16.7, 4.2, 3.7 mm

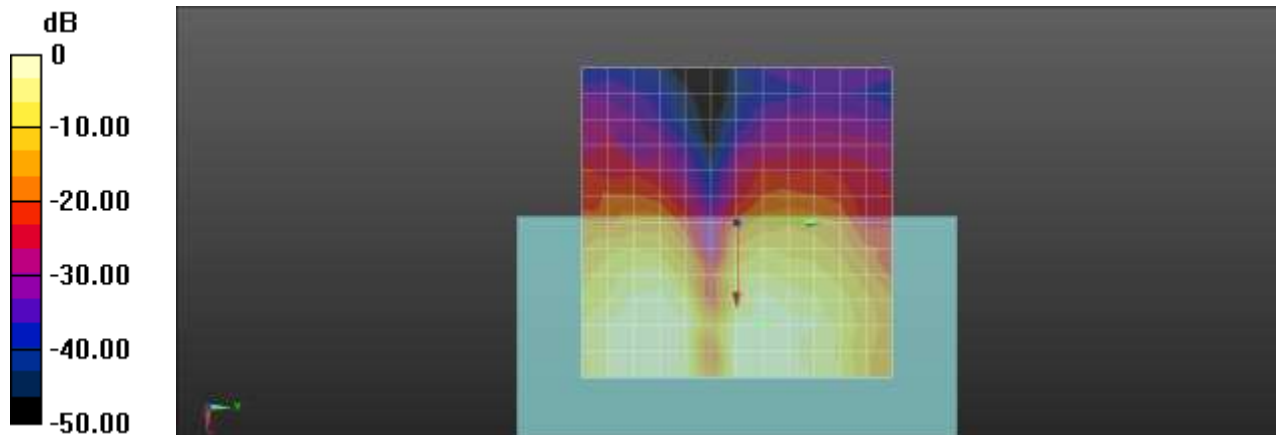

0 dB = 1.000 A/m = 0.00 dBA/m

Plot No.40

NR Band 66 QPSK 15MHz 39RB 40offset EVS WB 5.9 kbit/s 354500ch z(axial)

Communication System: UID 0, NR Band 66 (0); Frequency: 1772.5 MHz;Duty Cycle: 1:1
 Medium parameters used: $\sigma = 0$ S/m, $\epsilon_r = 1$; $\rho = 0$ kg/m³
 Phantom section: TCoil Section

DASY5 Configuration:

- Probe: AM1DV3 - 3049; ; Calibrated: 2021-06-01
- Sensor-Surface: 0mm (Fix Surface)
- Electronics: DAE4 Sn1686; Calibrated: 2021-06-21
- Phantom: HAC Test Arch with AMCC
- Measurement SW: DASY52, Version 52.10 (4)

T-Coil scan (scan for ANSI C63.19-2007 & 2011 compliance)/General Scans/z (axial) 4.2mm 50 x

50/ABM Signal(x,y,z) (13x13x1): Measurement grid: dx=10mm, dy=10mm

Signal Type: Audio File (.wav) 48k_voice_1kHz_1s.wav

Output Gain: 43.9

Measure Window Start: 300ms

Measure Window Length: 3000ms

BWC applied: 0.17 dB

Device Reference Point: 0, 0, -6.3 mm

Cursor:

ABM1 comp = -0.68 dBA/m

BWC Factor = 0.17 dB

Location: 8.3, 0, 3.7 mm

Cursor:

ABM2 = -32.79 dBA/m

Location: 8.3, 0, 3.7 mm

Cursor:

ABM1/ABM2 = 32.11 dB

ABM1 comp = -0.68 dBA/m

BWC Factor = 0.17 dB

Location: 8.3, 0, 3.7 mm

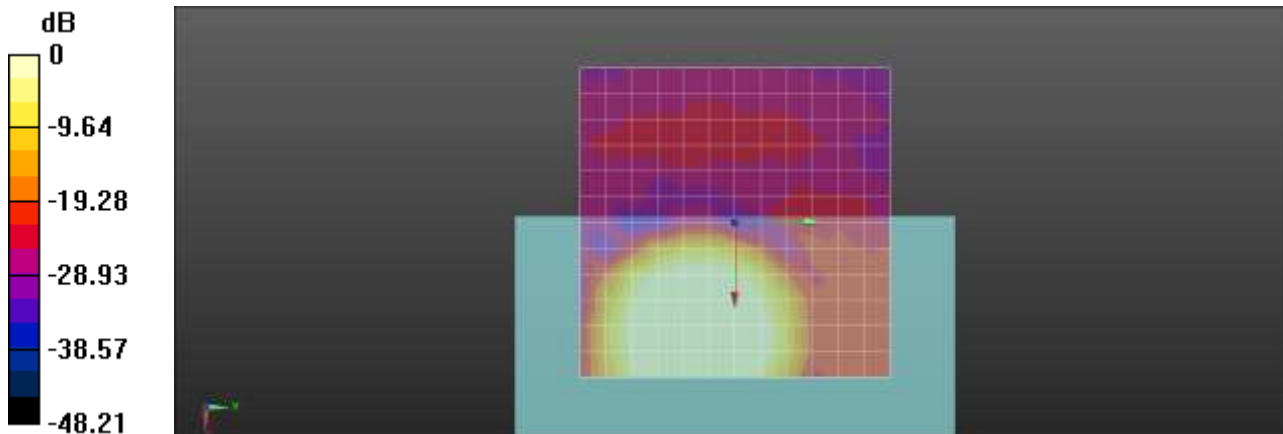

0 dB = 1.000 A/m = 0.00 dBA/m

Plot No.41

NR Band 66 QPSK 15MHz 40RB 39offset EVS WB 5.9 kbit/s 354500ch Freq. Response

Communication System: UID 0, NR Band 66 (0); Frequency: 1772.5 MHz;Duty Cycle: 1:1
 Medium parameters used: $\sigma = 0$ S/m, $\epsilon_r = 1$; $\rho = 0$ kg/m³
 Phantom section: TCoil Section

DASY5 Configuration:

- Probe: AM1DV3 - 3049; ; Calibrated: 2021-06-01
- Sensor-Surface: 0mm (Fix Surface)
- Electronics: DAE4 Sn1686; Calibrated: 2021-06-21
- Phantom: HAC Test Arch with AMCC
- Measurement SW: DASY52, Version 52.10 (4)

T-Coil scan (scan for ANSI C63.19-2007 & 2011 compliance)/General Scans/z (axial) wideband at best

S/N/ABM Freq Resp(x,y,z,f) (1x1x1): Measurement grid: dx=10mm, dy=10mm

Signal Type: Audio File (.wav) 48k_Normal_51s new.wav

Output Gain: 93.49

Measure Window Start: 300ms

Measure Window Length: 51000ms

BWC applied: 9.49 dB

Device Reference Point: 0, 0, -6.3 mm

Category	Telephone parameters WD signal quality [(signal+noise)-to-noise ratio in decibels]
Category T1	0 dB to 10 dB
Category T2	10 dB to 20 dB
Category T3	20 dB to 30 dB
Category T4	> 30 dB

Cursor:

Diff = 2.00 dB

BWC Factor = 9.49 dB

Location: 8.8, -0.2, 3.7 mm

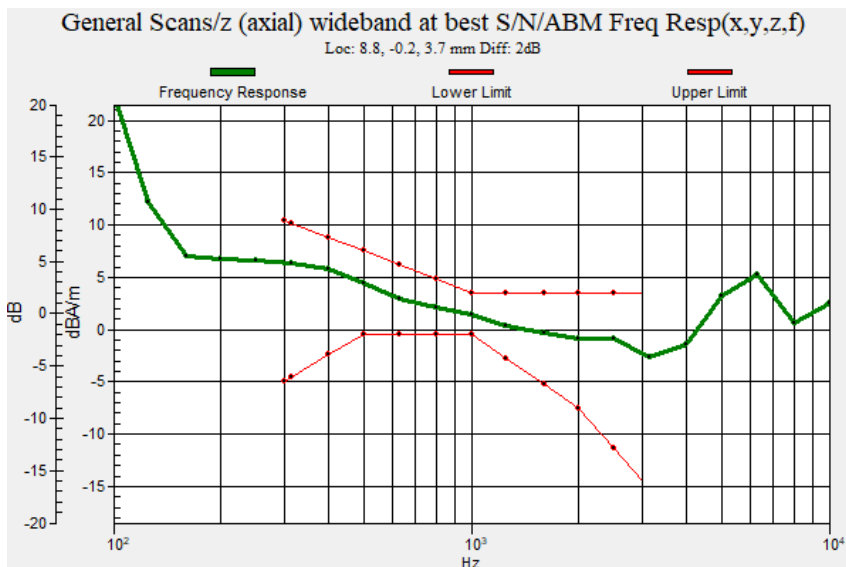

Plot No.42

NR Band 66 QPSK 15MHz 40RB 39offset EVS WB 5.9 kbit/s 354500ch y(transversal)

Communication System: UID 0, NR Band 66 (0); Frequency: 1772.5 MHz;Duty Cycle: 1:1
Medium parameters used: $\sigma = 0$ S/m, $\epsilon_r = 1$; $\rho = 0$ kg/m³
Phantom section: TCoil Section

DASY5 Configuration:

- Probe: AM1DV3 - 3049; ; Calibrated: 2021-06-01
- Sensor-Surface: 0mm (Fix Surface)
- Electronics: DAE4 Sn1686; Calibrated: 2021-06-21
- Phantom: HAC Test Arch with AMCC
- Measurement SW: DASY52, Version 52.10 (4)

T-Coil scan (scan for ANSI C63.19-2007 & 2011 compliance)/General Scans/y (transversal) 4.2mm 50

x 50/ABM Signal(x,y,z) (13x13x1): Measurement grid: dx=10mm, dy=10mm

Signal Type: Audio File (.wav) 48k_voice_1kHz_1s.wav

Output Gain: 43.9

Measure Window Start: 300ms

Measure Window Length: 3000ms

BWC applied: 0.17 dB

Device Reference Point: 0, 0, -6.3 mm

Cursor:

ABM1 comp = 0.51 dBA/m

BWC Factor = 0.17 dB

Location: 20.8, -12.5, 3.7 mm

Cursor:

ABM2 = -26.54 dBA/m

Location: 20.8, -12.5, 3.7 mm

Cursor:

ABM1/ABM2 = 27.05 dB

ABM1 comp = 0.51 dBA/m

BWC Factor = 0.17 dB

Location: 20.8, -12.5, 3.7 mm

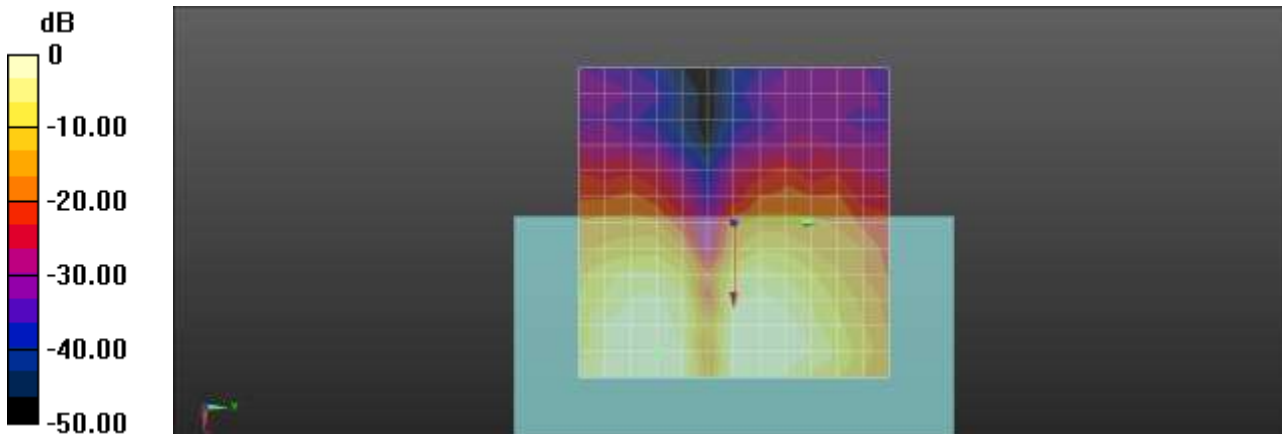

0 dB = 1.000 A/m = 0.00 dBA/m

Plot No.43

NR Band 77 QPSK 100MHz 270RB 0offset EVS WB 5.9 kbit/s 656000ch z(axial)

Communication System: UID 0, NR Band 77 (0); Frequency: 3840 MHz;Duty Cycle: 1:4.00037
Medium parameters used: $\sigma = 0$ S/m, $\epsilon_r = 1$; $\rho = 0$ kg/m³
Phantom section: TCoil Section

DASY5 Configuration:

- Probe: AM1DV3 - 3049; ; Calibrated: 2021-06-01
- Sensor-Surface: 0mm (Fix Surface)
- Electronics: DAE4 Sn1686; Calibrated: 2021-06-21
- Phantom: HAC Test Arch with AMCC
- Measurement SW: DASY52, Version 52.10 (4)

T-Coil scan (scan for ANSI C63.19-2007 & 2011 compliance)/General Scans/z (axial) 4.2mm 50 x

50/ABM Signal(x,y,z) (13x13x1): Measurement grid: dx=10mm, dy=10mm

Signal Type: Audio File (.wav) 48k_voice_1kHz_1s.wav

Output Gain: 43.9

Measure Window Start: 300ms

Measure Window Length: 3000ms

BWC applied: 0.16 dB

Device Reference Point: 0, 0, -6.3 mm

Cursor:

ABM1 comp = 1.36 dBA/m

BWC Factor = 0.16 dB

Location: 8.3, 0, 3.7 mm

Cursor:

ABM2 = -36.09 dBA/m

Location: 8.3, 0, 3.7 mm

Cursor:

ABM1/ABM2 = 37.45 dB

ABM1 comp = 1.36 dBA/m

BWC Factor = 0.16 dB

Location: 8.3, 0, 3.7 mm

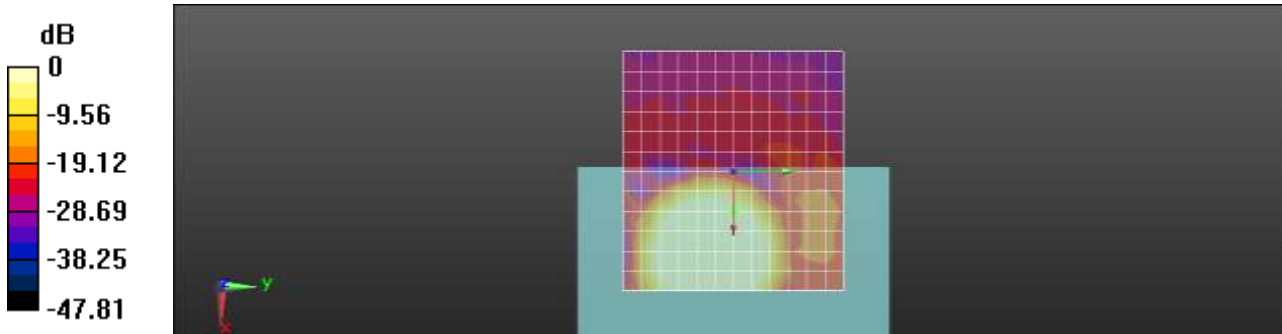

0 dB = 1.000 A/m = 0.00 dBA/m

Plot No.44

NR Band 77 QPSK 100MHz 270RB 0offset EVS WB 5.9 kbit/s 656000ch Freq. Response

Communication System: UID 0, NR Band 77 (0); Frequency: 3840 MHz;Duty Cycle: 1:4.00037

Medium parameters used: $\sigma = 0$ S/m, $\epsilon_r = 1$; $\rho = 0$ kg/m³

Phantom section: TCoil Section

DASY5 Configuration:

- Probe: AM1DV3 - 3049; ; Calibrated: 2021-06-01
- Sensor-Surface: 0mm (Fix Surface)
- Electronics: DAE4 Sn1686; Calibrated: 2021-06-21
- Phantom: HAC Test Arch with AMCC
- Measurement SW: DASY52, Version 52.10 (4)

T-Coil scan (scan for ANSI C63.19-2007 & 2011 compliance)/General Scans/z (axial) wideband at best

S/N/ABM Freq Resp(x,y,z,f) (1x1x1): Measurement grid: dx=10mm, dy=10mm

Signal Type: Audio File (.wav) 48k_Normal_51s new.wav

Output Gain: 93.49

Measure Window Start: 300ms

Measure Window Length: 51000ms

BWC applied: 9.48 dB

Device Reference Point: 0, 0, -6.3 mm

Category	Telephone parameters WD signal quality [(signal+noise)-to-noise ratio in decibels]
Category T1	0 dB to 10 dB
Category T2	10 dB to 20 dB
Category T3	20 dB to 30 dB
Category T4	> 30 dB

Cursor:

Diff = 2.00 dB

BWC Factor = 9.48 dB

Location: 8.9, 0, 3.7 mm

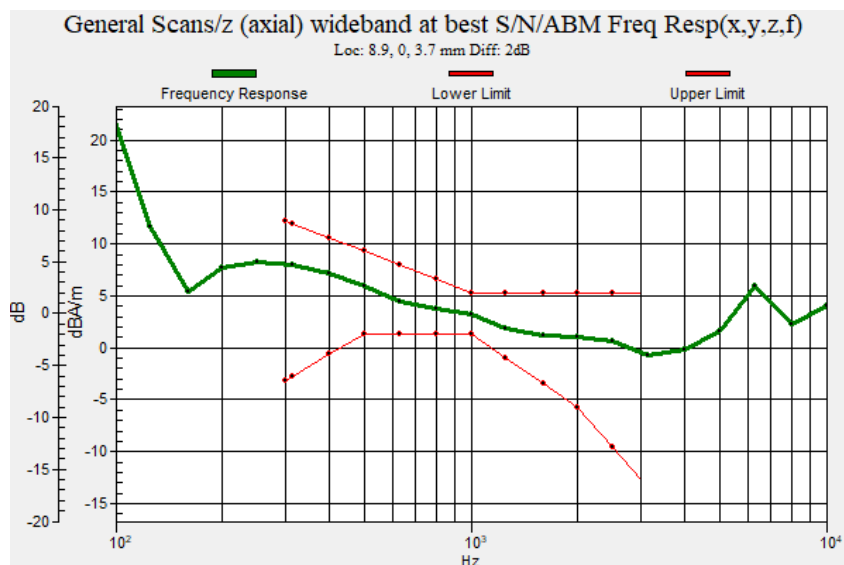

Plot No.45

NR Band 77 QPSK 100MHz 270RB 0offset EVS WB 5.9 kbit/s 656000ch y(transversal)

Communication System: UID 0, NR Band 77 (0); Frequency: 3840 MHz;Duty Cycle: 1:4.00037
 Medium parameters used: $\sigma = 0$ S/m, $\epsilon_r = 1$; $\rho = 0$ kg/m³
 Phantom section: TCoil Section

DASY5 Configuration:

- Probe: AM1DV3 - 3049; ; Calibrated: 2021-06-01
- Sensor-Surface: 0mm (Fix Surface)
- Electronics: DAE4 Sn1686; Calibrated: 2021-06-21
- Phantom: HAC Test Arch with AMCC
- Measurement SW: DASY52, Version 52.10 (4)

T-Coil scan (scan for ANSI C63.19-2007 & 2011 compliance)/General Scans/y (transversal) 4.2mm 50

x 50/ABM Signal(x,y,z) (13x13x1): Measurement grid: dx=10mm, dy=10mm

Signal Type: Audio File (.wav) 48k_voice_1kHz_1s.wav

Output Gain: 43.9

Measure Window Start: 300ms

Measure Window Length: 3000ms

BWC applied: 0.16 dB

Device Reference Point: 0, 0, -6.3 mm

Cursor:

ABM1 comp = 1.28 dBA/m

BWC Factor = 0.16 dB

Location: 16.7, 8.3, 3.7 mm

Cursor:

ABM2 = -21.78 dBA/m

Location: 16.7, 8.3, 3.7 mm

Cursor:

ABM1/ABM2 = 23.06 dB

ABM1 comp = 1.28 dBA/m

BWC Factor = 0.16 dB

Location: 16.7, 8.3, 3.7 mm

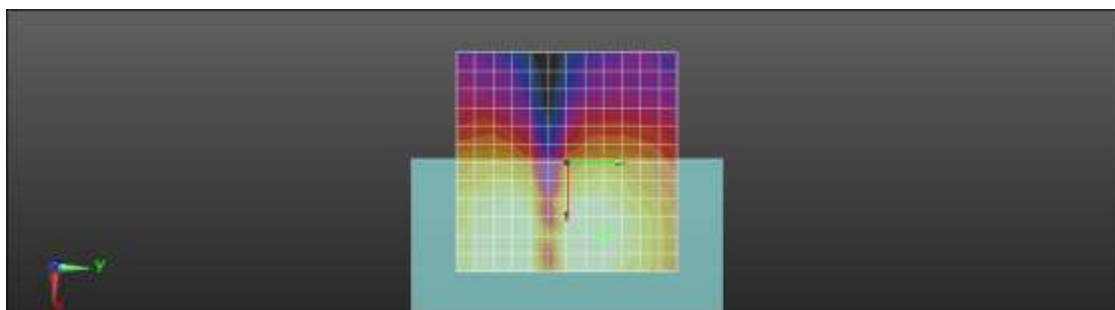
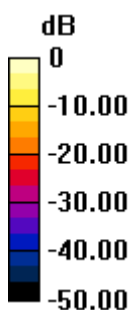

0 dB = 1.000 A/m = 0.00 dBA/m

Plot No.46

802.11b 11Mbps EVS WB 5.9 kbit/s 6ch z(axial)

Communication System: UID 0, 2450MHz FCC (0); Frequency: 2437 MHz;Duty Cycle: 1:1

Medium parameters used: $\sigma = 0$ S/m, $\epsilon_r = 1$; $\rho = 0$ kg/m³

Phantom section: TCoil Section

DASY5 Configuration:

- Probe: AM1DV3 - 3049; ; Calibrated: 6/1/2021
- Sensor-Surface: 0mm (Fix Surface)
- Electronics: DAE4 Sn1686; Calibrated: 6/21/2021
- Phantom: HAC Test Arch with AMCC
- Measurement SW: DASY52, Version 52.10 (4); SEMCAD X Version 14.6.14 (7483)

T-Coil scan (scan for ANSI C63.19-2007 & 2011 compliance)/General Scans/z (axial) 4.2mm 50 x

50/ABM Signal(x,y,z) (13x13x1): Measurement grid: dx=10mm, dy=10mm

Signal Type: Audio File (.wav) 48k_voice_1kHz_1s.wav

Output Gain: 15.51

Measure Window Start: 300ms

Measure Window Length: 1000ms

BWC applied: 0.15 dB

Device Reference Point: 0, 0, -6.3 mm

Cursor:

ABM1 comp = 13.73 dBA/m

BWC Factor = 0.15 dB

Location: 16.7, -4.2, 3.7 mm

Cursor:

ABM2 = -12.10 dBA/m

Location: 16.7, -4.2, 3.7 mm

Cursor:

ABM1/ABM2 = 25.82 dB

ABM1 comp = 13.73 dBA/m

BWC Factor = 0.15 dB

Location: 16.7, -4.2, 3.7 mm

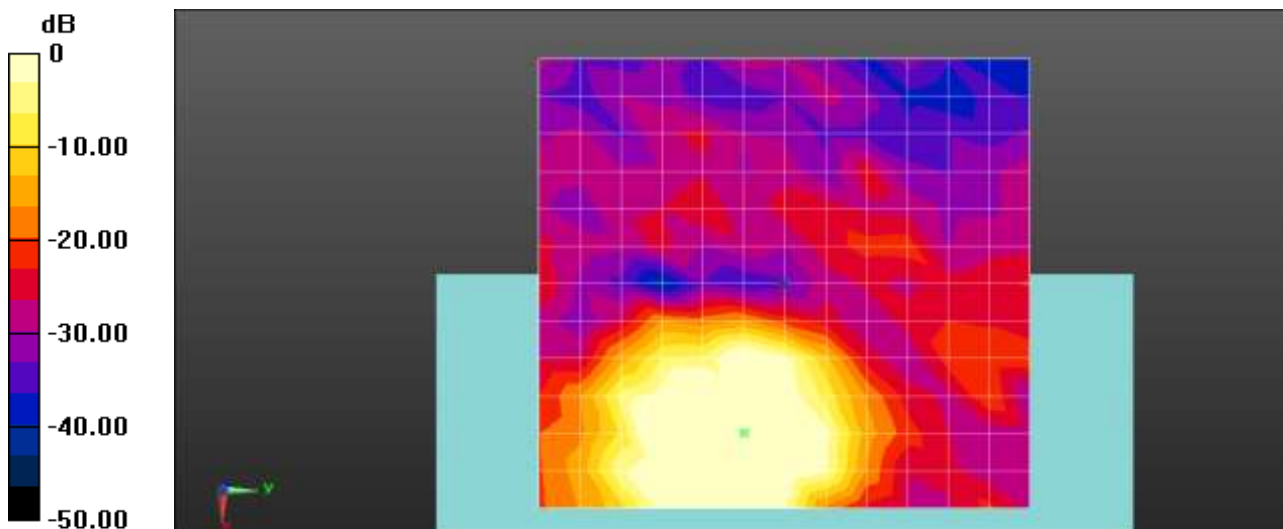

0 dB = 1.000 A/m = 0.00 dBA/m

Plot No.47

802.11b 11Mbps EVS WB 5.9 kbit/s 6ch Freq. Response

Communication System: UID 0, 2450MHz FCC (0); Frequency: 2437 MHz;Duty Cycle: 1:1
 Medium parameters used: $\sigma = 0$ S/m, $\epsilon_r = 1$; $\rho = 0$ kg/m³
 Phantom section: TCoil Section

DASY5 Configuration:

- Probe: AM1DV3 - 3049; ; Calibrated: 6/1/2021
- Sensor-Surface: 0mm (Fix Surface)
- Electronics: DAE4 Sn1686; Calibrated: 6/21/2021
- Phantom: HAC Test Arch with AMCC
- Measurement SW: DASY52, Version 52.10 (4); SEMCAD X Version 14.6.14 (7483)

T-Coil scan (scan for ANSI C63.19-2007 & 2011 compliance)/General Scans/z (axial) wideband at best

S/N/ABM Freq Resp(x,y,z,f) (1x1x1): Measurement grid: dx=10mm, dy=10mm

Signal Type: Audio File (.wav) 48k_Normal_51s new.wav

Output Gain: 47.17

Measure Window Start: 300ms

Measure Window Length: 51000ms

BWC applied: 9.47 dB

Device Reference Point: 0, 0, -6.3 mm

Category	Telephone parameters WD signal quality [(signal+noise)-to-noise ratio in decibels]
Category T1	0 dB to 10 dB
Category T2	10 dB to 20 dB
Category T3	20 dB to 30 dB
Category T4	> 30 dB

Cursor:

Diff = 1.26 dB

BWC Factor = 9.47 dB

Location: 16.7, -4, 3.7 mm

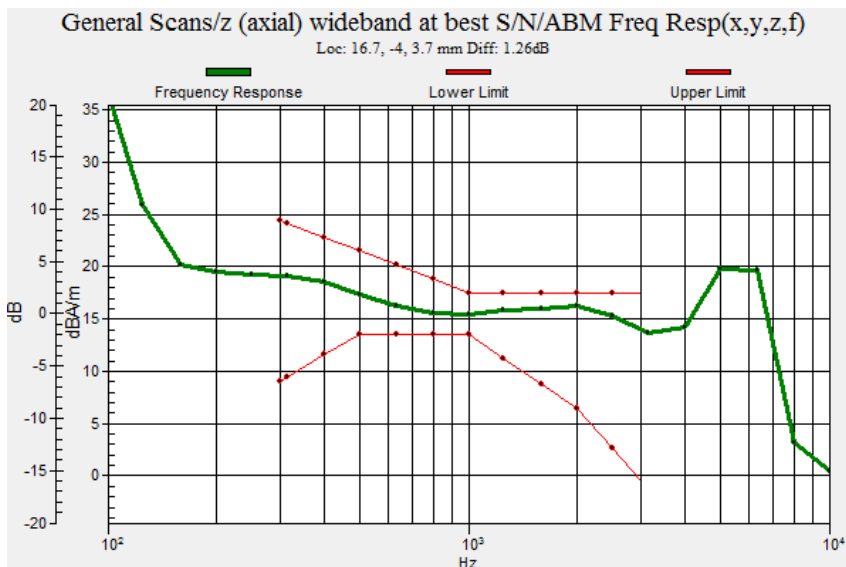

Plot No.48

802.11b 11Mbps EVS WB 5.9 kbit/s 6ch y(transversal)

Communication System: UID 0, 2450MHz FCC (0); Frequency: 2437 MHz;Duty Cycle: 1:1
Medium parameters used: $\sigma = 0$ S/m, $\epsilon_r = 1$; $\rho = 0$ kg/m³
Phantom section: TCoil Section

DASY5 Configuration:

- Probe: AM1DV3 - 3049; ; Calibrated: 6/1/2021
- Sensor-Surface: 0mm (Fix Surface)
- Electronics: DAE4 Sn1686; Calibrated: 6/21/2021
- Phantom: HAC Test Arch with AMCC
- Measurement SW: DASY52, Version 52.10 (4); SEMCAD X Version 14.6.14 (7483)

T-Coil scan (scan for ANSI C63.19-2007 & 2011 compliance)/General Scans/y (transversal) 4.2mm 50

x 50/ABM Signal(x,y,z) (13x13x1): Measurement grid: dx=10mm, dy=10mm

Signal Type: Audio File (.wav) 48k_voice_1kHz_1s.wav

Output Gain: 15.51

Measure Window Start: 300ms

Measure Window Length: 1000ms

BWC applied: 0.15 dB

Device Reference Point: 0, 0, -6.3 mm

Cursor:

ABM1 comp = -11.80 dBA/m

BWC Factor = 0.15 dB

Location: 0, -20.8, 3.7 mm

Cursor:

ABM2 = -36.25 dBA/m

Location: 0, -20.8, 3.7 mm

Cursor:

ABM1/ABM2 = 24.45 dB

ABM1 comp = -11.80 dBA/m

BWC Factor = 0.15 dB

Location: 0, -20.8, 3.7 mm

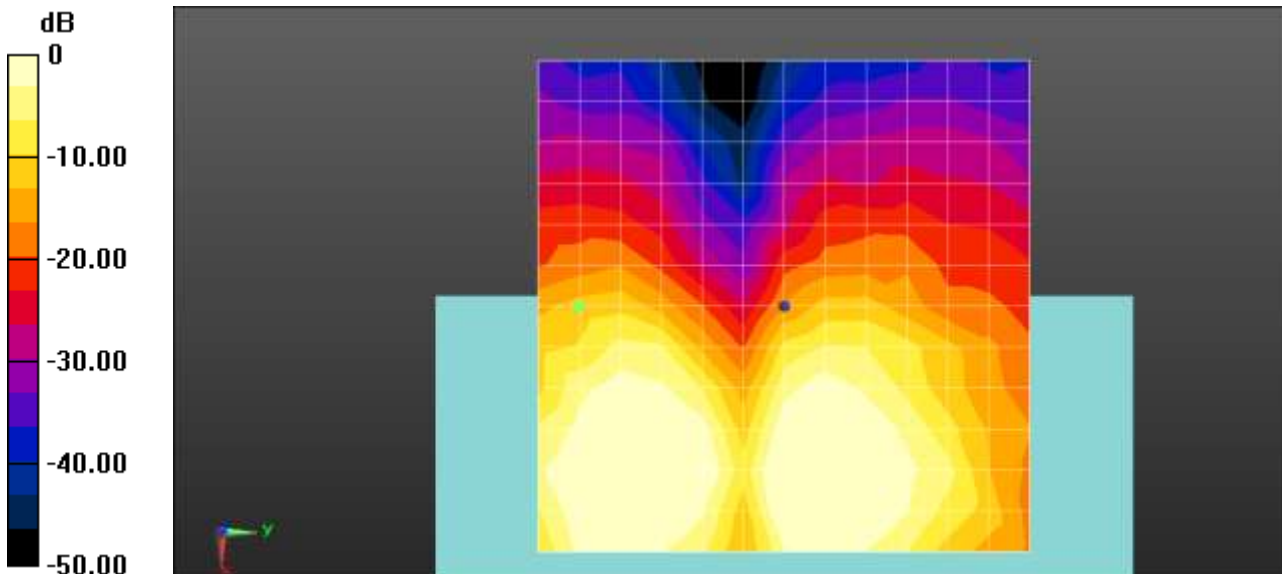

0 dB = 1.000 A/m = 0.00 dBA/m

Plot No.49

802.11n20 MCS0 AMR WB 6.6 kbit/s 40ch z(axial)

Communication System: UID 0, WIFI 5GHz (0); Frequency: 5200 MHz;Duty Cycle: 1:1

Medium parameters used: $\sigma = 0$ S/m, $\epsilon_r = 1$; $\rho = 0$ kg/m³

Phantom section: TCoil Section

DASY5 Configuration:

- Probe: AM1DV3 - 3049; ; Calibrated: 2021-06-01
- Sensor-Surface: 0mm (Fix Surface)
- Electronics: DAE4 Sn1686; Calibrated: 2021-06-21
- Phantom: HAC Test Arch with AMCC
- Measurement SW: DASY52, Version 52.10 (4)

T-Coil scan (scan for ANSI C63.19-2007 & 2011 compliance)/General Scans/z (axial) 4.2mm 50 x

50/ABM Signal(x,y,z) (13x13x1): Measurement grid: dx=10mm, dy=10mm

Signal Type: Audio File (.wav) 48k_voice_1kHz_1s.wav

Output Gain: 15.51

Measure Window Start: 300ms

Measure Window Length: 1000ms

BWC applied: 0.15 dB

Device Reference Point: 0, 0, -6.3 mm

Cursor:

ABM1 comp = 13.27 dBA/m

BWC Factor = 0.15 dB

Location: 12.5, -4.2, 3.7 mm

Cursor:

ABM2 = -15.85 dBA/m

Location: 12.5, -4.2, 3.7 mm

Cursor:

ABM1/ABM2 = 29.12 dB

ABM1 comp = 13.27 dBA/m

BWC Factor = 0.15 dB

Location: 12.5, -4.2, 3.7 mm

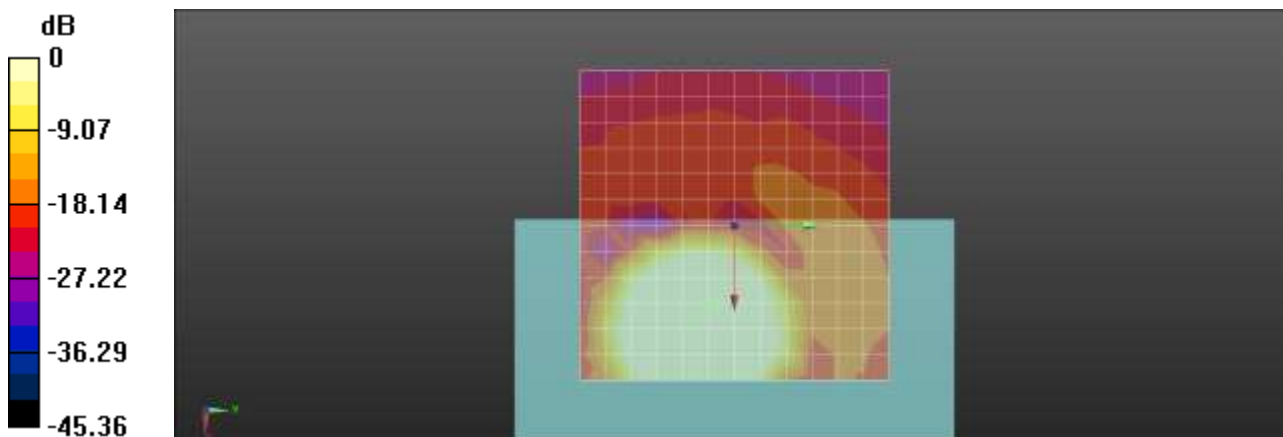

0 dB = 1.000 A/m = 0.00 dBA/m

Plot No.50

802.11n20 MCS0 AMR WB 6.6 kbit/s 40ch Freq. Response

Communication System: UID 0, WIFI 5GHz (0); Frequency: 5200 MHz;Duty Cycle: 1:1

Medium parameters used: $\sigma = 0$ S/m, $\epsilon_r = 1$; $\rho = 0$ kg/m³

Phantom section: TCoil Section

DASY5 Configuration:

- Probe: AM1DV3 - 3049; ; Calibrated: 2021-06-01
- Sensor-Surface: 0mm (Fix Surface)
- Electronics: DAE4 Sn1686; Calibrated: 2021-06-21
- Phantom: HAC Test Arch with AMCC
- Measurement SW: DASY52, Version 52.10 (4)

T-Coil scan (scan for ANSI C63.19-2007 & 2011 compliance)/General Scans/z (axial) wideband at best

S/N/ABM Freq Resp(x,y,z,f) (1x1x1): Measurement grid: dx=10mm, dy=10mm

Signal Type: Audio File (.wav) 48k_Normal_51s new.wav

Output Gain: 47.17

Measure Window Start: 300ms

Measure Window Length: 51000ms

BWC applied: 9.47 dB

Device Reference Point: 0, 0, -6.3 mm

Category	Telephone parameters WD signal quality [(signal+noise)-to-noise ratio in decibels]
Category T1	0 dB to 10 dB
Category T2	10 dB to 20 dB
Category T3	20 dB to 30 dB
Category T4	> 30 dB

Cursor:

Diff = 1.80 dB

BWC Factor = 9.47 dB

Location: 13.2, -3.9, 3.7 mm

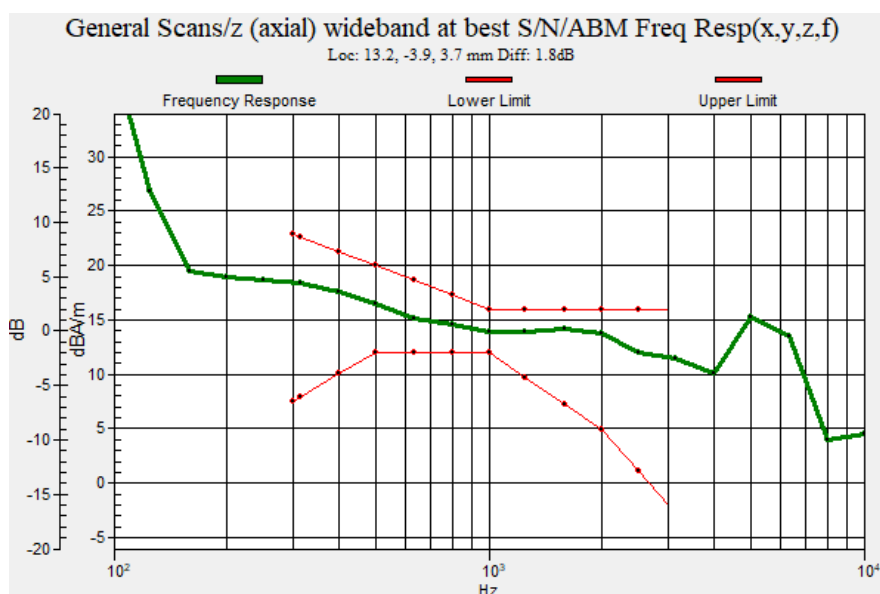

Plot No.51

802.11n20 MCS0 AMR WB 6.6 kbit/s 40ch y(transversal)

Communication System: UID 0, WIFI 5GHz (0); Frequency: 5200 MHz;Duty Cycle: 1:1

Medium parameters used: $\sigma = 0$ S/m, $\epsilon_r = 1$; $\rho = 0$ kg/m³

Phantom section: TCoil Section

DASY5 Configuration:

- Probe: AM1DV3 - 3049; ; Calibrated: 2021-06-01
- Sensor-Surface: 0mm (Fix Surface)
- Electronics: DAE4 Sn1686; Calibrated: 2021-06-21
- Phantom: HAC Test Arch with AMCC
- Measurement SW: DASY52, Version 52.10 (4)

T-Coil scan (scan for ANSI C63.19-2007 & 2011 compliance)/General Scans/y (transversal) 4.2mm 50

x 50/ABM Signal(x,y,z) (13x13x1): Measurement grid: dx=10mm, dy=10mm

Signal Type: Audio File (.wav) 48k_voice_1kHz_1s.wav

Output Gain: 15.51

Measure Window Start: 300ms

Measure Window Length: 1000ms

BWC applied: 0.15 dB

Device Reference Point: 0, 0, -6.3 mm

Cursor:

ABM1 comp = 3.78 dBA/m

BWC Factor = 0.15 dB

Location: 12.5, 8.3, 3.7 mm

Cursor:

ABM2 = -24.88 dBA/m

Location: 12.5, 8.3, 3.7 mm

Cursor:

ABM1/ABM2 = 28.66 dB

ABM1 comp = 3.78 dBA/m

BWC Factor = 0.15 dB

Location: 12.5, 8.3, 3.7 mm

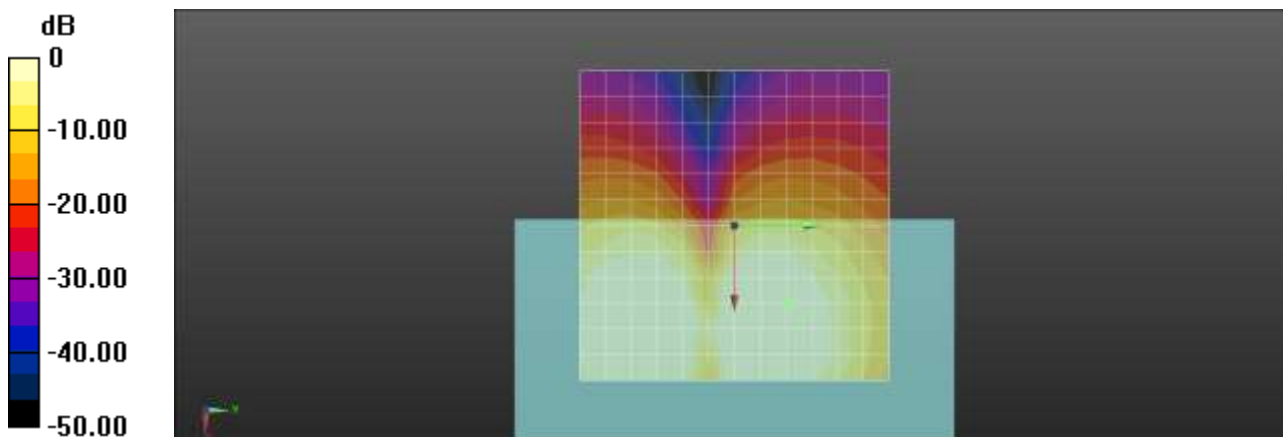

0 dB = 1.000 A/m = 0.00 dBA/m

Plot No.52

802.11n20 MCS0 AMR WB 6.6 kbit/s 56ch z(axial)

Communication System: UID 0, WIFI 5GHz (0); Frequency: 5280 MHz;Duty Cycle: 1:1

Medium parameters used: $\sigma = 0$ S/m, $\epsilon_r = 1$; $\rho = 0$ kg/m³

Phantom section: TCoil Section

DASY5 Configuration:

- Probe: AM1DV3 - 3049; ; Calibrated: 2021-06-01
- Sensor-Surface: 0mm (Fix Surface)
- Electronics: DAE4 Sn1686; Calibrated: 2021-06-21
- Phantom: HAC Test Arch with AMCC
- Measurement SW: DASY52, Version 52.10 (4)

T-Coil scan (scan for ANSI C63.19-2007 & 2011 compliance)/General Scans/z (axial) 4.2mm 50 x

50/ABM Signal(x,y,z) (13x13x1): Measurement grid: dx=10mm, dy=10mm

Signal Type: Audio File (.wav) 48k_voice_1kHz_1s.wav

Output Gain: 15.51

Measure Window Start: 300ms

Measure Window Length: 1000ms

BWC applied: 0.16 dB

Device Reference Point: 0, 0, -6.3 mm

Cursor:

ABM1 comp = 15.46 dBA/m

BWC Factor = 0.16 dB

Location: 16.7, -8.3, 3.7 mm

Cursor:

ABM2 = -14.13 dBA/m

Location: 16.7, -8.3, 3.7 mm

Cursor:

ABM1/ABM2 = 29.59 dB

ABM1 comp = 15.46 dBA/m

BWC Factor = 0.16 dB

Location: 16.7, -8.3, 3.7 mm

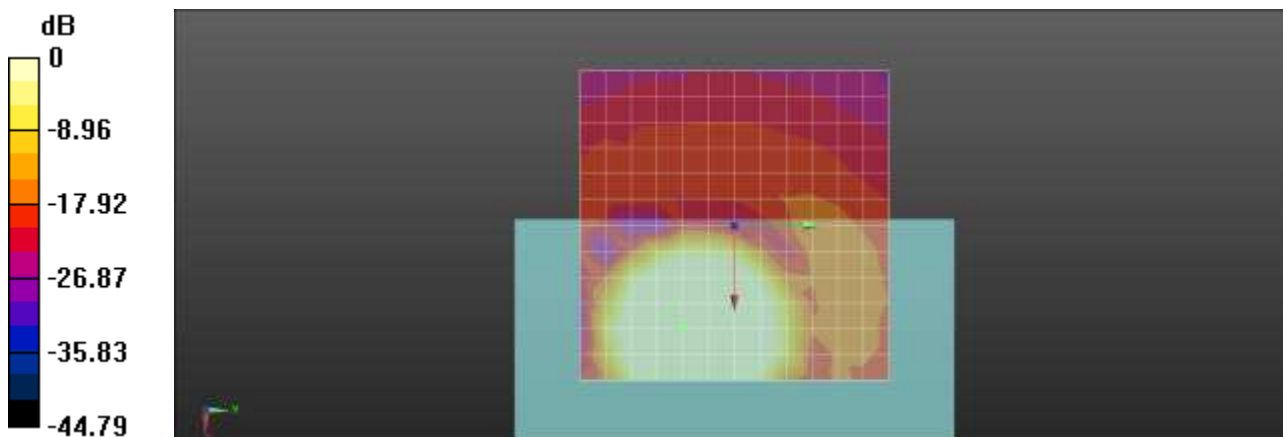

0 dB = 1.000 A/m = 0.00 dBA/m

Plot No.53
802.11n20 MCS0 AMR WB 6.6 kbit/s 56ch Freq. Response

Communication System: UID 0, WIFI 5GHz (0); Frequency: 5280 MHz;Duty Cycle: 1:1
 Medium parameters used: $\sigma = 0$ S/m, $\epsilon_r = 1$; $\rho = 0$ kg/m³
 Phantom section: TCoil Section

DASY5 Configuration:

- Probe: AM1DV3 - 3049; ; Calibrated: 2021-06-01
- Sensor-Surface: 0mm (Fix Surface)
- Electronics: DAE4 Sn1686; Calibrated: 2021-06-21
- Phantom: HAC Test Arch with AMCC
- Measurement SW: DASY52, Version 52.10 (4)

T-Coil scan (scan for ANSI C63.19-2007 & 2011 compliance)/General Scans/z (axial) wideband at best S/N/ABM Freq Resp(x,y,z,f) (1x1x1): Measurement grid: dx=10mm, dy=10mm
 Signal Type: Audio File (.wav) 48k_Normal_51s new.wav
 Output Gain: 47.17
 Measure Window Start: 300ms
 Measure Window Length: 51000ms
 BWC applied: 9.47 dB
 Device Reference Point: 0, 0, -6.3 mm

Category	Telephone parameters WD signal quality [(signal+noise)-to-noise ratio in decibels]
Category T1	0 dB to 10 dB
Category T2	10 dB to 20 dB
Category T3	20 dB to 30 dB
Category T4	> 30 dB

Cursor:

Diff = 1.90 dB
 BWC Factor = 9.47 dB
 Location: 18.8, -7.3, 3.7 mm

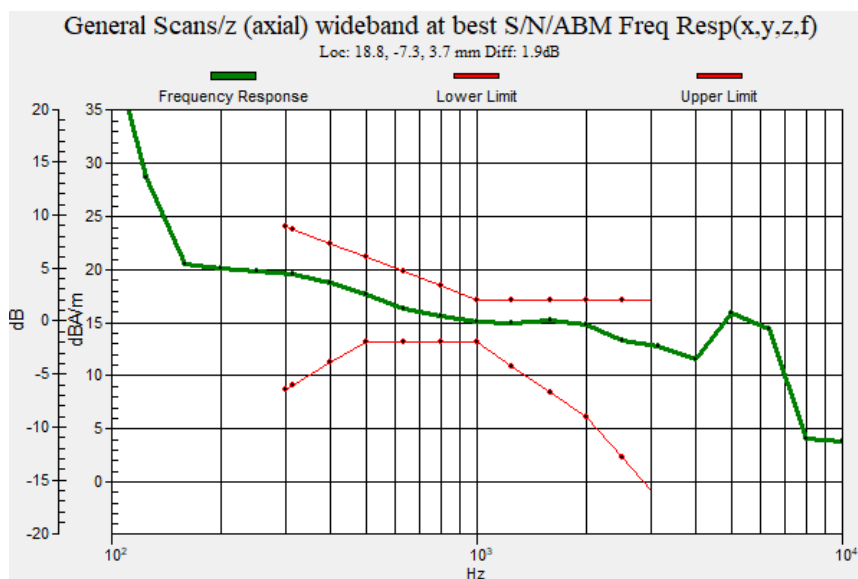

Plot No.54

802.11n20 MCS0 AMR WB 6.6 kbit/s 56ch y(transversal)

Communication System: UID 0, WIFI 5GHz (0); Frequency: 5280 MHz;Duty Cycle: 1:1

Medium parameters used: $\sigma = 0$ S/m, $\epsilon_r = 1$; $\rho = 0$ kg/m³

Phantom section: TCoil Section

DASY5 Configuration:

- Probe: AM1DV3 - 3049; ; Calibrated: 2021-06-01
- Sensor-Surface: 0mm (Fix Surface)
- Electronics: DAE4 Sn1686; Calibrated: 2021-06-21
- Phantom: HAC Test Arch with AMCC
- Measurement SW: DASY52, Version 52.10 (4)

T-Coil scan (scan for ANSI C63.19-2007 & 2011 compliance)/General Scans/y (transversal) 4.2mm 50

x 50/ABM Signal(x,y,z) (13x13x1): Measurement grid: dx=10mm, dy=10mm

Signal Type: Audio File (.wav) 48k_voice_1kHz_1s.wav

Output Gain: 15.51

Measure Window Start: 300ms

Measure Window Length: 1000ms

BWC applied: 0.16 dB

Device Reference Point: 0, 0, -6.3 mm

Cursor:

ABM1 comp = 5.90 dBA/m

BWC Factor = 0.16 dB

Location: 12.5, 4.2, 3.7 mm

Cursor:

ABM2 = -23.91 dBA/m

Location: 12.5, 4.2, 3.7 mm

Cursor:

ABM1/ABM2 = 29.81 dB

ABM1 comp = 5.90 dBA/m

BWC Factor = 0.16 dB

Location: 12.5, 4.2, 3.7 mm

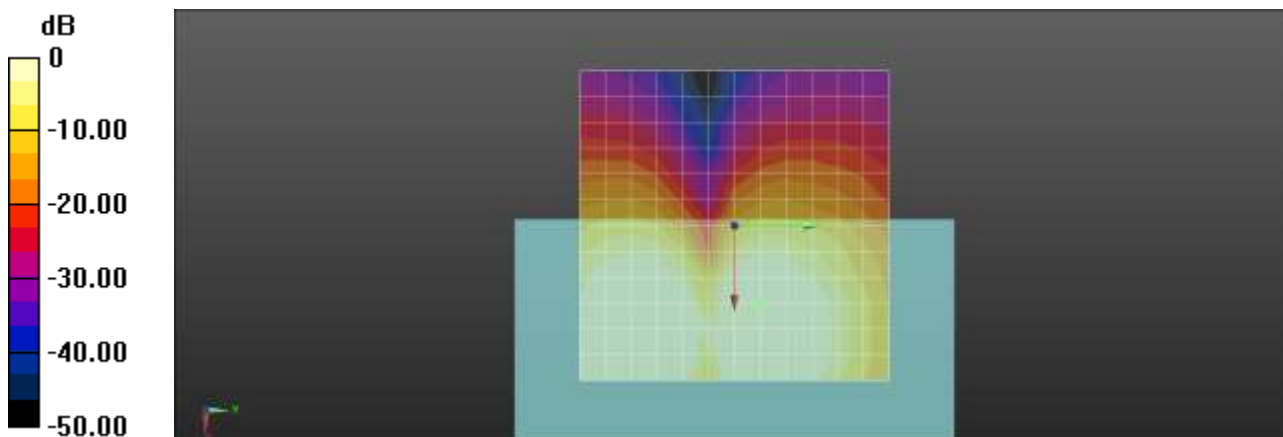

0 dB = 1.000 A/m = 0.00 dBA/m

Plot No.55

802.11n20 MCS0 AMR WB 6.6 kbit/s 120ch z(axial)

Communication System: UID 0, WIFI 5GHz (0); Frequency: 5600 MHz;Duty Cycle: 1:1

Medium parameters used: $\sigma = 0$ S/m, $\epsilon_r = 1$; $\rho = 0$ kg/m³

Phantom section: TCoil Section

DASY5 Configuration:

- Probe: AM1DV3 - 3049; ; Calibrated: 2021-06-01
- Sensor-Surface: 0mm (Fix Surface)
- Electronics: DAE4 Sn1686; Calibrated: 2021-06-21
- Phantom: HAC Test Arch with AMCC
- Measurement SW: DASY52, Version 52.10 (4)

T-Coil scan (scan for ANSI C63.19-2007 & 2011 compliance)/General Scans/z (axial) 4.2mm 50 x

50/ABM Signal(x,y,z) (13x13x1): Measurement grid: dx=10mm, dy=10mm

Signal Type: Audio File (.wav) 48k_voice_1kHz_1s.wav

Output Gain: 15.51

Measure Window Start: 300ms

Measure Window Length: 1000ms

BWC applied: 0.16 dB

Device Reference Point: 0, 0, -6.3 mm

Cursor:

ABM1 comp = 9.94 dBA/m

BWC Factor = 0.16 dB

Location: 12.5, 0, 3.7 mm

Cursor:

ABM2 = -19.58 dBA/m

Location: 12.5, 0, 3.7 mm

Cursor:

ABM1/ABM2 = 29.52 dB

ABM1 comp = 9.94 dBA/m

BWC Factor = 0.16 dB

Location: 12.5, 0, 3.7 mm

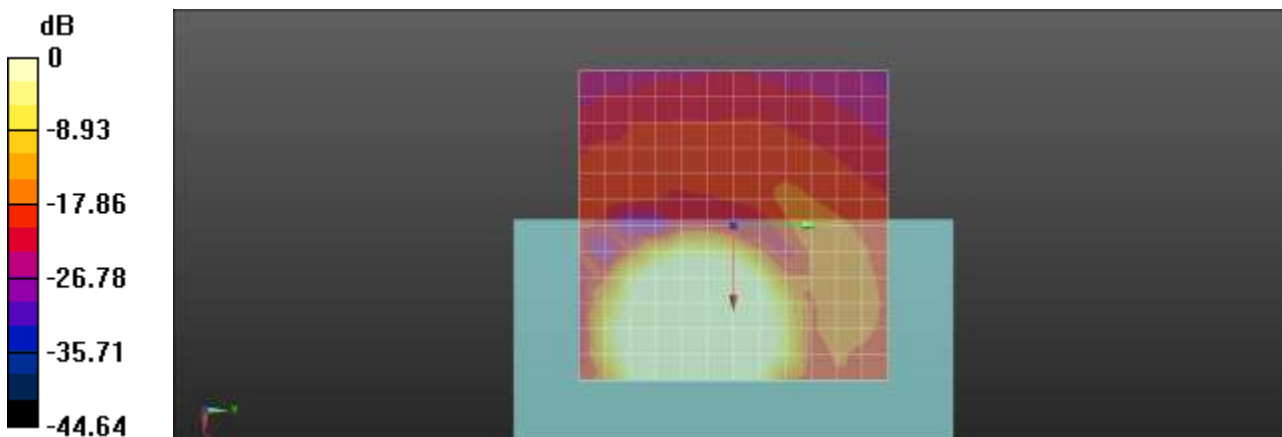

0 dB = 1.000 A/m = 0.00 dBA/m

Plot No.56
802.11n20 MCS0 AMR WB 6.6 kbit/s 120ch Freq. Response

Communication System: UID 0, WIFI 5GHz (0); Frequency: 5600 MHz;Duty Cycle: 1:1
Medium parameters used: $\sigma = 0$ S/m, $\epsilon_r = 1$; $\rho = 0$ kg/m³
Phantom section: TCoil Section

DASY5 Configuration:

- Probe: AM1DV3 - 3049; ; Calibrated: 2021-06-01
- Sensor-Surface: 0mm (Fix Surface)
- Electronics: DAE4 Sn1686; Calibrated: 2021-06-21
- Phantom: HAC Test Arch with AMCC
- Measurement SW: DASY52, Version 52.10 (4)

T-Coil scan (scan for ANSI C63.19-2007 & 2011 compliance)/General Scans/z (axial) wideband at best S/N/ABM Freq Resp(x,y,z,f) (1x1x1): Measurement grid: dx=10mm, dy=10mm
Signal Type: Audio File (.wav) 48k_Normal_51s new.wav
Output Gain: 47.17
Measure Window Start: 300ms
Measure Window Length: 51000ms
BWC applied: 9.47 dB
Device Reference Point: 0, 0, -6.3 mm

Category	Telephone parameters WD signal quality [(signal+noise)-to-noise ratio in decibels]
Category T1	0 dB to 10 dB
Category T2	10 dB to 20 dB
Category T3	20 dB to 30 dB
Category T4	> 30 dB

Cursor:

Diff = 1.69 dB
BWC Factor = 9.47 dB
Location: 13.7, -0.2, 3.7 mm

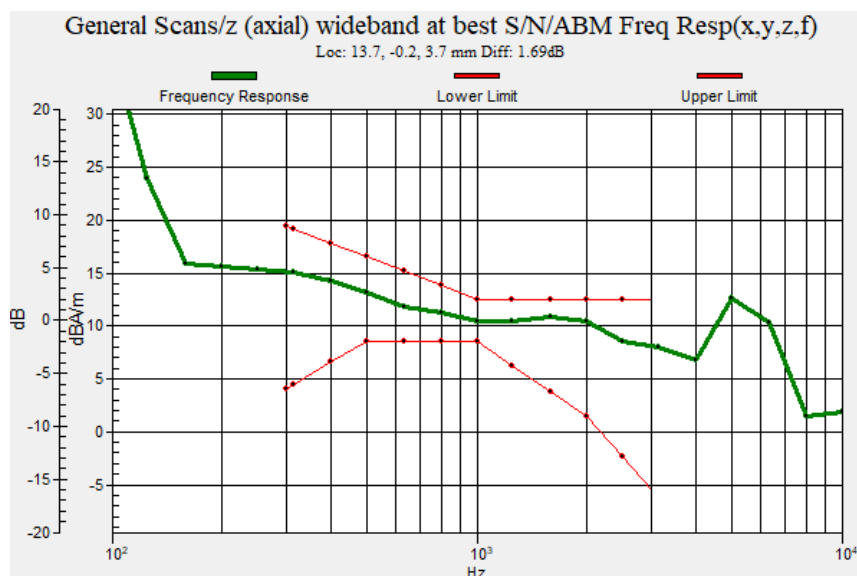

Plot No.57

802.11n20 MCS0 AMR WB 6.6 kbit/s 120ch y(transversal)

Communication System: UID 0, WIFI 5GHz (0); Frequency: 5600 MHz;Duty Cycle: 1:1

Medium parameters used: $\sigma = 0$ S/m, $\epsilon_r = 1$; $\rho = 0$ kg/m³

Phantom section: TCoil Section

DASY5 Configuration:

- Probe: AM1DV3 - 3049; ; Calibrated: 2021-06-01
- Sensor-Surface: 0mm (Fix Surface)
- Electronics: DAE4 Sn1686; Calibrated: 2021-06-21
- Phantom: HAC Test Arch with AMCC
- Measurement SW: DASY52, Version 52.10 (4)

T-Coil scan (scan for ANSI C63.19-2007 & 2011 compliance)/General Scans/y (transversal) 4.2mm 50

x 50/ABM Signal(x,y,z) (13x13x1): Measurement grid: dx=10mm, dy=10mm

Signal Type: Audio File (.wav) 48k_voice_1kHz_1s.wav

Output Gain: 15.51

Measure Window Start: 300ms

Measure Window Length: 1000ms

BWC applied: 0.16 dB

Device Reference Point: 0, 0, -6.3 mm

Cursor:

ABM1 comp = 3.65 dBA/m

BWC Factor = 0.16 dB

Location: 12.5, 8.3, 3.7 mm

Cursor:

ABM2 = -25.47 dBA/m

Location: 12.5, 8.3, 3.7 mm

Cursor:

ABM1/ABM2 = 29.12 dB

ABM1 comp = 3.65 dBA/m

BWC Factor = 0.16 dB

Location: 12.5, 8.3, 3.7 mm

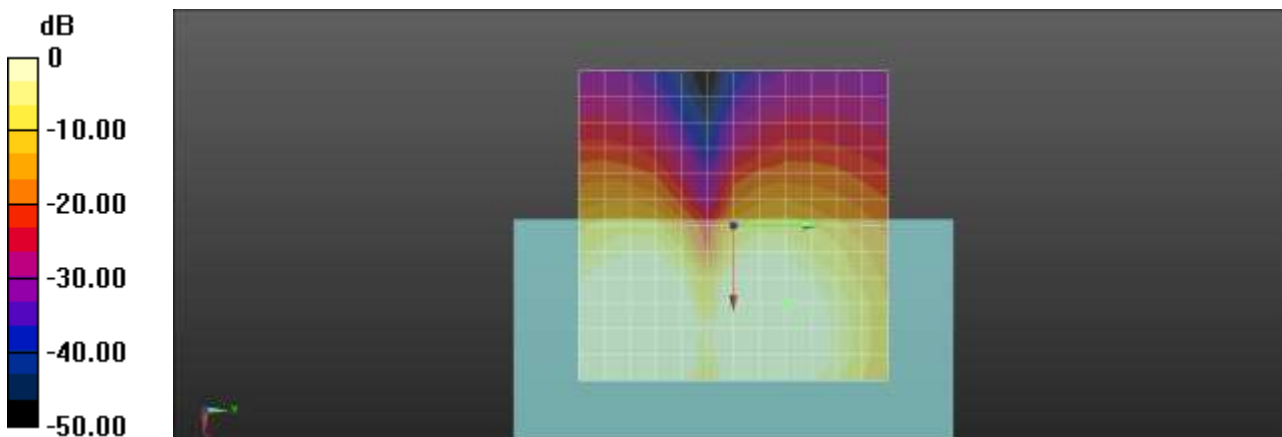

0 dB = 1.000 A/m = 0.00 dBA/m

Plot No.58

802.11n20 MCS0 AMR WB 6.6 kbit/s 157ch z(axial)

Communication System: UID 0, WIFI 5GHz (0); Frequency: 5785 MHz;Duty Cycle: 1:1

Medium parameters used: $\sigma = 0$ S/m, $\epsilon_r = 1$; $\rho = 0$ kg/m³

Phantom section: TCoil Section

DASY5 Configuration:

- Probe: AM1DV3 - 3049; ; Calibrated: 2021-06-01
- Sensor-Surface: 0mm (Fix Surface)
- Electronics: DAE4 Sn1686; Calibrated: 2021-06-21
- Phantom: HAC Test Arch with AMCC
- Measurement SW: DASY52, Version 52.10 (4)

T-Coil scan (scan for ANSI C63.19-2007 & 2011 compliance)/General Scans/z (axial) 4.2mm 50 x

50/ABM Signal(x,y,z) (13x13x1): Measurement grid: dx=10mm, dy=10mm

Signal Type: Audio File (.wav) 48k_voice_1kHz_1s.wav

Output Gain: 15.51

Measure Window Start: 300ms

Measure Window Length: 1000ms

BWC applied: 0.15 dB

Device Reference Point: 0, 0, -6.3 mm

Cursor:

ABM1 comp = 11.98 dBA/m

BWC Factor = 0.15 dB

Location: 16.7, 0, 3.7 mm

Cursor:

ABM2 = -17.34 dBA/m

Location: 16.7, 0, 3.7 mm

Cursor:

ABM1/ABM2 = 29.31 dB

ABM1 comp = 11.98 dBA/m

BWC Factor = 0.15 dB

Location: 16.7, 0, 3.7 mm

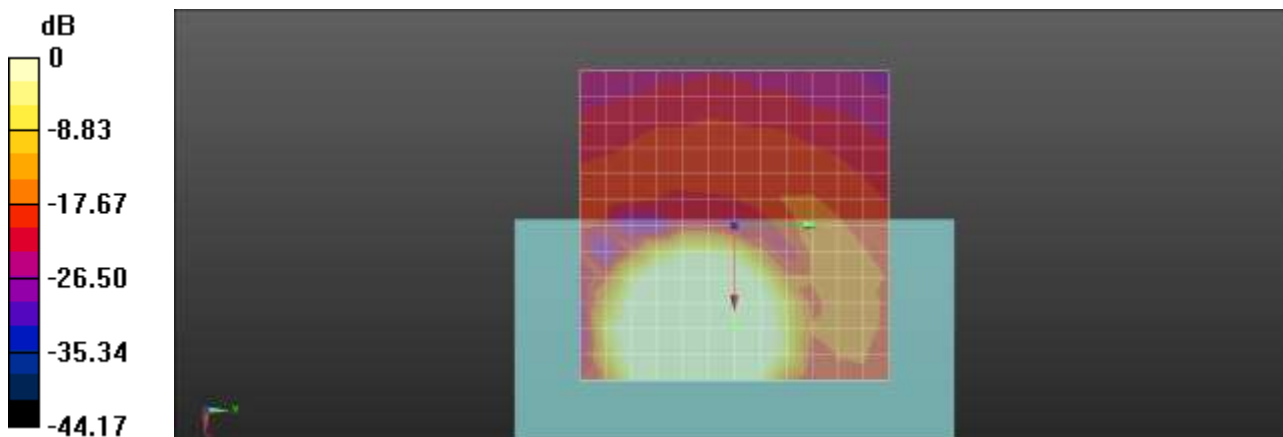

0 dB = 1.000 A/m = 0.00 dBA/m

Plot No.59
802.11n20 MCS0 AMR WB 6.6 kbit/s 157ch Freq. Response

Communication System: UID 0, WIFI 5GHz (0); Frequency: 5785 MHz;Duty Cycle: 1:1
Medium parameters used: $\sigma = 0$ S/m, $\epsilon_r = 1$; $\rho = 0$ kg/m³
Phantom section: TCoil Section

DASY5 Configuration:

- Probe: AM1DV3 - 3049; ; Calibrated: 2021-06-01
- Sensor-Surface: 0mm (Fix Surface)
- Electronics: DAE4 Sn1686; Calibrated: 2021-06-21
- Phantom: HAC Test Arch with AMCC
- Measurement SW: DASY52, Version 52.10 (4)

T-Coil scan (scan for ANSI C63.19-2007 & 2011 compliance)/General Scans/z (axial) wideband at best S/N/ABM Freq Resp(x,y,z,f) (1x1x1): Measurement grid: dx=10mm, dy=10mm
Signal Type: Audio File (.wav) 48k_Normal_51s new.wav
Output Gain: 47.17
Measure Window Start: 300ms
Measure Window Length: 51000ms
BWC applied: 9.47 dB
Device Reference Point: 0, 0, -6.3 mm

Category	Telephone parameters WD signal quality [(signal+noise)-to-noise ratio in decibels]
Category T1	0 dB to 10 dB
Category T2	10 dB to 20 dB
Category T3	20 dB to 30 dB
Category T4	> 30 dB

Cursor:
Diff = 1.86 dB
BWC Factor = 9.47 dB
Location: 9, -1.9, 3.7 mm

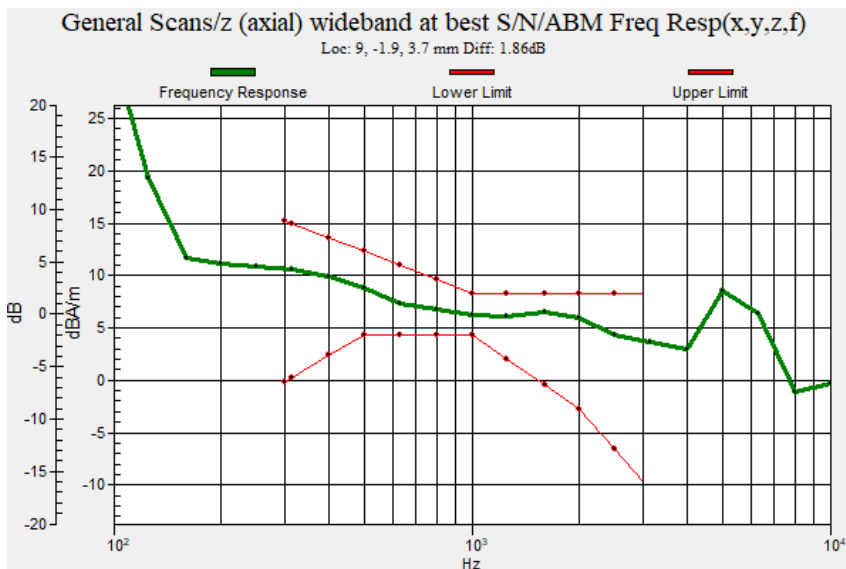

Plot No.60

802.11n20 MCS0 AMR WB 6.6 kbit/s 157ch y(transversal)

Communication System: UID 0, WIFI 5GHz (0); Frequency: 5785 MHz;Duty Cycle: 1:1

Medium parameters used: $\sigma = 0$ S/m, $\epsilon_r = 1$; $\rho = 0$ kg/m³

Phantom section: TCoil Section

DASY5 Configuration:

- Probe: AM1DV3 - 3049; ; Calibrated: 2021-06-01
- Sensor-Surface: 0mm (Fix Surface)
- Electronics: DAE4 Sn1686; Calibrated: 2021-06-21
- Phantom: HAC Test Arch with AMCC
- Measurement SW: DASY52, Version 52.10 (4)

T-Coil scan (scan for ANSI C63.19-2007 & 2011 compliance)/General Scans/y (transversal) 4.2mm 50

x 50/ABM Signal(x,y,z) (13x13x1): Measurement grid: dx=10mm, dy=10mm

Signal Type: Audio File (.wav) 48k_voice_1kHz_1s.wav

Output Gain: 15.51

Measure Window Start: 300ms

Measure Window Length: 1000ms

BWC applied: 0.15 dB

Device Reference Point: 0, 0, -6.3 mm

Cursor:

ABM1 comp = -4.83 dBA/m

BWC Factor = 0.15 dB

Location: 4.2, -20.8, 3.7 mm

Cursor:

ABM2 = -33.91 dBA/m

Location: 4.2, -20.8, 3.7 mm

Cursor:

ABM1/ABM2 = 29.08 dB

ABM1 comp = -4.83 dBA/m

BWC Factor = 0.15 dB

Location: 4.2, -20.8, 3.7 mm

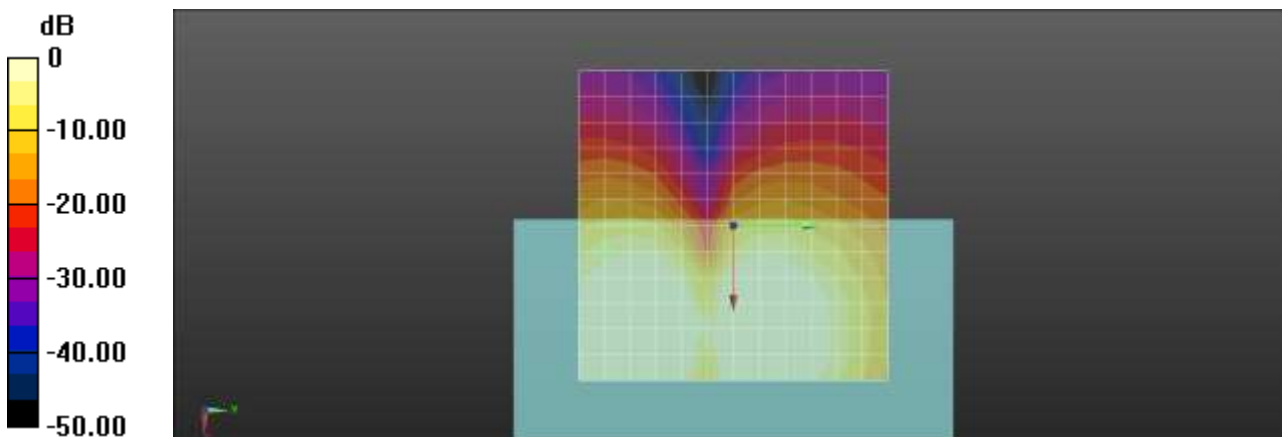

0 dB = 1.000 A/m = 0.00 dBA/m

Plot No.61
GSM850 Edge 2Tx 190ch 40kbit/s z(axial)

Communication System: UID 0, GSM850 GPRS 2TX (0); Frequency: 836.6 MHz;Duty Cycle: 1:4.14954
Medium parameters used: $\sigma = 0$ S/m, $\epsilon_r = 1$; $\rho = 0$ kg/m³
Phantom section: TCoil Section

DASY5 Configuration:

- Probe: AM1DV3 - 3050; ; Calibrated: 2021-11-23
- Sensor-Surface: 0mm (Fix Surface)
- Electronics: DAE4 Sn466; Calibrated: 2021-04-23
- Phantom: HAC Test Arch with AMCC
- Measurement SW: DASY52, Version 52.10 (4)

T-Coil scan (scan for ANSI C63.19-2007 & 2011 compliance)/General Scans/z (axial) 4.2mm 50 x 50/ABM Signal(x,y,z) (13x13x1): Measurement grid: dx=10mm, dy=10mm

Signal Type: Audio File (.wav) 48k_voice_1kHz_1s.wav
Output Gain: 19.05
Measure Window Start: 300ms
Measure Window Length: 3000ms
BWC applied: 0.16 dB
Device Reference Point: 0, 0, -6.3 mm

Cursor:

ABM1 comp = 15.76 dBA/m
BWC Factor = 0.16 dB
Location: 12.5, -4.2, 3.7 mm

Cursor:

ABM2 = -29.86 dBA/m
Location: 12.5, -4.2, 3.7 mm

Cursor:

ABM1/ABM2 = 45.62 dB
ABM1 comp = 15.76 dBA/m
BWC Factor = 0.16 dB
Location: 12.5, -4.2, 3.7 mm

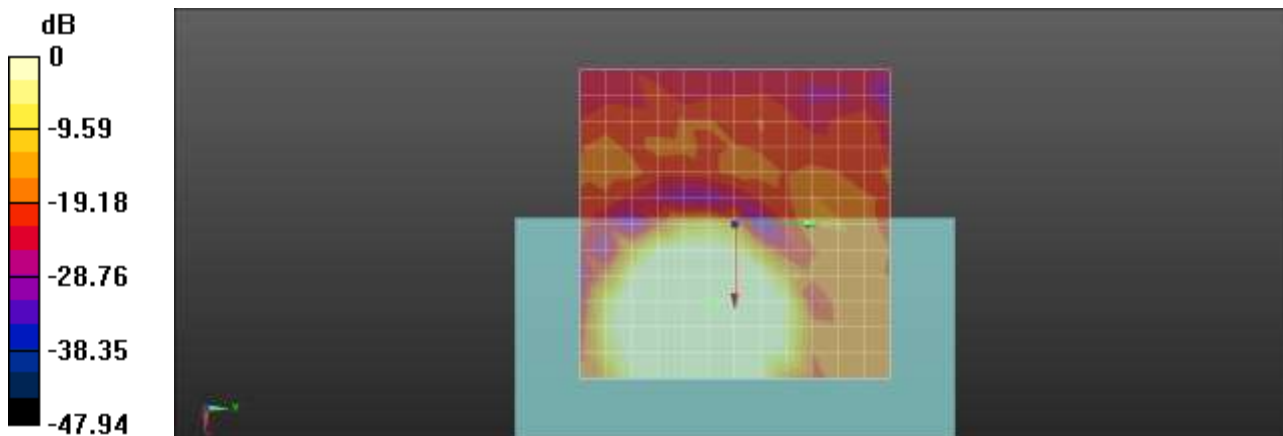

0 dB = 1.000 A/m = 0.00 dBA/m

Plot No.62
GSM850 Edge 2Tx 190ch 40kbit/s Freq. Response

Communication System: UID 0, GSM850 GPRS 2TX (0); Frequency: 836.6 MHz;Duty Cycle: 1:4.14954
 Medium parameters used: $\sigma = 0$ S/m, $\epsilon_r = 1$; $\rho = 0$ kg/m³
 Phantom section: TCoil Section

DASY5 Configuration:

- Probe: AM1DV3 - 3050; ; Calibrated: 2021-11-23
- Sensor-Surface: 0mm (Fix Surface)
- Electronics: DAE4 Sn466; Calibrated: 2021-04-23
- Phantom: HAC Test Arch with AMCC
- Measurement SW: DASY52, Version 52.10 (4)

T-Coil scan (scan for ANSI C63.19-2007 & 2011 compliance)/General Scans/z (axial) wideband at best S/N/ABM Freq Resp(x,y,z,f) (1x1x1): Measurement grid: dx=10mm, dy=10mm
 Signal Type: Audio File (.wav) 48k_Normal_51s new.wav
 Output Gain: 58
 Measure Window Start: 300ms
 Measure Window Length: 51000ms
 BWC applied: 9.49 dB
 Device Reference Point: 0, 0, -6.3 mm

Category	Telephone parameters WD signal quality [(signal+noise)-to-noise ratio in decibels]
Category T1	0 dB to 10 dB
Category T2	10 dB to 20 dB
Category T3	20 dB to 30 dB
Category T4	> 30 dB

Cursor:
 Diff = 1.29 dB
 BWC Factor = 9.49 dB
 Location: 11.4, -3.7, 3.7 mm

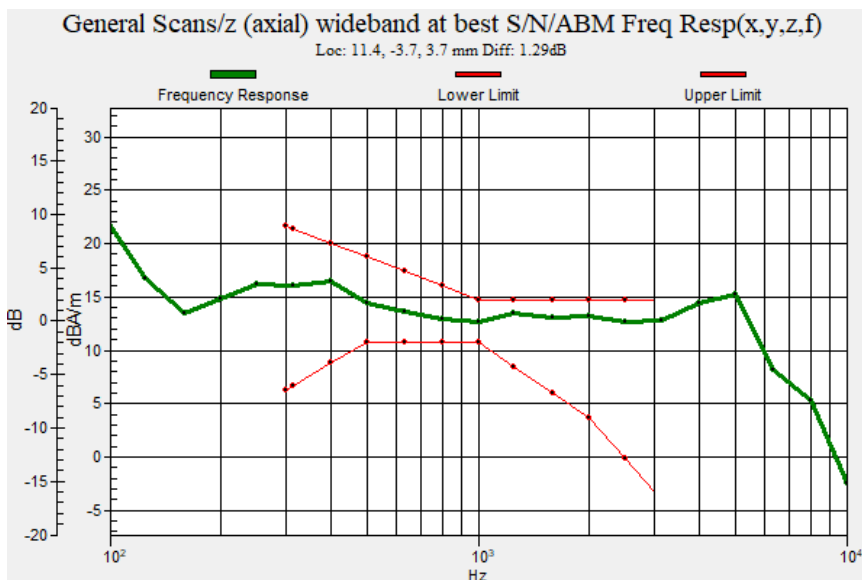

Plot No.63
GSM850 Edge 2Tx 190ch 40kbit/s y(transversal)

Communication System: UID 0, GSM850 GPRS 2TX (0); Frequency: 836.6 MHz;Duty Cycle: 1:4.14954
Medium parameters used: $\sigma = 0$ S/m, $\epsilon_r = 1$; $\rho = 0$ kg/m³
Phantom section: TCoil Section

DASY5 Configuration:

- Probe: AM1DV3 - 3050; ; Calibrated: 2021-11-23
- Sensor-Surface: 0mm (Fix Surface)
- Electronics: DAE4 Sn466; Calibrated: 2021-04-23
- Phantom: HAC Test Arch with AMCC
- Measurement SW: DASY52, Version 52.10 (4)

T-Coil scan (scan for ANSI C63.19-2007 & 2011 compliance)/General Scans/y (transversal) 4.2mm 50 x 50/ABM Signal(x,y,z) (13x13x1): Measurement grid: dx=10mm, dy=10mm

Signal Type: Audio File (.wav) 48k_voice_1kHz_1s.wav
Output Gain: 19.05
Measure Window Start: 300ms
Measure Window Length: 3000ms
BWC applied: 0.16 dB
Device Reference Point: 0, 0, -6.3 mm

Cursor:

ABM1 comp = 9.69 dBA/m
BWC Factor = 0.16 dB
Location: 12.5, 4.2, 3.7 mm

Cursor:

ABM2 = -29.13 dBA/m
Location: 12.5, 4.2, 3.7 mm

Cursor:

ABM1/ABM2 = 38.82 dB
ABM1 comp = 9.69 dBA/m
BWC Factor = 0.16 dB
Location: 12.5, 4.2, 3.7 mm

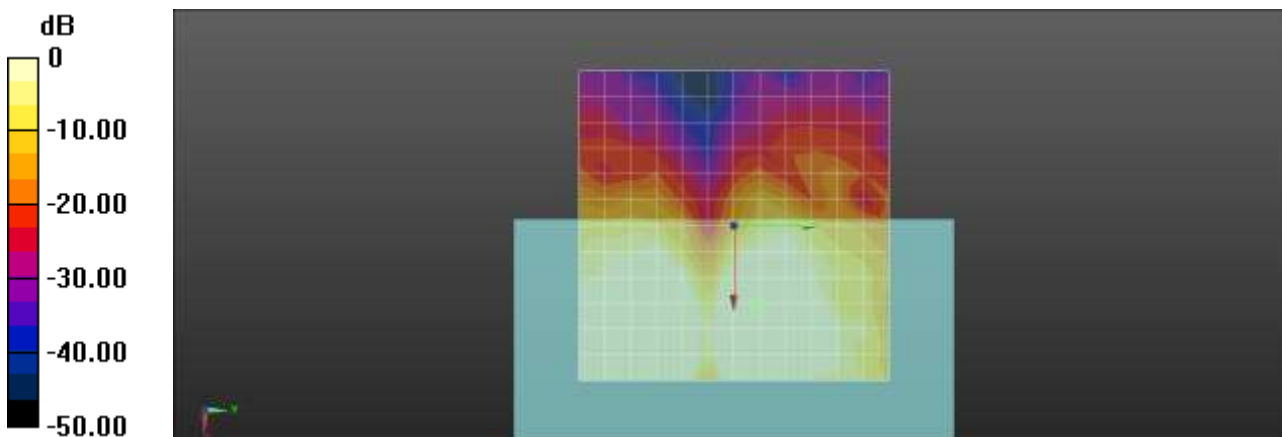

0 dB = 1.000 A/m = 0.00 dBA/m

Plot No.64
GSM1900 Edge 2Tx 810ch 40kbit/s z(axial)

Communication System: UID 0, GSM 1900 2TX (0); Frequency: 1909.8 MHz;Duty Cycle: 1:4.14954
 Medium parameters used: $\sigma = 0$ S/m, $\epsilon_r = 1$; $\rho = 0$ kg/m³
 Phantom section: TCoil Section

DASY5 Configuration:

- Probe: AM1DV3 - 3050; ; Calibrated: 2021-11-23
- Sensor-Surface: 0mm (Fix Surface)
- Electronics: DAE4 Sn466; Calibrated: 2021-04-23
- Phantom: HAC Test Arch with AMCC
- Measurement SW: DASY52, Version 52.10 (4)

T-Coil scan (scan for ANSI C63.19-2007 & 2011 compliance)/General Scans/z (axial) 4.2mm 50 x 50/ABM Signal(x,y,z) (13x13x1): Measurement grid: dx=10mm, dy=10mm
 Signal Type: Audio File (.wav) 48k_voice_1kHz_1s.wav
 Output Gain: 19.05
 Measure Window Start: 300ms
 Measure Window Length: 3000ms
 BWC applied: 0.15 dB
 Device Reference Point: 0, 0, -6.3 mm

Cursor:

ABM1 comp = 9.46 dBA/m
 BWC Factor = 0.15 dB
 Location: 12.5, -4.2, 3.7 mm

Cursor:

ABM2 = -34.64 dBA/m
 Location: 12.5, -4.2, 3.7 mm

Cursor:

ABM1/ABM2 = 44.10 dB
 ABM1 comp = 9.46 dBA/m
 BWC Factor = 0.15 dB
 Location: 12.5, -4.2, 3.7 mm

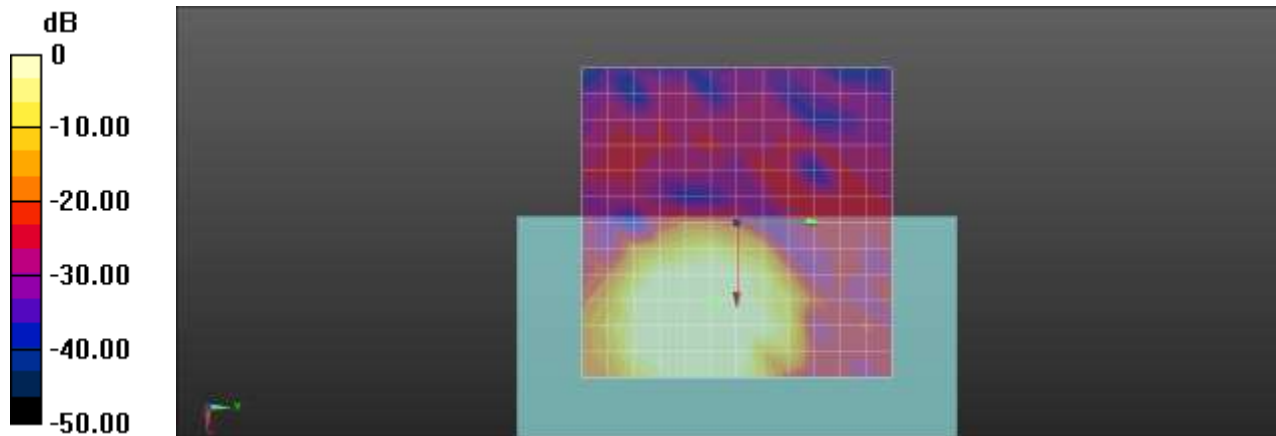

0 dB = 1.000 A/m = 0.00 dBA/m

Plot No.65
GSM1900 Edge 2Tx 810ch 40kbit/s Freq. Response

Communication System: UID 0, GSM 1900 2TX (0); Frequency: 1909.8 MHz;Duty Cycle: 1:4.14954
Medium parameters used: $\sigma = 0$ S/m, $\epsilon_r = 1$; $\rho = 0$ kg/m³
Phantom section: TCoil Section

DASY5 Configuration:

- Probe: AM1DV3 - 3050; ; Calibrated: 2021-11-23
- Sensor-Surface: 0mm (Fix Surface)
- Electronics: DAE4 Sn466; Calibrated: 2021-04-23
- Phantom: HAC Test Arch with AMCC
- Measurement SW: DASY52, Version 52.10 (4)

T-Coil scan (scan for ANSI C63.19-2007 & 2011 compliance)/General Scans/z (axial) wideband at best S/N/ABM Freq Resp(x,y,z,f) (1x1x1): Measurement grid: dx=10mm, dy=10mm
Signal Type: Audio File (.wav) 48k_Normal_51s new.wav
Output Gain: 58
Measure Window Start: 300ms
Measure Window Length: 51000ms
BWC applied: 9.48 dB
Device Reference Point: 0, 0, -6.3 mm

Category	Telephone parameters WD signal quality [(signal+noise)-to-noise ratio in decibels]
Category T1	0 dB to 10 dB
Category T2	10 dB to 20 dB
Category T3	20 dB to 30 dB
Category T4	> 30 dB

Cursor:
Diff = 1.79 dB
BWC Factor = 9.48 dB
Location: 12.5, -4, 3.7 mm

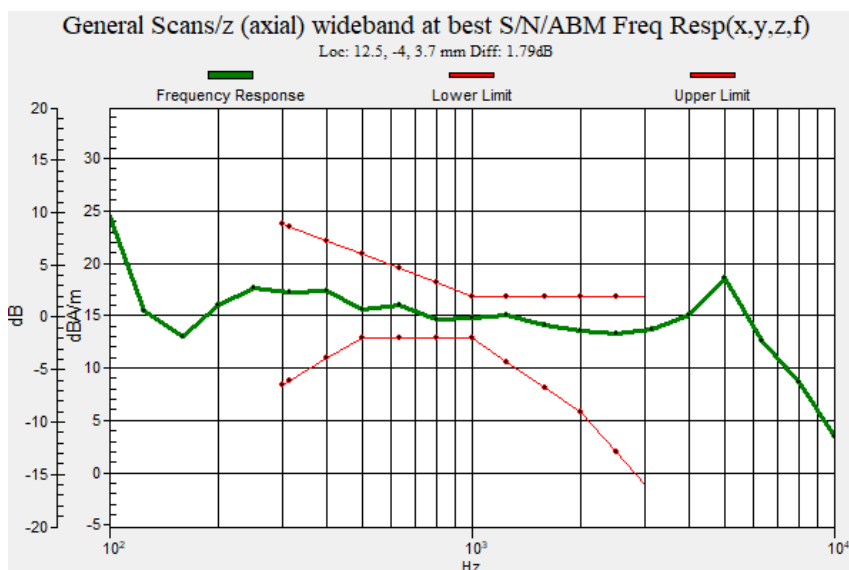

Plot No.66

GSM1900 Edge 2Tx 810ch 40kbit/s y(transversal)

Communication System: UID 0, GSM 1900 2TX (0); Frequency: 1909.8 MHz;Duty Cycle: 1:4.14954

Medium parameters used: $\sigma = 0$ S/m, $\epsilon_r = 1$; $\rho = 0$ kg/m³

Phantom section: TCoil Section

DASY5 Configuration:

- Probe: AM1DV3 - 3050; ; Calibrated: 2021-11-23
- Sensor-Surface: 0mm (Fix Surface)
- Electronics: DAE4 Sn466; Calibrated: 2021-04-23
- Phantom: HAC Test Arch with AMCC
- Measurement SW: DASY52, Version 52.10 (4)

T-Coil scan (scan for ANSI C63.19-2007 & 2011 compliance)/General Scans/y (transversal) 4.2mm 50

x 50/ABM Signal(x,y,z) (13x13x1): Measurement grid: dx=10mm, dy=10mm

Signal Type: Audio File (.wav) 48k_voice_1kHz_1s.wav

Output Gain: 19.05

Measure Window Start: 300ms

Measure Window Length: 3000ms

BWC applied: 0.15 dB

Device Reference Point: 0, 0, -6.3 mm

Cursor:

ABM1 comp = -10.70 dBA/m

BWC Factor = 0.15 dB

Location: -4.2, -20.8, 3.7 mm

Cursor:

ABM2 = -43.83 dBA/m

Location: -4.2, -20.8, 3.7 mm

Cursor:

ABM1/ABM2 = 33.13 dB

ABM1 comp = -10.70 dBA/m

BWC Factor = 0.15 dB

Location: -4.2, -20.8, 3.7 mm

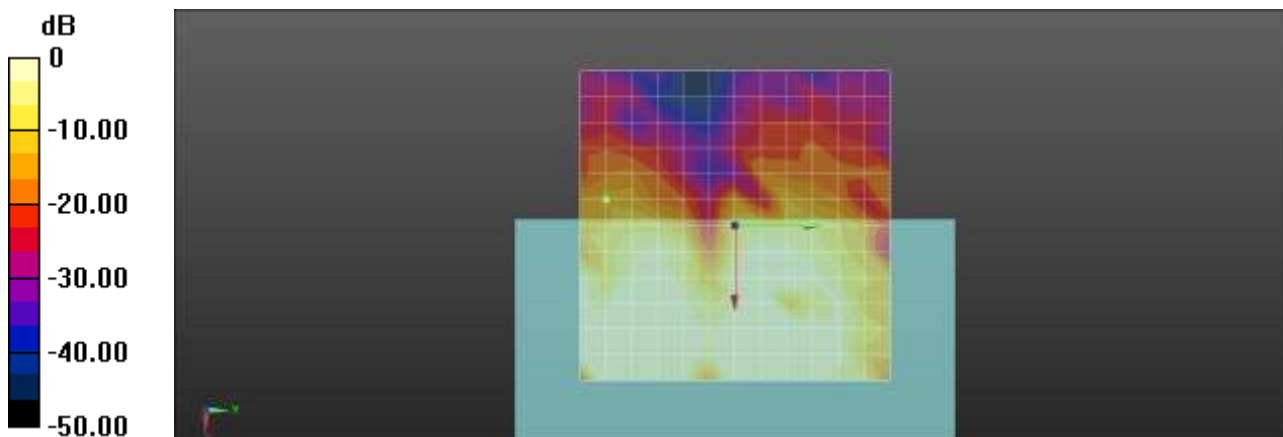

0 dB = 1.000 A/m = 0.00 dBA/m

Plot No.67

WCDMA1900 9400ch 6kbit/s z(axial)

Communication System: UID 0, WCDMA1900 (0); Frequency: 1880 MHz;Duty Cycle: 1:1

Medium parameters used: $\sigma = 0$ S/m, $\epsilon_r = 1$; $\rho = 0$ kg/m³

Phantom section: TCoil Section

DASY5 Configuration:

- Probe: AM1DV3 - 3050; ; Calibrated: 2021-11-23
- Sensor-Surface: 0mm (Fix Surface)
- Electronics: DAE4 Sn466; Calibrated: 2021-04-23
- Phantom: HAC Test Arch with AMCC
- Measurement SW: DASY52, Version 52.10 (4)

T-Coil scan (scan for ANSI C63.19-2007 & 2011 compliance)/General Scans/z (axial) 4.2mm 50 x

50/ABM Signal(x,y,z) (13x13x1): Measurement grid: dx=10mm, dy=10mm

Signal Type: Audio File (.wav) 48k_voice_1kHz_1s.wav

Output Gain: 19.05

Measure Window Start: 300ms

Measure Window Length: 1000ms

BWC applied: 0.15 dB

Device Reference Point: 0, 0, -6.3 mm

Cursor:

ABM1 comp = 19.13 dBA/m

BWC Factor = 0.15 dB

Location: 16.7, -4.2, 3.7 mm

Cursor:

ABM2 = -33.76 dBA/m

Location: 16.7, -4.2, 3.7 mm

Cursor:

ABM1/ABM2 = 52.89 dB

ABM1 comp = 19.13 dBA/m

BWC Factor = 0.15 dB

Location: 16.7, -4.2, 3.7 mm

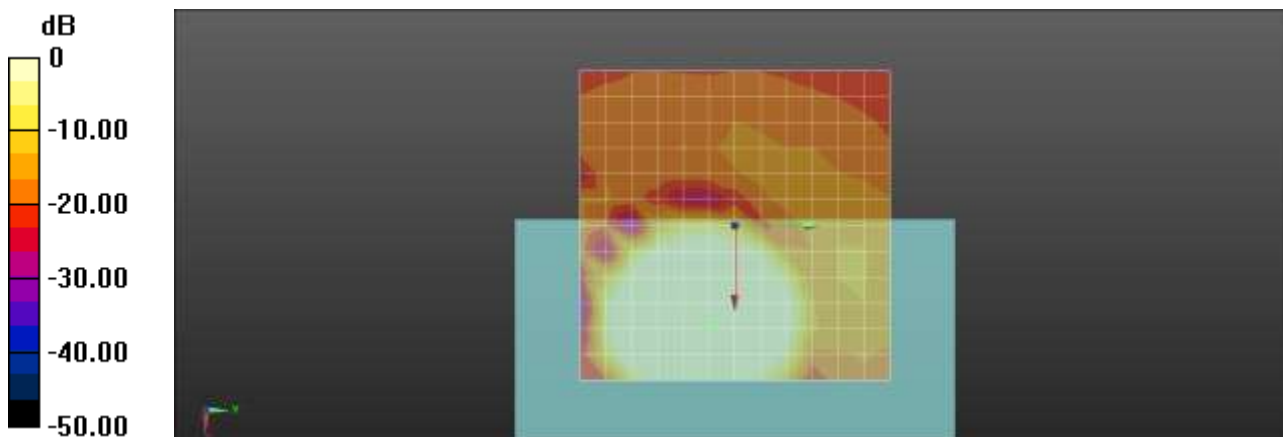

0 dB = 1.000 A/m = 0.00 dBA/m

Plot No.68

WCDMA1900 9400ch 6kbit/s Freq. Response

Communication System: UID 0, WCDMA1900 (0); Frequency: 1880 MHz;Duty Cycle: 1:1
 Medium parameters used: $\sigma = 0$ S/m, $\epsilon_r = 1$; $\rho = 0$ kg/m³
 Phantom section: TCoil Section

DASY5 Configuration:

- Probe: AM1DV3 - 3050; ; Calibrated: 2021-11-23
- Sensor-Surface: 0mm (Fix Surface)
- Electronics: DAE4 Sn466; Calibrated: 2021-04-23
- Phantom: HAC Test Arch with AMCC
- Measurement SW: DASY52, Version 52.10 (4)

T-Coil scan (scan for ANSI C63.19-2007 & 2011 compliance)/General Scans/z (axial) wideband at best

S/N/ABM Freq Resp(x,y,z,f) (1x1x1): Measurement grid: dx=10mm, dy=10mm

Signal Type: Audio File (.wav) 48k_Normal_51s new.wav

Output Gain: 58

Measure Window Start: 300ms

Measure Window Length: 51000ms

BWC applied: 9.48 dB

Device Reference Point: 0, 0, -6.3 mm

Category	Telephone parameters WD signal quality [(signal+noise)-to-noise ratio in decibels]
Category T1	0 dB to 10 dB
Category T2	10 dB to 20 dB
Category T3	20 dB to 30 dB
Category T4	> 30 dB

Cursor:

Diff = 1.63 dB

BWC Factor = 9.48 dB

Location: 15.8, -4.5, 3.7 mm

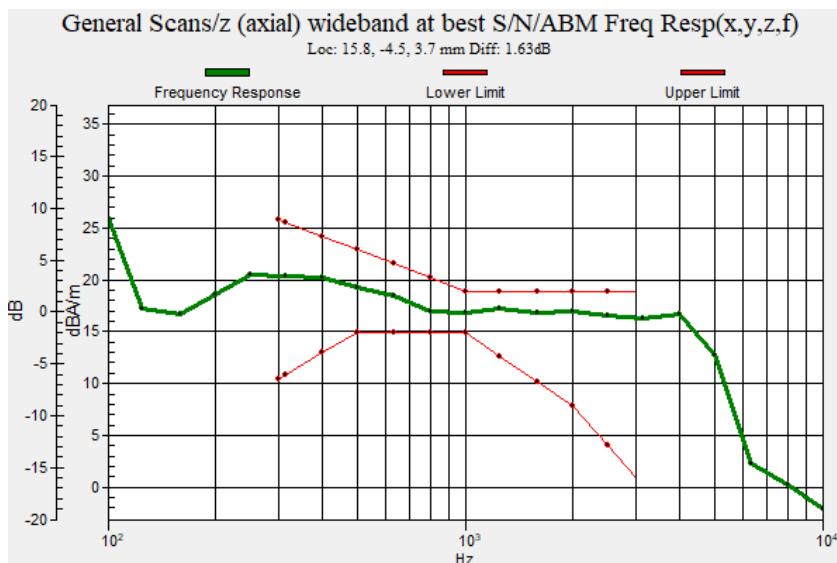

Plot No.69

WCDMA1900 9400ch 6kbit/s y(transversal)

Communication System: UID 0, WCDMA1900 (0); Frequency: 1880 MHz;Duty Cycle: 1:1

Medium parameters used: $\sigma = 0$ S/m, $\epsilon_r = 1$; $\rho = 0$ kg/m³

Phantom section: TCoil Section

DASY5 Configuration:

- Probe: AM1DV3 - 3050; ; Calibrated: 2021-11-23
- Sensor-Surface: 0mm (Fix Surface)
- Electronics: DAE4 Sn466; Calibrated: 2021-04-23
- Phantom: HAC Test Arch with AMCC
- Measurement SW: DASY52, Version 52.10 (4)

T-Coil scan (scan for ANSI C63.19-2007 & 2011 compliance)/General Scans/y (transversal) 4.2mm 50

x 50/ABM Signal(x,y,z) (13x13x1): Measurement grid: dx=10mm, dy=10mm

Signal Type: Audio File (.wav) 48k_voice_1kHz_1s.wav

Output Gain: 19.05

Measure Window Start: 300ms

Measure Window Length: 1000ms

BWC applied: 0.15 dB

Device Reference Point: 0, 0, -6.3 mm

Cursor:

ABM1 comp = 7.36 dBA/m

BWC Factor = 0.15 dB

Location: 8.3, 4.2, 3.7 mm

Cursor:

ABM2 = -45.81 dBA/m

Location: 8.3, 4.2, 3.7 mm

Cursor:

ABM1/ABM2 = 53.17 dB

ABM1 comp = 7.36 dBA/m

BWC Factor = 0.15 dB

Location: 8.3, 4.2, 3.7 mm

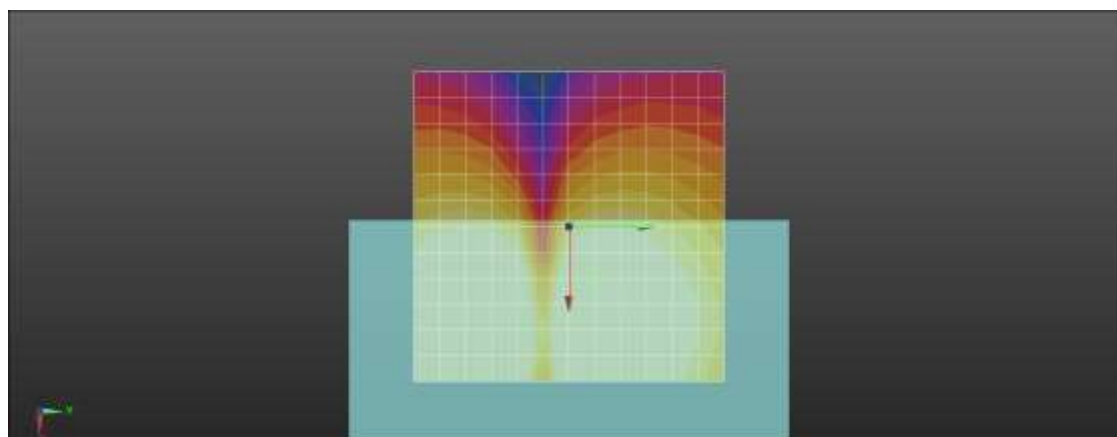
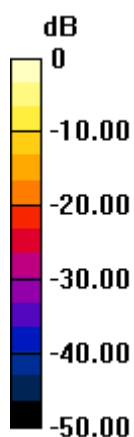

0 dB = 1.000 A/m = 0.00 dBA/m

Plot No.70

WCDMA850 4132ch 6kbit/s z(axial)

Communication System: UID 0, WCDMA850 (0); Frequency: 826.4 MHz;Duty Cycle: 1:1
Medium parameters used: $\sigma = 0$ S/m, $\epsilon_r = 1$; $\rho = 0$ kg/m³
Phantom section: TCoil Section

DASY5 Configuration:

- Probe: AM1DV3 - 3050; ; Calibrated: 2021-11-23
- Sensor-Surface: 0mm (Fix Surface)
- Electronics: DAE4 Sn466; Calibrated: 2021-04-23
- Phantom: HAC Test Arch with AMCC
- Measurement SW: DASY52, Version 52.10 (4)

T-Coil scan (scan for ANSI C63.19-2007 & 2011 compliance)/General Scans/z (axial) 4.2mm 50 x 50/ABM Signal(x,y,z) (13x13x1): Measurement grid: dx=10mm, dy=10mm

Signal Type: Audio File (.wav) 48k_voice_1kHz_1s.wav

Output Gain: 19.05

Measure Window Start: 300ms

Measure Window Length: 1000ms

BWC applied: 0.16 dB

Device Reference Point: 0, 0, -6.3 mm

Cursor:

ABM1 comp = 16.90 dBA/m

BWC Factor = 0.16 dB

Location: 12.5, -4.2, 3.7 mm

Cursor:

ABM2 = -36.96 dBA/m

Location: 12.5, -4.2, 3.7 mm

Cursor:

ABM1/ABM2 = 53.86 dB

ABM1 comp = 16.90 dBA/m

BWC Factor = 0.16 dB

Location: 12.5, -4.2, 3.7 mm

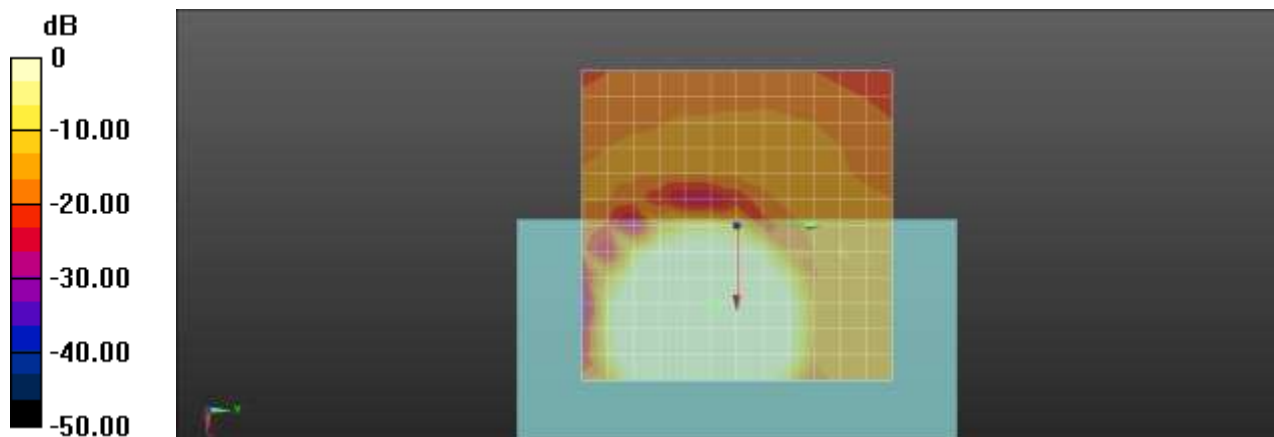

0 dB = 1.000 A/m = 0.00 dBA/m

Plot No.71
WCDMA850 4132ch 6kbit/s Freq. Response

Communication System: UID 0, WCDMA850 (0); Frequency: 826.4 MHz;Duty Cycle: 1:1
Medium parameters used: $\sigma = 0$ S/m, $\epsilon_r = 1$; $\rho = 0$ kg/m³
Phantom section: TCoil Section

DASY5 Configuration:

- Probe: AM1DV3 - 3050; ; Calibrated: 2021-11-23
- Sensor-Surface: 0mm (Fix Surface)
- Electronics: DAE4 Sn466; Calibrated: 2021-04-23
- Phantom: HAC Test Arch with AMCC
- Measurement SW: DASY52, Version 52.10 (4)

T-Coil scan (scan for ANSI C63.19-2007 & 2011 compliance)/General Scans/z (axial) wideband at best S/N/ABM Freq Resp(x,y,z,f) (1x1x1): Measurement grid: dx=10mm, dy=10mm
Signal Type: Audio File (.wav) 48k_Normal_51s new.wav
Output Gain: 58
Measure Window Start: 300ms
Measure Window Length: 51000ms
BWC applied: 9.48 dB
Device Reference Point: 0, 0, -6.3 mm

Category	Telephone parameters WD signal quality [(signal+noise)-to-noise ratio in decibels]
Category T1	0 dB to 10 dB
Category T2	10 dB to 20 dB
Category T3	20 dB to 30 dB
Category T4	> 30 dB

Cursor:
Diff = 1.80 dB
BWC Factor = 9.48 dB
Location: 14.5, -4.4, 3.7 mm

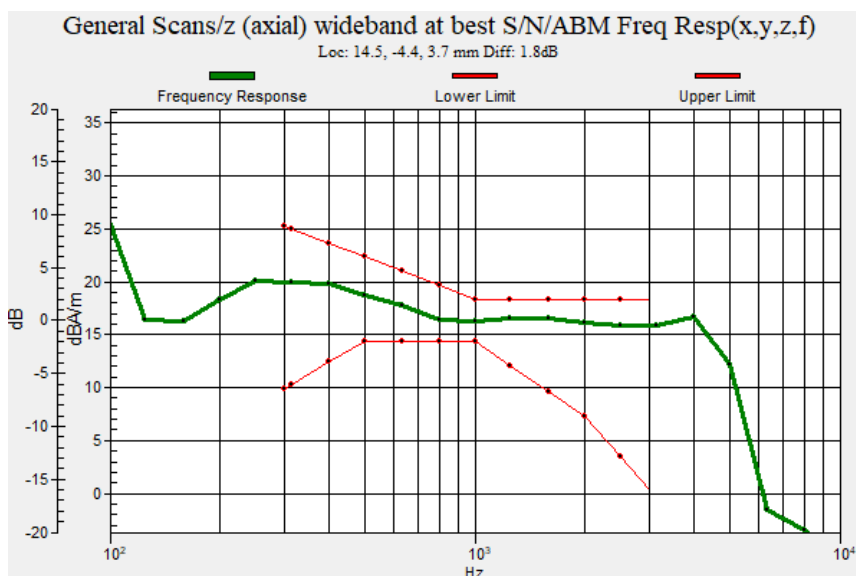

Plot No.72

WCDMA850 4132ch 6kbit/s y(transversal)

Communication System: UID 0, WCDMA850 (0); Frequency: 826.4 MHz;Duty Cycle: 1:1

Medium parameters used: $\sigma = 0$ S/m, $\epsilon_r = 1$; $\rho = 0$ kg/m³

Phantom section: TCoil Section

DASY5 Configuration:

- Probe: AM1DV3 - 3050; ; Calibrated: 2021-11-23
- Sensor-Surface: 0mm (Fix Surface)
- Electronics: DAE4 Sn466; Calibrated: 2021-04-23
- Phantom: HAC Test Arch with AMCC
- Measurement SW: DASY52, Version 52.10 (4)

T-Coil scan (scan for ANSI C63.19-2007 & 2011 compliance)/General Scans/y (transversal) 4.2mm 50

x 50/ABM Signal(x,y,z) (13x13x1): Measurement grid: dx=10mm, dy=10mm

Signal Type: Audio File (.wav) 48k_voice_1kHz_1s.wav

Output Gain: 19.05

Measure Window Start: 300ms

Measure Window Length: 1000ms

BWC applied: 0.16 dB

Device Reference Point: 0, 0, -6.3 mm

Cursor:

ABM1 comp = 7.22 dBA/m

BWC Factor = 0.16 dB

Location: 8.3, 4.2, 3.7 mm

Cursor:

ABM2 = -47.00 dBA/m

Location: 8.3, 4.2, 3.7 mm

Cursor:

ABM1/ABM2 = 54.23 dB

ABM1 comp = 7.22 dBA/m

BWC Factor = 0.16 dB

Location: 8.3, 4.2, 3.7 mm

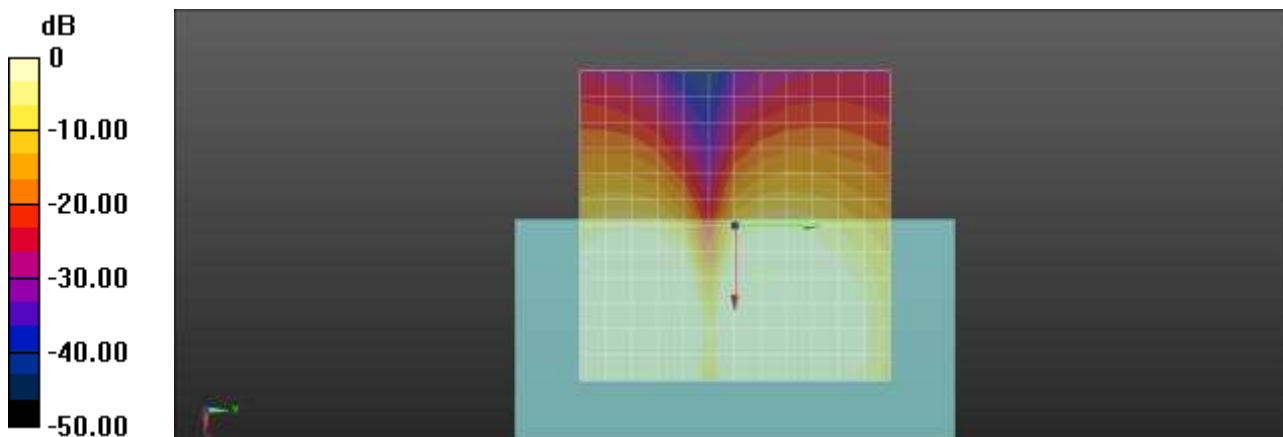

0 dB = 1.000 A/m = 0.00 dBA/m

Plot No.73

LTE Band 2 QPSK 20MHz 50RB 0offset 40kbit/s 18900ch z(axial)

Communication System: UID 0, LTE Band 2 (0); Frequency: 1880 MHz;Duty Cycle: 1:1

Medium parameters used: $\sigma = 0$ S/m, $\epsilon_r = 1$; $\rho = 0$ kg/m³

Phantom section: TCoil Section

DASY5 Configuration:

- Probe: AM1DV3 - 3050; ; Calibrated: 2021-11-23
- Sensor-Surface: 0mm (Fix Surface)
- Electronics: DAE4 Sn466; Calibrated: 2021-04-23
- Phantom: HAC Test Arch with AMCC
- Measurement SW: DASY52, Version 52.10 (4)

T-Coil scan (scan for ANSI C63.19-2007 & 2011 compliance)/General Scans/z (axial) 4.2mm 50 x

50/ABM Signal(x,y,z) (13x13x1): Measurement grid: dx=10mm, dy=10mm

Signal Type: Audio File (.wav) 48k_voice_1kHz_1s.wav

Output Gain: 19.05

Measure Window Start: 300ms

Measure Window Length: 1000ms

BWC applied: 0.16 dB

Device Reference Point: 0, 0, -6.3 mm

Cursor:

ABM1 comp = 18.03 dBA/m

BWC Factor = 0.16 dB

Location: 12.5, -4.2, 3.7 mm

Cursor:

ABM2 = -32.92 dBA/m

Location: 12.5, -4.2, 3.7 mm

Cursor:

ABM1/ABM2 = 50.95 dB

ABM1 comp = 18.03 dBA/m

BWC Factor = 0.16 dB

Location: 12.5, -4.2, 3.7 mm

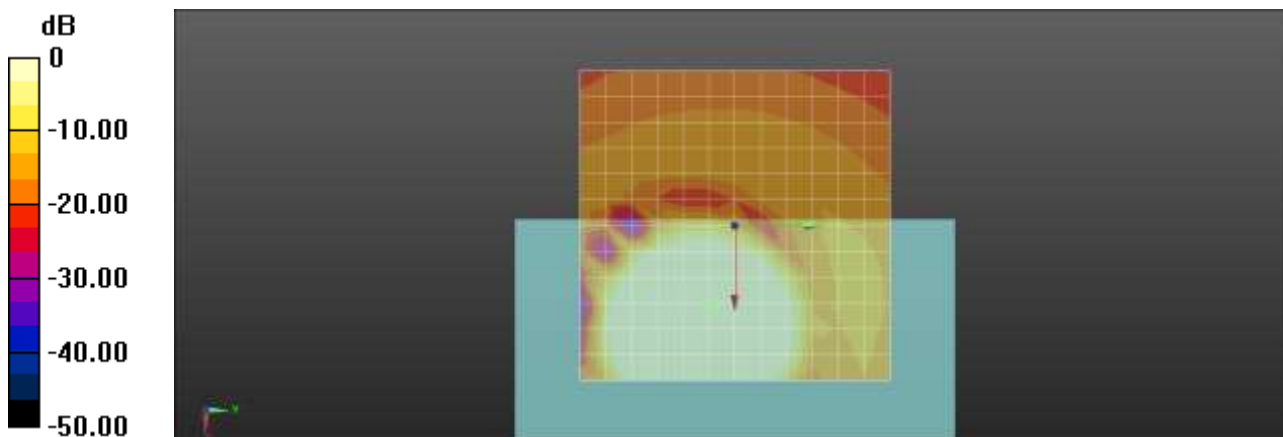

Plot No.74

LTE Band 2 QPSK 20MHz 50RB 0offset 40kbit/s 18900ch Freq. Response

Communication System: UID 0, LTE Band 2 (0); Frequency: 1880 MHz;Duty Cycle: 1:1
 Medium parameters used: $\sigma = 0$ S/m, $\epsilon_r = 1$; $\rho = 0$ kg/m³
 Phantom section: TCoil Section

DASY5 Configuration:

- Probe: AM1DV3 - 3050; ; Calibrated: 2021-11-23
- Sensor-Surface: 0mm (Fix Surface)
- Electronics: DAE4 Sn466; Calibrated: 2021-04-23
- Phantom: HAC Test Arch with AMCC
- Measurement SW: DASY52, Version 52.10 (4)

T-Coil scan (scan for ANSI C63.19-2007 & 2011 compliance)/General Scans/z (axial) wideband at best

S/N/ABM Freq Resp(x,y,z,f) (1x1x1): Measurement grid: dx=10mm, dy=10mm

Signal Type: Audio File (.wav) 48k_Normal_51s new.wav

Output Gain: 58

Measure Window Start: 300ms

Measure Window Length: 51000ms

BWC applied: 9.48 dB

Device Reference Point: 0, 0, -6.3 mm

Category	Telephone parameters WD signal quality [(signal+noise)-to-noise ratio in decibels]
Category T1	0 dB to 10 dB
Category T2	10 dB to 20 dB
Category T3	20 dB to 30 dB
Category T4	> 30 dB

Cursor:

Diff = 1.87 dB

BWC Factor = 9.48 dB

Location: 13.9, -3.7, 3.7 mm

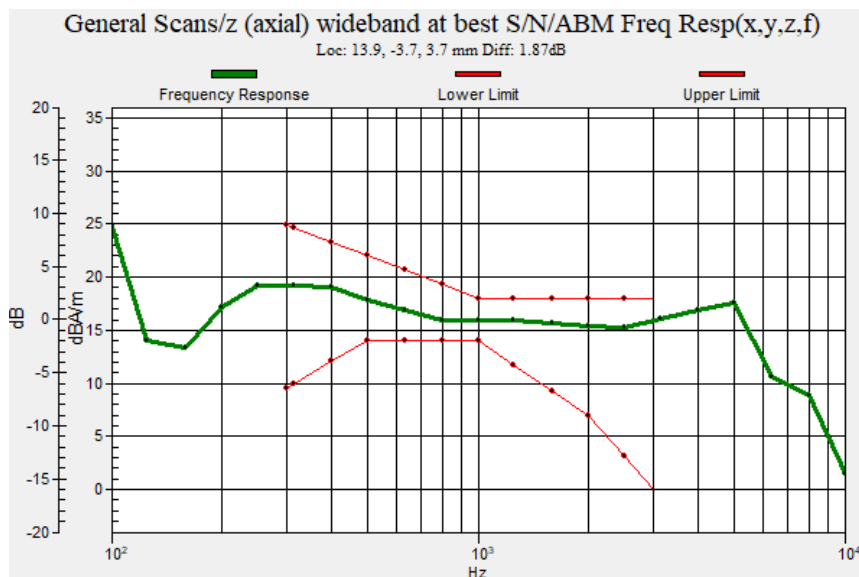

Plot No.75

LTE Band 2 QPSK 20MHz 50RB 0offset 40kbit/s 18900ch y(transversal)

Communication System: UID 0, LTE Band 2 (0); Frequency: 1880 MHz;Duty Cycle: 1:1

Medium parameters used: $\sigma = 0$ S/m, $\epsilon_r = 1$; $\rho = 0$ kg/m³

Phantom section: TCoil Section

DASY5 Configuration:

- Probe: AM1DV3 - 3050; ; Calibrated: 2021-11-23
- Sensor-Surface: 0mm (Fix Surface)
- Electronics: DAE4 Sn466; Calibrated: 2021-04-23
- Phantom: HAC Test Arch with AMCC
- Measurement SW: DASY52, Version 52.10 (4)

T-Coil scan (scan for ANSI C63.19-2007 & 2011 compliance)/General Scans/y (transversal) 4.2mm 50

x 50/ABM Signal(x,y,z) (13x13x1): Measurement grid: dx=10mm, dy=10mm

Signal Type: Audio File (.wav) 48k_voice_1kHz_1s.wav

Output Gain: 19.05

Measure Window Start: 300ms

Measure Window Length: 1000ms

BWC applied: 0.16 dB

Device Reference Point: 0, 0, -6.3 mm

Cursor:

ABM1 comp = 11.10 dBA/m

BWC Factor = 0.16 dB

Location: 12.5, 4.2, 3.7 mm

Cursor:

ABM2 = -40.53 dBA/m

Location: 12.5, 4.2, 3.7 mm

Cursor:

ABM1/ABM2 = 51.63 dB

ABM1 comp = 11.10 dBA/m

BWC Factor = 0.16 dB

Location: 12.5, 4.2, 3.7 mm

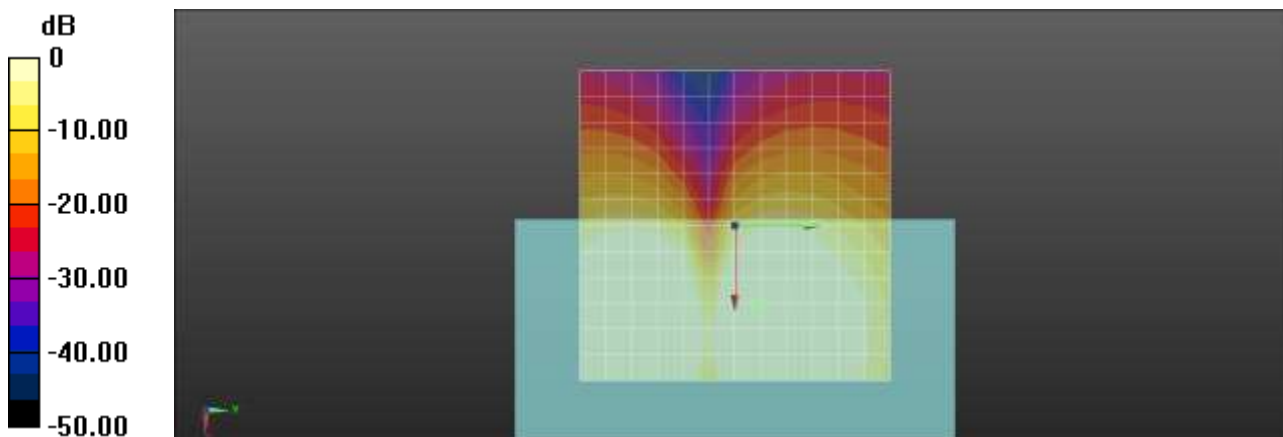

0 dB = 1.000 A/m = 0.00 dBA/m

Plot No.76

LTE Band 5 QPSK 10MHz 25RB 0offset 40kbit/s 20525ch z(axial)

Communication System: UID 0, LTE Band 5 (0); Frequency: 836.5 MHz;Duty Cycle: 1:1

Medium parameters used: $\sigma = 0$ S/m, $\epsilon_r = 1$; $\rho = 0$ kg/m³

Phantom section: TCoil Section

DASY5 Configuration:

- Probe: AM1DV3 - 3050; ; Calibrated: 2021-11-23
- Sensor-Surface: 0mm (Fix Surface)
- Electronics: DAE4 Sn466; Calibrated: 2021-04-23
- Phantom: HAC Test Arch with AMCC
- Measurement SW: DASY52, Version 52.10 (4)

T-Coil scan (scan for ANSI C63.19-2007 & 2011 compliance)/General Scans/z (axial) 4.2mm 50 x

50/ABM Signal(x,y,z) (13x13x1): Measurement grid: dx=10mm, dy=10mm

Signal Type: Audio File (.wav) 48k_voice_1kHz_1s.wav

Output Gain: 19.05

Measure Window Start: 300ms

Measure Window Length: 1000ms

BWC applied: 0.15 dB

Device Reference Point: 0, 0, -6.3 mm

Cursor:

ABM1 comp = 17.98 dBA/m

BWC Factor = 0.15 dB

Location: 12.5, -4.2, 3.7 mm

Cursor:

ABM2 = -33.86 dBA/m

Location: 12.5, -4.2, 3.7 mm

Cursor:

ABM1/ABM2 = 51.84 dB

ABM1 comp = 17.98 dBA/m

BWC Factor = 0.15 dB

Location: 12.5, -4.2, 3.7 mm

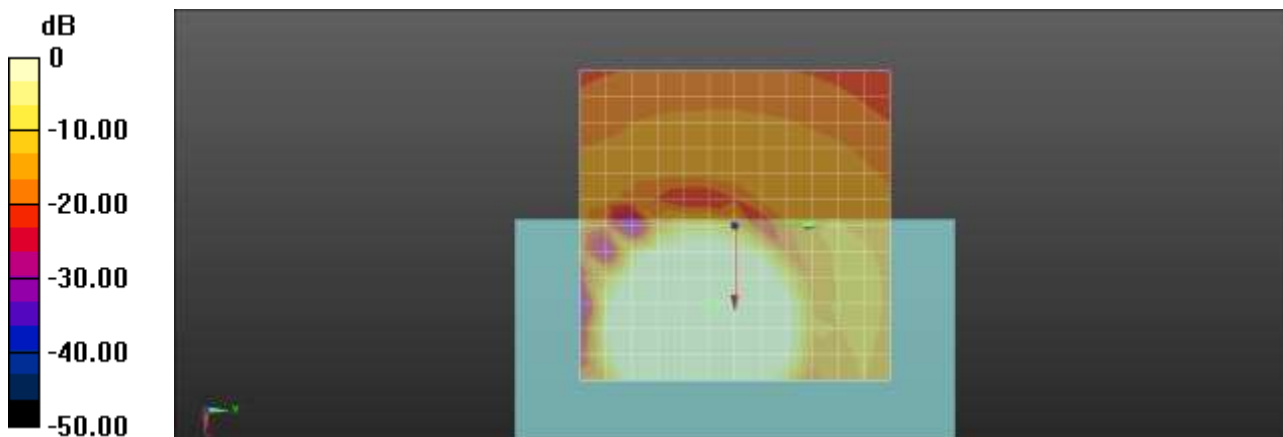

0 dB = 1.000 A/m = 0.00 dBA/m

Plot No.77

LTE Band 5 QPSK 10MHz 25RB 0offset 40kbit/s 20525ch Freq. Response

Communication System: UID 0, LTE Band 5 (0); Frequency: 836.5 MHz;Duty Cycle: 1:1
 Medium parameters used: $\sigma = 0$ S/m, $\epsilon_r = 1$; $\rho = 0$ kg/m³
 Phantom section: TCoil Section

DASY5 Configuration:

- Probe: AM1DV3 - 3050; ; Calibrated: 2021-11-23
- Sensor-Surface: 0mm (Fix Surface)
- Electronics: DAE4 Sn466; Calibrated: 2021-04-23
- Phantom: HAC Test Arch with AMCC
- Measurement SW: DASY52, Version 52.10 (4)

T-Coil scan (scan for ANSI C63.19-2007 & 2011 compliance)/General Scans/z (axial) wideband at best

S/N/ABM Freq Resp(x,y,z,f) (1x1x1): Measurement grid: dx=10mm, dy=10mm

Signal Type: Audio File (.wav) 48k_Normal_51s new.wav

Output Gain: 58

Measure Window Start: 300ms

Measure Window Length: 51000ms

BWC applied: 9.48 dB

Device Reference Point: 0, 0, -6.3 mm

Category	Telephone parameters WD signal quality [(signal+noise)-to-noise ratio in decibels]
Category T1	0 dB to 10 dB
Category T2	10 dB to 20 dB
Category T3	20 dB to 30 dB
Category T4	> 30 dB

Cursor:

Diff = 1.92 dB

BWC Factor = 9.48 dB

Location: 14.5, -4, 3.7 mm

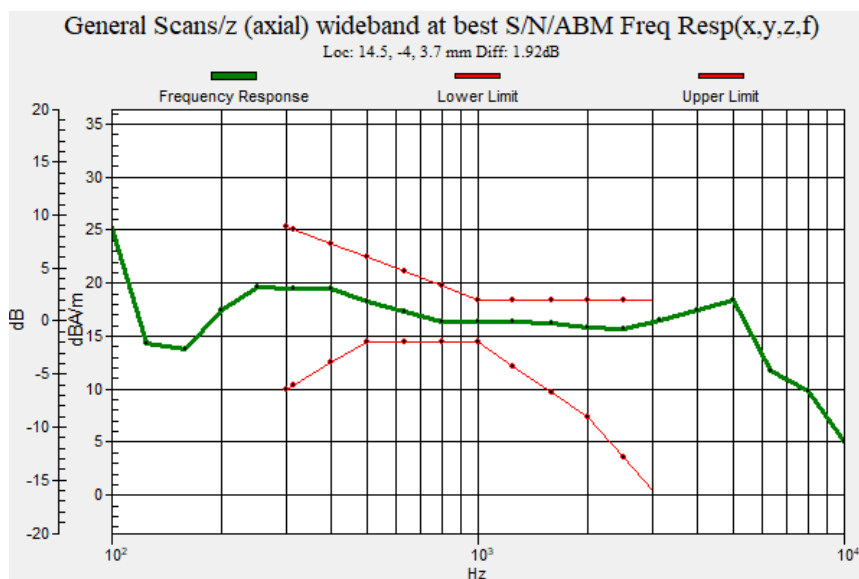

Plot No.78

LTE Band 5 QPSK 10MHz 25RB 0offset 40kbit/s 20525ch y(transversal)

Communication System: UID 0, LTE Band 5 (0); Frequency: 836.5 MHz;Duty Cycle: 1:1

Medium parameters used: $\sigma = 0$ S/m, $\epsilon_r = 1$; $\rho = 0$ kg/m³

Phantom section: TCoil Section

DASY5 Configuration:

- Probe: AM1DV3 - 3050; ; Calibrated: 2021-11-23
- Sensor-Surface: 0mm (Fix Surface)
- Electronics: DAE4 Sn466; Calibrated: 2021-04-23
- Phantom: HAC Test Arch with AMCC
- Measurement SW: DASY52, Version 52.10 (4)

T-Coil scan (scan for ANSI C63.19-2007 & 2011 compliance)/General Scans/y (transversal) 4.2mm 50

x 50/ABM Signal(x,y,z) (13x13x1): Measurement grid: dx=10mm, dy=10mm

Signal Type: Audio File (.wav) 48k_voice_1kHz_1s.wav

Output Gain: 19.05

Measure Window Start: 300ms

Measure Window Length: 1000ms

BWC applied: 0.15 dB

Device Reference Point: 0, 0, -6.3 mm

Cursor:

ABM1 comp = 11.42 dBA/m

BWC Factor = 0.15 dB

Location: 12.5, 4.2, 3.7 mm

Cursor:

ABM2 = -40.75 dBA/m

Location: 12.5, 4.2, 3.7 mm

Cursor:

ABM1/ABM2 = 52.16 dB

ABM1 comp = 11.42 dBA/m

BWC Factor = 0.15 dB

Location: 12.5, 4.2, 3.7 mm

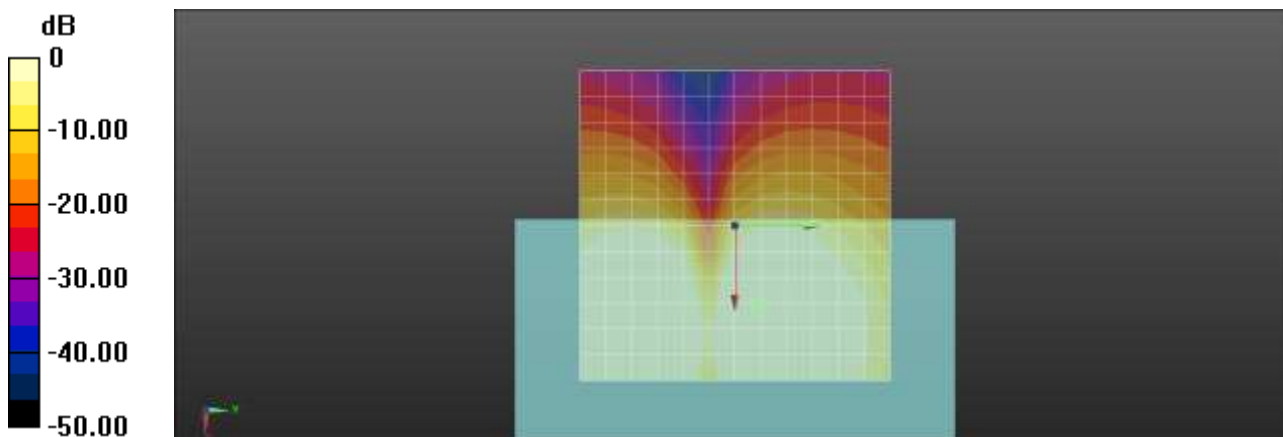

0 dB = 1.000 A/m = 0.00 dBA/m

Plot No.79

LTE Band 7 QPSK 20MHz 50RB 0offset 40kbit/s 21100ch z(axial)

Communication System: UID 0, LTE Band 7 (0); Frequency: 2535 MHz;Duty Cycle: 1:1

Medium parameters used: $\sigma = 0$ S/m, $\epsilon_r = 1$; $\rho = 0$ kg/m³

Phantom section: TCoil Section

DASY5 Configuration:

- Probe: AM1DV3 - 3050; ; Calibrated: 2021-11-23
- Sensor-Surface: 0mm (Fix Surface)
- Electronics: DAE4 Sn466; Calibrated: 2021-04-23
- Phantom: HAC Test Arch with AMCC
- Measurement SW: DASY52, Version 52.10 (4)

T-Coil scan (scan for ANSI C63.19-2007 & 2011 compliance)/General Scans/z (axial) 4.2mm 50 x

50/ABM Signal(x,y,z) (13x13x1): Measurement grid: dx=10mm, dy=10mm

Signal Type: Audio File (.wav) 48k_voice_1kHz_1s.wav

Output Gain: 19.05

Measure Window Start: 300ms

Measure Window Length: 1000ms

BWC applied: 0.15 dB

Device Reference Point: 0, 0, -6.3 mm

Cursor:

ABM1 comp = 17.71 dBA/m

BWC Factor = 0.15 dB

Location: 12.5, -4.2, 3.7 mm

Cursor:

ABM2 = -35.09 dBA/m

Location: 12.5, -4.2, 3.7 mm

Cursor:

ABM1/ABM2 = 52.81 dB

ABM1 comp = 17.71 dBA/m

BWC Factor = 0.15 dB

Location: 12.5, -4.2, 3.7 mm

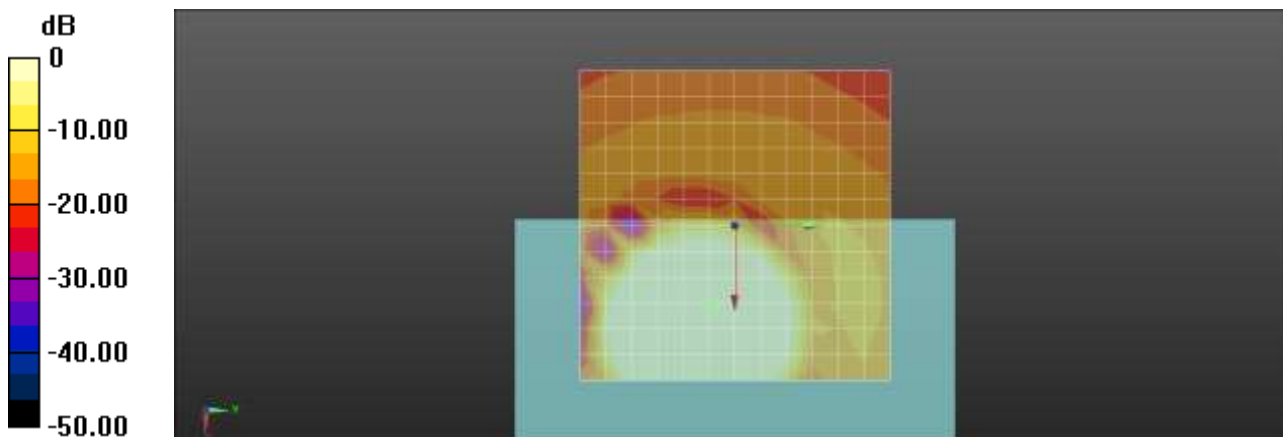

0 dB = 1.000 A/m = 0.00 dBA/m

Plot No.80

LTE Band 7 QPSK 20MHz 50RB 0offset 40kbit/s 21100ch Freq. Response

Communication System: UID 0, LTE Band 7 (0); Frequency: 2535 MHz;Duty Cycle: 1:1
 Medium parameters used: $\sigma = 0$ S/m, $\epsilon_r = 1$; $\rho = 0$ kg/m³
 Phantom section: TCoil Section

DASY5 Configuration:

- Probe: AM1DV3 - 3050; ; Calibrated: 2021-11-23
- Sensor-Surface: 0mm (Fix Surface)
- Electronics: DAE4 Sn466; Calibrated: 2021-04-23
- Phantom: HAC Test Arch with AMCC
- Measurement SW: DASY52, Version 52.10 (4)

T-Coil scan (scan for ANSI C63.19-2007 & 2011 compliance)/General Scans/z (axial) wideband at best

S/N/ABM Freq Resp(x,y,z,f) (1x1x1): Measurement grid: dx=10mm, dy=10mm

Signal Type: Audio File (.wav) 48k_Normal_51s new.wav

Output Gain: 58

Measure Window Start: 300ms

Measure Window Length: 51000ms

BWC applied: 9.48 dB

Device Reference Point: 0, 0, -6.3 mm

Category	Telephone parameters WD signal quality [(signal+noise)-to-noise ratio in decibels]
Category T1	0 dB to 10 dB
Category T2	10 dB to 20 dB
Category T3	20 dB to 30 dB
Category T4	> 30 dB

Cursor:

Diff = 1.93 dB

BWC Factor = 9.48 dB

Location: 13.5, -4.2, 3.7 mm

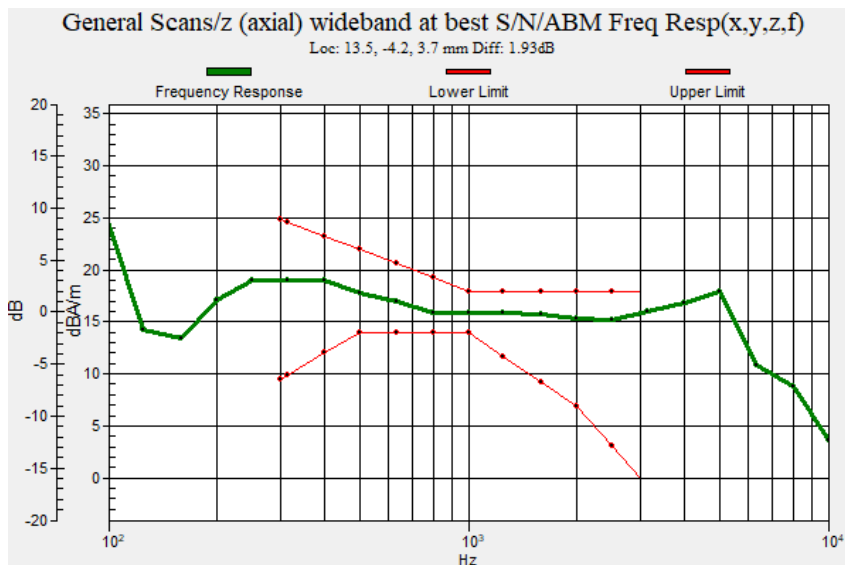

Plot No.81

LTE Band 7 QPSK 20MHz 50RB 0offset 40kbit/s 21100ch y(transversal)

Communication System: UID 0, LTE Band 7 (0); Frequency: 2535 MHz;Duty Cycle: 1:1

Medium parameters used: $\sigma = 0$ S/m, $\epsilon_r = 1$; $\rho = 0$ kg/m³

Phantom section: TCoil Section

DASY5 Configuration:

- Probe: AM1DV3 - 3050; ; Calibrated: 2021-11-23
- Sensor-Surface: 0mm (Fix Surface)
- Electronics: DAE4 Sn466; Calibrated: 2021-04-23
- Phantom: HAC Test Arch with AMCC
- Measurement SW: DASY52, Version 52.10 (4)

T-Coil scan (scan for ANSI C63.19-2007 & 2011 compliance)/General Scans/y (transversal) 4.2mm 50

x 50/ABM Signal(x,y,z) (13x13x1): Measurement grid: dx=10mm, dy=10mm

Signal Type: Audio File (.wav) 48k_voice_1kHz_1s.wav

Output Gain: 19.05

Measure Window Start: 300ms

Measure Window Length: 1000ms

BWC applied: 0.15 dB

Device Reference Point: 0, 0, -6.3 mm

Cursor:

ABM1 comp = 10.99 dBA/m

BWC Factor = 0.15 dB

Location: 12.5, 4.2, 3.7 mm

Cursor:

ABM2 = -40.80 dBA/m

Location: 12.5, 4.2, 3.7 mm

Cursor:

ABM1/ABM2 = 51.78 dB

ABM1 comp = 10.99 dBA/m

BWC Factor = 0.15 dB

Location: 12.5, 4.2, 3.7 mm

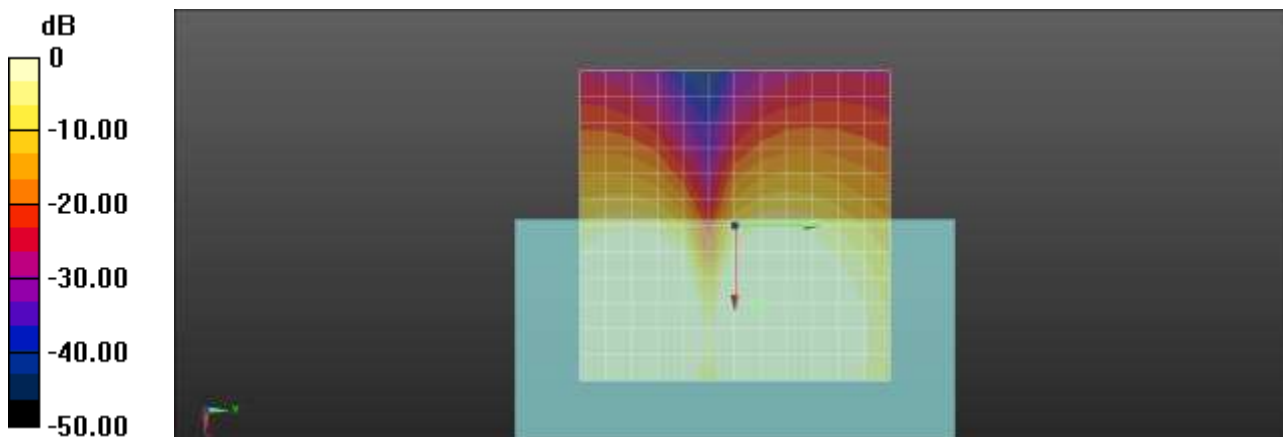

0 dB = 1.000 A/m = 0.00 dBA/m

Plot No.82

LTE Band 12 QPSK 10MHz 25RB 0offset 40kbit/s 23095ch z(axial)

Communication System: UID 0, LTE Band 12 (0); Frequency: 707.5 MHz;Duty Cycle: 1:1

Medium parameters used: $\sigma = 0$ S/m, $\epsilon_r = 1$; $\rho = 0$ kg/m³

Phantom section: TCoil Section

DASY5 Configuration:

- Probe: AM1DV3 - 3050; ; Calibrated: 2021-11-23
- Sensor-Surface: 0mm (Fix Surface)
- Electronics: DAE4 Sn466; Calibrated: 2021-04-23
- Phantom: HAC Test Arch with AMCC
- Measurement SW: DASY52, Version 52.10 (4)

T-Coil scan (scan for ANSI C63.19-2007 & 2011 compliance)/General Scans/z (axial) 4.2mm 50 x

50/ABM Signal(x,y,z) (13x13x1): Measurement grid: dx=10mm, dy=10mm

Signal Type: Audio File (.wav) 48k_voice_1kHz_1s.wav

Output Gain: 19.05

Measure Window Start: 300ms

Measure Window Length: 1000ms

BWC applied: 0.17 dB

Device Reference Point: 0, 0, -6.3 mm

Cursor:

ABM1 comp = 18.61 dBA/m

BWC Factor = 0.17 dB

Location: 12.5, -4.2, 3.7 mm

Cursor:

ABM2 = -33.03 dBA/m

Location: 12.5, -4.2, 3.7 mm

Cursor:

ABM1/ABM2 = 51.64 dB

ABM1 comp = 18.61 dBA/m

BWC Factor = 0.17 dB

Location: 12.5, -4.2, 3.7 mm

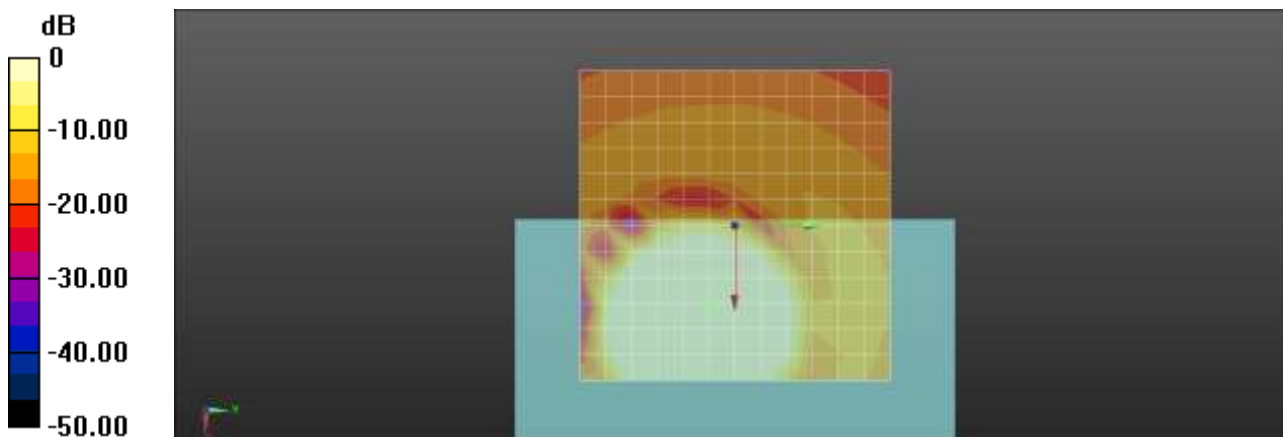

0 dB = 1.000 A/m = 0.00 dBA/m

Plot No.83

LTE Band 12 QPSK 10MHz 25RB 0offset 40kbit/s 23095ch Freq. Respons

Communication System: UID 0, LTE Band 12 (0); Frequency: 707.5 MHz;Duty Cycle: 1:1

Medium parameters used: $\sigma = 0$ S/m, $\epsilon_r = 1$; $\rho = 0$ kg/m³

Phantom section: TCoil Section

DASY5 Configuration:

- Probe: AM1DV3 - 3050; ; Calibrated: 2021-11-23
- Sensor-Surface: 0mm (Fix Surface)
- Electronics: DAE4 Sn466; Calibrated: 2021-04-23
- Phantom: HAC Test Arch with AMCC
- Measurement SW: DASY52, Version 52.10 (4)

T-Coil scan (scan for ANSI C63.19-2007 & 2011 compliance)/General Scans/z (axial) wideband at best

S/N/ABM Freq Resp(x,y,z,f) (1x1x1): Measurement grid: dx=10mm, dy=10mm

Signal Type: Audio File (.wav) 48k_Normal_51s new.wav

Output Gain: 58

Measure Window Start: 300ms

Measure Window Length: 51000ms

BWC applied: 9.49 dB

Device Reference Point: 0, 0, -6.3 mm

Category	Telephone parameters WD signal quality [(signal+noise)-to-noise ratio in decibels]
Category T1	0 dB to 10 dB
Category T2	10 dB to 20 dB
Category T3	20 dB to 30 dB
Category T4	> 30 dB

Cursor:

Diff = 1.95 dB

BWC Factor = 9.49 dB

Location: 14.5, -4.1, 3.7 mm

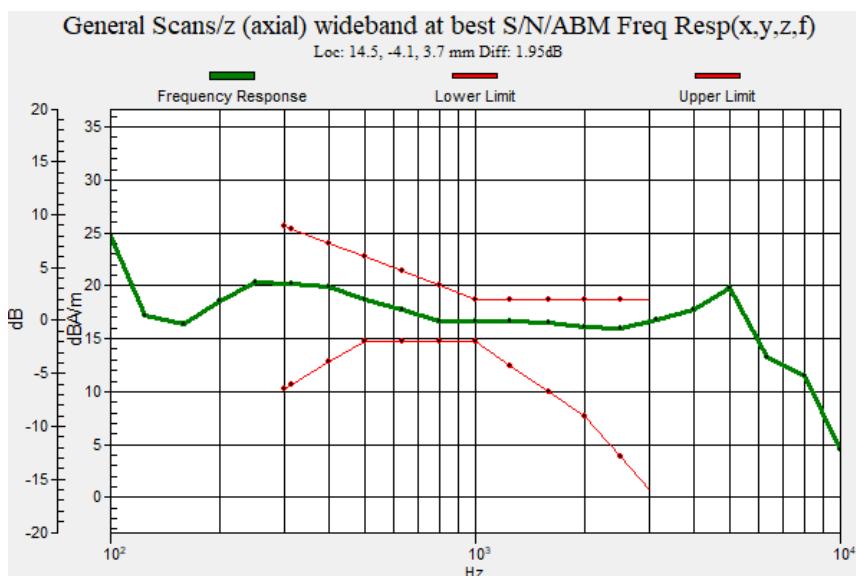

Plot No.84

LTE Band 12 QPSK 10MHz 25RB 0offset 40kbit/s 23095ch y(transversal)

Communication System: UID 0, LTE Band 12 (0); Frequency: 707.5 MHz;Duty Cycle: 1:1

Medium parameters used: $\sigma = 0$ S/m, $\epsilon_r = 1$; $\rho = 0$ kg/m³

Phantom section: TCoil Section

DASY5 Configuration:

- Probe: AM1DV3 - 3050; ; Calibrated: 2021-11-23
- Sensor-Surface: 0mm (Fix Surface)
- Electronics: DAE4 Sn466; Calibrated: 2021-04-23
- Phantom: HAC Test Arch with AMCC
- Measurement SW: DASY52, Version 52.10 (4)

T-Coil scan (scan for ANSI C63.19-2007 & 2011 compliance)/General Scans/y (transversal) 4.2mm 50 x 50/ABM Signal(x,y,z) (13x13x1): Measurement grid: dx=10mm, dy=10mm

Signal Type: Audio File (.wav) 48k_voice_1kHz_1s.wav

Output Gain: 19.05

Measure Window Start: 300ms

Measure Window Length: 1000ms

BWC applied: 0.17 dB

Device Reference Point: 0, 0, -6.3 mm

Cursor:

ABM1 comp = 11.66 dBA/m

BWC Factor = 0.17 dB

Location: 12.5, 4.2, 3.7 mm

Cursor:

ABM2 = -39.40 dBA/m

Location: 12.5, 4.2, 3.7 mm

Cursor:

ABM1/ABM2 = 51.06 dB

ABM1 comp = 11.66 dBA/m

BWC Factor = 0.17 dB

Location: 12.5, 4.2, 3.7 mm

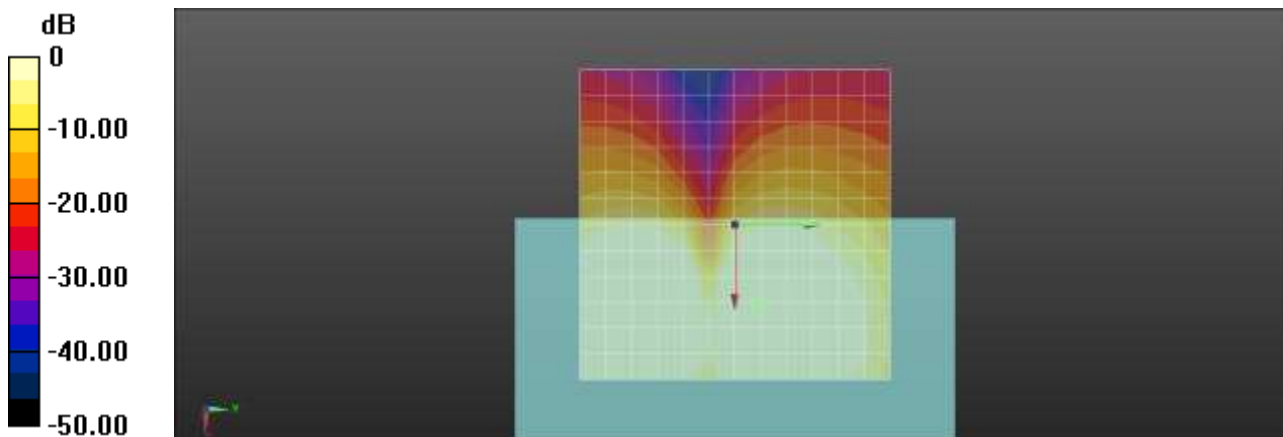

0 dB = 1.000 A/m = 0.00 dBA/m

Plot No.85

LTE Band 13 QPSK 10MHz 25RB 0offset 40kbit/s 23230ch z(axial)

Communication System: UID 0, LTE Band 13 (0); Frequency: 782 MHz;Duty Cycle: 1:1
 Medium parameters used: $\sigma = 0$ S/m, $\epsilon_r = 1$; $\rho = 0$ kg/m³
 Phantom section: TCoil Section

DASY5 Configuration:

- Probe: AM1DV3 - 3050; ; Calibrated: 2021-11-23
- Sensor-Surface: 0mm (Fix Surface)
- Electronics: DAE4 Sn466; Calibrated: 2021-04-23
- Phantom: HAC Test Arch with AMCC
- Measurement SW: DASY52, Version 52.10 (4)

T-Coil scan (scan for ANSI C63.19-2007 & 2011 compliance)/General Scans/z (axial) 4.2mm 50 x 50/ABM Signal(x,y,z) (13x13x1): Measurement grid: dx=10mm, dy=10mm

Signal Type: Audio File (.wav) 48k_voice_1kHz_1s.wav
 Output Gain: 19.05
 Measure Window Start: 300ms
 Measure Window Length: 1000ms
 BWC applied: 0.16 dB
 Device Reference Point: 0, 0, -6.3 mm

Cursor:

ABM1 comp = 18.26 dBA/m
 BWC Factor = 0.16 dB
 Location: 12.5, -4.2, 3.7 mm

Cursor:

ABM2 = -32.43 dBA/m
 Location: 12.5, -4.2, 3.7 mm

Cursor:

ABM1/ABM2 = 50.70 dB
 ABM1 comp = 18.26 dBA/m
 BWC Factor = 0.16 dB
 Location: 12.5, -4.2, 3.7 mm

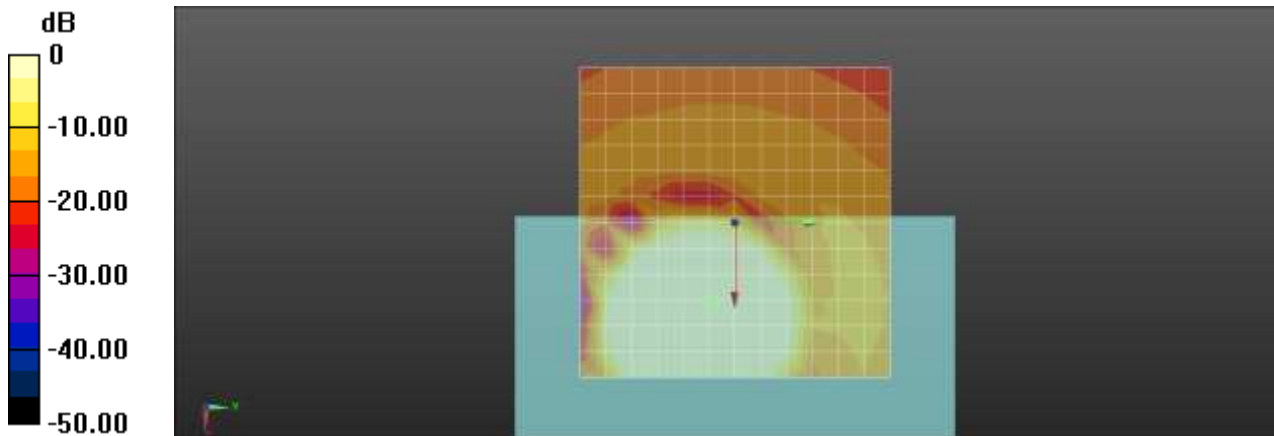

0 dB = 1.000 A/m = 0.00 dBA/m

Plot No.86

LTE Band 13 QPSK 10MHz 25RB 0offset 40kbit/s 23230ch Freq. Response

Communication System: UID 0, LTE Band 13 (0); Frequency: 782 MHz;Duty Cycle: 1:1
 Medium parameters used: $\sigma = 0$ S/m, $\epsilon_r = 1$; $\rho = 0$ kg/m³
 Phantom section: TCoil Section

DASY5 Configuration:

- Probe: AM1DV3 - 3050; ; Calibrated: 2021-11-23
- Sensor-Surface: 0mm (Fix Surface)
- Electronics: DAE4 Sn466; Calibrated: 2021-04-23
- Phantom: HAC Test Arch with AMCC
- Measurement SW: DASY52, Version 52.10 (4)

T-Coil scan (scan for ANSI C63.19-2007 & 2011 compliance)/General Scans/z (axial) wideband at best

S/N/ABM Freq Resp(x,y,z,f) (1x1x1): Measurement grid: dx=10mm, dy=10mm

Signal Type: Audio File (.wav) 48k_Normal_51s new.wav

Output Gain: 58

Measure Window Start: 300ms

Measure Window Length: 51000ms

BWC applied: 9.48 dB

Device Reference Point: 0, 0, -6.3 mm

Category	Telephone parameters WD signal quality [(signal+noise)-to-noise ratio in decibels]
Category T1	0 dB to 10 dB
Category T2	10 dB to 20 dB
Category T3	20 dB to 30 dB
Category T4	> 30 dB

Cursor:

Diff = 1.89 dB

BWC Factor = 9.48 dB

Location: 14.6, -4.1, 3.7 mm

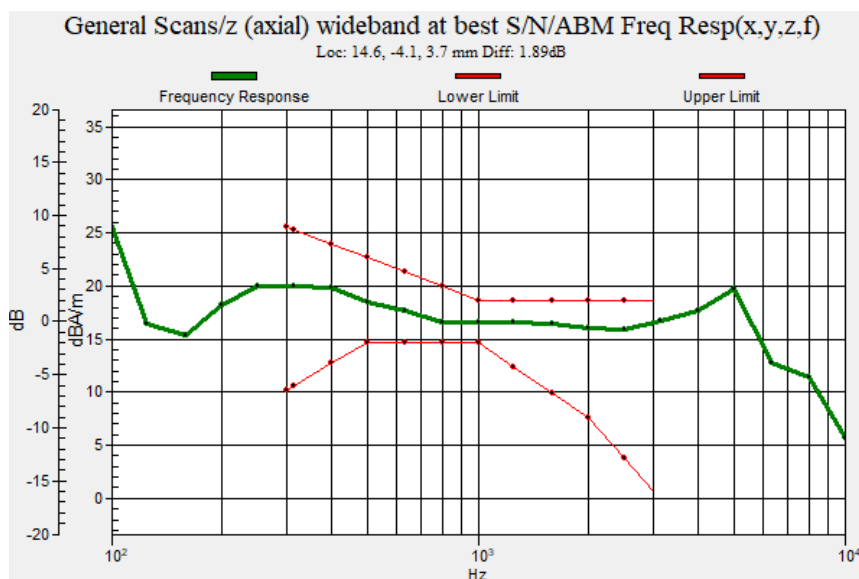

Plot No.87

LTE Band 13 QPSK 10MHz 25RB 0offset 40kbit/s 23230ch y(transversal)

Communication System: UID 0, LTE Band 13 (0); Frequency: 782 MHz;Duty Cycle: 1:1

Medium parameters used: $\sigma = 0$ S/m, $\epsilon_r = 1$; $\rho = 0$ kg/m³

Phantom section: TCoil Section

DASY5 Configuration:

- Probe: AM1DV3 - 3050; ; Calibrated: 2021-11-23
- Sensor-Surface: 0mm (Fix Surface)
- Electronics: DAE4 Sn466; Calibrated: 2021-04-23
- Phantom: HAC Test Arch with AMCC
- Measurement SW: DASY52, Version 52.10 (4)

T-Coil scan (scan for ANSI C63.19-2007 & 2011 compliance)/General Scans/y (transversal) 4.2mm 50

x 50/ABM Signal(x,y,z) (13x13x1): Measurement grid: dx=10mm, dy=10mm

Signal Type: Audio File (.wav) 48k_voice_1kHz_1s.wav

Output Gain: 19.05

Measure Window Start: 300ms

Measure Window Length: 1000ms

BWC applied: 0.16 dB

Device Reference Point: 0, 0, -6.3 mm

Cursor:

ABM1 comp = 11.59 dBA/m

BWC Factor = 0.16 dB

Location: 12.5, 4.2, 3.7 mm

Cursor:

ABM2 = -39.18 dBA/m

Location: 12.5, 4.2, 3.7 mm

Cursor:

ABM1/ABM2 = 50.77 dB

ABM1 comp = 11.59 dBA/m

BWC Factor = 0.16 dB

Location: 12.5, 4.2, 3.7 mm

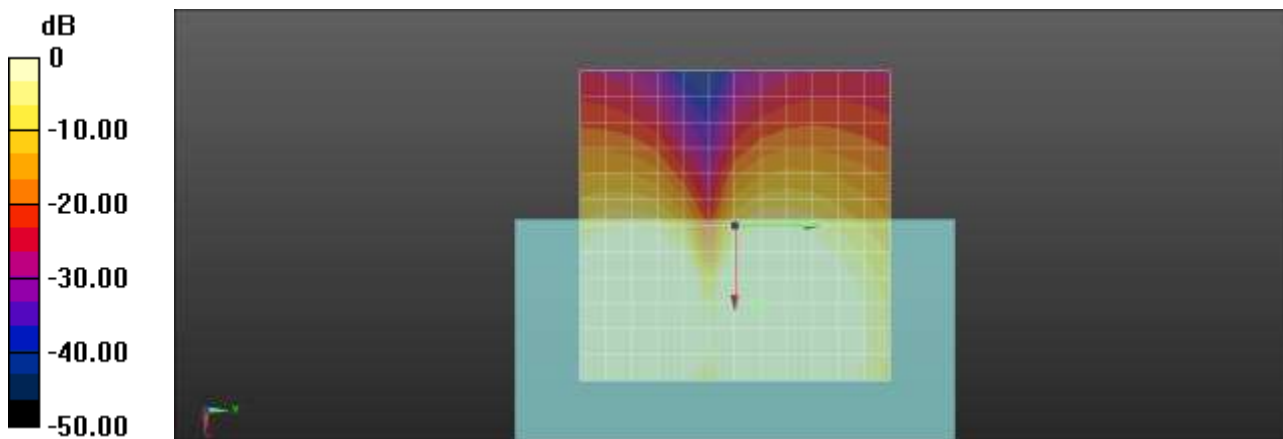

0 dB = 1.000 A/m = 0.00 dBA/m

Plot No.88

LTE Band 66 QPSK 20MHz 50RB 0offset 40kbit/s 132322ch z(axial)

Communication System: UID 0, LTE 66 (0); Frequency: 1745 MHz;Duty Cycle: 1:1

Medium parameters used: $\sigma = 0$ S/m, $\epsilon_r = 1$; $\rho = 0$ kg/m³

Phantom section: TCoil Section

DASY5 Configuration:

- Probe: AM1DV3 - 3050; ; Calibrated: 2021-11-23
- Sensor-Surface: 0mm (Fix Surface)
- Electronics: DAE4 Sn466; Calibrated: 2021-04-23
- Phantom: HAC Test Arch with AMCC
- Measurement SW: DASY52, Version 52.10 (4)

T-Coil scan (scan for ANSI C63.19-2007 & 2011 compliance)/General Scans/z (axial) 4.2mm 50 x

50/ABM Signal(x,y,z) (13x13x1): Measurement grid: dx=10mm, dy=10mm

Signal Type: Audio File (.wav) 48k_voice_1kHz_1s.wav

Output Gain: 19.05

Measure Window Start: 300ms

Measure Window Length: 1000ms

BWC applied: 0.15 dB

Device Reference Point: 0, 0, -6.3 mm

Cursor:

ABM1 comp = 17.73 dBA/m

BWC Factor = 0.15 dB

Location: 12.5, -4.2, 3.7 mm

Cursor:

ABM2 = -37.01 dBA/m

Location: 12.5, -4.2, 3.7 mm

Cursor:

ABM1/ABM2 = 54.74 dB

ABM1 comp = 17.73 dBA/m

BWC Factor = 0.15 dB

Location: 12.5, -4.2, 3.7 mm

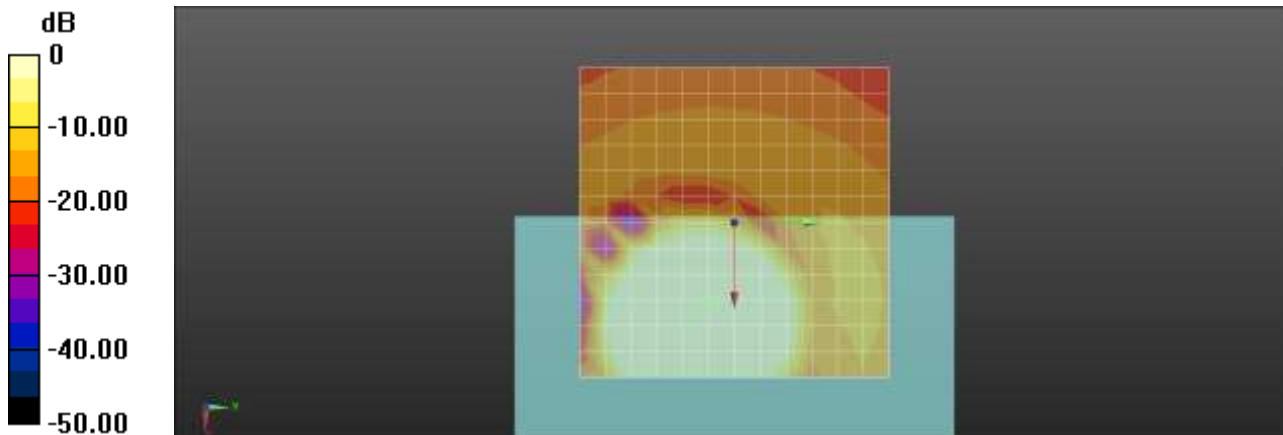

0 dB = 1.000 A/m = 0.00 dBA/m

Plot No.89

LTE Band 66 QPSK 20MHz 50RB 0offset 40kbit/s 132322ch Freq. Response

Communication System: UID 0, LTE 66 (0); Frequency: 1745 MHz;Duty Cycle: 1:1
 Medium parameters used: $\sigma = 0$ S/m, $\epsilon_r = 1$; $\rho = 0$ kg/m³
 Phantom section: TCoil Section

DASY5 Configuration:

- Probe: AM1DV3 - 3050; ; Calibrated: 2021-11-23
- Sensor-Surface: 0mm (Fix Surface)
- Electronics: DAE4 Sn466; Calibrated: 2021-04-23
- Phantom: HAC Test Arch with AMCC
- Measurement SW: DASY52, Version 52.10 (4)

T-Coil scan (scan for ANSI C63.19-2007 & 2011 compliance)/General Scans/z (axial) wideband at best

S/N/ABM Freq Resp(x,y,z,f) (1x1x1): Measurement grid: dx=10mm, dy=10mm

Signal Type: Audio File (.wav) 48k_Normal_51s new.wav

Output Gain: 58

Measure Window Start: 300ms

Measure Window Length: 51000ms

BWC applied: 9.48 dB

Device Reference Point: 0, 0, -6.3 mm

Category	Telephone parameters WD signal quality [(signal+noise)-to-noise ratio in decibels]
Category T1	0 dB to 10 dB
Category T2	10 dB to 20 dB
Category T3	20 dB to 30 dB
Category T4	> 30 dB

Cursor:

Diff = 1.84 dB

BWC Factor = 9.48 dB

Location: 13.7, -4.1, 3.7 mm

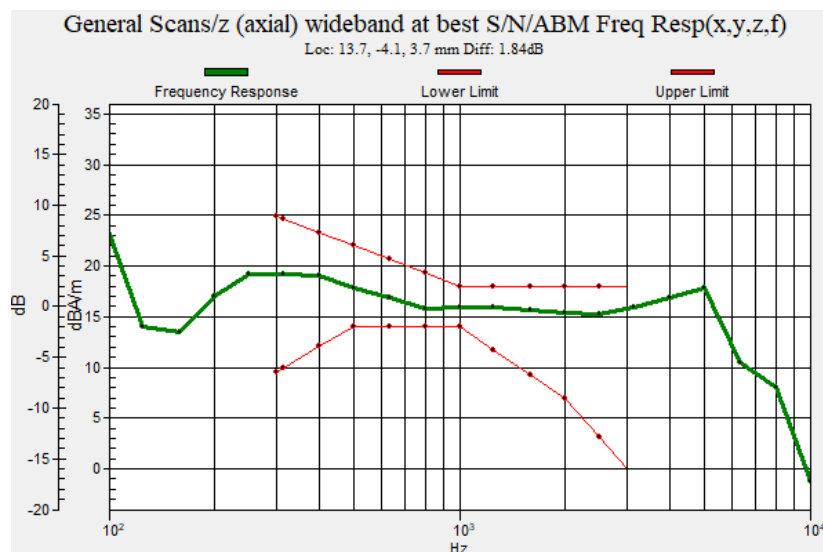

Plot No.90

LTE Band 66 QPSK 20MHz 50RB 0offset 40kbit/s 132322ch y(transversal)

Communication System: UID 0, LTE 66 (0); Frequency: 1745 MHz;Duty Cycle: 1:1
 Medium parameters used: $\sigma = 0$ S/m, $\epsilon_r = 1$; $\rho = 0$ kg/m³
 Phantom section: TCoil Section

DASY5 Configuration:

- Probe: AM1DV3 - 3050; ; Calibrated: 2021-11-23
- Sensor-Surface: 0mm (Fix Surface)
- Electronics: DAE4 Sn466; Calibrated: 2021-04-23
- Phantom: HAC Test Arch with AMCC
- Measurement SW: DASY52, Version 52.10 (4)

T-Coil scan (scan for ANSI C63.19-2007 & 2011 compliance)/General Scans/y (transversal) 4.2mm 50 x 50/ABM Signal(x,y,z) (13x13x1): Measurement grid: dx=10mm, dy=10mm

Signal Type: Audio File (.wav) 48k_voice_1kHz_1s.wav
 Output Gain: 19.05
 Measure Window Start: 300ms
 Measure Window Length: 1000ms
 BWC applied: 0.15 dB
 Device Reference Point: 0, 0, -6.3 mm

Cursor:

ABM1 comp = 10.89 dBA/m
 BWC Factor = 0.15 dB
 Location: 12.5, 4.2, 3.7 mm

Cursor:

ABM2 = -38.86 dBA/m
 Location: 12.5, 4.2, 3.7 mm

Cursor:

ABM1/ABM2 = 49.75 dB
 ABM1 comp = 10.89 dBA/m
 BWC Factor = 0.15 dB
 Location: 12.5, 4.2, 3.7 mm

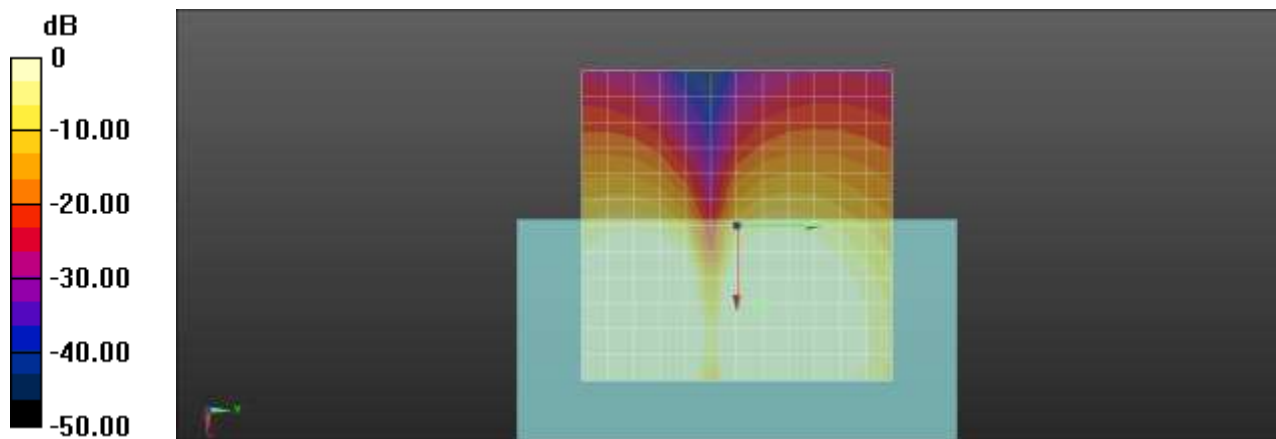

0 dB = 1.000 A/m = 0.00 dBA/m

Plot No.91

LTE Band 48 QPSK 20MHz 1RB 24offset 6kbit/s 55265ch z(axial)

Communication System: UID 0, LTE Band 48 (0); Frequency: 3552.5 MHz;Duty Cycle: 1:2.30728

Medium parameters used: $\sigma = 0$ S/m, $\epsilon_r = 1$; $\rho = 0$ kg/m³

Phantom section: TCoil Section

DASY5 Configuration:

- Probe: AM1DV3 - 3050; ; Calibrated: 2021-11-23
- Sensor-Surface: 0mm (Fix Surface)
- Electronics: DAE4 Sn466; Calibrated: 2021-04-23
- Phantom: HAC Test Arch with AMCC
- Measurement SW: DASY52, Version 52.10 (4)

T-Coil scan (scan for ANSI C63.19-2007 & 2011 compliance)/General Scans/z (axial) 4.2mm 50 x

50/ABM Signal(x,y,z) (13x13x1): Measurement grid: dx=10mm, dy=10mm

Signal Type: Audio File (.wav) 48k_voice_1kHz_1s.wav

Output Gain: 19.05

Measure Window Start: 300ms

Measure Window Length: 1000ms

BWC applied: 0.15 dB

Device Reference Point: 0, 0, -6.3 mm

Cursor:

ABM1 comp = 17.90 dBA/m

BWC Factor = 0.15 dB

Location: 12.5, -4.2, 3.7 mm

Cursor:

ABM2 = -34.30 dBA/m

Location: 12.5, -4.2, 3.7 mm

Cursor:

ABM1/ABM2 = 52.20 dB

ABM1 comp = 17.90 dBA/m

BWC Factor = 0.15 dB

Location: 12.5, -4.2, 3.7 mm

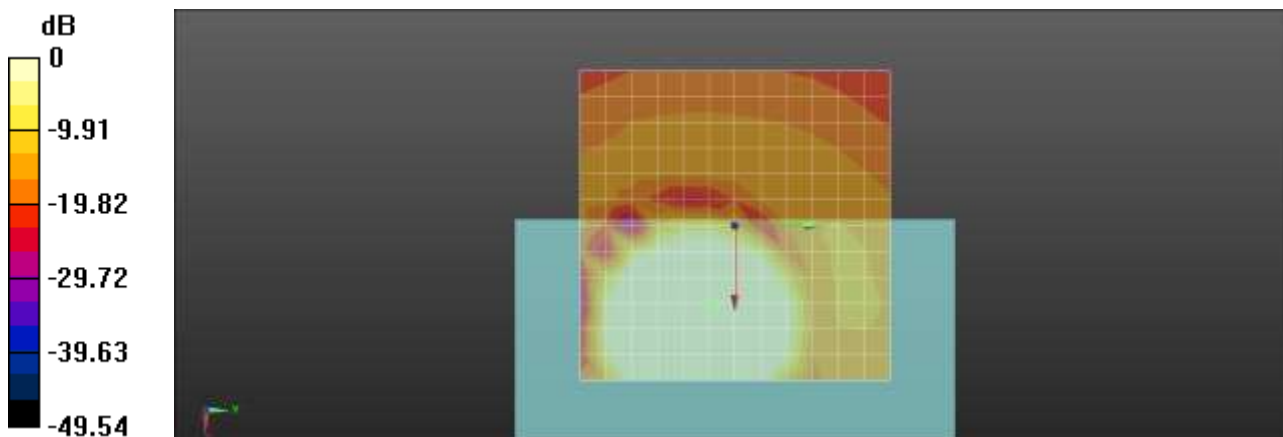

0 dB = 1.000 A/m = 0.00 dBA/m

Plot No.92

LTE Band 48 QPSK 20MHz 1RB 24offset 6kbit/s 55265ch Freq. Response

Communication System: UID 0, LTE Band 48 (0); Frequency: 3552.5 MHz;Duty Cycle: 1:2.30728
 Medium parameters used: $\sigma = 0$ S/m, $\epsilon_r = 1$; $\rho = 0$ kg/m³
 Phantom section: TCoil Section

DASY5 Configuration:

- Probe: AM1DV3 - 3050; ; Calibrated: 2021-11-23
- Sensor-Surface: 0mm (Fix Surface)
- Electronics: DAE4 Sn466; Calibrated: 2021-04-23
- Phantom: HAC Test Arch with AMCC
- Measurement SW: DASY52, Version 52.10 (4)

T-Coil scan (scan for ANSI C63.19-2007 & 2011 compliance)/General Scans/z (axial) wideband at best

S/N/ABM Freq Resp(x,y,z,f) (1x1x1): Measurement grid: dx=10mm, dy=10mm

Signal Type: Audio File (.wav) 48k_Normal_51s new.wav

Output Gain: 58

Measure Window Start: 300ms

Measure Window Length: 51000ms

BWC applied: 9.48 dB

Device Reference Point: 0, 0, -6.3 mm

Category	Telephone parameters WD signal quality [(signal+noise)-to-noise ratio in decibels]
Category T1	0 dB to 10 dB
Category T2	10 dB to 20 dB
Category T3	20 dB to 30 dB
Category T4	> 30 dB

Cursor:

Diff = 1.72 dB

BWC Factor = 9.48 dB

Location: 14.3, -3.5, 3.7 mm

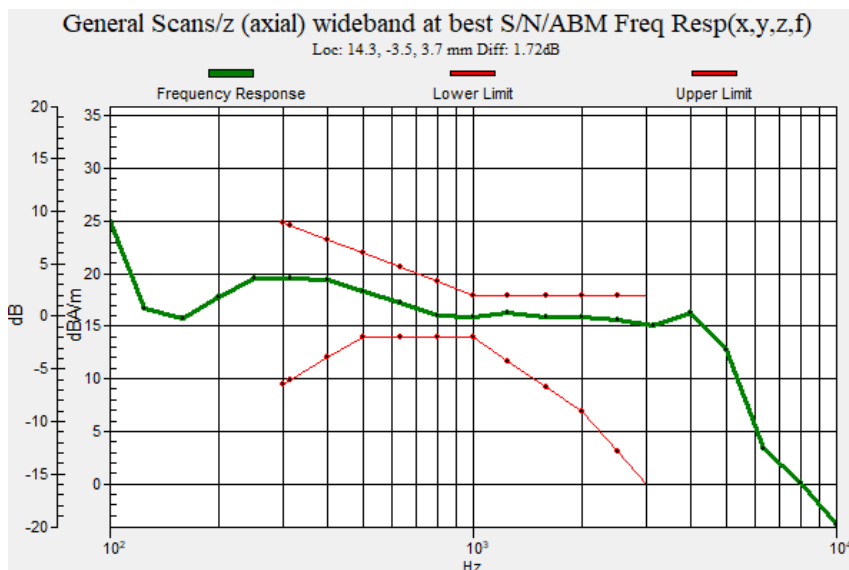

Plot No.93

LTE Band 48 QPSK 20MHz 1RB 24offset 6kbit/s 55265ch y(transversal)

Communication System: UID 0, LTE Band 48 (0); Frequency: 3552.5 MHz;Duty Cycle: 1:2.30728

Medium parameters used: $\sigma = 0$ S/m, $\epsilon_r = 1$; $\rho = 0$ kg/m³

Phantom section: TCoil Section

DASY5 Configuration:

- Probe: AM1DV3 - 3050; ; Calibrated: 2021-11-23
- Sensor-Surface: 0mm (Fix Surface)
- Electronics: DAE4 Sn466; Calibrated: 2021-04-23
- Phantom: HAC Test Arch with AMCC
- Measurement SW: DASY52, Version 52.10 (4)

T-Coil scan (scan for ANSI C63.19-2007 & 2011 compliance)/General Scans/y (transversal) 4.2mm 50

x 50/ABM Signal(x,y,z) (13x13x1): Measurement grid: dx=10mm, dy=10mm

Signal Type: Audio File (.wav) 48k_voice_1kHz_1s.wav

Output Gain: 19.05

Measure Window Start: 300ms

Measure Window Length: 1000ms

BWC applied: 0.15 dB

Device Reference Point: 0, 0, -6.3 mm

Cursor:

ABM1 comp = 8.81 dBA/m

BWC Factor = 0.15 dB

Location: 12.5, 8.3, 3.7 mm

Cursor:

ABM2 = -36.50 dBA/m

Location: 12.5, 8.3, 3.7 mm

Cursor:

ABM1/ABM2 = 45.31 dB

ABM1 comp = 8.81 dBA/m

BWC Factor = 0.15 dB

Location: 12.5, 8.3, 3.7 mm

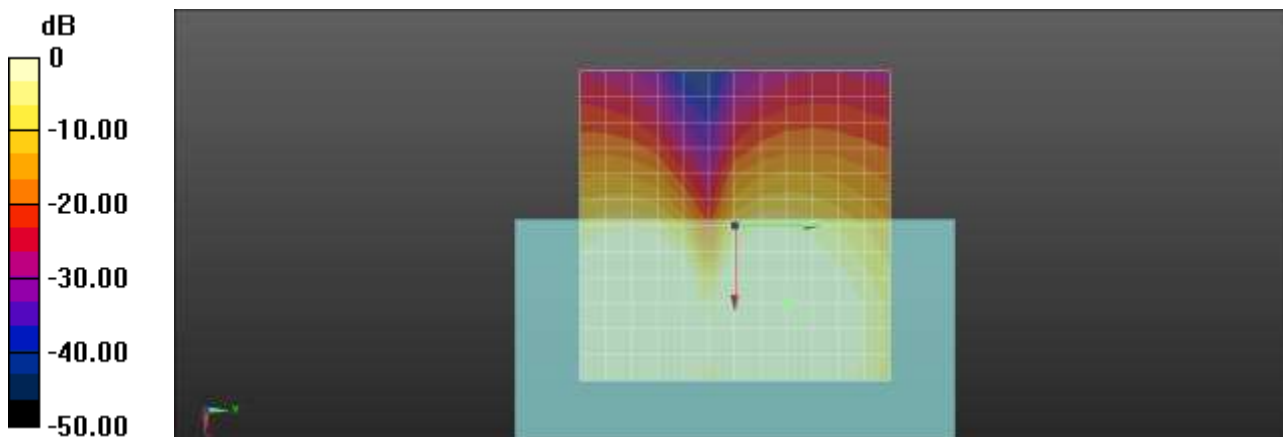

0 dB = 1.000 A/m = 0.00 dBA/m

Plot No.94

802.11b 11Mbps 6kbit/s 6ch z(axial)

Communication System: UID 0, 2450MHz FCC (0); Frequency: 2437 MHz;Duty Cycle: 1:1

Medium parameters used: $\sigma = 0$ S/m, $\epsilon_r = 1$; $\rho = 0$ kg/m³

Phantom section: TCoil Section

DASY5 Configuration:

- Probe: AM1DV3 - 3050; ; Calibrated: 2021-11-23
- Sensor-Surface: 0mm (Fix Surface)
- Electronics: DAE4 Sn466; Calibrated: 2021-04-23
- Phantom: HAC Test Arch with AMCC
- Measurement SW: DASY52, Version 52.10 (4)

T-Coil scan (scan for ANSI C63.19-2007 & 2011 compliance)/General Scans/z (axial) 4.2mm 50 x

50/ABM Signal(x,y,z) (13x13x1): Measurement grid: dx=10mm, dy=10mm

Signal Type: Audio File (.wav) 48k_voice_1kHz_1s.wav

Output Gain: 19.05

Measure Window Start: 300ms

Measure Window Length: 1000ms

BWC applied: 0.16 dB

Device Reference Point: 0, 0, -6.3 mm

Cursor:

ABM1 comp = 18.25 dBA/m

BWC Factor = 0.16 dB

Location: 12.5, -4.2, 3.7 mm

Cursor:

ABM2 = -37.20 dBA/m

Location: 12.5, -4.2, 3.7 mm

Cursor:

ABM1/ABM2 = 55.45 dB

ABM1 comp = 18.25 dBA/m

BWC Factor = 0.16 dB

Location: 12.5, -4.2, 3.7 mm

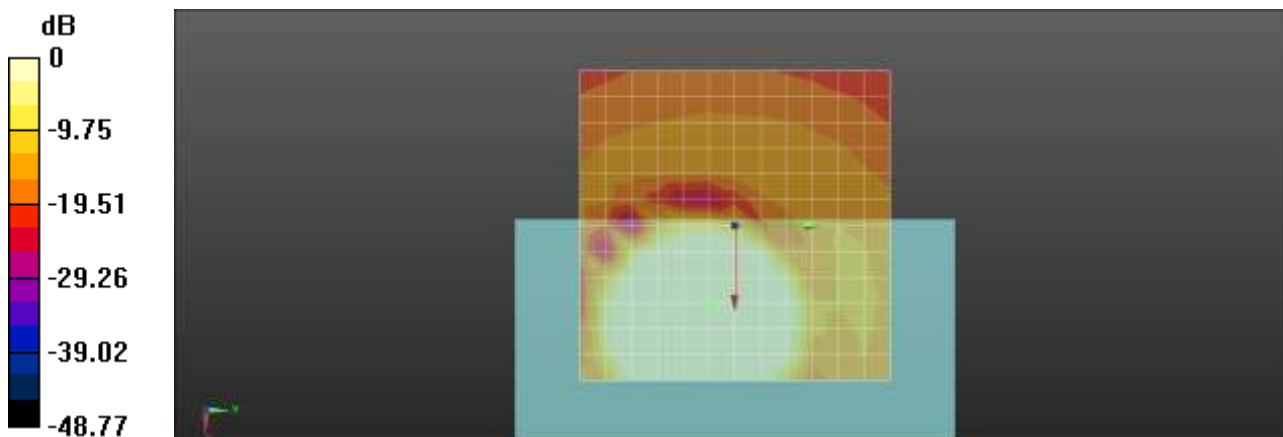

0 dB = 1.000 A/m = 0.00 dBA/m

Plot No.95

802.11b 11Mbps 6kbit/s 6ch Freq. Response

Communication System: UID 0, 2450MHz FCC (0); Frequency: 2437 MHz;Duty Cycle: 1:1
 Medium parameters used: $\sigma = 0$ S/m, $\epsilon_r = 1$; $\rho = 0$ kg/m³
 Phantom section: TCoil Section

DASY5 Configuration:

- Probe: AM1DV3 - 3050; ; Calibrated: 2021-11-23
- Sensor-Surface: 0mm (Fix Surface)
- Electronics: DAE4 Sn466; Calibrated: 2021-04-23
- Phantom: HAC Test Arch with AMCC
- Measurement SW: DASY52, Version 52.10 (4)

T-Coil scan (scan for ANSI C63.19-2007 & 2011 compliance)/General Scans/z (axial) wideband at best

S/N/ABM Freq Resp(x,y,z,f) (1x1x1): Measurement grid: dx=10mm, dy=10mm

Signal Type: Audio File (.wav) 48k_Normal_51s new.wav

Output Gain: 58

Measure Window Start: 300ms

Measure Window Length: 51000ms

BWC applied: 9.48 dB

Device Reference Point: 0, 0, -6.3 mm

Category	Telephone parameters WD signal quality [(signal+noise)-to-noise ratio in decibels]
Category T1	0 dB to 10 dB
Category T2	10 dB to 20 dB
Category T3	20 dB to 30 dB
Category T4	> 30 dB

Cursor:

Diff = 1.74 dB

BWC Factor = 9.48 dB

Location: 12.5, -4, 3.7 mm

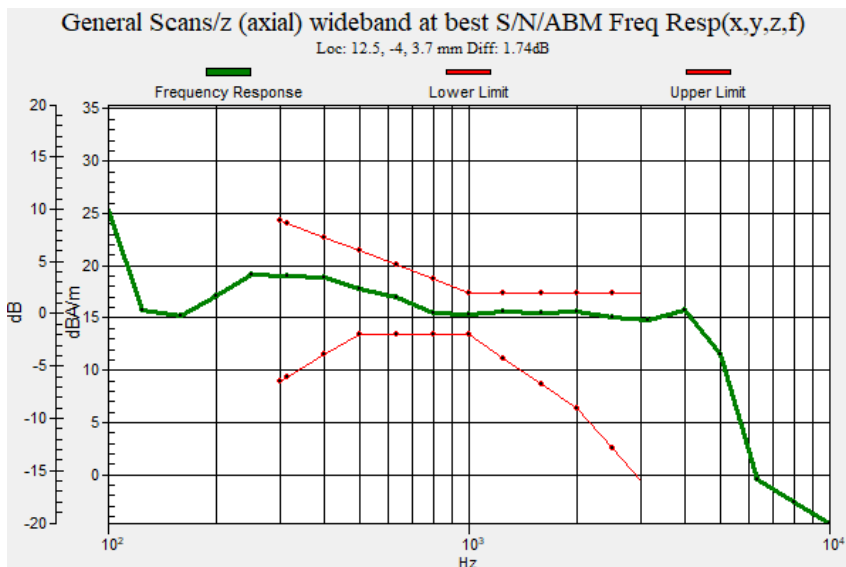

Plot No.96

802.11b 11Mbps 6kbit/s 6ch y(transversal)

Communication System: UID 0, 2450MHz FCC (0); Frequency: 2437 MHz;Duty Cycle: 1:1

Medium parameters used: $\sigma = 0$ S/m, $\epsilon_r = 1$; $\rho = 0$ kg/m³

Phantom section: TCoil Section

DASY5 Configuration:

- Probe: AM1DV3 - 3050; ; Calibrated: 2021-11-23
- Sensor-Surface: 0mm (Fix Surface)
- Electronics: DAE4 Sn466; Calibrated: 2021-04-23
- Phantom: HAC Test Arch with AMCC
- Measurement SW: DASY52, Version 52.10 (4)

T-Coil scan (scan for ANSI C63.19-2007 & 2011 compliance)/General Scans/y (transversal) 4.2mm 50

x 50/ABM Signal(x,y,z) (13x13x1): Measurement grid: dx=10mm, dy=10mm

Signal Type: Audio File (.wav) 48k_voice_1kHz_1s.wav

Output Gain: 19.05

Measure Window Start: 300ms

Measure Window Length: 1000ms

BWC applied: 0.16 dB

Device Reference Point: 0, 0, -6.3 mm

Cursor:

ABM1 comp = 11.96 dBA/m

BWC Factor = 0.16 dB

Location: 12.5, 4.2, 3.7 mm

Cursor:

ABM2 = -29.92 dBA/m

Location: 12.5, 4.2, 3.7 mm

Cursor:

ABM1/ABM2 = 41.88 dB

ABM1 comp = 11.96 dBA/m

BWC Factor = 0.16 dB

Location: 12.5, 4.2, 3.7 mm

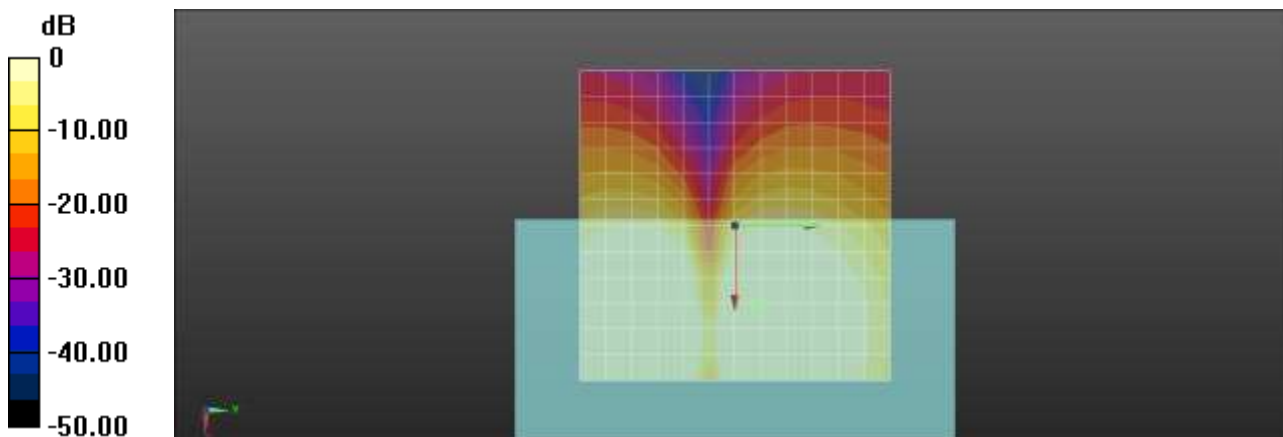

0 dB = 1.000 A/m = 0.00 dBA/m

Plot No.97

802.11n20 MCS0 40kbit/s 40ch z(axial)

Communication System: UID 0, WIFI 5GHz (0); Frequency: 5200 MHz;Duty Cycle: 1:1

Medium parameters used: $\sigma = 0$ S/m, $\epsilon_r = 1$; $\rho = 0$ kg/m³

Phantom section: TCoil Section

DASY5 Configuration:

- Probe: AM1DV3 - 3050; ; Calibrated: 2021-11-23
- Sensor-Surface: 0mm (Fix Surface)
- Electronics: DAE4 Sn466; Calibrated: 2021-04-23
- Phantom: HAC Test Arch with AMCC
- Measurement SW: DASY52, Version 52.10 (4)

T-Coil scan (scan for ANSI C63.19-2007 & 2011 compliance)/General Scans/z (axial) 4.2mm 50 x

50/ABM Signal(x,y,z) (13x13x1): Measurement grid: dx=10mm, dy=10mm

Signal Type: Audio File (.wav) 48k_voice_1kHz_1s.wav

Output Gain: 19.05

Measure Window Start: 300ms

Measure Window Length: 1000ms

BWC applied: 0.16 dB

Device Reference Point: 0, 0, -6.3 mm

Cursor:

ABM1 comp = 18.75 dBA/m

BWC Factor = 0.16 dB

Location: 12.5, -4.2, 3.7 mm

Cursor:

ABM2 = -36.56 dBA/m

Location: 12.5, -4.2, 3.7 mm

Cursor:

ABM1/ABM2 = 55.32 dB

ABM1 comp = 18.75 dBA/m

BWC Factor = 0.16 dB

Location: 12.5, -4.2, 3.7 mm

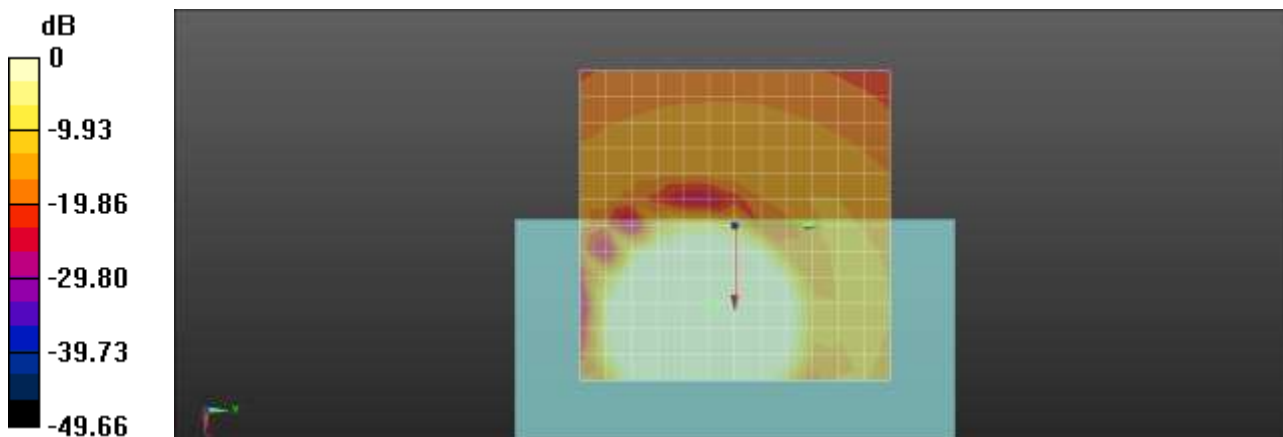

0 dB = 1.000 A/m = 0.00 dBA/m

Plot No.98

802.11n20 MCS0 40kbit/s 40ch Freq. Response

Communication System: UID 0, WIFI 5GHz (0); Frequency: 5200 MHz;Duty Cycle: 1:1

Medium parameters used: $\sigma = 0$ S/m, $\epsilon_r = 1$; $\rho = 0$ kg/m³

Phantom section: TCoil Section

DASY5 Configuration:

- Probe: AM1DV3 - 3050; ; Calibrated: 2021-11-23
- Sensor-Surface: 0mm (Fix Surface)
- Electronics: DAE4 Sn466; Calibrated: 2021-04-23
- Phantom: HAC Test Arch with AMCC
- Measurement SW: DASY52, Version 52.10 (4)

T-Coil scan (scan for ANSI C63.19-2007 & 2011 compliance)/General Scans/z (axial) wideband at best

S/N/ABM Freq Resp(x,y,z,f) (1x1x1): Measurement grid: dx=10mm, dy=10mm

Signal Type: Audio File (.wav) 48k_Normal_51s new.wav

Output Gain: 58

Measure Window Start: 300ms

Measure Window Length: 51000ms

BWC applied: 9.48 dB

Device Reference Point: 0, 0, -6.3 mm

Category	Telephone parameters WD signal quality [(signal+noise)-to-noise ratio in decibels]
Category T1	0 dB to 10 dB
Category T2	10 dB to 20 dB
Category T3	20 dB to 30 dB
Category T4	> 30 dB

Cursor:

Diff = 2.00 dB

BWC Factor = 9.48 dB

Location: 13.3, -3.9, 3.7 mm

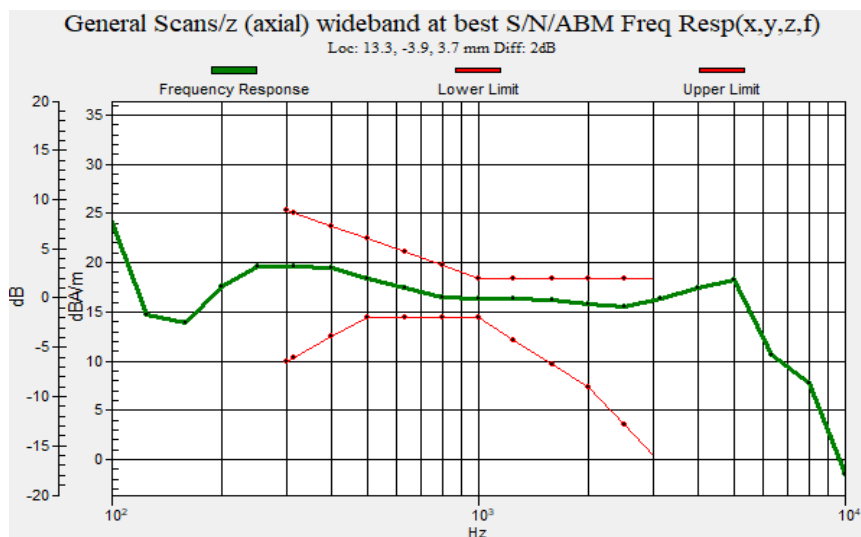

Plot No.99

802.11n20 MCS0 40kbit/s 40ch y(transversal)

Communication System: UID 0, WIFI 5GHz (0); Frequency: 5200 MHz;Duty Cycle: 1:1

Medium parameters used: $\sigma = 0$ S/m, $\epsilon_r = 1$; $\rho = 0$ kg/m³

Phantom section: TCoil Section

DASY5 Configuration:

- Probe: AM1DV3 - 3050; ; Calibrated: 2021-11-23
- Sensor-Surface: 0mm (Fix Surface)
- Electronics: DAE4 Sn466; Calibrated: 2021-04-23
- Phantom: HAC Test Arch with AMCC
- Measurement SW: DASY52, Version 52.10 (4)

T-Coil scan (scan for ANSI C63.19-2007 & 2011 compliance)/General Scans/y (transversal) 4.2mm 50

x 50/ABM Signal(x,y,z) (13x13x1): Measurement grid: dx=10mm, dy=10mm

Signal Type: Audio File (.wav) 48k_voice_1kHz_1s.wav

Output Gain: 19.05

Measure Window Start: 300ms

Measure Window Length: 1000ms

BWC applied: 0.16 dB

Device Reference Point: 0, 0, -6.3 mm

Cursor:

ABM1 comp = 12.00 dBA/m

BWC Factor = 0.16 dB

Location: 12.5, 4.2, 3.7 mm

Cursor:

ABM2 = -35.85 dBA/m

Location: 12.5, 4.2, 3.7 mm

Cursor:

ABM1/ABM2 = 47.84 dB

ABM1 comp = 12.00 dBA/m

BWC Factor = 0.16 dB

Location: 12.5, 4.2, 3.7 mm

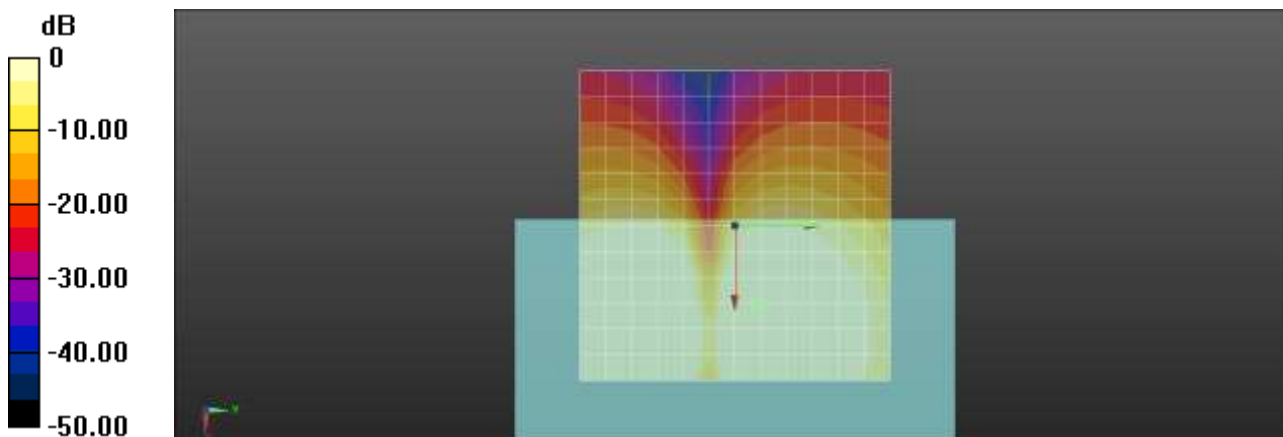

0 dB = 1.000 A/m = 0.00 dBA/m

Plot No.100

802.11n20 MCS0 40kbit/s 56ch z(axial)

Communication System: UID 0, WIFI 5GHz (0); Frequency: 5280 MHz;Duty Cycle: 1:1

Medium parameters used: $\sigma = 0$ S/m, $\epsilon_r = 1$; $\rho = 0$ kg/m³

Phantom section: TCoil Section

DASY5 Configuration:

- Probe: AM1DV3 - 3050; ; Calibrated: 2021-11-23
- Sensor-Surface: 0mm (Fix Surface)
- Electronics: DAE4 Sn466; Calibrated: 2021-04-23
- Phantom: HAC Test Arch with AMCC
- Measurement SW: DASY52, Version 52.10 (4)

T-Coil scan (scan for ANSI C63.19-2007 & 2011 compliance)/General Scans/z (axial) 4.2mm 50 x

50/ABM Signal(x,y,z) (13x13x1): Measurement grid: dx=10mm, dy=10mm

Signal Type: Audio File (.wav) 48k_voice_1kHz_1s.wav

Output Gain: 19.05

Measure Window Start: 300ms

Measure Window Length: 1000ms

BWC applied: 0.16 dB

Device Reference Point: 0, 0, -6.3 mm

Cursor:

ABM1 comp = 18.43 dBA/m

BWC Factor = 0.16 dB

Location: 12.5, -4.2, 3.7 mm

Cursor:

ABM2 = -36.93 dBA/m

Location: 12.5, -4.2, 3.7 mm

Cursor:

ABM1/ABM2 = 55.36 dB

ABM1 comp = 18.43 dBA/m

BWC Factor = 0.16 dB

Location: 12.5, -4.2, 3.7 mm

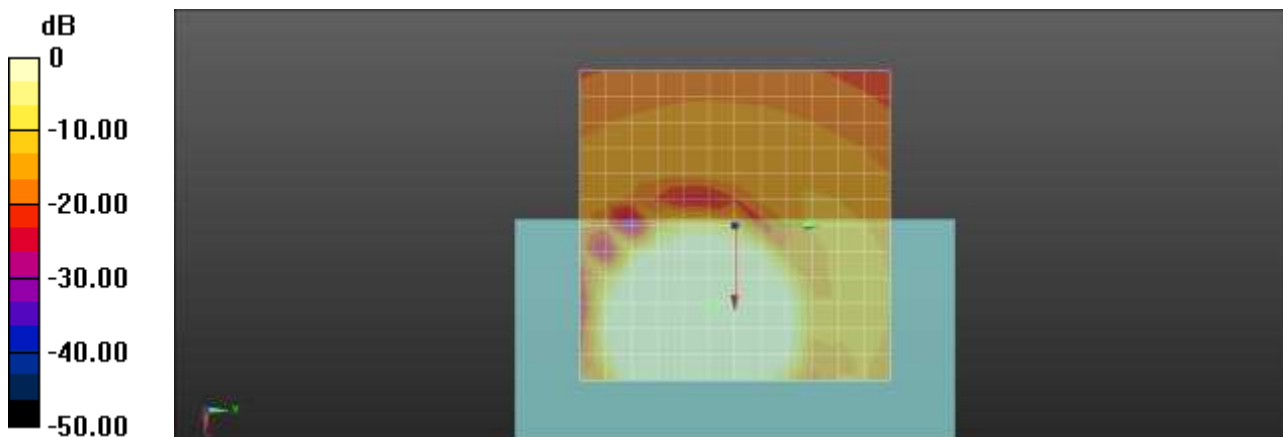

0 dB = 1.000 A/m = 0.00 dBA/m

Plot No.101
802.11n20 MCS0 40kbit/s 56ch Freq. Response

Communication System: UID 0, WIFI 5GHz (0); Frequency: 5280 MHz;Duty Cycle: 1:1
Medium parameters used: $\sigma = 0$ S/m, $\epsilon_r = 1$; $\rho = 0$ kg/m³
Phantom section: TCoil Section

DASY5 Configuration:

- Probe: AM1DV3 - 3050; ; Calibrated: 2021-11-23
- Sensor-Surface: 0mm (Fix Surface)
- Electronics: DAE4 Sn466; Calibrated: 2021-04-23
- Phantom: HAC Test Arch with AMCC
- Measurement SW: DASY52, Version 52.10 (4)

T-Coil scan (scan for ANSI C63.19-2007 & 2011 compliance)/General Scans/z (axial) wideband at best S/N/ABM Freq Resp(x,y,z,f) (1x1x1): Measurement grid: dx=10mm, dy=10mm
Signal Type: Audio File (.wav) 48k_Normal_51s new.wav
Output Gain: 58
Measure Window Start: 300ms
Measure Window Length: 51000ms
BWC applied: 9.48 dB
Device Reference Point: 0, 0, -6.3 mm

Category	Telephone parameters WD signal quality [(signal+noise)-to-noise ratio in decibels]
Category T1	0 dB to 10 dB
Category T2	10 dB to 20 dB
Category T3	20 dB to 30 dB
Category T4	> 30 dB

Cursor:
Diff = 2.00 dB
BWC Factor = 9.48 dB
Location: 12.8, -3.9, 3.7 mm

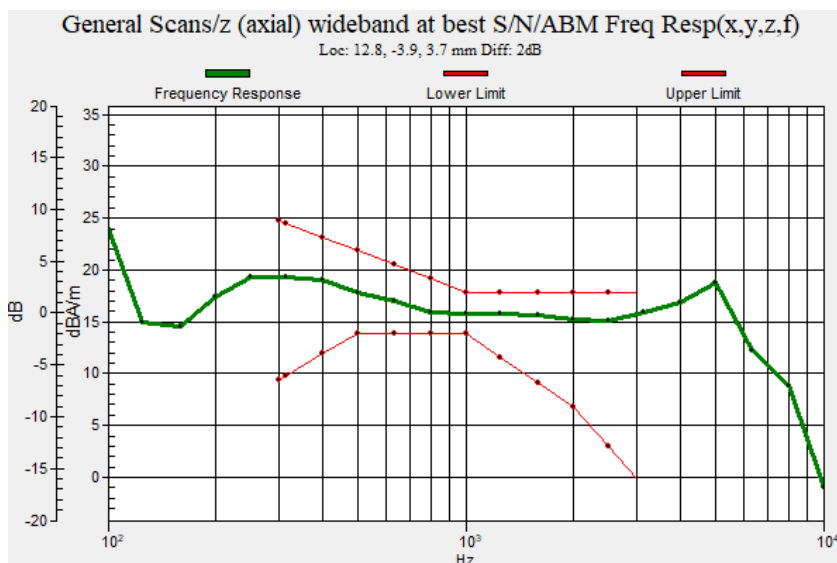

Plot No.102

802.11n20 MCS0 40kbit/s 56ch y(transversal)

Communication System: UID 0, WIFI 5GHz (0); Frequency: 5280 MHz;Duty Cycle: 1:1

Medium parameters used: $\sigma = 0$ S/m, $\epsilon_r = 1$; $\rho = 0$ kg/m³

Phantom section: TCoil Section

DASY5 Configuration:

- Probe: AM1DV3 - 3050; ; Calibrated: 2021-11-23
- Sensor-Surface: 0mm (Fix Surface)
- Electronics: DAE4 Sn466; Calibrated: 2021-04-23
- Phantom: HAC Test Arch with AMCC
- Measurement SW: DASY52, Version 52.10 (4)

T-Coil scan (scan for ANSI C63.19-2007 & 2011 compliance)/General Scans/y (transversal) 4.2mm 50

x 50/ABM Signal(x,y,z) (13x13x1): Measurement grid: dx=10mm, dy=10mm

Signal Type: Audio File (.wav) 48k_voice_1kHz_1s.wav

Output Gain: 19.05

Measure Window Start: 300ms

Measure Window Length: 1000ms

BWC applied: 0.16 dB

Device Reference Point: 0, 0, -6.3 mm

Cursor:

ABM1 comp = 12.07 dBA/m

BWC Factor = 0.16 dB

Location: 12.5, 4.2, 3.7 mm

Cursor:

ABM2 = -33.25 dBA/m

Location: 12.5, 4.2, 3.7 mm

Cursor:

ABM1/ABM2 = 45.33 dB

ABM1 comp = 12.07 dBA/m

BWC Factor = 0.16 dB

Location: 12.5, 4.2, 3.7 mm

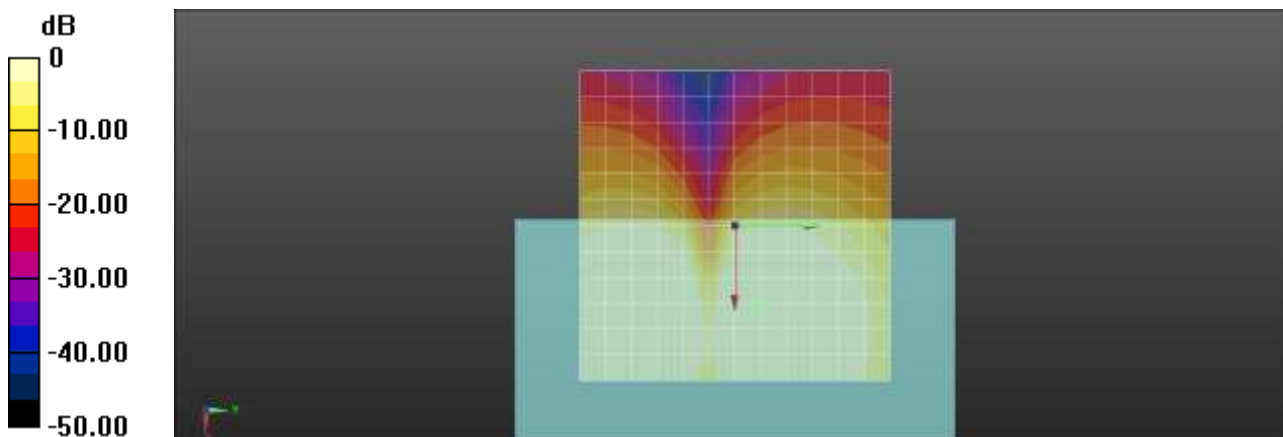

0 dB = 1.000 A/m = 0.00 dBA/m

Plot No.103

802.11n20 MCS0 40kbit/s 120ch z(axial)

Communication System: UID 0, WIFI 5GHz (0); Frequency: 5600 MHz;Duty Cycle: 1:1

Medium parameters used: $\sigma = 0$ S/m, $\epsilon_r = 1$; $\rho = 0$ kg/m³

Phantom section: TCoil Section

DASY5 Configuration:

- Probe: AM1DV3 - 3050; ; Calibrated: 2021-11-23
- Sensor-Surface: 0mm (Fix Surface)
- Electronics: DAE4 Sn466; Calibrated: 2021-04-23
- Phantom: HAC Test Arch with AMCC
- Measurement SW: DASY52, Version 52.10 (4)

T-Coil scan (scan for ANSI C63.19-2007 & 2011 compliance)/General Scans/z (axial) 4.2mm 50 x

50/ABM Signal(x,y,z) (13x13x1): Measurement grid: dx=10mm, dy=10mm

Signal Type: Audio File (.wav) 48k_voice_1kHz_1s.wav

Output Gain: 19.05

Measure Window Start: 300ms

Measure Window Length: 1000ms

BWC applied: 0.15 dB

Device Reference Point: 0, 0, -6.3 mm

Cursor:

ABM1 comp = 18.57 dBA/m

BWC Factor = 0.15 dB

Location: 12.5, -4.2, 3.7 mm

Cursor:

ABM2 = -36.12 dBA/m

Location: 12.5, -4.2, 3.7 mm

Cursor:

ABM1/ABM2 = 54.68 dB

ABM1 comp = 18.57 dBA/m

BWC Factor = 0.15 dB

Location: 12.5, -4.2, 3.7 mm

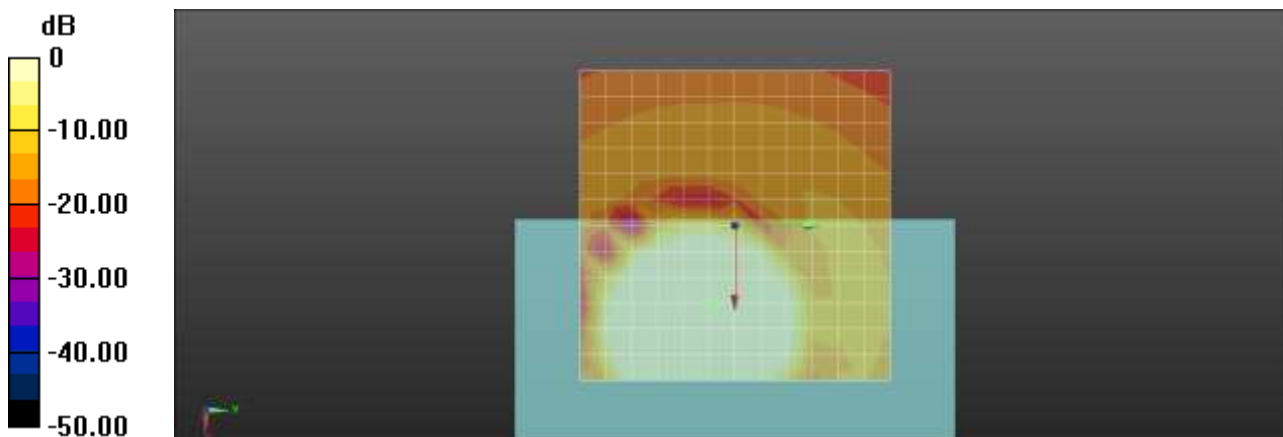

0 dB = 1.000 A/m = 0.00 dBA/m

Plot No.104
802.11n20 MCS0 40kbit/s 120ch Freq. Response

Communication System: UID 0, WIFI 5GHz (0); Frequency: 5600 MHz;Duty Cycle: 1:1
 Medium parameters used: $\sigma = 0$ S/m, $\epsilon_r = 1$; $\rho = 0$ kg/m³
 Phantom section: TCoil Section

DASY5 Configuration:

- Probe: AM1DV3 - 3050; ; Calibrated: 2021-11-23
- Sensor-Surface: 0mm (Fix Surface)
- Electronics: DAE4 Sn466; Calibrated: 2021-04-23
- Phantom: HAC Test Arch with AMCC
- Measurement SW: DASY52, Version 52.10 (4)

T-Coil scan (scan for ANSI C63.19-2007 & 2011 compliance)/General Scans/z (axial) wideband at best S/N/ABM Freq Resp(x,y,z,f) (1x1x1): Measurement grid: dx=10mm, dy=10mm
 Signal Type: Audio File (.wav) 48k_Normal_51s new.wav
 Output Gain: 58
 Measure Window Start: 300ms
 Measure Window Length: 51000ms
 BWC applied: 9.48 dB
 Device Reference Point: 0, 0, -6.3 mm

Category	Telephone parameters WD signal quality [(signal+noise)-to-noise ratio in decibels]
Category T1	0 dB to 10 dB
Category T2	10 dB to 20 dB
Category T3	20 dB to 30 dB
Category T4	> 30 dB

Cursor:
 Diff = 2.00 dB
 BWC Factor = 9.48 dB
 Location: 12.5, -3.7, 3.7 mm

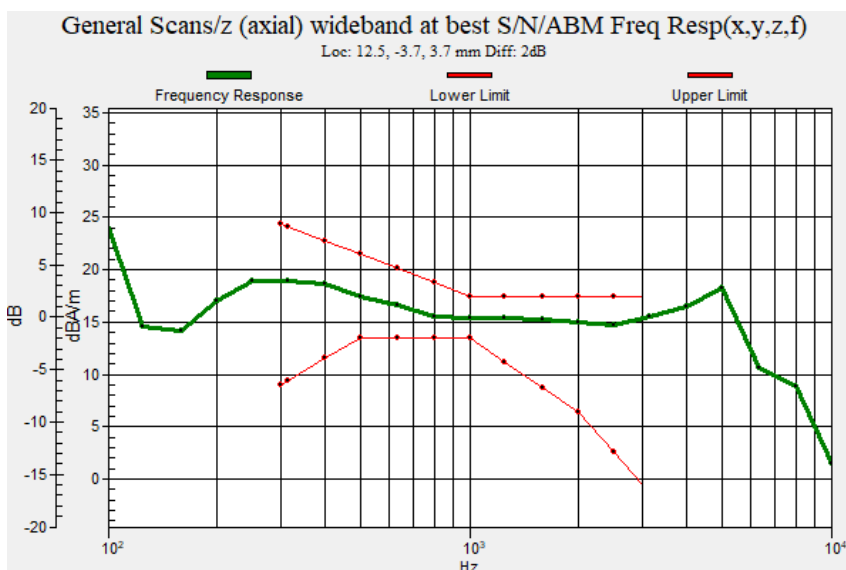

Plot No.105

802.11n20 MCS0 40kbit/s 120ch y(transversal)

Communication System: UID 0, WIFI 5GHz (0); Frequency: 5600 MHz;Duty Cycle: 1:1

Medium parameters used: $\sigma = 0$ S/m, $\epsilon_r = 1$; $\rho = 0$ kg/m³

Phantom section: TCoil Section

DASY5 Configuration:

- Probe: AM1DV3 - 3050; ; Calibrated: 2021-11-23
- Sensor-Surface: 0mm (Fix Surface)
- Electronics: DAE4 Sn466; Calibrated: 2021-04-23
- Phantom: HAC Test Arch with AMCC
- Measurement SW: DASY52, Version 52.10 (4)

T-Coil scan (scan for ANSI C63.19-2007 & 2011 compliance)/General Scans/y (transversal) 4.2mm 50

x 50/ABM Signal(x,y,z) (13x13x1): Measurement grid: dx=10mm, dy=10mm

Signal Type: Audio File (.wav) 48k_voice_1kHz_1s.wav

Output Gain: 19.05

Measure Window Start: 300ms

Measure Window Length: 1000ms

BWC applied: 0.15 dB

Device Reference Point: 0, 0, -6.3 mm

Cursor:

ABM1 comp = 9.83 dBA/m

BWC Factor = 0.15 dB

Location: 12.5, 8.3, 3.7 mm

Cursor:

ABM2 = -35.39 dBA/m

Location: 12.5, 8.3, 3.7 mm

Cursor:

ABM1/ABM2 = 45.21 dB

ABM1 comp = 9.83 dBA/m

BWC Factor = 0.15 dB

Location: 12.5, 8.3, 3.7 mm

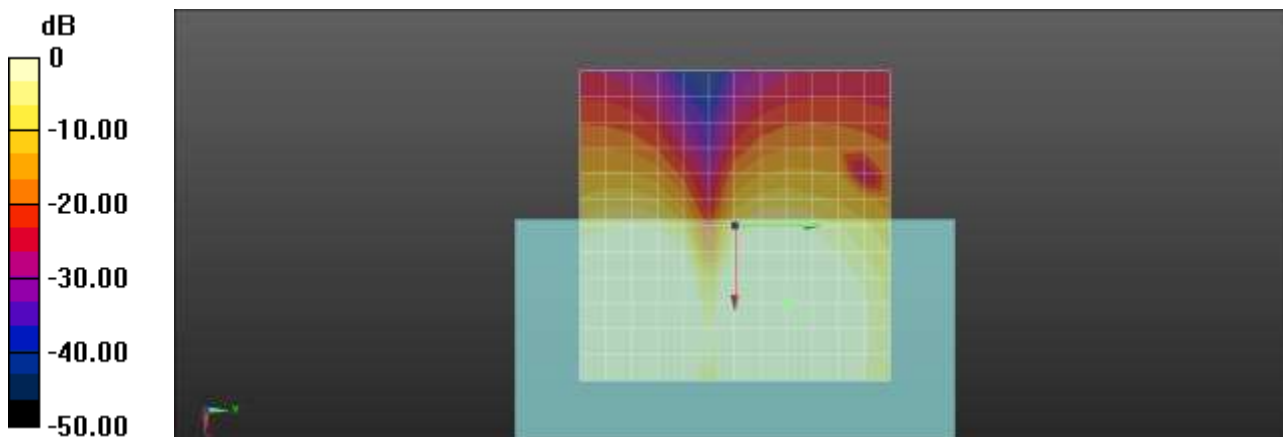

0 dB = 1.000 A/m = 0.00 dBA/m

Plot No.106

802.11n20 MCS0 40kbit/s 157ch z(axial)

Communication System: UID 0, WIFI 5GHz (0); Frequency: 5785 MHz;Duty Cycle: 1:1

Medium parameters used: $\sigma = 0$ S/m, $\epsilon_r = 1$; $\rho = 0$ kg/m³

Phantom section: TCoil Section

DASY5 Configuration:

- Probe: AM1DV3 - 3050; ; Calibrated: 2021-11-23
- Sensor-Surface: 0mm (Fix Surface)
- Electronics: DAE4 Sn466; Calibrated: 2021-04-23
- Phantom: HAC Test Arch with AMCC
- Measurement SW: DASY52, Version 52.10 (4)

T-Coil scan (scan for ANSI C63.19-2007 & 2011 compliance)/General Scans/z (axial) 4.2mm 50 x

50/ABM Signal(x,y,z) (13x13x1): Measurement grid: dx=10mm, dy=10mm

Signal Type: Audio File (.wav) 48k_voice_1kHz_1s.wav

Output Gain: 19.05

Measure Window Start: 300ms

Measure Window Length: 1000ms

BWC applied: 0.15 dB

Device Reference Point: 0, 0, -6.3 mm

Cursor:

ABM1 comp = 15.84 dBA/m

BWC Factor = 0.15 dB

Location: 12.5, 0, 3.7 mm

Cursor:

ABM2 = -33.27 dBA/m

Location: 12.5, 0, 3.7 mm

Cursor:

ABM1/ABM2 = 49.11 dB

ABM1 comp = 15.84 dBA/m

BWC Factor = 0.15 dB

Location: 12.5, 0, 3.7 mm

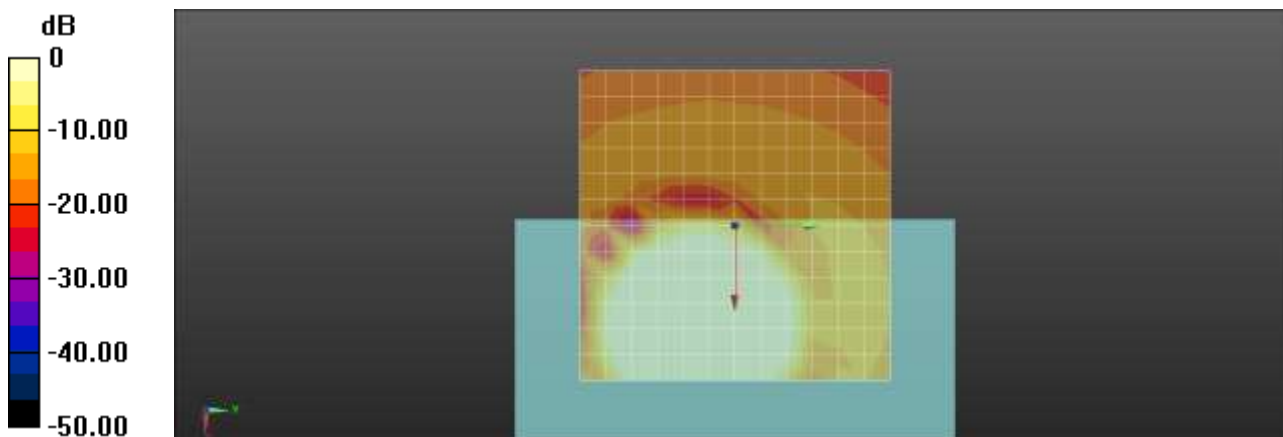

0 dB = 1.000 A/m = 0.00 dBA/m

Plot No.107
802.11n20 MCS0 40kbit/s 157ch Freq. Response

Communication System: UID 0, WIFI 5GHz (0); Frequency: 5785 MHz;Duty Cycle: 1:1
Medium parameters used: $\sigma = 0$ S/m, $\epsilon_r = 1$; $\rho = 0$ kg/m³
Phantom section: TCoil Section

DASY5 Configuration:

- Probe: AM1DV3 - 3050; ; Calibrated: 2021-11-23
- Sensor-Surface: 0mm (Fix Surface)
- Electronics: DAE4 Sn466; Calibrated: 2021-04-23
- Phantom: HAC Test Arch with AMCC
- Measurement SW: DASY52, Version 52.10 (4)

T-Coil scan (scan for ANSI C63.19-2007 & 2011 compliance)/General Scans/z (axial) wideband at best S/N/ABM Freq Resp(x,y,z,f) (1x1x1): Measurement grid: dx=10mm, dy=10mm
Signal Type: Audio File (.wav) 48k_Normal_51s new.wav
Output Gain: 58
Measure Window Start: 300ms
Measure Window Length: 51000ms
BWC applied: 9.48 dB
Device Reference Point: 0, 0, -6.3 mm

Category	Telephone parameters WD signal quality [(signal+noise)-to-noise ratio in decibels]
Category T1	0 dB to 10 dB
Category T2	10 dB to 20 dB
Category T3	20 dB to 30 dB
Category T4	> 30 dB

Cursor:
Diff = 2.00 dB
BWC Factor = 9.48 dB
Location: 11.4, -1.3, 3.7 mm

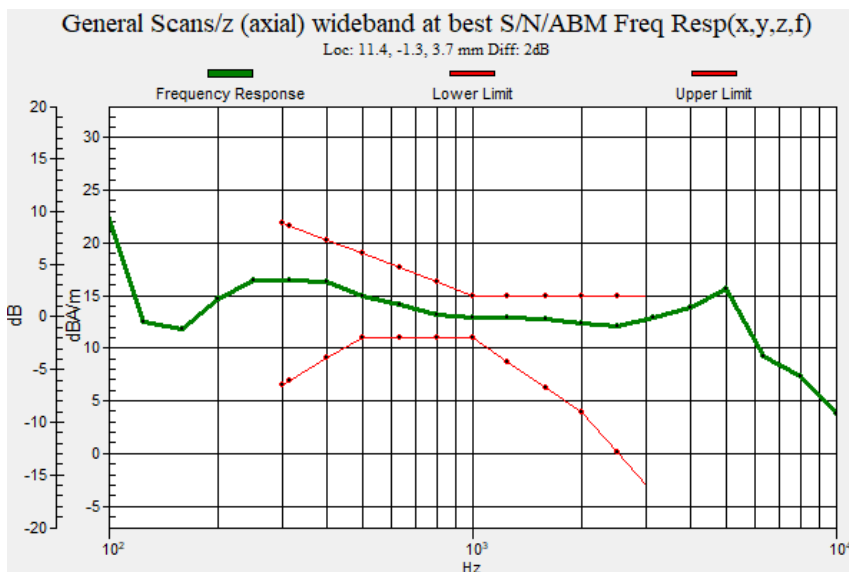

Plot No.108

802.11n20 MCS0 40kbit/s 157ch y(transversal)

Communication System: UID 0, WIFI 5GHz (0); Frequency: 5785 MHz;Duty Cycle: 1:1

Medium parameters used: $\sigma = 0$ S/m, $\epsilon_r = 1$; $\rho = 0$ kg/m³

Phantom section: TCoil Section

DASY5 Configuration:

- Probe: AM1DV3 - 3050; ; Calibrated: 2021-11-23
- Sensor-Surface: 0mm (Fix Surface)
- Electronics: DAE4 Sn466; Calibrated: 2021-04-23
- Phantom: HAC Test Arch with AMCC
- Measurement SW: DASY52, Version 52.10 (4)

T-Coil scan (scan for ANSI C63.19-2007 & 2011 compliance)/General Scans/y (transversal) 4.2mm 50

x 50/ABM Signal(x,y,z) (13x13x1): Measurement grid: dx=10mm, dy=10mm

Signal Type: Audio File (.wav) 48k_voice_1kHz_1s.wav

Output Gain: 19.05

Measure Window Start: 300ms

Measure Window Length: 1000ms

BWC applied: 0.15 dB

Device Reference Point: 0, 0, -6.3 mm

Cursor:

ABM1 comp = 9.72 dBA/m

BWC Factor = 0.15 dB

Location: 12.5, 8.3, 3.7 mm

Cursor:

ABM2 = -33.65 dBA/m

Location: 12.5, 8.3, 3.7 mm

Cursor:

ABM1/ABM2 = 43.38 dB

ABM1 comp = 9.72 dBA/m

BWC Factor = 0.15 dB

Location: 12.5, 8.3, 3.7 mm

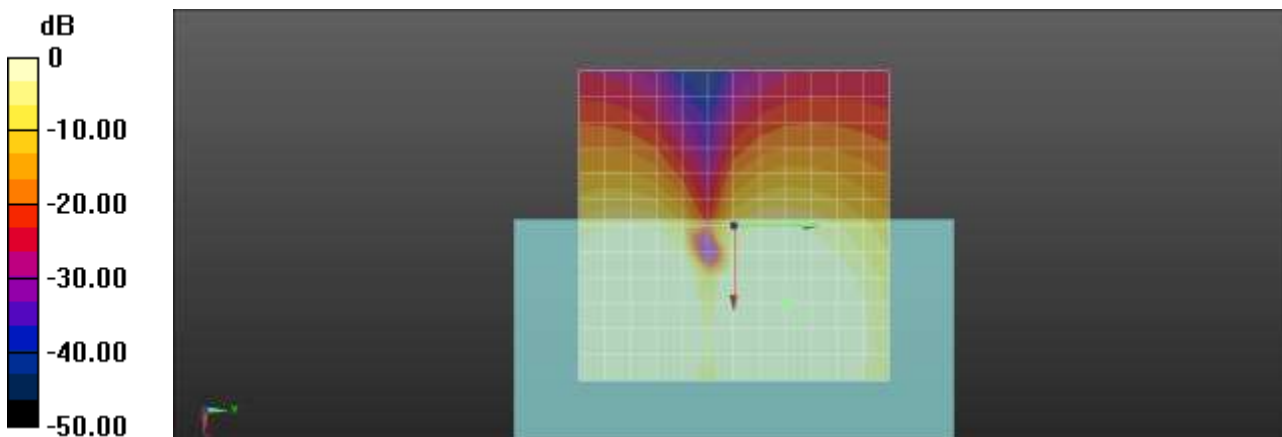

0 dB = 1.000 A/m = 0.00 dBA/m

Plot No.109

NR Band 2 CP QPSK 15MHz 40RB 39offset 6kbit/s 376000ch z(axial)

Communication System: UID 0, NR Band 2 (0); Frequency: 1880 MHz;Duty Cycle: 1:1

Medium parameters used: $\sigma = 0$ S/m, $\epsilon_r = 1$; $\rho = 0$ kg/m³

Phantom section: TCoil Section

DASY5 Configuration:

- Probe: AM1DV3 - 3049; ; Calibrated: 6/1/2021
- Sensor-Surface: 0mm (Fix Surface)
- Electronics: DAE4 Sn1686; Calibrated: 6/21/2021
- Phantom: HAC Test Arch with AMCC
- Measurement SW: DASY52, Version 52.10 (4); SEMCAD X Version 14.6.14 (7483)

T-Coil scan (scan for ANSI C63.19-2007 & 2011 compliance)/General Scans/z (axial) 4.2mm 50 x

50/ABM Signal(x,y,z) (13x13x1): Measurement grid: dx=10mm, dy=10mm

Signal Type: Audio File (.wav) 48k_voice_1kHz_1s.wav

Output Gain: 19.84

Measure Window Start: 300ms

Measure Window Length: 1000ms

BWC applied: 0.16 dB

Device Reference Point: 0, 0, -6.3 mm

Cursor:

ABM1 comp = 9.56 dBA/m

BWC Factor = 0.16 dB

Location: 8.3, 0, 3.7 mm

Cursor:

ABM2 = -32.22 dBA/m

Location: 8.3, 0, 3.7 mm

Cursor:

ABM1/ABM2 = 41.78 dB

ABM1 comp = 9.56 dBA/m

BWC Factor = 0.16 dB

Location: 8.3, 0, 3.7 mm

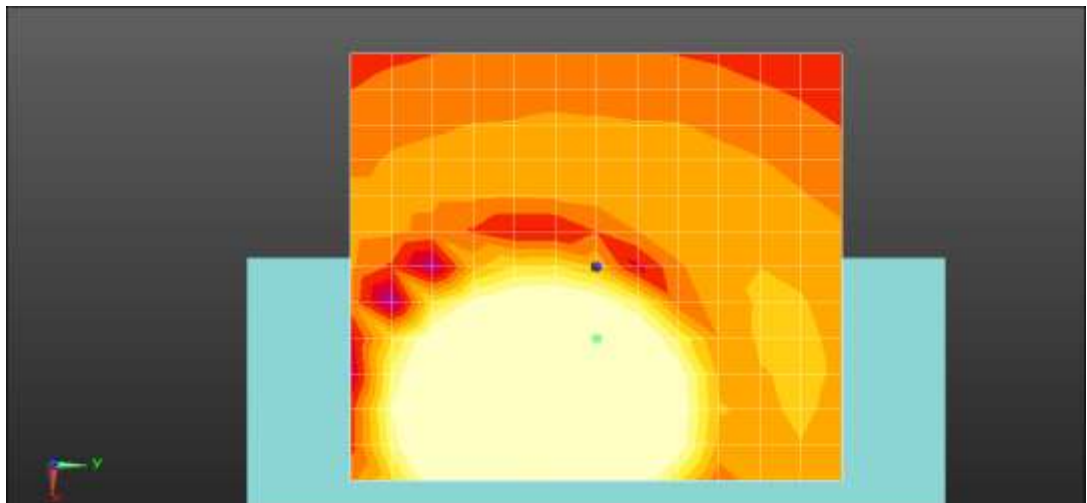
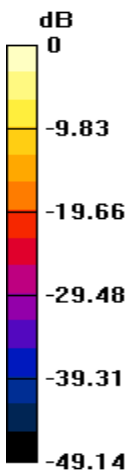

0 dB = 1.000 A/m = 0.00 dBA/m

Plot No.110

NR Band 2 CP QPSK 15MHz 40RB 39offset 6kbit/s 376000ch Freq. Response

Communication System: UID 0, NR Band 2 (0); Frequency: 1880 MHz;Duty Cycle: 1:1
 Medium parameters used: $\sigma = 0$ S/m, $\epsilon_r = 1$; $\rho = 0$ kg/m³
 Phantom section: TCoil Section

DASY5 Configuration:

- Probe: AM1DV3 - 3049; ; Calibrated: 6/1/2021
- Sensor-Surface: 0mm (Fix Surface)
- Electronics: DAE4 Sn1686; Calibrated: 6/21/2021
- Phantom: HAC Test Arch with AMCC
- Measurement SW: DASY52, Version 52.10 (4); SEMCAD X Version 14.6.14 (7483)

T-Coil scan (scan for ANSI C63.19-2007 & 2011 compliance)/General Scans/z (axial) wideband at best S/N/ABM Freq Resp(x,y,z,f) (1x1x1): Measurement grid: dx=10mm, dy=10mm

Signal Type: Audio File (.wav) 48k_Normal_51s new.wav
 Output Gain: 60.33
 Measure Window Start: 300ms
 Measure Window Length: 51000ms
 BWC applied: 9.48 dB
 Device Reference Point: 0, 0, -6.3 mm

Category	Telephone parameters WD signal quality [(signal+noise)-to-noise ratio in decibels]
Category T1	0 dB to 10 dB
Category T2	10 dB to 20 dB
Category T3	20 dB to 30 dB
Category T4	> 30 dB

Cursor:

Diff = 1.88 dB
 BWC Factor = 9.48 dB
 Location: 9, -0.4, 3.7 mm

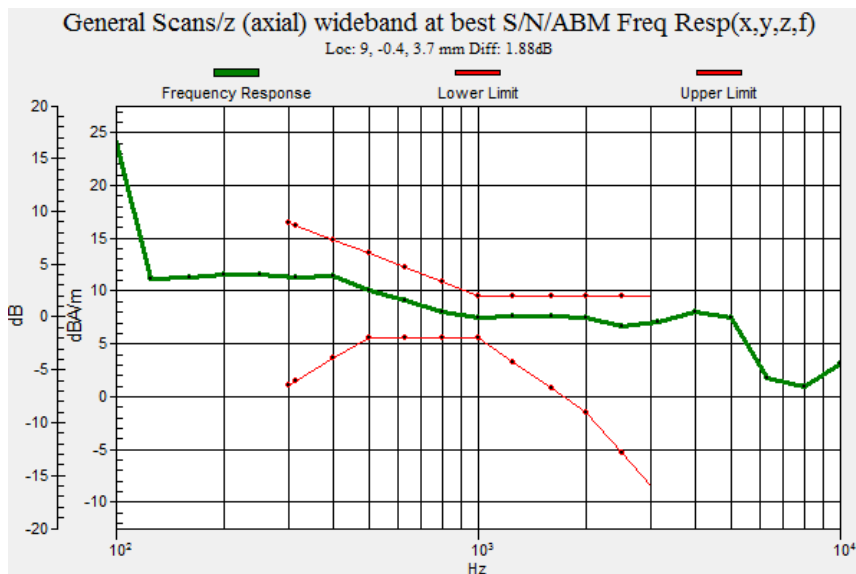

Plot No.111

NR Band 2 CP QPSK 15MHz 40RB 39offset 6kbit/s 376000ch y(transversal)

Communication System: UID 0, NR Band 2 (0); Frequency: 1880 MHz;Duty Cycle: 1:1

Medium parameters used: $\sigma = 0$ S/m, $\epsilon_r = 1$; $\rho = 0$ kg/m³

Phantom section: TCoil Section

DASY5 Configuration:

- Probe: AM1DV3 - 3049; ; Calibrated: 6/1/2021
- Sensor-Surface: 0mm (Fix Surface)
- Electronics: DAE4 Sn1686; Calibrated: 6/21/2021
- Phantom: HAC Test Arch with AMCC
- Measurement SW: DASY52, Version 52.10 (4); SEMCAD X Version 14.6.14 (7483)

T-Coil scan (scan for ANSI C63.19-2007 & 2011 compliance)/General Scans/y (transversal) 4.2mm 50

x 50/ABM Signal(x,y,z) (13x13x1): Measurement grid: dx=10mm, dy=10mm

Signal Type: Audio File (.wav) 48k_voice_1kHz_1s.wav

Output Gain: 19.84

Measure Window Start: 300ms

Measure Window Length: 1000ms

BWC applied: 0.16 dB

Device Reference Point: 0, 0, -6.3 mm

Cursor:

ABM1 comp = 10.06 dBA/m

BWC Factor = 0.16 dB

Location: 12.5, 4.2, 3.7 mm

Cursor:

ABM2 = -30.58 dBA/m

Location: 12.5, 4.2, 3.7 mm

Cursor:

ABM1/ABM2 = 40.64 dB

ABM1 comp = 10.06 dBA/m

BWC Factor = 0.16 dB

Location: 12.5, 4.2, 3.7 mm

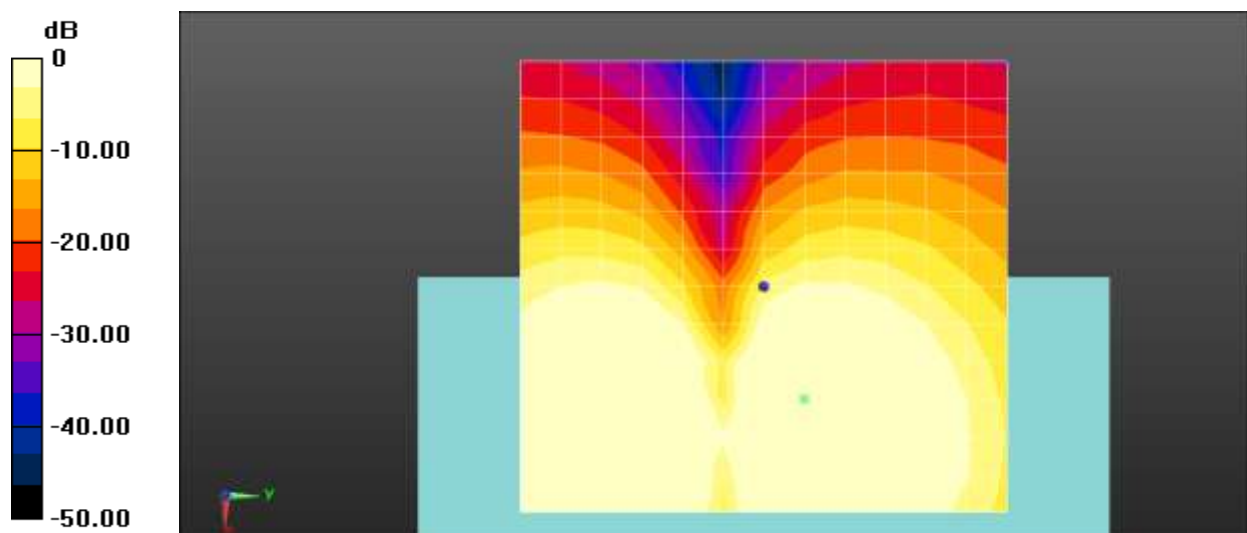

0 dB = 1.000 A/m = 0.00 dBA/m

Plot No.112

NR Band 5 CP QPSK 15MHz 39RB 40offset 6kbit/s 167300ch z(axial)

Communication System: UID 0, NR Band 5 (0); Frequency: 836.5 MHz;Duty Cycle: 1:1

Medium parameters used: $\sigma = 0$ S/m, $\epsilon_r = 1$; $\rho = 0$ kg/m³

Phantom section: TCoil Section

DASY5 Configuration:

- Probe: AM1DV3 - 3049; ; Calibrated: 6/1/2021
- Sensor-Surface: 0mm (Fix Surface)
- Electronics: DAE4 Sn1686; Calibrated: 6/21/2021
- Phantom: HAC Test Arch with AMCC
- Measurement SW: DASY52, Version 52.10 (4); SEMCAD X Version 14.6.14 (7483)

T-Coil scan (scan for ANSI C63.19-2007 & 2011 compliance)/General Scans/z (axial) 4.2mm 50 x

50/ABM Signal(x,y,z) (13x13x1): Measurement grid: dx=10mm, dy=10mm

Signal Type: Audio File (.wav) 48k_voice_1kHz_1s.wav

Output Gain: 19.84

Measure Window Start: 300ms

Measure Window Length: 1000ms

BWC applied: 0.16 dB

Device Reference Point: 0, 0, -6.3 mm

Cursor:

ABM1 comp = 17.54 dBA/m

BWC Factor = 0.16 dB

Location: 12.5, -4.2, 3.7 mm

Cursor:

ABM2 = -26.36 dBA/m

Location: 12.5, -4.2, 3.7 mm

Cursor:

ABM1/ABM2 = 43.90 dB

ABM1 comp = 17.54 dBA/m

BWC Factor = 0.16 dB

Location: 12.5, -4.2, 3.7 mm

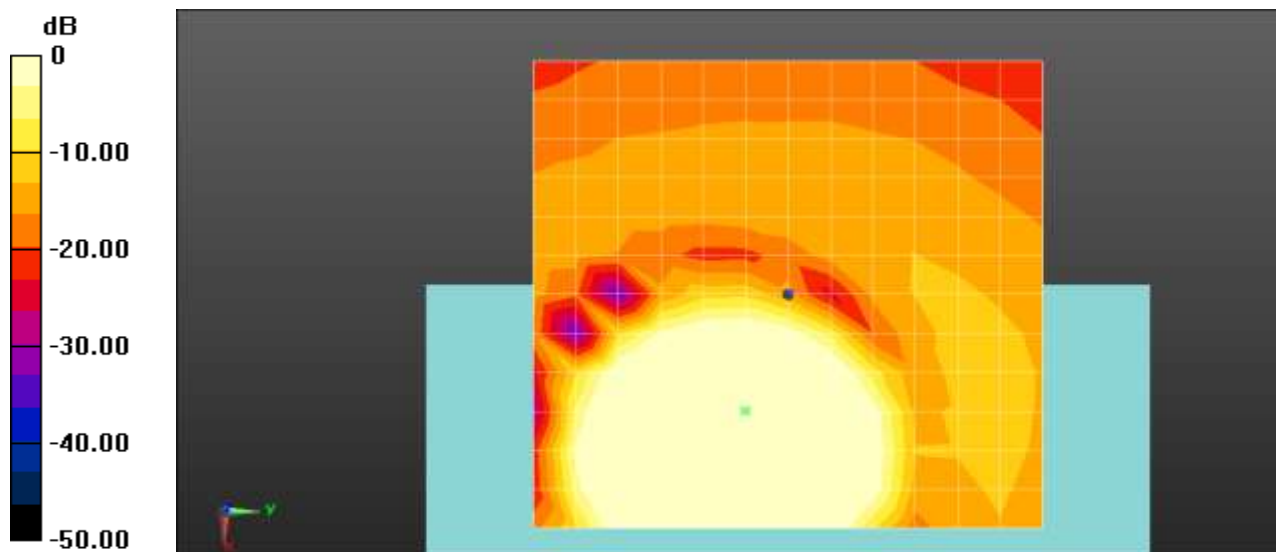

0 dB = 1.000 A/m = 0.00 dBA/m

Plot No.113

NR Band 5 CP QPSK 15MHz 39RB 40offset 6kbit/s 167300ch Freq. Response

Communication System: UID 0, NR Band 5 (0); Frequency: 836.5 MHz;Duty Cycle: 1:1

Medium parameters used: $\sigma = 0$ S/m, $\epsilon_r = 1$; $\rho = 0$ kg/m³

Phantom section: TCoil Section

DASY5 Configuration:

- Probe: AM1DV3 - 3049; ; Calibrated: 6/1/2021
- Sensor-Surface: 0mm (Fix Surface)
- Electronics: DAE4 Sn1686; Calibrated: 6/21/2021
- Phantom: HAC Test Arch with AMCC
- Measurement SW: DASY52, Version 52.10 (4); SEMCAD X Version 14.6.14 (7483)

T-Coil scan (scan for ANSI C63.19-2007 & 2011 compliance)/General Scans/z (axial) wideband at best

S/N/ABM Freq Resp(x,y,z,f) (1x1x1): Measurement grid: dx=10mm, dy=10mm

Signal Type: Audio File (.wav) 48k_Normal_51s new.wav

Output Gain: 60.33

Measure Window Start: 300ms

Measure Window Length: 51000ms

BWC applied: 9.47 dB

Device Reference Point: 0, 0, -6.3 mm

Category	Telephone parameters WD signal quality [(signal+noise)-to-noise ratio in decibels]
Category T1	0 dB to 10 dB
Category T2	10 dB to 20 dB
Category T3	20 dB to 30 dB
Category T4	> 30 dB

Cursor:

Diff = 1.81 dB

BWC Factor = 9.47 dB

Location: 12.7, -3.1, 3.7 mm

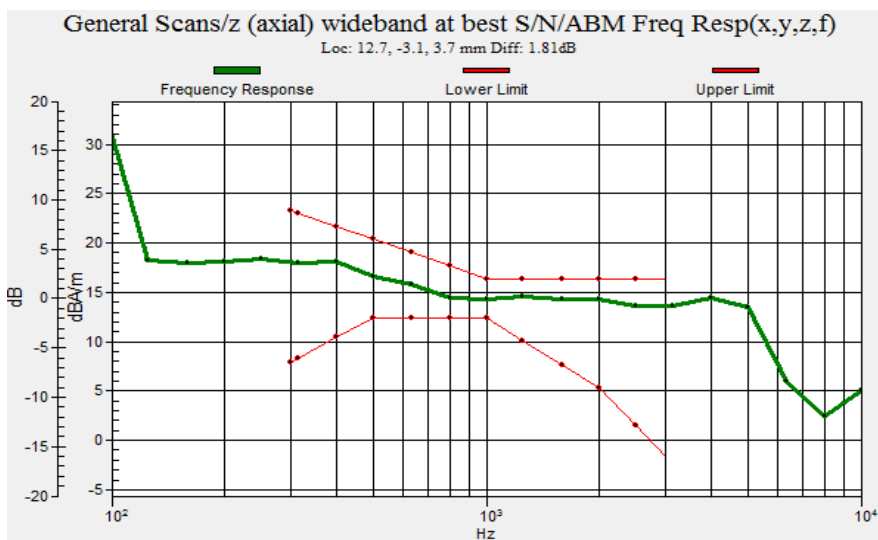

Plot No.114

NR Band 5 CP QPSK 15MHz 39RB 40offset 6kbit/s 167300ch y(transversal)

Communication System: UID 0, NR Band 5 (0); Frequency: 836.5 MHz;Duty Cycle: 1:1

Medium parameters used: $\sigma = 0$ S/m, $\epsilon_r = 1$; $\rho = 0$ kg/m³

Phantom section: TCoil Section

DASY5 Configuration:

- Probe: AM1DV3 - 3049; ; Calibrated: 6/1/2021
- Sensor-Surface: 0mm (Fix Surface)
- Electronics: DAE4 Sn1686; Calibrated: 6/21/2021
- Phantom: HAC Test Arch with AMCC
- Measurement SW: DASY52, Version 52.10 (4); SEMCAD X Version 14.6.14 (7483)

T-Coil scan (scan for ANSI C63.19-2007 & 2011 compliance)/General Scans/y (transversal) 4.2mm 50

x 50/ABM Signal(x,y,z) (13x13x1): Measurement grid: dx=10mm, dy=10mm

Signal Type: Audio File (.wav) 48k_voice_1kHz_1s.wav

Output Gain: 19.84

Measure Window Start: 300ms

Measure Window Length: 1000ms

BWC applied: 0.16 dB

Device Reference Point: 0, 0, -6.3 mm

Cursor:

ABM1 comp = 10.17 dBA/m

BWC Factor = 0.16 dB

Location: 12.5, 4.2, 3.7 mm

Cursor:

ABM2 = -36.98 dBA/m

Location: 12.5, 4.2, 3.7 mm

Cursor:

ABM1/ABM2 = 47.15 dB

ABM1 comp = 10.17 dBA/m

BWC Factor = 0.16 dB

Location: 12.5, 4.2, 3.7 mm

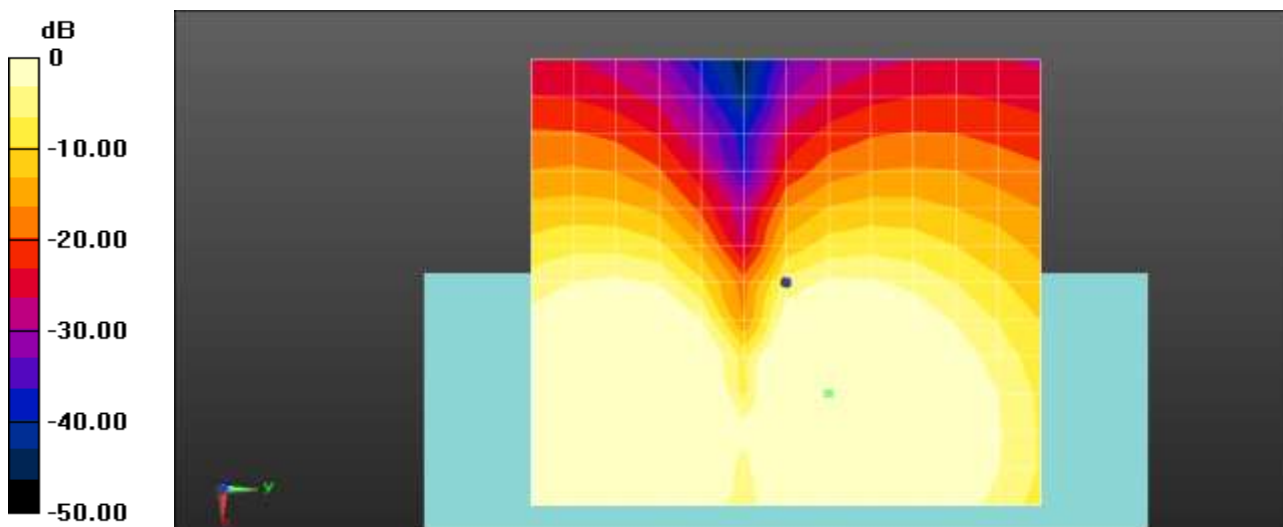

0 dB = 1.000 A/m = 0.00 dBA/m

Plot No.115

NR Band 66 CP QPSK 15MHz 39RB 40offset 6kbit/s 354500ch z(axial)

Communication System: UID 0, NR Band 66 (0); Frequency: 1772.5 MHz;Duty Cycle: 1:1

Medium parameters used: $\sigma = 0$ S/m, $\epsilon_r = 1$; $\rho = 0$ kg/m³

Phantom section: TCoil Section

DASY5 Configuration:

- Probe: AM1DV3 - 3049; ; Calibrated: 6/1/2021
- Sensor-Surface: 0mm (Fix Surface)
- Electronics: DAE4 Sn1686; Calibrated: 6/21/2021
- Phantom: HAC Test Arch with AMCC
- Measurement SW: DASY52, Version 52.10 (4); SEMCAD X Version 14.6.14 (7483)

T-Coil scan (scan for ANSI C63.19-2007 & 2011 compliance)/General Scans/z (axial) 4.2mm 50 x

50/ABM Signal(x,y,z) (13x13x1): Measurement grid: dx=10mm, dy=10mm

Signal Type: Audio File (.wav) 48k_voice_1kHz_1s.wav

Output Gain: 19.84

Measure Window Start: 300ms

Measure Window Length: 1000ms

BWC applied: 0.16 dB

Device Reference Point: 0, 0, -6.3 mm

Cursor:

ABM1 comp = 9.12 dBA/m

BWC Factor = 0.16 dB

Location: 8.3, 0, 3.7 mm

Cursor:

ABM2 = -32.89 dBA/m

Location: 8.3, 0, 3.7 mm

Cursor:

ABM1/ABM2 = 42.01 dB

ABM1 comp = 9.12 dBA/m

BWC Factor = 0.16 dB

Location: 8.3, 0, 3.7 mm

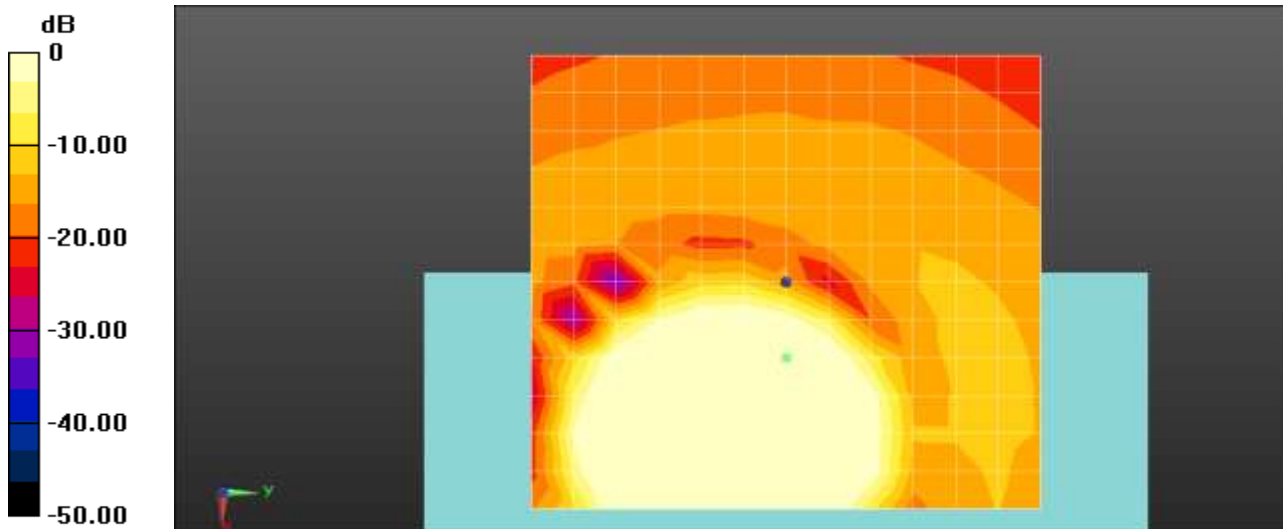

0 dB = 1.000 A/m = 0.00 dBA/m

Plot No.116

NR Band 66 CP QPSK 15MHz 39RB 40offset 6kbit/s 354500ch Freq. Response

Communication System: UID 0, NR Band 66 (0); Frequency: 1772.5 MHz;Duty Cycle: 1:1

Medium parameters used: $\sigma = 0$ S/m, $\epsilon_r = 1$; $\rho = 0$ kg/m³

Phantom section: TCoil Section

DASY5 Configuration:

- Probe: AM1DV3 - 3049; ; Calibrated: 6/1/2021
- Sensor-Surface: 0mm (Fix Surface)
- Electronics: DAE4 Sn1686; Calibrated: 6/21/2021
- Phantom: HAC Test Arch with AMCC
- Measurement SW: DASY52, Version 52.10 (4); SEMCAD X Version 14.6.14 (7483)

T-Coil scan (scan for ANSI C63.19-2007 & 2011 compliance)/General Scans/z (axial) wideband at best

S/N/ABM Freq Resp(x,y,z,f) (1x1x1): Measurement grid: dx=10mm, dy=10mm

Signal Type: Audio File (.wav) 48k_Normal_51s new.wav

Output Gain: 60.33

Measure Window Start: 300ms

Measure Window Length: 51000ms

BWC applied: 9.48 dB

Device Reference Point: 0, 0, -6.3 mm

Category	Telephone parameters WD signal quality [(signal+noise)-to-noise ratio in decibels]
Category T1	0 dB to 10 dB
Category T2	10 dB to 20 dB
Category T3	20 dB to 30 dB
Category T4	> 30 dB

Cursor:

Diff = 1.55 dB

BWC Factor = 9.48 dB

Location: 9, -0.4, 3.7 mm

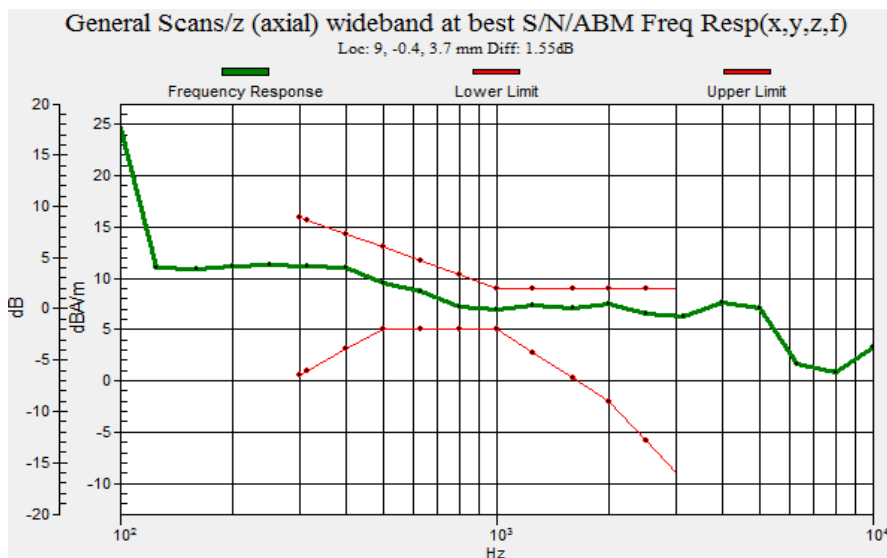

Plot No.117

NR Band 66 CP QPSK 15MHz 39RB 40offset 6kbit/s 354500ch y(transversal)

Communication System: UID 0, NR Band 66 (0); Frequency: 1772.5 MHz;Duty Cycle: 1:1

Medium parameters used: $\sigma = 0$ S/m, $\epsilon_r = 1$; $\rho = 0$ kg/m³

Phantom section: TCoil Section

DASY5 Configuration:

- Probe: AM1DV3 - 3049; ; Calibrated: 6/1/2021
- Sensor-Surface: 0mm (Fix Surface)
- Electronics: DAE4 Sn1686; Calibrated: 6/21/2021
- Phantom: HAC Test Arch with AMCC
- Measurement SW: DASY52, Version 52.10 (4); SEMCAD X Version 14.6.14 (7483)

T-Coil scan (scan for ANSI C63.19-2007 & 2011 compliance)/General Scans/y (transversal) 4.2mm 50

x 50/ABM Signal(x,y,z) (13x13x1): Measurement grid: dx=10mm, dy=10mm

Signal Type: Audio File (.wav) 48k_voice_1kHz_1s.wav

Output Gain: 19.84

Measure Window Start: 300ms

Measure Window Length: 1000ms

BWC applied: 0.16 dB

Device Reference Point: 0, 0, -6.3 mm

Cursor:

ABM1 comp = 10.00 dBA/m

BWC Factor = 0.16 dB

Location: 12.5, 4.2, 3.7 mm

Cursor:

ABM2 = -30.56 dBA/m

Location: 12.5, 4.2, 3.7 mm

Cursor:

ABM1/ABM2 = 40.56 dB

ABM1 comp = 10.00 dBA/m

BWC Factor = 0.16 dB

Location: 12.5, 4.2, 3.7 mm

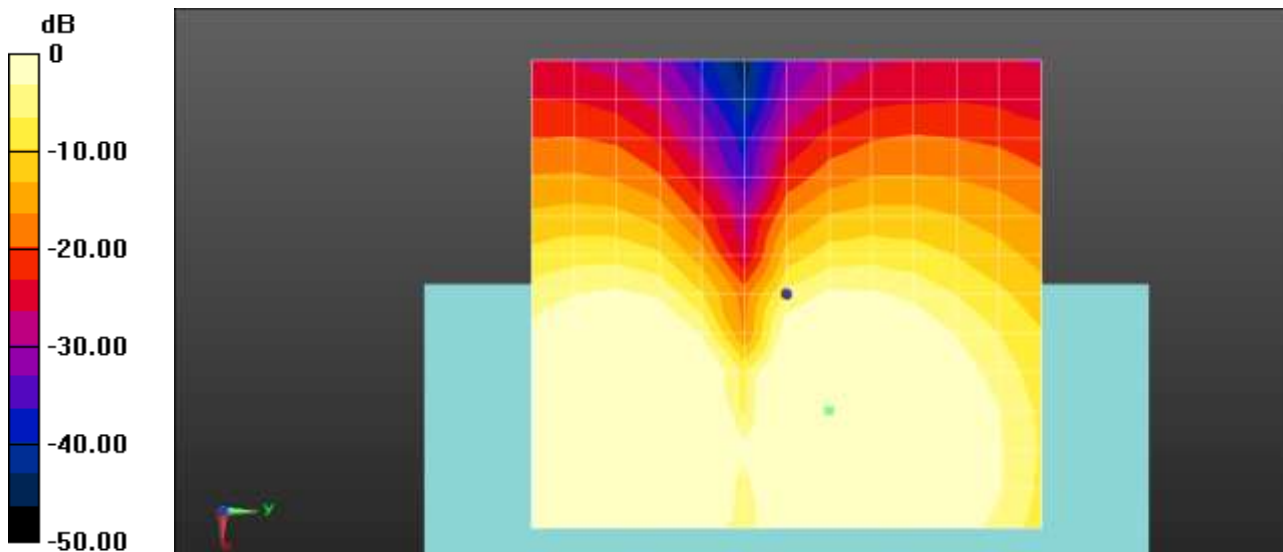

0 dB = 1.000 A/m = 0.00 dBA/m

Plot No.118

NR Band 77 DFTs QPSK 100MHz 270RB 0offset 6kbit/s 656000ch z(axial)

Communication System: UID 0, NR Band 77 (0); Frequency: 3840 MHz;Duty Cycle: 1:4.00037

Medium parameters used: $\sigma = 0$ S/m, $\epsilon_r = 1$; $\rho = 0$ kg/m³

Phantom section: TCoil Section

DASY5 Configuration:

- Probe: AM1DV3 - 3049; ; Calibrated: 6/1/2021
- Sensor-Surface: 0mm (Fix Surface)
- Electronics: DAE4 Sn1686; Calibrated: 6/21/2021
- Phantom: HAC Test Arch with AMCC
- Measurement SW: DASY52, Version 52.10 (4); SEMCAD X Version 14.6.14 (7483)

T-Coil scan (scan for ANSI C63.19-2007 & 2011 compliance)/General Scans/z (axial) 4.2mm 50 x

50/ABM Signal(x,y,z) (13x13x1): Measurement grid: dx=10mm, dy=10mm

Signal Type: Audio File (.wav) 48k_voice_1kHz_1s.wav

Output Gain: 19.84

Measure Window Start: 300ms

Measure Window Length: 1000ms

BWC applied: 0.16 dB

Device Reference Point: 0, 0, -6.3 mm

Cursor:

ABM1 comp = 9.43 dBA/m

BWC Factor = 0.16 dB

Location: 8.3, 0, 3.7 mm

Cursor:

ABM2 = -31.36 dBA/m

Location: 8.3, 0, 3.7 mm

Cursor:

ABM1/ABM2 = 40.79 dB

ABM1 comp = 9.43 dBA/m

BWC Factor = 0.16 dB

Location: 8.3, 0, 3.7 mm

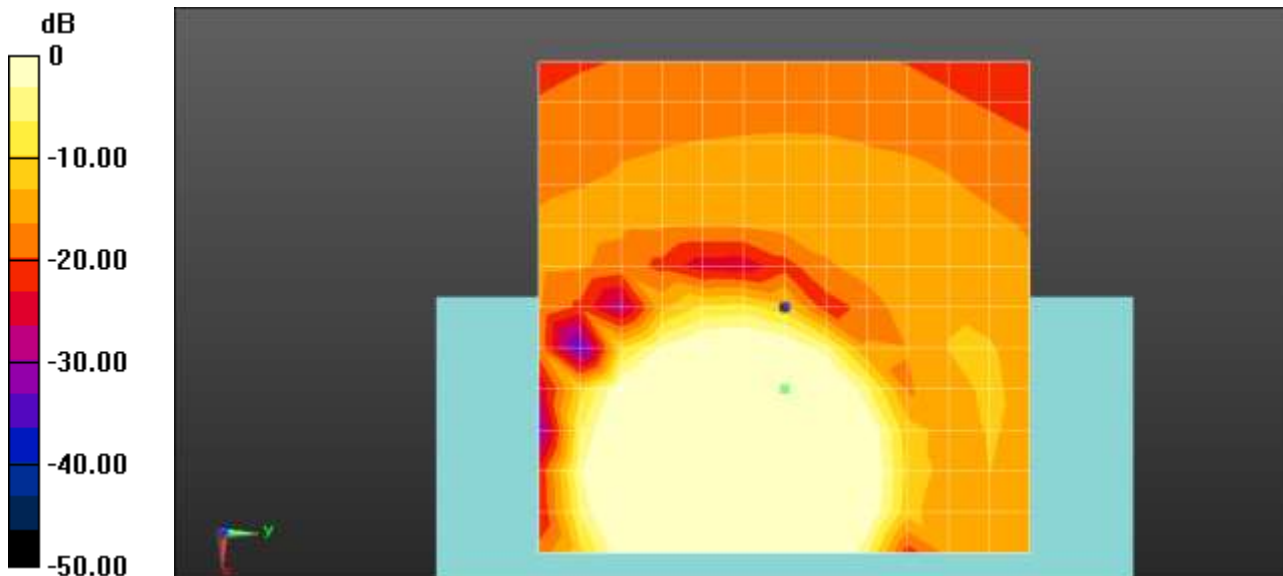

0 dB = 1.000 A/m = 0.00 dBA/m

Plot No.119

NR Band 77 DFTs QPSK 100MHz 270RB 0offset 6kbit/s 656000ch Freq. Response

Communication System: UID 0, NR Band 77 (0); Frequency: 3840 MHz;Duty Cycle: 1:4.00037

Medium parameters used: $\sigma = 0$ S/m, $\epsilon_r = 1$; $\rho = 0$ kg/m³

Phantom section: TCoil Section

DASY5 Configuration:

- Probe: AM1DV3 - 3049; ; Calibrated: 6/1/2021
- Sensor-Surface: 0mm (Fix Surface)
- Electronics: DAE4 Sn1686; Calibrated: 6/21/2021
- Phantom: HAC Test Arch with AMCC
- Measurement SW: DASY52, Version 52.10 (4); SEMCAD X Version 14.6.14 (7483)

T-Coil scan (scan for ANSI C63.19-2007 & 2011 compliance)/General Scans/z (axial) wideband at best

S/N/ABM Freq Resp(x,y,z,f) (1x1x1): Measurement grid: dx=10mm, dy=10mm

Signal Type: Audio File (.wav) 48k_Normal_51s new.wav

Output Gain: 60.33

Measure Window Start: 300ms

Measure Window Length: 51000ms

BWC applied: 9.48 dB

Device Reference Point: 0, 0, -6.3 mm

Category	Telephone parameters WD signal quality [(signal+noise)-to-noise ratio in decibels]
Category T1	0 dB to 10 dB
Category T2	10 dB to 20 dB
Category T3	20 dB to 30 dB
Category T4	> 30 dB

Cursor:

Diff = 1.84 dB

BWC Factor = 9.48 dB

Location: 8.7, 0.2, 3.7 mm

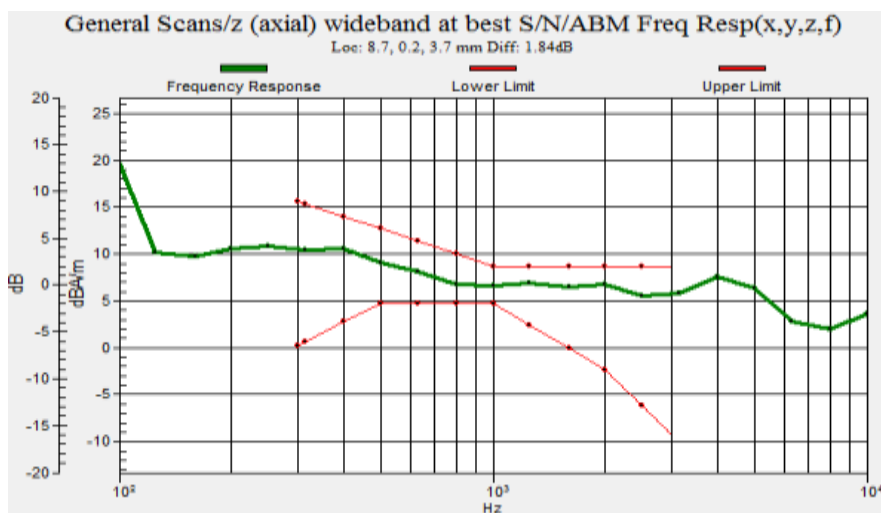

Plot No.120

NR Band 77 DFTs QPSK 100MHz 270RB 0offset 6kbit/s 656000ch y(transversal)

Communication System: UID 0, NR Band 77 (0); Frequency: 3840 MHz;Duty Cycle: 1:4.00037
 Medium parameters used: $\sigma = 0$ S/m, $\epsilon_r = 1$; $\rho = 0$ kg/m³
 Phantom section: TCoil Section

DASY5 Configuration:

- Probe: AM1DV3 - 3049; ; Calibrated: 6/1/2021
- Sensor-Surface: 0mm (Fix Surface)
- Electronics: DAE4 Sn1686; Calibrated: 6/21/2021
- Phantom: HAC Test Arch with AMCC
- Measurement SW: DASY52, Version 52.10 (4); SEMCAD X Version 14.6.14 (7483)

T-Coil scan (scan for ANSI C63.19-2007 & 2011 compliance)/General Scans/y (transversal) 4.2mm 50 x 50/ABM Signal(x,y,z) (13x13x1): Measurement grid: dx=10mm, dy=10mm
 Signal Type: Audio File (.wav) 48k_voice_1kHz_1s.wav
 Output Gain: 19.84
 Measure Window Start: 300ms
 Measure Window Length: 1000ms
 BWC applied: 0.16 dB
 Device Reference Point: 0, 0, -6.3 mm

Cursor:

ABM1 comp = 9.53 dBA/m
 BWC Factor = 0.16 dB
 Location: 12.5, 4.2, 3.7 mm

Cursor:

ABM2 = -21.44 dBA/m
 Location: 12.5, 4.2, 3.7 mm

Cursor:

ABM1/ABM2 = 30.97 dB
 ABM1 comp = 9.53 dBA/m
 BWC Factor = 0.16 dB
 Location: 12.5, 4.2, 3.7 mm

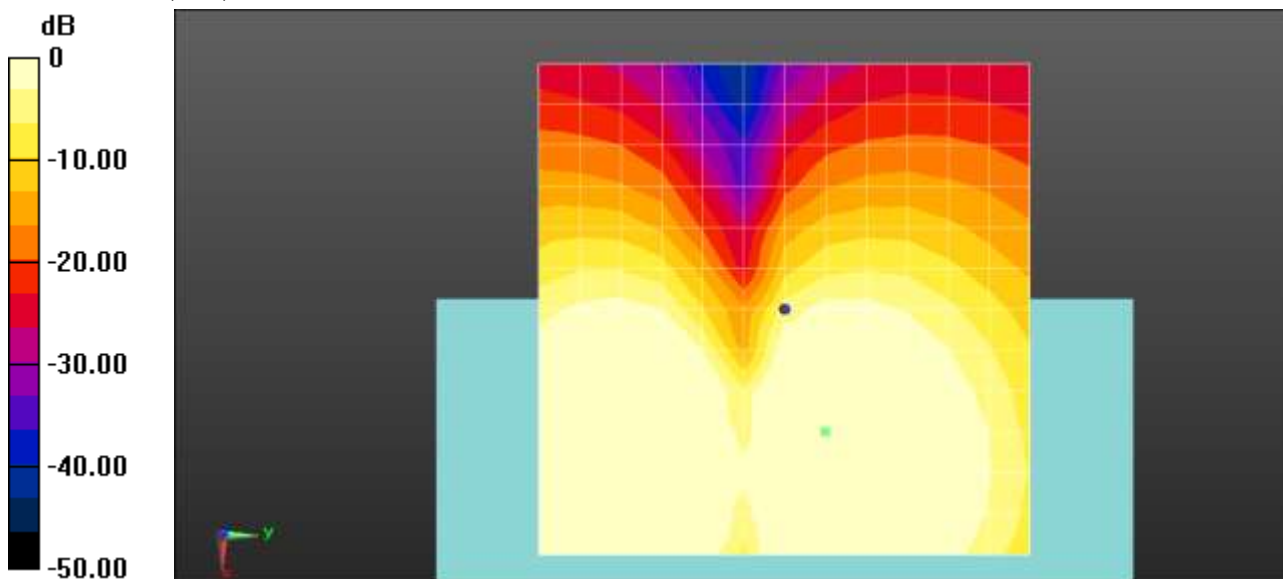

0 dB = 1.000 A/m = 0.00 dBA/m

Appendix B. HAC T-Coil Probe Certificates

**Calibration Laboratory of
Schmid & Partner
Engineering AG**
Zeughausstrasse 43, 8004 Zurich, Switzerland



S Schweizerischer Kalibrierdienst
C Service suisse d'étalonnage
S Servizio svizzero di taratura
S Swiss Calibration Service

Accredited by the Swiss Accreditation Service (SAS)
The Swiss Accreditation Service is one of the signatories to the EA
Multilateral Agreement for the recognition of calibration certificates

Accreditation No.: **SCS 0108**

Client **HCT (Dymstec)**

Certificate No: **AM1DV3-3050_Nov21**

CALIBRATION CERTIFICATE

Object: **AM1DV3 - SN: 3050**

Calibration procedure(s): **QA CAL-24.v4
Calibration procedure for AM1D magnetic field probes and TMFS in the audio range**

Calibration date: **November 23, 2021**

This calibration certificate documents the traceability to national standards, which realize the physical units of measurements (SI).
The measurements and the uncertainties with confidence probability are given on the following pages and are part of the certificate.

All calibrations have been conducted in the closed laboratory facility: environment temperature (22 ± 3)°C and humidity < 70%.

Calibration Equipment used (M&TE critical for calibration)

Primary Standards	ID #	Cal Date (Certificate No.)	Scheduled Calibration
Keithley Multimeter Type 2001	SN: 0810278	31-Aug-21 (No. 31368)	Aug-22
Reference Probe AM1DV2	SN: 1008	15-Dec-20 (No. AM1DV2-1008_Dec20)	Dec-21
DAE4	SN: 781	23-Dec-20 (No. DAE4-781_Dec20)	Dec-21
Secondary Standards	ID #	Check Date (in house)	Scheduled Check
AMCC	SN: 1050	01-Oct-13 (in house check Oct-20)	Oct-23
AMMI Audio Measuring Instrument	SN: 1062	26-Sep-12 (in house check Oct-20)	Oct-23

Calibrated by: **Leaf Klysner** (Name), **Laboratory Technician** (Function), *[Signature]* (Signature)

Approved by: **Niels Kuster** (Name), **Quality Manager** (Function), *[Signature]* (Signature)

Issued: November 24, 2021

This calibration certificate shall not be reproduced except in full without written approval of the laboratory.

결	담당자	확인자
재	DL 박성철 2021.12.09	CS 최영철 2021.12.09

References

- [1] ANSI-C63.19-2007
American National Standard for Methods of Measurement of Compatibility between Wireless Communications Devices and Hearing Aids.
- [2] ANSI-C63.19-2019 (ANSI-C63.19-2011)
American National Standard, Methods of Measurement of Compatibility between Wireless Communications Devices and Hearing Aids.
- [3] DASY5 manual, Chapter: Hearing Aid Compatibility (HAC) T-Coil Extension

Description of the AM1D probe

The AM1D Audio Magnetic Field Probe is a fully shielded magnetic field probe for the frequency range from 100 Hz to 20 kHz. The pickup coil is compliant with the dimensional requirements of [1+2]. The probe includes a symmetric low noise amplifier for the signal available at the shielded 3 pin connector at the side. Power is supplied via the same connector (phantom power supply) and monitored via the LED near the connector. The 7 pin connector at the end of the probe does not carry any signals, but determines the angle of the sensor when mounted on the DAE. The probe supports mechanical detection of the surface.

The single sensor in the probe is arranged in a tilt angle allowing measurement of 3 orthogonal field components when rotating the probe by 120° around its axis. It is aligned with the perpendicular component of the field, if the probe axis is tilted nominally 35.3° above the measurement plane, using the connector rotation and sensor angle stated below.

The probe is fully RF shielded when operated with the matching signal cable (shielded) and allows measurement of audio magnetic fields in the close vicinity of RF emitting wireless devices according to [1+2] without additional shielding.

Handling of the item

The probe is manufactured from stainless steel. In order to maintain the performance and calibration of the probe, it must not be opened. The probe is designed for operation in air and shall not be exposed to humidity or liquids. For proper operation of the surface detection and emergency stop functions in a DASY system, the probe must be operated with the special probe cup provided (larger diameter).

Methods Applied and Interpretation of Parameters

- *Coordinate System:* The AM1D probe is mounted in the DASY system for operation with a HAC Test Arch phantom with AMCC Helmholtz calibration coil according to [3], with the tip pointing to "southwest" orientation.
- *Functional Test:* The functional test preceding calibration includes test of Noise level RF immunity (1kHz AM modulated signal). The shield of the probe cable must be well connected. Frequency response verification from 100 Hz to 10 kHz.
- *Connector Rotation:* The connector at the end of the probe does not carry any signals and is used for fixation to the DAE only. The probe is operated in the center of the AMCC Helmholtz coil using a 1 kHz magnetic field signal. Its angle is determined from the two minima at nominally +120° and -120° rotation, so the sensor in the tip of the probe is aligned to the vertical plane in z-direction, corresponding to the field maximum in the AMCC Helmholtz calibration coil.
- *Sensor Angle:* The sensor tilting in the vertical plane from the ideal vertical direction is determined from the two minima at nominally +120° and -120°. DASY system uses this angle to align the sensor for radial measurements to the x and y axis in the horizontal plane.
- *Sensitivity:* With the probe sensor aligned to the z-field in the AMCC, the output of the probe is compared to the magnetic field in the AMCC at 1 kHz. The field in the AMCC Helmholtz coil is given by the geometry and the current through the coil, which is monitored on the precision shunt resistor of the coil.

AM1D probe identification and configuration data

Item	AM1DV3 Audio Magnetic 1D Field Probe
Type No	SP AM1 001 BA
Serial No	3050

Overall length	296 mm
Tip diameter	6.0 mm (at the tip)
Sensor offset	3.0 mm (centre of sensor from tip)
Internal Amplifier	20 dB

Manufacturer / Origin	Schmid & Partner Engineering AG, Zurich, Switzerland
-----------------------	--

Calibration data

Connector rotation angle	(in DASYS system)	213.5 °	+/- 3.6 ° (k=2)
Sensor angle	(in DASYS system)	0.17 °	+/- 0.5 ° (k=2)
Sensitivity at 1 kHz	(in DASYS system)	0.00752 V/(A/m)	+/- 2.2 % (k=2)

The reported uncertainty of measurement is stated as the standard uncertainty of measurement multiplied by the coverage factor k=2, which for a normal distribution corresponds to a coverage probability of approximately 95%.

Calibration Laboratory of
Schmid & Partner
Engineering AG
Zeughausstrasse 43, 8004 Zurich, Switzerland



S Schweizerischer Kalibrierdienst
C Service suisse d'étalonnage
S Servizio svizzero di taratura
S Swiss Calibration Service

Accredited by the Swiss Accreditation Service (SAS)
The Swiss Accreditation Service is one of the signatories to the EA
Multilateral Agreement for the recognition of calibration certificates

Accreditation No.: SCS 0108

Client **HCT (Dymstec)**

Certificate No: **AM1DV3-3049_Jun21**

CALIBRATION CERTIFICATE		결	담당자	확인자																												
Object	AM1DV3 - SN: 3049	재	DL 박정호 2021.06.10	김경호 2021.06.10																												
Calibration procedure(s)	QA CAL-24.v4 Calibration procedure for AM1D magnetic field probes and TMFS in the audio range																															
Calibration date:	June 1, 2021																															
<p>This calibration certificate documents the traceability to national standards, which realize the physical units of measurements (SI). The measurements and the uncertainties with confidence probability are given on the following pages and are part of the certificate.</p> <p>All calibrations have been conducted in the closed laboratory facility; environment temperature (22 ± 3)°C and humidity < 70%.</p> <p>Calibration Equipment used (M&TE critical for calibration)</p> <table border="1"> <thead> <tr> <th>Primary Standards</th> <th>ID #</th> <th>Cal Date (Certificate No.)</th> <th>Scheduled Calibration</th> </tr> </thead> <tbody> <tr> <td>Keithley Multimeter Type 2001</td> <td>SN: 0810278</td> <td>07-Sep-20 (No. 28647)</td> <td>Sep-21</td> </tr> <tr> <td>Reference Probe AM1DV2</td> <td>SN: 1008</td> <td>15-Dec-20 (No. AM1DV2-1008_Dec20)</td> <td>Dec-21</td> </tr> <tr> <td>DAE4</td> <td>SN: 781</td> <td>23-Dec-20 (No. DAE4-781_Dec20)</td> <td>Dec-21</td> </tr> </tbody> </table> <table border="1"> <thead> <tr> <th>Secondary Standards</th> <th>ID #</th> <th>Check Date (In house)</th> <th>Scheduled Check</th> </tr> </thead> <tbody> <tr> <td>AMCC</td> <td>SN: 1050</td> <td>01-Oct-13 (in house check Oct-20)</td> <td>Oct-23</td> </tr> <tr> <td>AMMI Audio Measuring Instrument</td> <td>SN: 1062</td> <td>28-Sep-12 (in house check Oct-20)</td> <td>Oct-23</td> </tr> </tbody> </table>					Primary Standards	ID #	Cal Date (Certificate No.)	Scheduled Calibration	Keithley Multimeter Type 2001	SN: 0810278	07-Sep-20 (No. 28647)	Sep-21	Reference Probe AM1DV2	SN: 1008	15-Dec-20 (No. AM1DV2-1008_Dec20)	Dec-21	DAE4	SN: 781	23-Dec-20 (No. DAE4-781_Dec20)	Dec-21	Secondary Standards	ID #	Check Date (In house)	Scheduled Check	AMCC	SN: 1050	01-Oct-13 (in house check Oct-20)	Oct-23	AMMI Audio Measuring Instrument	SN: 1062	28-Sep-12 (in house check Oct-20)	Oct-23
Primary Standards	ID #	Cal Date (Certificate No.)	Scheduled Calibration																													
Keithley Multimeter Type 2001	SN: 0810278	07-Sep-20 (No. 28647)	Sep-21																													
Reference Probe AM1DV2	SN: 1008	15-Dec-20 (No. AM1DV2-1008_Dec20)	Dec-21																													
DAE4	SN: 781	23-Dec-20 (No. DAE4-781_Dec20)	Dec-21																													
Secondary Standards	ID #	Check Date (In house)	Scheduled Check																													
AMCC	SN: 1050	01-Oct-13 (in house check Oct-20)	Oct-23																													
AMMI Audio Measuring Instrument	SN: 1062	28-Sep-12 (in house check Oct-20)	Oct-23																													
Calibrated by:	Name Leif Klynsner	Function Laboratory Technician	Signature 																													
Approved by:	Name Kajla Pokovic	Function Technical Manager	Signature 																													
This calibration certificate shall not be reproduced except in full without written approval of the laboratory.				Issued: June 2, 2021																												

References

- [1] ANSI-C63.19-2007
American National Standard for Methods of Measurement of Compatibility between Wireless Communications Devices and Hearing Aids.
- [2] ANSI-C63.19-2011
American National Standard, Methods of Measurement of Compatibility between Wireless Communications Devices and Hearing Aids.
- [3] DASY5 manual, Chapter: Hearing Aid Compatibility (HAC) T-Coil Extension

Description of the AM1D probe

The AM1D Audio Magnetic Field Probe is a fully shielded magnetic field probe for the frequency range from 100 Hz to 20 kHz. The pickup coil is compliant with the dimensional requirements of [1+2]. The probe includes a symmetric low noise amplifier for the signal available at the shielded 3 pin connector at the side. Power is supplied via the same connector (phantom power supply) and monitored via the LED near the connector. The 7 pin connector at the end of the probe does not carry any signals, but determines the angle of the sensor when mounted on the DAE. The probe supports mechanical detection of the surface.

The single sensor in the probe is arranged in a tilt angle allowing measurement of 3 orthogonal field components when rotating the probe by 120° around its axis. It is aligned with the perpendicular component of the field, if the probe axis is tilted nominally 35.3° above the measurement plane, using the connector rotation and sensor angle stated below.

The probe is fully RF shielded when operated with the matching signal cable (shielded) and allows measurement of audio magnetic fields in the close vicinity of RF emitting wireless devices according to [1+2] without additional shielding.

Handling of the item

The probe is manufactured from stainless steel. In order to maintain the performance and calibration of the probe, it must not be opened. The probe is designed for operation in air and shall not be exposed to humidity or liquids. For proper operation of the surface detection and emergency stop functions in a DASY system, the probe must be operated with the special probe cup provided (larger diameter).

Methods Applied and Interpretation of Parameters

- *Coordinate System:* The AM1D probe is mounted in the DASY system for operation with a HAC Test Arch phantom with AMCC Helmholtz calibration coil according to [3], with the tip pointing to "southwest" orientation.
- *Functional Test:* The functional test preceding calibration includes test of Noise level RF immunity (1kHz AM modulated signal). The shield of the probe cable must be well connected. Frequency response verification from 100 Hz to 10 kHz.
- *Connector Rotation:* The connector at the end of the probe does not carry any signals and is used for fixation to the DAE only. The probe is operated in the center of the AMCC Helmholtz coil using a 1 kHz magnetic field signal. Its angle is determined from the two minima at nominally +120° and -120° rotation, so the sensor in the tip of the probe is aligned to the vertical plane in z-direction, corresponding to the field maximum in the AMCC Helmholtz calibration coil.
- *Sensor Angle:* The sensor tilting in the vertical plane from the ideal vertical direction is determined from the two minima at nominally +120° and -120°. DASY system uses this angle to align the sensor for radial measurements to the x and y axis in the horizontal plane.
- *Sensitivity:* With the probe sensor aligned to the z-field in the AMCC, the output of the probe is compared to the magnetic field in the AMCC at 1 kHz. The field in the AMCC Helmholtz coil is given by the geometry and the current through the coil, which is monitored on the precision shunt resistor of the coil.

AM1D probe identification and configuration data

Item	AM1DV3 Audio Magnetic 1D Field Probe
Type No	SP AM1 001 BA
Serial No	3049

Overall length	296 mm
Tip diameter	6.0 mm (at the tip)
Sensor offset	3.0 mm (centre of sensor from tip)
Internal Amplifier	20 dB

Manufacturer / Origin	Schmid & Partner Engineering AG, Zurich, Switzerland
-----------------------	--

Calibration data

Connector rotation angle	(in DASY system)	280.1 °	+/- 3.6 ° (k=2)
Sensor angle	(in DASY system)	-0.52 °	+/- 0.5 ° (k=2)
Sensitivity at 1 kHz	(in DASY system)	0.00746 V/(A/m)	+/- 2.2 % (k=2)

The reported uncertainty of measurement is stated as the standard uncertainty of measurement multiplied by the coverage factor k=2, which for a normal distribution corresponds to a coverage probability of approximately 95%.