







TEST REPORT

KCTL Inc. 65, Sinwon-ro, Yeongtong-gu, Suwon-si, Gyeonggi-do, 16677, Korea Tel: 82-31-285-0894 Fax: 82-505-299-8311 www.kctl.co.kr	Report No.: KR22-SEF0063-A Page (1) of (21)	 
1. Client		
<ul style="list-style-type: none"> ◦ Name : Samsung Electronics Co., Ltd. ◦ Address : 129, Samsung-ro, Yeongtong-gu, Suwon-si, Gyeonggi-do, 16677, Rep. of Korea ◦ Date of Receipt : 2022-02-03 		
2. Use of Report : -		
3. Name of Product / Model : Mobile phone / SC-53C, SCG15		
4. Manufacturer / Country of Origin : Samsung Electronics Co., Ltd. / Vietnam		
5. Date of Test : 2022-03-11		
6. Location of Test : <input checked="" type="checkbox"/> Permanent Testing Lab <input type="checkbox"/> On Site Testing (Address: 65, Sinwon-ro, Yeongtong-gu, Suwon-si, Gyeonggi-do, 16677, Korea)		
7. Test method used : ANSI C63.4:2014, Class B		
8. FCC ID : A3LSMA536JPN		
9. Test Results : Refer to the test result in the test report		
Affirmation	Tested by 	Technical Manager 
	Name : Junggil Ryu (Signature)	Name : Gunsu Park (Signature)
2022-03-23		
<h2>KCTL Inc.</h2>		
As a test result of the sample which was submitted from the client, this report does not guarantee the whole product quality. This test report should not be used and copied without a written agreement by KCTL Inc.		

REPORT REVISION HISTORY

Date	Revision	Page No
2022-03-16	Originally issued	-
2022-03-23	Revised the Section 4.5	12 Page

This report shall not be reproduced except in full, without the written approval of KCTL Inc. This document may be altered or revised by KCTL Inc. personnel only, and shall be noted in the revision section of the document. Any alteration of this document not carried out by KCTL Inc. will constitute fraud and shall nullify the document. The KCTL is operated as EMC testing laboratory in accordance with the requirements of ISO/IEC 17025.

Note. The report No. KR22-SEF0063 is superseded by the report No. KR22-SEF0063-A.

General remarks for test reports

Statement concerning the uncertainty of the measurement systems used for the tests

(may be required by the product standard or client)

Internal procedure used for type testing through which traceability of the measuring uncertainty has been established:

Procedure number, issue date and title:

Calculations leading to the reported values are on file with the testing laboratory that conducted the testing.

Statement not required by the standard or client used for type testing

Contents

1. Applicant information	4
2. Laboratory information.....	5
3. Test system configuration.....	6
3.1 Operation environment.....	6
3.2 Measurement Uncertainty	7
4. Description of EUT	9
4.1 General information.....	9
4.2 Product description.....	10
4.3 Auxiliary equipments	10
4.4 Test configuration	11
4.5 Operating conditions	12
5. Summary of test results	13
5.1 Summary of EMI emission test results	13
6. Test results	14
6.1 Conducted Emissions.....	14
6.2 Radiated Emission	17

KCTL Inc.

65, Sinwon-ro, Yeongtong-gu,
Suwon-si, Gyeonggi-do, 16677, Korea
Tel: 82-31-285-0894 Fax: 82-505-299-8311
www.kctl.co.kr

Report No.:
KR22-SEF0063-A
Page (4) of (21)



KCTL

1. Applicant information

Applicant: Samsung Electronics Co., Ltd.
Address: 129, Samsung-ro, Yeongtong-gu, Suwon-si, Gyeonggi-do,
16677, Rep. of Korea

Manufacturer: Samsung Electronics Co., Ltd.
Address: 129, Samsung-ro, Yeongtong-gu, Suwon-si, Gyeonggi-do,
16677, Rep. of Korea

Factory: Samsung Electronics Vietnam Thai Nguyen Co., Ltd
Yen Binh Industrial Park, Dong Tien Ward, Pho Yen Town,
Thai Nguyen Province, Vietnam

KCTL Inc.

65, Sinwon-ro, Yeongtong-gu,
Suwon-si, Gyeonggi-do, 16677, Korea
Tel: 82-31-285-0894 Fax: 82-505-299-8311
www.kctl.co.kr

Report No.:
KR22-SEF0063-A
Page (5) of (21)



KCTL

2. Laboratory information

Address

KCTL Inc. (Suwon Lab.)

65, Sinwon-ro, Yeongtong-gu, Suwon-si, Gyeonggi-do, 16677, Korea

Telephone Number: 82 31 285 0894

Facsimile Number: 82 505 299 8311

FCC Site Designation No: KR0040

VCCI Registration No.: R-20080, G-20078, C-20059, T-20056

Industry Canada Registration No. : 8035A

KOLAS NO.: KT231

SITE MAP

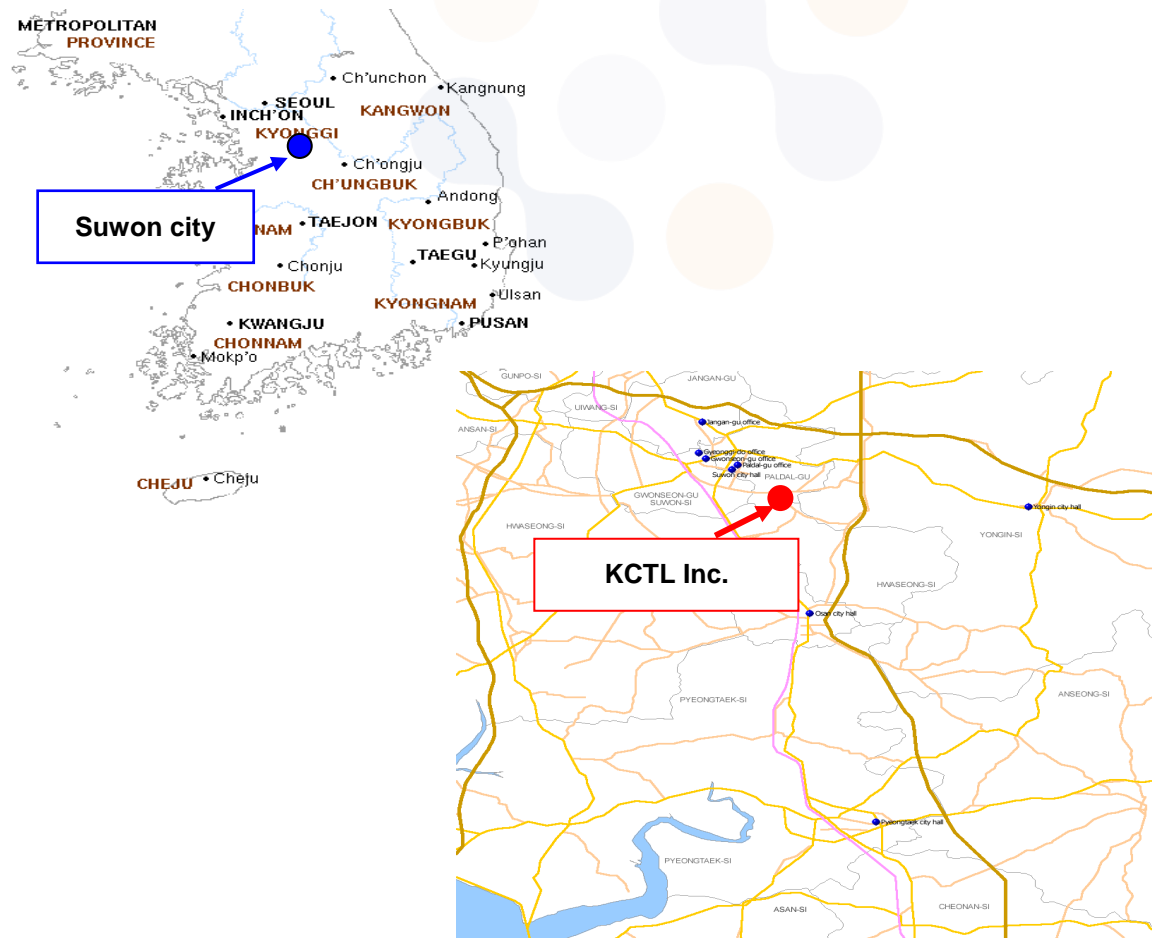

3. Test system configuration

3.1 Operation environment

	Temperature	Humidity	Pressure
Chamber 10 m (RE)	20.9 °C	32.6 % R.H.	-
Shielded room(CE)	23.1 °C	36.1 % R.H.	-

Test site

These testing items were performed following locations;

Test item	Test site
Conducted Emission	Shielded Room
Radiated Emission	10 m Chamber

3.2 Measurement Uncertainty

All measurements involve certain levels of uncertainties, especially in field of EMC.

The factors contributing to uncertainties are test receiver, cable loss, antenna factor calibration, Antenna directivity, antenna factor variation with height, antenna phase center variation, antenna frequency interpolation, measurement distance variation, site imperfection, mismatch, and system repeatability. Based on CISPR 16-4-2, the measurement uncertainty level with a 95 % confidence level was applied.

Conducted Emission measurement (Confidence level about 95 %, $k = 2$)			
Shielded Room (CE#1)	9 kHz ~ 150 kHz:	3.50 dB	
	150 kHz ~ 30 MHz:	3.06 dB	
Shielded Room (CE#2)	9 kHz ~ 150 kHz:	3.05 dB	
	150 kHz ~ 30 MHz:	3.06 dB	
Radiated Emission measurement (Confidence level about 95 %, $k = 2$)			
10 m Chamber (4F)	30 MHz ~ 200 MHz	3 m:	4.98 dB
		10 m:	4.96 dB
	200 MHz ~ 1 000 MHz	3 m:	4.28 dB
		10 m:	4.28 dB
	1 GHz ~ 6 GHz	3 m:	5.08 dB
	6 GHz ~ 18 GHz	3 m:	5.38 dB
	18 GHz ~ 30 GHz	3 m:	5.22 dB
30 GHz ~ 40 GHz	3 m:	4.44 dB	
10 m Chamber (2F)	30 MHz ~ 200 MHz	3 m:	4.50 dB
		10 m:	4.48 dB
	200 MHz ~ 1 000 MHz	3 m:	3.72 dB
		10 m:	3.70 dB
1 GHz ~ 6 GHz	3 m:	5.08 dB	

3.3 Measurement Program

These test items were performed by software programs;

Test item	Measurement Program		Used
Conducted Emission	EP5/CE_Ver 5.4.0(TOYO)		☒
Radiated Emission	2F	EP10/RE_Ver 2021.01.000 (TOYO)	☒
	4F	EP5/RE_Ver 5.11.10(TOYO)	



4. Description of EUT

4.1 General information

Declared Hardware Version	REV1.0
Declared Software Version	SC-53C(A536D.001)/ SCG15(A536J.001)
IMEI No	358542660014431 / 01
Operating Band(s)	GSM 850/900/1800/1900 WCDMA FDD 1/5 LTE FDD 1/3/5/12/18/19/21 LTE TDD 38/39/41/42 5G NR n1/n28/n41/n77/n78/n79

4.2 Product description

Type of product	Mobile phone
Model name (Basic)	SC-53C, SCG15
Model name (Variant)	-
Difference	-
Serial no	-
Testing voltage	120 V, 60 Hz
Input/Output rating	AC 100 V - 240 V, 50-60 Hz
Internal clock frequency	Above 108 MHz
RF Frequency	LTE Band 5: 869 MHz ~ 894 MHz LTE Band 12: 729 MHz ~ 746 MHz GSM 850: 869 MHz ~ 894 MHz WCDMA 850: 869 MHz ~ 894 MHz
Note	-The following accessory was not provided by the manufacturer.

4.3 Auxiliary equipments

Type	Model / Part #	S/N	Manufacturer
Adapter	EP-TA200	-	SAMSUNG
USIM Card	-	-	-
Micro SD Card (64 GB)	Samsung Pro Plus MB-MD64G	-	SAMSUNG
Wideband Radio Communication Tester	CMW500	-	R&S
Spiral ANT	-	-	-

4.4 Test configuration

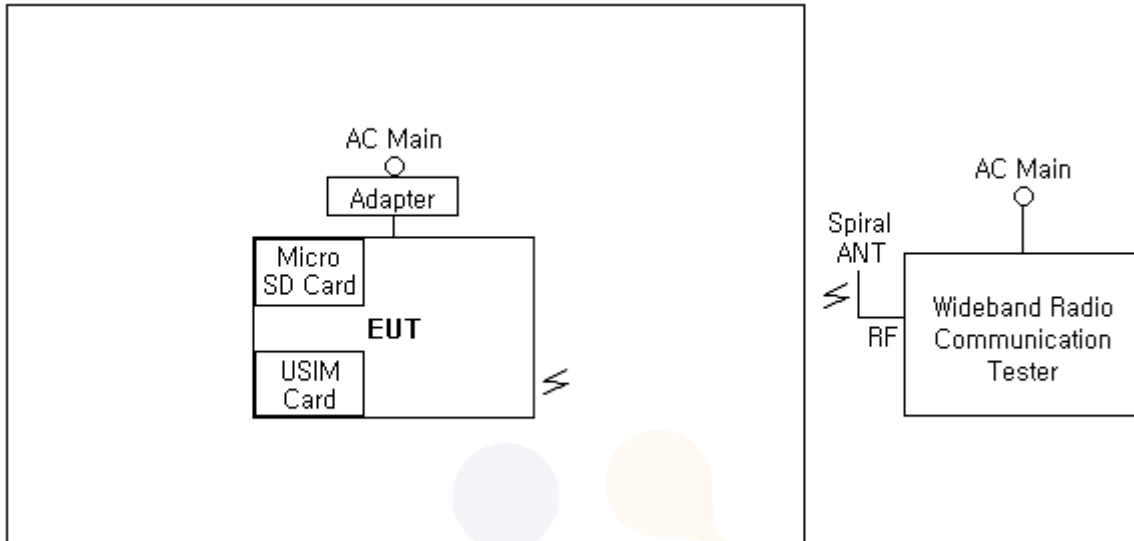

	Start		End		Cable	
	Name	I/O port	Name	I/O port	Length (m)	Spec.
1	EUT	Power	Adapter	-	1.0	Shield
2		USIM	USIM Card	-	Direct	-
3		Micro SD	Micro SD Card	-	Direct	-
4	Wideband Radio Communication Tester	RF	Spiral ANT	-	3.0	Shield

4.5 Operating conditions

The EUT was configured as normal intended use.

Test mode	Normal operating
Test #1	Charging(w/TA) + Cellular receiver (LTE Band 12_Low)

Note 1. All cellular RX bands operating below 1 GHz, including GSM, WCDMA and LTE have been investigated with low/middle/high channels. Among the bands, LTE Band 12 is the worst mode.

Note 2. It means this device needs to be tested with 3 orientations (x, y and z) and at least the worst case orientation shall be set for final test.

It was determined that Z orientation was worst-case orientation. Therefore, all final radiated testing was performed with the EUT in Z orientation.

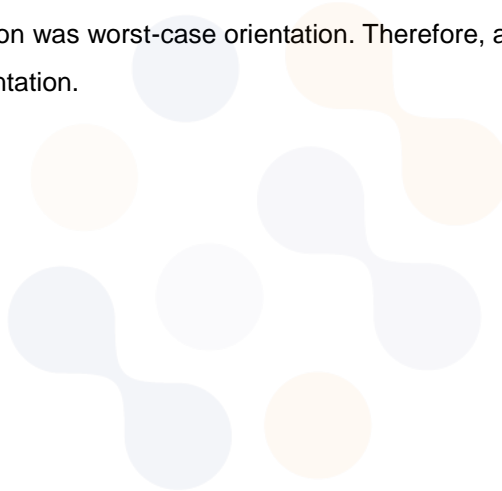

5. Summary of test results

5.1 Summary of EMI emission test results

Applied	Test items	Test method	Result
☒	Conducted Emission	ANSI C63.4:2014, Class B FCC Part 15 Subpart B	Pass
☒	Radiated Emission	ANSI C63.4:2014, Class B FCC Part 15 Subpart B	Pass



6. Test results

6.1 Conducted Emissions

Testing voltage	120 V, 60 Hz		
Test facility	Shielded room (CE#2)		
Date	2022-03-11		
Temperature (°C)	23.1 °C	Humidity (% R.H.)	36.1 % R.H.
Remarks	Pass		

6.1.1 Limits of conducted emissions measurement

Frequency [MHz]	Class A (dB(μ V))		Class B (dB(μ V))	
	Quasi-peak	Average	Quasi-peak	Average
0.15 ~ 0.5	79	66	66 ~ 56 ¹⁾	56 ~ 46 ¹⁾
0.5 ~ 5	73	60	56	46
5 ~ 30	73	60	60	50

¹⁾ The limit decreases linearly with the logarithm of frequency

6.1.2 Measurement procedure

The measurements were performed in a shielded room. EUT was setup as shown in photograph and placed on a non-metallic table height of 0.8 m above the reference ground plane. The rear of table was located 0.4 m to the vertical conducted plane. EUT was power through the LISN, which was bonded to the ground plane. The LISN power was filtered. Each EUT power lead, except ground (safety) lead was individually connected through a LISN to input power source. EUT signal cables that hung closer than 0.4 m to the Horizontal metal ground 0.3 m ~ 0.4 m long. The power cord was bundles in the center. All peripheral equipment was powered from a sub LISN. The LISN and ISN were positioned 0.8 m from the EUT. Peak and Average detection were used in preliminary testing and Quasi-peak and Average detections were used at final measurement.

6.1.3 Used equipments

Equipment	Model no.	Serial no.	Makers	Next Cal. Date	Used
EMI TEST RECEIVER	ESCI	100710	R&S	2022.04.14	<input checked="" type="checkbox"/>
TWO-LINE V-NETWORK	ENV216	101584	R&S	2022.04.05	<input checked="" type="checkbox"/>
TWO-LINE V-NETWORK	NNLK8121	8121-472	SCHWARZBECK	2022.08.19	<input type="checkbox"/>

KCTL Inc.

65, Sinwon-ro, Yeongtong-gu,
Suwon-si, Gyeonggi-do, 16677, Korea
Tel: 82-31-285-0894 Fax: 82-505-299-8311
www.kctl.co.kr

Report No.:
KR22-SEF0063-A
Page (16) of (21)



KCTL

6.1.4 Conducted emissions measurement result

AC Main

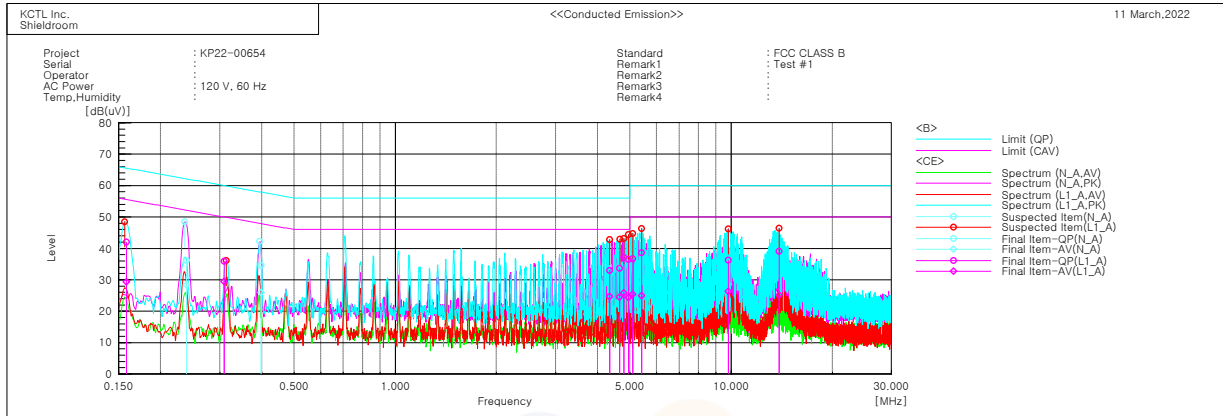

Final Result

--- N_A Phase ---

No.	Frequency [MHz]	Reading QP [dB(uV)]	Reading CAV [dB(uV)]	c.f [dB]	Result QP [dB(uV)]	Result CAV [dB(uV)]	Limit QP [dB(uV)]	Limit AV [dB(uV)]	Margin QP [dB]	Margin CAV [dB]
1	0.23874	26.5	18.7	9.6	36.1	28.3	62.1	52.1	26.0	23.8
2	0.39867	24.7	16.1	9.8	34.5	25.9	57.9	47.9	23.4	22.0

--- L1_A Phase ---

No.	Frequency [MHz]	Reading QP [dB(uV)]	Reading CAV [dB(uV)]	c.f [dB]	Result QP [dB(uV)]	Result CAV [dB(uV)]	Limit QP [dB(uV)]	Limit AV [dB(uV)]	Margin QP [dB]	Margin CAV [dB]
1	0.15824	32.2	19.6	9.8	42.0	29.4	65.6	55.6	23.6	26.2
2	0.3092	26.2	19.7	9.7	35.9	29.4	60.0	50.0	24.1	20.6
3	4.34202	23.1	14.8	9.8	32.9	24.6	56.0	46.0	23.1	21.4
4	4.65862	23.8	14.6	9.8	33.6	24.4	56.0	46.0	22.4	21.6
5	4.7946	27.3	16.0	9.8	37.1	25.8	56.0	46.0	18.9	20.2
6	4.93988	26.6	14.5	9.8	36.4	24.3	56.0	46.0	19.6	21.7
7	5.08869	26.9	15.5	9.8	36.7	25.3	60.0	50.0	23.3	24.7
8	5.41232	28.7	15.1	9.8	38.5	24.9	60.0	50.0	21.5	25.1
9	9.80612	26.0	16.1	10.2	36.2	26.3	60.0	50.0	23.8	23.7
10	13.88403	28.7	14.8	10.4	39.1	25.2	60.0	50.0	20.9	24.8

6.2 Radiated Emission

Testing voltage	120 V, 60 Hz		
Test facility	10 m Chamber (4F)		
Test distance	3 m		
Date	2022-03-11		
Temperature (°C)	20.9 °C	Humidity (% R.H.)	32.6 % R.H.
Remarks	Pass		

6.2.1 Limits of radiated emission measurement

Frequency [MHz]	Class A at 10 m QP(dB(μV/m))		Class B at 3 m QP(dB(μV/m))	
	FCC ¹⁾	ISED (ICES Issue 7)	FCC ¹⁾	ISED (ICES Issue 7)
30-88	39.1	40.0	40.0	40.0
88-216	43.5	43.5	43.5	43.5
216-230	46.4	46.4	46.0	46.0
230-960	46.4	47.0	46.0	47.0
Above 960	49.5	49.5	54.0	54.0

- ¹⁾: Alternative standard: CISPR, Pub. 22

- Test data in this section has been taken against the FCC 15.109(a) or (B) Limit as it is the most stringent limit.

By complying with more restrictive FCC 15.109 Limit compliance with the ICES-003 Issue 7 limit also demonstrated.

6.2.2 Measurement procedure

The test was done at a 10 m chamber with a quasi-peak detector. EUT was placed on a non-metallic table height of 0.8 m above the reference ground plane. Cables were folded back and forth forming a bundle 0.3 m to 0.4 m long and were hanged at a 0.4 m height to the ground plane.

Cables connected to EUT were fixed to cause maximum emission. Test was made with the antenna positioned in both the horizontal and vertical planes of polarization. The measurement antenna was varied in height above the conducting ground plane to obtain the maximum signal strength.

6.2.3 Used equipments

Equipment	Model no.	Serial no.	Makers	Next Cal. Date	Used
EMI TEST RECEIVER	ESR7	101078	R&S	2022.08.19	☒
Bilog Antenna	CBL 6112D	37876	TESEQ	2022.12.08	☒
AMPLIFIER	310N	293004	SONOMA	2022.08.19	☒
ATTENUATOR	8491B	MY39270292	AGILENT	-	☒
Antenna Mast	MA4640-XP-ET	-	Innco Systems	-	☒
Turn Table	TT 3.0-3t	-	MATURO	-	☒
DOUBLE RIDGED HORN ANTENNA	3117	00161083	ETS-LINDGREN	2023.01.21	☒
Horn antenna	3116	00086635	ETS-LINDGREN	2022.05.17	☒
AMPLIFIER	JS44-18004000-33-8P	2000996	L-3Narda-MITEQ	2023.01.21	☒
AMPLIFIER	LLA01185522Q-B	140	LTC MICROWAVE	2022.07.19	☒
Spectrum Analyzer	N9040B	MY57010132	AGILENT	2022.07.28	☒

6.2.4 Sample calculation

The field strength is calculated adding the antenna Factor, cable loss and, Antenna pad adding, subtracting the amplifier gain from the measured reading.

The sample calculation is as follow:

$$\text{Result} = \text{M.R} + \text{C.F}(\text{A.F} + \text{C.L} + 6 \text{ dB Att} - \text{A.G})$$

M.R = Meter Reading

C.F = Correction Factor

A.F = Antenna Factor

C.L = Cable Loss

A.G = Amplifier Gain

6 dB Att = 6 dB Attenuator

If M.R is 30 dB, A.F 12 dB, C.L 5 dB, 6 dB, A.G 35 dB

The result is $30 + 12 + 5 + 6 - 35 = 18 \text{ dB } (\mu\text{V/m})$

Bilog Antenna and ATTENUATOR (6 dB) were calibrated together.

AV = CAV : Abbreviation of CISPR Average

KCTL Inc.

65, Sinwon-ro, Yeongtong-gu,
Suwon-si, Gyeonggi-do, 16677, Korea
Tel: 82-31-285-0894 Fax: 82-505-299-8311
www.kctl.co.kr

Report No.:
KR22-SEF0063-A
Page (19) of (21)



KCTL

6.2.5 Radiated emission measurement result

30 MHz ~ 1 GHz

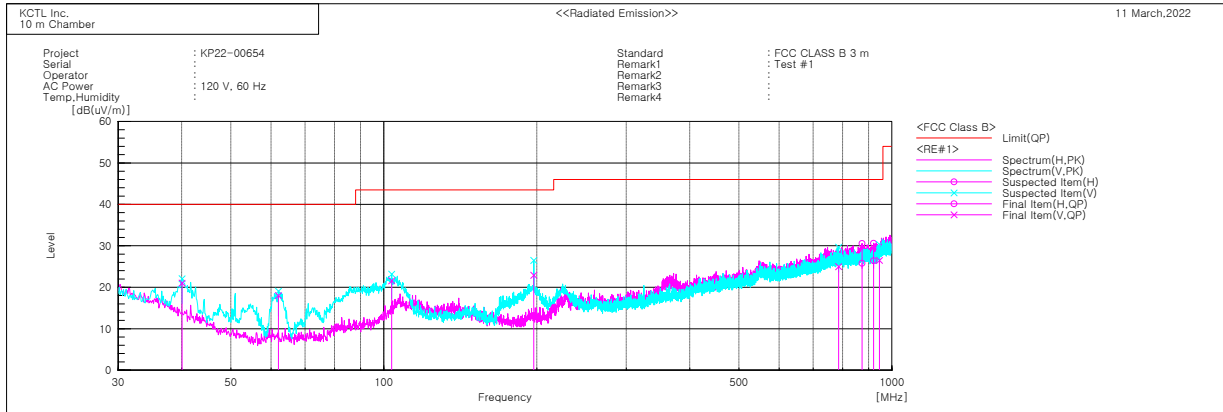

Final Result

No.	Frequency [MHz]	(P)	Reading [dB(uV)]	c.f [dB(1/m)]	Result [dB(uV/m)]	Limit [dB(uV/m)]	Margin [dB]	Height [cm]	Angle [deg]
1	40.064	V	31.0	-10.0	21.0	40.0	19.0	106.0	229.0
2	62.010	V	34.4	-16.4	18.0	40.0	22.0	101.0	306.0
3	103.599	V	32.0	-10.4	21.6	43.5	21.9	149.0	162.0
4	197.325	V	33.4	-10.5	22.9	43.5	20.6	202.0	166.0
5	785.630	V	15.9	9.1	25.0	46.0	21.0	199.0	77.0
6	873.900	H	15.8	10.0	25.8	46.0	20.2	372.0	231.0
7	920.703	H	16.2	10.2	26.4	46.0	19.6	117.0	42.0
8	945.316	V	15.4	11.1	26.5	46.0	19.5	110.0	223.0

KCTL Inc.

65, Sinwon-ro, Yeongtong-gu,
Suwon-si, Gyeonggi-do, 16677, Korea
Tel: 82-31-285-0894 Fax: 82-505-299-8311
www.kctl.co.kr

Report No.:
KR22-SEF0063-A
Page (20) of (21)



KCTL

1 GHz ~ 18 GHz

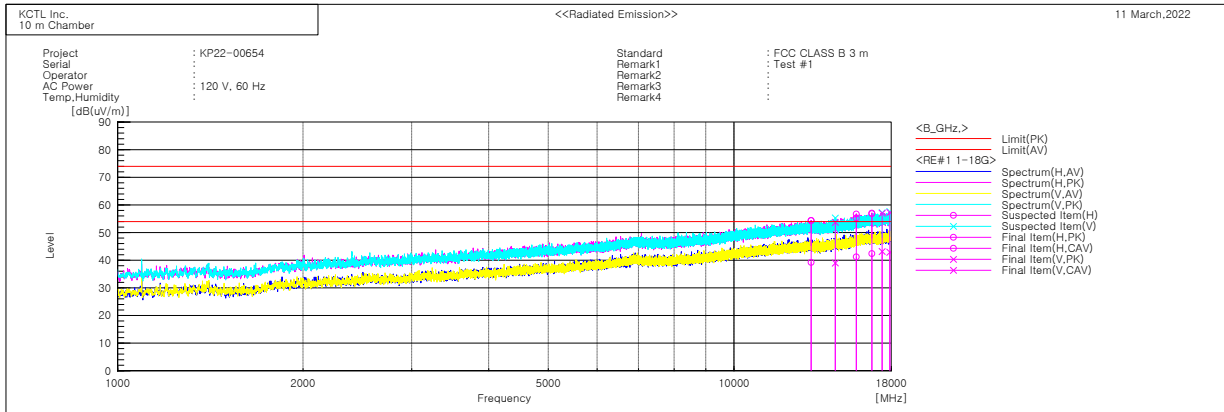

Final Result

No.	Frequency [MHz]	(P)	Reading PK [dB(uV)]	Reading CAV [dB(uV)]	c.f [dB(1/m)]	Result PK [dB(uV/m)]	Result CAV [dB(uV/m)]	Limit PK [dB(uV/m)]	Limit AV [dB(uV/m)]	Margin PK [dB]	Margin CAV [dB]	Height [cm]	Angle [deg]
1	13346.020	H	65.3	50.1	-10.9	54.4	39.2	74.0	54.0	19.6	14.8	110.0	33.0
2	14603.230	V	63.3	48.6	-9.6	53.7	39.0	74.0	54.0	20.3	15.0	198.0	219.0
3	15794.990	H	64.3	50.2	-9.0	55.3	41.2	74.0	54.0	18.7	12.8	228.0	31.0
4	16747.040	H	65.0	50.6	-8.2	56.8	42.4	74.0	54.0	17.2	11.6	101.0	291.0
5	17400.720	V	65.0	51.2	-8.0	57.0	43.2	74.0	54.0	17.0	10.8	399.0	294.0
6	17903.940	V	64.0	49.6	-6.7	57.3	42.9	74.0	54.0	16.7	11.1	104.0	352.0

KCTL Inc.

65, Sinwon-ro, Yeongtong-gu,
Suwon-si, Gyeonggi-do, 16677, Korea
Tel: 82-31-285-0894 Fax: 82-505-299-8311
www.kctl.co.kr

Report No.:
KR22-SEF0063-A
Page (21) of (21)



KCTL

18 GHz ~ 30 GHz

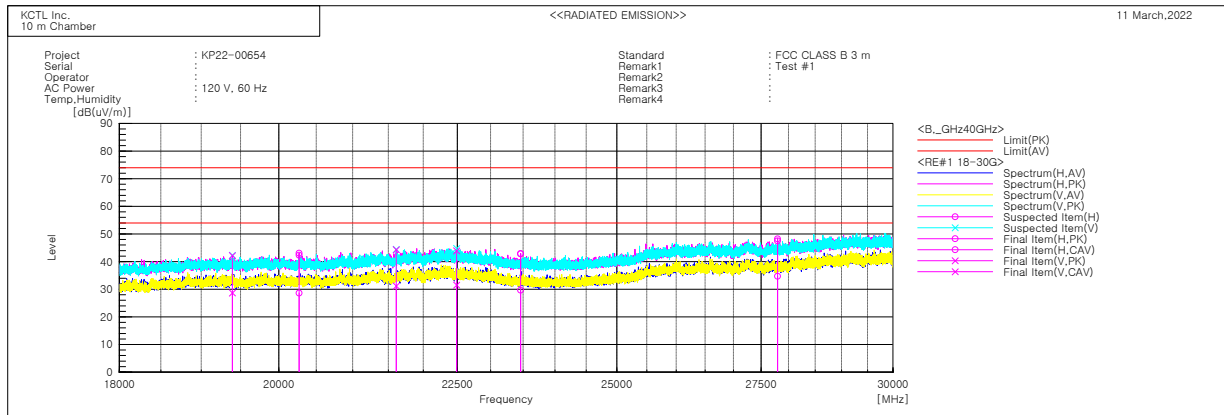

Final Result

No.	Frequency [MHz]	(P)	Reading PK [dB(uV)]	Reading CAV [dB(uV)]	c.f [dB(1/m)]	Result PK [dB(uV/m)]	Result CAV [dB(uV/m)]	Limit PK [dB(uV/m)]	Limit AV [dB(uV/m)]	Margin PK [dB]	Margin CAV [dB]	Height [cm]	Angle [deg]
1	19395.670	V	37.6	24.1	4.6	42.2	28.7	74.0	54.0	31.8	25.3	100.0	319.0
2	20268.110	H	37.0	23.3	5.3	42.3	28.6	74.0	54.0	31.7	25.4	168.0	301.0
3	21610.380	V	38.2	25.1	6.1	44.3	31.2	74.0	54.0	29.7	22.8	296.0	289.0
4	22490.620	V	37.0	24.6	6.9	43.9	31.5	74.0	54.0	30.1	22.5	221.0	101.0
5	23460.270	H	36.0	22.9	6.8	42.8	29.7	74.0	54.0	31.2	24.3	306.0	211.0
6	27797.890	H	38.6	25.8	8.9	47.5	34.7	74.0	54.0	26.5	19.3	210.0	198.0