



# CERTIFICATION TEST REPORT

**Report Number.** : 4790160849-E6V2

**Applicant** : SAMSUNG ELECTRONICS CO., LTD.  
129 SAMSUNG-RO, YEONGTONG-GU, SUWON-SI,  
GYEONGGI-DO, 16677, KOREA

**Model** : SM-A536E/DS, SM-A536E

**FCC ID** : A3LSMA536E

**EUT Description** : GSM/WCDMA/LTE/5G NR Phone + BT/BLE, DTS/UNII a/b/g/n/ac and  
NFC

**Test Standard(s)** : FCC 47 CFR PART 15 SUBPART E

**Date Of Issue:**  
2022-01-06

**Prepared by:**  
UL Korea, Ltd.  
26th floor, 152, Teheran-ro, Gangnam-gu Seoul, 06236, Korea

Suwon Test Site: UL Korea, Ltd. Suwon Laboratory  
218 Maeyeong-ro, Yeongtong-gu,  
Suwon-si, Gyeonggi-do, 16675, Korea  
TEL: (031) 337-9902  
FAX: (031) 213-5433



ACCREDITED

**Testing Laboratory**  
**TL-637**

Revision History

<u>Rev.</u>	<u>Issue Date</u>	<u>Revisions</u>	<u>Revised By</u>
V1	2021-12-29	Initial issue	Hyunsik Yun
V2	2022-01-06	Updated to address TCB's question	Hyunsik Yun

## TABLE OF CONTENTS

<b>1. ATTESTATION OF TEST RESULTS .....</b>	<b>5</b>
<b>2. TEST METHODOLOGY .....</b>	<b>6</b>
<b>3. FACILITIES AND ACCREDITATION .....</b>	<b>6</b>
<b>4. CALIBRATION AND UNCERTAINTY .....</b>	<b>6</b>
4.1. <i>MEASURING INSTRUMENT CALIBRATION .....</i>	<i>6</i>
4.2. <i>SAMPLE CALCULATION .....</i>	<i>6</i>
4.3. <i>MEASUREMENT UNCERTAINTY.....</i>	<i>7</i>
4.4. <i>DECISION RULE.....</i>	<i>7</i>
<b>5. EQUIPMENT UNDER TEST.....</b>	<b>8</b>
5.1. <i>DESCRIPTION OF EUT .....</i>	<i>8</i>
5.2. <i>DESCRIPTION OF AVAILABLE ANTENNAS .....</i>	<i>9</i>
5.3. <i>List of test reduction and modes covering other modes: .....</i>	<i>9</i>
5.4. <i>WORST-CASE CONFIGURATION AND MODE.....</i>	<i>10</i>
5.5. <i>DESCRIPTION OF TEST SETUP.....</i>	<i>12</i>
<b>6. TEST AND MEASUREMENT EQUIPMENT .....</b>	<b>14</b>
<b>7. SUMMARY TABLE .....</b>	<b>15</b>
<b>8. MEASUREMENT METHODS .....</b>	<b>16</b>
<b>9. REFERENCE MEASUREMENTS RESULTS .....</b>	<b>17</b>
9.1. <i>ON TIME AND DUTY CYCLE RESULTS.....</i>	<i>17</i>
9.2. <i>DUTY CYCLE PLOTS .....</i>	<i>17</i>
9.3. <i>26 dB BANDWIDTH.....</i>	<i>18</i>
9.3.1. <i>802.11a.....</i>	<i>19</i>
9.3.2. <i>802.11n HT20.....</i>	<i>19</i>
9.3.3. <i>802.11n HT40.....</i>	<i>19</i>
9.3.4. <i>802.11ac VHT80.....</i>	<i>20</i>
9.3.5. <i>STRADDLE CHANNEL.....</i>	<i>20</i>
<b>10. ANTENNA PORT TEST RESULTS.....</b>	<b>21</b>
10.1. <i>6 dB BANDWIDTH .....</i>	<i>21</i>
10.1.1. <i>UNII-3 &amp; 4 BAND .....</i>	<i>22</i>
10.2. <i>OUTPUT POWER AND PPSD .....</i>	<i>23</i>
10.2.1. <i>802.11a MODE .....</i>	<i>25</i>
10.2.2. <i>802.11n HT20 MODE .....</i>	<i>26</i>

10.2.3.	802.11n HT40 MODE .....	27
10.2.4.	802.11ac VHT80 MODE .....	28
10.2.5.	STRADDLE CHANNEL.....	29
10.2.6.	OUTPUT POWER AND PPSD PLOTS (WORST CASE).....	30
<b>11.</b>	<b>TRANSMITTER ABOVE 1 GHz.....</b>	<b>35</b>
11.1.	TX ABOVE 1GHz 1Tx MODE IN THE 5.2GHz BAND.....	38
11.2.	TX ABOVE 1GHz 1Tx MODE IN THE 5.3GHz BAND.....	42
11.3.	TX ABOVE 1GHz 1Tx MODE IN THE 5.5 GHz BAND.....	46
11.4.	TX ABOVE 1GHz 1Tx MODE IN THE 5.8 GHz BAND.....	50
11.5.	TX ABOVE 1GHz 1Tx MODE IN THE 5.9 GHz BAND.....	54
<b>12.</b>	<b>WORST-CASE BELOW 1 GHz .....</b>	<b>58</b>
<b>13.</b>	<b>AC POWER LINE CONDUCTED EMISSIONS .....</b>	<b>59</b>
<b>14.</b>	<b>DYNAMIC FREQUENCY SELECTION.....</b>	<b>62</b>
14.1.	OVERVIEW.....	62
14.1.1.	LIMITS.....	62
14.1.2.	TEST AND MEASUREMENT SYSTEM.....	65
14.1.3.	SETUP OF EUT.....	68
14.1.4.	DESCRIPTION OF EUT .....	69
14.2.	RESULTS FOR 80 MHz BANDWIDTH (UNII-2A BAND).....	70
14.2.1.	TEST CHANNEL .....	70
14.2.2.	RADAR WAVEFORM AND TRAFFIC.....	70
14.2.3.	OVERLAPPING CHANNEL TESTS.....	71
14.2.4.	MOVE AND CLOSING TIME .....	71
14.3.	RESULTS FOR 80 MHz BANDWIDTH (UNII-2C BAND).....	74
14.3.1.	TEST CHANNEL .....	74
14.3.2.	RADAR WAVEFORM AND TRAFFIC.....	74
14.3.3.	OVERLAPPING CHANNEL TESTS.....	75
14.3.4.	MOVE AND CLOSING TIME .....	75

# 1. ATTESTATION OF TEST RESULTS

**COMPANY NAME:** SAMSUNG ELECTRONICS CO., LTD.  
**EUT DESCRIPTION:** GSM/WCDMA/LTE/5G NR Phone + BT/BLE, DTS/UNII a/b/g/n/ac and NFC  
**MODEL NUMBER:** SM-A536E/DS, SM-A536E  
**SERIAL NUMBER:** R3CRA0RNS7M, R3CRA0RNQHP (CONDUCTED); R3CRA0RNRAJ, R3CRA0RNTME (RADIATED);  
**DATE TESTED:** 2021-11-19 ~ 2021-12-29;

APPLICABLE STANDARDS	
STANDARD	TEST RESULTS
CFR 47 Part 15 Subpart E	Complies

UL Korea, Ltd. tested the above equipment in accordance with the requirements set forth in the above standards. All indications of Pass/Fail in this report are opinions expressed by UL Korea, Ltd. based on interpretations and/or observations of test results. Measurement Uncertainties were not taken into account and are published for informational purposes only. The test results show that the equipment tested is capable of demonstrating compliance with the requirements as documented in this report.

**Note:** The results documented in this report apply only to the tested sample, under the conditions and modes of operation as described herein. This document may not be altered or revised in any way unless done so by UL Korea, Ltd. and all revisions are duly noted in the revisions section. Any alteration of this document not carried out by UL Korea, Ltd. will constitute fraud and shall nullify the document. This report must not be used by the client to claim product certification, approval, or endorsement by IAS, any agency of the Federal Government, or any agency of any government.

Approved & Released For  
UL Korea, Ltd. By:



Seokhwan Hong  
Suwon Lab Engineer  
UL Korea, Ltd.

Tested By:



Hyunsik Yun  
Suwon Lab Engineer  
UL Korea, Ltd.

## 2. TEST METHODOLOGY

The tests documented in this report were performed in accordance with following methods.

1. FCC CFR 47 Part 2.
2. FCC CFR 47 Part 15.
3. KDB 789033 D02 General UNII Test Procedures New Rules v02r01
4. KDB 905462 D02 UNII DFS Compliance Procedures New Rules v02
5. KDB 905462 D03 UNII Clients Without Radar Detection New Rules v01r02
6. KDB 291071 DR01-44460(Sept 21, 2021)
7. ANSI C63.10-2013.

## 3. FACILITIES AND ACCREDITATION

The test sites and measurement facilities used to collect data are located at 218 Maeyeong-ro, Yeongtong-gu, Suwon-si, Gyeonggi-do, 16675, Korea. Line conducted emissions are measured only at the 218 address. The following table identifies which facilities were utilized for radiated emission measurements documented in this report. Specific facilities are also identified in the test results sections.

218 Maeyeong-ro	
<input checked="" type="checkbox"/>	Chamber 1
<input checked="" type="checkbox"/>	Chamber 2
<input checked="" type="checkbox"/>	Chamber 3

UL Korea, Ltd. is accredited by IAS, Laboratory Code TL-637. The full scope of accreditation can be viewed at <https://www.iasonline.org/wp-content/uploads/2017/05/TL-637-cert-New.pdf>.

## 4. CALIBRATION AND UNCERTAINTY

### 4.1. MEASURING INSTRUMENT CALIBRATION

The measuring equipment utilized to perform the tests documented in this report has been calibrated in accordance with the manufacturer's recommendations, and is traceable to recognized national standards.

### 4.2. SAMPLE CALCULATION

Where relevant, the following sample calculation is provided:

$$\begin{aligned} \text{Field Strength (dBuV/m)} &= \text{Measured Voltage (dBuV)} + \text{Antenna Factor (dB/m)} + \\ &\text{Cable Loss (dB)} - \text{Preamp Gain (dB)} \\ 36.5 \text{ dBuV} + 18.7 \text{ dB/m} + 0.6 \text{ dB} - 26.9 \text{ dB} &= 28.9 \text{ dBuV/m} \end{aligned}$$

### 4.3. MEASUREMENT UNCERTAINTY

Where relevant, the following measurement uncertainty levels have been estimated for tests performed on the apparatus:

PARAMETER	UNCERTAINTY
Conducted Disturbance, 0.15 to 30 MHz	3.02 dB
Radiated Disturbance, 30 MHz to 1 GHz	4.05 dB
Radiated Disturbance, 1 GHz to 18 GHz	5.78 dB
Radiated Disturbance, 18 GHz to 40 GHz	5.58 dB

Uncertainty figures are valid to a confidence level of 95%.

### 4.4. DECISION RULE

Decision rule for statement(s) of conformity is based on Procedure 2, Clause 4.4.3 in IEC Guide 115:2007.

## 5. EQUIPMENT UNDER TEST

### 5.1. DESCRIPTION OF EUT

The EUT is a GSM/WCDMA/LTE/5G NR Phone + BT/BLE, DTS/UNII a/b/g/n/ac and NFC.  
 This test report addresses the NII (WLAN) operational mode.

This report covers the Samsung models SM-A536E/DS and SM-A536E.  
 These models are identical in hardware except SM-A536E has single SIM tray.  
 With some pre-scan, model SM-A536E/DS was set for final test.

#### WiFi operating mode

Frequency range	Mode	Ant.
5GHz (5180 MHz ~ 5885 MHz)	802.11a SISO	TX/RX
	802.11n SISO	TX/RX
	802.11ac SISO	TX/RX

#### MAXIMUM OUTPUT POWER

The transmitter has a maximum total conducted average output power as follows:

Band	Frequency Range [MHz]	Mode	Output Power [dBm]	ANT Gain [mW]	e.i.r.p [dBm]	Output Power [mW]
UNII-1	5180 - 5240	802.11a	12.92	-	-	19.59
		802.11n(HT20)	12.88	-	-	19.41
	5190 - 5230	802.11n(HT40)	12.12	-	-	16.29
		5210	802.11ac(VHT80)	10.11	-	-
UNII-2A	5260 - 5320	802.11a	12.70	-	-	18.62
		802.11n(HT20)	12.41	-	-	17.42
	5190 - 5230	802.11n(HT40)	12.04	-	-	16.00
		5270 - 5310	802.11ac(VHT80)	6.60	-	-
UNII-2C	5500 - 5720	802.11a	15.35	-	-	34.28
		802.11n(HT20)	15.09	-	-	32.28
	5510 - 5710	802.11n(HT40)	12.83	-	-	19.19
		5530 - 5690	802.11ac(VHT80)	11.84	-	-
UNII-3	5745 - 5825	802.11a	14.02	-	-	25.23
		802.11n(HT20)	13.95	-	-	24.83
	5755 - 5795	802.11n(HT40)	13.52	-	-	22.49
		5775	802.11ac(VHT80)	11.40	-	-
UNII-4 <sup>note1</sup>	5845 - 5885	802.11a	12.33	-5.40	6.93	4.93
		802.11n(HT20)	12.28	-5.40	6.88	4.88
	5835 - 5875	802.11n(HT40)	13.61	-5.40	8.21	6.62
		5855	802.11ac(VHT80)	11.70	-5.40	6.30

Note1. e.i.r.p = Output power [dBm] + ANT Gain [dBi]



## 5.2. DESCRIPTION OF AVAILABLE ANTENNAS

An intentional radiator antenna shall be designed to ensure that no antenna other than that furnished by the responsible party can be used with the device. The use of a permanently attached antenna or of an antenna that uses a unique coupling to the intentional radiator shall be considered sufficient to comply with the provisions of this section.

**The internal antenna was Permanently attached.  
 Therefore this E.U.T Complies with the requirement of §15.203.**

The radio utilizes a internal antenna, with a maximum gain of:

Frequency Band [MHz]	ANT Gain [dBi]
UNII 1 5150 - 5250	-4.10
UNII 2A 5250 - 5350	-4.10
UNII 2C 5470 - 5725	-4.70
UNII 3 5725 - 5850	-5.40
UNII 4 5850 - 5925	-5.40

## 5.3. List of test reduction and modes covering other modes:

The output power on covered modes is equal to or less than one referenced.

Authorized Frequency Band			
Mode	Antenna Stream	Mode	Covered by
802.11a	SISO	802.11a 1TX	
802.11n HT20		802.11n HT20 1TX	
802.11ac VHT20		802.11ac VHT20 1TX	802.11n HT20 1TX
802.11n HT40		802.11n HT40 1TX	
802.11ac VHT40		802.11ac VHT40 1TX	802.11n HT40 1TX
802.11ac VHT80		802.11ac VHT80 1TX	

Note. The target power is the same, and there is no difference in 11ac(VHT20,40) mode and 11n(HT20,40) spot-check data. Test data was reported in 11n(HT20, 40) modes.



**Test case configuration for 802.11a, 802.11n HT20 & 40, 802.11ac VHT20 & 40 & 80 modes :**

Mode	Band	SISO Target[dBm]		
		802.11a	802.11n	802.11ac
5GHz (20 MHz)	UNII-1	12	12	12
	UNII-2A	12	12 (CH64: 8)	12 (CH64: 8)
	UNII-2C	15	15 (CH140:13)	15 (CH140:13)
	UNII-3	14	14	14
	UNII-4	12	12	12
5GHz (40 MHz)	UNII-1		12	12
	UNII-2A		12	12
	UNII-2C		13	13
	UNII-3		14	14
	UNII-4		14	14
5GHz (80 MHz)	UNII-1			10
	UNII-2A			6
	UNII-2C			12
	UNII-3			12
	UNII-4			12

Note. Compared to the 802.11a mode, target power is the same or lower and the density is low, so only the spot-check test was performed in the 802.11n & 802.11ac mode. Spot check test was performed in the worst tested band of 802.11a mode.

## 5.5. DESCRIPTION OF TEST SETUP

### SUPPORT EQUIPMENT

Support Equipment List				
Description	Manufacturer	Model	Serial Number	FCC ID
Charger	SAMSUNG	EP-TA800	R37N3MAH988DK3	N/A
Data Cable	SAMSUNG	EP-DN980	N/A	N/A

### I/O CABLE

I/O Cable List						
Cable No.	Port	# of identical ports	Connector Type	Cable Type	Cable Length (m)	Remarks
1	DC Power	1	C Type	Shielded	1.0 m	N/A

### TEST SETUP

The EUT is a stand-alone unit during the tests.  
Test software exercised the EUT to enable NII mode.

**SETUP DIAGRAM FOR TESTS (CONDUCTED TEST SETUP)**

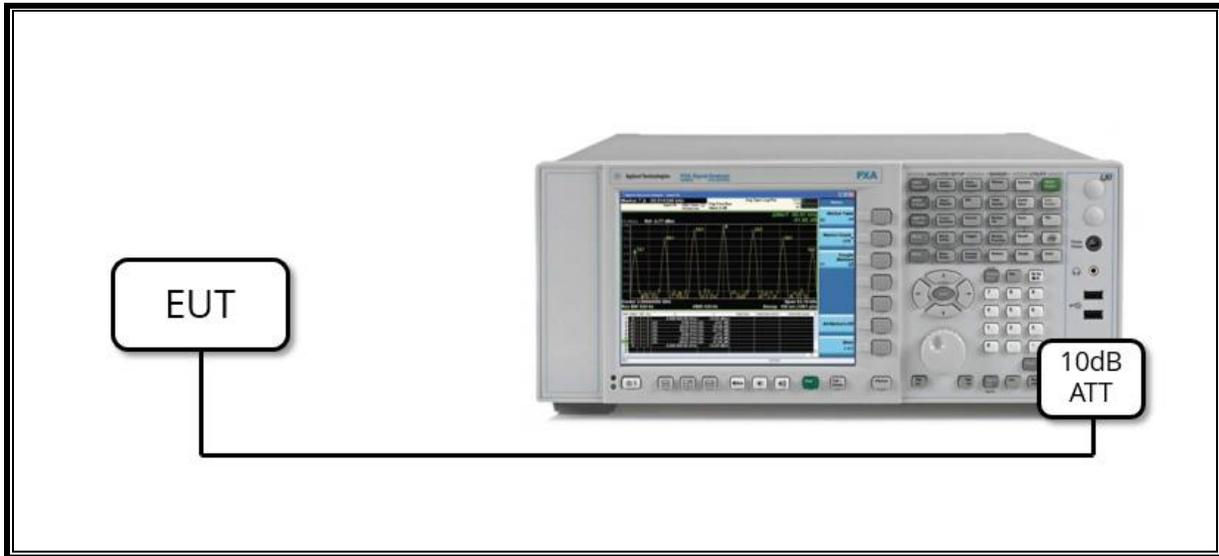

**SETUP DIAGRAM FOR TESTS (RADIATED TEST SETUP)**

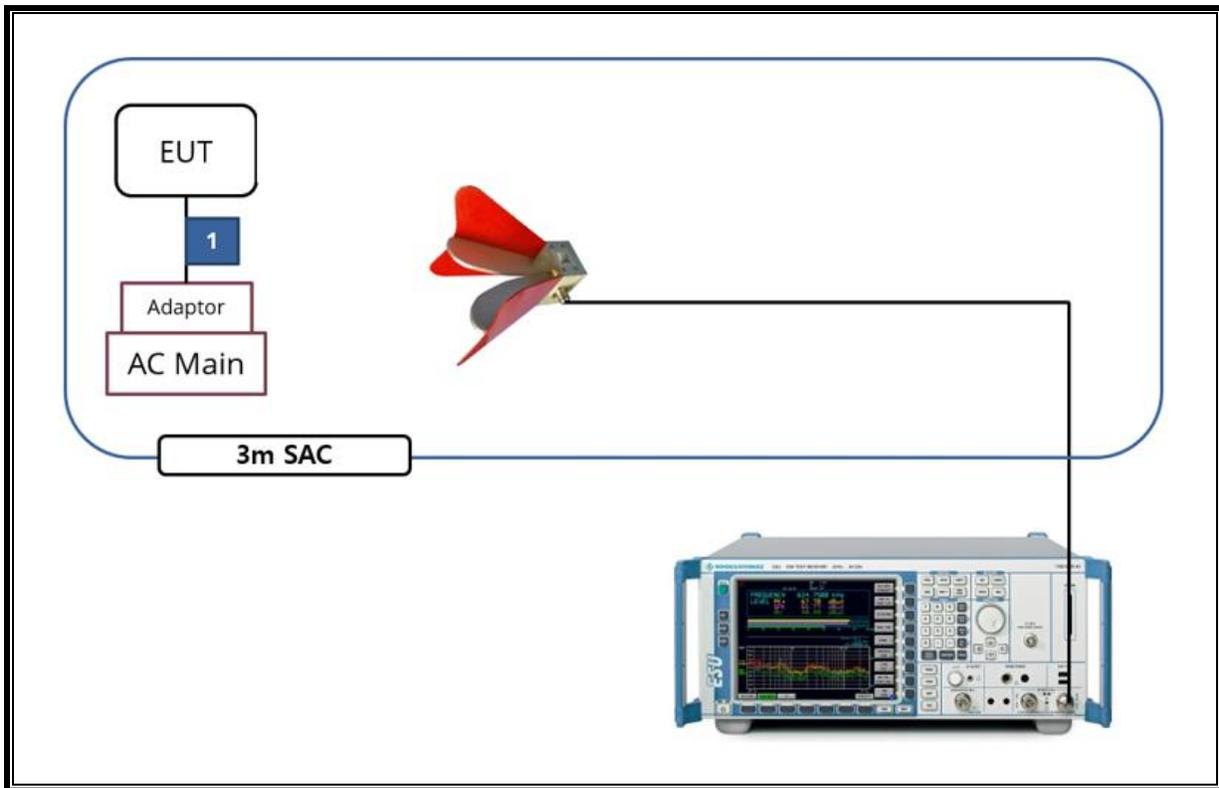

## 6. TEST AND MEASUREMENT EQUIPMENT

The following test and measurement equipment was utilized for the tests documented in this report:

Test Equipment List				
Description	Manufacturer	Model	S/N	Cal Due
Antenna, Bilog, 30MHz-1GHz	SCHWARZBECK	VULB9163	750	2022-08-19
Antenna, Bilog, 30MHz-1GHz	SCHWARZBECK	VULB9163	749	2022-08-13
Antenna, Bilog, 30MHz-1GHz	SCHWARZBECK	VULB9163	845	2022-08-13
Antenna, Horn, 18 GHz	ETS	3115	00167211	2022-07-27
Antenna, Horn, 18 GHz	ETS	3115	00161451	2022-08-15
Antenna, Horn, 18 GHz	ETS	3117	00168724	2022-07-27
Antenna, Horn, 18 GHz	ETS	3117	00168717	2022-08-15
Antenna, Horn, 18 GHz	ETS	3117	00218957	2023-01-15
Antenna, Horn, 40 GHz	ETS	3116C	00166155	2023-01-15
Antenna, Horn, 40 GHz	ETS	3116C	00168645	2023-10-13
Preamplifier	ETS	3116C-PA	00168841	2022-08-04
Preamplifier, 1000 MHz	Sonoma	310N	341282	2022-08-02
Preamplifier, 1000 MHz	Sonoma	310N	351741	2022-08-02
Preamplifier, 1000 MHz	Sonoma	310N	370599	2022-08-02
Preamplifier, 18 GHz	Miteq	AFS42-00101800-25-S-42	1876511	2022-08-02
Preamplifier, 18 GHz	Miteq	AFS42-00101800-25-S-42	1896138	2022-08-02
Preamplifier, 18 GHz	Miteq	AFS42-00101800-25-S-42	2029168	2022-08-02
Spectrum Analyzer, 44 GHz	Agilent / HP	N9030A	MY54170614	2022-08-04
Spectrum Analyzer, 44 GHz	Agilent / HP	N9030A	MY54490312	2022-08-04
Average Power Sensor	Agilent / HP	U2000	MY54270007	2022-08-04
Average Power Sensor	Agilent / HP	U2000	MY54260010	2022-08-04
Attenuator	PASTERNAK	PE7087-10	A001	2022-08-03
Attenuator	PASTERNAK	PE7087-10	A008	2022-08-03
Attenuator	PASTERNAK	PE7004-10	2	2022-08-02
Attenuator	PASTERNAK	PE7087-10	A009	2022-08-03
EMI Test Receive, 40 GHz	R&S	ESU40	100439	2022-08-02
EMI Test Receive, 40 GHz	R&S	ESU40	100457	2022-08-02
EMI Test Receive, 3 GHz	R&S	ESR3	101832	2022-08-02
Notch Filter	Micro-Tronics	BRM50702-02	G037	2022-08-03
Notch Filter	Micro-Tronics	BRM50716-2	006	2022-08-02
Low Pass Filter 5GHz	Micro-Tronics	LPS17541	009	2022-08-02
Low Pass Filter 5GHz	Micro-Tronics	LPS17541	015	2022-08-02
Low Pass Filter 5GHz	Micro-Tronics	LPS17541	019	2022-08-02
High Pass Filter 3GHz	Micro-Tronics	HPM17543	010	2022-08-02
High Pass Filter 3GHz	Micro-Tronics	HPM17543	015	2022-08-02
High Pass Filter 3GHz	Micro-Tronics	HPM17543	020	2022-08-02
High Pass Filter 6GHz	Micro-Tronics	HPS17542	009	2022-08-02
High Pass Filter 6GHz	Micro-Tronics	HPS17542	016	2022-08-02
High Pass Filter 6GHz	Micro-Tronics	HPS17542	020	2022-08-02
LISN	R&S	ENV-216	101837	2022-08-05
Antenna, Loop, 9kHz-30MHz	R&S	HFH2-Z2	100418	2023-10-06
Termination	WEINSCHTEL	M1406A	T09	2022-08-03
Attenuator	WEINSCHTEL	WA76-30-21	A015	2022-08-03
UL Software				
Description	Manufacturer	Model	Version	
Radiated software	UL	UL EMC	Ver 9.5	
AC Line Conducted software	UL	UL EMC	Ver 9.5	

## 7. SUMMARY TABLE

FCC Part Section	Test Description	Test Limit	Test Condition	Test Result
15.407(e)	6dB Band width (5.8GHz)	> 500kHz	Conducted	Complies
15.407 (a)(1)(iv)	TX Cond. Power (5.150-5.250)	< 24dBm		Complies
15.407 (a)(2)	TX Cond. Power (5.250-5.350 & 5.470-5.725)	< 24dBm or 11+10Log(26dB BW)		Complies
15.407 (a)(3)(i)	TX Cond. Power (5.725-5.850)	< 30dBm		Complies
15.407 (a)(3)(iii)	TX Cond. Power (5.850-5.895)	< 30dBm e.i.r.p.		Complies
15.407 (a)(1)(iv) & (a)(2)	PSD (5.150-5.250 5.250-5.350 & 5.470-5.725)	< 11dBm/MHz		Complies
15.407 (a)(3)	PSD (5.725-5.850)	< 30dBm/500kHz		Complies
15.407 (a)(3)(iii)	PSD (5.850-5.895)	< 14dBm/MHz e.i.r.p.		Complies
15.207 (a)	AC Power Line conducted emissions	Section 13		Radiated
15.407 (b) & 15.209	Radiated Spurious Emission	< 74dBuV/m PK < 54dBuV/m AV	Complies	
15.407 (h)(2)	Dynamic Frequency Selection	N/A	Conducted	Complies <sup>Note</sup>

Note. This EUT does not support channel puncturing.

## 8. MEASUREMENT METHODS

On-Time and Duty Cycle : KDB 789033 D02 v02r01, Section II.B.

6dB Emission BW : KDB 789033 D02 v02r01, Section II.C.2.

26dB Emission BW : KDB 789033 D02 v02r01, Section II.C.1.

99% Occupied BW : KDB 789033 D02 v02r01, Section II.D.

Conducted Output Power : KDB 789033 D02 v02r01, Section II.E.3.b(Method PM-G)

Conducted Output Power for Straddle Channel (ch144/142/138 for 20/40/80MHz BW):

KDB 789033 D02 v02r01, Section II.E.2.b(Method SA-1)

Power Spectral Density : KDB 789033 D02 v02r01, Section II.F.

Unwanted emissions in restricted bands : KDB 789033 D02 v02r01, Section II.G.3 – II.G.6.

Unwanted emissions in non-restricted bands : KDB 789033 D02 v02r01, Section II.G.3 – II.G.6.

AC Power Line Conducted Emission : ANSI C63.10-2013, Section 6.2.



## 9. REFERENCE MEASUREMENTS RESULTS

### 9.1. ON TIME AND DUTY CYCLE RESULTS

Mode	On Time [ms]	Period [ms]	Duty Cycle X [Linear]	Duty Cycle X [%]	Duty Cycle Correction Factor[dB]
802.11a	2.792	2.900	0.963	96.276	0.16
802.11n(HT20)	2.596	2.721	0.954	95.406	0.20
802.11n(HT40)	2.492	2.599	0.959	95.883	0.18
802.11ac(VHT80)	1.972	2.088	0.944	94.444	0.25

Note. If the duty cycle is over 98%, compensation is not included in average measurement.

#### LIMITS

None; for reporting purposes only.

#### PROCEDURE

KDB 789033 D02 v02r01 Zero-Span Spectrum Analyzer Method.

### 9.2. DUTY CYCLE PLOTS



### 9.3. 26 dB BANDWIDTH

#### LIMITS

None; for reporting purposes only.

#### TEST PROCEDURE

Reference to 789033 D02 General UNII Test Procedures New Rules v02r01: The transmitter output is connected to a spectrum analyzer with the RBW set to approximately 1% of EBW, the VBW > RBW, peak detector and max hold.

#### RESULTS

- Please refer to the next page

#### WORST CASE TEST PLOTS

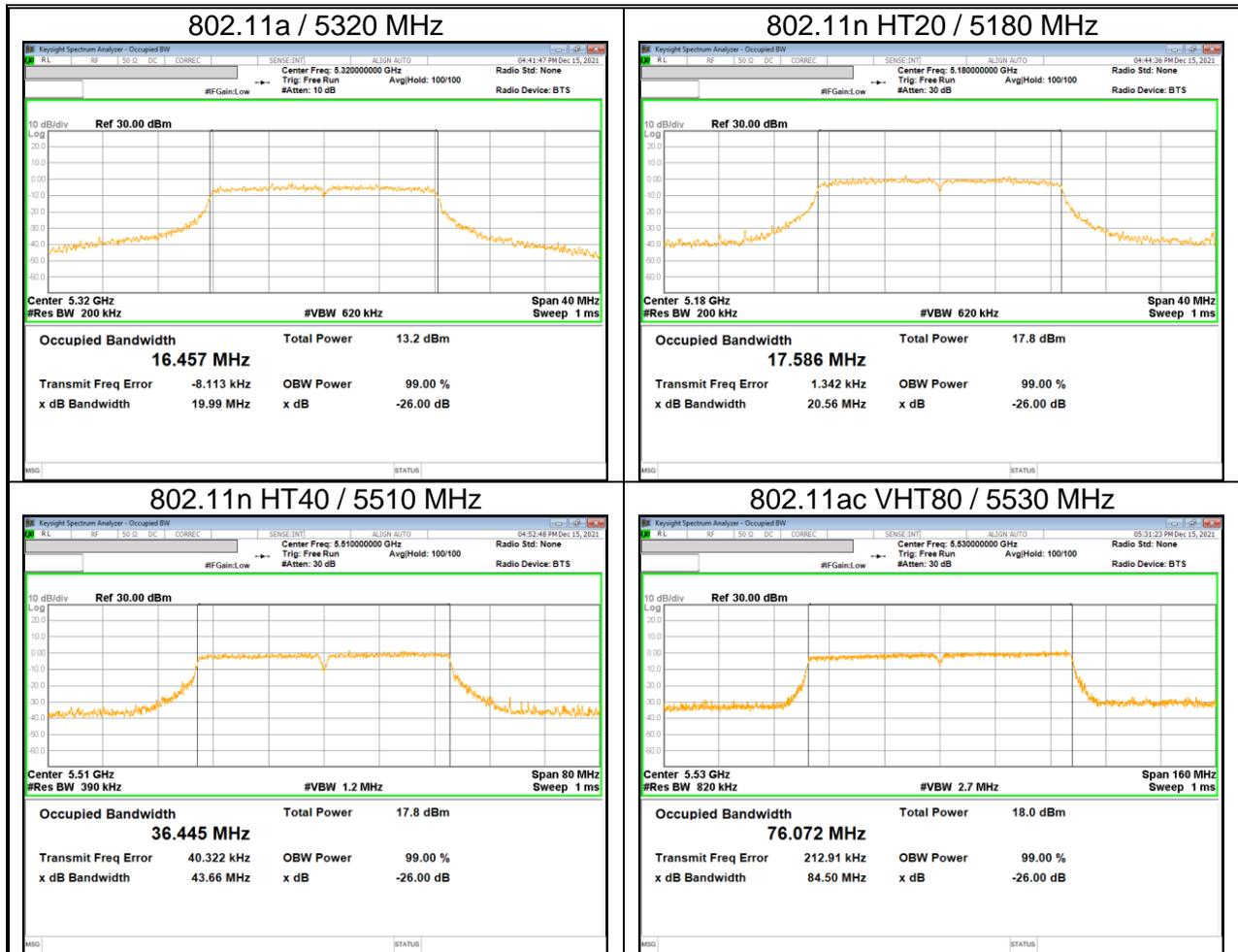

**9.3.1. 802.11a**

Band	Channel	Center Freq. [MHz]	26 dB BW [MHz]	Worst	99% BW [MHz]
UNII-1 <sup>Note</sup>	36	5180	20.42	20.22	16.47
	40	5200	20.22		16.43
	48	5240	20.66		16.48
UNII-2A <sup>Note</sup>	52	5260	20.50	19.99	16.47
	60	5300	20.12		16.43
	64	5320	19.99		16.46
UNII-2C	100	5500	21.79	20.87	
	116	5580	20.87		
	140	5700	22.53		

Note. As a result of 99% bandwidth test, the bandwidth of UNII-1 does not interfere with UNII-2A.

**9.3.2. 802.11n HT20**

Band	Channel	Center Freq. [MHz]	26 dB BW [MHz]	Worst	99% BW [MHz]
UNII-1 <sup>Note</sup>	36	5180	20.56	20.56	17.59
	40	5200	20.66		17.59
	48	5240	20.58		17.58
UNII-2A <sup>Note</sup>	52	5260	20.87	20.80	17.59
	60	5300	21.16		17.59
	64	5320	20.80		17.60
UNII-2C	100	5500	23.41	21.12	
	116	5580	21.97		
	140	5700	21.12		

Note. As a result of 99% bandwidth test, the bandwidth of UNII-1 does not interfere with UNII-2A.

**9.3.3. 802.11n HT40**

Band	Channel	Center Freq. [MHz]	26 dB BW [MHz]	Worst	99% BW [MHz]
UNII-1 <sup>Note</sup>	38	5190	49.33	44.95	36.57
	46	5230	44.95		36.47
UNII-2A <sup>Note</sup>	54	5270	44.44	44.44	36.49
	62	5310	44.45		36.43
UNII-2C	102	5510	43.66	43.66	
	118	5590	44.93		
	134	5670	43.97		

Note. As a result of 99% bandwidth test, the bandwidth of UNII-1 does not interfere with UNII-2A.

**9.3.4. 802.11ac VHT80**

Band	Channel	Center Freq. [MHz]	26 dB BW [MHz]	Worst	99% BW [MHz]
UNII-1 <sup>Note</sup>	42	5210	86.38	86.38	76.07
UNII-2A <sup>Note</sup>	58	5290	87.45	87.45	76.13
UNII-2C	106	5530	84.50	84.50	
	122	5610	85.49		

Note. As a result of 99% bandwidth test, the bandwidth of UNII-1 does not interfere with UNII-2A.

**9.3.5. STRADDLE CHANNEL**

Mode	Channel	Center Freq. [MHz]	26 dB BW [MHz]	
			UNII-2C	UNII-3
802.11a	Straddle	5720	15.34	5.74
802.11n HT20	Straddle	5720	16.20	7.64
802.11n HT40	Straddle	5710	38.14	7.66
802.11ac VHT80	Straddle	5690	77.96	8.73

# 10. ANTENNA PORT TEST RESULTS

## 10.1. 6 dB BANDWIDTH

### LIMITS

FCC §15.407

The minimum 6 dB bandwidth shall be at least 500 kHz.

### TEST PROCEDURE

Reference to 789033 D02 General UNII Test Procedures New Rules v02r01: The transmitter output is connected to a spectrum analyzer with the RBW set to 100kHz, the VBW >= 3 x RBW, peak detector and max hold.

### RESULTS

- Please refer to the next page

### WORST CASE TEST PLOTS

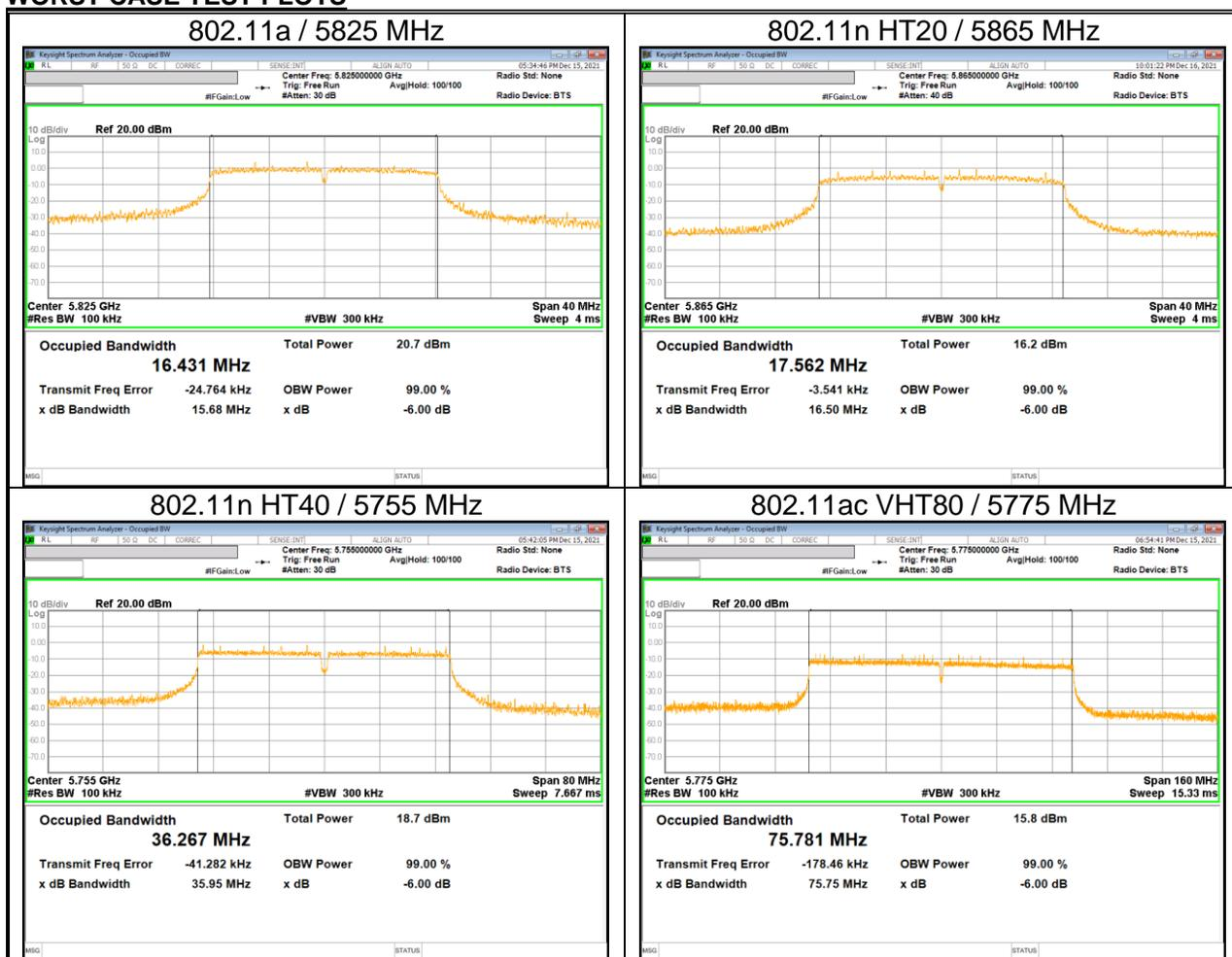

**10.1.1. UNII-3 & 4 BAND**

Mode	Channel	Center Freq. [MHz]	6 dB BW [MHz]	Worst	Minimum Limit [MHz]
802.11a	149	5745	16.29	15.68	0.5
	157	5785	16.31		
	165	5825	15.68		
	169	5845	16.31		
	173	5865	16.35		
	177	5885	16.05		
802.11n HT20	149	5745	17.04	16.50	
	157	5785	16.92		
	165	5825	16.67		
	169	5845	17.57		
	173	5865	16.50		
	177	5885	17.58		
802.11n HT40	151	5755	35.95	35.95	
	159	5795	36.33		
	167	5835	36.32		
	175	5875	36.32		
802.11ac VHT80	155	5775	75.75	75.75	
	171	5855	75.76		

## 10.2. OUTPUT POWER AND PPSD

### LIMITS

FCC §15.407 (a)(1)(iv), (a)(2), (a)(3)(i), (a)(3)(iii)

### FCC

For client devices in the 5.15-5.25 GHz band, the maximum conducted output power over the frequency band of operation shall not exceed 250 mW provided the maximum antenna gain does not exceed 6 dBi. In addition, the maximum power spectral density shall not exceed 11 dBm in any 1 megahertz band. If transmitting antennas of directional gain greater than 6 dBi are used, both the maximum conducted output power and the maximum power spectral density shall be reduced by the amount in dB that the directional gain of the antenna exceeds 6 dBi.

For the 5.25-5.35 GHz and 5.47-5.725 GHz bands, the maximum conducted output power over the frequency bands of operation shall not exceed the lesser of 250 mW or  $11 \text{ dBm} + 10 \log B$ , where B is the 26 dB emission bandwidth in megahertz. In addition, the maximum power spectral density shall not exceed 11 dBm in any 1 megahertz band. If transmitting antennas of directional gain greater than 6 dBi are used, both the maximum conducted output power and the maximum power spectral density shall be reduced by the amount in dB that the directional gain of the antenna exceeds 6 dBi.

For the band 5.725-5.850 GHz, the maximum conducted output power over the frequency band of operation shall not exceed 1 W. In addition, the maximum power spectral density shall not exceed 30 dBm in any 500-kHz band. If transmitting antennas of directional gain greater than 6 dBi are used, both the maximum conducted output power and the maximum power spectral density shall be reduced by the amount in dB that the directional gain of the antenna exceeds 6 dBi.

For client devices operating under the control of an indoor access point in the 5.850-5.895 GHz band, the maximum power spectral density must not exceed 14 dBm e.i.r.p. in any 1-megahertz band, and the maximum e.i.r.p. over the frequency band of operation must not exceed 30 dBm. Client devices operating on a channel that spans the 5.725-5.850 GHz and 5.850-5.895 GHz bands must not exceed an e.i.r.p. of 30 dBm.

**TEST PROCEDURE**

KDB 789033 Method PM is used for output power.

KDB 789033 Method SA-2 is used for only power of straddle Ch. and PPSD. RBW set to 1MHz(500kHz for the band 5.725-5.85 GHz, the VBW  $\geq 3 \times$  RBW, RMS detector and trace averaging). Band power function used for power and peak marker value of the spectrum is used for PSD. For the band 5.850-5.895 GHz, The correlated gain is added to the result to convert e.i.r.p.

**DIRECTIONAL ANTENNA GAIN**

For OUTPUT POWER and PSD: The TX chains are correlated and the antenna gains are unequal among the chains. The directional gain is:

Frequency Band [MHz]	ANT Gain [dBi]
UNII 1 5150 - 5250	-4.10
UNII 2A 5250 - 5350	-4.10
UNII 2C 5470 - 5725	-4.70
UNII 3 5725 - 5850	-5.40
UNII 4 5850 - 5925	-5.40

Note. Since the correlated gain does not exceed 6dBi, bands except for UNII-4 do not consider the antenna gain.



**10.2.1. 802.11a MODE**

**Output Power Results**

Band	Channel	Center Freq. [MHz]	Average Power [dBm]	Direct. Gain [dBi]	Corr'd Power [dBm]	Limit [dBm]
UNII-1	36	5180	12.72		12.72	23.98
	40	5200	12.92		12.92	
	48	5240	11.84		11.84	
UNII-2A	52	5260	12.35		12.35	23.98
	60	5300	12.70		12.70	
	64	5320	8.28		8.28	
UNII-2C	100	5500	15.35		15.35	23.98
	116	5580	15.26		15.26	
	140	5700	15.22		15.22	
UNII-3	149	5745	14.02		14.02	30.00
	157	5785	13.71		13.71	
	165	5825	13.92		13.92	
UNII-3&4	169	5845	12.33		12.33	30.00
		5845	12.33	-5.40	6.93	30.00 <sub>(e.i.r.p)</sub>
UNII-4	173	5865	12.08	-5.40	6.68	30.00 <sub>(e.i.r.p)</sub>
	177	5885	11.81	-5.40	6.41	

\* Calculation of Output Power : Average Power = Meas Power + Duty CF[dB]

**PSD Results**

Band	Channel	Center Freq. [MHz]	Meas PSD [dBm/MHz]	DCCF.	Direct. Gain [dBi]	Corr'd PSD [dBm]	Limit [dBm/MHz]
UNII-1	36	5180	1.18	0.16		1.34	11.00
	40	5200	1.56	0.16		1.72	
	48	5240	0.47	0.16		0.63	
UNII-2A	52	5260	0.85	0.16		1.01	11.00
	60	5300	1.40	0.16		1.56	
	64	5320	-3.29	0.16		-3.13	
UNII-2C	100	5500	2.65	0.16		2.81	11.00
	116	5580	2.84	0.16		3.00	
	140	5700	3.58	0.16		3.74	
UNII-3	149	5745	-0.44	0.16		-0.28	30.00/500kHz
	157	5785	-0.37	0.16		-0.21	
	165	5825	-0.22	0.16		-0.06	
UNII-3&4	169	5845	-2.61	0.16		-2.45	30.00/500kHz
		5845	-0.74	0.16	-5.40	-5.98	14.00 <sub>(e.i.r.p)</sub>
UNII-4	173	5865	0.43	0.16	-5.40	-4.81	14.00 <sub>(e.i.r.p)</sub>
	177	5885	-0.06	0.16	-5.40	-5.30	

\* Calculation of PSD: Corr'd PSD = Meas PSD + Duty CF [dB] (in case of UNII-4: added directional gain)

**10.2.2. 802.11n HT20 MODE**

**Output Power Results**

Band	Channel	Center Freq. [MHz]	Average Power [dBm]	Direct. Gain [dBi]	Corr'd Power [dBm]	Limit [dBm]
UNII-1	36	5180	12.51		12.51	23.98
	40	5200	12.88		12.88	
	48	5240	11.71		11.71	
UNII-2A	52	5260	12.33		12.33	23.98
	60	5300	12.41		12.41	
	64	5320	8.11		8.11	
UNII-2C	100	5500	15.08		15.08	23.98
	116	5580	15.09		15.09	
	140	5700	13.35		13.35	
UNII-3	149	5745	13.95		13.95	30.00
	157	5785	13.62		13.62	
	165	5825	13.83		13.83	
UNII-3&4	169	5845	12.28		12.28	30.00
		5845	12.28	-5.40	6.88	30.00 <sub>(e.i.r.p)</sub>
UNII-4	173	5865	11.89	-5.40	6.49	30.00 <sub>(e.i.r.p)</sub>
	177	5885	11.42	-5.40	6.02	

\* Calculation of Output Power : Average Power = Meas Power + Duty CF[dB]

**PSD Results**

Band	Channel	Center Freq. [MHz]	Meas PSD [dBm/MHz]	DCCF.	Direct. Gain [dBi]	Corr'd PSD [dBm]	Limit [dBm/MHz]
UNII-1	36	5180	0.91	0.20		1.11	11.00
	40	5200	1.30	0.20		1.50	
	48	5240	0.18	0.20		0.38	
UNII-2A	52	5260	0.61	0.20		0.81	11.00
	60	5300	0.69	0.20		0.89	
	64	5320	-3.41	0.20		-3.21	
UNII-2C	100	5500	2.60	0.20		2.80	11.00
	116	5580	2.60	0.20		2.80	
	140	5700	1.59	0.20		1.79	
UNII-3	149	5745	-0.30	0.20		-0.10	30.00/500kHz
	157	5785	-0.65	0.20		-0.45	
	165	5825	-0.30	0.20		-0.10	
UNII-3&4	169	5845	-2.99	0.20		-2.79	30.00/500kHz
		5845	-0.43	0.20	-5.40	-5.63	14.00 <sub>(e.i.r.p)</sub>
UNII-4	173	5865	-0.11	0.20	-5.40	-5.31	14.00 <sub>(e.i.r.p)</sub>
	177	5885	-0.40	0.20	-5.40	-5.60	

\* Calculation of PSD: Corr'd PSD = Meas PSD + Duty CF [dB] (in case of UNII-4: added directional gain)

### 10.2.3. 802.11n HT40 MODE

#### Output Power Results

Band	Channel	Center Freq. [MHz]	Average Power [dBm]	Direct. Gain [dBi]	Corr'd Power [dBm]	Limit [dBm]
UNII-1	38	5190	12.12		12.12	23.98
	46	5230	11.60		11.60	
UNII-2A	54	5270	12.04		12.04	23.98
	62	5310	11.61		11.61	
UNII-2C	102	5510	12.72		12.72	23.98
	118	5590	12.82		12.82	
	134	5670	12.83		12.83	
UNII-3	151	5755	13.40		13.40	30.00
	159	5795	13.52		13.52	
UNII-3&4	167	5835	13.61		13.61	30.00
		5835	13.61	-5.40	8.21	30.00 <sub>(e.i.r.p)</sub>
UNII-4	175	5875	13.15	-5.40	7.75	30.00 <sub>(e.i.r.p)</sub>

\* Calculation of Output Power : Average Power = Meas Power + Duty CF[dB]

#### PSD Results

Band	Channel	Center Freq. [MHz]	Meas PSD [dBm/MHz]	DCCF.	Direct. Gain [dBi]	Corr'd PSD [dBm]	Limit [dBm/MHz]
UNII-1	38	5190	-2.75	0.18		-2.57	11.00
	46	5230	-3.27	0.18		-3.09	
UNII-2A	54	5270	-3.08	0.18		-2.90	11.00
	62	5310	-3.59	0.18		-3.41	
UNII-2C	102	5510	-2.25	0.18		-2.07	11.00
	118	5590	-1.97	0.18		-1.79	
	134	5670	-1.34	0.18		-1.16	
UNII-3	151	5755	-3.65	0.18		-3.47	30.00/500kHz
	159	5795	-3.49	0.18		-3.31	
UNII-3&4	167	5835	-3.64	0.18		-3.46	30.00/500kHz
		5835	-2.01	0.18	-5.40	-7.23	14.00 <sub>(e.i.r.p)</sub>
UNII-4	175	5875	-1.00	0.18	-5.40	-6.22	14.00 <sub>(e.i.r.p)</sub>

\* Calculation of PSD: Corr'd PSD = Meas PSD + Duty CF [dB] (in case of UNII-4: added directional gain)

**10.2.4. 802.11ac VHT80 MODE**

**Output Power Results**

Band	Channel	Center Freq. [MHz]	Average Power [dBm]	Direct. Gain [dBi]	Corr'd Power [dBm]	Limit [dBm]
UNII-1	42	5210	10.11		10.11	23.98
UNII-2A	58	5290	6.60		6.60	23.98
UNII-2C	106	5530	11.60		11.60	23.98
	122	5610	11.84		11.84	
UNII-3	155	5775	11.40		11.40	30.00
UNII-3&4	171	5855	11.70		11.70	30.00
		5855	11.70	-5.40	6.30	30.00 <sub>(e.i.r.p)</sub>

\* Calculation of Output Power : Average Power = Meas Power + Duty CF[dB]

**PSD Results**

Band	Channel	Center Freq. [MHz]	Meas PSD [dBm/MHz]	DCCF.	Direct. Gain [dBi]	Corr'd PSD [dBm]	Limit [dBm/MHz]
UNII-1	42	5210	-8.23	0.25		-7.98	11.00
UNII-2A	58	5290	-11.70	0.25		-11.45	11.00
UNII-2C	106	5530	-6.03	0.25		-5.78	11.00
	122	5610	-6.09	0.25		-5.84	
UNII-3	155	5775	-8.87	0.25		-8.62	30.00/500kHz
UNII-3&4	171	5855	-8.45	0.25		-8.20	30.00/500kHz
		5855	-6.24	0.25	-5.40	-11.39	14.00 <sub>(e.i.r.p.)</sub>

\* Calculation of PSD: Corr'd PSD = Meas PSD + Duty CF [dB] (in case of UNII-4: added directional gain)

### 10.2.5. STRADDLE CHANNEL

#### Output Power Results

Mode	Band	Center Freq. [MHz]	Meas Power [dBm]	DCCF.	Corr'd Power [dBm]	Limit [dBm]
802.11a	UNII-2C	5720	13.63	0.16	13.79	22.86
	UNII-3		7.18	0.16	7.34	30.00
802.11n HT20	UNII-2C	5720	13.62	0.20	13.82	23.09
	UNII-3		7.58	0.20	7.78	30.00
802.11n HT40	UNII-2C	5710	12.40	0.18	12.58	23.98
	UNII-3		2.73	0.18	2.91	30.00
802.11ac VHT80	UNII-2C	5690	11.41	0.25	11.66	23.98
	UNII-3		-1.88	0.25	-1.63	30.00

\* Calculation of Output Power : Corr'd Power = Meas. Power + Duty CF [dB]

#### PSD Results

Mode	Band	Center Freq. [MHz]	Meas PSD [dBm/MHz]	DCCF.	Corr'd PSD [dBm]	Limit [dBm/MHz]
802.11a	UNII-2C	5720	3.54	0.16	3.70	11.00
	UNII-3		-0.45	0.16	-0.29	30.00/500kHz
802.11n HT20	UNII-2C	5720	2.92	0.20	3.12	11.00
	UNII-3		-0.77	0.20	-0.57	30.00/500kHz
802.11n HT40	UNII-2C	5710	-1.62	0.18	-1.44	11.00
	UNII-3		-5.53	0.18	-5.35	30.00/500kHz
802.11ac VHT80	UNII-2C	5690	-6.14	0.25	-5.89	11.00
	UNII-3		-9.98	0.25	-9.73	30.00/500kHz

\* Calculation of PSD: Corr'd PSD = Meas PSD + Duty CF [dB]

### 10.2.6. OUTPUT POWER AND PPSD PLOTS (WORST CASE)

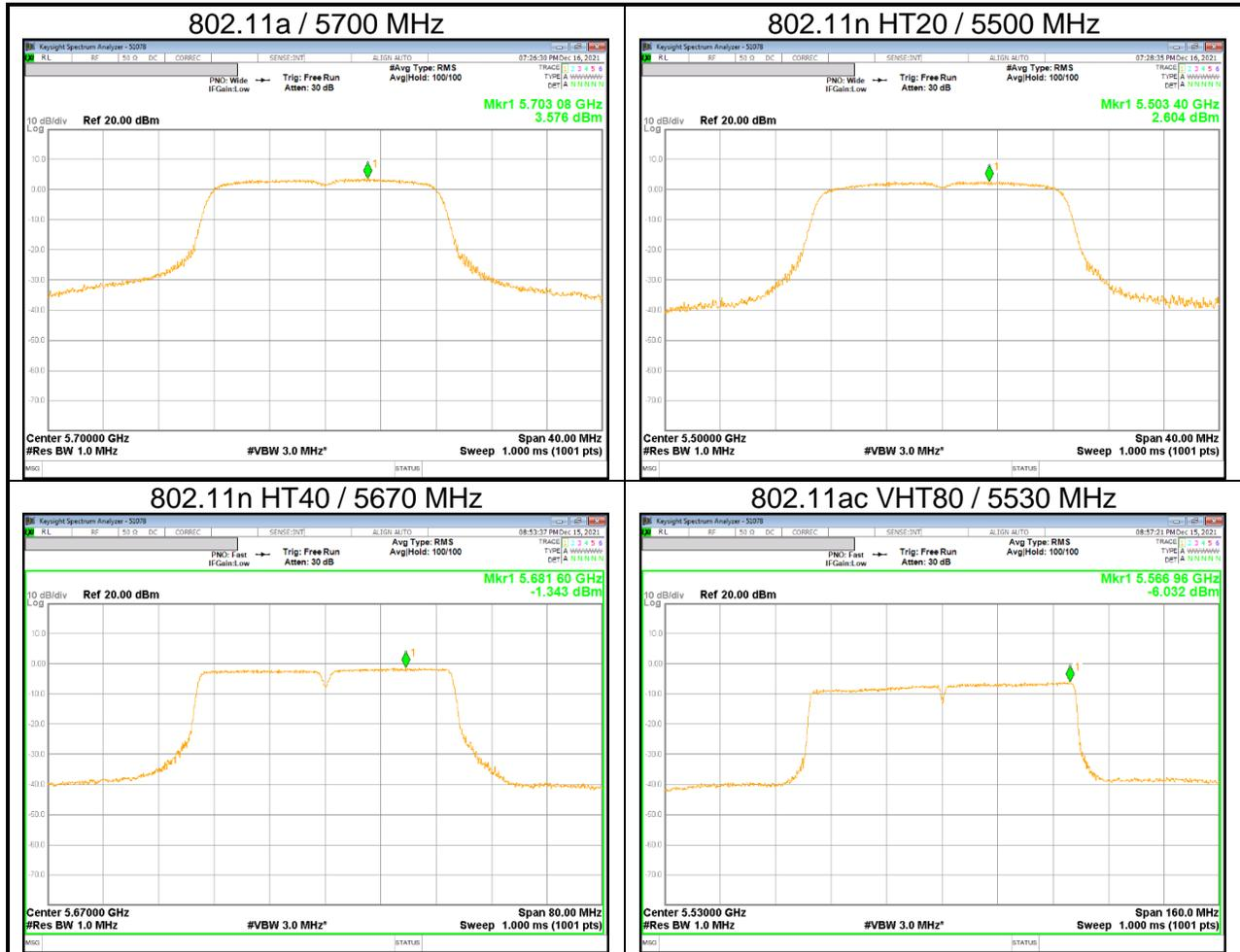

**UNII Straddle Ch. IEEE 802.11a mode Output Power and PSD**

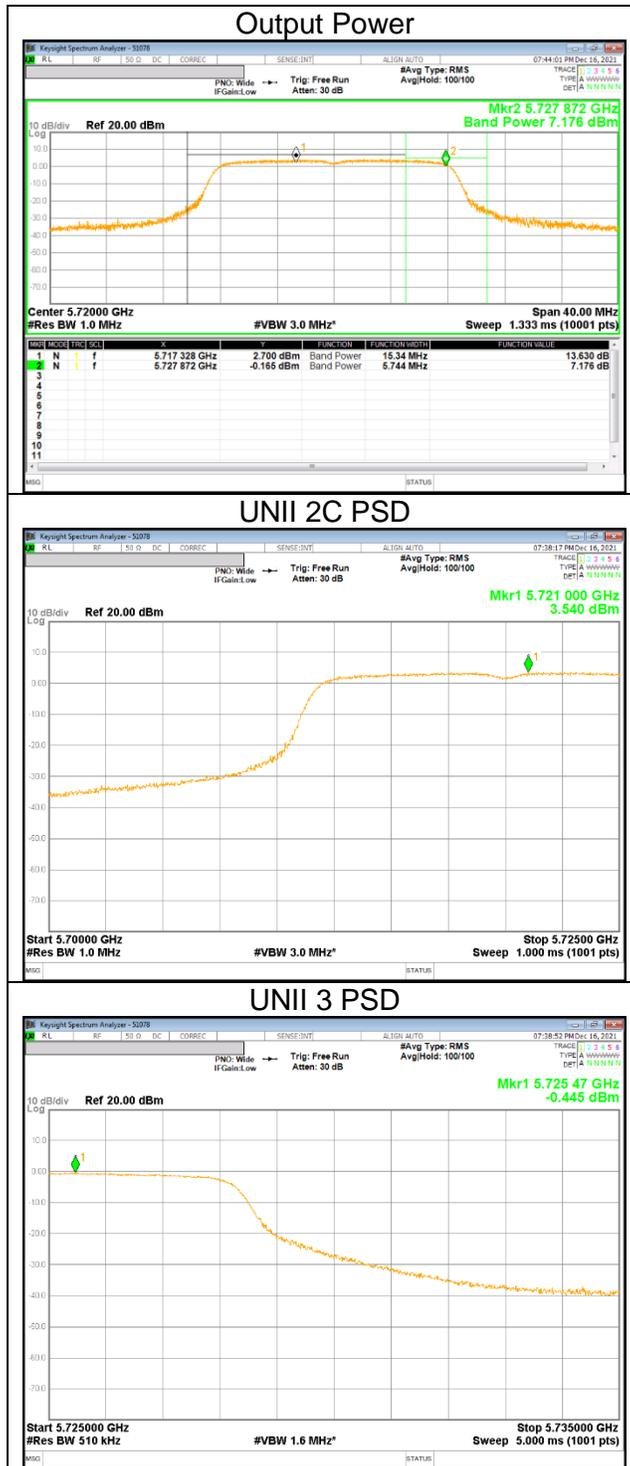

**UNII Straddle Ch. IEEE 802.11n HT20 mode Output Power and PSD**

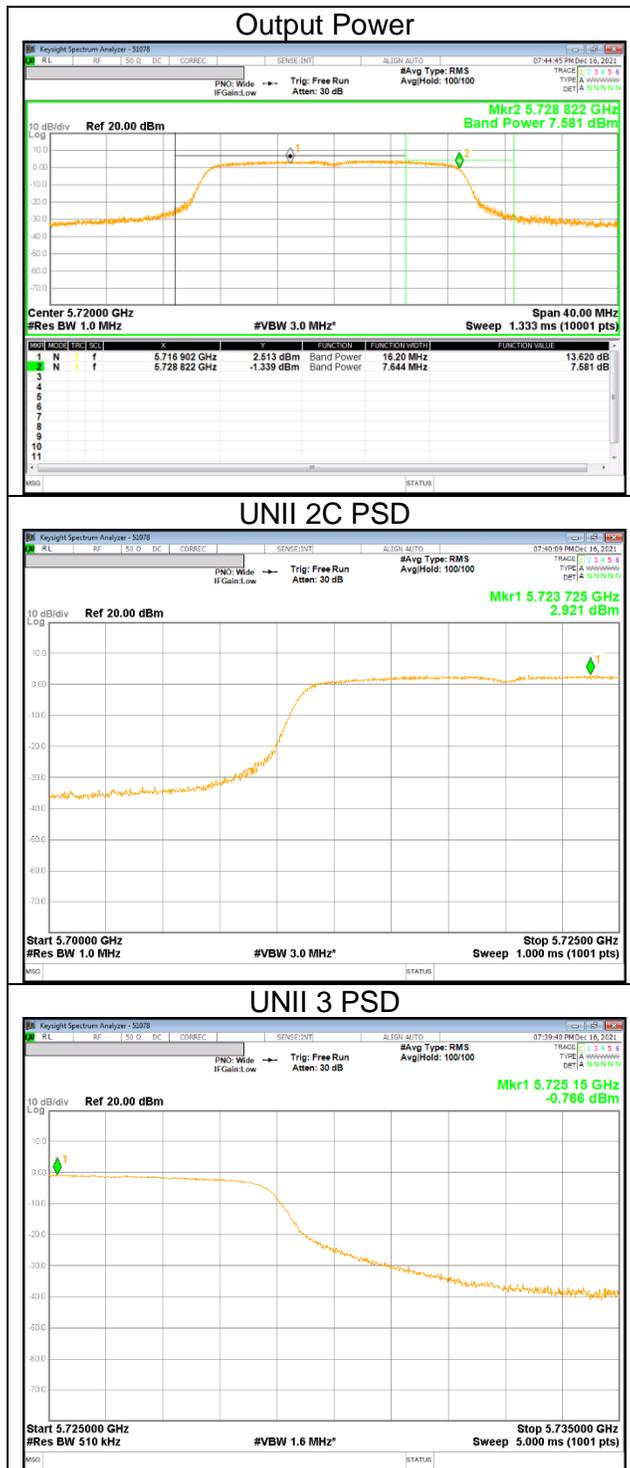



**UNII Straddle Ch. IEEE 802.11n HT40 mode Output Power and PSD**

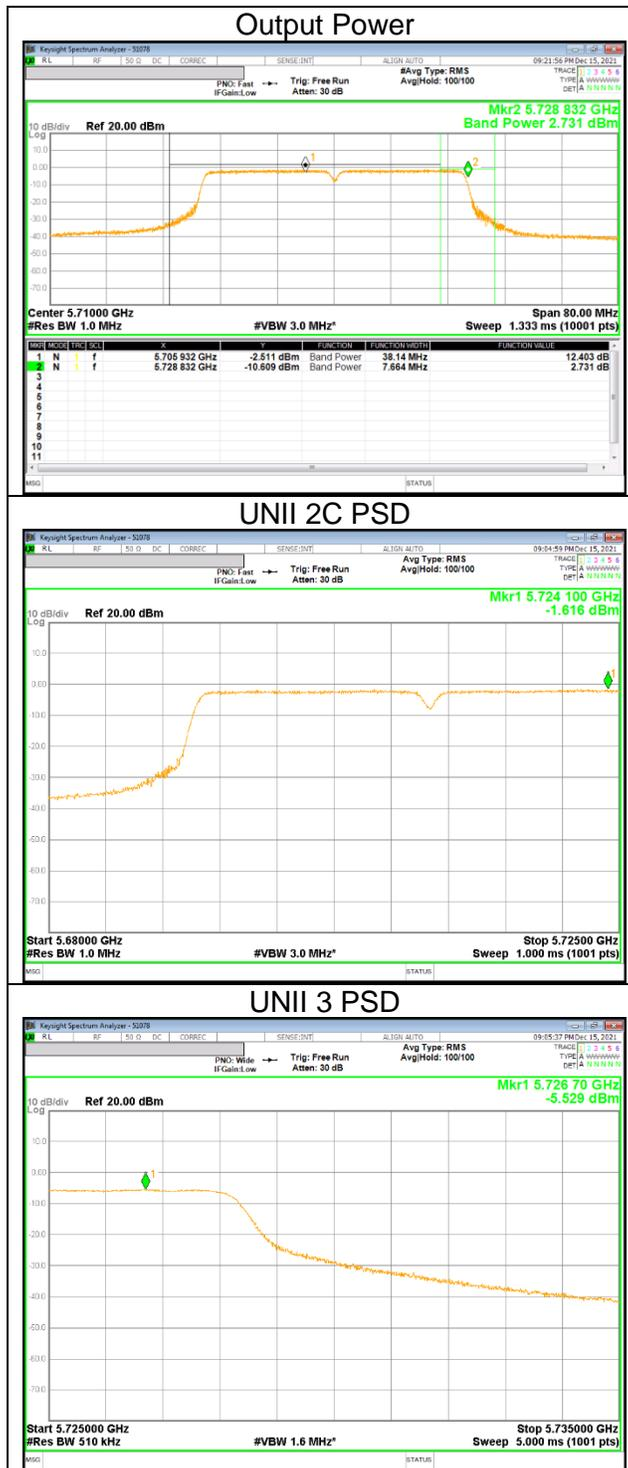

**UNII Straddle Ch. IEEE 802.11ac VHT80 mode Output Power and PSD**

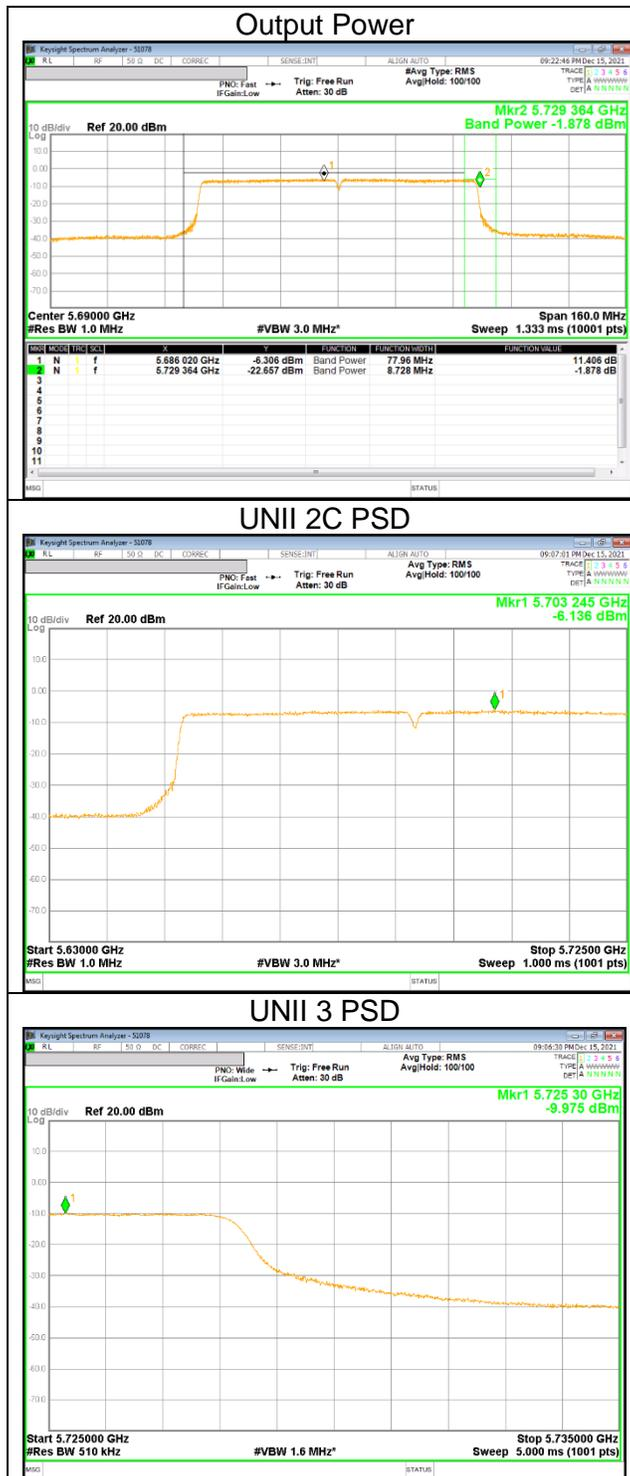

## 11. TRANSMITTER ABOVE 1 GHz

### LIMITS

FCC §15.205 and §15.209

Limits for radiated disturbance of an intentional radiator		
Frequency range (MHz)	Limits (µV/m)	Measurement Distance (m)
0.009 – 0.490	2400 / F (kHz)	300
0.490 – 1.705	24000 / F (kHz)	30
1.705 – 30.0	30	30
30 – 88	100**	3
88 - 216	150**	3
216 – 960	200**	3
Above 960	500	3

\*\* Except as provided in paragraph (g), fundamental emissions from intentional radiators operating under this section shall not be located in the frequency bands 54-72 MHz, 76-88 MHz, 174-216 MHz or 470-806 MHz. However, operation within these frequency bands is permitted under other sections of this part, e.g. §§ 15.231 and 15.241.

FCC Part 15.205 (a) : Only spurious emissions are permitted in any of the frequency bands listed below :

MHz	MHz	MHz	MHz	GHz	GHz
0.009 ~ 0.110	8.41425 ~ 8.41475	108 ~ 121.94	1300 ~ 1427	4.5 ~ 5.15	14.47 ~ 14.5
0.495 ~ 0.505	12.29 ~ 12.293	123 ~ 138	1435 ~ 1626.5	5.35 ~ 5.46	15.35 ~ 16.2
2.1735 ~ 2.1905	12.51975 ~ 12.52025	149.9 ~ 150.05	1645.5 ~ 1646.5	7.25 ~ 7.75	17.7 ~ 21.4
4.125 ~ 4.128	12.57675 ~ 12.57725	156.52475 ~ 156.52525	1660 ~ 1710	8.025 ~ 8.5	22.01 ~ 23.12
4.17725 ~ 4.17775	13.36 ~ 13.41	156.7 ~ 156.9	1718.8 ~ 1722.2	9.0 ~ 9.2	23.6 ~ 24.0
4.20725 ~ 4.20775	16.42 ~ 16.423	162.0125 ~ 167.17	2200 ~ 2300	9.3 ~ 9.5	31.2 ~ 31.8
6.215 ~ 6.218	16.69475 ~ 16.69525	167.72 ~ 173.2	2310 ~ 2390	10.6 ~ 12.7	36.43 ~ 36.5
6.26775 ~ 6.26825	16.80425 ~ 16.80475	240 ~ 285	2483.5 ~ 2500	13.25 ~ 13.4	Above 38.6
6.31175 ~ 6.31225	25.5 ~ 25.67	322 ~ 335.4	2655 ~ 2900		
8.291 ~ 8.294	37.5 ~ 38.25	399.90 ~ 410	3260 ~ 3267		
8.362 ~ 8.366	73 ~ 74.6	608 ~ 614	3332 ~ 3339		
8.37625 ~ 8.38675	74.8 ~ 75.2	960 ~ 1240	3345.8 ~ 3358 3600 ~ 4400		

▪ FCC Part 15.205(b) : The field strength of emissions appearing within these frequency bands shall not exceed the limits shown in §15.209. At frequencies equal to or less than 1000 MHz, compliance with the limits in §15.209 shall be demonstrated using measurement instrumentation employing a CISPR quasi-peak detector. Above 1000 MHz, compliance with the emission limits in §15.209 shall be demonstrated based on the average value of the measured emissions. The provisions in §15.35 apply to these measurements.

**FCC §15.407 (b)**

(b) Undesirable emission limits. Except as shown in paragraph (b)(7) of this section, the maximum emissions outside of the frequency bands of operation shall be attenuated in accordance with the following limits:

- (1) For transmitters operating in the 5.15-5.25 GHz band: All emissions outside of the 5.15-5.35 GHz band shall not exceed an e.i.r.p. of -27 dBm/MHz.
- (2) For transmitters operating in the 5.25-5.35 GHz band: All emissions outside of the 5.15-5.35 GHz band shall not exceed an e.i.r.p. of -27 dBm/MHz.
- (3) For transmitters operating in the 5.47-5.725 GHz band: All emissions outside of the 5.47-5.725 GHz band shall not exceed an e.i.r.p. of -27 dBm/MHz.
- (4) For transmitters operating solely in the 5.850-5.895 GHz band or operating on a channel that spans across 5.725-5.895 GHz:

(iii) For a client device or indoor access point or subordinate device, all emissions below 5.725 GHz shall not exceed an e.i.r.p. of -27 dBm/MHz at 5.65 GHz increasing linearly to 10 dBm/MHz at 5.7 GHz, and from 5.7 GHz increasing linearly to a level of 15.6 dBm/MHz at 5.72 GHz, and from 5.72 GHz increasing linearly to a level of 27 dBm/MHz at 5.725 GHz

- (5) The emission measurements shall be performed using a minimum resolution bandwidth of 1 MHz. A lower resolution bandwidth may be employed near the band edge, when necessary,  
provided the measured energy is integrated to show the total power over 1 MHz.
- (6) Unwanted emissions below 1 GHz must comply with the general field strength limits set forth in §15.209. Further, any U-NII devices using an AC power line are required to comply also with the conducted limits set forth in §15.207.
- (7) The provisions of §15.205 apply to intentional radiators operating under this section.
- (8) When measuring the emission limits, the nominal carrier frequency shall be adjusted as close to the upper and lower frequency band edges as the design of the equipment permits.

**Note**

- Limit translation to field strength level (FCC §15.407)

$$E[\text{dBuV/m}] = \text{EIRP}[\text{dBm}] + 95.2 = -27\text{dBm} + 95.2 = 68.2\text{dBuV/m}$$

$$E[\text{dBuV/m}] = \text{EIRP}[\text{dBm}] + 95.2 = -17\text{dBm} + 95.2 = 78.2\text{dBuV/m}$$

## **TEST PROCEDURE**

The EUT is placed on a non-conducting table 80 cm above the ground plane for below 1GHz and 100 cm for above 1GHz. The antenna to EUT distance is 3 meters. The EUT is configured in accordance with ANSI C63.10. The EUT is set to transmit in a continuous mode.

For measurements below 1 GHz the resolution bandwidth is set to 100 kHz for peak detection measurements or 120 kHz for quasi-peak detection measurements. Peak detection is used unless otherwise noted as quasi-peak.

Reference to KDB 789033 D02 v02r01 UNII part G) 6) c) Method AD:

For measurements above 1 GHz the resolution bandwidth is set to 1 MHz; the video bandwidth is set to 3 MHz for peak measurements and add duty cycle factor to the reading offset for average measurements. In UNII-4, unwanted emissions outside of restricted bands are measured with an RMS detector.

Pre-scans to detect harmonic and spurious emissions, the resolution bandwidth is set to 1 MHz; the video bandwidth is set to 30 kHz for peak measurements.

The spectrum from 1GHz to 40 GHz is investigated with the transmitter set to the lowest, middle, and highest channels in each applicable band.  
(From 30MHz to 1GHz, test was performed with the EUT set to transmit at the channel with highest output power)

The frequency range of interest is monitored at a fixed antenna height and EUT azimuth. The EUT is rotated through 360 degrees to maximize emissions received. The antenna is scanned from 1 to 4 meters above the ground plane to further maximize the emission. Measurements are made with the antenna polarized in both the vertical and the horizontal positions.

Note : Emission was pre-scanned from 9kHz to 30MHz; No emissions were detected which was at least 20dB below the specification limit (consider distance correction factor).  
Per FCC part 15.31(o), test results were not reported.

Although these tests were performed other than open field test site, adequate comparison measurements were confirmed against 30 m open area test site.  
Therefore sufficient tests were made to demonstrate that the alternative site produces results that correlate with the one of tests made in an open field based on KDB 414788.



**BANDEDGE TEST DATA**

Mode	Freq. [MHz]	Antenna	Frequency [GHz]	Reading [dBuV]	Detector Mode	ANT Factor	Loss [dB]	DC Corr [dB]	Result [dBuV/m]	AV Limit [dBuV/m]	AV Margin [dB]	PK Limit [dBuV/m]	PK Margin [dB]	Azimuth [Degs]	Height [cm]	Polarity		
802.11a	5180	ANT1	* 5.14999	51.76	Pk	34.80	-21.20	0.00	65.36	-	-	74.00	-8.64	117	250	H		
			* 5.14837	51.83	Pk	34.80	-21.10	0.00	65.53	-	-	74.00	-8.47	-	117	250	H	
			* 5.14999	35.49	RMS	34.80	-21.20	0.16	49.25	54.00	-4.75	-	-	-	117	250	H	
			* 5.14852	35.57	RMS	34.80	-21.10	0.16	49.43	54.00	-4.57	-	-	-	117	250	H	
			* 5.14999	47.69	Pk	34.80	-21.20	0.00	61.29	-	-	74.00	-12.71	-	-	105	121	V
			* 5.14874	52.77	Pk	34.80	-21.10	0.00	66.47	-	-	74.00	-7.53	-	-	105	121	V
			* 5.14999	35.31	RMS	34.80	-21.20	0.16	49.07	54.00	-4.93	-	-	-	-	105	121	V
802.11n (HT20)	5180	ANT1	* 5.14884	36.44	RMS	34.80	-21.10	0.16	50.30	54.00	-3.70	-	-	105	121	V		
			* 5.14999	53.31	Pk	34.80	-21.20	0.00	66.91	-	-	74.00	-7.09	-	114	248	H	
			* 5.14714	52.60	Pk	34.80	-21.10	0.00	66.30	-	-	74.00	-7.70	-	114	248	H	
			* 5.14999	35.21	RMS	34.80	-21.20	0.20	49.01	54.00	-4.99	-	-	-	114	248	H	
			* 5.14977	36.35	RMS	34.80	-21.20	0.20	50.15	54.00	-3.85	-	-	-	114	248	H	
			* 5.14999	51.92	Pk	34.80	-21.20	0.00	65.52	-	-	74.00	-8.48	-	-	96	101	V
			* 5.14997	51.19	Pk	34.80	-21.20	0.00	64.79	-	-	74.00	-9.21	-	-	96	101	V
802.11n (HT40)	5190	ANT1	* 5.14999	34.41	RMS	34.80	-21.20	0.20	48.21	54.00	-5.79	-	-	96	101	V		
			* 5.14979	35.18	RMS	34.80	-21.20	0.20	48.98	54.00	-5.02	-	-	-	96	101	V	
			* 5.14999	51.94	Pk	34.80	-21.20	0.00	65.54	-	-	74.00	-8.46	-	117	254	H	
			* 5.14887	54.18	Pk	34.80	-21.10	0.00	67.88	-	-	74.00	-6.12	-	-	117	254	H
			* 5.14999	36.03	RMS	34.80	-21.20	0.18	49.81	54.00	-4.19	-	-	-	117	254	H	
			* 5.14957	37.58	RMS	34.80	-21.20	0.18	51.36	54.00	-2.64	-	-	-	117	254	H	
			* 5.14999	51.48	Pk	34.80	-21.20	0.00	65.08	-	-	74.00	-8.92	-	-	100	133	V
802.11ac (VHT80)	5210	ANT1	* 5.14867	53.20	Pk	34.80	-21.10	0.00	66.90	-	-	74.00	-7.10	-	100	133	V	
			* 5.14999	34.66	RMS	34.80	-21.20	0.18	48.44	54.00	-5.56	-	-	-	100	133	V	
			* 5.14794	36.36	RMS	34.80	-21.10	0.18	50.24	54.00	-3.76	-	-	-	100	133	V	
			* 5.14999	48.32	Pk	34.80	-21.20	0.00	61.92	-	-	74.00	-12.08	-	-	114	242	H
			* 5.14179	51.88	Pk	34.80	-21.10	0.00	65.58	-	-	74.00	-8.42	-	-	114	242	H
			* 5.14999	35.95	RMS	34.80	-21.20	0.25	49.80	54.00	-4.20	-	-	-	114	242	H	
			* 5.14734	37.49	RMS	34.80	-21.10	0.25	51.44	54.00	-2.56	-	-	-	114	242	H	
802.11ac (VHT80)	5210	ANT1	* 5.14999	42.19	Pk	34.80	-21.20	0.00	55.79	-	-	74.00	-18.21	-	164	185	V	
			* 5.14572	46.73	Pk	34.80	-21.10	0.00	60.43	-	-	74.00	-13.57	-	-	164	185	V
			* 5.14999	31.69	RMS	34.80	-21.20	0.25	45.54	54.00	-8.46	-	-	-	164	185	V	
			* 5.14792	33.15	RMS	34.80	-21.10	0.25	47.10	54.00	-6.90	-	-	-	164	185	V	

Note1. Pk - Peak detector, RMS - RMS detector  
 Note2. \* - indicates frequency in CFR47 Pt 15 / IC RSS-Restricted Band

**HARMONICS AND SPURIOUS EMISSIONS(WORST CASE: 802.11a / 5200 MHz)**  
**5200 MHz HORIZONTAL**

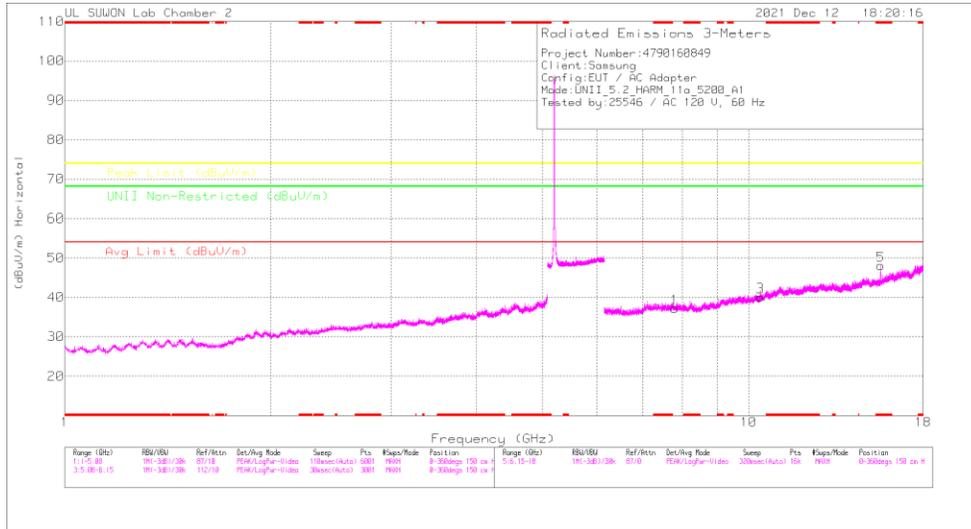

**5200 MHz VERTICAL**

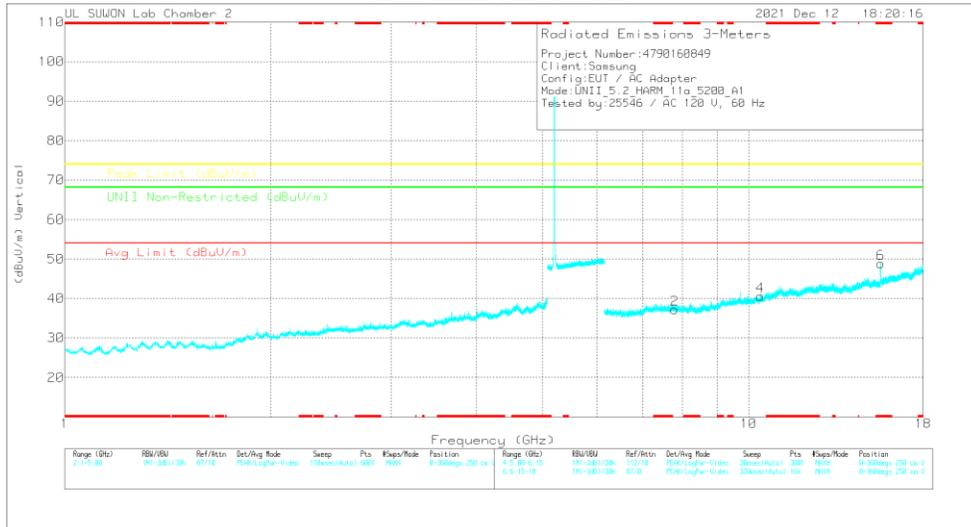

Note: Emission was scanned up to 40GHz; No emissions were detected above the noise floor which was at least 20dB below the specification limit.

**5200 MHz DATA**

**Radiated Emissions**

Frequency (GHz)	Meas Reading (dBuV)	Det	3117_50168724	8GHz_HF(dB)	DC Corr (dB)	Corrected Reading (dBuV/m)	Avg Limit (dBuV/m)	Margin (dB)	Peak Limit (dBuV/m)	Margin (dB)	UNII Non-Restricted (dBuV/m)	Margin (dB)	Altitude (Meters)	Height (cm)	Polarity
7.80538	36.23	PK-U	36	-24	0	48.23	-	-	-	-	68.2	-18.97	360	100	H
7.8247	36.41	PK-U	36	-24.2	0	48.21	-	-	-	-	68.2	-18.99	186	220	V
10.40107	34.08	PK-U	37.7	-20.9	0	50.88	-	-	-	-	68.2	-17.32	360	100	H
10.3987	34.22	PK-U	37.7	-20.9	0	51.02	-	-	-	-	68.2	-17.18	186	220	V
* 15.6048	42.81	PK-U	40	-20	0	62.81	-	-	74	-11.19	-	-	204	100	H
* 15.5989	29.11	ADR	40	-19.9	-16	49.37	54	-4.63	-	-	-	-	204	100	H
* 15.6056	43.84	PK-U	40	-19.9	0	63.84	-	-	74	-10.06	-	-	186	220	V
* 15.5989	29.76	ADR	40	-19.9	-16	50.02	54	-3.98	-	-	-	-	186	220	V

\* - indicates frequency in CFR47 Pt 15 / IC RSS-Restricted Band  
 PK-U - U-NII: Maximum Peak  
 ADR - U-NII AD primary method, RMS average



**HARMONICS AND SPURIOUS EMISSIONS TEST DATA**

Mode	Freq. [MHz]	Antenna	Frequency [GHz]	Reading [dBuV]	Detector Mode	ANT Factor	Loss [dB]	DC Corr [dB]	Result [dBuV/m]	AV Limit [dBuV/m]	AV Margin [dB]	PK Limit [dBuV/m]	PK Margin [dB]	Non-Restricted [dBuV/m]	Margin [dB]	Azimuth [Degs]	Height [cm]	Polarity		
802.11a	5180	ANT1	7.792	35.68	PK-U	36.00	-23.80	0.00	47.88	-	-	-	-	-	68.20	-20.32	360	100	H	
			7.775	36.14	PK-U	36.00	-23.70	0.00	48.44	-	-	-	-	-	-	68.20	-19.76	0	100	V
			10.353	34.00	PK-U	37.70	-20.90	0.00	50.80	-	-	-	-	-	-	68.20	-17.40	360	100	H
			10.316	34.70	PK-U	37.60	-20.70	0.00	51.60	-	-	-	-	-	-	68.20	-16.60	0	100	V
			* 15.5447	41.91	PK-U	40.00	-19.70	0.00	62.21	-	-	74.00	-11.79	-	-	-	-	205	100	H
	* 15.5392	28.19	ADR	40.00	-19.60	0.16	48.75	54.00	-5.25	-	-	-	-	-	-	205	100	H		
	* 15.5444	42.29	PK-U	40.00	-19.70	0.00	62.59	-	-	74.00	-11.41	-	-	-	-	189	213	V		
	* 15.5391	28.57	ADR	40.00	-19.60	0.16	49.13	54.00	-4.87	-	-	-	-	-	-	189	213	V		
	5200	ANT1	7.805	36.23	PK-U	36.00	-24.00	0.00	48.23	-	-	-	-	-	68.20	-19.97	360	100	H	
			7.825	36.41	PK-U	36.00	-24.20	0.00	48.21	-	-	-	-	-	68.20	-19.99	186	220	V	
			10.401	34.08	PK-U	37.70	-20.90	0.00	50.88	-	-	-	-	-	68.20	-17.32	360	100	H	
			10.399	34.22	PK-U	37.70	-20.90	0.00	51.02	-	-	-	-	-	68.20	-17.18	186	220	V	
			* 15.6048	42.81	PK-U	40.00	-20.00	0.00	62.81	-	-	74.00	-11.19	-	-	-	-	204	100	H
	* 15.5989	29.11	ADR	40.00	-19.90	0.16	49.37	54.00	-4.63	-	-	-	-	-	-	204	100	H		
	* 15.6056	43.84	PK-U	40.00	-19.90	0.00	63.94	-	-	74.00	-10.06	-	-	-	-	186	220	V		
* 15.5989	29.76	ADR	40.00	-19.90	0.16	50.02	54.00	-3.98	-	-	-	-	-	-	186	220	V			
5240	ANT1	7.862	36.76	PK-U	36.00	-24.40	0.00	48.36	-	-	-	-	-	68.20	-19.84	0	100	H		
		7.877	37.01	PK-U	36.00	-24.30	0.00	48.71	-	-	-	-	-	68.20	-19.49	360	100	V		
		10.476	33.55	PK-U	37.80	-20.70	0.00	50.65	-	-	-	-	-	68.20	-17.55	0	100	H		
		10.485	33.41	PK-U	37.80	-20.70	0.00	50.51	-	-	-	-	-	68.20	-17.69	360	100	V		
		* 15.7247	41.59	PK-U	40.20	-19.60	0.00	62.19	-	-	74.00	-11.81	-	-	-	-	201	100	H	
* 15.7189	27.74	ADR	40.20	-19.60	0.16	48.50	54.00	-5.50	-	-	-	-	-	-	201	100	H			
* 15.725	41.62	PK-U	40.20	-19.60	0.00	62.22	-	-	74.00	-11.78	-	-	-	-	162	267	V			
* 15.7209	27.73	ADR	40.20	-19.60	0.16	48.49	54.00	-5.51	-	-	-	-	-	-	162	267	V			
802.11ac (VHT80) Spot-Check	5210	ANT1	* 5.06297	48.65	PK-U	34.70	-28.80	0.00	54.55	-	-	74.00	-19.45	-	-	114	229	H		
			* 5.06489	47.85	PK-U	34.70	-28.60	0.00	53.95	-	-	74.00	-20.05	-	-	94	113	V		
			* 5.06326	34.00	ADR	34.70	-28.80	0.25	40.15	54.00	-13.85	-	-	-	-	-	114	229	H	
			* 5.07981	33.31	ADR	34.80	-27.10	0.25	41.26	54.00	-12.74	-	-	-	-	-	94	113	V	
			5.656	44.22	PK-U	35.50	-20.20	0.00	59.52	-	-	-	-	-	68.20	-8.68	112	266	H	
			5.660	43.22	PK-U	35.50	-20.30	0.00	58.42	-	-	-	-	-	68.20	-9.78	95	100	V	
			7.821	36.28	PK-U	36.30	-24.60	0.00	47.98	-	-	-	-	-	68.20	-20.22	0	100	H	
			7.808	36.55	PK-U	36.30	-24.70	0.00	48.15	-	-	-	-	-	68.20	-20.05	0	100	V	
			10.414	34.21	PK-U	38.10	-21.40	0.00	50.91	-	-	-	-	-	68.20	-17.29	0	100	H	
			10.415	34.78	PK-U	38.10	-21.50	0.00	51.38	-	-	-	-	-	68.20	-16.82	0	100	V	

Note1. PK-U - U-NII: Maximum Peak  
 Note2. \* - indicates frequency in CFR47 Pt 15 / IC RSS-Restricted Band

## 11.2. TX ABOVE 1GHz 1Tx MODE IN THE 5.3GHz BAND

### BANDEDGE (WORST CASE: 802.11a / 5320 MHz)

#### HORIZONTAL PEAK AND AVERAGE DATA

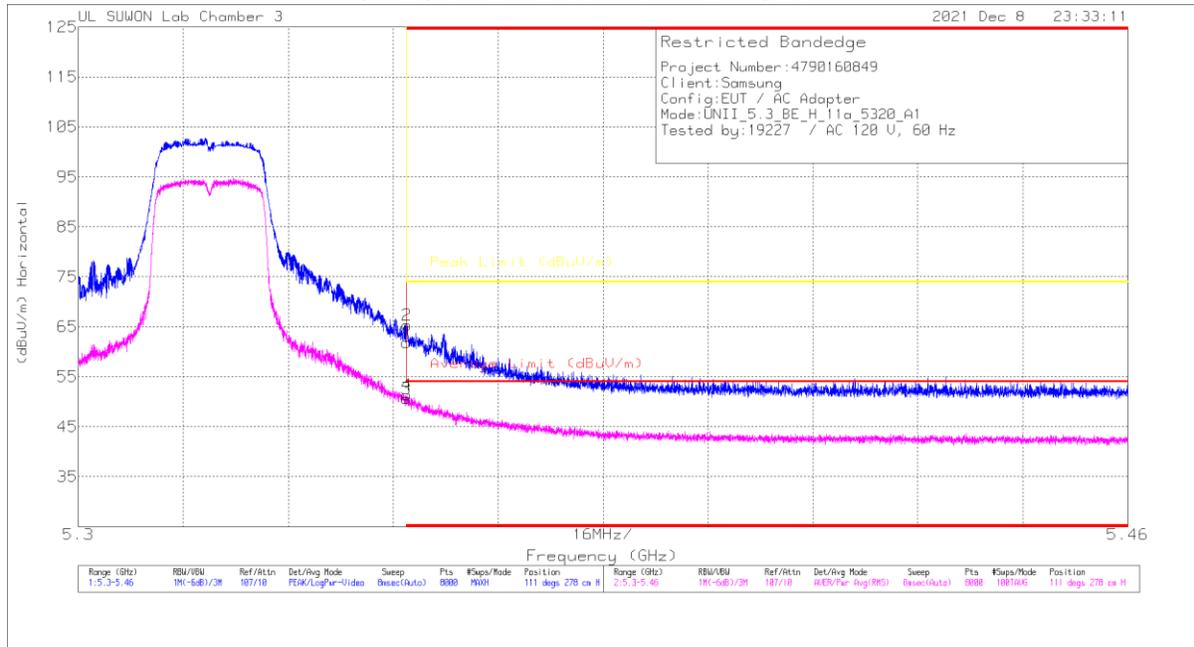

#### Trace Markers

Marker	Frequency (GHz)	Meter Reading (dBu/m)	Det	3117_00218957	10dB_ATT(dB)	DC Cor (dB)	Corrected Reading (dBu/m)	Average Limit (dBu/m)	Margin (dB)	Peak Limit (dBu/m)	PK Margin (dB)	Azimuth (Degs)	Height (cm)	Polarity
1	* 5.35001	47.44	Pk	35.1	-20.7	0	61.84	-	-	74	-12.16	111	278	H
2	* 5.35005	50.89	Pk	35.1	-20.7	0	65.29	-	-	74	-8.71	111	278	H
3	* 5.35001	36.06	RMS	35.1	-20.7	-16	50.62	54	-3.38	-	-	111	278	H
4	* 5.35011	36.87	RMS	35.1	-20.7	-16	51.43	54	-2.67	-	-	111	278	H

\* - indicates frequency in CFR47 Pt 15 / IC RSS-Restricted Band

Pk - Peak detector

RMS - RMS detection

**BANDEDGE TEST DATA**

Mode	Freq. [MHz]	Antenna	Frequency [GHz]	Reading [dBuV]	Detector Mode	ANT Factor	Loss [dB]	DC Corr [dB]	Result [dBuV/m]	AV Limit [dBuV/m]	AV Margin [dB]	PK Limit [dBuV/m]	PK Margin [dB]	Azimuth [Degs]	Height [cm]	Polarity		
802.11a	5320	ANT1	* 5.35001	47.44	Pk	35.10	-20.70	0.00	61.84	-	-	74.00	-12.16	111	278	H		
			* 5.35005	50.89	Pk	35.10	-20.70	0.00	65.29	-	-	74.00	-8.71	-	111	278	H	
			* 5.35001	36.06	RMS	35.10	-20.70	0.16	50.62	54.00	-3.38	-	-	-	111	278	H	
			* 5.35011	36.87	RMS	35.10	-20.70	0.16	51.43	54.00	-2.57	-	-	-	111	278	H	
			* 5.35001	49.80	Pk	35.10	-20.70	0.00	64.20	-	-	74.00	-9.80	-	-	164	146	V
			* 5.35329	51.69	Pk	35.10	-20.70	0.00	66.09	-	-	74.00	-7.91	-	-	164	146	V
802.11n (HT20)	5320	ANT1	* 5.35001	35.22	RMS	35.10	-20.70	0.16	49.78	54.00	-4.22	-	-	164	146	V		
			* 5.35029	36.68	RMS	35.10	-20.70	0.16	51.24	54.00	-2.76	-	-	-	164	146	V	
			* 5.35001	52.57	Pk	35.10	-20.70	0.00	66.97	-	-	74.00	-7.03	-	163	103	H	
			* 5.35163	55.20	Pk	35.10	-20.80	0.00	69.50	-	-	74.00	-4.50	-	163	103	H	
			* 5.35001	33.99	RMS	35.10	-20.70	0.20	48.59	54.00	-5.41	-	-	-	163	103	H	
			* 5.35009	35.21	RMS	35.10	-20.70	0.20	49.81	54.00	-4.19	-	-	-	163	103	H	
802.11n (HT40)	5310	ANT1	* 5.35001	48.86	Pk	35.10	-20.70	0.00	63.26	-	-	74.00	-10.74	133	391	V		
			* 5.35105	52.04	Pk	35.10	-20.90	0.00	66.34	-	-	74.00	-7.66	133	391	V		
			* 5.35001	34.84	RMS	35.10	-20.70	0.20	49.44	54.00	-4.56	-	-	-	133	391	V	
			* 5.35013	36.27	RMS	35.10	-20.70	0.20	50.87	54.00	-3.13	-	-	-	133	391	V	
			* 5.35001	50.75	Pk	35.10	-20.70	0.00	65.15	-	-	74.00	-8.85	-	114	272	H	
			* 5.35005	50.98	Pk	35.10	-20.70	0.00	65.38	-	-	74.00	-8.62	-	114	272	H	
802.11ac (VHT80)	5290	ANT1	* 5.35001	35.63	RMS	35.10	-20.70	0.18	50.21	54.00	-3.79	-	-	114	272	H		
			* 5.35133	36.50	RMS	35.10	-20.80	0.18	50.98	54.00	-3.02	-	-	-	114	272	H	
			* 5.35001	49.38	Pk	35.10	-20.70	0.00	63.78	-	-	74.00	-10.22	-	101	111	V	
			* 5.35311	51.21	Pk	35.10	-20.70	0.00	65.61	-	-	74.00	-8.39	-	101	111	V	
			* 5.35001	34.69	RMS	35.10	-20.70	0.18	49.27	54.00	-4.73	-	-	-	101	111	V	
			* 5.35003	35.21	RMS	35.10	-20.70	0.18	49.79	54.00	-4.21	-	-	-	101	111	V	

Note1. Pk - Peak detector, RMS - RMS detector  
 Note2. \* - indicates frequency in CFR47 Pt 15 / IC RSS-Restricted Band

**HARMONICS AND SPURIOUS EMISSIONS(WORST CASE: 802.11a / 5260 MHz)**  
**5260 MHz HORIZONTAL**

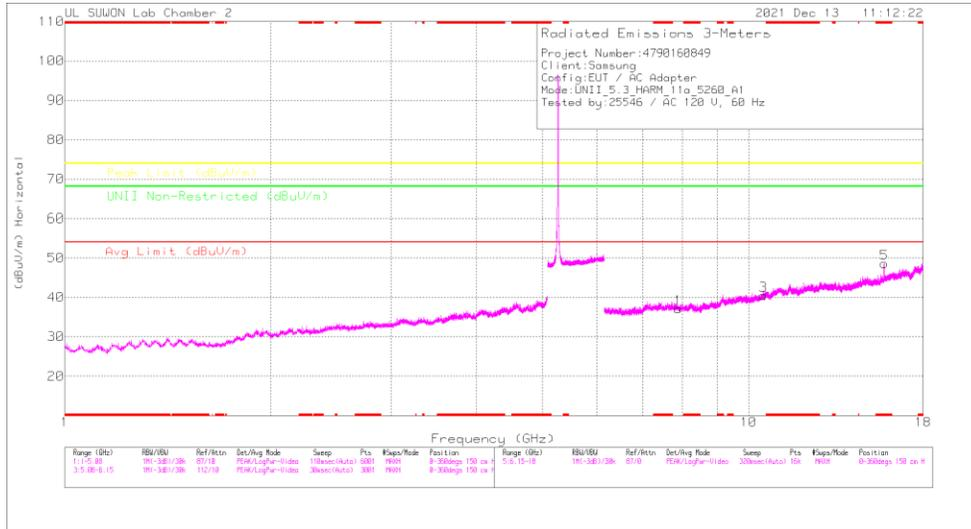

**5260 MHz VERTICAL**

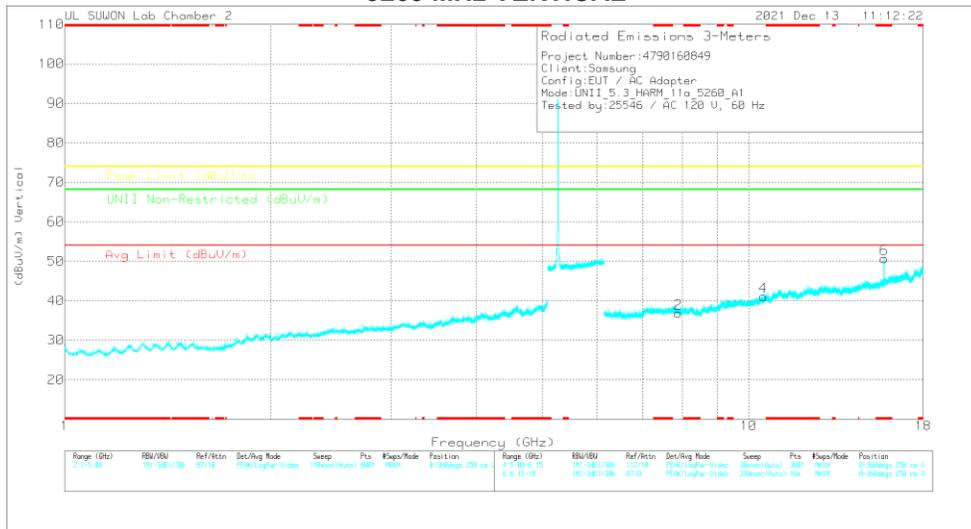

Note: Emission was scanned up to 40GHz; No emissions were detected above the noise floor which was at least 20dB below the specification limit.

**5260 MHz DATA**

**Radiated Emissions**

Frequency (GHz)	Meas Reading (dBuV)	Det	317..00168724	6GHz_HPSISB	DC Corr (dB)	Consolid Reading (dBuV/m)	Avg Limit (dBuV/m)	Margin (dB)	Peak Limit (dBuV/m)	Margin (dB)	UNII Non-Restricted (dBuV/m)	Margin (dB)	Altitude (m)	Height (m)	Polarity
7.91811	36.28	PK-U	36	-23.9	0	48.38	-	-	-	-	68.2	-19.82	211	100	H
7.9095	37.05	PK-U	36	-24	0	49.05	-	-	-	-	68.2	-19.15	0	100	V
10.52746	36.27	PK-U	37.8	-20.5	0	53.57	-	-	-	-	68.2	-14.63	211	100	H
10.5202	35.16	PK-U	37.8	-20.6	0	52.36	-	-	-	-	68.2	-15.84	185	329	V
*15.785	42.57	PK-U	40.3	-19.7	0	63.17	-	-	74	-10.83	-	-	206	100	H
*15.7806	29.52	ADR	40.3	-19.7	-16	50.28	54	-3.72	-	-	-	-	206	100	H
*15.7847	42.36	PK-U	40.3	-19.7	0	62.96	-	-	74	-11.04	-	-	183	270	V
*15.7795	28.36	ADR	40.3	-19.7	-16	49.12	54	-4.98	-	-	-	-	163	270	V

\* - indicates frequency in CFR47 Pt 15 / IC RSS-Restricted Band  
 PK-U - U-NII: Maximum Peak  
 ADR - U-NII AD primary method, RMS average

**HARMONICS AND SPURIOUS EMISSIONS TEST DATA**

Mode	Freq. [MHz]	Antenna	Frequency [GHz]	Reading [dBuV]	Detector Mode	ANT Factor	Loss [dB]	DC Corr [dB]	Result [dBuV/m]	AV Limit [dBuV/m]	AV Margin [dB]	PK Limit [dBuV/m]	PK Margin [dB]	Non-Restricted [dBuV/m]	Margin [dB]	Azimuth [Degs]	Height [cm]	Polarity	
802.11a	5260	ANT1	7.918	36.28	PK-U	36.00	-23.90	0.00	48.38	-	-	-	-	68.20	-19.82	211	100	H	
			7.910	37.05	PK-U	36.00	-24.00	0.00	49.05	-	-	-	-	68.20	-19.15	0	100	V	
			10.527	36.27	PK-U	37.80	-20.50	0.00	53.57	-	-	-	-	68.20	-14.63	211	100	H	
			10.520	35.16	PK-U	37.80	-20.60	0.00	52.36	-	-	-	-	68.20	-15.84	185	329	V	
			* 15.785	42.57	PK-U	40.30	-19.70	0.00	63.17	-	-	-	74.00	-10.83	-	-	206	100	H
			* 15.78006	29.52	ADR	40.30	-19.70	0.16	50.28	54.00	-3.72	-	-	-	-	-	206	100	H
			* 15.7847	42.36	PK-U	40.30	-19.70	0.00	62.96	-	-	-	74.00	-11.04	-	-	163	270	V
			* 15.7795	28.36	ADR	40.30	-19.70	0.16	49.12	54.00	-4.88	-	-	-	-	-	163	270	V
			7.951	35.76	PK2	36.30	-24.60	0.00	47.46	-	-	-	-	-	68.20	-20.74	0	100	H
			7.950	35.93	PK-U	36.30	-24.60	0.00	47.63	-	-	-	-	-	68.20	-20.57	0	100	V
			10.598	36.70	PK-U	38.30	-21.50	0.00	53.50	-	-	-	-	-	68.20	-14.70	80	103	H
			10.600	25.82	ADR	38.30	-21.50	0.16	42.78	-	-	-	-	-	-	-	80	103	H
	10.597	36.57	PK-U	38.30	-21.50	0.00	53.37	-	-	-	-	-	68.20	-14.83	175	246	V		
	10.600	24.87	ADR	38.30	-21.50	0.16	41.83	-	-	-	-	-	-	-	175	246	V		
	* 15.90492	42.51	PK-U	40.80	-21.00	0.00	62.31	-	-	-	74.00	-11.69	-	-	156	100	H		
	* 15.89697	29.28	ADR	40.80	-21.00	0.16	49.24	54.00	-4.76	-	-	-	-	-	156	100	H		
	* 15.90417	41.73	PK-U	40.80	-20.90	0.00	61.63	-	-	-	74.00	-12.37	-	-	160	102	V		
	* 15.89837	28.96	ADR	40.80	-21.00	0.16	48.92	54.00	-5.08	-	-	-	-	-	160	102	V		
	7.979	35.99	PK-U	36.30	-24.70	0.00	47.59	-	-	-	-	-	68.20	-20.61	0	100	H		
	7.987	35.99	PK-U	36.30	-24.70	0.00	47.59	-	-	-	-	-	68.20	-20.61	0	100	V		
	* 10.64085	33.51	PK-U	38.30	-21.50	0.00	50.31	-	-	-	74.00	-23.69	-	-	0	100	H		
	* 10.63609	34.41	PK-U	38.30	-21.60	0.00	51.11	-	-	-	74.00	-22.89	-	-	0	100	V		
	* 15.96145	34.81	PK-U	40.90	-20.90	0.00	54.81	-	-	-	74.00	-19.19	-	-	0	100	H		
	* 15.96234	34.45	PK-U	40.90	-20.90	0.00	54.45	-	-	-	74.00	-19.55	-	-	0	100	V		

Note1. PK-U - U-NII: Maximum Peak / ADR - U-NII AD primary method, RMS average

Note2. \* - indicates frequency in CFR47 Pt 15 / IC RSS-Restricted Band

### 11.3. TX ABOVE 1GHz 1Tx MODE IN THE 5.5 GHz BAND

#### BANDEDGE (WORST CASE: 802.11a / 5700 MHz)

#### HORIZONTAL PEAK AND AVERAGE DATA

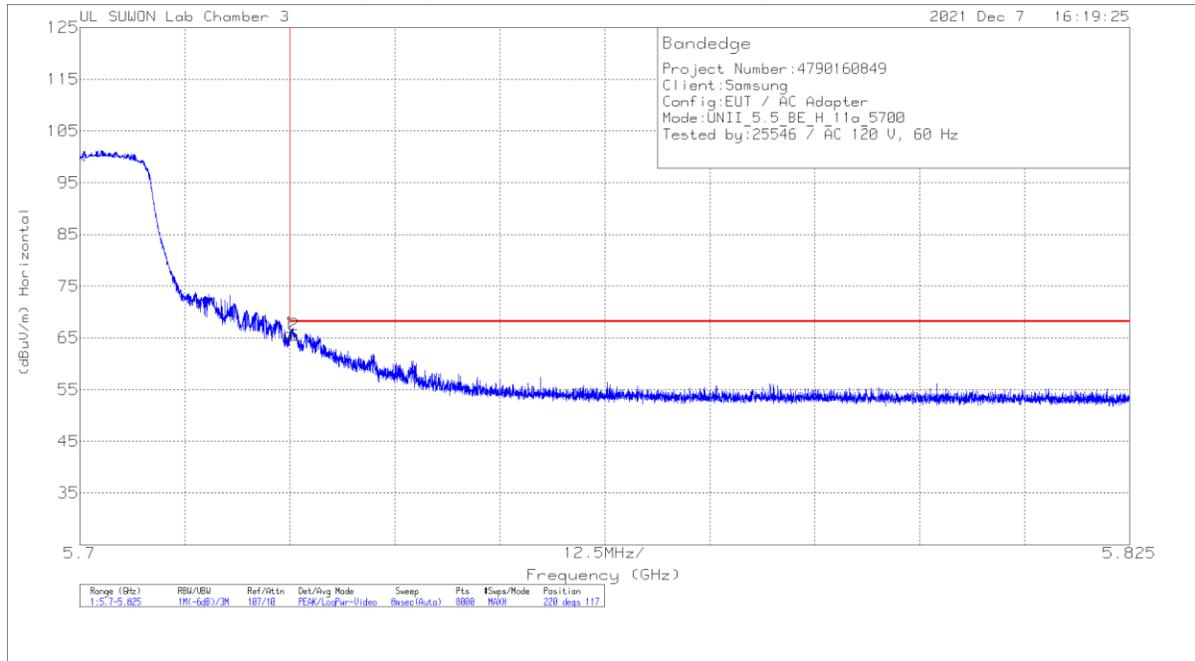

#### Trace Markers

Marker	Frequency (GHz)	Meter Reading (dBuV)	Det	3117_00218957	10dB_ATT[dB]	DC Corr (dB)	Corrected Reading (dBuV/m)	Peak Limit (dBuV/m)	PK Margin (dB)	Azimuth (Degs)	Height (cm)	Polarity
1	5.725	50.17	Pk	35.7	-20	0	65.87	68.2	-2.33	220	117	H
2	5.7255	49.86	Pk	35.7	-20	0	65.56	68.2	-2.64	220	117	H

\* - indicates frequency in CFR47 Pt 15 / IC RSS-Restricted Band  
 PK - Peak detector

**BANDEDGE TEST DATA**

Mode	Freq. [MHz]	Antenna	Frequency [GHz]	Reading [dBuV]	Detector Mode	ANT Factor	Loss [dB]	DC Corr [dB]	Result [dBuV/m]	AV Limit [dBuV/m]	AV Margin [dB]	PK Limit [dBuV/m]	PK Margin [dB]	Azimuth [Degs]	Height [cm]	Polarity
802.11a	5500	ANT1	* 5.45998	38.21	Pk	35.30	-20.60	0.00	52.91	-	-	74.00	-21.09	238	108	H
			* 5.459	40.61	Pk	35.30	-20.50	0.00	55.41	-	-	74.00	-18.59	238	108	H
			5.46998	41.35	Pk	35.30	-20.60	0.00	56.05	-	-	68.20	-12.15	238	108	H
			5.46972	44.40	Pk	35.30	-20.60	0.00	59.10	-	-	68.20	-9.10	238	108	H
			* 5.45998	27.73	RMS	35.30	-20.60	0.16	42.59	54.00	-11.41	-	-	238	108	H
			* 5.42132	29.43	RMS	35.20	-20.60	0.16	44.19	54.00	-9.81	-	-	238	108	H
			5.46998	30.41	RMS	35.30	-20.60	0.16	45.27	-	-	-	-	238	108	H
			5.46980	31.08	RMS	35.30	-20.60	0.16	45.94	-	-	-	-	238	108	H
			* 5.45998	38.06	Pk	35.30	-20.60	0.00	52.76	-	-	74.00	-21.24	177	206	V
			* 5.44963	40.33	Pk	35.30	-20.60	0.00	55.03	-	-	74.00	-18.97	177	206	V
			5.46998	40.73	Pk	35.30	-20.60	0.00	55.43	-	-	68.20	-12.77	177	206	V
			5.46869	43.07	Pk	35.30	-20.60	0.00	57.77	-	-	68.20	-10.43	177	206	V
			* 5.45998	27.92	RMS	35.30	-20.60	0.16	42.78	54.00	-11.22	-	-	177	206	V
			* 5.4518	28.91	RMS	35.30	-20.60	0.16	43.77	54.00	-10.23	-	-	177	206	V
			5.46998	29.86	RMS	35.30	-20.60	0.16	44.72	-	-	-	-	177	206	V
			5.46972	30.01	RMS	35.30	-20.60	0.16	44.87	-	-	-	-	177	206	V
			5.72500	50.17	Pk	35.70	-20.00	0.00	65.87	-	-	68.20	-2.33	220	117	H
			5.72550	49.86	Pk	35.70	-20.00	0.00	65.56	-	-	68.20	-2.64	220	117	H
			5.72500	49.23	Pk	35.70	-20.00	0.00	64.93	-	-	68.20	-3.27	188	220	V
			5.72502	48.83	Pk	35.70	-20.00	0.00	64.53	-	-	68.20	-3.67	188	220	V
802.11n (HT20)	5500	ANT1	* 5.45998	40.76	Pk	35.30	-20.60	0.00	55.46	-	-	74.00	-18.54	234	243	H
			* 5.45843	41.21	Pk	35.30	-20.60	0.00	55.91	-	-	74.00	-18.09	234	243	H
			5.46998	46.72	Pk	35.30	-20.60	0.00	61.42	-	-	68.20	-6.78	234	243	H
			5.46939	46.58	Pk	35.30	-20.60	0.00	61.28	-	-	68.20	-6.92	234	243	H
			* 5.45998	29.03	RMS	35.30	-20.60	0.20	43.93	54.00	-10.07	-	-	234	243	H
			* 5.45919	29.44	RMS	35.30	-20.50	0.20	44.44	54.00	-9.56	-	-	234	243	H
			5.46998	30.70	RMS	35.30	-20.60	0.20	45.60	-	-	-	-	234	243	H
			5.46902	32.24	RMS	35.30	-20.60	0.20	47.14	-	-	-	-	234	243	H
			* 5.45998	37.34	Pk	35.30	-20.60	0.00	52.04	-	-	74.00	-21.96	175	207	V
			* 5.45604	40.63	Pk	35.30	-20.60	0.00	55.33	-	-	74.00	-18.67	175	207	V
			5.46998	44.32	Pk	35.30	-20.60	0.00	59.02	-	-	68.20	-9.18	175	207	V
			5.46626	44.45	Pk	35.30	-20.60	0.00	59.15	-	-	68.20	-9.05	175	207	V
			* 5.45998	28.23	RMS	35.30	-20.60	0.20	43.13	54.00	-10.87	-	-	175	207	V
			* 5.45878	28.87	RMS	35.30	-20.50	0.20	43.87	54.00	-10.13	-	-	175	207	V
			5.46998	29.43	RMS	35.30	-20.60	0.20	44.33	-	-	-	-	175	207	V
			5.46792	29.96	RMS	35.30	-20.60	0.20	44.86	-	-	-	-	175	207	V
			5.72500	46.51	Pk	35.70	-20.00	0.00	62.21	-	-	68.20	-5.99	204	105	H
			5.72628	48.15	Pk	35.70	-20.00	0.00	63.85	-	-	68.20	-4.35	204	105	H
			5.72500	47.26	Pk	35.70	-20.00	0.00	62.96	-	-	68.20	-5.24	190	223	V
			5.72610	49.32	Pk	35.70	-20.00	0.00	65.02	-	-	68.20	-3.18	190	223	V
802.11n (HT40)	5510	ANT1	* 5.45998	42.29	Pk	35.30	-20.60	0.00	56.99	-	-	74.00	-17.01	253	103	H
			* 5.45543	43.03	Pk	35.30	-20.60	0.00	57.73	-	-	74.00	-16.27	253	103	H
			5.46998	44.99	Pk	35.30	-20.60	0.00	59.69	-	-	68.20	-8.51	253	103	H
			5.46904	46.01	Pk	35.30	-20.60	0.00	60.71	-	-	68.20	-7.49	253	103	H
			* 5.45998	28.42	RMS	35.30	-20.60	0.18	43.30	54.00	-10.70	-	-	253	103	H
			* 5.45913	29.71	RMS	35.30	-20.50	0.18	44.69	54.00	-9.31	-	-	253	103	H
			5.46998	32.70	RMS	35.30	-20.60	0.18	47.58	-	-	-	-	253	103	H
			5.46930	33.39	RMS	35.30	-20.60	0.18	48.27	-	-	-	-	253	103	H
			* 5.45998	39.91	Pk	35.30	-20.60	0.00	54.61	-	-	74.00	-19.39	167	155	V
			* 5.45714	42.85	Pk	35.30	-20.60	0.00	57.55	-	-	74.00	-16.45	167	155	V
			5.46998	42.71	Pk	35.30	-20.60	0.00	57.41	-	-	68.20	-10.79	167	155	V
			5.46965	44.96	Pk	35.30	-20.60	0.00	59.66	-	-	68.20	-8.54	167	155	V
			* 5.45998	28.82	RMS	35.30	-20.60	0.18	43.70	54.00	-10.30	-	-	167	155	V
			* 5.45961	29.25	RMS	35.30	-20.60	0.18	44.13	54.00	-9.87	-	-	167	155	V
			5.46998	30.96	RMS	35.30	-20.60	0.18	45.84	-	-	-	-	167	155	V
			5.46919	32.27	RMS	35.30	-20.60	0.18	47.15	-	-	-	-	167	155	V
			5.72500	43.20	Pk	35.70	-20.00	0.00	58.90	-	-	68.20	-9.30	202	101	H
			5.72530	45.14	Pk	35.70	-20.00	0.00	60.84	-	-	68.20	-7.36	202	101	H
			5.72500	46.35	Pk	35.70	-20.00	0.00	62.05	-	-	68.20	-6.15	183	205	V
			5.72539	46.30	Pk	35.70	-20.00	0.00	62.00	-	-	68.20	-6.20	183	205	V
802.11ac (VHT80)	5530	ANT1	* 5.45998	41.64	Pk	35.30	-20.60	0.00	56.34	-	-	74.00	-17.66	117	100	H
			* 5.45307	44.39	Pk	35.30	-20.60	0.00	59.09	-	-	74.00	-14.91	117	100	H
			5.46998	40.98	Pk	35.30	-20.60	0.00	55.68	-	-	68.20	-12.52	117	100	H
			5.46797	44.34	Pk	35.30	-20.60	0.00	59.04	-	-	68.20	-9.16	117	100	H
			* 5.45998	30.76	RMS	35.30	-20.60	0.25	45.71	54.00	-8.29	-	-	117	100	H
			* 5.45897	31.22	RMS	35.30	-20.50	0.25	46.27	54.00	-7.73	-	-	117	100	H
			5.46998	30.39	RMS	35.30	-20.60	0.25	45.34	-	-	-	-	117	100	H
			5.46582	31.95	RMS	35.30	-20.60	0.25	46.90	-	-	-	-	117	100	H
			* 5.45998	42.40	Pk	35.30	-20.60	0.00	57.10	-	-	74.00	-16.90	167	135	V
			* 5.45816	45.72	Pk	35.30	-20.60	0.00	60.42	-	-	74.00	-13.58	167	135	V
			5.46998	42.17	Pk	35.30	-20.60	0.00	56.87	-	-	68.20	-11.33	167	135	V
			5.46571	46.46	Pk	35.30	-20.60	0.00	61.16	-	-	68.20	-7.04	167	135	V
			* 5.45998	30.61	RMS	35.30	-20.60	0.25	45.56	54.00	-8.44	-	-	167	135	V
			* 5.45989	32.40	RMS	35.30	-20.60	0.25	47.35	54.00	-6.65	-	-	167	135	V
			5.46998	32.00	RMS	35.30	-20.60	0.25	46.95	-	-	-	-	167	135	V
			5.46759	32.93	RMS	35.30	-20.60	0.25	47.88	-	-	-	-	167	135	V
			5.72500	39.17	Pk	35.70	-20.00	0.00	54.87	-	-	68.20	-13.33	111	122	H
			5.79837	40.47	Pk	35.80	-19.80	0.00	56.47	-	-	68.20	-11.73	111	122	H
			5.72500	37.92	Pk	35.70	-20.00	0.00	53.62	-	-	68.20	-14.58	160	158	V
			5.72969	39.98	Pk	35.70	-20.00	0.00	55.68	-	-	68.20	-12.52	160	158	V

Note1. Pk - Peak detector, RMS - RMS detector  
 Note2. \* - indicates frequency in CFR47 Pt 15 / IC RSS-Restricted Band

**HARMONICS AND SPURIOUS EMISSIONS(WORST CASE: 802.11a / 5580 MHz)**  
**5580 MHz HORIZONTAL**

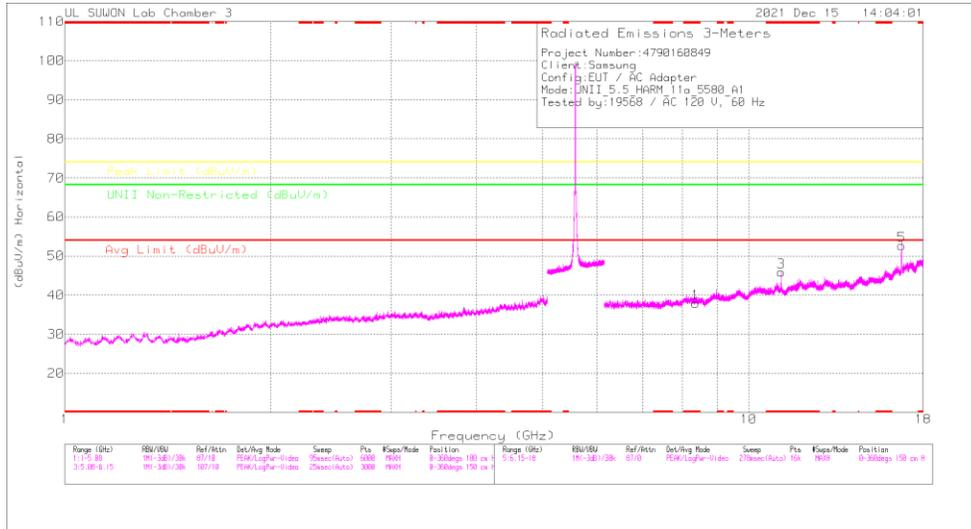

**5580 MHz VERTICAL**

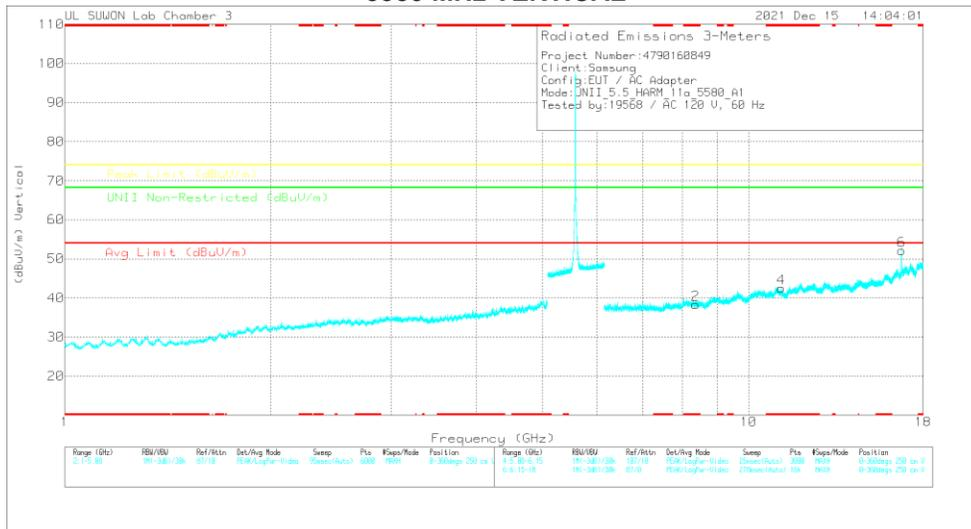

Note. Emission was scanned up to 40GHz; No emissions were detected above the noise floor which was at least 20dB below the specification limit.

**5580 MHz DATA**

**Radiated Emissions**

Frequency (GHz)	Meas Reading (dBuV)	Det	317_00218657	6GHz_HPSDR	DC Corr (dB)	Corrected Reading (dBuV/m)	Avg Limit (dBuV/m)	Margin (dB)	Peak Limit (dBuV/m)	Margin (dB)	UNII Non-Restricted (dBuV/m)	Margin (dB)	Altitude (m)	Height (m)	Polarity
* 8.37	37.39	PK-U	36.2	-23.9	0	49.69	-	-	74	-24.31	-	-	0	100	H
* 8.36985	36.5	PK-U	36.2	-23.9	0	48.8	-	-	74	-25.2	-	-	360	100	V
* 11.15992	39.08	PK-U	38.6	-21.8	0	55.88	-	-	74	-18.12	-	-	183	106	H
* 11.16107	28.48	ADR	38.6	-21.8	-16	45.64	54	-8.56	-	-	-	-	183	106	H
* 11.15988	37.37	PK-U	38.6	-21.8	0	54.17	-	-	74	-19.83	-	-	169	103	V
* 11.15988	26.53	ADR	38.6	-21.8	-16	43.49	54	-10.51	-	-	-	-	169	103	V
16/4032	41.99	PK-U	42.3	-19.1	0	65.19	-	-	-	-	68.2	-3.01	209	100	H
16/2972	39.98	PK-U	42.3	-19.1	0	63.18	-	-	-	-	68.2	-5.02	209	100	V

\* - indicates frequency in CFR47 Pt 15 / IC RSS-Restricted Band  
 PK-U - U-NII: Maximum Peak  
 ADR - U-NII AD primary method, RMS average



**HARMONICS AND SPURIOUS EMISSIONS TEST DATA**

Mode	Freq. [MHz]	Antenna	Frequency [GHz]	Reading [dBuV]	Detector Mode	ANT Factor	Loss [dB]	DC Corr [dB]	Result [dBuV/m]	AV Limit [dBuV/m]	AV Margin [dB]	PK Limit [dBuV/m]	PK Margin [dB]	Non-Restricted [dBuV/m]	Margin [dB]	Azimuth [Degs]	Height [cm]	Polarity	
802.11a	5500	ANT1	* 8.24074	35.99	PK-U	36.20	-23.90	0.00	48.29	-	-	74.00	-25.71	-	-	360	100	H	
			* 8.25765	35.93	PK-U	36.20	-24.00	0.00	48.13	-	-	74.00	-25.87	-	-	360	100	V	
			* 10.99991	35.07	PK-U	38.50	-21.70	0.00	51.87	-	-	74.00	-22.13	-	-	179	100	H	
			* 11.00023	25.79	ADR	38.50	-21.70	0.16	42.75	54.00	-11.25	-	-	-	-	179	100	H	
			* 10.99991	34.40	PK-U	38.50	-21.70	0.00	51.20	-	-	74.00	-22.80	-	-	162	106	V	
			* 10.99995	24.17	ADR	38.50	-21.70	0.16	41.13	54.00	-12.87	-	-	-	-	162	106	V	
			* 16.505	37.73	PK-U	42.00	-19.60	0.00	60.13	-	-	-	-	68.20	-8.07	199	100	H	
			* 16.505	37.43	PK-U	42.00	-19.60	0.00	59.83	-	-	-	-	68.20	-8.37	202	100	V	
			* 8.37	37.39	PK-U	36.20	-23.90	0.00	49.69	-	-	74.00	-24.31	-	-	0	100	H	
			* 8.36985	36.50	PK-U	36.20	-23.90	0.00	48.80	-	-	74.00	-25.20	-	-	360	100	V	
			* 11.15992	39.08	PK-U	38.60	-21.80	0.00	55.88	-	-	74.00	-18.12	-	-	183	106	H	
			* 11.16027	28.48	ADR	38.60	-21.80	0.16	45.44	54.00	-8.56	-	-	-	-	183	106	H	
	* 11.15988	37.37	PK-U	38.60	-21.80	0.00	54.17	-	-	74.00	-19.83	-	-	169	103	V			
	* 11.15988	26.53	ADR	38.60	-21.80	0.16	43.49	54.00	-10.51	-	-	-	-	169	103	V			
	* 16.740	41.99	PK-U	42.30	-19.10	0.00	65.19	-	-	-	-	68.20	-3.01	209	100	H			
	* 16.740	39.98	PK-U	42.30	-19.10	0.00	63.18	-	-	-	-	68.20	-5.02	208	100	V			
	5700	ANT1	8.543	35.52	PK-U	36.50	-23.20	0.00	48.82	-	-	-	-	68.20	-19.38	0	100	H	
			8.547	34.93	PK-U	36.50	-23.20	0.00	48.23	-	-	-	-	68.20	-19.97	0	100	V	
			* 11.40811	33.20	PK-U	38.60	-21.70	0.00	50.10	-	-	74.00	-23.90	-	-	0	100	H	
			* 11.39661	33.47	PK-U	38.60	-21.80	0.00	50.27	-	-	74.00	-23.73	-	-	0	100	V	
			* 17.100	35.66	PK-U	42.30	-18.50	0.00	59.46	-	-	-	-	68.20	-8.74	138	100	H	
			* 17.104	36.18	PK-U	42.30	-18.50	0.00	59.98	-	-	-	-	68.20	-8.22	145	130	V	
			8.579	34.84	PK-U	36.50	-23.30	0.00	48.04	-	-	-	-	68.20	-20.16	360	100	H	
			8.587	34.95	PK-U	36.50	-23.40	0.00	48.05	-	-	-	-	68.20	-20.15	0	100	V	
			* 11.43941	37.00	PK-U	38.60	-21.70	0.00	53.90	-	-	74.00	-20.10	-	-	205	100	H	
			* 11.44029	25.95	ADR	38.60	-21.80	0.16	42.91	54.00	-11.09	-	-	-	-	205	100	H	
			* 11.44544	37.39	PK-U	38.60	-21.80	0.00	54.19	-	-	74.00	-19.81	-	-	164	103	V	
			* 11.44009	26.76	ADR	38.60	-21.80	0.16	43.72	54.00	-10.28	-	-	-	-	164	103	V	
	* 17.160	40.35	PK-U	42.20	-18.30	0.00	64.25	-	-	-	-	68.20	-3.95	317	117	V			
	* 17.160	40.78	PK-U	42.20	-18.30	0.00	64.68	-	-	-	-	68.20	-3.52	203	100	H			
	802.11n (HT20) Spot-Check	5580	ANT1	* 11.16009	37.73	PK-U	38.60	-21.80	0.00	54.53	-	-	74.00	-19.47	-	-	178	101	H
				* 11.16004	27.61	ADR	38.60	-21.80	0.20	44.61	54.00	-9.39	-	-	-	178	101	H	
				* 11.15216	35.70	PK-U	38.60	-21.80	0.00	52.50	-	-	74.00	-21.50	-	-	154	304	V
				* 11.15991	24.85	ADR	38.60	-21.80	0.20	41.85	54.00	-12.15	-	-	-	154	304	V	
				13.901	37.15	PK-U	39.00	-23.30	0.00	52.85	-	-	-	-	68.20	-15.35	14	146	H
				13.910	37.44	PK-U	39.00	-23.20	0.00	53.24	-	-	-	-	68.20	-14.96	0	150	V
16.741				34.51	PK-U	42.30	-19.10	0.00	57.71	-	-	-	-	68.20	-10.49	184	125	H	
16.736				36.55	PK-U	42.30	-19.20	0.00	59.65	-	-	-	-	68.20	-8.55	319	113	V	
802.11n (HT40) Spot-Check	5510	ANT1	* 8.26552	36.02	PK-U	36.20	-24.00	0.00	48.22	-	-	74.00	-25.78	-	-	360	150	H	
			* 8.26785	36.33	PK-U	36.20	-24.00	0.00	48.53	-	-	74.00	-25.47	-	-	360	250	V	
			* 11.02462	33.83	PK-U	38.50	-21.70	0.00	50.63	-	-	74.00	-23.37	-	-	360	150	H	
			* 11.01726	34.11	PK-U	38.50	-21.70	0.00	50.91	-	-	74.00	-23.09	-	-	360	150	V	
			16.528	33.66	PK-U	42.10	-19.70	0.00	56.06	-	-	-	-	68.20	-12.14	360	150	H	
			16.532	33.02	PK-U	42.10	-19.80	0.00	55.32	-	-	-	-	68.20	-12.88	360	150	V	
802.11ac (VHT80) Spot-Check	5530	ANT1	* 8.28776	35.97	PK-U	36.20	-23.90	0.00	48.27	-	-	74.00	-25.73	-	-	360	150	H	
			* 8.28951	36.32	PK-U	36.20	-23.90	0.00	48.62	-	-	74.00	-25.38	-	-	360	150	V	
			* 11.06147	34.42	PK-U	38.50	-21.80	0.00	51.12	-	-	74.00	-22.88	-	-	360	150	H	
			* 11.06185	34.31	PK-U	38.50	-21.80	0.00	51.01	-	-	74.00	-22.99	-	-	360	150	V	
			16.585	32.52	PK-U	42.20	-19.60	0.00	55.12	-	-	-	-	68.20	-13.08	360	150	H	
			16.587	32.86	PK-U	42.20	-19.60	0.00	55.46	-	-	-	-	68.20	-12.74	360	150	V	

Note1. PK-U - U-NII: Maximum Peak / ADR - U-NII AD primary method, RMS average  
 Note2. \* - indicates frequency in CFR47 Pt 15 / IC RSS-Restricted Band

### 11.4. TX ABOVE 1GHz 1Tx MODE IN THE 5.8 GHz BAND

**BANDEDGE (WORST CASE: 802.11ac VHT80 LOWER SIDE / 5775 MHz)**

#### HORIZONTAL PEAK DATA

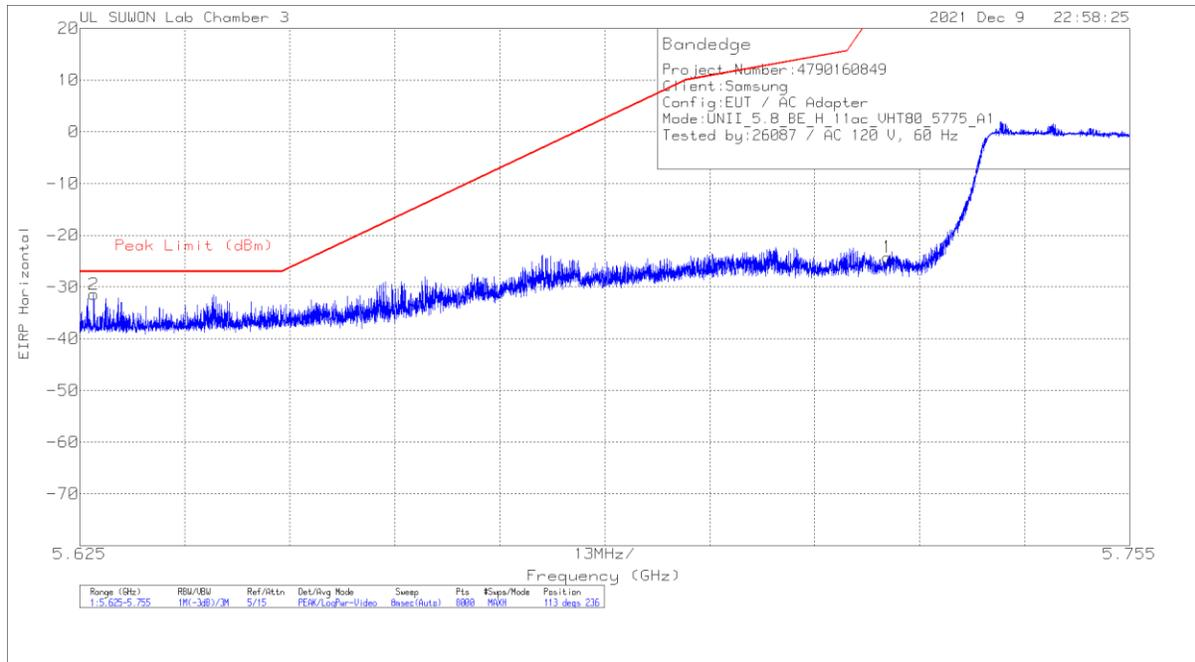

#### Trace Markers

Marker	Frequency (GHz)	Marker Reading (dBm)	Det	3117_00218957	10dB_ATT[dB]	Conversion Factor (dB)	DC Corr (dB)	Corrected Reading EIRP	Peak Limit (dBm)	PK Margin (dB)	Azimuth (Degs)	Height (cm)	Polarity
1	5.725	-51.65	Pk	35.6	-20	11.8	0	-24.25	27	-51.25	113	236	H
2	5.62672	-58.41	Pk	35.5	-20.3	11.8	0	-31.41	-27	-4.41	113	236	H

PK - Peak detector

**BANDEDGE TEST DATA**

Mode	Freq. [MHz]	Antenna	Frequency [GHz]	Reading [dBm]	Detector Mode	ANT Factor	Loss [dB]	Conv. F [dB]	DC Corr [dB]	Result [dBm]	PK Limit [dBm]	PK Margin [dB]	Azimuth [Degs]	Height [cm]	Polarity
802.11a	5745	ANT1	5.72500	-43.43	Pk	35.60	-20.00	11.80	0.00	-16.03	27.00	-43.03	112	237	H
			5.64845	-62.46	Pk	35.50	-20.30	11.80	0.00	-35.46	-27.00	-8.46	112	237	H
			5.72500	-47.84	Pk	35.60	-20.00	11.80	0.00	-20.44	27.00	-47.44	82	185	V
			5.64977	-63.51	Pk	35.50	-20.20	11.80	0.00	-36.41	-27.00	-9.41	82	185	V
802.11n (HT20)	5745	ANT1	5.72500	-44.69	Pk	35.60	-20.00	11.80	0.00	-17.29	27.00	-44.29	112	237	H
			5.64962	-61.53	Pk	35.50	-20.20	11.80	0.00	-34.43	-27.00	-7.43	112	237	H
			5.72500	-45.72	Pk	35.60	-20.00	11.80	0.00	-18.32	27.00	-45.32	94	118	V
			5.64403	-62.76	Pk	35.50	-20.30	11.80	0.00	-35.76	-27.00	-8.76	94	118	V
802.11n (HT40)	5755	ANT1	5.72500	-50.18	Pk	35.60	-20.00	11.80	0.00	-22.78	27.00	-49.78	110	133	H
			5.64741	-62.43	Pk	35.50	-20.30	11.80	0.00	-35.43	-27.00	-8.43	110	133	H
			5.72500	-51.15	Pk	35.60	-20.00	11.80	0.00	-23.75	27.00	-50.75	94	103	V
			5.64481	-63.12	Pk	35.50	-20.30	11.80	0.00	-36.12	-27.00	-9.12	94	103	V
802.11ac (VHT80)	5775	ANT1	5.72500	-51.65	Pk	35.60	-20.00	11.80	0.00	-24.25	27.00	-51.25	113	236	H
			5.62672	-58.41	Pk	35.50	-20.30	11.80	0.00	-31.41	-27.00	-4.41	113	236	H
			5.72500	-56.82	Pk	35.60	-20.00	11.80	0.00	-29.42	27.00	-56.42	94	103	V
			5.64226	-60.92	Pk	35.50	-20.30	11.80	0.00	-33.92	-27.00	-6.92	94	103	V

Note. Pk - Peak detector

**HARMONICS AND SPURIOUS EMISSIONS(WORST CASE: 802.11a / 5745 MHz)**  
**5745 MHz HORIZONTAL**

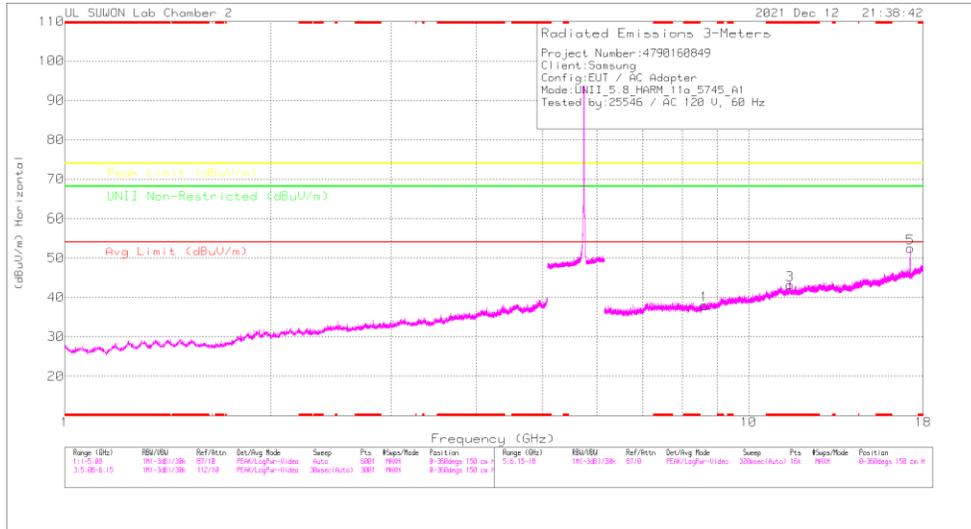

**5745 MHz VERTICAL**

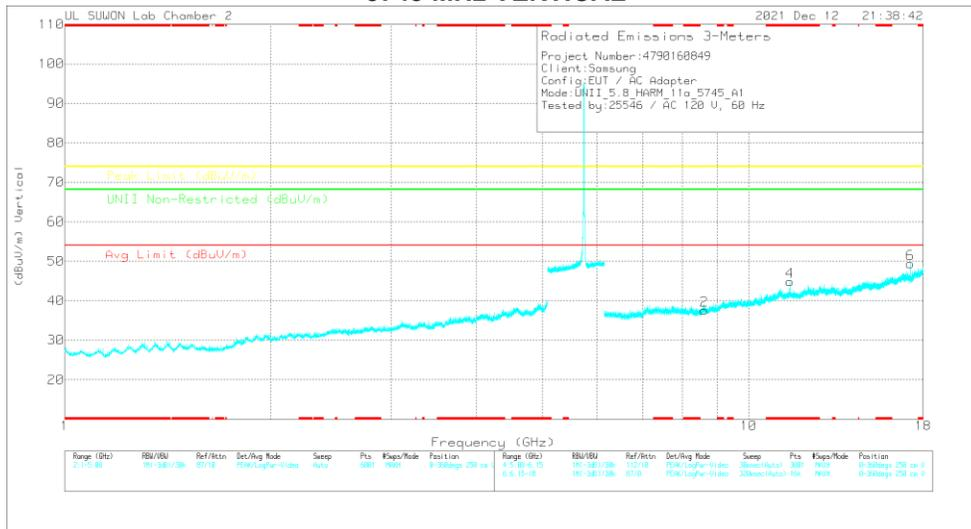

Note: Emission was scanned up to 40GHz; No emissions were detected above the noise floor which was at least 20dB below the specification limit.

**5745 MHz DATA**

**Radiated Emissions**

Frequency (GHz)	Meas Reading (dBm)	Det	317_00160724	6GHz_HPSIS	DC Corr (dB)	Consolid Reading (dBm)	Avg Limit (dBuV/m)	Margin (dB)	Peak Limit (dBuV/m)	Margin (dB)	UNII Non-Restricted (dBuV/m)	Margin (dB)	Altitude (m)	Height (m)	Polarity
8.63808	35.25	PK-U	36.1	-22	0	49.35	-	-	-	-	68.2	-18.85	0	100	H
8.60305	35.06	PK-U	36.1	-21.7	0	49.46	-	-	-	-	68.2	-18.74	0	100	V
*11.4839	35.12	PK-U	38.3	-19.8	0	53.62	-	-11.4	74	-20.38	-	-	176	104	H
*11.4902	23.94	ADR	38.3	-19.8	-16	42.6	54	-	-	-	-	-	176	104	H
*11.48579	36.8	PK-U	38.3	-19.7	0	55.4	-	-	74	-18.6	-	-	179	100	V
*11.48989	25.12	ADR	38.3	-19.8	-16	43.78	54	-10.22	-	-	-	-	179	100	V
*17.2407	42.56	PK-U	40.9	-18.7	0	64.76	-	-	-	-	68.2	-3.44	203	100	H
17.23515	41.79	PK-U	40.9	-18.7	0	63.99	-	-	-	-	68.2	-4.21	309	104	V

\* - indicates frequency in CFR47 Pt 15 / IC RSS-Restricted Band  
 PK-U - U-NII: Maximum Peak  
 ADR - U-NII AD primary method, RMS average

**HARMONICS AND SPURIOUS EMISSIONS TEST DATA**

Mode	Freq. [MHz]	Antenna	Frequency [GHz]	Reading [dBuV]	Detector Mode	ANT Factor	Loss [dB]	DC Corr [dB]	Result [dBuV/m]	AV Limit [dBuV/m]	AV Margin [dB]	PK Limit [dBuV/m]	PK Margin [dB]	Non-Restricted [dBuV/m]	Margin [dB]	Azimuth [Degs]	Height [cm]	Polarity			
802.11a	5745	ANT1	8.638	35.25	PK-U	36.10	-22.00	0.00	49.35	-	-	-	-	-	68.20	-18.85	0	100	H		
			8.603	35.06	PK-U	36.10	-21.70	0.00	49.46	-	-	-	-	-	-	68.20	-18.74	0	100	V	
			* 11.4839	35.12	PK-U	38.30	-19.80	0.00	53.62	-	-	-	74.00	-20.38	-	-	-	176	104	H	
			* 11.4902	23.94	ADR	38.30	-19.80	0.16	42.60	54.00	-11.40	-	-	-	-	-	-	-	176	104	H
			* 11.48579	36.80	PK-U	38.30	-19.70	0.00	55.40	-	-	-	74.00	-18.60	-	-	-	-	179	100	V
			* 11.48989	25.12	ADR	38.30	-19.80	0.16	43.78	54.00	-10.22	-	-	-	-	-	-	-	179	100	V
			17.241	42.56	PK-U	40.90	-18.70	0.00	64.76	-	-	-	-	-	-	68.20	-3.44	203	100	H	
			17.235	41.79	PK-U	40.90	-18.70	0.00	63.99	-	-	-	-	-	-	68.20	-4.21	309	104	V	
	5785	ANT1	8.678	35.85	PK-U	36.20	-22.80	0.00	49.25	-	-	-	-	-	68.20	-18.95	0	100	H		
			8.700	35.66	PK-U	36.20	-23.10	0.00	48.76	-	-	-	-	-	68.20	-19.44	0	100	V		
			* 11.5656	36.25	PK-U	38.30	-19.90	0.00	54.65	-	-	-	74.00	-19.35	-	-	-	180	100	H	
			* 11.5701	24.49	ADR	38.30	-19.90	0.16	43.05	54.00	-10.95	-	-	-	-	-	-	180	100	H	
			* 11.5742	37.09	PK-U	38.30	-19.90	0.00	55.49	-	-	-	74.00	-18.51	-	-	-	176	100	V	
			* 11.5702	25.50	ADR	38.30	-19.90	0.16	44.06	54.00	-9.94	-	-	-	-	-	-	176	100	V	
			17.360	42.15	PK-U	41.00	-18.60	0.00	64.55	-	-	-	-	-	-	68.20	-3.65	204	100	H	
			17.360	42.10	PK-U	41.00	-18.60	0.00	64.50	-	-	-	-	-	-	68.20	-3.70	310	101	V	
	5825	ANT1	8.738	35.07	PK-U	36.50	-23.10	0.00	48.47	-	-	-	-	-	68.20	-19.73	360	100	H		
			8.731	34.91	PK-U	36.50	-23.10	0.00	48.31	-	-	-	-	-	68.20	-19.89	0	100	V		
			* 11.65474	40.17	PK-U	38.90	-21.70	0.00	57.37	-	-	-	74.00	-16.63	-	-	-	243	101	H	
			* 11.65054	28.34	ADR	38.90	-21.70	0.16	45.70	54.00	-8.30	-	-	-	-	-	-	243	101	H	
			* 11.65516	38.99	PK-U	38.90	-21.70	0.00	56.19	-	-	-	74.00	-17.81	-	-	-	165	100	V	
			* 11.64984	28.05	ADR	38.80	-21.70	0.16	45.31	54.00	-8.69	-	-	-	-	-	-	165	100	V	
			17.480	39.77	PK-U	42.00	-17.40	0.00	64.37	-	-	-	-	-	-	68.20	-3.83	151	100	H	
			17.479	40.07	PK-U	42.00	-17.50	0.00	64.57	-	-	-	-	-	-	68.20	-3.63	316	110	V	

Note1. PK-U - U-NII: Maximum Peak / ADR - U-NII AD primary method, RMS average

Note2. \* - indicates frequency in CFR47 Pt 15 / IC RSS-Restricted Band

### 11.5. TX ABOVE 1GHz 1Tx MODE IN THE 5.9 GHz BAND

**BANDEDGE (WORST CASE: 802.11ac VHT80 / 5855 MHz)**

**VERTICAL PEAK DATA**

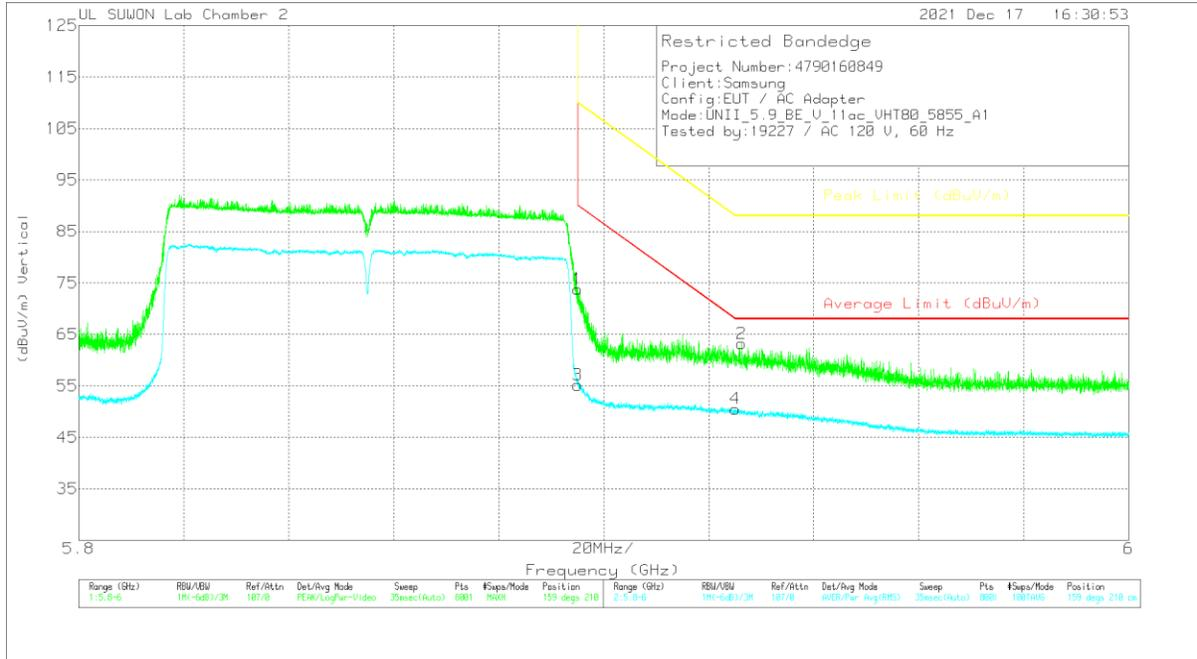

**Trace Markers**

Marker	Frequency (GHz)	Meter Reading (dBuV)	Det	3117_00168724	10dB_ATT(dB)	DC Corr (dB)	Corrected Reading (dBuV/m)	Average Limit (dBuV/m)	Margin (dB)	Peak Limit (dBuV/m)	PK Margin (dB)	Azimuth (Degs)	Height (cm)	Polarity
1	5.895	55.68	PK	35	-16.9	0	73.78	-	-	110	-36.22	159	210	V
2	5.92623	45.1	PK	35.1	-17	0	63.2	-	-	88	-24.8	159	210	V
3	5.895	36.81	RMS	35	-16.9	.25	55.16	90	-34.84	-	-	159	210	V
4	5.92503	32.08	RMS	35.1	-16.9	.25	50.53	88	-17.47	-	-	159	210	V

Pk - Peak detector  
 RMS - RMS detection

**BANDEDGE TEST DATA**

Mode	Freq. [MHz]	Antenna	Frequency [GHz]	Reading [dBuV]	Detector Mode	ANT Factor	Loss [dB]	DC Corr [dB]	Result [dBuV/m]	AV Limit [dBuV/m]	AV Margin [dB]	PK Limit [dBuV/m]	PK Margin [dB]	Azimuth [Degs]	Height [cm]	Polarity
802.11a	5885	ANT1	5.89501	61.73	Pk	36.00	-19.90	0.00	77.83	-	-	109.99	-32.16	110	259	H
			5.92602	39.90	Pk	36.00	-19.90	0.00	56.00	-	-	88.00	-32.00	110	259	H
			5.89501	44.22	RMS	36.00	-19.90	0.16	60.48	89.99	-29.51	-	-	110	259	H
			5.92527	28.32	RMS	36.00	-19.80	0.16	44.68	68.00	-23.32	-	-	110	259	H
			5.89501	58.37	Pk	36.00	-19.90	0.00	74.47	-	-	109.99	-36.52	80	101	V
			5.99172	39.56	Pk	36.00	-19.70	0.00	55.86	-	-	88.00	-32.14	80	101	V
			5.89501	42.63	RMS	36.00	-19.90	0.16	58.89	89.99	-31.10	-	-	80	100	V
5.99702	28.15	RMS	36.00	-19.70	0.16	44.61	68.00	-23.39	-	-	80	100	V			
802.11n (HT20)	5885	ANT1	5.89501	68.02	Pk	36.00	-19.90	0.00	84.12	-	-	109.99	-25.87	107	259	H
			5.89509	67.45	Pk	36.00	-19.90	0.00	83.55	-	-	109.94	-26.39	107	259	H
			5.89501	49.20	RMS	36.00	-19.90	0.20	65.50	89.99	-24.49	-	-	107	259	H
			5.92469	31.15	RMS	36.00	-19.80	0.20	47.55	68.23	-20.68	-	-	107	259	H
			5.89501	64.38	Pk	36.00	-19.90	0.00	80.48	-	-	109.99	-29.51	77	105	V
			5.89514	63.41	Pk	36.00	-19.90	0.00	79.51	-	-	109.90	-30.39	77	105	V
			5.89501	46.57	RMS	36.00	-19.90	0.20	62.87	89.99	-27.12	-	-	77	105	V
5.92519	29.10	RMS	36.00	-19.80	0.20	45.50	68.00	-22.50	-	-	77	105	V			
802.11n (HT40)	5875	ANT1	5.89503	56.02	Pk	35.00	-16.90	0.00	74.12	-	-	109.98	-35.86	160	158	H
			5.92748	40.60	Pk	35.10	-16.90	0.00	58.80	-	-	88.00	-29.20	160	158	H
			5.89505	36.20	RMS	35.00	-16.90	0.18	54.48	89.96	-35.48	-	-	160	158	H
			5.92728	28.01	RMS	35.10	-16.90	0.18	46.39	68.00	-21.61	-	-	160	158	H
			5.89505	59.91	Pk	35.00	-16.90	0.00	78.01	-	-	109.96	-31.95	152	223	V
			5.92240	45.72	Pk	35.00	-16.90	0.00	63.82	-	-	89.91	-26.09	152	223	V
			5.89505	40.65	RMS	35.00	-16.90	0.18	58.93	89.96	-31.03	-	-	152	223	V
5.92518	29.13	RMS	35.10	-16.90	0.18	47.51	68.00	-20.49	-	-	152	223	V			
802.11ac (VHT80)	5855	ANT1	5.89503	53.13	Pk	35.00	-16.90	0.00	71.23	-	-	109.98	-38.75	240	371	H
			5.92700	44.76	Pk	35.10	-16.90	0.00	62.96	-	-	88.00	-25.04	240	371	H
			5.89503	36.13	RMS	35.00	-16.90	0.25	54.48	89.98	-35.50	-	-	240	371	H
			5.92608	31.09	RMS	35.10	-17.00	0.25	49.44	68.00	-18.56	-	-	240	371	H
			5.89500	55.68	Pk	35.00	-16.90	0.00	73.78	-	-	110.00	-36.22	159	210	V
			5.92623	45.10	Pk	35.10	-17.00	0.00	63.20	-	-	88.00	-24.80	159	210	V
			5.89500	36.81	RMS	35.00	-16.90	0.25	55.16	90.00	-34.84	-	-	159	210	V
5.92503	32.08	RMS	35.10	-16.90	0.25	50.53	68.00	-17.47	-	-	159	210	V			

Note. RMS - RMS detection

**HARMONICS AND SPURIOUS EMISSIONS(WORST CASE: 802.11a / 5865 MHz)**  
**5865 MHz HORIZONTAL**

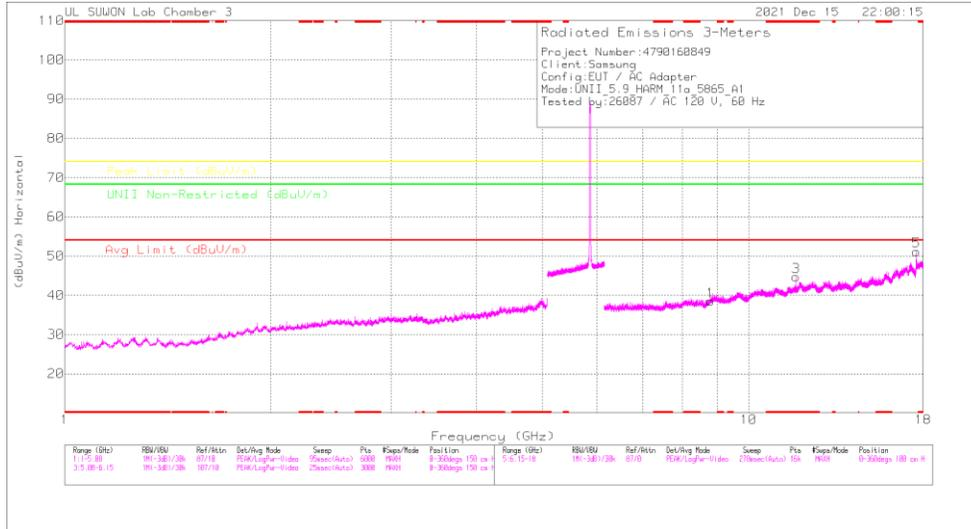

**5865 MHz VERTICAL**

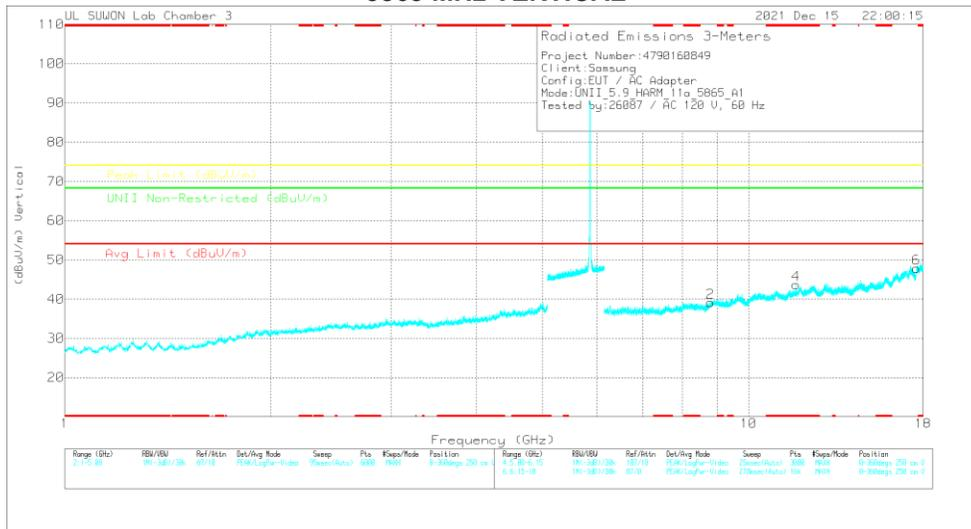

Note: Emission was scanned up to 40GHz; No emissions were detected above the noise floor which was at least 20dB below the specification limit.

**5865 MHz DATA**

**Radiated Emissions**

Frequency (GHz)	Missed Reading (dBuV)	Det	317_00218967	60Hz_HPSDR	DC Corr (dB)	Consolidated Reading (dBuV/m)	Avg Limit (dBuV/m)	Margin (dB)	Peak Limit (dBuV/m)	Margin (dB)	UNII Non-Restricted (dBuV/m)	Margin (dB)	Altitude (Height) (m)	Height (m)	Polarity
8.79928	35.48	PK-U	36.5	-22.6	0	49.38	-	-	-	-	68.2	-18.82	0	100	H
8.80077	35.34	PK-U	36.5	-22.6	0	49.24	-	-	-	-	68.2	-18.96	0	100	V
*11.73495	39.5	PK-U	38.9	-21.7	0	56.7	-	-	74	-17.3	-	-	242	100	H
*11.73026	28.13	ADR	38.9	-21.7	-16	45.49	54	-8.51	-	-	-	-	242	100	H
*11.72911	38.12	PK-U	38.9	-21.7	0	55.32	-	-	74	-18.68	-	-	171	100	V
*11.72976	27.14	ADR	38.9	-21.7	-16	44.5	54	-9.5	-	-	-	-	171	100	V
17.59975	37.65	PK-U	42	-17	0	62.65	-	-	-	-	68.2	-5.55	173	100	H
17.60053	31.9	PK-U	42	-17	0	56.9	-	-	-	-	68.2	-11.3	0	100	V

\* - indicates frequency in CFR47 Pt 15 / IC RSS-Restricted Band  
 PK-U - U-NII: Maximum Peak  
 ADR - U-NII AD primary method, RMS average



**HARMONICS AND SPURIOUS EMISSIONS TEST DATA**

Mode	Freq. [MHz]	Antenna	Frequency [GHz]	Reading [dBuV]	Detector Mode	ANT Factor	Loss [dB]	DC Corr [dB]	Result [dBuV/m]	AV Limit [dBuV/m]	AV Margin [dB]	PK Limit [dBuV/m]	PK Margin [dB]	Non-Restricted [dBuV/m]	Margin [dB]	Azimuth [Degs]	Height [cm]	Polarity		
802.11a	5845	ANT1	8.774	35.30	PK-U	36.30	-22.90	0.00	48.70	-	-	-	-	68.20	-19.50	360	100	H		
			8.763	35.35	PK-U	36.30	-23.10	0.00	48.55	-	-	-	-	68.20	-19.65	0	100	V		
			* 11.68902	36.67	PK-U	38.50	-19.70	0.00	55.47	-	-	74.00	-18.53	-	-	-	243	113	H	
			* 11.6901	24.75	ADR	38.50	-19.70	0.16	43.71	54.00	-10.29	-	-	-	-	-	-	243	113	H
			* 11.68995	36.42	PK-U	38.50	-19.70	0.00	55.22	-	-	74.00	-18.78	-	-	-	-	180	109	V
			* 11.68999	24.98	ADR	38.50	-19.70	0.16	43.94	54.00	-10.06	-	-	-	-	-	-	180	109	V
			17.540	38.61	PK-U	41.30	-17.30	0.00	62.61	-	-	-	-	-	-	68.20	-5.59	288	109	H
			17.539	38.49	PK-U	41.30	-17.30	0.00	62.49	-	-	-	-	-	-	68.20	-5.71	311	100	V
			8.799	35.48	PK-U	36.50	-22.60	0.00	49.38	-	-	-	-	-	-	68.20	-18.82	0	100	H
			8.801	35.34	PK-U	36.50	-22.60	0.00	49.24	-	-	-	-	-	-	68.20	-18.96	0	100	V
	* 11.73495	39.50	PK-U	38.90	-21.70	0.00	56.70	-	-	74.00	-17.30	-	-	-	-	242	100	H		
	* 11.73026	28.13	ADR	38.90	-21.70	0.16	45.49	54.00	-8.51	-	-	-	-	-	-	242	100	H		
	* 11.72911	38.12	PK-U	38.90	-21.70	0.00	55.32	-	-	74.00	-18.68	-	-	-	-	171	100	V		
	* 11.72976	27.14	ADR	38.90	-21.70	0.16	44.50	54.00	-9.50	-	-	-	-	-	-	171	100	V		
	17.600	37.65	PK-U	42.00	-17.00	0.00	62.65	-	-	-	-	-	-	68.20	-5.55	173	100	H		
	17.601	31.90	PK-U	42.00	-17.00	0.00	56.90	-	-	-	-	-	-	68.20	-11.30	0	100	V		
	8.822	35.67	PK-U	36.30	-22.30	0.00	49.67	-	-	-	-	-	-	68.20	-18.53	0	100	H		
	8.819	34.97	PK-U	36.30	-22.40	0.00	48.87	-	-	-	-	-	-	68.20	-19.33	360	100	V		
	* 11.76415	33.80	PK-U	38.60	-20.20	0.00	52.20	-	-	74.00	-21.80	-	-	-	-	0	100	H		
	* 11.76453	36.75	PK-U	38.60	-20.20	0.00	55.15	-	-	74.00	-18.85	-	-	-	-	169	100	V		
	* 11.77009	25.33	ADR	38.60	-20.20	0.16	43.89	54.00	-10.11	-	-	-	-	-	-	169	100	V		
	17.661	37.79	PK-U	41.50	-17.80	0.00	61.49	-	-	-	-	-	-	68.20	-6.71	221	217	H		

Note1. PK-U - U-NII: Maximum Peak / ADR - U-NII AD primary method, RMS average

Note2. \* - indicates frequency in CFR47 Pt 15 / IC RSS-Restricted Band

## 12. WORST-CASE BELOW 1 GHz SPURIOUS EMISSIONS 30 TO 1000 MHz (WORST-CASE CONFIGURATION, HORIZONTAL)

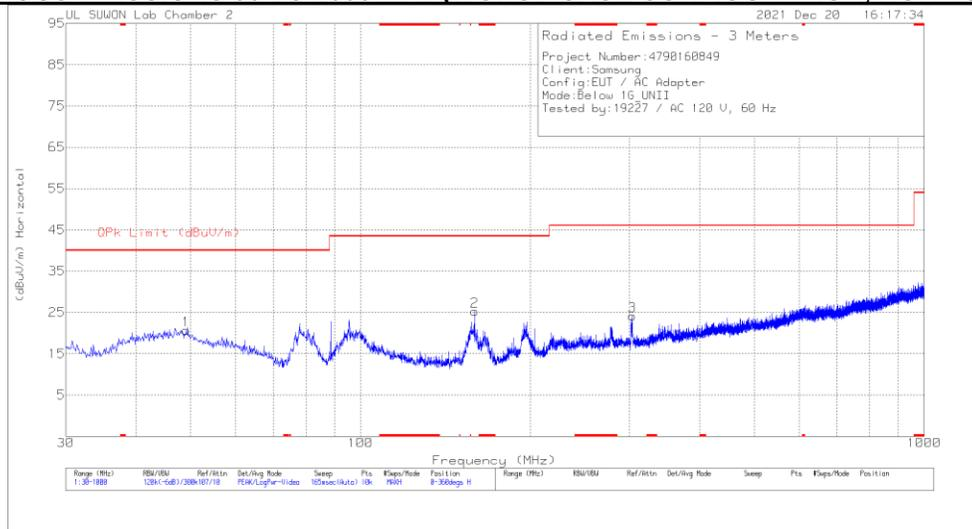

## SPURIOUS EMISSIONS 30 TO 1000 MHz (WORST-CASE CONFIGURATION, VERTICAL)

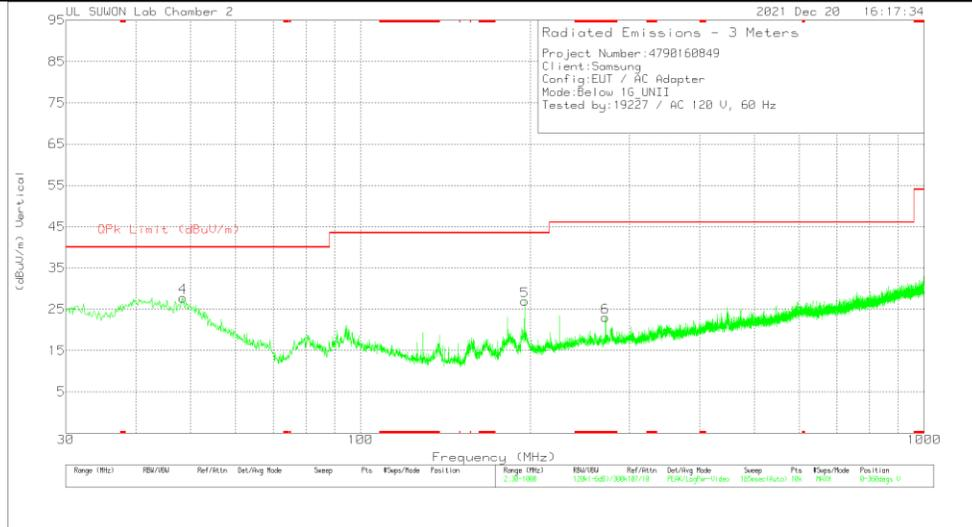

### Trace Markers

Marker	Frequency (MHz)	Meter Reading (dBuV)	Det	VULB9163_749	Below 1G[dB]	DC Corr (dB)	Corrected Reading (dBuV/m)	OPK Limit (dBuV/m)	Margin (dB)	Azimuth (Degs)	Height (cm)	Polarity
1	49.012	32.63	Pk	19.9	-31.8	0	20.73	40	-19.27	0-360	100	H
2	159.495	42.02	Pk	14.2	-31	0	25.22	43.52	-18.3	0-360	100	H
3	303.346	35.23	Pk	19.2	-30.3	0	24.13	46.02	-21.89	0-360	100	H
4	48.43	39.61	Pk	19.9	-31.7	0	27.81	40	-12.19	0-360	100	V
5	195.579	40.46	Pk	17.4	-30.8	0	27.06	43.52	-16.46	0-360	100	V
6	* 272.112	34.97	Pk	18.5	-30.4	0	23.07	46.02	-22.95	0-360	100	V

\* - indicates frequency in CFR47 Pt 15 / IC RSS-Restricted Band  
 Pk - Peak detector

### 13. AC POWER LINE CONDUCTED EMISSIONS

#### LIMITS

FCC §15.207 (a)  
IC RSS-GEN Clause 8.8

Frequency of Emission (MHz)	Conducted Limit (dBuV)	
	Quasi-peak	Average
0.15-0.5	66 to 56 <sup>*</sup>	56 to 46 <sup>*</sup>
0.5-5	56	46
5-30	60	50

<sup>\*</sup>Decreases with the logarithm of the frequency.

#### TEST PROCEDURE

The EUT is placed on a non-conducting table 40 cm from the vertical ground plane and 80 cm above the horizontal ground plane. The EUT is configured in accordance with ANSI C63.10.

The receiver is set to a resolution bandwidth of 9 kHz. Peak detection is used unless otherwise noted as quasi-peak or average.

Line conducted data is recorded for both NEUTRAL and HOT lines.

#### RESULTS

**WORST EMISSIONS**

**LINE 1 DATA**

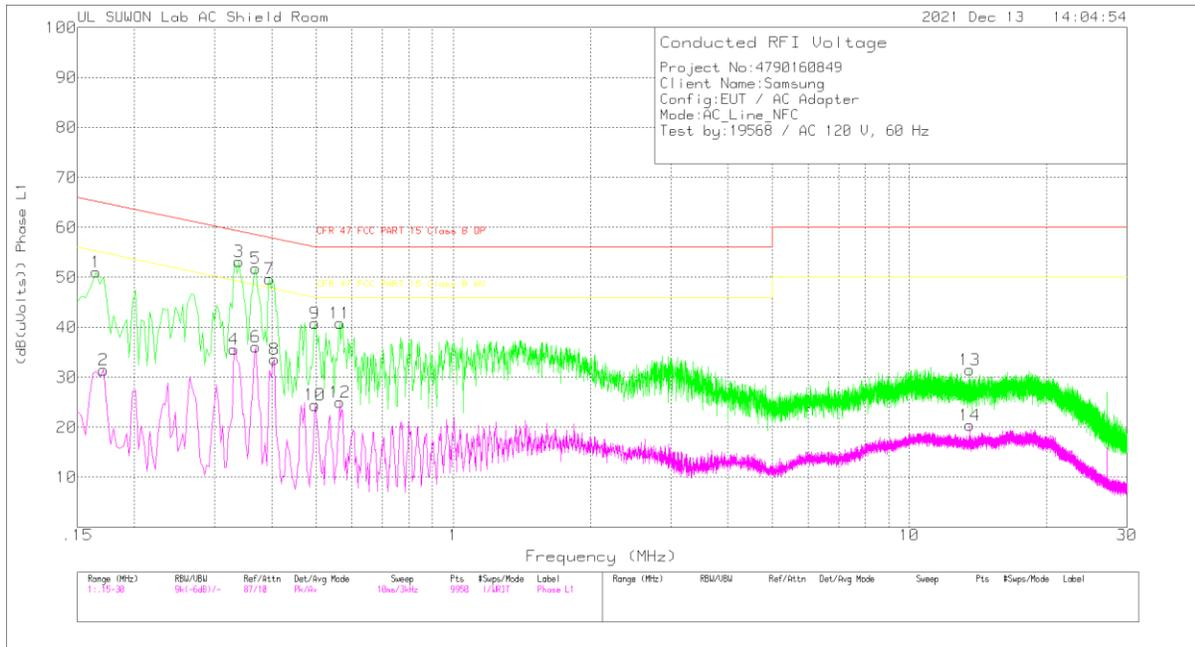

**Trace Markers**

Range 1: Phase L1 .15 - 30MHz

Marker	Frequency (MHz)	Meter Reading (dBuV)	Det	101836_Wit h EX_L1[dB]	CABLELOS S(dB)	Corrected Reading (dB(uVolts))	CFR 47 FCC PART 15 Class B QP	Margin (dB)	CFR 47 FCC PART 15 Class B AV	Margin (dB)
1	.165	41.01	Pk	9.9	.1	51.01	65.21	-14.2	-	-
2	.171	21.23	Av	10	.2	31.43	-	-	54.91	-23.48
3	.339	43.21	Pk	9.8	.2	53.21	59.23	-6.02	-	-
4	.33	25.62	Av	9.8	.2	35.62	-	-	49.45	-13.83
5	.369	41.79	Pk	9.8	.2	51.79	58.52	-6.73	-	-
6	.369	26.09	Av	9.8	.2	36.09	-	-	48.52	-12.43
7	.396	39.68	Pk	9.8	.2	49.68	57.94	-8.26	-	-
8	.405	23.64	Av	9.8	.2	33.64	-	-	47.75	-14.11
9	.498	30.76	Pk	9.9	.2	40.86	56.03	-15.17	-	-
10	.498	14.35	Av	9.9	.2	24.45	-	-	46.03	-21.58
11	.564	30.78	Pk	9.8	.2	40.78	56	-15.22	-	-
12	.564	15	Av	9.8	.2	25	-	-	46	-21
13	13.563	21.11	Pk	10	.4	31.51	60	-28.49	-	-
14	13.56	9.99	Av	10	.4	20.39	-	-	50	-29.61

Pk - Peak detector  
 Av - Average detection

**Quasi-Peak Emissions**

Range 1: Phase L1 .15 - 30MHz

Frequency (MHz)	Meter Reading (dBuV)	Det	101836_Wit h EX_L1[dB]	CABLELOS S(dB)	Corrected Reading (dB(uVolts))	CFR 47 FCC PART 15 Class B QP	Margin (dB)	CFR 47 FCC PART 15 Class B AV	Margin (dB)
.33825	41.42	Qp	9.8	.2	51.42	59.25	-7.83	-	-
.36915	39.93	Qp	9.8	.2	49.93	58.52	-8.59	-	-
.40425	37.47	Qp	9.8	.2	47.47	57.77	-10.3	-	-

Qp - Quasi-Peak detector

### LINE 2 DATA

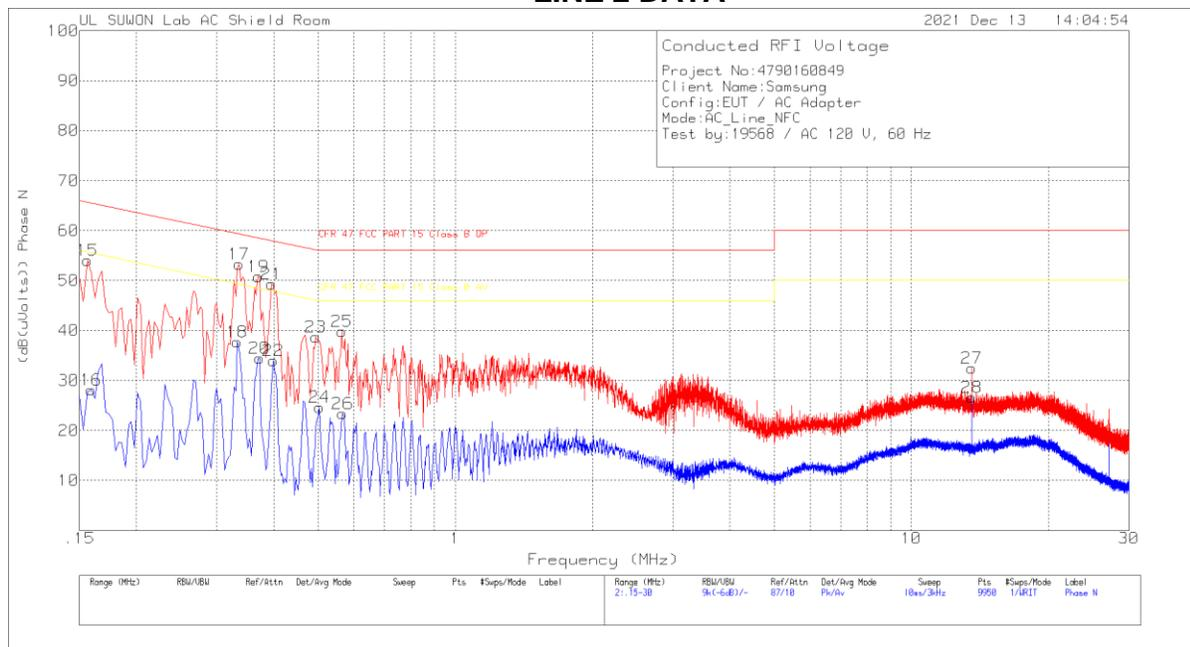

#### Trace Markers

Range 2: Phase N .15 - 30MHz

Marker	Frequency (MHz)	Meter Reading (dBuV)	Det	101836_Wit h EX_N[dB]	CABLELOS S(dB)	Corrected Reading (dB(uVolts))	CFR 47 FCC PART 15 Class B QP	Margin (dB)	CFR 47 FCC PART 15 Class B AV	Margin (dB)
15	.156	44.15	Pk	9.8	.1	54.05	65.67	-11.62	-	-
16	.159	18.27	Av	9.8	.1	28.17	-	-	55.52	-27.35
17	.336	43.32	Pk	9.8	.2	53.32	59.3	-5.98	-	-
18	.333	27.71	Av	9.8	.2	37.71	-	-	49.38	-11.67
19	.3705	40.79	Pk	9.8	.2	50.79	58.49	-7.7	-	-
20	.372	24.48	Av	9.8	.2	34.48	-	-	48.46	-13.98
21	.396	39.36	Pk	9.8	.2	49.36	57.94	-8.58	-	-
22	.399	23.93	Av	9.8	.2	33.93	-	-	47.87	-13.94
23	.495	28.67	Pk	9.9	.2	38.77	56.08	-17.31	-	-
24	.504	14.59	Av	9.9	.2	24.69	-	-	46	-21.31
25	.564	29.77	Pk	9.9	.2	39.87	56	-16.13	-	-
26	.567	13.29	Av	9.9	.2	23.39	-	-	46	-22.61
27	13.56	22.09	Pk	10	.4	32.49	60	-27.51	-	-
28	13.56	16.24	Av	10	.4	26.64	-	-	50	-23.36

Pk - Peak detector

Av - Average detection

#### Quasi-Peak Emissions

Range 2: Phase N .15 - 30MHz

Frequency (MHz)	Meter Reading (dBuV)	Det	101836_Wit h EX_N[dB]	CABLELOS S(dB)	Corrected Reading (dB(uVolts))	CFR 47 FCC PART 15 Class B QP	Margin (dB)	CFR 47 FCC PART 15 Class B AV	Margin (dB)
.33615	41.78	Qp	9.8	.2	51.78	59.3	-7.52	-	-
.36975	39.18	Qp	9.8	.2	49.18	58.51	-9.33	-	-
.39675	37.28	Qp	9.8	.2	47.28	57.92	-10.64	-	-

Qp - Quasi-Peak detector

## 14. DYNAMIC FREQUENCY SELECTION

### 14.1. OVERVIEW

#### 14.1.1. LIMITS

#### FCC

§15.407 (h), FCC KDB 905462 D02 “COMPLIANCE MEASUREMENT PROCEDURES FOR UNLICENSED-NATIONAL INFORMATION INFRASTRUCTURE DEVICES OPERATING IN THE 5250-5350 MHz AND 5470-5725 MHz BANDS INCORPORATING DYNAMIC FREQUENCY SELECTION” and KDB 905462 D03 “U-NII CLIENT DEVICES WITHOUT RADAR DETECTION CAPABILITY”.

**Table 1: Applicability of DFS requirements prior to use of a channel**

Requirement	Operational Mode		
	Master	Client (without radar detection)	Client (with radar detection)
Non-Occupancy Period	Yes	Not required	Yes
DFS Detection Threshold	Yes	Not required	Yes
Channel Availability Check Time	Yes	Not required	Not required
U-NII Detection Bandwidth	Yes	Not required	Yes

**Table 2: Applicability of DFS requirements during normal operation**

Requirement	Operational Mode		
	Master	Client (without DFS)	Client (with DFS)
DFS Detection Threshold	Yes	Not required	Yes
Channel Closing Transmission Time	Yes	Yes	Yes
Channel Move Time	Yes	Yes	Yes
U-NII Detection Bandwidth	Yes	Not required	Yes

Additional requirements for devices with multiple bandwidth modes	Master Device or Client with Radar DFS	Client (without DFS)
U-NII Detection Bandwidth and Statistical Performance Check	All BW modes must be tested	Not required
Channel Move Time and Channel Closing Transmission Time	Test using widest BW mode available	Test using the widest BW mode available for the link
All other tests	Any single BW mode	Not required

**Note:** Frequencies selected for statistical performance check (Section 7.8.4) should include several frequencies within the radar detection bandwidth and frequencies near the edge of the radar detection bandwidth. For 802.11 devices it is suggested to select frequencies in all 20 MHz channel blocks and a null frequency between the bonded 20 MHz channel blocks.

**Table 3: Interference Threshold values, Master or Client incorporating In-Service Monitoring**

Maximum Transmit Power	Value (see notes)
E.I.R.P. $\geq$ 200 mill watt	-64 dBm
E.I.R.P. < 200 mill watt and power spectral density < 10 dBm/MHz	-62 dBm
E.I.R.P. < 200 mill watt that do not meet power spectral density requirement	-64 dBm
<p><b>Note 1:</b> This is the level at the input of the receiver assuming a 0 dBi receive antenna  <b>Note 2:</b> Throughout these test procedures an additional 1 dB has been added to the amplitude of the test transmission waveforms to account for variations in measurement equipment. This will ensure that the test signal is at or above the detection threshold level to trigger a DFS response.  <b>Note 3:</b> E.I.R.P. is based on the highest antenna gain. For MIMO devices refer to KDB publication 662911 D01.</p>	

**Table 4: DFS Response requirement values**

Parameter	Value
<i>Non-occupancy period</i>	30 minutes
<i>Channel Availability Check Time</i>	60 seconds
<i>Channel Move Time</i>	10 seconds (See Note 1)
<i>Channel Closing Transmission Time</i>	200 milliseconds + approx. 60 milliseconds over remaining 10 second period. (See Notes 1 and 2)
<i>U-NII Detection Bandwidth</i>	Minimum 100% of the U- NII 99% transmission power bandwidth. (See Note 3)
<p><b>Note 1:</b> <i>Channel Move Time</i> and the <i>Channel Closing Transmission Time</i> should be performed with Radar Type 0. The measurement timing begins at the end of the Radar Type 0 burst.  <b>Note 2:</b> The <i>Channel Closing Transmission Time</i> is comprised of 200 milliseconds starting at the beginning of the <i>Channel Move Time</i> plus any additional intermittent control signals required to facilitate a <i>Channel</i> move (an aggregate of 60 milliseconds) during the remainder of the 10 second period. The aggregate duration of control signals will not count quiet periods in between transmissions.  <b>Note 3:</b> During the <i>U-NII Detection Bandwidth</i> detection test, radar type 0 should be used. For each frequency step the minimum percentage of detection is 90 percent. Measurements are performed with no data traffic.</p>	

**Table 5 – Short Pulse Radar Test Waveforms**

Radar Type	Pulse Width (usec)	PRI (usec)	Pulses	Minimum Percentage of Successful Detection	Minimum Trials
0	1	1428	18	See Note 1	See Note 1
1	1	Test A: 15 unique PRI values randomly selected from the list of 23 PRI values in table 5a	Roundup: $\{(1/360) \times (19 \times 10^6 \text{ PRI}_{\text{usec}})\}$	60%	30
		Test B: 15 unique PRI values randomly selected within the range of 518-3066 usec. With a minimum increment of 1 usec, excluding PRI values selected in Test A			
2	1-5	150-230	23-29	60%	30
3	6-10	200-500	16-18	60%	30
4	11-20	200-500	12-16	60%	30
Aggregate (Radar Types 1-4)				80%	120
<b>Note 1:</b> Short Pulse Radar Type 0 should be used for the <i>Detection Bandwidth</i> test, <i>Channel Move Time</i> , and <i>Channel Closing Time</i> tests.					

**Table 6 – Long Pulse Radar Test Signal**

Radar Waveform Type	Pulse Width (μsec)	Chirp Width (MHz)	PRI (μsec)	Pulses per Burst	Number of Bursts	Minimum Percentage of Successful Detection	Minimum Trials
5	50-100	5-20	1000-2000	1-3	8-20	80%	30

**Table 7 – Frequency Hopping Radar Test Signal**

Radar Waveform Type	Pulse Width (μsec)	PRI (μsec)	Pulses per Hop	Hopping Rate (kHz)	Hopping Sequence Length (msec)	Minimum Percentage of Successful Detection	Minimum Trials
6	1	333	9	0.333	300	70%	30



### 14.1.2. TEST AND MEASUREMENT SYSTEM

#### CONDUCTED METHOD SYSTEM BLOCK DIAGRAM

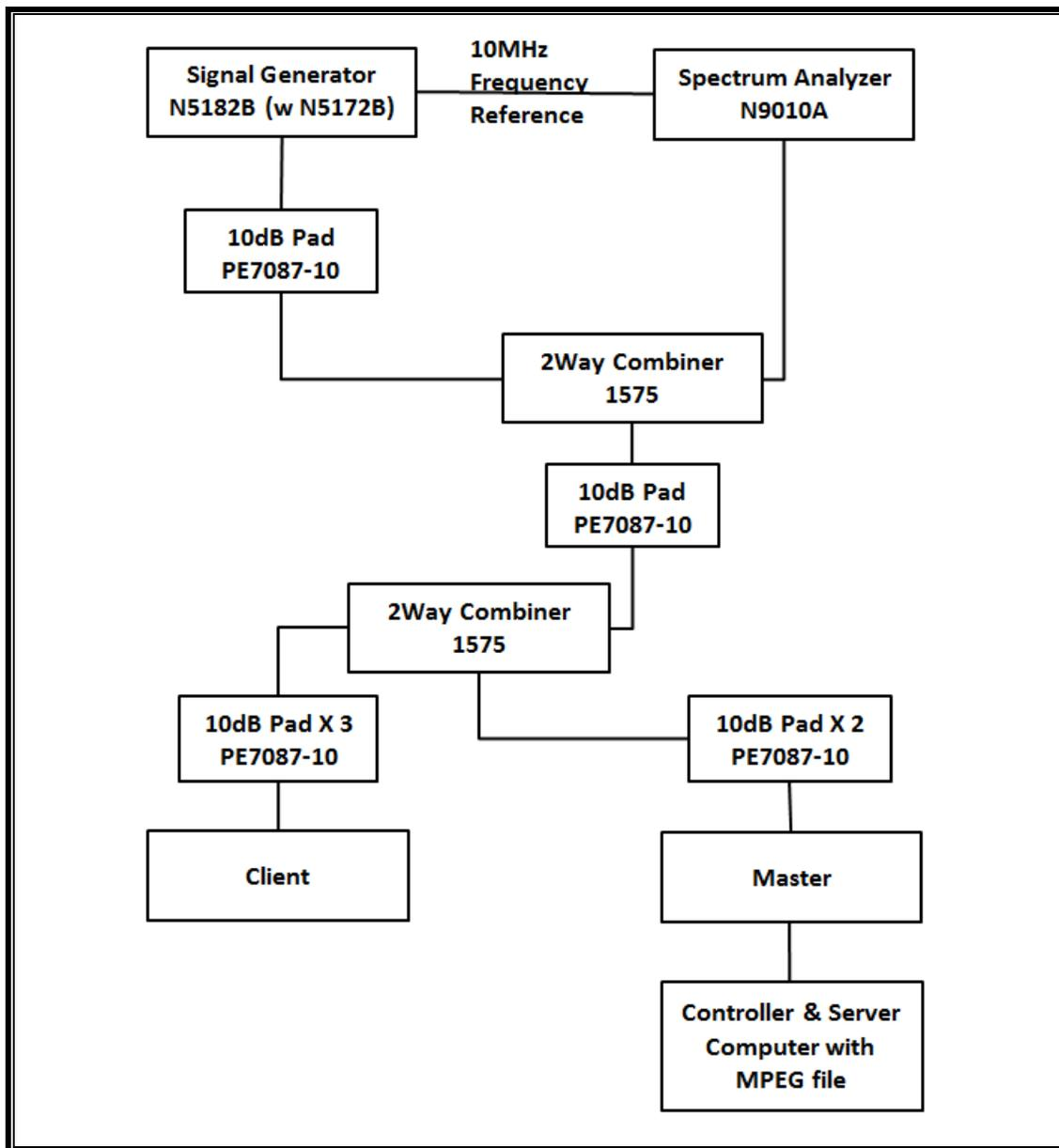

## **SYSTEM OVERVIEW**

The short pulse and long pulse signal generating system utilizes the Keysite Signal Studio for Pulse Building as N5172B. The Vector Signal Generator has been validated by the NTIA. The hopping signal generating system utilizes the CCS simulated hopping method and system, which has been validated by the DoD, FCC and NTIA. The software selects waveform parameters from within the bounds of the signal type on a random basis using uniform distribution.

The short pulse types 1, 2, 3 and 4, and the long pulse type 5 parameters are randomized at run-time.

The hopping type 6 pulse parameters are fixed while the hopping sequence is based on the August 2005 NTIA Hopping Frequency List. The initial starting point randomized at run-time and each subsequent starting point is incremented by 475. Each frequency in the 100-length segment is compared to the boundaries of the EUT Detection Bandwidth and the software creates a hopping burst pattern in accordance with Section 7.4.1.3 Method #2 Simulated Frequency Hopping Radar Waveform Generating Subsystem of KDB 905462 D02. The frequency of the signal generator is incremented in 1 MHz steps from  $F_L$  to  $F_H$  for each successive trial. This incremental sequence is repeated as required to generate a minimum of 30 total trials and to maintain a uniform frequency distribution over the entire Detection Bandwidth.

The signal monitoring equipment consists of a spectrum analyzer. The aggregate ON time is calculated by multiplying the number of bins above a threshold during a particular observation period by the dwell time per bin, with the analyzer set to peak detection and max hold.

## **SYSTEM CALIBRATION**

A 50-ohm load is connected in place of the spectrum analyzer, and the spectrum analyzer is connected to a horn antenna via a coaxial cable, with the reference level offset set to (horn antenna gain – coaxial cable loss). The signal generator is set to CW mode. The amplitude of the signal generator is adjusted to yield a level of –64 dBm as measured on the spectrum analyzer.

Without changing any of the instrument settings, the spectrum analyzer is reconnected to the Common port of the Spectrum Analyzer Combiner/Divider. The Reference Level Offset of the spectrum analyzer is adjusted so that the displayed amplitude of the signal is –64 dBm.

The spectrum analyzer displays the level of the signal generator as received at the antenna ports of the Master Device. The interference detection threshold may be varied from the calibrated value of –64 dBm and the spectrum analyzer will still indicate the level as received by the Master Device.

**ADJUSTMENT OF DISPLAYED TRAFFIC LEVEL**

A link is established between the Master and Slave and the distance between the units is adjusted as needed to provide a suitable received level at the Master and Slave devices. The video test file is streamed to generate WLAN traffic. The monitoring antenna is adjusted so that the WLAN traffic level, as displayed on the spectrum analyzer, is at lower amplitude than the radar detection threshold.

**TEST AND MEASUREMENT EQUIPMENT**

The following test and measurement equipment was utilized for the DFS tests documented in this report:

TEST EQUIPMENT LIST				
Description	Manufacturer	Model	S/N	Next Cal Due
Spectrum Analyzer, 7 GHz	Agilent / HP	N9010A	MY54200580	08-02-22
Vector Signal Generator, 6GHz	Agilent / HP	N5182B	MY53051241	08-02-22
Combiner	WEINSCHTEL	WA1534	UL001	01-27-22
Combiner	WEINSCHTEL	WA1535	UL002	01-27-22

### 14.1.3. SETUP OF EUT

#### CONDUCTED METHOD EUT TEST SETUP

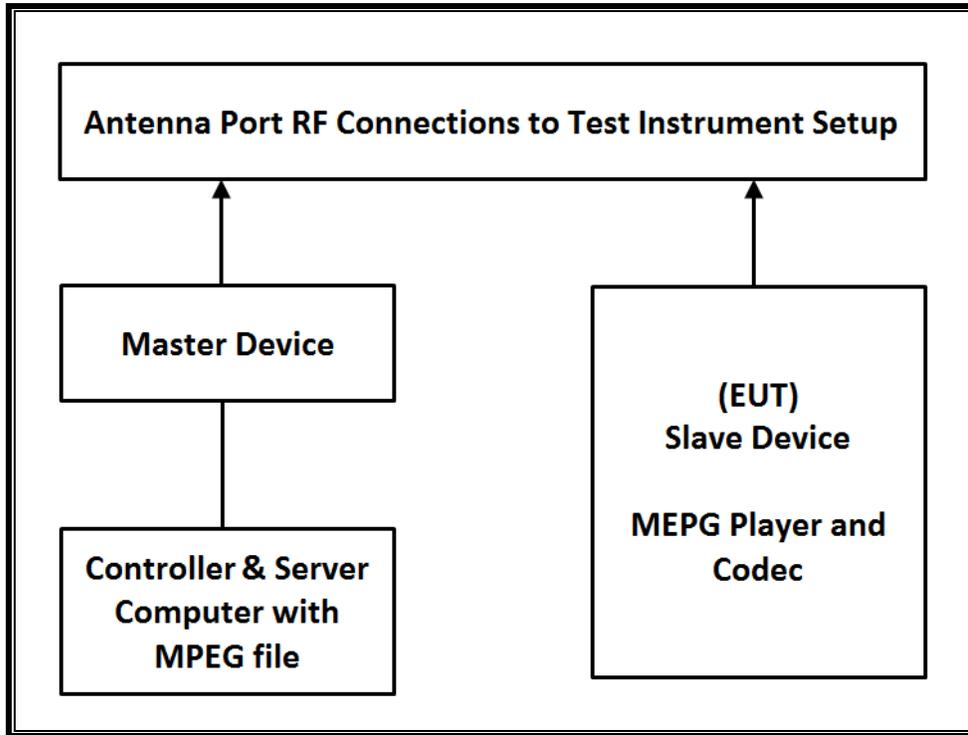

#### SUPPORT EQUIPMENT

The following support equipment was utilized for the DFS tests documented in this report:

PERIPHERAL SUPPORT EQUIPMENT LIST				
Description	Manufacturer	Model	Serial Number	FCC ID
Wireless Access Point	Cisco	AIR-CAP3702E-A-K9	FTX182276QX	LDK102087
Notebook PC (Controller/Server)	HP	HP EliteDesk 800 G1 TWR	CZC4125J25	DoC

#### **14.1.4. DESCRIPTION OF EUT**

The EUT operates over the 5250-5350 MHz and 5470-5725 MHz ranges.

The EUT is a Slave Device without Radar Detection.

The highest power level of the widest bandwidth (802.11ac VHT80) within these bands is 14.74 dBm in the 5250-5350 MHz band and 15.10 dBm in the 5470-5725 MHz band.

The antenna assembly utilized two antenna.

Gain of ANT: -4.10 dBi for UNII 2A and -4.70 dBi for UNII 2C.

The rated output power of the Master unit is > 23dBm (EIRP). Therefore the required interference threshold level is -64 dBm. After correction for procedural adjustments, the required conducted threshold at the antenna port is  $-64 + 1 = -63$  dBm.

The calibrated radiated DFS Detection Threshold level is set to -64 dBm. The tested level is lower than the required level hence it provides a margin to the limit.

The EUT uses one transmitter/receiver chain connected to an antenna to perform radiated tests. WLAN traffic that meets or exceeds the minimum required loading was generated by transferring a data stream from the controller/server PC to the EUT using iPerf version 2.0.5 software package.

TPC is not required since the maximum EIRP is less than 500 mW (27 dBm).

The EUT utilizes the 802.11 architecture. Three nominal channel bandwidths are implemented: 20 MHz, 40 MHz and 80 MHz.

The software installed in the access point is 12.4(25d)JA1.

#### **UNIFORM CHANNEL SPREADING**

This requirement is not applicable to Slave radio devices.

#### **OVERVIEW OF MASTER DEVICE WITH RESPECT TO §15.407 (h) REQUIREMENTS**

The Master Device is a Cisco Access Point, FCC ID: LDK102087. The minimum antenna gain for the Master Device is 6 dBi.

The rated output power of the Master unit is > 23dBm (EIRP). Therefore the required interference threshold level is -64 dBm. After correction for procedural adjustments, the required radiated threshold at the antenna port is  $-64 + 1 = -63$  dBm.

The calibrated radiated DFS Detection Threshold level is set to -64 dBm. The tested level is lower than the required level hence it provides a margin to the limit.

## 14.2. RESULTS FOR 80 MHz BANDWIDTH (UNII-2A BAND)

### 14.2.1. TEST CHANNEL

All tests were performed at a channel center frequency of 5290 MHz.

### 14.2.2. RADAR WAVEFORM AND TRAFFIC

#### RADAR WAVEFORM



### 14.2.3. OVERLAPPING CHANNEL TESTS

#### RESULTS

These tests are not applicable.

### 14.2.4. MOVE AND CLOSING TIME

#### REPORTING NOTES

The reference marker is set at the end of last radar pulse.

The delta marker is set at the end of the last WLAN transmission following the radar pulse. This delta is the channel move time.

The aggregate channel closing transmission time is calculated as follows:

Aggregate Transmission Time =  
(Number of analyzer bins showing transmission) \* (dwell time per bin)

The observation period over which the aggregate time is calculated begins at (Reference Marker + 200 msec) and ends no earlier than (Reference Marker + 10 sec).

#### RESULTS

Channel Move Time (sec)	Limit (sec)
0.602	10

Aggregate Channel Closing Transmission Time (msec)	Limit (msec)
3.375	60

**MOVE TIME & CHANNEL CLOSING TIME**

**AGGREGATE CHANNEL CLOSING TRANSMISSION TIME**

No transmissions are observed during the aggregate monitoring period.

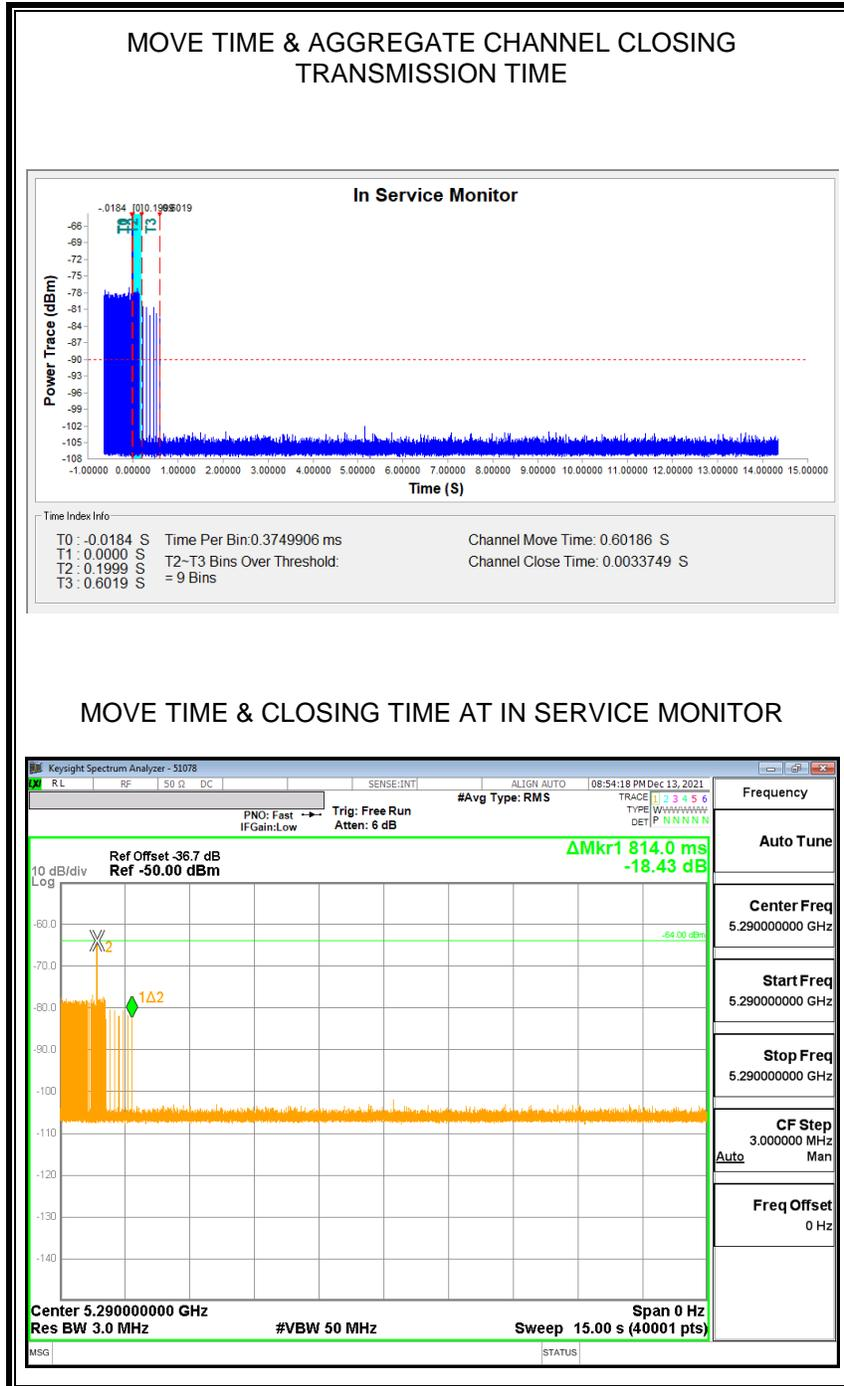





### 14.3. RESULTS FOR 80 MHz BANDWIDTH (UNII-2C BAND)

#### 14.3.1. TEST CHANNEL

All tests were performed at a channel center frequency of 5530 MHz.

#### 14.3.2. RADAR WAVEFORM AND TRAFFIC

##### RADAR WAVEFORM

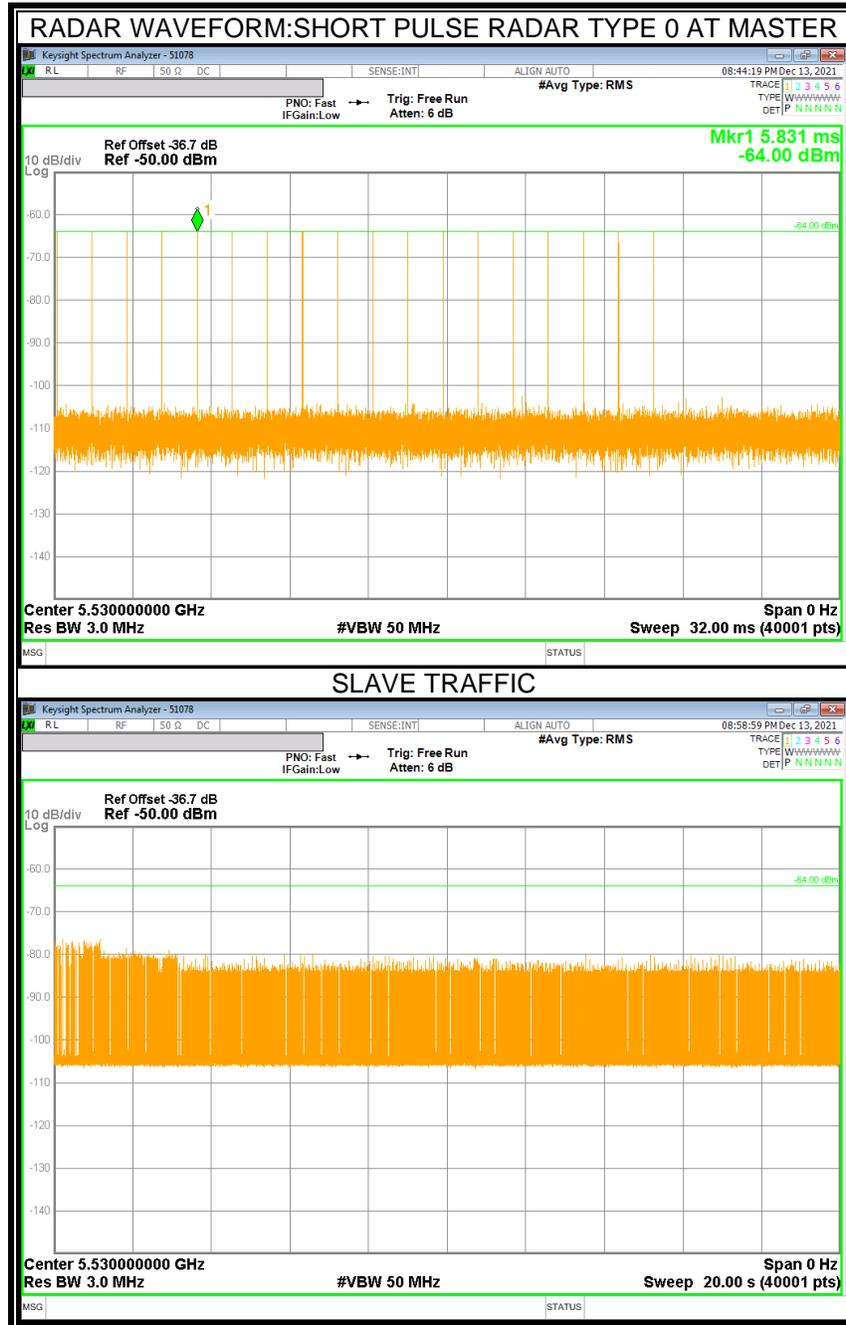

### 14.3.3. OVERLAPPING CHANNEL TESTS

#### RESULTS

These tests are not applicable.

### 14.3.4. MOVE AND CLOSING TIME

#### REPORTING NOTES

The reference marker is set at the end of last radar pulse.

The delta marker is set at the end of the last WLAN transmission following the radar pulse. This delta is the channel move time.

The aggregate channel closing transmission time is calculated as follows:

Aggregate Transmission Time =  
(Number of analyzer bins showing transmission) \* (dwell time per bin)

The observation period over which the aggregate time is calculated begins at (Reference Marker + 200 msec) and ends no earlier than (Reference Marker + 10 sec).

#### RESULTS

Channel Move Time (sec)	Limit (sec)
0.802	10

Aggregate Channel Closing Transmission Time (msec)	Limit (msec)
6.375	60

**MOVE TIME & CHANNEL CLOSING TIME**

**AGGREGATE CHANNEL CLOSING TRANSMISSION TIME**

No transmissions are observed during the aggregate monitoring period.

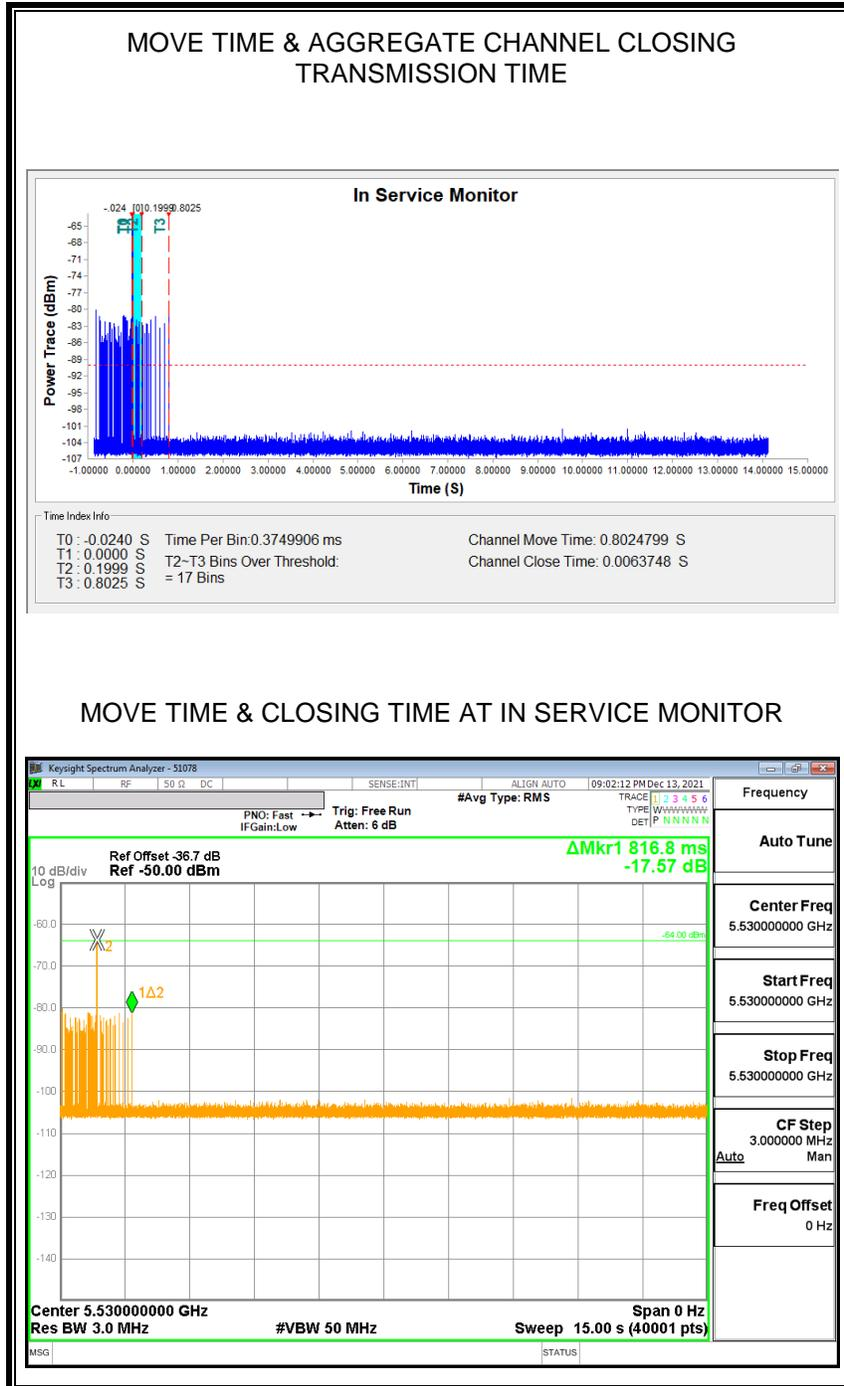

**NON-OCCUPANCY PERIOD**

**RESULTS**

No EUT transmissions were observed on the test channel during the 10-minute observation time.

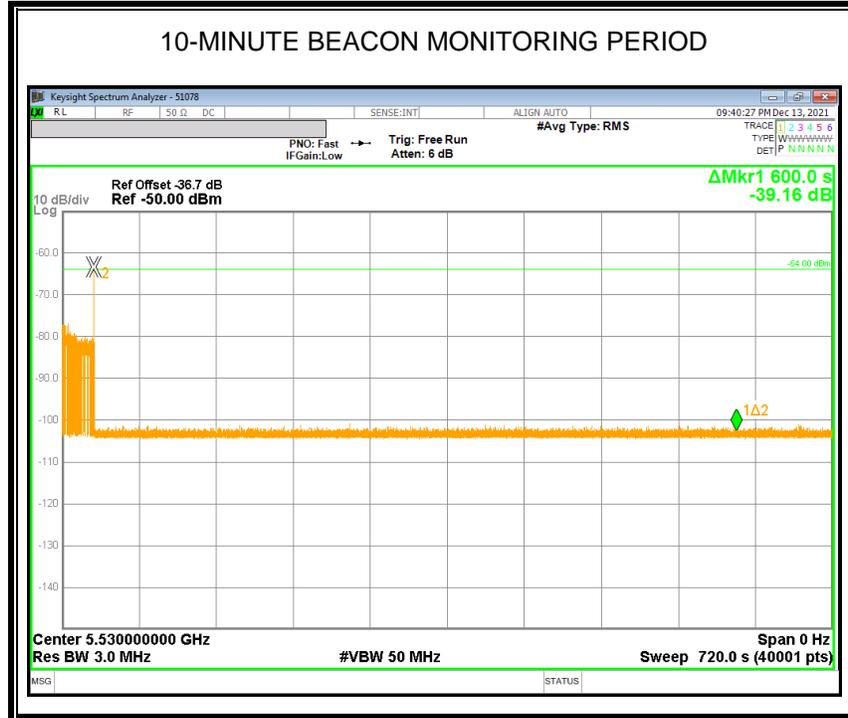

**END OF TEST REPORT**