



HCT Co., Ltd.  
74, Seoicheon-ro 578beon-gil, Majang-myeon, Icheon-si, Gyeonggi-do, 17383  
KOREA Tel. +82 31 634 6300 Fax. +82 31 645 6401

FCC ID: A3LSMA516V

## Appendix A.

### - DUT Antenna Information and SAR Test SETUP PHOTOGRAPHS

#### REVISION HISTORY

The revision history for this document is shown in table.

Revision No.	Date of Issue	Description
0	Jun 22, 2020	Initial Release

## - DUT Antenna Information

\* Placement of each antenna

Confidential

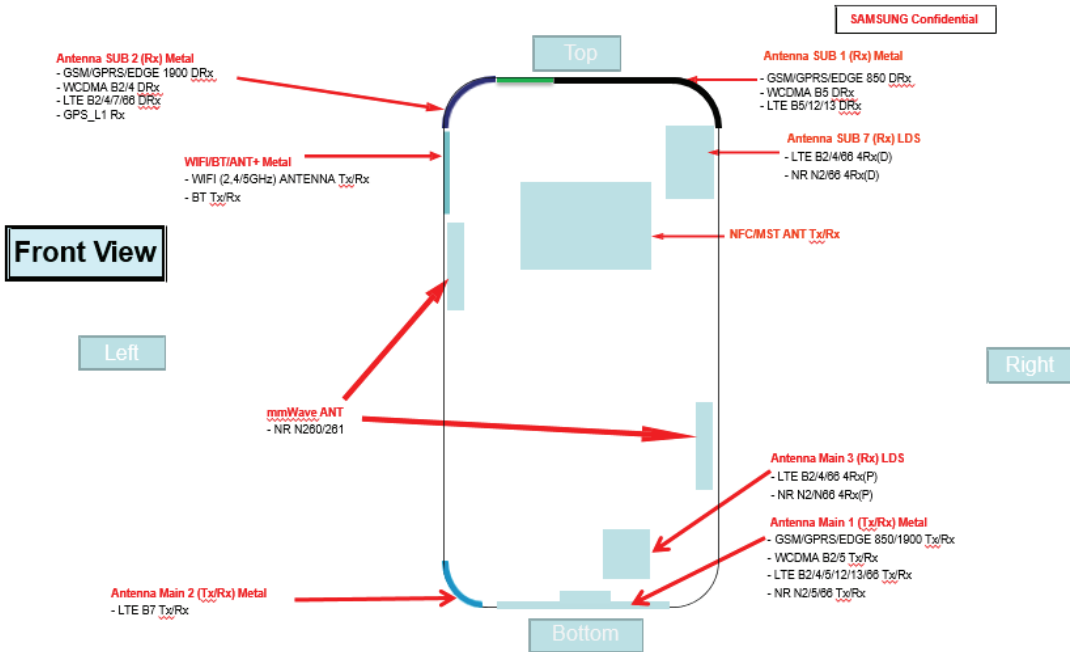

\* Distance between BT/WLAN/ANT+ antenna and edge

Confidential

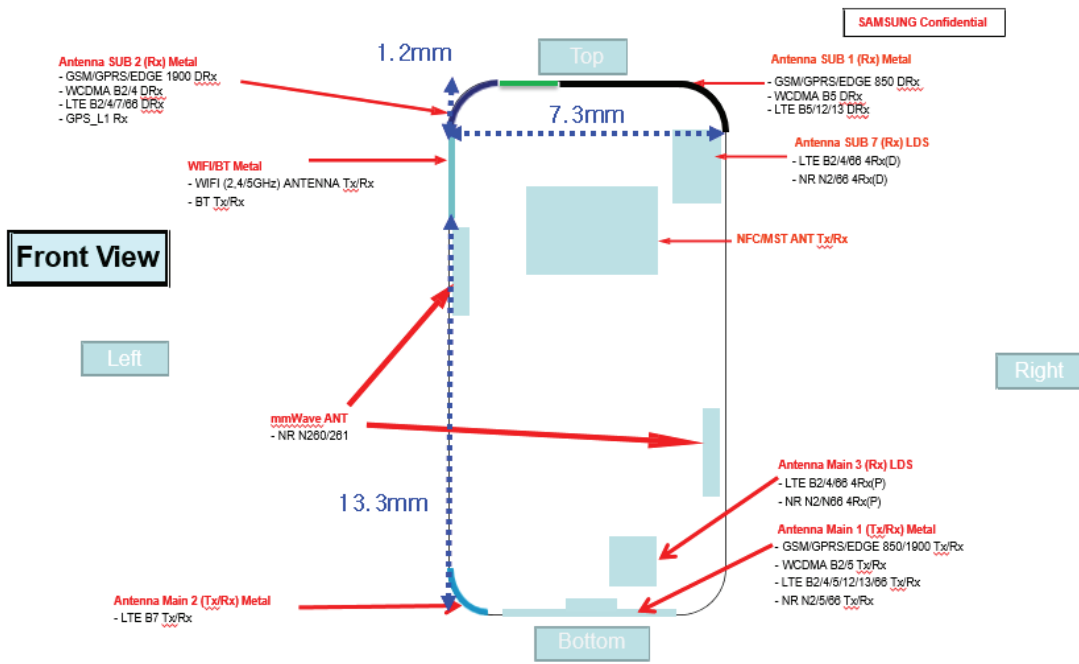

\* Distance between main antenna and edge

Confidential

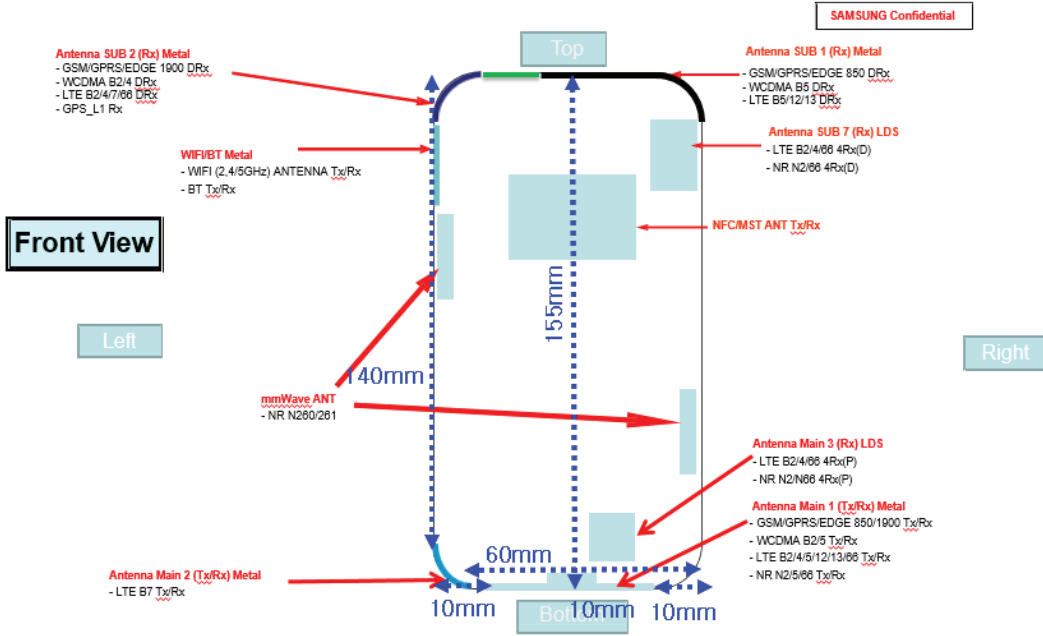

\* Diagonal dimension of Display and Device

Confidential

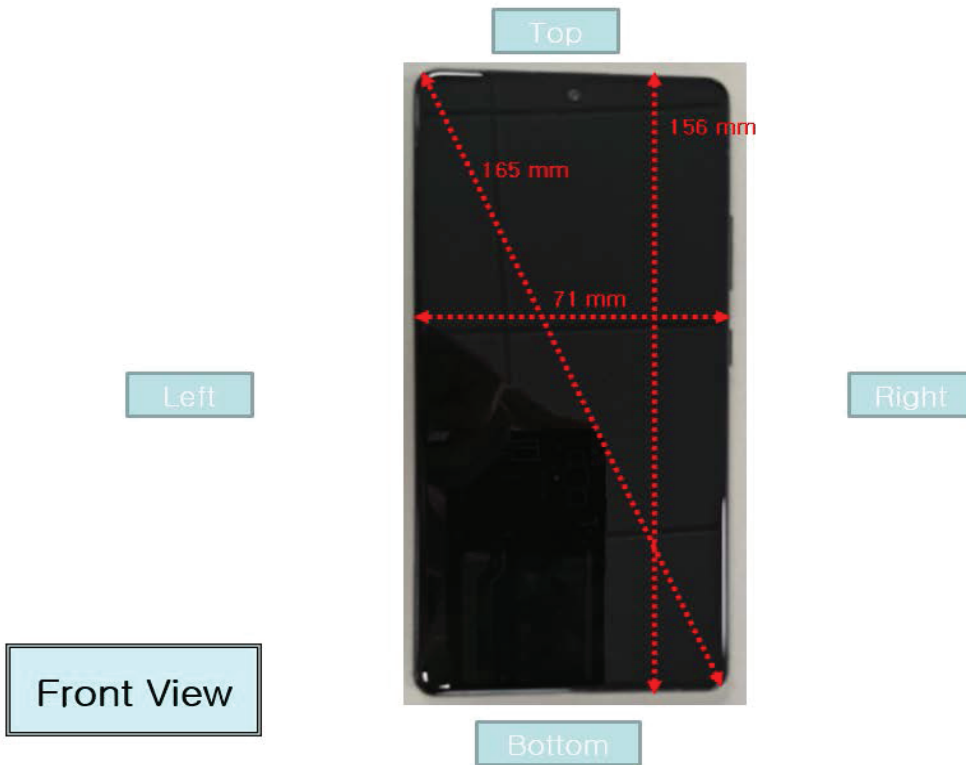

---

**- SAR Test SETUP PHOTOGRAPHS**

## 1. Head 1.1 Left All



## 1.2 Left Touch / Left Tilt

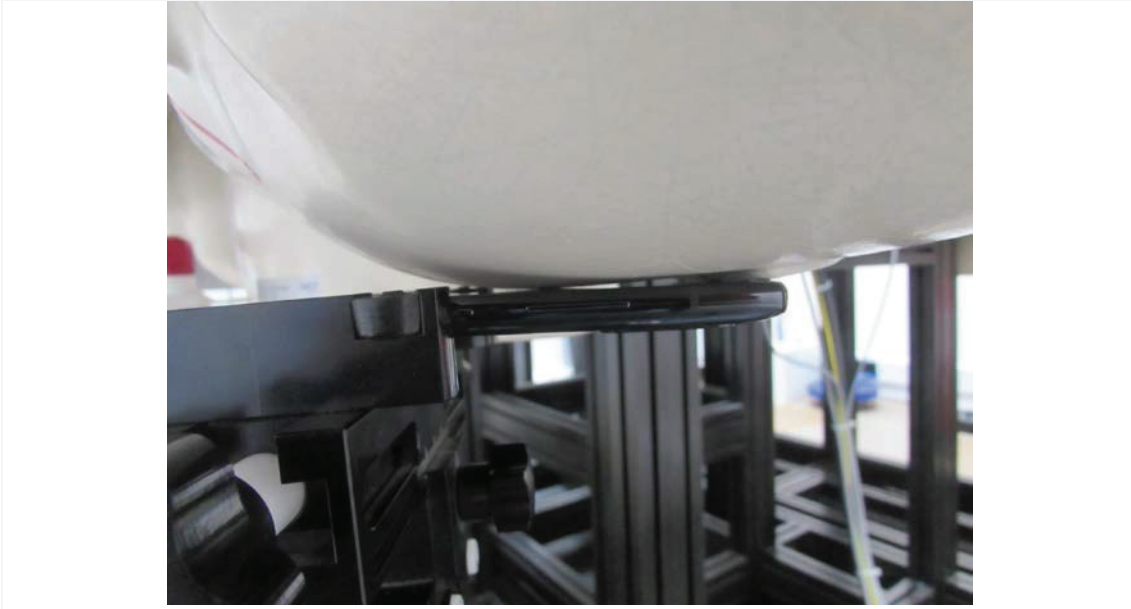

1.3 Right All

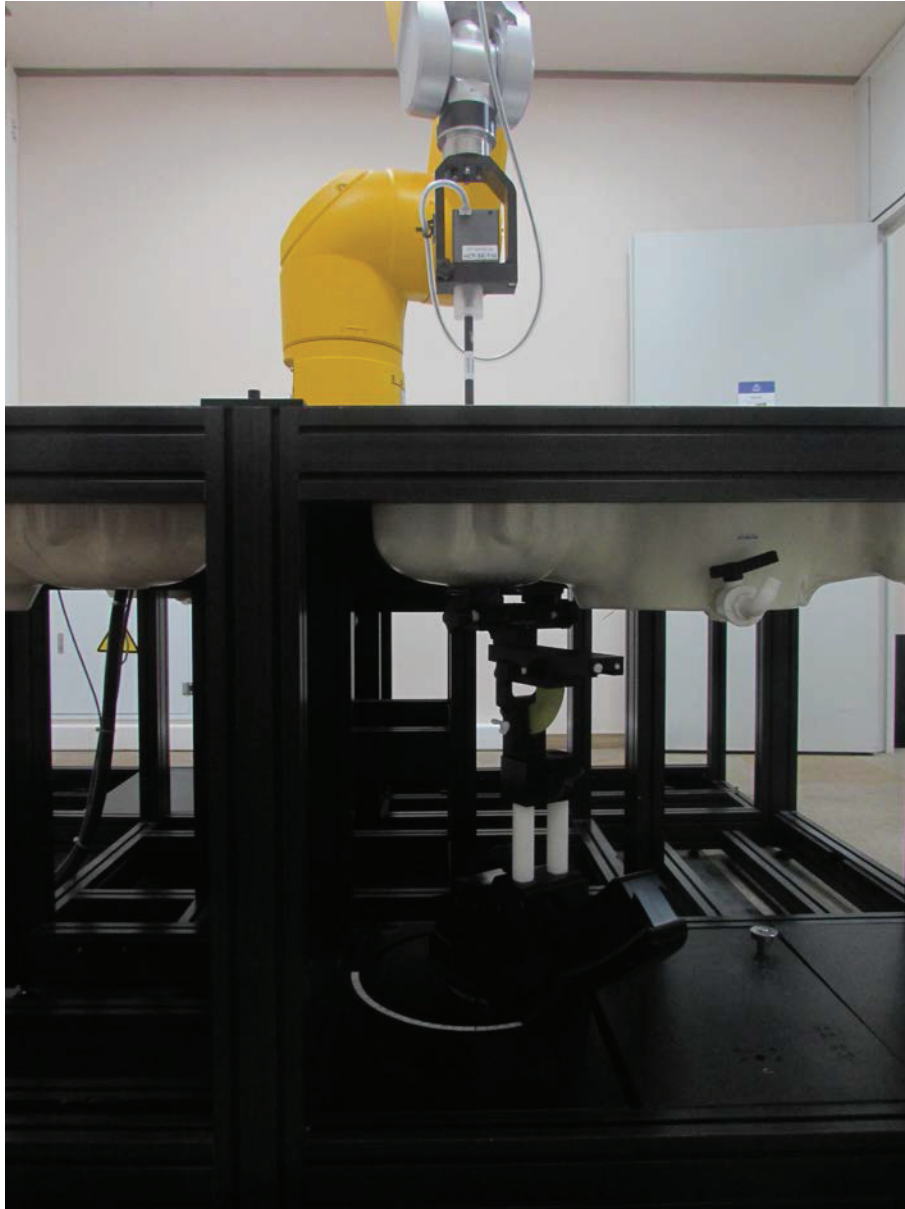



## 1.4 Right Touch / Right Tilt

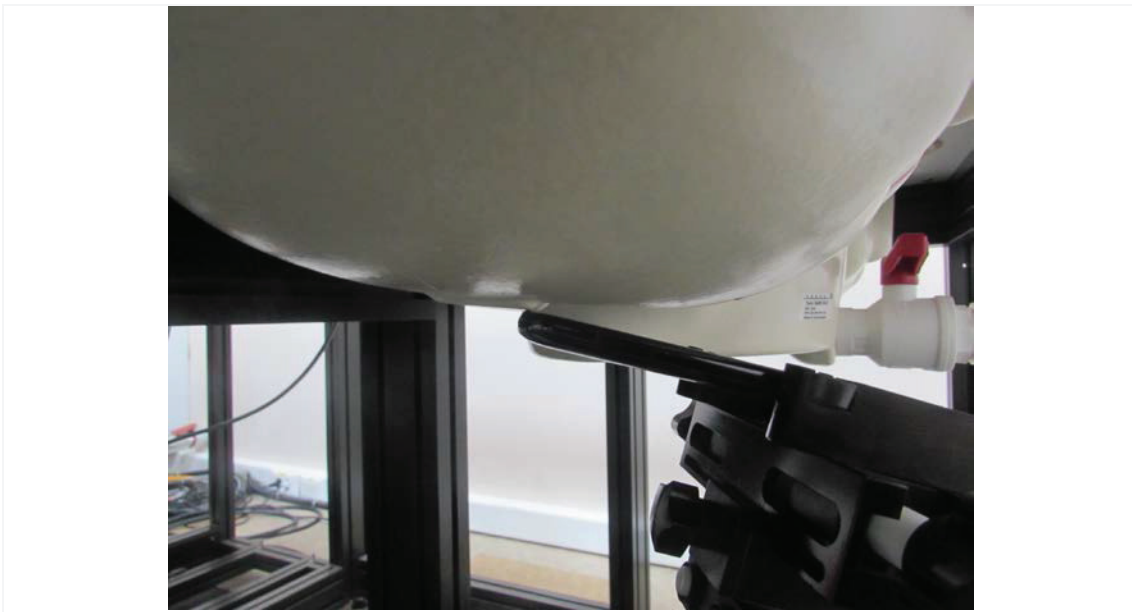

## 2. Body

### 2.1 Body All

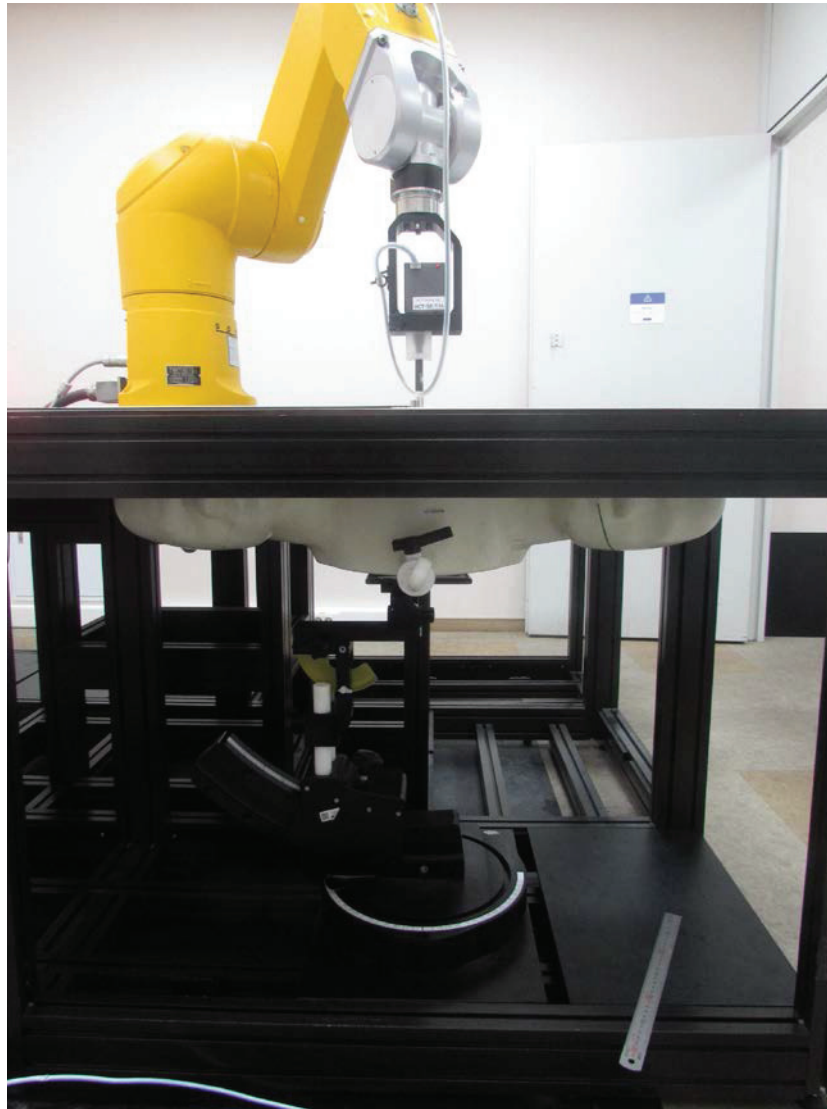

## 2.2 Body Rear

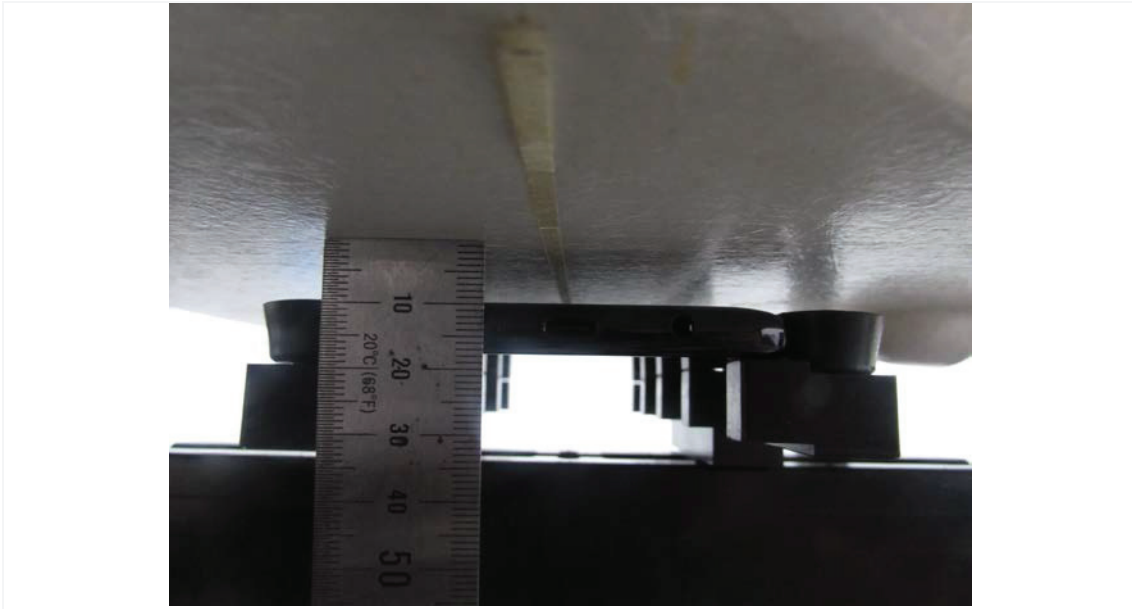

Distance of 10 mm from the EUT

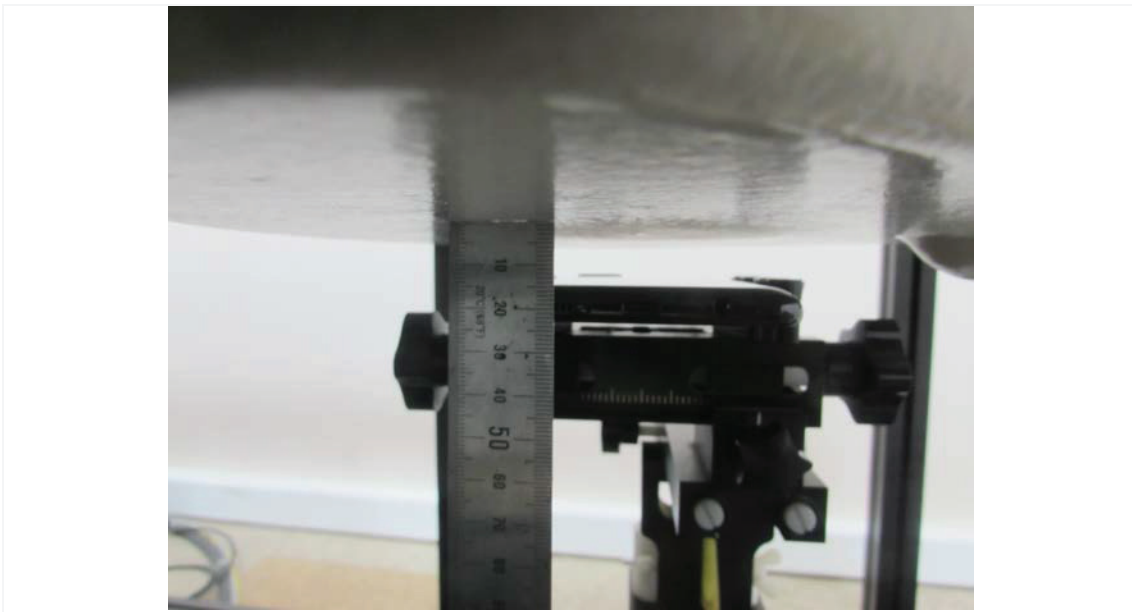

Distance of 15 mm from the EUT

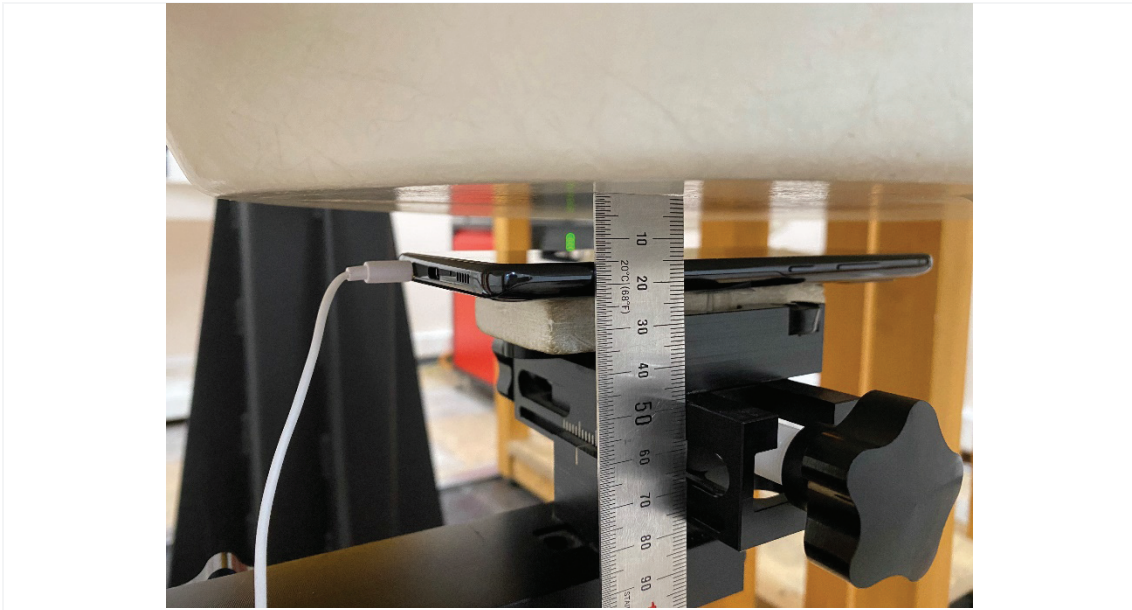

Distance of 15 mm from the EUT with Earphone

## 2.3 Body Front

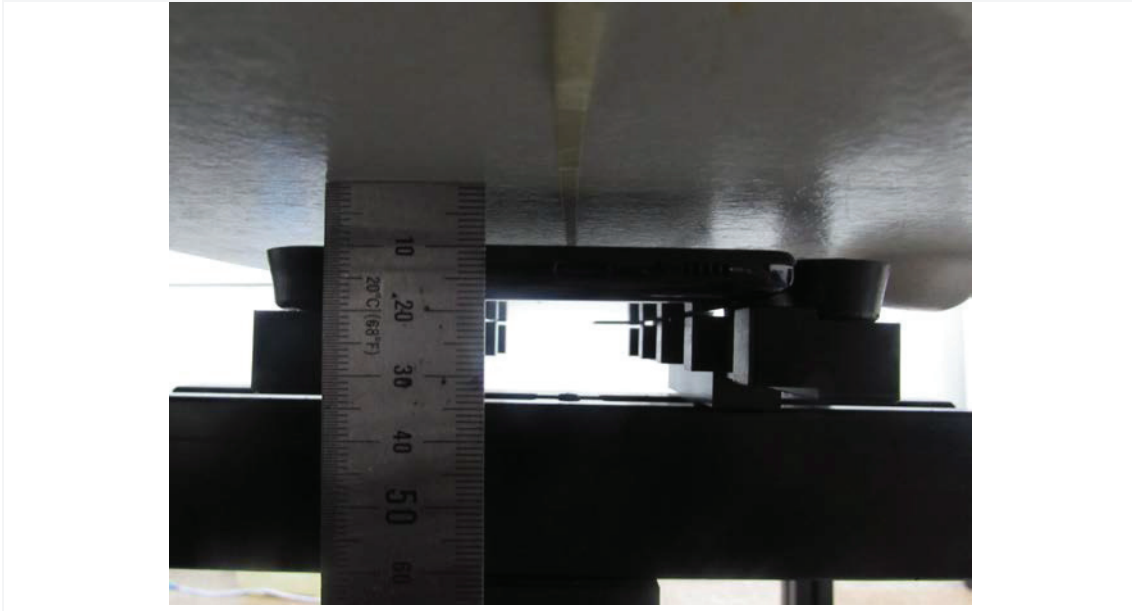

Distance of 10 mm from the EUT

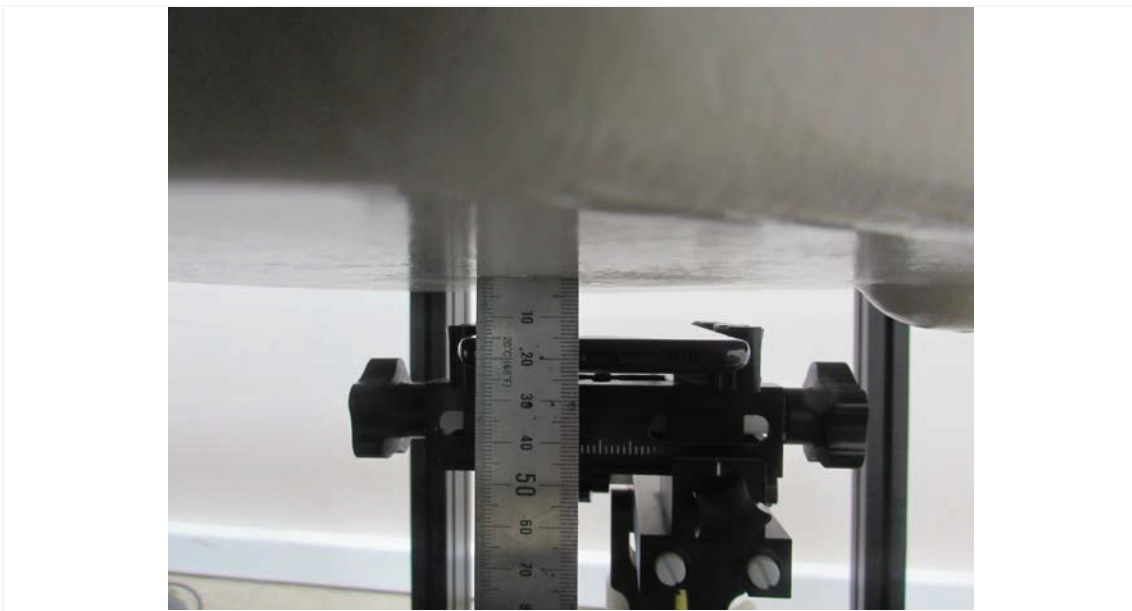

Distance of 15 mm from the EUT

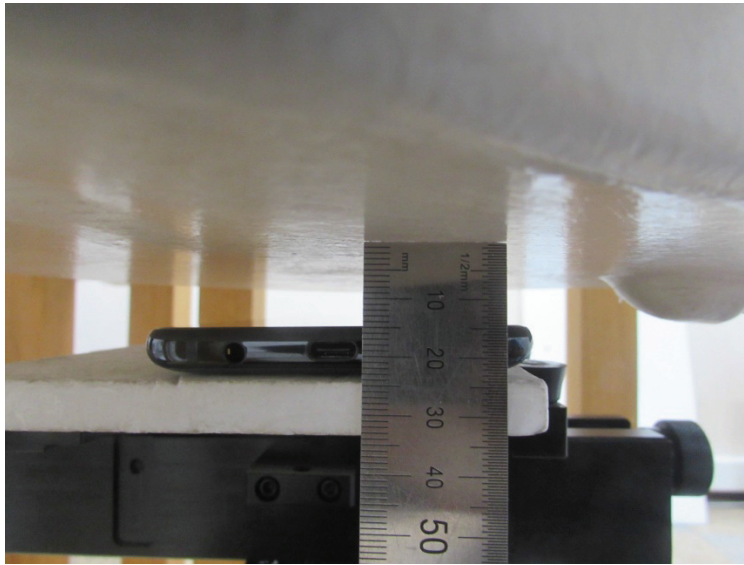

Distance of 15 mm from the EUT (DUT Holder Perturbation)



## 2.4 Body Left

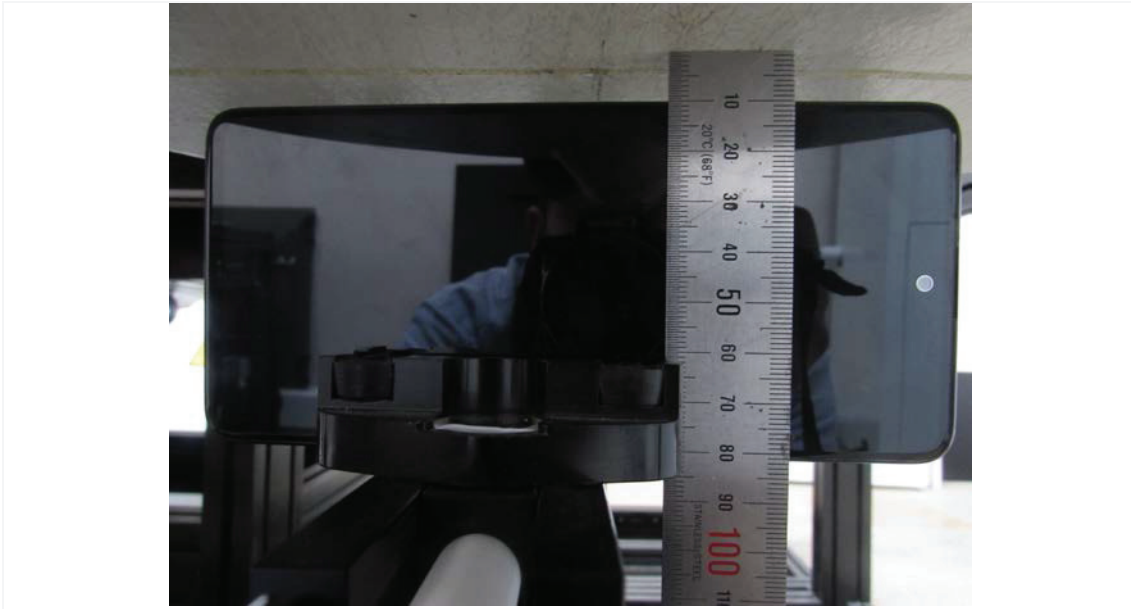

Distance of 10 mm from the EUT

## 2.5 Body Right



Distance of 10 mm from the EUT

## 2.6 Body Bottom



Distance of 10 mm from the EUT

## 2.7 Body Top



Distance of 10 mm from the EUT



### 3. Phablet

#### 3.1 Phablet SAR Test Setup Rear

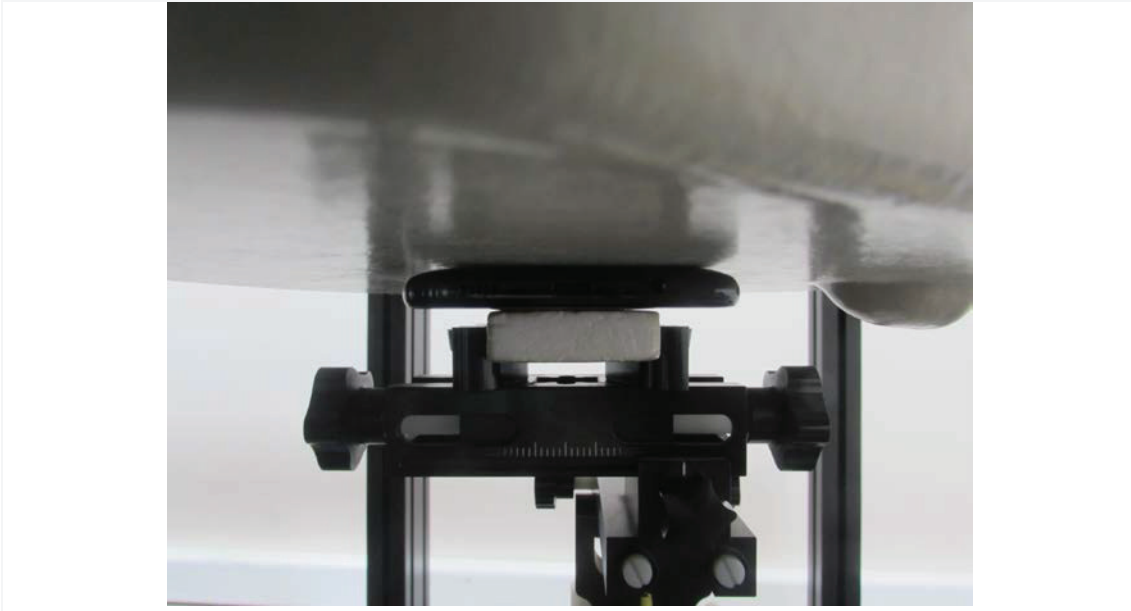

Distance of 0 mm from the EUT

#### 3.2 Phablet SAR Test Setup Front

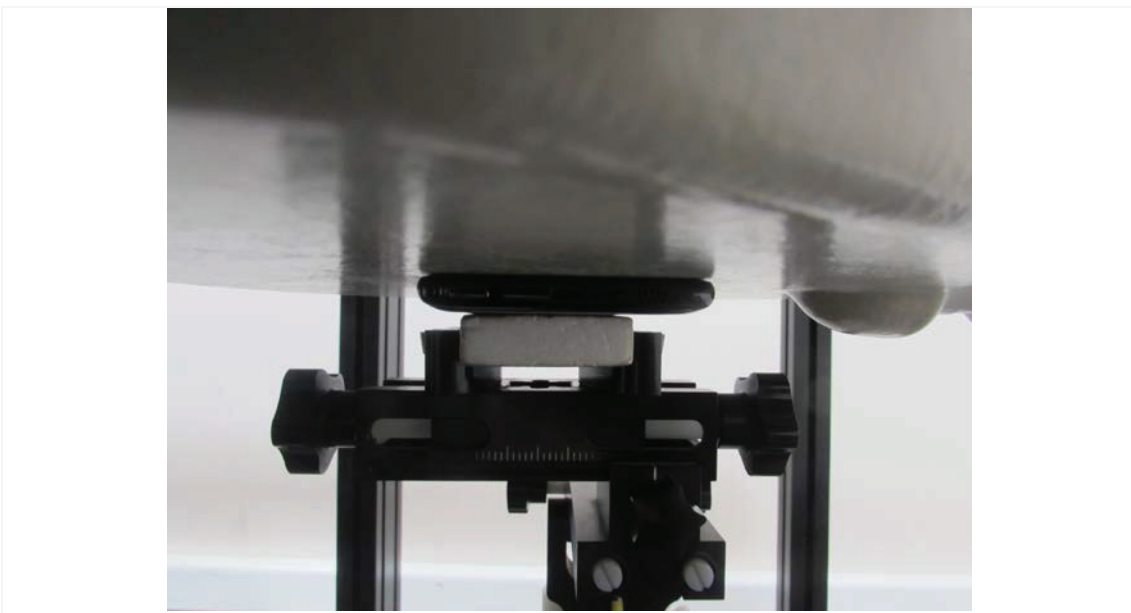

Distance of 0 mm from the EUT

### 3.3 Phablet SAR Test Setup Left

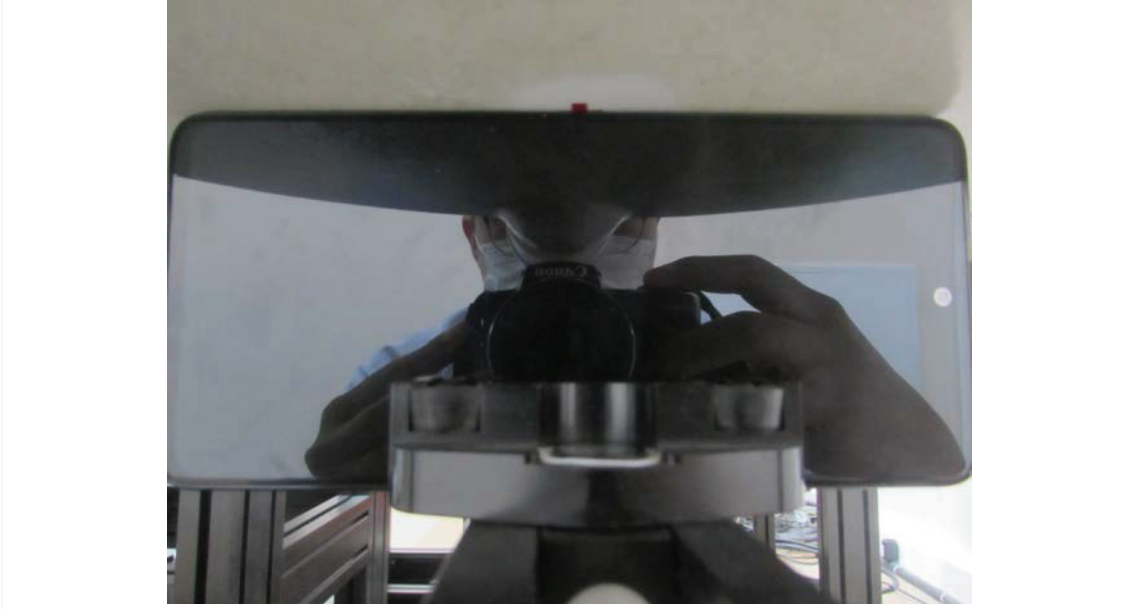

Distance of 0 mm from the EUT

### 3.4 Phablet SAR Test Setup Right

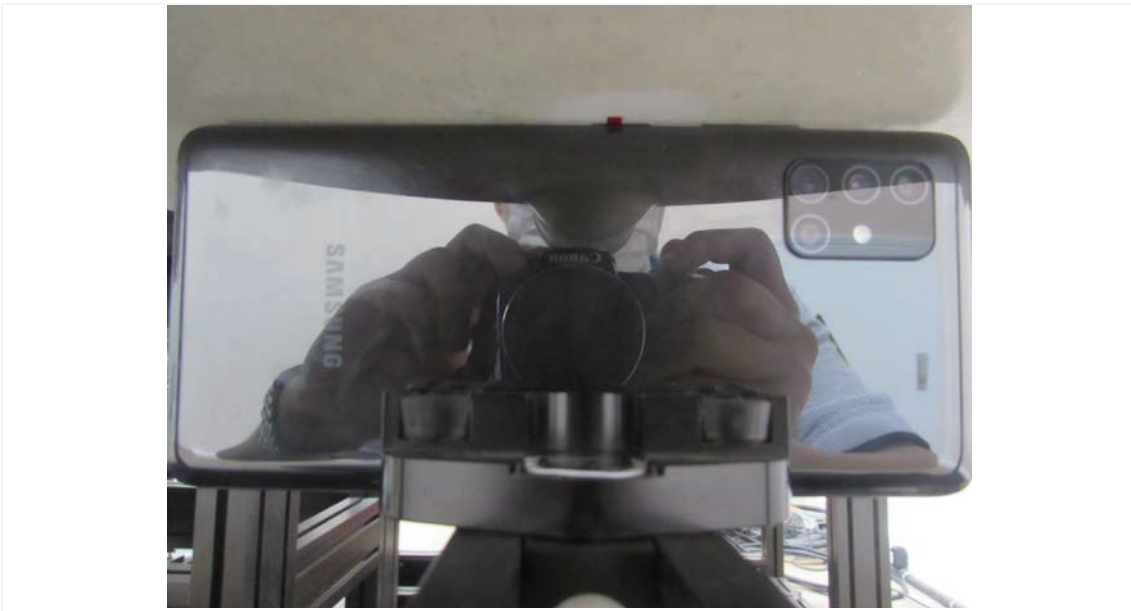

Distance of 0 mm from the EUT

### 3.5 Phablet SAR Test Setup Bottom



Distance of 0 mm from the EUT

### 3.6 Phablet SAR Test Setup Rear

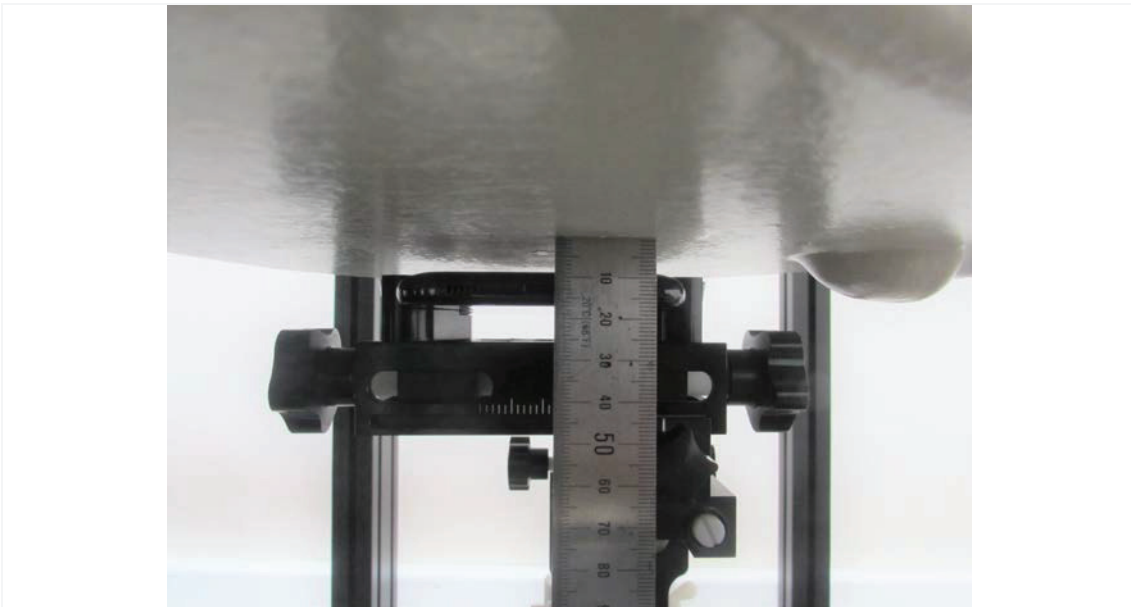

Distance of 9 mm from the EUT

### 3.8 Phablet SAR Test Setup Front

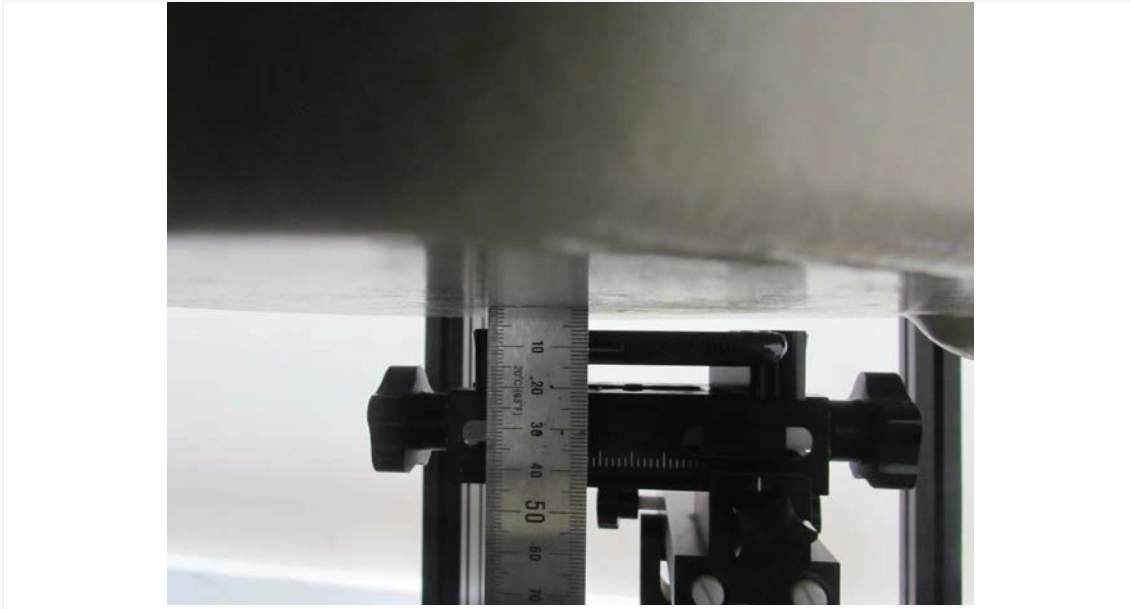

Distance of 6 mm from the EUT

### 3.9 Phablet SAR Test Setup Bottom



Distance of 11 mm from the EUT