

EMI TEST REPORT FCC CERTIFICATION

Applicant:

SAMSUNG Electronics Co., Ltd.
129, Samsung-ro, Yeongtong-gu, Suwon-si,
Gyeonggi-do, 16677, Korea

Date of Issue: April 29, 2020

Test Report No. HCT-EM-2004-FC008-R1

Test Site: HCT CO., LTD.

FCC ID :

A3LSMA516B

Rule Part(s) / Standard(s) : 47 CFR PART 15 Subpart B Class B
ANSI C63.4-2014

Product Name : Mobile Phone

Model Name : SM-A516B/DS

Date of Test : April 14, 2020 to April 16, 2020

The device bearing the trade name and model specified above, has been shown to comply with the applicable technical standards as indicated in the measurement report and was tested in accordance with the measurement procedures specified in ANSI C63.4-2014. (See Test Report if any modifications were made for compliance)

I attest to the accuracy of data. All measurements reported herein were performed by me or were made under my supervision and are correct to the best of my knowledge and belief. I assume full responsibility for the completeness of these measurements and vouch for the qualifications of all persons taking them.

HCT certifies that no party to application has been denied the FCC benefits pursuant to Section 5301 of the Anti-Drug Abuse Act of 1988, 21 U.S.C 862

Tested By



Kyoung-Hee Yoon
Test Engineer
EMC Team
Certification Division

Reviewed



Jeong-Hyun Choi
Technical Manager
EMC Team
Certification Division

This report only responds to the tested sample and may not be reproduced, except in full, without written approval of the HCT Co., Ltd.



REVISION HISTORY

The revision history for this document is shown in table.

Report No.	Issue Date	Information About Changes
0	April 17, 2020	Initial Release
1	April 29, 2020	Revised the frequency band in clause 1.1 Revised the photo title in APPENDIX A

This Test Report is not related to the accredited test result by (KS Q) ISO/IEC 17025 and KOLAS (Korea Laboratory Accreditation Scheme) / A2LA (American Association for Laboratory Accreditation), which signed the ILAC-MRA. This report only responds to the tested sample and may not be reproduced, except in full, without written approval of the HCT Co., Ltd.



TABLE OF CONTENTS

	PAGE
1. GENERAL INFORMATION	4
1.1 Description of EUT	4
1.2 Tested System Details	4
1.3 Cable Description.....	5
1.4 Noise Suppression Parts on Cable. (I/O Cable)	5
1.5 Test Facility.....	6
1.6 Calibration of Measuring Instrument	6
1.7 Measurement Uncertainty	6
2. LIST OF TEST EQUIPMENT	7
3. DESCRIPTION OF TEST.....	8
3.1 Measurement of Conducted Emission.....	8
3.2 Measurement of Radiated Emission.....	9
4. PRELIMINARY TEST.....	11
4.1 Conducted Emission.....	11
4.2 Rediated Emission.....	11
5. CONDUCTED AND RADIATED EMISSION TEST SUMMARY.....	12
5.1 Conducted Emission.....	12
5.2 Radiated Emission.....	13
6. CONCLUSION	21
7. APPENDIX A. TEST SETUP PHOTO	22



1. GENERAL INFORMATION

1.1 Description of EUT

FCC ID	A3LSMA516B
Model Name	SM-A516B/DS
Product Name	Mobile Phone
Frequency Band	GSM 850/1900, WCDMA B2/5, LTE B4/5/12/41 Bluetooth, WLAN a/b/g/n/ac, NFC, ANT+
Power Supply	Travel adaptor: Input: AC (100 to 240) V, (50 to 60) Hz, 0.5 A Output: DC 9.0 V, 1.67 A or DC 5.0 V, 2.0 A

1.2 Tested System Details

All equipment descriptions used in the tested system (including inserted cards) are:

Device Type	Model Name	Serial Number	Manufacturer
EUT	SM-A516B/DS	-	SAMSUNG
TA	EP-TA200	-	SOLUM
Data Cable	EP-DA140ABE	-	CRESYN
Earphone	EHS61ASF	-	CRESYN
Micro SD Card	-	-	SAMSUNG



1.3 Cable Description

Product Name	Port	Power Cord Shielded (Y/N)	I/O Cable Shielded (Y/N)	Length (m)
EUT	USB Type C	Y	N/A	(P) 1.0
	Earphone	N/A	N	(D) 1.6

* The marked "(D)" means the data cable and "(P)" means the power cable.

1.4 Noise Suppression Parts on Cable. (I/O Cable)

Product Name	Port	Ferrite Bead (Y/N)	Location	Metal Hood (Y/N)	Location
EUT	USB Type C	N	N/A	Y	Both End
	Earphone	N	N/A	Y	EUT End



1.5 Test Facility

Test site is located at 74, SEOICHEON-RO, 578BEON-GIL, MAJANG-MYEON, ICHEON-SI, GYEONGGI-DO, SOUTH KOREA. Those measurement facilities are constructed in conformance with the requirements of ANSI C63.4-2014. The Normalized site attenuations (30 MHz to 1 GHz) and Site validation (1 GHz to 18 GHz) were performed in accordance with the standard in ANSI C63.4-2014

Measurement Facilities	Registration Number
Radiated Field strength measurement facility 3 m Semi Anechoic chamber	KR0032
Radiated Field strength measurement facility 10 m Semi Anechoic chamber #1	
Radiated Field strength measurement facility 10 m Semi Anechoic chamber #2	

1.6 Calibration of Measuring Instrument

The measuring equipment, which was utilized in performing the tests documented herein, has been calibrated in accordance with the manufacturers recommendations for utilizing calibration equipment, which is traceable to recognized national standards.

Especially, all antenna for measurement is calibrated in accordance with the requirements of C63.5:2017

1.7 Measurement Uncertainty

The measurement uncertainties shown below were calculated in accordance with the requirements of ANSI C63.4-2014.

All measurement uncertainty values are shown with a coverage factor of $k = 2$ to indicate a 95 % level of confidence. The measurement data shown herein meets or exceeds the U_{CISPR} measurement uncertainty values specified in CISPR 16-4-2 and, thus, can be compared directly to specified limits to determine compliance.

Parameter	Expanded Uncertainty (dB)
Conducted Emission (0.15 MHz to 30 MHz)	1.8 dB
Radiated Emissions (30 MHz to 1 GHz)	4.8 dB
Radiated Emissions (1 GHz to 18 GHz)	5.4 dB
Radiated Emissions (18 GHz to 40 GHz)	5.7 dB



2. LIST OF TEST EQUIPMENT

<u>Type</u>	<u>Model Name</u>	<u>Manufacturer</u>	<u>Serial Number</u>	<u>Calibration Cycle</u>	<u>Calibration Date</u>
<u>Conducted Emission (Not applicable)</u>					
<input type="checkbox"/> EMI Test Receiver	ESCI	Rohde & Schwarz	100584	1 year	06.18.2019
<input type="checkbox"/> LISN	ENV216	Rohde & Schwarz	102245	1 year	09.11.2019
<input type="checkbox"/> LISN	ENV216	Rohde & Schwarz	100073	1 year	04.30.2019
<input type="checkbox"/> Radio communication analyzer	MT8820C	ANRITSU	6201138643	1 year	08.20.2019
<input type="checkbox"/> Antenna (for Communication)	USLP9142	Schwarzbeck	VSLP 9142-200	-	-
<input type="checkbox"/> Software	EMC32	Rohde & Schwarz	-	-	-
<u>Radiated Emission</u>					
-For measurement below 1 GHz					
<input checked="" type="checkbox"/> EMI Test Receiver	ESU40	Rohde & Schwarz	100524	1 year	05.17.2019
<input checked="" type="checkbox"/> Bi-Log Antenna	VULB 9168	Schwarzbeck	255	2 year	03.26.2019
<input checked="" type="checkbox"/> Antenna master	MA4640-XP-ET	INNCO Systems	-	N/A	-
<input checked="" type="checkbox"/> Antenna master controller	CO3000	INNCO Systems	CO3000/870/ 35990515/L	N/A	-
<input checked="" type="checkbox"/> Turn Table	1060	INNCO Systems	-	N/A	-
<input checked="" type="checkbox"/> Turn Table controller	CO2000	INNCO Systems	CO2000/095/ 7590304/L	N/A	-
<input checked="" type="checkbox"/> Radio communication analyzer	MT8820C	ANRITSU	6201138643	1 year	08.20.2019
<input checked="" type="checkbox"/> Antenna (for Communication)	USLP9142	Schwarzbeck	VSLP 9142-200	-	-
<input checked="" type="checkbox"/> Software	EMC32	Rohde & Schwarz	-	-	-
-For measurement above 1 GHz					
<input checked="" type="checkbox"/> EMI Test Receiver	ESU40	Rohde & Schwarz	100524	1 year	05.17.2019
<input checked="" type="checkbox"/> Antenna master	MA4640-XP-ET	INNCO Systems	-	N/A	-
<input checked="" type="checkbox"/> Antenna master controller	CO3000	INNCO Systems	CO3000/870/ 35990515/L	N/A	-
<input checked="" type="checkbox"/> Turn Table	1060	INNCO Systems	-	N/A	-
<input checked="" type="checkbox"/> Turn Table controller	CO2000	INNCO Systems	CO2000/095/ 7590304/L	N/A	-
<input checked="" type="checkbox"/> Horn Antenna	BBHA 9120D	Schwarzbeck	01836	1 year	07.19.2019
<input checked="" type="checkbox"/> Low Noise Amplifier	TK-PA18H	TESTEK	170034-L	1 year	03.03.2020
<input checked="" type="checkbox"/> Low Noise Amplifier	TK-PA1840H	TESTEK	170030-L	1 year	02.13.2020
<input checked="" type="checkbox"/> Horn Antenna	BBHA 9170	Schwarzbeck	BBHA 9170#786	1 year	12.03.2019
<input checked="" type="checkbox"/> Radio communication analyzer	MT8820C	ANRITSU	6201138643	1 year	08.20.2019
<input checked="" type="checkbox"/> Antenna (for Communication)	USLP9142	Schwarzbeck	VSLP 9142-200	-	-
<input checked="" type="checkbox"/> Software	EMC32	Rohde & Schwarz	-	-	-



3. DESCRIPTION OF TEST

3.1 Measurement of Conducted Emission

The test procedure was in accordance with ANSI C63.4-2014, Clause 7.3

- a. The EUT was placed 0.4 meters from the conducting wall of the shielded room with EUT being connected to the power mains through a line impedance stabilization network (LISN).
If the EUT is connected to the PC through USB, the AC power-line adapter of the PC is directly connected to a line impedance stabilization network (LISN).
Other support units were connected to the power mains through another LISN. The two LISNs provide 50 Ohm/ 50uH of coupling impedance for the measuring instrument.
- b. Both conducted lines are measured in Quasi-Peak and Average mode, including the worst-case data points for each tested configuration.
- c. The frequency range from 150 kHz to 30 MHz was searched.

[Conducted Emission Limits]

Frequency (MHz)	Resolution Bandwidth (kHz)	Quasi-Peak (dB(μV))	Average (dB(μV))
0.15 to 0.5	9	66 to 56*	56 to 46*
0.5 to 5	9	56	46
5 to 30	9	60	50

**Decreases with the logarithm of the frequency.*



3.2 Measurement of Radiated Emission

The test procedure was in accordance with ANSI C63.4-2014, Clause 8.3

- a. The EUT was placed on the top of a turn table 0.8 meters above the ground at a semi-anechoic chamber. The table was rotated 360 degrees to determine the position of the highest radiation.
- b. The EUT was set 3 m away from the interference-receiving antenna, which was mounted on the top of a variable-height antenna tower.
- c. The antenna height is varied from 1 m to 4 m above the ground to determine the maximum value of the field strength. Both horizontal and vertical polarizations of the antenna are set to make the measurement.
- d. For each suspected emission, the EUT was arranged to its worst case and then the antenna was tuned to heights from 1 m to 4 m and the turn table was turned from 0 degrees to 360 degrees to find the maximum reading.
- e. The test-receiver system was set to Quasi-Peak detect function and specified bandwidth with maximum hold mode when the test frequency is below 1 GHz.
- f. The test-receiver system was set to Peak and Average detect function and specified bandwidth with maximum hold mode when the test frequency is above 1 GHz.
- g. Place the measurement antenna away from each area of the EUT determined to be a source of emissions at the specified measurement distance, while keeping the measurement antenna aimed at the source of emissions at each frequency of significant emissions, with polarization oriented for maximum response.(1 GHz to 40 GHz)

[Radiated Emission Limits]

Frequency (MHz)	Antenna Distance (m)	Field Strength ($\mu\text{V}/\text{m}$)	Quasi-Peak ($\text{dB}(\mu\text{V}/\text{m})$)
30 to 88	3	100	40.0
88 to 216	3	150	43.5
216 to 960	3	200	46.0
Above 960	3	500	54.0
Frequency (MHz)	Antenna Distance (m)	Peak ($\text{dB}(\mu\text{V}/\text{m})$)	Average ($\text{dB}(\mu\text{V}/\text{m})$)
Above 1 000	3	74	54

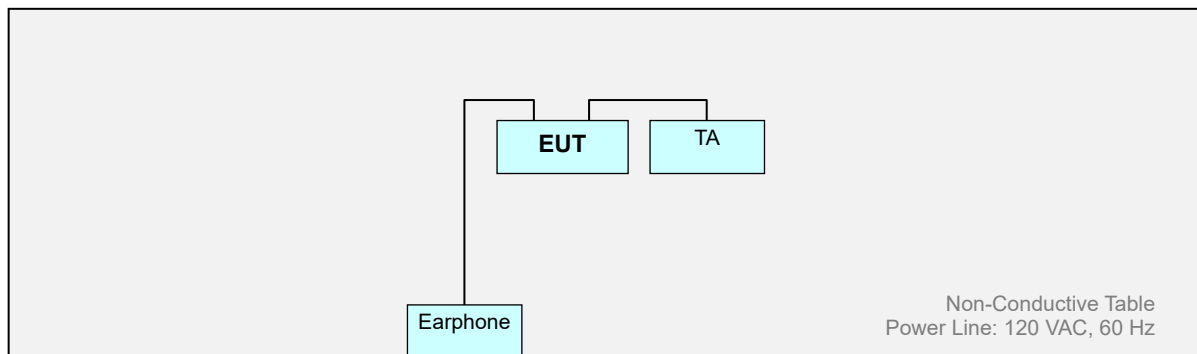


3.2.1 Frequency Range of Radiated Measurements

An unintentional radiator, including a digital device, the spectrum shall be investigated from the lowest radio frequency signal generated or used in the device, without going below the lowest frequency for which a Radiated Emission limit is specified, up to the frequency shown in the following table

Highest frequency generated or used in the device or on which the device operates or tunes (MHz)	Upper frequency of measurement range (MHz)
Below 1.705	30
1.705 to 108	1 000
108 to 500	2 000
500 to 1 000	5 000
Above 1 000	5 th harmonic of the highest frequency or 40 GHz, whichever is lower

3.3 Configuration of Tested System





4. PRELIMINARY TEST

During preliminary tests, the following operating mode was investigated.

Receiver mode(GSM 850 Low/Middle/High CH Idle)
Receiver mode(WCDMA B5 Low/Middle/High CH Idle)
Receiver mode(LTE B5 Low/Middle/High CH Idle)
Receiver mode(LTE B12 Low/Middle/High CH Idle)

NOTE. The worst band is tested.

4.1 Conducted Emission (Not applicable)

It was tested the following operating mode, after connecting all peripheral devices.

Operating Mode: Not Applicable

NOTE.

Compliance with Part 15B requirement for the conducted emissions is covered by SAMSUNG test report.

4.2 Radiated Emission

It was tested the following operating mode, after connecting all peripheral devices.

Operating Mode:

For Blow 1 GHz

Receiver mode (LTE B5 Low CH Idle) *
Receiver mode (LTE B5 Middle CH Idle)
Receiver mode (LTE B5 High CH Idle)
Receiver mode (LTE B12 Low CH Idle)
Receiver mode (LTE B12 Middle CH Idle) *
Receiver mode (LTE B12 High CH Idle)

For Above 1 GHz

Receiver mode (LTE B5 Low CH Idle) *
Receiver mode (LTE B12 Middle CH Idle) *

NOTE.

1. Three orientations have been investigated and the worst case orientation (x-axis: The display of EUT placed on the table is facing upwards) is reported.
2. The worst case of operating mode is reported. [*].



5. CONDUCTED AND RADIATED EMISSION TEST SUMMARY

5.1 Conducted Emission(Not applicable)

The test results of conducted emission at mains ports provide the following information:

Rule Part / Standard	47 CFR PART 15 Subpart B Class B ANSI C63.4-2014
Detector	Quasi-Peak, CISPR-Average
Bandwidth	9 kHz (6 dB)
Operating Mode	Not applicable
Kind of Test Site	Shielded Room
Temperature	- °C
Relative Humidity	- %
Test Date	-



5.2 Radiated Emission

5.2.1 For Measurement Below 1 GHz

The test results of radiated emission provide the following information:

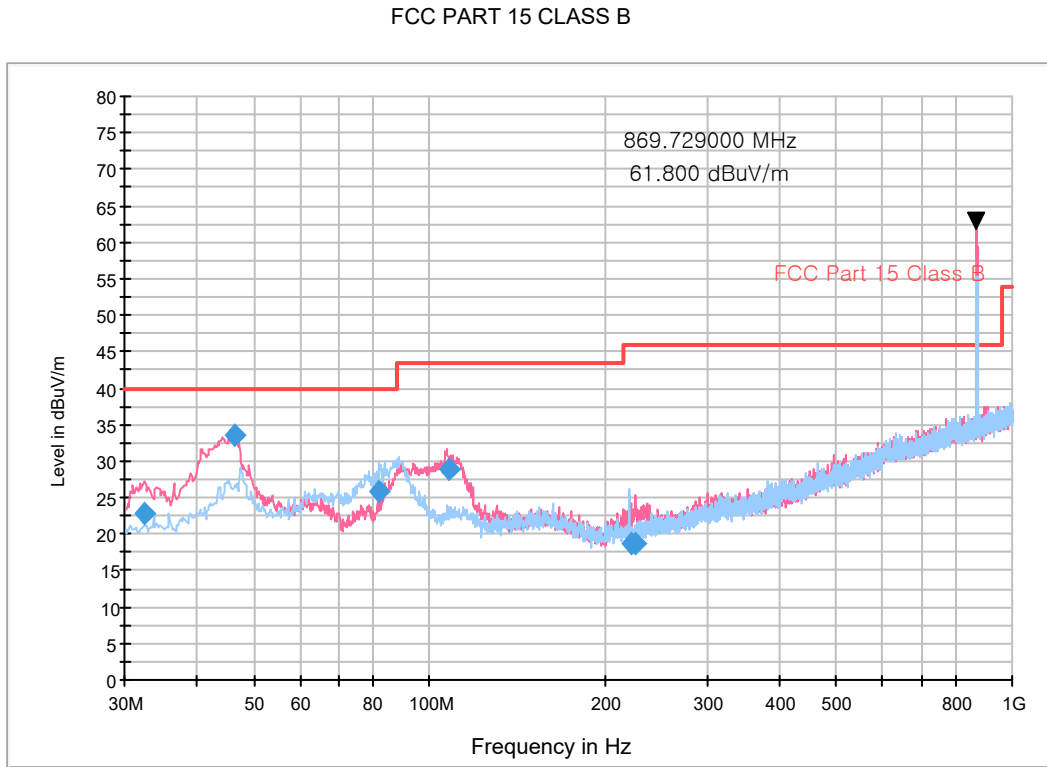
Applicable Standards	47 CFR PART 15 Subpart B Class B ANSI C63.4-2014
Detector	Quasi-Peak
Bandwidth	120 kHz (6 dB)
Worst Case of Operating Mode	Receiver mode (LTE B5 Low CH Idle) Receiver mode (LTE B12 Middle CH Idle)
Kind of Test Site	3 m semi anechoic chamber
Temperature	25.9 °C
Relative Humidity	45.1 %
Test Date	April 14, 2020

- Calculation Formula:

1. POL. H = Horizontal, POL. V = Vertical
2. QuasiPeak = Reading (Receiver Reading) + Corr.
3. Corr. (Correction Factor) = Antenna Factor + Cable Loss
4. Margin = Limit - QuasiPeak



Figure 1: Radiated Emission (30 MHz to 1 GHz), Receiver mode (LTE B5 Low Idle)



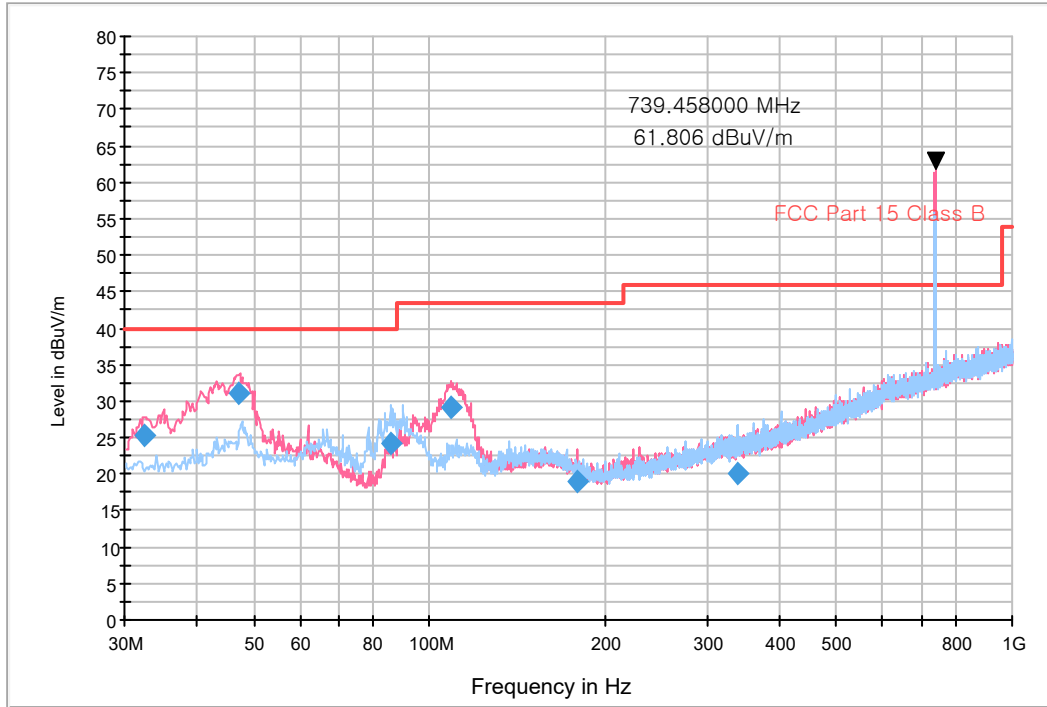
NOTE. 1. Carrier Frequency: RX 869.729 MHz
 2. These are signals for fundamental frequency from the base station

Frequency (MHz)	Quasi Peak (dBμV/m)	Antenna Height (cm)	POL. (H/V)	Azimuth (deg)	Corr. (dB)	Margin (dB)	Limit (dBμV/m)
32.385400	22.9	125.3	V	106.0	18.5	17.1	40.0
46.465000	33.6	100.0	V	30.0	19.5	6.4	40.0
82.225800	25.8	325.1	H	328.0	15.4	14.2	40.0
108.010000	29.0	100.0	V	0.0	16.1	14.5	43.5
221.509000	18.8	125.1	H	106.0	17.5	27.2	46.0
225.589200	18.6	100.0	V	8.0	17.7	27.4	46.0



Figure 2: Radiated Emission (30 MHz to 1 GHz), Receiver mode (LTE B12 Middle Idle)

FCC PART 15 CLASS B



- NOTE. 1. Carrier Frequency: RX 739.458 MHz
 2. These are signals for fundamental frequency from the base station

Frequency (MHz)	Quasi Peak (dBμV/m)	Antenna Height (cm)	POL. (H/V)	Azimuth (deg)	Corr. (dB)	Margin (dB)	Limit (dBμV/m)
32.517400	25.2	100.0	V	85.0	18.5	14.8	40.0
47.279000	31.1	125.0	V	53.0	19.6	8.9	40.0
86.105800	24.2	174.9	H	142.0	14.8	15.8	40.0
109.155000	29.1	100.0	V	7.0	16.2	14.4	43.5
178.984400	18.9	308.7	V	0.0	18.4	24.6	43.5
338.253200	20.1	100.0	H	53.0	21.4	25.9	46.0



5.2.2 For Measurement Above 1 GHz

The test results of radiated emission provide the following information:

Applicable Standards	47 CFR PART 15 Subpart B Class B ANSI C63.4-2014
Detector	Peak mode: Peak (RBW: 1 MHz, VBW: 3 MHz) CISPR-Average mode: Peak (RBW: 1 MHz, VBW: 10 Hz)
Highest Frequency	5 825 MHz
Tested Frequency Range	1 GHz to 30 GHz
Worst Case of Operating Mode	Receiver mode (LTE B5 Low CH Idle) Receiver mode (LTE B12 Middle CH Idle)
Kind of Test Site	3 m semi anechoic chamber
Temperature	23.1 °C
Relative Humidity	42.6 %
Test Date	April 16, 2020

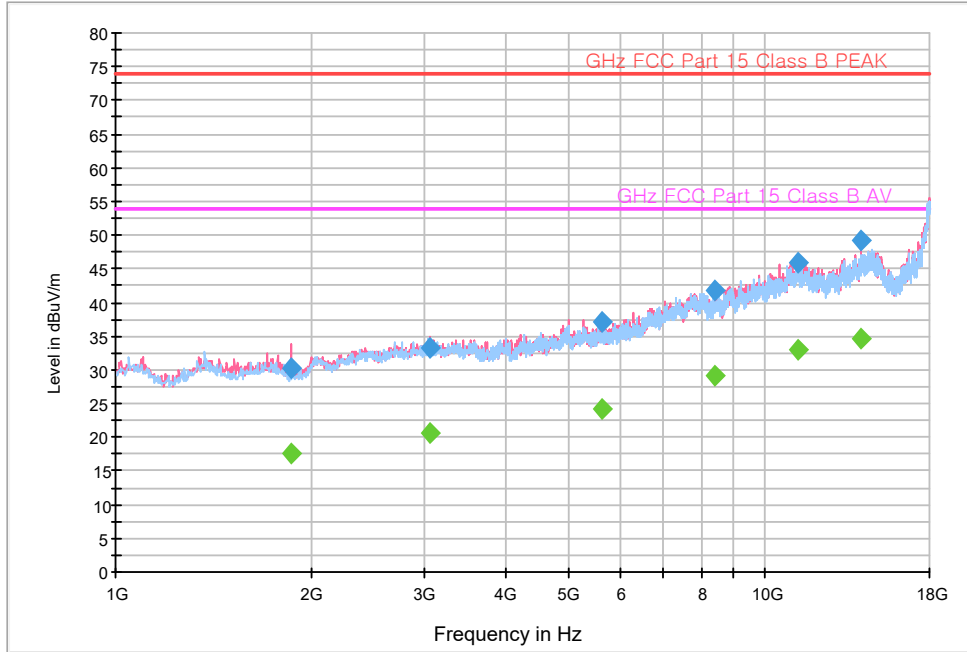
- Calculation Formula:

1. POL. H = Horizontal, POL. V = Vertical
2. Peak or CAverage = Reading (Receiver Reading) + Corr.
3. Corr. (Correction Factor) = Antenna Factor+ Cable Loss –Amplifier Gain
4. Margin = Limit - Peak or CAverage

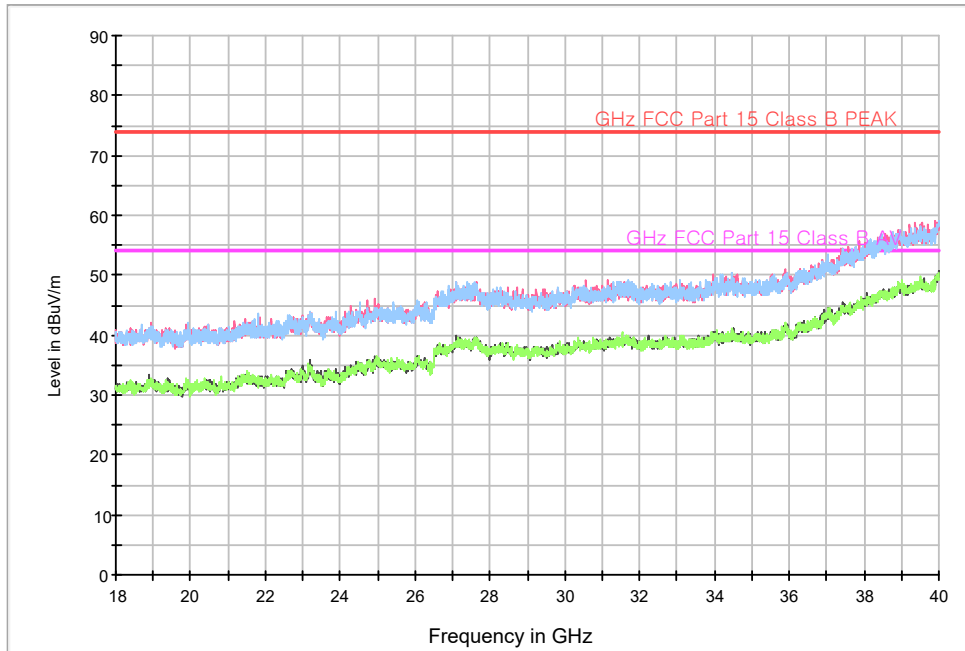


Figure 3: Radiated Emission (1 GHz to 30 GHz), Receiver mode (LTE B5 Low CH Idle)

Tilting of GHz FCC PART 15 CLASS B



Tilting of GHz FCC PART 15 CLASS B_18~40GHz





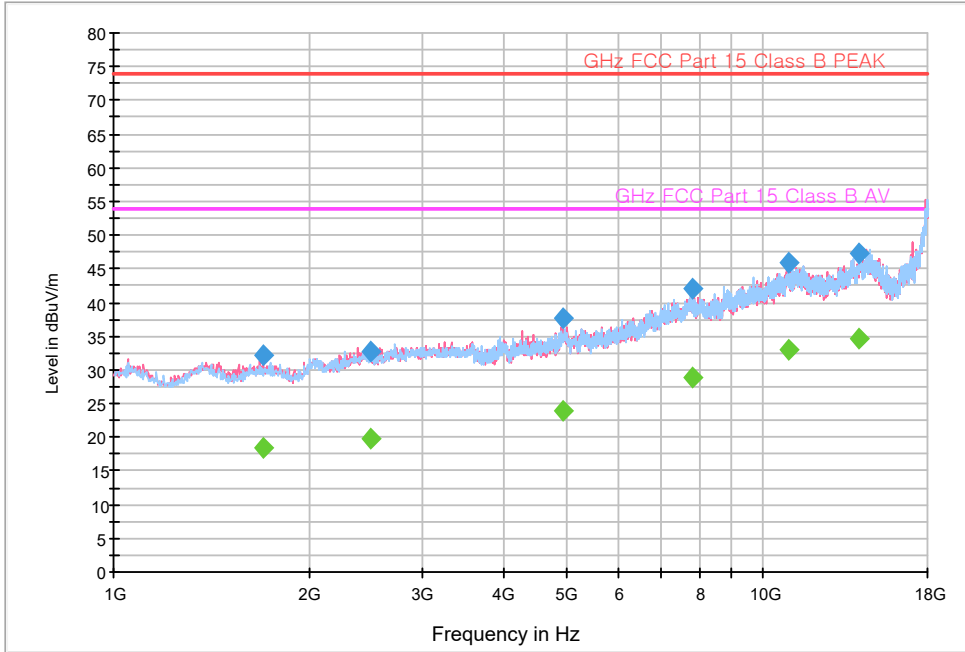
Frequency (MHz)	Peak (dB μ V/m)	Antenna Height (cm)	POL. (H/V)	Azimuth (deg)	Corr. (dB)	Margin (dB)	Limit (dB μ V/m)
1863.460000	30.3	160.5	V	210.0	-26.9	43.7	74.0
3057.040000	33.3	149.9	V	115.0	-22.6	40.7	74.0
5639.095000	37.0	242.6	V	71.0	-17.0	37.0	74.0
8404.625000	41.8	140.5	V	115.0	-12.0	32.2	74.0
11318.620000	45.9	100.0	H	20.0	-4.7	28.1	74.0
14152.410000	49.1	100.0	V	249.0	-1.9	24.9	74.0

Frequency (MHz)	CAverage (dB μ V/m)	Antenna Height (cm)	POL. (H/V)	Azimuth (deg)	Corr. (dB)	Margin (dB)	Limit (dB μ V/m)
1863.460000	17.6	160.5	V	210.0	-26.9	36.4	54.0
3057.040000	20.7	149.9	V	115.0	-22.6	33.3	54.0
5639.095000	24.3	242.6	V	71.0	-17.0	29.7	54.0
8404.625000	29.1	140.5	V	115.0	-12.0	24.9	54.0
11318.620000	33.1	100.0	H	20.0	-4.7	20.9	54.0
14152.410000	34.8	100.0	V	249.0	-1.9	19.2	54.0

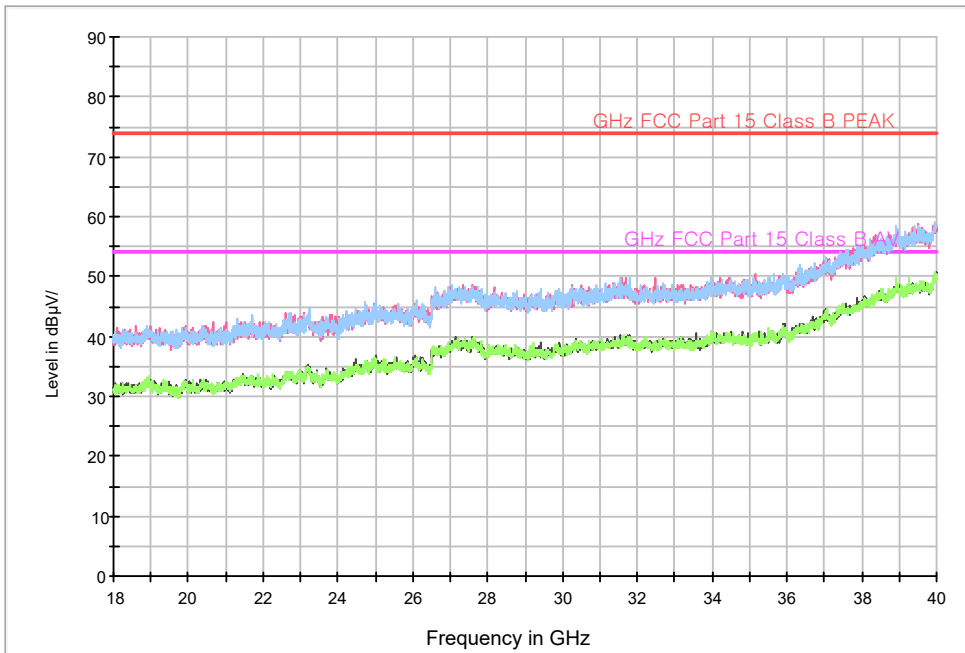


Figure 4: Radiated Emission (1 GHz to 30 GHz), Receiver mode (LTE B12 Middle CH Idle)

Tilting of GHz FCC PART 15 CLASS B



Tilting of GHz FCC PART 15 CLASS B_18~40GHz





Frequency (MHz)	Peak (dB μ V/m)	Antenna Height (cm)	POL. (H/V)	Azimuth (deg)	Corr. (dB)	Margin (dB)	Limit (dB μ V/m)
1697.530000	32.2	111.4	V	0.0	-27.3	41.8	74.0
2486.490000	32.8	189.5	V	262.0	-24.2	41.2	74.0
4927.475000	37.8	230.5	V	260.0	-17.9	36.2	74.0
7814.195000	42.1	126.8	V	59.0	-11.8	31.9	74.0
11007.750000	45.9	100.0	V	0.0	-5.3	28.1	74.0
14133.720000	47.2	140.6	H	51.0	-1.9	26.8	74.0

Frequency (MHz)	CAverage (dB μ V/m)	Antenna Height (cm)	POL. (H/V)	Azimuth (deg)	Corr. (dB)	Margin (dB)	Limit (dB μ V/m)
1697.530000	18.5	111.4	V	0.0	-27.3	35.5	54.0
2486.490000	19.7	189.5	V	262.0	-24.2	34.3	54.0
4927.475000	24.0	230.5	V	260.0	-17.9	30.0	54.0
7814.195000	28.9	126.8	V	59.0	-11.8	25.1	54.0
11007.750000	33.0	100.0	V	0.0	-5.3	21.0	54.0
14133.720000	34.7	140.6	H	51.0	-1.9	19.3	54.0



6. CONCLUSION

The data collected shows that the **Product Name: Mobile Phone and Model Name: SM-A516B/DS** complies with §15.107 and §15.109 of the FCC rules.



7. APPENDIX A. TEST SETUP PHOTO

Please refer to EMI Test Setup Photo and test setup photo file no. as follows;

Rev. No.	Issue Date	File No.
0	April 17, 2020	HCT-EM-2004-FC008-P
1	April 29, 2020	HCT-EM-2004-FC008-R1-P

End of report