



CERTIFICATION TEST REPORT

Report Number. : 13171837-E9V2

Applicant : SAMSUNG ELECTRONICS CO., LTD.
129 SAMSUNG-RO, YEONGTONG-GU, SUWON-SI,
GYEONGGI-DO, 16677, KOREA

Model : SM-A515U, SM-A515U1, SM-A515W and SM-S515DL

FCC ID : A3LSMA515U

ISED : 649E-SMA515W

EUT Description : GSM/CDMA/WCDMA/LTE Phablet with BT/BLE,
DTS/UNII a/b/g/n/ac, NFC and ANT+

Test Standard(s) : FCC 47 CFR PART 15 SUBPART B
ISED ICES-003 ISSUE 6

Date Of Issue:

March 05, 2020

Prepared by:

UL Korea, Ltd.

26th floor, 152, Teheran-ro, Gangnam-gu Seoul, 06236, Korea

Suwon Test Site: UL Korea, Ltd. Suwon Laboratory

218 Maeyeong-ro, Yeongtong-gu,
Suwon-si, Gyeonggi-do, 16675, Korea

TEL: (031) 337-9902

FAX: (031) 213-5433



ACCREDITED

Testing Laboratory

TL-637

Revision History

<u>Rev.</u>	<u>Issue Date</u>	<u>Revisions</u>	<u>Revised By</u>
V1	30/01/20	Initial issue	Sangyun Kim
V2	05/03/20	Updated to address TCB's question	Sangyun Kim

TABLE OF CONTENTS

1. ATTESTATION OF TEST RESULTS	4
2. TEST METHODOLOGY	5
3. FACILITIES AND ACCREDITATION	5
4. CALIBRATION AND UNCERTAINTY	5
4.1. MEASURING INSTRUMENT CALIBRATION.....	5
4.2. SAMPLE CALCULATION.....	5
4.3. MEASUREMENT UNCERTAINTY	6
4.4. DECISION RULE	6
5. EQUIPMENT UNDER TEST	7
5.1. DESCRIPTION OF EUT.....	7
5.2. PRELIMINARY TEST CONFIGURATIONS.....	7
5.3. MODE(S) OF OPERATION INVESTIGATED.....	7
5.4. MODIFICATIONS.....	8
5.5. DETAILS OF TESTED SYSTEM.....	8
6. APPLICABLE LIMITS AND TEST RESULTS	12
6.1. RADIATED EMISSIONS	12
6.2. CONDUCTED EMISSIONS.....	43
7. SETUP PHOTOS.....	68

1. ATTESTATION OF TEST RESULTS

COMPANY NAME: SAMSUNG ELECTRONICS CO., LTD.

EUT DESCRIPTION: GSM/CDMA/WCDMA/LTE Phablet with BT/BLE, DTS/UNII a/b/g/n/ac, NFC and ANT+

MODEL NUMBER: SM-A515U, SM-A515U1, SM-A515W and SM-S515DL

SERIAL NUMBER: R38MB04NP8Y

DATE TESTED: DEC 24, 2019 – JAN 10, 2020

APPLICABLE STANDARDS	
STANDARD	TEST RESULTS
FCC PART 15 SUBPART B	Pass
ISED ICES-003 ISSUE 6	Pass

UL Verification Services Inc. tested the above equipment in accordance with the requirements set forth in the above standards. All indications of Pass/Fail in this report are opinions expressed by UL Verification Services Inc. based on interpretations and/or observations of test results. Measurement Uncertainties were not taken into account and are published for informational purposes only. The test results show that the equipment tested is capable of demonstrating compliance with the requirements as documented in this report.

Note: The results documented in this report apply only to the tested sample, under the conditions and modes of operation as described herein. This document may not be altered or revised in any way unless done so by UL Verification Services Inc. and all revisions are duly noted in the revisions section. Any alteration of this document not carried out by UL Verification Services Inc. will constitute fraud and shall nullify the document. This report must not be used by the client to claim product certification, approval, or endorsement by NVLAP, NIST, any agency of the Federal Government, or any agency of any government.

Approved & Released For
UL Korea, Ltd. By:



Junwhan Lee
Suwon Lab Engineer
UL Korea, Ltd.

Tested By:



Sangyun Kim
Suwon Lab Laboratory Engineer
UL Korea, Ltd.

2. TEST METHODOLOGY

The tests documented in this report were performed in accordance with ANSI C63.4-2014, FCC CFR 47 Part 15, ISED ICES-003 Issue 6.

3. FACILITIES AND ACCREDITATION

The test sites and measurement facilities used to collect data are located at 218 Maeyeong-ro, Yeongtong-gu, Suwon-si, Gyeonggi-do, 16675, Korea. Line conducted emissions are measured only at the 218 address. The following table identifies which facilities were utilized for radiated emission measurements documented in this report. Specific facilities are also identified in the test results sections.

218 Maeyeong-ro	
<input checked="" type="checkbox"/>	Chamber 1
<input type="checkbox"/>	Chamber 2
<input type="checkbox"/>	Chamber 3

UL Korea, Ltd. is accredited by IAS, Laboratory Code TL-637. The full scope of accreditation can be viewed at <http://www.iasonline.org/wp-content/uploads/2017/05/TL-637.pdf>.

4. CALIBRATION AND UNCERTAINTY

4.1. MEASURING INSTRUMENT CALIBRATION

The measuring equipment utilized to perform the tests documented in this report has been calibrated in accordance with the manufacturer's recommendations, and is traceable to recognized national standards.

4.2. SAMPLE CALCULATION

Where relevant, the following sample calculation is provided:

$$\begin{aligned} \text{Field Strength (dBuV/m)} &= \text{Measured Voltage (dBuV)} + \text{Antenna Factor (dB/m)} + \\ &\text{Cable Loss (dB)} - \text{Preamp Gain (dB)} \\ 36.5 \text{ dBuV} + 18.7 \text{ dB/m} + 0.6 \text{ dB} - 26.9 \text{ dB} &= 28.9 \text{ dBuV/m} \end{aligned}$$

4.3. MEASUREMENT UNCERTAINTY

Where relevant, the following measurement uncertainty levels have been estimated for tests performed on the apparatus:

PARAMETER	UNCERTAINTY
Conducted Disturbance, 0.15 to 30 MHz	2.35 dB
Radiated Disturbance, 30 MHz to 1 GHz	3.49 dB
Radiated Disturbance, 1 GHz to 18 GHz	5.82 dB
Radiated Disturbance, 18 GHz to 30 GHz	5.49 dB

Uncertainty figures are valid to a confidence level of 95%.

4.4. DECISION RULE

Decision rule for statement(s) of conformity is based on Procedure 1, Clause 4.4.2 in IEC Guide 115:2007.

5. EQUIPMENT UNDER TEST

5.1. DESCRIPTION OF EUT

The EUT is a GSM/CDMA/WCDMA/LTE Phablet with BT/BLE, DTS/UNII a/b/g/n/ac, NFC and ANT+.

The model SM-A515U was used for final testing and is representative of the test result in this report

GENERAL INFORMATION

Type of device	Class B personal computers and peripherals Other Class B digital devices & peripherals
Personal Computer power requirements	100-240 VAC / 50-60 Hz, 1.8 A
Travel Adapter power requirements	100-240 VAC / 50-60 Hz, 0.7 A
List of frequencies generated or used by the EUT	30 GHz (5 th harmonic of the frequency of 5GHz UNII)

5.2. PRELIMINARY TEST CONFIGURATIONS

This EUT have a camera pop up function when user operate front camera function. The fundamental of the EUT was investigated in three orthogonal orientations X, Y and Z. It was normal mode and camera pop up mode. It was determined that X on normal mode orientation was worst-case orientation; therefore, all final radiated testing was performed with the EUT in X orientation with data transfer.

5.3. MODE(S) OF OPERATION INVESTIGATED

Mode	Description
Test Case 1	Camera(Rear) + Charging + FM Radio Low Ch
Test Case 2	Camera(Rear) + Charging + FM Radio Mid Ch
Test Case 3	Camera(Front) + Charging + FM Radio High Ch
Test Case 4	Video and Audio Play + Charging
Test Case 5	USB Data Communication with PC
Test Case 6	Receiver Mode (Licensed Band within 30-960MHz)

Note: Receiver Mode (Licensed Band within 30-960MHz) radiated test result refer to FCC Report WWAN Part15B.

Receiver Mode (Licensed Band within 30-960MHz) AC mains line conducted test was tested to high power licensed band(GSM850).

5.4. MODIFICATIONS

No modifications were made during testing.

5.5. DETAILS OF TESTED SYSTEM

SUPPORT EQUIPMENT & PERIPHERALS

Support Equipment List				
Description	Manufacturer	Model	Serial Number	FCC ID/DoC
Laptop PC	Lenovo	L480	PF-18QBWC	DoC
AC/DC Adapter	Lenovo	ADLX65YDC3A	8SSA10M13946-1SG85B05SR	N/A
Mouse	Lenovo	MSU1175	4G084D5273B	DoC
Data Cable	SAMSUNG	EP-DG977	N/A	N/A
Charger	SAMSUNG	EP-TA200	R37KBKL01W1DK3	N/A
Earphone	SAMSUNG	EHS61ASFBE	N/A	N/A
Micro SD Card	SAMSUNG	MB-MC256GA	-	-

I/O CABLES

[DIAGRAM 1]

I/O Cable List						
Cable No	Port	# of identical ports	Connector Type	Cable Type	Cable Length(m)	Remarks
1	AC Power	1	Power	Direct	-	From Charger to AC Main
2	USB	1	Type-C	Shielded	0.8m	From Charger to EUT
3	Earphone	1	Mini-Jack	Shielded	1.5m	From EUT to Earphone

[DIAGRAM 2]

I/O Cable List						
Cable No	Port	# of identical ports	Connector Type	Cable Type	Cable Length(m)	Remarks
1	AC Power	1	Power	Unshielded	1.0m	From AC/DC Adapter to AC Main
2	DC Power	1	Power	Unshielded	1.5m	From AD/DC Adapter to Laptop PC
3	Audio	1	Mini-Jack	Shielded	1.5m	From EUT to Earphone
4	USB	1	USB	Shielded	1.8m	From Mouse to PC
5	USB	1	Type-C	Shielded	0.8m	From EUT to PC
6	LAN	1	RJ-45	Shielded	1.0m	From Laptop PC to Ethernet (Outside of test site)

TEST SETUP

The EUT is installed in a typical configuration. Copy files from PC to EUT fitted Micro sd card.

TEST SETUP DIAGRAM 1 for Test Case 1 to 4 and 6

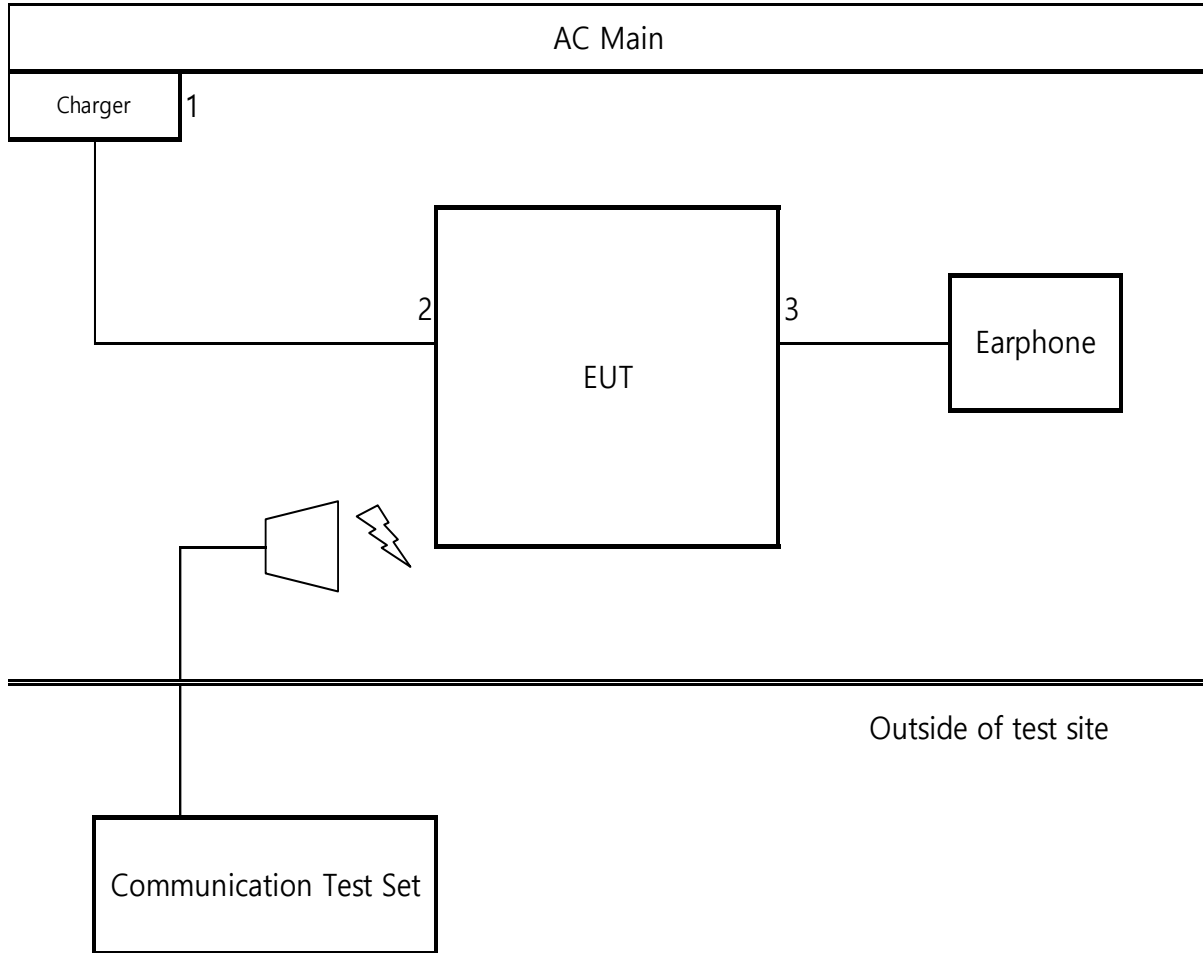

TEST SETUP DIAGRAM 2 for Test case 5

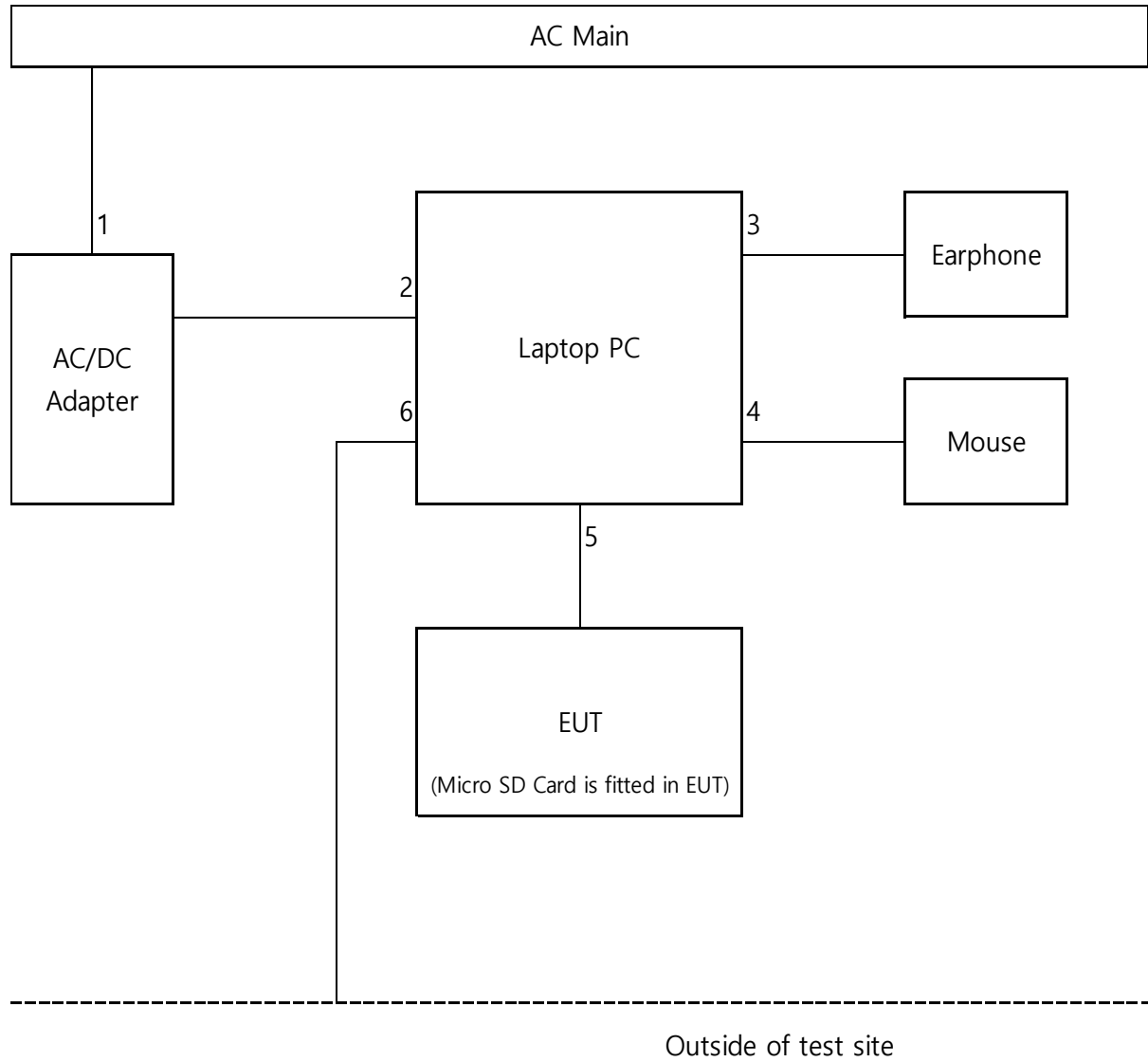

TEST AND MEASUREMENT EQUIPMENT

The following test and measurement equipment was utilized for the tests documented in this report:

Test Equipment List				
Description	Manufacturer	Model	S/N	New Cal Due
Antenna, Bilog, 30MHz-1GHz	SCHWARZBECK	VULB9163	750	08-04-20
Antenna, Bilog, 30MHz-1GHz	SCHWARZBECK	VULB9163	749	08-04-20
Antenna, Bilog, 30MHz-1GHz	SCHWARZBECK	VULB9163	845	08-04-20
Antenna, Horn, 18 GHz	ETS	3115	00167211	08-04-20
Antenna, Horn, 18 GHz	ETS	3115	00161451	08-04-20
Antenna, Horn, 18 GHz	ETS	3117	00168724	08-04-20
Antenna, Horn, 18 GHz	ETS	3117	00168717	08-04-20
Antenna, Horn, 18 GHz	ETS	3117	00205959	08-04-20
Antenna, Horn, 40 GHz	ETS	3116C	00166155	08-14-20
Antenna, Horn, 40 GHz	ETS	3116C	00168645	10-02-21
Preamplifier	ETS	3116C-PA	00168841	08-08-20
Preamplifier, 1000 MHz	Sonoma	310N	341282	08-05-20
Preamplifier, 1000 MHz	Sonoma	310N	351741	08-05-20
Preamplifier, 1000 MHz	Sonoma	310N	370599	08-05-20
Preamplifier, 18 GHz	Miteq	AFS42-00101800-25-S-42	1876511	08-06-20
Preamplifier, 18 GHz	Miteq	AFS42-00101800-25-S-42	1896138	08-06-20
Preamplifier, 18 GHz	Miteq	AFS42-00101800-25-S-42	2029169	08-06-20
Attenuator	PASTERNAK	PE7087-10	A001	08-08-20
Attenuator	PASTERNAK	PE7087-10	A008	08-08-20
Attenuator	PASTERNAK	PE7004-10	2	08-06-20
Attenuator	PASTERNAK	PE7087-10	A009	08-08-20
EMI Test Receive, 40 GHz	R&S	ESU40	100439	08-06-20
EMI Test Receive, 40 GHz	R&S	ESU40	100457	08-06-20
EMI Test Receive, 44 GHz	R&S	ESW44	101590	08-05-20
EMI Test Receive, 3 GHz	R&S	ESR3	101832	08-05-20
LISN	R&S	ENV-216	101836	08-09-20
LISN	R&S	ENV-216	101837	08-09-20
Antenna, Loop, 9kHz-30MHz				
Description	Manufacturer	Model	Version	
Radiated software	UL	UL EMC	Ver 9.5	
AC Line Conducted software	UL	UL EMC	Ver 9.5	

6. APPLICABLE LIMITS AND TEST RESULTS

6.1. RADIATED EMISSIONS

TEST PROCEDURE

ANSI C63.4: 2014

The highest clock frequency generated or used in the EUT is 5.8GHz therefore the frequency range was investigated from 30 MHz to 30 GHz.

LIMIT

§15.109 (a) and ICES-003 Except for Class A digital devices, the field strength of radiated emissions from unintentional radiators at a distance of 3 meters shall not exceed the following values:

Limits for radiated disturbance of Class B ITE at measuring distance of 3 m	
Frequency range (MHz)	Quasi-peak limits (dB μ V/m)
30 to 88	40
88 to 216	43.5
216 to 960	46
Above 960 MHz	54

Note: The lower limit shall apply at the transition frequency.

RESULTS Test Case 1

RADIATED EMISSIONS 30 to 1000 MHz

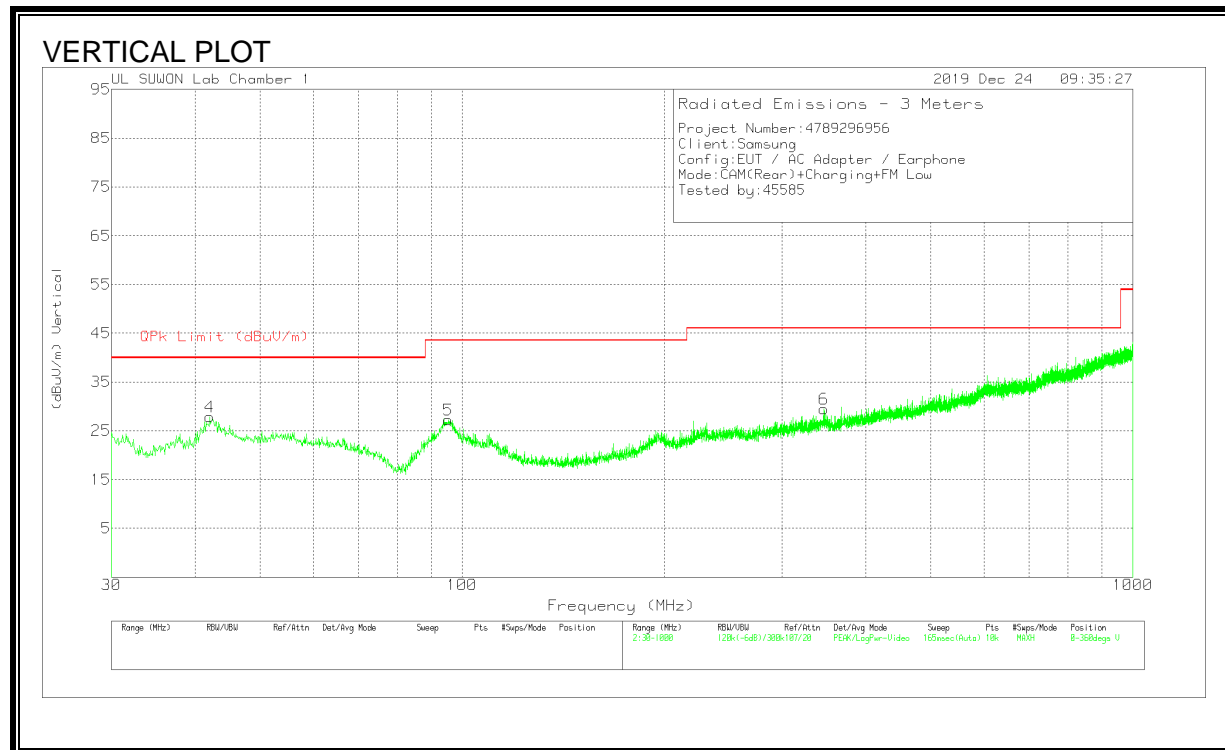
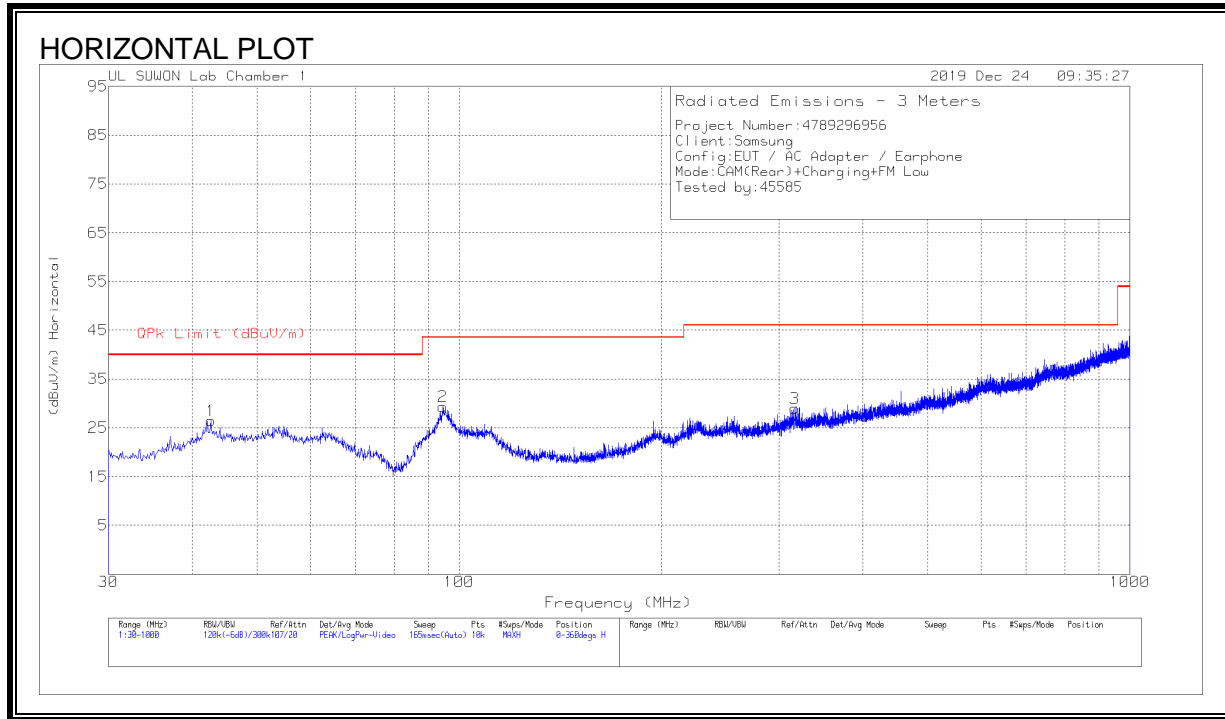

HORIZONTAL AND VERTICAL DATA

Trace Markers

Marker	Frequency (MHz)	Meter Reading (dBuV)	Det	VULB9163_750	Below_1G[dB]	Corrected Reading (dBuV/m)	QPk Limit (dBuV/m)	Margin (dB)	Azimuth (Degs)	Height (cm)	Polarity
1	42.61	36.84	Pk	19.2	-29.6	26.44	40	-13.56	0-360	200	H
2	94.505	40.85	Pk	17.2	-28.7	29.35	43.52	-14.17	0-360	300	H
3	316.732	36.04	Pk	19.7	-26.8	28.94	46.02	-17.08	0-360	100	H
4	42.028	38.67	Pk	19.1	-29.9	27.87	40	-12.13	0-360	100	V
5	95.378	38.58	Pk	17.3	-28.7	27.18	43.52	-16.34	0-360	100	V
6	346.511	35.03	Pk	21	-26.5	29.53	46.02	-16.49	0-360	400	V

Pk - Peak detector

Note: Only peak measurement was performed. Because peak measurement result of unwanted emission is less than average limit (54dBuV/m).

RADIATED EMISSIONS 1GHz to 18GHz

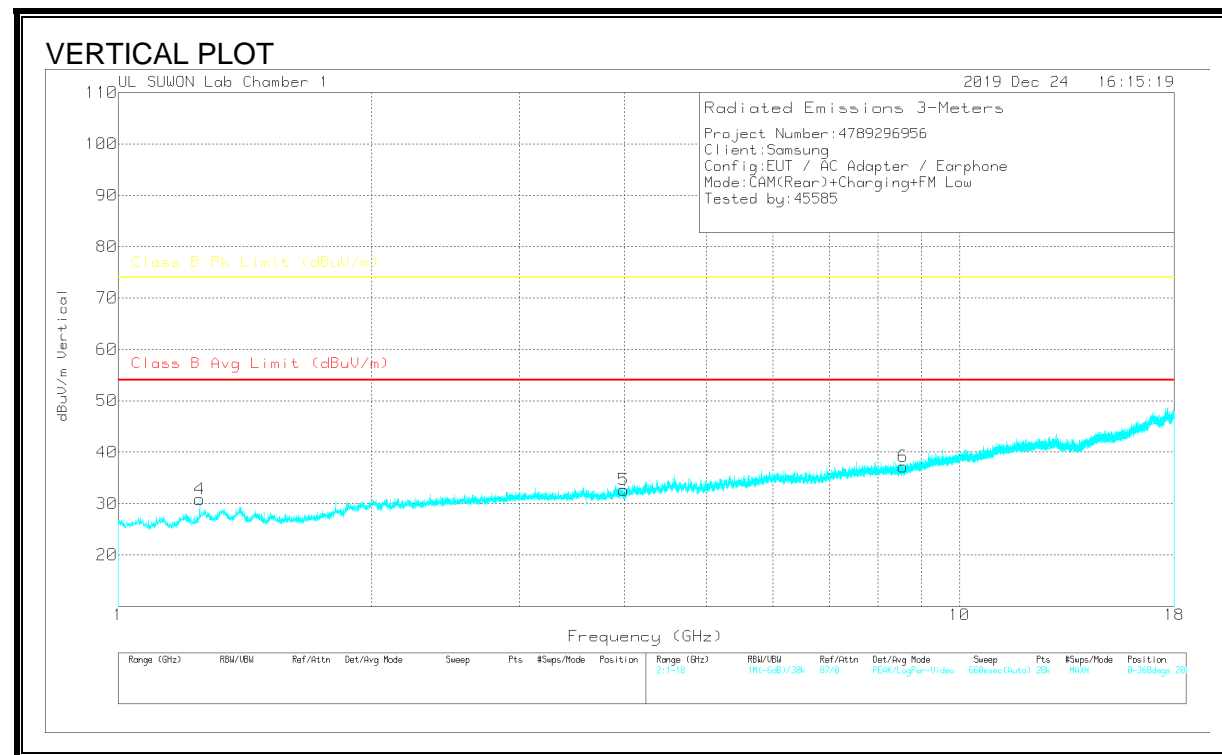
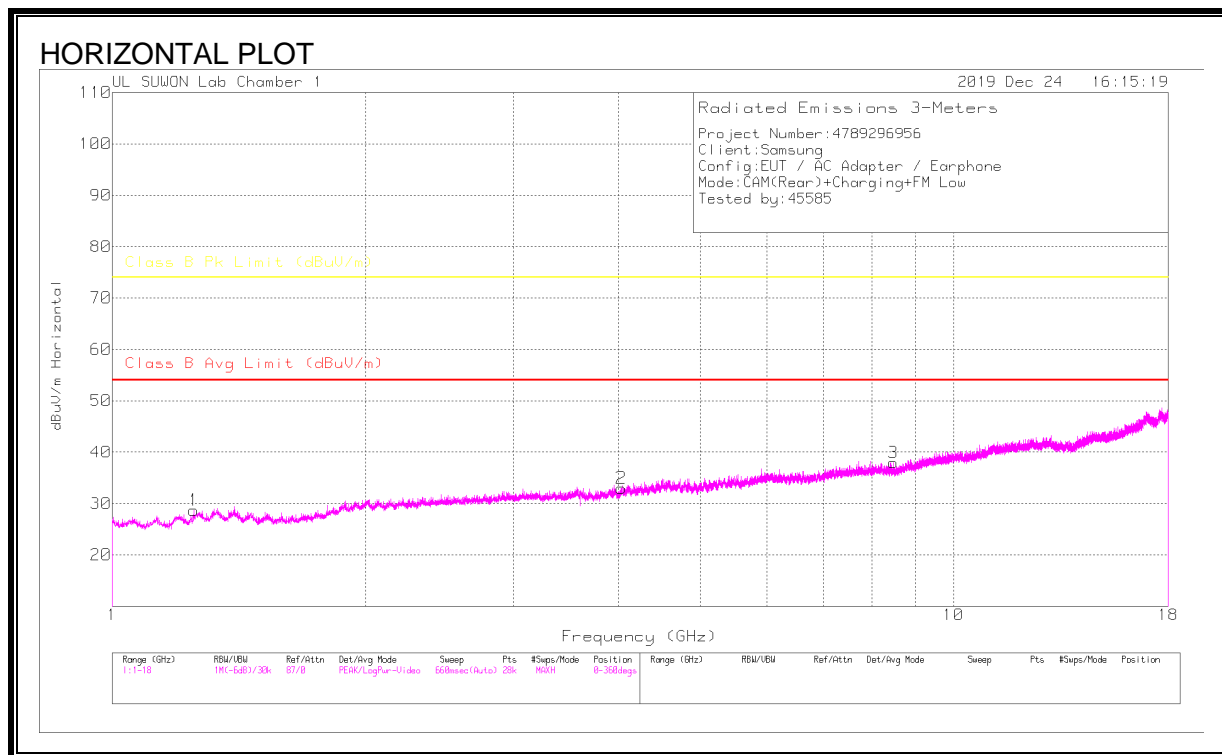

HORIZONTAL AND VERTICAL DATA

Trace Markers

Marker	Frequency (GHz)	Meter Reading (dBuV)	Det	3117_00168717	1-18GHz[dB]	Corrected Reading dBuV/m	Class B Avg Limit (dBuV/m)	Av(CISPR)Margin (dB)	Class B Pk Limit (dBuV/m)	Margin (dB)	Azimuth (Degs)	Height (cm)	Polarity
1	1.24951	36.79	PK	29.2	-37.3	28.69	-	-	74	-45.31	0-360	200	H
2	4.02811	32.08	PK	33.6	-32.7	32.98	-	-	74	-41.02	0-360	100	H
3	8.47981	27.65	PK	36.3	-26	37.95	-	-	74	-36.05	0-360	100	H
4	1.24951	38.94	PK	29.2	-37.3	30.84	-	-	74	-43.16	0-360	200	V
5	3.98743	31.97	PK	33.5	-32.8	32.67	-	-	74	-41.33	0-360	100	V
6	8.56844	26.89	PK	36.3	-26	37.19	-	-	74	-36.81	0-360	100	V

PK – Peak Detector

Note: Only peak measurement was performed. Because peak measurement result of unwanted emission is less than average limit (54dBuV/m).

RADIATED EMISSIONS 18GHz to 30GHz

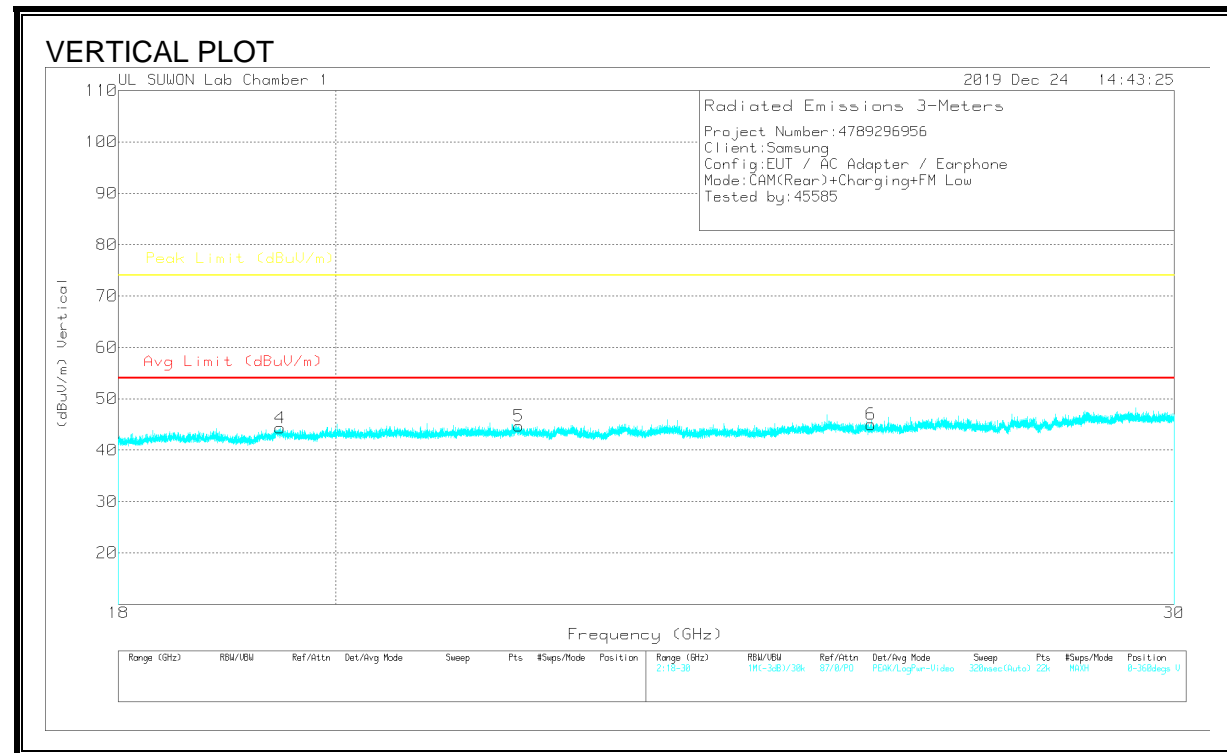
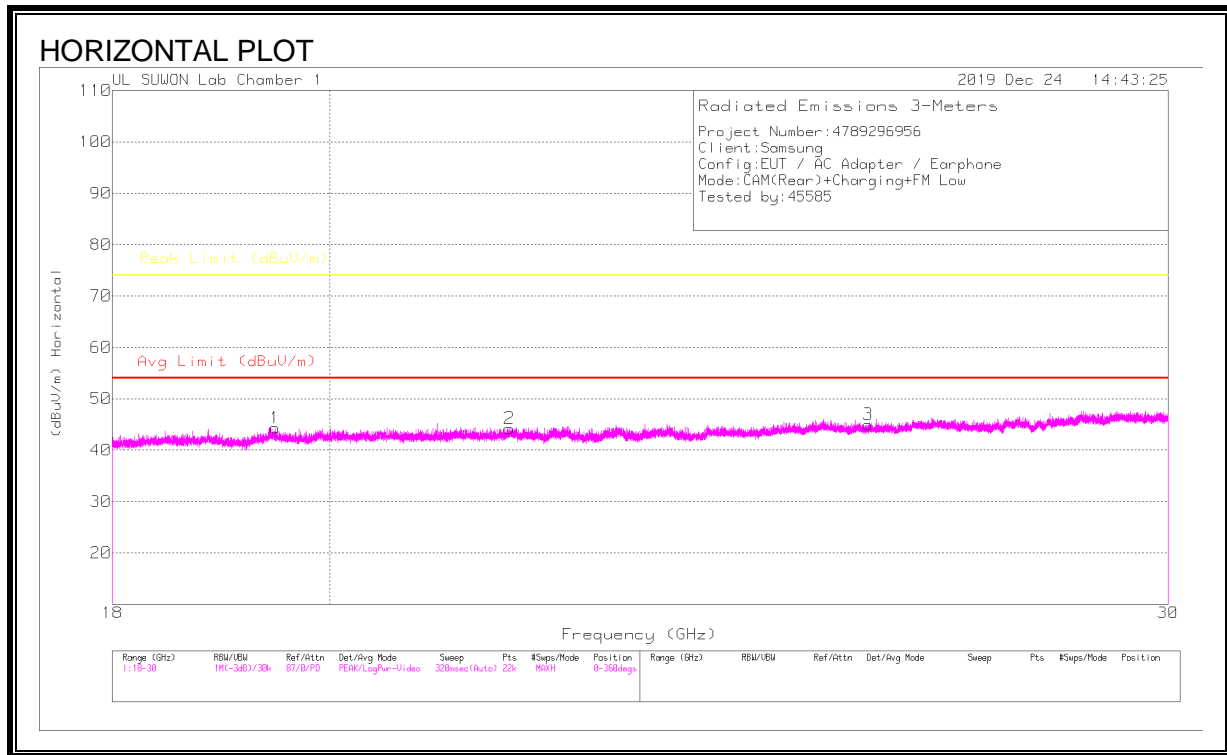

HORIZONTAL AND VERTICAL DATA

Trace Markers

Marker	Frequency (GHz)	Meter Reading (dBuV)	Det	3116C-PA	18-40GHz[dB]	Corrected Reading (dBuV/m)	Avg Limit (dBuV/m)	Margin (dB)	Peak Limit (dBuV/m)	Margin (dB)	Azimuth (Degs)	Height (cm)	Polarity
1	19.47648	23.61	PK	5.2	15.5	44.31	-	-	74	-29.69	0-360	100	H
2	21.81256	17.72	PK	10.1	16.4	44.22	-	-	74	-29.78	0-360	100	H
3	25.94746	19.79	PK	7.1	18.1	44.99	-	-	74	-29.01	0-360	100	H
4	19.46612	23.7	PK	5.2	15.4	44.3	-	-	74	-29.7	0-360	100	V
5	21.84964	18.1	PK	10.1	16.5	44.7	-	-	74	-29.3	0-360	100	V
6	25.90546	19.91	PK	7.1	18	45.01	-	-	74	-28.99	0-360	100	V

PK – Peak Detector

Note: Only peak measurement was performed. Because peak measurement result of unwanted emission is less than average limit (54dBuV/m).

RESULTS Test Case 2

RADIATED EMISSIONS 30 to 1000 MHz

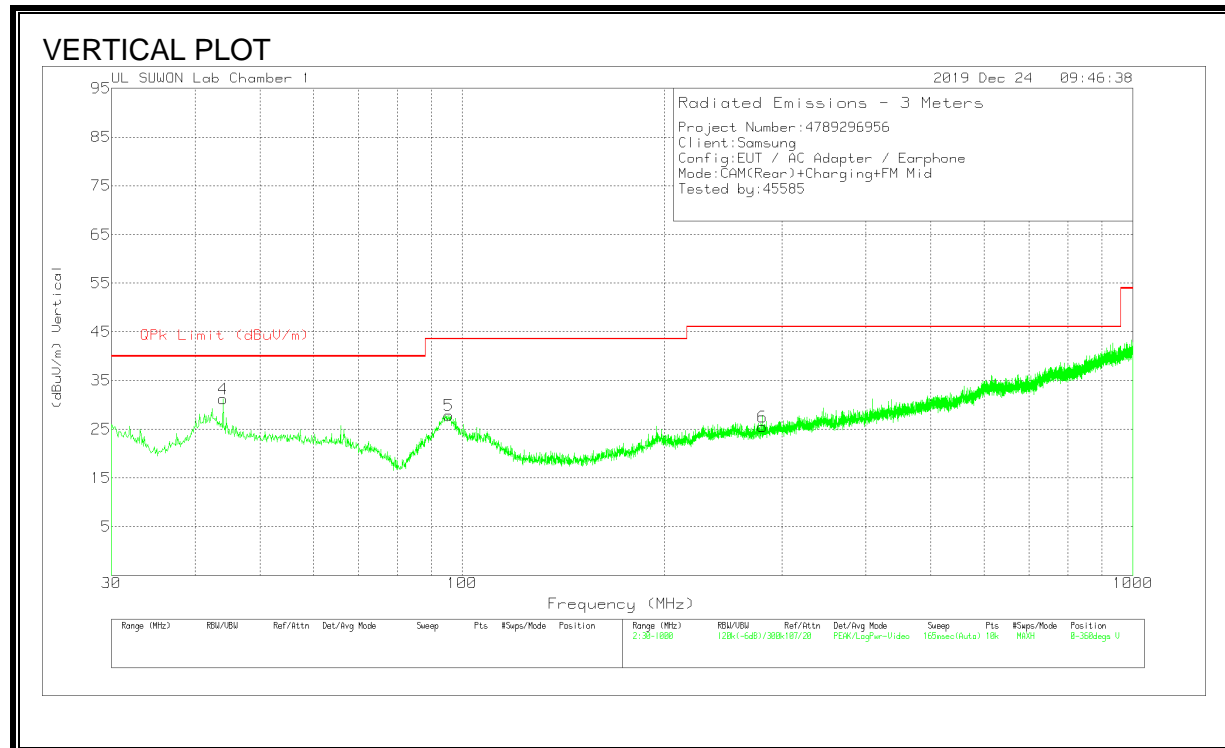
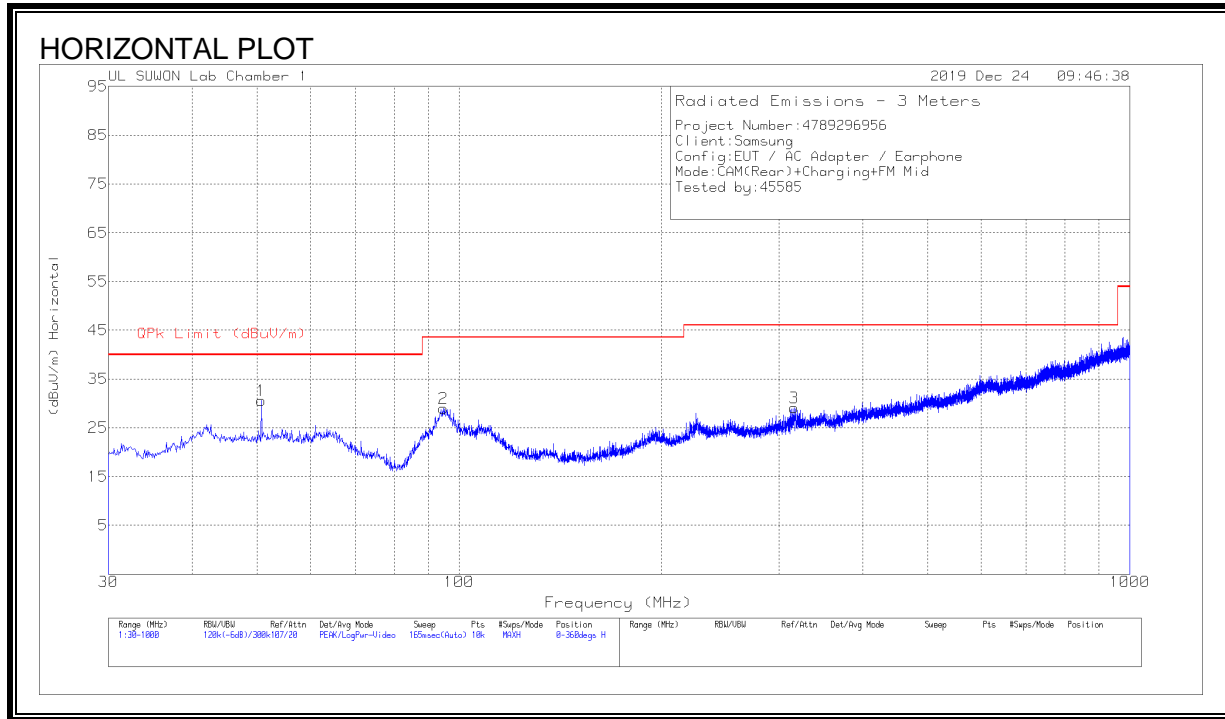

HORIZONTAL AND VERTICAL DATA

Trace Markers

Marker	Frequency (MHz)	Meter Reading (dBuV)	Det	VULB9163_750	Below_1G[dB]	Corrected Reading (dBuV/m)	QPk Limit (dBuV/m)	Margin (dB)	Azimuth (Degs)	Height (cm)	Polarity
1	50.661	40.55	Pk	19.7	-29.6	30.65	40	-9.35	0-360	300	H
2	94.699	40.53	Pk	17.2	-28.7	29.03	43.52	-14.49	0-360	300	H
3	315.956	36.19	Pk	19.7	-26.8	29.09	46.02	-16.93	0-360	100	H
4	43.968	41.55	Pk	19.5	-29.8	31.25	40	-8.75	0-360	100	V
5	95.572	39.27	Pk	17.4	-28.8	27.87	43.52	-15.65	0-360	100	V
6	280.26	33.71	Pk	18.9	-27.1	25.51	46.02	-20.51	0-360	200	V

Pk - Peak detector

Note: Only peak measurement was performed. Because peak measurement result of unwanted emission is less than average limit (54dBuV/m).

RADIATED EMISSIONS 1GHz to 18GHz

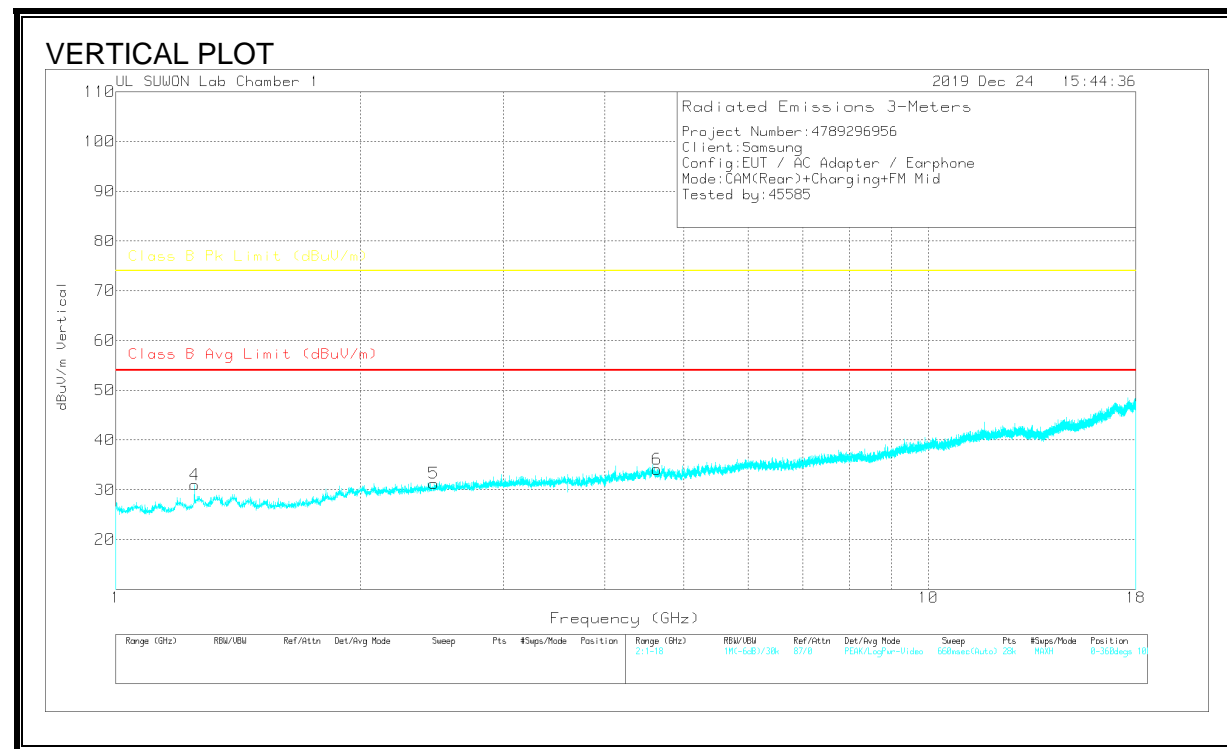
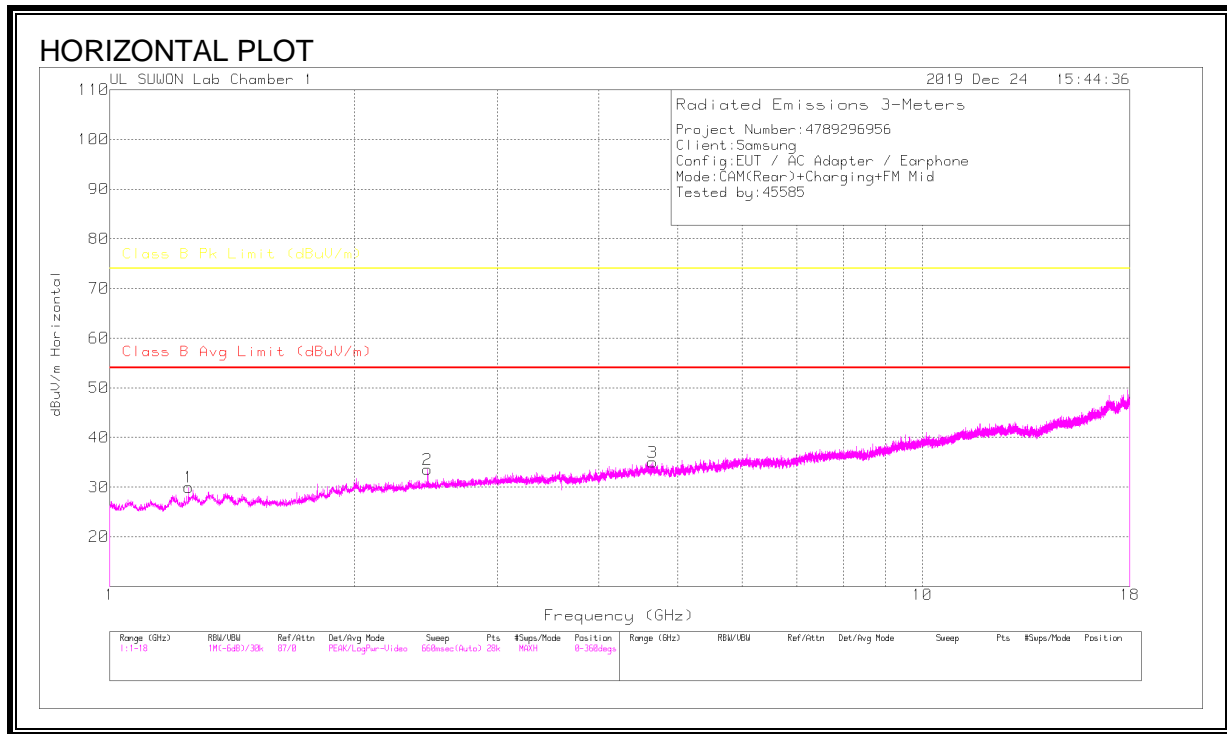

HORIZONTAL AND VERTICAL DATA

Trace Markers

Marker	Frequency (GHz)	Meter Reading (dBuV)	Det	3117_00168717	1-18GHz(dB)	Corrected Reading dBuV/m	Class B Avg Limit (dBuV/m)	Av(CISPR)Margin (dB)	Class B Pk Limit (dBuV/m)	Margin (dB)	Azimuth (Degs)	Height (cm)	Polarity
1	1.25012	38.07	PK	29.2	-37.3	29.97	-	-	74	-44.03	0-360	100	H
2	2.46002	36.57	PK	31.9	-34.9	33.57	-	-	74	-40.43	0-360	200	H
3	4.65461	33.04	PK	34.2	-32.2	35.04	-	-	74	-38.96	0-360	200	H
4	1.25012	39.12	PK	29.2	-37.3	31.02	-	-	74	-42.98	0-360	200	V
5	2.46245	34.41	PK	31.9	-35	31.31	-	-	74	-42.69	0-360	100	V
6	4.637	32.13	PK	34.2	-32.2	34.13	-	-	74	-39.87	0-360	100	V

PK – Peak Detector

Note: Only peak measurement was performed. Because peak measurement result of unwanted emission is less than average limit (54dBuV/m).

RADIATED EMISSIONS 18GHz to 30GHz

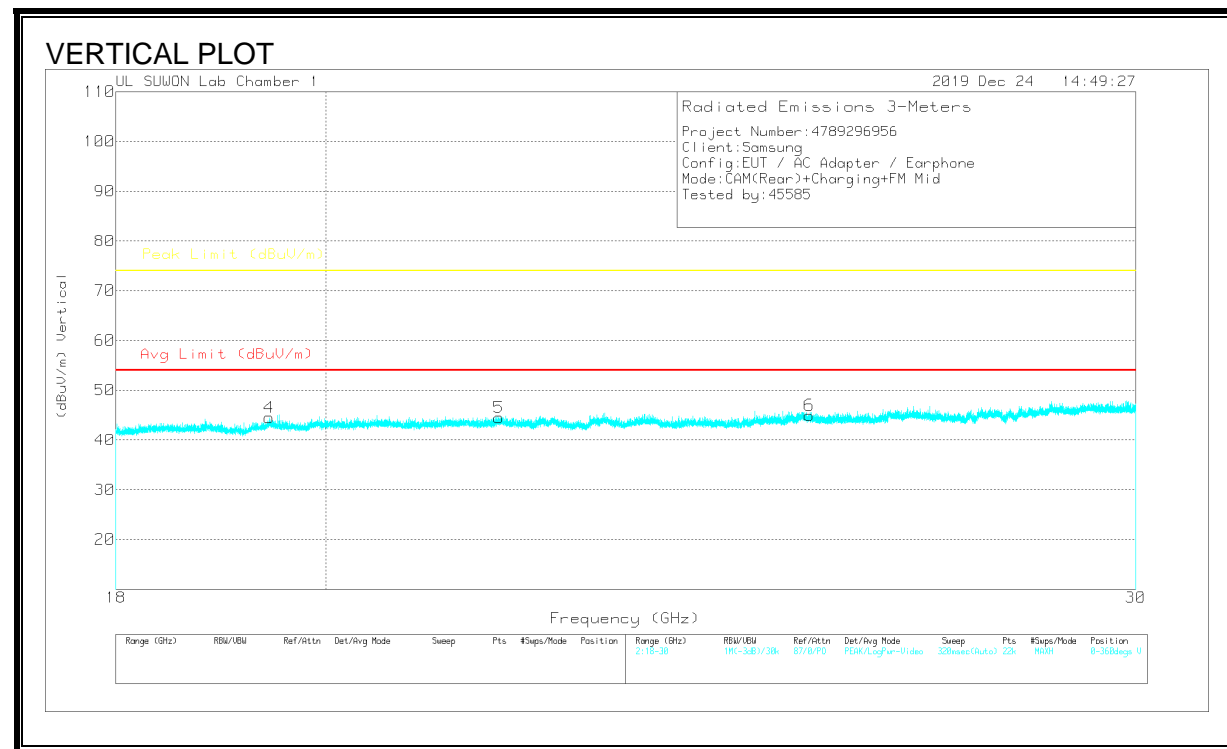

HORIZONTAL AND VERTICAL DATA

Trace Markers

Marker	Frequency (GHz)	Meter Reading (dBuV)	Det	3116C-PA	18-40GHz[dB]	Corrected Reading (dBuV/m)	Avg Limit (dBuV/m)	Margin (dB)	Peak Limit (dBuV/m)	Margin (dB)	Azimuth (Degs)	Height (cm)	Polarity
1	19.48084	23.45	PK	5.2	15.5	44.15	-	-	74	-29.85	0-360	100	H
2	21.79183	18.47	PK	10	16.4	44.87	-	-	74	-29.13	0-360	100	H
3	25.40258	20.73	PK	7.4	17.9	46.03	-	-	74	-27.97	0-360	100	H
4	19.43612	24.02	PK	5.1	15.4	44.52	-	-	74	-29.48	0-360	100	V
5	21.80601	18.02	PK	10.1	16.4	44.52	-	-	74	-29.48	0-360	100	V
6	25.47403	19.69	PK	7.4	17.9	44.99	-	-	74	-29.01	0-360	100	V

PK – Peak Detector

Note: Only peak measurement was performed. Because peak measurement result of unwanted emission is less than average limit (54dBuV/m).

RESULTS Test Case 3

RADIATED EMISSIONS 30 to 1000 MHz

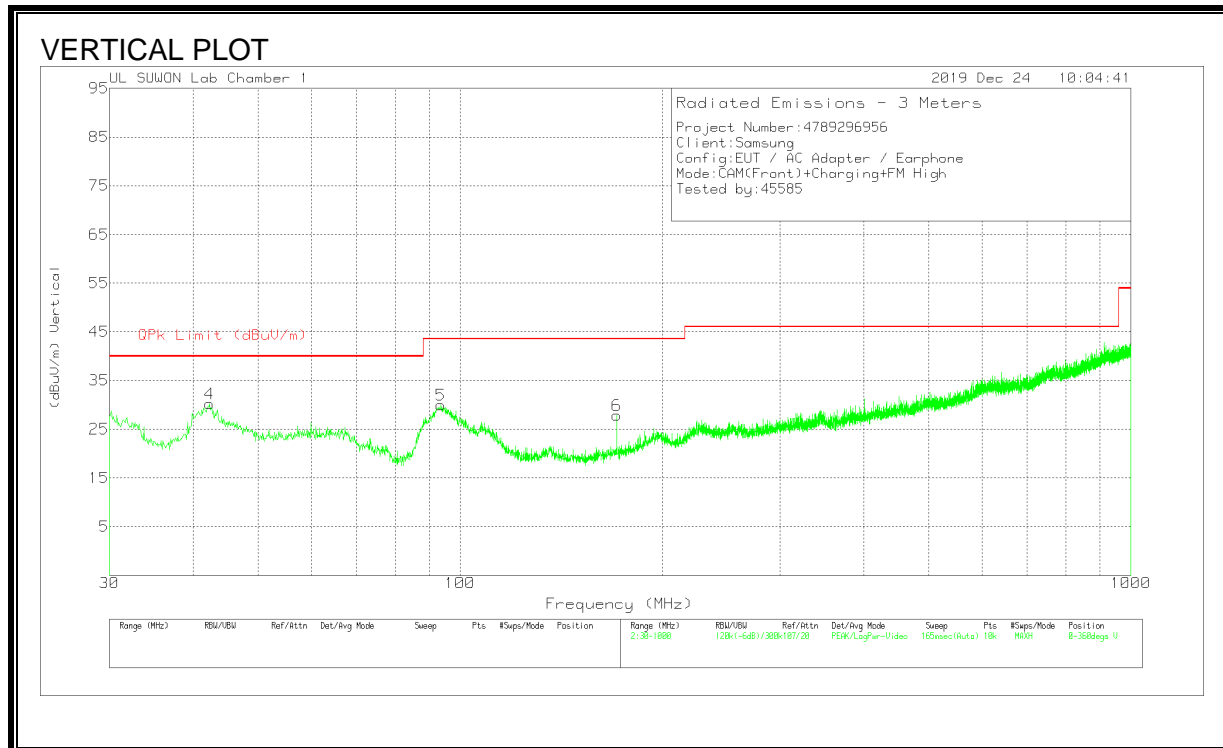
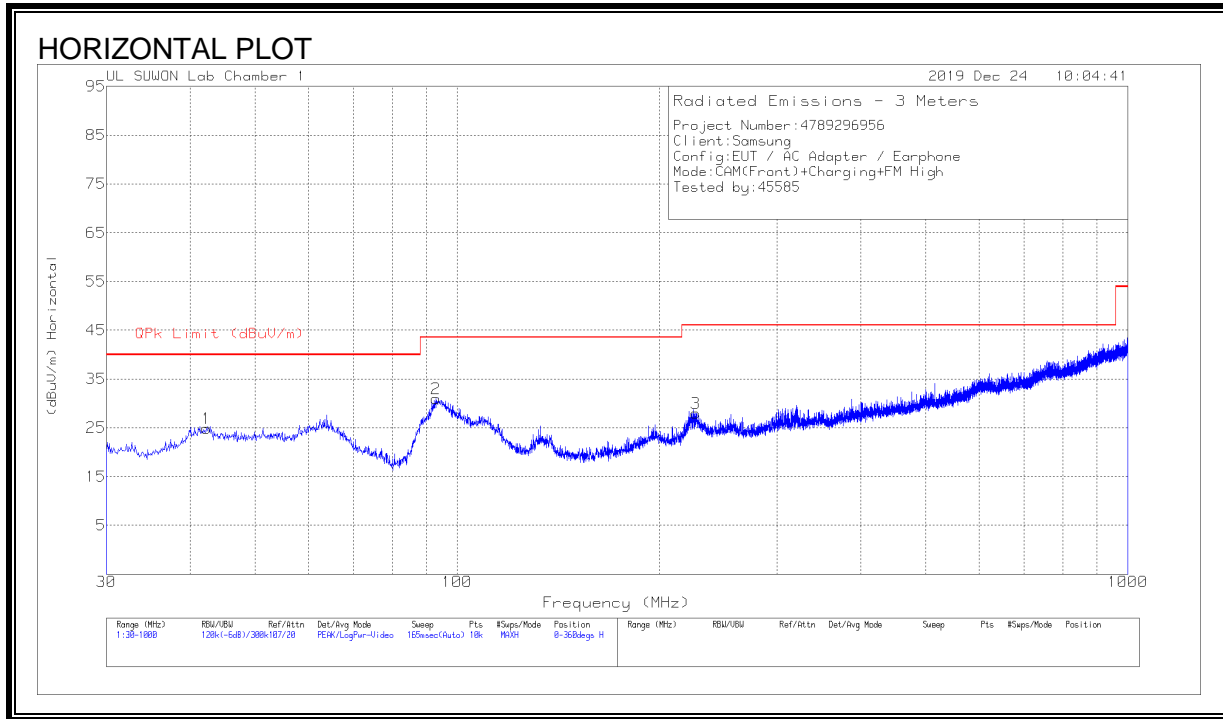

HORIZONTAL AND VERTICAL DATA

Trace Markers

Marker	Frequency (MHz)	Meter Reading (dBuV)	Det	VULB9163_750	Below_1G[dB]	Corrected Reading (dBuV/m)	QPk Limit (dBuV/m)	Margin (dB)	Azimuth (Degs)	Height (cm)	Polarity
1	42.319	35.38	Pk	19.2	-29.7	24.88	40	-15.12	0-360	400	H
2	92.953	42.95	Pk	16.8	-28.8	30.95	43.52	-12.57	0-360	300	H
3	226.813	37.33	Pk	18.1	-27.4	28.03	46.02	-17.99	0-360	100	H
4	42.319	40.78	Pk	19.2	-29.7	30.28	40	-9.72	0-360	100	V
5	93.632	41.75	Pk	17	-28.8	29.95	43.52	-13.57	0-360	100	V
6	171.232	40.94	Pk	14.8	-27.9	27.84	43.52	-15.68	0-360	100	V

Pk - Peak detector

Note: Only peak measurement was performed. Because peak measurement result of unwanted emission is less than average limit (54dBuV/m).

RADIATED EMISSIONS 1GHz to 18GHz

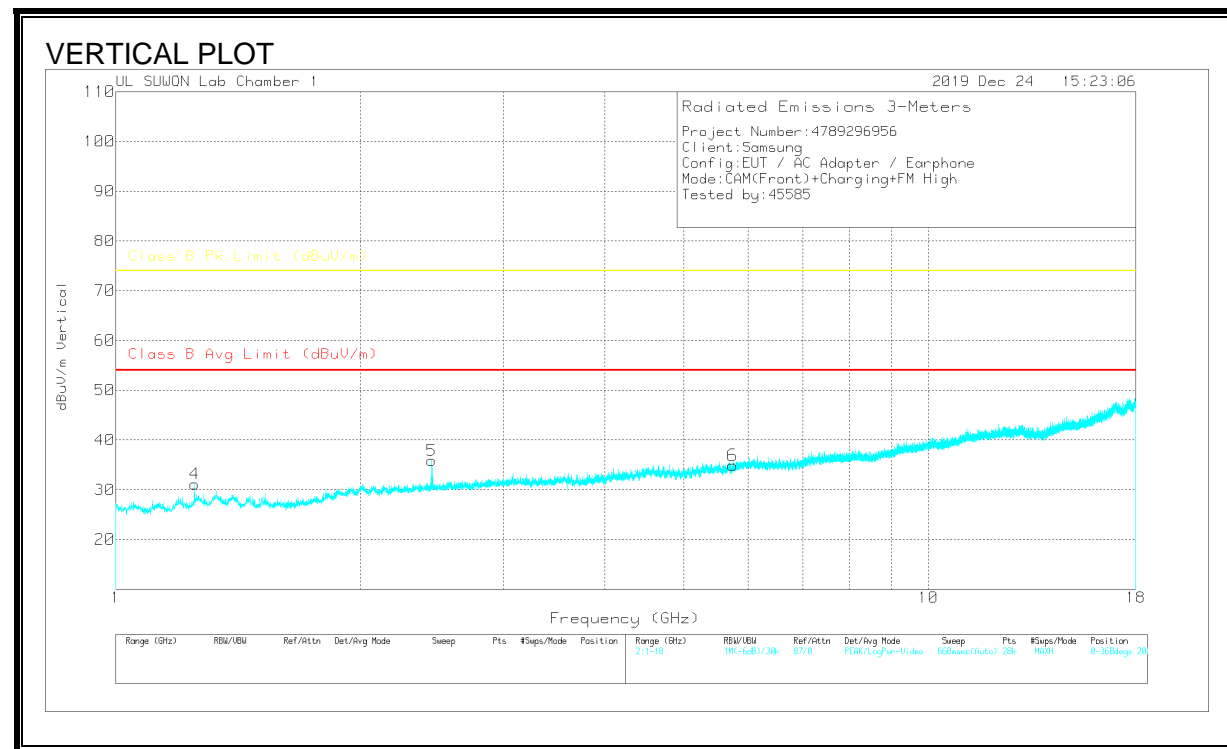
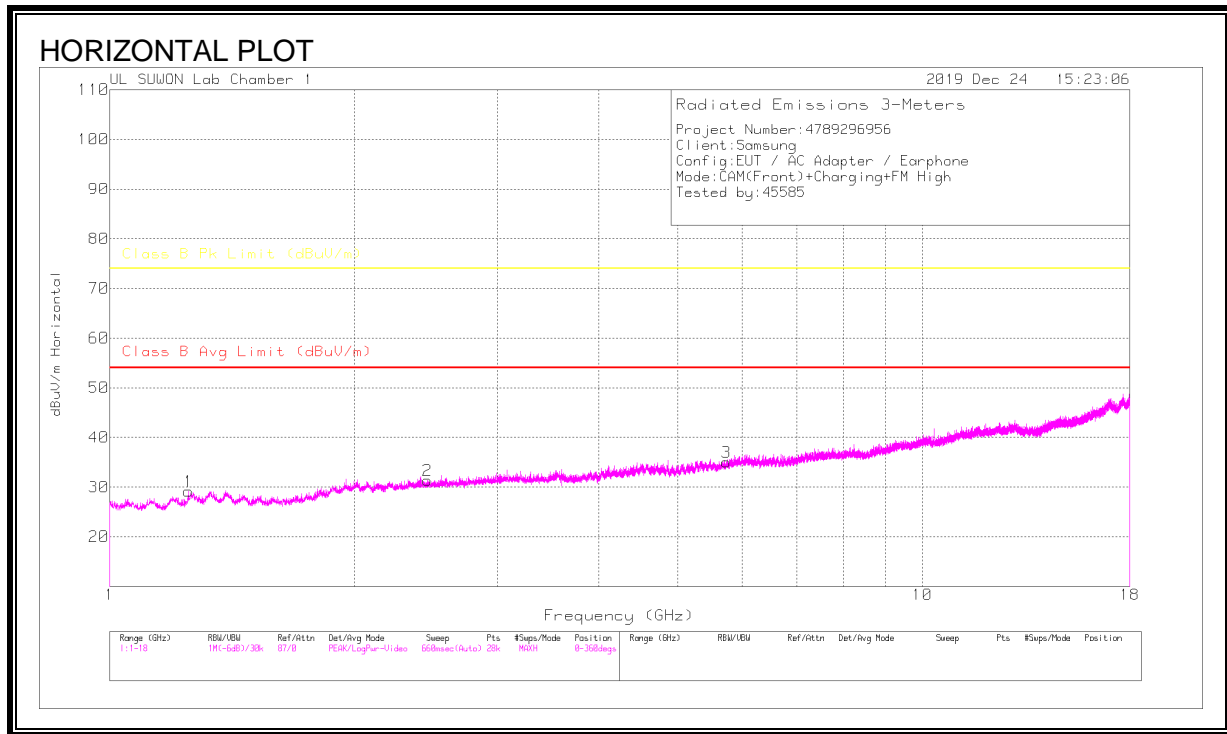

HORIZONTAL AND VERTICAL DATA

Trace Markers

Marker	Frequency (GHz)	Meter Reading (dBuV)	Det	3117_00168717	1-18GHz[dB]	Corrected Reading dBuV/m	Class B Avg Limit (dBuV/m)	Av(CISPR)Margin (dB)	Class B Pk Limit (dBuV/m)	Margin (dB)	Azimuth (Degs)	Height (cm)	Polarity
1	1.24951	37.27	PK	29.2	-37.3	29.17	-	-	74	-44.83	0-360	100	H
2	2.46124	34.34	PK	31.9	-34.9	31.34	-	-	74	-42.66	0-360	100	H
3	5.74128	31.23	PK	34.8	-31	35.03	-	-	74	-38.97	0-360	100	H
4	1.25012	39.29	PK	29.2	-37.3	31.19	-	-	74	-42.81	0-360	200	V
5	2.44606	39.28	PK	31.8	-35.2	35.88	-	-	74	-38.12	0-360	200	V
6	5.7431	31.14	PK	34.8	-31	34.94	-	-	74	-39.06	0-360	200	V

PK – Peak Detector

Radiated Emissions

Frequency (GHz)	Meter Reading (dBuV)	Det	3117_00168717	1-18GHz[dB]	Corrected Reading dBuV/m	Class B Avg Limit (dBuV/m)	Av(CISPR)Margin (dB)	Class B Pk Limit (dBuV/m)	Margin (dB)	Azimuth (Degs)	Height (cm)	Polarity
2.44606	42.49	Pk	31.8	-35.2	39.09	-	-	74	-34.91	14	114	V
2.44606	29.46	Ca	31.8	-35.2	26.06	54	-27.94	-	-	14	114	V

Pk - Peak detector

Ca - CISPR average detection

RADIATED EMISSIONS 18GHz to 30GHz

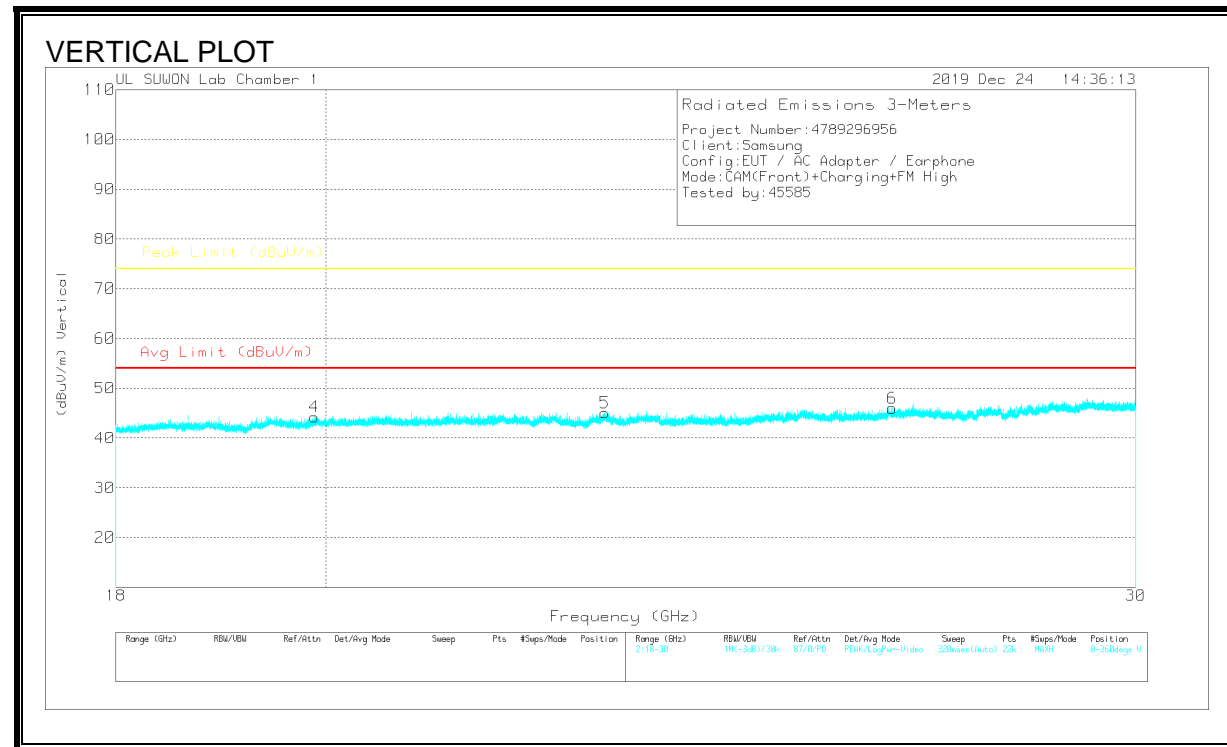
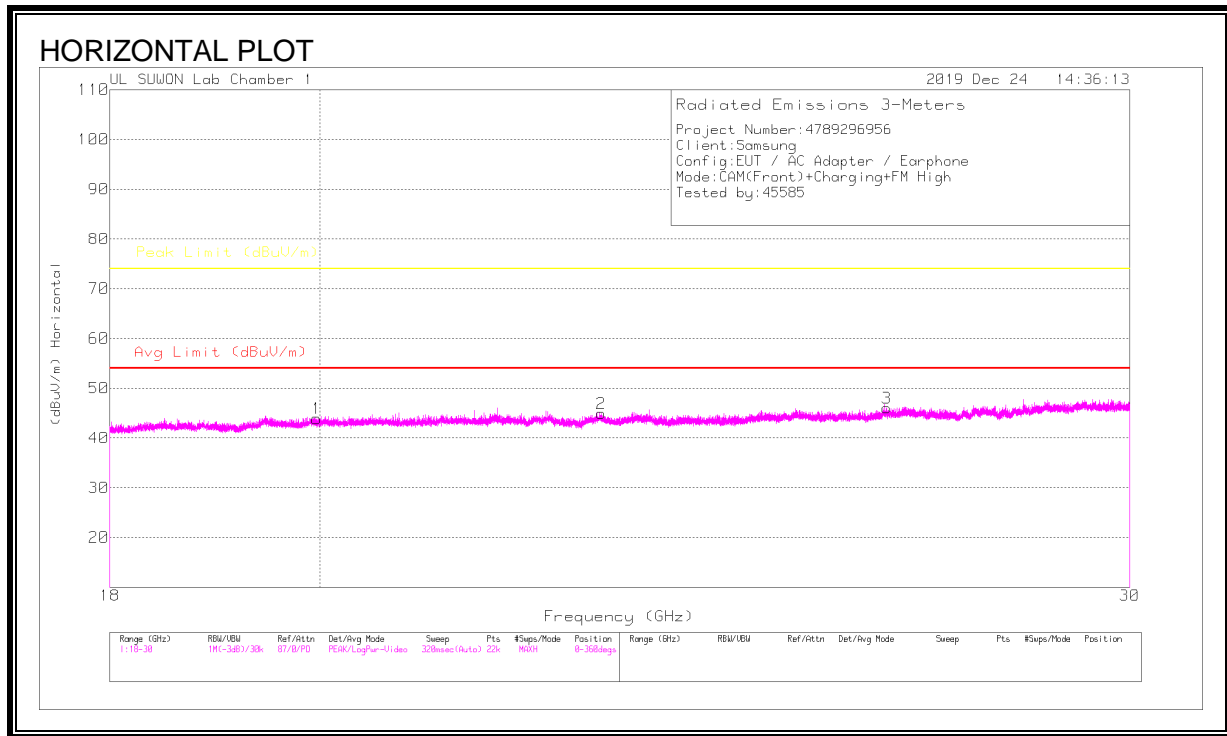

HORIZONTAL AND VERTICAL DATA

Trace Markers

Marker	Frequency (GHz)	Meter Reading (dBuV)	Det	3116C-PA	18-40GHz[dB]	Corrected Reading (dBuV/m)	Avg Limit (dBuV/m)	Margin (dB)	Peak Limit (dBuV/m)	Margin (dB)	Azimuth (Degs)	Height (cm)	Polarity
1	19.96409	21.81	PK	6.4	15.7	43.91	-	-	74	-30.09	0-360	100	H
2	23.0215	17.93	PK	10.1	16.9	44.93	-	-	74	-29.07	0-360	100	H
3	26.56271	19.74	PK	8	18.3	46.04	-	-	74	-27.96	0-360	100	H
4	19.88282	22.46	PK	6.2	15.6	44.26	-	-	74	-29.74	0-360	100	V
5	22.99341	18.09	PK	10.1	16.9	45.09	-	-	74	-28.91	0-360	100	V
6	26.55234	19.8	PK	7.9	18.3	46	-	-	74	-28	0-360	100	V

PK – Peak Detector

Note: Only peak measurement was performed. Because peak measurement result of unwanted emission is less than average limit (54dBuV/m).

RESULTS Test Case 4

RADIATED EMISSIONS 30 to 1000 MHz

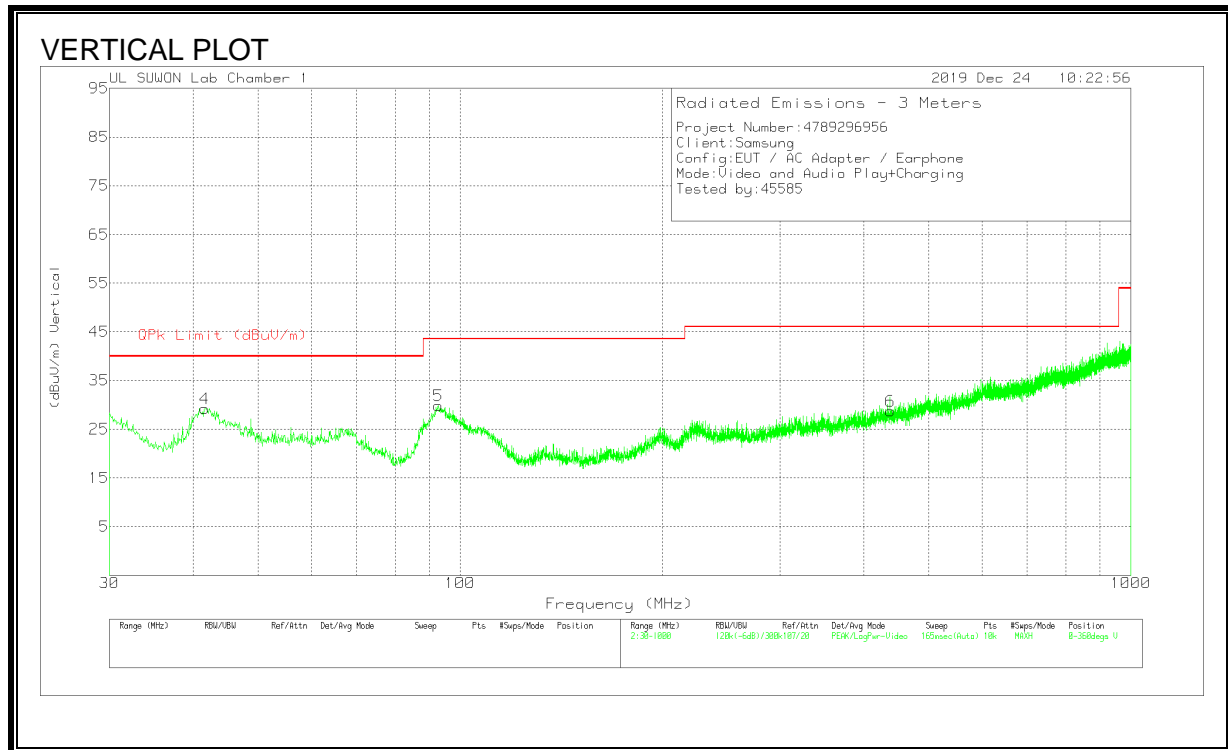
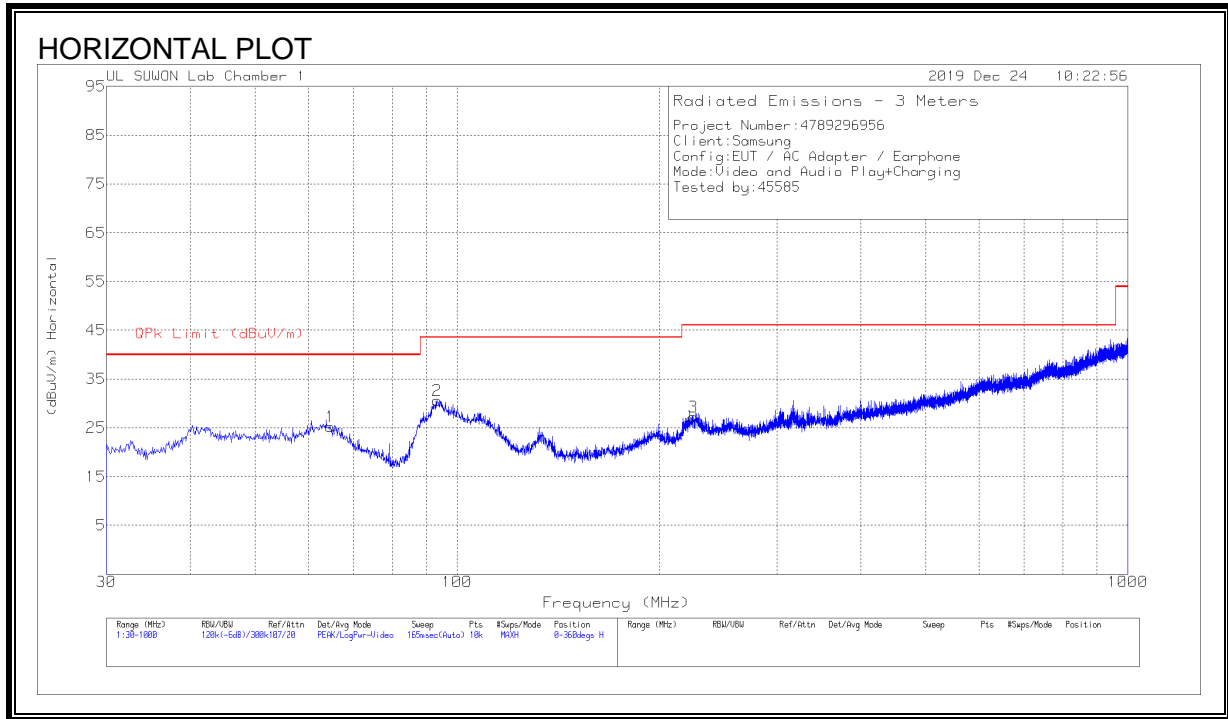

HORIZONTAL AND VERTICAL DATA

Trace Markers

Marker	Frequency (MHz)	Meter Reading (dBuV)	Det	VULB9163_750	Below_1G[dB]	Corrected Reading (dBuV/m)	QPk Limit (dBuV/m)	Margin (dB)	Azimuth (Degs)	Height (cm)	Polarity
1	64.726	37.29	Pk	17.4	-29.4	25.29	40	-14.71	0-360	400	H
2	93.341	42.47	Pk	16.9	-28.8	30.57	43.52	-12.95	0-360	300	H
3	224.97	36.78	Pk	17.9	-27.5	27.18	46.02	-18.84	0-360	100	H
4	41.64	39.81	Pk	19.1	-29.7	29.21	40	-10.79	0-360	100	V
5	92.759	41.99	Pk	16.7	-28.8	29.89	43.52	-13.63	0-360	100	V
6	438.467	32.66	Pk	22	-25.9	28.76	46.02	-17.26	0-360	100	V

Pk - Peak detector

Note: Only peak measurement was performed. Because peak measurement result of unwanted emission is less than average limit (54dBuV/m).

RADIATED EMISSIONS 1GHz to 18GHz

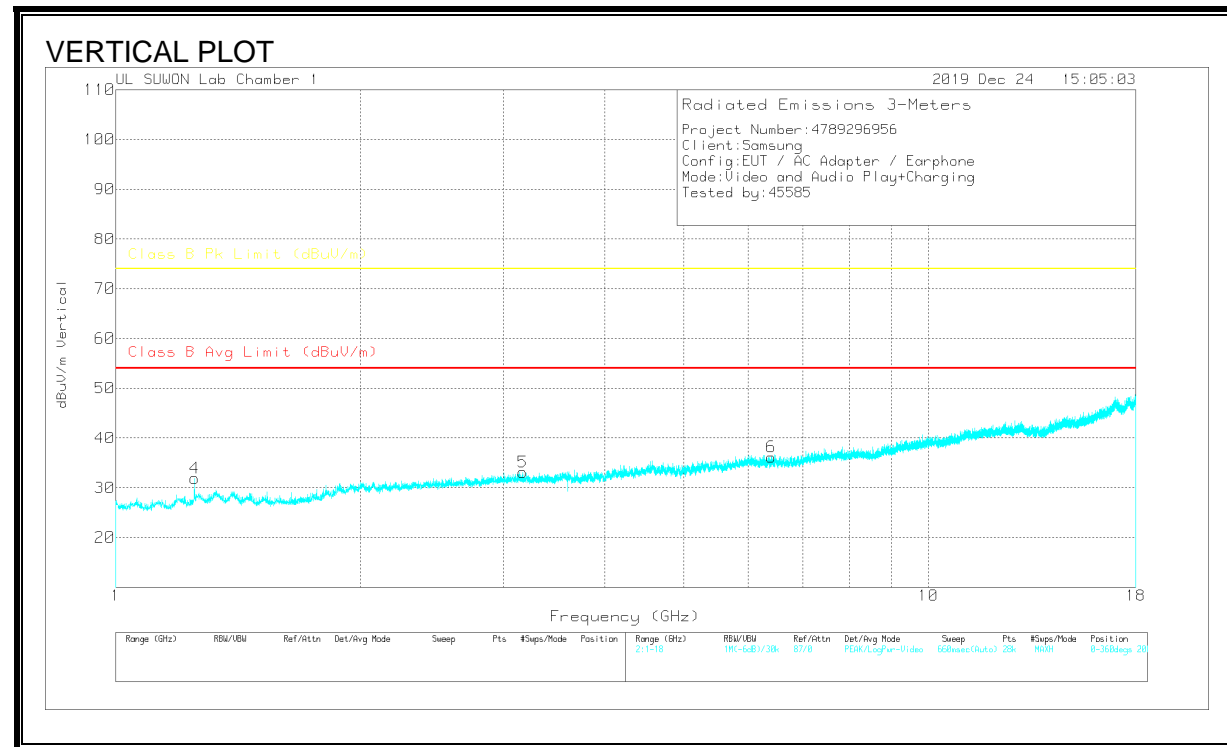
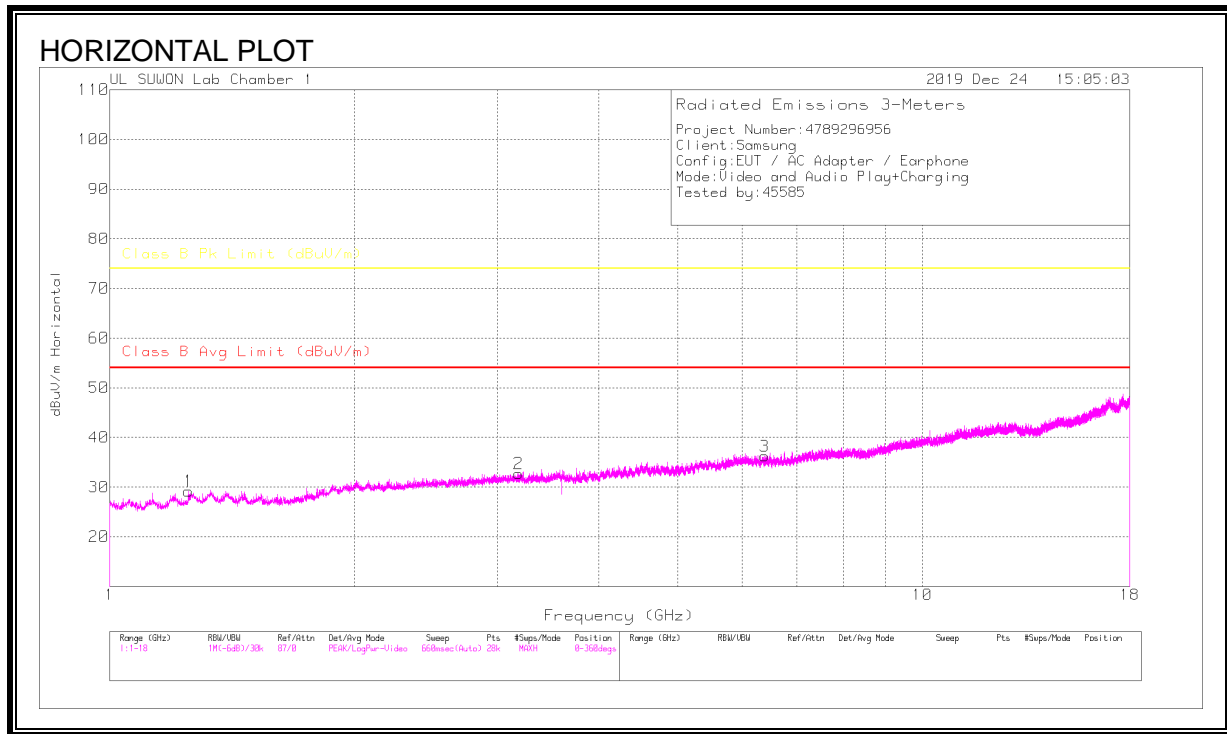

HORIZONTAL AND VERTICAL DATA

Trace Markers

Marker	Frequency (GHz)	Meter Reading (dBuV)	Det	3117_00168717	1-18GHz[dB]	Corrected Reading dBuV/m	Class B Avg Limit (dBuV/m)	Av(CISPR)Margin (dB)	Class B Pk Limit (dBuV/m)	Margin (dB)	Azimuth (Degs)	Height (cm)	Polarity
1	1.24951	37.31	PK	29.2	-37.3	29.21	-	-	74	-44.79	0-360	201	H
2	3.18366	33.95	PK	32.7	-33.9	32.75	-	-	74	-41.25	0-360	201	H
3	6.39632	30.74	PK	35.3	-29.8	36.24	-	-	74	-37.76	0-360	100	H
4	1.25012	40.03	PK	29.2	-37.3	31.93	-	-	74	-42.07	0-360	200	V
5	3.16666	34.35	PK	32.7	-33.9	33.15	-	-	74	-40.85	0-360	200	V
6	6.40603	30.8	PK	35.3	-29.9	36.2	-	-	74	-37.8	0-360	100	V

PK – Peak Detector

Note: Only peak measurement was performed. Because peak measurement result of unwanted emission is less than average limit (54dBuV/m).

RADIATED EMISSIONS 18GHz to 30GHz

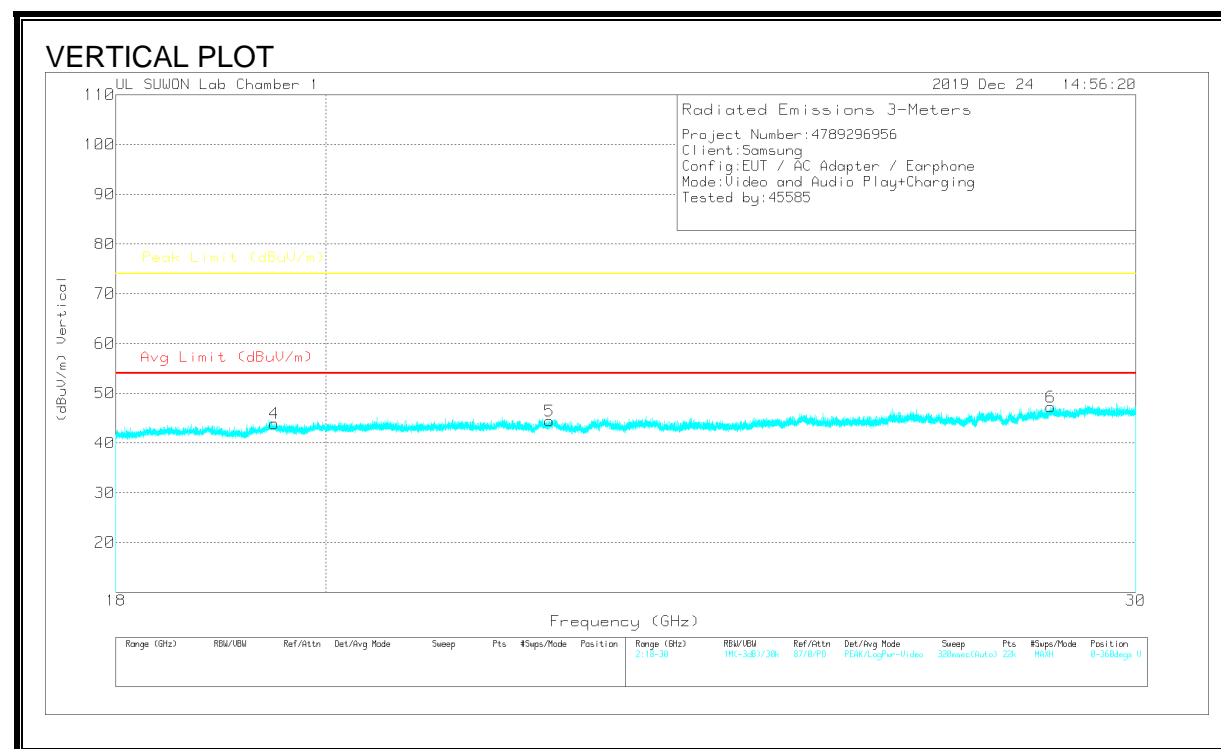
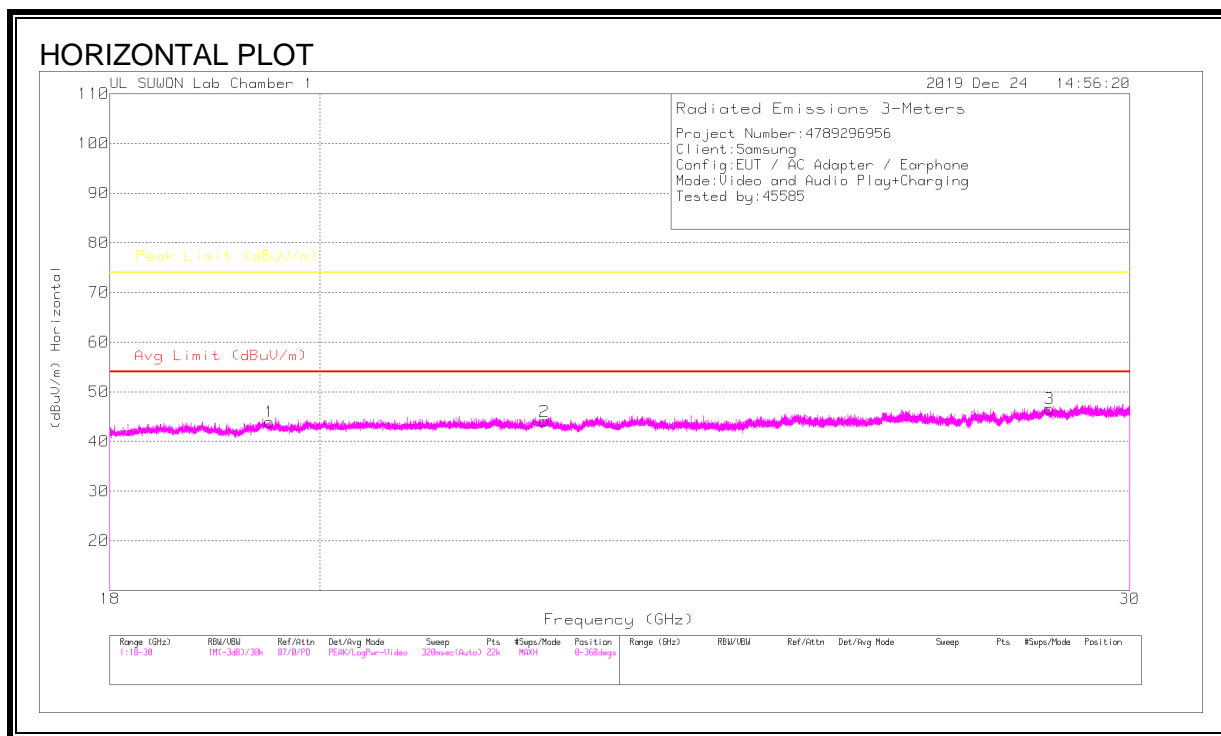

HORIZONTAL AND VERTICAL DATA

Trace Markers

Marker	Frequency (GHz)	Meter Reading (dBuV)	Det	3116C-PA	18-40GHz[dB]	Corrected Reading (dBuV/m)	Avg Limit (dBuV/m)	Margin (dB)	Peak Limit (dBuV/m)	Margin (dB)	Azimuth (Degs)	Height (cm)	Polarity
1	19.49666	23.13	PK	5.3	15.5	43.93	-	-	74	-30.07	0-360	100	H
2	22.37653	17.29	PK	10.2	16.6	44.09	-	-	74	-29.91	0-360	100	H
3	28.81915	15.22	PK	12.2	19.2	46.62	-	-	74	-27.38	0-360	100	H
4	19.48466	23.11	PK	5.3	15.5	43.91	-	-	74	-30.09	0-360	100	V
5	22.36671	17.63	PK	10.2	16.6	44.43	-	-	74	-29.57	0-360	100	V
6	28.74552	15.96	PK	12.1	19.2	47.26	-	-	74	-26.74	0-360	100	V

PK – Peak Detector

Note: Only peak measurement was performed. Because peak measurement result of unwanted emission is less than average limit (54dBuV/m).

RESULTS Test Case 5

RADIATED EMISSIONS 30 to 1000 MHz

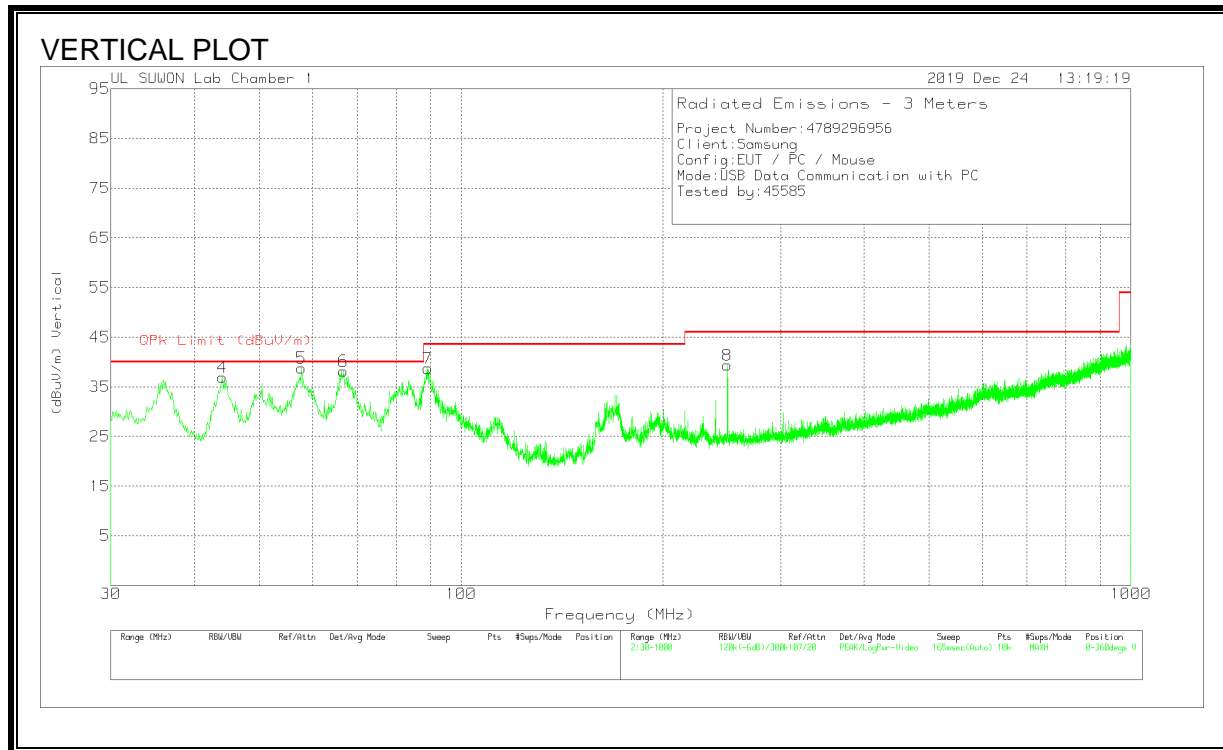
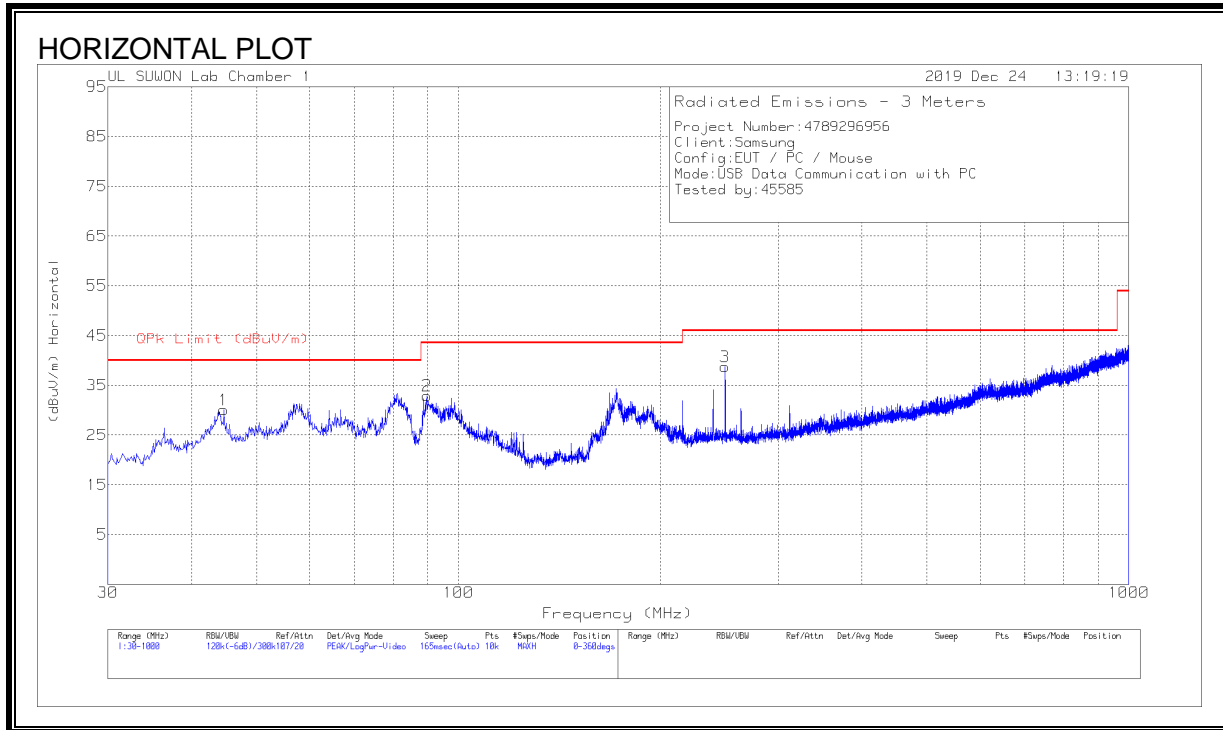

HORIZONTAL AND VERTICAL DATA

Trace Markers

Marker	Frequency (MHz)	Meter Reading (dBuV)	Det	VULB9163_750	Below_1G[dB]	Corrected Reading (dBuV/m)	QPk Limit (dBuV/m)	Margin (dB)	Azimuth (Degs)	Height (cm)	Polarity
1	44.647	40.06	Pk	19.6	-29.6	30.06	40	-9.94	0-360	400	H
2	89.752	46.09	Pk	15.6	-28.8	32.89	43.52	-10.63	0-360	200	H
3	249.996	46.94	Pk	19.1	-27.3	38.74	46.02	-7.28	0-360	100	H
4	44.065	47.01	Pk	19.6	-29.7	36.91	40	-3.09	0-360	100	V
5	57.742	49.16	Pk	18.9	-29.3	38.76	40	-1.24	0-360	100	V
6	66.763	50.87	Pk	16.7	-29.4	38.17	40	-1.83	0-360	100	V
7	89.17	52.11	Pk	15.4	-28.8	38.71	43.52	-4.81	0-360	100	V
8	249.996	47.55	Pk	19.1	-27.3	39.35	46.02	-6.67	0-360	100	V

Pk - Peak detector

Radiated Emissions

Frequency (MHz)	Meter Reading (dBuV)	Det	VULB9163_750	Below_1G[dB]	Corrected Reading (dBuV/m)	QPk Limit (dBuV/m)	Margin (dB)	Azimuth (Degs)	Height (cm)	Polarity
44.281	42.92	Qp	19.6	-29.8	32.72	40	-7.28	195	100	V
58.0926	42.31	Qp	18.9	-29.3	31.91	40	-8.09	246	181	V
66.8011	45.91	Qp	16.7	-29.4	33.21	40	-6.79	231	102	V

Qp - Quasi-Peak detector

RADIATED EMISSIONS 1GHz to 18GHz

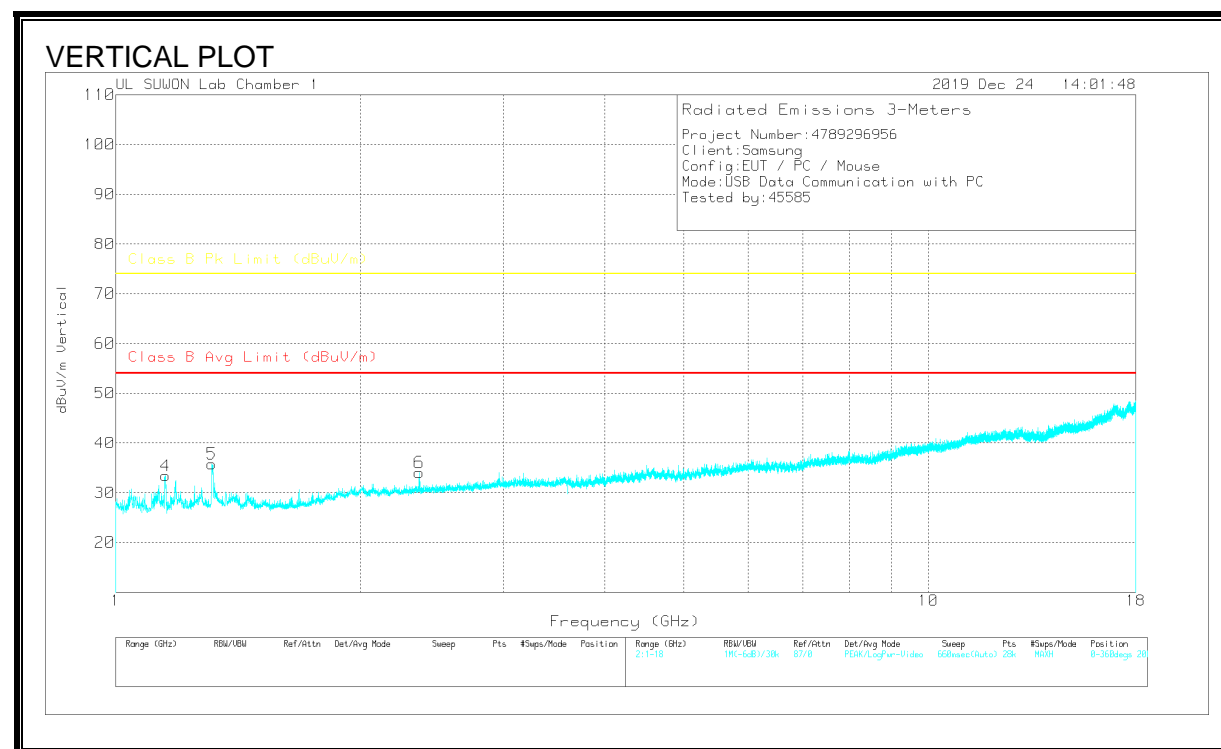
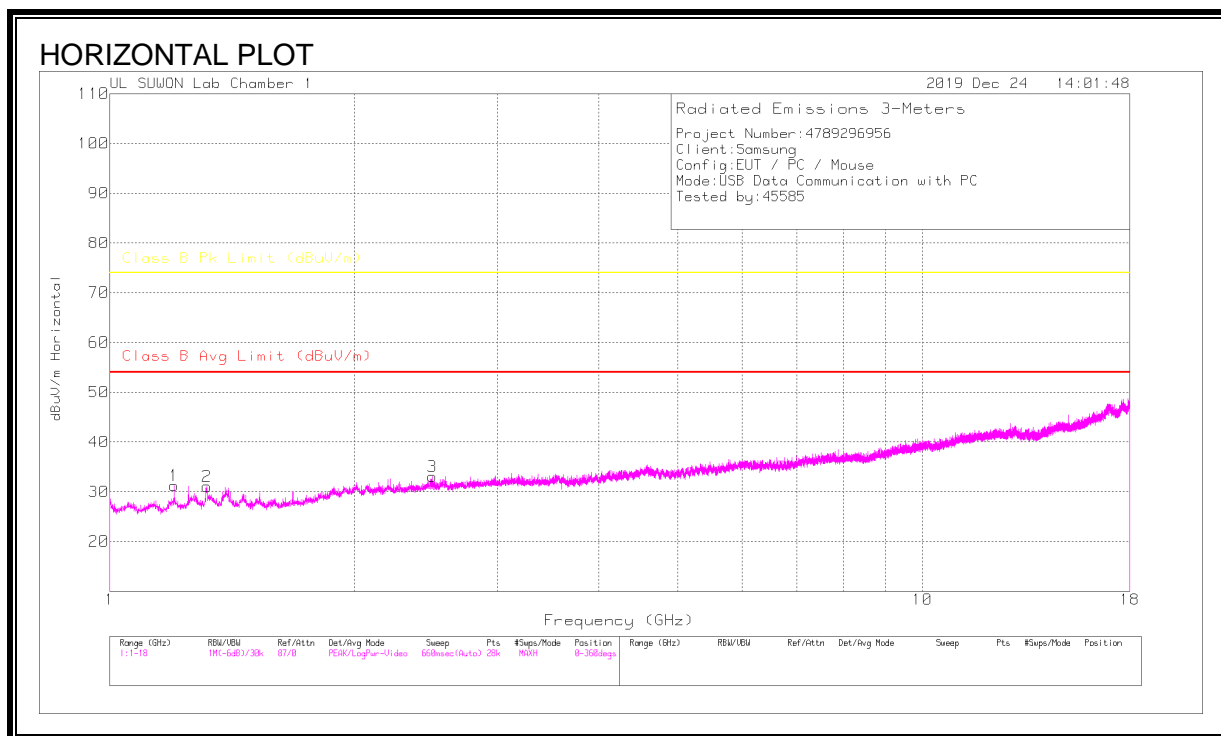

HORIZONTAL AND VERTICAL DATA

Trace Markers

Marker	Frequency (GHz)	Meter Reading (dBuV)	Det	3117_00168717	1-18GHz(dB)	Corrected Reading dBuV/m	Class B Avg Limit (dBuV/m)	Av(CISPR)Margin (dB)	Class B Pk Limit (dBuV/m)	Margin (dB)	Azimuth (Degs)	Height (cm)	Polarity
1	1.19973	40.06	PK	28.6	-37.4	31.26	-	-	74	-42.74	0-360	200	H
2	1.3175	38.79	PK	29.5	-37.2	31.09	-	-	74	-42.91	0-360	100	H
3	2.49463	36.06	PK	31.9	-34.9	33.06	-	-	74	-40.94	0-360	100	H
4	1.15116	42.73	PK	28.2	-37.5	33.43	-	-	74	-40.57	0-360	100	V
5	1.31265	43.42	PK	29.5	-37.1	35.82	-	-	74	-38.18	0-360	200	V
6	2.36228	37.8	PK	31.6	-35.3	34.1	-	-	74	-39.9	0-360	100	V

PK – Peak Detector

Radiated Emissions

Frequency (GHz)	Meter Reading (dBuV)	Det	3117_00168717	1-18GHz(dB)	Corrected Reading dBuV/m	Class B Avg Limit (dBuV/m)	Av(CISPR)Margin (dB)	Class B Pk Limit (dBuV/m)	Margin (dB)	Azimuth (Degs)	Height (cm)	Polarity
1.31265	33.58	Ca	29.5	-37.1	25.98	54	-28.02	-	-	200	208	V
1.31265	55.14	Pk	29.5	-37.1	47.54	-	-	74	-26.46	200	208	V

Pk - Peak detector

Ca - CISPR average detection

RADIATED EMISSIONS 18GHz to 30GHz

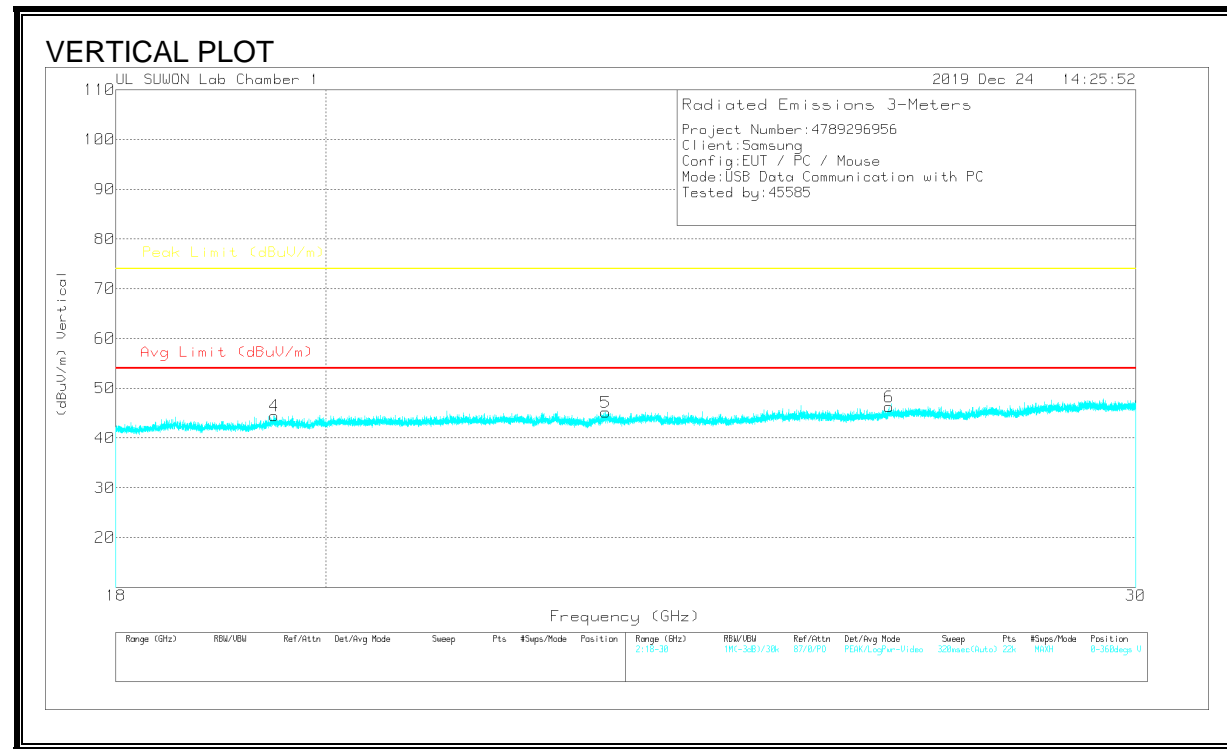
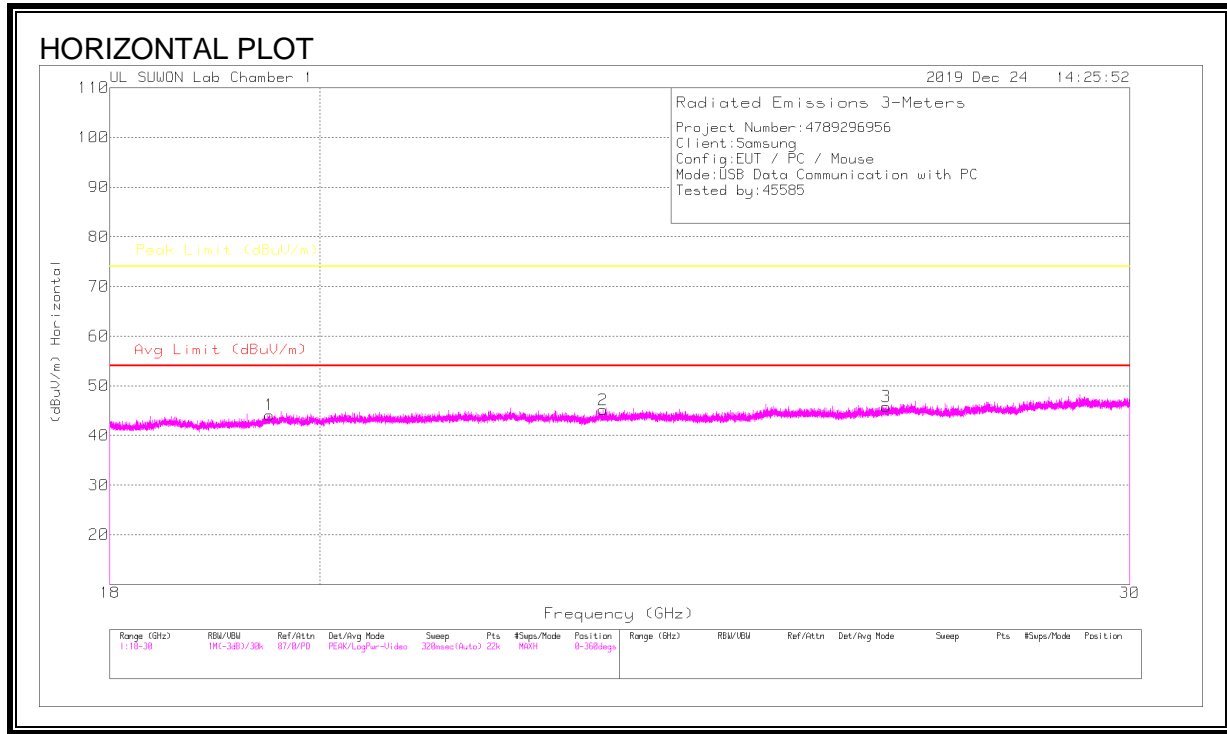

HORIZONTAL AND VERTICAL DATA

Trace Markers

Marker	Frequency (GHz)	Meter Reading (dBuV)	Det	3116C-PA	18-40GHz[dB]	Corrected Reading (dBuV/m)	Avg Limit (dBuV/m)	Margin (dB)	Peak Limit (dBuV/m)	Margin (dB)	Azimuth (Degs)	Height (cm)	Polarity
1	19.49884	23.34	PK	5.3	15.5	44.14	-	-	74	-29.86	0-360	100	H
2	23.04468	18.29	PK	10.1	16.8	45.19	-	-	74	-28.81	0-360	100	H
3	26.55452	19.53	PK	8	18.3	45.83	-	-	74	-28.17	0-360	100	H
4	19.48793	23.67	PK	5.3	15.5	44.47	-	-	74	-29.53	0-360	100	V
5	23.00432	18.18	PK	10.1	16.9	45.18	-	-	74	-28.82	0-360	100	V
6	26.51307	20.08	PK	7.9	18.3	46.28	-	-	74	-27.72	0-360	100	V

PK – Peak Detector

Note: Only peak measurement was performed. Because peak measurement result of unwanted emission is less than average limit (54dBuV/m).

6.2. CONDUCTED EMISSIONS

TEST PROCEDURE

ANSI C63.4: 2014

LIMIT

§15.107 (a) and ICES-003 Except for Class A digital devices, for equipment that is designed to be connected to the public utility (AC) power line, the radio frequency voltage that is conducted back onto the AC power line on any frequency or frequencies within the band 150 kHz to 30 MHz shall not exceed the limits in the following table, as measured using a 50 μ H/50 ohms line impedance stabilization network (LISN). Compliance with the provisions of this paragraph shall be based on the measurement of the radio frequency voltage between each power line and ground at the power terminal. The lower limit applies at the band edges.

Frequency range (MHz)	Limits (dB μ V)	
	Quasi-peak	Average
0.15 to 0.50	66 to 56	56 to 46
0.50 to 5	56	46
5 to 30	60	50

Notes:
 1. The lower limit shall apply at the transition frequencies
 2. The limit decreases linearly with the logarithm of the frequency in the range 0.15 MHz to 0.50 MHz.

RESULTS

6 WORST EMISSIONS Test Case 1

Line-L1 .15 - 30MHz

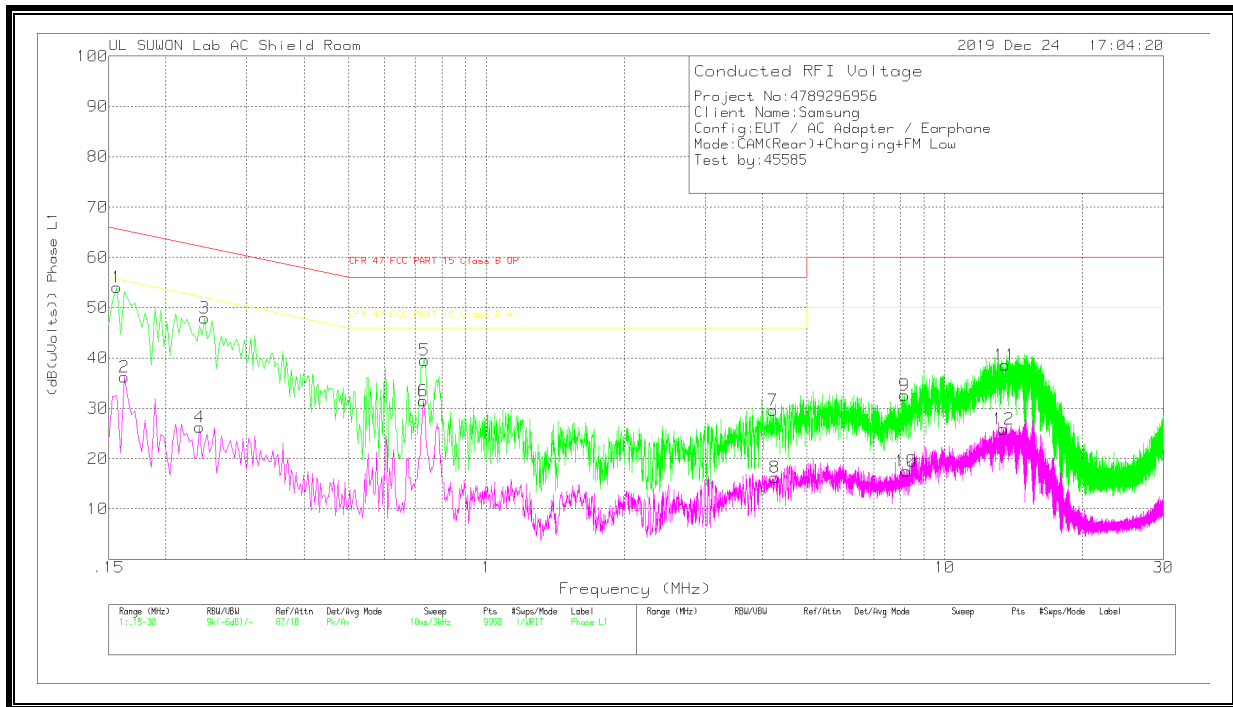

LINE 1 RESULTS

Trace Markers

Range 1: Phase L1 .15 - 30MHz

Marker	Frequency (MHz)	Meter Reading (dBuV)	Det	101836_With Ex_L1[dB]	CABLELOSS (dB)	Corrected Reading (dB(uVolts))	CFR 47 FCC PART 15 Class B QP	Margin (dB)	CFR 47 FCC PART 15 Class B AV	Margin (dB)
1	.156	44.03	Pk	9.9	.1	54.03	65.67	-11.64	-	-
2	.162	26.16	Av	10	.1	36.26	-	-	55.36	-19.1
3	.243	38.08	Pk	9.7	.2	47.98	61.99	-14.01	-	-
4	.237	16.36	Av	9.7	.2	26.26	-	-	52.2	-25.94
5	.732	29.43	Pk	9.9	.2	39.53	56	-16.47	-	-
6	.729	21.37	Av	9.9	.2	31.47	-	-	46	-14.53
7	4.218	19.51	Pk	9.8	.3	29.61	56	-26.39	-	-
8	4.257	6.18	Av	9.8	.3	16.28	-	-	46	-29.72
9	8.175	22.36	Pk	9.9	.3	32.56	60	-27.44	-	-
10	8.238	7.38	Av	9.9	.3	17.58	-	-	50	-32.42
11	13.536	28.06	Pk	10.1	.4	38.56	60	-21.44	-	-
12	13.455	15.32	Av	10.1	.4	25.82	-	-	50	-24.18

Pk - Peak detector

Av - Average detection

Line-L2 .15 - 30MHz

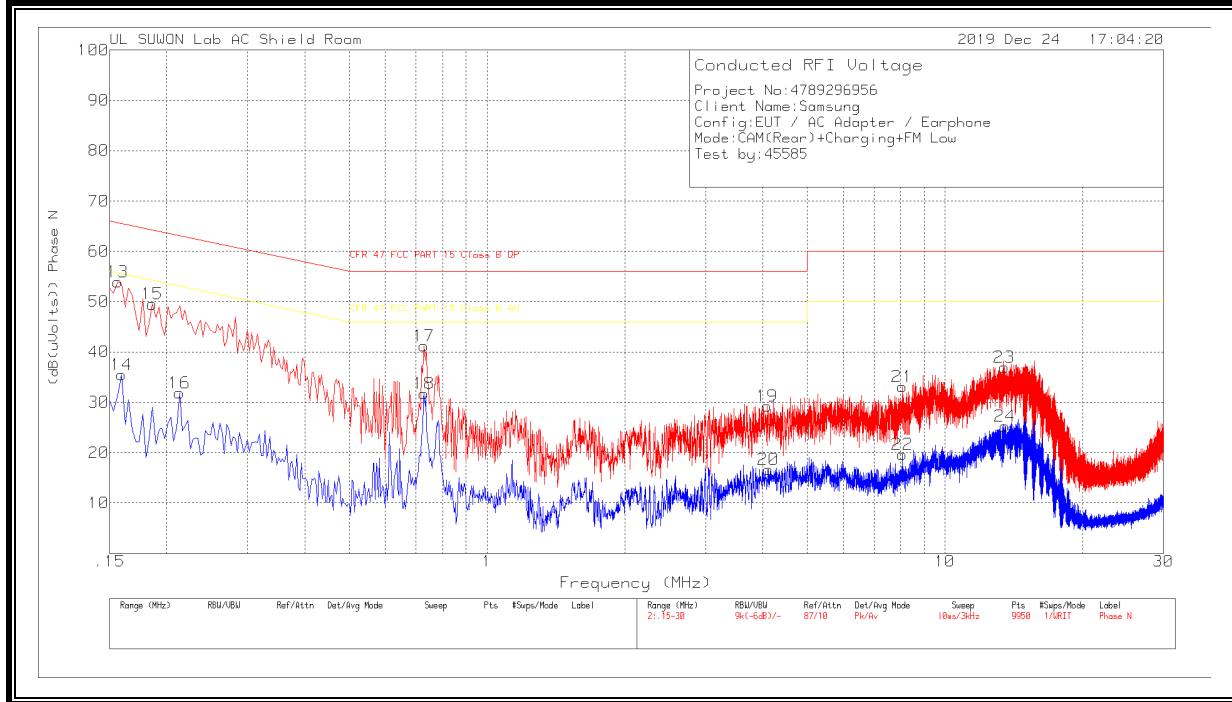

LINE 2 RESULTS

Trace Markers

Range 2: Phase N .15 - 30MHz

Marker	Frequency (MHz)	Meter Reading (dBuV)	Det	101836_With EX_N[dB]	CABLELOSS (dB)	Corrected Reading (dB(uVolts))	CFR 47 FCC PART 15 Class B QP	Margin (dB)	CFR 47 FCC PART 15 Class B AV	Margin (dB)
13	.156	43.96	Pk	9.9	.1	53.96	65.67	-11.71	-	-
14	.159	25.48	Av	9.9	.1	35.48	-	-	55.52	-20.04
15	.186	39.3	Pk	10	.2	49.5	64.21	-14.71	-	-
16	.213	21.71	Av	9.9	.2	31.81	-	-	53.09	-21.28
17	.729	31.08	Pk	9.9	.2	41.18	56	-14.82	-	-
18	.729	21.68	Av	9.9	.2	31.78	-	-	46	-14.22
19	4.089	19.13	Pk	9.8	.3	29.23	56	-26.77	-	-
20	4.116	6.57	Av	9.8	.3	16.67	-	-	46	-29.33
21	8.07	22.92	Pk	9.9	.3	33.12	60	-26.88	-	-
22	8.07	9.45	Av	9.9	.3	19.65	-	-	50	-30.35
23	13.497	26.47	Pk	10.1	.4	36.97	60	-23.03	-	-
24	13.512	14.73	Av	10.1	.4	25.23	-	-	50	-24.77

Pk - Peak detector

Av - Average detection

6 WORST EMISSIONS Test Case 2

Line-L1 .15 - 30MHz

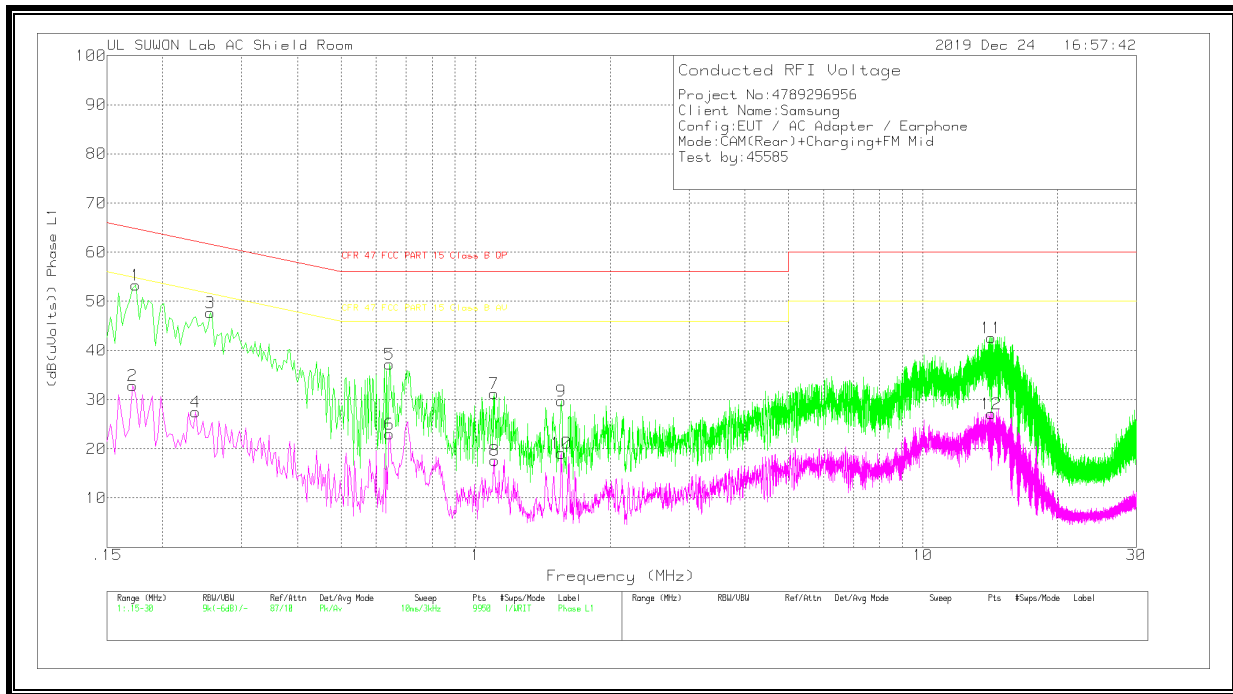

LINE 1 RESULTS

Trace Markers

Range 1: Phase L1 .15 - 30MHz

Marker	Frequency (MHz)	Meter Reading (dBuV)	Det	101836_Wit h Ex_L1[dB]	CABLELOS S(dB)	Corrected Reading (dB(uVolts))	CFR 47 FCC PART 15 Class B QP	Margin (dB)	CFR 47 FCC PART 15 Class B AV	Margin (dB)
1	.174	43	Pk	10.1	.2	53.3	64.77	-11.47	-	-
2	.171	22.6	Av	10.1	.2	32.9	-	-	54.91	-22.01
3	.255	37.79	Pk	9.7	.2	47.69	61.59	-13.9	-	-
4	.237	17.61	Av	9.7	.2	27.51	-	-	52.2	-24.69
5	.642	27.15	Pk	9.9	.2	37.25	56	-18.75	-	-
6	.642	12.94	Av	9.9	.2	23.04	-	-	46	-22.96
7	1.101	21.11	Pk	9.8	.3	31.21	56	-24.79	-	-
8	1.104	7.55	Av	9.8	.3	17.65	-	-	46	-28.35
9	1.554	19.62	Pk	9.8	.3	29.72	56	-26.28	-	-
10	1.554	8.99	Av	9.8	.3	19.09	-	-	46	-26.91
11	14.223	32.1	Pk	10.1	.4	42.6	60	-17.4	-	-
12	14.232	16.58	Av	10.1	.4	27.08	-	-	50	-22.92

Pk - Peak detector

Av - Average detection

Line-L2 .15 - 30MHz

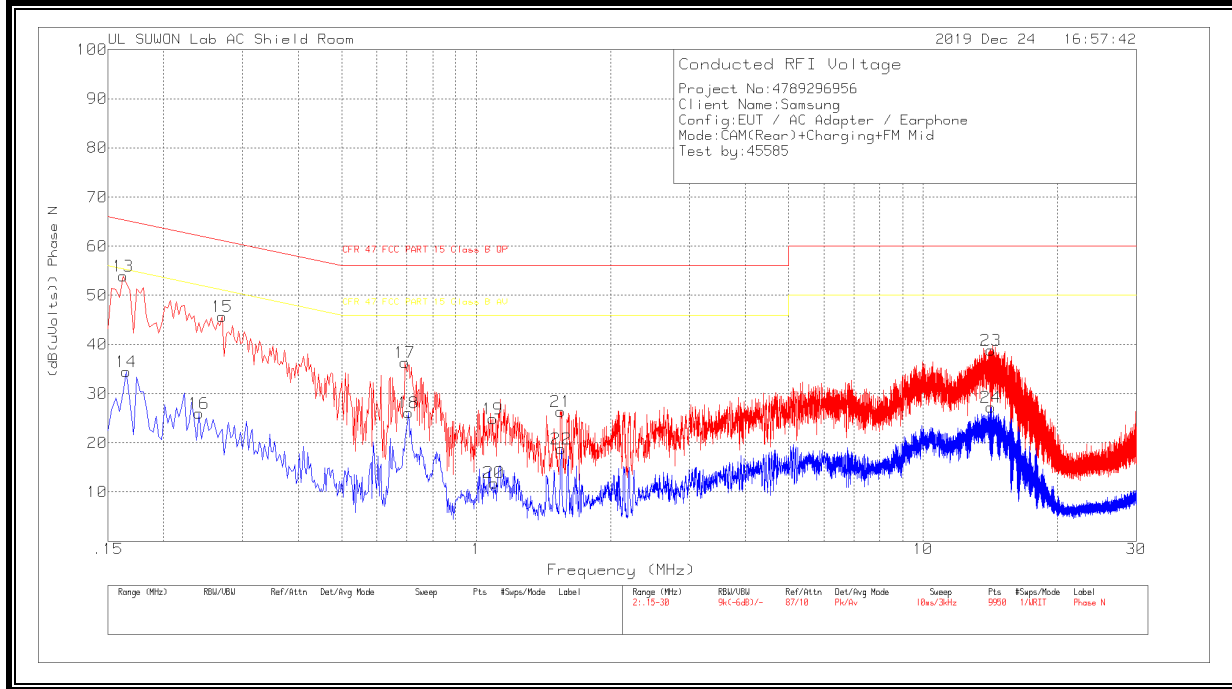

LINE 2 RESULTS

Trace Markers

Range 2: Phase N .15 - 30MHz

Marker	Frequency (MHz)	Meter Reading (dBuV)	Det	101836_Wit h EX_N[dB]	CABLELOS S(dB)	Corrected Reading (dB(uVolts))	CFR 47 FCC PART 15 Class B QP	Margin (dB)	CFR 47 FCC PART 15 Class B AV	Margin (dB)
13	.162	43.82	Pk	10	.1	53.92	65.36	-11.44	-	-
14	.165	24.41	Av	10	.1	34.51	-	-	55.21	-20.7
15	.27	35.8	Pk	9.7	.2	45.7	61.12	-15.42	-	-
16	.24	16.05	Av	9.7	.2	25.95	-	-	52.1	-26.15
17	.693	26.29	Pk	9.9	.2	36.39	56	-19.61	-	-
18	.705	16.08	Av	9.9	.2	26.18	-	-	46	-19.82
19	1.089	14.76	Pk	9.8	.3	24.86	56	-31.14	-	-
20	1.095	1.76	Av	9.8	.3	11.86	-	-	46	-34.14
21	1.545	16.25	Pk	9.8	.3	26.35	56	-29.65	-	-
22	1.551	8.68	Av	9.8	.3	18.78	-	-	46	-27.22
23	14.172	28.37	Pk	10.1	.4	38.87	60	-21.13	-	-
24	14.175	16.77	Av	10.1	.4	27.27	-	-	50	-22.73

Pk - Peak detector

Av - Average detection

6 WORST EMISSIONS Test Case 3

Line-L1 .15 - 30MHz

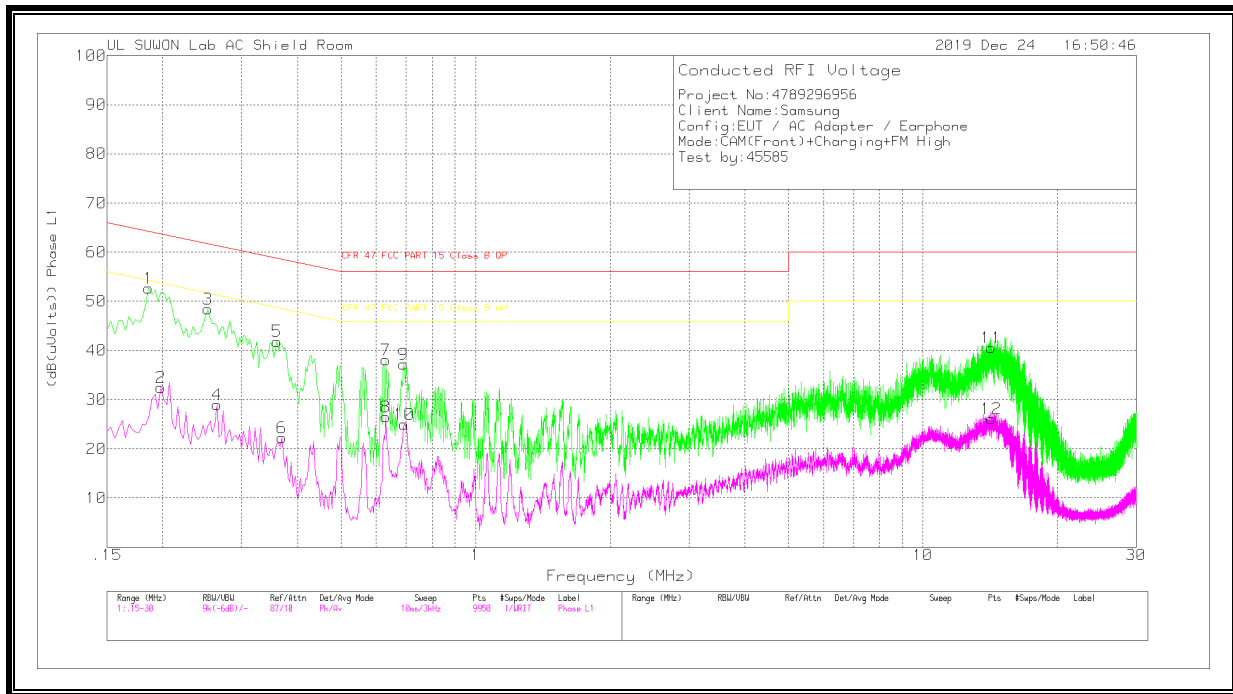

LINE 1 RESULTS

Trace Markers

Range 1: Phase L1 .15 - 30MHz

Marker	Frequency (MHz)	Meter Reading (dBuV)	Det	101836_Wit h Ex_L1[dB]	CABLELOS S(dB)	Corrected Reading (dB(uVolts))	CFR 47 FCC PART 15 Class B QP	Margin (dB)	CFR 47 FCC PART 15 Class B AV	Margin (dB)
1	.186	42.5	Pk	10	.2	52.7	64.21	-11.51	-	-
2	.198	22.44	Av	9.9	.2	32.54	-	-	53.69	-21.15
3	.252	38.51	Pk	9.7	.2	48.41	61.69	-13.28	-	-
4	.264	19.06	Av	9.7	.2	28.96	-	-	51.3	-22.34
5	.36	31.79	Pk	9.9	.2	41.89	58.73	-16.84	-	-
6	.369	12.17	Av	9.9	.2	22.27	-	-	48.52	-26.25
7	.63	27.99	Pk	9.9	.2	38.09	56	-17.91	-	-
8	.63	16.36	Av	9.9	.2	26.46	-	-	46	-19.54
9	.69	27.16	Pk	9.9	.2	37.26	56	-18.74	-	-
10	.693	14.93	Av	9.9	.2	25.03	-	-	46	-20.97
11	14.235	30.07	Pk	10.1	.4	40.57	60	-19.43	-	-
12	14.229	15.64	Av	10.1	.4	26.14	-	-	50	-23.86

Pk - Peak detector

Av - Average detection

Line-L2 .15 - 30MHz

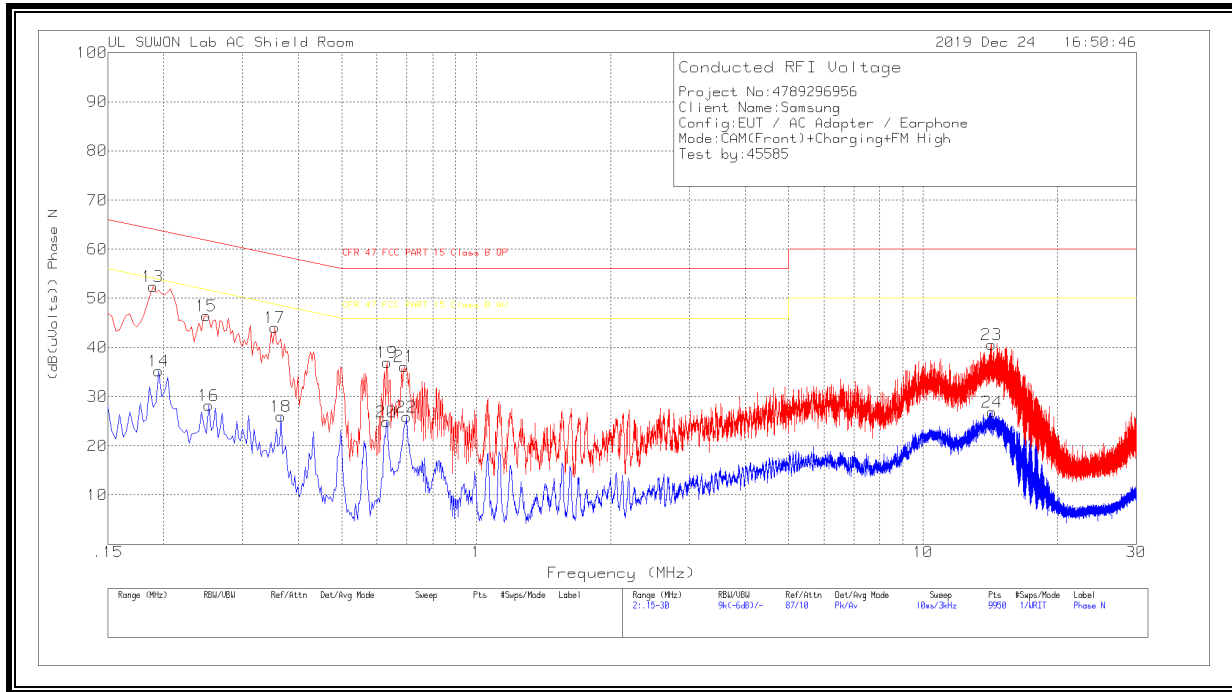

LINE 2 RESULTS

Trace Markers

Range 2: Phase N .15 - 30MHz

Marker	Frequency (MHz)	Meter Reading (dBuV)	Det	101836_With EX_N[dB]	CABLELOSS (dB)	Corrected Reading (dB(uVolts))	CFR 47 FCC PART 15 Class B QP	Margin (dB)	CFR 47 FCC PART 15 Class B AV	Margin (dB)
13	.189	42.21	Pk	10	.2	52.41	64.08	-11.67	-	-
14	.195	25.12	Av	9.9	.2	35.22	-	-	53.82	-18.6
15	.249	36.51	Pk	9.7	.2	46.41	61.79	-15.38	-	-
16	.252	18.3	Av	9.7	.2	28.2	-	-	51.69	-23.49
17	.354	33.96	Pk	9.9	.2	44.06	58.87	-14.81	-	-
18	.366	15.89	Av	9.9	.2	25.99	-	-	48.59	-22.6
19	.633	26.83	Pk	9.9	.2	36.93	56	-19.07	-	-
20	.63	14.77	Av	9.9	.2	24.87	-	-	46	-21.13
21	.69	26.06	Pk	9.9	.2	36.16	56	-19.84	-	-
22	.699	15.74	Av	9.9	.2	25.84	-	-	46	-20.16
23	14.223	30.13	Pk	10.1	.4	40.63	60	-19.37	-	-
24	14.25	16.35	Av	10.1	.4	26.85	-	-	50	-23.15

Pk - Peak detector

Av - Average detection

6 WORST EMISSIONS Test Case 4

Line-L1 .15 - 30MHz

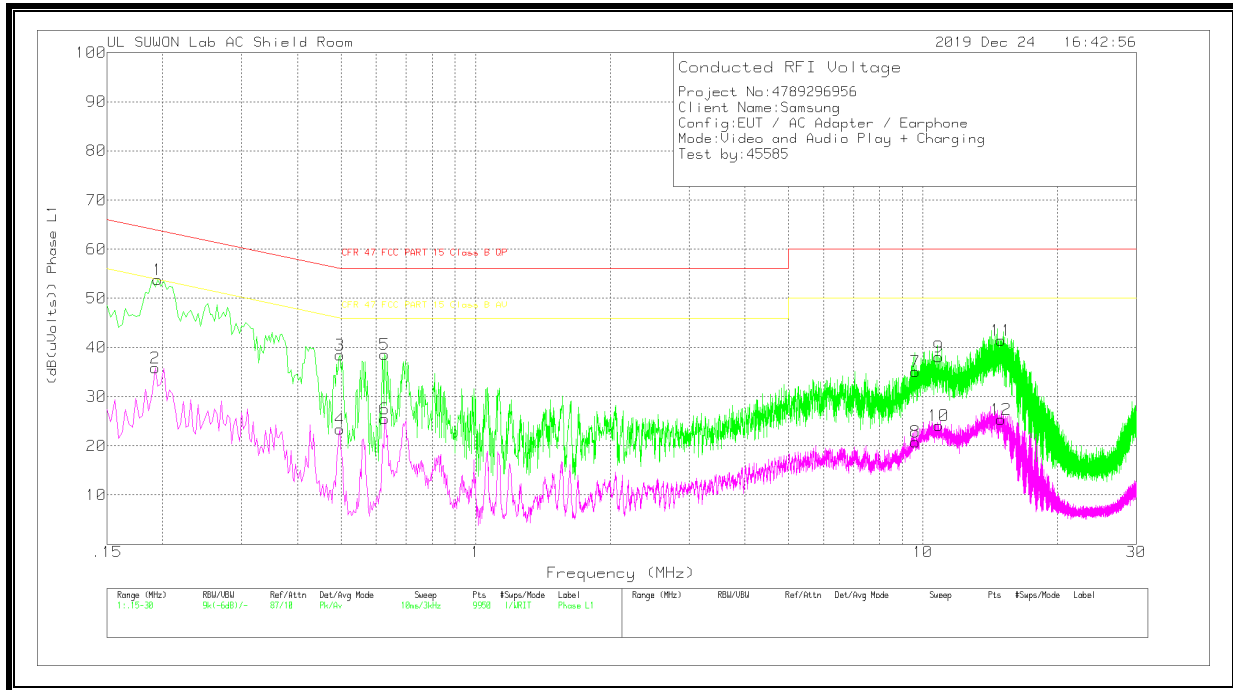

LINE 1 RESULTS

Trace Markers

Range 1: Phase L1 .15 - 30MHz

Marker	Frequency (MHz)	Meter Reading (dBuV)	Det	101836_Wit h Ex_L1[dB]	CABLELOSS (dB)	Corrected Reading (dB(uVolts))	CFR 47 FCC PART 15 Class B QP	Margin (dB)	CFR 47 FCC PART 15 Class B AV	Margin (dB)
1	.195	43.64	Pk	9.9	.2	53.74	63.82	-10.08	-	-
2	.192	25.67	Av	10	.2	35.87	-	-	53.95	-18.08
3	.498	28.37	Pk	9.9	.2	38.47	56.03	-17.56	-	-
4	.498	13.28	Av	9.9	.2	23.38	-	-	46.03	-22.65
5	.627	28.44	Pk	9.9	.2	38.54	56	-17.46	-	-
6	.627	15.41	Av	9.9	.2	25.51	-	-	46	-20.49
7	9.636	24.77	Pk	9.9	.4	35.07	60	-24.93	-	-
8	9.63	10.53	Av	9.9	.4	20.83	-	-	50	-29.17
9	10.842	27.76	Pk	10	.3	38.06	60	-21.94	-	-
10	10.863	13.82	Av	10	.3	24.12	-	-	50	-25.88
11	14.964	30.98	Pk	10.1	.4	41.48	60	-18.52	-	-
12	14.97	14.9	Av	10.1	.4	25.4	-	-	50	-24.6

Pk - Peak detector

Av - Average detection

Line-L2 .15 - 30MHz

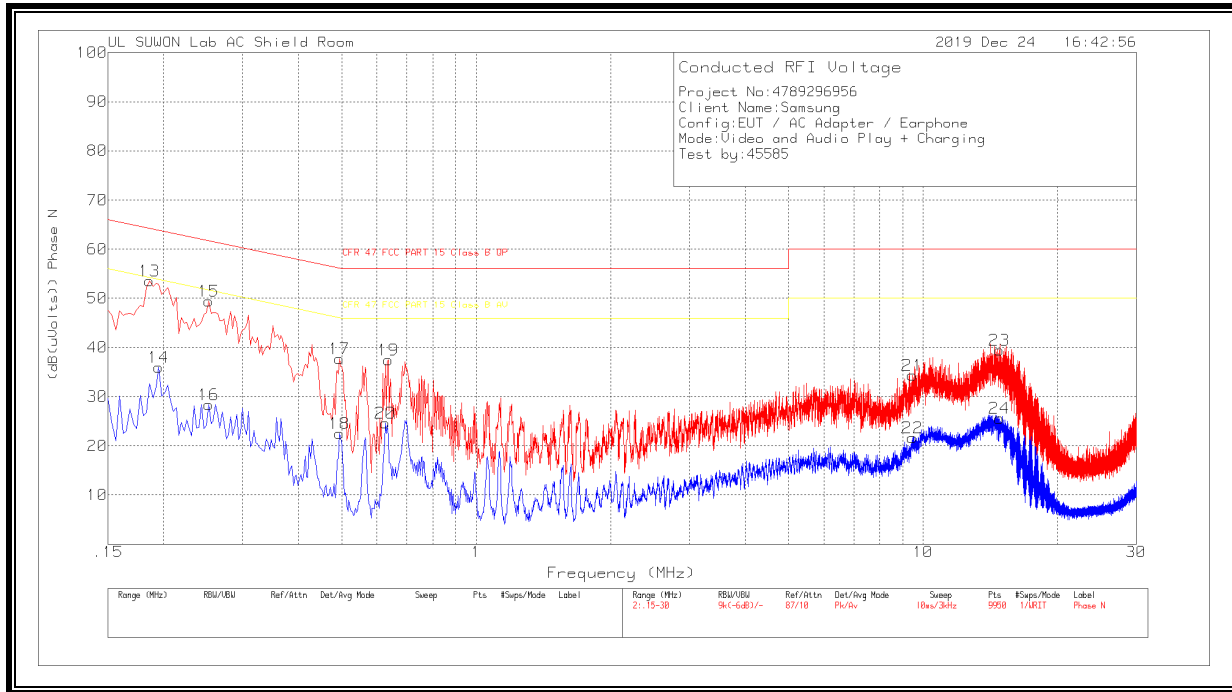

LINE 2 RESULTS

Trace Markers

Range 2: Phase N .15 - 30MHz

Marker	Frequency (MHz)	Meter Reading (dBuV)	Det	101836_With EX_N[dB]	CABLELOSS (dB)	Corrected Reading (dB(uVolts))	CFR 47 FCC PART 15 Class B QP	Margin (dB)	CFR 47 FCC PART 15 Class B AV	Margin (dB)
13	.186	43.4	Pk	10	.2	53.6	64.21	-10.61	-	-
14	.195	25.83	Av	9.9	.2	35.93	-	-	53.82	-17.89
15	.252	39.54	Pk	9.7	.2	49.44	61.69	-12.25	-	-
16	.252	18.52	Av	9.7	.2	28.42	-	-	51.69	-23.27
17	.495	27.62	Pk	9.9	.2	37.72	56.08	-18.36	-	-
18	.495	12.39	Av	9.9	.2	22.49	-	-	46.08	-23.59
19	.636	27.32	Pk	9.9	.2	37.42	56	-18.58	-	-
20	.627	14.56	Av	9.9	.2	24.66	-	-	46	-21.34
21	9.462	24.07	Pk	9.9	.4	34.37	60	-25.63	-	-
22	9.462	11.37	Av	9.9	.4	21.67	-	-	50	-28.33
23	14.82	28.95	Pk	10.1	.4	39.45	60	-20.55	-	-
24	14.814	15.07	Av	10.1	.4	25.57	-	-	50	-24.43

Pk - Peak detector
 Av - Average detection

6 WORST EMISSIONS Test Case 5

Line-L1 .15 - 30MHz

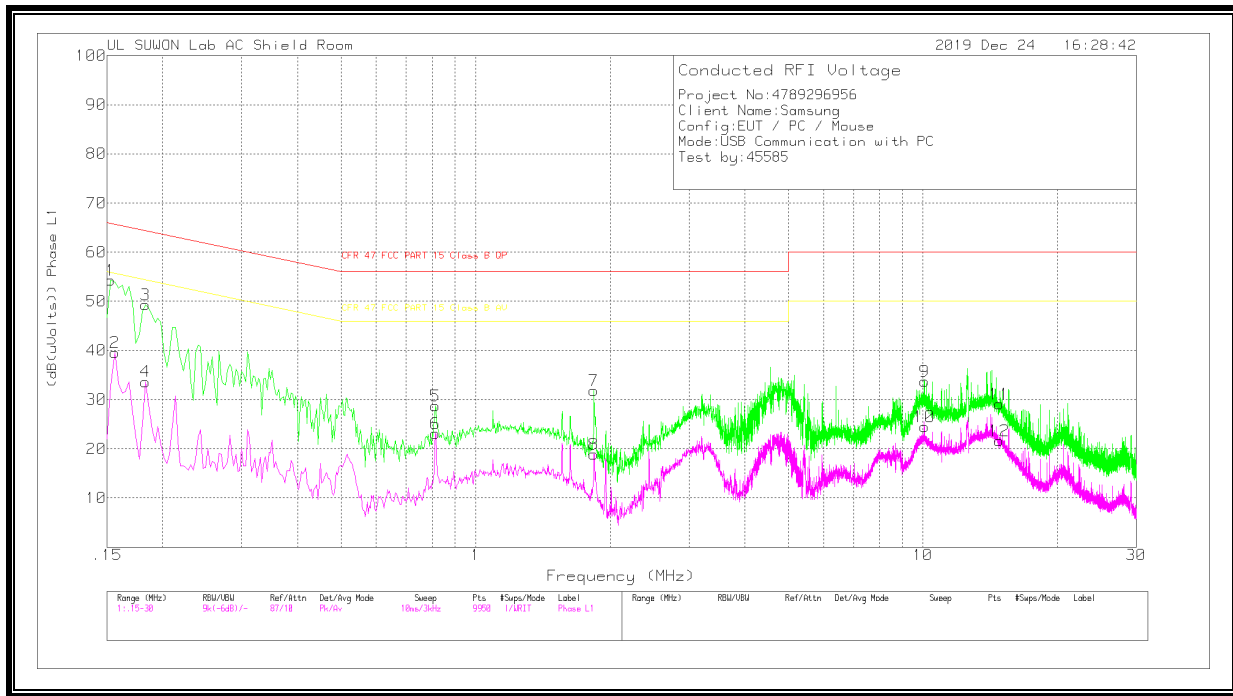

LINE 1 RESULTS

Trace Markers

Range 1: Phase L1 .15 - 30MHz

Marker	Frequency (MHz)	Meter Reading (dBuV)	Det	101836_L1[dB]	CABLELOS S(dB)	Corrected Reading (dB(uVolts))	CFR 47 FCC PART 15 Class B QP	Margin (dB)	CFR 47 FCC PART 15 Class B AV	Margin (dB)
1	.153	44.44	Pk	9.7	.1	54.24	65.84	-11.6	-	-
2	.156	29.7	Av	9.8	.1	39.6	-	-	55.67	-16.07
3	.183	39.17	Pk	9.9	.2	49.27	64.35	-15.08	-	-
4	.183	23.57	Av	9.9	.2	33.67	-	-	54.35	-20.68
5	.813	18.71	Pk	9.8	.2	28.71	56	-27.29	-	-
6	.813	13.19	Av	9.8	.2	23.19	-	-	46	-22.81
7	1.839	21.85	Pk	9.7	.3	31.85	56	-24.15	-	-
8	1.839	8.89	Av	9.7	.3	18.89	-	-	46	-27.11
9	10.077	23.59	Pk	9.7	.4	33.69	60	-26.31	-	-
10	10.077	14.41	Av	9.7	.4	24.51	-	-	50	-25.49
11	14.811	19.03	Pk	9.7	.4	29.13	60	-30.87	-	-
12	14.82	11.51	Av	9.7	.4	21.61	-	-	50	-28.39

Pk - Peak detector

Av - Average detection

Line-L2 .15 - 30MHz

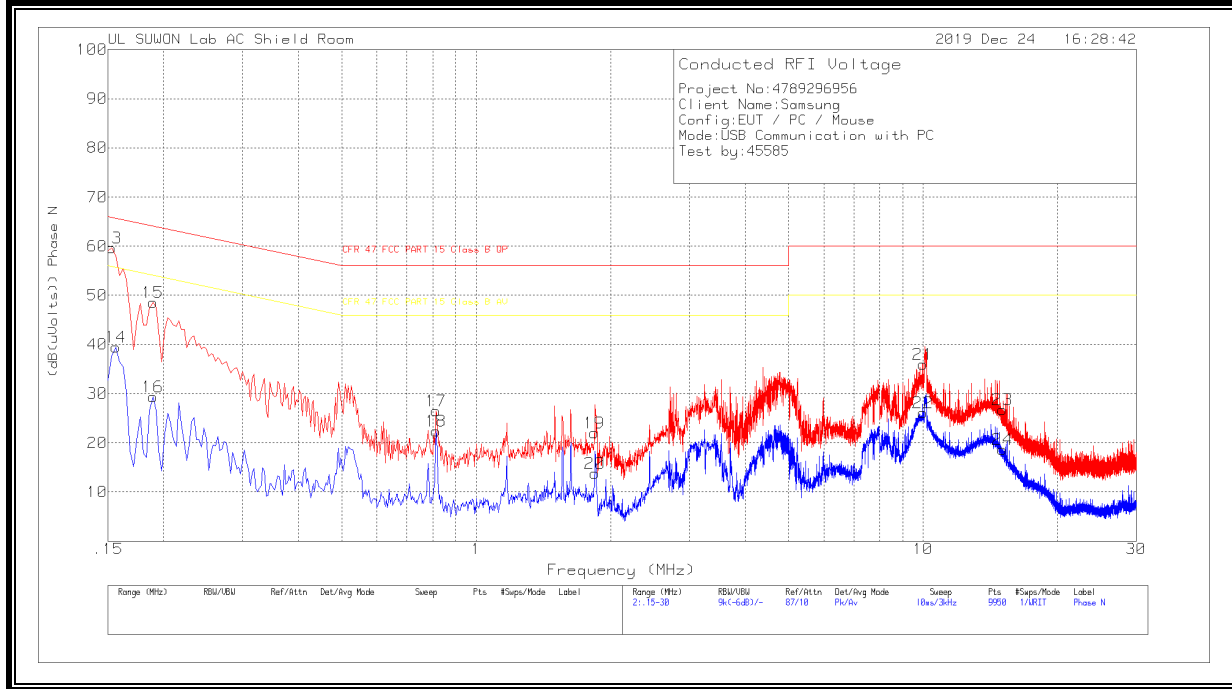

LINE 2 RESULTS

Trace Markers

Range 2: Phase N .15 - 30MHz

Marker	Frequency (MHz)	Meter Reading (dBuV)	Det	101836_N[d B]	CABLELOS S(dB)	Corrected Reading (dB(uVolts))	CFR 47 FCC PART 15 Class B QP	Margin (dB)	CFR 47 FCC PART 15 Class B AV	Margin (dB)
13	.153	49.88	Pk	9.7	.1	59.68	65.84	-6.16	-	-
14	.156	29.61	Av	9.8	.1	39.51	-	-	55.67	-16.16
15	.189	38.45	Pk	9.9	.2	48.55	64.08	-15.53	-	-
16	.189	19.3	Av	9.9	.2	29.4	-	-	54.08	-24.68
17	.813	16.48	Pk	9.8	.2	26.48	56	-29.52	-	-
18	.813	12.39	Av	9.8	.2	22.39	-	-	46	-23.61
19	1.839	12.03	Pk	9.7	.3	22.03	56	-33.97	-	-
20	1.842	3.78	Av	9.7	.3	13.78	-	-	46	-32.22
21	9.999	25.88	Pk	9.7	.4	35.98	60	-24.02	-	-
22	9.999	16.03	Av	9.7	.4	26.13	-	-	50	-23.87
23	15.066	16.68	Pk	9.7	.4	26.78	60	-33.22	-	-
24	15.063	8.55	Av	9.7	.4	18.65	-	-	50	-31.35

Pk - Peak detector
 Av - Average detection

Quasi-Peak Emissions

Range 2: Phase N .15 - 30MHz

Frequency (MHz)	Meter Reading (dBuV)	Det	101836_N[d B]	CABLELOS S(dB)	Corrected Reading (dB(uVolts))	CFR 47 FCC PART 15 Class B QP	Margin (dB)	CFR 47 FCC PART 15 Class B AV	Margin (dB)
.15225	44.8	Qp	9.7	.1	54.6	65.88	-11.28	-	-

Qp - Quasi-Peak detector

6 WORST EMISSIONS Test Case 6

Line-L1 .15 - 30MHz

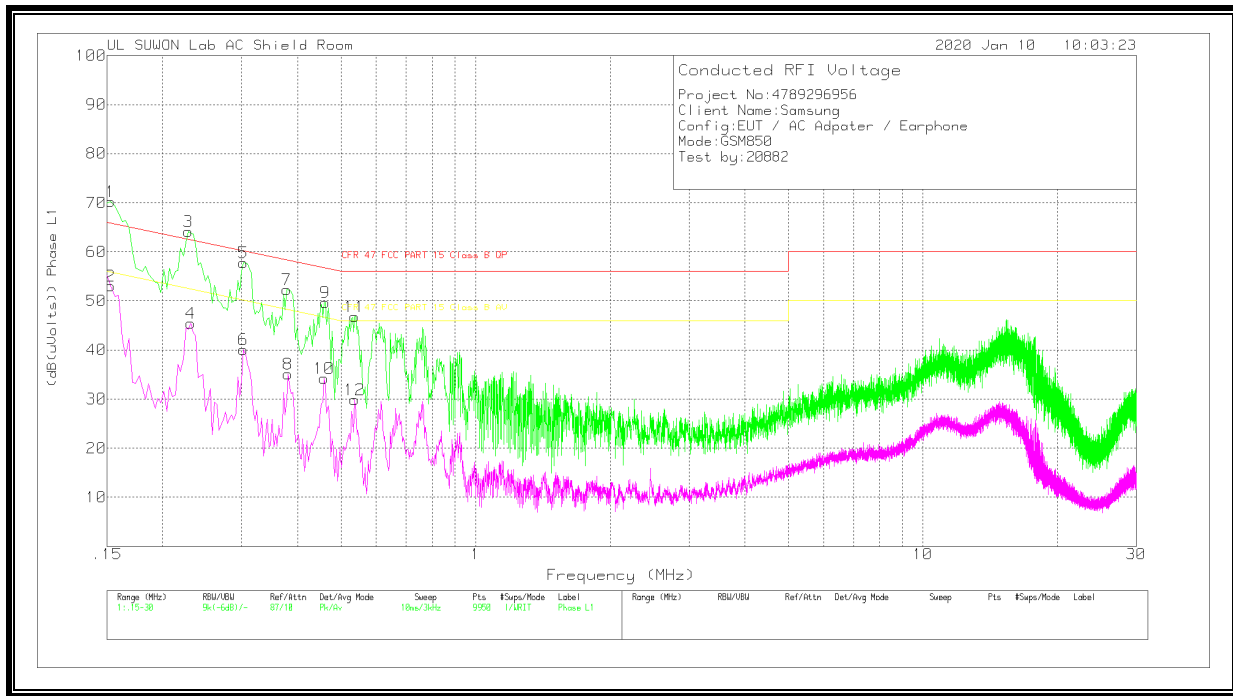

LINE 1 RESULTS

Trace Markers

Range 1: Phase L1 .15 - 30MHz

Marker	Frequency (MHz)	Meter Reading (dBuV)	Det	101836_With Ex_L1[dB]	CABLELOSS(dB)	Corrected Reading (dB(uVolts))	CFR 47 FCC PART 15 Class B QP	Margin (dB)	CFR 47 FCC PART 15 Class B AV	Margin (dB)
1	.153	60.4	Pk	9.8	.1	70.3	65.84	4.46	-	-
2	.153	43.16	Av	9.8	.1	53.06	-	-	55.84	-2.78
3	.228	54.15	Pk	9.8	.2	64.15	62.52	1.63	-	-
4	.231	35.4	Av	9.8	.2	45.4	-	-	52.41	-7.01
5	.303	47.82	Pk	9.8	.2	57.82	60.16	-2.34	-	-
6	.303	30.14	Av	9.8	.2	40.14	-	-	50.16	-10.02
7	.378	42.18	Pk	9.9	.2	52.28	58.32	-6.04	-	-
8	.381	25.01	Av	9.9	.2	35.11	-	-	48.26	-13.15
9	.462	39.6	Pk	9.9	.2	49.7	56.66	-6.96	-	-
10	.459	24.09	Av	9.9	.2	34.19	-	-	46.71	-12.52
11	.537	36.74	Pk	9.9	.2	46.84	56	-9.16	-	-
12	.537	19.82	Av	9.9	.2	29.92	-	-	46	-16.08

Pk - Peak detector
 Av - Average detection

Quasi-Peak Emissions

Range 1: Phase L1 .15 - 30MHz

Frequency (MHz)	Meter Reading (dBuV)	Det	101836_With Ex_L1[dB]	CABLELOSS(dB)	Corrected Reading (dB(uVolts))	CFR 47 FCC PART 15 Class B QP	Margin (dB)	CFR 47 FCC PART 15 Class B AV	Margin (dB)
.15315	47.41	Qp	9.8	.1	57.31	65.83	-8.52	-	-
.22875	40.97	Qp	9.8	.2	50.97	62.49	-11.52	-	-
.30315	33.65	Qp	9.8	.2	43.65	60.16	-16.51	-	-
.37875	27.32	Qp	9.9	.2	37.42	58.31	-20.89	-	-
.46275	27.46	Qp	9.9	.2	37.56	56.64	-19.08	-	-
.53625	24.68	Qp	9.9	.2	34.78	56	-21.22	-	-

Qp - Quasi-Peak detector

Line-L2 .15 - 30MHz

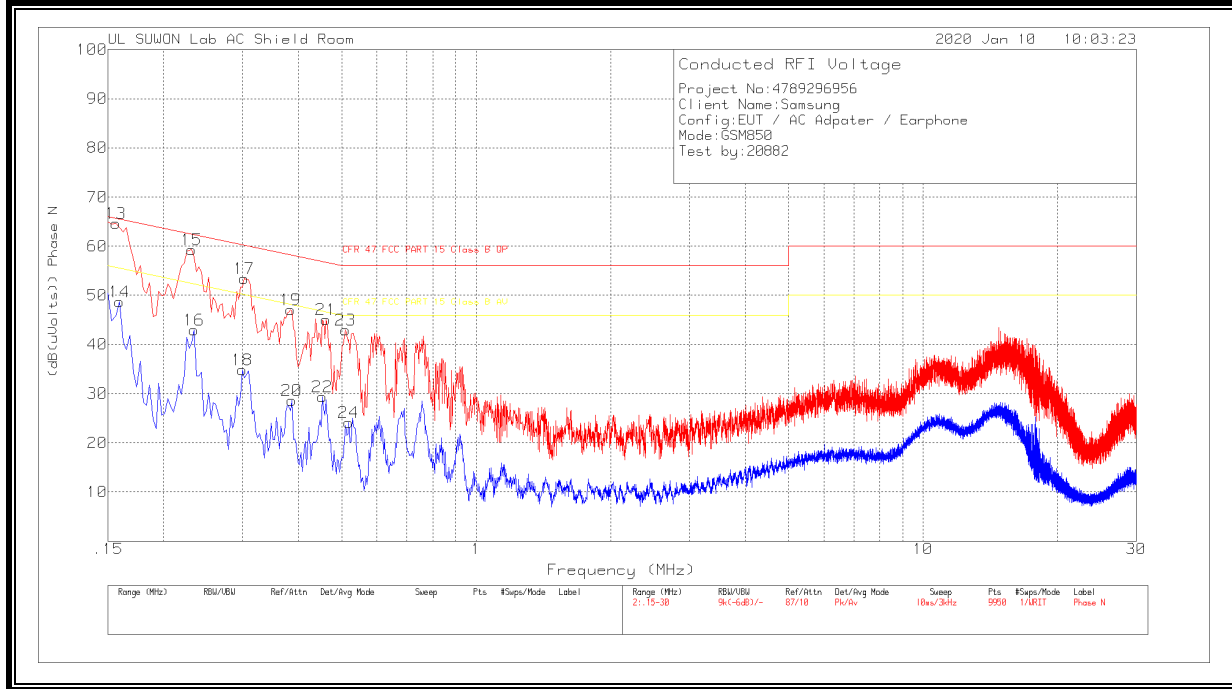

LINE 2 RESULTS

Trace Markers

Range 2: Phase N .15 - 30MHz

Marker	Frequency (MHz)	Meter Reading (dBuV)	Det	101836_With EX_N[dB]	CABLELOS S(dB)	Corrected Reading (dB(uVolts))	CFR 47 FCC PART 15 Class B QP	Margin (dB)	CFR 47 FCC PART 15 Class B AV	Margin (dB)
13	.156	54.67	Pk	9.9	.1	64.67	65.67	-1	-	-
14	.159	38.66	Av	9.9	.1	48.66	-	-	55.52	-6.86
15	.231	49.32	Pk	9.8	.2	59.32	62.41	-3.09	-	-
16	.234	32.99	Av	9.8	.2	42.99	-	-	52.31	-9.32
17	.303	43.46	Pk	9.8	.2	53.46	60.16	-6.7	-	-
18	.3	24.85	Av	9.8	.2	34.85	-	-	50.24	-15.39
19	.384	37.01	Pk	9.9	.2	47.11	58.19	-11.08	-	-
20	.387	18.53	Av	9.9	.2	28.63	-	-	48.13	-19.5
21	.462	34.96	Pk	9.9	.2	45.06	56.66	-11.6	-	-
22	.453	19.25	Av	9.9	.2	29.35	-	-	46.82	-17.47
23	.51	32.85	Pk	9.9	.2	42.95	56	-13.05	-	-
24	.519	14.02	Av	9.9	.2	24.12	-	-	46	-21.88

Pk - Peak detector
 Av - Average detection

Quasi-Peak Emissions

Range 2: Phase N .15 - 30MHz

Frequency (MHz)	Meter Reading (dBuV)	Det	101836_With EX_N[dB]	CABLELOS S(dB)	Corrected Reading (dB(uVolts))	CFR 47 FCC PART 15 Class B QP	Margin (dB)	CFR 47 FCC PART 15 Class B AV	Margin (dB)
.15525	45.35	Qp	9.9	.1	55.35	65.71	-10.36	-	-
.23025	40.05	Qp	9.8	.2	50.05	62.44	-12.39	-	-
.30375	32.66	Qp	9.8	.2	42.66	60.14	-17.48	-	-

Qp - Quasi-Peak detector