



FCC CFR47 PART 15 SUBPART C

DTS Wireless LAN

CERTIFICATION TEST REPORT

FOR

GSM/WCDMA/LTE Phone + BT/BLE, DTS/UNII a/b/g/n/ac and ANT+

MODEL NUMBER : SM-A505GT/DS

FCC ID: A3LSMA505GT

REPORT NUMBER: 4788805359-E2V2

ISSUE DATE: FEB 13, 2019

Prepared for
SAMSUNG ELECTRONICS CO., LTD.
129 SAMSUNG-RO, YEONGTONG-GU, SUWON-SI,
GYEONGGI-DO, 16677, KOREA

Prepared by
UL Korea, Ltd.
26th floor, 152, Teheran-ro, Gangnam-gu Seoul, 06236, Korea

Suwon Test Site: UL Korea, Ltd. Suwon Laboratory
218 Maeyeong-ro, Yeongtong-gu,
Suwon-si, Gyeonggi-do, 16675, Korea
TEL: (031) 337-9902
FAX: (031) 213-5433



ACCREDITED*

Testing
Laboratory

TL-637

Revision History

<u>Rev.</u>	<u>Issue Date</u>	<u>Revisions</u>	<u>Revised By</u>
V1	02/08/19	Initial issue	Hoonpyo Lee
V2	02/13/19	Updated to address TCB's question	Hoonpyo Lee

TABLE OF CONTENTS

1. ATTESTATION OF TEST RESULTS	5
1.1. INTRODUCTION OF TEST DATA REUSE	6
1.2. DIFFERENCE	6
1.3. SPOT CHECK VERIFICATION DATA.....	6
1.4. REFERENCE DETAIL.....	7
2. TEST METHODOLOGY	8
3. FACILITIES AND ACCREDITATION	8
4. CALIBRATION AND UNCERTAINTY	8
4.1. MEASURING INSTRUMENT CALIBRATION.....	8
4.2. SAMPLE CALCULATION.....	8
4.3. MEASUREMENT UNCERTAINTY	8
5. EQUIPMENT UNDER TEST	9
5.1. DESCRIPTION OF EUT.....	9
5.2. MAXIMUM OUTPUT POWER.....	9
5.3. DESCRIPTION OF AVAILABLE ANTENNAS	9
5.4. WORST-CASE CONFIGURATION AND MODE	9
5.5. DESCRIPTION OF TEST SETUP.....	10
6. TEST AND MEASUREMENT EQUIPMENT	12
7. REFERENCE MEASUREMENT RESULTS.....	13
7.1. ON TIME AND DUTY CYCLE RESULTS.....	13
7.1. 99% BANDWIDTH	14
7.1.1. 802.11b MODE IN THE 2.4 GHz BAND.....	14
7.1.2. 802.11g MODE IN THE 2.4 GHz BAND.....	14
7.1.3. 802.11n HT20 MODE IN THE 2.4 GHz BAND	14
7.1.4. 99% BANDWIDTH PLOTS	15
8. MEASUREMENT METHODS	18
9. SUMMARY TABLE	19
10. ANTENNA PORT TEST RESULTS	20
10.1. 6 dB BANDWIDTH.....	20
10.1.1. 802.11b MODE IN THE 2.4 GHz BAND.....	21
10.1.1.1. 802.11g MODE IN THE 2.4 GHz BAND	21
10.1.2. 802.11n HT20 MODE IN THE 2.4 GHz BAND	21
10.1.3. 6 dB BANDWIDTH PLOTS.....	22

10.2.	OUTPUT POWER.....	25
10.2.1.	802.11b MODE IN THE 2.4 GHz BAND.....	26
10.2.2.	802.11g MODE IN THE 2.4 GHz BAND.....	27
10.2.3.	802.11n HT20 MODE IN THE 2.4 GHz BAND.....	28
10.3.	PSD.....	29
10.3.1.	802.11b MODE IN THE 2.4 GHz BAND.....	30
10.3.2.	802.11g MODE IN THE 2.4 GHz BAND.....	30
10.3.3.	802.11n HT20 MODE IN THE 2.4 GHz BAND.....	30
10.3.4.	PSD PLOTS.....	31
10.4.	OUT-OF-BAND EMISSIONS.....	34
10.4.1.	802.11b MODE IN THE 2.4 GHz BAND.....	35
10.4.2.	802.11g MODE IN THE 2.4 GHz BAND.....	40
10.4.3.	802.11n HT20 MODE IN THE 2.4 GHz BAND.....	46
11.	RADIATED TEST RESULTS.....	52
11.1.	LIMITS AND PROCEDURE.....	52
11.2.	TRANSMITTER ABOVE 1 GHz.....	54
11.2.1.	TX ABOVE 1 GHz 802.11b MODE IN THE 2.4 GHz BAND.....	54
11.2.2.	TX ABOVE 1 GHz 802.11g MODE IN THE 2.4 GHz BAND.....	68
11.2.3.	TX ABOVE 1 GHz 802.11n HT20 MODE IN THE 2.4 GHz BAND.....	84
11.3.	WORST-CASE BELOW 1 GHz.....	100
12.	AC POWER LINE CONDUCTED EMISSIONS.....	102
13.	SETUP PHOTOS.....	105

1. ATTESTATION OF TEST RESULTS

COMPANY NAME: SAMSUNG ELECTRONICS CO., LTD.
EUT DESCRIPTION: GSM/WCDMA/LTE Phone + BT/BLE, DTS/UNII a/b/g/n/ac and ANT+
MODEL NUMBER: SM-A505GT/DS
SERIAL NUMBER: R38M102EE1R (RADIATED, Original);
R38KB0HB5BP (CONDUCTED, Original)
983248424a313446 (RADIATED, Spot check)
DATE TESTED: JAN 10, 2019 - JAN 31, 2019 (Original)
JAN 23, 2019 - FEB 07, 2019 (Spot check)

APPLICABLE STANDARDS	
STANDARD	TEST RESULTS
CFR 47 Part 15 Subpart C	Pass

UL Korea, Ltd. tested the above equipment in accordance with the requirements set forth in the above standards. All indications of Pass/Fail in this report are opinions expressed by UL Korea, Ltd. based on interpretations and/or observations of test results. Measurement Uncertainties were not taken into account and are published for informational purposes only. The test results show that the equipment tested is capable of demonstrating compliance with the requirements as documented in this report.

Note: The results documented in this report apply only to the tested sample, under the conditions and modes of operation as described herein. This document may not be altered or revised in any way unless done so by UL Korea, Ltd. and all revisions are duly noted in the revisions section. Any alteration of this document not carried out by UL Korea, Ltd. will constitute fraud and shall nullify the document. This report must not be used by the client to claim product certification, approval, or endorsement by IAS, any agency of the Federal Government, or any agency of any government.

Approved & Released For
UL Korea, Ltd. By:

Tested By:



SungGil Park
Suwon Lab Engineer
UL Korea, Ltd.

Hoonpyo Lee
Suwon Lab Engineer
UL Korea, Ltd.

1.1. INTRODUCTION OF TEST DATA REUSE

This report referenced from the FCC ID: A3LSMA505GN DTS WLAN(FCC CFR 47 Part 15). And the applicant takes full responsibility that the test data as referenced in this report represent compliance for this FCC ID.

1.2. DIFFERENCE

The FCC ID: A3LSMA505GT shares the same enclosure and circuit board as FCC ID: A3LSMA505GN. The WLAN antennas and surrounding circuitry and layout are identical between these two units for re-used bands.

After confirming through preliminary radiated emissions that the performance of the FCC ID: A3LSMA505GN remains representative of FCC ID: A3LSMA505GT. The test data of FCC ID: A3LSMA505GN being submitted for this application to cover WLAN features.

1.3. SPOT CHECK VERIFICATION DATA

Band	Test Item	Mode	Frequency	Test Limit	Original model	Spot check model	Deviation	Remark
					SM-A505GN/DS	SM-A505GT/DS		
					FCC ID : A3LSMA505GN	FCC ID : A3LSMA505GT		
DTS WLAN (2.4GHz)	Band Edge	802.11b	2472 MHz	54 dBuV/m	49.57 dBuV/m	50.12 dBuV/m	0.55 dB	
	RSE	802.11b	2437 MHz	54 dBuV/m	50.34 dBuV/m	48.21 dBuV/m	-2.13 dB	2nd Harmonic
	Band Edge	802.11g	2412 MHz	54 dBuV/m	50.08 dBuV/m	51.11 dBuV/m	1.03 dB	
	RSE	802.11g	2437 MHz	54 dBuV/m	38.57 dBuV/m	37.79 dBuV/m	-0.78 dB	2nd Harmonic
	Band Edge	802.11n	2412 MHz	54 dBuV/m	51.03 dBuV/m	50.46 dBuV/m	-0.57 dB	
	RSE	802.11n	2437 MHz	54 dBuV/m	38.67 dBuV/m	37.64 dBuV/m	-1.03 dB	2nd Harmonic

Comparison of two models, upper deviation is within 3dB range and all test results are under FCC Technical Limits. Output power verification was performed for the spot check model, all conducted power test results were in the tune up tolerance range. Also deviation for maximum output power result is within upper 0.5dB range.

1.4. REFERENCE DETAIL

Reference application that contains the reused reference data.

Equipment Class	Reference FCC ID	Type Grant/Permissive Change	Reference Application	Folder Test/RF Exposure	Report Tittle / Section
PCE	A3LSMA505GN	Grant	4788805413-E1	Test	FCC Report WWAN / All sections
DTS	A3LSMA505GN	Grant	4788805413-E2	Test	FCC Report DTS WLAN / All sections
			4788805413-E3	Test	FCC Report BLE All sections
DSS	A3LSMA505GN	Grant	4788805413-E4	Test	FCC Report BT / All sections
NII	A3LSMA505GN	Grant	4788805413-E5	Test	FCC Report UNII WLAN / All sections
DXX	A3LSMA505GN	Grant	4788805413-E6	Test	FCC Report ANT+ / All sections

2. TEST METHODOLOGY

The tests documented in this report were performed in accordance with following methods.

1. FCC CFR 47 Part 2.
2. FCC CFR 47 Part 15.
3. KDB 558074 D01 15.247 Meas Guidance v05.
4. KDB 484596 D01 v01
5. ANSI C63.10-2013.

3. FACILITIES AND ACCREDITATION

The test sites and measurement facilities used to collect data are located at 218 Maeyeong-ro, Yeongtong-gu, Suwon-si, Gyeonggi-do, 16675, Korea. Line conducted emissions are measured only at the 218 address. The following table identifies which facilities were utilized for radiated emission measurements documented in this report. Specific facilities are also identified in the test results sections.

218 Maeyeong-ro	
<input checked="" type="checkbox"/>	Chamber 1
<input checked="" type="checkbox"/>	Chamber 2
<input type="checkbox"/>	Chamber 3

UL Korea, Ltd. is accredited by IAS, Laboratory Code TL-637. The full scope of accreditation can be viewed at <http://www.iasonline.org/PDF/TL/TL-637.pdf>.

4. CALIBRATION AND UNCERTAINTY

4.1. MEASURING INSTRUMENT CALIBRATION

The measuring equipment utilized to perform the tests documented in this report has been calibrated in accordance with the manufacturer's recommendations, and is traceable to recognized national standards.

4.2. SAMPLE CALCULATION

Where relevant, the following sample calculation is provided:

$$\begin{aligned} \text{Field Strength (dBuV/m)} &= \text{Measured Voltage (dBuV)} + \text{Antenna Factor (dB/m)} + \\ &\text{Cable Loss (dB)} - \text{Preamp Gain (dB)} \\ 36.5 \text{ dBuV} + 18.7 \text{ dB/m} + 0.6 \text{ dB} - 26.9 \text{ dB} &= 28.9 \text{ dBuV/m} \end{aligned}$$

4.3. MEASUREMENT UNCERTAINTY

Where relevant, the following measurement uncertainty levels have been estimated for tests performed on the apparatus:

PARAMETER	UNCERTAINTY
Conducted Disturbance, 0.15 to 30 MHz	2.32 dB
Radiated Disturbance, Below 1GHz	3.86 dB
Radiated Disturbance, Above 1 GHz	5.97 dB

Uncertainty figures are valid to a confidence level of 95%.

5. EQUIPMENT UNDER TEST

5.1. DESCRIPTION OF EUT

The EUT is a GSM/WCDMA/LTE Phone + BT/BLE, DTS/UNII a/b/g/n/ac and ANT+. This test report addresses the DTS (WLAN) operational mode.

5.2. MAXIMUM OUTPUT POWER

The transmitter has a maximum total conducted average output power as follows:

Frequency Range [MHz]	Mode	Output Power [dBm]	Output Power [mW]
2412 - 2472	802.11b	16.82	48.08
	802.11g	16.63	46.03
	802.11n HT20	16.45	44.16

5.3. DESCRIPTION OF AVAILABLE ANTENNAS

The radio utilizes an internal antennas, with a antenna's maximum gain of -2.11 dBi.

5.4. WORST-CASE CONFIGURATION AND MODE

Radiated emission below 1GHz and power line conducted emission were performed with the EUT set to transmit at the channel with highest output power as worst-case scenario.

Radiated emission above 1GHz was performed with the EUT set to transmit low/mid/high Channels.

The fundamental of the EUT was investigated in three orthogonal orientations X, Y and Z it was determined that Y orientation was worst-case orientation; therefore, all final radiated testing was performed with the EUT in Y orientation.

Based on the baseline scan, the worst-case data rates were:

802.11b mode: 1 Mbps
802.11g mode: 6 Mbps
802.11n HT20 mode: MCS0

Note : All radiated and power line conducted tests were performed connected with earphone and charger for evaluation of worst case mode.

5.5. DESCRIPTION OF TEST SETUP

SUPPORT EQUIPMENT

Support Equipment List				
Description	Manufacturer	Model	Serial Number	FCC ID
Charger	SAMSUNG	EP-TA200	R37KC3B01G0RC3	N/A
Data Cable	SAMSUNG	EP-D140AWE	N/A	N/A
Earphone	SAMSUNG	EHS61ASFWE	N/A	N/A

I/O CABLES

I/O Cable List						
Cable No	Port	# of identical ports	Connector Type	Cable Type	Cable Length (m)	Remarks
1	DC Power	1	Mini-USB	Shielded	1.2m	N/A
2	Audio	2	Mini-Jack	Unshielded	1.2m	N/A

TEST SETUP

The EUT is a stand-alone unit during the tests.
 Test software in hidden menu exercised the EUT to enable DTS mode.

SETUP DIAGRAM FOR TESTS (CONDUCTED TEST SETUP)

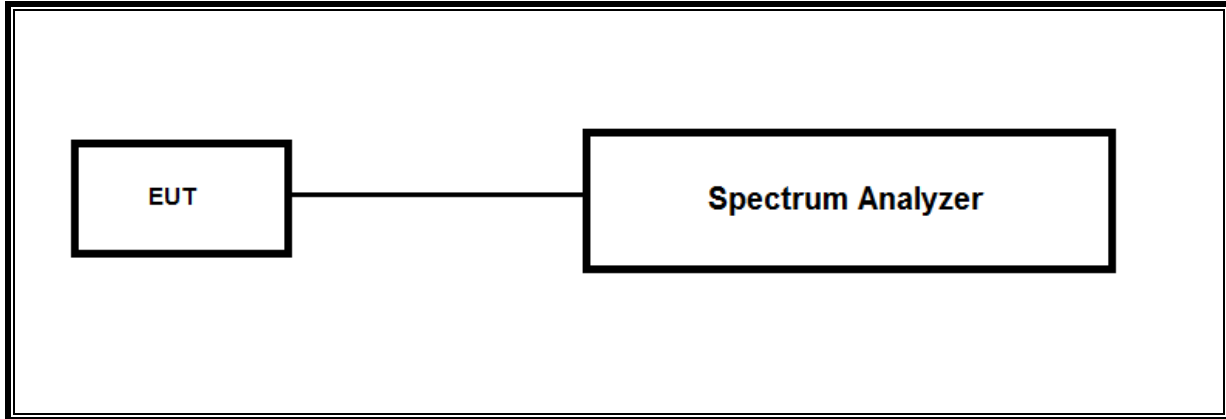

SETUP DIAGRAM FOR TESTS (RADIATED TEST SETUP)

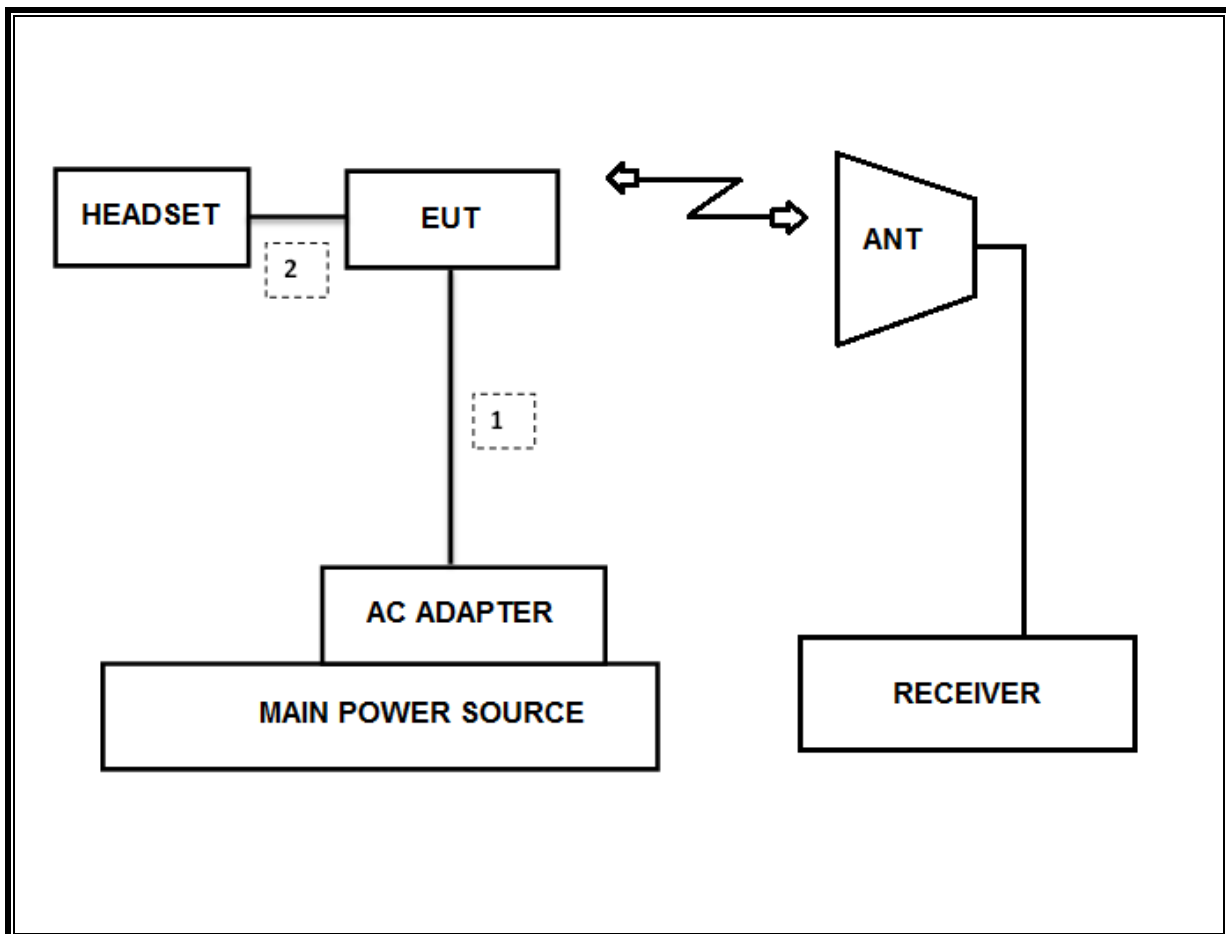

6. TEST AND MEASUREMENT EQUIPMENT

The following test and measurement equipment was utilized for the tests documented in this report:

Test Equipment List				
Description	Manufacturer	Model	S/N	Cal Due
Antenna, Bilog, 30MHz-1GHz	SCHWARZBECK	VULB9163	750	08-04-20
Antenna, Bilog, 30MHz-1GHz	SCHWARZBECK	VULB9163	749	08-04-20
Antenna, Bilog, 30MHz-1GHz	SCHWARZBECK	VULB9163	845	08-04-20
Antenna, Horn, 18 GHz	ETS	3115	00167211	08-04-20
Antenna, Horn, 18 GHz	ETS	3115	00161451	08-04-20
Antenna, Horn, 18 GHz	ETS	3117	00168724	08-04-20
Antenna, Horn, 18 GHz	ETS	3117	00168717	08-04-20
Antenna, Horn, 18 GHz	ETS	3117	00205959	08-04-20
Antenna, Horn, 40 GHz	ETS	3116C	00166155	12-04-19
Antenna, Horn, 40 GHz	ETS	3116C	00168645	12-04-19
Antenna, Horn, 40 GHz	ETS	3116C-PA	00168841	08-09-19
Preamplifier, 1000 MHz	Sonoma	310N	341282	08-07-19
Preamplifier, 1000 MHz	Sonoma	310N	351741	08-07-19
Preamplifier, 1000 MHz	Sonoma	310N	370599	08-06-19
Preamplifier, 18 GHz	Miteq	AFS42-00101800-25-S-42	1876511	08-07-19
Preamplifier, 18 GHz	Miteq	AFS42-00101800-25-S-42	1896138	08-07-19
Preamplifier, 18 GHz	Miteq	AFS42-00101800-25-S-42	2029169	08-07-19
Spectrum Analyzer, 44 GHz	Agilent / HP	N9030A	MY54170614	08-07-19
Spectrum Analyzer, 44 GHz	Agilent / HP	N9030A	MY54490312	08-06-19
Spectrum Analyzer, 43.5 GHz	R&S	FSW43	104089	08-06-19
Average Power Sensor	Agilent / HP	U2000	MY54270007	08-07-19
Attenuator	PASTERNAK	PE7087-10	A001	08-08-19
Attenuator	PASTERNAK	PE7087-10	A008	08-08-19
Attenuator	PASTERNAK	PE7004-10	2	08-07-19
Attenuator	PASTERNAK	PE7087-10	A009	08-08-19
EMI Test Receive, 40 GHz	R&S	ESU40	100439	08-06-19
EMI Test Receive, 40 GHz	R&S	ESU40	100457	08-06-19
EMI Test Receive, 44 GHz	R&S	ESW44	101590	08-06-19
EMI Test Receive, 3 GHz	R&S	ESR3	101832	08-06-19
Low Pass Filter 5GHz	Micro-Tronics	LPS17541	009	08-07-19
Low Pass Filter 5GHz	Micro-Tronics	LPS17541	015	08-07-19
Low Pass Filter 5GHz	Micro-Tronics	LPS17541	020	08-06-19
High Pass Filter 3GHz	Micro-Tronics	HPM17543	010	08-07-19
High Pass Filter 3GHz	Micro-Tronics	HPM17543	015	08-07-19
High Pass Filter 3GHz	Micro-Tronics	HPM17543	020	08-06-19
High Pass Filter 6GHz	Micro-Tronics	HPS17542	009	08-07-19
High Pass Filter 6GHz	Micro-Tronics	HPS17542	016	08-07-19
High Pass Filter 6GHz	Micro-Tronics	HPS17542	021	08-06-19
Antenna, Loop, 9kHz-30MHz	R&S	HFH2-Z2	100418	10-26-19
LISN	R&S	ENV-216	101837	08-09-19
UL Software				
Description	Manufacturer	Model	Version	
Radiated software	UL	UL EMC	Ver 9.5	
AC Line Conducted software	UL	UL EMC	Ver 9.5	

7. REFERENCE MEASUREMENT RESULTS

7.1. ON TIME AND DUTY CYCLE RESULTS

LIMITS

None; for reporting purposes only.

Mode	ON Time B [msec]	Period [msec]	Duty Cycle x [linear]	Duty Cycle [%]	Duty Cycle Correction Factor [dB]	1/T Minimum VBW [kHz]
2400MHz Bands						
802.11b	16.45	16.48	0.998	99.8%	0.00	0.061
802.11g	2.736	2.816	0.972	97.2%	0.13	0.365
802.11n HT20	2.544	2.624	0.970	97.0%	0.13	0.393

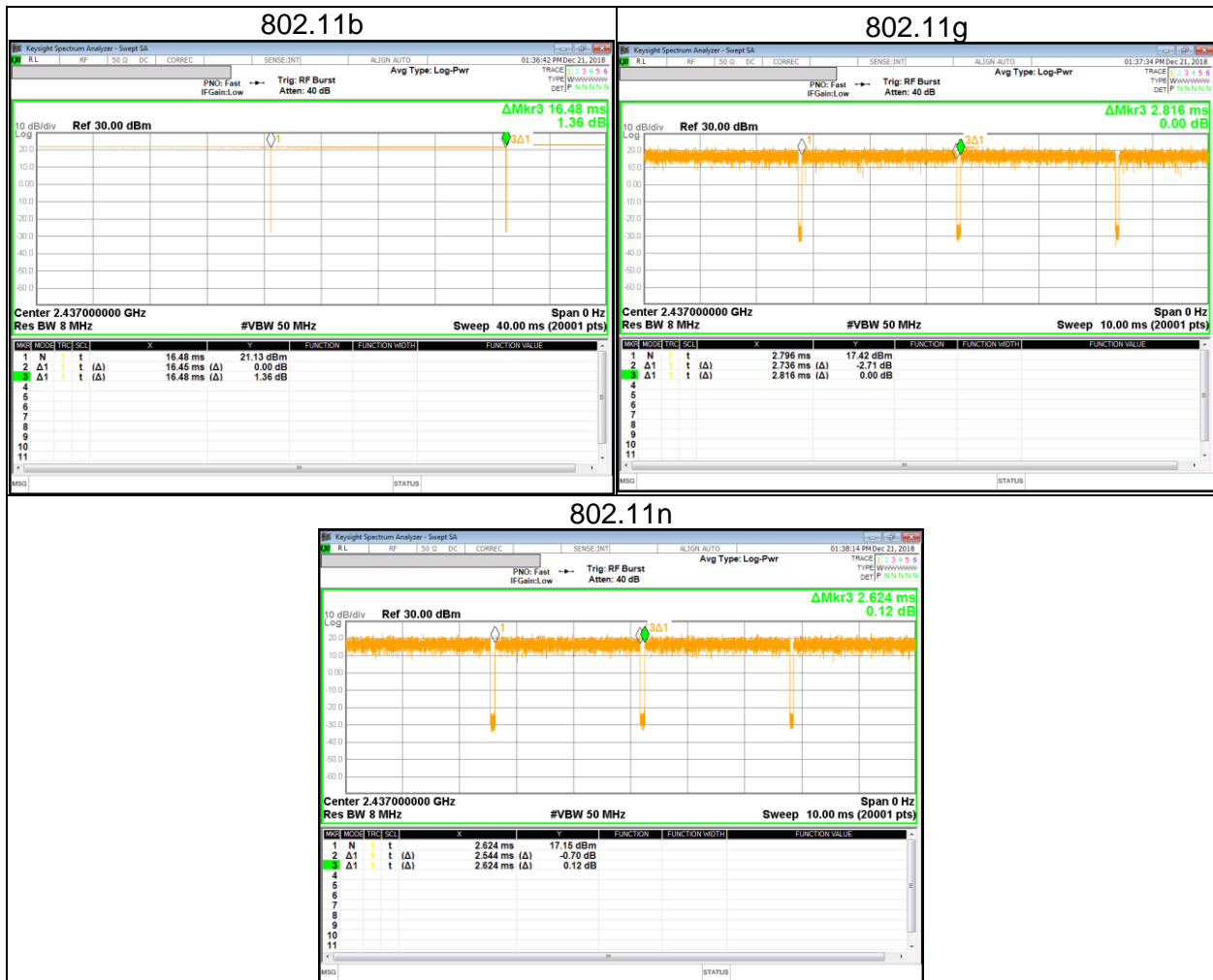

7.1. 99% BANDWIDTH

LIMITS

None; for reporting purposes only.

RESULTS

7.1.1. 802.11b MODE IN THE 2.4 GHz BAND

Channel	Frequency [MHz]	99% Bandwidth [MHz]
1	2412	6.000
6	2437	13.449
11	2462	13.595
12	2467	13.938
13	2472	13.201
Worst		13.938

7.1.2. 802.11g MODE IN THE 2.4 GHz BAND

Channel	Frequency [MHz]	99% Bandwidth [MHz]
1	2412	16.025
6	2437	16.049
10	2457	16.000
11	2462	16.025
12	2467	16.078
13	2472	16.068
Worst		16.078

7.1.3. 802.11n HT20 MODE IN THE 2.4 GHz BAND

Channel	Frequency [MHz]	99% Bandwidth [MHz]
1	2412	17.005
6	2437	17.094
10	2457	17.051
11	2462	17.088
12	2467	17.092
13	2472	17.101
Worst		17.101

7.1.4. 99% BANDWIDTH PLOTS

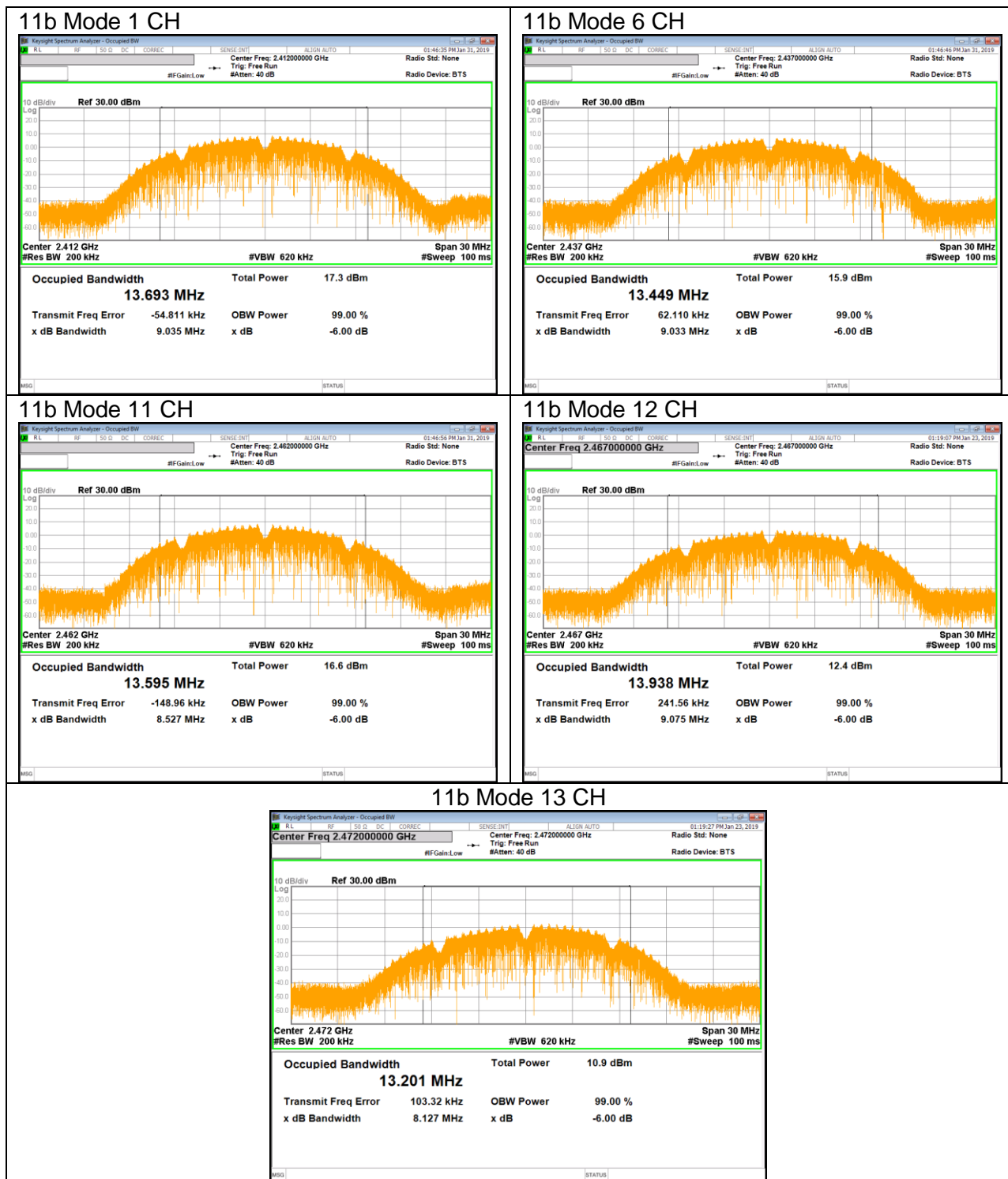

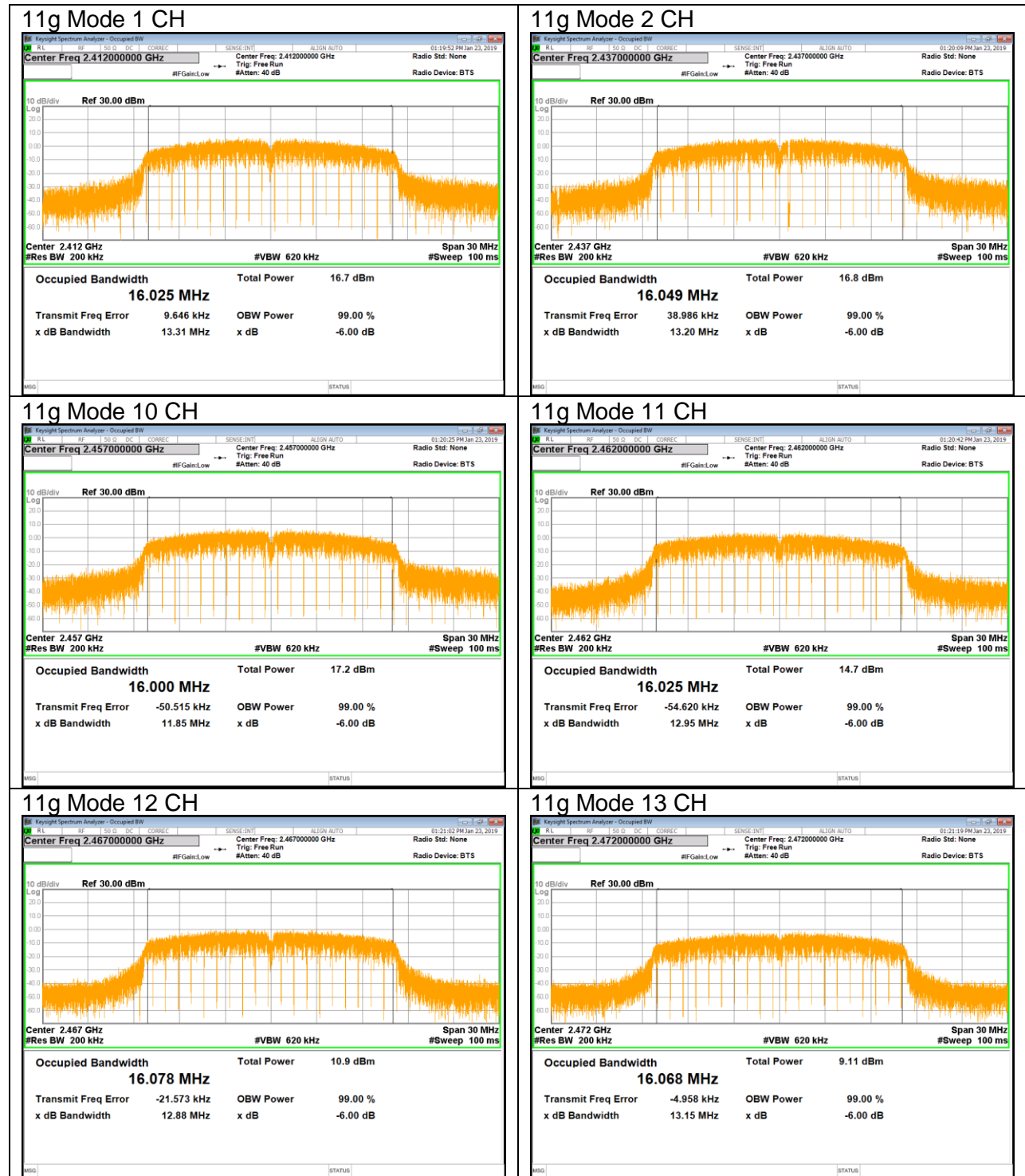

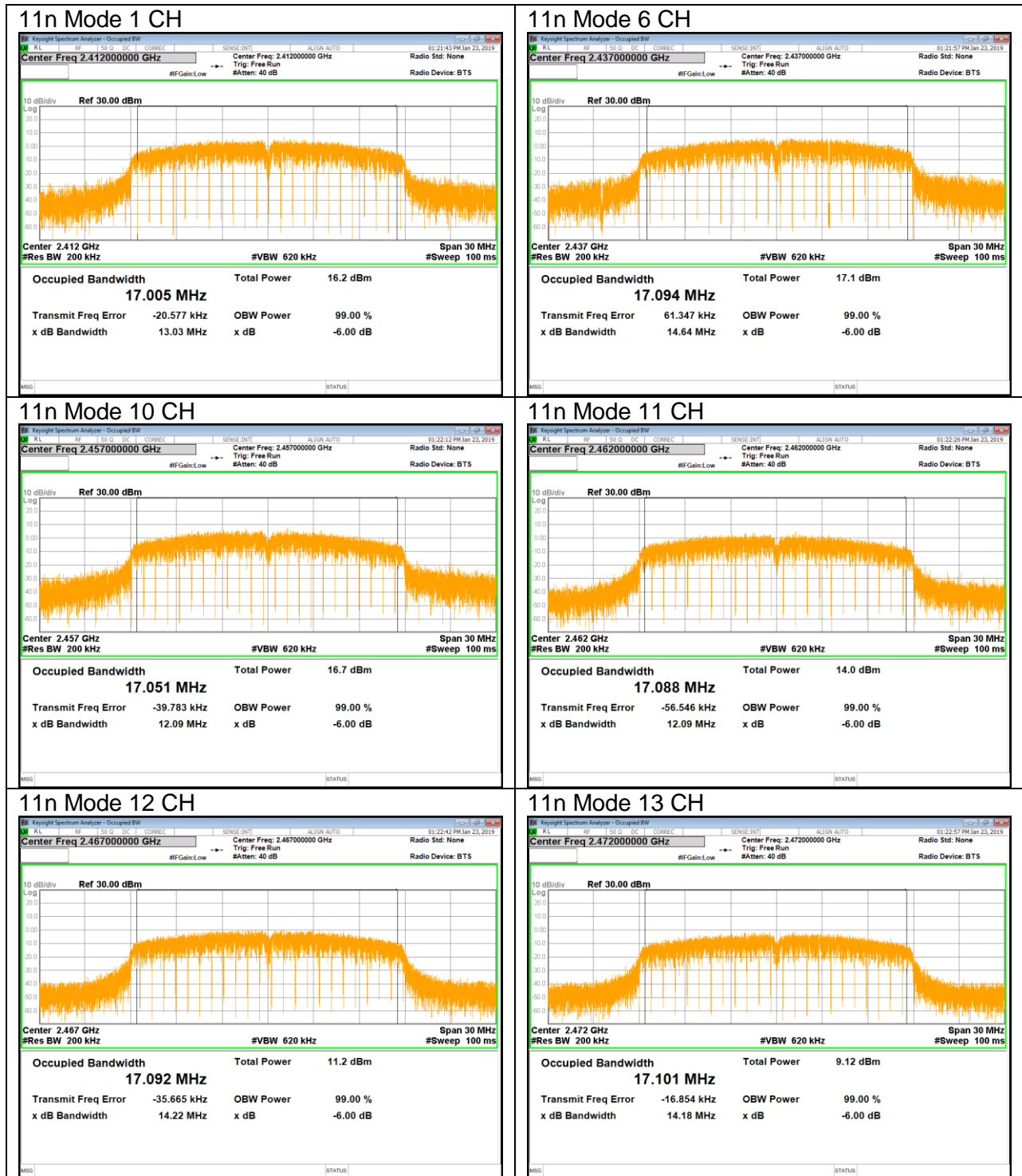

8. MEASUREMENT METHODS

6 dB BW : KDB 558074 D01 v05, Section 8.2.

OUTPUT POWER : KDB 558074 D01 v05, Section 8.3.2.3.

POWER SPECTRAL DENSITY : KDB 558074 D01 v05, Section 8.4.

Out-of-band EMISSIONS (Conducted) : KDB 558074 D01 v05, Section 8.5, 8.7.

Out-of-band EMISSIONS IN NON-RESTRICTED BANDS: KDB 558074 D01 v05, Section 8.5.

Out-of-band EMISSIONS IN RESTRICTED BANDS : KDB 558074 D01 v05, Section 8.6.

AC Power Line Conducted Emission : ANSI C63.10-2013, Section 6.2.

9. SUMMARY TABLE

FCC Part Section	Test Description	Test Limit	Test Condition	Test Result
15.247 (a)(2)	Occupied Band width (6dB)	>500KHz	Conducted	Pass
2.1051, 15.247 (d)	Band Edge / Conducted Spurious Emission	-30dBc		Pass
15.247 (b)(3)	TX conducted output power	<30dBm		Pass
15.247 (e)	PSD	<8dBm		Pass
15.207 (a)	AC Power Line conducted emissions	Section 10	Power Line conducted	Pass
15.205, 15.209	Radiated Spurious Emission	< 54dBuV/m	Radiated	Pass

10. ANTENNA PORT TEST RESULTS

10.1. 6 dB BANDWIDTH

LIMITS

FCC §15.247 (a) (2)

The minimum 6 dB bandwidth shall be at least 500 kHz.

TEST PROCEDURE

Reference to section 11.8 in ANSI C63.10(2013): The transmitter output is connected to a spectrum analyzer with the RBW set to 100KHz, the VBW $\geq 3 \times$ RBW, peak detector and max hold.

RESULTS

10.1.1.802.11b MODE IN THE 2.4 GHz BAND

Channel	Frequency [MHz]	6 dB Bandwidth [MHz]	Minimum Limit [MHz]
1	2412	9.521	0.5
6	2437	8.516	0.5
11	2462	8.513	0.5
12	2467	8.534	0.5
13	2472	9.019	0.5
Worst		8.513	0.5

10.1.1.1. 802.11g MODE IN THE 2.4 GHz BAND

Channel	Frequency [MHz]	6 dB Bandwidth [MHz]	Minimum Limit [MHz]
1	2412	13.140	0.5
6	2437	12.750	0.5
10	2457	12.150	0.5
11	2462	12.160	0.5
12	2467	11.750	0.5
13	2472	14.020	0.5
Worst		11.750	0.5

10.1.2.802.11n HT20 MODE IN THE 2.4 GHz BAND

Channel	Frequency [MHz]	6 dB Bandwidth [MHz]	Minimum Limit [MHz]
1	2412	15.030	0.5
6	2437	12.190	0.5
10	2457	11.680	0.5
11	2462	15.010	0.5
12	2467	13.690	0.5
13	2472	15.050	0.5
Worst		11.680	0.5

10.1.3. 6 dB BANDWIDTH PLOTS

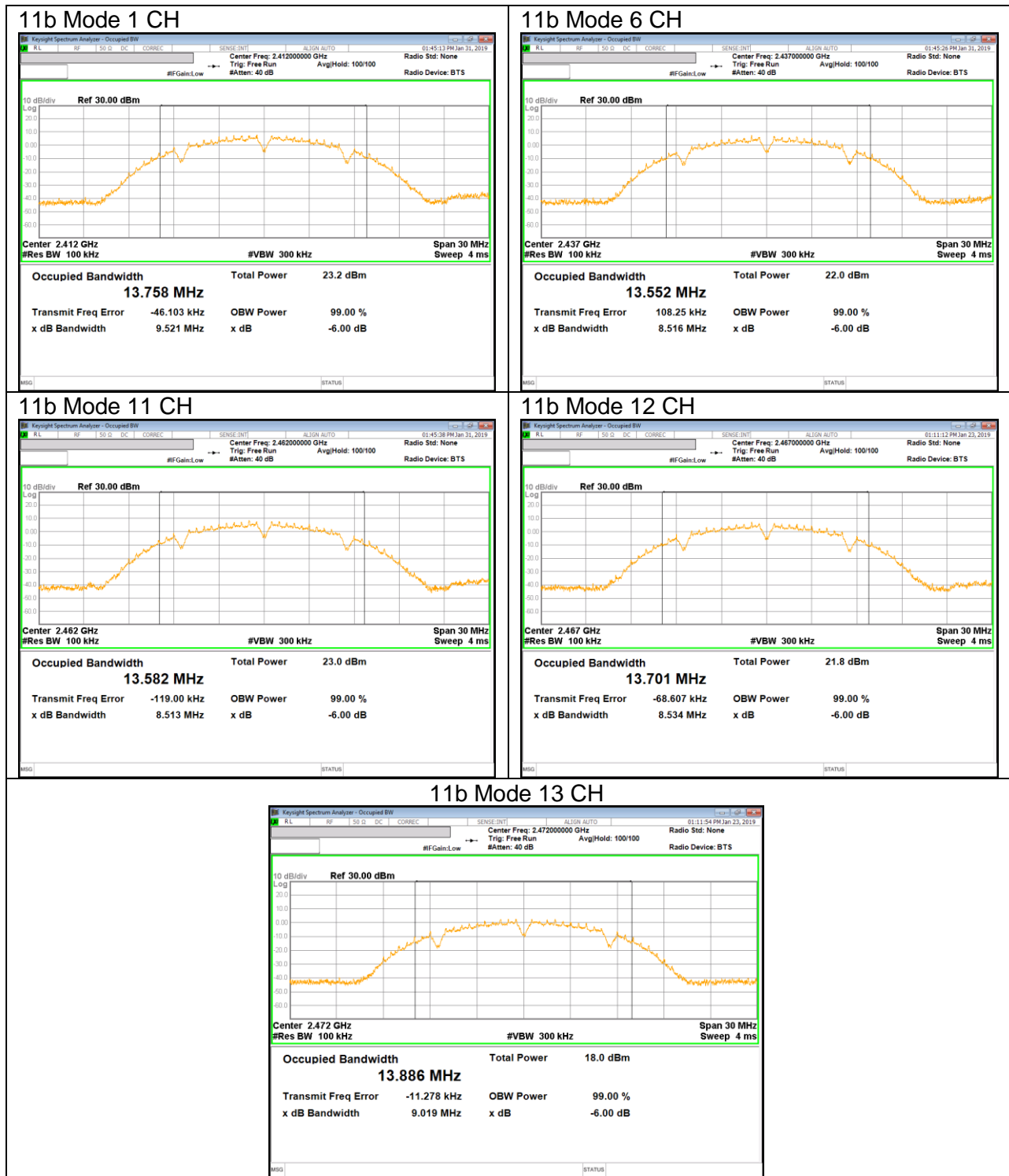

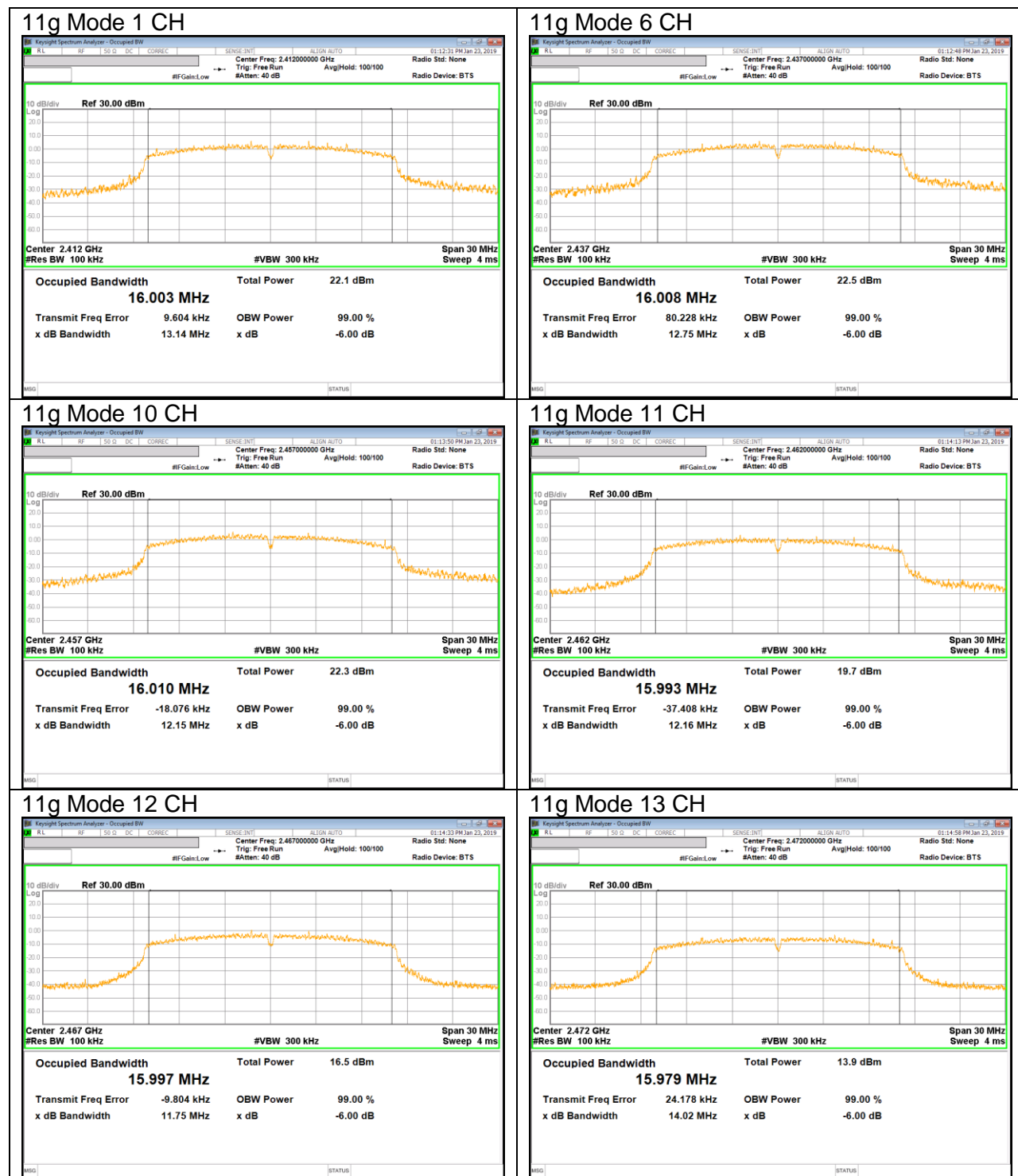

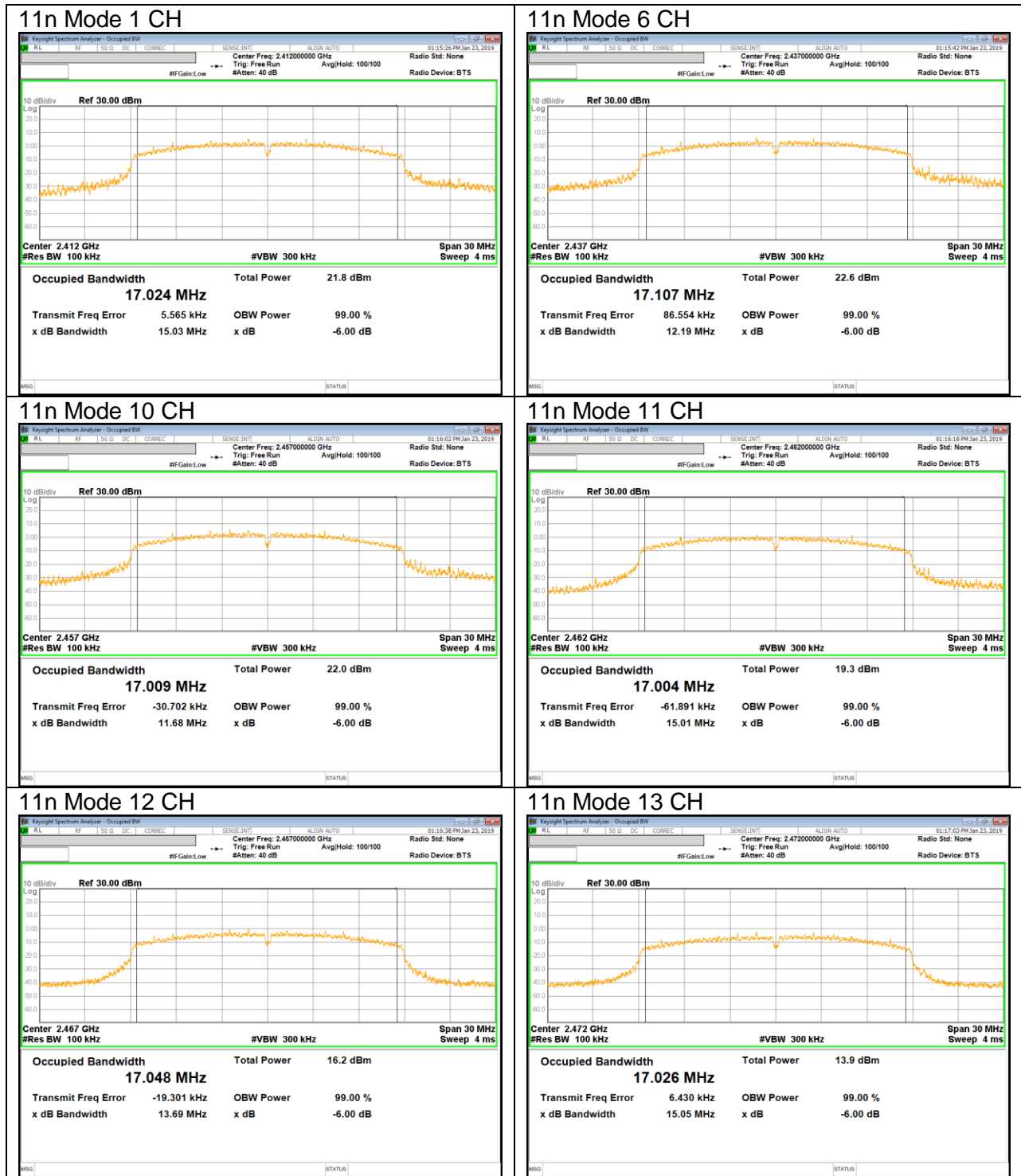

10.2. OUTPUT POWER

LIMITS

FCC §15.247

For systems using digital modulation in the 902–928 MHz, 2400–2483.5 MHz, and 5725–5850 MHz bands: 1 Watt, based on the use of antennas with directional gains that do not exceed 6 dBi. If transmitting antennas of directional gain greater than 6 dBi are used, the conducted output power from the intentional radiator shall be reduced by the amount in dB that the directional gain of the antenna exceeds 6 dBi.

DIRECTIONAL ANTENNA GAIN

There is only one transmitter output therefore the directional gain is equal to the antenna gain.

TEST PROCEDURE

The transmitter output is connected to a power meter.

The cable assembly insertion loss was entered as an offset in the power meter to allow for direct reading of power.

Output power measurement was performed utilizing the “§11.9.2.3.1 Method AVGPM” under ANSI C63.10(2013).

Duty cycle correction factor is not added to the average output power results for duty cycle factor > 98%. (802.11b mode)

Duty cycle correction factor is already added to the average output power results for duty cycle factor < 98%. (802.11g, 802.11n mode)

RESULTS

10.2.1.802.11b MODE IN THE 2.4 GHz BAND

Limits

Channel	Frequency [MHz]	Directional Gain Primary [dBi]	FCC Power Limit [dBm]	Max Power [dBm]
1	2412	-2.11	30.00	30.00
6	2437		30.00	30.00
11	2462		30.00	30.00
12	2467		30.00	30.00
13	2472		30.00	30.00

Results

Channel	Frequency [MHz]	Meas Power [dBm]	Total Power [dBm]	Power Limit [dBm]	Margin [dB]
1	2412	16.76	16.76	30.00	-13.24
6	2437	16.36	16.36	30.00	-13.64
11	2462	16.82	16.82	30.00	-13.18
12	2467	15.53	15.53	30.00	-14.47
13	2472	11.44	11.44	30.00	-18.56
Worst			16.82	30.00	-13.18

10.2.2.802.11g MODE IN THE 2.4 GHz BAND

Limits

Channel	Frequency [MHz]	Directional Gain Primary [dBi]	FCC Power Limit [dBm]	Max Power [dBm]
1	2412	-2.11	30.00	30.00
6	2437		30.00	30.00
10	2457		30.00	30.00
11	2462		30.00	30.00
12	2467		30.00	30.00
13	2472		30.00	30.00

Results

Channel	Frequency [MHz]	Meas Power [dBm]	Total Power [dBm]	Power Limit [dBm]	Margin [dB]
1	2412	16.15	16.15	30.00	-13.85
6	2437	16.63	16.63	30.00	-13.37
10	2457	16.62	16.62	30.00	-13.38
11	2462	14.40	14.40	30.00	-15.60
12	2467	10.74	10.74	30.00	-19.26
13	2472	8.94	8.94	30.00	-21.06
Worst			16.63	30.00	-13.37

10.2.3.802.11n HT20 MODE IN THE 2.4 GHz BAND

Limits

Channel	Frequency [MHz]	Directional Gain Primary [dBi]	FCC Power Limit [dBm]	Max Power [dBm]
1	2412	-2.11	30.00	30.00
6	2437		30.00	30.00
10	2457		30.00	30.00
11	2462		30.00	30.00
12	2467		30.00	30.00
13	2472		30.00	30.00

Results

Channel	Frequency [MHz]	Meas Power [dBm]	Total Power [dBm]	Power Limit [dBm]	Margin [dB]
1	2412	15.83	15.83	30.00	-14.17
6	2437	16.45	16.45	30.00	-13.55
10	2457	16.25	16.25	30.00	-13.75
11	2462	13.26	13.26	30.00	-16.74
12	2467	11.11	11.11	30.00	-18.89
13	2472	9.34	9.34	30.00	-20.66
Worst			16.45	30.00	-13.55

10.3. PSD

LIMITS

FCC §15.247

The power spectral density conducted from the transmitter to the antenna shall not be greater than 8 dBm in any 3 kHz band during any time interval of continuous transmission.

TEST PROCEDURE

Power Spectral Density was performed utilizing the "Method § 11.10.3 Method AVGPS-1 (802.11 b mode) and § 11.10.5 Method AVGPS-2 (802.11 g/n mode) under ANSI C63.10(2013).

RESULTS

10.3.1.802.11b MODE IN THE 2.4 GHZ BAND

PSD Results

Channel	Frequency [MHz]	PSD Meas [dBm]	Duty Factor [dB]	Final PSD [dBm/3kHz]	Limit [dBm/3kHz]	Margin [dB]
1	2412	-14.078	0.00	-14.078	8.00	-22.078
6	2437	-14.496	0.00	-14.496	8.00	-22.496
11	2462	-14.780	0.00	-14.780	8.00	-22.780
12	2467	-16.580	0.00	-16.580	8.00	-24.580
13	2472	-18.612	0.00	-18.612	8.00	-26.612

10.3.2.802.11g MODE IN THE 2.4 GHZ BAND

PSD Results

Channel	Frequency [MHz]	PSD Meas [dBm]	Duty Factor [dB]	Final PSD [dBm/3kHz]	Limit [dBm/3kHz]	Margin [dB]
1	2412	-14.677	0.13	-14.547	8.00	-22.677
6	2437	-14.915	0.13	-14.785	8.00	-22.915
10	2457	-14.686	0.13	-14.556	8.00	-22.686
11	2462	-16.786	0.13	-16.656	8.00	-24.786
12	2467	-21.525	0.13	-21.395	8.00	-29.525
13	2472	-22.675	0.13	-22.545	8.00	-30.675

10.3.3.802.11n HT20 MODE IN THE 2.4 GHZ BAND

PSD Results

Channel	Frequency [MHz]	PSD Meas [dBm]	Duty Factor [dB]	Final PSD [dBm/3kHz]	Limit [dBm/3kHz]	Margin [dB]
1	2412	-15.084	0.13	-14.954	8.00	-23.084
6	2437	-14.869	0.13	-14.739	8.00	-22.869
10	2457	-14.665	0.13	-14.535	8.00	-22.665
11	2462	-17.636	0.13	-17.506	8.00	-25.636
12	2467	-20.565	0.13	-20.435	8.00	-28.565
13	2472	-22.620	0.13	-22.490	8.00	-30.620

10.3.4.PSD PLOTS

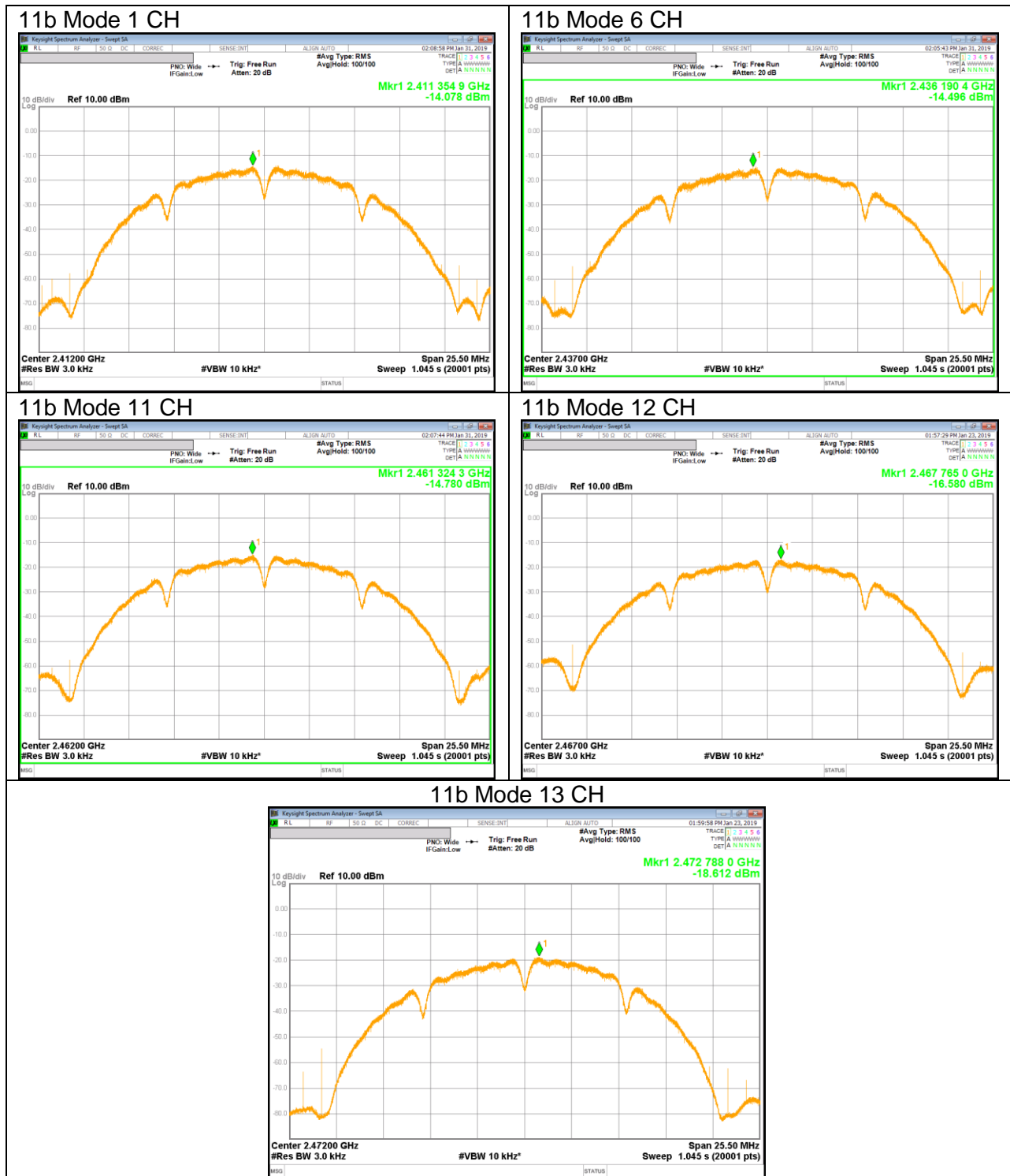

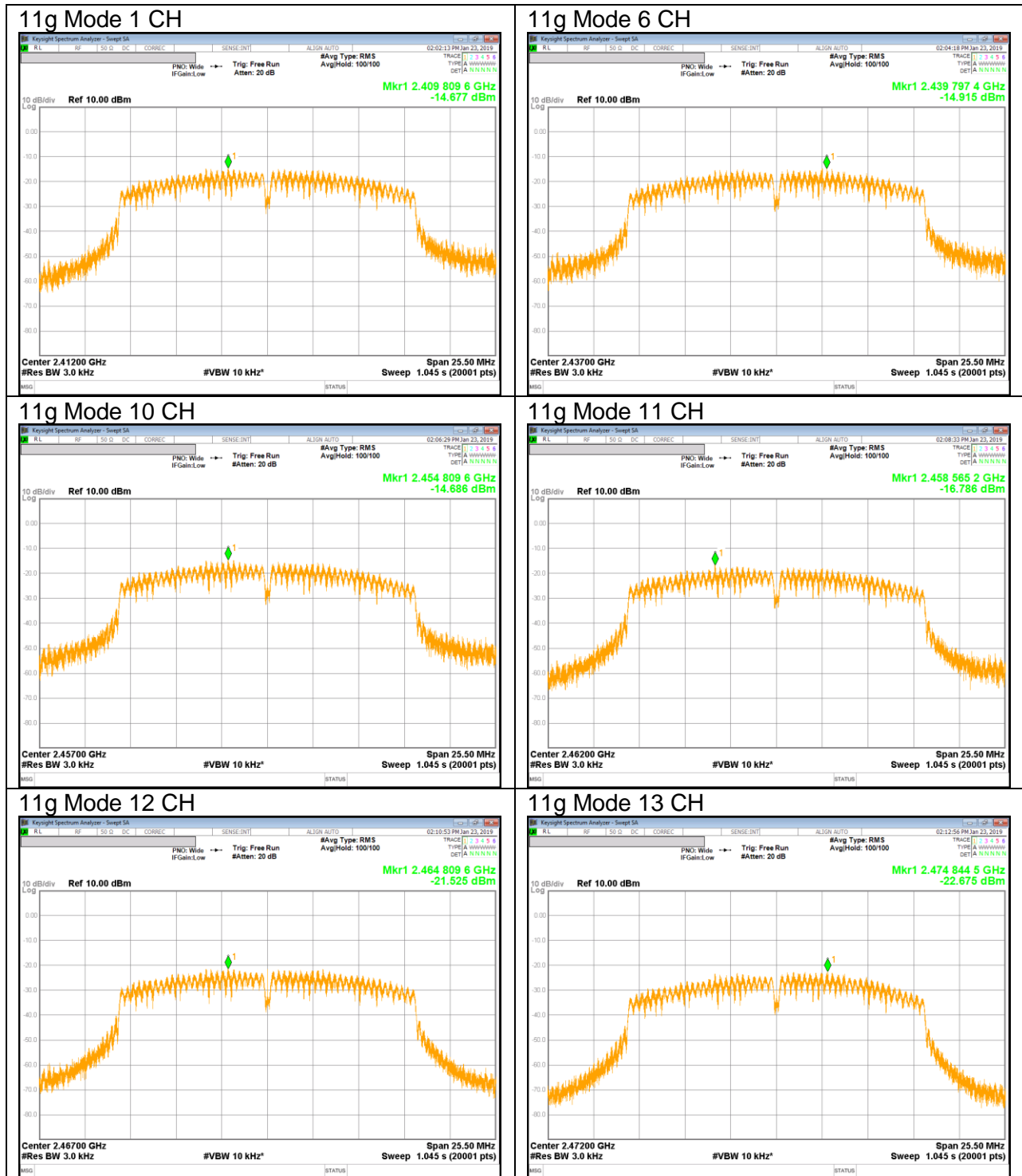

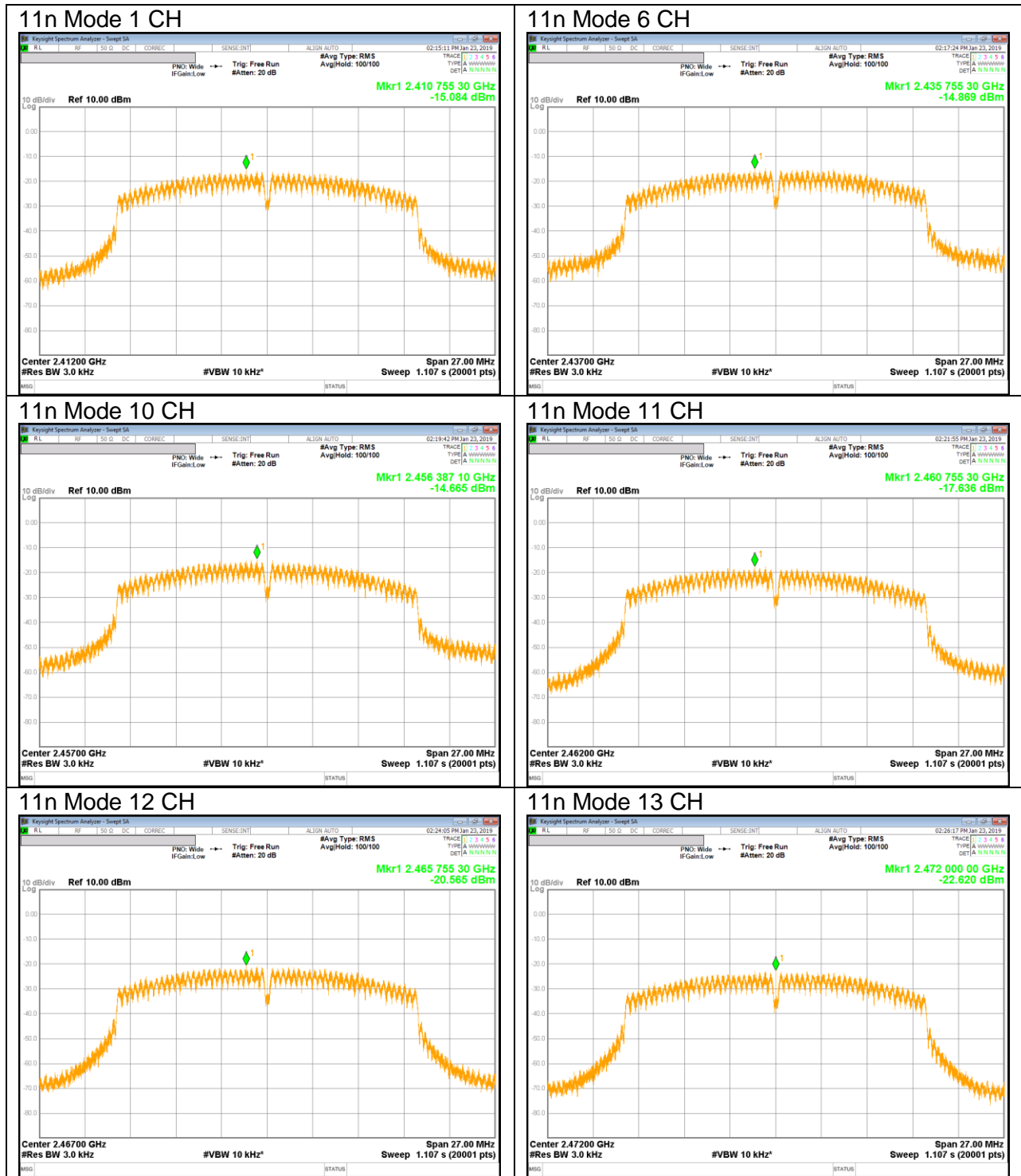

10.4. OUT-OF-BAND EMISSIONS

LIMITS

FCC §15.247 (d)

In any 100 kHz bandwidth outside the frequency band in which the spread spectrum or digitally modulated intentional radiator is operating, the radio frequency power that is produced by the intentional radiator shall be at least 20 dB below that in the 100 kHz bandwidth within the band that contains the highest level of the desired power, based on either an RF conducted or a radiated measurement, provided the transmitter demonstrates compliance with the peak conducted power limits. If the transmitter complies with the conducted power limits based on the use of RMS averaging over a time interval, as permitted under paragraph (b)(3) of this section, the attenuation required under this paragraph shall be 30 dB instead of 20 dB. Attenuation below the general limits specified in §15.209(a) is not required.

TEST PROCEDURE

The transmitter output is connected to a spectrum analyzer with RBW = 100 kHz, VBW = 300 kHz, peak detector, and max hold. Measurements utilizing these settings are made of the in-band reference level, bandedge, out-of-band emissions (where measurements to the general radiated limits will not be made)

RESULTS

10.4.1.802.11b MODE IN THE 2.4 GHz BAND

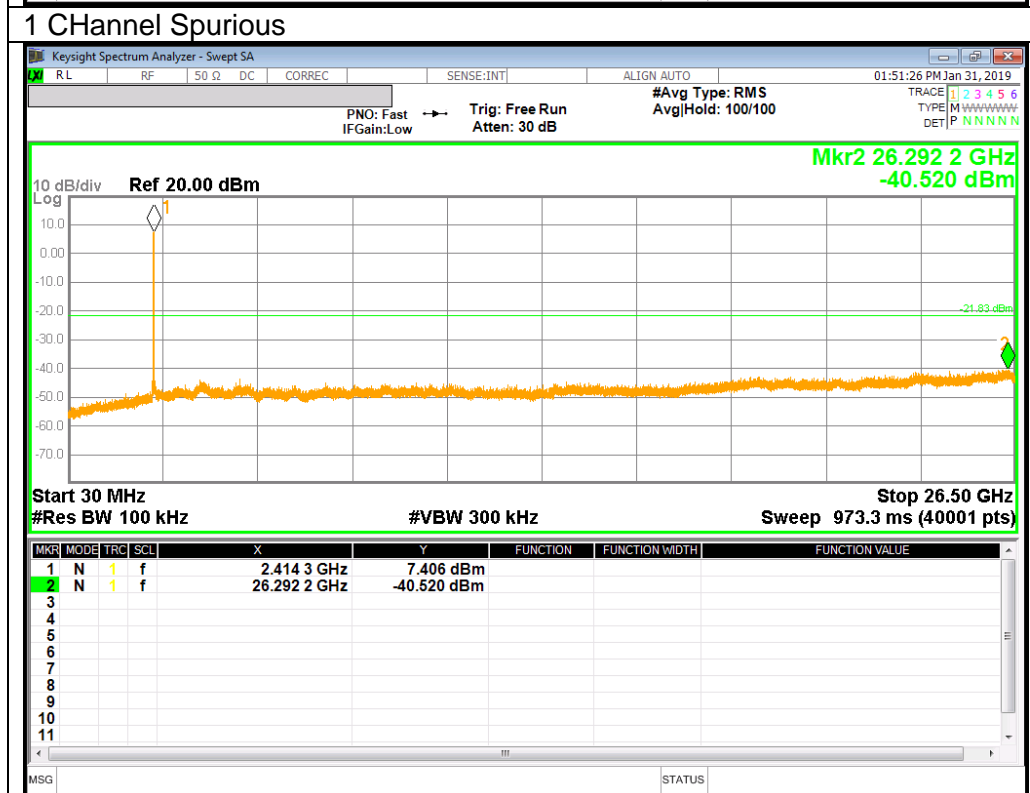
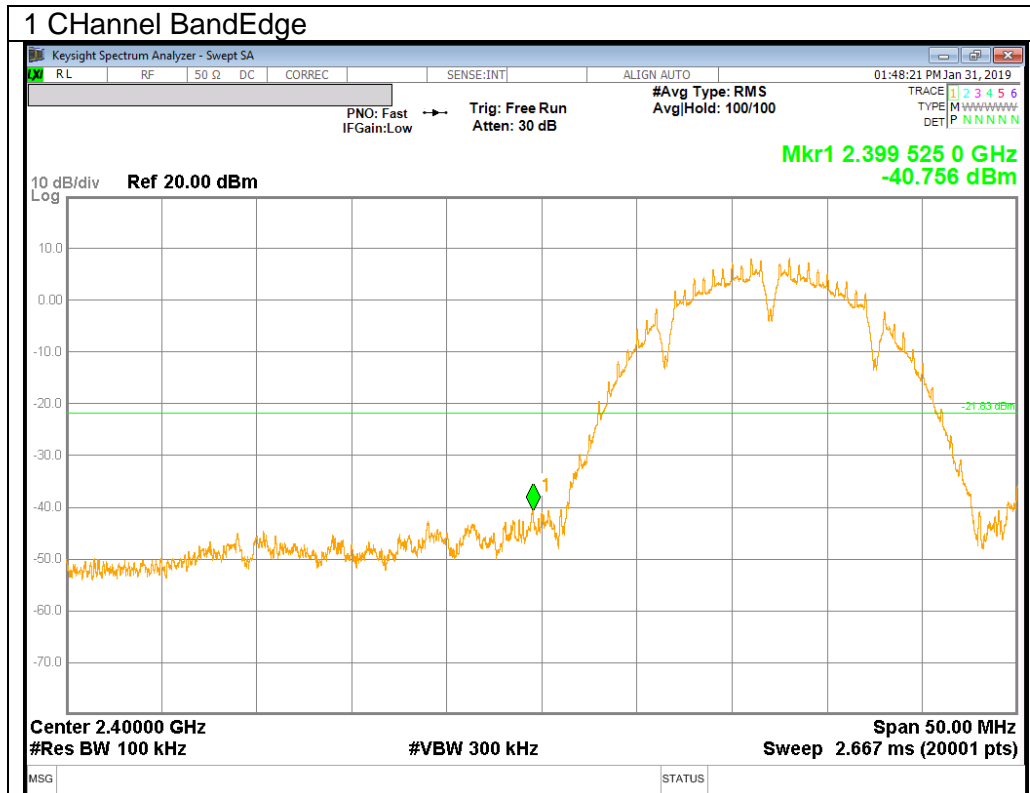

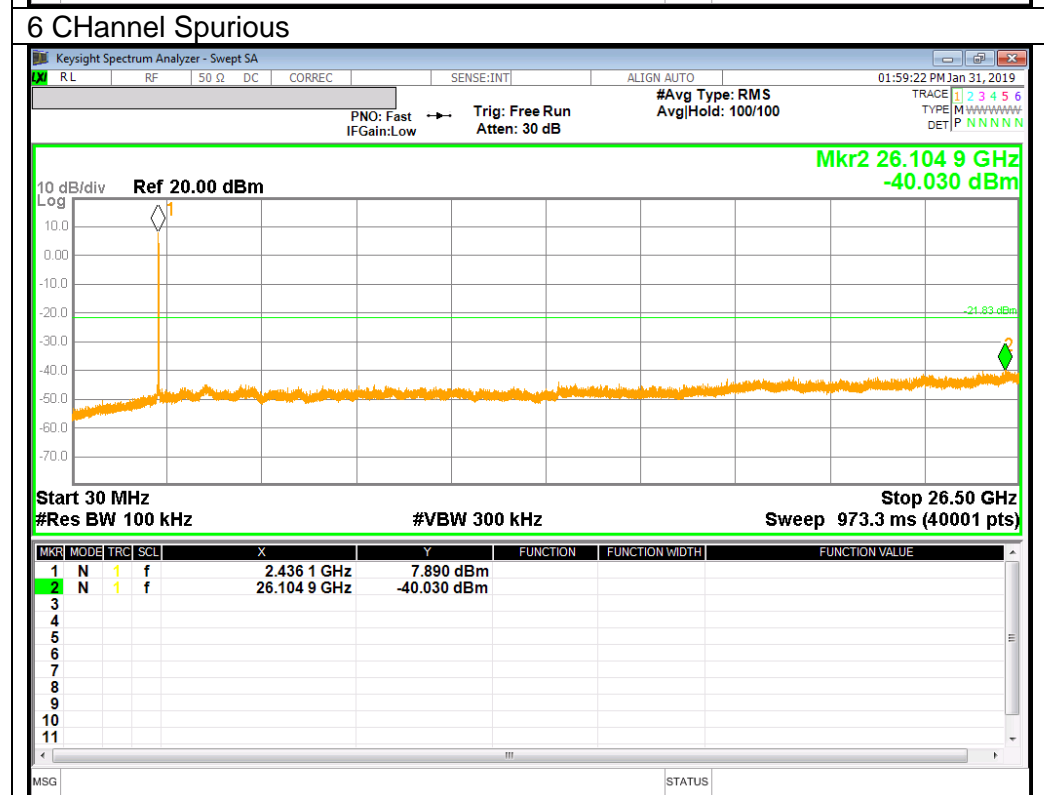
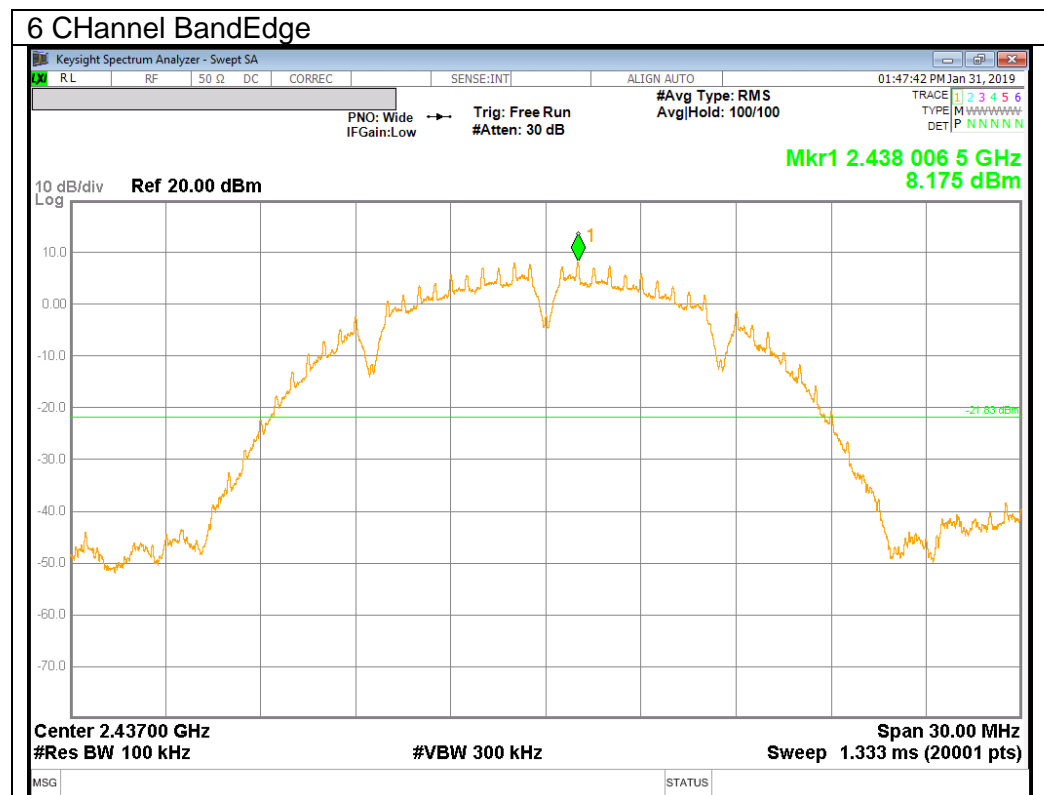

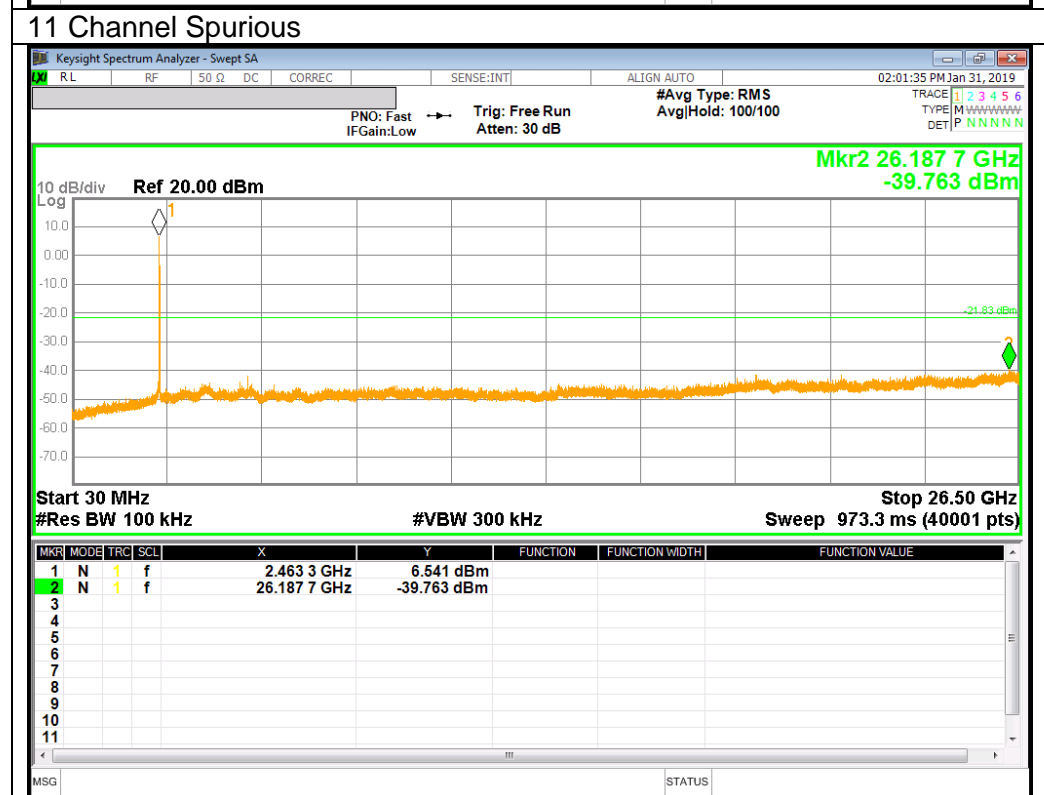
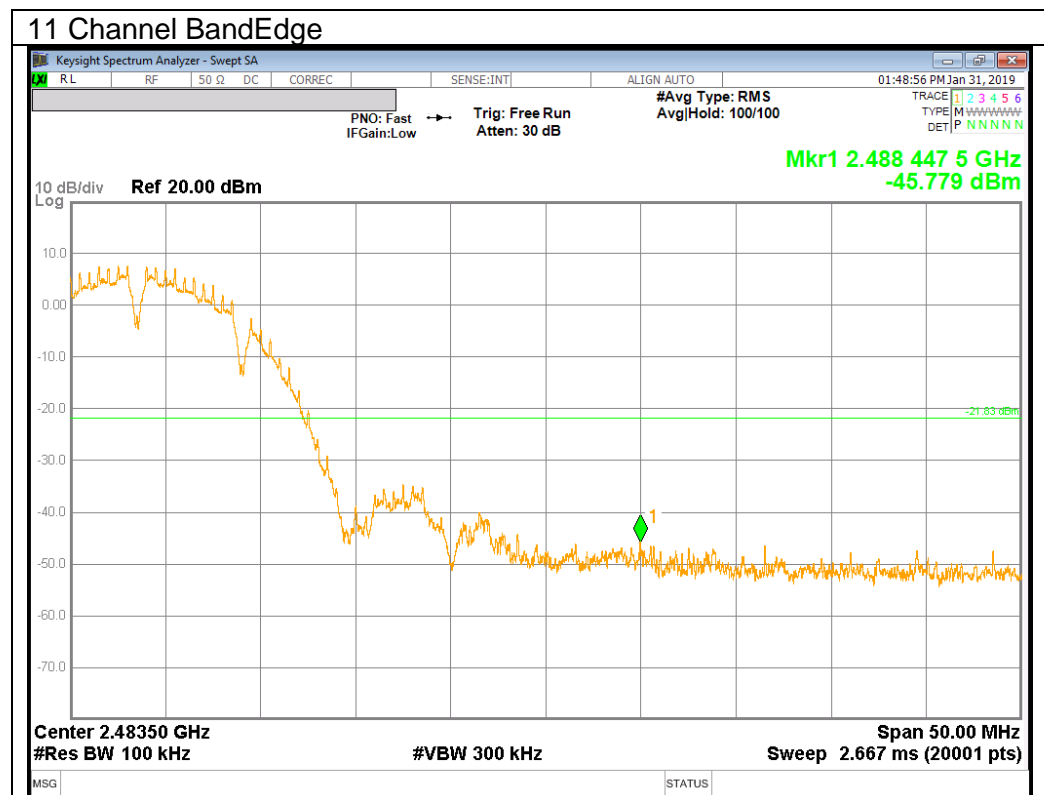

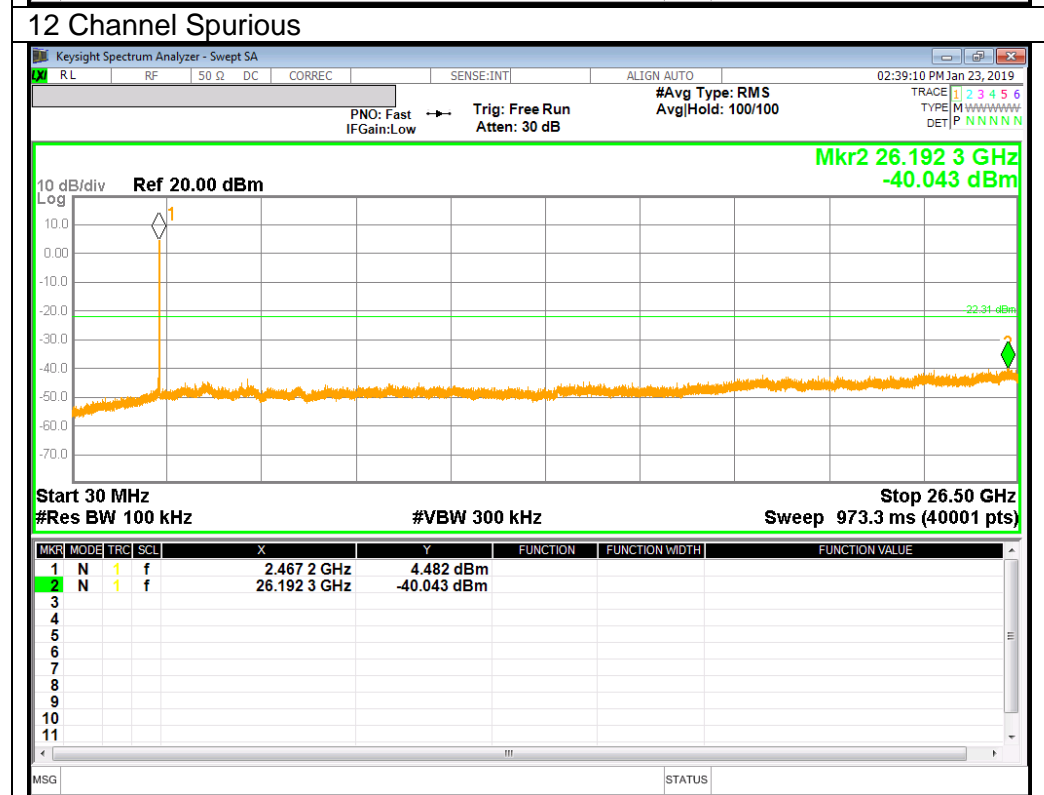
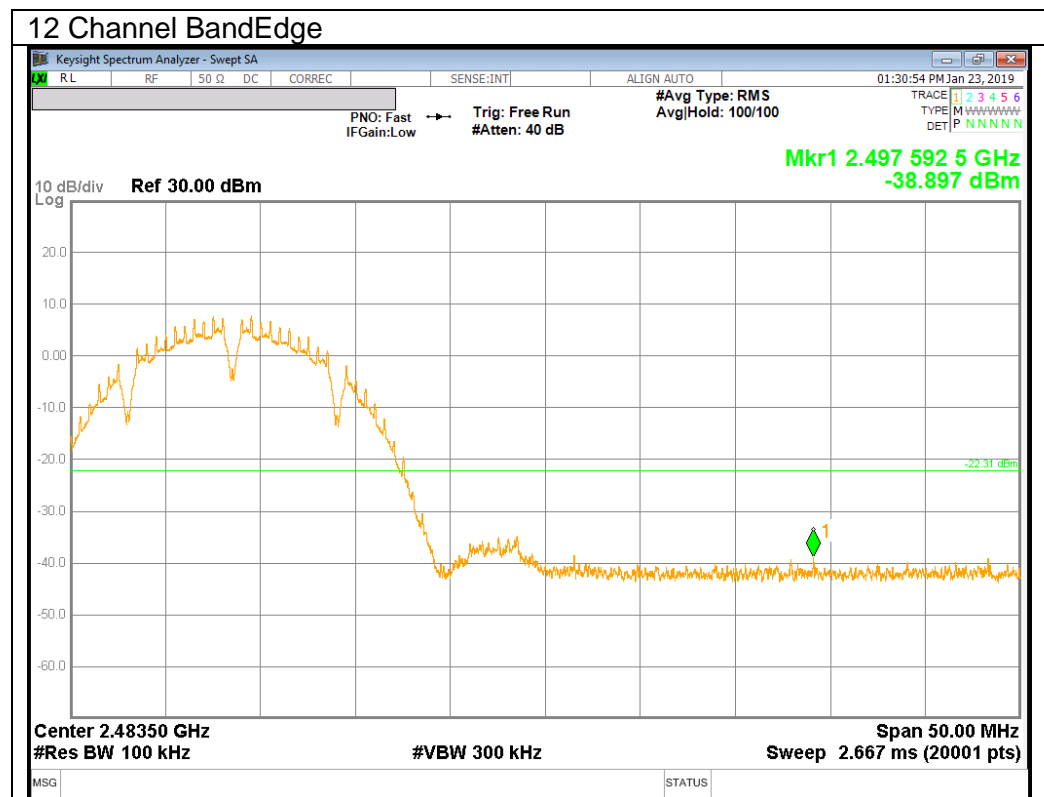

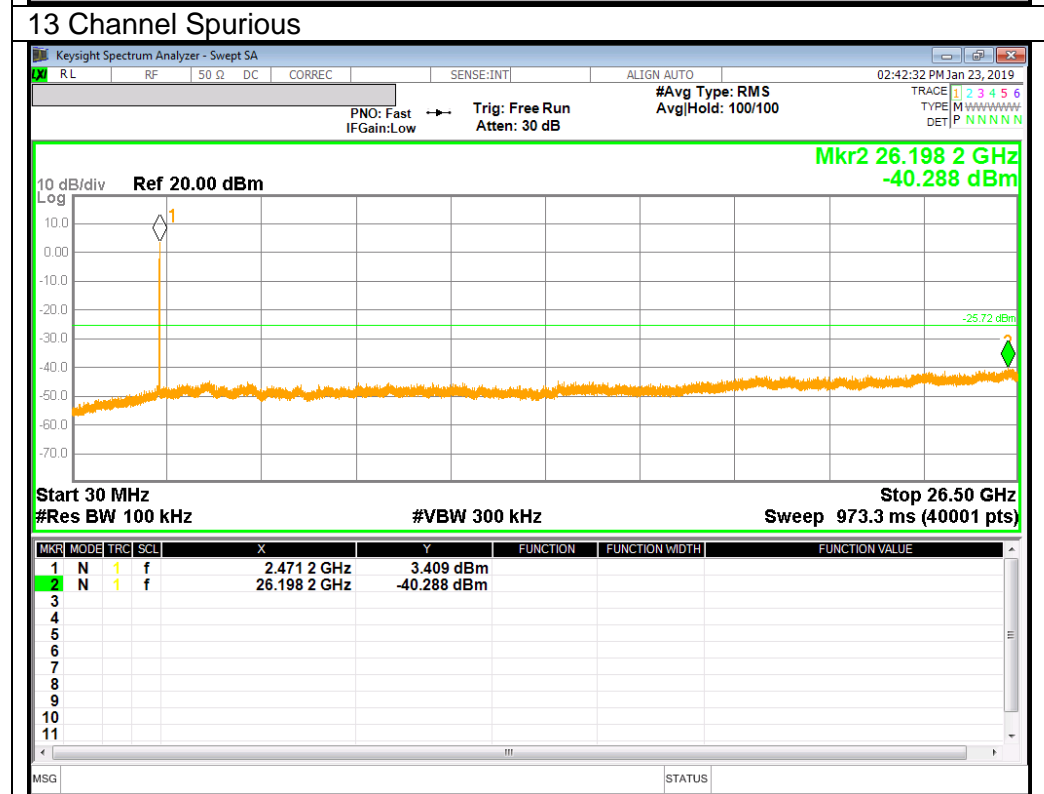
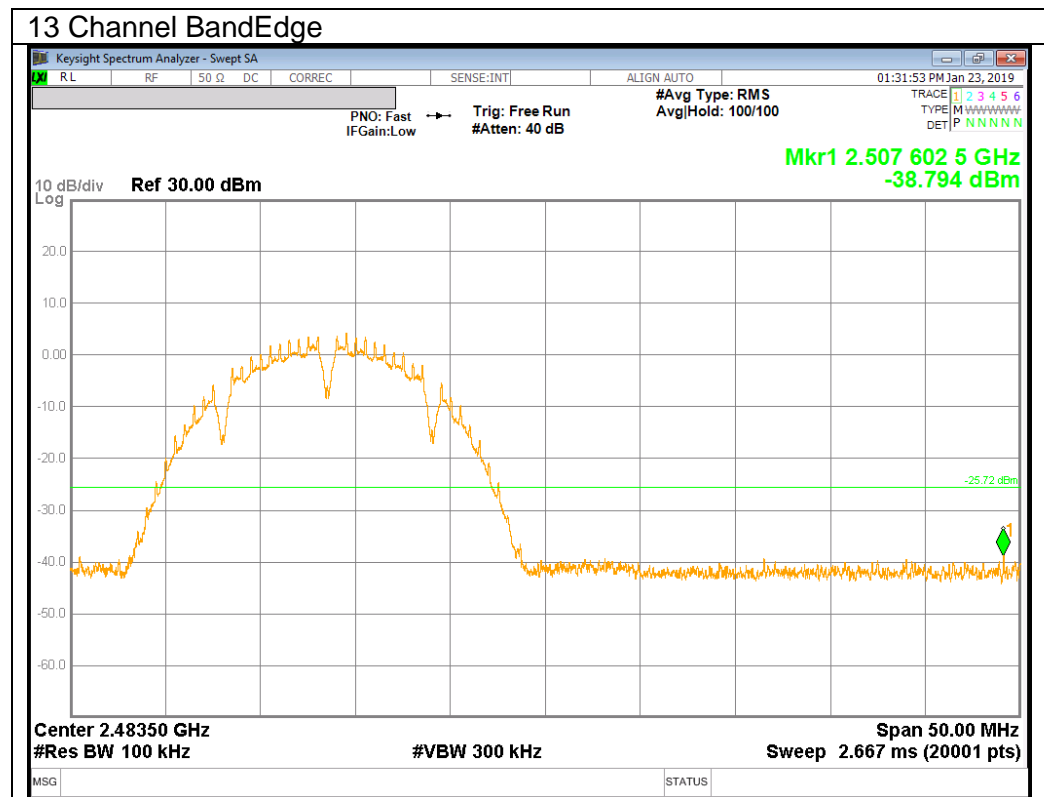

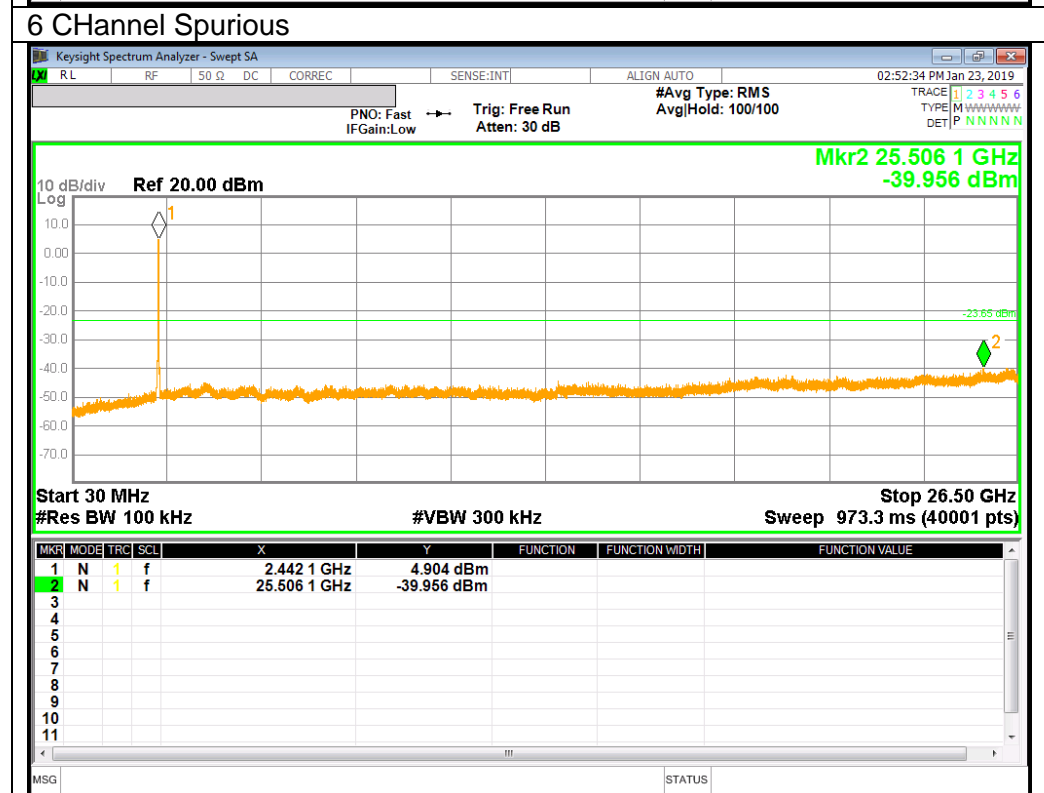
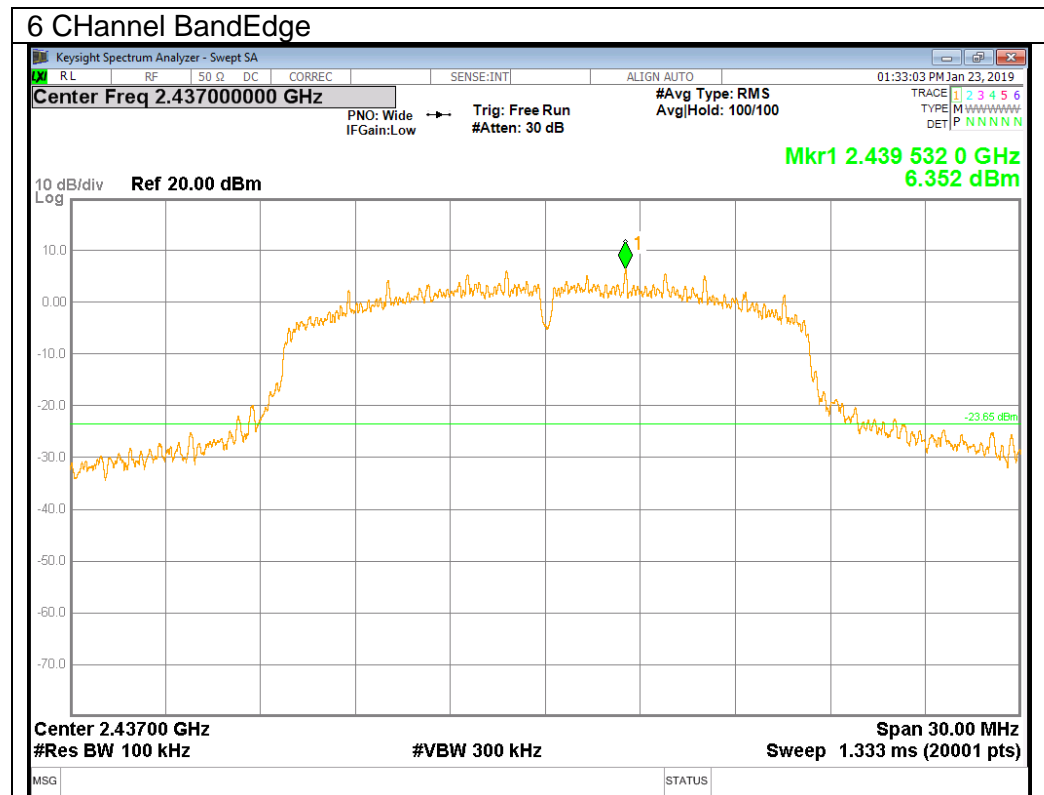

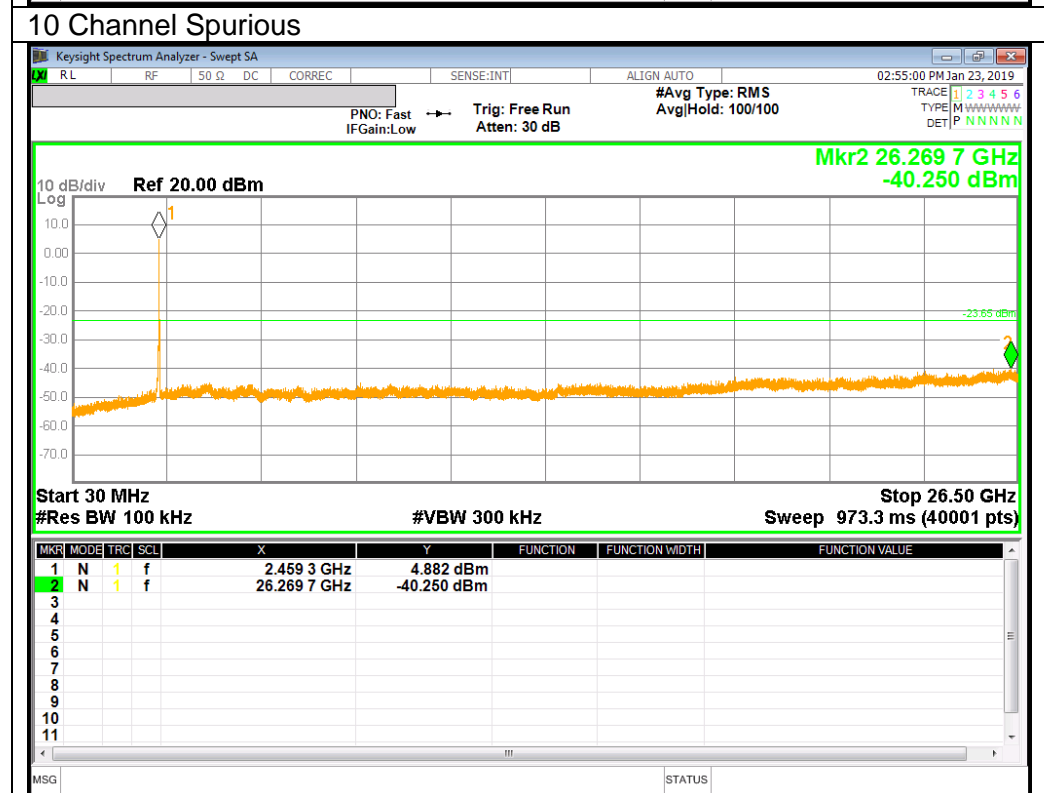
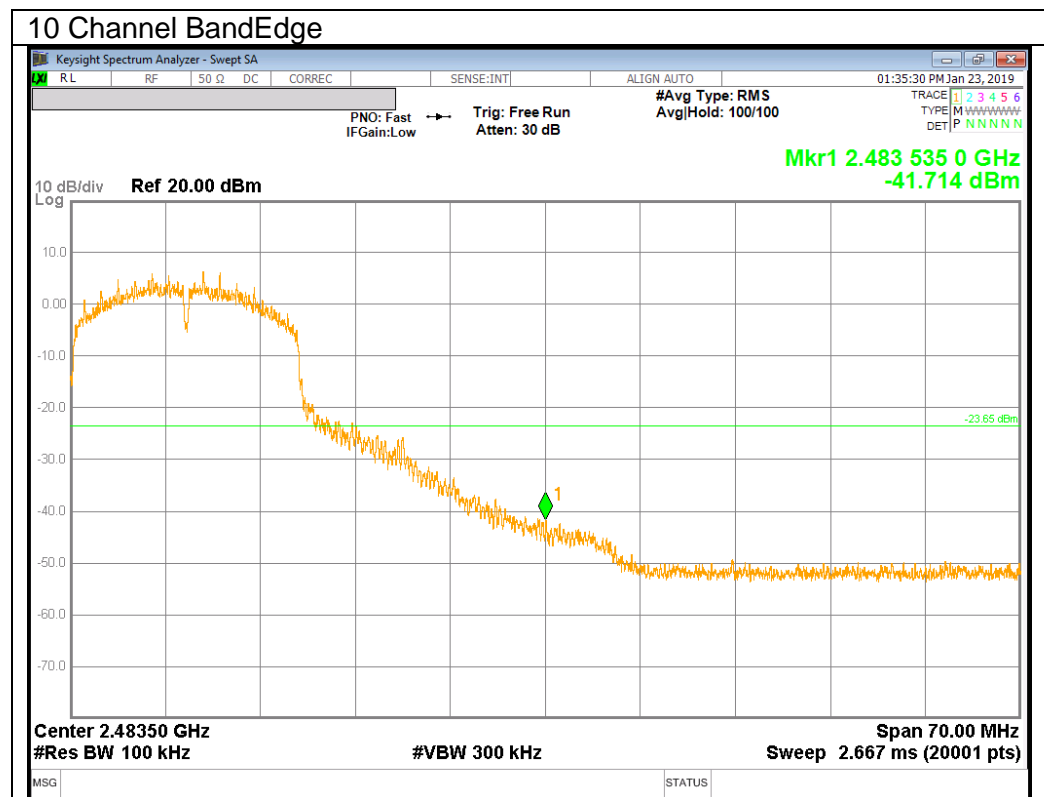

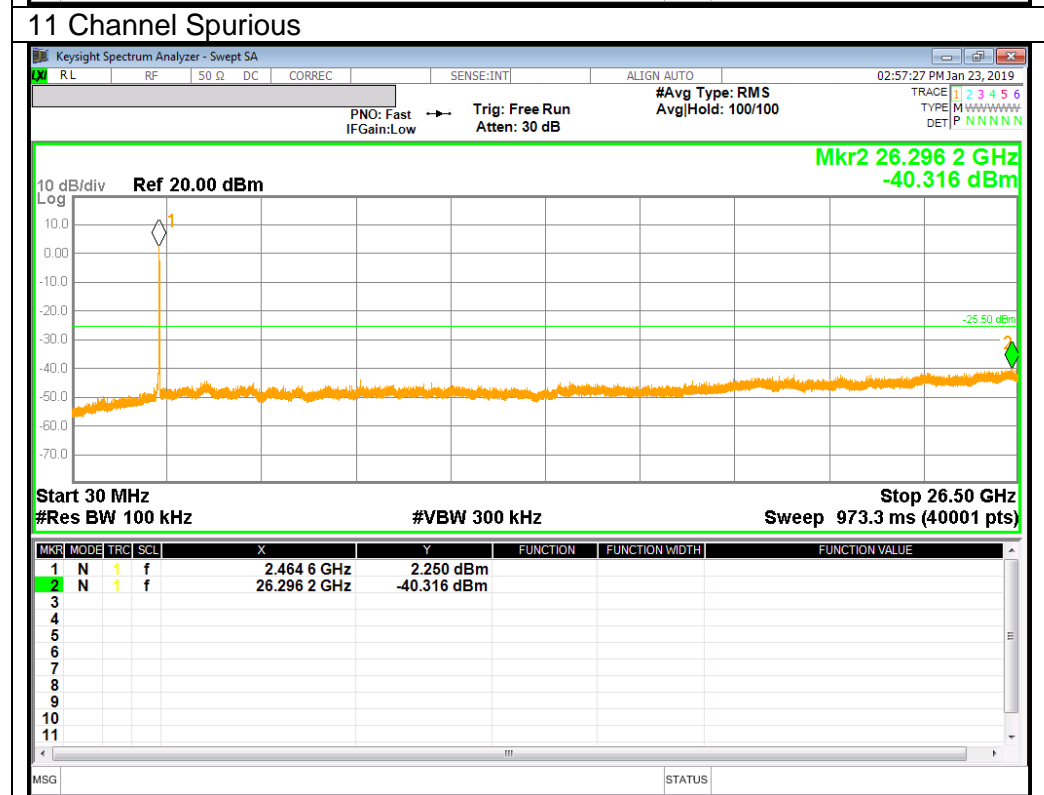
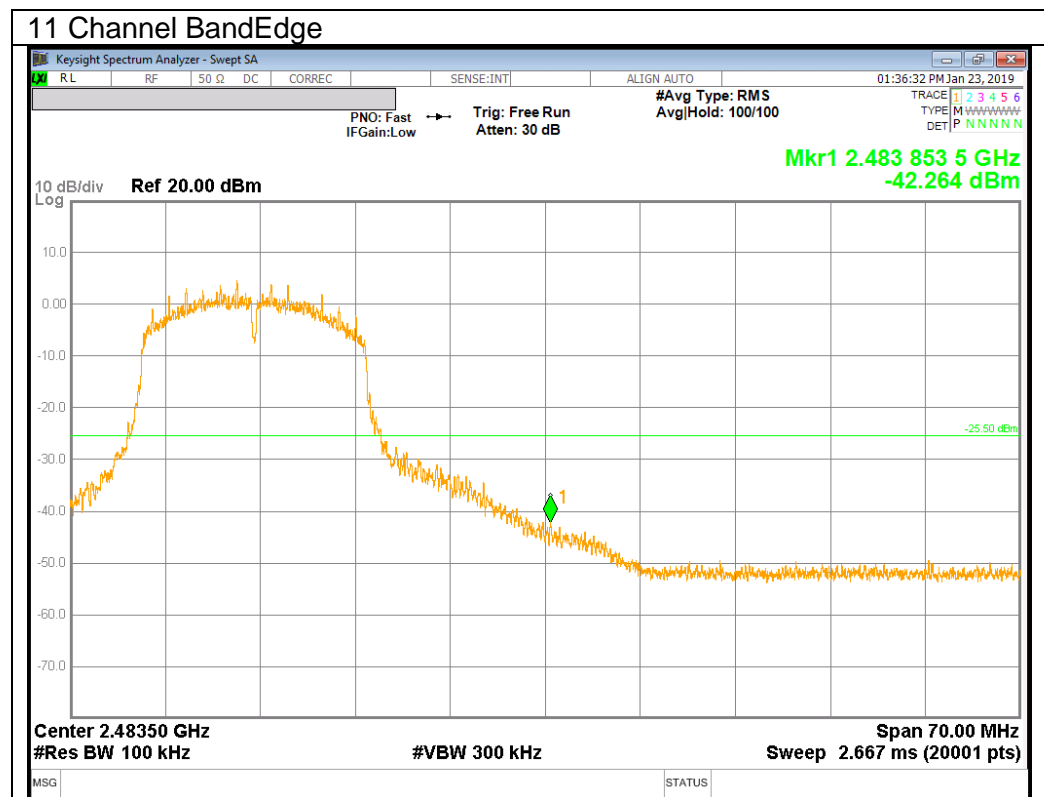

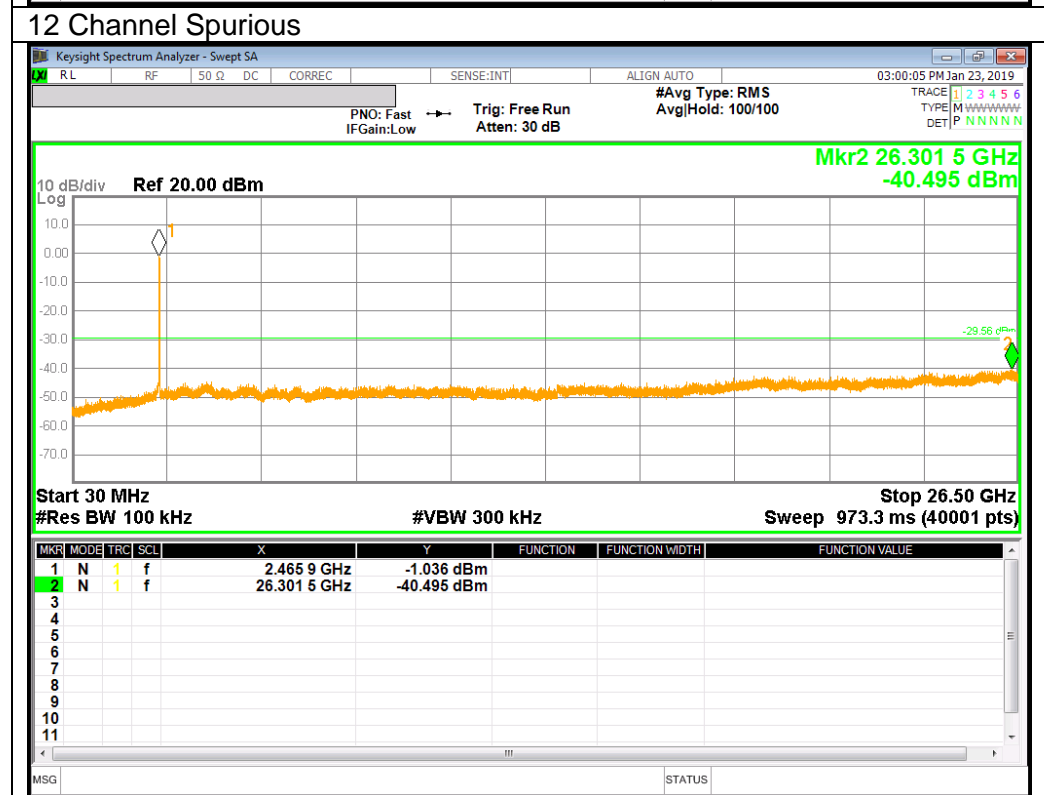
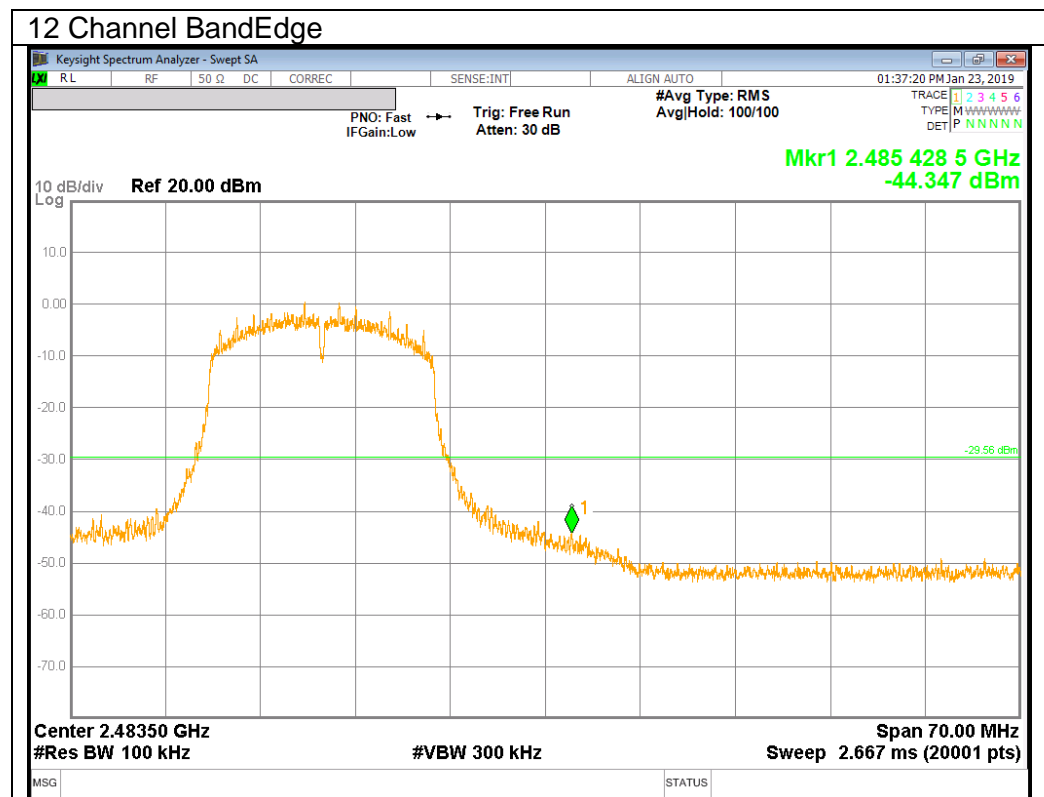

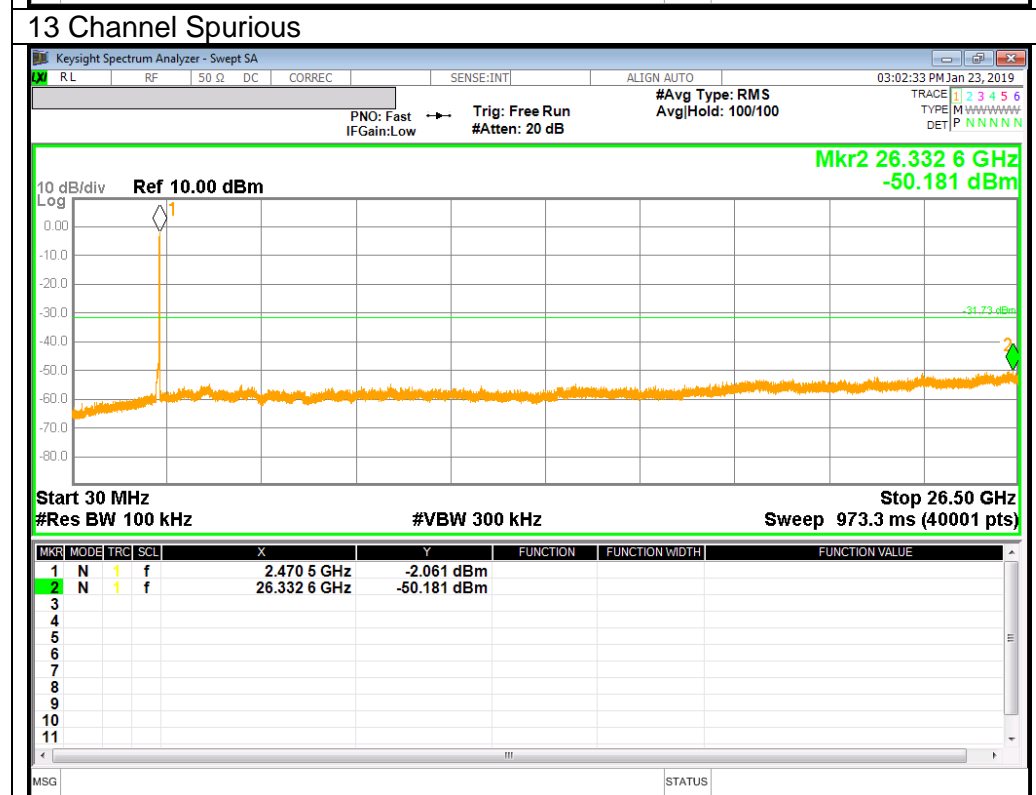
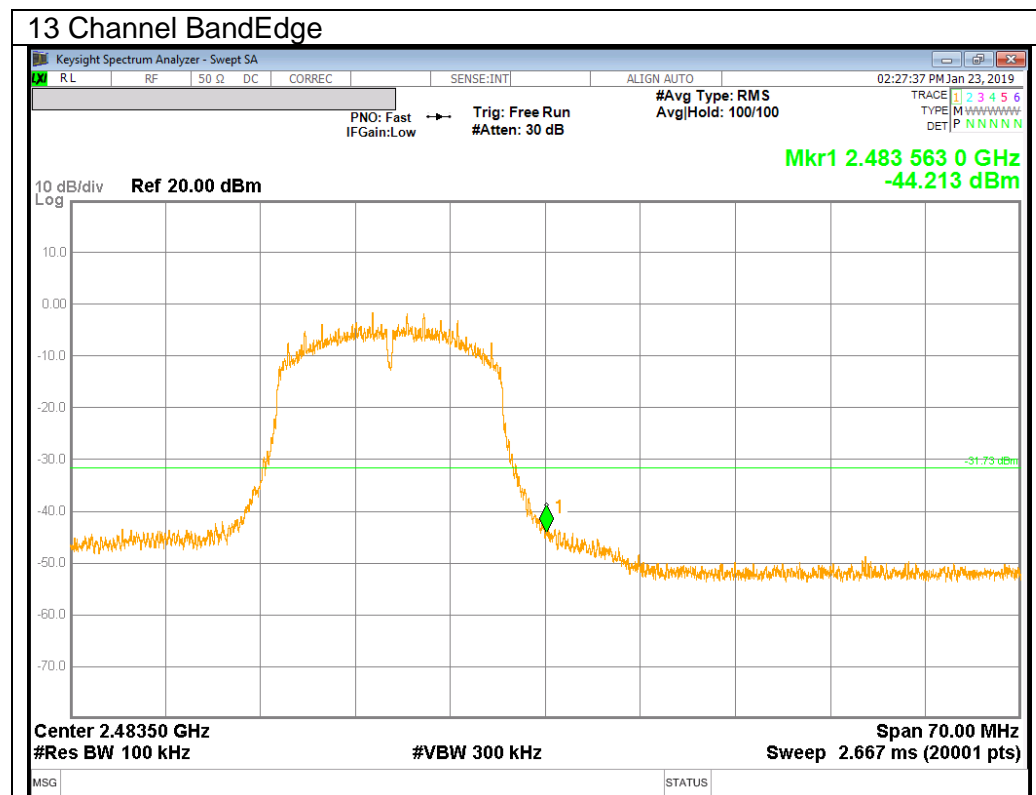

10.4.3.802.11n HT20 MODE IN THE 2.4 GHz BAND

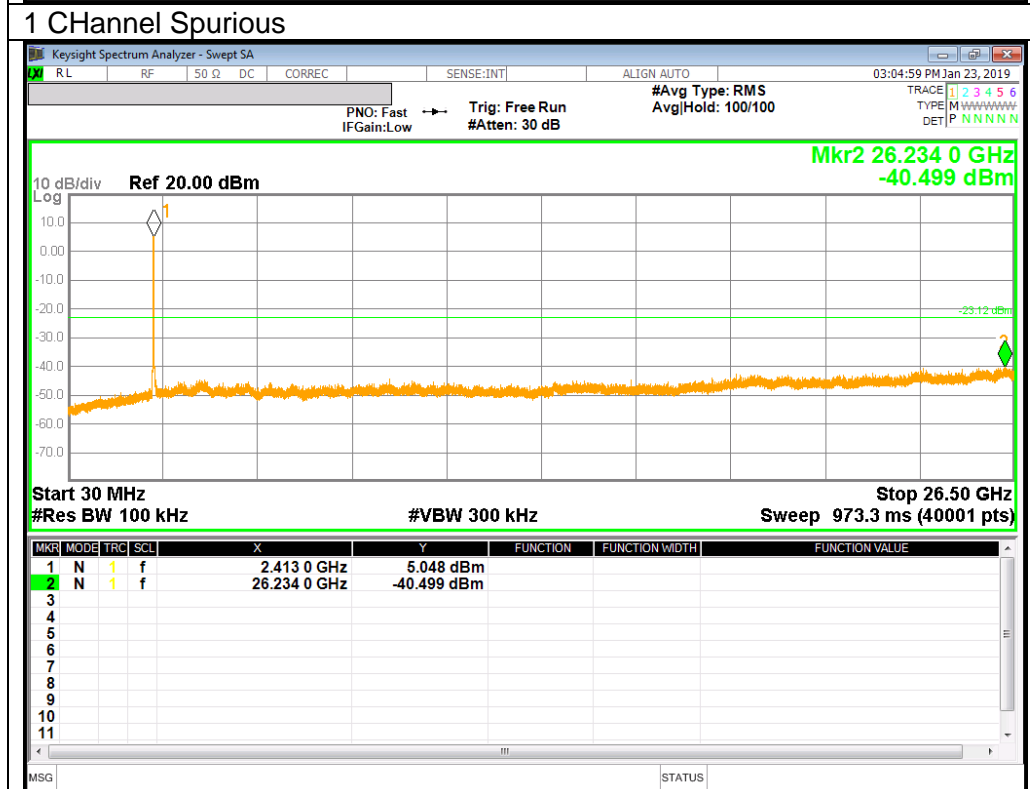
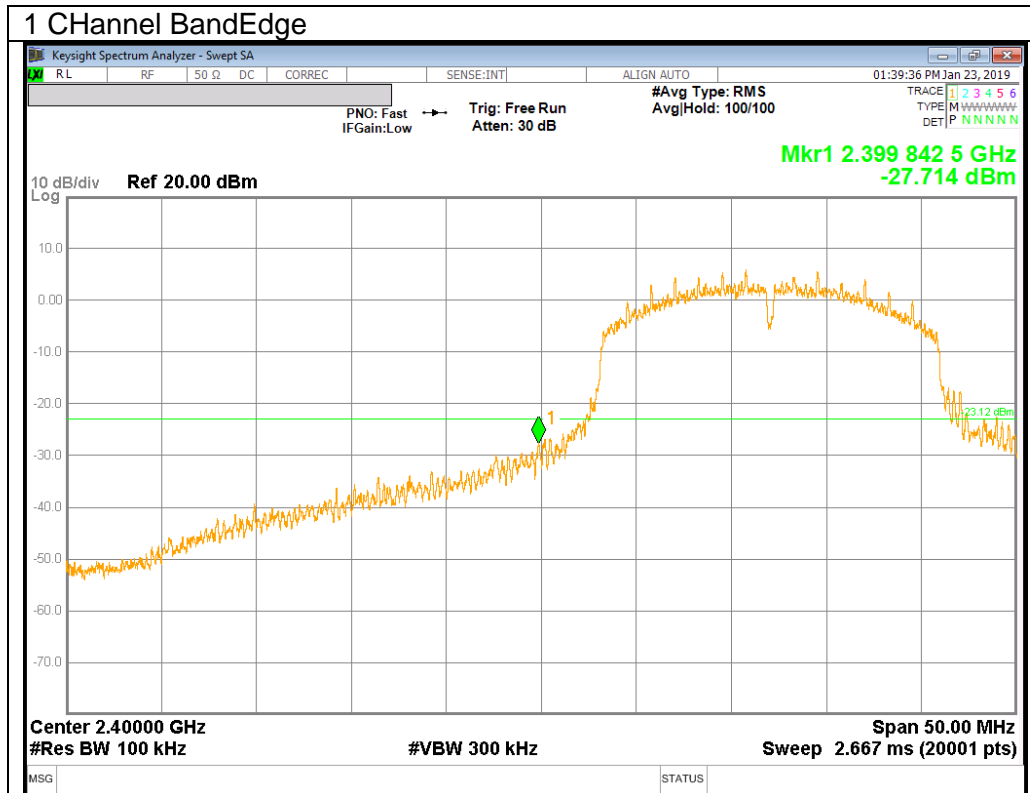

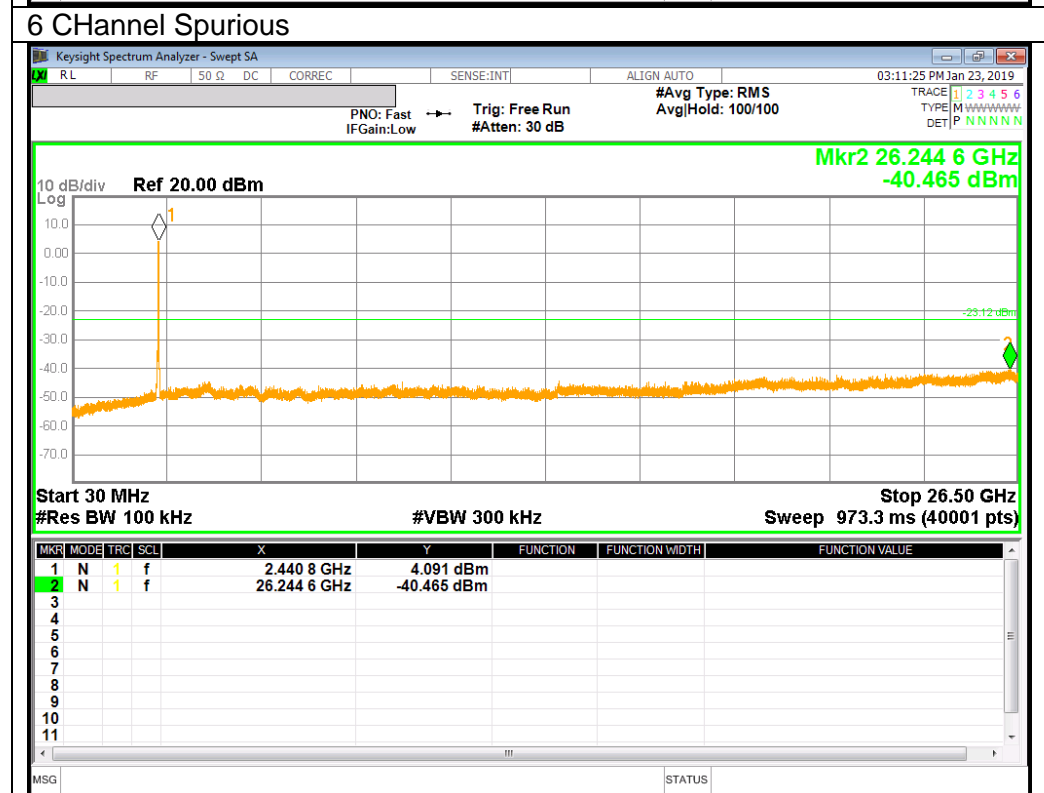
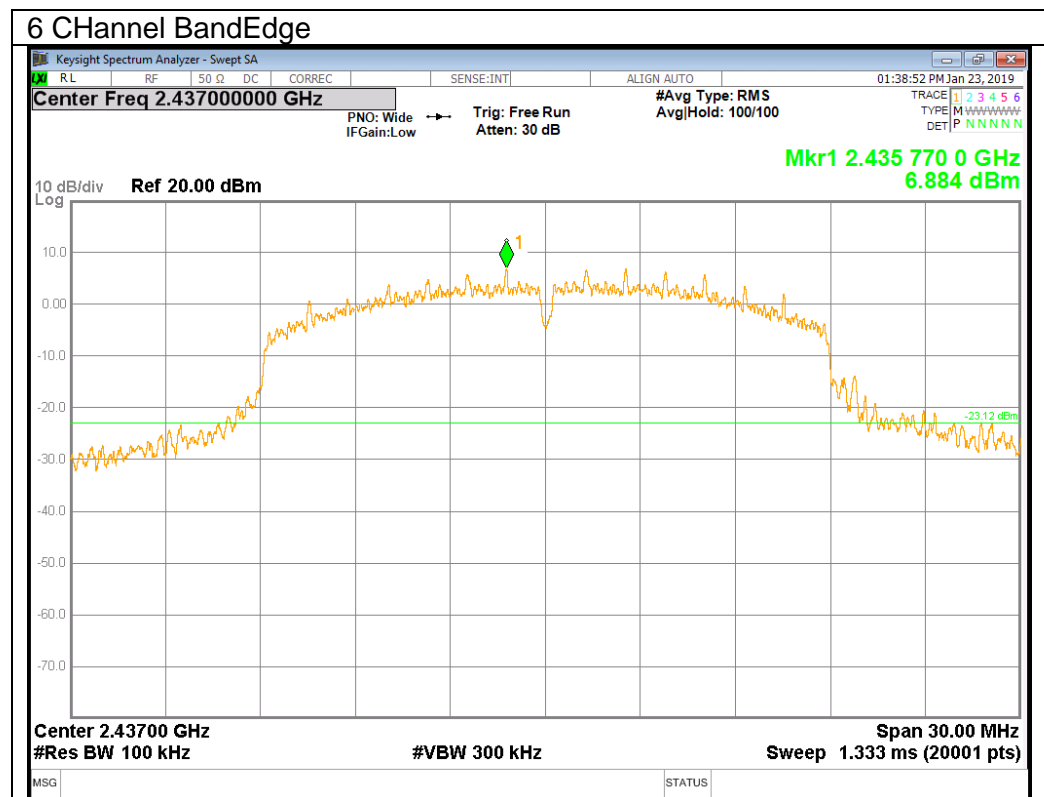

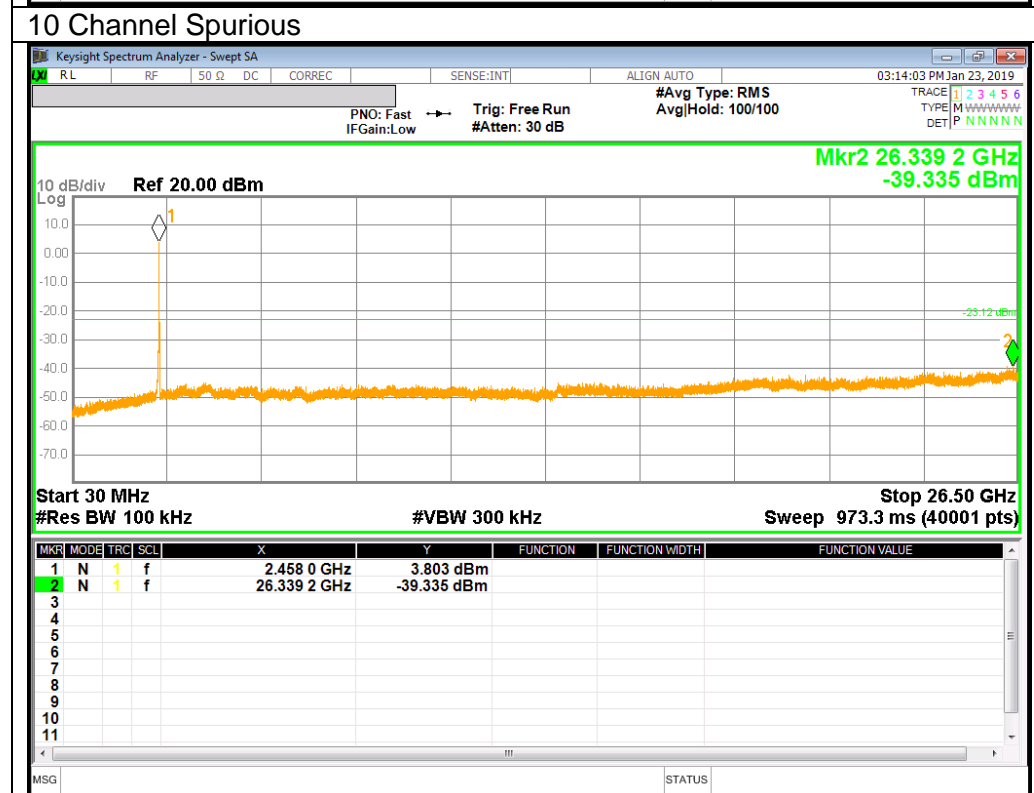
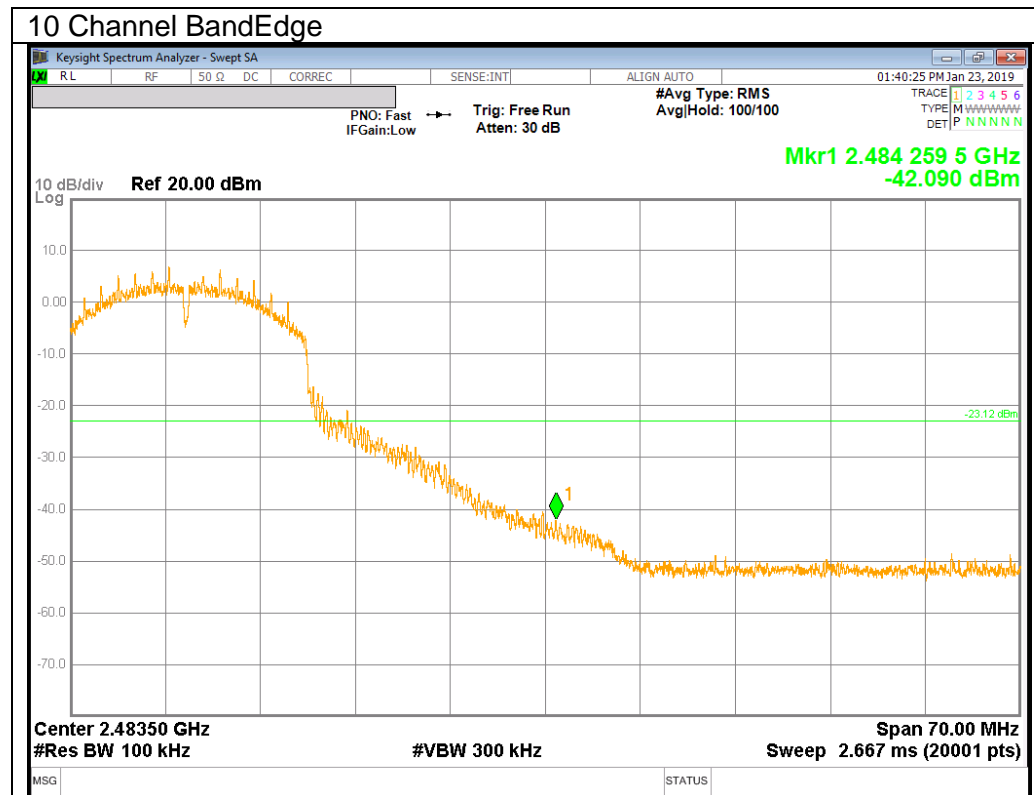

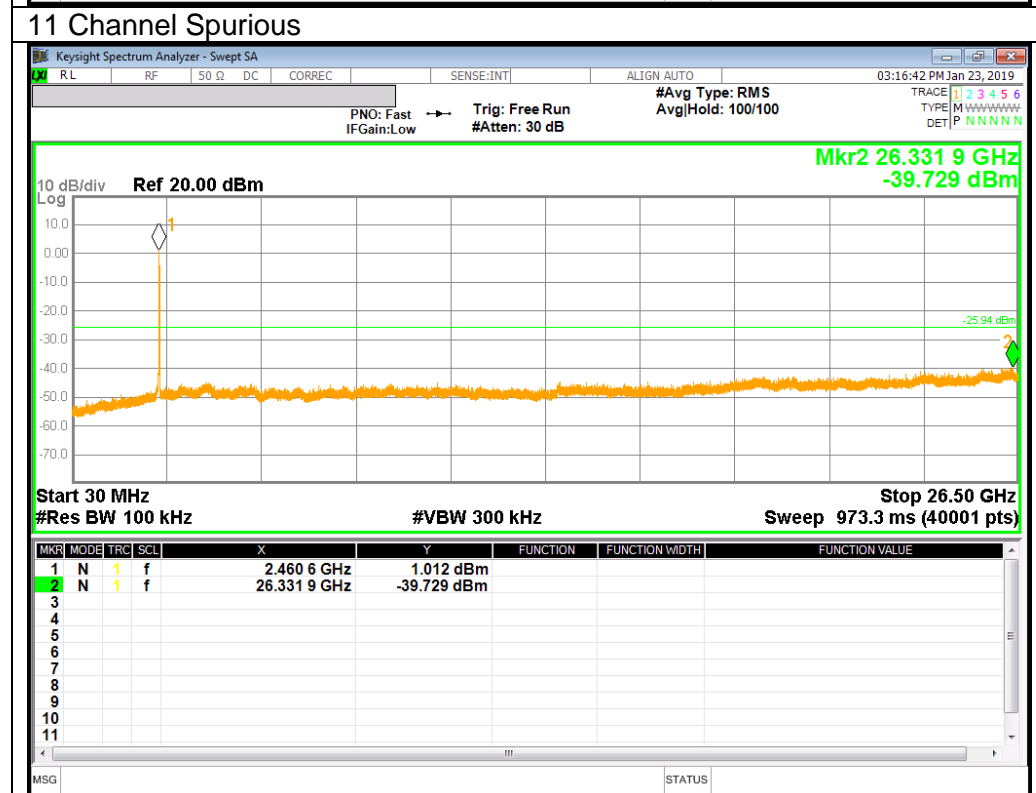
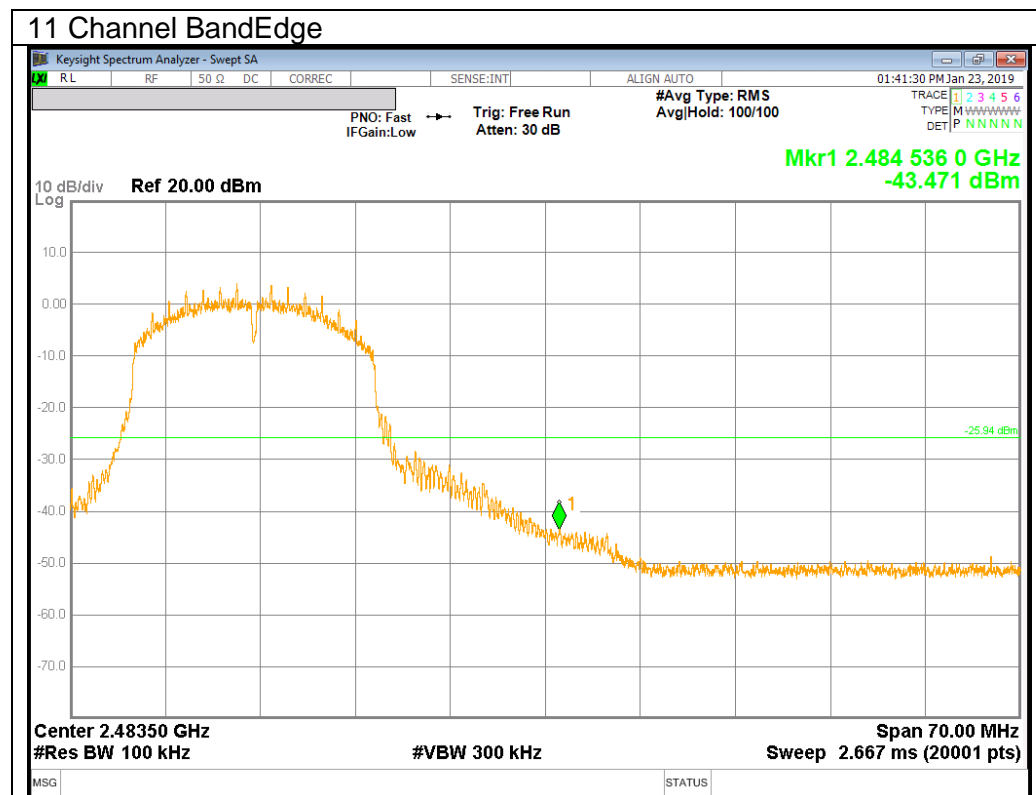

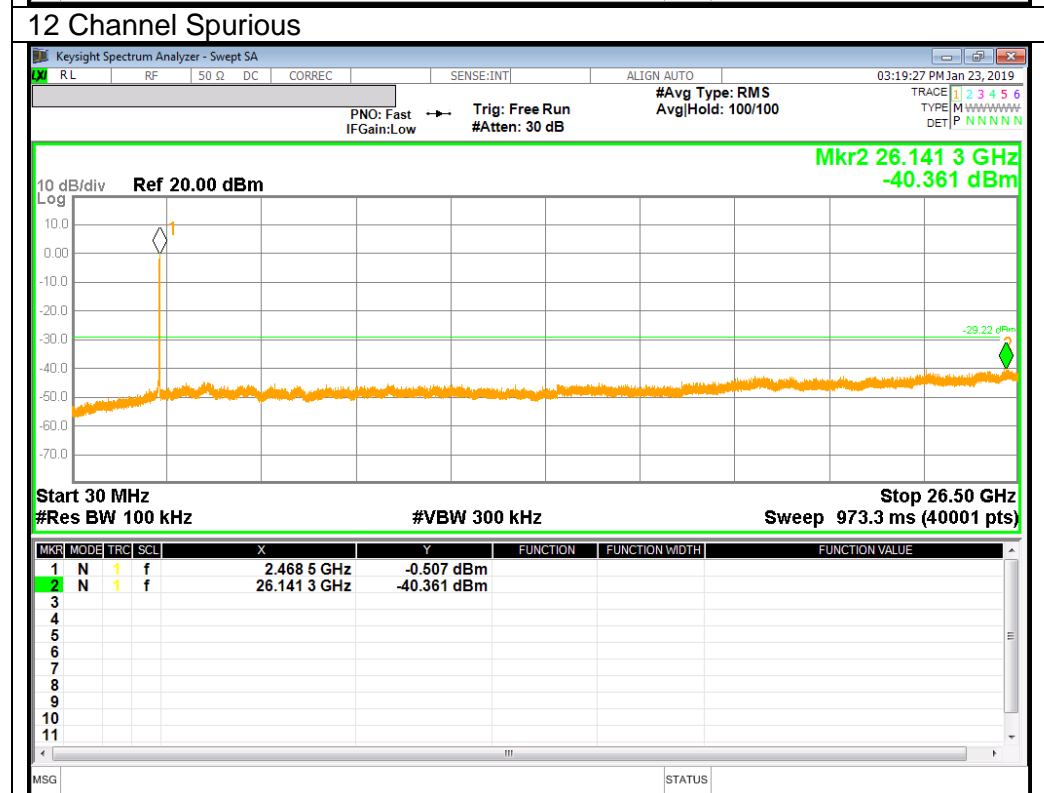
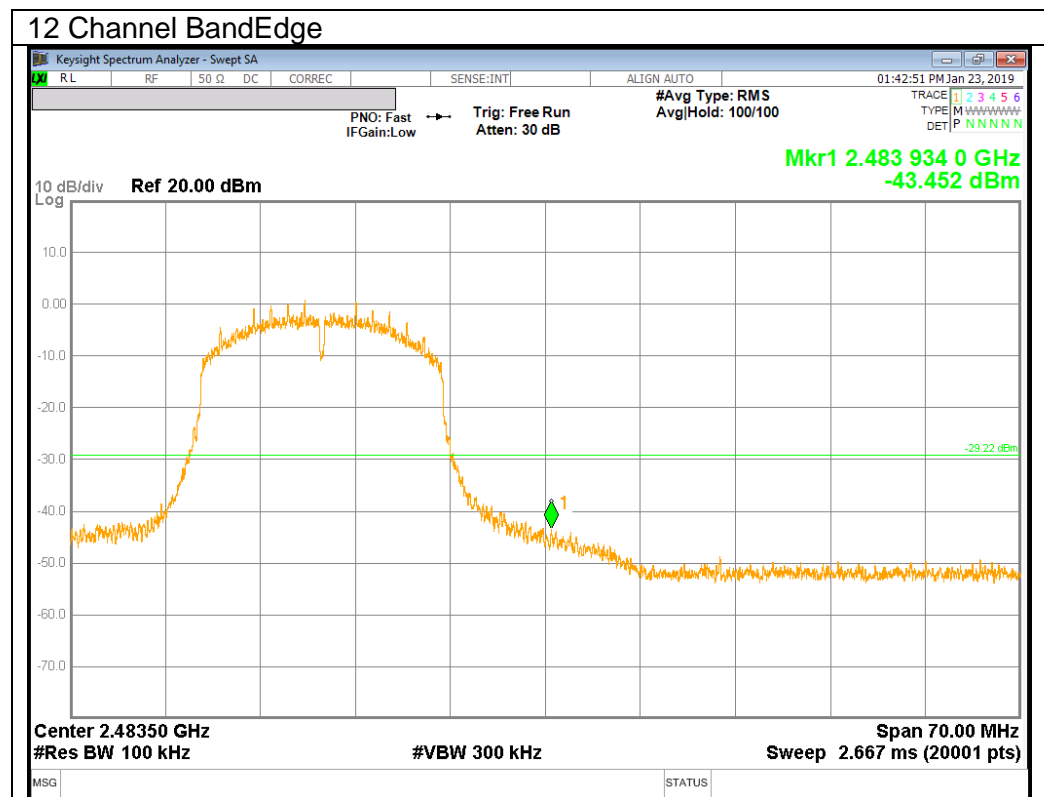

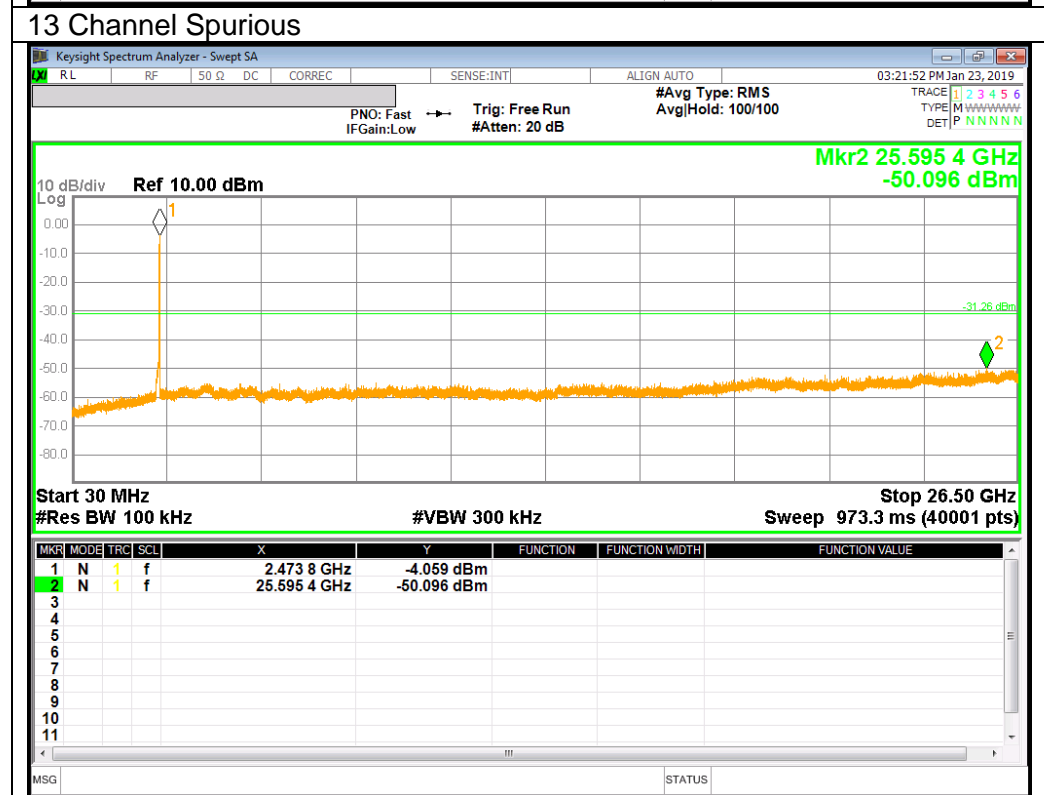
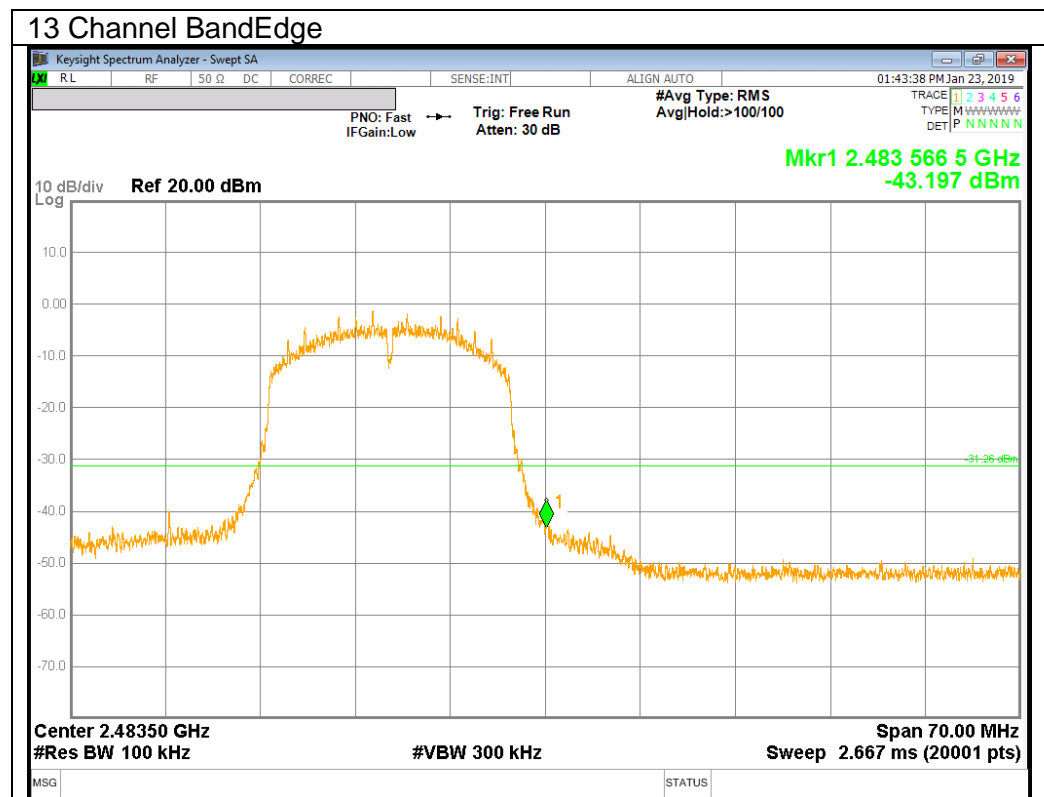

11. RADIATED TEST RESULTS

11.1. LIMITS AND PROCEDURE

LIMITS

FCC §15.205 and §15.209

Limits for radiated disturbance of an intentional radiator		
Frequency range (MHz)	Limits ($\mu\text{V/m}$)	Measurement Distance (m)
0.009 – 0.490	2400 / F (kHz)	300
0.490 – 1.705	24000 / F (kHz)	30
1.705 – 30.0	30	30
30 – 88	100**	3
88 - 216	150**	3
216 – 960	200**	3
Above 960	500	3

** Except as provided in paragraph (g), fundamental emissions from intentional radiators operating under this section shall not be located in the frequency bands 54-72 MHz, 76-88 MHz, 174-216 MHz or 470-806 MHz. However, operation within these frequency bands is permitted under other sections of this part, e.g. §§ 15.231 and 15.241.

TEST PROCEDURE

The EUT is placed on a non-conducting table 80 cm above the ground plane for below 1GHz and 150 cm for above 1GHz. The antenna to EUT distance is 3 meters. The EUT is configured in accordance with ANSI C63.10. The EUT is set to transmit in a continuous mode.

For measurements below 1 GHz the resolution bandwidth is set to 100 kHz for peak detection measurements or 120 kHz for quasi-peak detection measurements. Peak detection is used unless otherwise noted as quasi-peak.

For measurements above 1 GHz the resolution bandwidth is set to 1 MHz; the video bandwidth is set to 3 MHz for peak measurements and add duty cycle factor for average measurements. (Restricted bandedge, Final detection of spurious harmonic emissions)
Duty cycle factor= $10\log(1/x)$ For this sample B mode = 0dB (duty cycle >98%); G mode = 0.13dB ; N mode = 0.13dB.

Pre-scans to detect harmonic and spurious emissions, the resolution bandwidth is set to 1 MHz; the video bandwidth is set to 30 KHz for peak measurements.

The spectrum from 1 GHz to 26 GHz is investigated with the transmitter set to the lowest, middle, and highest channels in each applicable band.
(From 30MHz to 1GHz, test was performed with the EUT set to transmit at the channel with highest output power)

The frequency range of interest is monitored at a fixed antenna height and EUT azimuth. The EUT is rotated through 360 degrees to maximize emissions received. The antenna is scanned from 1 to 4 meters above the ground plane to further maximize the emission. Measurements are made with the antenna polarized in both the vertical and the horizontal positions.

Note : Emission was pre-scanned from 9KHz to 30MHz; No emissions were detected which was at least 20dB below the specification limit (consider distance correction factor).
Per FCC part 15.31(o), test results were not reported.

Although these tests were performed other than open area test site, adequate comparison measurements were confirmed against 30 m open are test site.
Therefore sufficient tests were made to demonstrate that the alternative site produces results that correlate with the one of tests made in an open field based on KDB 414788.

11.2. TRANSMITTER ABOVE 1 GHz

11.2.1.TX ABOVE 1 GHz 802.11b MODE IN THE 2.4 GHz BAND

RESTRICTED BANDEDGE (1 CHANNEL)

HORIZONTAL PEAK AND AVERAGE PLOT

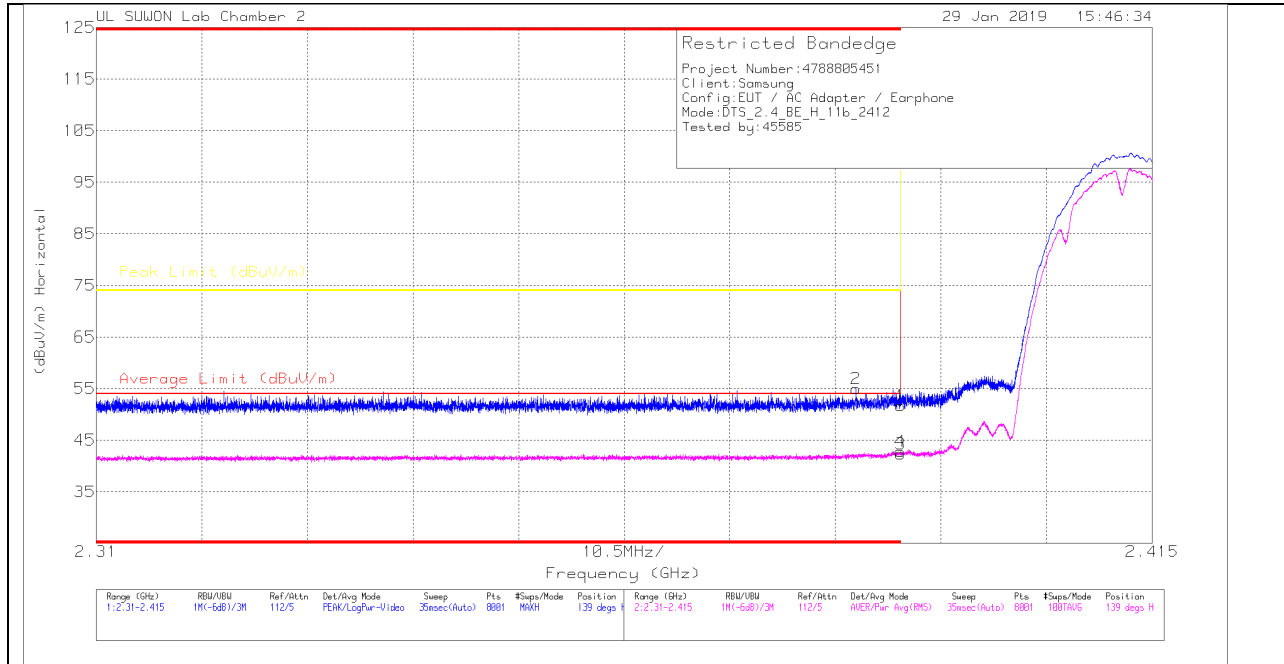

HORIZONTAL DATA

Trace Markers

Marker	Frequency (GHz)	Meter Reading (dBuV)	Det	3117_00168724	10dB(dB)	DC Corr (dB)	Corrected Reading (dBuV/m)	Average Limit (dBuV/m)	Margin (dB)	Peak Limit (dBuV/m)	PK Margin (dB)	Azimuth (Degs)	Height (cm)	Polarity
1	* 2.39	40.88	Pk	31.6	-20.8	0	51.68	-	-	74	-22.32	139	324	H
2	* 2.386	44.18	Pk	31.6	-20.8	0	54.98	-	-	74	-19.02	139	324	H
3	* 2.39	31.51	RMS	31.6	-20.8	0	42.31	54	-11.69	-	-	139	324	H
4	* 2.39	32.01	RMS	31.6	-20.8	0	42.81	54	-11.19	-	-	139	324	H

* - indicates frequency in CFR47 Pt 15 / IC RSS-Restricted Band

Pk - Peak detector

RMS - RMS detection

VERTICAL PEAK AND AVERAGE PLOT

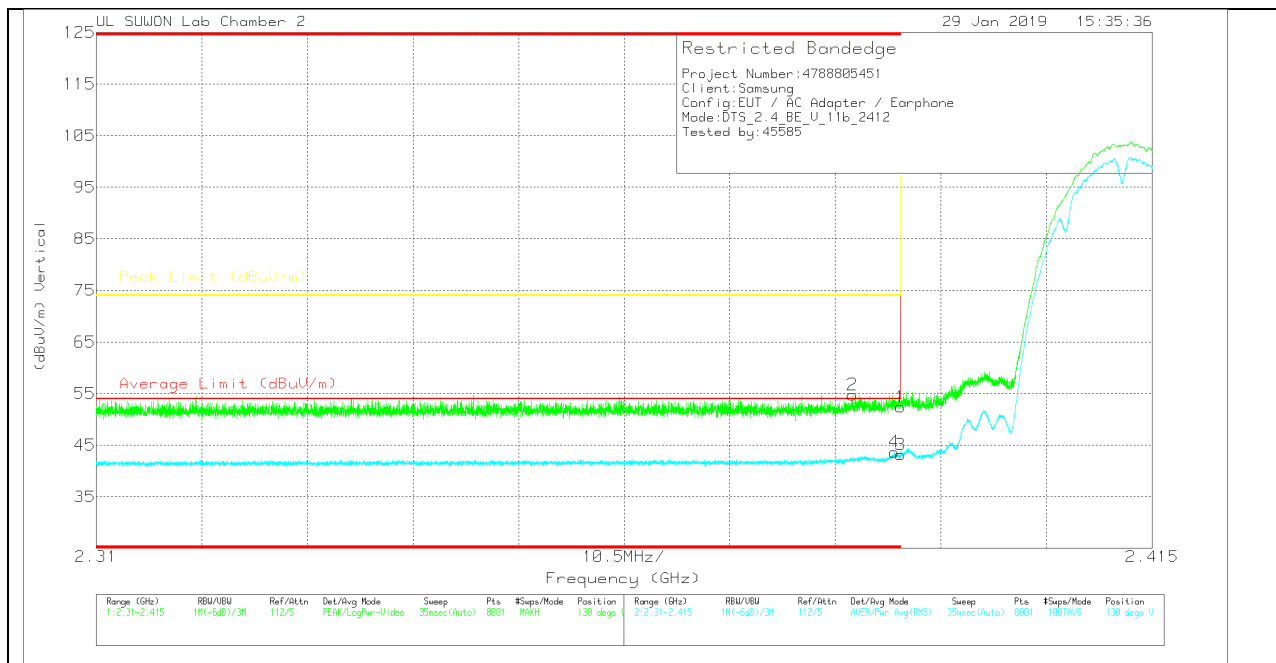

VERTICAL DATA

Trace Markers

Marker	Frequency (GHz)	Meter Reading (dBuV)	Det	3117_00168724	10dB(dB)	DC Corr (dB)	Corrected Reading (dBuV/m)	Average Limit (dBuV/m)	Margin (dB)	Peak Limit (dBuV/m)	PK Margin (dB)	Azimuth (Degs)	Height (cm)	Polarity
1	* 2.39	41.64	Pk	31.6	-20.8	0	52.44	-	-	74	-21.56	130	179	V
2	* 2.385	43.97	PK	31.6	-20.8	0	54.77	-	-	74	-19.23	130	179	V
3	* 2.39	32.39	RMS	31.6	-20.8	0	43.19	54	-10.81	-	-	130	179	V
4	* 2.389	32.9	RMS	31.6	-20.8	0	43.7	54	-10.3	-	-	130	179	V

* - indicates frequency in CFR47 Pt 15 / IC RSS-Restricted Band

Pk - Peak detector

RMS - RMS detection

AUTHORIZED BANDEDGE (11 CHANNEL)

HORIZONTAL PEAK AND AVERAGE PLOT

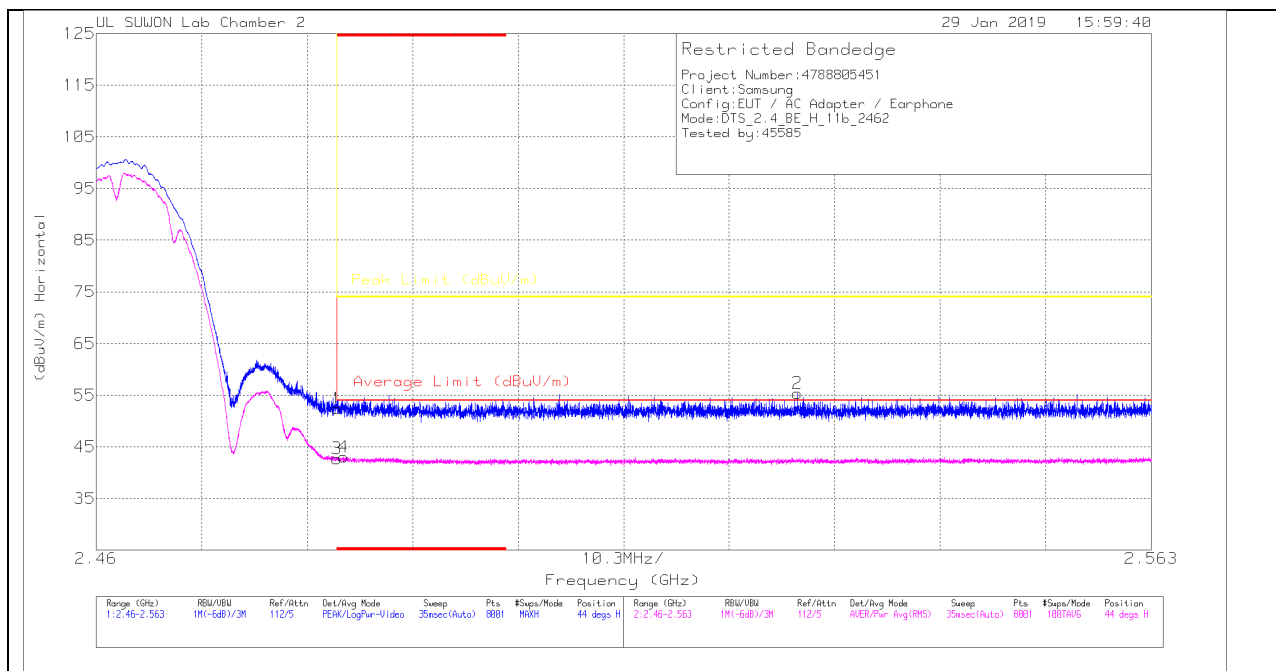

HORIZONTAL DATA

Trace Markers

Marker	Frequency (GHz)	Meter Reading (dBuV)	Det	3117_00168724	10dB(dB)	DC Corr (dB)	Corrected Reading (dBuV/m)	Average Limit (dBuV/m)	Margin (dB)	Peak Limit (dBuV/m)	PK Margin (dB)	Azimuth (Degs)	Height (cm)	Polarity
1	* 2.484	41.14	PK	31.9	-20.6	0	52.44	-	-	74	-21.56	44	111	H
2	2.528	43.88	PK	32	-20.5	0	55.38	-	-	74	-18.62	44	111	H
3	* 2.484	31.42	RMS	31.9	-20.6	0	42.72	54	-11.28	-	-	44	111	H
4	* 2.484	31.77	RMS	31.9	-20.6	0	43.07	54	-10.93	-	-	44	111	H

* - indicates frequency in CFR47 Pt 15 / IC RSS-Restricted Band

PK - Peak detector

RMS - RMS detection

VERTICAL PEAK AND AVERAGE PLOT

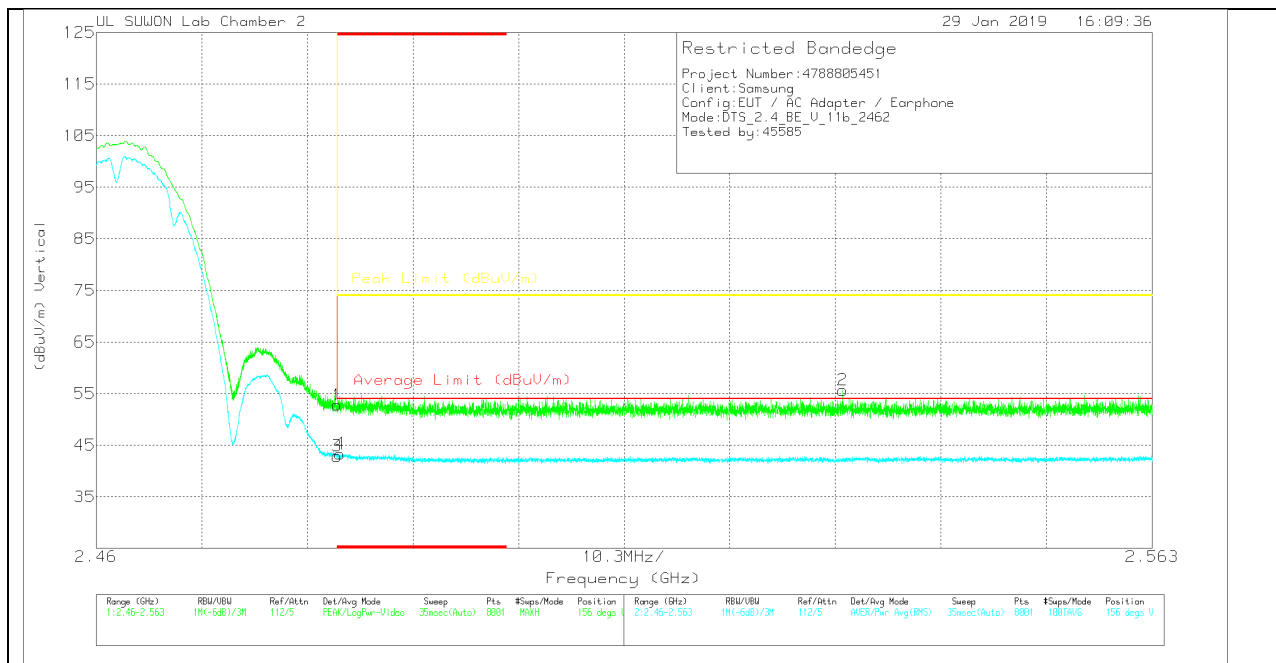

VERTICAL DATA

Trace Markers

Marker	Frequency (GHz)	Meter Reading (dBuV)	Det	3117_00168724	10dB(dB)	DC Corr (dB)	Corrected Reading (dBuV/m)	Average Limit (dBuV/m)	Margin (dB)	Peak Limit (dBuV/m)	PK Margin (dB)	Azimuth (Degs)	Height (cm)	Polarity
1	* 2.484	41.47	Pk	31.9	-20.6	0	52.77	-	-	74	-21.23	156	155	V
2	2.533	44.27	Pk	32	-20.6	0	55.67	-	-	74	-18.33	156	155	V
3	* 2.484	31.59	RMS	31.9	-20.6	0	42.89	54	-11.11	-	-	156	155	V
4	* 2.484	32.02	RMS	31.9	-20.6	0	43.32	54	-10.68	-	-	156	155	V

* - indicates frequency in CFR47 Pt 15 / IC RSS-Restricted Band

Pk - Peak detector

RMS - RMS detection

AUTHORIZED BANDEDGE (12 CHANNEL)

HORIZONTAL PEAK AND AVERAGE PLOT

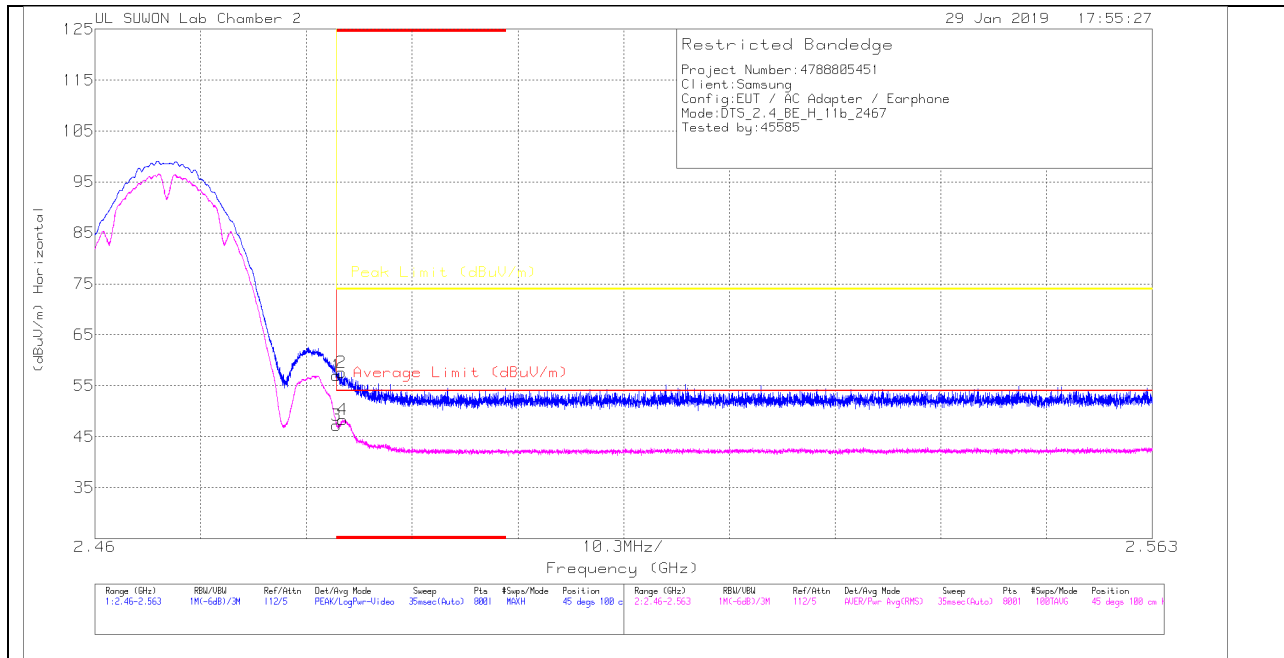

HORIZONTAL DATA

Trace Markers

Marker	Frequency (GHz)	Meter Reading (dBuV)	Det	3117_00168724	10dB(dB)	DC Corr (dB)	Corrected Reading (dBuV/m)	Average Limit (dBuV/m)	Margin (dB)	Peak Limit (dBuV/m)	PK Margin (dB)	Azimuth (Degs)	Height (cm)	Polarity
1	* 2.484	45.65	Pk	31.9	-20.6	0	56.95	-	-	74	-17.05	45	100	H
2	* 2.484	46.3	Pk	31.9	-20.6	0	57.6	-	-	74	-16.4	45	100	H
3	* 2.484	35.94	RMS	31.9	-20.6	0	47.24	54	-6.76	-	-	45	100	H
4	* 2.484	37.02	RMS	31.9	-20.6	0	48.32	54	-5.68	-	-	45	100	H

* - indicates frequency in CFR47 Pt 15 / IC RSS-Restricted Band

Pk - Peak detector

RMS - RMS detection

VERTICAL PEAK AND AVERAGE PLOT

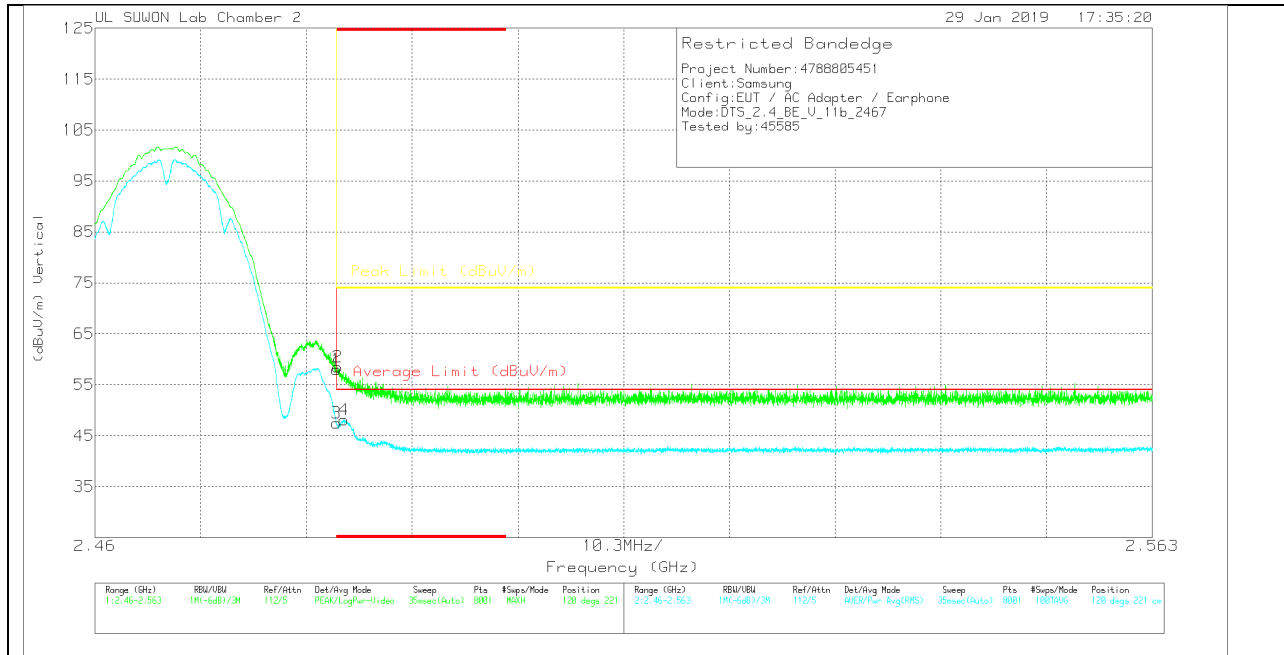

VERTICAL DATA

Trace Markers

Marker	Frequency (GHz)	Meter Reading (dBuV)	Det	3117_00168724	10dB(dB)	DC Corr (dB)	Corrected Reading (dBuV/m)	Average Limit (dBuV/m)	Margin (dB)	Peak Limit (dBuV/m)	PK Margin (dB)	Altitude (Degs)	Height (cm)	Polarity
1	* 2.484	46.67	PK	31.9	-20.6	0	57.97	-	-	74	-16.03	120	221	V
2	* 2.484	47.18	PK	31.9	-20.6	0	58.48	-	-	74	-15.52	120	221	V
3	* 2.484	36.21	RMS	31.9	-20.6	0	47.51	54	-6.49	-	-	120	221	V
4	* 2.484	36.85	RMS	31.9	-20.6	0	48.15	54	-5.85	-	-	120	221	V

* - indicates frequency in CFR47 Pt 15 / IC RSS-Restricted Band
 PK - Peak detector
 RMS - RMS detection

AUTHORIZED BANDEDGE (13 CHANNEL)

HORIZONTAL PEAK AND AVERAGE PLOT

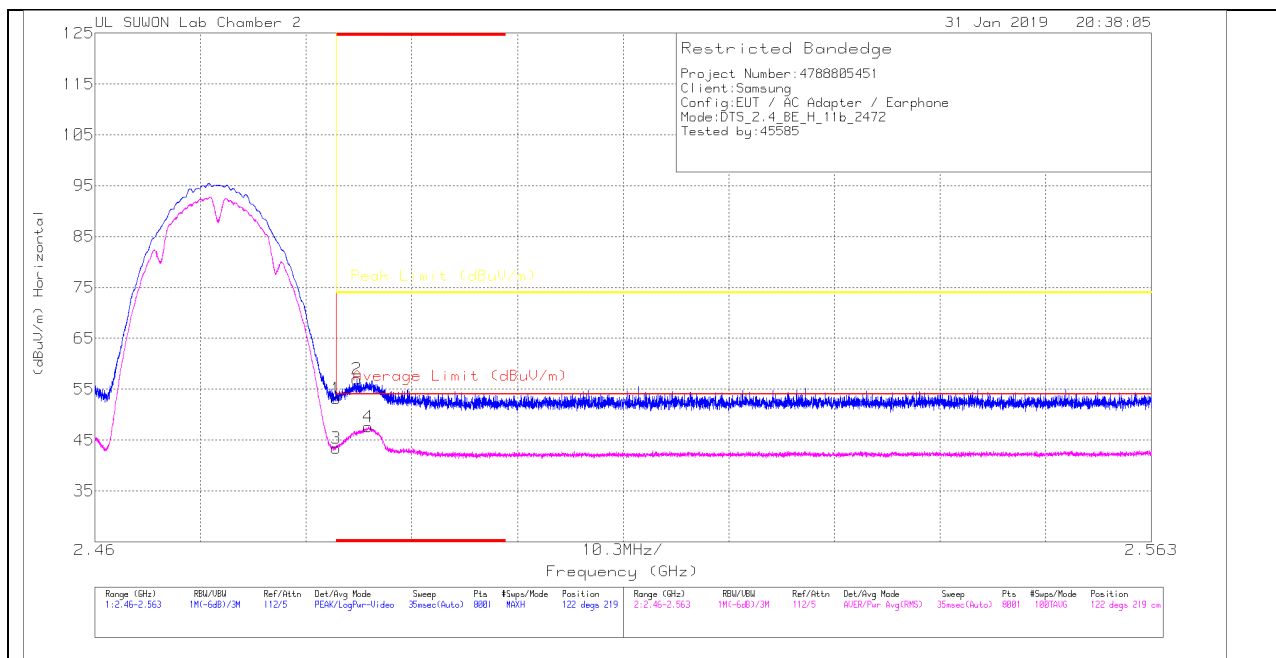

HORIZONTAL DATA

Trace Markers

Marker	Frequency (GHz)	Meter Reading (dBuV)	Det	3117_00168724	10dB[dB]	Corrected Reading (dBuV/m)	Average Limit (dBuV/m)	Margin (dB)	Peak Limit (dBuV/m)	PK Margin (dB)	Azimuth (Degs)	Height (cm)	Polarity
1	* 2.484	41.83	Pk	31.9	-20.6	53.13	-	-	74	-20.87	122	219	H
2	* 2.486	45.74	Pk	31.9	-20.6	57.04	-	-	74	-16.96	122	219	H
3	* 2.484	32.13	RMS	31.9	-20.6	43.43	54	-10.57	-	-	122	219	H
4	* 2.487	36.46	RMS	31.9	-20.7	47.66	54	-6.34	-	-	122	219	H

* - indicates frequency in CFR47 Pt 15 / IC RSS-Restricted Band

Pk - Peak detector

RMS - RMS detection

VERTICAL PEAK AND AVERAGE PLOT

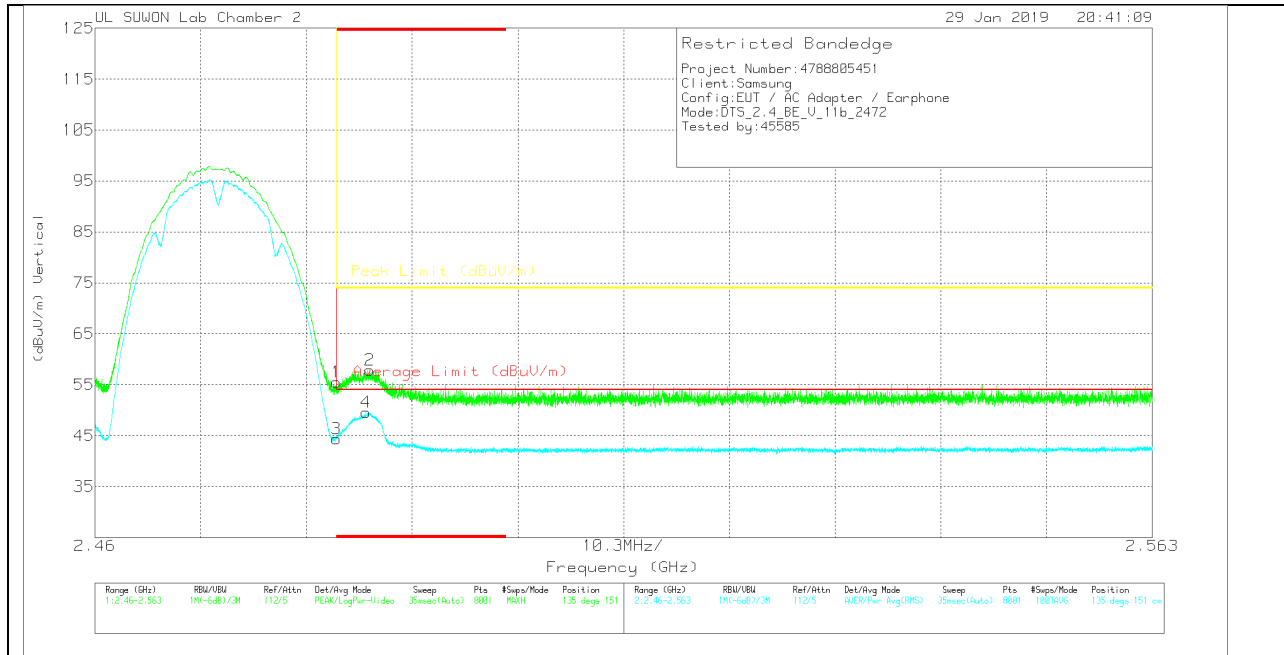

VERTICAL DATA

Trace Markers

Marker	Frequency (GHz)	Meter Reading (dBuV)	Det	3117_00168724	10dB(dB)	DC Corr (dB)	Corrected Reading (dBuV/m)	Average Limit (dBuV/m)	Margin (dB)	Peak Limit (dBuV/m)	PK Margin (dB)	Altitude (Degs)	Height (cm)	Polarity
1	* 2.484	44.2	PK	31.9	-20.6	0	55.5	-	-	74	-18.5	135	151	V
2	* 2.487	46.71	PK	31.9	-20.7	0	57.91	-	-	74	-16.09	135	151	V
3	* 2.484	33.08	RMS	31.9	-20.6	0	44.38	54	-9.62	-	-	135	151	V
4	* 2.486	38.37	RMS	31.9	-20.7	0	49.57	54	-4.43	-	-	135	151	V

* - indicates frequency in CFR47 Pt 15 / IC RSS-Restricted Band
 PK - Peak detector
 RMS - RMS detection

HARMONICS AND SPURIOUS EMISSIONS

1 CHANNEL HORIZONTAL

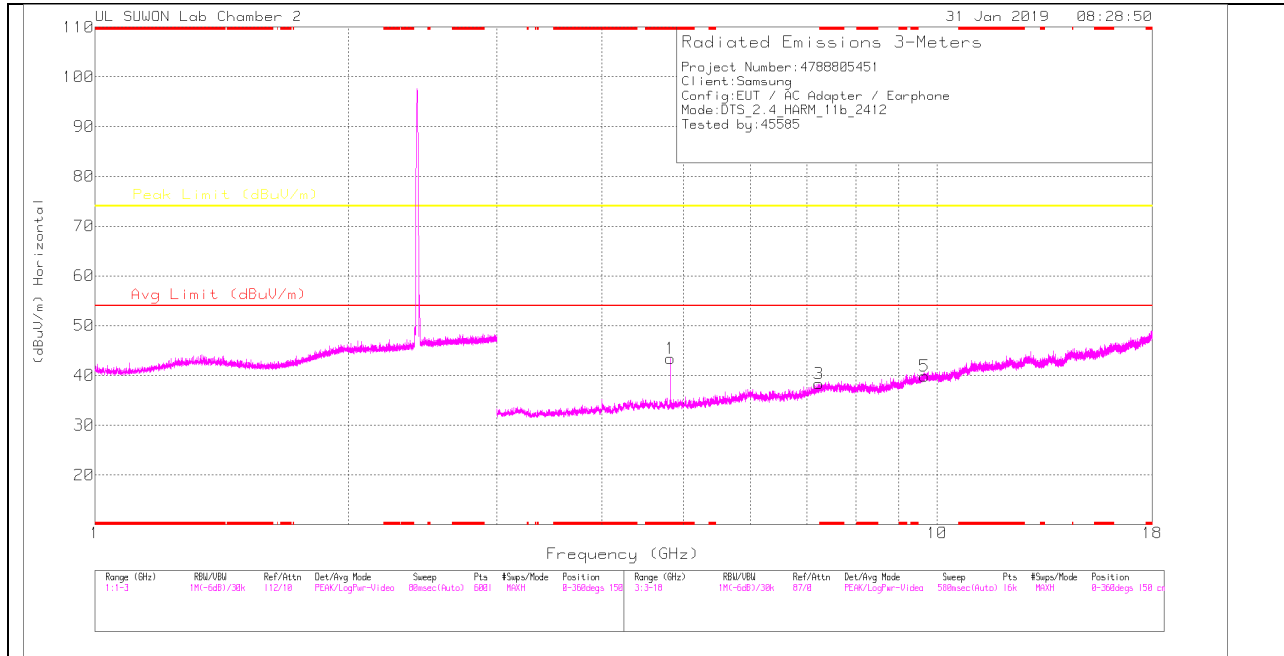

1 CHANNEL VERTICAL

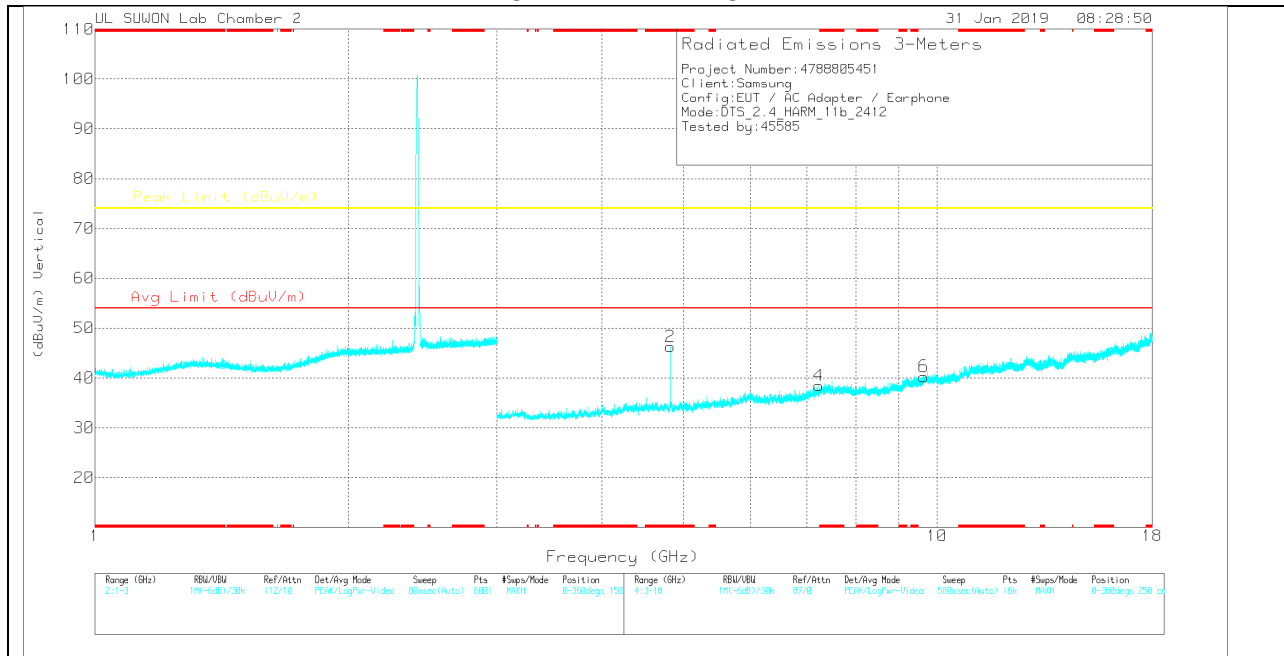

Note: Emission was scanned up to 26GHz; No emissions were detected above the noise floor which was at least 20dB below the specification limit.

1 CHANNEL DATA

Trace Markers

Marker	Frequency (GHz)	Meter Reading (dBuV)	Det	3117_00168724	3GHz_HP[dB]	DC Corr (dB)	Corrected Reading (dBuV/m)	Avg Limit (dBuV/m)	Margin (dB)	Peak Limit (dBuV/m)	Margin (dB)	Azimuth (Degs)	Height (cm)	Polarity
1	* 4.823	37.64	PK	34	-28.2	0	43.44	-	-	74	-30.56	0-360	250	H
3	7.232	27.79	PK	36.1	-25.5	0	38.39	-	-	74	-35.61	0-360	250	H
5	9.65	24.33	PK	37.1	-21.6	0	39.83	-	-	74	-34.17	0-360	150	H
2	* 4.823	40.45	PK	34	-28.2	0	46.25	-	-	74	-27.75	0-360	250	V
4	7.238	27.85	PK	36.1	-25.5	0	38.45	-	-	74	-35.55	0-360	250	V
6	9.646	25	PK	37	-21.7	0	40.3	-	-	74	-33.7	0-360	150	V

* - indicates frequency in CFR47 Pt 15 / IC RSS-Restricted Band

PK – Peak Detector

Radiated Emissions

Frequency (GHz)	Meter Reading (dBuV)	Det	3117_00168724	3GHz_HP[dB]	DC Corr (dB)	Corrected Reading (dBuV/m)	Avg Limit (dBuV/m)	Margin (dB)	Peak Limit (dBuV/m)	Margin (dB)	Azimuth (Degs)	Height (cm)	Polarity
* 4.824	41.94	PK2	34	-28.1	0	47.84	-	-	74	-26.16	112	199	H
* 4.824	37.22	MAv1	34	-28.1	0	43.12	54	-10.88	-	-	112	199	H
* 4.824	44.61	PK2	34	-28.1	0	50.51	-	-	74	-23.49	199	227	V
* 4.824	40.72	MAv1	34	-28.1	0	46.62	54	-7.38	-	-	199	227	V

* - indicates frequency in CFR47 Pt 15 / IC RSS-Restricted Band

PK2 - KDB558074 Method: Maximum Peak

MAv1 - KDB558074 Option 1 Maximum RMS Average

6 CHANNEL HORIZONTAL

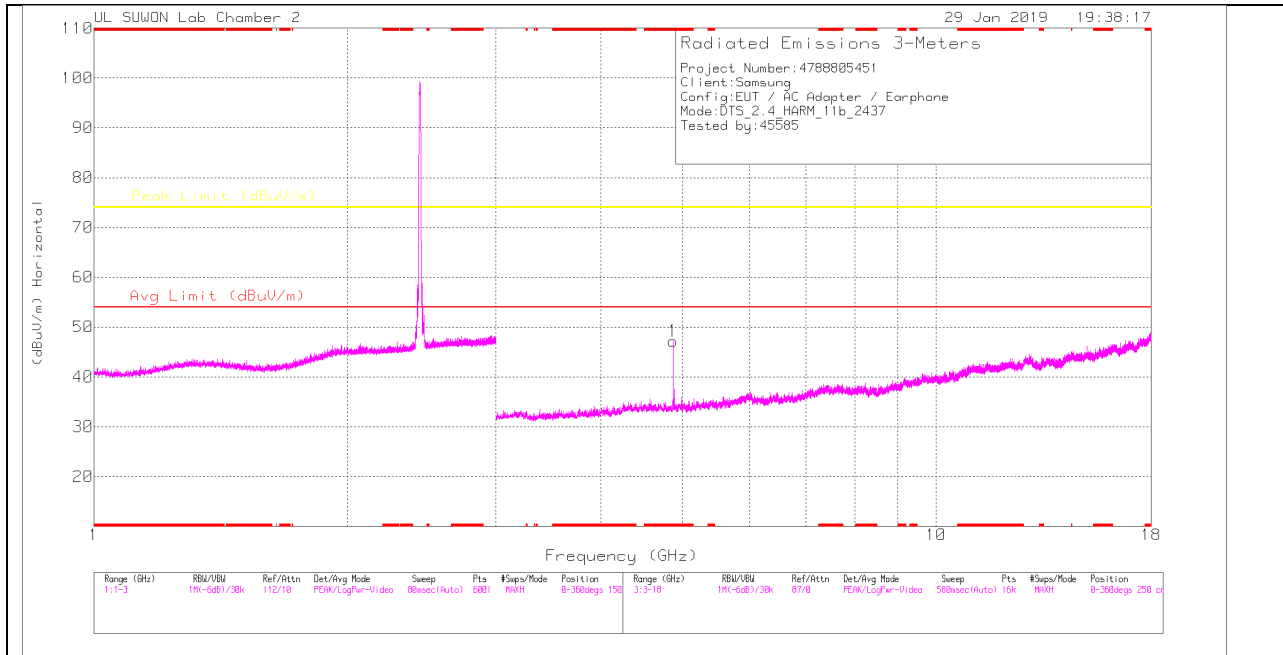

6 CHANNEL VERTICAL

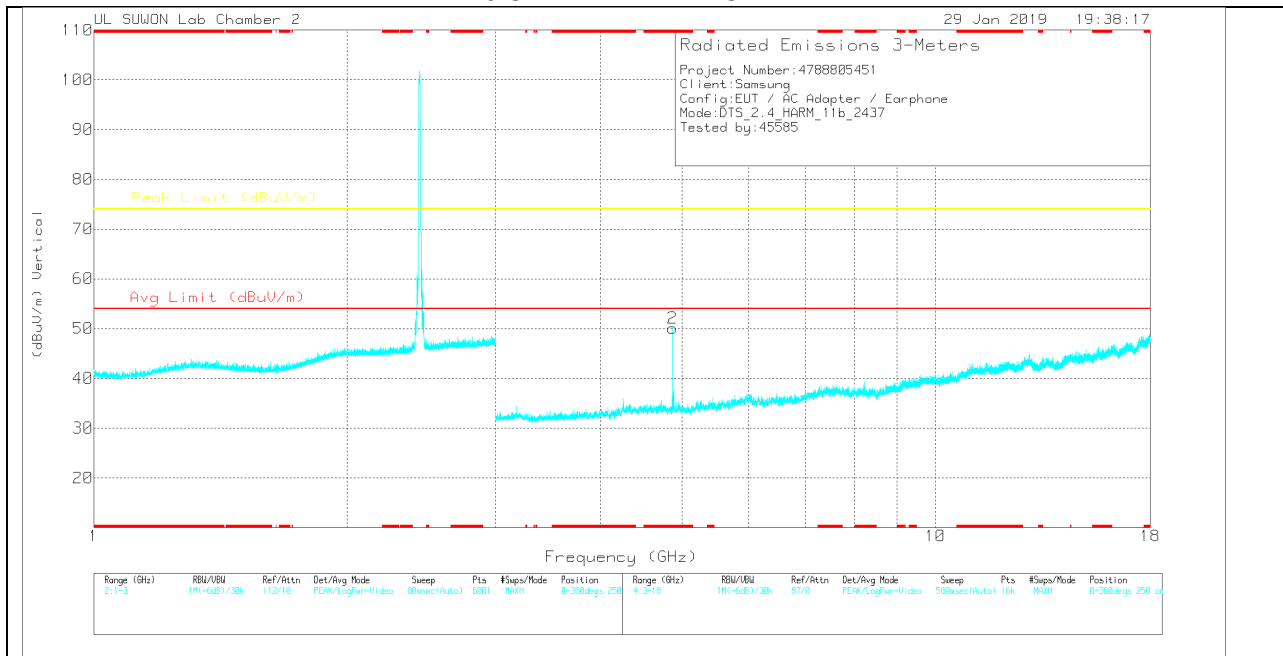

Note: Emission was scanned up to 26GHz; No emissions were detected above the noise floor which was at least 20dB below the specification limit.

6 CHANNEL DATA

Trace Markers

Marker	Frequency (GHz)	Meter Reading (dBuV)	Det	3117_00168724	3GHz_HP[dB]	DC Corr (dB)	Corrected Reading (dBuV/m)	Avg Limit (dBuV/m)	Margin (dB)	Peak Limit (dBuV/m)	Margin (dB)	Azimuth (Degs)	Height (cm)	Polarity
1	* 4.874	41.25	PK	34	-28	0	47.25	-	-	74	-26.75	0-360	250	H
2	* 4.874	44.06	PK	34	-28	0	50.06	-	-	74	-23.94	0-360	250	V

* - indicates frequency in CFR47 Pt 15 / IC RSS-Restricted Band

PK – Peak Detector

Radiated Emissions

Frequency (GHz)	Meter Reading (dBuV)	Det	3117_00168724	3GHz_HP[dB]	DC Corr (dB)	Corrected Reading (dBuV/m)	Avg Limit (dBuV/m)	Margin (dB)	Peak Limit (dBuV/m)	Margin (dB)	Azimuth (Degs)	Height (cm)	Polarity
* 4.874	46.99	PK2	34	-28	0	52.99	-	-	74	-21.01	200	239	V
* 4.874	44.34	MAv1	34	-28	0	50.34	54	-3.66	-	-	200	239	V

* - indicates frequency in CFR47 Pt 15 / IC RSS-Restricted Band

PK2 - KDB558074 Method: Maximum Peak

MAv1 - KDB558074 Option 1 Maximum RMS Average

11 CHANNEL HORIZONTAL

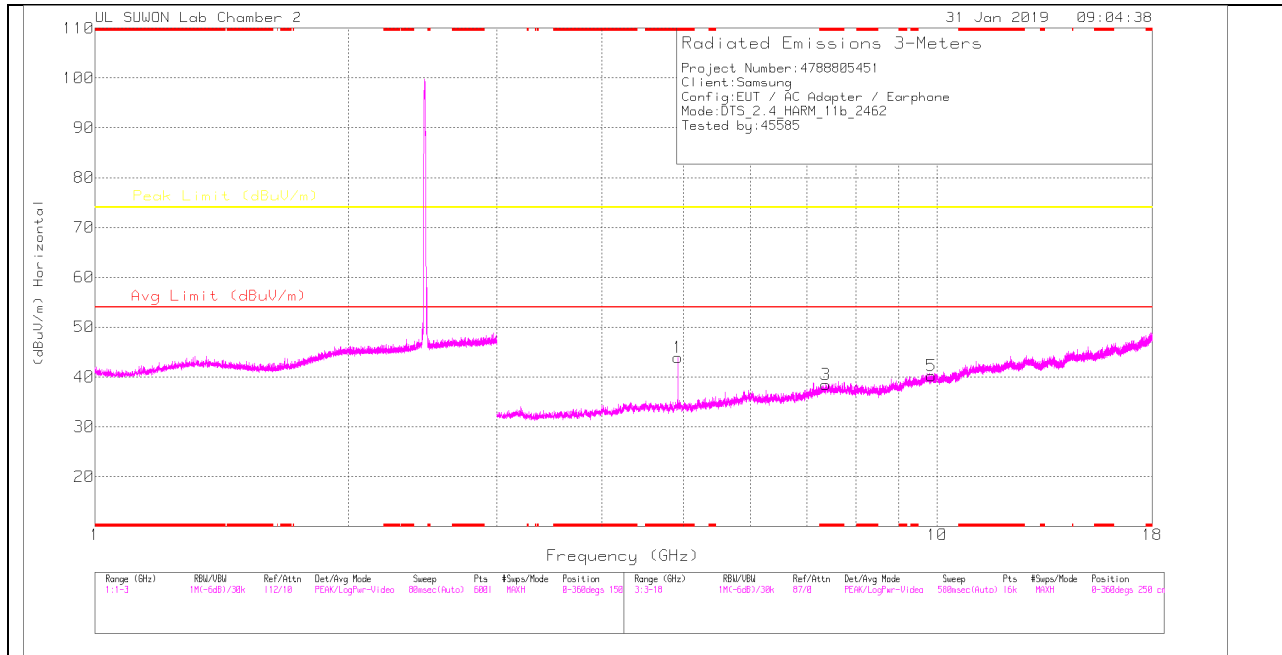

11 CHANNEL VERTICAL

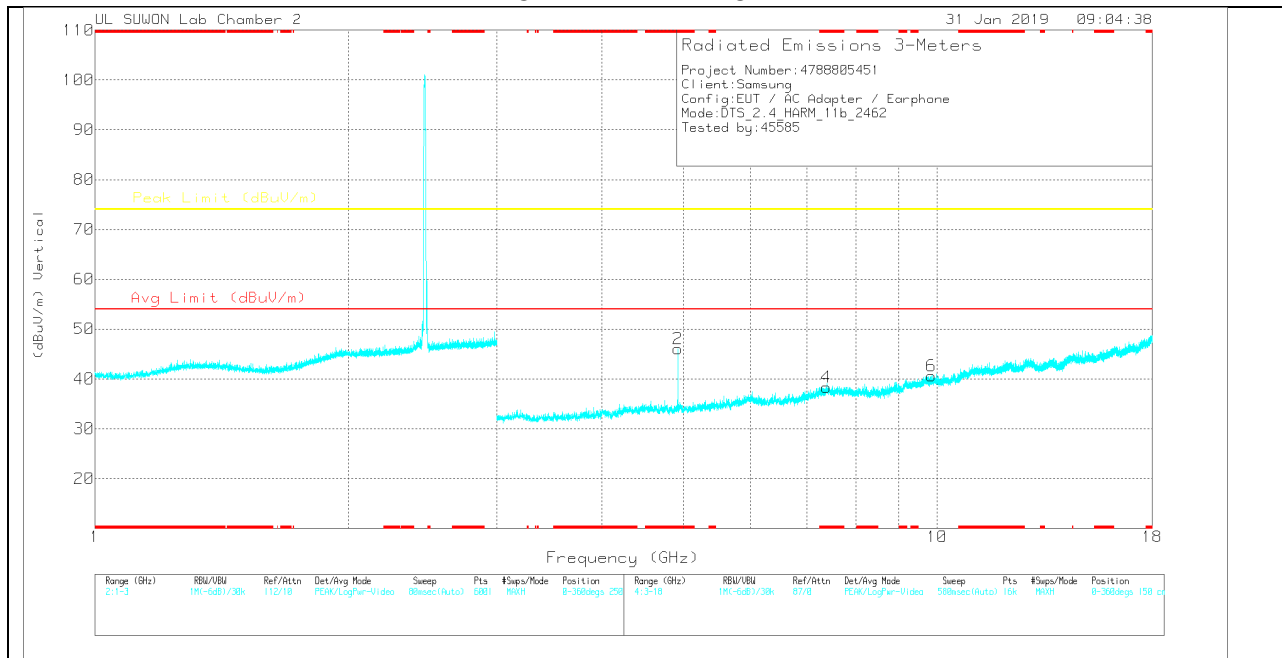

Note: Emission was scanned up to 26GHz; No emissions were detected above the noise floor which was at least 20dB below the specification limit.

11 CHANNEL DATA

Trace Markers

Marker	Frequency (GHz)	Meter Reading (dBuV)	Det	3117_00168724	3GHz_HP[dB]	DC Corr (dB)	Corrected Reading (dBuV/m)	Avg Limit (dBuV/m)	Margin (dB)	Peak Limit (dBuV/m)	Margin (dB)	Azimuth (Degs)	Height (cm)	Polarity
1	* 4.924	37.22	PK	34	-27.3	0	43.92	-	-	74	-30.08	0-360	250	H
3	* 7.378	26.65	PK	36.2	-24.4	0	38.45	-	-	74	-35.55	0-360	150	H
5	9.849	24.78	PK	37.3	-21.8	0	40.28	-	-	74	-33.72	0-360	150	H
2	* 4.924	39.39	PK	34	-27.3	0	46.09	-	-	74	-27.91	0-360	250	V
4	* 7.386	26.29	PK	36.2	-24.2	0	38.29	-	-	74	-35.71	0-360	250	V
6	9.847	25.16	PK	37.3	-21.8	0	40.66	-	-	74	-33.34	0-360	150	V

* - indicates frequency in CFR47 Pt 15 / IC RSS-Restricted Band
 Peak Detector

Radiated Emissions

Frequency (GHz)	Meter Reading (dBuV)	Det	3117_00168724	3GHz_HP[dB]	DC Corr (dB)	Corrected Reading (dBuV/m)	Avg Limit (dBuV/m)	Margin (dB)	Peak Limit (dBuV/m)	Margin (dB)	Azimuth (Degs)	Height (cm)	Polarity
* 4.924	41.49	PK2	34	-27.3	0	48.19	-	-	74	-25.81	225	155	H
* 4.924	36.94	MAv1	34	-27.3	0	43.64	54	-10.36	-	-	225	155	H
* 4.924	42.53	PK2	34	-27.3	0	49.23	-	-	74	-24.77	200	234	V
* 4.924	38.4	MAv1	34	-27.3	0	45.1	54	-8.9	-	-	200	234	V

* - indicates frequency in CFR47 Pt 15 / IC RSS-Restricted Band
 PK2 - KDB558074 Method: Maximum Peak
 MAv1 - KDB558074 Option 1 Maximum RMS Average

11.2.2.TX ABOVE 1 GHz 802.11g MODE IN THE 2.4 GHz BAND

RESTRICTED BANDEDGE (1 CHANNEL)

HORIZONTAL PEAK AND AVERAGE PLOT

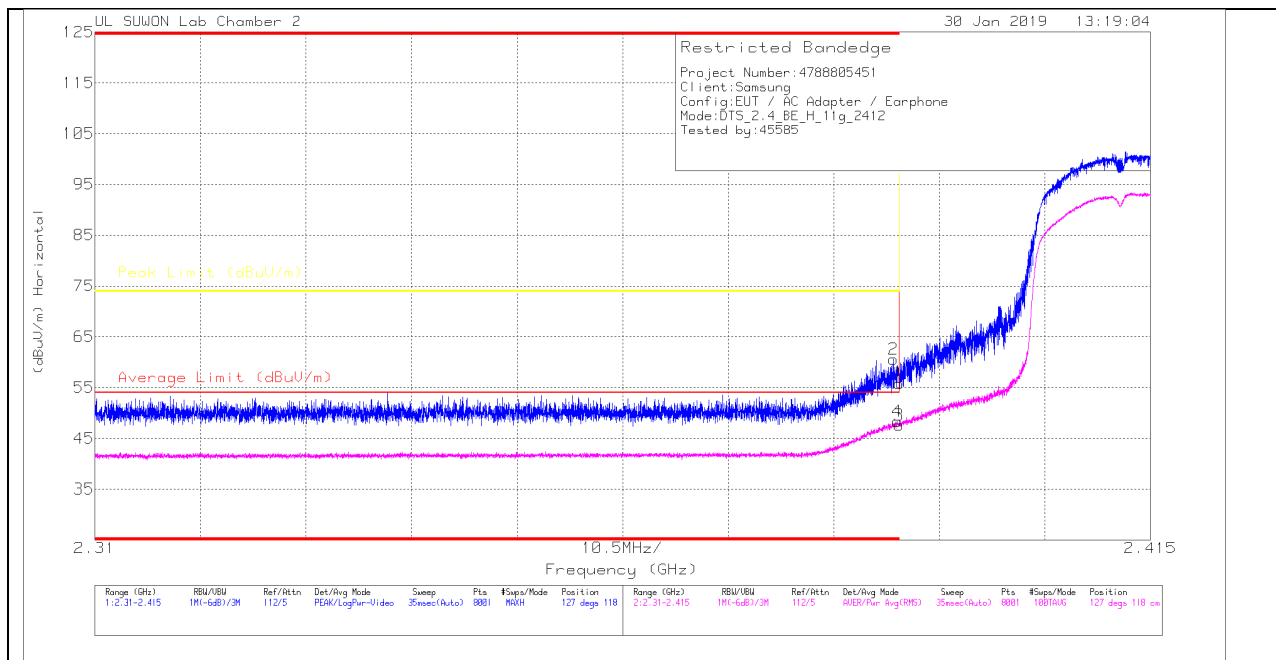

HORIZONTAL DATA

Trace Markers

Marker	Frequency (GHz)	Meter Reading (dBuV)	Det	3117_00168724	10dB(dB)	DC Corr (dB)	Corrected Reading (dBuV/m)	Average Limit (dBuV/m)	Margin (dB)	Peak Limit (dBuV/m)	Pk Margin (dB)	Altitude (Degs)	Height (cm)	Polarity
1	* 2.39	45.03	Pk	31.6	-20.8	0	55.83	-	-	74	-18.17	127	118	H
2	* 2.389	49.77	Pk	31.6	-20.8	0	60.57	-	-	74	-13.43	127	118	H
3	* 2.39	36.73	RMS	31.6	-20.8	.13	47.66	54	-6.34	-	-	127	118	H
4	* 2.39	37.41	RMS	31.6	-20.8	.13	48.34	54	-5.66	-	-	127	118	H

* - indicates frequency in CFR47 Pt 15 / IC RSS-Restricted Band

Pk - Peak detector

RMS - RMS detection

VERTICAL PEAK AND AVERAGE PLOT

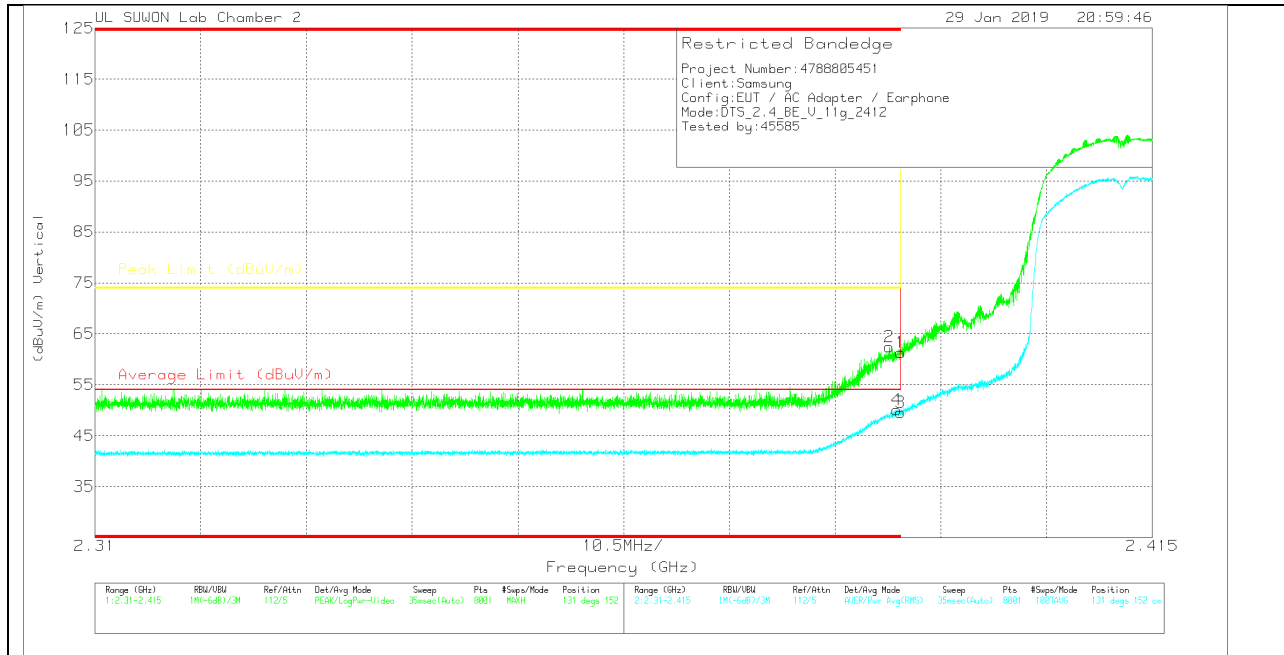

VERTICAL DATA

Trace Markers

Marker	Frequency (GHz)	Meter Reading (dBu/m)	Det	3117_00168724	10dB(dB)	DC Corr (dB)	Corrected Reading (dBu/m)	Average Limit (dBu/m)	Margin (dB)	Peak Limit (dBu/m)	PK Margin (dB)	Azimuth (Degs)	Height (cm)	Polarity
1	* 2.39	50.56	Pk	31.6	-20.8	0	61.36	-	-	74	-12.64	131	152	V
2	* 2.389	51.61	Pk	31.6	-20.8	0	62.41	-	-	74	-11.59	131	152	V
3	* 2.39	38.68	RMS	31.6	-20.8	.13	49.61	54	-4.39	-	-	131	152	V
4	* 2.39	39.15	RMS	31.6	-20.8	.13	50.08	54	-3.92	-	-	131	152	V

* - indicates frequency in CFR47 Pt 15 / IC RSS-Restricted Band

Pk - Peak detector

RMS - RMS detection