

## Appendix B : Cellular receiver Part15B test results

### 1. TEST METHODOLOGY

The tests documented in this report were performed in accordance with following methods.

1. FCC CFR 47 Part 2.
2. FCC CFR 47 Part 15.
3. ANSI C63.4 : 2014

### 2. EQUIPMENT UNDER TEST

#### 2.1. DESCRIPTION OF EUT

The EUT is a GSM/WCDMA/LTE Phone + BT/BLE, DTS/UNII a/b/g/n/ac and ANT+.  
This test report addresses the WWAN receiver mode.  
(GSM850/WCDMA B5/LTE B5/LTE B12/LTE B13/LTE B26)

#### 2.2. TEST MODE

Mode	Description
GSM850	Communicating with Call simulator(CMW500)
WCDMA BAND 5	Communicating with Call simulator(CMW500)
LTE BAND 5	Communicating with Call simulator(CMW500)
LTE BAND 12	Communicating with Call simulator(CMW500)
LTE BAND 13	Communicating with Call simulator(CMW500)
LTE BAND 26	Communicating with Call simulator(CMW500)

NOTE : All Test data were re-used from FCC ID : A3LSMA505GN.

## 2.3. DESCRIPTION OF TEST SETUP

### SUPPORT EQUIPMENT

Support Equipment List				
Description	Manufacturer	Model	Serial Number	FCC ID
Charger	SAMSUNG	EP-TA200	R37KC3B01GORC3	N/A
Data Cable	SAMSUNG	EP-D140AWE	N/A	N/A
Earphone	SAMSUNG	EHS61ASFWE	N/A	N/A

### I/O CABLE

I/O Cable List						
Cable No	Port	# of identical ports	Connector Type	Cable Type	Cable Length (m)	Remarks
1	DC Power	1	C Type	Shielded	1.1m	N/A
2	Audio	2	Mini-Jack	Unshielded	1.2m	N/A

### TEST SETUP

The EUT is continuously communicated to the call box during the tests.

**SETUP DIAGRAM FOR TESTS (RADIATED TEST SETUP)**

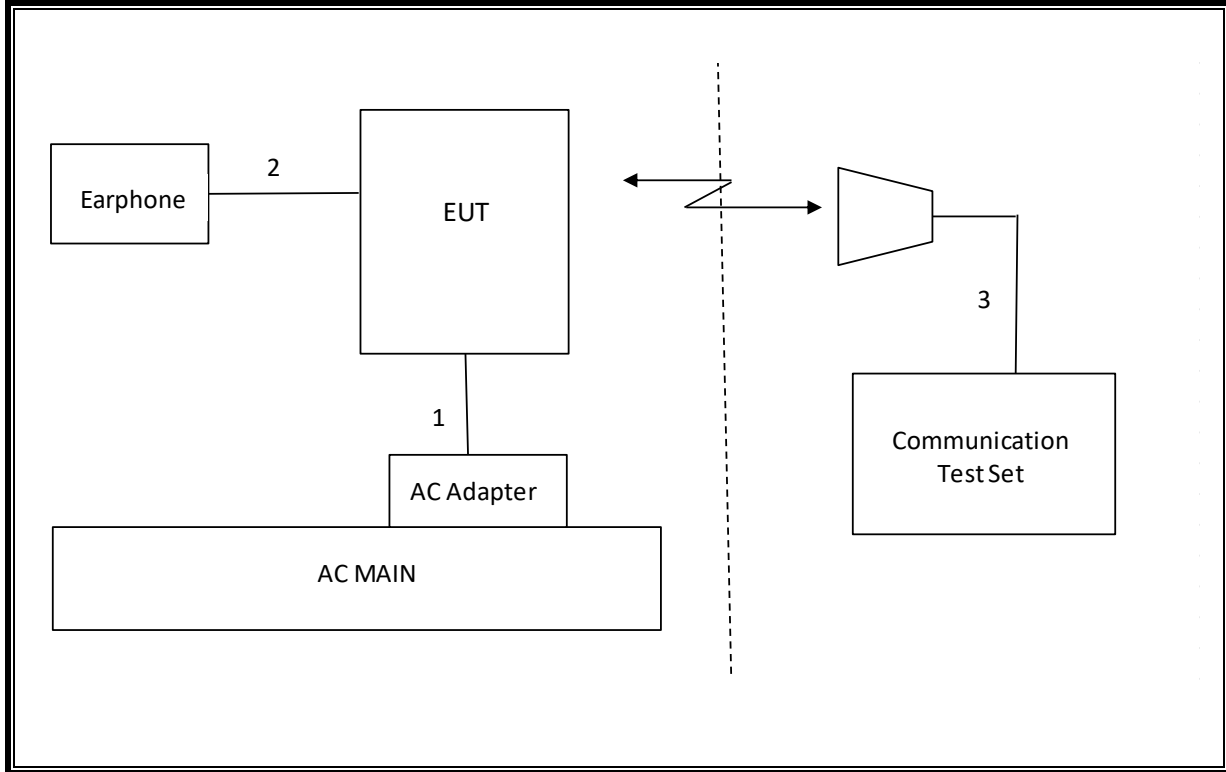

### 3. TEST AND MEASUREMENT EQUIPMENT

The following test and measurement equipment was utilized for the tests documented in this report:

Test Equipment List				
Description	Manufacturer	Model	S/N	Cal Due
Antenna, Tuned Dipole 400~1000 MHz	ETS	3121D DB4	00164753	06-30-19
Antenna, Horn, 40 GHz	ETS	3116C	00166155	12-04-19
Preamplifier	ETS	3116C-PA	00168841	08-09-19
Antenna, Horn, 40 GHz	ETS	3116C	00168645	12-04-19
Antenna, Bilog, 30MHz-1GHz	SCHWARZBECK	VULB9163	750	08-04-20
Antenna, Bilog, 30MHz-1GHz	SCHWARZBECK	VULB9163	845	08-04-20
Antenna, Bilog, 30MHz-1GHz	SCHWARZBECK	VULB9163	749	08-04-20
Antenna, Horn, 18 GHz	ETS	3115	00167211	08-04-20
Antenna, Horn, 18 GHz	ETS	3115	00161451	08-04-20
Antenna, Horn, 18 GHz	ETS	3117	00168724	08-04-20
Antenna, Horn, 18 GHz	ETS	3117	00205959	08-04-20
Antenna, Horn, 18 GHz	ETS	3117	00168717	08-04-20
Combiner	WEINSCHTEL	1575	2152	08-08-19
Communications Test Set	R&S	CMW500	115331	08-07-19
DC Power Supply	Agilent / HP	E3640A	MY54226395	08-06-19
Preamplifier, 1000 MHz	Sonoma	310N	341282	08-07-19
Preamplifier, 1000 MHz	Sonoma	310N	370599	08-06-19
Preamplifier, 1000 MHz	Sonoma	310N	351741	08-07-19
Preamplifier, 18 GHz	Miteq	AFS42-00101800-25-S-42	1876511	08-07-19
Preamplifier, 18 GHz	Miteq	AFS42-00101800-25-S-42	2029169	08-07-19
Preamplifier, 18 GHz	Miteq	AFS42-00101800-25-S-42	1896138	08-07-19
Spectrum Analyzer, 44 GHz	Agilent / HP	N9030A	MY54490312	08-06-19
EMI Test Receive, 40 GHz	R&S	ESU40	100439	08-06-19
EMI Test Receive, 40 GHz	R&S	ESU40	100457	08-06-19
EMI Test Receive, 44 GHz	R&S	ESW40	101590	08-06-19
High Pass Filter 1.2GHz	Micro-Tronics	HPM50108-02	G005	08-08-19
High Pass Filter 1.2GHz	Micro-Tronics	HPM50108-02	G006	08-08-19
High Pass Filter 2.8GHz	Micro-Tronics	HPM50111-02	010	08-08-19
High Pass Filter 2.8GHz	Micro-Tronics	HPM50111-02	011	08-08-19
High Pass Filter 4GHz	Micro-Tronics	HPM50118-02	G001	08-08-19
High Pass Filter 4GHz	Micro-Tronics	HPM50118-02	G002	08-08-19
Attenuator	PASTERNAK	PE7087-10	A009	08-08-19
Attenuator	PASTERNAK	PE7087-10	A001	08-08-19
Attenuator	PASTERNAK	PE7087-10	A008	08-08-19
Attenuator	PASTERNAK	PE7087-10	2	08-07-19
Attenuator	PASTERNAK	PE7395-10	A011	08-08-19
Antenna, Loop, 9kHz-30MHz	R&S	HFH2-Z2	100418	10-26-19
Temperature Chamber	ESPEC	SH-642	93001109	08-06-19
UL Software				
Description	Manufacturer	Model	Version	
Antenna port test software	UL	CLT	Ver 2.5	

## 4. APPLICABLE LIMITS AND TEST RESULTS

### TEST PROCEDURE

ANSI C63.4: 2014

### LIMIT

§15.109 (a) Except for Class A digital devices, the field strength of radiated emissions from unintentional radiators at a distance of 3 meters shall not exceed the following values:

Limits for radiated disturbance of Class B ITE at measuring distance of 3 m	
Frequency range (MHz)	Quasi-peak limits (dB $\mu$ V/m)
30 to 88	40
88 to 216	43.5
216 to 960	46
Above 960 MHz	54

Note: The lower limit shall apply at the transition frequency.

### 4.1. Above 1 GHz in the GSM850

#### LOW CHANNEL(869.2MHz)

#### HORIZONTAL PEAK PLOT

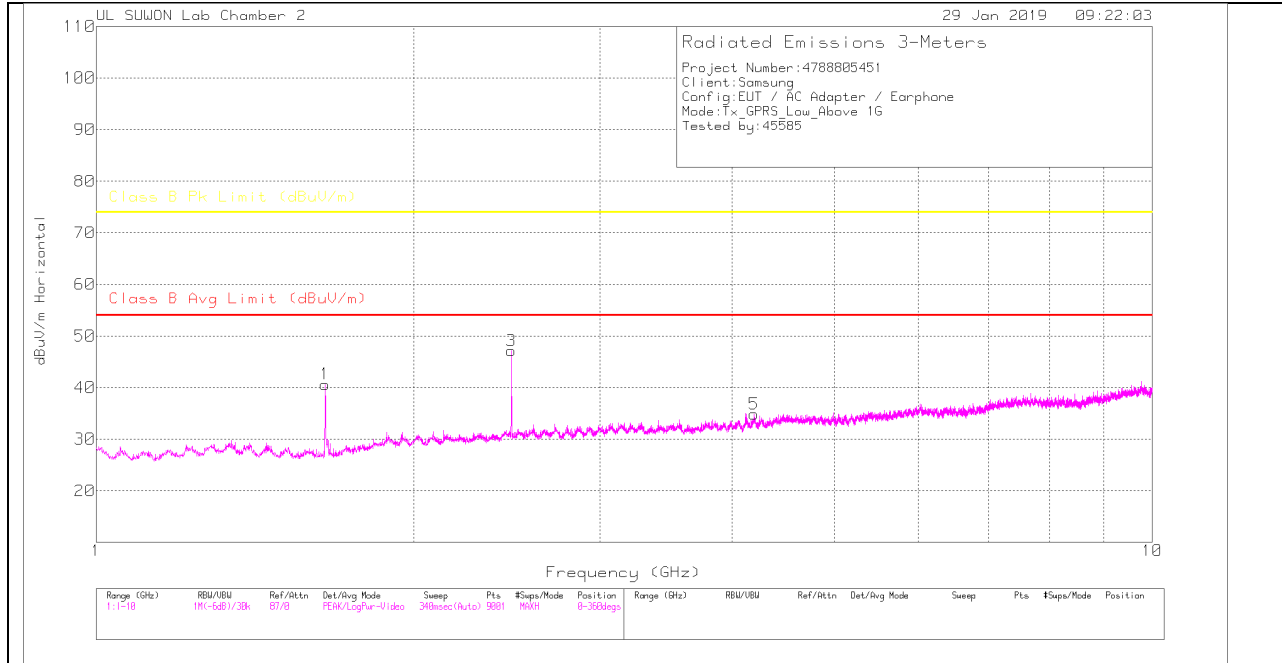

#### VERTICAL PEAK PLOT

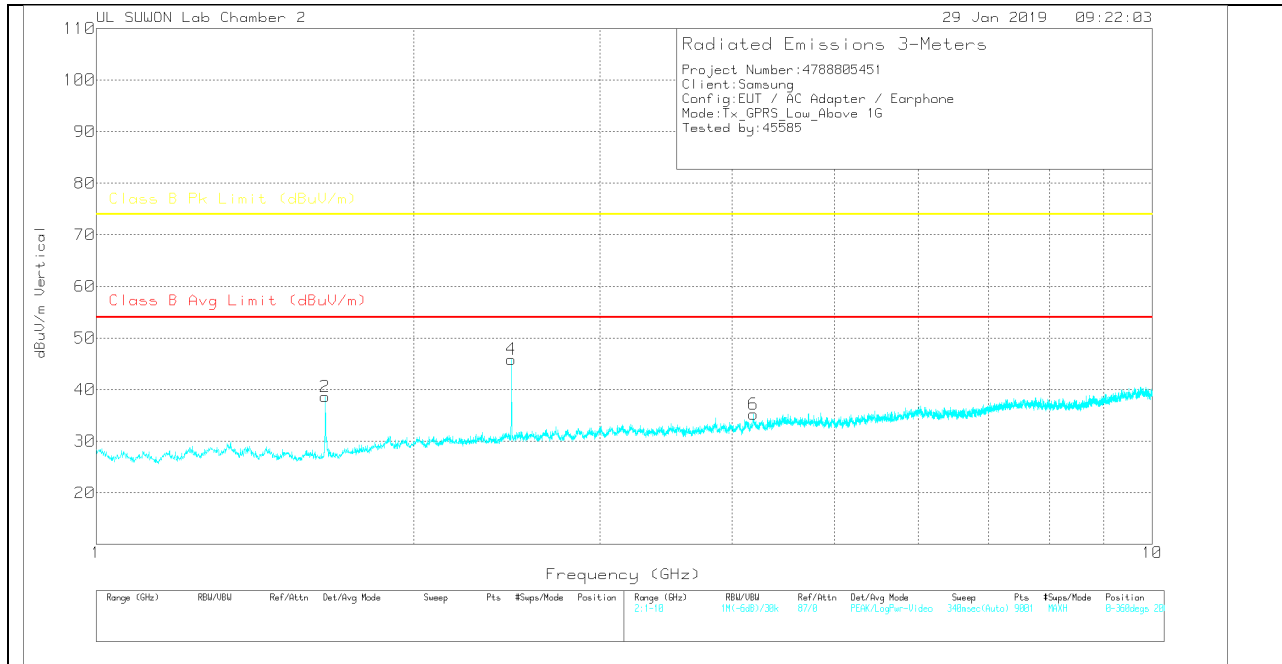

**DATA**

Trace Markers

Marker	Frequency (GHz)	Meter Reading (dBuV)	Det	3117_00168724	1-18GHz(dB)	1GHz_HPF	Corrected Reading dBuV/m	Class B Avg Limit (dBuV/m)	Av(CSFR)Margin (dB)	Class B Pk Limit (dBuV/m)	Margin (dB)	Azimuth (Degs)	Height (cm)	Polarity
1	1.648	43.16	PK	28.3	-31.4	.6	40.66	-	-	74	-33.34	0-360	200	H
3	2.472	44.85	PK	31.8	-30.2	.7	47.15	-	-	74	-26.85	0-360	200	H
5	4.199	29.24	PK	33.4	-28.2	.4	34.84	-	-	74	-39.16	0-360	100	H
2	1.648	41.12	PK	28.3	-31.4	.6	38.62	-	-	74	-35.38	0-360	200	V
4	2.472	43.57	PK	31.8	-30.2	.7	45.87	-	-	74	-28.13	0-360	100	V
6	4.193	29.65	PK	33.4	-28.2	.4	35.25	-	-	74	-38.75	0-360	200	V

PK – Peak Detector

Note: Unwanted emissions on the harmonic frequency were generated from the call-simulator with the TX and RX signals.

**MID CHANNEL(881.6MHz)**

**HORIZONTAL PEAK PLOT**

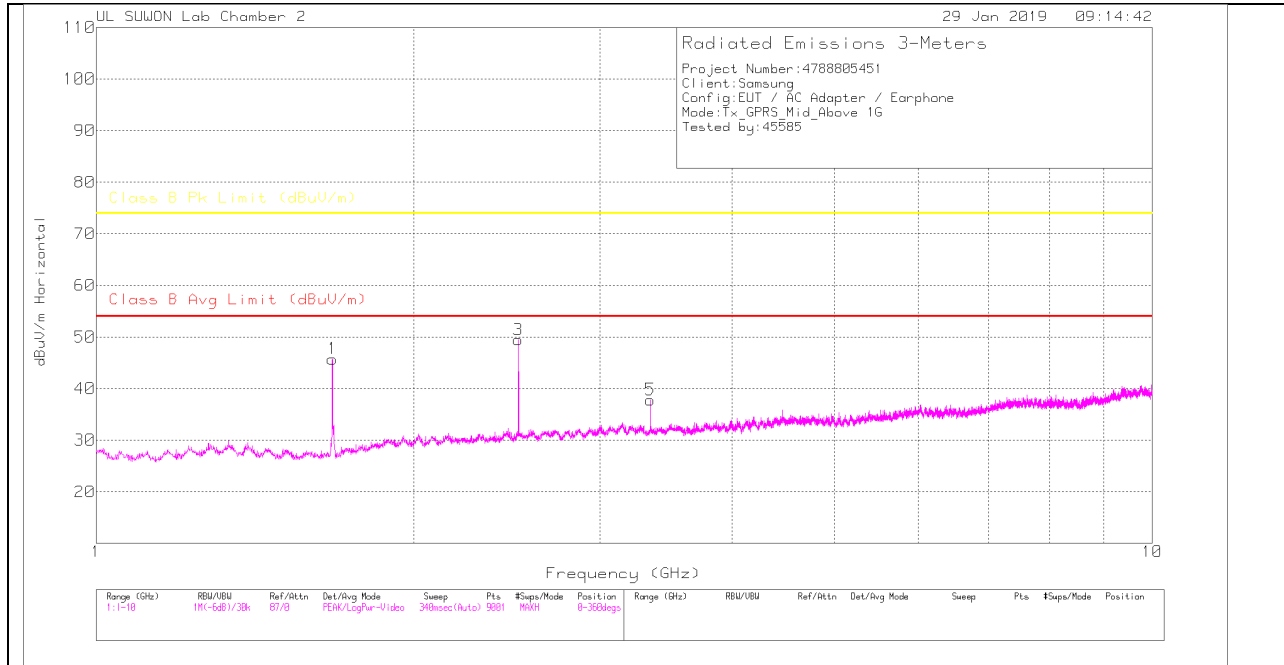

**VERTICAL PEAK PLOT**

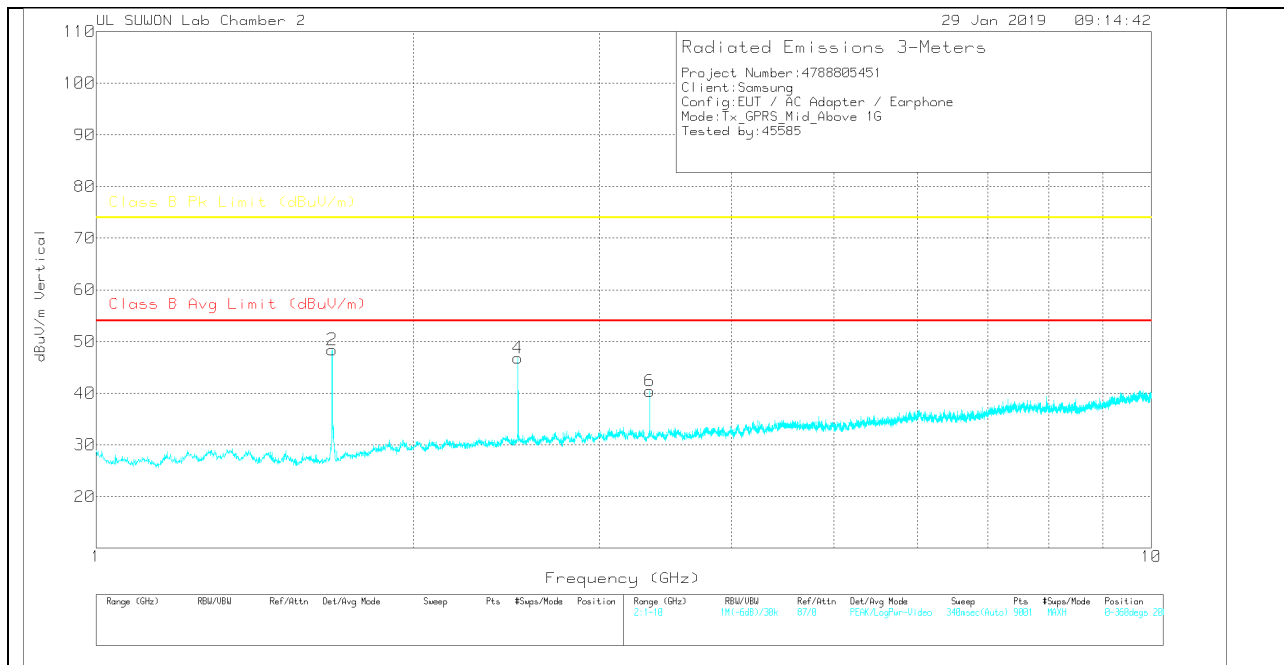

**DATA**

Trace Markers

Marker	Frequency (GHz)	Meter Reading (dBuV)	Det	3117_00168724	1-18GHz(dB)	1GHz_HPF	Corrected Reading dBuV/m	Class B Avg Limit (dBuV/m)	Av(CSPK)Margin (dB)	Class B PK Limit (dBuV/m)	Margin (dB)	Azimuth (Degs)	Height (cm)	Polarity
1	1.674	48.16	PK	28.5	-31.4	.5	45.76	-	-	74	-28.24	0-360	100	H
3	2.511	47.27	PK	31.9	-30.2	.5	49.47	-	-	74	-24.53	0-360	200	H
5	3.348	34.64	PK	32.6	-29.9	.5	37.84	-	-	74	-36.16	0-360	200	H
2	1.674	50.81	PK	28.5	-31.4	.5	48.41	-	-	74	-25.59	0-360	100	V
4	2.511	44.63	PK	31.9	-30.2	.5	46.83	-	-	74	-27.17	0-360	100	V
6	3.348	37.23	PK	32.6	-29.9	.5	40.43	-	-	74	-33.57	0-360	200	V

PK – Peak Detector

Note: Unwanted emissions on the harmonic frequency were generated from the call-simulator with the TX and RX signals.

**HIGH CHANNEL(893.8MHz)**

**HORIZONTAL PEAK PLOT**

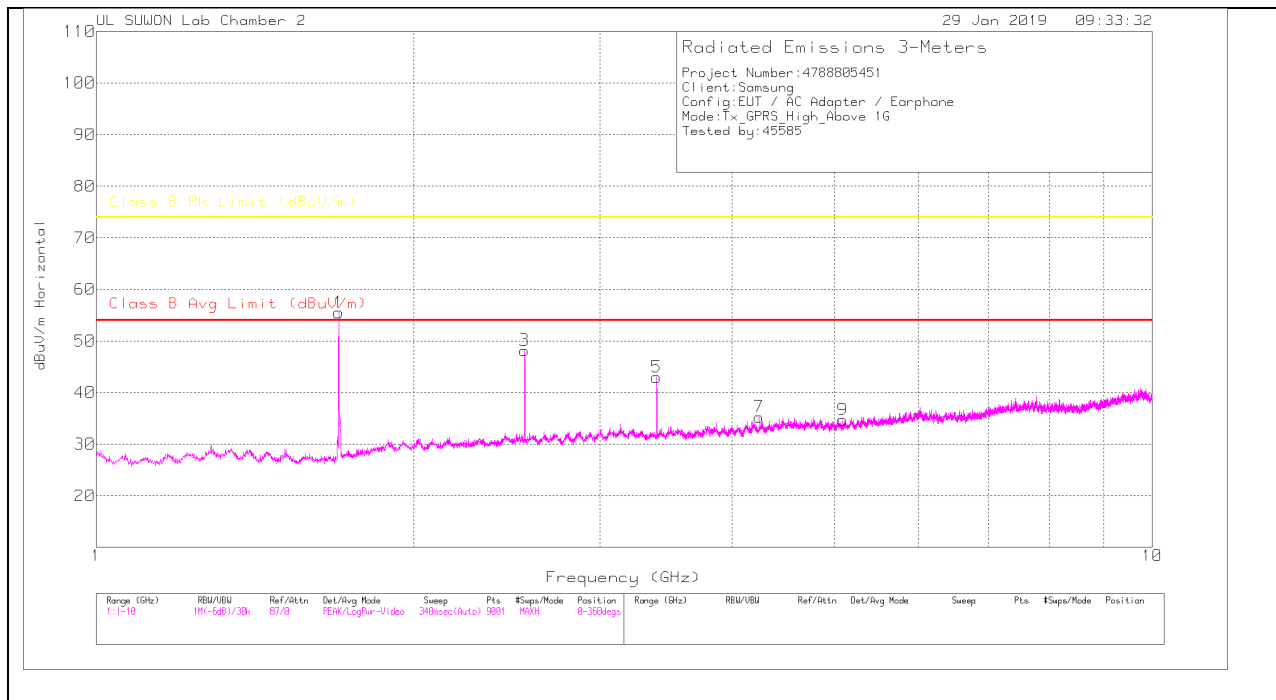

**VERTICAL PEAK PLOT**

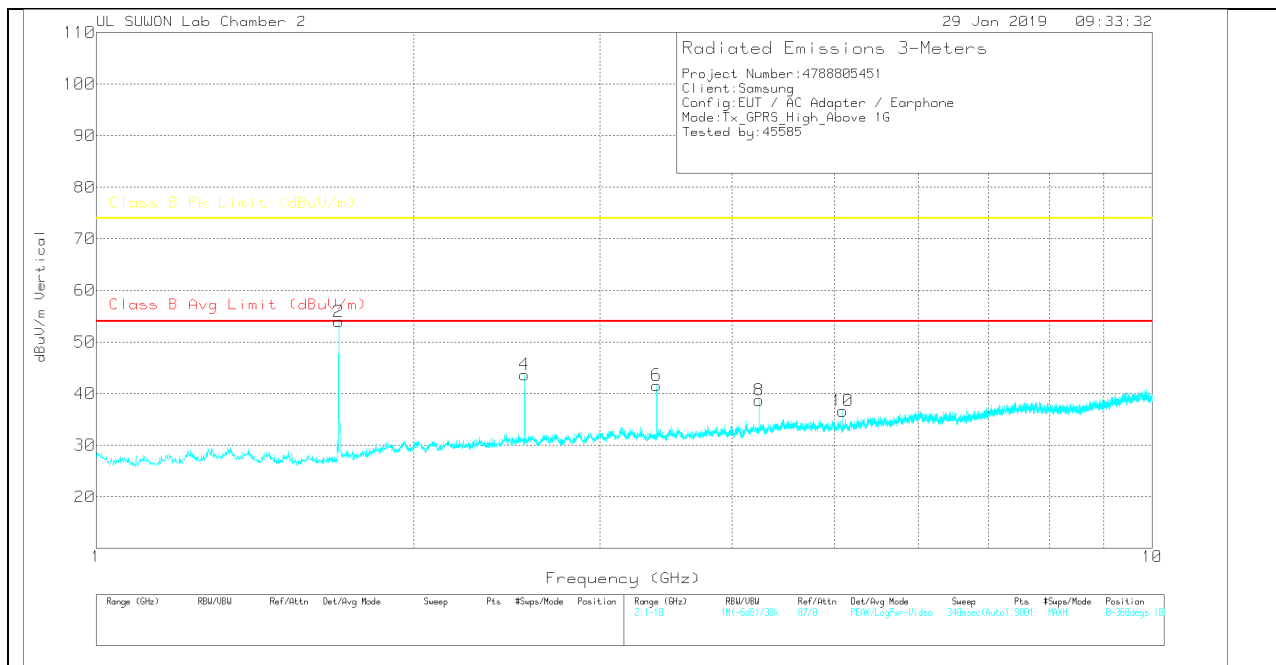

**DATA**

Trace Markers

Marker	Frequency (GHz)	Meter Reading (dBuV)	Det	3117_00168724	1-18GHz(dB)	1GHz_HPF	Corrected Reading dBuV/m	Class B Avg Limit (dBuV/m)	Av(CSPK)Margin (dB)	Class B Pk Limit (dBuV/m)	Margin (dB)	Azimuth (Degs)	Height (cm)	Polarity
1	1.697	57.63	PK	28.6	-31.3	.6	55.53	-	-	74	-18.47	0-360	200	H
3	2.546	45.68	PK	32	-30.2	.7	48.18	-	-	74	-25.82	0-360	100	H
5	3.395	39.09	PK	32.6	-29.4	.7	42.99	-	-	74	-31.01	0-360	200	H
7	4.244	30	PK	33.4	-28.5	.4	35.3	-	-	74	-38.7	0-360	200	H
9	5.092	28.11	PK	34.2	-28	.4	34.71	-	-	74	-39.29	0-360	100	H
2	1.697	56.09	PK	28.6	-31.3	.6	53.99	-	-	74	-20.01	0-360	100	V
4	2.546	41.19	PK	32	-30.2	.7	43.69	-	-	74	-30.31	0-360	200	V
6	3.395	37.72	PK	32.6	-29.4	.7	41.62	-	-	74	-32.38	0-360	200	V
8	4.244	33.43	PK	33.4	-28.5	.4	38.73	-	-	74	-35.27	0-360	200	V
10	5.093	30.16	PK	34.2	-28.1	.4	36.66	-	-	74	-37.34	0-360	200	V

PK – Peak Detector

Note: Unwanted emissions on the harmonic frequency were generated from the call-simulator with the TX and RX signals.

### 4.1. Above 1 GHz in the WCDMA Band 5

#### LOW CHANNEL(871.4MHz)

#### HORIZONTAL PEAK PLOT

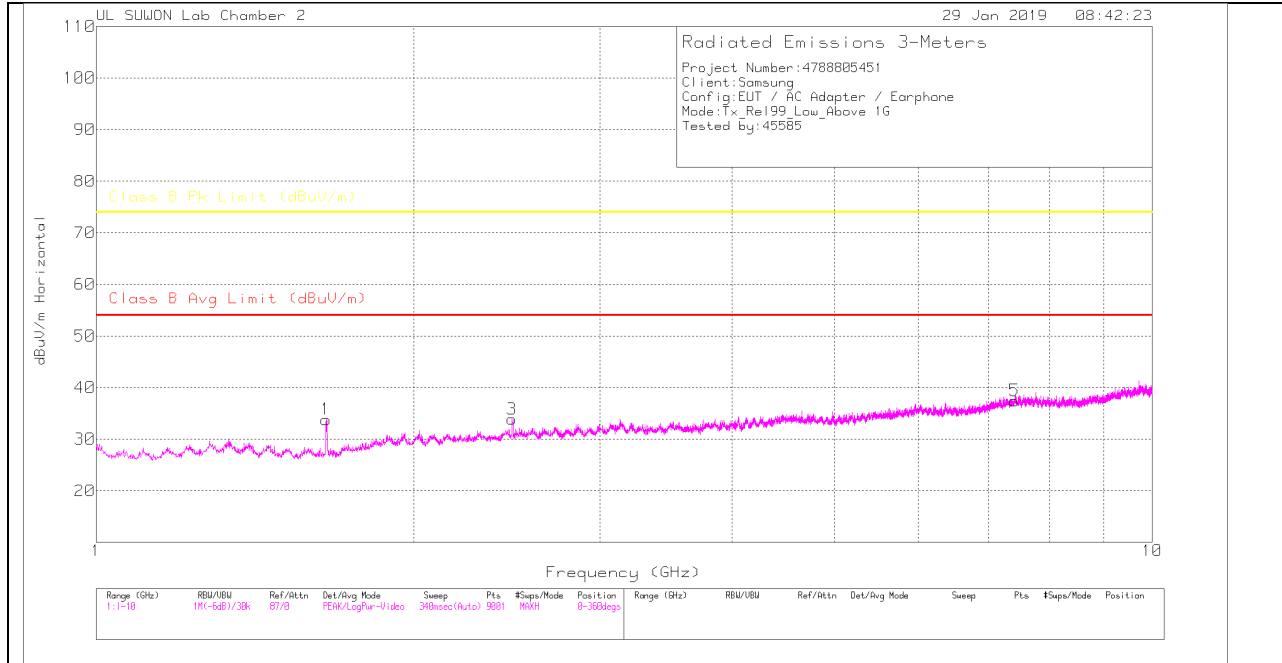

#### VERTICAL PEAK PLOT

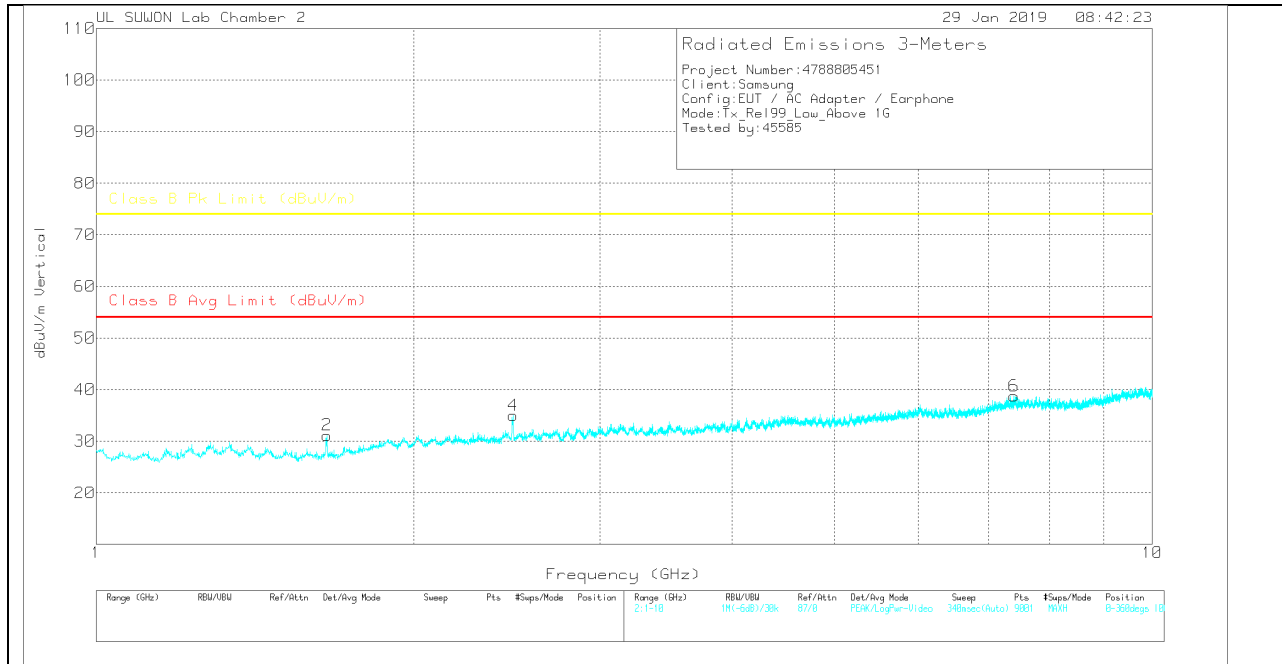

**DATA**

Trace Markers

Marker	Frequency (GHz)	Meter Reading (dBuV)	Det	3117_00168724	1-18GHz(dB)	1GHz_HPF	Corrected Reading dBuV/m	Class B Avg Limit (dBuV/m)	Av(CSFR)Margin (dB)	Class B Pk Limit (dBuV/m)	Margin (dB)	Azimuth (Degs)	Height (cm)	Polarity
1	1.651	36.34	PK	28.3	-31.4	.6	33.84	-	-	74	-40.16	0-360	200	H
3	2.476	31.38	PK	31.9	-30.1	.7	33.88	-	-	74	-40.12	0-360	100	H
5	7.402	26.08	PK	36.2	-25.4	.6	37.48	-	-	74	-36.52	0-360	200	H
2	1.654	33.86	PK	28.3	-31.5	.5	31.16	-	-	74	-42.84	0-360	100	V
4	2.483	32.57	PK	31.9	-30.1	.6	34.97	-	-	74	-39.03	0-360	200	V
6	7.399	27.34	PK	36.2	-25.4	.6	38.74	-	-	74	-35.26	0-360	100	V

PK – Peak Detector

Note: Unwanted emissions on the harmonic frequency were generated from the call-simulator with the TX and RX signals.

**MID CHANNEL(881.6MHz)**

**HORIZONTAL PEAK PLOT**

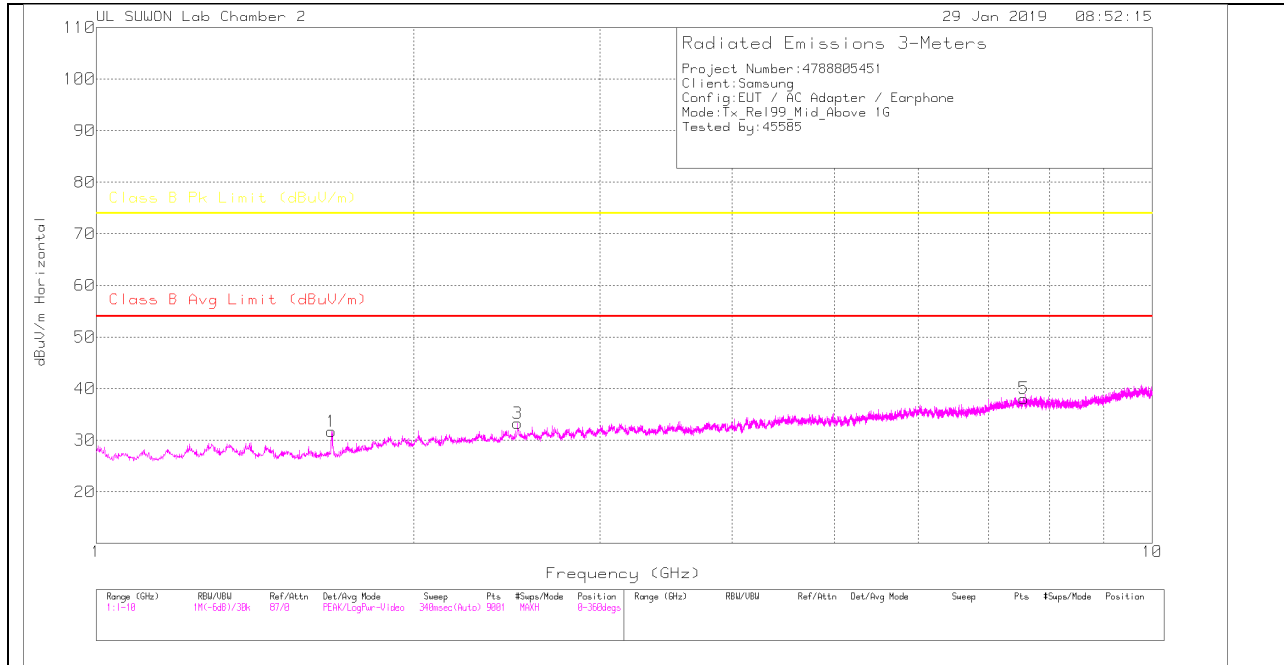

**VERTICAL PEAK PLOT**

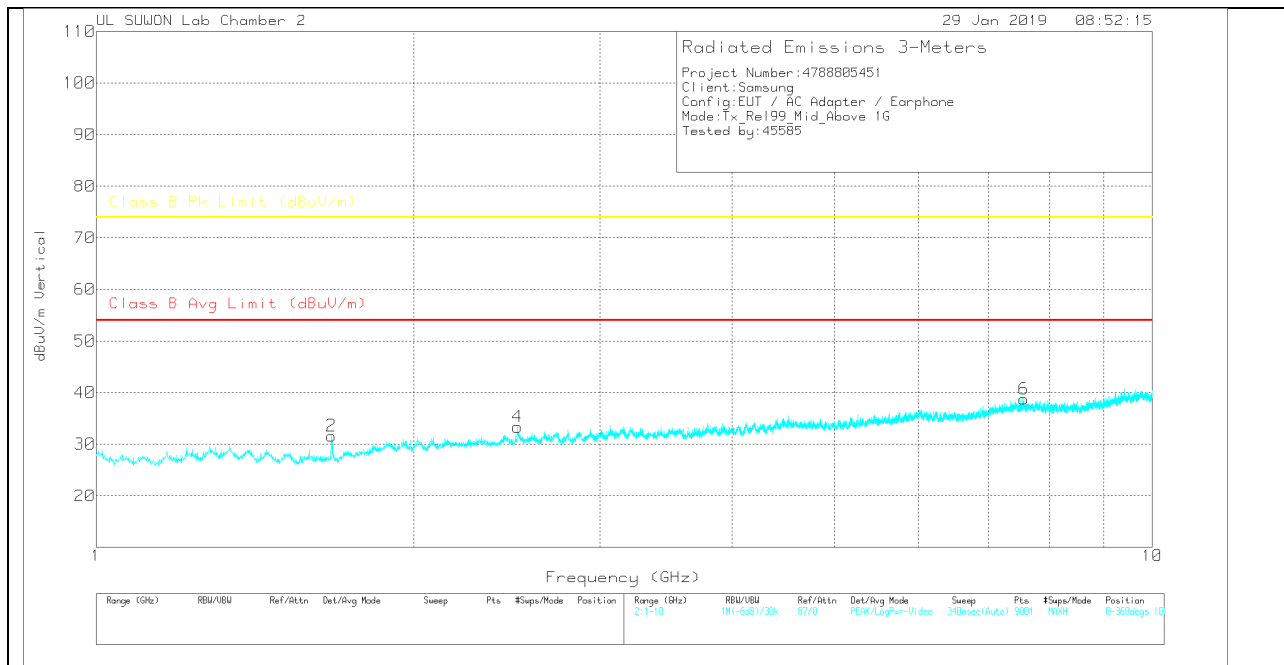

**DATA**

Trace Markers

Marker	Frequency (GHz)	Meter Reading (dBuV)	Det	3117_00168724	1-18GHz(dB)	1GHz_HPF	Corrected Reading dBuV/m	Class B Avg Limit (dBuV/m)	Av(CSPK)Margin (dB)	Class B PK Limit (dBuV/m)	Margin (dB)	Azimuth (Degs)	Height (cm)	Polarity
1	1.671	34.08	PK	28.5	-31.4	.5	31.68	-	-	74	-42.32	0-360	200	H
3	2.507	31.07	PK	31.9	-30.2	.5	33.27	-	-	74	-40.73	0-360	200	H
5	7.557	26.39	PK	36.1	-25.1	.7	38.09	-	-	74	-35.91	0-360	200	H
2	1.671	34.02	PK	28.5	-31.4	.5	31.62	-	-	74	-42.38	0-360	100	V
4	2.506	31.37	PK	31.9	-30.4	.5	33.37	-	-	74	-40.63	0-360	200	V
6	7.562	27.05	PK	36.1	-25.1	.7	38.75	-	-	74	-35.25	0-360	100	V

PK – Peak Detector

Note: Unwanted emissions on the harmonic frequency were generated from the call-simulator with the TX and RX signals.

**HIGH CHANNEL(891.6MHz)**

**HORIZONTAL PEAK PLOT**

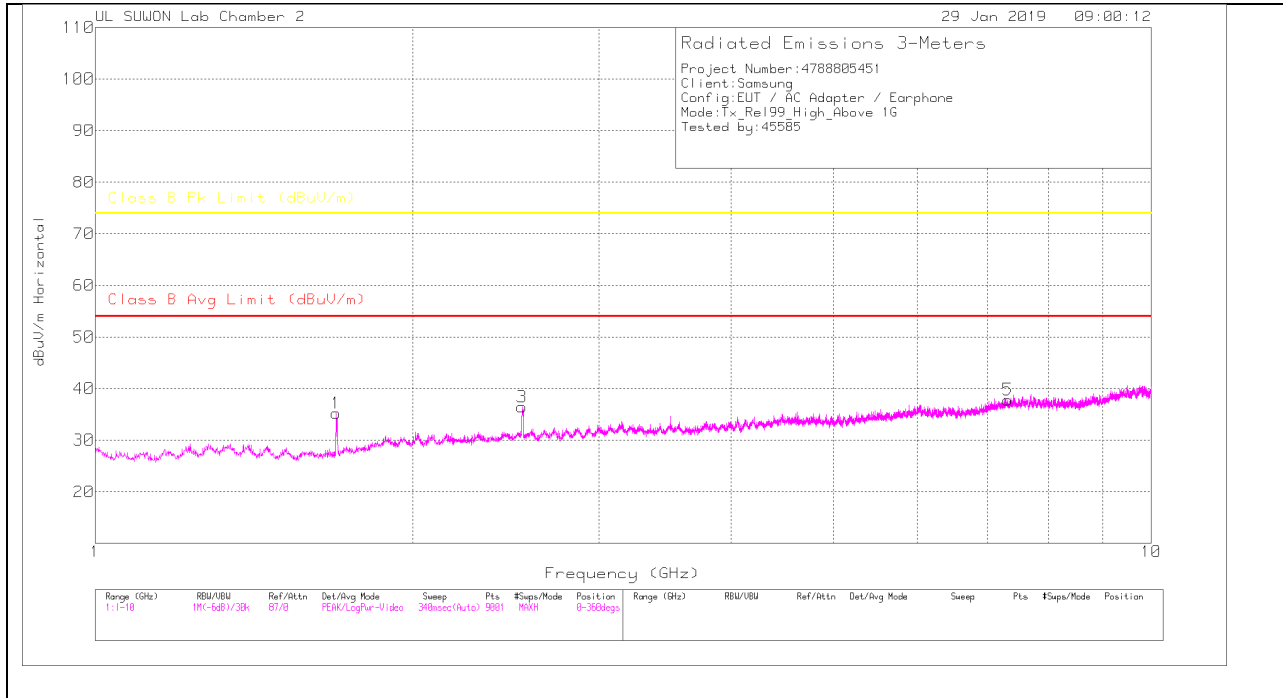

**VERTICAL PEAK PLOT**

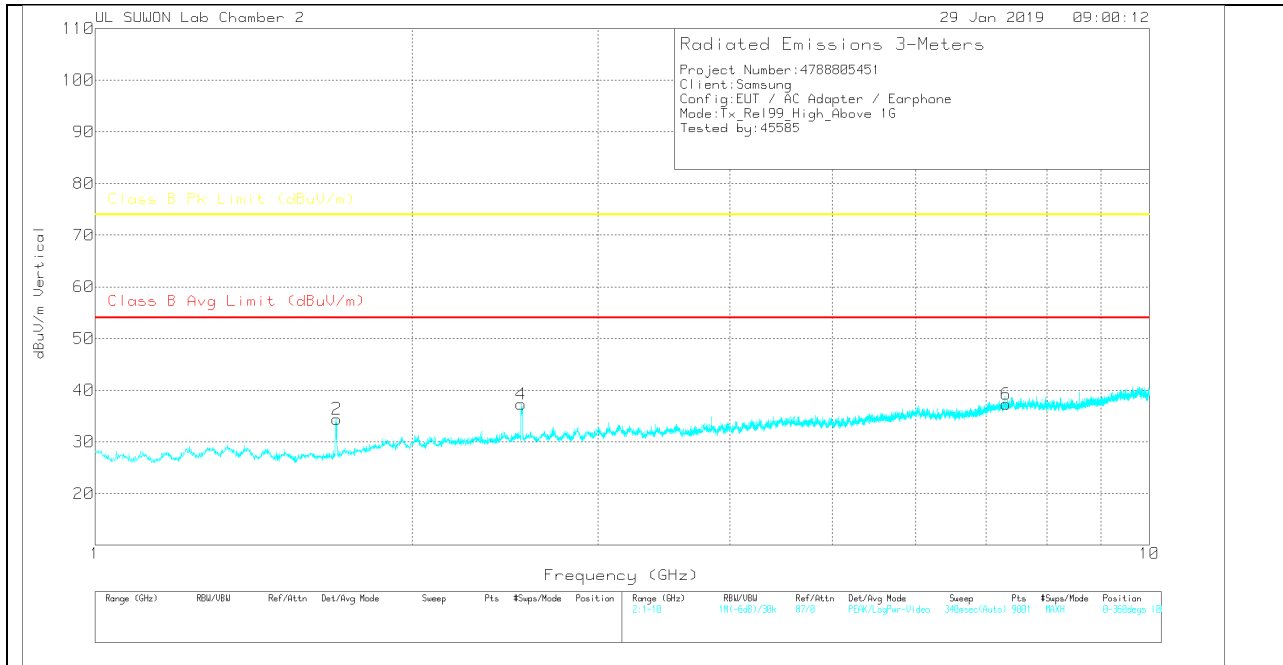

**DATA**

Trace Markers

Marker	Frequency (GHz)	Meter Reading (dBuV)	Det	3117_00168724	1-18GHz(dB)	1GHz_HPF	Corrected Reading dBuV/m	Class B Avg Limit (dBuV/m)	Av(CSPK)Margin (dB)	Class B PK Limit (dBuV/m)	Margin (dB)	Azimuth (Degs)	Height (cm)	Polarity
1	1.691	37.25	PK	28.6	-31.2	.6	35.25	-	-	74	-38.75	0-360	200	H
3	2.536	34.03	PK	32	-30.2	.6	36.43	-	-	74	-37.57	0-360	100	H
5	7.313	27.14	PK	36.2	-25.9	.4	37.84	-	-	74	-36.16	0-360	100	H
2	1.695	36.51	PK	28.6	-31.3	.6	34.41	-	-	74	-39.59	0-360	100	V
4	2.536	34.89	PK	32	-30.2	.6	37.29	-	-	74	-36.71	0-360	100	V
6	7.314	26.49	PK	36.2	-25.8	.4	37.29	-	-	74	-36.71	0-360	200	V

PK – Peak Detector

Note: Unwanted emissions on the harmonic frequency were generated from the call-simulator with the TX and RX signals.

## 4.2. Above 1 GHz in the LTE Band 5

### LOW CHANNEL(870.5MHz)

#### HORIZONTAL PEAK PLOT

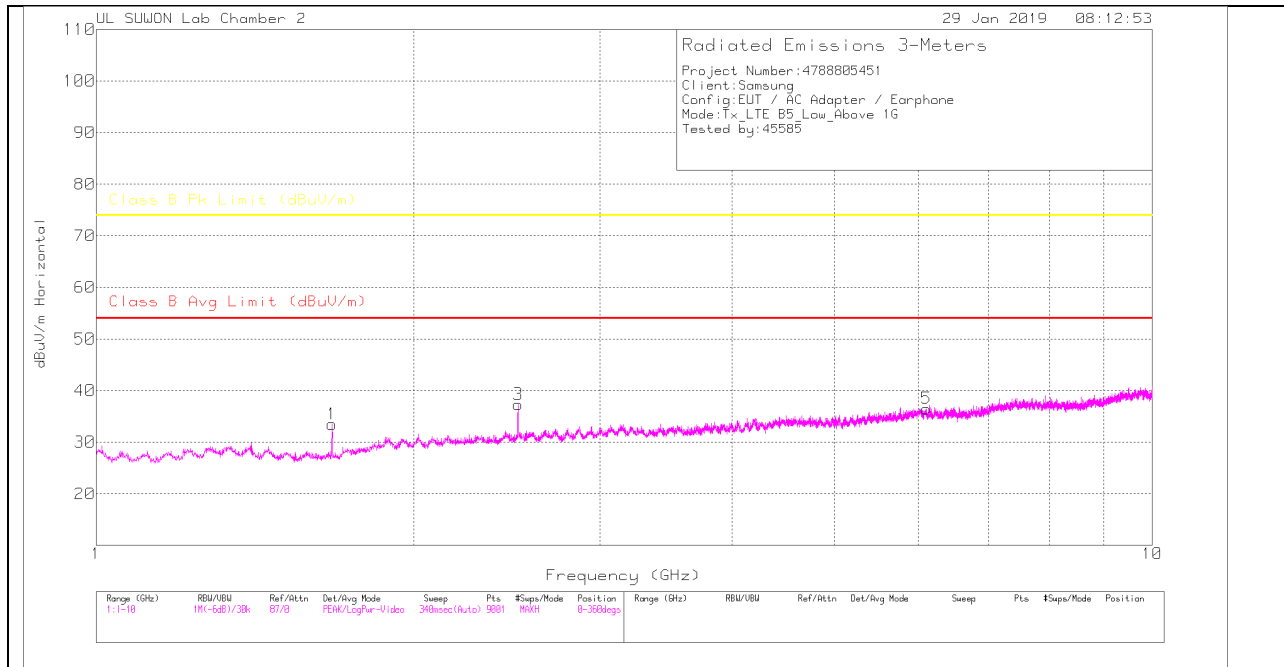

#### VERTICAL PEAK PLOT

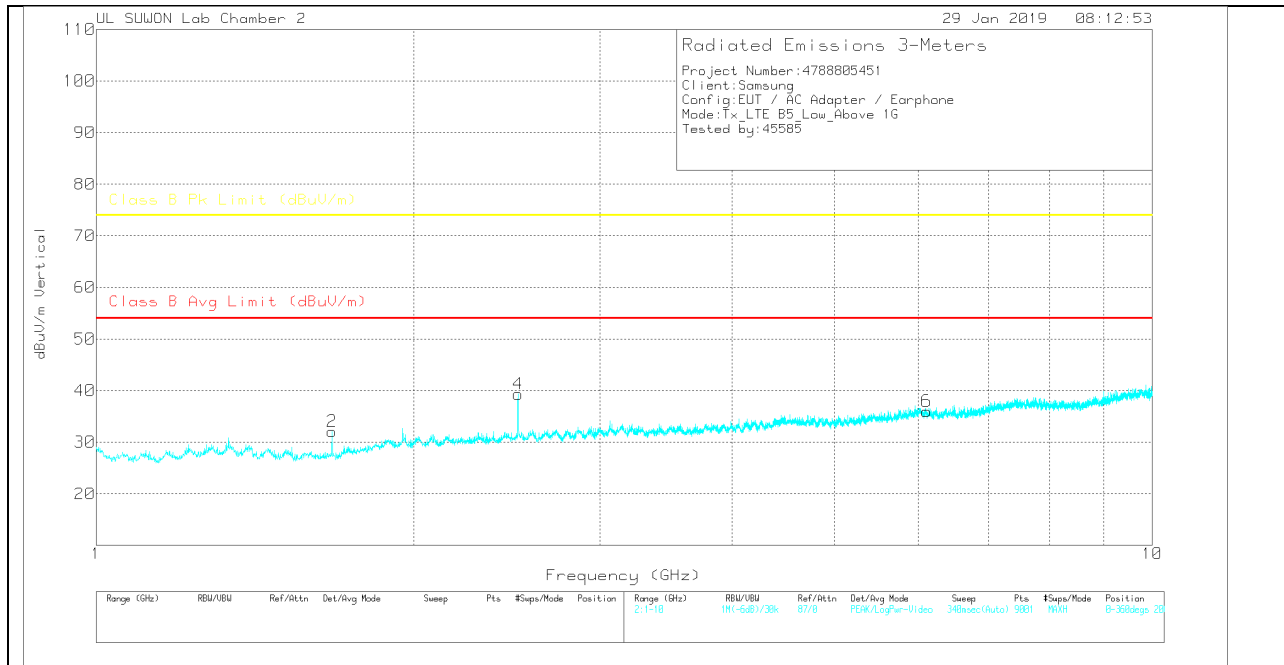

**DATA**

Trace Markers

Marker	Frequency (GHz)	Meter Reading (dBuV)	Det	3117_00168724	1-18GHz(dB)	1GHz_HPF	Corrected Reading dBuV/m	Class B Avg Limit (dBuV/m)	Av(CSFR)Margin (dB)	Class B Pk Limit (dBuV/m)	Margin (dB)	Azimuth (Degs)	Height (cm)	Polarity
1	1.673	35.79	PK	28.5	-31.3	.5	33.49	-	-	74	-40.51	0-360	100	H
3	2.51	35.23	PK	31.9	-30.3	.5	37.33	-	-	74	-36.67	0-360	200	H
5	6.111	28.02	PK	35.1	-27	.4	36.52	-	-	74	-37.48	0-360	200	H
2	1.672	34.39	PK	28.5	-31.3	.5	32.09	-	-	74	-41.91	0-360	200	V
4	2.509	37.23	PK	31.9	-30.3	.5	39.33	-	-	74	-34.67	0-360	100	V
6	6.115	27.51	PK	35.1	-27	.4	36.01	-	-	74	-37.99	0-360	200	V

PK – Peak Detector

Note: Unwanted emissions on the harmonic frequency were generated from the call-simulator with the TX and RX signals.

**MID CHANNEL(881.5MHz)**

**HORIZONTAL PEAK PLOT**

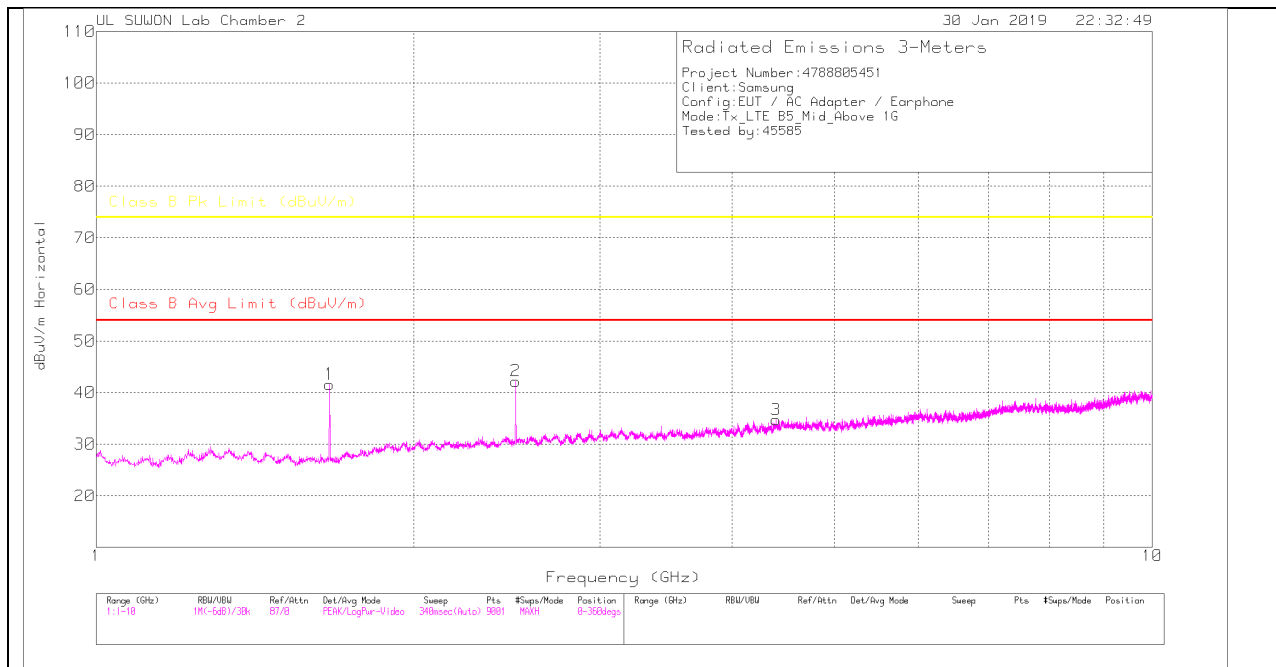

**VERTICAL PEAK PLOT**

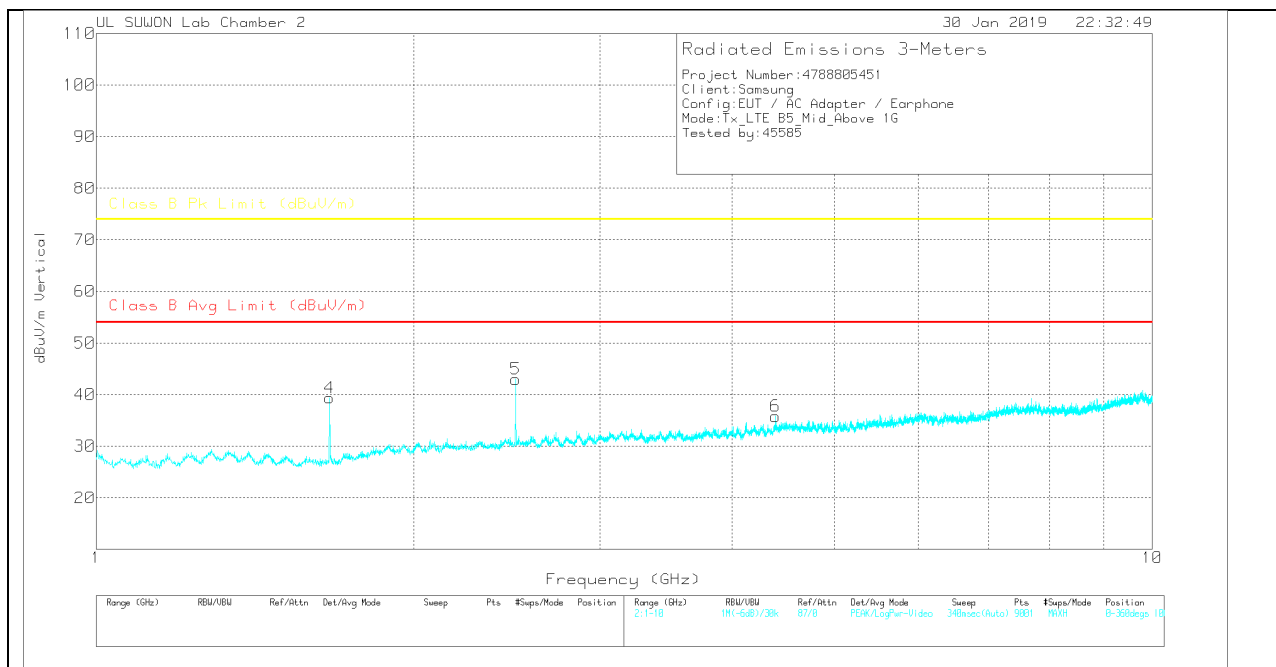

**DATA**

Trace Markers

Marker	Frequency (GHz)	Meter Reading (dBuV)	Det	3117_00168724	1-18GHz(dB)	1GHz_HPF	Corrected Reading dBuV/m	Class B Avg Limit (dBuV/m)	Av(CSPK)Margin (dB)	Class B PK Limit (dBuV/m)	Margin (dB)	Azimuth (Degs)	Height (cm)	Polarity
1	1.664	44.11	PK	28.4	-31.4	.5	41.61	-	-	74	-32.39	0-360	200	H
2	2.496	39.94	PK	31.9	-30.2	.6	42.24	-	-	74	-31.76	0-360	200	H
3	4.404	29.23	PK	33.7	-28.6	.4	34.73	-	-	74	-39.27	0-360	200	H
4	1.664	41.89	PK	28.4	-31.4	.5	39.39	-	-	74	-34.61	0-360	100	V
5	2.496	40.68	PK	31.9	-30.2	.6	42.98	-	-	74	-31.02	0-360	100	V
6	4.4	30.3	PK	33.7	-28.6	.4	35.8	-	-	74	-38.2	0-360	200	V

PK – Peak Detector

Note: Unwanted emissions on the harmonic frequency were generated from the call-simulator with the TX and RX signals.

**HIGH CHANNEL(892.5MHz)**

**HORIZONTAL PEAK PLOT**

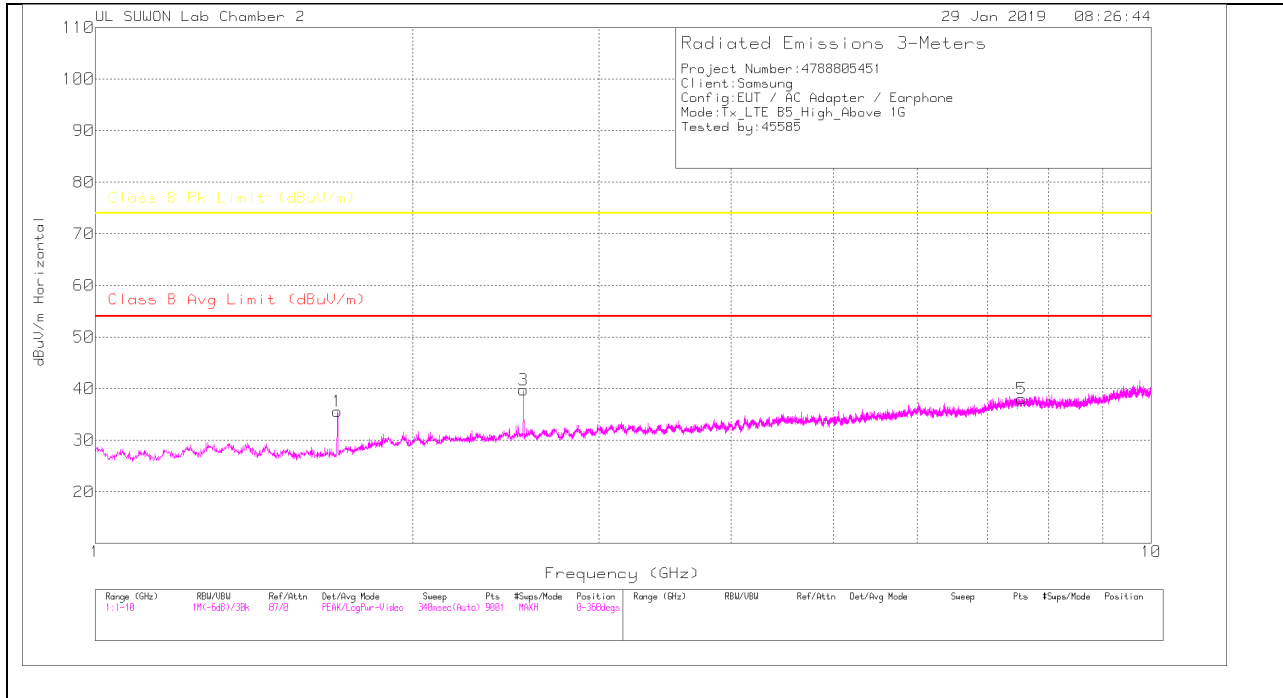

**VERTICAL PEAK PLOT**

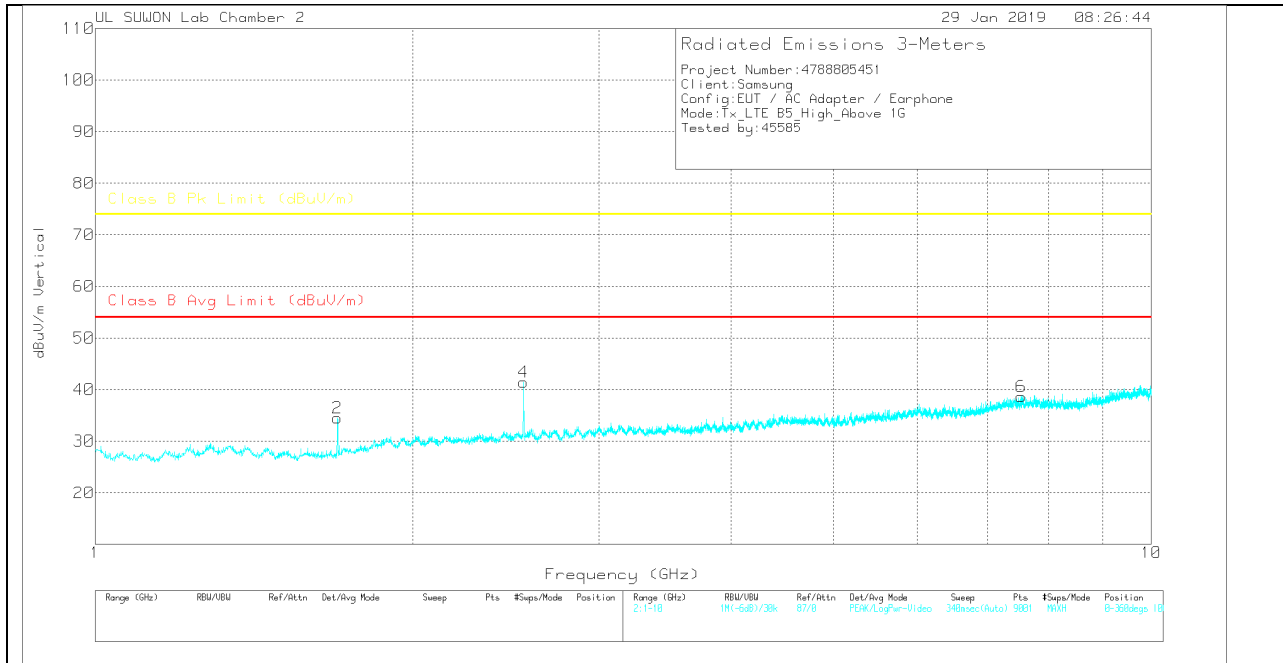

**DATA**

Trace Markers

Marker	Frequency (GHz)	Meter Reading (dBuV)	Det	3117_00168724	1-18GHz(dB)	1GHz_HPF	Corrected Reading dBuV/m	Class B Avg Limit (dBuV/m)	Av(CSPK)Margin (dB)	Class B PK Limit (dBuV/m)	Margin (dB)	Azimuth (Degs)	Height (cm)	Polarity
1	1.696	37.67	PK	28.6	-31.3	.6	35.57	-	-	74	-38.43	0-360	200	H
3	2.545	37.03	PK	32	-30	.7	39.73	-	-	74	-34.27	0-360	100	H
5	7.537	26.32	PK	36.1	-25.1	.7	38.02	-	-	74	-35.98	0-360	100	H
2	1.696	36.61	PK	28.6	-31.3	.6	34.51	-	-	74	-39.49	0-360	100	V
4	2.545	38.76	PK	32	-30	.7	41.46	-	-	74	-32.54	0-360	100	V
6	7.532	27.04	PK	36.1	-25.1	.6	38.64	-	-	74	-35.36	0-360	100	V

PK – Peak Detector

Note: Unwanted emissions on the harmonic frequency were generated from the call-simulator with the TX and RX signals.

### 4.3. Above 1 GHz in the LTE Band 12

#### LOW CHANNEL(730.5MHz)

#### HORIZONTAL PEAK PLOT

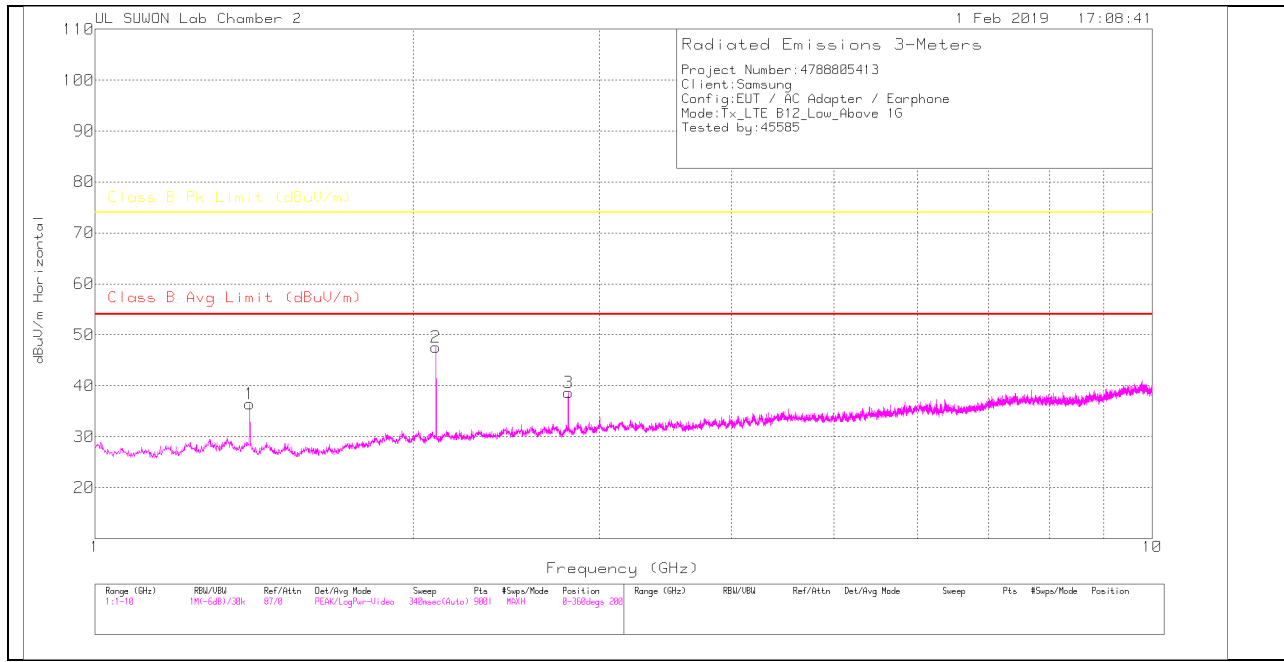

#### VERTICAL PEAK PLOT

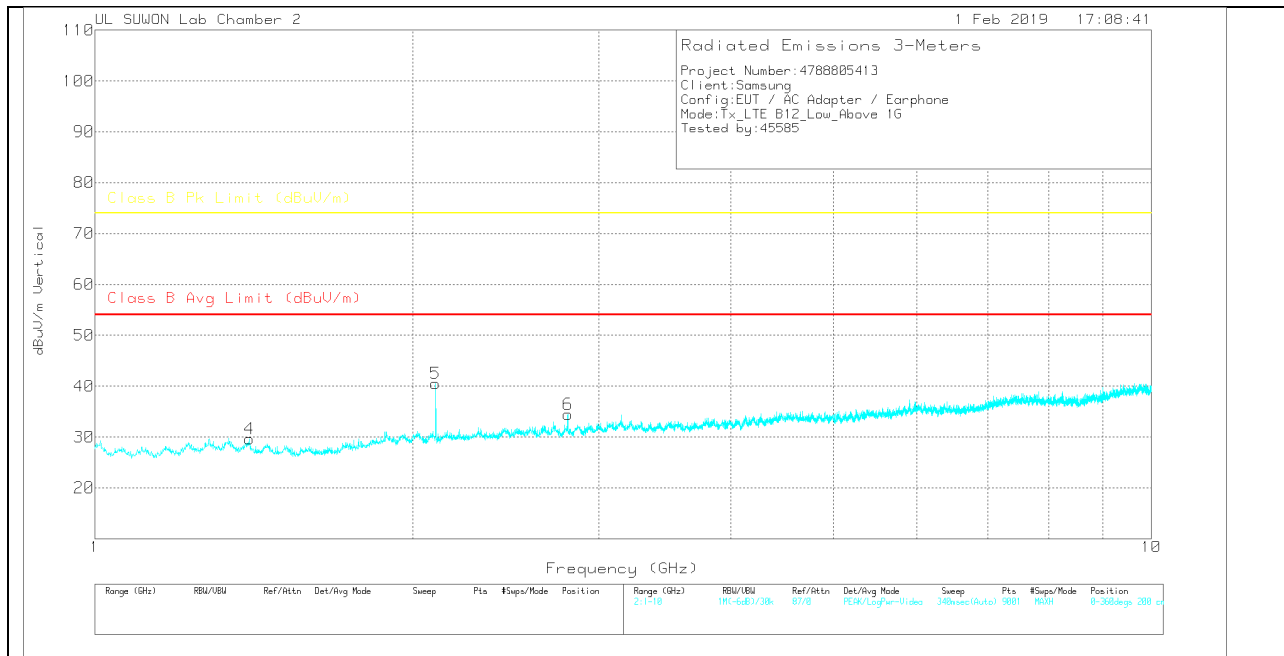

**DATA**

Trace Markers

Marker	Frequency (GHz)	Meter Reading (dBuV)	Det	3117_00168724	1-18GHz(dB)	1GHz_HPF	Corrected Reading dBuV/m	Class B Avg Limit (dBuV/m)	Av(CSFR)Margin (dB)	Class B Pk Limit (dBuV/m)	Margin (dB)	Azimuth (Degs)	Height (cm)	Polarity
1	1.401	38.16	PK	29.4	-31.7	.6	36.46	-	-	74	-37.54	0-360	100	H
2	2.102	46.48	PK	31.3	-30.7	.5	47.58	-	-	74	-26.42	0-360	100	H
3	2.803	36.02	PK	32	-30	.6	38.62	-	-	74	-35.38	0-360	100	H
4	1.401	31.34	PK	29.4	-31.7	.6	29.64	-	-	74	-44.36	0-360	200	V
5	2.102	39.39	PK	31.3	-30.7	.5	40.49	-	-	74	-33.51	0-360	200	V
6	2.803	31.89	PK	32	-30	.6	34.49	-	-	74	-39.51	0-360	200	V

PK – Peak Detector

Note: Unwanted emissions on the harmonic frequency were generated from the call-simulator with the TX and RX signals.

**MID CHANNEL(737.5MHz)**

**HORIZONTAL PEAK PLOT**

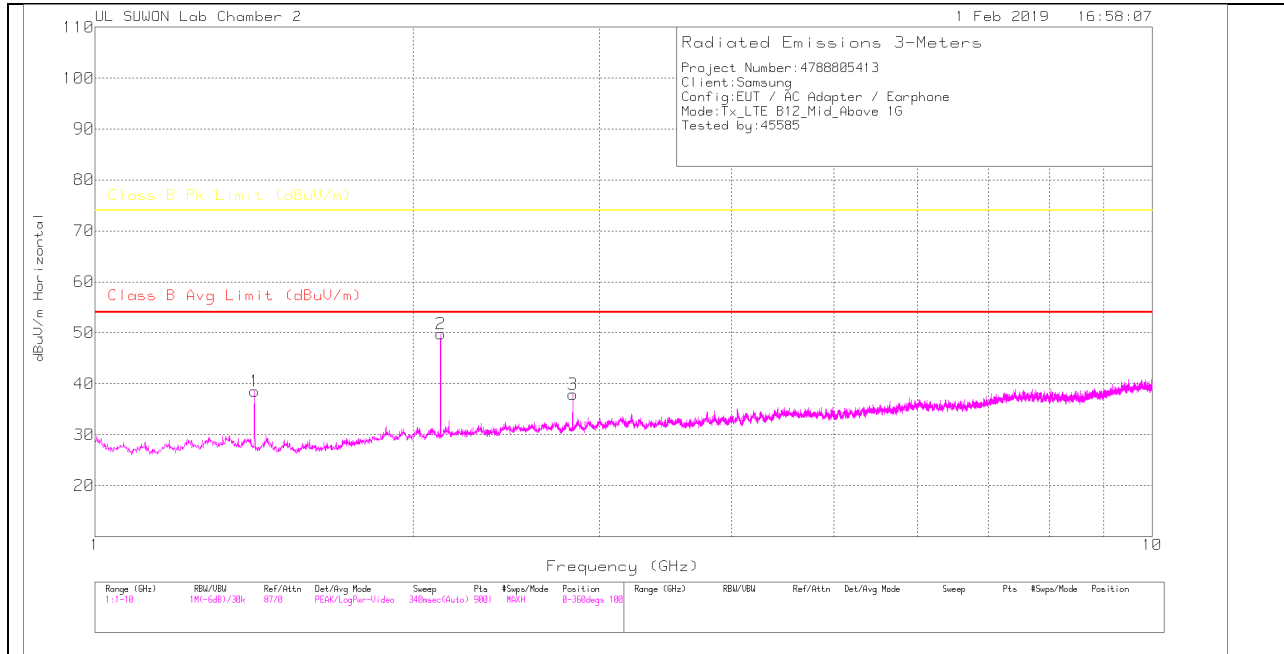

**VERTICAL PEAK PLOT**

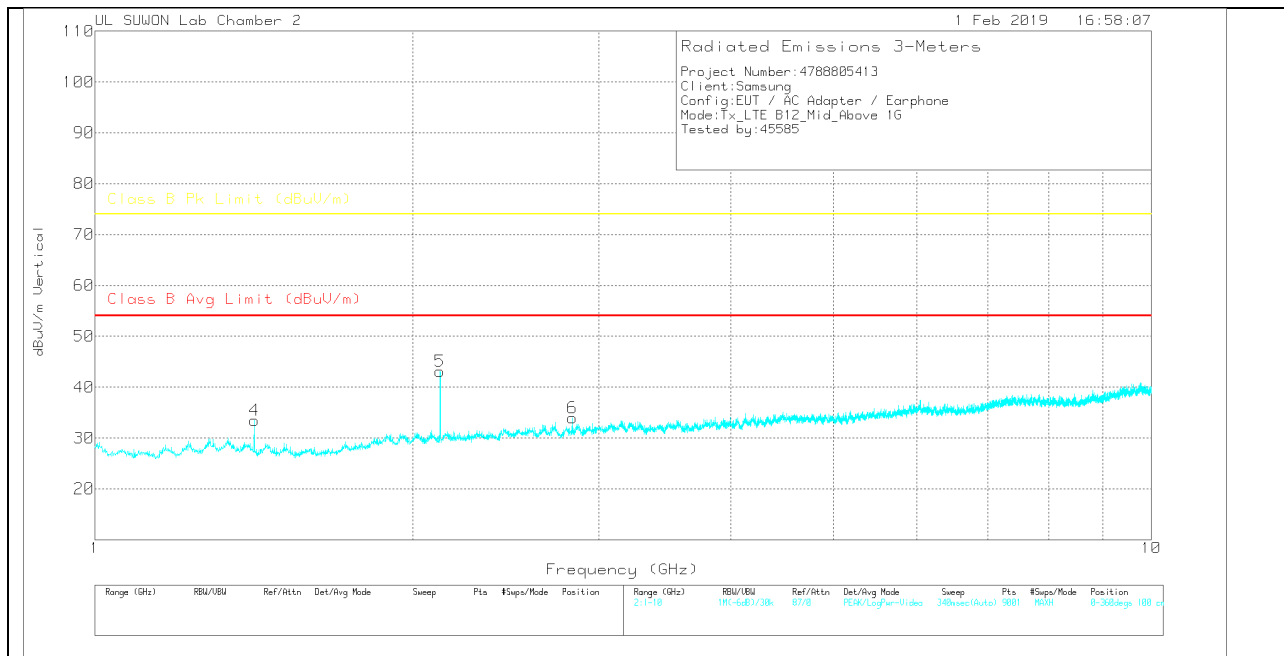

**DATA**

Trace Markers

Marker	Frequency (GHz)	Meter Reading (dBuV)	Det	3117_00168724	1-18GHz(dB)	1GHz_HPF	Corrected Reading dBuV/m	Class B Avg Limit (dBuV/m)	Av(CSPK)Margin (dB)	Class B PK Limit (dBuV/m)	Margin (dB)	Azimuth (Degs)	Height (cm)	Polarity
1	1.415	40.45	PK	29.3	-31.8	.6	38.55	-	-	74	-35.45	0-360	100	H
2	2.123	48.47	PK	31.3	-30.6	.6	49.77	-	-	74	-24.23	0-360	100	H
3	2.831	35.03	PK	32	-29.9	.8	37.93	-	-	74	-36.07	0-360	100	H
4	1.415	35.35	PK	29.3	-31.8	.6	33.45	-	-	74	-40.55	0-360	200	V
5	2.122	41.89	PK	31.3	-30.7	.6	43.09	-	-	74	-30.91	0-360	200	V
6	2.83	31.14	PK	32	-30	.8	33.94	-	-	74	-40.06	0-360	200	V

PK – Peak Detector

Note: Unwanted emissions on the harmonic frequency were generated from the call-simulator with the TX and RX signals.

**HIGH CHANNEL(744.5MHz)**

**HORIZONTAL PEAK PLOT**

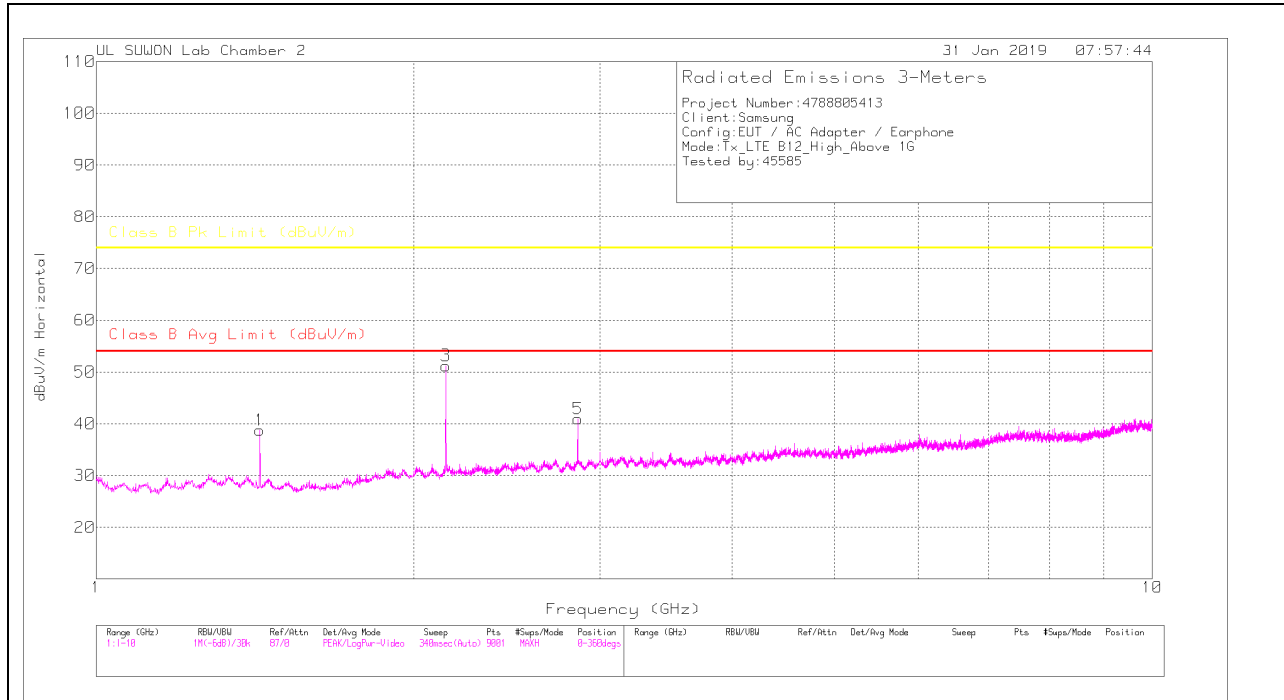

**VERTICAL PEAK PLOT**

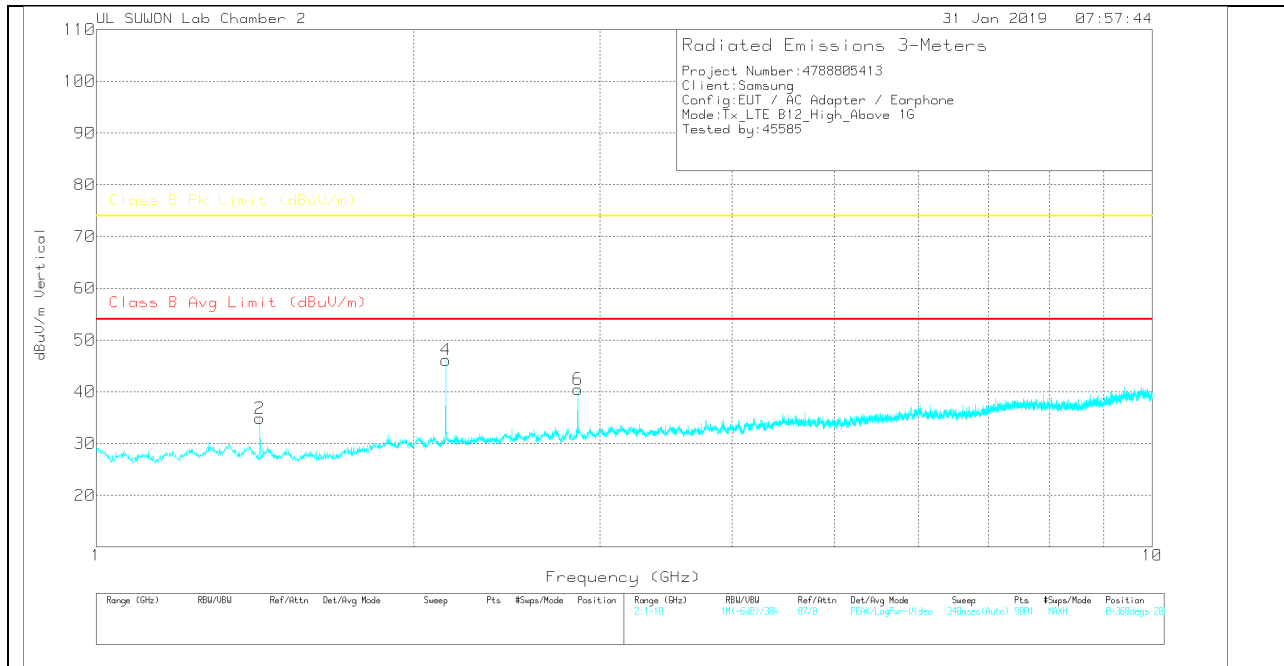

**DATA**

Trace Markers

Marker	Frequency (GHz)	Meter Reading (dBuV)	Det	3117_00168724	1-18GHz(dB)	1GHz_HPF	Corrected Reading dBuV/m	Class B Avg Limit (dBuV/m)	Av(CISPR)Margin (dB)	Class B Pk Limit (dBuV/m)	Margin (dB)	Azimuth (Degs)	Height (cm)	Polarity
1	1.429	40.77	Pk	29.2	-31.8	.6	38.77	-	-	74	-35.23	0-360	100	H
3	2.144	49.92	Pk	31.3	-30.7	.7	51.22	-	-	74	-22.78	0-360	200	H
5	2.858	37.97	Pk	32.1	-29.9	.8	40.97	-	-	74	-33.03	0-360	100	H
2	1.429	36.84	Pk	29.2	-31.8	.6	34.84	-	-	74	-39.16	0-360	100	V
4	2.144	44.84	Pk	31.3	-30.7	.7	46.14	-	-	74	-27.86	0-360	200	V
6	2.858	37.49	Pk	32.1	-29.9	.8	40.49	-	-	74	-33.51	0-360	200	V

PK – Peak Detector

Note: Unwanted emissions on the harmonic frequency were generated from the call-simulator with the TX and RX signals.

### 4.4. Above 1 GHz in the LTE Band 13

#### LOW CHANNEL(748.5MHz)

#### HORIZONTAL PEAK PLOT

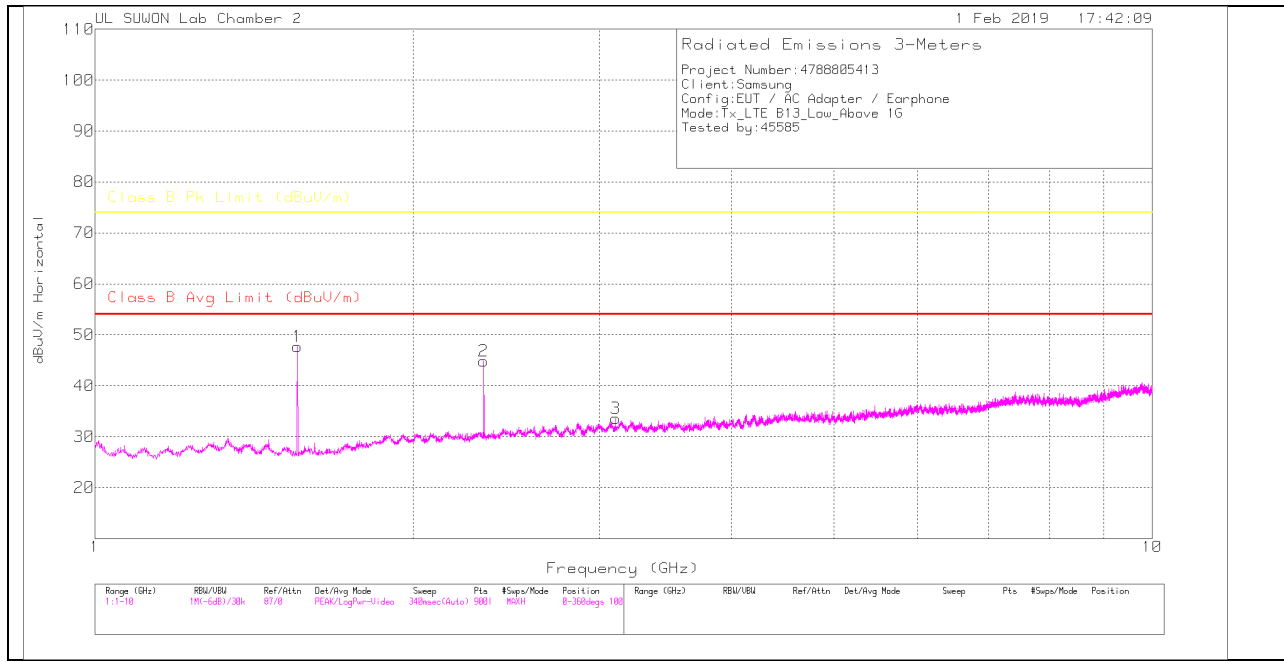

#### VERTICAL PEAK PLOT

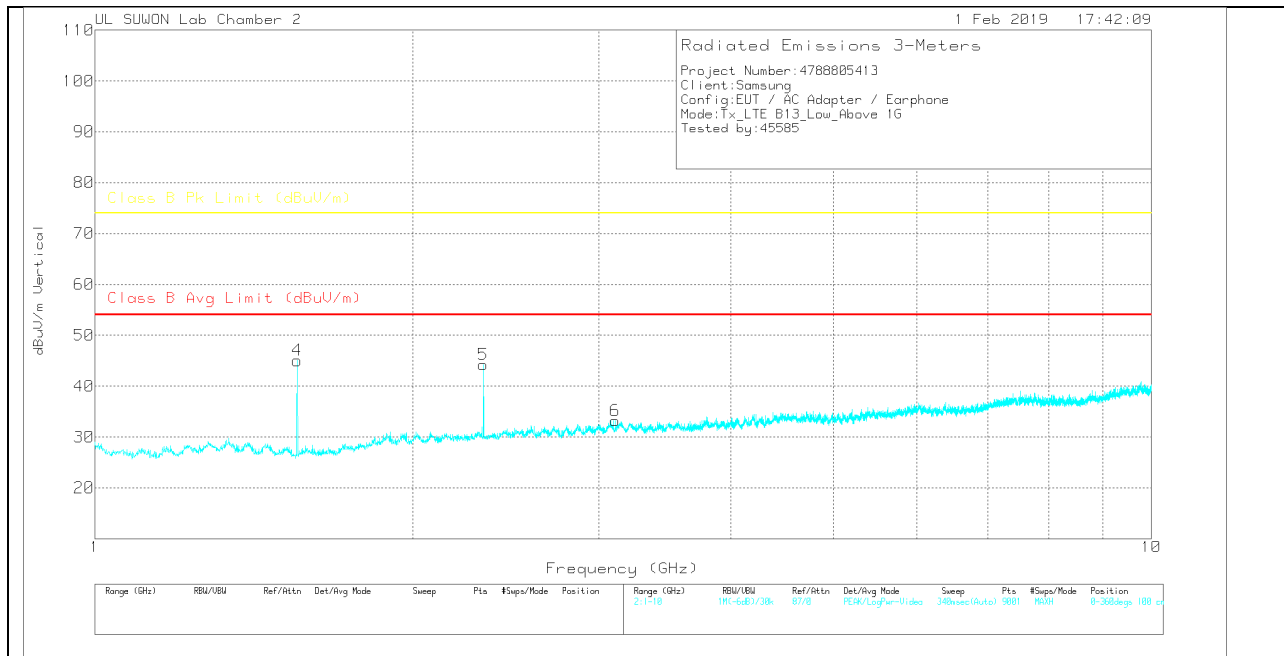

**DATA**

Trace Markers

Marker	Frequency (GHz)	Meter Reading (dBuV)	Det	3117_00168724	1-18GHz(dB)	1GHz_HPF	Corrected Reading dBuV/m	Class B Avg Limit (dBuV/m)	Av(CSFR)Margin (dB)	Class B Pk Limit (dBuV/m)	Margin (dB)	Azimuth (Degs)	Height (cm)	Polarity
1	1.554	50.32	PK	28.3	-31.4	.5	47.72	-	-	74	-26.28	0-360	100	H
2	2.332	43.35	PK	31.5	-30.7	.7	44.85	-	-	74	-29.15	0-360	100	H
3	3.109	29.74	PK	32.8	-29.7	.7	33.54	-	-	74	-40.46	0-360	200	H
4	1.554	47.64	PK	28.3	-31.4	.5	45.04	-	-	74	-28.96	0-360	100	V
5	2.332	42.7	PK	31.5	-30.7	.7	44.2	-	-	74	-29.8	0-360	200	V
6	3.109	29.41	PK	32.8	-29.7	.7	33.21	-	-	74	-40.79	0-360	100	V

PK – Peak Detector

Note: Unwanted emissions on the harmonic frequency were generated from the call-simulator with the TX and RX signals.

**MID CHANNEL(751.0MHz)**

**HORIZONTAL PEAK PLOT**

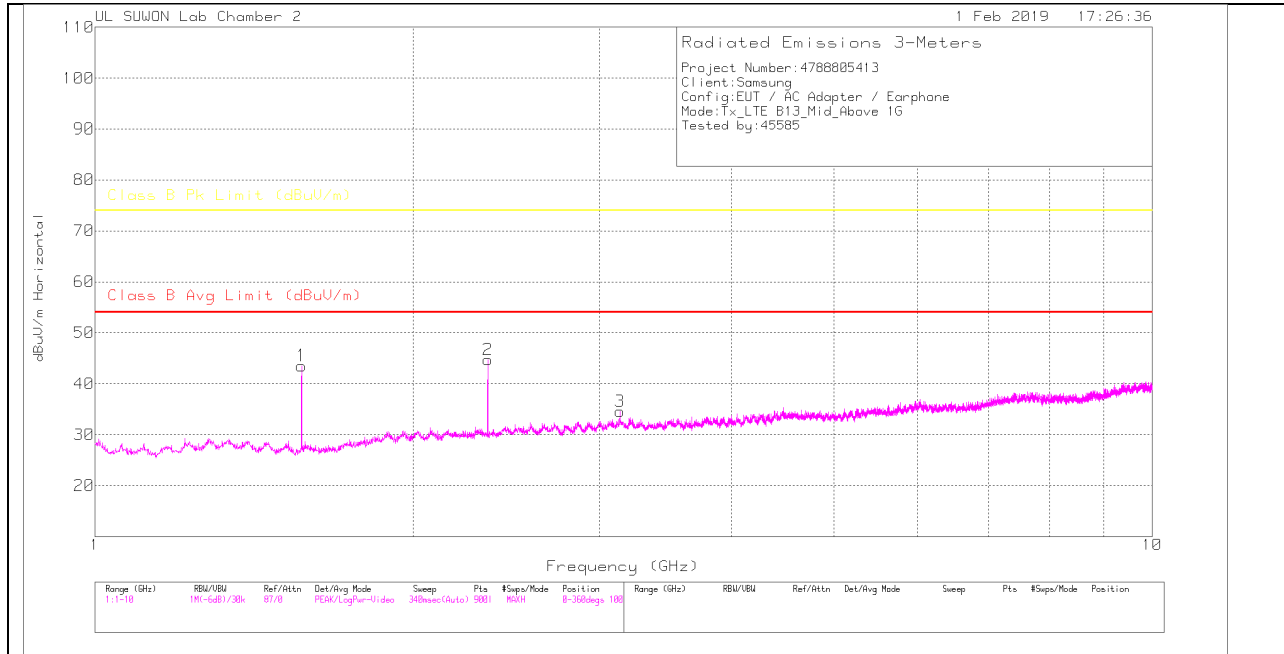

**VERTICAL PEAK PLOT**

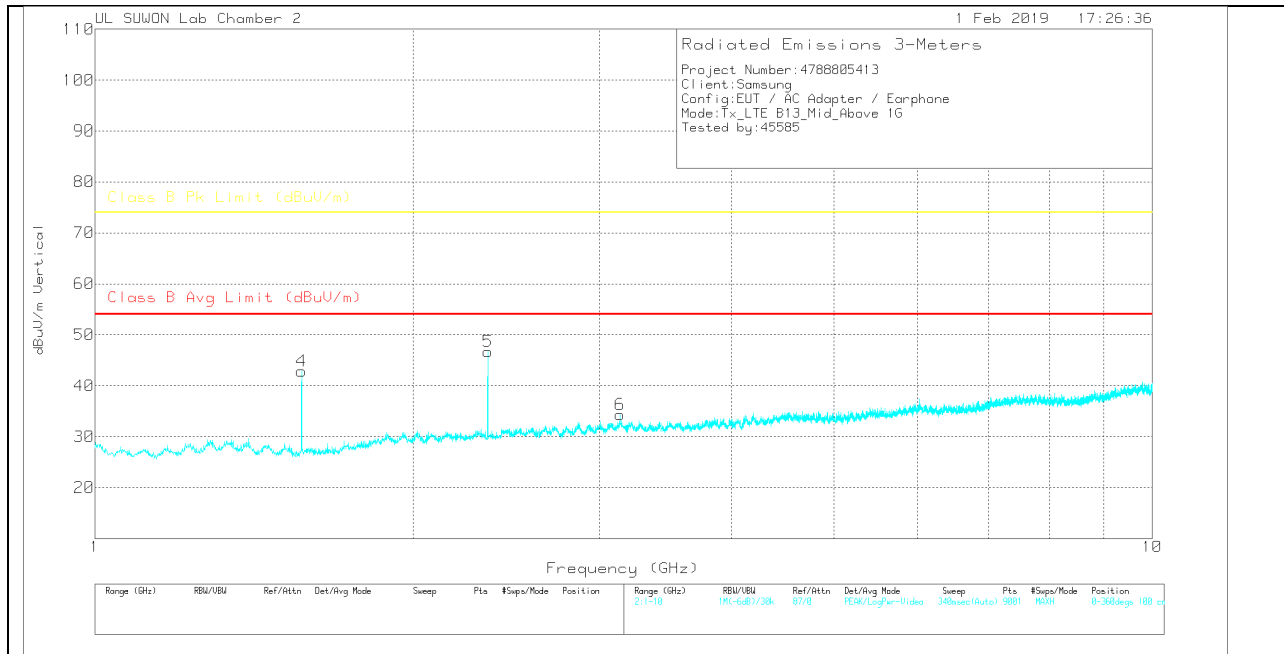

**DATA**

Trace Markers

Marker	Frequency (GHz)	Meter Reading (dBuV)	Det	3117_00168724	1-18GHz(dB)	1GHz_HPF	Corrected Reading dBuV/m	Class B Avg Limit (dBuV/m)	Av(CSPK)Margin (dB)	Class B PK Limit (dBuV/m)	Margin (dB)	Azimuth (Degs)	Height (cm)	Polarity
1	1.568	46.05	PK	28.3	-31.4	.6	43.55	-	-	74	-30.45	0-360	200	H
2	2.352	43.31	PK	31.6	-30.7	.5	44.71	-	-	74	-29.29	0-360	100	H
3	3.136	30.62	PK	32.9	-29.6	.7	34.62	-	-	74	-39.38	0-360	200	H
4	1.568	45.37	PK	28.3	-31.4	.6	42.87	-	-	74	-31.13	0-360	100	V
5	2.352	45.35	PK	31.6	-30.7	.5	46.75	-	-	74	-27.25	0-360	200	V
6	3.137	30.4	PK	32.9	-29.7	.7	34.3	-	-	74	-39.7	0-360	200	V

PK – Peak Detector

Note: Unwanted emissions on the harmonic frequency were generated from the call-simulator with the TX and RX signals.

**HIGH CHANNEL(753.5MHz)**

**HORIZONTAL PEAK PLOT**

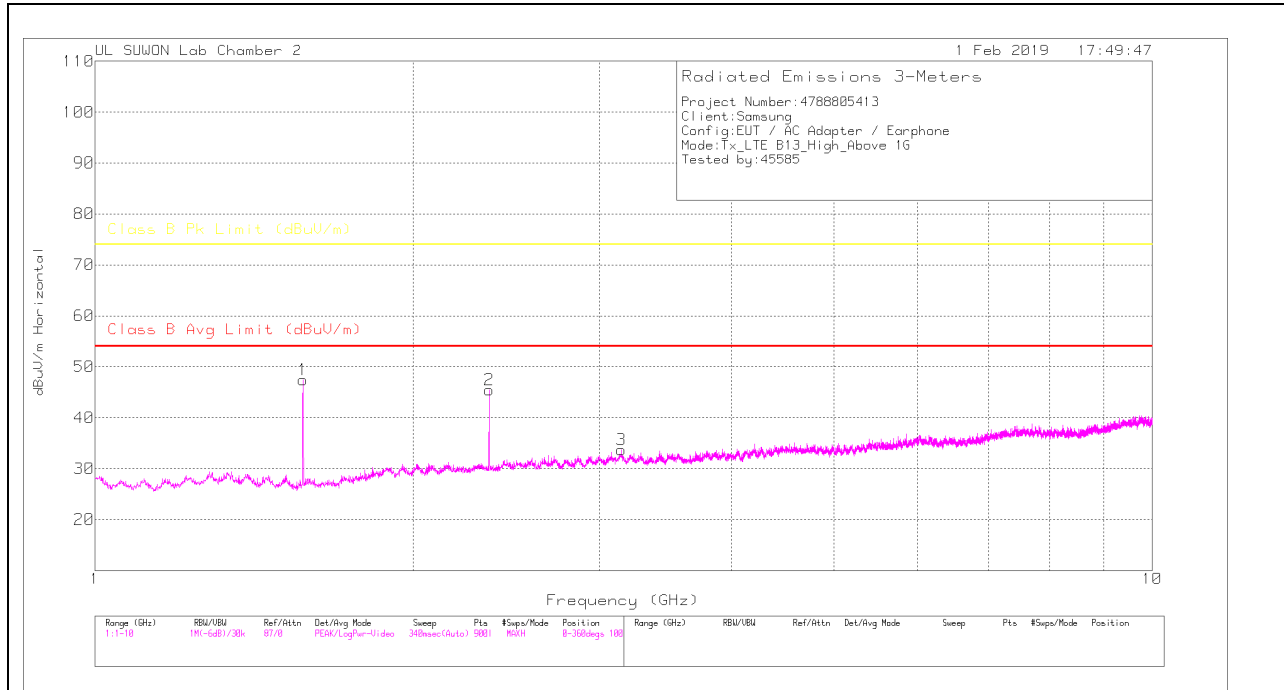

**VERTICAL PEAK PLOT**

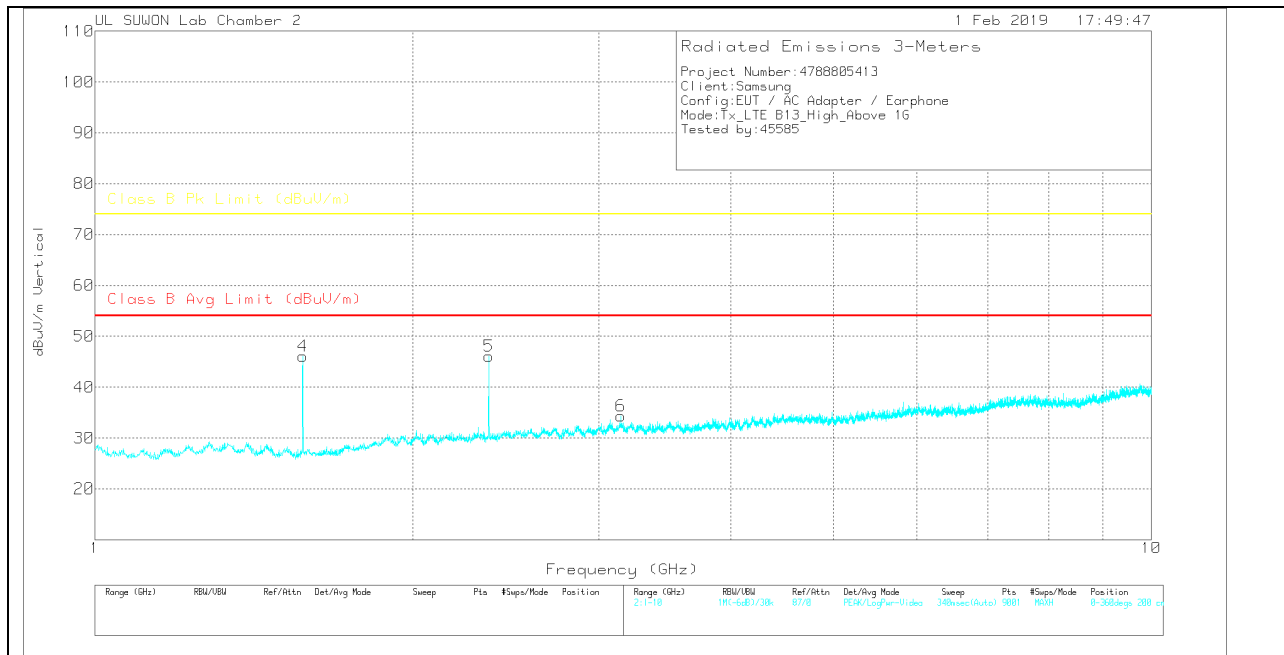

**DATA**

Trace Markers

Marker	Frequency (GHz)	Meter Reading (dBuV)	Det	3117_00168724	1-18GHz(dB)	1GHz_HPF	Corrected Reading dBuV/m	Class B Avg Limit (dBuV/m)	Av(CSPK)Margin (dB)	Class B Pk Limit (dBuV/m)	Margin (dB)	Azimuth (Degs)	Height (cm)	Polarity
1	1.573	49.94	PK	28.3	-31.5	.7	47.44	-	-	74	-26.56	0-360	100	H
2	2.36	44.24	PK	31.6	-30.8	.4	45.44	-	-	74	-28.56	0-360	100	H
3	3.146	29.77	PK	32.9	-29.6	.7	33.77	-	-	74	-40.23	0-360	200	H
4	1.573	48.54	PK	28.3	-31.5	.7	46.04	-	-	74	-27.96	0-360	100	V
5	2.359	44.87	PK	31.6	-30.8	.4	46.07	-	-	74	-27.93	0-360	200	V
6	3.146	30.36	PK	32.9	-29.6	.7	34.36	-	-	74	-39.64	0-360	100	V

PK – Peak Detector

Note: Unwanted emissions on the harmonic frequency were generated from the call-simulator with the TX and RX signals.

### 4.5. Above 1 GHz in the LTE Band 26

#### LOW CHANNEL(860.5MHz)

#### HORIZONTAL PEAK PLOT

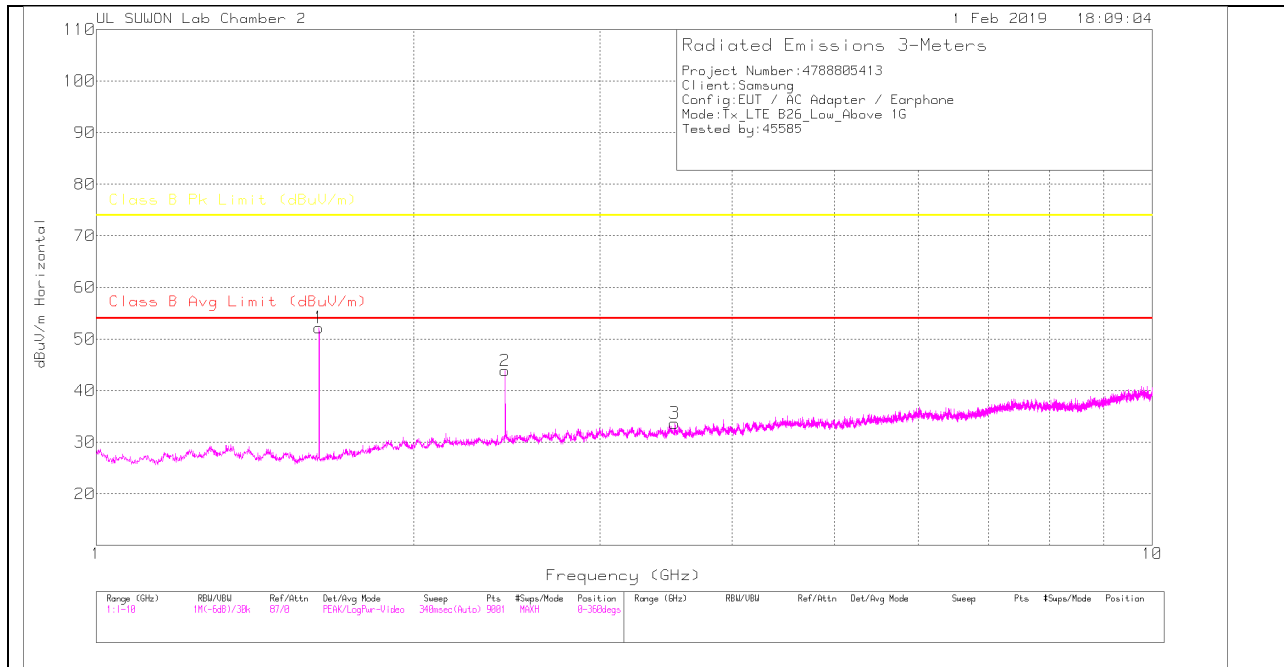

#### VERTICAL PEAK PLOT

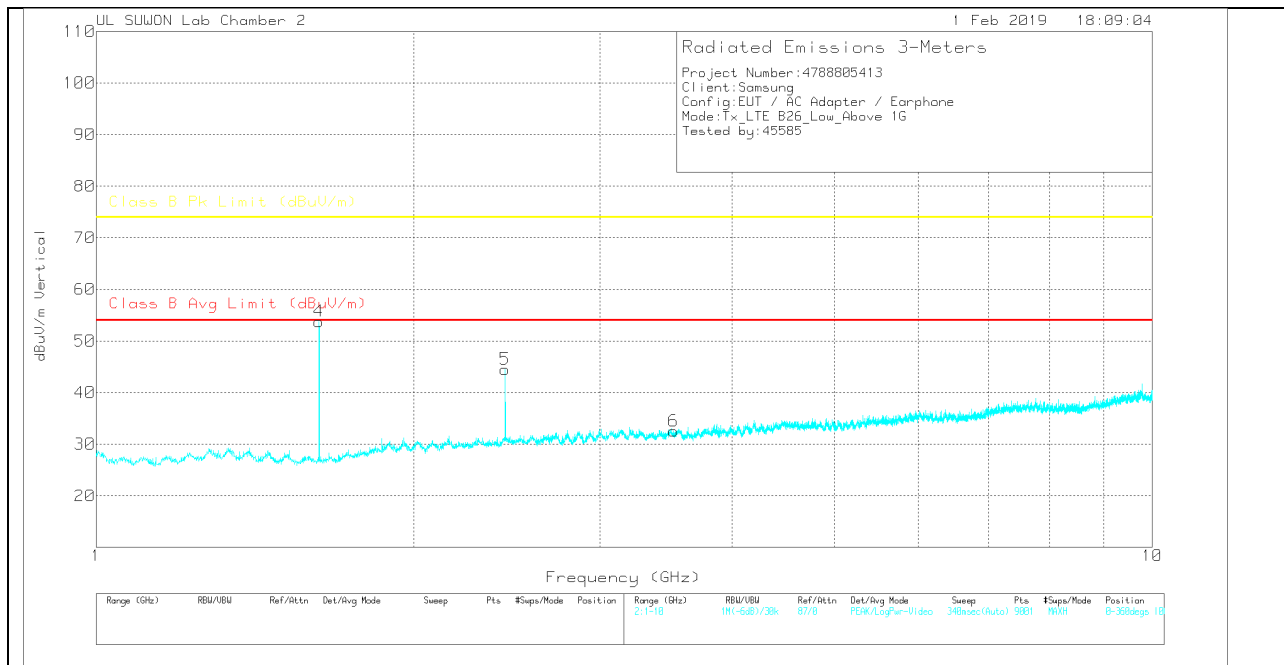

**DATA**

Trace Markers

Marker	Frequency (GHz)	Meter Reading (dBuV)	Det	3117_00168724	1-18GHz(dB)	1GHz_HPF	Corrected Reading dBuV/m	Class B Avg Limit (dBuV/m)	Av(CSFR)Margin (dB)	Class B Pk Limit (dBuV/m)	Margin (dB)	Azimuth (Degs)	Height (cm)	Polarity
1	1.626	54.51	PK	28.3	-31.4	.8	52.21	-	-	74	-21.79	0-360	200	H
2	2.44	41.67	PK	31.8	-30.4	.8	43.87	-	-	74	-30.13	0-360	100	H
3	3.529	29.4	PK	32.7	-29	.6	33.7	-	-	74	-40.3	0-360	100	H
4	1.626	56.1	PK	28.3	-31.4	.8	53.8	-	-	74	-20.2	0-360	200	V
5	2.44	42.33	PK	31.8	-30.4	.8	44.53	-	-	74	-29.47	0-360	200	V
6	3.521	28.27	PK	32.7	-29	.6	32.57	-	-	74	-41.43	0-360	100	V

PK – Peak Detector

Note: Unwanted emissions on the harmonic frequency were generated from the call-simulator with the TX and RX signals.

**MID CHANNEL(876.5MHz)**

**HORIZONTAL PEAK PLOT**

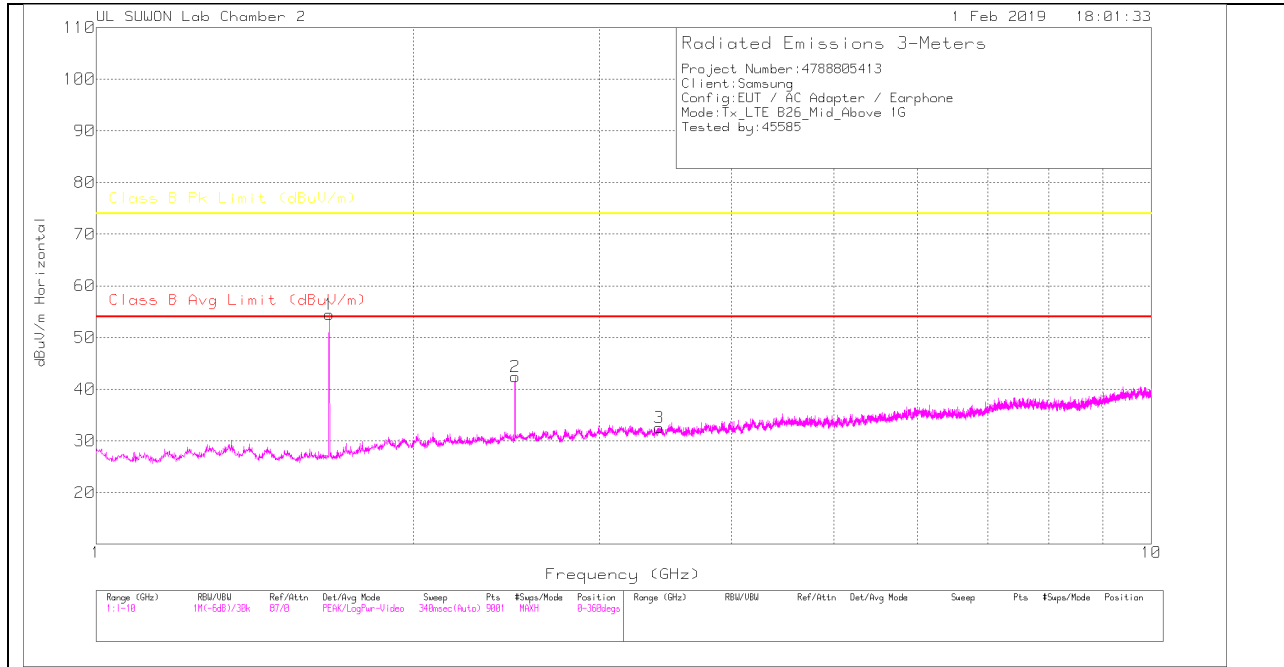

**VERTICAL PEAK PLOT**

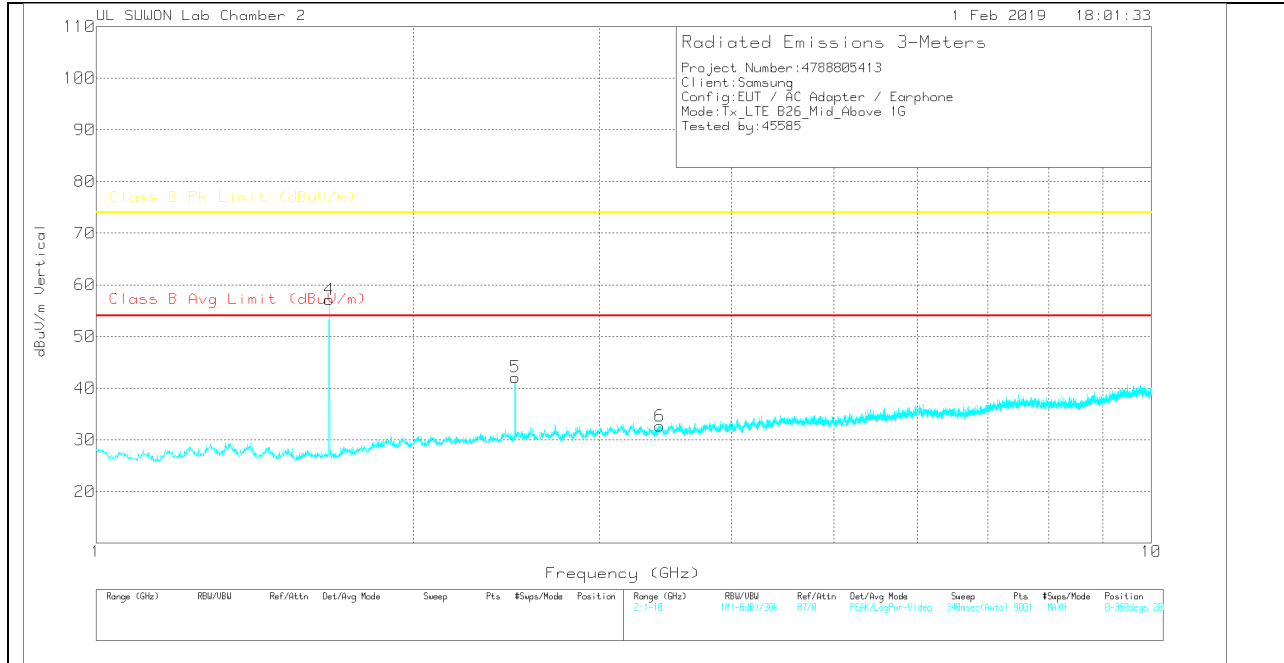

**DATA**

Trace Markers

Marker	Frequency (GHz)	Meter Reading (dBuV)	Det	3117_00168724	1-18GHz(dB)	1GHz_HPF	Corrected Reading dBuV/m	Class B Avg Limit (dBuV/m)	Av(CSPK)Margin (dB)	Class B Pk Limit (dBuV/m)	Margin (dB)	Azimuth (Degs)	Height (cm)	Polarity
1	1.663	56.96	PK	28.4	-31.4	.5	54.46	-	-	74	-19.54	0-360	200	H
2	2.495	40.12	PK	31.9	-30.2	.6	42.42	-	-	74	-31.58	0-360	100	H
3	3.417	28.56	PK	32.6	-29.3	.7	32.56	-	-	74	-41.44	0-360	100	H
4	1.663	59.62	PK	28.4	-31.4	.5	57.12	-	-	74	-16.88	0-360	200	V
5	2.495	39.82	PK	31.9	-30.2	.6	42.12	-	-	74	-31.88	0-360	100	V
6	3.422	28.79	PK	32.6	-29.3	.6	32.69	-	-	74	-41.31	0-360	200	V

PK – Peak Detector

Note: Unwanted emissions on the harmonic frequency were generated from the call-simulator with the TX and RX signals.

**HIGH CHANNEL(892.5MHz)**

**HORIZONTAL PEAK PLOT**

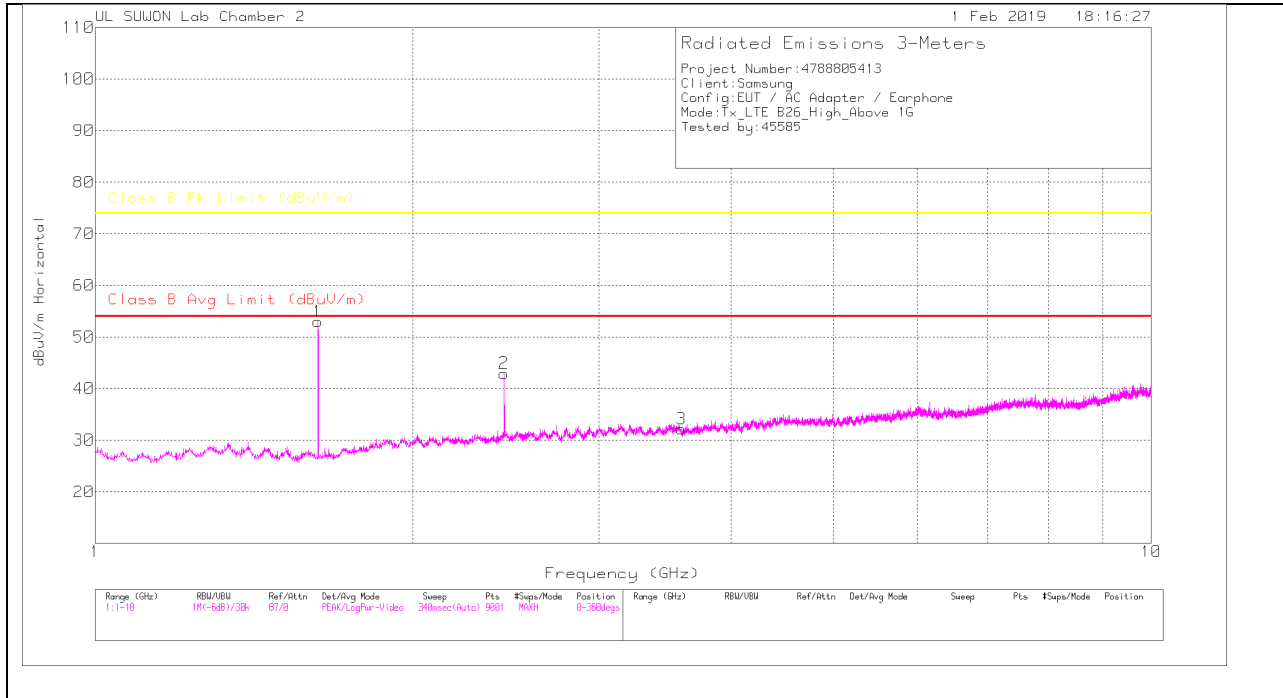

**VERTICAL PEAK PLOT**

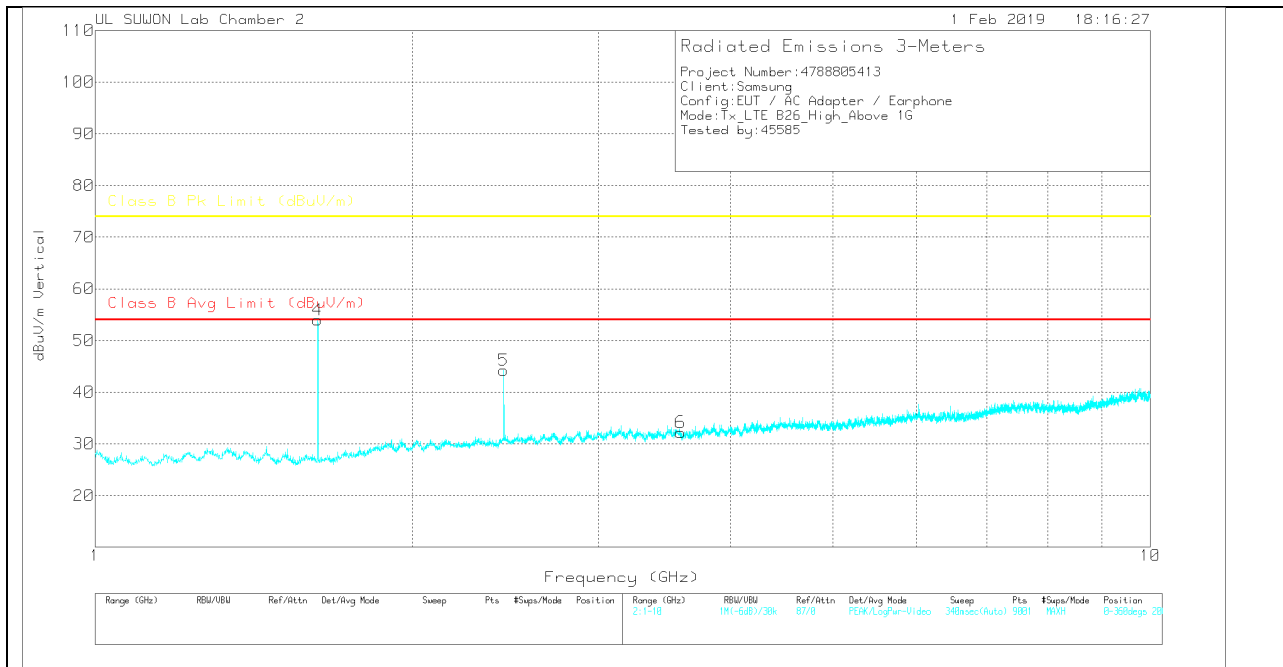

**DATA**

Trace Markers

Marker	Frequency (GHz)	Meter Reading (dBuV)	Det	3117_00168724	1-18GHz(dB)	1GHz_HPF	Corrected Reading dBuV/m	Class B Avg Limit (dBuV/m)	Av(CSPK)Margin (dB)	Class B Pk Limit (dBuV/m)	Margin (dB)	Azimuth (Degs)	Height (cm)	Polarity
1	1.626	55.3	PK	28.3	-31.4	.8	53	-	-	74	-21	0-360	200	H
2	2.44	40.75	PK	31.8	-30.4	.8	42.95	-	-	74	-31.05	0-360	100	H
3	3.59	28.29	PK	32.7	-29.3	.5	32.19	-	-	74	-41.81	0-360	100	H
4	1.626	56.28	PK	28.3	-31.4	.8	53.98	-	-	74	-20.02	0-360	200	V
5	2.44	42.02	PK	31.8	-30.4	.8	44.22	-	-	74	-29.78	0-360	200	V
6	3.588	28.31	PK	32.7	-29.3	.5	32.21	-	-	74	-41.79	0-360	200	V

PK – Peak Detector

Note: Unwanted emissions on the harmonic frequency were generated from the call-simulator with the TX and RX signals.

### 4.6. Below 1 GHz in the GSM850

#### LOW CHANNEL(869.2MHz)

#### HORIZONTAL PEAK PLOT

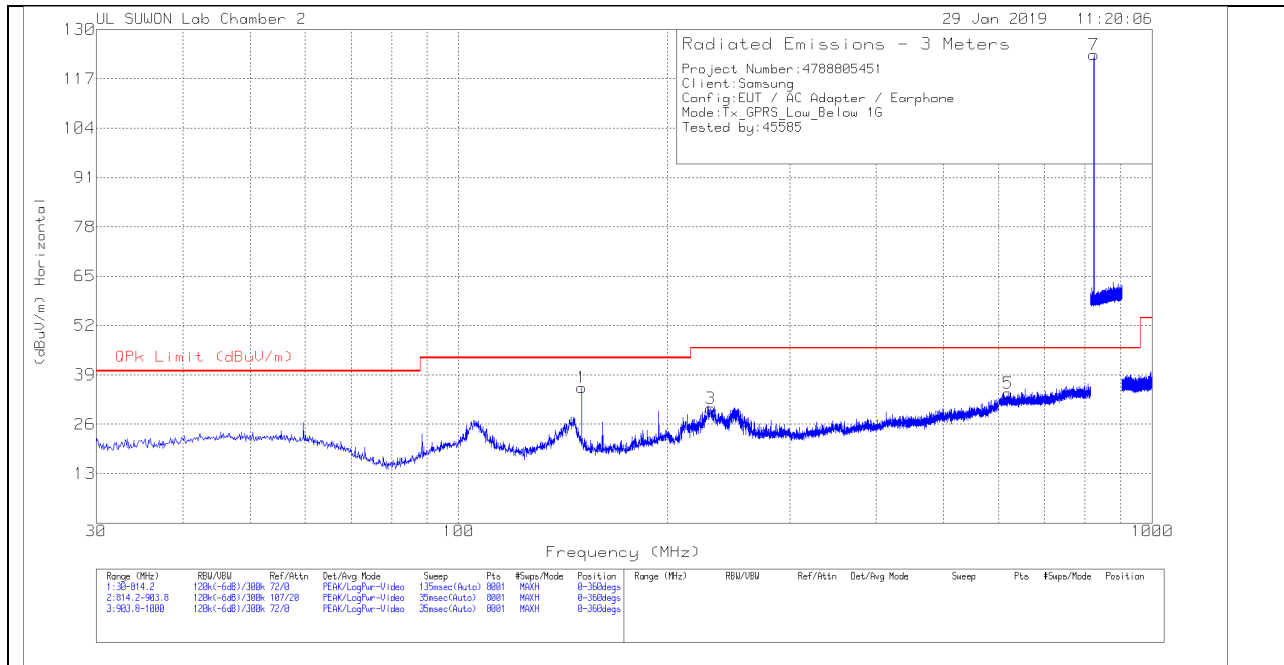

#### VERTICAL PEAK PLOT

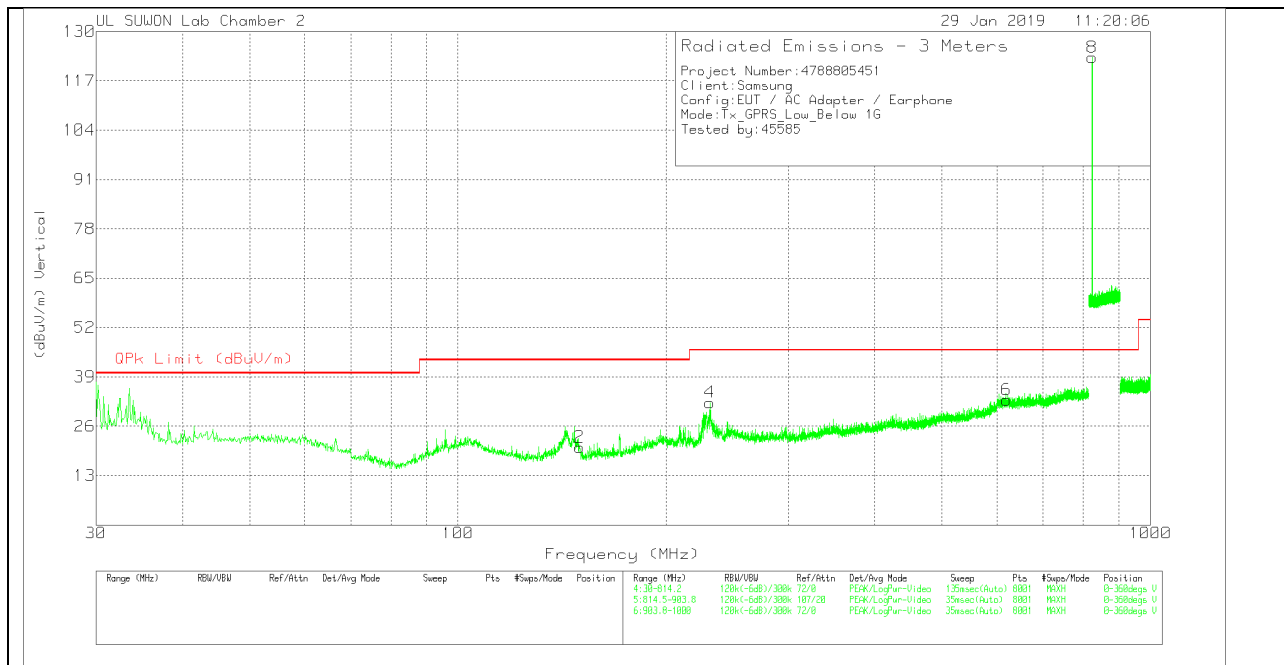

**DATA**

Trace Markers

Marker	Frequency (MHz)	Meter Reading (dBuV)	Det	VULB9163_749	Bypass_Below_1G[dB]	Corrected Reading (dBuV/m)	QPk Limit (dBuV/m)	Margin (dB)	Azimuth (Degs)	Height (cm)	Polarity
1	150.3747	20.23	Pk	14.1	1.3	35.63	43.52	-7.89	0-360	400	H
3	230.7552	10.29	Pk	18.3	1.6	30.19	46.02	-15.83	0-360	100	H
5	620.0125	6.03	Pk	25.4	2.7	34.13	46.02	-11.89	0-360	100	H
7	824.1904	93.35	Pk	26.9	3.1	123.35	46.02	77.33	0-360	200	H
2	149.8846	5.11	Pk	14.1	1.3	20.51	43.52	-23.01	0-360	100	V
4	231.0493	12.37	Pk	18.3	1.6	32.27	46.02	-13.75	0-360	100	V
6	619.6204	4.85	Pk	25.4	2.7	32.95	46.02	-13.07	0-360	200	V
8	824.223	93.19	Pk	26.9	3.1	123.19	46.02	77.17	0-360	100	V

Pk - Peak detector

Note: Unwanted emissions captured from 824MHz to 849MHz and from 869MHz to 894MHz were the TX and RX signals generated from the call-simulator.

**MID CHANNEL(881.6MHz)**

**HORIZONTAL PEAK PLOT**

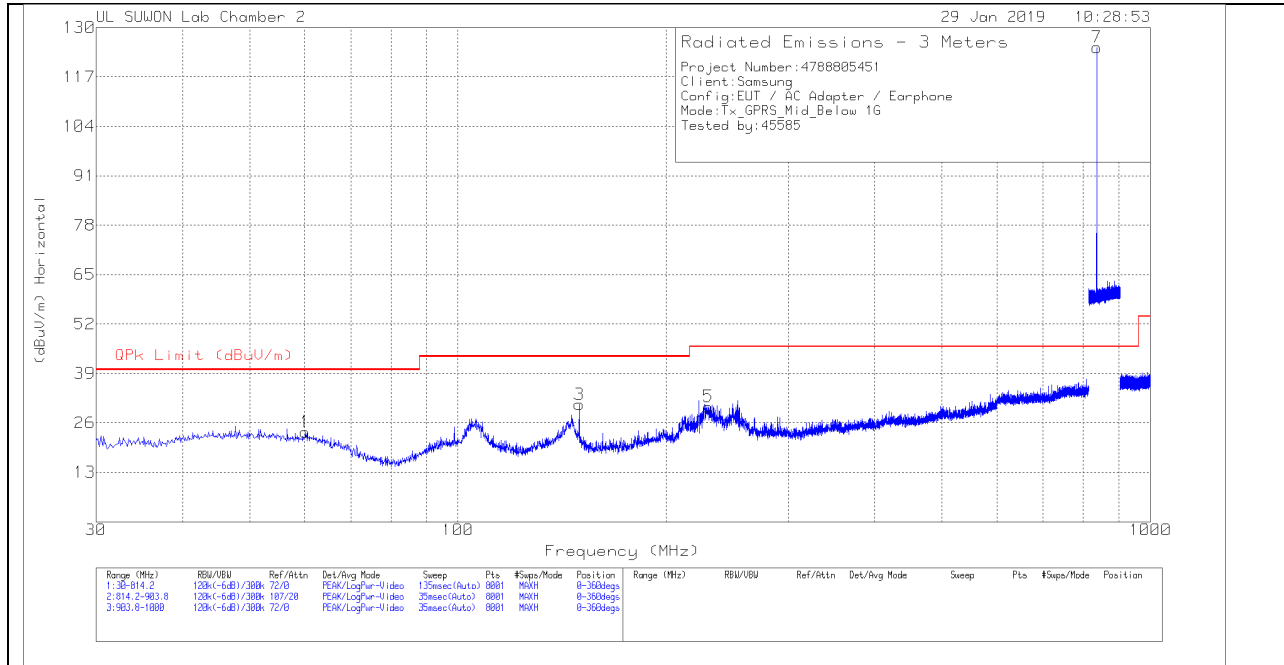

**VERTICAL PEAK PLOT**

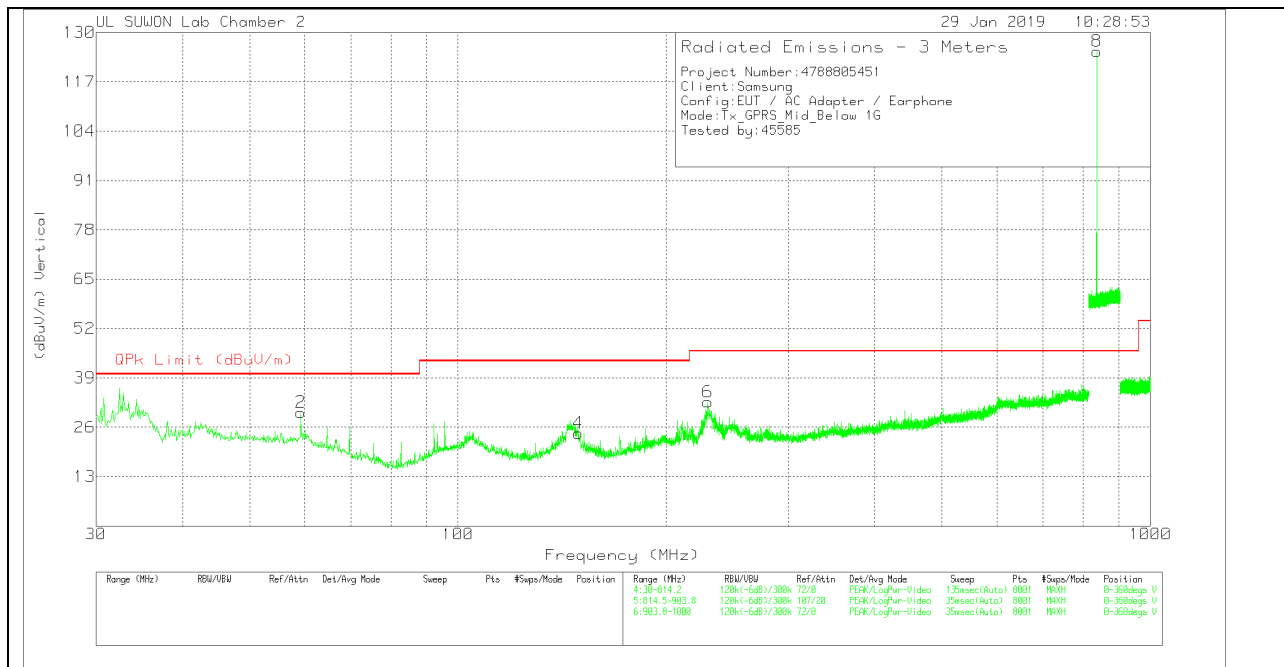

**DATA**

Trace Markers

Marker	Frequency (MHz)	Meter Reading (dBuV)	Det	VULB9163_749	Bypass_Below_1G[dB]	Corrected Reading (dBuV/m)	QPk Limit (dBuV/m)	Margin (dB)	Azimuth (Degs)	Height (cm)	Polarity
1	60.1917	4.21	Pk	18.5	.9	23.61	40	-16.39	0-360	400	H
3	149.6885	15.56	Pk	14	1.3	30.86	43.52	-12.66	0-360	100	H
5	229.971	10.27	Pk	18.4	1.6	30.27	46.02	-15.75	0-360	100	H
7	836.6112	94.56	Pk	27.1	3.1	124.76	46.02	78.74	0-360	200	H
2	59.3095	10.51	Pk	18.6	.8	29.91	40	-10.09	0-360	200	V
4	149.1984	9.14	Pk	14	1.3	24.44	43.52	-19.08	0-360	100	V
6	229.5789	12.64	Pk	18.3	1.7	32.64	46.02	-13.38	0-360	100	V
8	836.5358	94.85	Pk	27.1	3.1	125.05	46.02	79.03	0-360	100	V

Pk - Peak detector

Note: Unwanted emissions captured from 824MHz to 849MHz and from 869MHz to 894MHz were the TX and RX signals generated from the call-simulator.

**HIGH CHANNEL(893.8MHz)**

**HORIZONTAL PEAK PLOT**

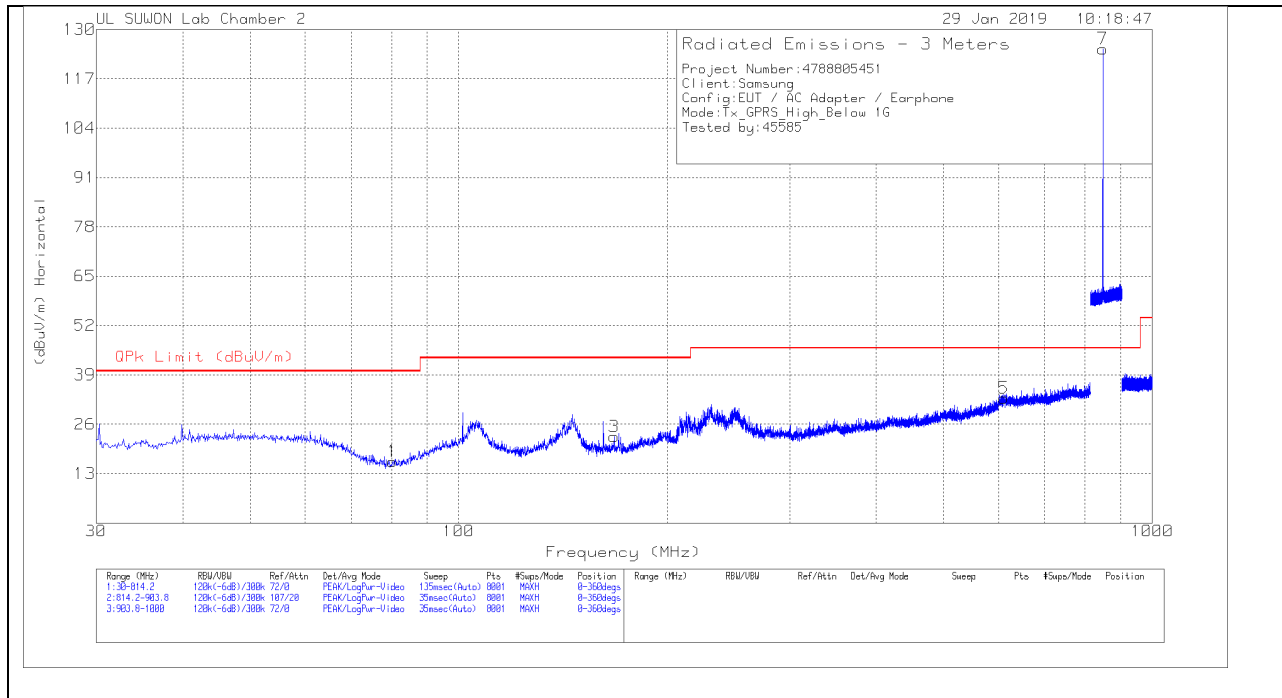

**VERTICAL PEAK PLOT**

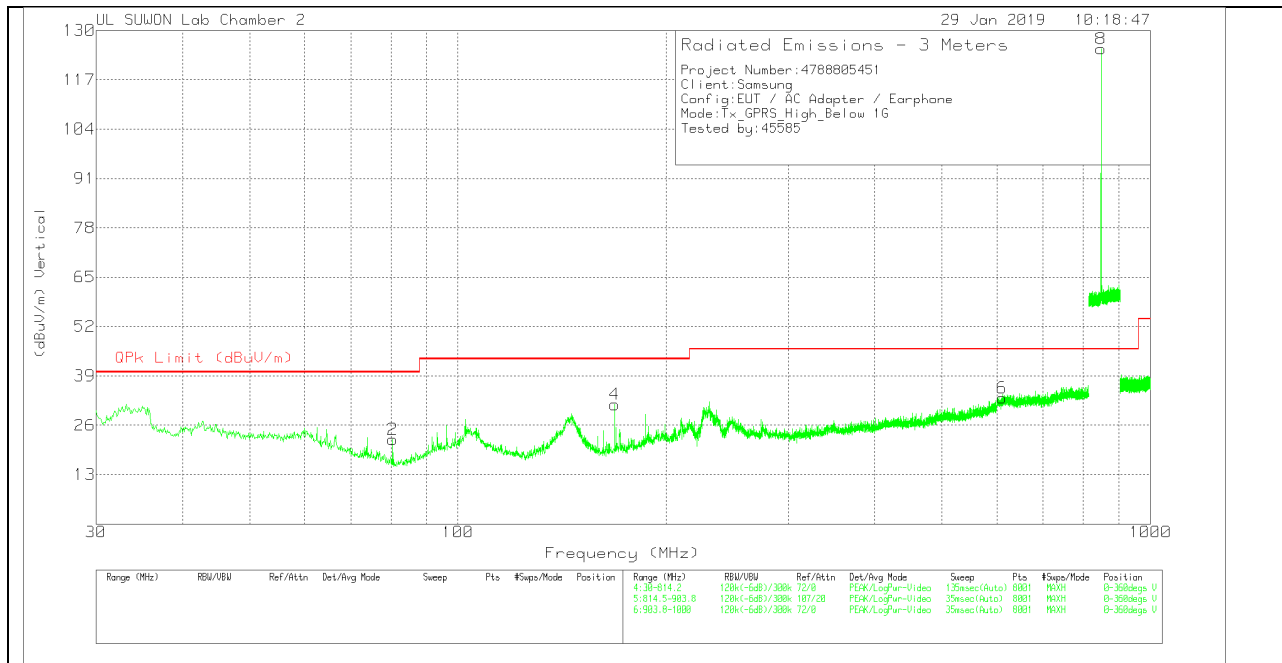

**DATA**

Trace Markers

Marker	Frequency (MHz)	Meter Reading (dBuV)	Det	VULB9163_749	Bypass_Below_1G[dB]	Corrected Reading (dBuV/m)	QPk Limit (dBuV/m)	Margin (dB)	Azimuth (Degs)	Height (cm)	Polarity
1	80.1888	2.57	Pk	12.6	1	16.17	40	-23.83	0-360	200	H
3	167.5291	6.43	Pk	14.9	1.4	22.73	43.52	-20.79	0-360	200	H
5	610.9942	4.88	Pk	25.3	2.7	32.88	46.02	-13.14	0-360	400	H
7	848.7968	94.28	Pk	27.4	3.2	124.88	46.02	78.86	0-360	200	H
2	80.4829	8.67	Pk	12.6	1	22.27	40	-17.73	0-360	100	V
4	168.4113	15.16	Pk	14.9	1.4	31.46	43.52	-12.06	0-360	100	V
6	610.8962	5.19	Pk	25.3	2.7	33.19	46.02	-12.83	0-360	100	V
8	848.7592	94.55	Pk	27.4	3.2	125.15	46.02	79.13	0-360	100	V

Pk - Peak detector

Note: Unwanted emissions captured from 824MHz to 849MHz and from 869MHz to 894MHz were the TX and RX signals generated from the call-simulator.

### 4.1. Below 1 GHz in the WCDMA Band 5

#### LOW CHANNEL(871.4MHz)

#### HORIZONTAL PEAK PLOT

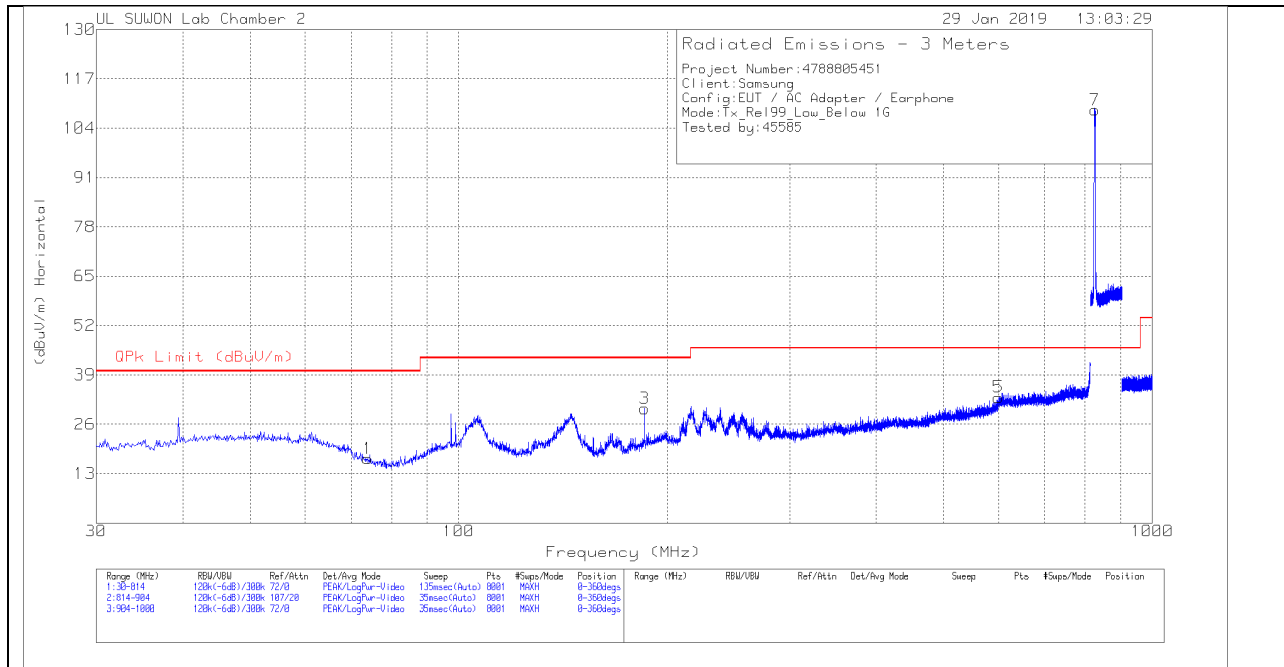

#### VERTICAL PEAK PLOT

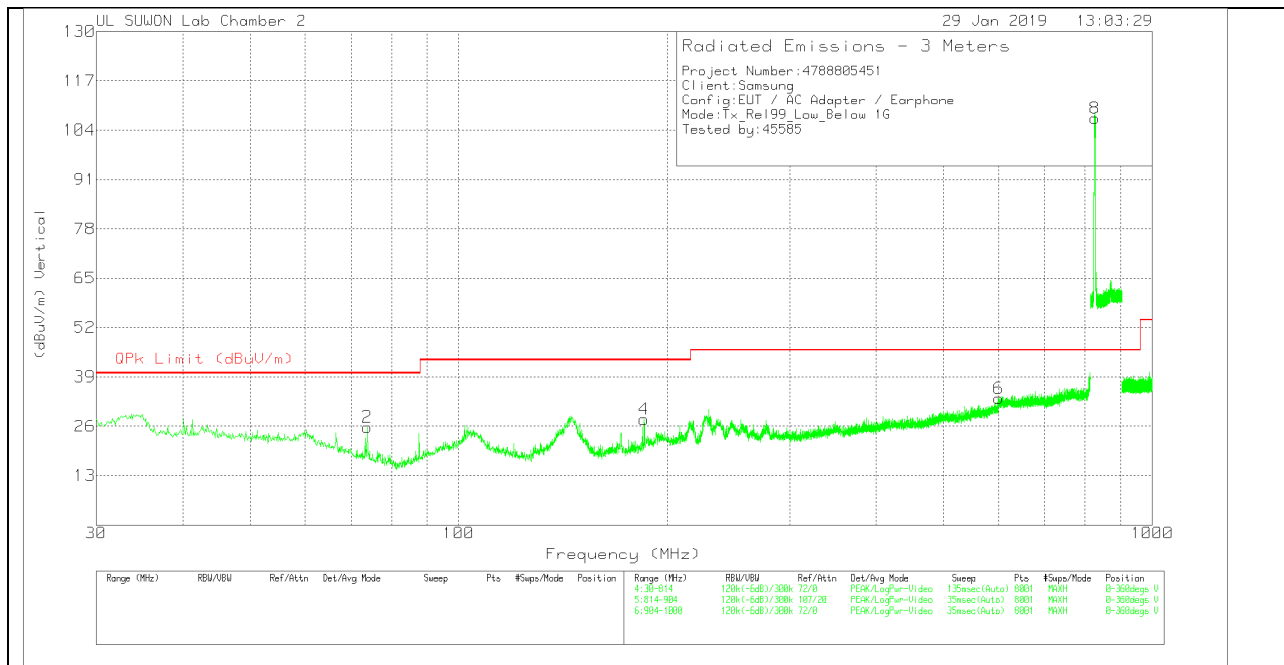

**DATA**

Trace Markers

Marker	Frequency (MHz)	Meter Reading (dBuV)	Det	VULB9163_749	Bypass_Below_1G[dB]	Corrected Reading (dBuV/m)	QPk Limit (dBuV/m)	Margin (dB)	Azimuth (Degs)	Height (cm)	Polarity
1	73.904	2.18	Pk	13.9	.9	16.98	40	-23.02	0-360	300	H
3	185.33	12.35	Pk	16.4	1.4	30.15	43.52	-13.37	0-360	200	H
5	600.066	5.09	Pk	25.3	2.7	33.09	46.02	-12.93	0-360	400	H
7	826.465	78.68	Pk	27	3.1	108.78	46.02	62.76	0-360	100	H
2	73.806	10.96	Pk	13.9	.9	25.76	40	-14.24	0-360	200	V
4	185.134	9.93	Pk	16.4	1.5	27.83	43.52	-15.69	0-360	200	V
6	600.556	5.4	Pk	25.3	2.6	33.3	46.02	-12.72	0-360	300	V
8	826.3863	77.01	Pk	27	3.1	107.11	46.02	61.09	0-360	100	V

Pk - Peak detector

Note: Unwanted emissions captured from 824MHz to 849MHz and from 869MHz to 894MHz were the TX and RX signals generated from the call-simulator.

**MID CHANNEL(881.6MHz)**

**HORIZONTAL PEAK PLOT**

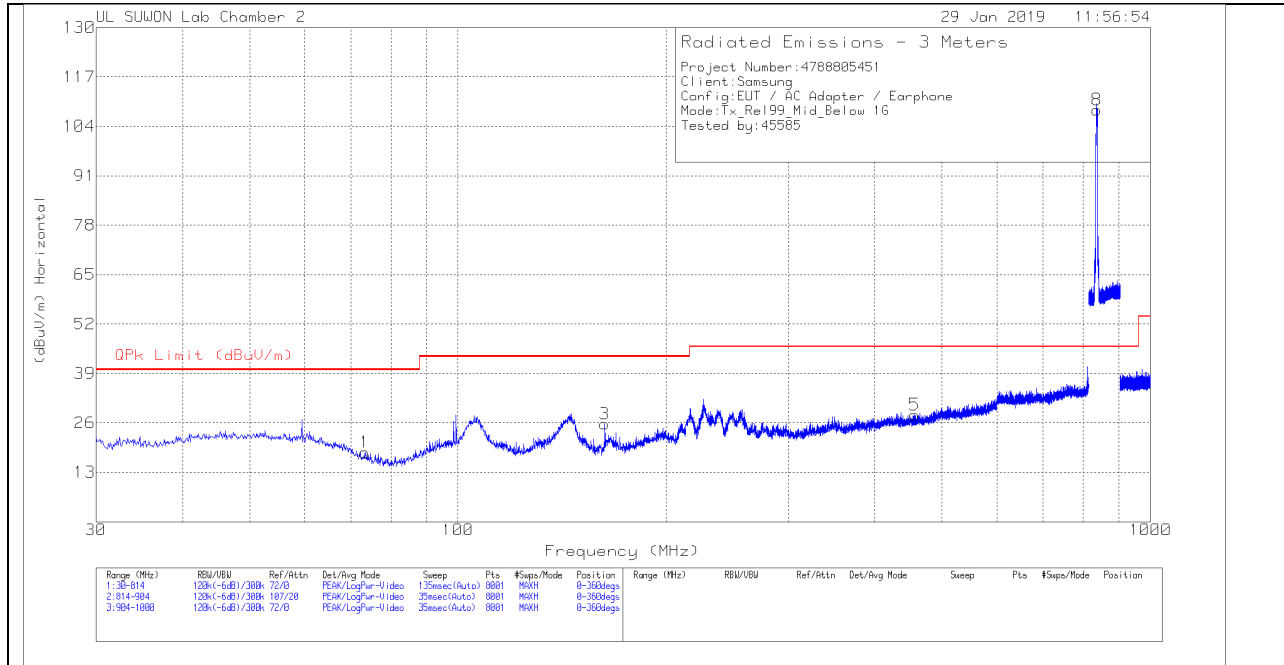

**VERTICAL PEAK PLOT**

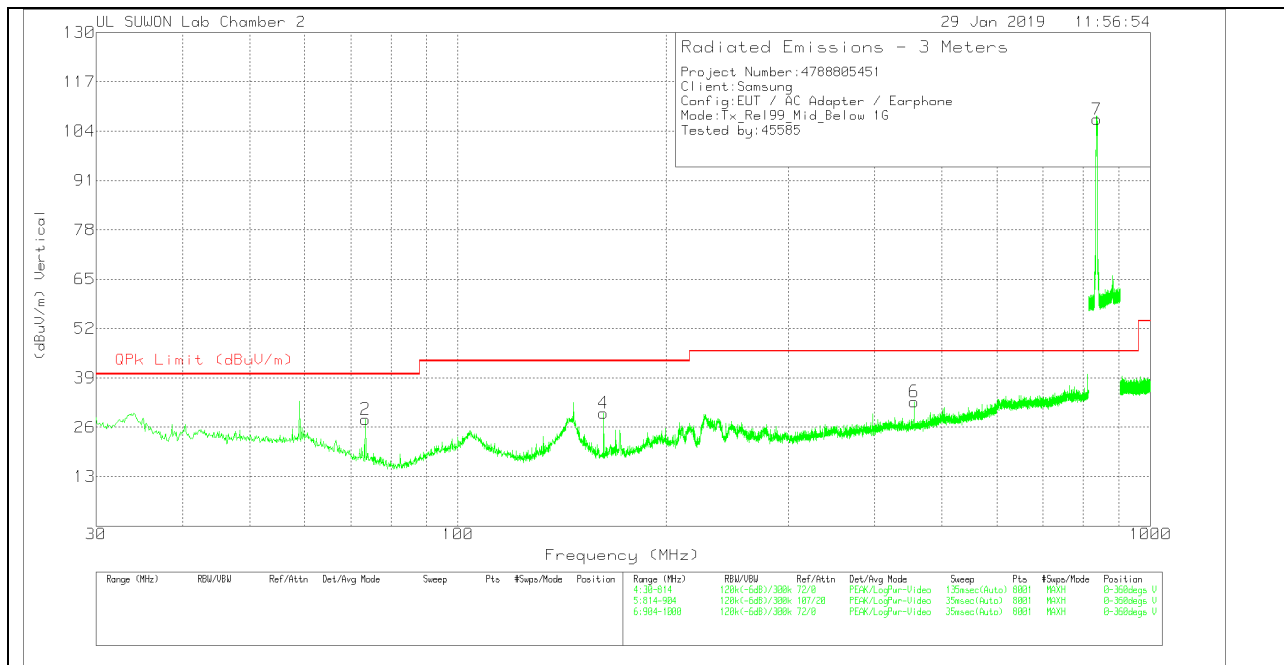

**DATA**

Trace Markers

Marker	Frequency (MHz)	Meter Reading (dBuV)	Det	VULB9163_749	Bypass_Below_1G[dB]	Corrected Reading (dBuV/m)	QPk Limit (dBuV/m)	Margin (dB)	Azimuth (Degs)	Height (cm)	Polarity
1	73.316	3.12	Pk	14.2	.9	18.22	40	-21.78	0-360	200	H
3	162.986	9.59	Pk	14.7	1.4	25.69	43.52	-17.83	0-360	200	H
5	456.398	3.51	Pk	22.3	2.3	28.11	46.02	-17.91	0-360	400	H
8	836.6125	78.12	Pk	27.1	3.1	108.32	46.02	62.3	0-360	100	H
2	73.512	13.09	Pk	14.1	.9	28.09	40	-11.91	0-360	100	V
4	162.3	13.65	Pk	14.7	1.4	29.75	43.52	-13.77	0-360	200	V
6	455.81	8.11	Pk	22.3	2.3	32.71	46.02	-13.31	0-360	100	V
7	836.545	76.9	Pk	27.1	3.1	107.1	46.02	61.08	0-360	200	V

Pk - Peak detector

Note: Unwanted emissions captured from 824MHz to 849MHz and from 869MHz to 894MHz were the TX and RX signals generated from the call-simulator.

**HIGH CHANNEL(891.6MHz)**

**HORIZONTAL PEAK PLOT**

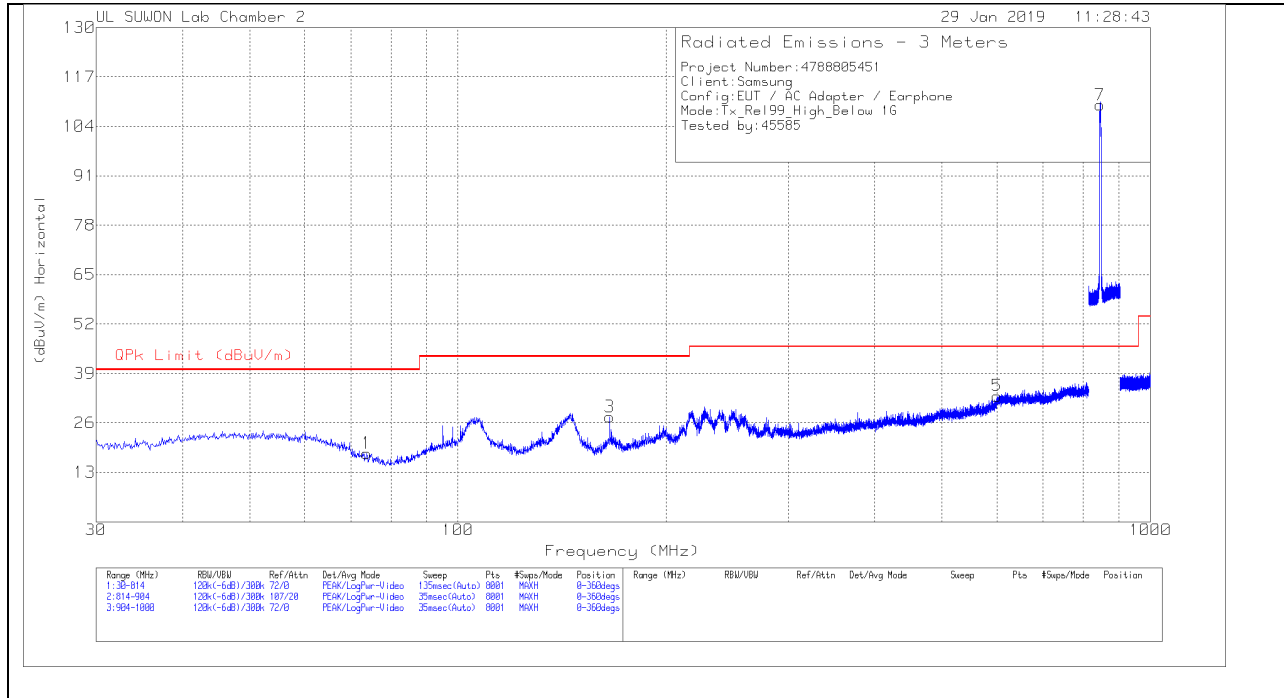

**VERTICAL PEAK PLOT**

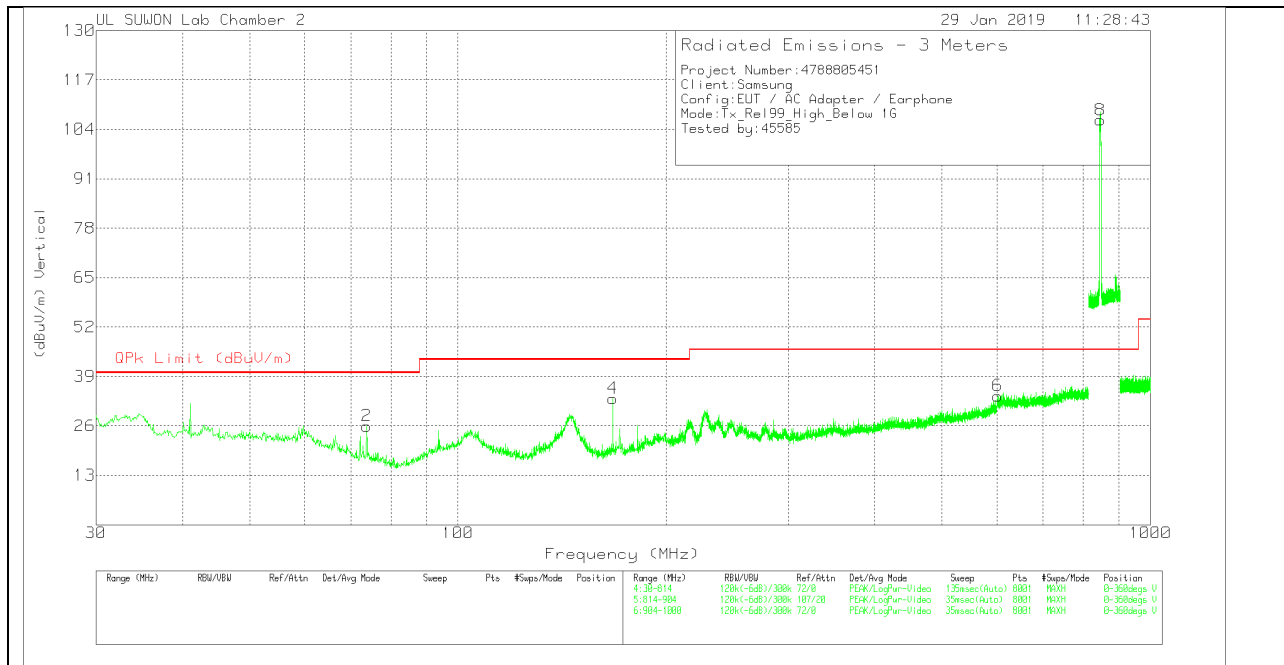

**DATA**

Trace Markers

Marker	Frequency (MHz)	Meter Reading (dBuV)	Det	VULB9163_749	Bypass_Below_1G[dB]	Corrected Reading (dBuV/m)	QPk Limit (dBuV/m)	Margin (dB)	Azimuth (Degs)	Height (cm)	Polarity
1	73.806	3.23	Pk	13.9	.9	18.03	40	-21.97	0-360	400	H
3	165.534	11.38	Pk	14.8	1.4	27.58	43.52	-15.94	0-360	100	H
5	601.046	5.1	Pk	25.3	2.7	33.1	46.02	-12.92	0-360	400	H
7	846.6588	79.13	Pk	27.3	3.2	109.63	46.02	63.61	0-360	100	H
2	73.806	11.18	Pk	13.9	.9	25.98	40	-14.02	0-360	200	V
4	167.396	16.94	Pk	14.9	1.4	33.24	43.52	-10.28	0-360	100	V
6	601.732	6.03	Pk	25.3	2.6	33.93	46.02	-12.09	0-360	400	V
8	846.6813	75.93	Pk	27.3	3.2	106.43	46.02	60.41	0-360	100	V

Pk - Peak detector

Note: Unwanted emissions captured from 824MHz to 849MHz and from 869MHz to 894MHz were the TX and RX signals generated from the call-simulator.

## 4.2. Below 1 GHz in the LTE Band 5

### LOW CHANNEL(870.5MHz)

#### HORIZONTAL PEAK PLOT

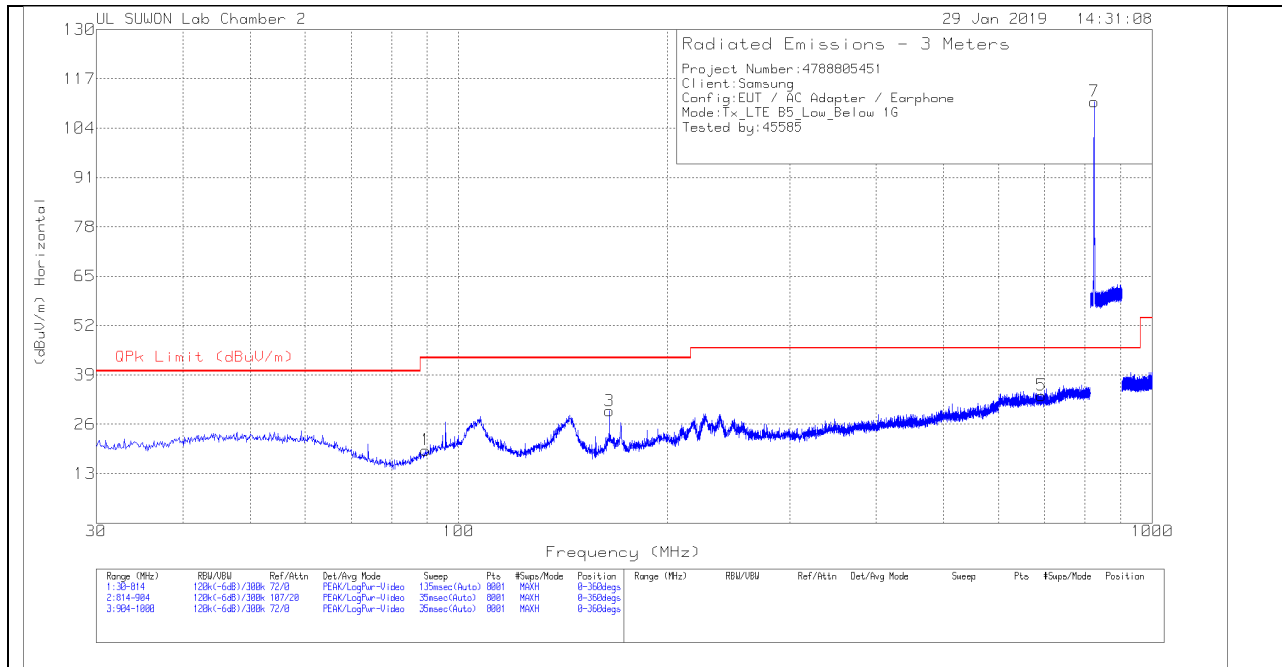

#### VERTICAL PEAK PLOT

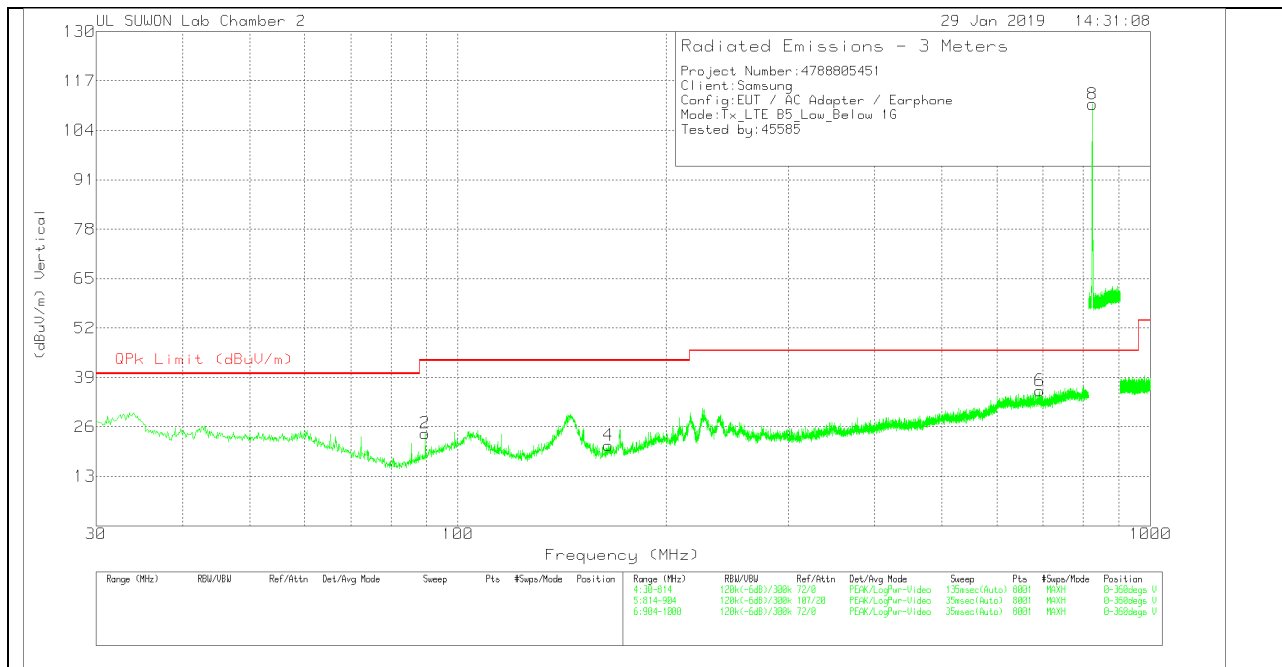

**DATA**

Trace Markers

Marker	Frequency (MHz)	Meter Reading (dBuV)	Det	VULB9163_749	Bypass_Below_1G[dB]	Corrected Reading (dBuV/m)	QPk Limit (dBuV/m)	Margin (dB)	Azimuth (Degs)	Height (cm)	Polarity
1	89.682	2.69	Pk	15.5	1	19.19	43.52	-24.33	0-360	400	H
3	164.848	13.33	Pk	14.8	1.4	29.53	43.52	-13.99	0-360	200	H
5	692.284	5.1	Pk	25.6	2.9	33.6	46.02	-12.42	0-360	300	H
7	824.6875	81.02	Pk	26.9	3.1	111.02	46.02	65	0-360	200	H
2	89.682	7.82	Pk	15.5	1	24.32	43.52	-19.2	0-360	300	V
4	164.946	4.97	Pk	14.8	1.4	21.17	43.52	-22.35	0-360	200	V
6	692.088	7.12	Pk	25.6	2.8	35.52	46.02	-10.5	0-360	200	V
8	824.7438	80.89	Pk	26.9	3.1	110.89	46.02	64.87	0-360	100	V

Pk - Peak detector

Note: Unwanted emissions captured from 824MHz to 849MHz and from 869MHz to 894MHz were the TX and RX signals generated from the call-simulator.

**MID CHANNEL(881.5MHz)**

**HORIZONTAL PEAK PLOT**

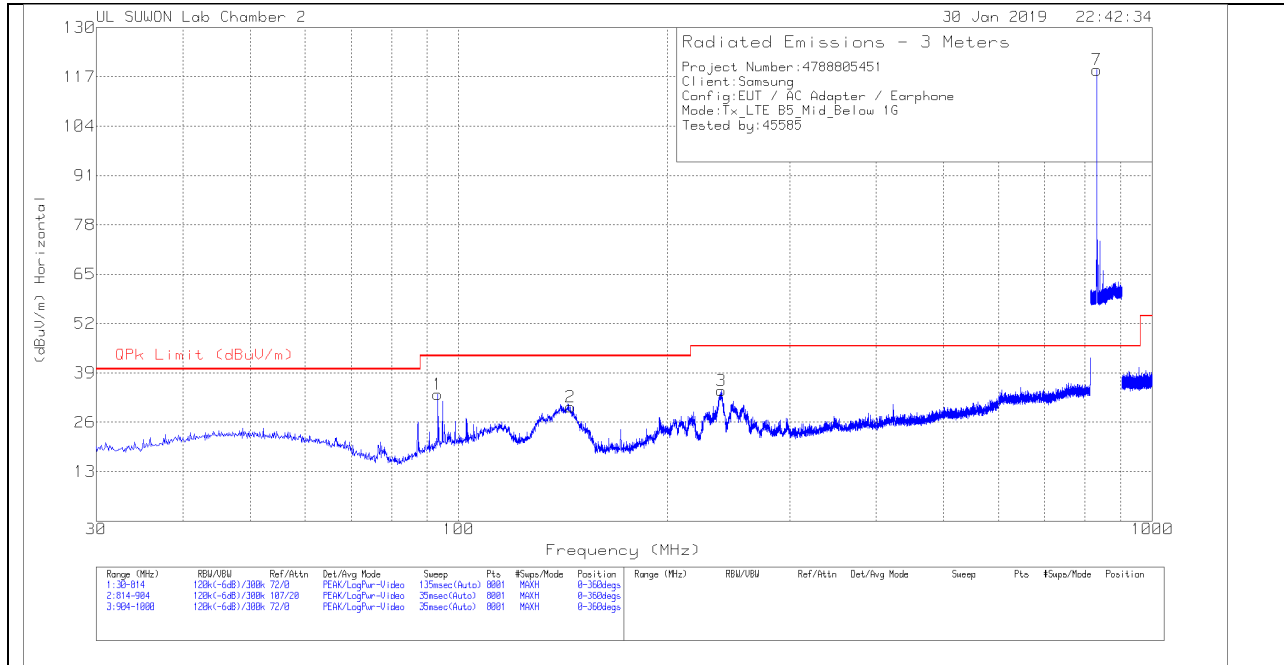

**VERTICAL PEAK PLOT**

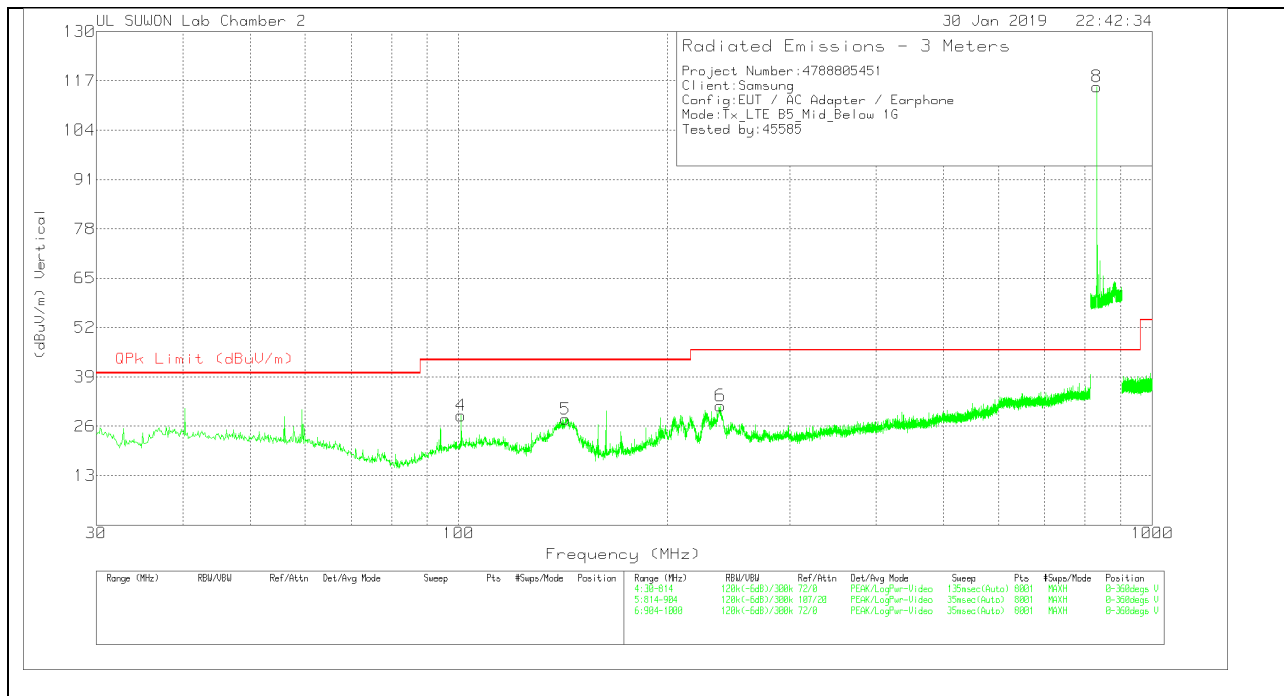

**DATA**

Trace Markers

Marker	Frequency (MHz)	Meter Reading (dBuV)	Det	VULB9163_749	Bypass_Below_1G[dB]	Corrected Reading (dBuV/m)	QPk Limit (dBuV/m)	Margin (dB)	Azimuth (Degs)	Height (cm)	Polarity
1	93.308	15.5	Pk	16.8	1	33.3	43.52	-10.22	0-360	100	H
2	144.954	14.61	Pk	14.1	1.3	30.01	43.52	-13.51	0-360	200	H
3	239.23	14.15	Pk	18.5	1.7	34.35	46.02	-11.67	0-360	100	H
7	832.1013	88.62	Pk	27.1	3.1	118.82	46.02	72.8	0-360	200	H
4	100.756	10.02	Pk	17.7	1.1	28.82	43.52	-14.7	0-360	100	V
5	142.504	12.44	Pk	14.1	1.3	27.84	43.52	-15.68	0-360	100	V
6	238.446	11.31	Pk	18.4	1.7	31.41	46.02	-14.61	0-360	100	V
8	832.0563	85.25	Pk	27.1	3.1	115.45	46.02	69.43	0-360	100	V

Pk - Peak detector

Note: Unwanted emissions captured from 824MHz to 849MHz and from 869MHz to 894MHz were the TX and RX signals generated from the call-simulator.

**HIGH CHANNEL(892.5MHz)**

**HORIZONTAL PEAK PLOT**

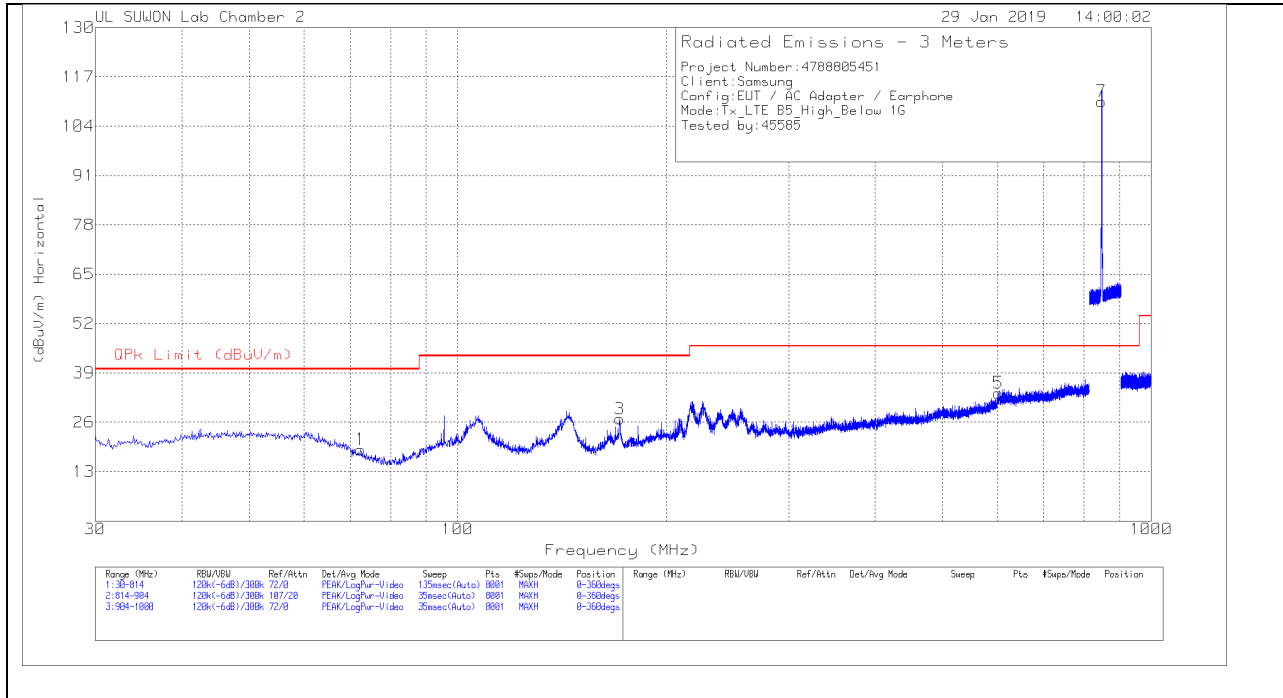

**VERTICAL PEAK PLOT**

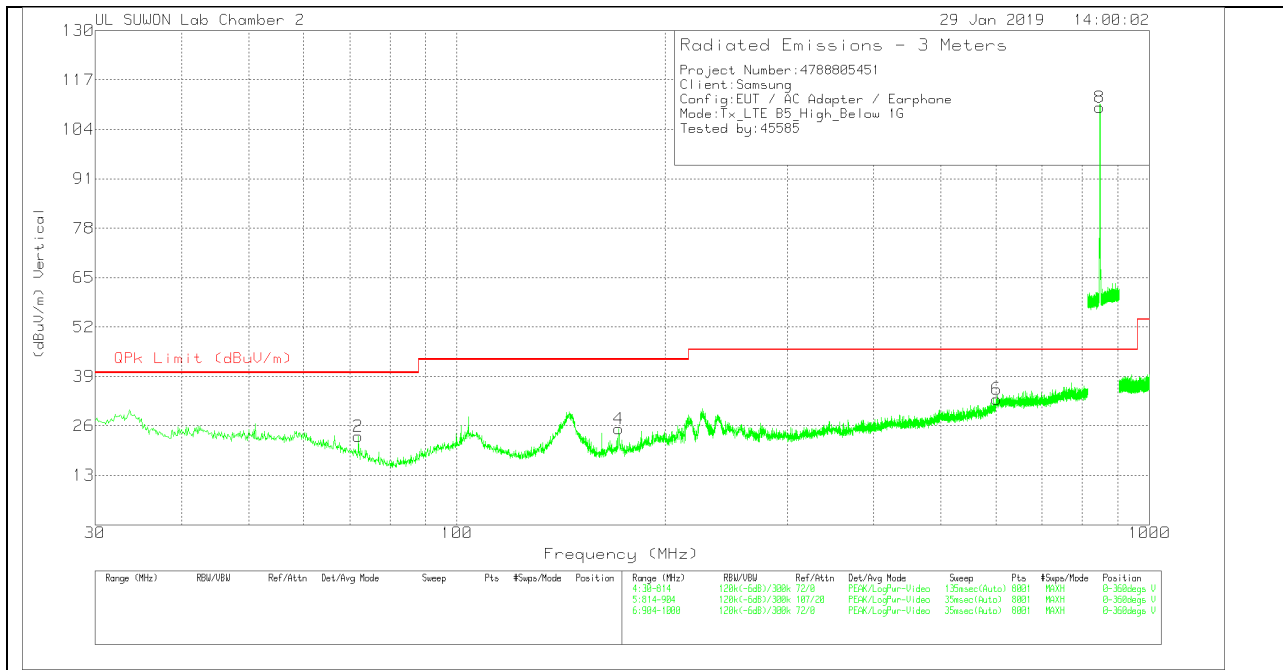

**DATA**

Trace Markers

Marker	Frequency (MHz)	Meter Reading (dBuV)	Det	VULB9163_749	Bypass_Below_1G[dB]	Corrected Reading (dBuV/m)	QPk Limit (dBuV/m)	Margin (dB)	Azimuth (Degs)	Height (cm)	Polarity
1	72.434	3.34	Pk	14.6	.9	18.84	40	-21.16	0-360	400	H
3	171.12	10.56	Pk	14.9	1.4	26.86	43.52	-16.66	0-360	100	H
5	601.928	5.71	Pk	25.3	2.7	33.71	46.02	-12.31	0-360	200	H
7	848.0988	79.86	Pk	27.4	3.2	110.46	46.02	64.44	0-360	100	H
2	72.042	7.55	Pk	14.8	.9	23.25	40	-16.75	0-360	200	V
4	171.218	8.93	Pk	14.9	1.4	25.23	43.52	-18.29	0-360	100	V
6	602.222	5.05	Pk	25.3	2.7	33.05	46.02	-12.97	0-360	100	V
8	848.1213	79.18	Pk	27.4	3.2	109.78	46.02	63.76	0-360	100	V

Pk - Peak detector

Note: Unwanted emissions captured from 824MHz to 849MHz and from 869MHz to 894MHz were the TX and RX signals generated from the call-simulator.

### 4.3. Below 1 GHz in the LTE Band 12

#### LOW CHANNEL(730.5MHz)

#### HORIZONTAL PEAK PLOT

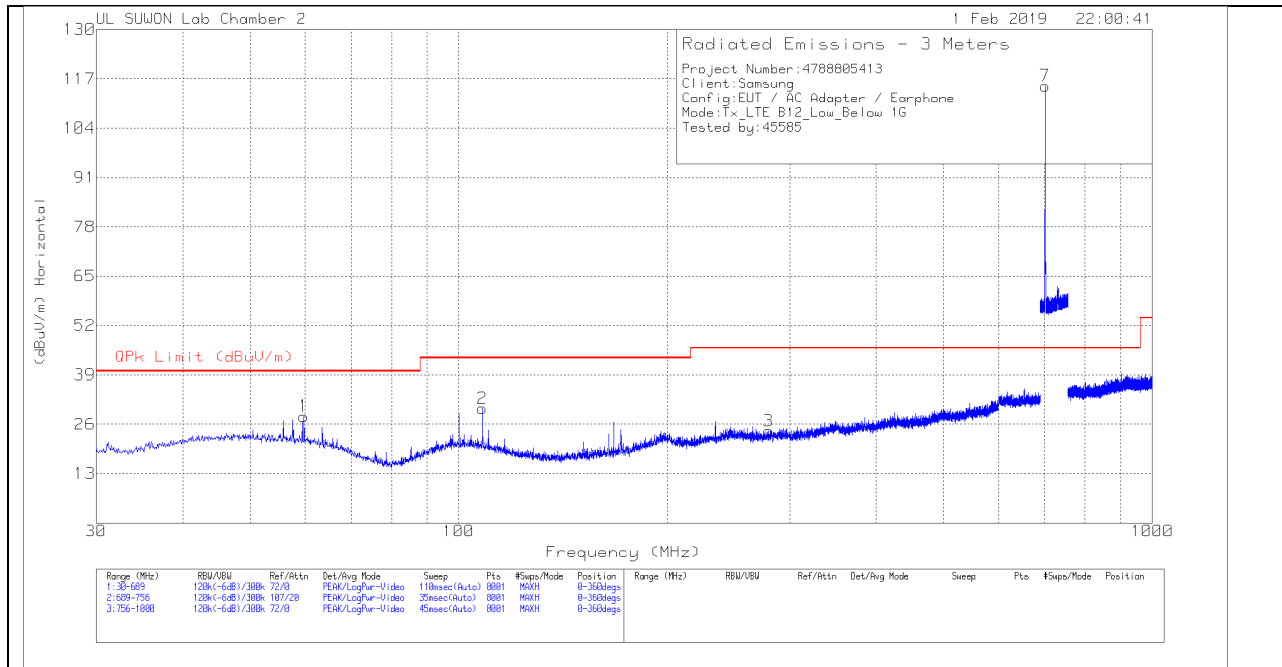

#### VERTICAL PEAK PLOT

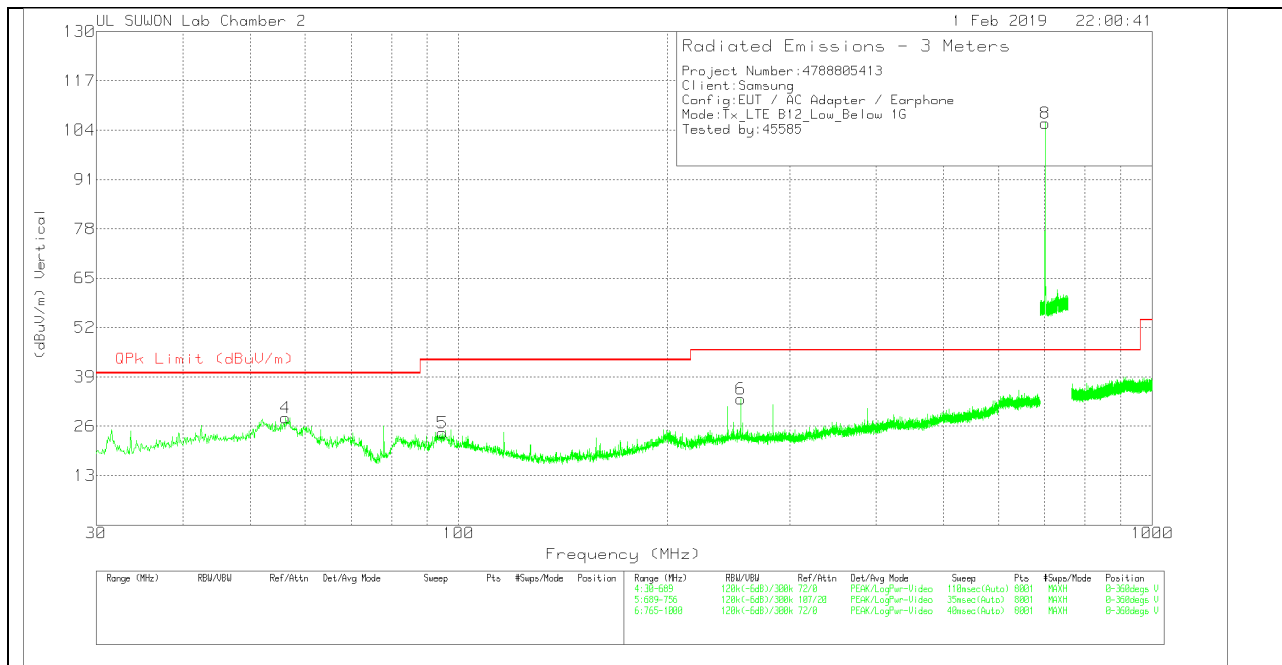

**DATA**

Trace Markers

Marker	Frequency (MHz)	Meter Reading (dBuV)	Det	VULB9163_749	Bypass_Below_1G[dB]	Corrected Reading (dBuV/m)	QPk Limit (dBuV/m)	Margin (dB)	Azimuth (Degs)	Height (cm)	Polarity
1	59.8198	8.69	Pk	18.6	.8	28.09	40	-11.91	0-360	200	H
2	108.1739	11.81	Pk	17.3	1.1	30.21	43.52	-13.31	0-360	100	H
3	279.5139	3.63	Pk	18.8	1.8	24.23	46.02	-21.79	0-360	300	H
7	700.6748	86.63	Pk	25.6	2.9	115.13	46.02	69.11	0-360	100	H
4	56.2776	8.28	Pk	19.1	.8	28.18	40	-11.82	0-360	100	V
5	94.7468	6.05	Pk	17.1	1.1	24.25	43.52	-19.27	0-360	100	V
6	255.1309	12.27	Pk	19.2	1.7	33.17	46.02	-12.85	0-360	200	V
8	700.6748	77.28	Pk	25.6	2.9	105.78	46.02	59.76	0-360	200	V

Pk - Peak detector

Note: Unwanted emissions captured from 699MHz to 716MHz and from 729MHz to 746MHz were the TX and RX signals generated from the call-simulator.

**MID CHANNEL(737.5MHz)**

**HORIZONTAL PEAK PLOT**

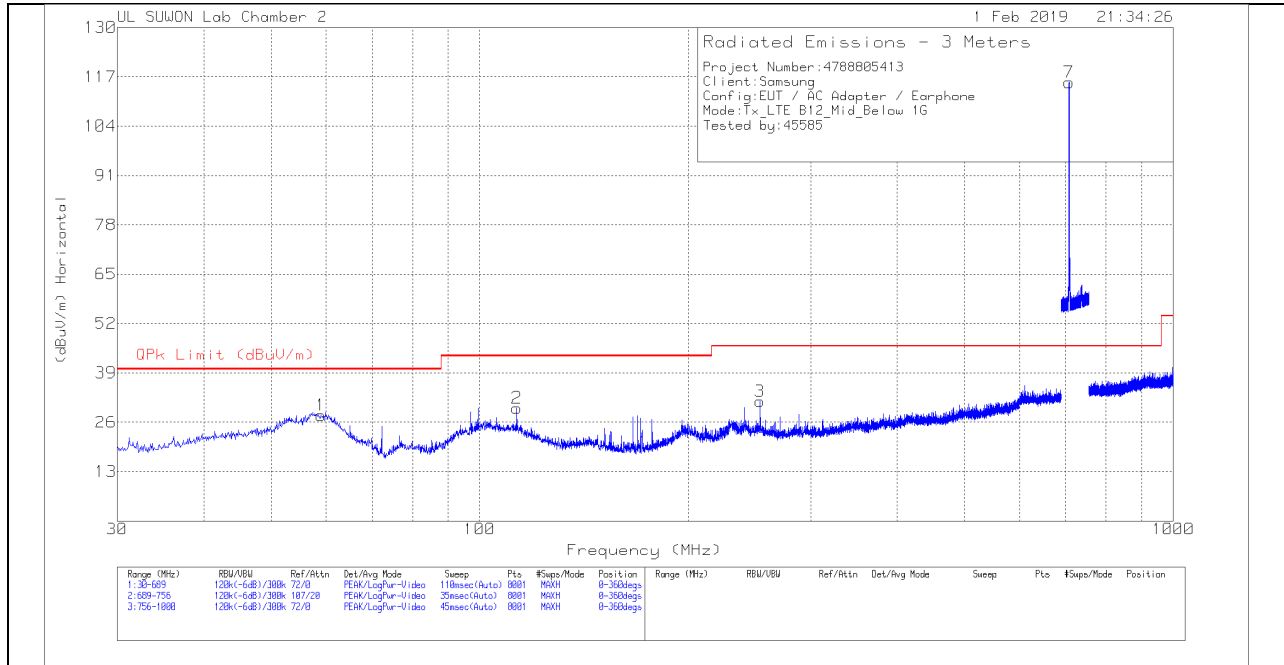

**VERTICAL PEAK PLOT**

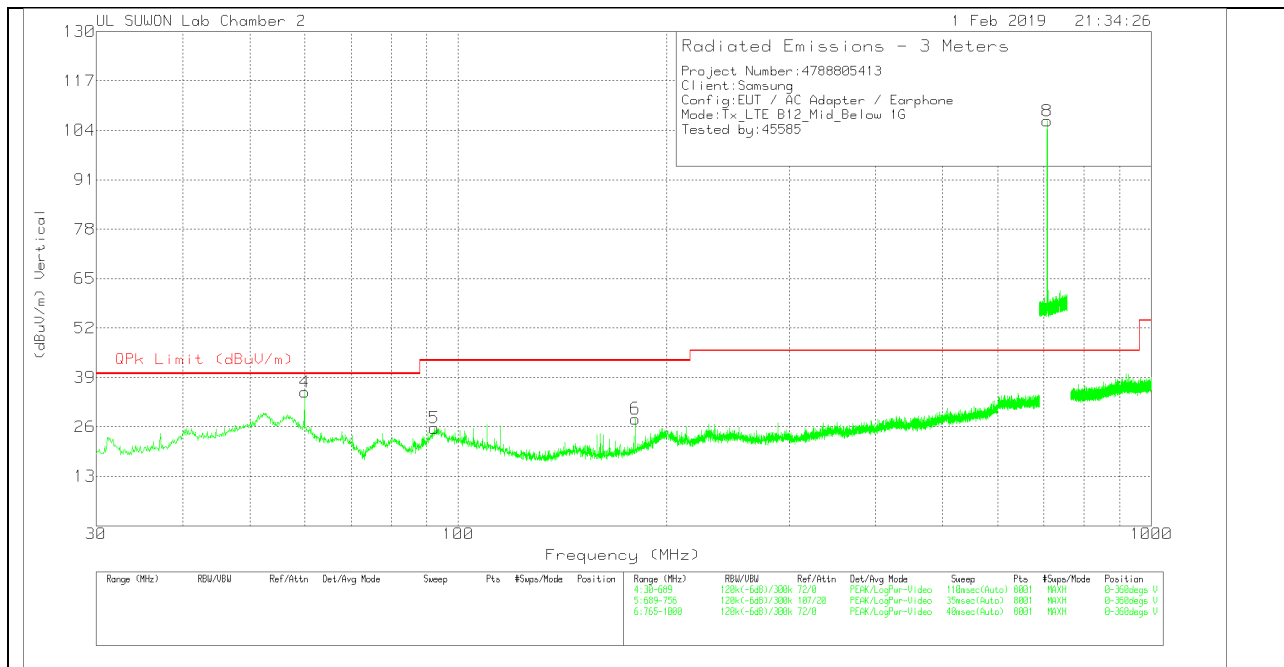

**DATA**

Trace Markers

Marker	Frequency (MHz)	Meter Reading (dBuV)	Det	VULB9163_749	Bypass_Below_1G[dB]	Corrected Reading (dBuV/m)	QPk Limit (dBuV/m)	Margin (dB)	Azimuth (Degs)	Height (cm)	Polarity
1	58.996	8.32	Pk	18.7	.8	27.82	40	-12.18	0-360	300	H
2	113.1164	12.13	Pk	16.5	1.1	29.73	43.52	-13.79	0-360	400	H
3	253.7305	10.74	Pk	19.1	1.7	31.54	46.02	-14.48	0-360	200	H
7	707.6093	87.12	Pk	25.5	2.9	115.52	46.02	69.5	0-360	100	H
4	59.9845	15.86	Pk	18.5	.8	35.16	40	-4.84	0-360	100	V
5	92.3579	8.18	Pk	16.5	1	25.68	43.52	-17.84	0-360	100	V
6	180.0049	11.02	Pk	15.7	1.4	28.12	43.52	-15.4	0-360	100	V
8	707.7014	78.03	Pk	25.5	2.9	106.43	46.02	60.41	0-360	200	V

Pk - Peak detector

Note: Unwanted emissions captured from 699MHz to 716MHz and from 729MHz to 746MHz were the TX and RX signals generated from the call-simulator.

**HIGH CHANNEL(744.5MHz)**

**HORIZONTAL PEAK PLOT**

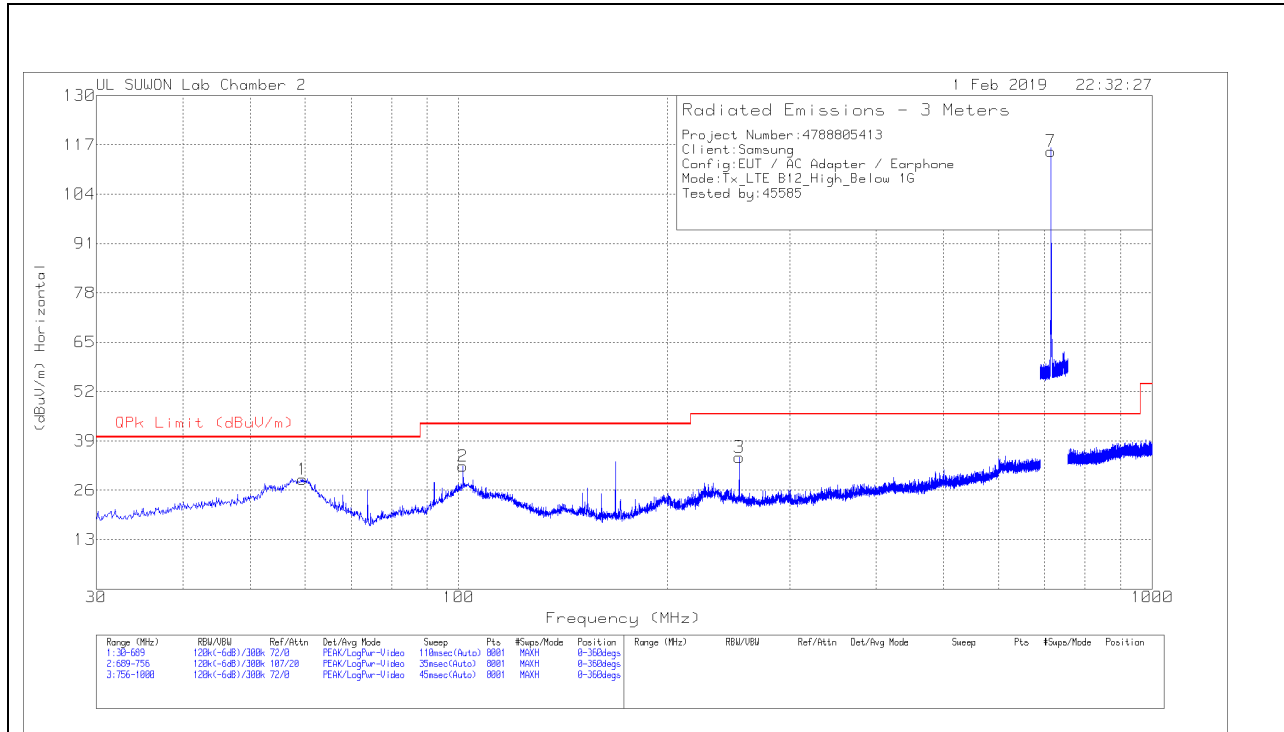

**VERTICAL PEAK PLOT**

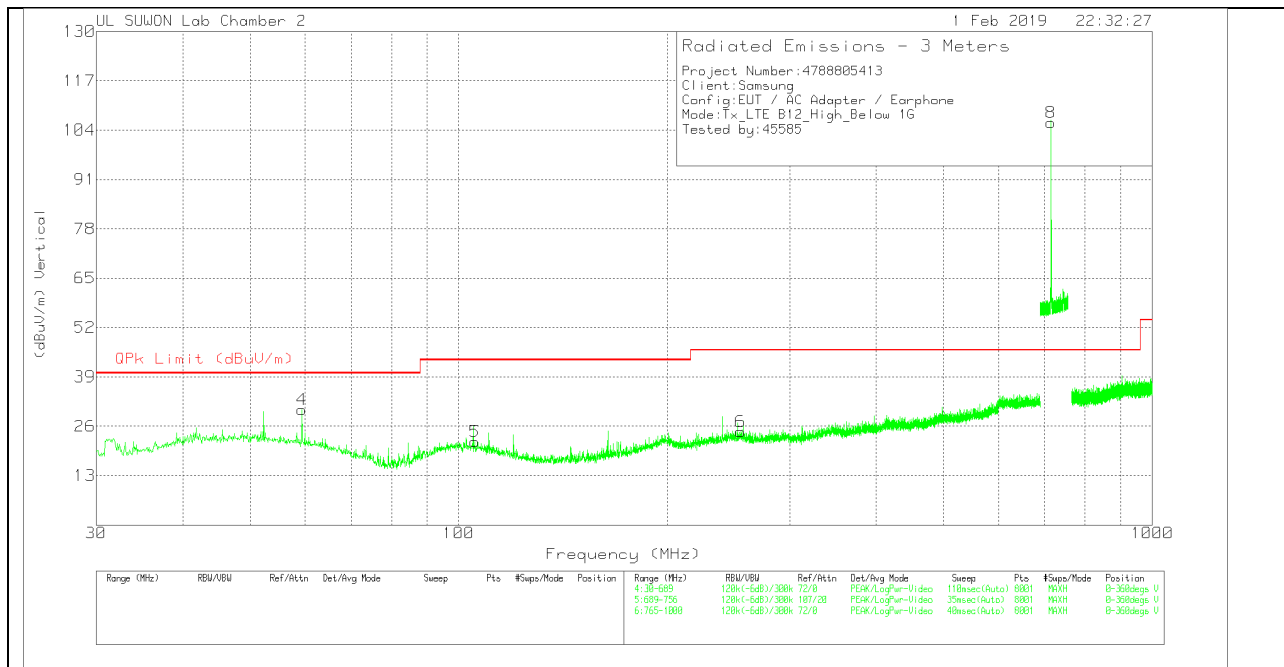

**DATA**

Trace Markers

Marker	Frequency (MHz)	Meter Reading (dBuV)	Det	VULB9163_749	Bypass_Below_1G[dB]	Corrected Reading (dBuV/m)	QPk Limit (dBuV/m)	Margin (dB)	Azimuth (Degs)	Height (cm)	Polarity
1	59.4903	9.46	Pk	18.6	.8	28.86	40	-11.14	0-360	400	H
2	101.4191	13.51	Pk	17.7	1.1	32.31	43.52	-11.21	0-360	200	H
3	253.8129	13.91	Pk	19.1	1.7	34.71	46.02	-11.31	0-360	100	H
7	714.7029	86.76	Pk	25.6	2.9	115.26	46.02	69.24	0-360	100	H
4	59.4079	10.97	Pk	18.6	.8	30.37	40	-9.63	0-360	300	V
5	105.4555	3.21	Pk	17.6	1.1	21.91	43.52	-21.61	0-360	200	V
6	254.8838	3.66	Pk	19.2	1.7	24.56	46.02	-21.46	0-360	200	V
8	714.7531	77.43	Pk	25.6	2.9	105.93	46.02	59.91	0-360	100	V

Pk - Peak detector

Note: Unwanted emissions captured from 699MHz to 716MHz and from 729MHz to 746MHz were the TX and RX signals generated from the call-simulator.

### 4.4. Below 1 GHz in the LTE Band 13

#### LOW CHANNEL(748.5MHz)

#### HORIZONTAL PEAK PLOT

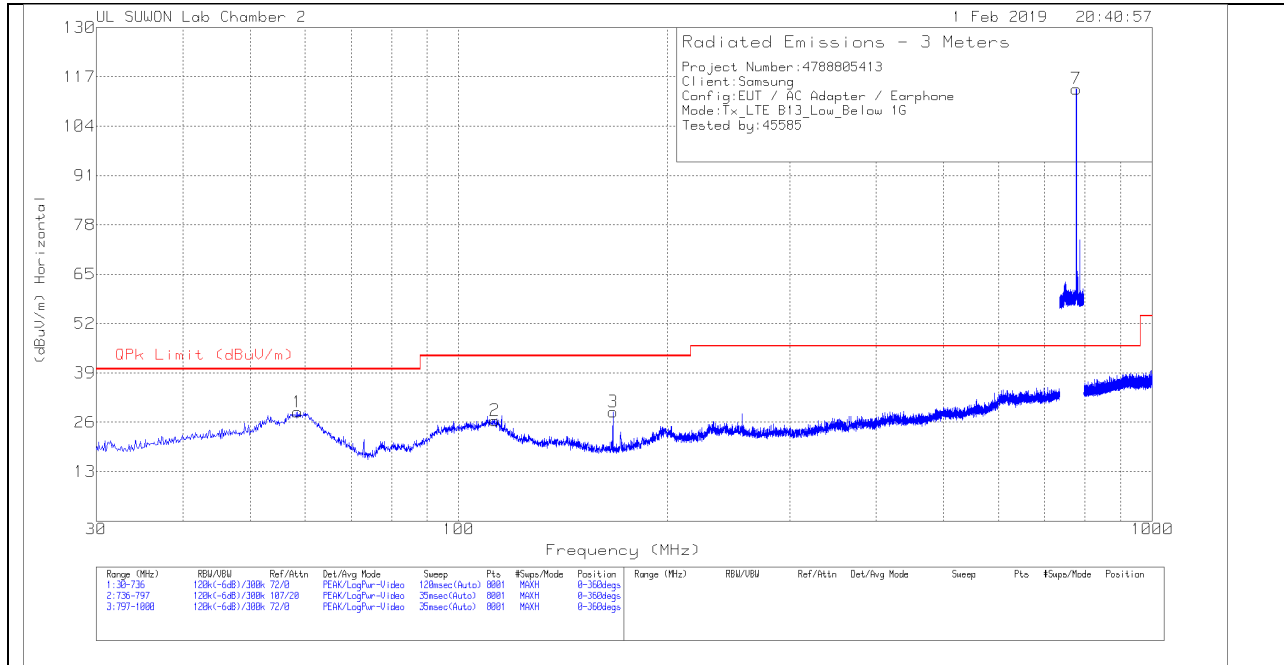

#### VERTICAL PEAK PLOT

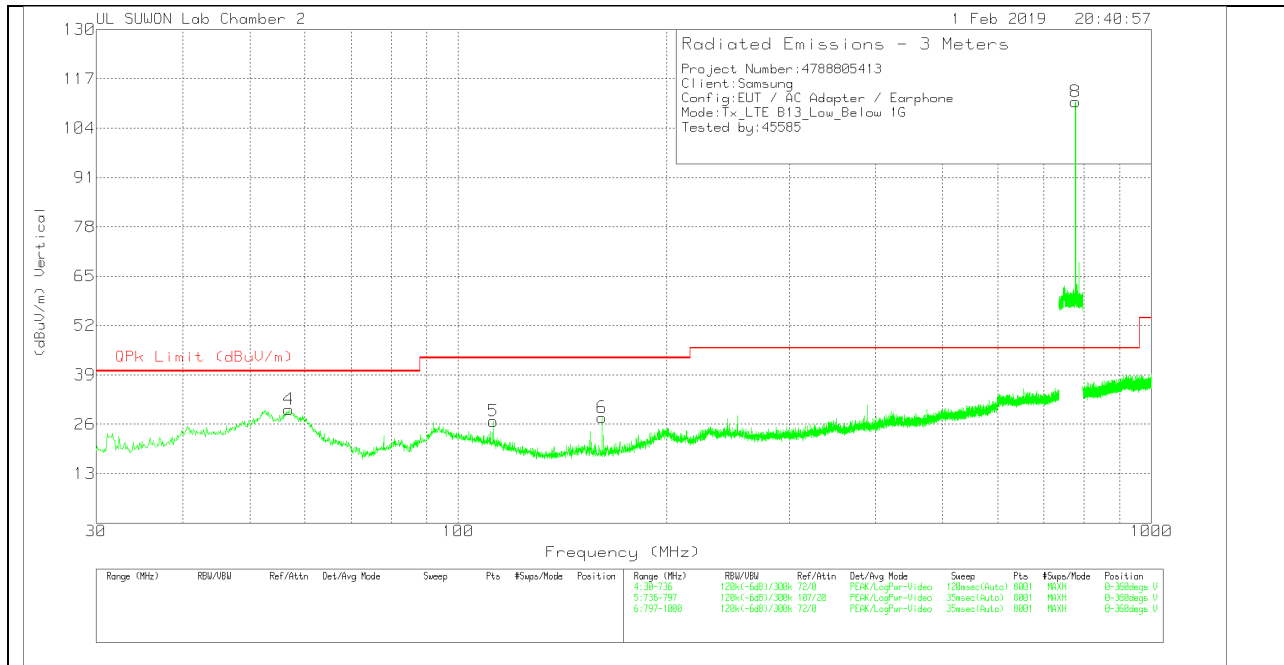

**DATA**

Trace Markers

Marker	Frequency (MHz)	Meter Reading (dBuV)	Det	VULB9163_749	Bypass_Below_1G[dB]	Corrected Reading (dBuV/m)	QPk Limit (dBuV/m)	Margin (dB)	Azimuth (Degs)	Height (cm)	Polarity
1	58.593	9.07	Pk	18.8	.8	28.67	40	-11.33	0-360	400	H
2	112.7785	8.76	Pk	16.6	1.1	26.46	43.52	-17.06	0-360	300	H
3	166.8758	12.44	Pk	14.9	1.4	28.74	43.52	-14.78	0-360	400	H
7	777.3046	84.13	Pk	26.7	3	113.83	46.02	67.81	0-360	100	H
4	56.9163	10.13	Pk	19	.8	29.93	40	-10.07	0-360	300	V
5	112.249	9.02	Pk	16.7	1.1	26.82	43.52	-16.7	0-360	400	V
6	161.2278	11.66	Pk	14.7	1.4	27.76	43.52	-15.76	0-360	100	V
8	777.2894	81.27	Pk	26.7	3	110.97	46.02	64.95	0-360	100	V

Pk - Peak detector

Note: Unwanted emissions captured from 777MHz to 787MHz and from 746MHz to 756MHz were the TX and RX signals generated from the call-simulator.

**MID CHANNEL(751.0MHz)**

**HORIZONTAL PEAK PLOT**

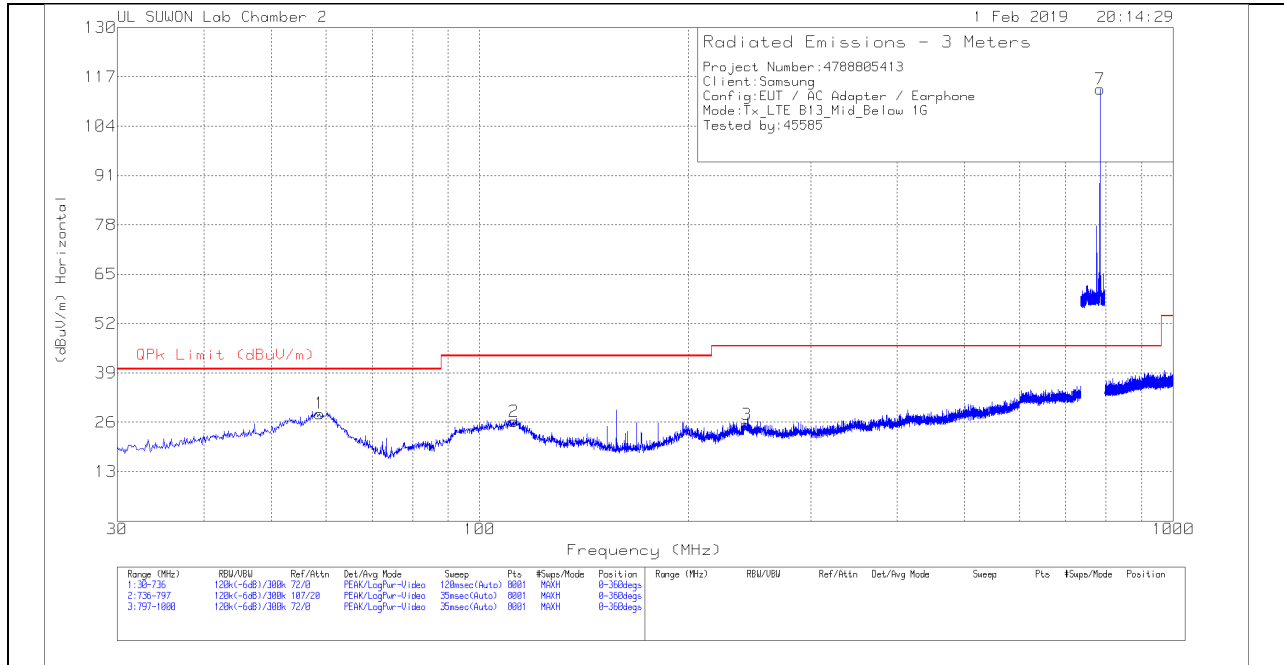

**VERTICAL PEAK PLOT**

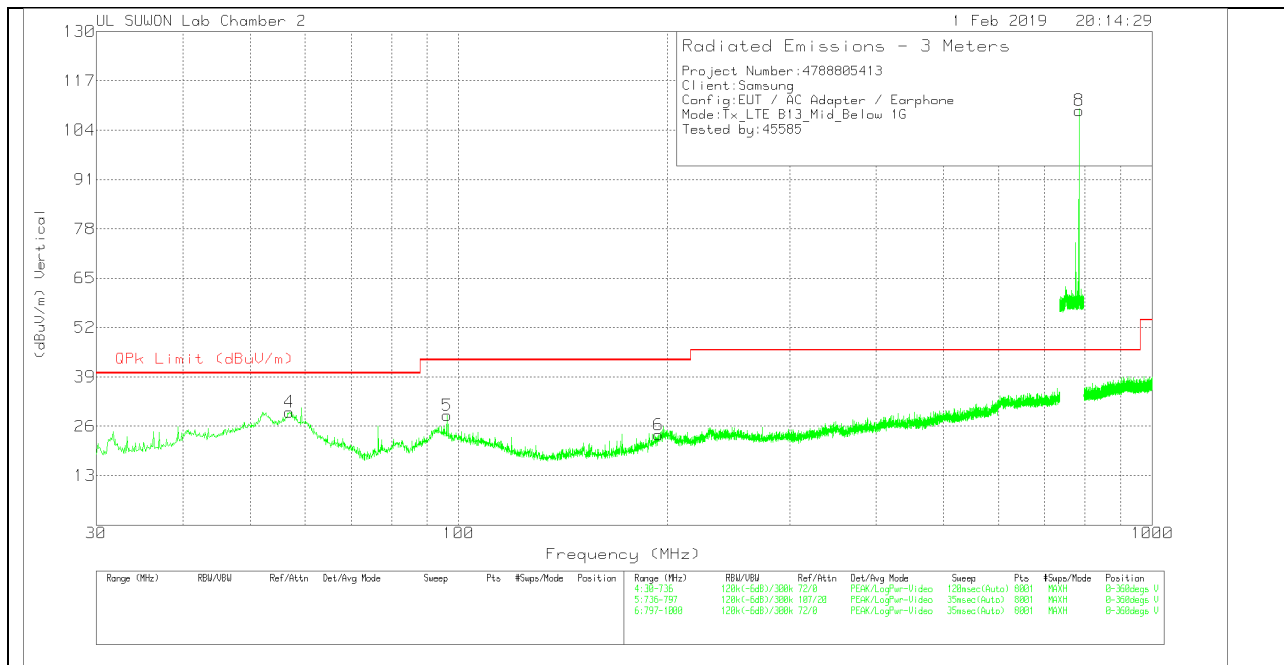

**DATA**

Trace Markers

Marker	Frequency (MHz)	Meter Reading (dBuV)	Det	VULB9163_749	Bypass_Below_1G[dB]	Corrected Reading (dBuV/m)	QPk Limit (dBuV/m)	Margin (dB)	Azimuth (Degs)	Height (cm)	Polarity
1	58.7695	8.8	Pk	18.7	.8	28.3	40	-11.7	0-360	400	H
2	112.0725	8.32	Pk	16.7	1.2	26.22	43.52	-17.3	0-360	300	H
3	242.859	5.02	Pk	18.7	1.7	25.42	46.02	-20.6	0-360	100	H
7	784.1138	84.04	Pk	26.7	3	113.74	46.02	67.72	0-360	200	H
4	57.0045	9.95	Pk	19	.8	29.75	40	-10.25	0-360	300	V
5	96.1875	10.39	Pk	17.4	1.1	28.89	43.52	-14.63	0-360	100	V
6	194.0568	4.43	Pk	17.8	1.5	23.73	43.52	-19.79	0-360	100	V
8	784.2205	79.47	Pk	26.7	3	109.17	46.02	63.15	0-360	100	V

Pk - Peak detector

Note: Unwanted emissions captured from 777MHz to 787MHz and from 746MHz to 756MHz were the TX and RX signals generated from the call-simulator.

**HIGH CHANNEL(753.5MHz)**

**HORIZONTAL PEAK PLOT**

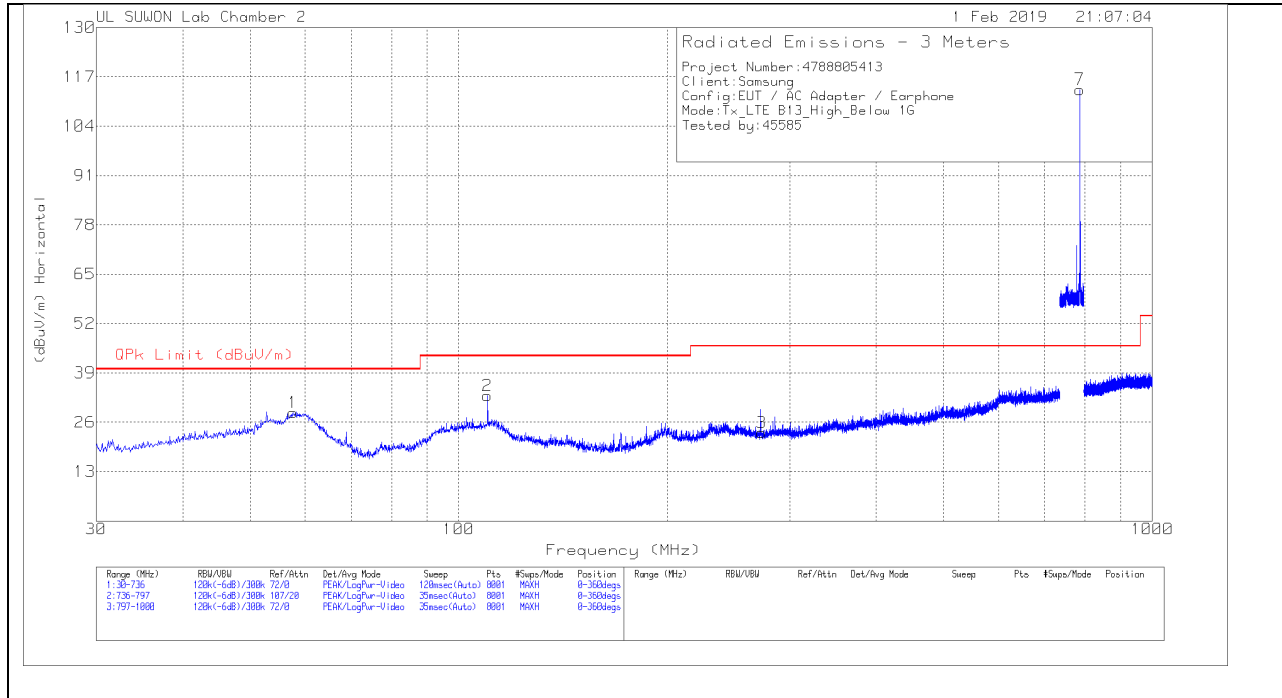

**VERTICAL PEAK PLOT**

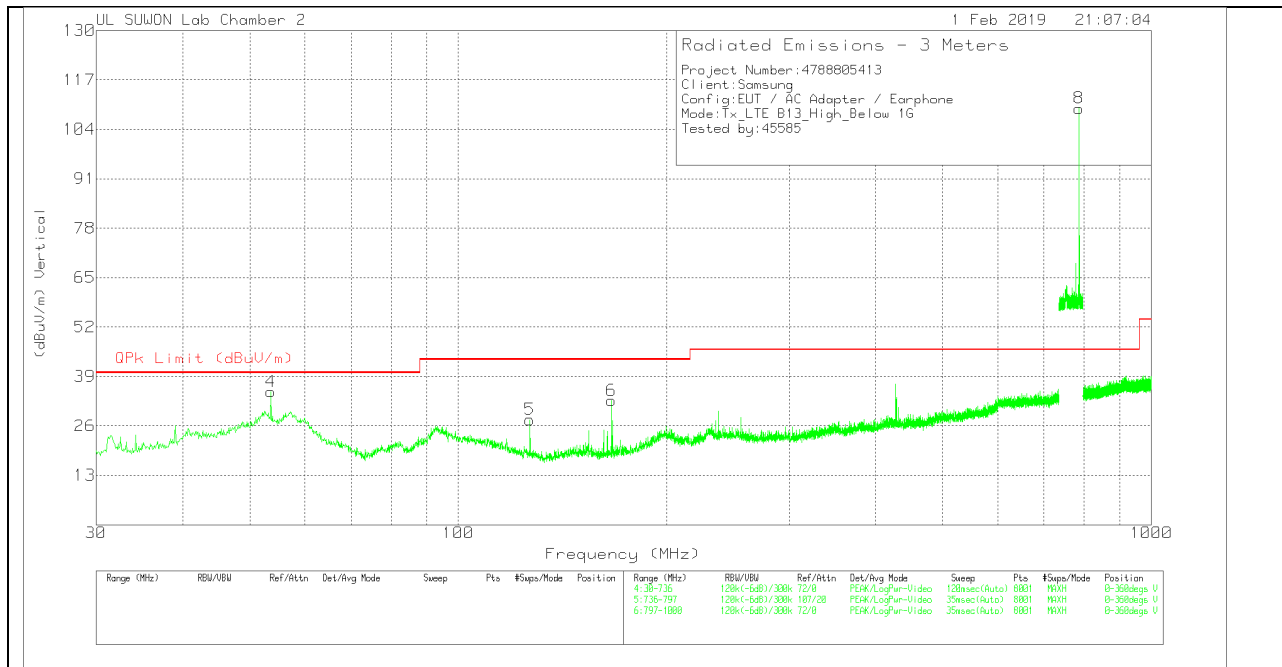

**DATA**

Trace Markers

Marker	Frequency (MHz)	Meter Reading (dBuV)	Det	VULB9163_749	Bypass_Below_1G[dB]	Corrected Reading (dBuV/m)	QPk Limit (dBuV/m)	Margin (dB)	Azimuth (Degs)	Height (cm)	Polarity
1	57.7105	8.85	Pk	18.9	.8	28.55	40	-11.45	0-360	300	H
2	110.0428	14.8	Pk	17.1	1.1	33	43.52	-10.52	0-360	300	H
3	273.217	2.74	Pk	18.7	1.8	23.24	46.02	-22.78	0-360	300	H
7	786.63	83.95	Pk	26.7	3	113.65	46.02	67.63	0-360	100	H
4	53.651	14.68	Pk	19.5	.8	34.98	40	-5.02	0-360	100	V
5	126.8103	11.95	Pk	14.5	1.2	27.65	43.52	-15.87	0-360	100	V
6	166.258	16.38	Pk	14.9	1.4	32.68	43.52	-10.84	0-360	100	V
8	786.6681	79.83	Pk	26.7	3	109.53	46.02	63.51	0-360	100	V

Pk - Peak detector

Note: Unwanted emissions captured from 777MHz to 787MHz and from 746MHz to 756MHz were the TX and RX signals generated from the call-simulator.

### 4.5. Below 1 GHz in the LTE Band 26

#### LOW CHANNEL(860.5MHz)

#### HORIZONTAL PEAK PLOT

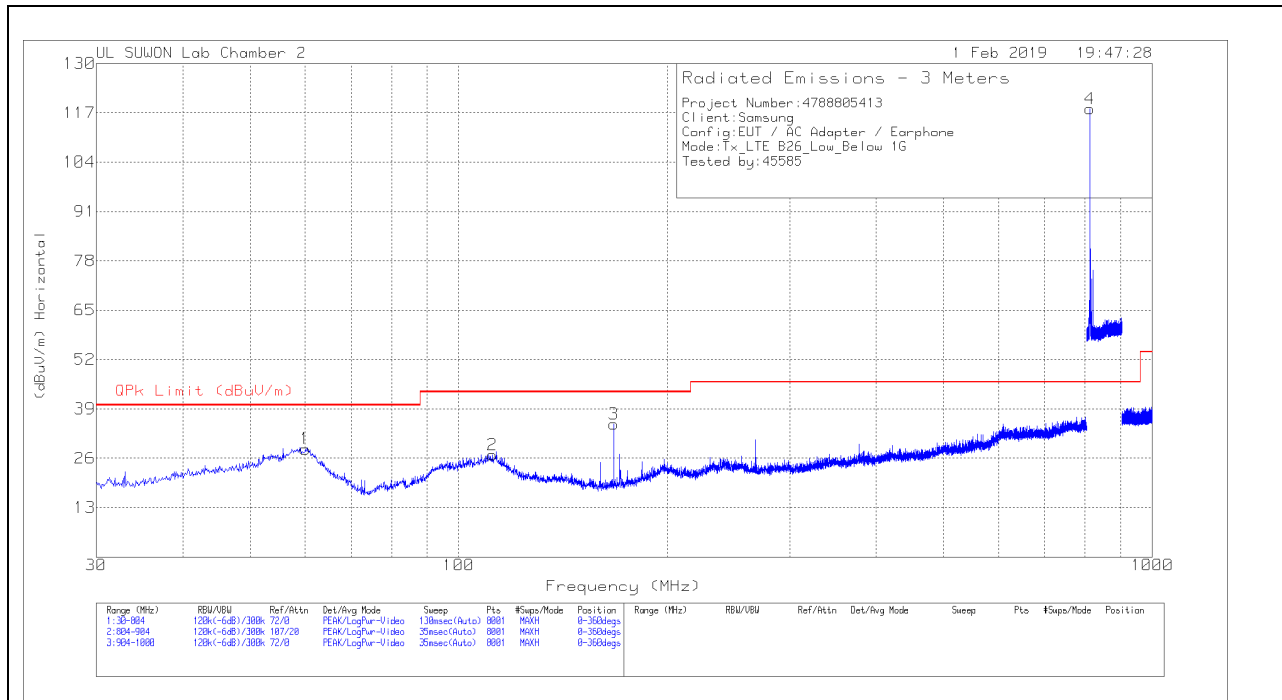

#### VERTICAL PEAK PLOT

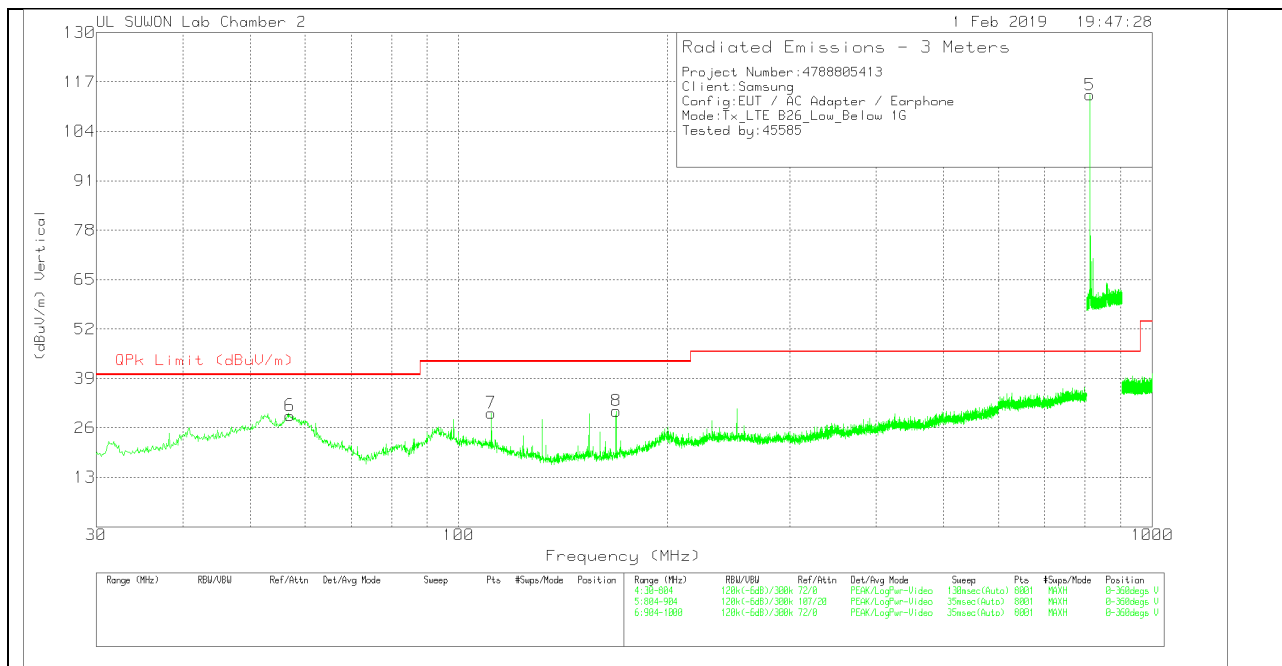

**DATA**

Trace Markers

Marker	Frequency (MHz)	Meter Reading (dBuV)	Det	VULB9163_749	Bypass_Below_1G[dB]	Corrected Reading (dBuV/m)	QPk Limit (dBuV/m)	Margin (dB)	Azimuth (Degs)	Height (cm)	Polarity
1	60.0893	9.17	Pk	18.5	.8	28.47	40	-11.53	0-360	400	H
2	111.8505	8.89	Pk	16.8	1.2	26.89	43.52	-16.63	0-360	300	H
3	167.385	18.68	Pk	14.9	1.4	34.98	43.52	-8.54	0-360	300	H
4	813.375	87.95	Pk	27	3.1	118.05	46.02	72.03	0-360	100	H
6	57.09	9.44	Pk	19	.8	29.24	40	-10.76	0-360	300	V
7	111.4635	12.02	Pk	16.8	1.1	29.92	43.52	-13.6	0-360	100	V
8	168.6428	14.16	Pk	14.9	1.4	30.46	43.52	-13.06	0-360	100	V
5	813.375	83.45	Pk	27	3.1	113.55	46.02	67.53	0-360	200	V

Pk - Peak detector

Note: Unwanted emissions captured from 814MHz to 849MHz and from 859MHz to 894MHz were the TX and RX signals generated from the call-simulator.

**MID CHANNEL(876.5MHz)**

**HORIZONTAL PEAK PLOT**

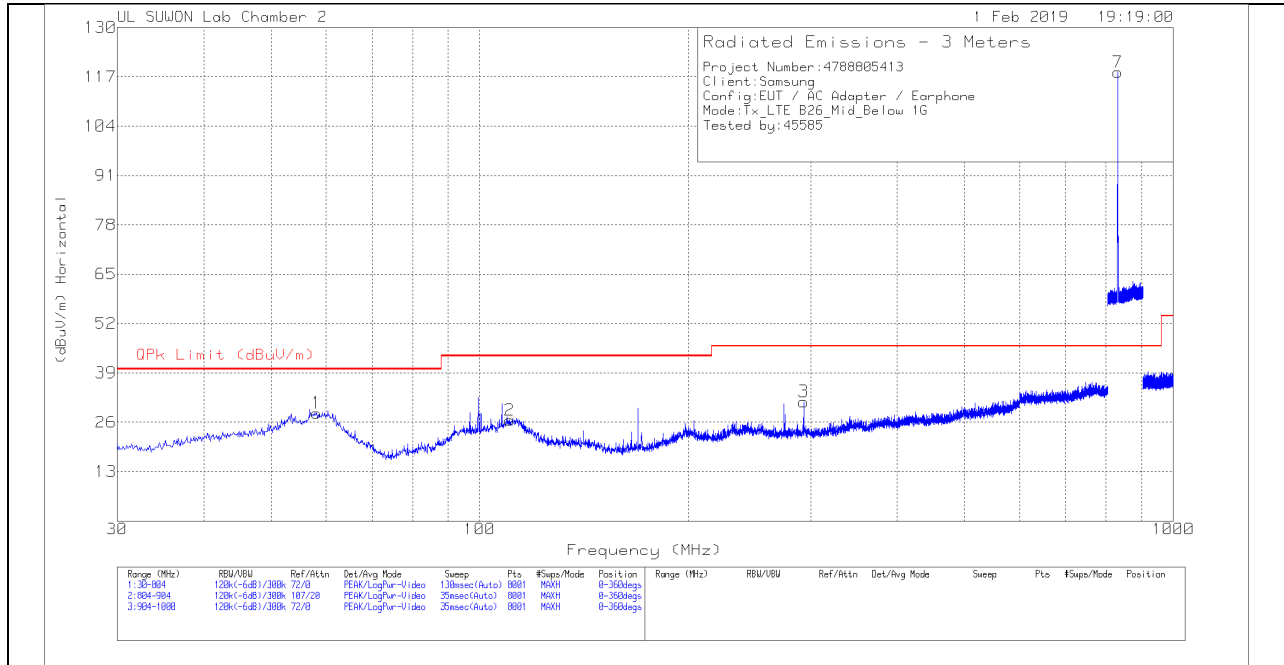

**VERTICAL PEAK PLOT**

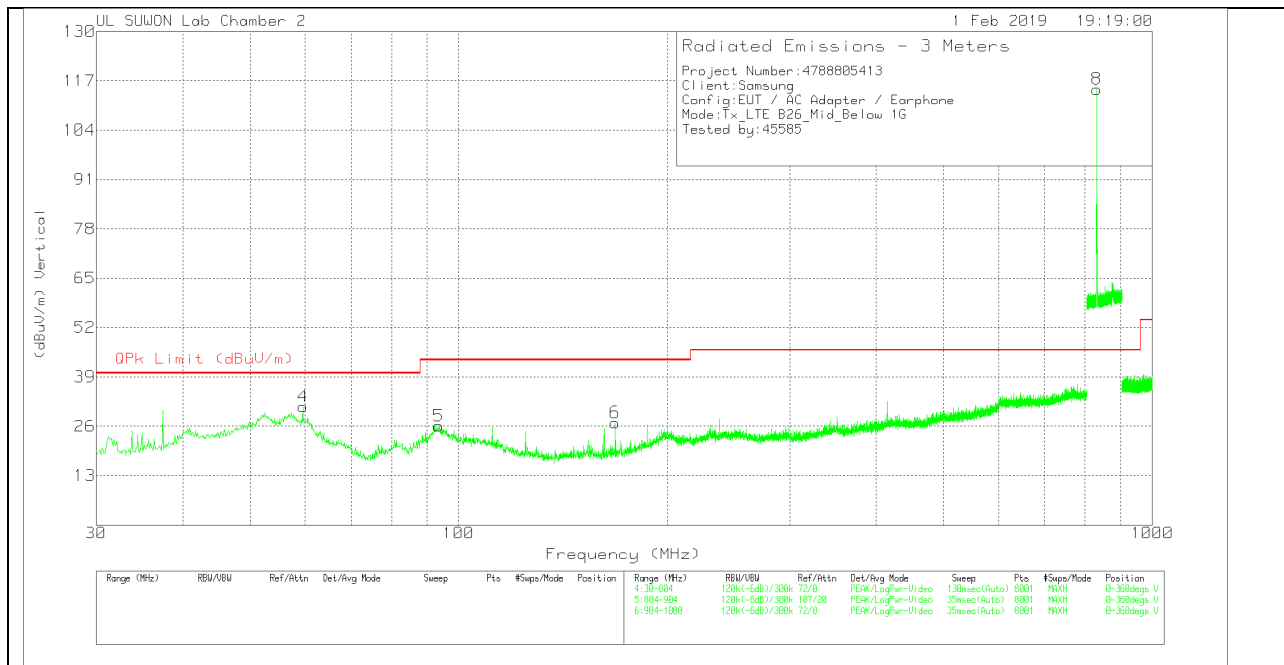

**DATA**

Trace Markers

Marker	Frequency (MHz)	Meter Reading (dBuV)	Det	VULB9163_749	Bypass_Below_1G[dB]	Corrected Reading (dBuV/m)	QPk Limit (dBuV/m)	Margin (dB)	Azimuth (Degs)	Height (cm)	Polarity
1	58.1543	8.84	Pk	18.8	.8	28.44	40	-11.56	0-360	400	H
2	110.496	8.47	Pk	17	1.1	26.57	43.52	-16.95	0-360	300	H
3	293.16	10.43	Pk	19.2	1.8	31.43	46.02	-14.59	0-360	100	H
7	831.625	88	Pk	27.1	3.1	118.2	46.02	72.18	0-360	200	H
4	59.6055	11.75	Pk	18.6	.8	31.15	40	-8.85	0-360	200	V
5	93.5648	8.12	Pk	16.8	1.1	26.02	43.52	-17.5	0-360	100	V
6	168.159	10.64	Pk	14.9	1.4	26.94	43.52	-16.58	0-360	100	V
8	831.675	84.61	Pk	27.1	3.1	114.81	46.02	68.79	0-360	100	V

Pk - Peak detector

Note: Unwanted emissions captured from 814MHz to 849MHz and from 859MHz to 894MHz were the TX and RX signals generated from the call-simulator.

**HIGH CHANNEL(892.5MHz)**

**HORIZONTAL PEAK PLOT**

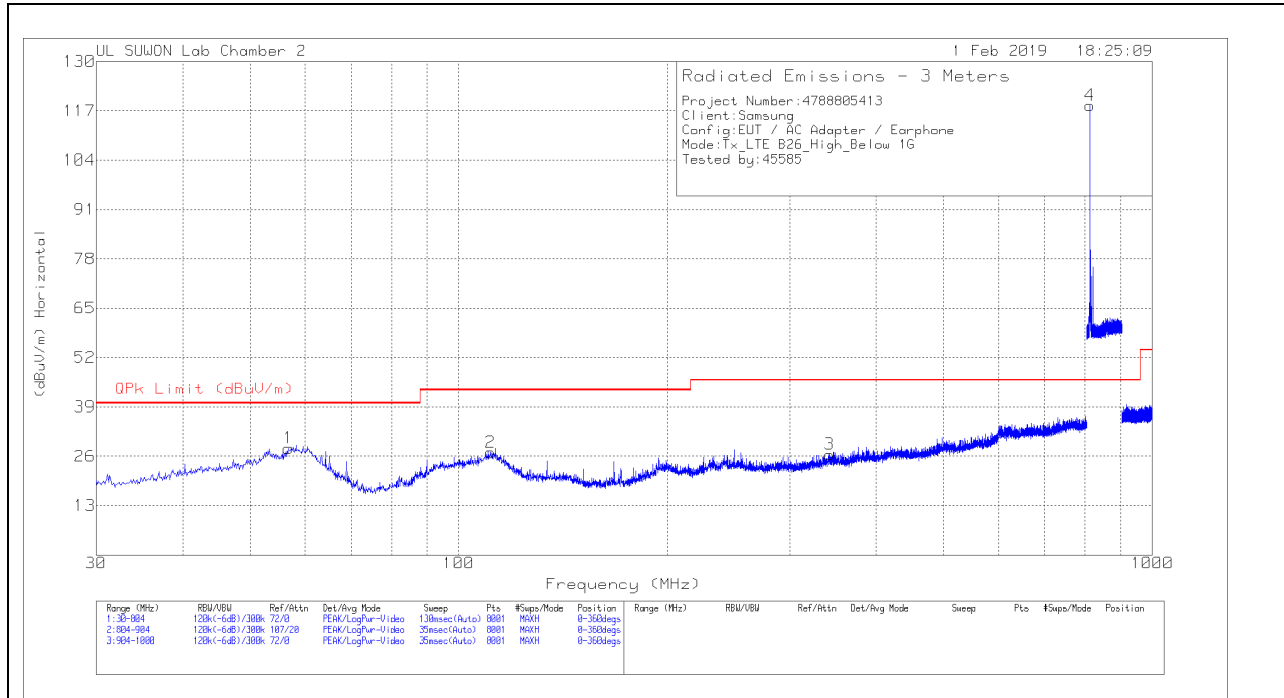

**VERTICAL PEAK PLOT**

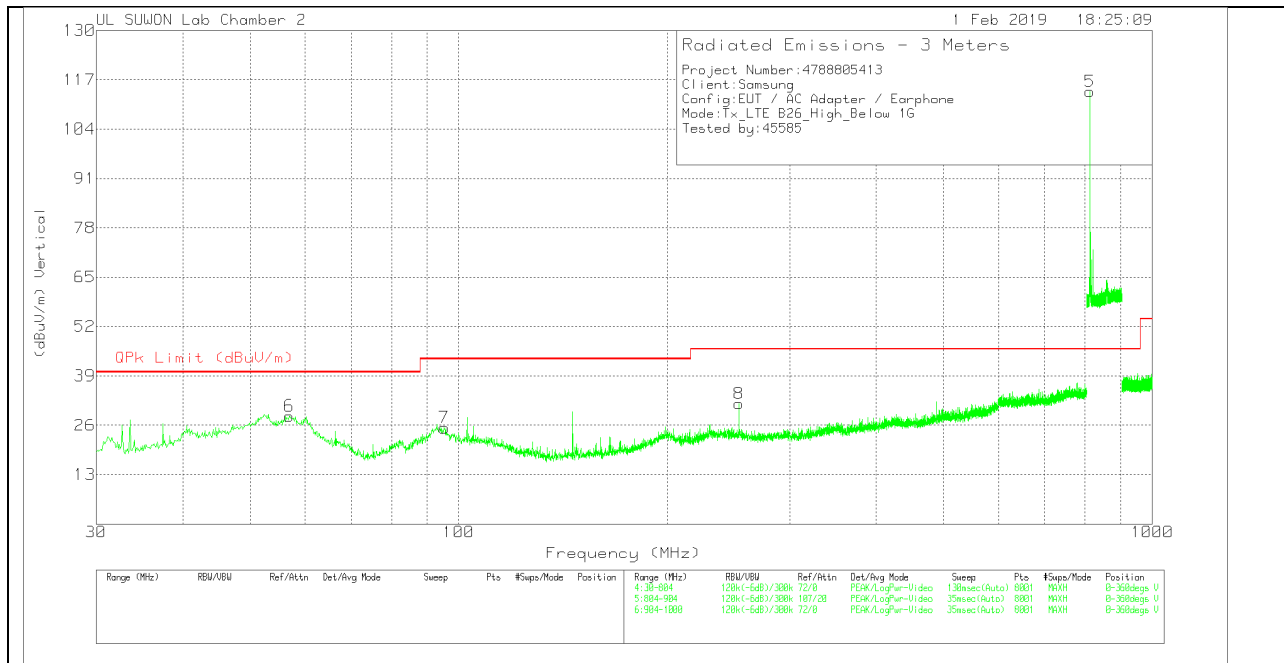

**DATA**

Trace Markers

Marker	Frequency (MHz)	Meter Reading (dBuV)	Det	VULB9163_749	Bypass_Below_1G[dB]	Corrected Reading (dBuV/m)	QPk Limit (dBuV/m)	Margin (dB)	Azimuth (Degs)	Height (cm)	Polarity
1	56.7998	8.34	Pk	19	.8	28.14	40	-11.86	0-360	300	H
2	111.0765	9	Pk	16.9	1.1	27	43.52	-16.52	0-360	400	H
3	342.696	3.78	Pk	20.7	2	26.48	46.02	-19.54	0-360	100	H
4	813.325	88.32	Pk	27	3.1	118.42	46.02	72.4	0-360	100	H
6	56.9933	8.62	Pk	19	.8	28.42	40	-11.58	0-360	300	V
7	95.3063	7.04	Pk	17.2	1.1	25.34	43.52	-18.18	0-360	100	V
8	253.686	10.9	Pk	19.1	1.7	31.7	46.02	-14.32	0-360	200	V
5	813.3	83.81	Pk	27	3.1	113.91	46.02	67.89	0-360	100	V

Pk - Peak detector

Note: Unwanted emissions captured from 814MHz to 849MHz and from 859MHz to 894MHz were the TX and RX signals generated from the call-simulator.