

MID CHANNEL DATA

Trace Markers

Marker	Frequency (GHz)	Meter Reading (dBuV)	Det	3117_00168717	6GHz_HF[dB]	DC Corr (dB)	Corrected Reading (dBuV/m)	Avg Limit (dBuV/m)	Margin (dB)	Peak Limit (dBuV/m)	Margin (dB)	Limit Non-Restricted (dBuV/m)	Margin (dB)	Azimuth (Degs)	Height (cm)	Polarity
1	* 10.601	25.48	PK	37.8	-22.3	0	40.98	-	-	74	-33.02	-	-	0-360	250	H
4	* 15.901	26.41	PK	40.6	-21.1	0	45.91	-	-	74	-28.09	-	-	0-360	250	H
5	* 7.337	30.09	PK	35.8	-27.3	0	38.59	-	-	74	-35.41	-	-	0-360	250	H
2	10.599	26.1	PK	37.8	-22.3	0	41.6	-	-	-	-	68.2	-26.6	0-360	250	V
3	* 15.907	25.97	PK	40.6	-21.1	0	45.47	-	-	74	-28.53	-	-	0-360	150	V
6	* 7.33	31.11	PK	35.8	-27.2	0	39.71	-	-	74	-34.29	-	-	0-360	150	V

* - indicates frequency in CFR47 Pt 15 / IC RSS-Restricted Band
 PK – Peak Detector

Note: Only peak measurement was performed. Because peak measurement result of unwanted emission is less than average limit (54dBuV/m).

HIGH CHANNEL HORIZONTAL

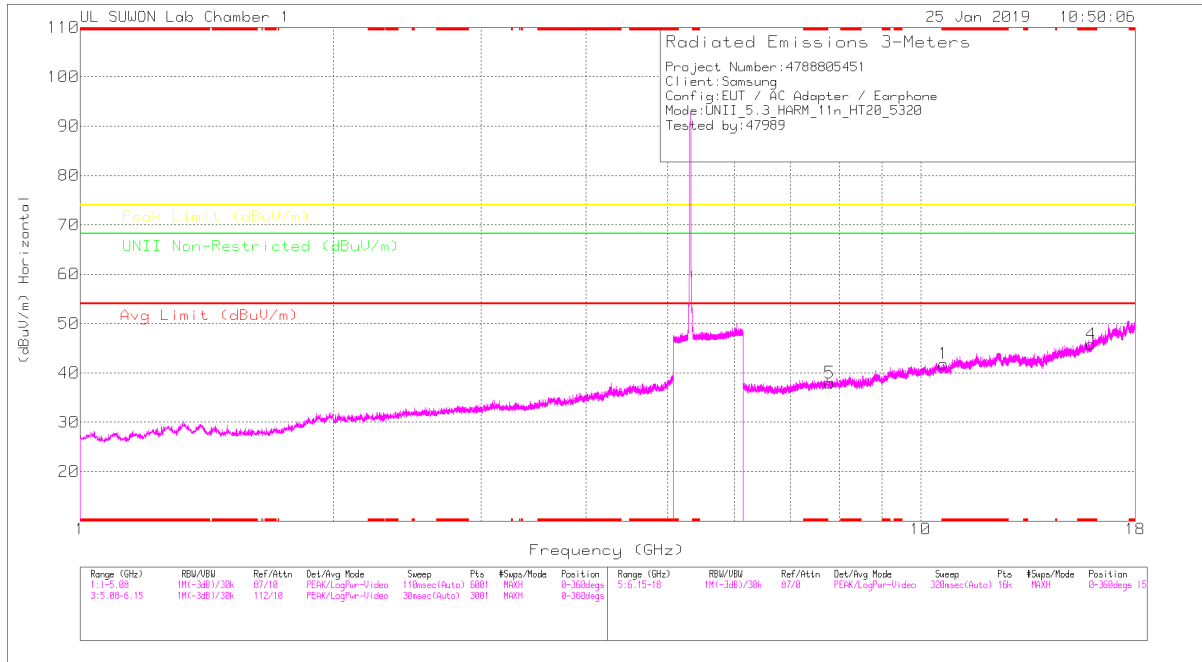

HIGH CHANNEL VERTICAL

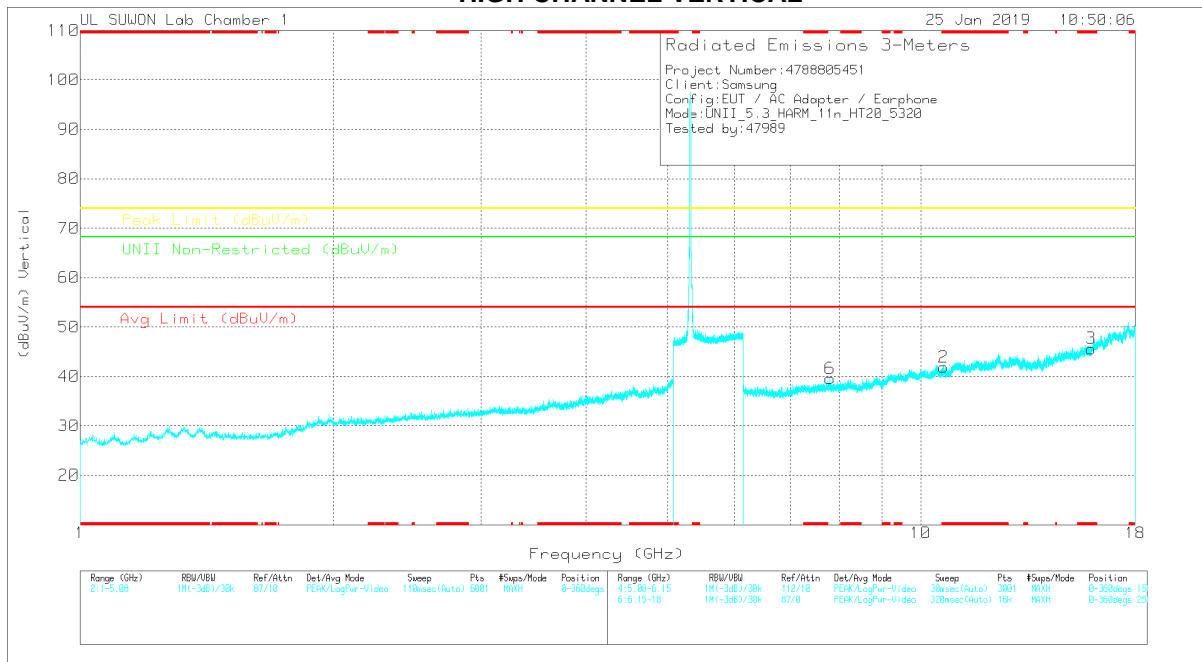

Note: Emission was scanned up to 40GHz; No emissions were detected above the noise floor which was at least 20dB below the specification limit.

HIGH CHANNEL DATA

Trace Markers

Marker	Frequency (GHz)	Meter Reading (dBuV)	Det	3117_00168717	6GHz_HF(dB)	DC Corr (dB)	Corrected Reading (dBuV/m)	Avg Limit (dBuV/m)	Margin (dB)	Peak Limit (dBuV/m)	Margin (dB)	LNI Non-Restricted (dBuV/m)	Margin (dB)	Asimuth (Degs)	Height (cm)	Polarity
1	* 10.641	26.13	PK	37.8	-22.1	0	41.83	-	-	74	-32.17	-	-	0-360	250	H
4	* 15.949	26.13	PK	40.7	-21	0	45.83	-	-	74	-28.17	-	-	0-360	250	H
5	7.796	28.56	PK	35.9	-26.5	0	37.96	-	-	-	-	68.2	-30.24	0-360	250	H
2	* 10.641	26.18	PK	37.8	-22.1	0	41.88	-	-	74	-32.12	-	-	0-360	150	V
3	* 15.962	25.74	PK	40.7	-20.8	0	45.64	-	-	74	-28.36	-	-	0-360	250	V
6	7.802	30.2	PK	35.9	-26.5	0	39.6	-	-	-	-	68.2	-28.6	0-360	250	V

* - indicates frequency in CFR47 Pt 15 / IC RSS-Restricted Band
 PK – Peak Detector

Note: Only peak measurement was performed. Because peak measurement result of unwanted emission is less than average limit (54dBuV/m).

11.2.3.TX ABOVE 1GHz 802.11n HT40 MODE IN THE 5.3GHz BAND

AUTHORIZED BANDEDGE (HIGH CHANNEL)

HORIZONTAL PEAK AND AVERAGE PLOT

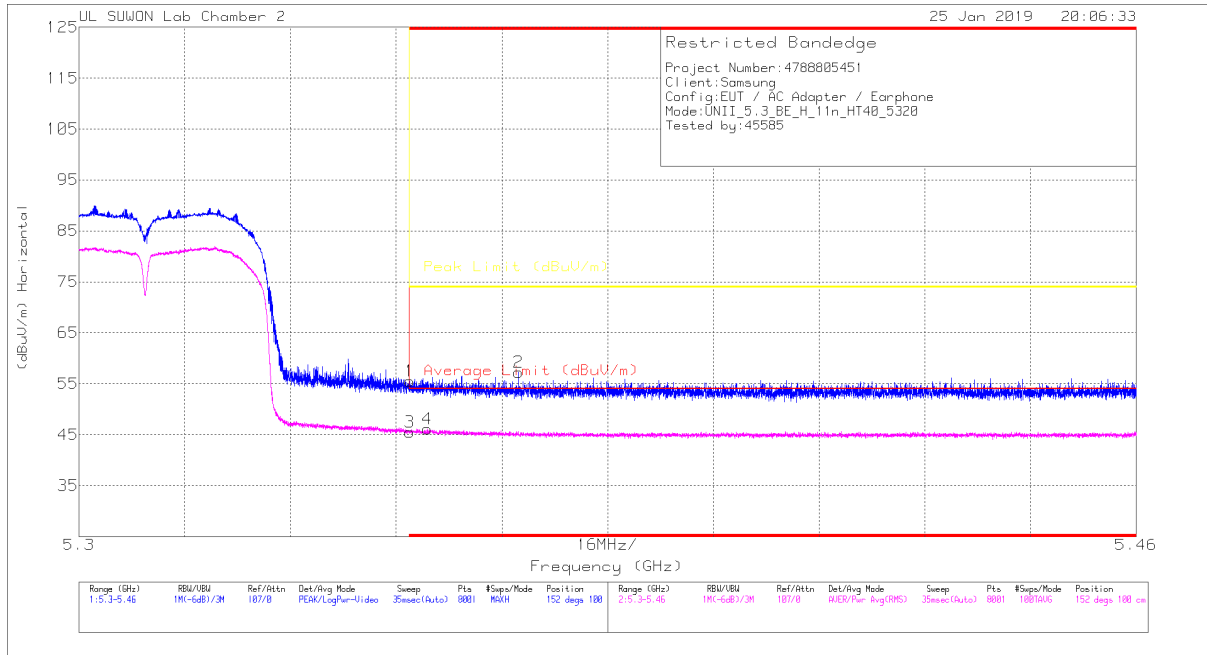

HORIZONTAL DATA

Trace Markers

Marker	Frequency (GHz)	Meter Reading (dBuV)	Det	3117_00168724	10dB(dB)	DC Corr (dB)	Corrected Reading (dBuV/m)	Average Limit (dBuV/m)	Margin (dB)	Peak Limit (dBuV/m)	PK Margin (dB)	Azimuth (Degs)	Height (cm)	Polarity
1	* 5.35	39.07	Pk		-18.1	0	55.47	-	-	74	-18.53	152	100	H
2	* 5.367	40.97	Pk		-18.2	0	57.27	-	-	74	-16.73	152	100	H
3	* 5.35	27.84	RMS		-17.1	.31	45.55	54	-8.45	-	-	152	100	H
4	* 5.353	28.44	RMS		-17.1	.31	46.15	54	-7.85	-	-	152	100	H

* - indicates frequency in CFR47 Pt 15 / IC RSS-Restricted Band

Pk - Peak detector

RMS - RMS detection

VERTICAL PEAK AND AVERAGE PLOT

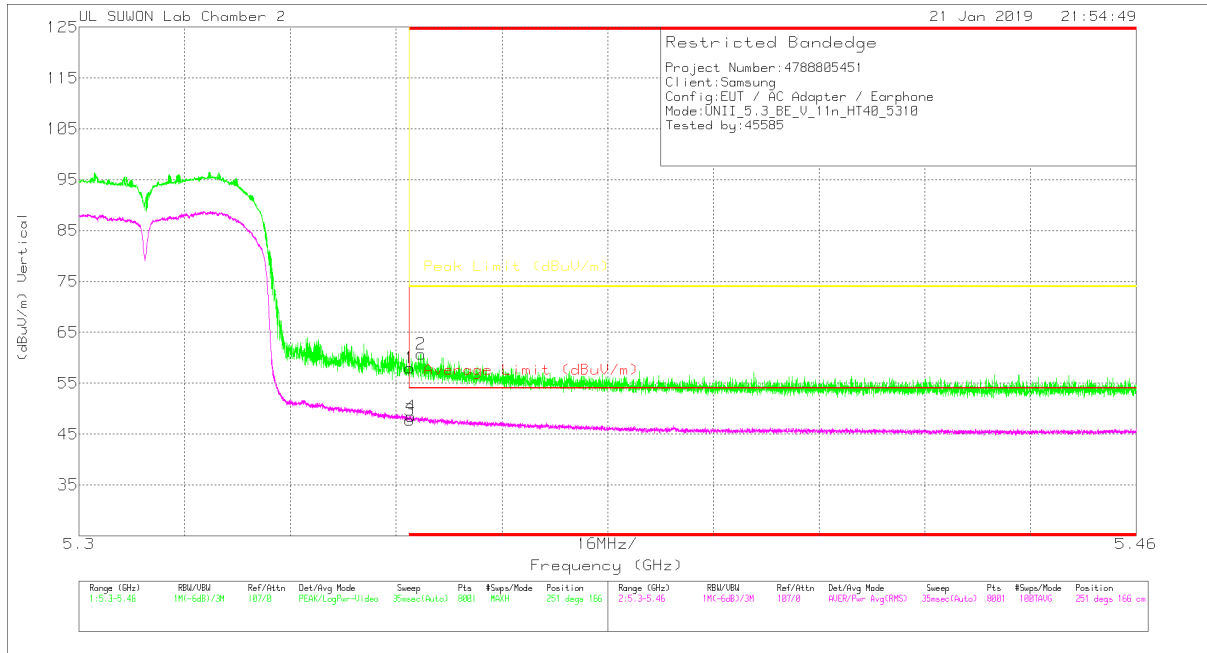

VERTICAL DATA

Trace Markers

Marker	Frequency (GHz)	Meter Reading (dBuV)	Det	3117_00168724	10dB[db]	DC Corr (dB)	Corrected Reading (dBuV/m)	Average Limit (dBuV/m)	Margin (dB)	Peak Limit (dBuV/m)	Pk Margin (dB)	Azimuth (Degs)	Height (cm)	Polarity
1	* 5.35	41.57	Pk	34.5	-18.1	0	57.97	-	-	74	-16.03	251	166	V
2	* 5.352	44.32	Pk	34.5	-18.1	0	60.72	-	-	74	-13.28	251	166	V
3	* 5.35	30.01	RMS	34.5	-17.1	.31	47.72	54	-6.28	-	-	251	166	V
4	* 5.35	30.73	RMS	34.5	-17.1	.31	48.44	54	-5.56	-	-	251	166	V

* - indicates frequency in CFR47 Pt 15 / IC RSS-Restricted Band

Pk - Peak detector

RMS - RMS detection

HARMONICS AND SPURIOUS EMISSIONS

LOW CHANNEL HORIZONTAL

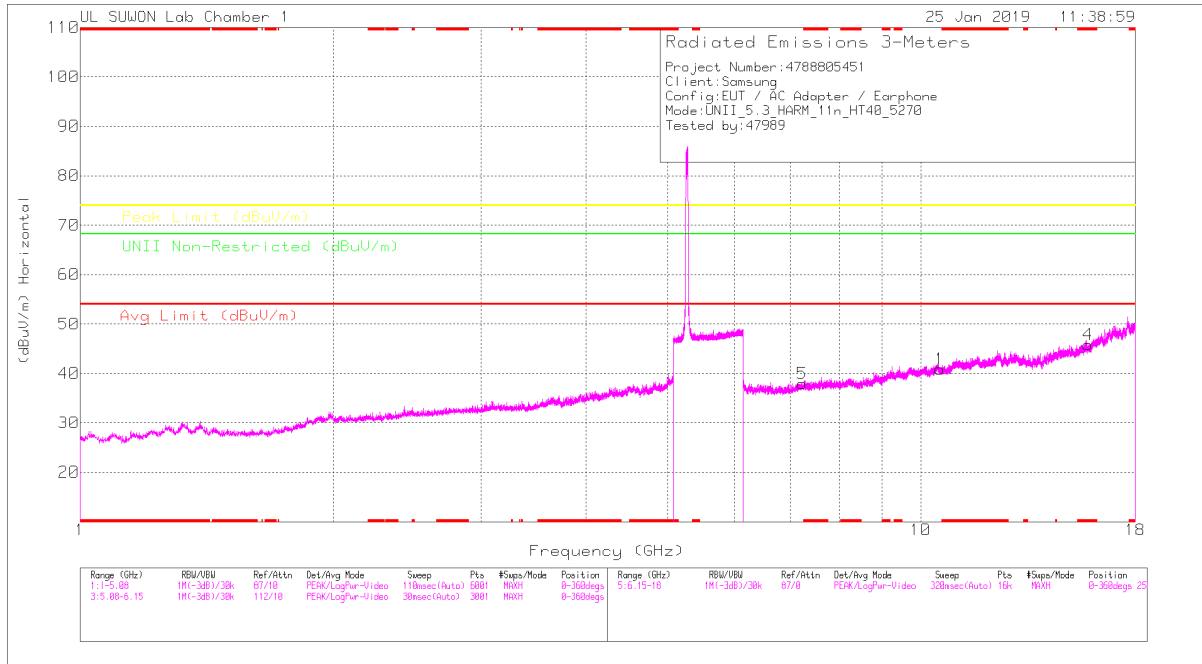

LOW CHANNEL VERTICAL

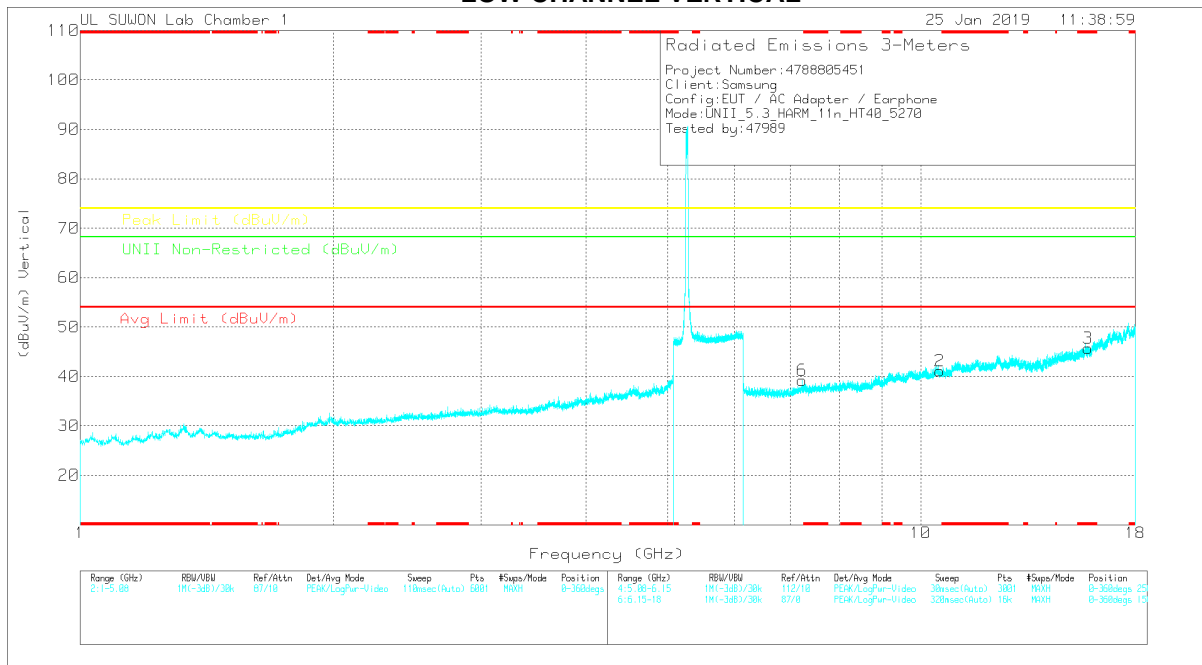

Note: Emission was scanned up to 40GHz; No emissions were detected above the noise floor which was at least 20dB below the specification limit.

LOW CHANNEL DATA

Trace Markers

Marker	Frequency (GHz)	Major Reading (dBuV)	Det	3117_00168717	66Hz_HF(dB)	DC Corr (dB)	Corrected Reading (dBuV/m)	Avg Limit (dBuV/m)	Margin (dB)	Peak Limit (dBuV/m)	Margin (dB)	Limit Non-Restricted (dBuV/m)	Margin (dB)	Altitude (Degs)	Height (cm)	Polarity
1	10.542	25.85	PK	37.8	-22.8	0	40.85	-	-	-	-	68.2	-27.35	0-360	150	H
4	* 15.817	26.43	PK	40.5	-21.1	0	45.83	-	-	74	-28.17	-	-	0-360	150	H
5	7.225	29.42	PK	35.8	-27.3	0	37.92	-	-	-	-	68.2	-30.28	0-360	150	H
2	10.54	26.09	PK	37.8	-22.8	0	41.09	-	-	-	-	68.2	-27.11	0-360	150	V
3	* 15.815	26.28	PK	40.5	-21.1	0	45.68	-	-	74	-28.32	-	-	0-360	250	V
6	7.228	30.59	PK	35.8	-27.2	0	39.19	-	-	-	-	68.2	-29.01	0-360	150	V

* - indicates frequency in CFR47 Pt 15 / IC RSS-Restricted Band
 PK – Peak Detector

Note: Only peak measurement was performed. Because peak measurement result of unwanted emission is less than average limit (54dBuV/m).

HIGH CHANNEL HORIZONTAL

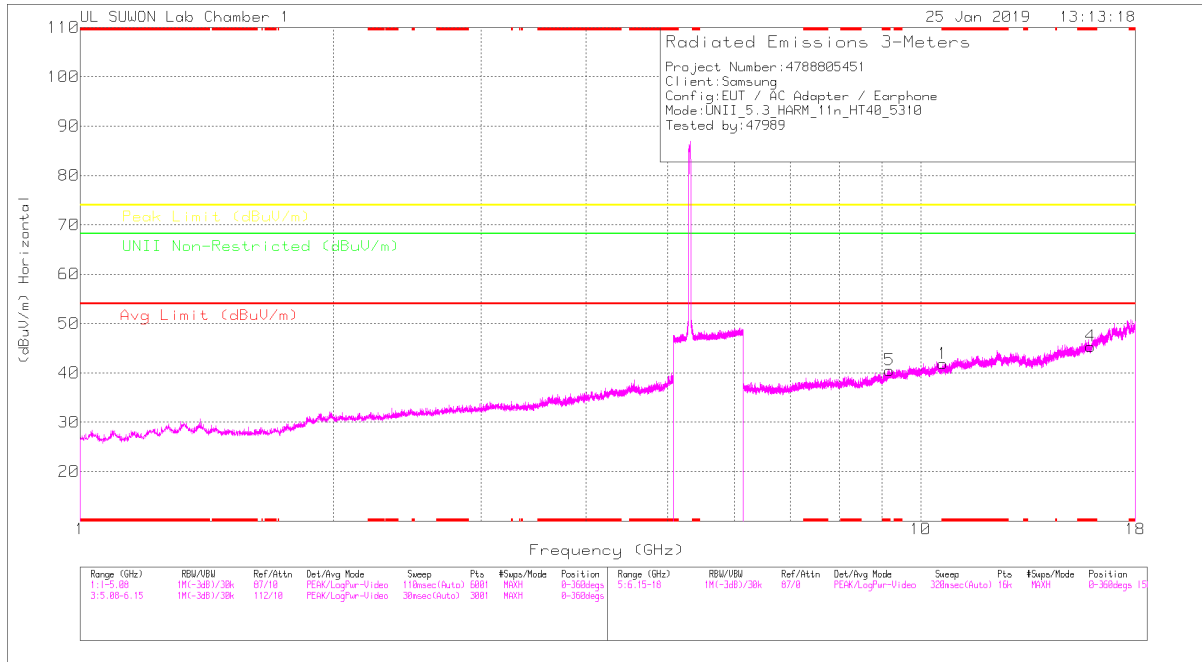

HIGH CHANNEL VERTICAL

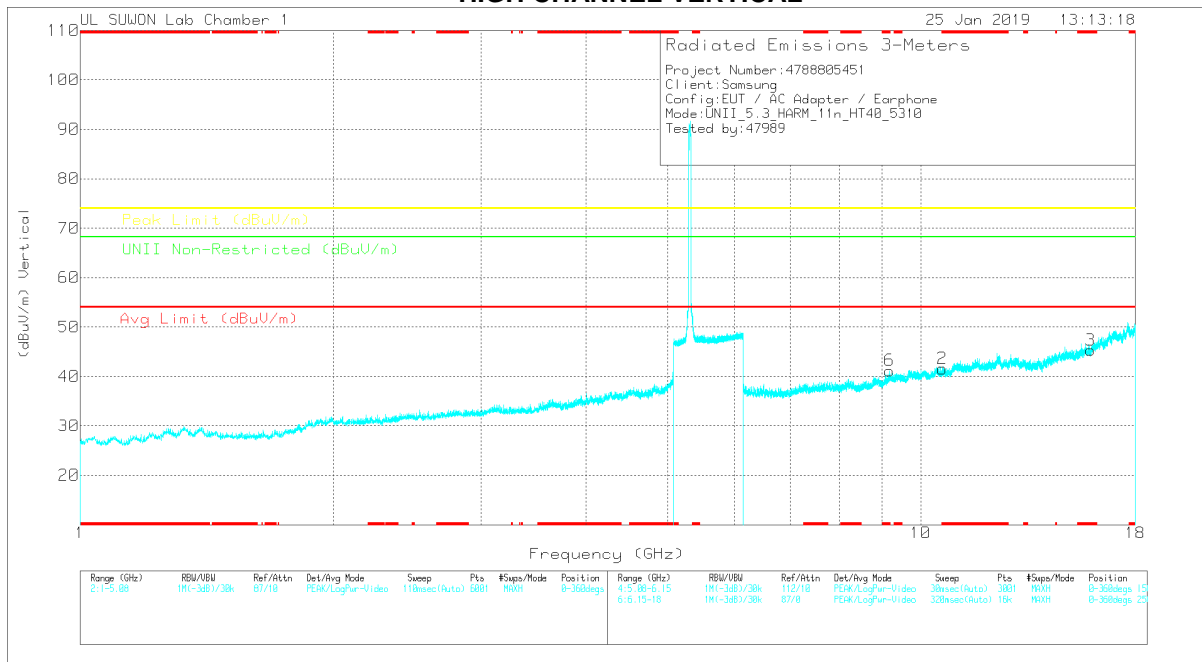

Note: Emission was scanned up to 40GHz; No emissions were detected above the noise floor which was at least 20dB below the specification limit.

HIGH CHANNEL DATA

Trace Markers

Marker	Frequency (GHz)	Marker Reading (dBuV)	Det	3117_00188717	66Hz_HF(dB)	DC Corr (dB)	Corrected Reading (dBuV/m)	Avg Limit (dBuV/m)	Margin (dB)	Peak Limit (dBuV/m)	Margin (dB)	Unli Non-Restricted (dBuV/m)	Margin (dB)	Altitude (Degs)	Height (cm)	Polarity
1	* 10.623	26.26	PK	37.8	-22.2	0	41.86	-	-	74	-32.14	-	-	0-360	150	H
4	* 15.932	25.78	PK	40.7	-21.1	0	45.38	-	-	74	-28.62	-	-	0-360	250	H
5	* 9.176	27.45	PK	36.7	-23.6	0	40.55	-	-	74	-33.45	-	-	0-360	250	H
2	* 10.615	25.99	PK	37.8	-22.2	0	41.59	-	-	74	-32.41	-	-	0-360	250	V
3	* 15.933	25.71	PK	40.7	-21.1	0	45.31	-	-	74	-28.69	-	-	0-360	250	V
6	* 9.183	28.09	PK	36.7	-23.6	0	41.19	-	-	74	-32.81	-	-	0-360	250	V

* - indicates frequency in CFR47 Pt 15 / IC RSS-Restricted Band
 PK – Peak Detector

Note: Only peak measurement was performed. Because peak measurement result of unwanted emission is less than average limit (54dBuV/m).

11.2.4.TX Above 1GHz 802.11ac VHT80 MODE IN THE 5.3GHz BAND RESTRICTED BANDEDGE (MID CHANNEL)

HORIZONTAL PEAK AND AVERAGE PLOT

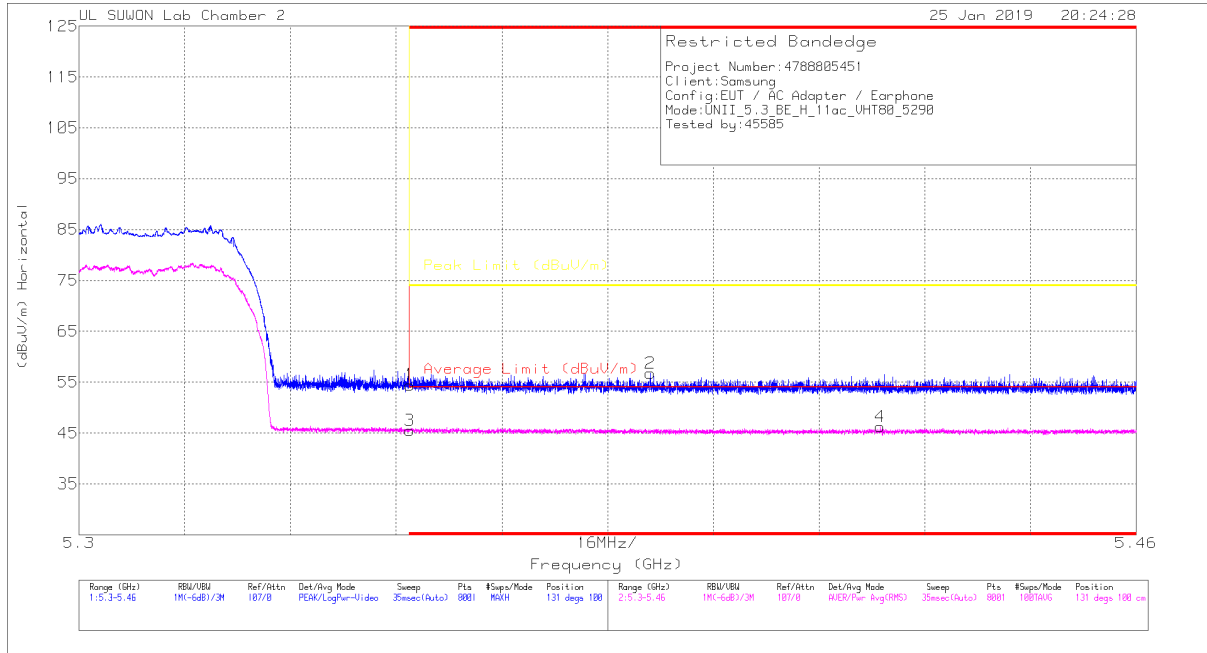

HORIZONTAL DATA

Trace Markers

Marker	Frequency (GHz)	Meter Reading (dBu/m)	Det	3117_00168724	10dB(dB)	DC Corr (dB)	Corrected Reading (dBu/m)	Average Limit (dBu/m)	Margin (dB)	Peak Limit (dBu/m)	PK Margin (dB)	Azimuth (Degs)	Height (cm)	Polarity
1	* 5.35	38.07	Pk	34.5	-18.1	0	54.47	-	-	74	-19.53	131	100	H
2	* 5.386	40.4	Pk	34.5	-18.1	0	56.8	-	-	74	-17.2	131	100	H
3	* 5.35	27.44	RMS	34.5	-17.1	.67	45.51	54	-8.49	-	-	131	100	H
4	* 5.421	28.03	RMS	34.5	-17	.67	46.2	54	-7.8	-	-	131	100	H

* - indicates frequency in CFR47 Pt 15 / IC RSS-Restricted Band

Pk - Peak detector

RMS - RMS detection

VERTICAL PEAK AND AVERAGE PLOT

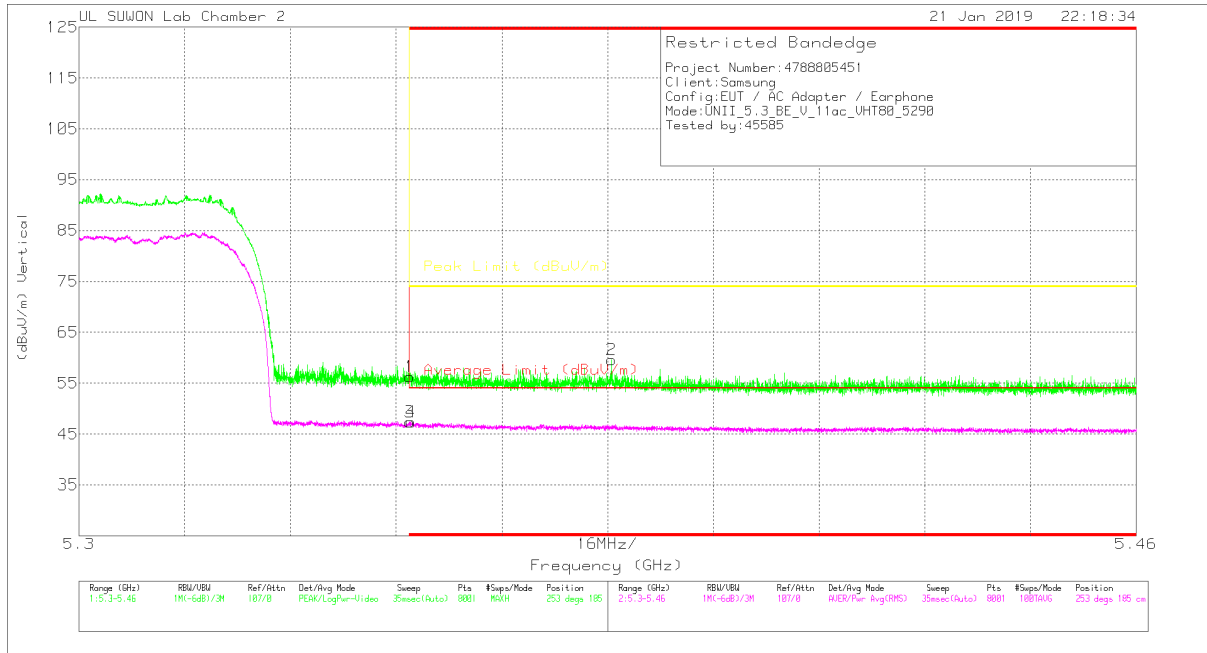

VERTICAL DATA

Trace Markers

Marker	Frequency (GHz)	Meter Reading (dBuV)	Det	3117_00168724	10dB[dB]	DC Corr (dB)	Corrected Reading (dBuV/m)	Average Limit (dBuV/m)	Margin (dB)	Peak Limit (dBuV/m)	Pk Margin (dB)	Azimuth (Degs)	Height (cm)	Polarity
1	* 5.35	39.92	Pk	34.5	-18.1	0	56.32	-	-	74	-17.68	253	185	V
2	* 5.381	43.34	Pk	34.5	-18.2	0	59.64	-	-	74	-14.36	253	185	V
3	* 5.35	29.26	RMS	34.5	-17.1	.67	47.33	54	-6.67	-	-	253	185	V
4	* 5.35	29.29	RMS	34.5	-17.1	.67	47.36	54	-6.64	-	-	253	185	V

* - indicates frequency in CFR47 Pt 15 / IC RSS-Restricted Band

Pk - Peak detector

RMS - RMS detection

HARMONICS AND SPURIOUS EMISSIONS

MID CHANNEL HORIZONTAL

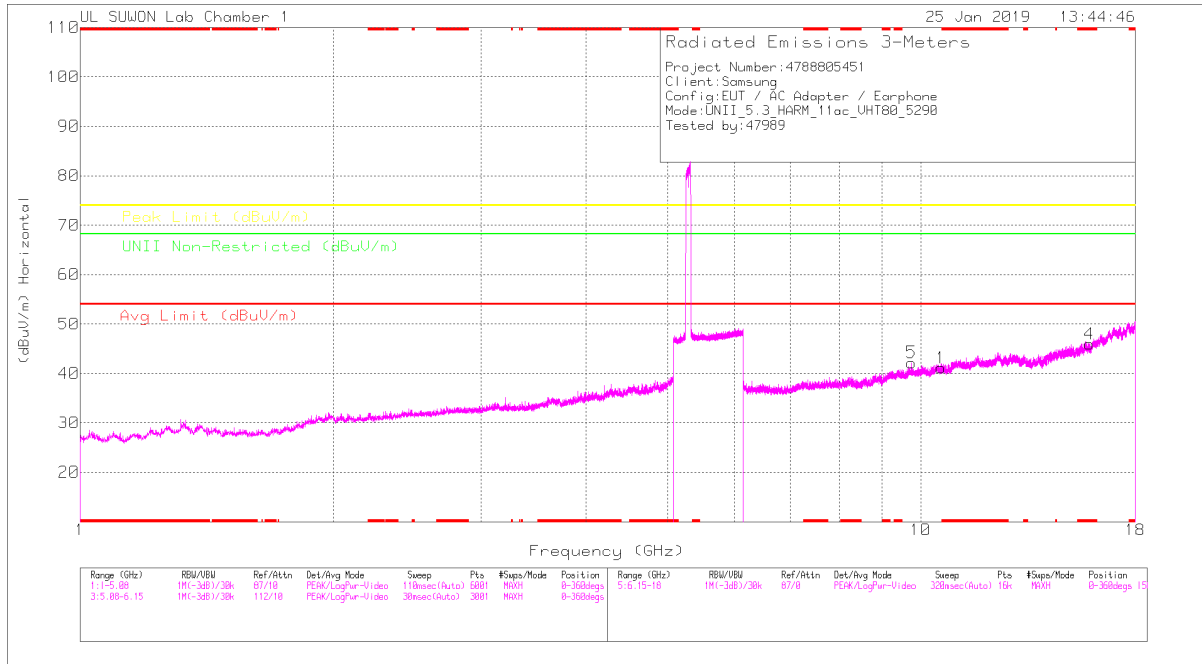

MID CHANNEL VERTICAL

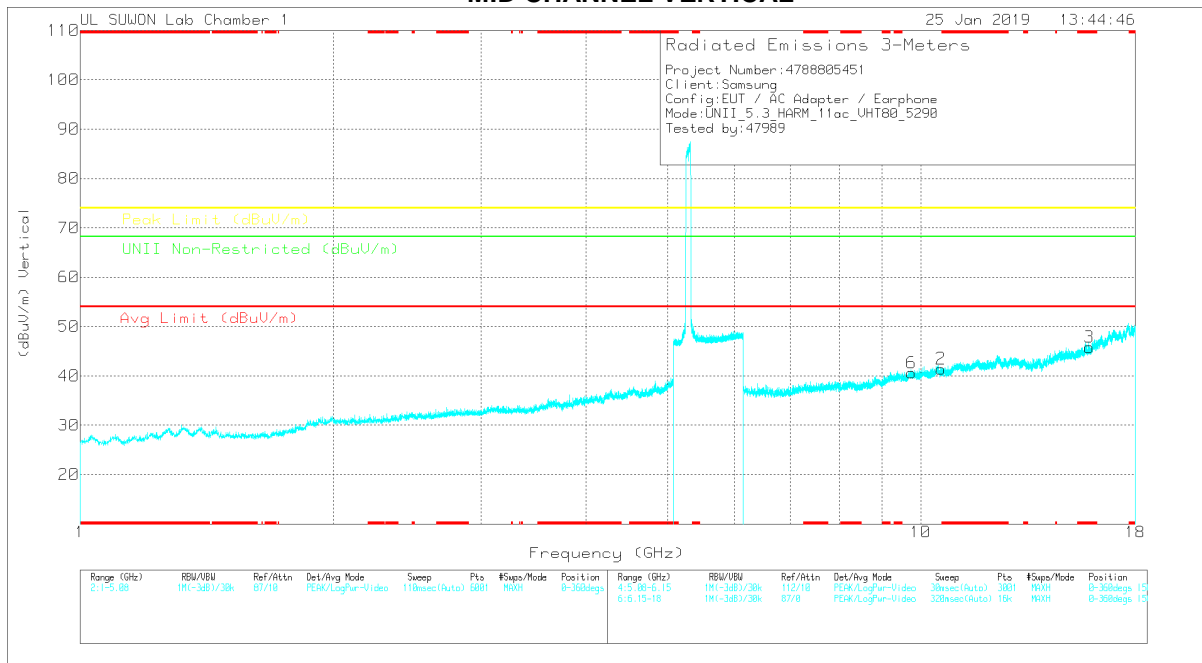

Note: Emission was scanned up to 40GHz; No emissions were detected above the noise floor which was at least 20dB below the specification limit.

MID CHANNEL DATA

Trace Markers

Marker	Frequency (GHz)	Marker Reading (dBuV)	Det	3117_00168717	60Hz_HR(dB)	DC Corr (dB)	Corrected Reading (dBuV/m)	Avg Limit (dBuV/m)	Margin (dB)	Peak Limit (dBuV/m)	Margin (dB)	Limit Non-Restricted (dBuV/m)	Margin (dB)	Altitude (Degs)	Height (cm)	Polarity
1	10.576	26.01	PK	37.8	-22.7	0	41.11	-	-	-	-	68.2	-27.09	0-360	150	H
4	* 15.869	26.33	PK	40.6	-21	0	45.93	-	-	74	-28.07	-	-	0-360	250	H
5	9.753	27.89	PK	37.2	-22.9	0	42.19	-	-	-	-	68.2	-26.01	0-360	150	H
2	10.577	26.31	PK	37.8	-22.7	0	41.41	-	-	-	-	68.2	-26.79	0-360	150	V
3	* 15.869	26.18	PK	40.6	-21	0	45.78	-	-	74	-28.22	-	-	0-360	250	V
6	9.749	26.28	PK	37.2	-22.9	0	40.58	-	-	-	-	68.2	-27.62	0-360	250	V

* - indicates frequency in CFR47 Pt 15 / IC RSS-Restricted Band
 PK – Peak Detector

Note: Only peak measurement was performed. Because peak measurement result of unwanted emission is less than average limit (54dBuV/m).

11.3. 5.5-5.6 GHz

11.3.1. TX ABOVE 1 GHz 802.11a MODE IN THE 5.5 GHz BAND

RESTRICTED BANDEDGE (LOW CHANNEL)

HORIZONTAL PEAK AND AVERAGE PLOT

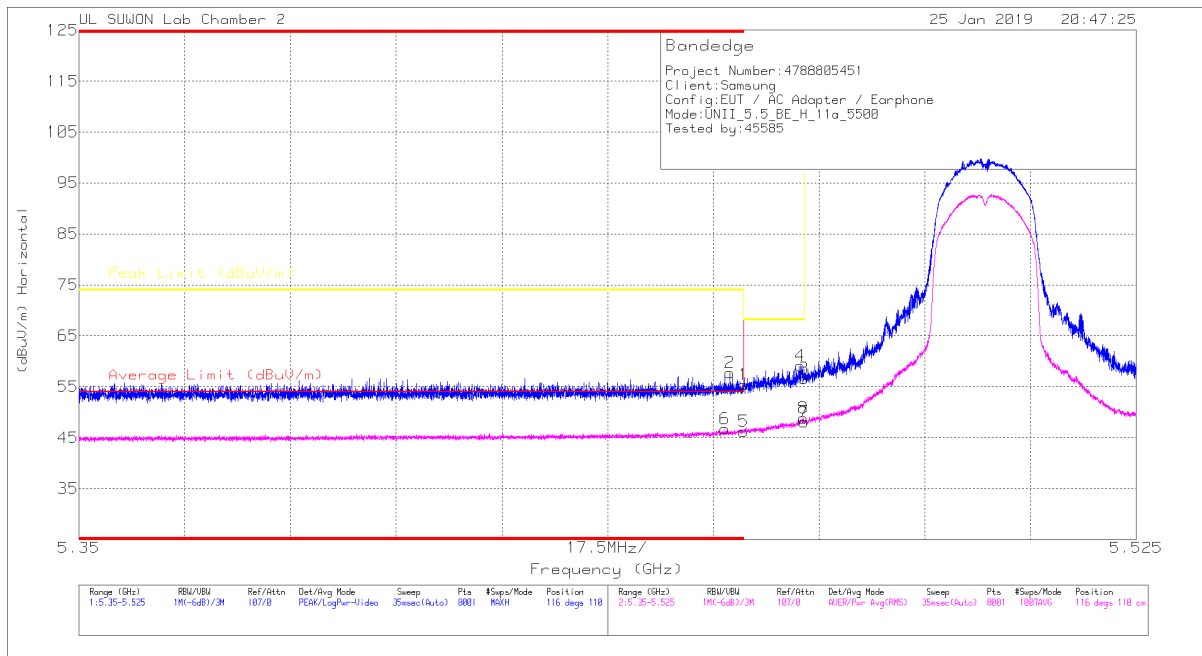

HORIZONTAL DATA

Trace Markers

Marker	Frequency (GHz)	Meter Reading (dBuV)	Det	3117_00168724	10dB(dB)	DC Corr (dB)	Corrected Reading (dBuV/m)	Average Limit (dBuV/m)	Margin (dB)	Peak Limit (dBuV/m)	PK Margin (dB)	Azimuth (Degs)	Height (cm)	Polarity
1	* 5.46	38.99	Pk		-18.2	0	55.39	-	-	74	-18.61	116	110	H
2	* 5.458	41.38	Pk		-18.2	0	57.78	-	-	74	-16.22	116	110	H
3	5.47	40.13	Pk		-18.1	0	56.63	-	-	68.2	-11.57	116	110	H
4	5.469	42.58	Pk		-18.1	0	59.08	-	-	68.2	-9.12	116	110	H
5	* 5.46	28.44	RMS		-16.9	.1	46.24	54	-7.76	-	-	116	110	H
6	* 5.457	28.9	RMS		-16.9	.1	46.7	54	-7.3	-	-	116	110	H
7	5.47	30.29	RMS		-16.9	.1	48.09	-	-	-	-	116	110	H
8	5.47	31.01	RMS		-16.9	.1	48.81	-	-	-	-	116	110	H

* - indicates frequency in CFR47 Pt 15 / IC RSS-Restricted Band

Pk - Peak detector

RMS - RMS detection

VERTICAL PEAK AND AVERAGE PLOT

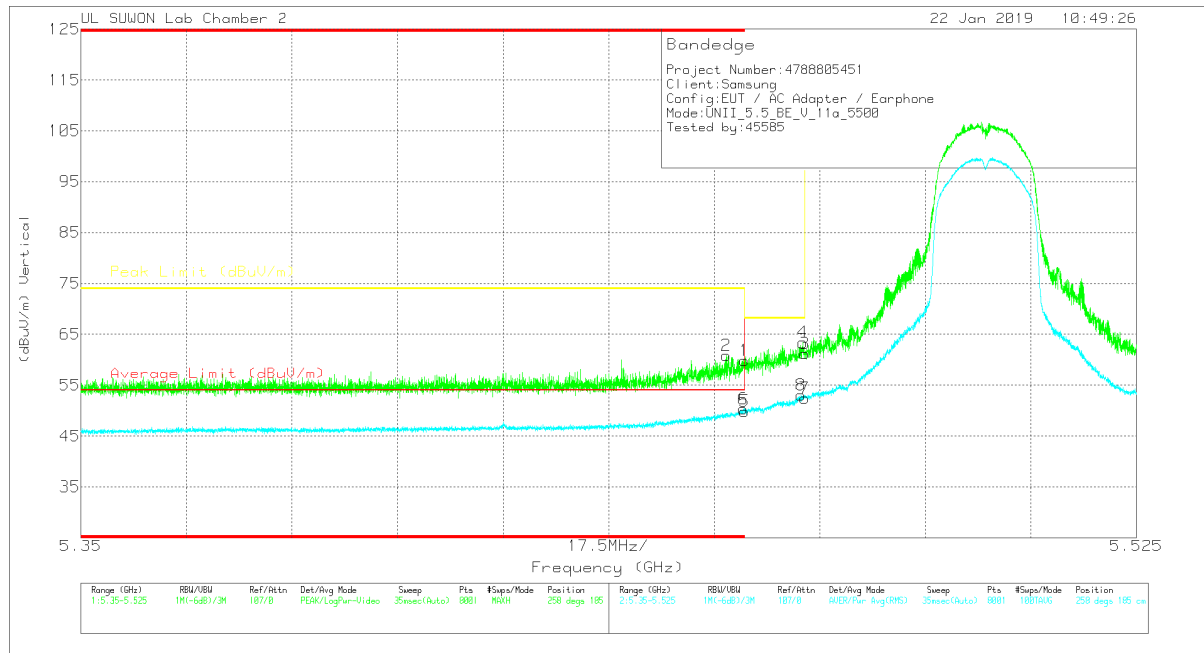

VERTICAL DATA

Trace Markers

Marker	Frequency (GHz)	Meter Reading (dBuV)	Det	3117_00168724	10dB[dB]	DC Corr (dB)	Corrected Reading (dBuV/m)	Average Limit (dBuV/m)	Margin (dB)	Peak Limit (dBuV/m)	PK Margin (dB)	Altitude (Degs)	Height (cm)	Polarity
1	* 5.46	43.49	Pk	34.6	-18.2	0	59.89	-	-	74	-14.11	258	185	V
2	* 5.457	44.42	Pk	34.6	-18.2	0	60.82	-	-	74	-13.18	258	185	V
3	5.47	44.72	Pk	34.6	-18.1	0	61.22	-	-	68.2	-6.98	258	185	V
4	5.47	46.88	Pk	34.6	-18.1	0	63.38	-	-	68.2	-4.82	258	185	V
5	* 5.46	32.09	RMS	34.6	-16.9	.1	49.89	54	-4.11	-	-	258	185	V
6	* 5.46	32.48	RMS	34.6	-16.9	.1	50.28	54	-3.72	-	-	258	185	V
7	5.47	34.64	RMS	34.6	-16.9	.1	52.44	-	-	-	-	258	185	V
8	5.469	35.3	RMS	34.6	-16.9	.1	53.1	-	-	-	-	258	185	V

* - indicates frequency in CFR47 Pt 15 / IC RSS-Restricted Band

Pk - Peak detector

RMS - RMS detection

AUTHORIZED BANDEDGE (HIGH CHANNEL)

HORIZONTAL PEAK AND AVERAGE PLOT

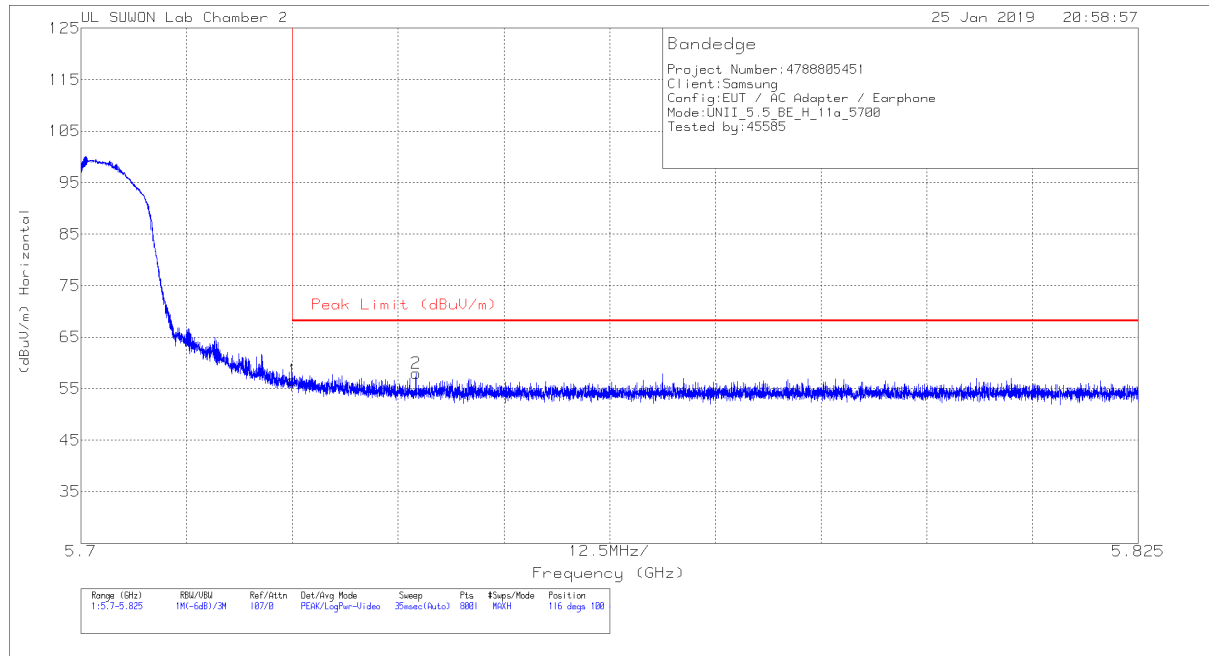

HORIZONTAL DATA

Trace Markers

Marker	Frequency (GHz)	Meter Reading (dBuV)	Det	3117_00168724	10dB[dB]	DC Corr (dB)	Corrected Reading (dBuV/m)	Peak Limit (dBuV/m)	PK Margin (dB)	Azimuth (Degs)	Height (cm)	Polarity
1	5.725	39.53	Pk	34.7	-17.6	0	56.63	68.2	-11.57	116	100	H
2	5.74	40.93	Pk	34.7	-17.6	0	58.03	68.2	-10.17	116	100	H

Pk - Peak detector

VERTICAL PEAK AND AVERAGE PLOT

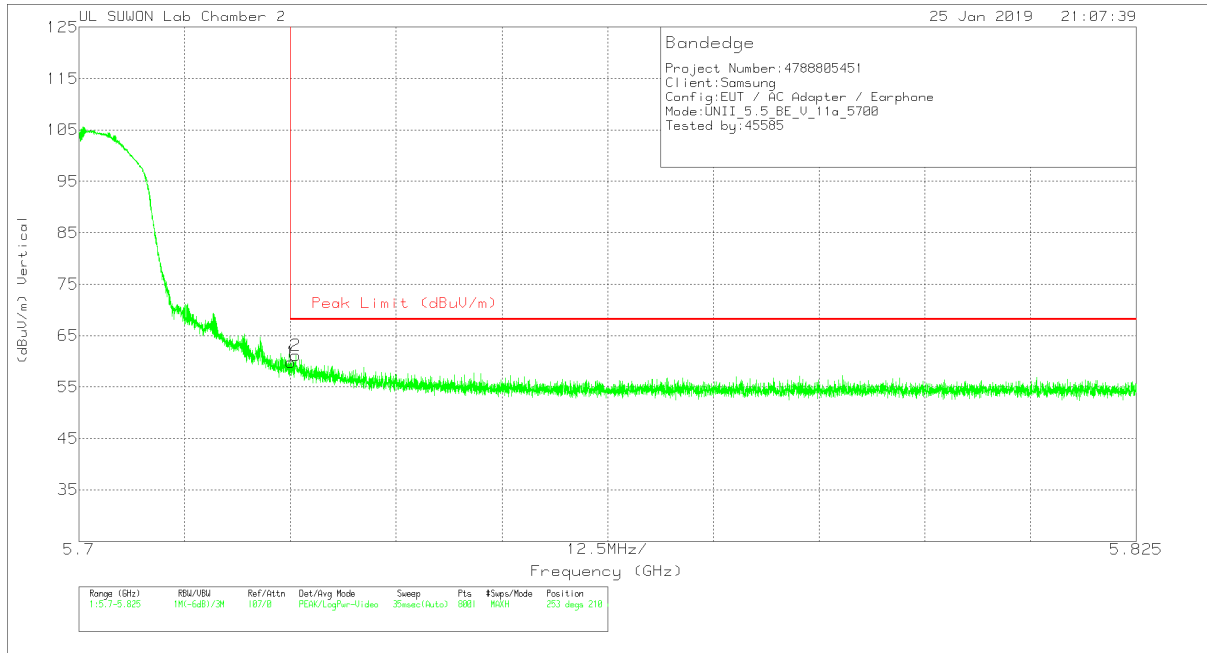

VERTICAL DATA

Trace Markers

Marker	Frequency (GHz)	Meter Reading (dBuV)	Det	3117_00168724	10dB[dB]	DC Corr (dB)	Corrected Reading (dBuV/m)	Peak Limit (dBuV/m)	PK Margin (dB)	Azimuth (Degs)	Height (cm)	Polarity
1	5.725	42.7	Pk	34.7	-17.6	0	59.8	68.2	-8.4	253	210	V
2	5.726	44	Pk	34.7	-17.5	0	61.2	68.2	-7	253	210	V

Pk - Peak detector

HARMONICS AND SPURIOUS EMISSIONS

LOW CHANNEL HORIZONTAL

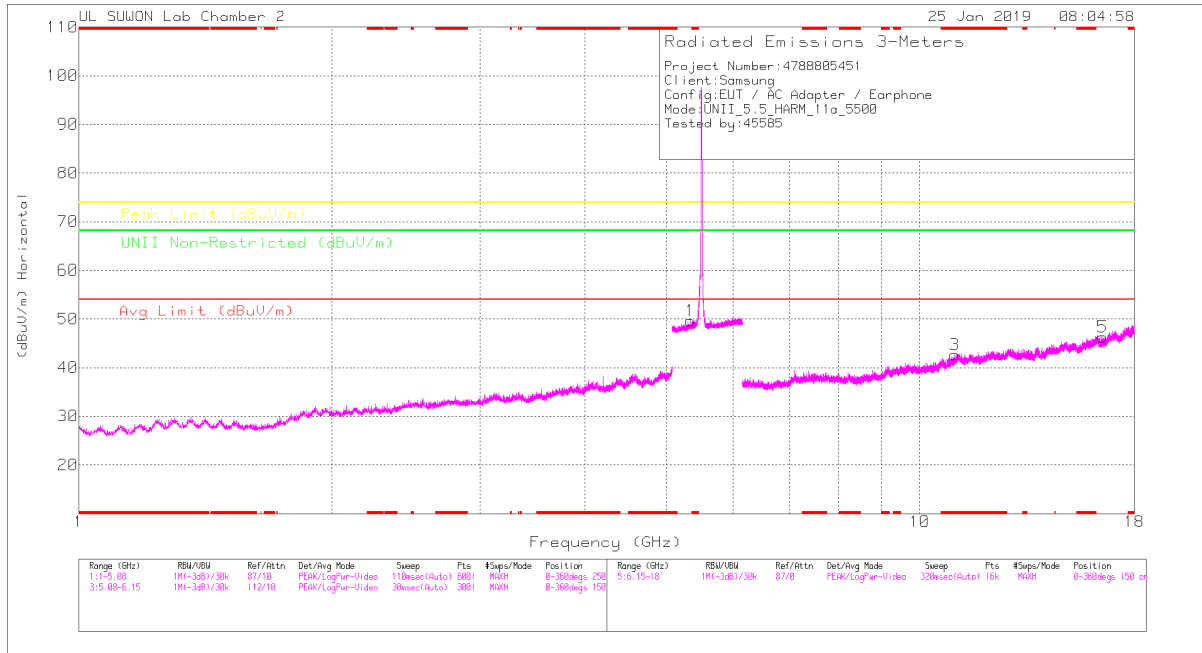

LOW CHANNEL VERTICAL

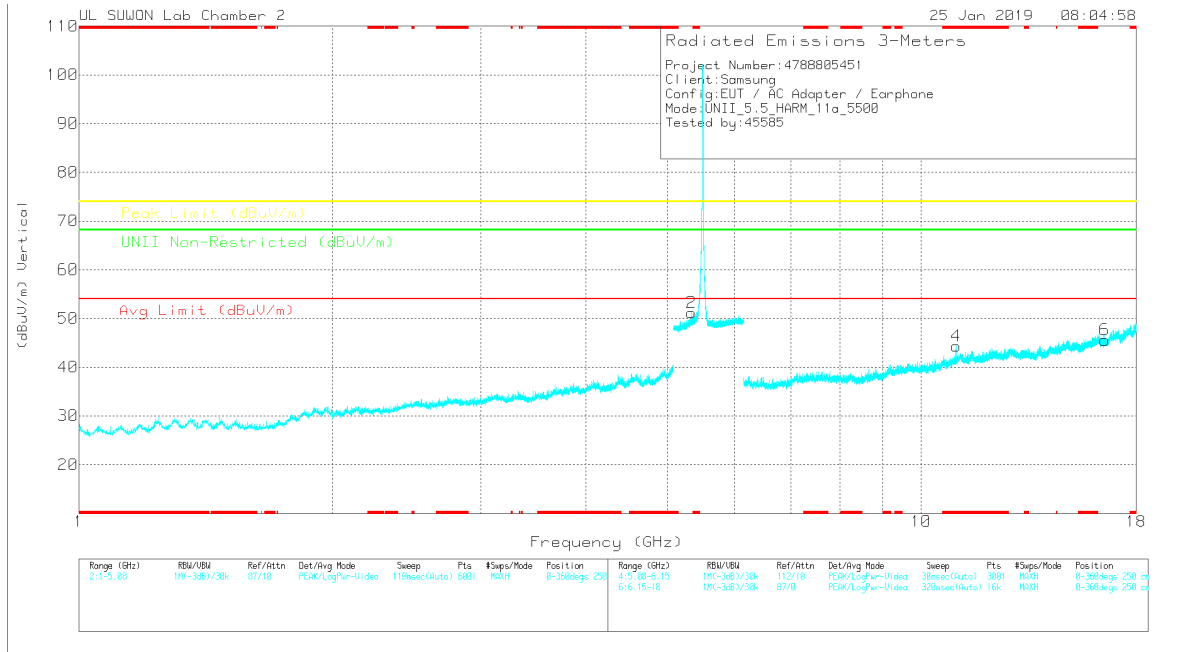

Note: Emission was scanned up to 40GHz; No emissions were detected above the noise floor which was at least 20dB below the specification limit.

LOW CHANNEL DATA

Trace Markers

Marker	Frequency (GHz)	Meter Reading (dBuV)	Det	3117_00168724	100dB(dB)	DC Corr (dB)	Corrected Reading (dBuV/m)	Avg Limit (dBuV/m)	Margin (dB)	Peak Limit (dBuV/m)	Margin (dB)	UNI Non-Restricted (dBuV/m)	Margin (dB)	Azimuth (Degs)	Height (cm)	Polarity
1	5.34	33.18	PK	34.5	-18	0	49.68	-	-	-	-	68.2	-18.52	0-360	150	H
2	5.34	34.68	PK	34.5	-18	0	51.18	-	-	-	-	68.2	-17.02	0-360	250	V
3	* 11.001	25.1	PK	38.1	-20.5	0	42.7	-	-	74	-31.3	-	-	0-360	150	H
5	16.499	25.7	PK	40.5	-19.9	0	46.3	-	-	-	-	68.2	-21.9	0-360	250	H
4	* 11	26.89	PK	38.1	-20.6	0	44.39	-	-	74	-29.61	-	-	0-360	150	V
6	16.502	24.87	PK	40.5	-19.8	0	45.57	-	-	-	-	68.2	-22.63	0-360	250	V

* - indicates frequency in CFR47 Pt 15 / IC RSS-Restricted Band
 PK – Peak Detector

Radiated Emissions

Frequency (GHz)	Meter Reading (dBuV)	Det	3117_00168724	100dB(dB)	DC Corr (dB)	Corrected Reading (dBuV/m)	Avg Limit (dBuV/m)	Margin (dB)	Peak Limit (dBuV/m)	Margin (dB)	UNI Non-Restricted (dBuV/m)	Margin (dB)	Azimuth (Degs)	Height (cm)	Polarity
5.339	44.32	PK-U	34.5	-18.1	0	60.72	-	-	-	-	68.2	-7.48	216	100	H
5.34	45.86	PK-U	34.5	-18	0	62.36	-	-	-	-	68.2	-5.84	253	211	V
* 11	26.26	ADR	38.1	-20.6	.1	43.86	54	-10.14	-	-	-	-	264	194	V
* 11	24.99	ADR	38.1	-20.6	.1	42.59	54	-11.41	-	-	-	-	158	174	H
* 11.004	37.62	PK-U	38.1	-20.5	0	55.22	-	-	74	-18.78	-	-	264	194	V
* 11	37.16	PK-U	38.1	-20.6	0	54.66	-	-	74	-19.34	-	-	158	174	H

* - indicates frequency in CFR47 Pt 15 / IC RSS-Restricted Band
 PK-U - U-NII: Maximum Peak
 ADR - U-NII AD primary method, RMS average

MID CHANNEL HORIZONTAL

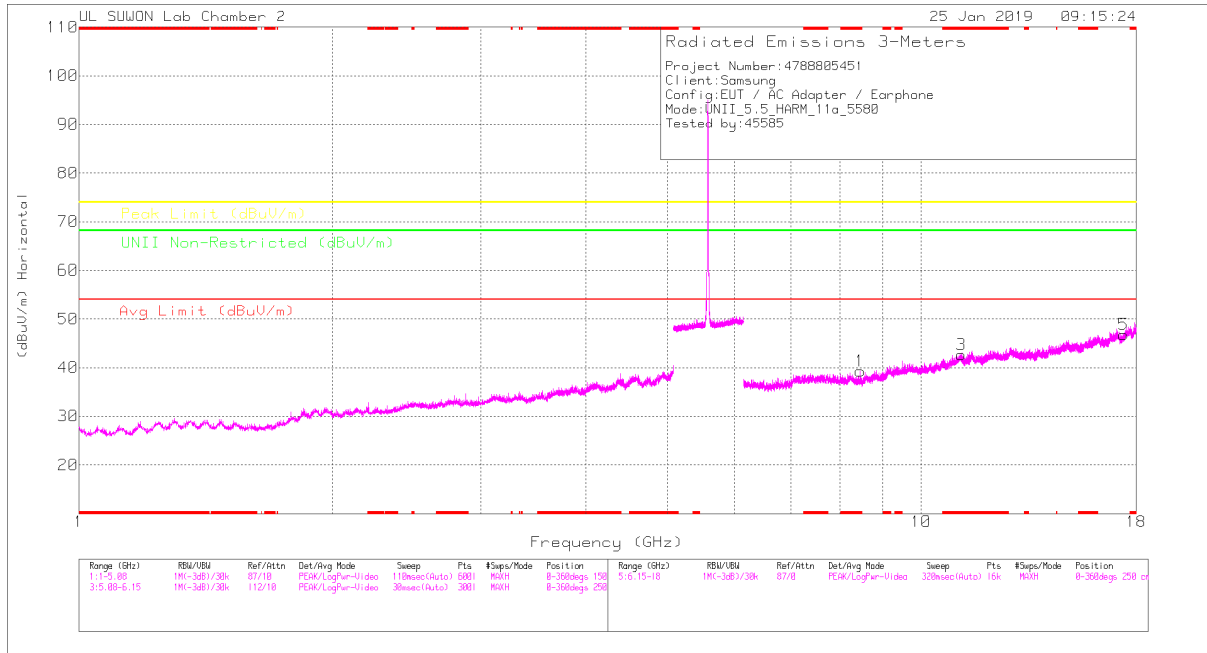

MID CHANNEL VERTICAL

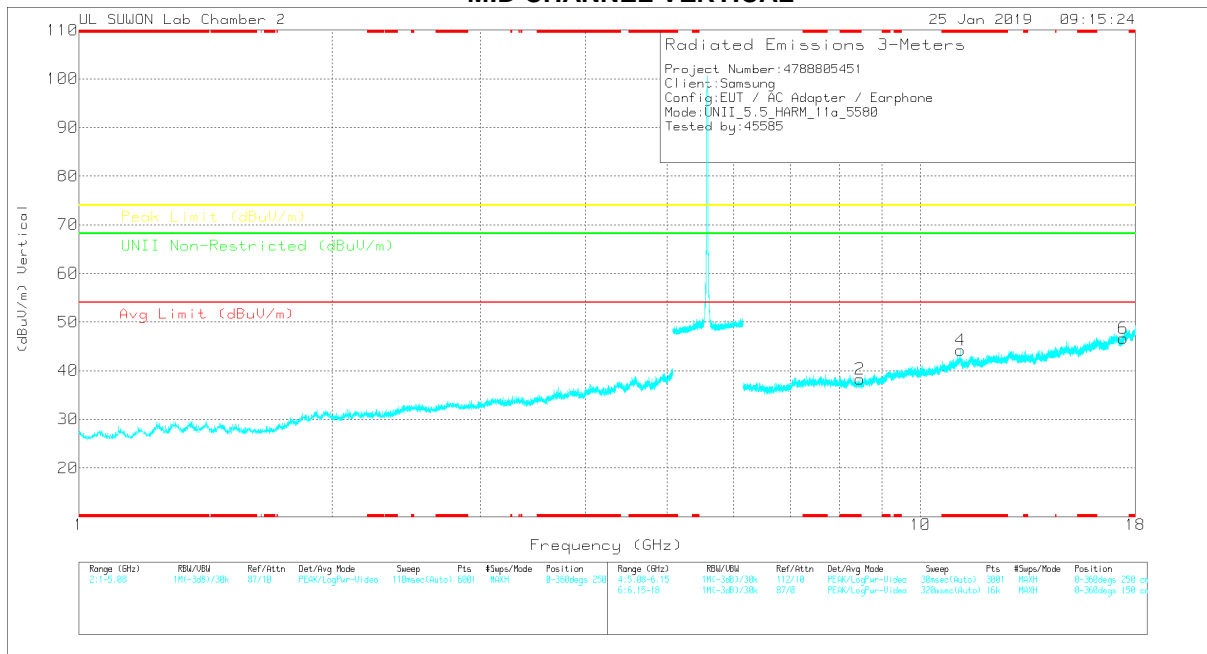

Note: Emission was scanned up to 40GHz; No emissions were detected above the noise floor which was at least 20dB below the specification limit.

MID CHANNEL DATA

Trace Markers

Marker	Frequency (GHz)	Meter Reading (dBuV)	Det	3117_00168724	6GHz_HF(dB)	DC Corr (dB)	Corrected Reading (dBuV/m)	Avg Limit (dBuV/m)	Margin (dB)	Peak Limit (dBuV/m)	Margin (dB)	U-NII Non-Restricted (dBuV/m)	Margin (dB)	Azimuth (Degs)	Height (cm)	Polarity
1	* 8.467	26.44	PK	36.1	-23.3	0	39.24	-	-	74	-34.76	-	-	0-360	250	H
3	* 11.16	24.05	PK	38.2	-19.6	0	42.65	-	-	74	-31.35	-	-	0-360	250	H
5	17.4	24.13	PK	41.4	-18.7	0	46.83	-	-	-	-	68.2	-21.37	0-360	250	H
2	* 8.472	25.55	PK	36.1	-23.4	0	38.25	-	-	74	-35.75	-	-	0-360	150	V
4	* 11.157	25.62	PK	38.2	-19.6	0	44.22	-	-	74	-29.78	-	-	0-360	150	V
6	17.405	23.93	PK	41.4	-18.7	0	46.63	-	-	-	-	68.2	-21.57	0-360	250	V

* - indicates frequency in CFR47 Pt 15 / IC RSS-Restricted Band
 PK – Peak detector

Radiated Emissions

Frequency (GHz)	Meter Reading (dBuV)	Det	3117_00168724	6GHz_HF(dB)	DC Corr (dB)	Corrected Reading (dBuV/m)	Avg Limit (dBuV/m)	Margin (dB)	Peak Limit (dBuV/m)	Margin (dB)	U-NII Non-Restricted (dBuV/m)	Margin (dB)	Azimuth (Degs)	Height (cm)	Polarity
* 11.16	36.41	PK-U	38.2	-19.6	0	55.01	-	-	74	-18.99	-	-	157	173	H
* 11.16	24.01	ADR	38.2	-19.6	.1	42.71	54	-11.29	-	-	-	-	157	173	H
* 11.165	36.8	PK-U	38.2	-19.6	0	55.4	-	-	74	-18.6	-	-	262	170	V
* 11.16	24.97	ADR	38.2	-19.6	.1	43.67	54	-10.33	-	-	-	-	262	170	V

* - indicates frequency in CFR47 Pt 15 / IC RSS-Restricted Band
 PK-U - U-NII: Maximum Peak
 ADR - U-NII AD primary method, RMS average

HIGH CHANNEL HORIZONTAL

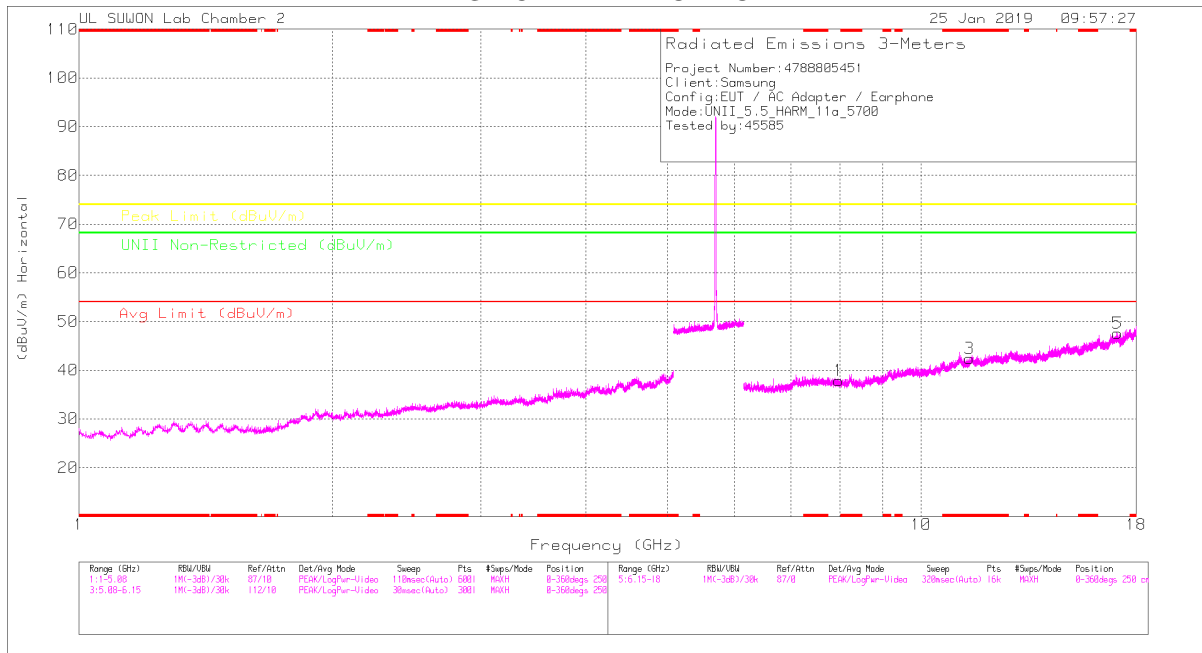

HIGH CHANNEL VERTICAL

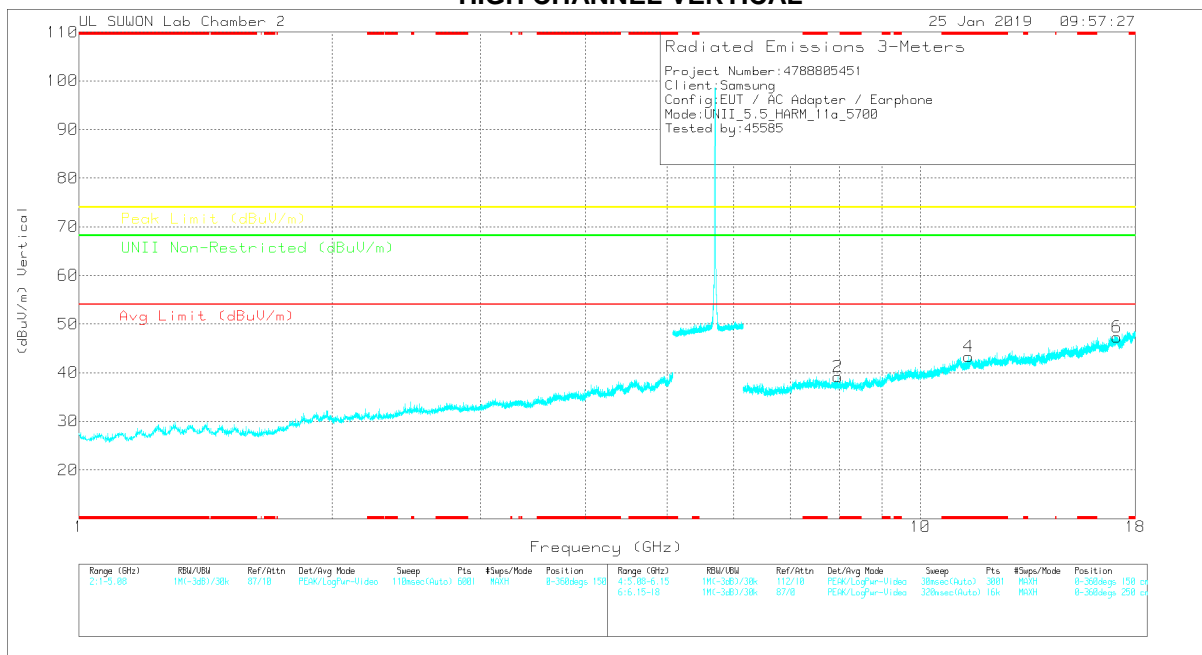

Note: Emission was scanned up to 40GHz; No emissions were detected above the noise floor which was at least 20dB below the specification limit.

HIGH CHANNEL DATA

Trace Markers

Marker	Frequency (GHz)	Major Reading (dBuV)	Det	3117_00168724	66Hz_HR(dB)	DC Corr (dB)	Corrected Reading (dBuV/m)	Avg Limit (dBuV/m)	Margin (dB)	Peak Limit (dBuV/m)	Margin (dB)	Limit Non-Restricted (dBuV/m)	Margin (dB)	Altitude (Degs)	Height (cm)	Polarity
1	7.976	25.89	PK	35.9	-23.9	0	37.89	-	-	-	-	68.2	-30.31	0-360	150	H
3	*11.402	24.34	PK	38.3	-20.2	0	42.44	-	-	74	-31.56	-	-	0-360	250	H
5	17.105	24.96	PK	41.3	-18.7	0	47.56	-	-	-	-	68.2	-20.64	0-360	250	H
2	7.979	27.21	PK	35.9	-23.9	0	39.21	-	-	-	-	68.2	-28.99	0-360	250	V
4	*11.404	25.17	PK	38.3	-20.2	0	43.27	-	-	74	-30.73	-	-	0-360	250	V
6	17.108	24.68	PK	41.3	-18.7	0	47.28	-	-	-	-	68.2	-20.92	0-360	150	V

* - indicates frequency in CFR47 Pt 15 / IC RSS-Restricted Band
 PK – Peak Detector

Note: Only peak measurement was performed. Because peak measurement result of unwanted emission is less than average limit (54dBuV/m).

11.3.2.TX ABOVE 1GHz 802.11n HT20 MODE IN THE 5.5GHz BAND RESTRICTED BANDEDGE (LOW CHANNEL)

HORIZONTAL PEAK AND AVERAGE PLOT

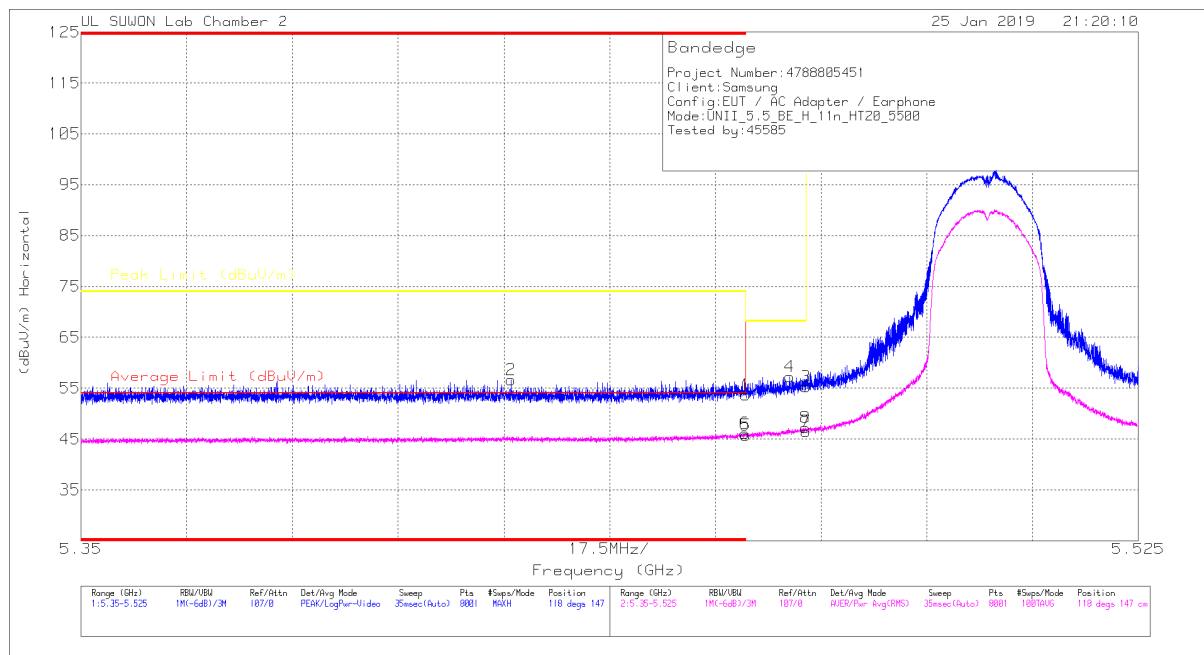

HORIZONTAL DATA

Trace Markers

Marker	Frequency (GHz)	Meter Reading (dBuV)	Det	3117_00168724	10dB(dB)	DC Corr (dB)	Corrected Reading (dBuV/m)	Average Limit (dBuV/m)	Margin (dB)	Peak Limit (dBuV/m)	PK Margin (dB)	Azimuth (Degs)	Height (cm)	Polarity
1	* 5.46	37.31	Pk	34.6	-18.2	0	53.71	-	-	74	-20.29	118	147	H
2	* 5.421	40.35	Pk	34.5	-18.2	0	56.65	-	-	74	-17.35	118	147	H
3	5.47	38.81	Pk	34.6	-18.1	0	55.31	-	-	68.2	-12.89	118	147	H
4	5.467	40.8	Pk	34.6	-18.2	0	57.2	-	-	68.2	-11	118	147	H
5	* 5.46	27.99	RMS	34.6	-16.9	.1	45.79	54	-8.21	-	-	118	147	H
6	* 5.46	28.36	RMS	34.6	-16.9	.1	46.16	54	-7.84	-	-	118	147	H
7	5.47	28.64	RMS	34.6	-16.9	.1	46.44	-	-	-	-	118	147	H
8	5.47	29.4	RMS	34.6	-16.9	.1	47.2	-	-	-	-	118	147	H

* - indicates frequency in CFR47 Pt 15 / IC RSS-Restricted Band

Pk - Peak detector

RMS - RMS detection

VERTICAL PEAK AND AVERAGE PLOT

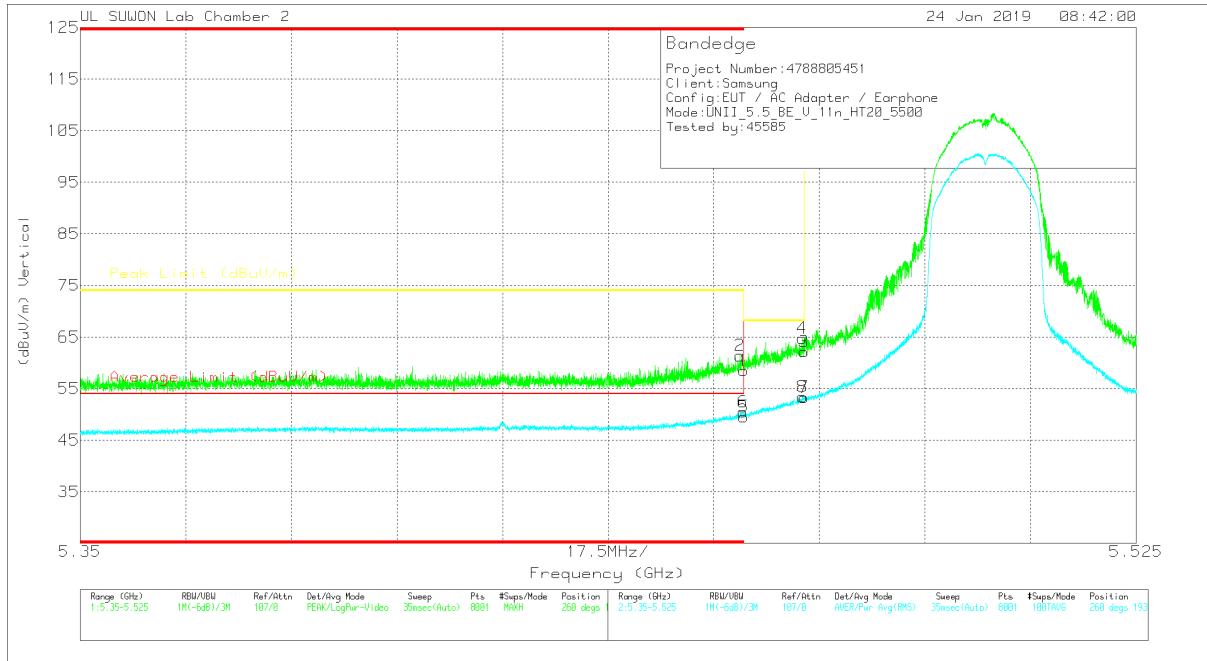

VERTICAL DATA

Trace Markers

Marker	Frequency (GHz)	Meter Reading (dBuV)	Det	3117_00168724	10dB(dB)	DC Corr (dB)	Corrected Reading (dBuV/m)	Average Limit (dBuV/m)	Margin (dB)	Peak Limit (dBuV/m)	PK Margin (dB)	Aimuth (Degs)	Height (cm)	Polarity
1	* 5.46	42.12	Pk	34.6	-18.2	0	58.52	-	-	74	-15.48	260	193	V
2	* 5.459	44.99	Pk	34.6	-18.2	0	61.39	-	-	74	-12.61	260	193	V
3	5.47	45.64	Pk	34.6	-18.1	0	62.14	-	-	68.2	-6.06	260	193	V
4	5.47	48.24	Pk	34.6	-18.1	0	64.74	-	-	68.2	-3.46	260	193	V
5	* 5.46	31.73	RMS	34.6	-16.9	.11	49.54	54	-4.46	-	-	260	193	V
6	* 5.46	32.64	RMS	34.6	-16.9	.11	50.45	54	-3.55	-	-	260	193	V
7	5.47	35.51	RMS	34.6	-16.9	.11	53.32	-	-	-	-	260	193	V
8	5.47	35.57	RMS	34.6	-16.9	.11	53.38	-	-	-	-	260	193	V

* - indicates frequency in CFR47 Pt 15 / IC RSS-Restricted Band

Pk - Peak detector

RMS - RMS detection

AUTHORIZED BANDEDGE (HIGH CHANNEL)

HORIZONTAL PEAK AND AVERAGE PLOT

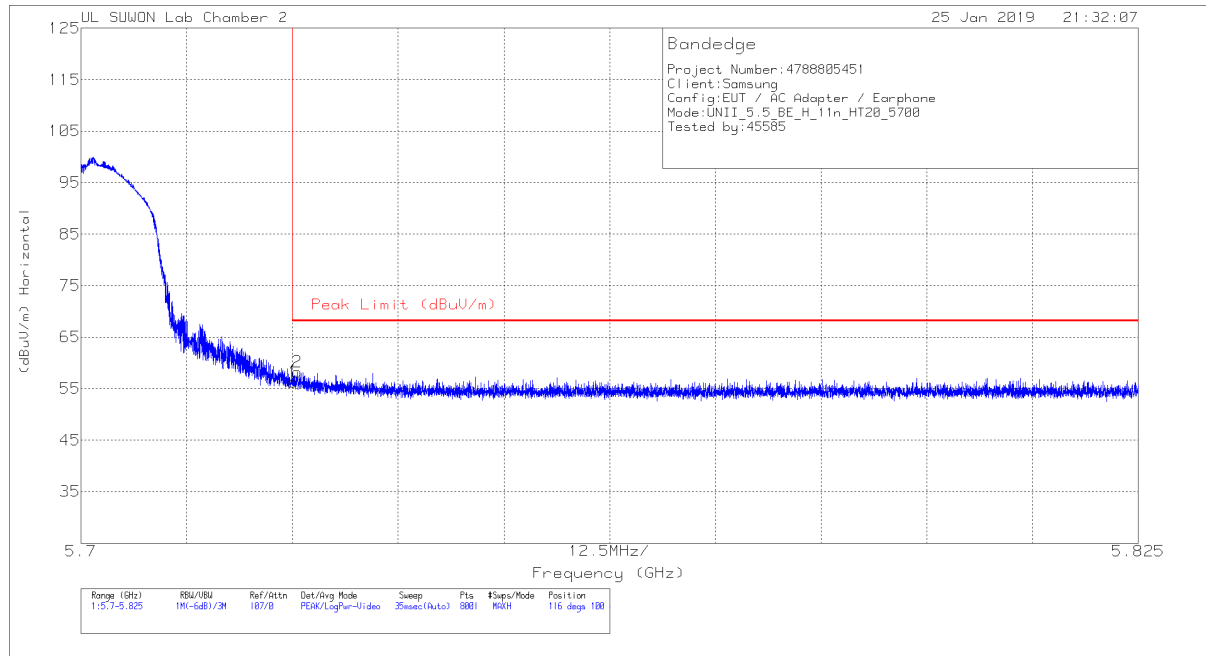

HORIZONTAL DATA

Trace Markers

Marker	Frequency (GHz)	Meter Reading (dBuV)	Det	3117_00168724	10dB[dB]	DC Corr (dB)	Corrected Reading (dBuV/m)	Peak Limit (dBuV/m)	PK Margin (dB)	Azimuth (Degs)	Height (cm)	Polarity
1	5.725	39.15	Pk	34.7	-17.6	0	56.25	68.2	-11.95	116	100	H
2	5.726	40.99	Pk	34.7	-17.5	0	58.19	68.2	-10.01	116	100	H

Pk - Peak detector

VERTICAL PEAK AND AVERAGE PLOT

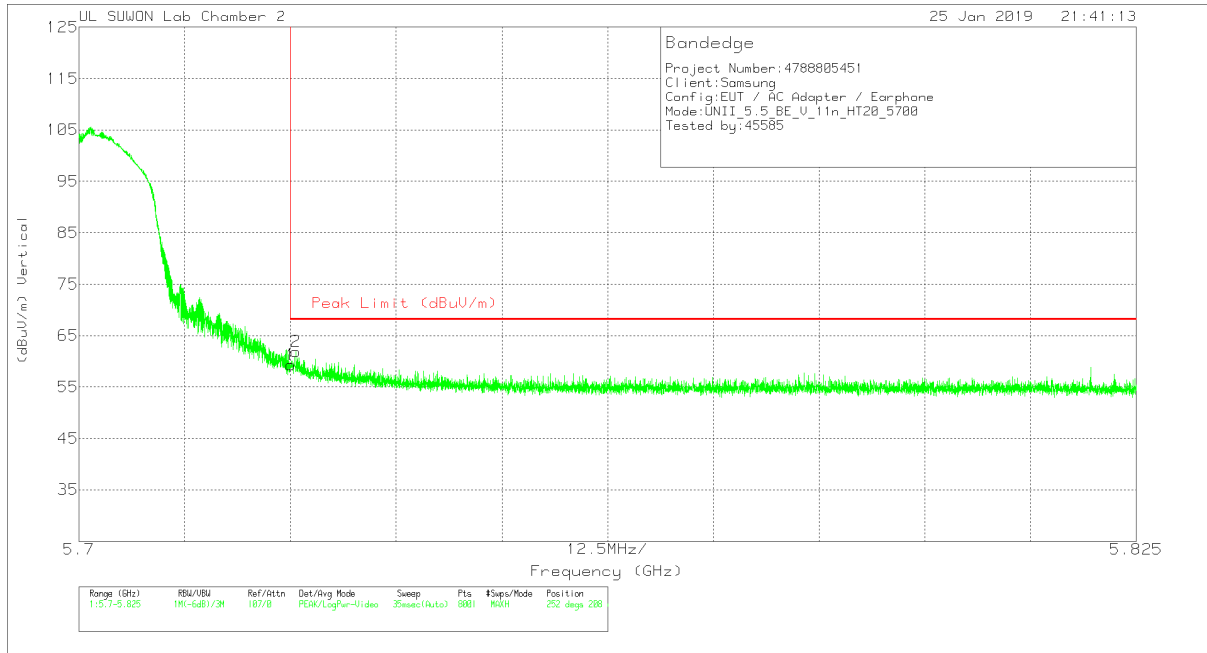

VERTICAL DATA

Trace Markers

Marker	Frequency (GHz)	Meter Reading (dBuV)	Det	3117_00168724	10dB[dB]	DC Corr (dB)	Corrected Reading (dBuV/m)	Peak Limit (dBuV/m)	PK Margin (dB)	Azimuth (Degs)	Height (cm)	Polarity
1	5.725	42.18	Pk	34.7	-17.6	0	59.28	68.2	-8.92	252	208	V
2	5.726	44.7	Pk	34.7	-17.5	0	61.9	68.2	-6.3	252	208	V

Pk - Peak detector

HARMONICS AND SPURIOUS EMISSIONS

LOW CHANNEL HORIZONTAL

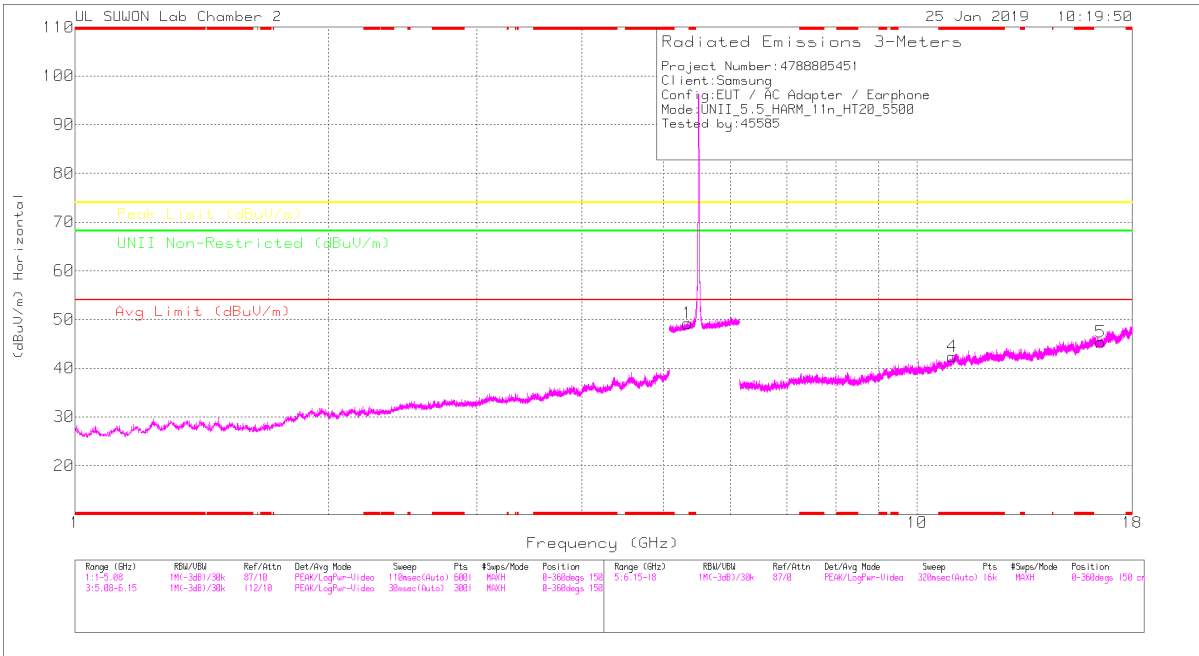

LOW CHANNEL VERTICAL

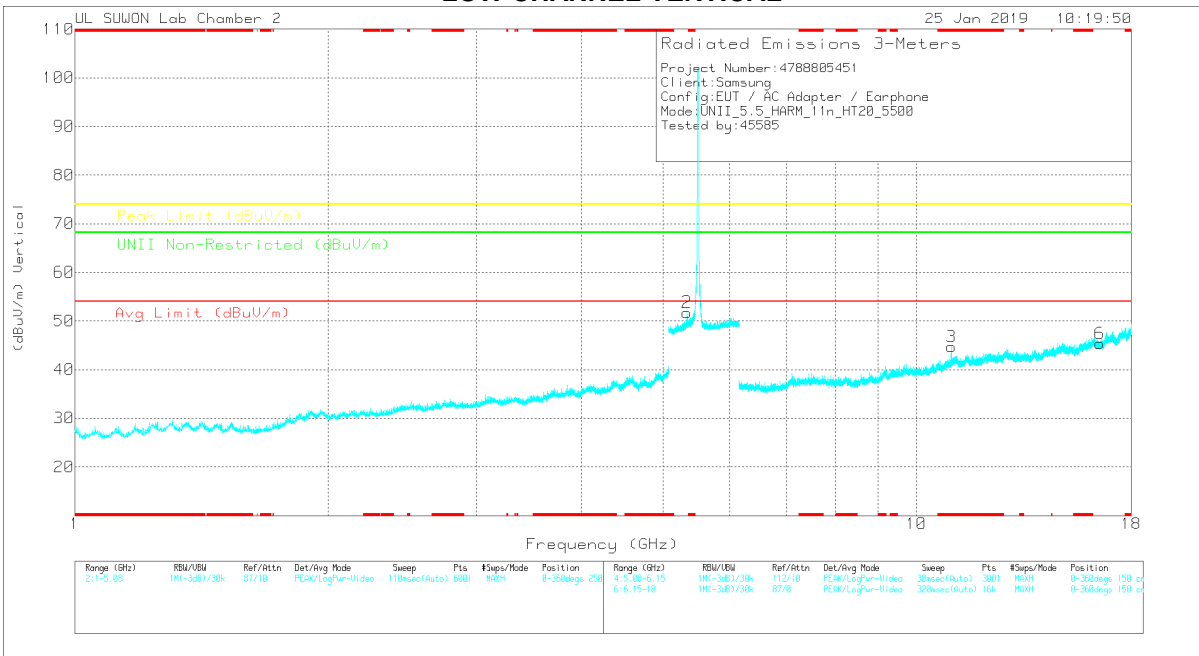

Note: Emission was scanned up to 40GHz; No emissions were detected above the noise floor which was at least 20dB below the specification limit.

LOW CHANNEL DATA

Trace Markers

Marker	Frequency (GHz)	Meter Reading (dBuV)	Det	3117_00168724	100B(dB)	DC Corr (dB)	Corrected Reading (dBuV/m)	Avg Limit (dBuV/m)	Margin (dB)	Peak Limit (dBuV/m)	Margin (dB)	UNII Non-Restricted (dBuV/m)	Margin (dB)	Azimuth (Degs)	Height (cm)	Polarity
1	5.34	32.69	PK	34.5	-18	0	49.19	-	-	-	-	68.2	-19.01	0-360	250	H
2	5.34	35.27	PK	34.5	-18	0	51.77	-	-	-	-	68.2	-16.43	0-360	150	V
4	* 11.001	24.83	PK	38.1	-20.5	0	42.43	-	-	74	-31.57	-	-	0-360	150	H
5	16.5	24.8	PK	40.5	-19.9	0	45.4	-	-	-	-	68.2	-22.8	0-360	250	H
3	* 11.001	27.16	PK	38.1	-20.5	0	44.76	-	-	74	-29.24	-	-	0-360	250	V
6	16.5	24.63	PK	40.5	-19.8	0	45.33	-	-	-	-	68.2	-22.87	0-360	150	V

* - indicates frequency in CFR47 Pt 15 / IC RSS-Restricted Band
 PK – Peak Detector

Radiated Emissions

Frequency (GHz)	Meter Reading (dBuV)	Det	3117_00168724	100B(dB)	DC Corr (dB)	Corrected Reading (dBuV/m)	Avg Limit (dBuV/m)	Margin (dB)	Peak Limit (dBuV/m)	Margin (dB)	UNII Non-Restricted (dBuV/m)	Margin (dB)	Azimuth (Degs)	Height (cm)	Polarity
5.341	42.91	PK-U	34.5	-18.1	0	59.31	-	-	-	-	68.2	-8.89	218	112	H
5.34	46.06	PK-U	34.5	-18	0	62.56	-	-	-	-	68.2	-5.64	253	183	V
* 11	26.08	ADR	38.1	-20.6	.11	43.69	54	-10.31	-	-	-	-	270	192	V
* 10.964	22.17	ADR	38.1	-20.5	.11	39.88	54	-14.12	-	-	-	-	97	207	H
* 11	38.4	PK-U	38.1	-20.6	0	55.9	-	-	74	-18.1	-	-	270	192	V
* 10.963	34.42	PK-U	38.1	-20.5	0	52.02	-	-	74	-21.98	-	-	97	207	H

* - indicates frequency in CFR47 Pt 15 / IC RSS-Restricted Band
 PK-U - U-NII: Maximum Peak
 ADR - U-NII AD primary method, RMS average

MID CHANNEL HORIZONTAL

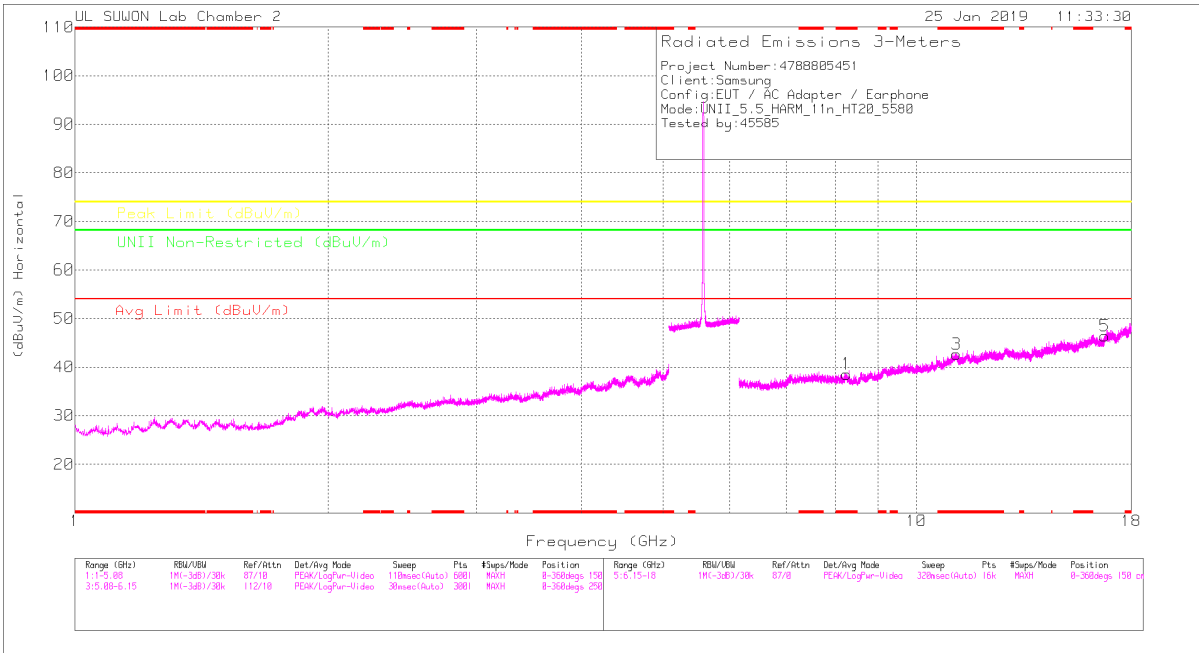

MID CHANNEL VERTICAL

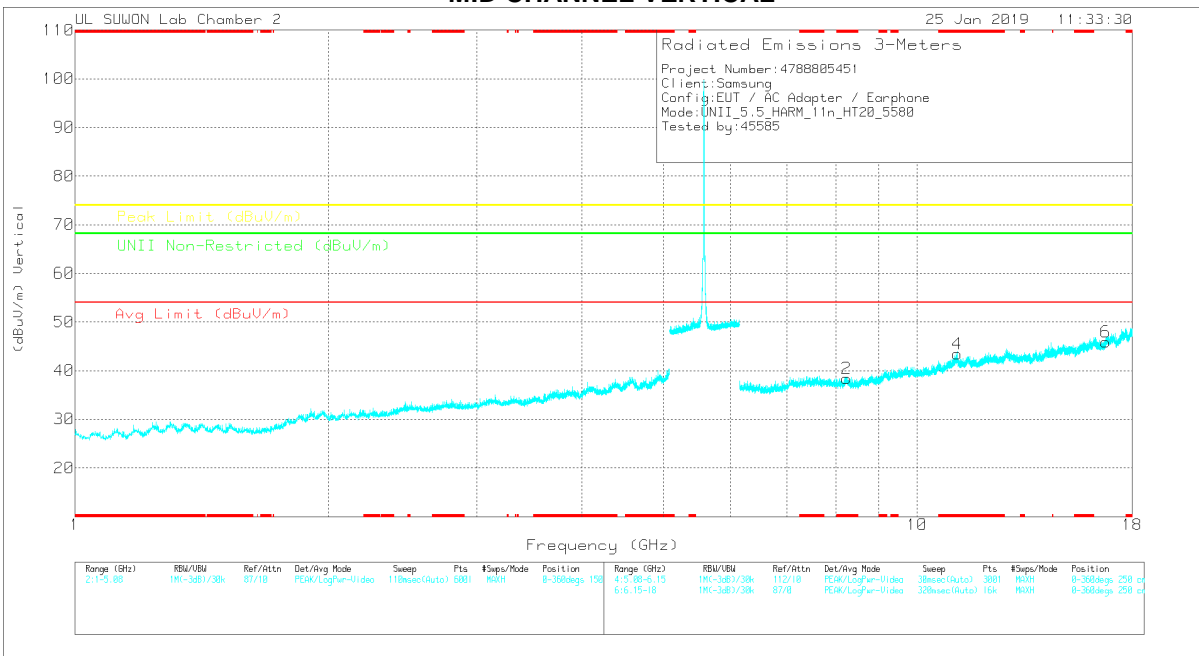

Note: Emission was scanned up to 40GHz; No emissions were detected above the noise floor which was at least 20dB below the specification limit.

MID CHANNEL DATA

Trace Markers

Marker	Frequency (GHz)	Meter Reading (dBuV)	Det	3117_00168724	6GHz_HF(dB)	DC Corr (dB)	Corrected Reading (dBuV/m)	Agc Limit (dBuV/m)	Margin (dB)	Peak Limit (dBuV/m)	Margin (dB)	U-NII Non-Restricted (dBuV/m)	Margin (dB)	Azimuth (Degs)	Height (cm)	Polarity
1	* 8.252	25.58	PK	36	-23	0	38.58	-	-	74	-35.42	-	-	0-360	150	H
3	* 11.16	24.05	PK	38.2	-19.6	0	42.65	-	-	74	-31.35	-	-	0-360	150	H
5	16.743	24.61	PK	40.9	-19.1	0	46.41	-	-	-	-	68.2	-21.79	0-360	150	H
2	* 8.247	25.44	PK	36	-23.1	0	38.34	-	-	74	-35.66	-	-	0-360	150	V
4	* 11.161	24.69	PK	38.2	-19.5	0	43.39	-	-	74	-30.61	-	-	0-360	250	V
6	16.744	24.12	PK	40.9	-19.1	0	45.92	-	-	-	-	68.2	-22.28	0-360	250	V

* - indicates frequency in CFR47 Pt 15 / IC RSS-Restricted Band
 PK – Peak Detector

Radiated Emissions

Frequency (GHz)	Meter Reading (dBuV)	Det	3117_00168724	6GHz_HF(dB)	DC Corr (dB)	Corrected Reading (dBuV/m)	Agc Limit (dBuV/m)	Margin (dB)	Peak Limit (dBuV/m)	Margin (dB)	U-NII Non-Restricted (dBuV/m)	Margin (dB)	Azimuth (Degs)	Height (cm)	Polarity
*11.157	35.22	PK-U	38.2	-19.6	0	53.82	-	-	74	-20.18	-	-	152	185	H
*11.16	23.17	ADR	38.2	-19.6	11	41.88	54	-12.12	-	-	-	-	152	185	H
*11.165	36.53	PK-U	38.2	-19.6	0	55.13	-	-	74	-18.87	-	-	263	178	V
*11.16	24.5	ADR	38.2	-19.6	11	43.21	54	-10.79	-	-	-	-	263	178	V

* - indicates frequency in CFR47 Pt 15 / IC RSS-Restricted Band
 PK-U - U-NII: Maximum Peak
 ADR - U-NII AD primary method, RMS average

HIGH CHANNEL HORIZONTAL

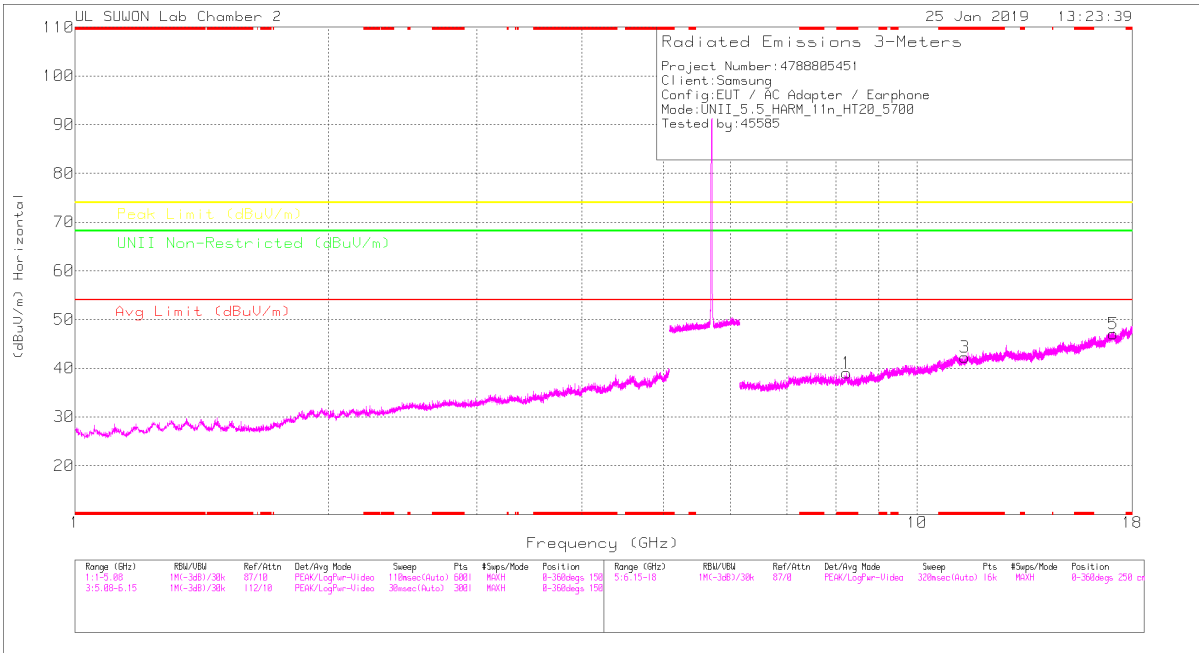

HIGH CHANNEL VERTICAL

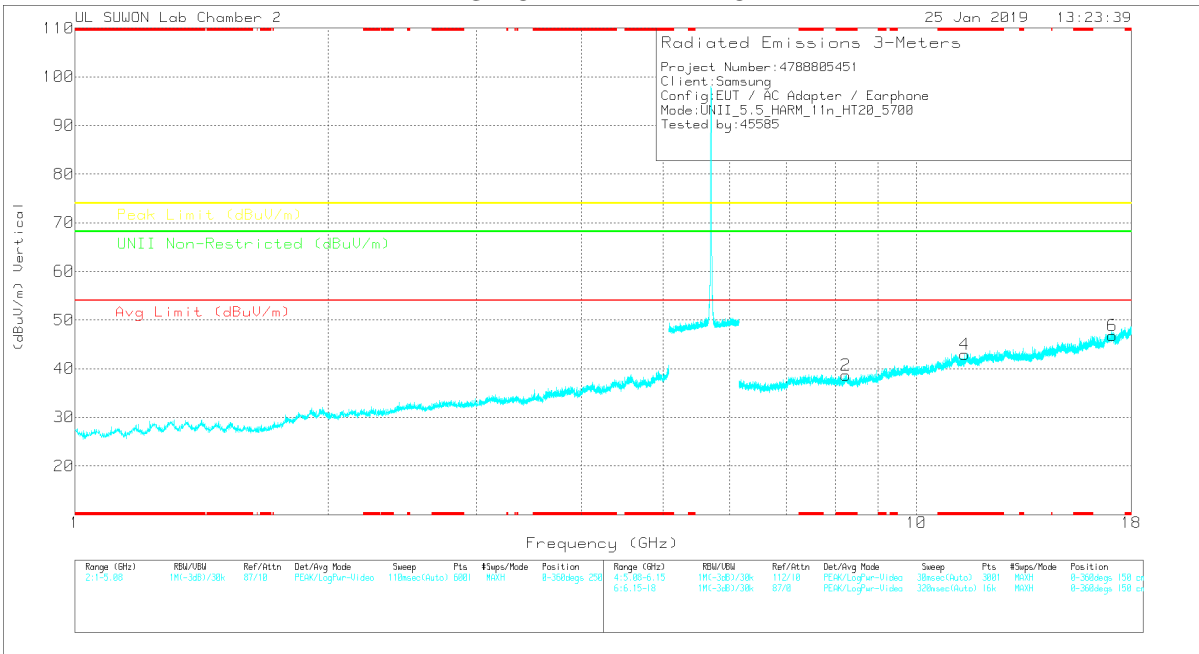

Note: Emission was scanned up to 40GHz; No emissions were detected above the noise floor which was at least 20dB below the specification limit.

HIGH CHANNEL DATA

Trace Markers

Marker	Frequency (GHz)	Major Reading (dBuV)	Det	3117_00168724	66Hz_HR(dB)	DC Corr (dB)	Corrected Reading (dBuV/m)	Avg Limit (dBuV/m)	Margin (dB)	Peak Limit (dBuV/m)	Margin (dB)	Limit Non-Restricted (dBuV/m)	Margin (dB)	Altitude (Degs)	Height (cm)	Polarity
1	* 8.24	26.19	PK	36	-23.2	0	38.99	-	-	74	-35.01	-	-	0-360	150	H
3	* 11.397	24.12	PK	38.3	-20.2	0	42.22	-	-	74	-31.78	-	-	0-360	250	H
5	17.102	24.34	PK	41.3	-18.6	0	47.04	-	-	-	-	68.2	-21.16	0-360	250	H
2	* 8.241	25.88	PK	36	-23.2	0	38.68	-	-	74	-35.32	-	-	0-360	150	V
4	* 11.401	24.79	PK	38.3	-20.2	0	42.89	-	-	74	-31.11	-	-	0-360	250	V
6	17.102	24.25	PK	41.3	-18.7	0	46.85	-	-	-	-	68.2	-21.35	0-360	250	V

* - indicates frequency in CFR47 Pt 15 / IC RSS-Restricted Band
 PK – Peak Detector

Note: Only peak measurement was performed. Because peak measurement result of unwanted emission is less than average limit (54dBuV/m).

11.3.3.TX ABOVE 1GHz 802.11n HT40 MODE IN THE 5.5GHz BAND RESTRICTED BANDEDGE (LOW CHANNEL)

HORIZONTAL PEAK AND AVERAGE PLOT

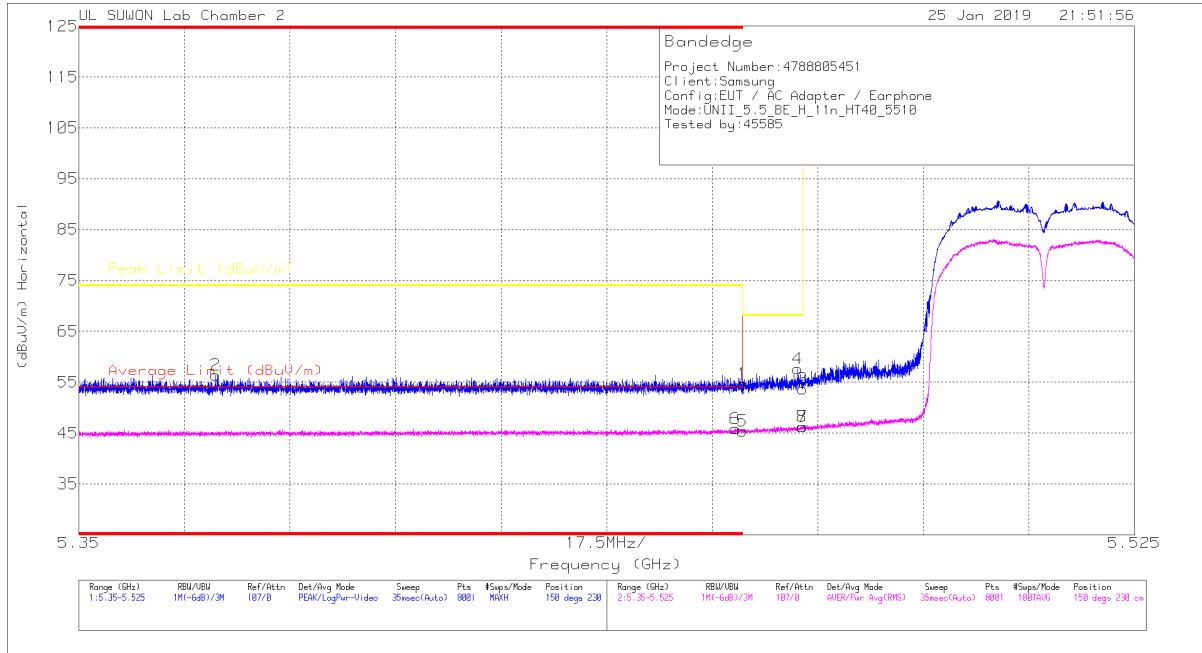

HORIZONTAL DATA

Trace Markers

Marker	Frequency (GHz)	Meter Reading (dBuV)	Det	3117_00168724	10dB(dB)	DC Corr (dB)	Corrected Reading (dBuV/m)	Average Limit (dBuV/m)	Margin (dB)	Peak Limit (dBuV/m)	PK Margin (dB)	Azimuth (Degs)	Height (cm)	Polarity
1	* 5.46	38.28	Pk	34.6	-18.2	0	54.68	-	-	74	-19.32	150	230	H
2	* 5.373	40.03	Pk	34.5	-18.1	0	56.43	-	-	74	-17.57	150	230	H
3	5.47	37.21	Pk	34.6	-18.1	0	53.71	-	-	68.2	-14.49	150	230	H
4	5.469	41.08	Pk	34.6	-18.1	0	57.58	-	-	68.2	-10.62	150	230	H
5	* 5.46	27.34	RMS	34.6	-16.9	.31	45.35	54	-8.65	-	-	150	230	H
6	* 5.459	27.92	RMS	34.6	-16.9	.31	45.93	-	-	-	-	150	230	H
7	5.47	28.22	RMS	34.6	-16.9	.31	46.23	-	-	-	-	150	230	H
8	5.47	28.29	RMS	34.6	-16.9	.31	46.3	-	-	-	-	150	230	H

* - indicates frequency in CFR47 Pt 15 / IC RSS-Restricted Band

Pk - Peak detector

RMS - RMS detection

VERTICAL PEAK AND AVERAGE PLOT

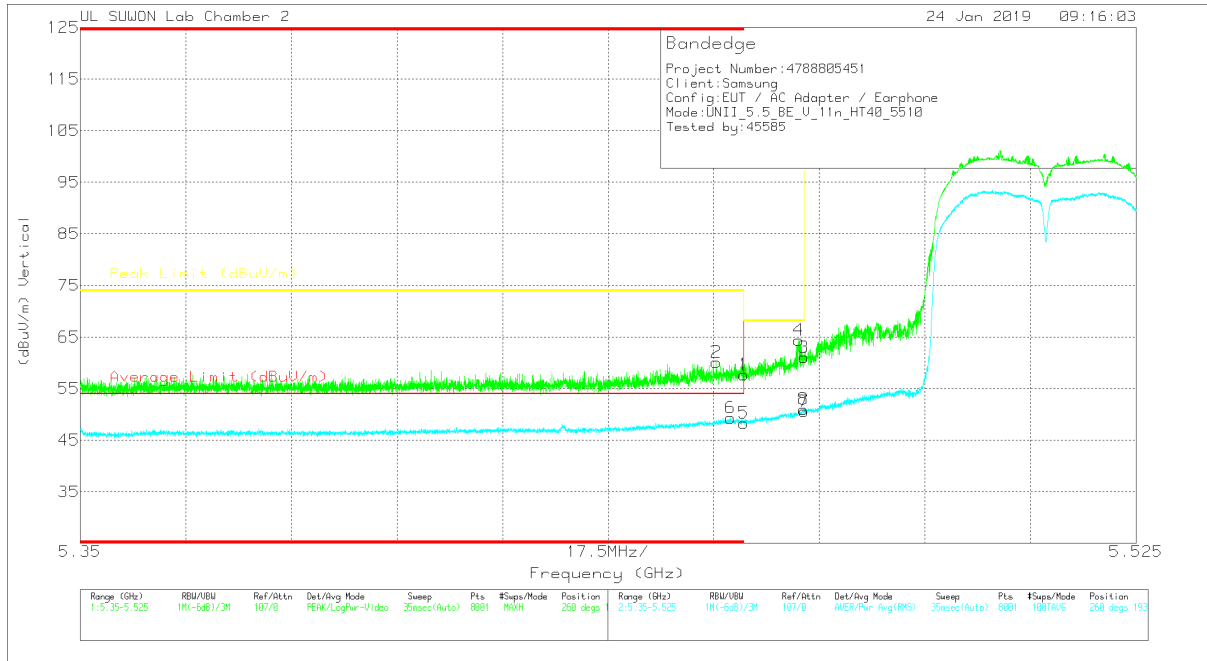

VERTICAL DATA

Trace Markers

Marker	Frequency (GHz)	Meter Reading (dBuV)	Det	3117_00168724	10dB(dB)	DC Corr (dB)	Corrected Reading (dBuV/m)	Average Limit (dBuV/m)	Margin (dB)	Peak Limit (dBuV/m)	PK Margin (dB)	Azimuth (Degs)	Height (cm)	Polarity
1	* 5.46	41.31	Pk	34.6	-18.2	0	57.71	-	-	74	-16.29	260	193	V
2	* 5.455	43.72	Pk	34.6	-18.2	0	60.12	-	-	74	-13.88	260	193	V
3	5.47	44.57	Pk	34.6	-18.1	0	61.07	-	-	68.2	-7.13	260	193	V
4	5.469	47.91	Pk	34.6	-18.1	0	64.41	-	-	68.2	-3.79	260	193	V
5	* 5.46	30.33	RMS	34.6	-16.9	.31	48.34	54	-5.66	-	-	260	193	V
6	* 5.458	31.33	RMS	34.6	-16.9	.31	49.34	54	-4.66	-	-	260	193	V
7	5.47	32.56	RMS	34.6	-16.9	.31	50.57	-	-	-	-	260	193	V
8	5.47	33	RMS	34.6	-16.9	.31	51.01	-	-	-	-	260	193	V

* - indicates frequency in CFR47 Pt 15 / IC RSS-Restricted Band

Pk - Peak detector

RMS - RMS detection

AUTHORIZED BANDEGE (HIGH CHANNEL)

HORIZONTAL PEAK AND AVERAGE PLOT

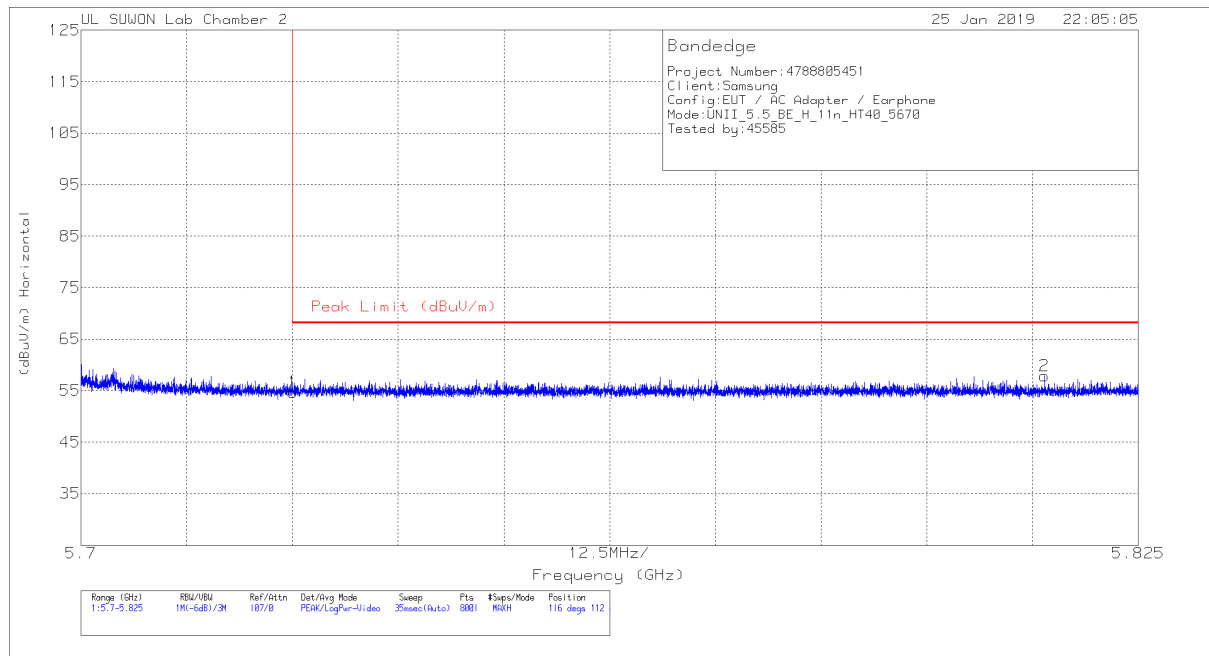

HORIZONTAL DATA

Trace Markers

Marker	Frequency (GHz)	Meter Reading (dBuV)	Det	3117_00168724	10dB[dB]	DC Corr (dB)	Corrected Reading (dBuV/m)	Peak Limit (dBuV/m)	PK Margin (dB)	Azimuth (Degs)	Height (cm)	Polarity
1	5.725	37.56	Pk	34.7	-17.6	0	54.66	68.2	-13.54	116	112	H
2	5.814	40.57	Pk	34.8	-17.5	0	57.87	68.2	-10.33	116	112	H

Pk - Peak detector

VERTICAL PEAK AND AVERAGE PLOT

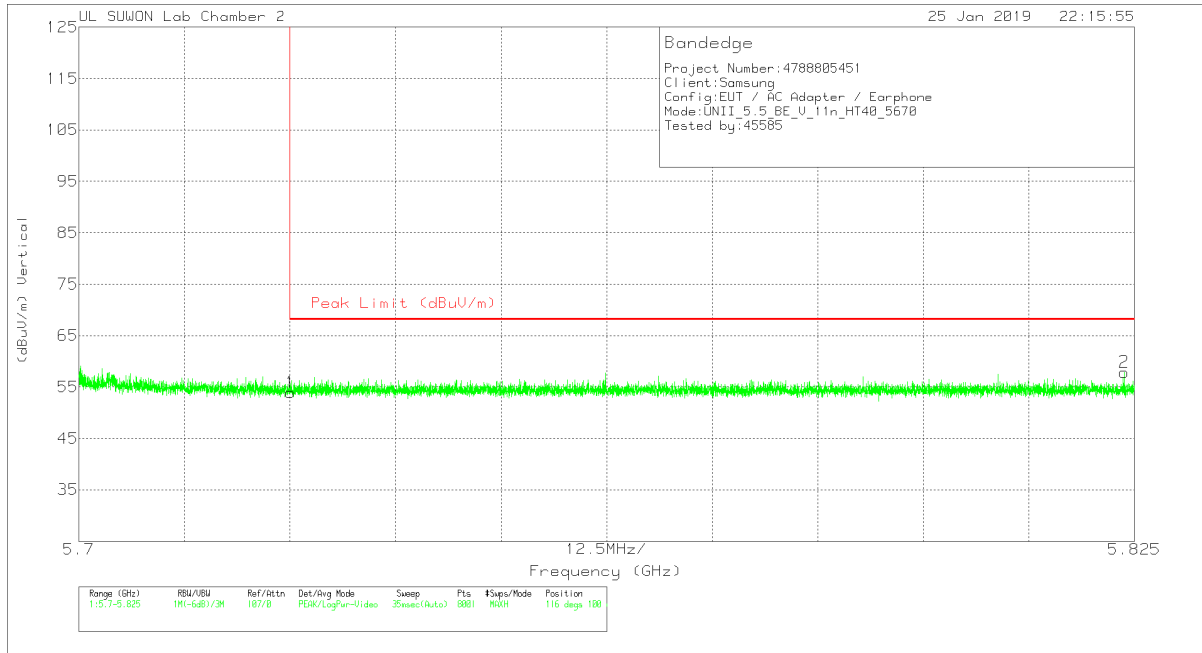

VERTICAL DATA

Trace Markers

Marker	Frequency (GHz)	Meter Reading (dBuV)	Det	3117_00168724	10dB[dB]	DC Corr (dB)	Corrected Reading (dBuV/m)	Peak Limit (dBuV/m)	PK Margin (dB)	Azimuth (Degs)	Height (cm)	Polarity
1	5.725	36.88	Pk	34.7	-17.6	0	53.98	68.2	-14.22	116	100	V
2	5.824	40.62	Pk	34.8	-17.5	0	57.92	68.2	-10.28	116	100	V

Pk - Peak detector

HARMONICS AND SPURIOUS EMISSIONS

LOW CHANNEL HORIZONTAL

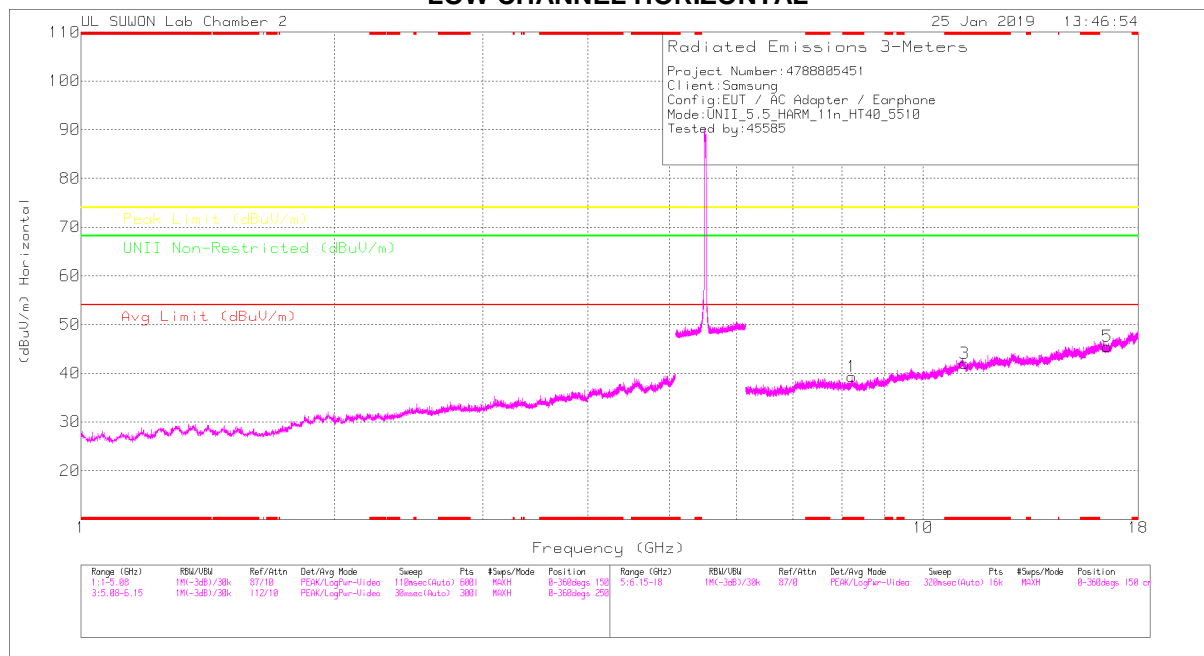

LOW CHANNEL VERTICAL

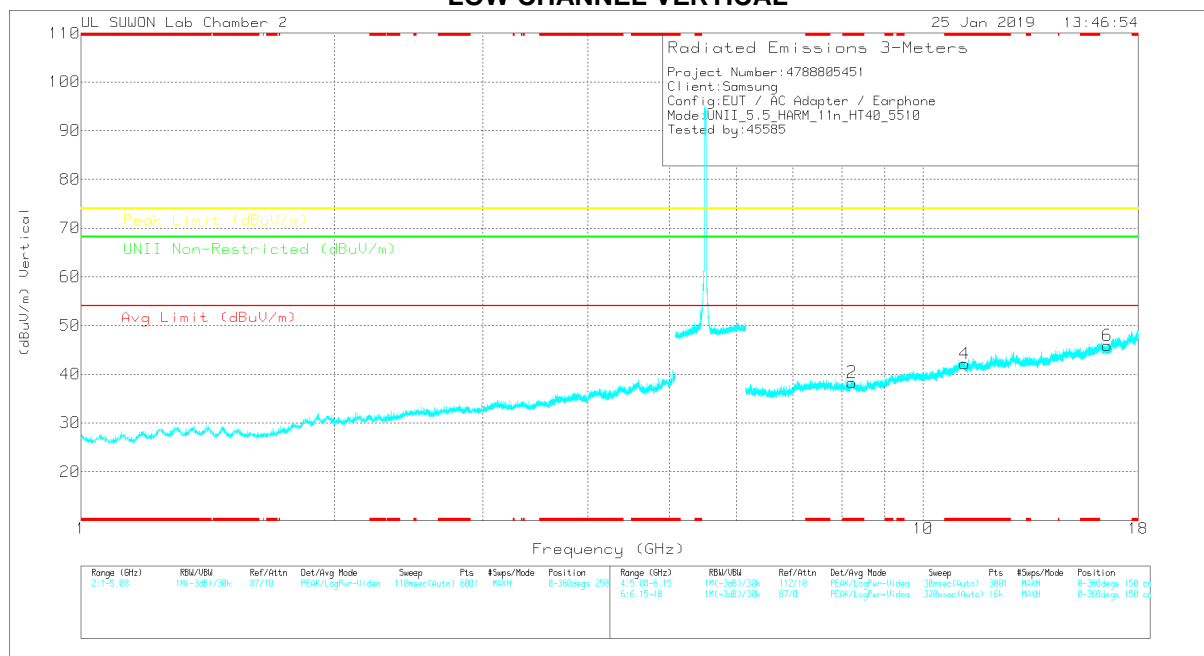

Note: Emission was scanned up to 40GHz; No emissions were detected above the noise floor which was at least 20dB below the specification limit.

LOW CHANNEL DATA

Trace Markers

Marker	Frequency (GHz)	Marker Reading (dBuV)	Det	3117_00168724	60Hz_HR(dB)	DC Corr (dB)	Corrected Reading (dBuV/m)	Avg Limit (dBuV/m)	Margin (dB)	Peak Limit (dBuV/m)	Margin (dB)	Limit Non-Restricted (dBuV/m)	Margin (dB)	Azimuth (Degs)	Height (cm)	Polarity
1	* 8.231	26.67	PK	36	-23.4	0	39.27	-	-	74	-34.73	-	-	0-360	150	H
3	* 11.204	23.74	PK	38.3	-20	0	42.04	-	-	74	-31.96	-	-	0-360	250	H
5	16.533	24.81	PK	40.5	-19.8	0	45.51	-	-	-	-	68.2	-22.69	0-360	250	H
2	* 8.232	25.62	PK	36	-23.3	0	38.32	-	-	74	-35.68	-	-	0-360	150	V
4	* 11.205	23.81	PK	38.3	-20	0	42.11	-	-	74	-31.89	-	-	0-360	250	V
6	16.532	25.22	PK	40.5	-19.8	0	45.92	-	-	-	-	68.2	-22.28	0-360	250	V

* - indicates frequency in CFR47 Pt 15 / IC RSS-Restricted Band
 PK – Peak Detector

Note: Only peak measurement was performed. Because peak measurement result of unwanted emission is less than average limit (54dBuV/m).

MID CHANNEL HORIZONTAL

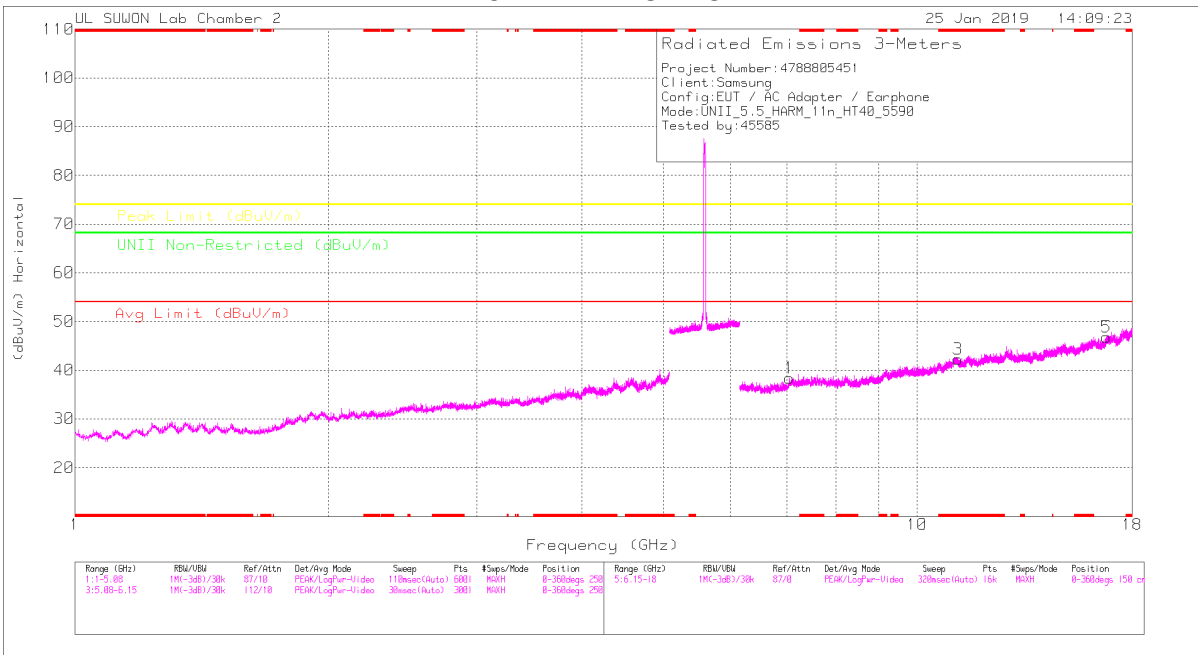

MID CHANNEL VERTICAL

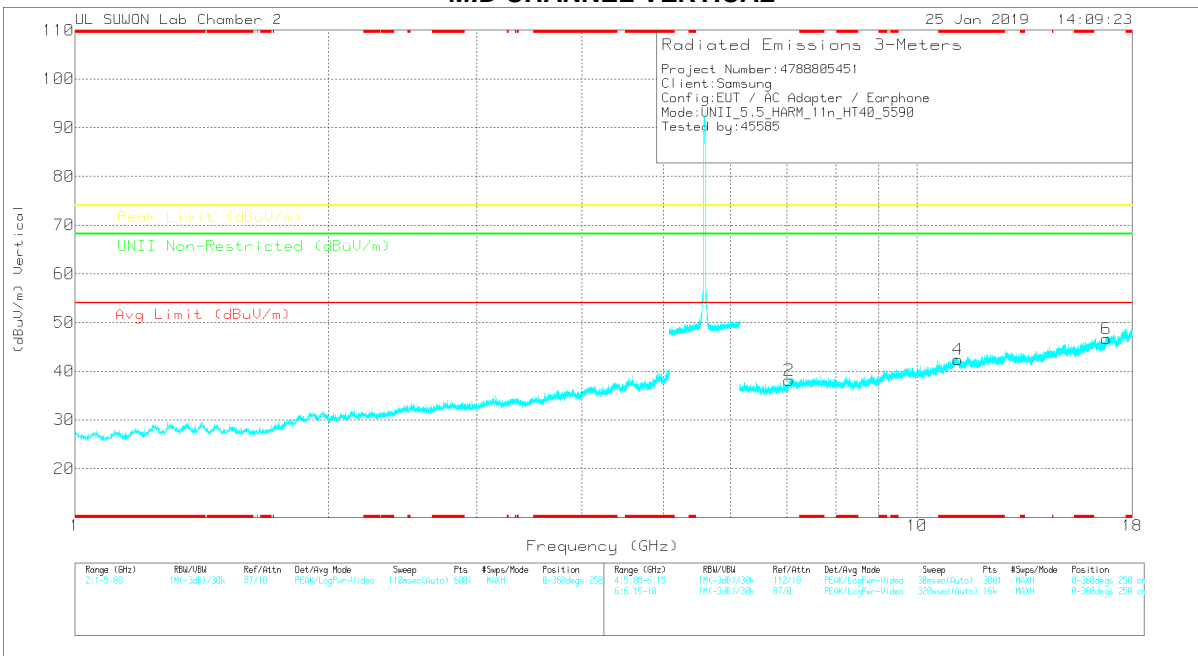

Note: Emission was scanned up to 40GHz; No emissions were detected above the noise floor which was at least 20dB below the specification limit.

MID CHANNEL DATA

Trace Markers

Marker	Frequency (GHz)	Major Reading (dBuV)	Det	3117_00168724	66Hz_HR(dB)	DC Corr (dB)	Corrected Reading (dBuV/m)	Avg Limit (dBuV/m)	Margin (dB)	Peak Limit (dBuV/m)	Margin (dB)	Limit Non-Restricted (dBuV/m)	Margin (dB)	Altitude (Degs)	Height (cm)	Polarity
1	7.047	27.14	PK	35.9	-24.7	0	38.34	-	-	-	-	68.2	-29.86	0-360	150	H
3	*11.184	23.76	PK	38.2	-19.7	0	42.26	-	-	74	-31.74	-	-	0-360	251	H
5	16.776	24.63	PK	41	-18.8	0	46.83	-	-	-	-	68.2	-21.37	0-360	251	H
2	7.044	27.05	PK	35.9	-24.8	0	38.15	-	-	-	-	68.2	-30.05	0-360	150	V
4	*11.181	23.81	PK	38.2	-19.6	0	42.41	-	-	74	-31.59	-	-	0-360	150	V
6	16.768	24.52	PK	41	-18.8	0	46.72	-	-	-	-	68.2	-21.48	0-360	250	V

* - indicates frequency in CFR47 Pt 15 / IC RSS-Restricted Band
 PK – Peak Detector

Note: Only peak measurement was performed. Because peak measurement result of unwanted emission is less than average limit (54dBuV/m).

HIGH CHANNEL HORIZONTAL

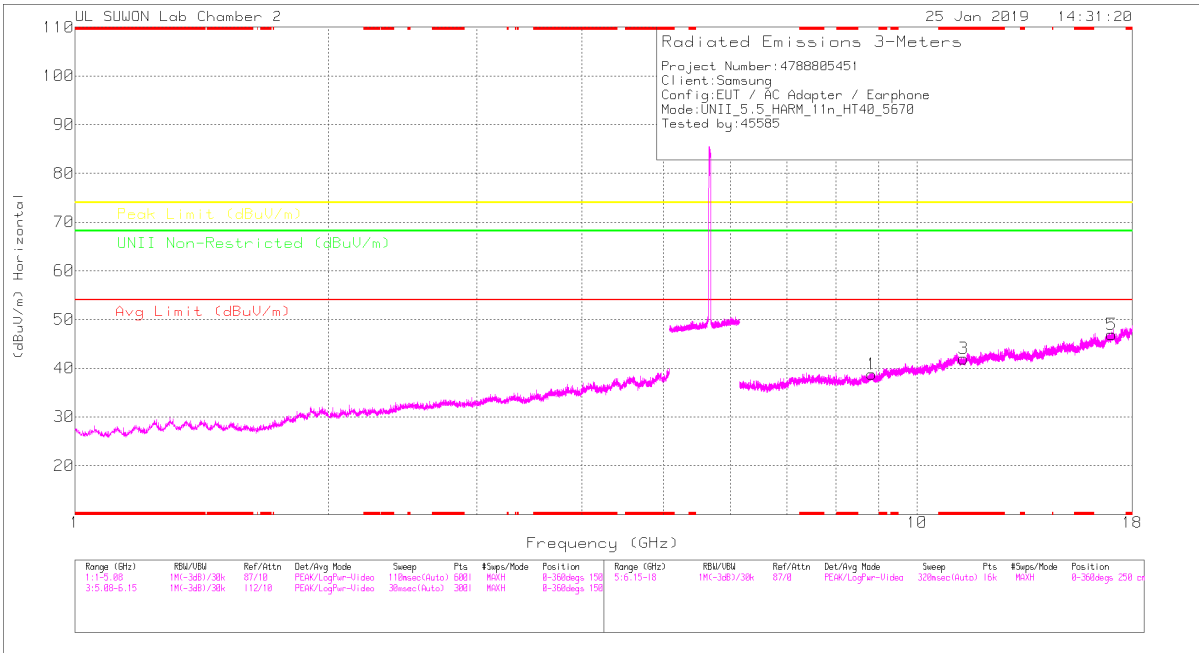

HIGH CHANNEL VERTICAL

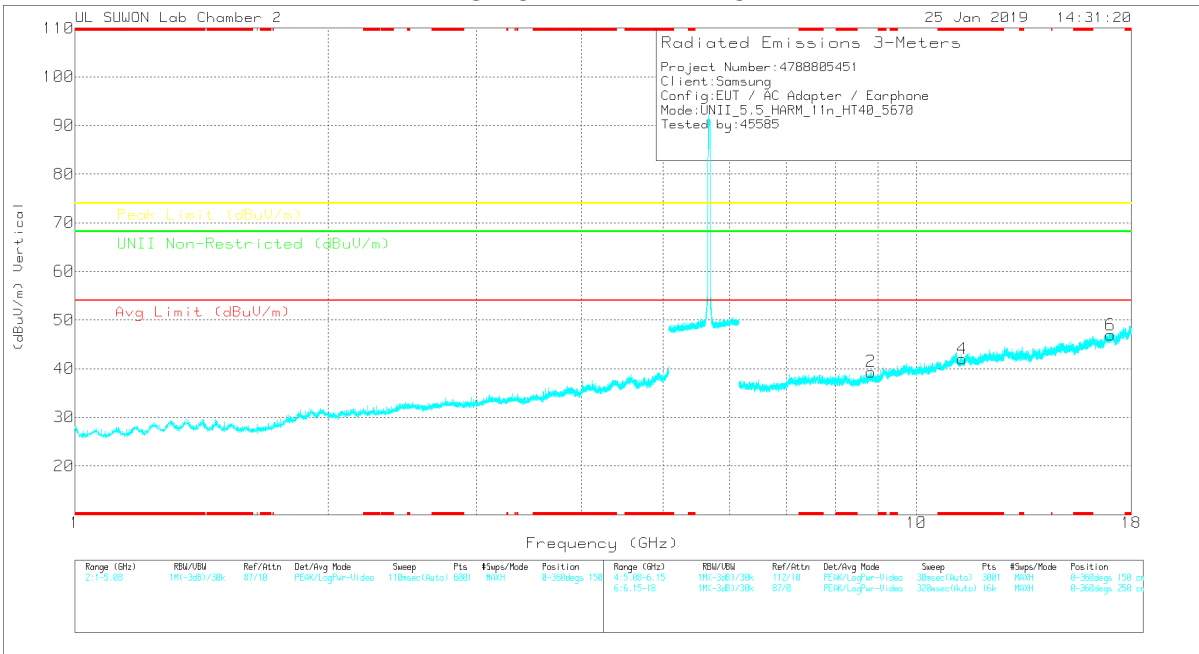

Note: Emission was scanned up to 40GHz; No emissions were detected above the noise floor which was at least 20dB below the specification limit.

HIGH CHANNEL DATA

Trace Markers

Marker	Frequency (GHz)	Meas Reading (dBuV)	Det	3117_00168724	60Hz_HR(dB)	DC Corr (dB)	Corrected Reading (dBuV/m)	Avg Limit (dBuV/m)	Margin (dB)	Peak Limit (dBuV/m)	Margin (dB)	Limit Non-Restricted (dBuV/m)	Margin (dB)	Azimuth (Degs)	Height (cm)	Polarity
1	8.825	24.61	PK	36.4	-22.2	0	38.81	-	-	-	-	68.2	-29.39	0-360	150	H
3	*11.344	23.85	PK	38.3	-20.2	0	41.95	-	-	74	-32.05	-	-	0-360	150	H
5	17.017	24.34	PK	41.3	-18.7	0	46.94	-	-	-	-	68.2	-21.26	0-360	250	H
2	8.829	25.06	PK	36.4	-22.1	0	39.36	-	-	-	-	68.2	-28.84	0-360	250	V
4	*11.341	23.97	PK	38.3	-20.3	0	41.97	-	-	74	-32.03	-	-	0-360	150	V
6	17.008	24.17	PK	41.3	-18.6	0	46.87	-	-	-	-	68.2	-21.33	0-360	250	V

* - indicates frequency in CFR47 Pt 15 / IC RSS-Restricted Band
 PK – Peak Detector

Note: Only peak measurement was performed. Because peak measurement result of unwanted emission is less than average limit (54dBuV/m).

11.3.4.TX ABOVE 1GHz 802.11ac VHT80 MODE IN THE 5.5GHz BAND RESTRICTED BANDEDGE (LOW CHANNEL)

HORIZONTAL PEAK AND AVERAGE PLOT

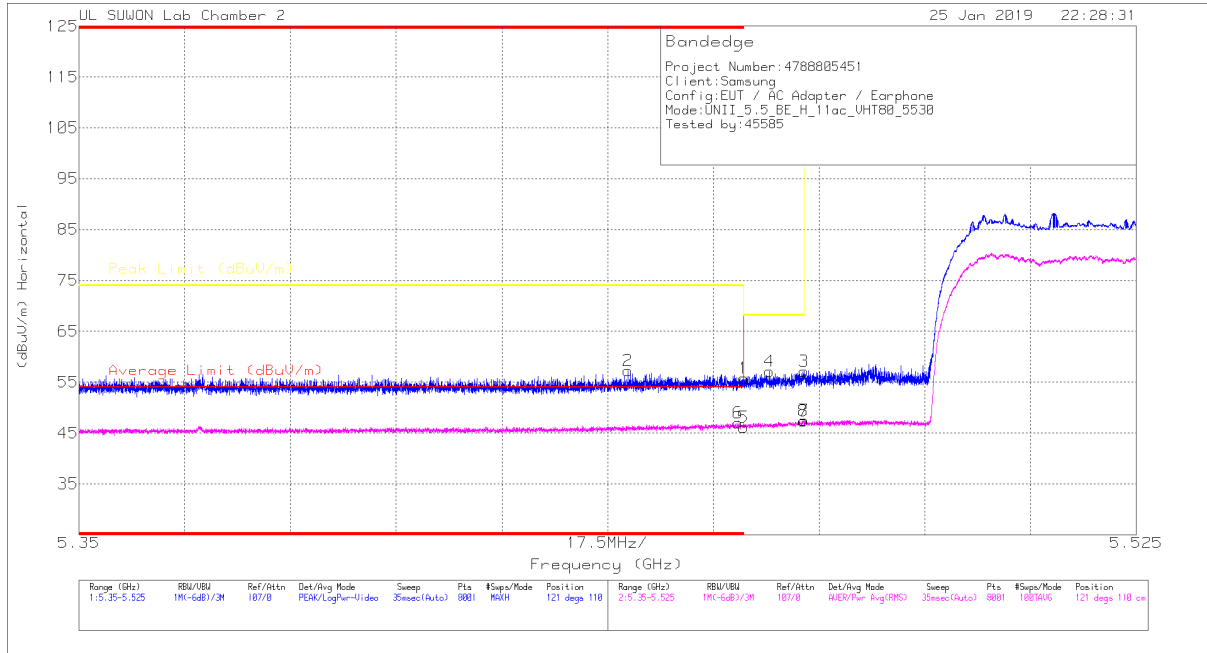

HORIZONTAL DATA

Trace Markers

Marker	Frequency (GHz)	Meter Reading (dBuV)	Det	3117_00168724	10dB(dB)	DC Corr (dB)	Corrected Reading (dBuV/m)	Average Limit (dBuV/m)	Margin (dB)	Peak Limit (dBuV/m)	PK Margin (dB)	Azimuth (Deg)	Height (cm)	Polarity
1	* 5.46	39.42	Pk	34.6	-18.2	0	55.82	-	-	74	-18.18	121	110	H
2	* 5.441	40.94	Pk	34.5	-18.2	0	57.24	-	-	74	-16.76	121	110	H
3	5.47	40.67	Pk	34.6	-18.1	0	57.17	-	-	68.2	-11.03	121	110	H
4	5.464	40.73	Pk	34.6	-18.2	0	57.13	-	-	68.2	-11.07	121	110	H
5	* 5.46	27.77	RMS	34.6	-16.9	.67	46.14	54	-7.86	-	-	121	110	H
6	* 5.459	28.62	RMS	34.6	-16.9	.67	46.99	54	-7.01	-	-	121	110	H
7	5.47	29.13	RMS	34.6	-16.9	.67	47.5	-	-	-	-	121	110	H
8	5.47	29.02	RMS	34.6	-16.9	.67	47.39	-	-	-	-	121	110	H

* - indicates frequency in CFR47 Pt 15 / IC RSS-Restricted Band

Pk - Peak detector

RMS - RMS detection

VERTICAL PEAK AND AVERAGE PLOT

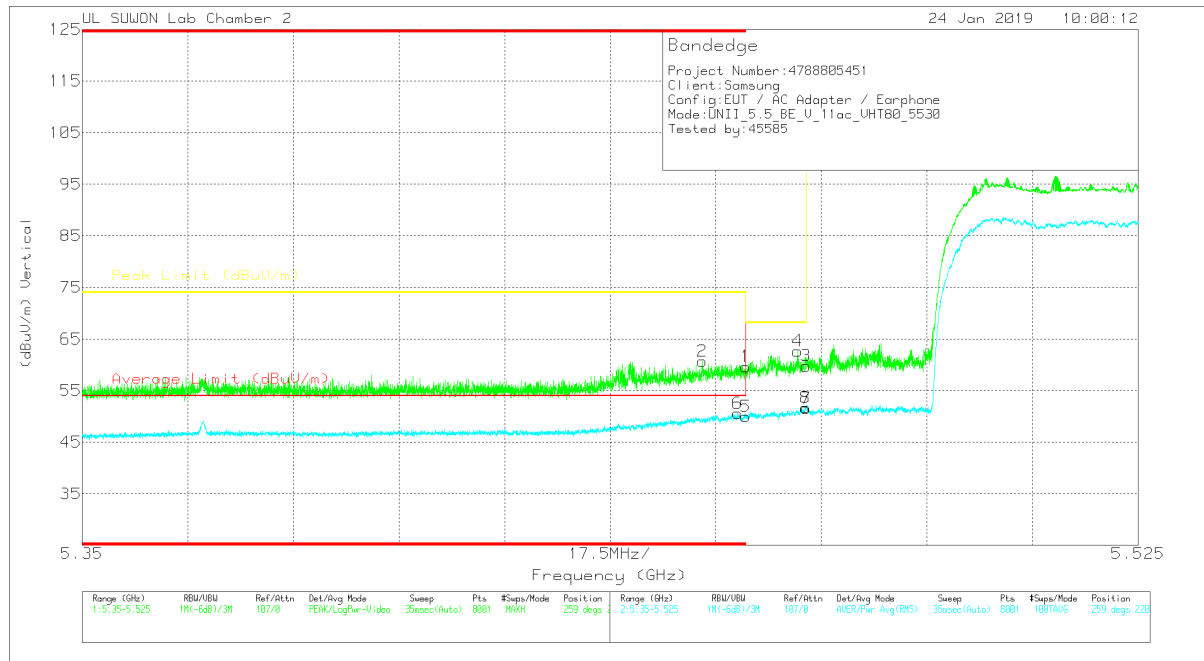

VERTICAL DATA

Trace Markers

Marker	Frequency (GHz)	Meter Reading (dBuV)	Det	3117_00168724	10dB(dB)	DC Corr (dB)	Corrected Reading (dBuV/m)	Average Limit (dBuV/m)	Margin (dB)	Peak Limit (dBuV/m)	PK Margin (dB)	Aimuth (Degs)	Height (cm)	Polarity
1	* 5.46	43.26	Pk	34.6	-18.2	0	59.66	-	-	74	-14.34	259	220	V
2	* 5.453	44.2	Pk	34.6	-18.1	0	60.7	-	-	74	-13.3	259	220	V
3	5.47	43.3	Pk	34.6	-18.1	0	59.8	-	-	68.2	-8.4	259	220	V
4	5.469	46.27	Pk	34.6	-18.2	0	62.67	-	-	68.2	-5.53	259	220	V
5	* 5.46	31.62	RMS	34.6	-16.9	.67	49.99	54	-4.01	-	-	259	220	V
6	* 5.459	32.22	RMS	34.6	-16.9	.67	50.59	54	-3.41	-	-	259	220	V
7	5.47	33.2	RMS	34.6	-16.9	.67	51.57	-	-	-	-	259	220	V
8	5.47	33.33	RMS	34.6	-16.9	.67	51.7	-	-	-	-	259	220	V

* - indicates frequency in CFR47 Pt 15 / IC RSS-Restricted Band

Pk - Peak detector

RMS - RMS detection

AUTHORIZED BANDEGE (HIGH CHANNEL)

HORIZONTAL PEAK AND AVERAGE PLOT

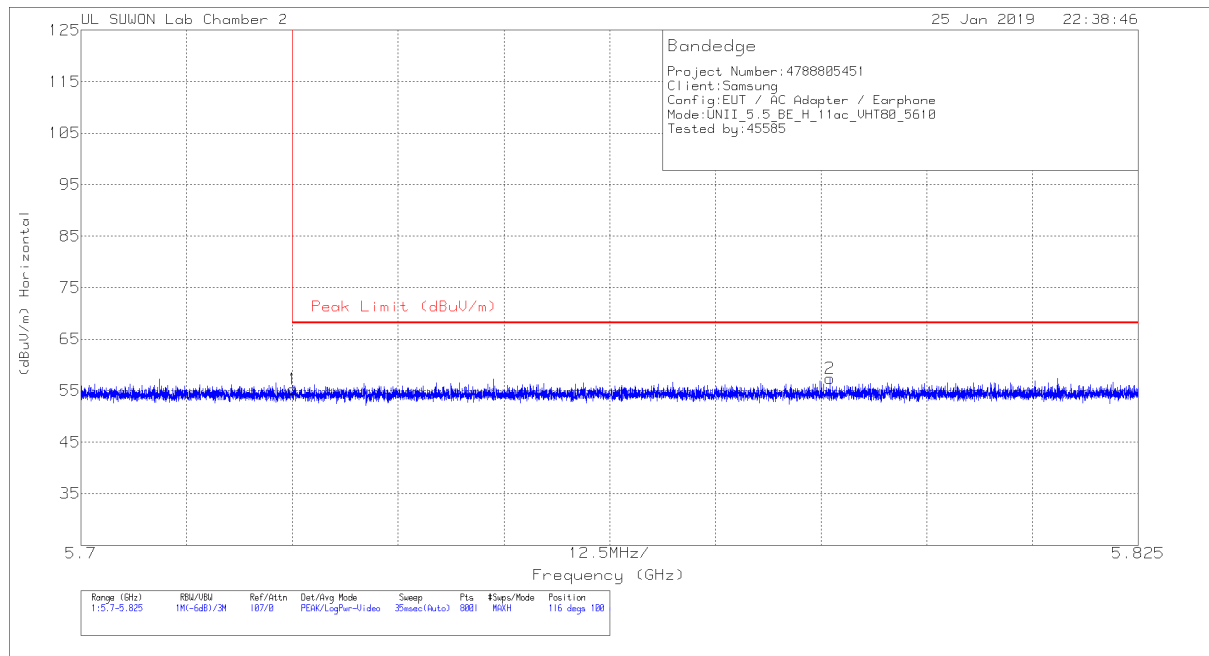

HORIZONTAL DATA

Trace Markers

Marker	Frequency (GHz)	Meter Reading (dBuV)	Det	3117_00168724	10dB[dB]	DC Corr (dB)	Corrected Reading (dBuV/m)	Peak Limit (dBuV/m)	PK Margin (dB)	Azimuth (Degs)	Height (cm)	Polarity
1	5.725	38.17	Pk	34.7	-17.6	0	55.27	68.2	-12.93	116	100	H
2	5.789	40.11	Pk	34.8	-17.5	0	57.41	68.2	-10.79	116	100	H

Pk - Peak detector

VERTICAL PEAK AND AVERAGE PLOT

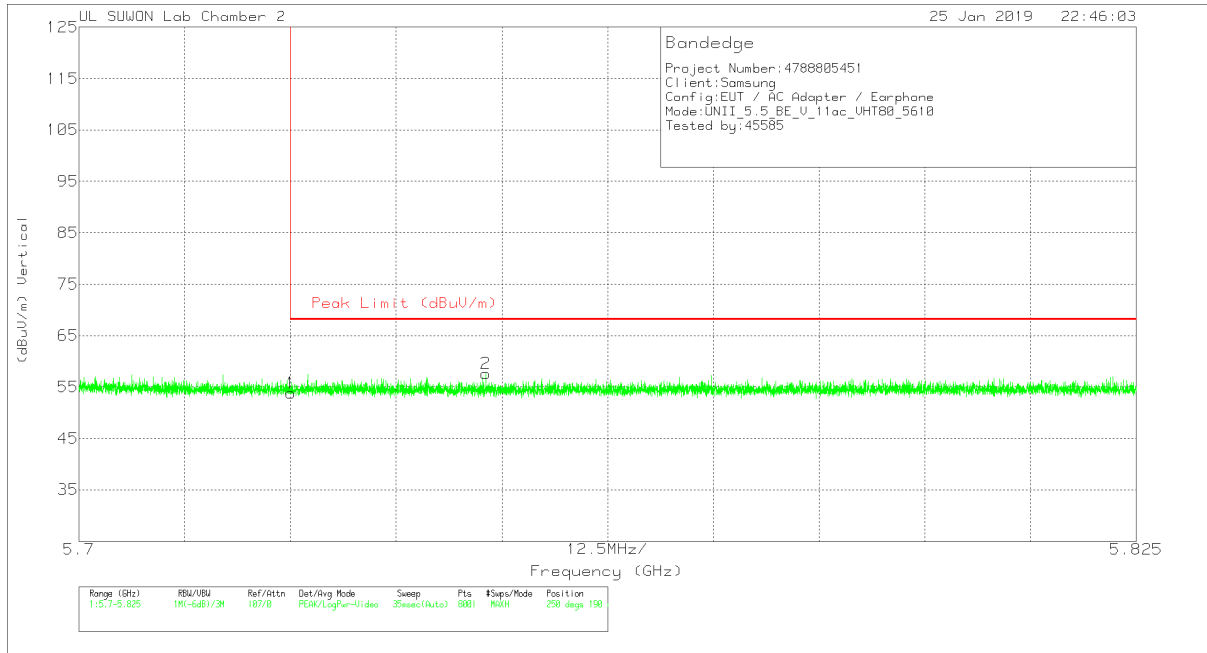

VERTICAL DATA

Trace Markers

Marker	Frequency (GHz)	Meter Reading (dBuV)	Det	3117_00168724	10dB[dB]	DC Corr (dB)	Corrected Reading (dBuV/m)	Peak Limit (dBuV/m)	PK Margin (dB)	Azimuth (Degs)	Height (cm)	Polarity
1	5.725	36.71	Pk	34.7	-17.6	0	53.81	68.2	-14.39	250	190	V
2	5.748	40.45	Pk	34.7	-17.5	0	57.65	68.2	-10.55	250	190	V

Pk - Peak detector

HARMONICS AND SPURIOUS EMISSIONS

LOW CHANNEL HORIZONTAL

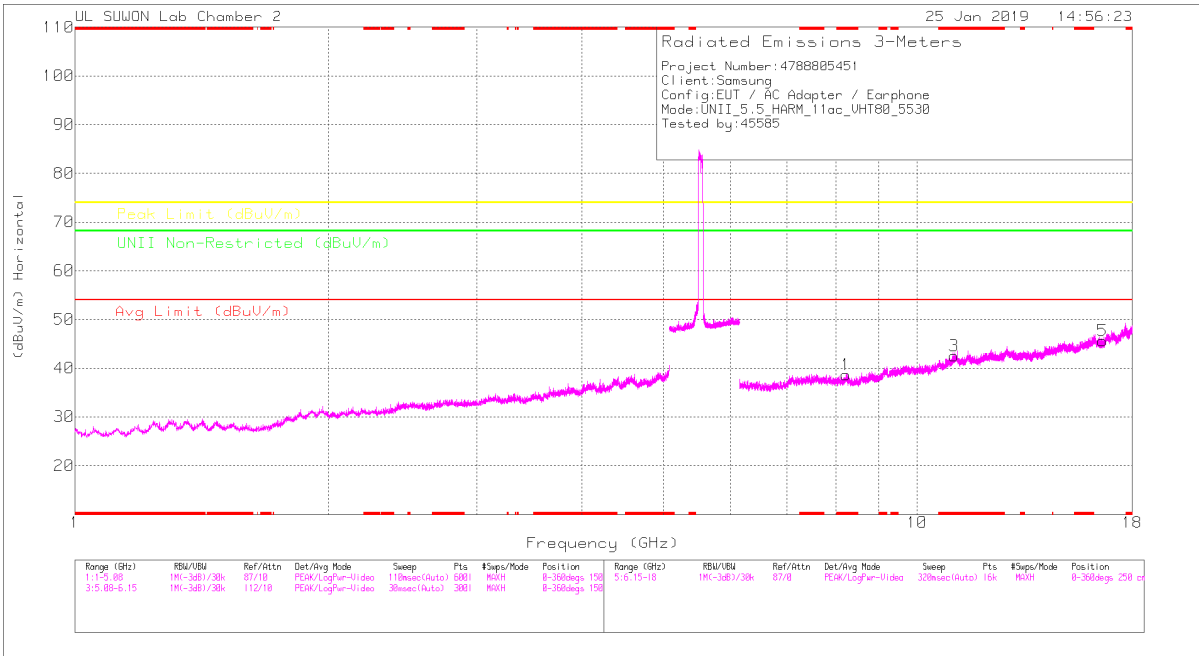

LOW CHANNEL VERTICAL

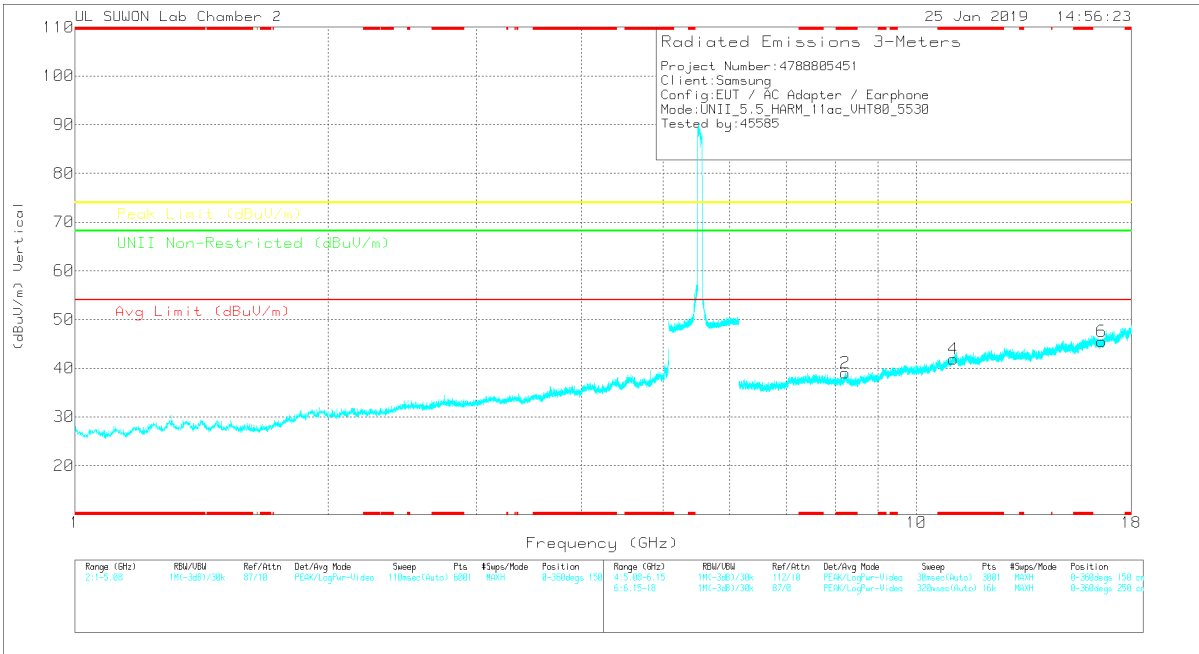

Note: Emission was scanned up to 40GHz; No emissions were detected above the noise floor which was at least 20dB below the specification limit.

LOW CHANNEL DATA

Trace Markers

Marker	Frequency (GHz)	Marker Reading (dBuV)	Det	3117_00168724	60Hz_HR(dB)	DC Corr (dB)	Corrected Reading (dBuV/m)	Avg Limit (dBuV/m)	Margin (dB)	Peak Limit (dBuV/m)	Margin (dB)	Limit Non-Restricted (dBuV/m)	Margin (dB)	Azimuth (Degs)	Height (cm)	Polarity
1	* 8.235	25.9	PK	36	-23.3	0	38.6	-	-	74	-35.4	-	-	0-360	250	H
3	* 11.067	24.87	PK	38.2	-20.5	0	42.57	-	-	74	-31.43	-	-	0-360	250	H
5	16.591	24.68	PK	40.6	-19.7	0	45.58	-	-	-	-	68.2	-22.62	0-360	150	H
2	* 8.235	26.38	PK	36	-23.3	0	39.08	-	-	74	-34.92	-	-	0-360	250	V
4	* 11.06	24.18	PK	38.2	-20.5	0	41.88	-	-	74	-32.12	-	-	0-360	150	V
6	16.592	24.58	PK	40.6	-19.7	0	45.48	-	-	-	-	68.2	-22.72	0-360	150	V

* - indicates frequency in CFR47 Pt 15 / IC RSS-Restricted Band
 PK – Peak Detector

Note: Only peak measurement was performed. Because peak measurement result of unwanted emission is less than average limit (54dBuV/m).

HIGH CHANNEL HORIZONTAL

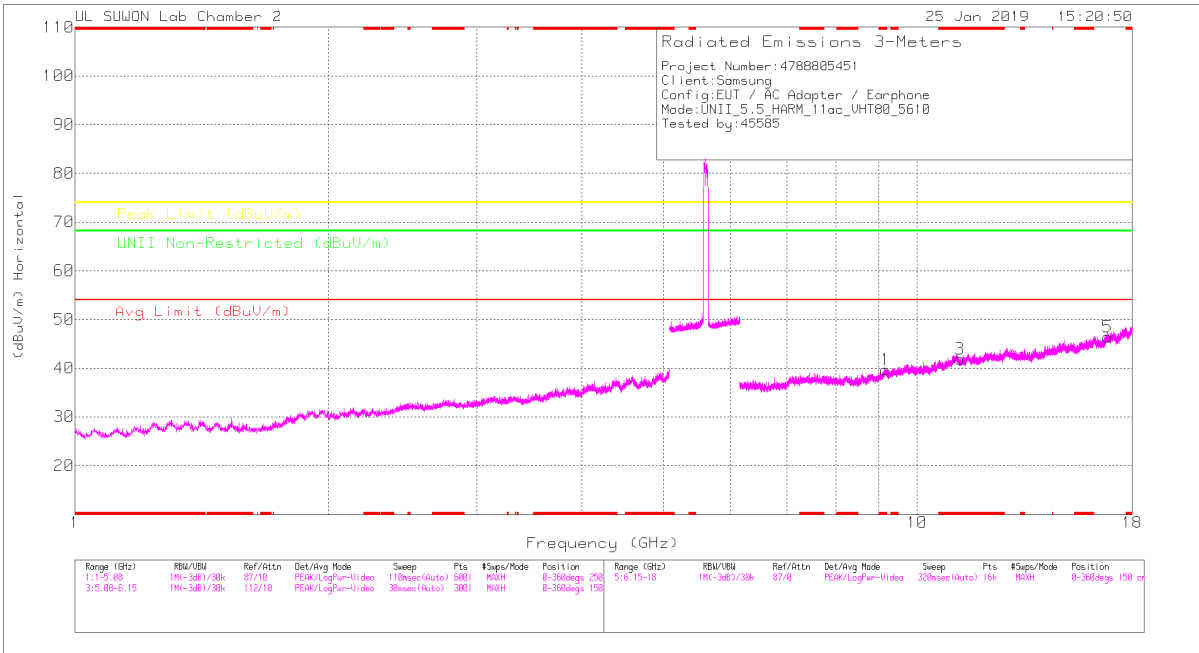

HIGH CHANNEL VERTICAL

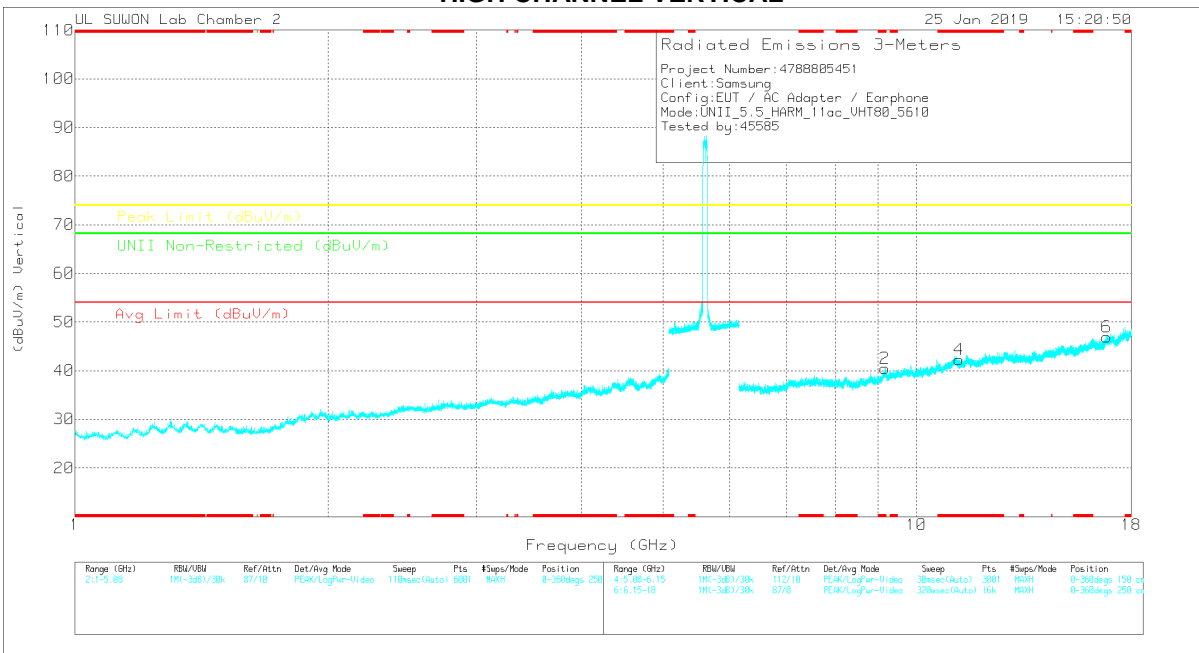

Note: Emission was scanned up to 40GHz; No emissions were detected above the noise floor which was at least 20dB below the specification limit.

HIGH CHANNEL DATA

Trace Markers

Marker	Frequency (GHz)	Marker Reading (dBuV)	Det	3117_00168724	GM1_HR(dB)	DC Corr (dB)	Corrected Reading (dBuV/m)	Avg Limit (dBuV/m)	Margin (dB)	Peak Limit (dBuV/m)	Margin (dB)	Limit Non-Restricted (dBuV/m)	Margin (dB)	Azimuth (Degs)	Height (cm)	Polarity
1	* 9.172	24.71	PK	36.6	-21.6	0	39.71	-	-	74	-34.29	-	-	0-360	150	H
3	* 11.227	23.85	PK	38.3	-20.3	0	41.85	-	-	74	-32.15	-	-	0-360	150	H
5	16.842	23.78	PK	41.2	-18.6	0	46.38	-	-	-	-	68.2	-21.82	0-360	150	H
2	* 9.174	25.4	PK	36.6	-21.5	0	40.5	-	-	74	-33.5	-	-	0-360	250	V
4	* 11.225	24.3	PK	38.3	-20.3	0	42.3	-	-	74	-31.7	-	-	0-360	250	V
6	16.84	24.31	PK	41.2	-18.6	0	46.91	-	-	-	-	68.2	-21.29	0-360	250	V

* - indicates frequency in CFR47 Pt 15 / IC RSS-Restricted Band
 PK – Peak Detector

Note: Only peak measurement was performed. Because peak measurement result of unwanted emission is less than average limit (54dBuV/m).

11.4. 5.8 GHz

11.4.1. TX ABOVE 1GHz 802.11a MODE IN THE 5.8GHz BAND BANDEDGE (LOW CHANNEL)

HORIZONTAL PEAK PLOT

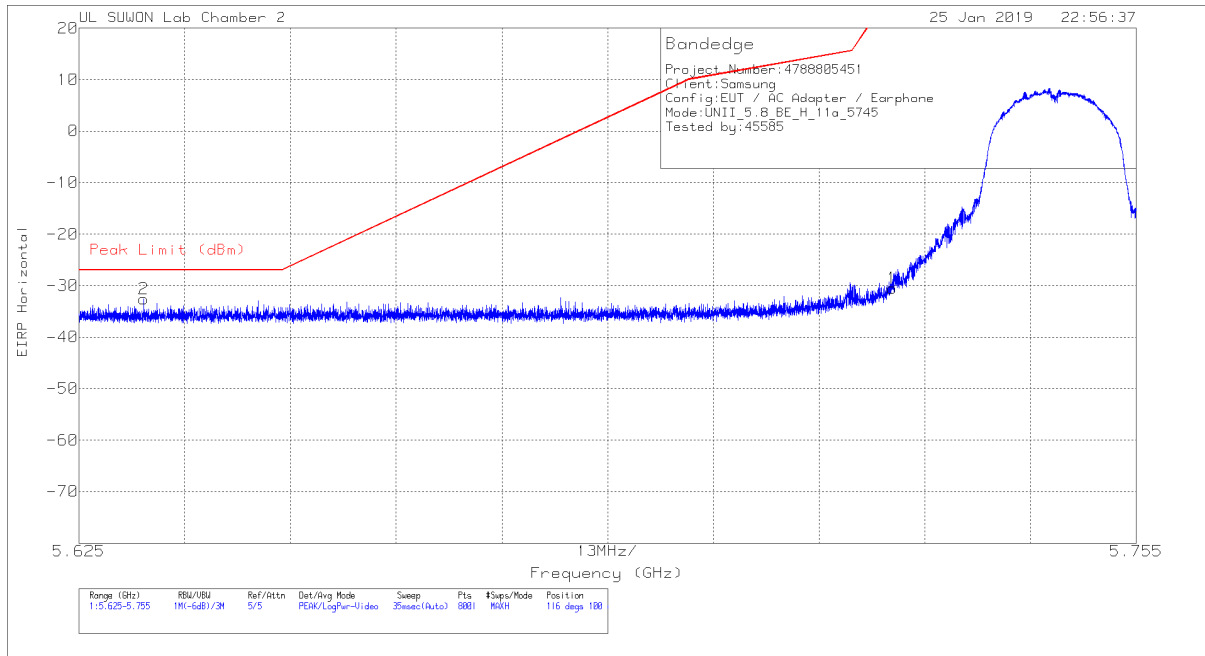

HORIZONTAL DATA

Trace Markers

Marker	Frequency (GHz)	Meter Reading (dBm)	Det	170531_3117[00 168724]	Path_2_10dB	Conversion Factor (dB)	DC Corr (dB)	Corrected Reading EIRP	Peak Limit (dBm)	PK Margin (dB)	Azimuth (Degs)	Height (cm)	Polarity
1	5.725	-61.25	Pk	34.5	-15.6	11.8	0	-30.55	26.97	-57.52	116	100	H
2	5.633	-63.06	Pk	34.4	-15.7	11.8	0	-32.56	-27	-5.56	116	100	H

Pk - Peak detector

VERTICAL PEAK PLOT

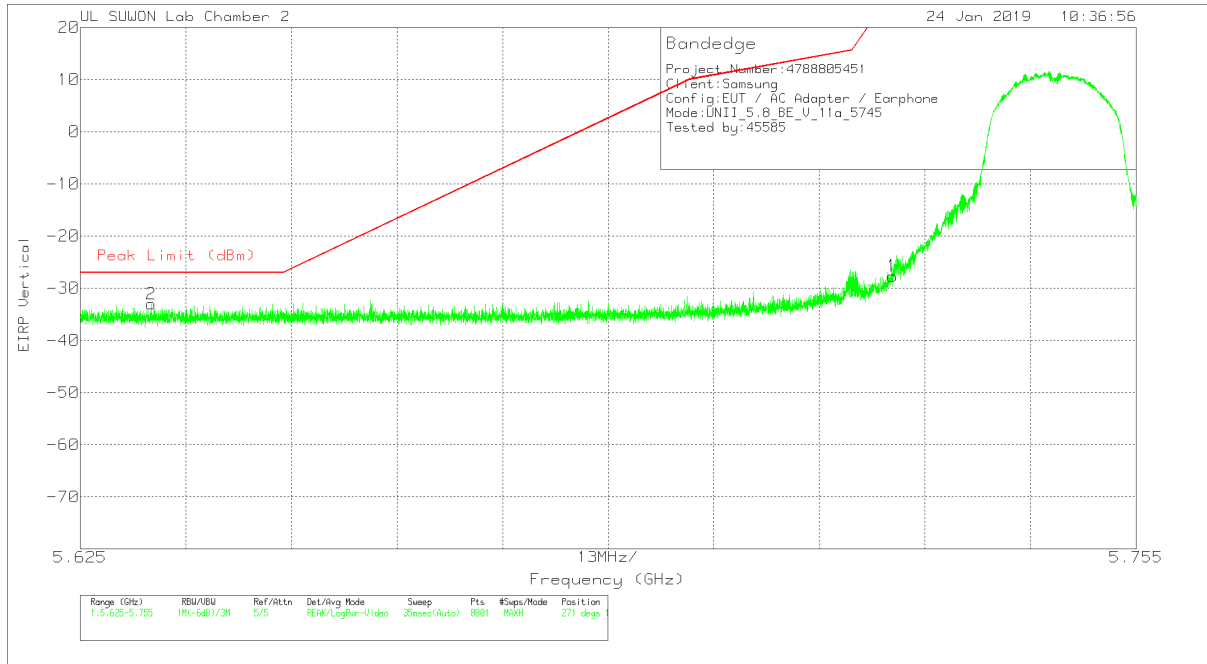

VERTICAL DATA

Trace Markers

Marker	Frequency (GHz)	Meter Reading (dBm)	Det	170531_3117[00 168724]	Path_2_10dB	Conversion Factor (dB)	DC Corr (dB)	Corrected Reading EIRP	Peak Limit (dBm)	PK Margin (dB)	Azimuth (Degs)	Height (cm)	Polarity
1	5.725	-58.38	Pk	34.5	-15.6	11.8	0	-27.68	26.97	-54.65	271	140	V
2	5.634	-63.5	Pk	34.4	-15.7	11.8	0	-33	-27	-6	271	140	V

Pk - Peak detector

BANDEDGE (HIGH CHANNEL)

HORIZONTAL PEAK PLOT

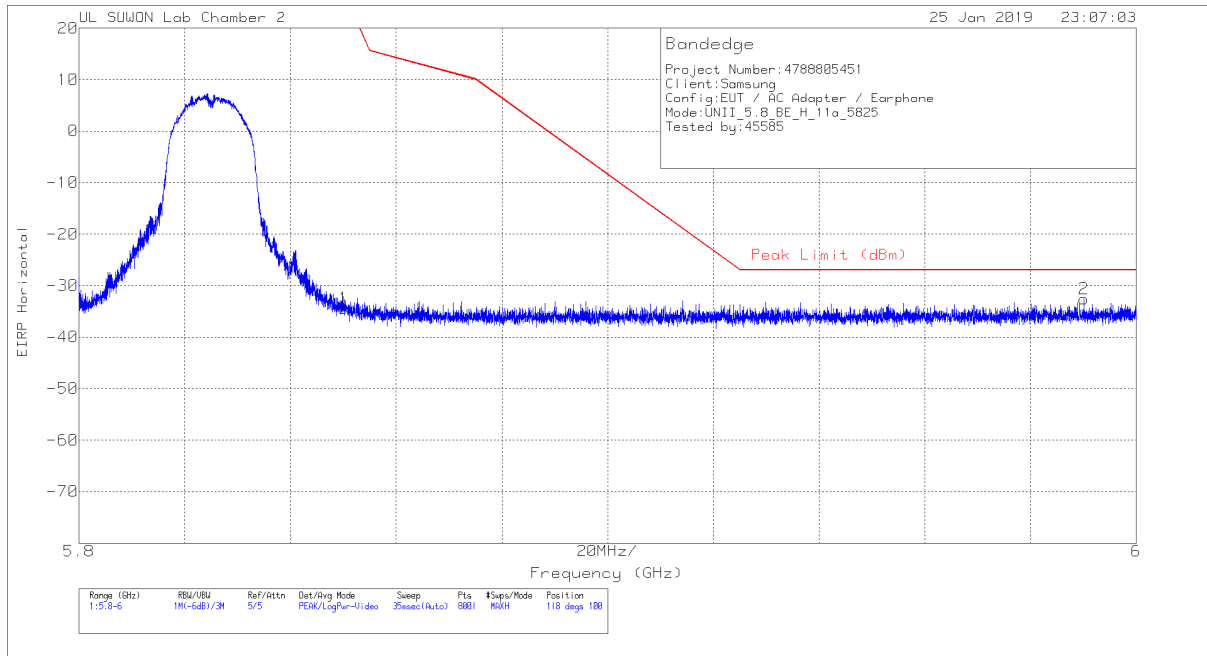

HORIZONTAL DATA

Trace Markers

Marker	Frequency (GHz)	Meter Reading (dBm)	Det	170531_3117[00 168724]	Path_2_10dB	Conversion Factor (dB)	DC Corr (dB)	Corrected Reading EIRP	Peak Limit (dBm)	PK Margin (dB)	Azimuth (Degs)	Height (cm)	Polarity
1	5.85	-65.16	Pk	34.5	-15.5	11.8	0	-34.36	26.94	-61.3	118	100	H
2	5.99	-63.83	Pk	34.8	-15.4	11.8	0	-32.63	-27	-5.63	118	100	H

Pk - Peak detector

VERTICAL PEAK PLOT

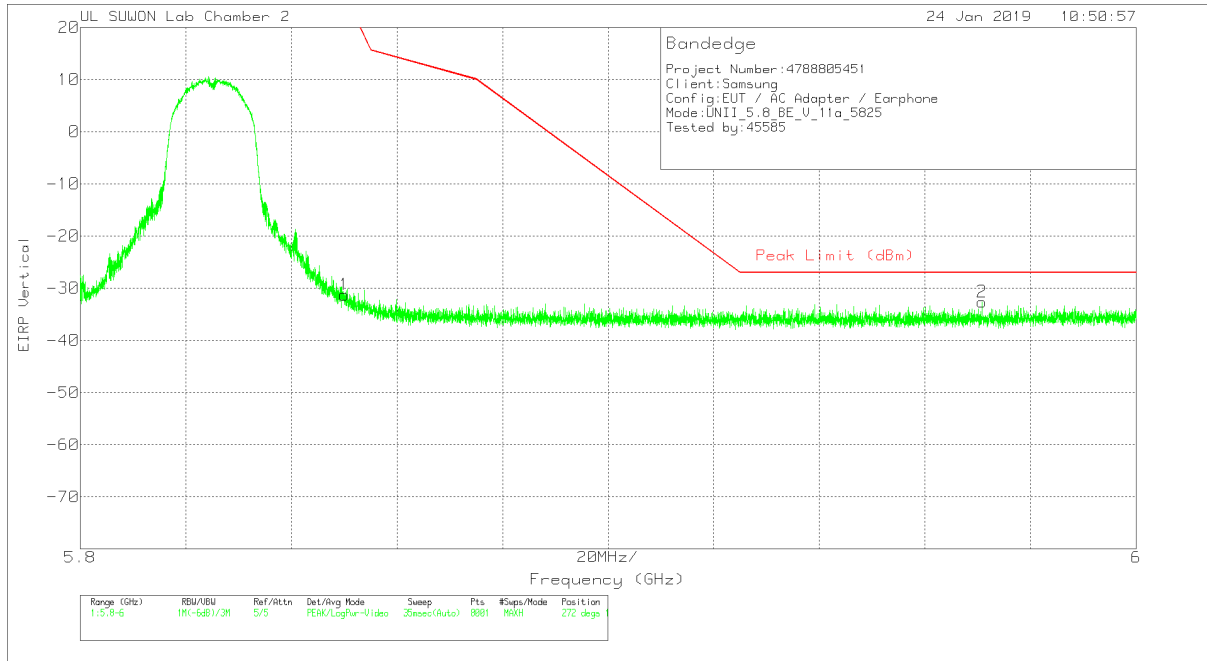

VERTICAL DATA

Trace Markers

Marker	Frequency (GHz)	Meter Reading (dBm)	Det	170531_3117[00 168724]	Path_2_10dB	Conversion Factor (dB)	DC Corr (dB)	Corrected Reading EIRP	Peak Limit (dBm)	PK Margin (dB)	Azimuth (Degs)	Height (cm)	Polarity
1	5.85	-62.04	Pk	34.5	-15.5	11.8	0	-31.24	26.94	-58.18	272	154	V
2	5.971	-63.72	Pk	34.7	-15.4	11.8	0	-32.62	-27	-5.62	272	154	V

Pk - Peak detector

HARMONICS AND SPURIOUS EMISSIONS

LOW CHANNEL HORIZONTAL

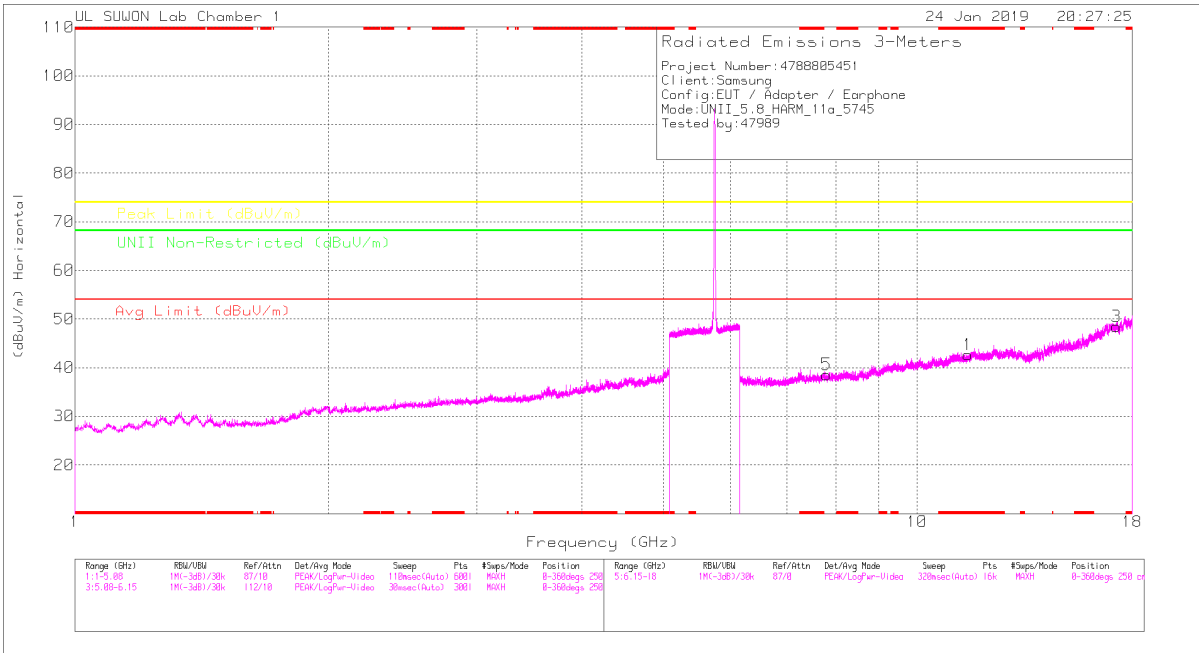

LOW CHANNEL VERTICAL

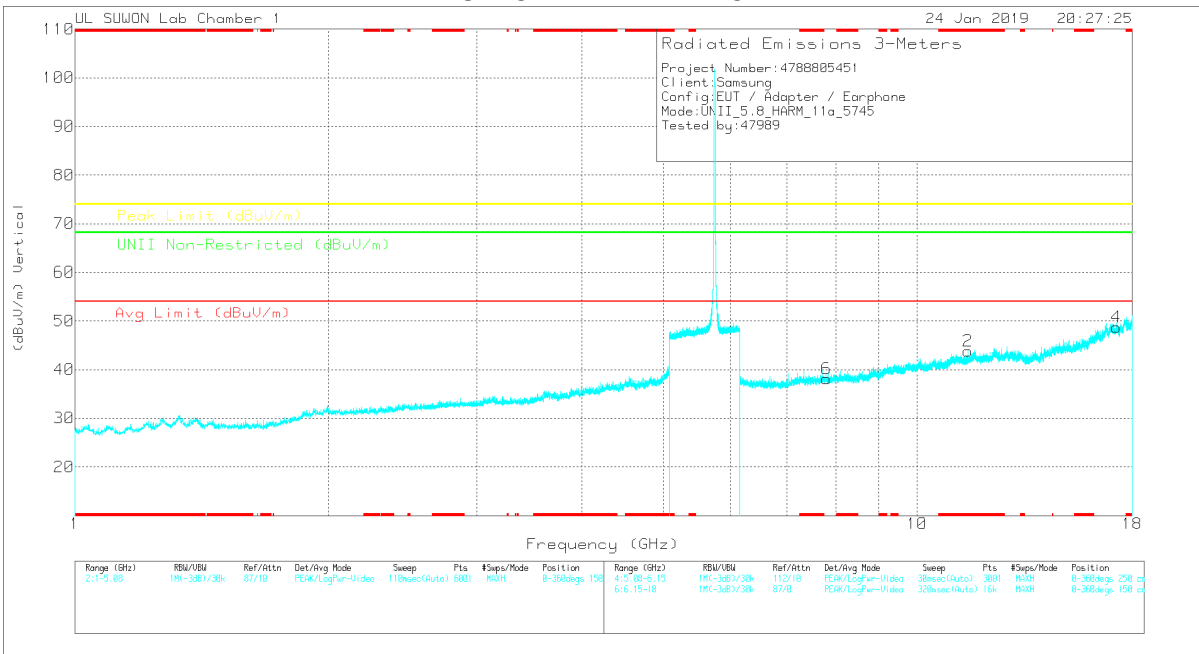

Note: Emission was scanned up to 40GHz; No emissions were detected above the noise floor which was at least 20dB below the specification limit.

LOW CHANNEL DATA

Trace Markers

Marker	Frequency (GHz)	Meas Reading (dBuV)	Det	3117_00168717	60Hz_HR(dB)	DC Corr (dB)	Corrected Reading (dBuV/m)	Avg Limit (dBuV/m)	Margin (dB)	Peak Limit (dBuV/m)	Margin (dB)	Limit Non-Restricted (dBuV/m)	Margin (dB)	Azimuth (Degs)	Height (cm)	Polarity
1	*11.487	26.46	PK	38.5	-22.3	0	42.66	-	-	74	-31.34	-	-	0-360	150	H
3	17.235	23.87	PK	41.3	-16.7	0	48.47	-	-	-	-	68.2	-19.73	0-360	250	H
5	7.803	29.18	PK	35.9	-26.5	0	38.58	-	-	-	-	68.2	-29.62	0-360	150	H
2	*11.489	27.59	PK	38.5	-22.3	0	43.79	-	-	74	-30.21	-	-	0-360	250	V
4	17.234	24.26	PK	41.3	-16.8	0	48.76	-	-	-	-	68.2	-19.44	0-360	250	V
6	7.806	28.73	PK	35.9	-26.5	0	38.13	-	-	-	-	68.2	-30.07	0-360	150	V

* - indicates frequency in CFR47 Pt 15 / IC RSS-Restricted Band
 PK – Peak Detector

Note: Only peak measurement was performed. Because peak measurement result of unwanted emission is less than average limit (54dBuV/m).

MID CHANNEL HORIZONTAL

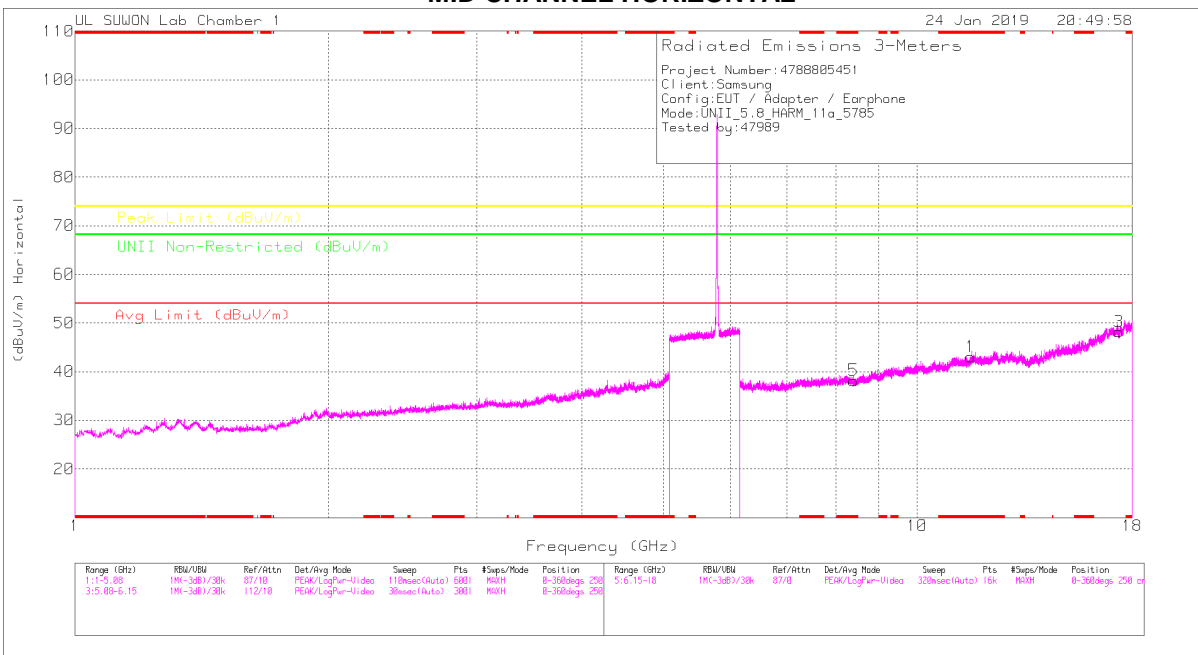

MID CHANNEL VERTICAL

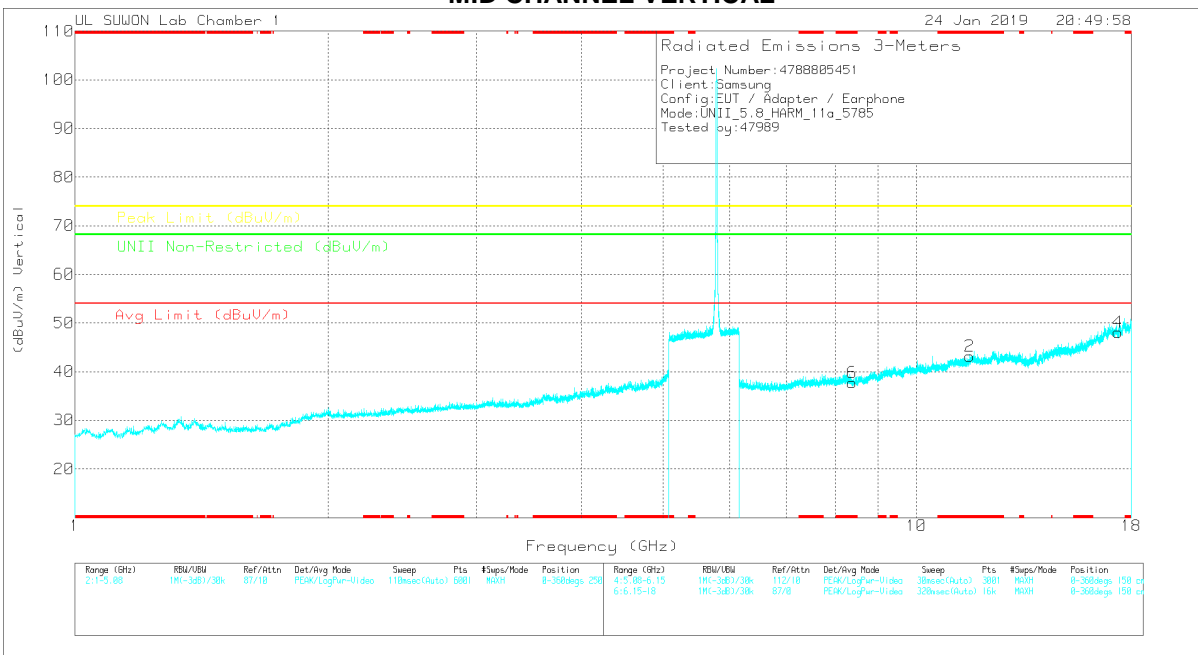

Note: Emission was scanned up to 40GHz; No emissions were detected above the noise floor which was at least 20dB below the specification limit.

MID CHANNEL DATA

Trace Markers

Marker	Frequency (GHz)	Marker Reading (dBuV)	Det	3117_00188717	66Hz_HR(dB)	DC Corr (dB)	Corrected Reading (dBuV/m)	Avg Limit (dBuV/m)	Margin (dB)	Peak Limit (dBuV/m)	Margin (dB)	Unit Non-Restricted (dBuV/m)	Margin (dB)	Azimuth (Degs)	Height (cm)	Polarity
1	*11.568	27	PK	38.6	-22.5	0	43.1	-	-	74	-30.9	-	-	0-360	150	H
3	17.35	24.51	PK	41.2	-17.5	0	48.21	-	-	-	-	68.2	-19.99	0-360	250	H
5	*8.395	27.69	PK	36.3	-25.8	0	38.19	-	-	74	-35.81	-	-	0-360	250	H
2	*11.566	27.08	PK	38.6	-22.5	0	43.18	-	-	74	-30.82	-	-	0-360	150	V
4	17.356	24.45	PK	41.2	-17.6	0	48.05	-	-	-	-	68.2	-20.15	0-360	250	V
6	*8.39	27.09	PK	36.3	-25.7	0	37.69	-	-	74	-36.31	-	-	0-360	150	V

* - indicates frequency in CFR47 Pt 15 / IC RSS-Restricted Band
 PK – Peak Detector

Note: Only peak measurement was performed. Because peak measurement result of unwanted emission is less than average limit (54dBuV/m).

HIGH CHANNEL HORIZONTAL

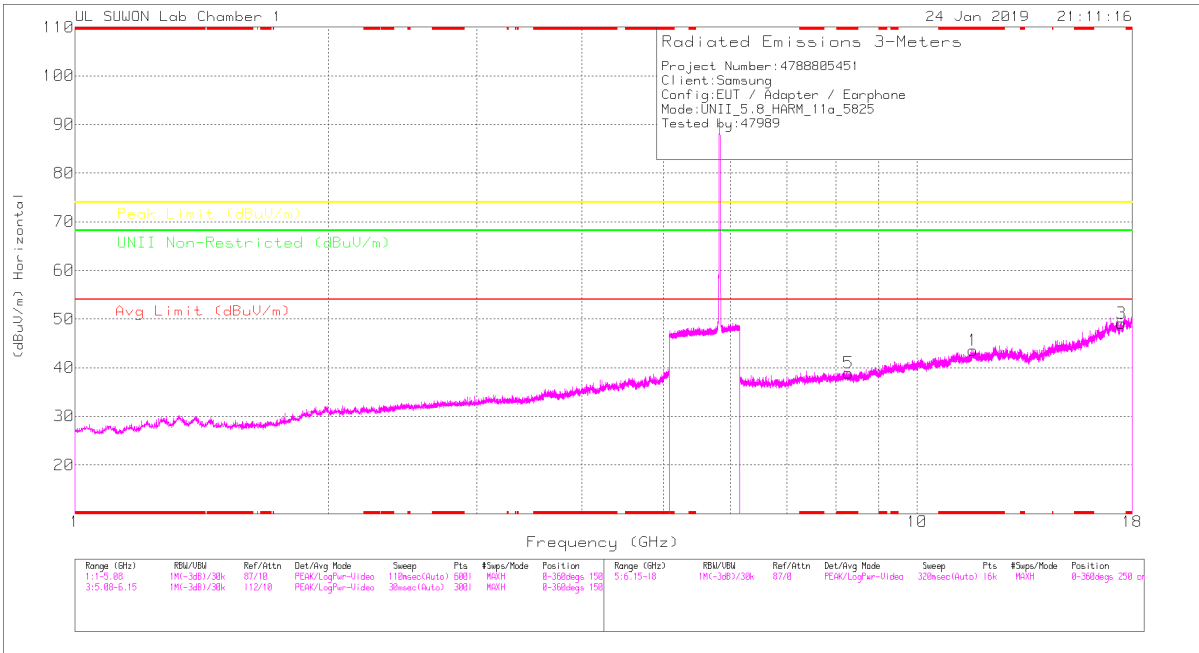

HIGH CHANNEL VERTICAL

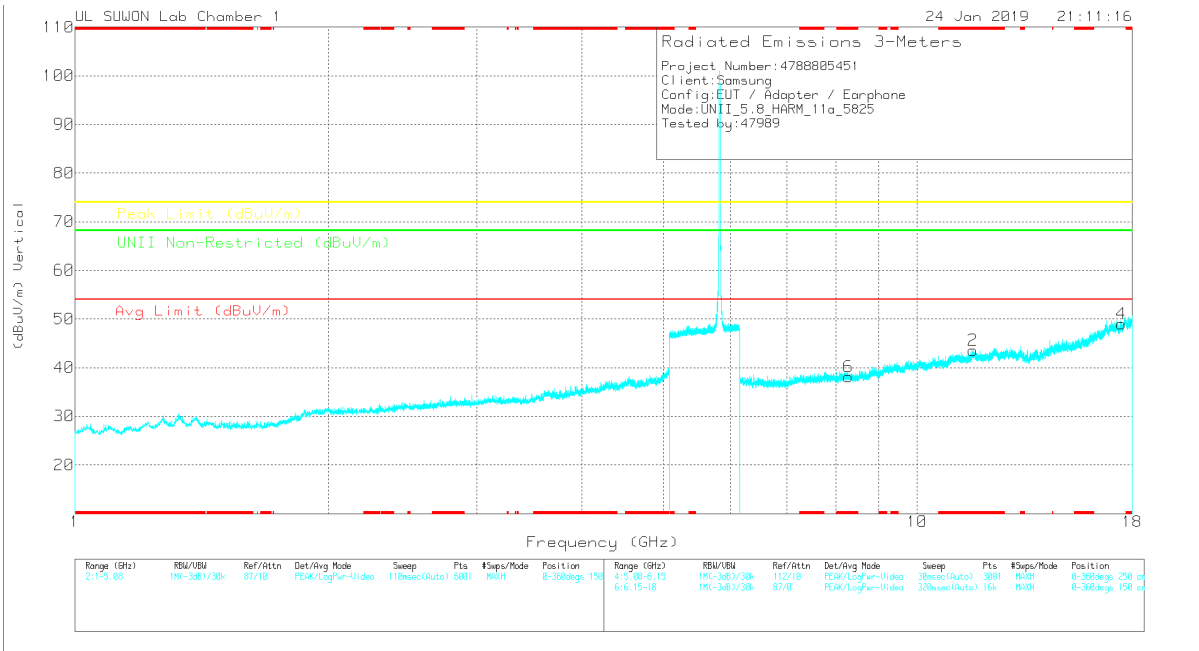

Note: Emission was scanned up to 40GHz; No emissions were detected above the noise floor which was at least 20dB below the specification limit.

HIGH CHANNEL DATA

Trace Markers

Marker	Frequency (GHz)	Marker Reading (dBuV)	Det	3117_00168717	GM1_H1(dB)	DC Corr (dB)	Corrected Reading (dBuV/m)	Avg Limit (dBuV/m)	Margin (dB)	Peak Limit (dBuV/m)	Margin (dB)	Limit Non-Restricted (dBuV/m)	Margin (dB)	Azimuth (Degs)	Height (cm)	Polarity
1	*11.643	26.62	PK	38.7	-21.7	0	43.62	-	-	74	-30.38	-	-	0-360	150	H
3	17.482	24.48	PK	41.2	-16.6	0	49.08	-	-	-	-	68.2	-19.12	0-360	150	H
5	*8.289	27.83	PK	36.4	-25.3	0	38.93	-	-	74	-35.07	-	-	0-360	250	H
2	*11.646	26.53	PK	38.7	-21.7	0	43.53	-	-	74	-30.47	-	-	0-360	250	V
4	17.476	24.27	PK	41.2	-16.5	0	48.97	-	-	-	-	68.2	-19.23	0-360	250	V
6	*8.29	27.08	PK	36.4	-25.4	0	38.08	-	-	74	-35.92	-	-	0-360	150	V

* - indicates frequency in CFR47 Pt 15 / IC RSS-Restricted Band
 PK – Peak Detector

Note: Only peak measurement was performed. Because peak measurement result of unwanted emission is less than average limit (54dBuV/m).

11.4.2.TX ABOVE 1GHz 802.11n HT20 MODE IN THE 5.8GHz BAND BANDEDGE (LOW CHANNEL)

HORIZONTAL PEAK PLOT

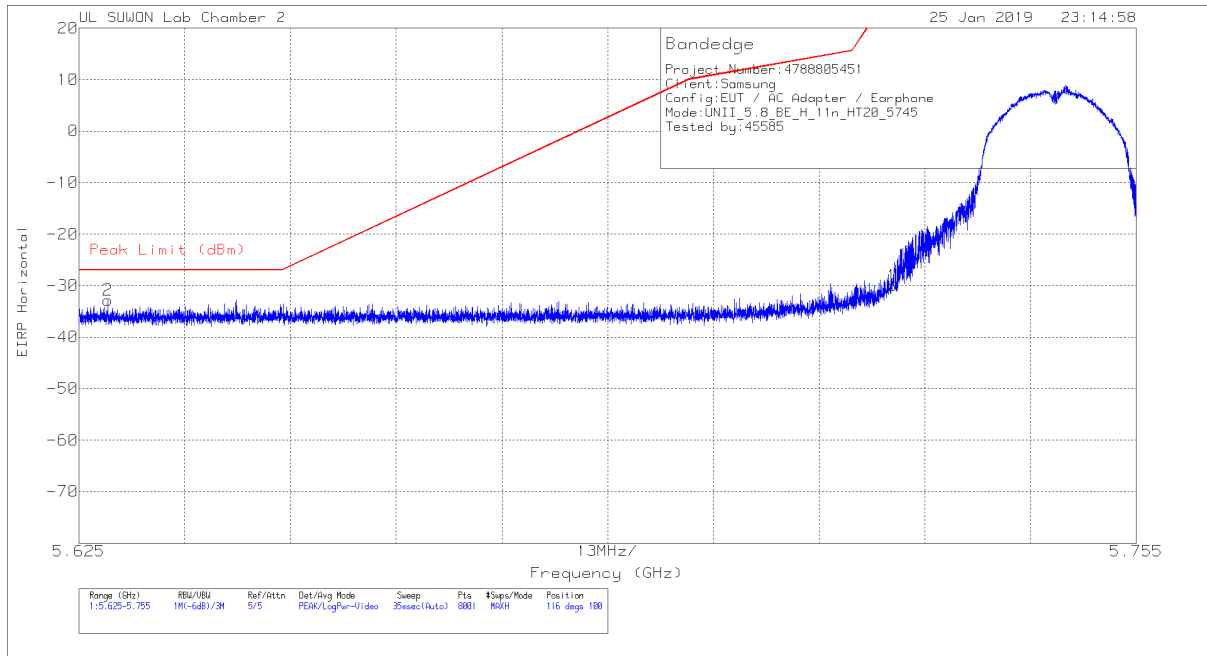

HORIZONTAL DATA

Trace Markers

Marker	Frequency (GHz)	Meter Reading (dBm)	Det	170531_3117[00 168724]	Path_2_10dB	Conversion Factor (dB)	DC Corr (dB)	Corrected Reading EIRP	Peak Limit (dBm)	PK Margin (dB)	Azimuth (Degs)	Height (cm)	Polarity
1	5.725	-60.74	Pk	34.5	-15.6	11.8	0	-30.04	26.97	-57.01	116	100	H
2	5.629	-63.27	Pk	34.4	-15.7	11.8	0	-32.77	-27	-5.77	116	100	H

Pk - Peak detector

VERTICAL PEAK PLOT

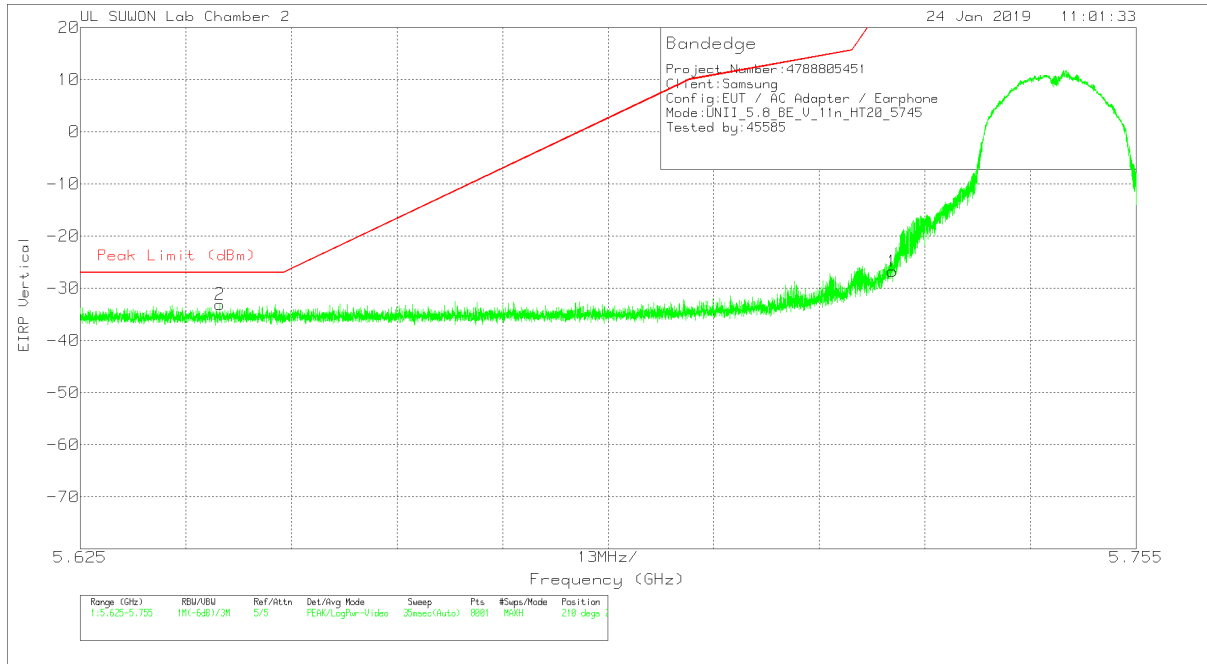

VERTICAL DATA

Trace Markers

Marker	Frequency (GHz)	Meter Reading (dBm)	Det	170531_3117[00 168724]	Path_2_10dB	Conversion Factor (dB)	DC Corr (dB)	Corrected Reading EIRP	Peak Limit (dBm)	PK Margin (dB)	Azimuth (Degs)	Height (cm)	Polarity
1	5.725	-57.46	Pk	34.5	-15.6	11.8	0	-26.76	26.97	-53.73	210	205	V
2	5.642	-63.6	Pk	34.4	-15.7	11.8	0	-33.1	-27	-6.1	210	205	V

Pk - Peak detector

BANDEDGE (HIGH CHANNEL)

HORIZONTAL PEAK AND AVERAGE PLOT

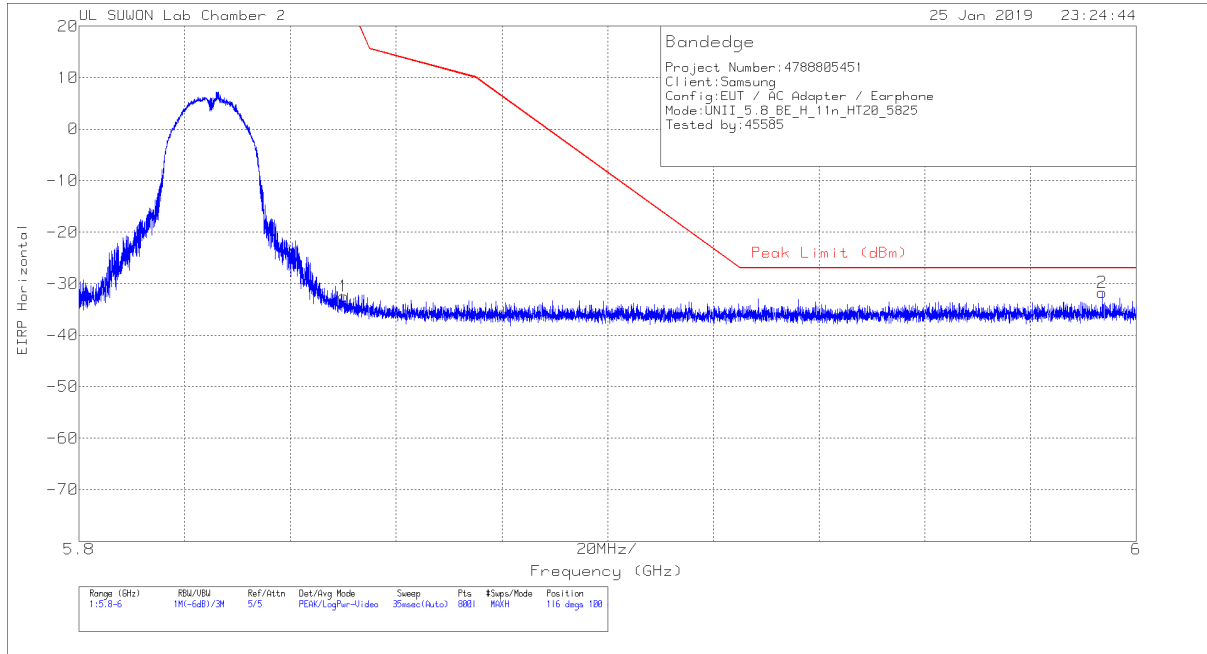

HORIZONTAL DATA

Trace Markers

Marker	Frequency (GHz)	Meter Reading (dBm)	Det	170531_3117[00 168724]	Path_2_10dB	Conversion Factor (dB)	DC Corr (dB)	Corrected Reading EIRP	Peak Limit (dBm)	PK Margin (dB)	Azimuth (Degs)	Height (cm)	Polarity
1	5.85	-63.28	Pk	34.5	-15.5	11.8	0	-32.48	26.94	-59.42	116	100	H
2	5.994	-62.9	Pk	34.8	-15.4	11.8	0	-31.7	-27	-4.7	116	100	H

Pk - Peak detector

VERTICAL PEAK PLOT

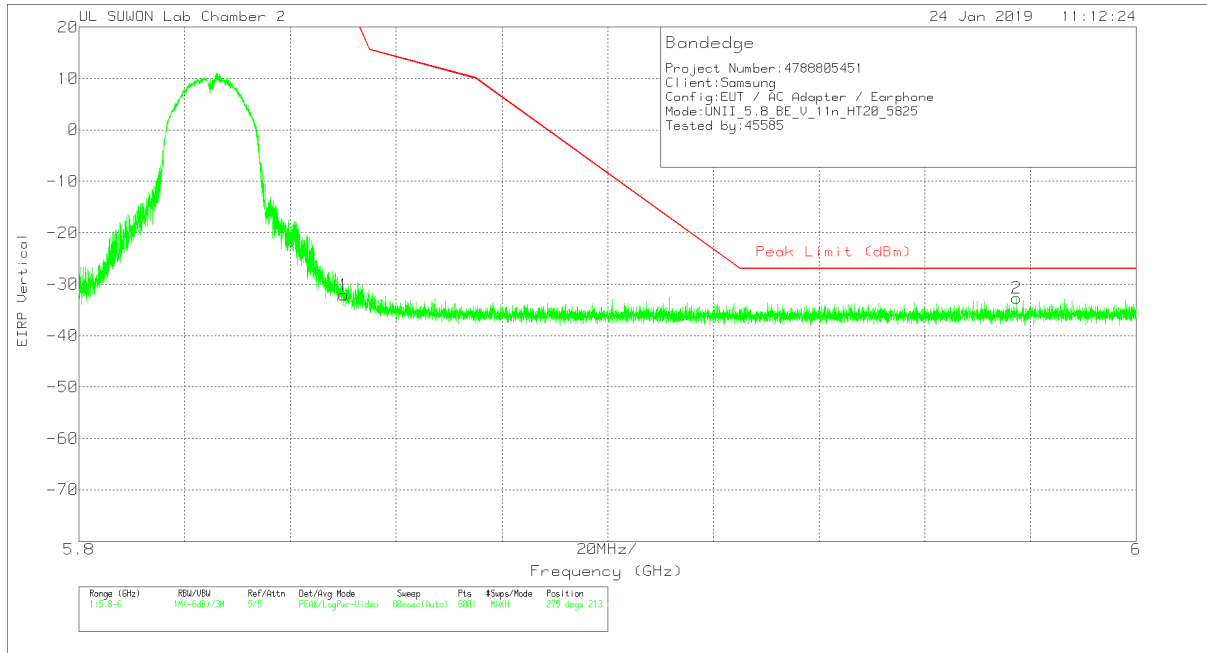

VERTICAL DATA

Trace Markers

Marker	Frequency (GHz)	Meter Reading (dBm)	Det	170531_3117[00 168724]	Path_2_10dB	Conversion Factor (dB)	DC Corr (dB)	Corrected Reading EIRP	Peak Limit (dBm)	PK Margin (dB)	Azimuth (Degs)	Height (cm)	Polarity
1	5.85	-62.86	Pk	34.5	-15.5	11.8	0	-32.06	26.94	-59	275	213	V
2	5.977	-63.77	Pk	34.7	-15.4	11.8	0	-32.67	-27	-5.67	275	213	V

Pk - Peak detector
 Radiated Emissions

HARMONICS AND SPURIOUS EMISSIONS

LOW CHANNEL HORIZONTAL

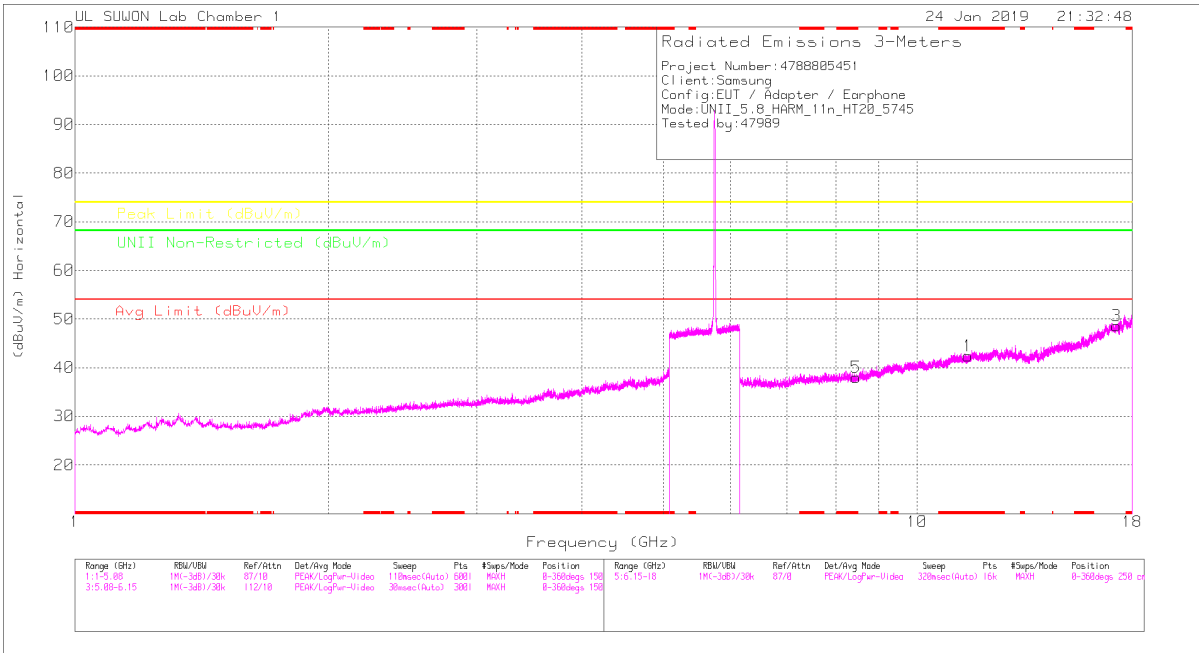

LOW CHANNEL VERTICAL

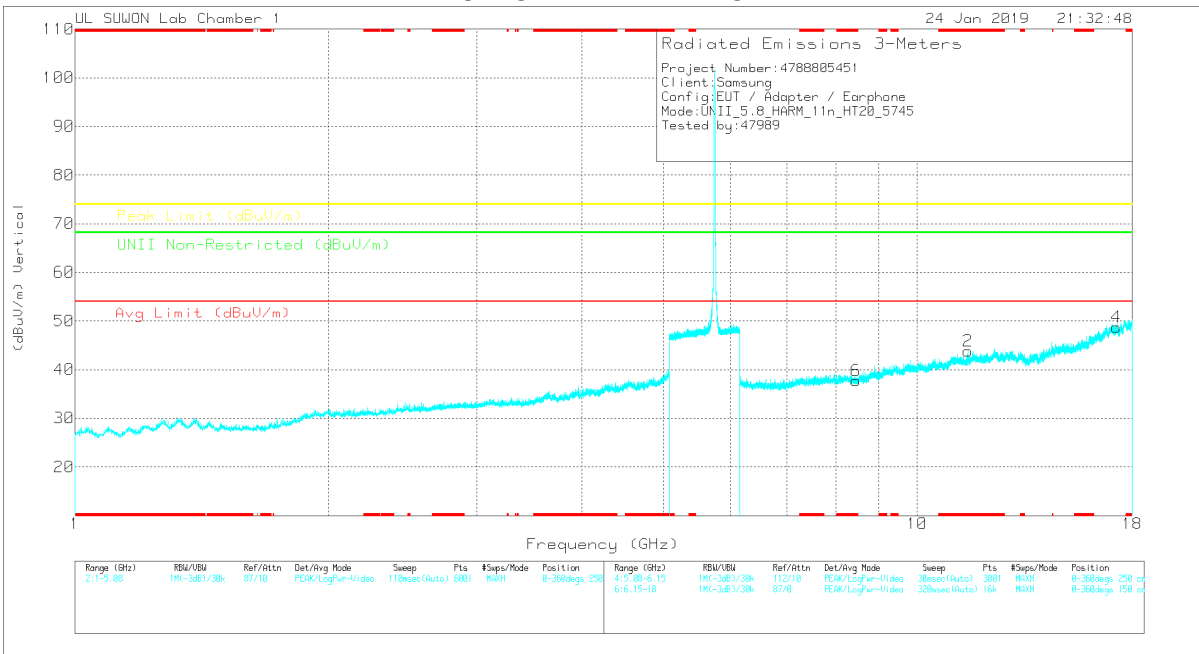

Note: Emission was scanned up to 40GHz; No emissions were detected above the noise floor which was at least 20dB below the specification limit.

LOW CHANNEL DATA

Trace Markers

Marker	Frequency (GHz)	Meas Reading (dBuV)	Det	3117_00168717	GM1_H1(dB)	DC Corr (dB)	Corrected Reading (dBuV/m)	Avg Limit (dBuV/m)	Margin (dB)	Peak Limit (dBuV/m)	Margin (dB)	Limit Non-Restricted (dBuV/m)	Margin (dB)	Azimuth (Degs)	Height (cm)	Polarity
1	*11.489	26.19	PK	38.5	-22.3	0	42.39	-	-	74	-31.61	-	-	0-360	150	H
3	17.234	24.16	PK	41.3	-16.8	0	48.66	-	-	-	-	68.2	-19.54	0-360	150	H
5	*8.455	27.47	PK	36.3	-25.8	0	37.97	-	-	74	-36.03	-	-	0-360	150	H
2	*11.49	27.65	PK	38.5	-22.3	0	43.85	-	-	74	-30.15	-	-	0-360	150	V
4	17.233	24.27	PK	41.3	-16.8	0	48.77	-	-	-	-	68.2	-19.43	0-360	150	V
6	*8.458	27.21	PK	36.3	-25.8	0	37.71	-	-	74	-36.29	-	-	0-360	250	V

* - indicates frequency in CFR47 Pt 15 / IC RSS-Restricted Band
 PK – Peak Detector

Note: Only peak measurement was performed. Because peak measurement result of unwanted emission is less than average limit (54dBuV/m).

MID CHANNEL HORIZONTAL

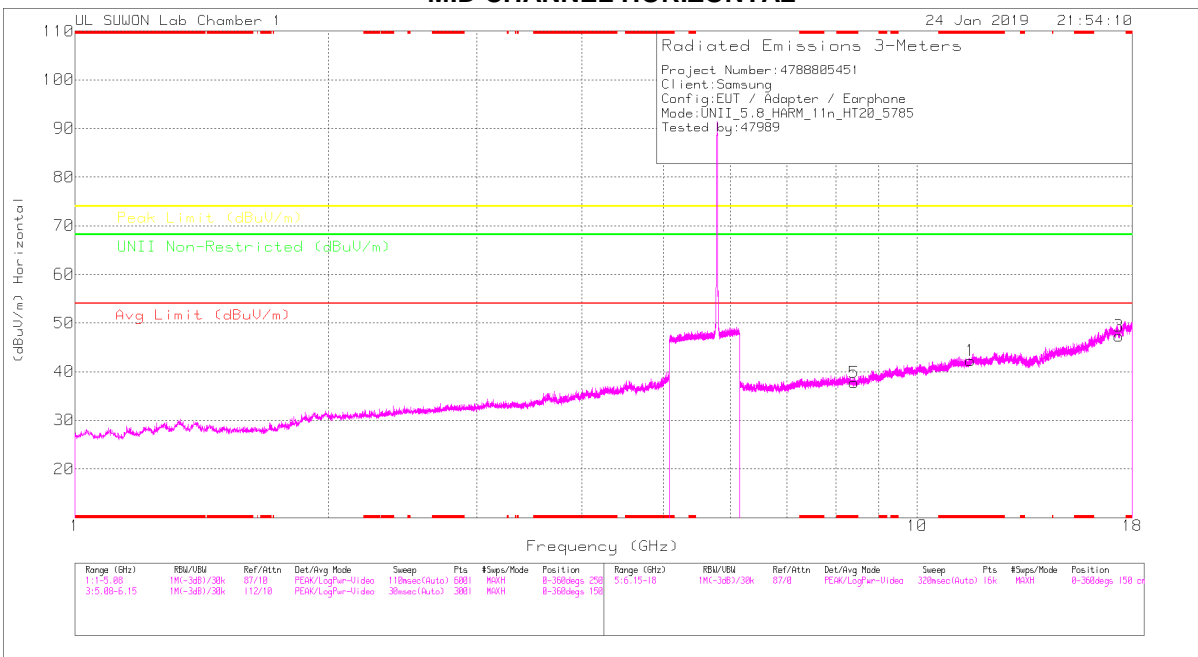

MID CHANNEL VERTICAL

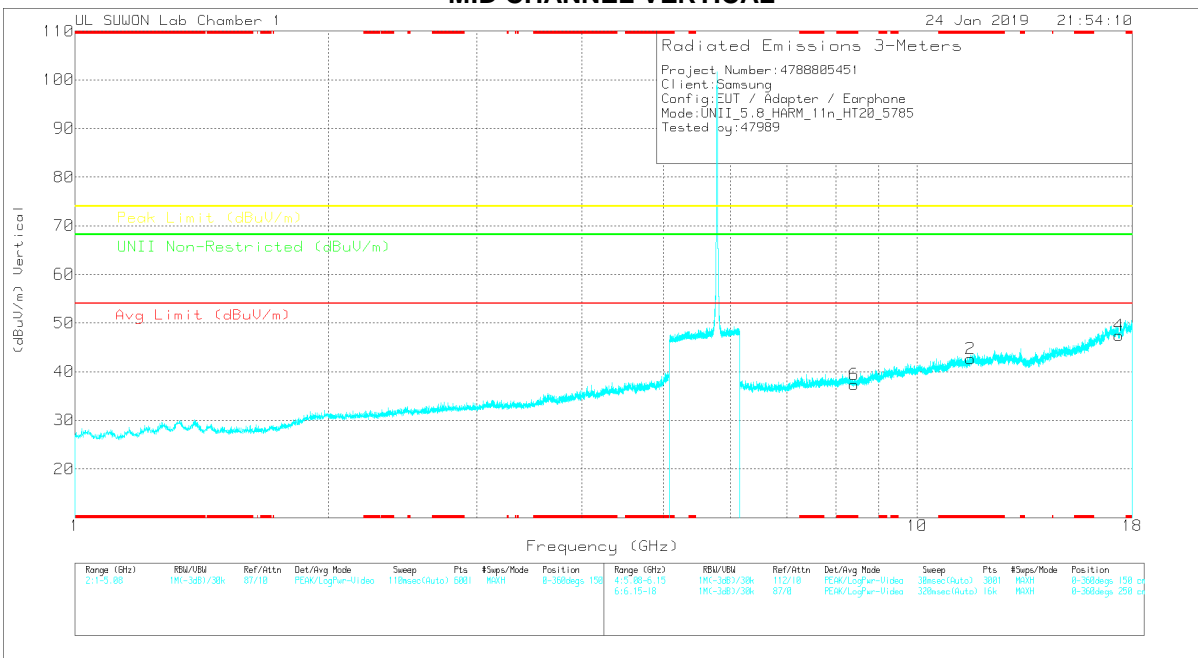

Note: Emission was scanned up to 40GHz; No emissions were detected above the noise floor which was at least 20dB below the specification limit.

MID CHANNEL DATA

Trace Markers

Marker	Frequency (GHz)	Marker Reading (dBuV)	Det	3117_00168717	66GHz_HP[dB]	DC Corr (dB)	Corrected Reading (dBuV/m)	Aug Limit (dBuV/m)	Margin (dB)	Peak Limit (dBuV/m)	Margin (dB)	Unit Non-Restricted (dBuV/m)	Margin (dB)	Altitude (Degs)	Height (cm)	Polarity
1	* 11.57	26.21	PK	38.6	-22.5	0	42.31	-	-	74	-31.69	-	-	0-360	150	H
3	17.355	23.69	PK	41.2	-17.6	0	47.29	-	-	-	-	68.2	-20.91	0-360	250	H
5	* 8.423	27.19	PK	36.3	-25.8	0	37.69	-	-	74	-36.31	-	-	0-360	250	H
2	* 11.57	26.6	PK	38.6	-22.5	0	42.7	-	-	74	-31.3	-	-	0-360	150	V
4	17.355	23.83	PK	41.2	-17.6	0	47.43	-	-	-	-	68.2	-20.77	0-360	150	V
6	* 8.423	26.88	PK	36.3	-25.8	0	37.38	-	-	74	-36.62	-	-	0-360	150	V

* - indicates frequency in CFR47 Pt 15 / IC RSS-Restricted Band
 PK – Peak Detector

Note: Only peak measurement was performed. Because peak measurement result of unwanted emission is less than average limit (54dBuV/m).

HIGH CHANNEL HORIZONTAL

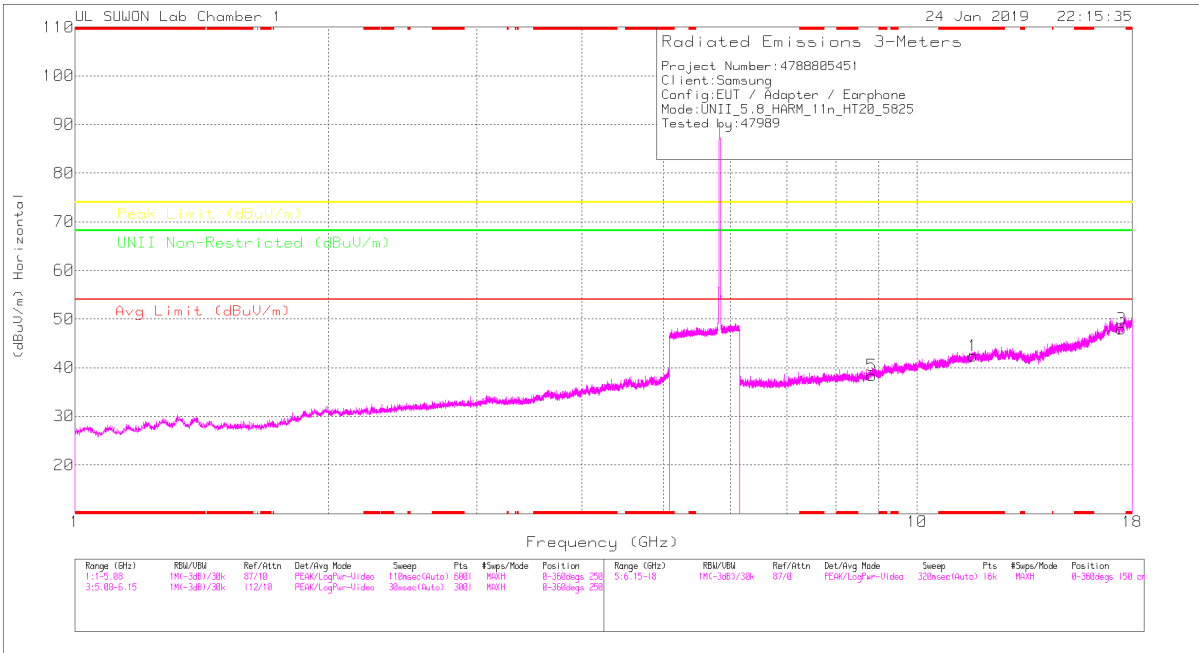

HIGH CHANNEL VERTICAL

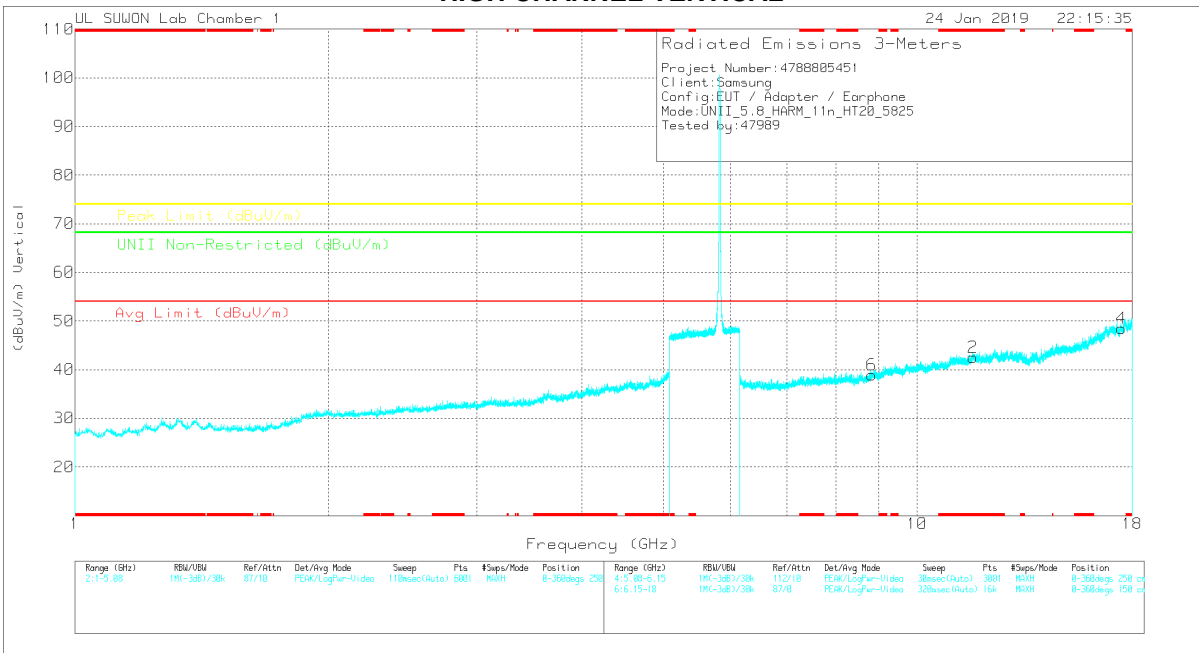

Note: Emission was scanned up to 40GHz; No emissions were detected above the noise floor which was at least 20dB below the specification limit.

HIGH CHANNEL DATA

Trace Markers

Marker	Frequency (GHz)	Meter Reading (dBuV)	Det	3117_00168717	60Hz_HF1(dB)	DC Corr (dB)	Corrected Reading (dBuV/m)	Avg Limit (dBuV/m)	Margin (dB)	Peak Limit (dBuV/m)	Margin (dB)	Limit Non-Restricted (dBuV/m)	Margin (dB)	Azimuth (Degs)	Height (cm)	Polarity
1	*11.65	25.35	PK	38.7	-21.7	0	42.35	-	-	74	-31.65	-	-	0-360	250	H
3	17.475	23.24	PK	41.2	-16.5	0	47.94	-	-	-	-	68.2	-20.26	0-360	150	H
5	8.833	26.17	PK	36.5	-24.3	0	38.37	-	-	-	-	68.2	-29.83	0-360	150	H
2	*11.65	25.53	PK	38.7	-21.7	0	42.53	-	-	74	-31.47	-	-	0-360	250	V
4	17.475	23.81	PK	41.2	-16.5	0	48.51	-	-	-	-	68.2	-19.69	0-360	250	V
6	8.832	26.86	PK	36.5	-24.4	0	38.96	-	-	-	-	68.2	-29.24	0-360	150	V

* - indicates frequency in CFR47 Pt 15 / IC RSS-Restricted Band
 PK – Peak Detector

Note: Only peak measurement was performed. Because peak measurement result of unwanted emission is less than average limit (54dBuV/m).

11.4.3.TX ABOVE 1GHz 802.11n HT40 MODE IN THE 5.8GHz BAND BANDEDGE (LOW CHANNEL)

HORIZONTAL PEAK PLOT

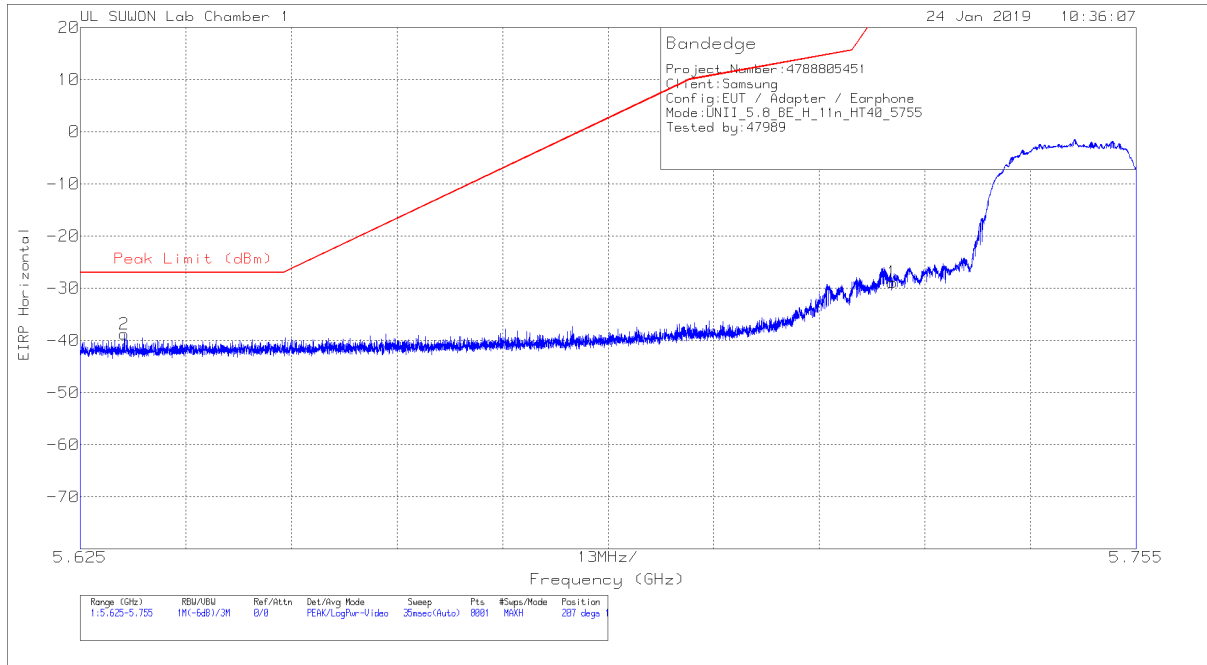

HORIZONTAL DATA

Trace Markers

Marker	Frequency (GHz)	Meter Reading (dBm)	Det	3117_00168717	10dB[dB]	Conversion Factor (dB)	DC Corr (dB)	Corrected Reading EIRP	Peak Limit (dBm)	PK Margin (dB)	Azimuth (Degs)	Height (cm)	Polarity	
1	5.725	-54.37	Pk		34.8	-21.1	11.8	0	-28.87	26.97	-55.84	207	187	H
2	5.63	-64.11	Pk		34.7	-21.2	11.8	0	-38.81	-27	-11.81	207	187	H

Pk - Peak detector

VERTICAL PEAK PLOT

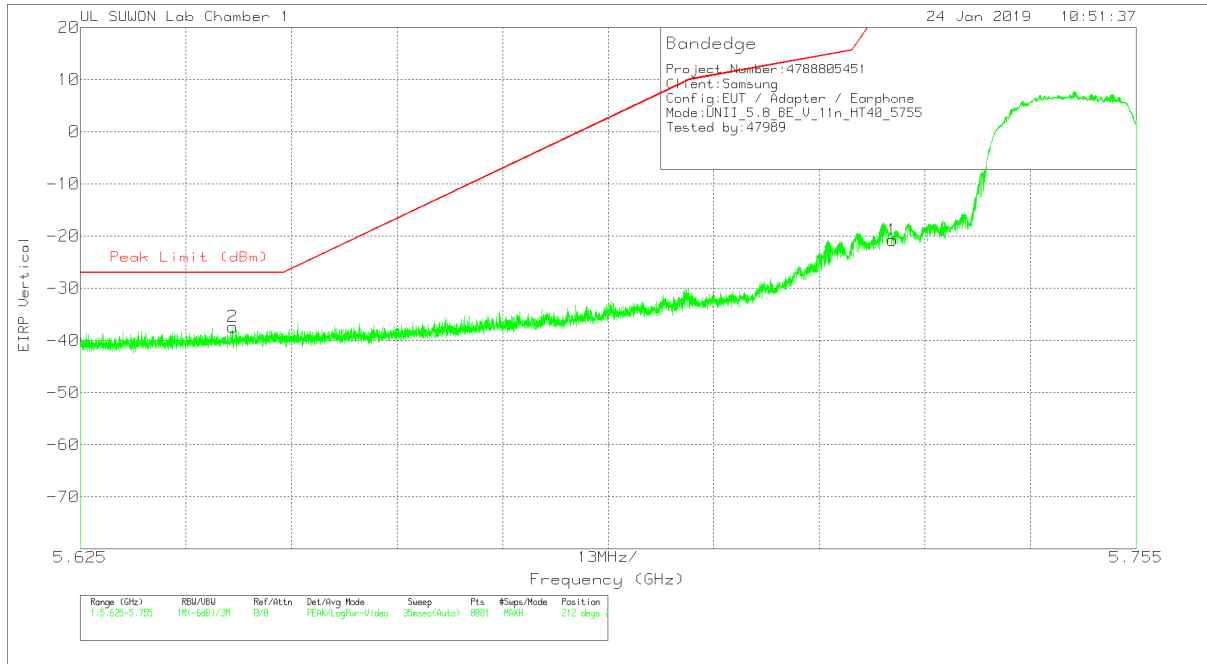

VERTICAL DATA

Trace Markers

Marker	Frequency (GHz)	Meter Reading (dBm)	Det	3117_00168717	10dB[dB]	Conversion Factor (dB)	DC Corr (dB)	Corrected Reading EIRP	Peak Limit (dBm)	PK Margin (dB)	Azimuth (Degs)	Height (cm)	Polarity
1	5.725	-46.26	Pk	34.8	-21.1	11.8	0	-20.76	26.97	-47.73	212	214	V
2	5.644	-62.78	Pk	34.7	-21.1	11.8	0	-37.38	-27	-10.38	212	214	V

Pk - Peak detector

BANDEDGE (HIGH CHANNEL)

HORIZONTAL PEAK PLOT

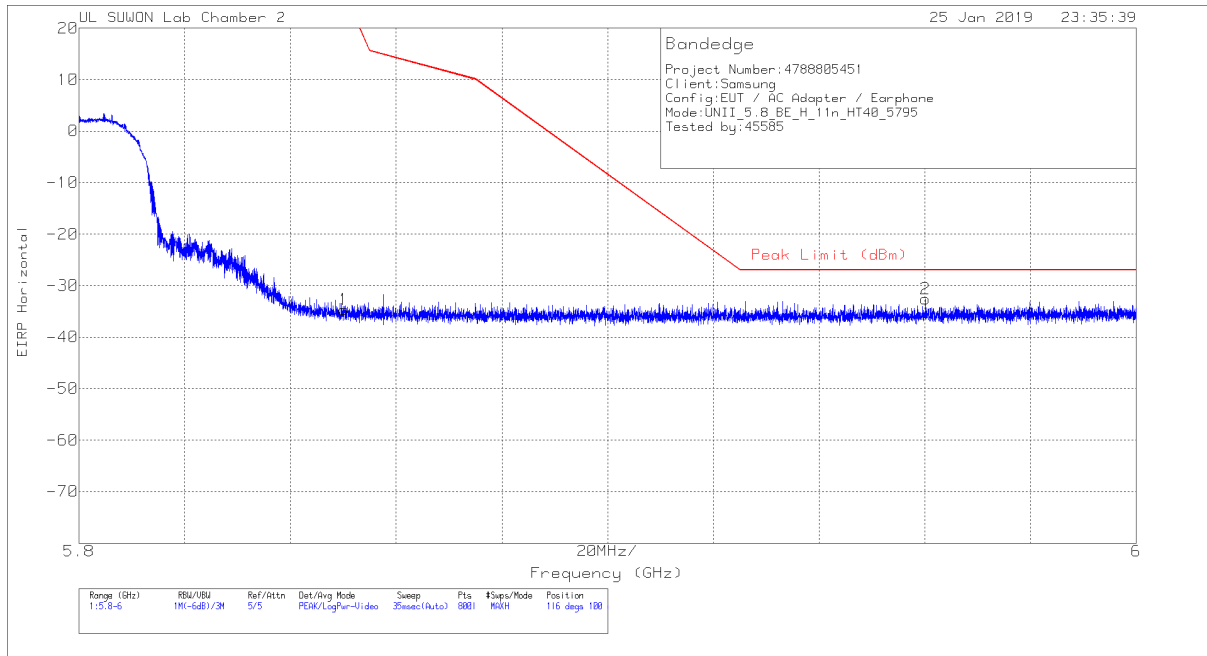

HORIZONTAL DATA

Trace Markers

Marker	Frequency (GHz)	Meter Reading (dBm)	Det	170531_3117[00 168724]	Path_2_10dB	Conversion Factor (dB)	DC Corr (dB)	Corrected Reading EIRP	Peak Limit (dBm)	PK Margin (dB)	Azimuth (Degs)	Height (cm)	Polarity
1	5.85	-65.46	Pk	34.5	-15.5	11.8	0	-34.66	26.94	-61.6	116	100	H
2	5.96	-63.6	Pk	34.6	-15.4	11.8	0	-32.6	-27	-5.6	116	100	H

Pk - Peak detector

VERTICAL PEAK PLOT

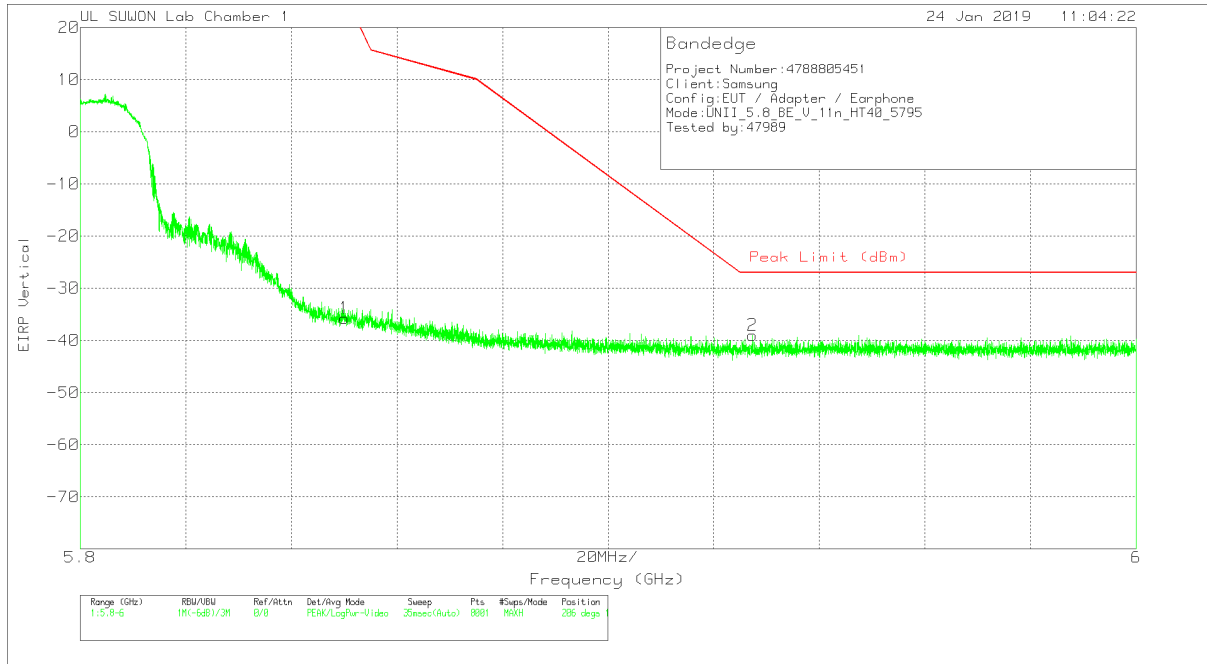

VERTICAL DATA

Trace Markers

Marker	Frequency (GHz)	Meter Reading (dBm)	Det	3117_00168717	10dB[dB]	Conversion Factor (dB)	DC Corr (dB)	Corrected Reading EIRP	Peak Limit (dBm)	PK Margin (dB)	Azimuth (Degs)	Height (cm)	Polarity
1	5.85	-61.54	Pk	35	-21	11.8	0	-35.74	26.94	-62.68	206	186	V
2	5.927	-65.1	Pk	35.1	-20.8	11.8	0	-39	-27	-12	206	186	V

Pk - Peak detector

HARMONICS AND SPURIOUS EMISSIONS

LOW CHANNEL HORIZONTAL

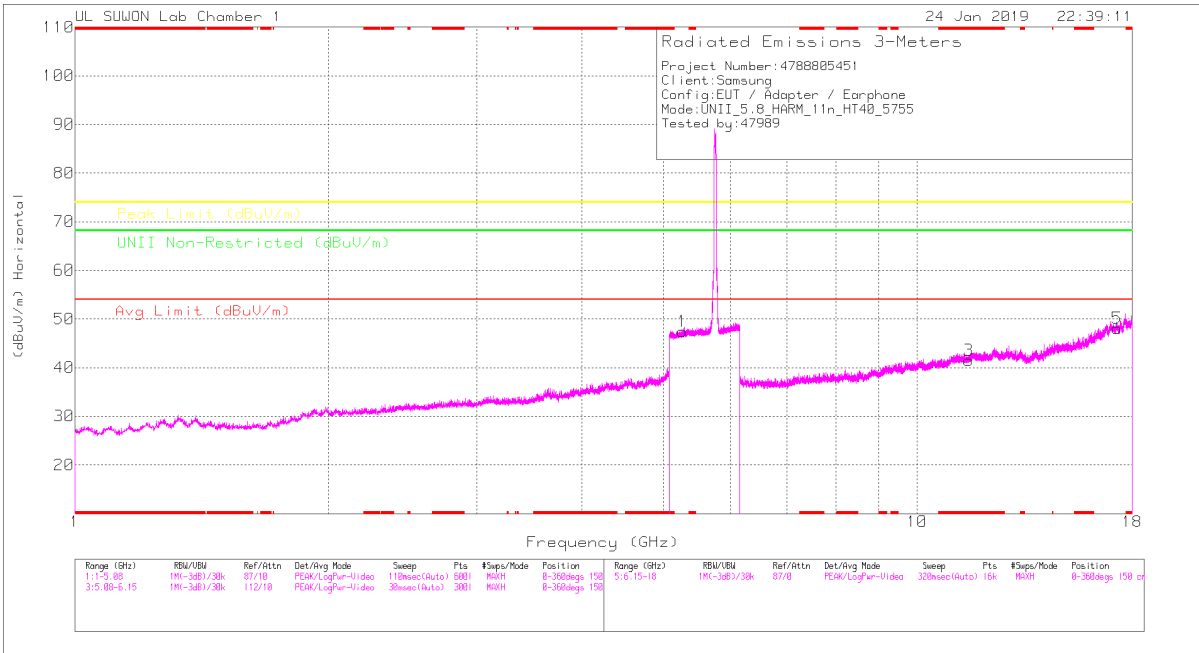

LOW CHANNEL VERTICAL

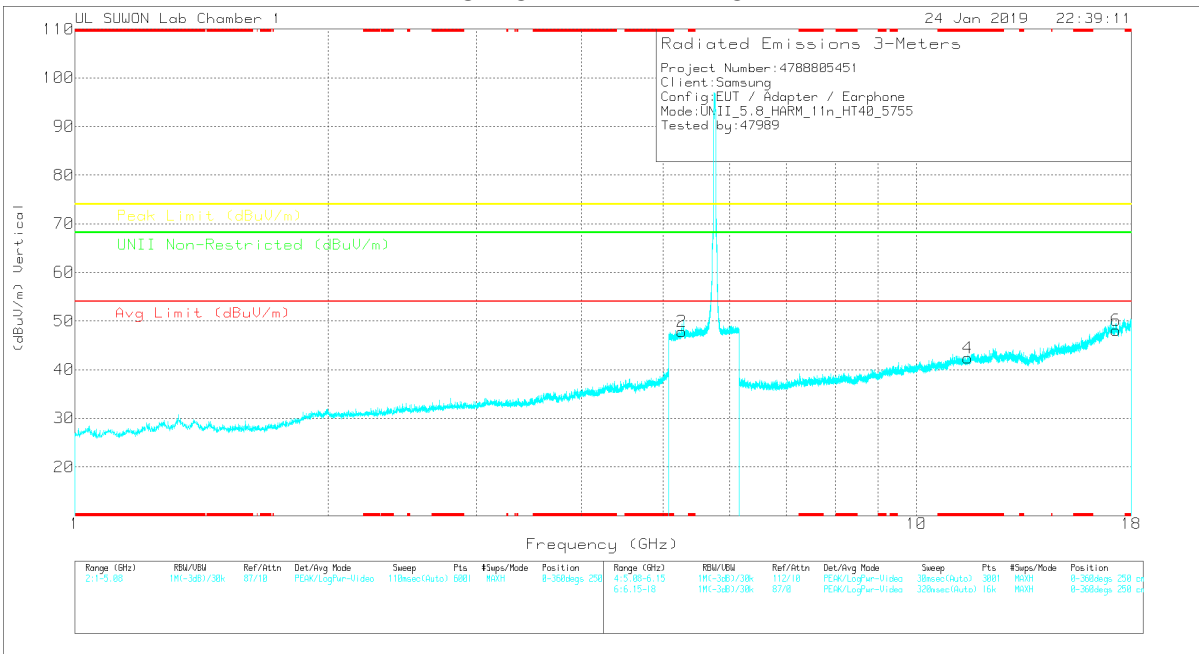

Note: Emission was scanned up to 40GHz; No emissions were detected above the noise floor which was at least 20dB below the specification limit.

LOW CHANNEL DATA

Trace Markers

Marker	Frequency (GHz)	Meter Reading (dBuV)	Det	3117_00168717	100B(dB)	DC Corr (dB)	Corrected Reading (dBuV/m)	Avg Limit (dBuV/m)	Margin (dB)	Peak Limit (dBuV/m)	Margin (dB)	U/NL Non-Restricted (dBuV/m)	Margin (dB)	Azimuth (Degs)	Height (cm)	Polarity
1	5.263	34.62	PK	34.6	-21.8	0	47.42	-	-	-	-	68.2	-20.78	0-360	250	H
2	5.265	34.99	PK	34.6	-21.8	0	47.79	-	-	-	-	68.2	-20.41	0-360	250	V
3	* 11.51	25.24	PK	38.5	-22.3	0	41.44	-	-	74	-32.56	-	-	0-360	250	H
5	17.265	23.34	PK	41.3	-16.5	0	48.14	-	-	-	-	68.2	-20.06	0-360	250	H
4	* 11.512	26.21	PK	38.5	-22.3	0	42.41	-	-	74	-31.59	-	-	0-360	250	V
6	17.265	23.25	PK	41.3	-16.5	0	48.05	-	-	-	-	68.2	-20.15	0-360	250	V

* - indicates frequency in CFR47 Pt 15 / IC RSS-Restricted Band
 PK – Peak Detector

Radiated Emissions

Frequency (GHz)	Meter Reading (dBuV)	Det	3117_00168717	100B(dB)	DC Corr (dB)	Corrected Reading (dBuV/m)	Avg Limit (dBuV/m)	Margin (dB)	Peak Limit (dBuV/m)	Margin (dB)	U/NL Non-Restricted (dBuV/m)	Margin (dB)	Azimuth (Degs)	Height (cm)	Polarity
5.263	45.46	PK-U	34.6	-21.8	0	58.26	-	-	-	-	68.2	-9.94	205	120	H
5.261	46.65	PK-U	34.6	-21.7	0	59.55	-	-	-	-	68.2	-8.65	229	133	V

* - indicates frequency in CFR47 Pt 15 / IC RSS-Restricted Band
 PK-U - U-NII: Maximum Peak

HIGH CHANNEL HORIZONTAL

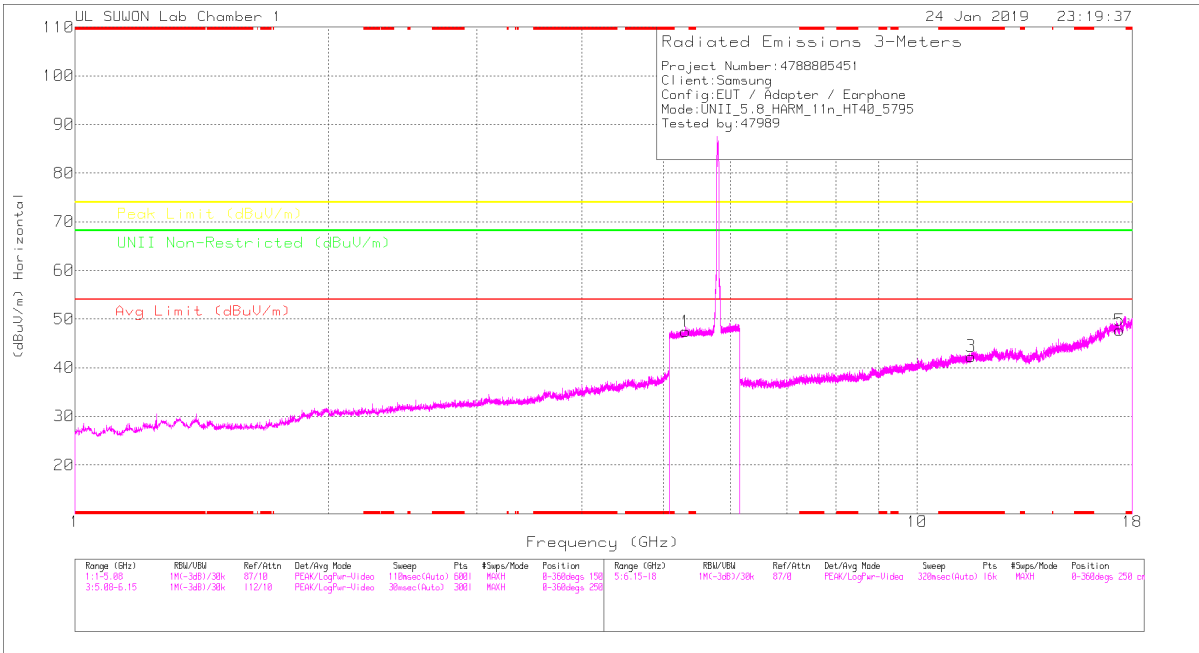

HIGH CHANNEL VERTICAL

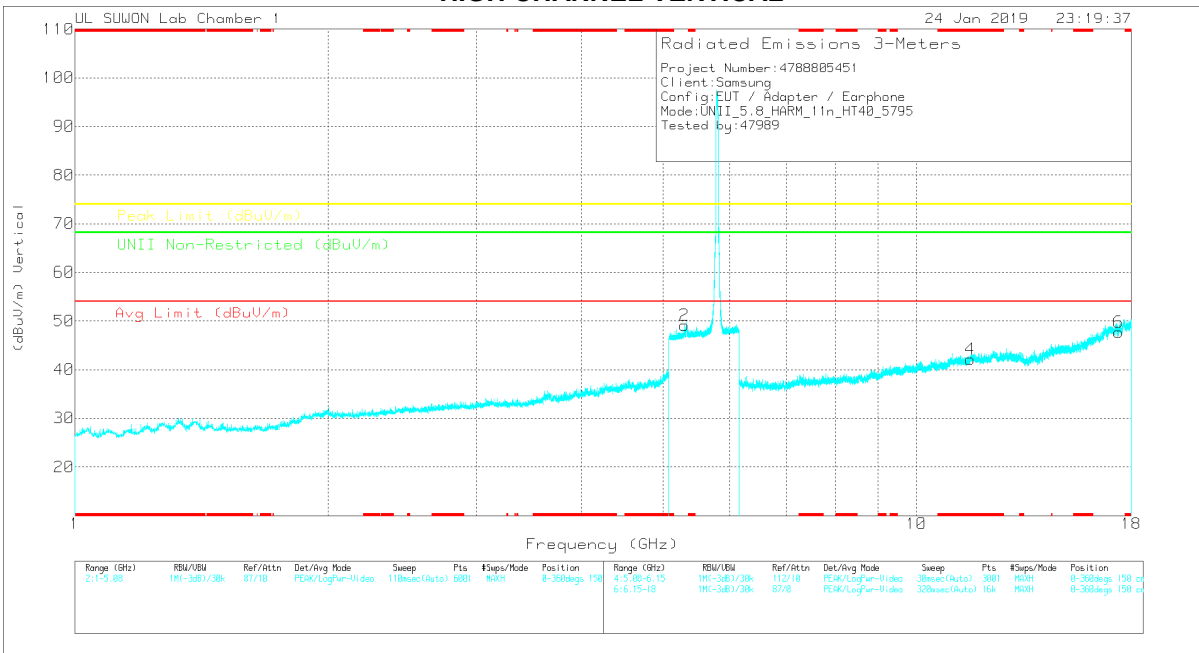

Note: Emission was scanned up to 40GHz; No emissions were detected above the noise floor which was at least 20dB below the specification limit.

HIGH CHANNEL DATA

Trace Markers

Marker	Frequency (GHz)	Meter Reading (dBuV)	Det	3117_00168717	100B(dB)	DC Corr (dB)	Corrected Reading (dBuV/m)	Avlg Limit (dBuV/m)	Margin (dB)	Peak Limit (dBuV/m)	Margin (dB)	U/NII Non-Restricted (dBuV/m)	Margin (dB)	Azimuth (Degs)	Height (cm)	Polarity
1	5.306	34.6	PK	34.6	-21.7	0	47.5	-	-	-	-	68.2	-20.7	0-360	250	H
2	5.302	36.28	PK	34.6	-21.7	0	49.18	-	-	-	-	68.2	-19.02	0-360	250	V
3	*11.59	26.13	PK	38.6	-22.4	0	42.33	-	-	74	-31.67	-	-	0-360	250	H
5	17.385	23.71	PK	41.2	-17.2	0	47.71	-	-	-	-	68.2	-20.49	0-360	150	H
4	*11.59	25.96	PK	38.6	-22.4	0	42.16	-	-	74	-31.84	-	-	0-360	250	V
6	17.385	23.75	PK	41.2	-17.2	0	47.75	-	-	-	-	68.2	-20.45	0-360	250	V

* - indicates frequency in CFR47 Pt 15 / IC RSS-Restricted Band
 PK – Peak Detector

Radiated Emissions

Frequency (GHz)	Meter Reading (dBuV)	Det	3117_00168717	100B(dB)	DC Corr (dB)	Corrected Reading (dBuV/m)	Avlg Limit (dBuV/m)	Margin (dB)	Peak Limit (dBuV/m)	Margin (dB)	U/NII Non-Restricted (dBuV/m)	Margin (dB)	Azimuth (Degs)	Height (cm)	Polarity
5.303	45.56	PK-U	34.6	-21.7	0	58.46	-	-	-	-	68.2	-9.74	204	100	H
5.302	47.79	PK-U	34.6	-21.7	0	60.69	-	-	-	-	68.2	-7.51	208	184	V

* - indicates frequency in CFR47 Pt 15 / IC RSS-Restricted Band
 PK-U - U-NII: Maximum Peak

11.4.1.TX ABOVE 1GHz 802.11ac VHT80 MODE IN THE 5.8GHz BAND LOWER BANDEDGE (MID CHANNEL)

HORIZONTAL PEAK PLOT

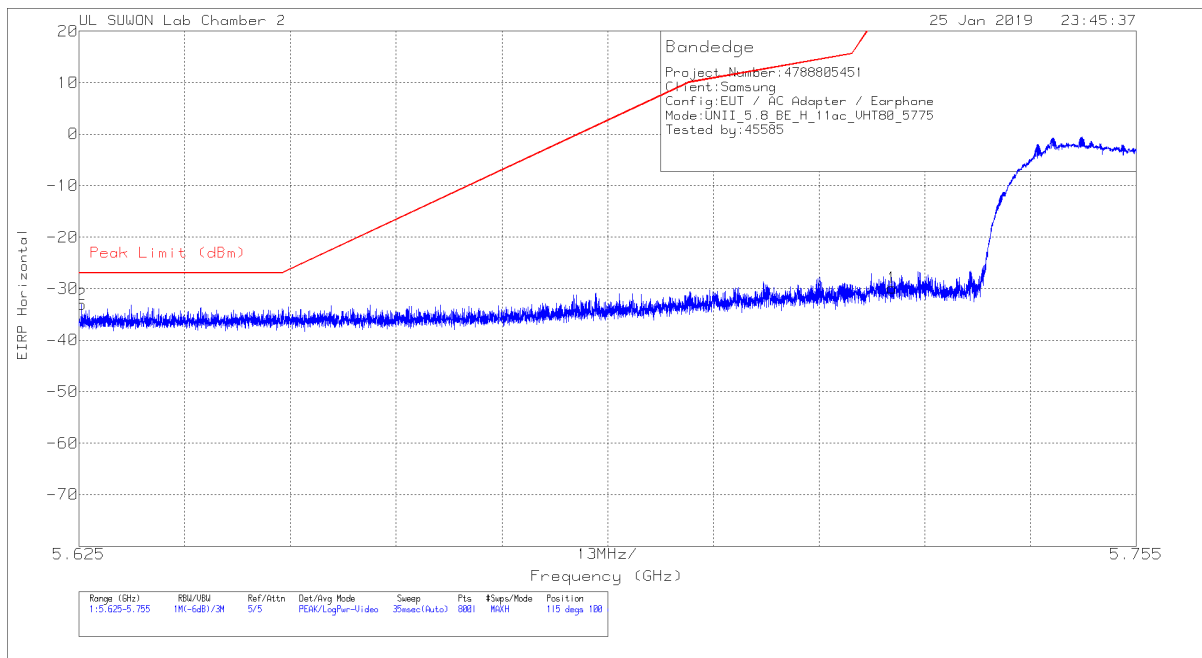

HORIZONTAL DATA

Trace Markers

Marker	Frequency (GHz)	Meter Reading (dBm)	Det	170531_3117[00 168724]	Path_2_10dB	Conversion Factor (dB)	DC Corr (dB)	Corrected Reading EIRP	Peak Limit (dBm)	PK Margin (dB)	Azimuth (Degs)	Height (cm)	Polarity
1	5.725	-60.62	Pk	34.5	-15.6	11.8	0	-29.92	26.97	-56.89	115	100	H
2	5.625	-63.52	Pk	34.4	-15.7	11.8	0	-33.02	-27	-6.02	115	100	H

Pk - Peak detector

VERTICAL PEAK PLOT

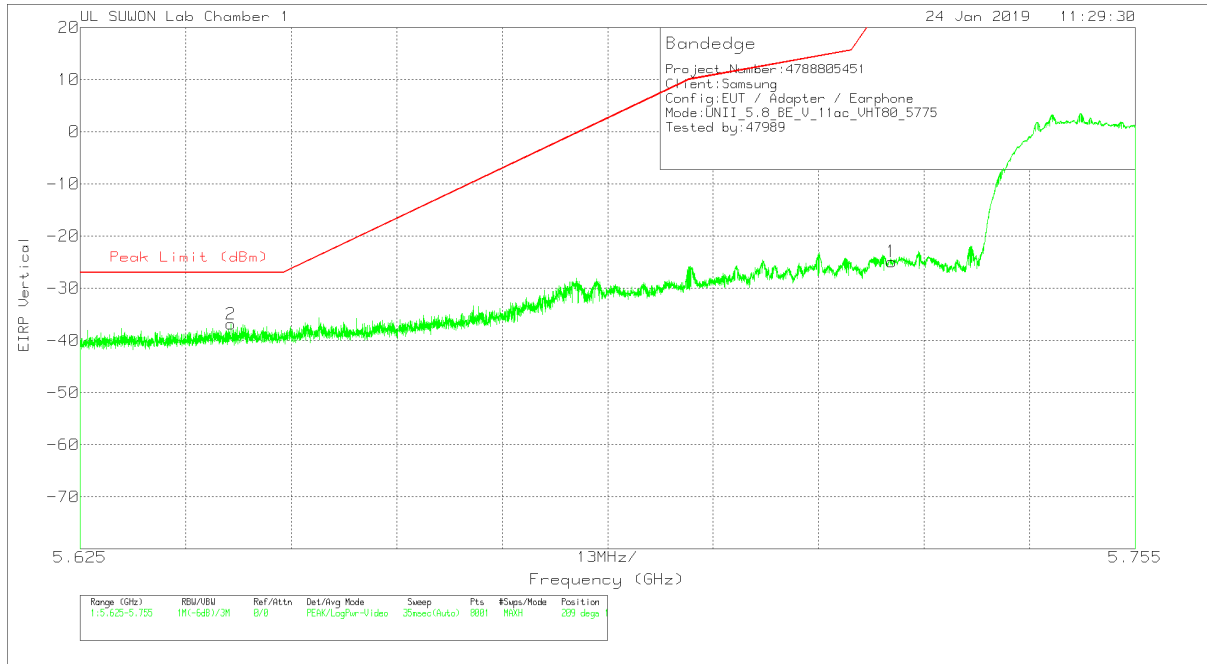

VERTICAL DATA

Trace Markers

Marker	Frequency (GHz)	Meter Reading (dBm)	Det	3117_00168717	10dB[dB]	Conversion Factor (dB)	DC Corr (dB)	Corrected Reading EIRP	Peak Limit (dBm)	PK Margin (dB)	Azimuth (Degs)	Height (cm)	Polarity
1	5.725	-50.41	Pk		-21.1	11.8	0	-24.91	26.97	-51.88	209	179	V
2	5.644	-62.25	Pk		-21.1	11.8	0	-36.85	-27	-9.85	209	179	V

Pk - Peak detector

UPPER BANDEDGE (MID CHANNEL)

HORIZONTAL PEAK PLOT

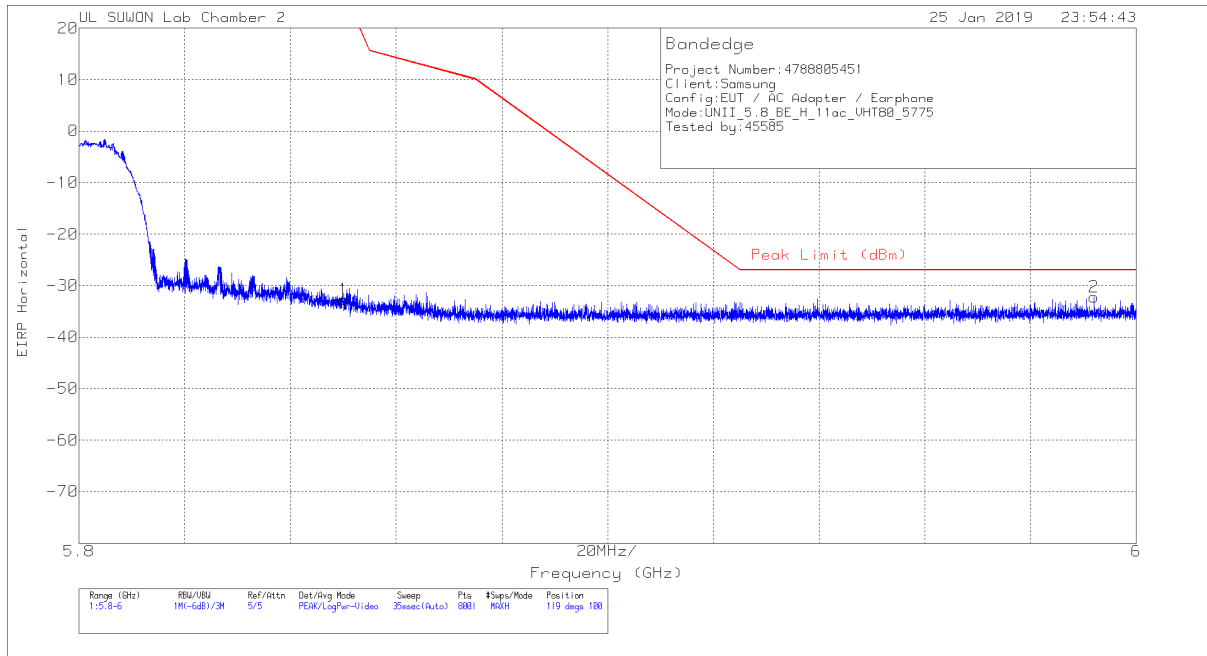

HORIZONTAL DATA

Trace Markers

Marker	Frequency (GHz)	Meter Reading (dBm)	Det	170531_3117[00 168724]	Path_2_10dB	Conversion Factor (dB)	DC Corr (dB)	Corrected Reading EIRP	Peak Limit (dBm)	PK Margin (dB)	Azimuth (Degs)	Height (cm)	Polarity
1	5.85	-63.47	Pk	34.5	-15.5	11.8	0	-32.67	26.94	-59.61	119	100	H
2	5.992	-63.44	Pk	34.8	-15.4	11.8	0	-32.24	-27	-5.24	119	100	H

Pk - Peak detector

VERTICAL PEAK PLOT

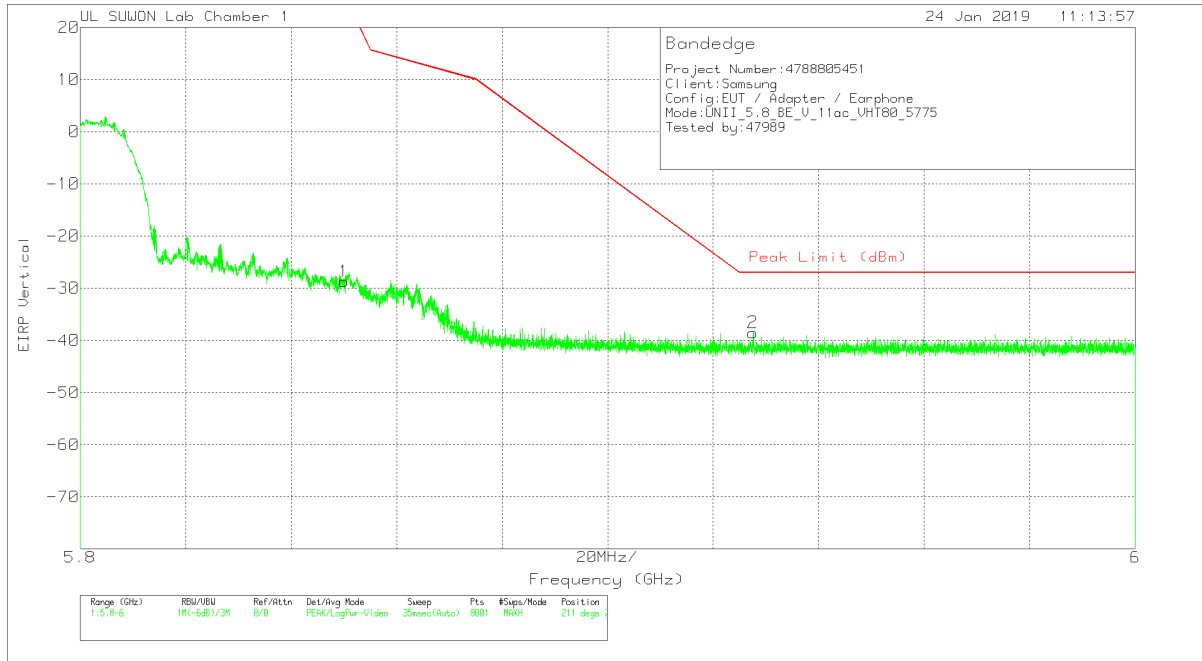

VERTICAL DATA

Trace Markers

Marker	Frequency (GHz)	Meter Reading (dBm)	Det	3117_00168717	10dB[dB]	Conversion Factor (dB)	DC Corr (dB)	Corrected Reading EIRP	Peak Limit (dBm)	PK Margin (dB)	Azimuth (Degs)	Height (cm)	Polarity
1	5.85	-54.46	Pk	35	-21	11.8	0	-28.66	26.94	-55.6	211	208	V
2	5.928	-64.6	Pk	35.1	-20.8	11.8	0	-38.5	-27	-11.5	211	208	V

Pk - Peak detector

HARMONICS AND SPURIOUS EMISSIONS

MID CHANNEL HORIZONTAL

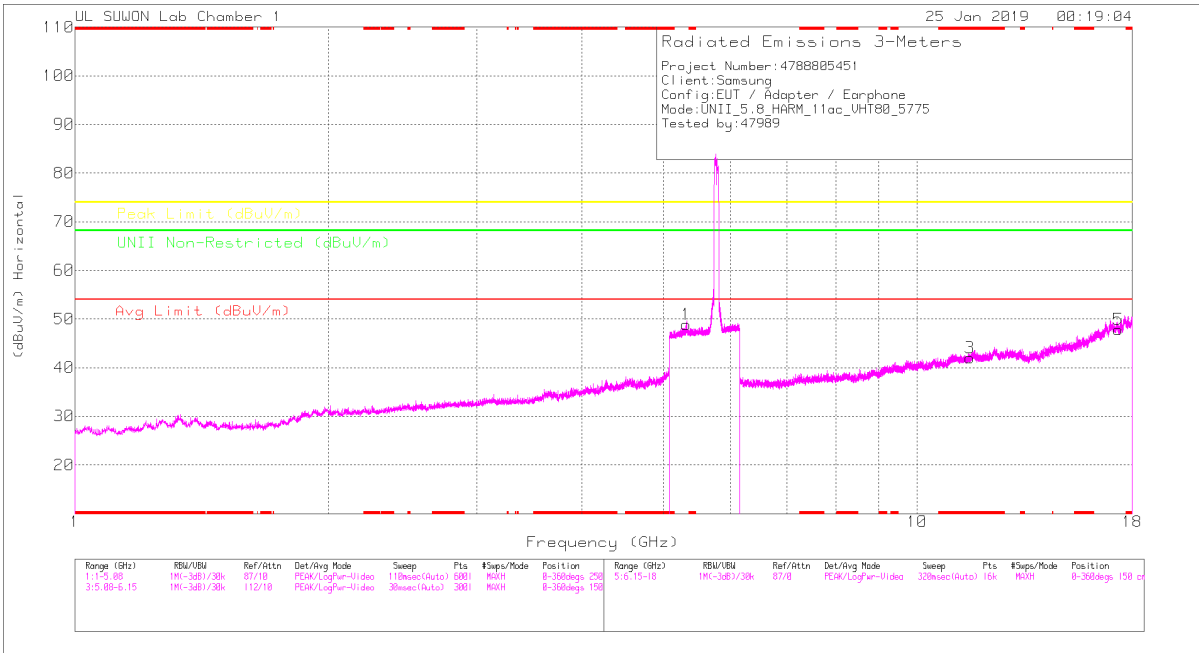

MID CHANNEL VERTICAL

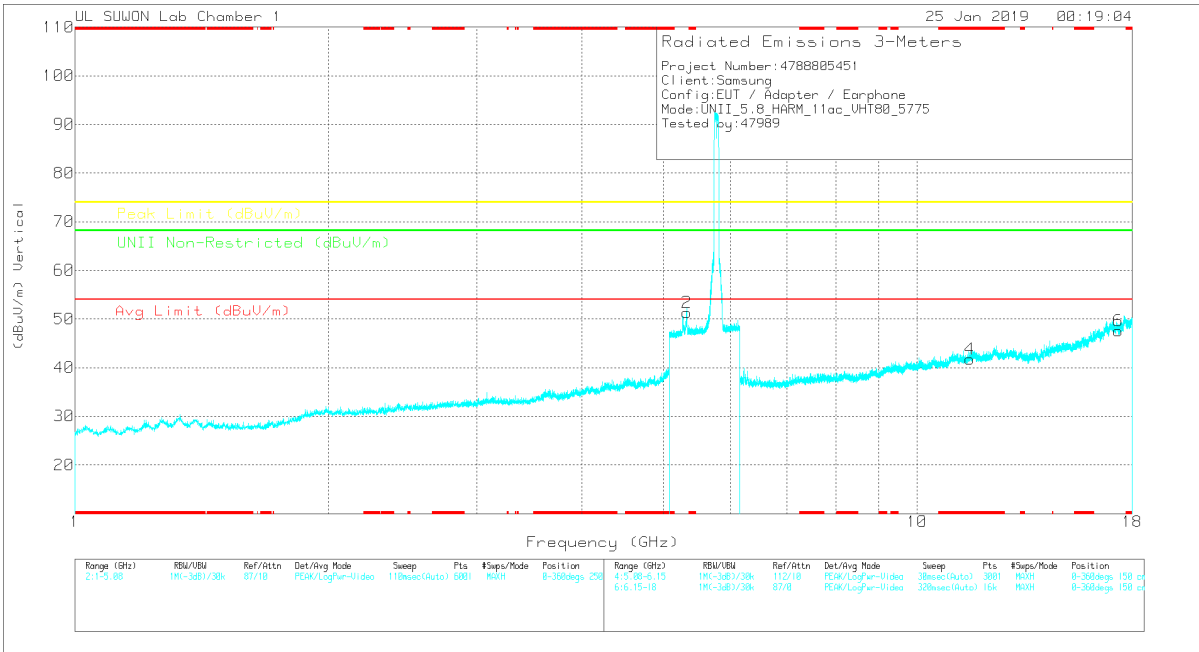

Note: Emission was scanned up to 40GHz; No emissions were detected above the noise floor which was at least 20dB below the specification limit.

MID CHANNEL DATA

Trace Markers

Marker	Frequency (GHz)	Meter Reading (dBuV)	Det	3117_00168717	100B(dB)	DC Corr (dB)	Corrected Reading (dBuV/m)	Avl Limit (dBuV/m)	Margin (dB)	Peak Limit (dBuV/m)	Margin (dB)	UNI Non-Restricted (dBuV/m)	Margin (dB)	Azimuth (Degs)	Height (cm)	Polarity
1	5.322	35.94	PK	34.6	-21.7	0	48.84	-	-	-	-	68.2	-19.36	0-360	150	H
2	5.326	38.47	PK	34.6	-21.7	0	51.37	-	-	-	-	68.2	-16.83	0-360	250	V
3	*11.55	25.91	PK	38.6	-22.5	0	42.01	-	-	74	-31.99	-	-	0-360	150	H
5	17.325	23.73	PK	41.2	-17.1	0	47.83	-	-	-	-	68.2	-20.37	0-360	150	H
4	*11.55	25.69	PK	38.6	-22.5	0	41.79	-	-	74	-32.21	-	-	0-360	150	V
6	17.325	23.48	PK	41.2	-17.1	0	47.58	-	-	-	-	68.2	-20.62	0-360	250	V

* - indicates frequency in CFR47 Pt 15 / IC RSS-Restricted Band
 PK – Peak Detector

Radiated Emissions

Frequency (GHz)	Meter Reading (dBuV)	Det	3117_00168717	100B(dB)	DC Corr (dB)	Corrected Reading (dBuV/m)	Avl Limit (dBuV/m)	Margin (dB)	Peak Limit (dBuV/m)	Margin (dB)	UNI Non-Restricted (dBuV/m)	Margin (dB)	Azimuth (Degs)	Height (cm)	Polarity
5.323	47.43	PK-U	34.6	-21.7	0	60.33	-	-	-	-	68.2	-7.87	203	112	H
5.323	50.35	PK-U	34.6	-21.7	0	63.25	-	-	-	-	68.2	-4.95	209	202	V

* - indicates frequency in CFR47 Pt 15 / IC RSS-Restricted Band
 PK-U - U-NII: Maximum Peak

12. WORST-CASE BELOW 1 GHz

SPURIOUS EMISSIONS 30 TO 1000 MHz (WORST-CASE CONFIGURATION, HORIZONTAL)

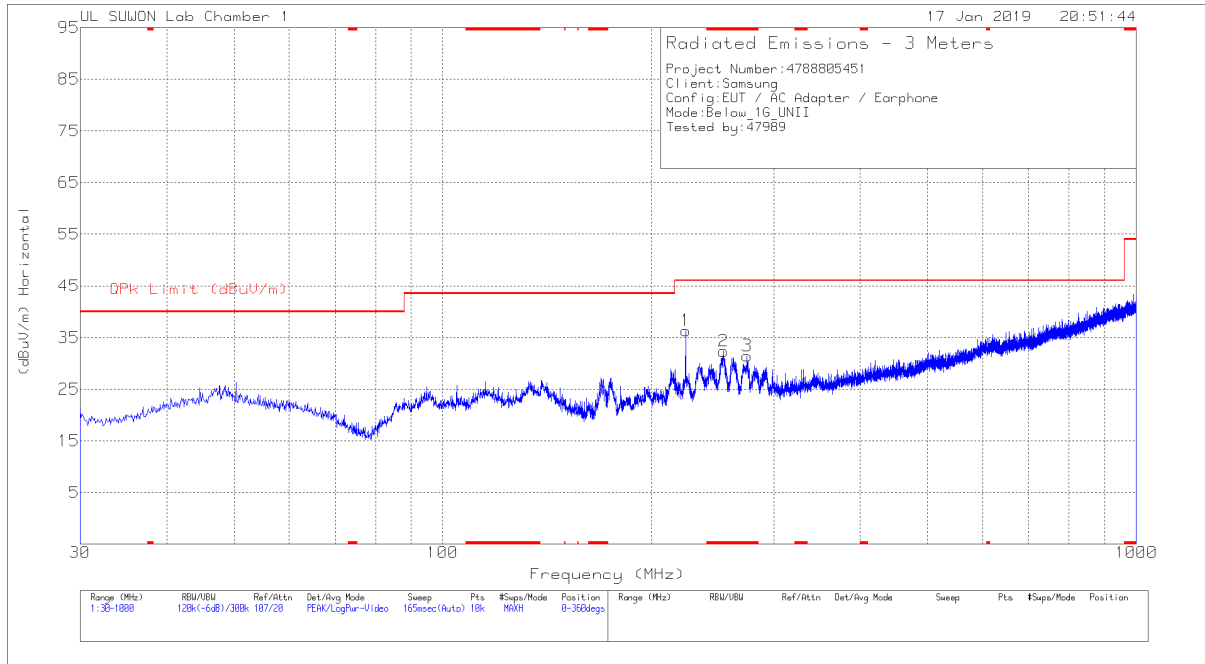

SPURIOUS EMISSIONS 30 TO 1000 MHz (WORST-CASE CONFIGURATION, VERTICAL)

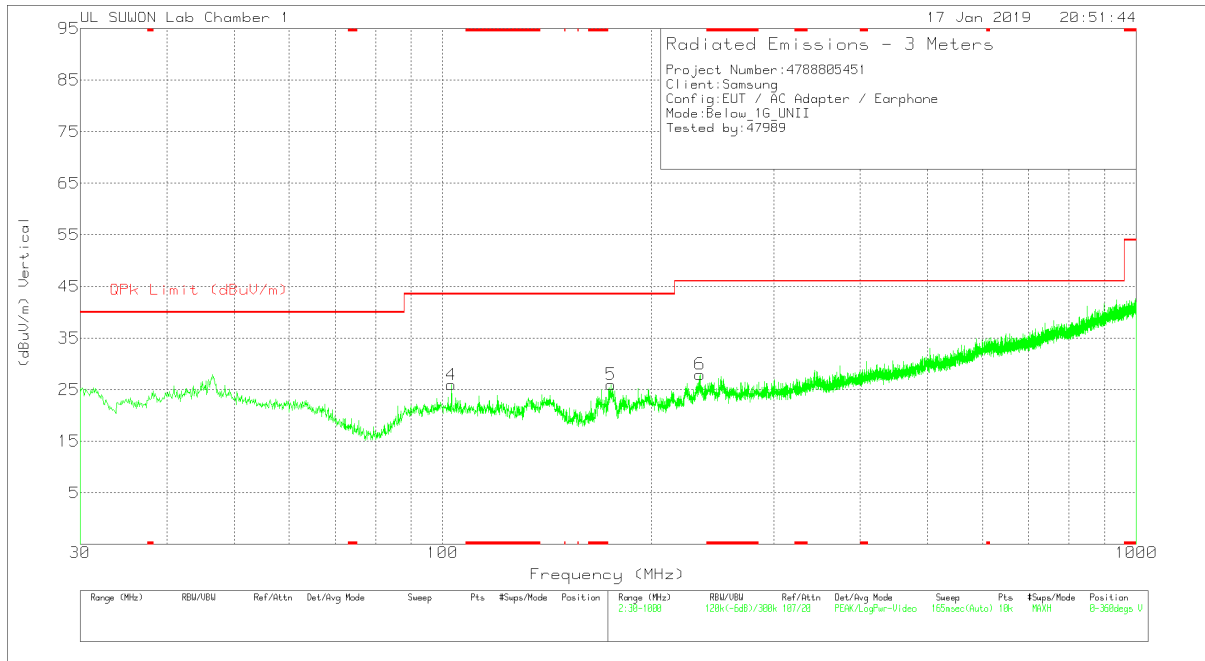

Below 1G Data

Trace Markers

Marker	Frequency (MHz)	Meter Reading (dBuV)	Det	VULB9163_750	Below_1G[dB]	Corrected Reading (dBuV/m)	QPk Limit (dBuV/m)	Margin (dB)	Azimuth (Degs)	Height (cm)	Polarity
1	224	46.83	Pk	17.8	-28.3	36.33	46.02	-9.69	0-360	100	H
2	* 253.973	41.17	Pk	19.2	-28	32.37	46.02	-13.65	0-360	100	H
3	* 274.731	40.47	Pk	18.8	-27.8	31.47	46.02	-14.55	0-360	100	H
4	102.944	37.74	Pk	17.9	-29.7	25.94	43.52	-17.58	0-360	300	V
5	174.821	39.79	Pk	15	-28.8	25.99	43.52	-17.53	0-360	100	V
6	234.961	37.96	Pk	18.2	-28.2	27.96	46.02	-18.06	0-360	200	V

* - indicates frequency in CFR47 Pt 15 / IC RSS-Restricted Band
 Pk - Peak detector

13. AC POWER LINE CONDUCTED EMISSIONS

LIMITS

FCC §15.207 (a)

Frequency of Emission (MHz)	Conducted Limit (dBuV)	
	Quasi-peak	Average
0.15-0.5	66 to 56	56 to 46
0.5-5	56	46
5-30	60	50

*Decreases with the logarithm of the frequency.

TEST PROCEDURE

The EUT is placed on a non-conducting table 40 cm from the vertical ground plane and 80 cm above the horizontal ground plane. The EUT is configured in accordance with ANSI C63.10.

The receiver is set to a resolution bandwidth of 9 kHz. Peak detection is used unless otherwise noted as quasi-peak or average.

Line conducted data is recorded for both NEUTRAL and HOT lines.

RESULTS

6 WORST EMISSIONS

LINE 1 PLOT

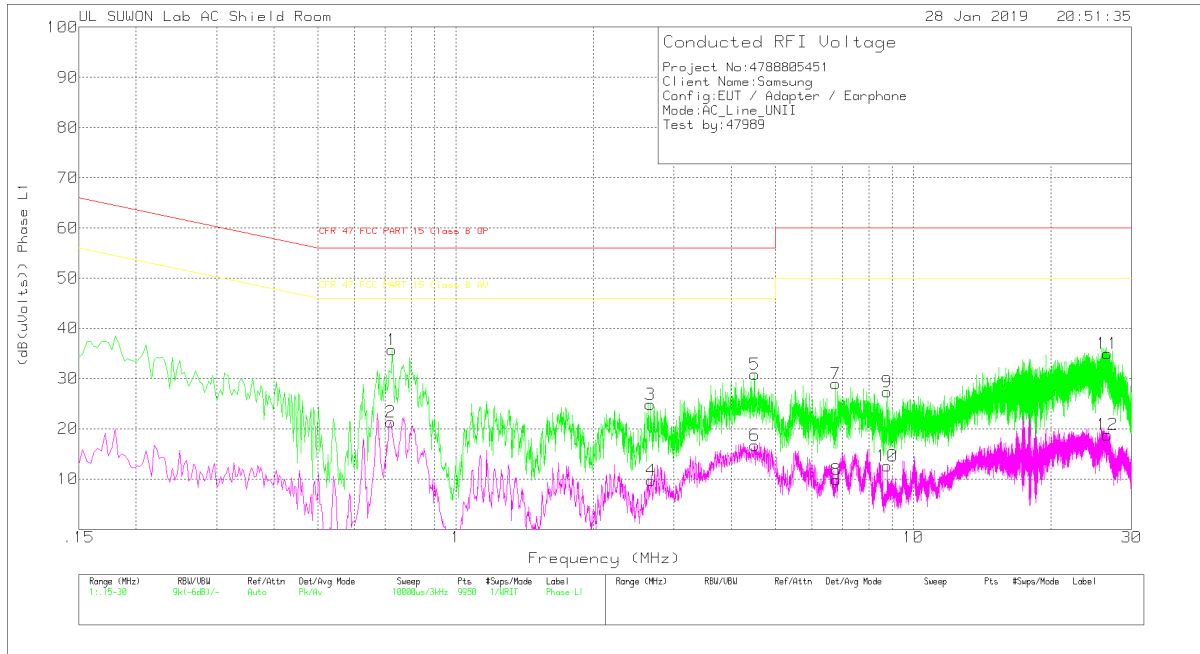

LINE 1 RESULTS

Trace Markers

Range 1: Phase L1 .15 - 30MHz

Marker	Frequency (MHz)	Meter Reading (dBuV)	Det	ENV216_10183 6_With ex-cord_L1	CABLELOSS(dB)	Corrected Reading (dB(uVolts))	CFR 47 FCC PART 15 Class B QP	Margin (dB)	CFR 47 FCC PART 15 Class B AV	Margin (dB)
1	.726	25.6	Pk	9.9	.2	35.7	56	-20.3	-	-
2	.72	11.27	Av	9.9	.2	21.37	-	-	46	-24.63
3	2.661	14.59	Pk	10	.3	24.89	56	-31.11	-	-
4	2.67	-.61	Av	10	.3	9.69	-	-	46	-36.31
5	4.497	20.74	Pk	9.8	.3	30.84	56	-25.16	-	-
6	4.497	6.57	Av	9.8	.3	16.67	-	-	46	-29.33
7	6.777	18.76	Pk	9.9	.3	28.96	60	-31.04	-	-
8	6.783	-.39	Av	9.9	.3	9.81	-	-	50	-40.19
9	8.778	16.95	Pk	10	.4	27.35	60	-32.65	-	-
10	8.778	2.14	Av	10	.4	12.54	-	-	50	-37.46
11	26.565	23.95	Pk	10.7	.3	34.95	60	-25.05	-	-
12	26.574	7.78	Av	10.7	.3	18.78	-	-	50	-31.22

Pk - Peak detector

Av - Average detection

LINE 2 PLOT

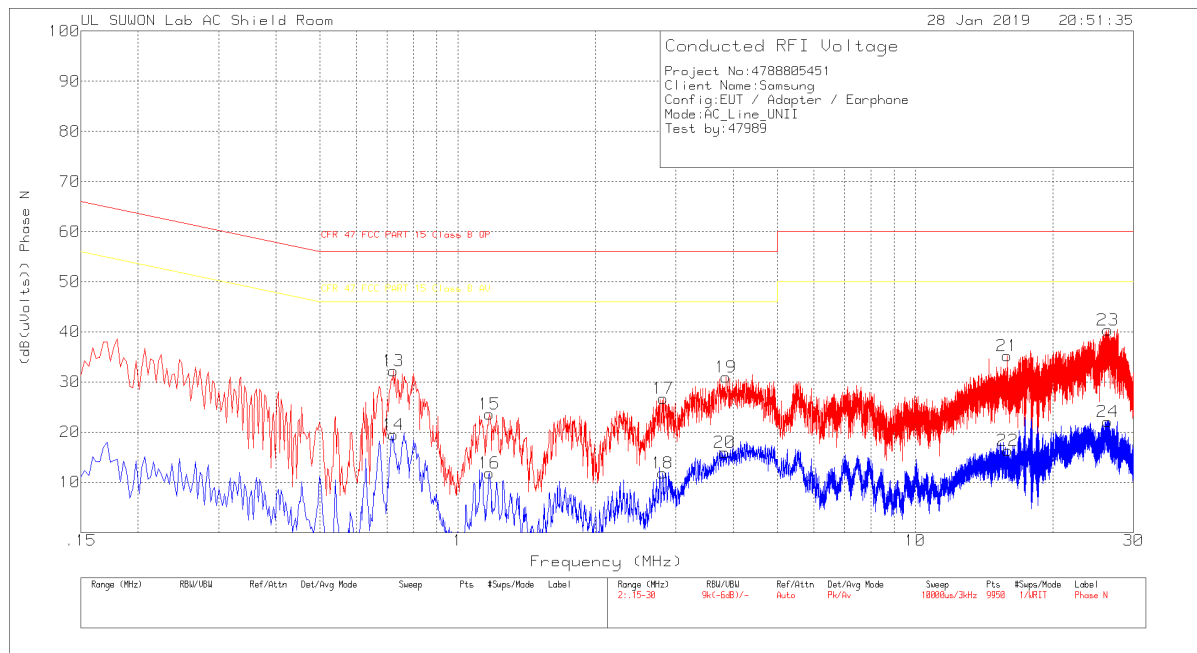

LINE 2 RESULTS

Trace Markers

Range 2: Phase N .15 - 30MHz

Marker	Frequency (MHz)	Meter Reading (dBuV)	Det	ENV216_10183 6_With ex-cord_N	CABLELOSS(dB)	Corrected Reading (dB(uVolts))	CFR 47 FCC PART 15 Class B QP	Margin (dB)	CFR 47 FCC PART 15 Class B AV	Margin (dB)
13	.723	22.11	Pk	9.9	.2	32.21	56	-23.79	-	-
14	.723	9.32	Av	9.9	.2	19.42	-	-	46	-26.58
15	1.173	13.49	Pk	9.8	.3	23.59	56	-32.41	-	-
16	1.173	1.76	Av	9.8	.3	11.86	-	-	46	-34.14
17	2.808	16.68	Pk	9.7	.3	26.68	56	-29.32	-	-
18	2.802	1.87	Av	9.7	.3	11.87	-	-	46	-34.13
19	3.852	20.91	Pk	9.8	.3	31.01	56	-24.99	-	-
20	3.837	5.85	Av	9.8	.3	15.95	-	-	46	-30.05
21	15.897	24.52	Pk	10.3	.4	35.22	60	-24.78	-	-
22	15.915	5.6	Av	10.3	.4	16.3	-	-	50	-33.7
23	26.364	29.29	Pk	10.8	.3	40.39	60	-19.61	-	-
24	26.361	11.02	Av	10.8	.3	22.12	-	-	50	-27.88

Pk - Peak detector

Av - Average detection

14. DYNAMIC FREQUENCY SELECTION

14.1. OVERVIEW

14.1.1. LIMITS

FCC

§15.407 (h), FCC KDB 905462 D02 “Compliance measurement procedures for unlicensed-national information infrastructure devices operating in the 5250-5350 MHz and 5470-5725 MHz bands incorporating dynamic frequency selection” and KDB 905462 D03 “U-NII client devices without radar detection capability”.

Table 1: Applicability of DFS requirements prior to use of a channel

Requirement	Operational Mode		
	Master	Client (without radar detection)	Client (with radar detection)
Non-Occupancy Period	Yes	Not required	Yes
DFS Detection Threshold	Yes	Not required	Yes
Channel Availability Check Time	Yes	Not required	Not required
U-NII Detection Bandwidth	Yes	Not required	Yes

Table 2: Applicability of DFS requirements during normal operation

Requirement	Operational Mode		
	Master	Client (without DFS)	Client (with DFS)
DFS Detection Threshold	Yes	Not required	Yes
Channel Closing Transmission Time	Yes	Yes	Yes
Channel Move Time	Yes	Yes	Yes
U-NII Detection Bandwidth	Yes	Not required	Yes

Additional requirements for devices with multiple bandwidth modes	Master Device or Client with Radar DFS	Client (without DFS)
U-NII Detection Bandwidth and Statistical Performance Check	All BW modes must be tested	Not required
Channel Move Time and Channel Closing Transmission Time	Test using widest BW mode available	Test using the widest BW mode available for the link
All other tests	Any single BW mode	Not required
Note: Frequencies selected for statistical performance check (Section 7.8.4) should include several frequencies within the radar detection bandwidth and frequencies near the edge of the radar detection bandwidth. For 802.11 devices it is suggested to select frequencies in all 20 MHz channel blocks and a null frequency between the bonded 20 MHz channel blocks.		

Table 3: Interference Threshold values, Master or Client incorporating In-Service Monitoring

Maximum Transmit Power	Value (see notes)
E.I.R.P. \geq 200 mill watt	-64 dBm
E.I.R.P. < 200 mill watt and power spectral density < 10 dBm/MHz	-62 dBm
E.I.R.P. < 200 mill watt that do not meet power spectral density requirement	-64 dBm
<p>Note 1: This is the level at the input of the receiver assuming a 0 dBi receive antenna Note 2: Throughout these test procedures an additional 1 dB has been added to the amplitude of the test transmission waveforms to account for variations in measurement equipment. This will ensure that the test signal is at or above the detection threshold level to trigger a DFS response. Note 3: E.I.R.P. is based on the highest antenna gain. For MIMO devices refer to KDB publication 662911 D01.</p>	

Table 4: DFS Response requirement values

Parameter	Value
<i>Non-occupancy period</i>	30 minutes
<i>Channel Availability Check Time</i>	60 seconds
<i>Channel Move Time</i>	10 seconds (See Note 1)
<i>Channel Closing Transmission Time</i>	200 milliseconds + approx. 60 milliseconds over remaining 10 second period. (See Notes 1 and 2)
<i>U-NII Detection Bandwidth</i>	Minimum 100% of the U-NII 99% transmission power bandwidth. (See Note 3)
<p>Note 1: <i>Channel Move Time</i> and the <i>Channel Closing Transmission Time</i> should be performed with Radar Type 0. The measurement timing begins at the end of the Radar Type 0 burst. Note 2: The <i>Channel Closing Transmission Time</i> is comprised of 200 milliseconds starting at the beginning of the <i>Channel Move Time</i> plus any additional intermittent control signals required to facilitate a <i>Channel</i> move (an aggregate of 60 milliseconds) during the remainder of the 10 second period. The aggregate duration of control signals will not count quiet periods in between transmissions. Note 3: During the <i>U-NII Detection Bandwidth</i> detection test, radar type 0 should be used. For each frequency step the minimum percentage of detection is 90 percent. Measurements are performed with no data traffic.</p>	

Table 5 – Short Pulse Radar Test Waveforms

Radar Type	Pulse Width (usec)	PRI (usec)	Pulses	Minimum Percentage of Successful Detection	Minimum Trials
0	1	1428	18	See Note 1	See Note 1
1	1	Test A: 15 unique PRI values randomly selected from the list of 23 PRI values in table 5a	Roundup: $\{(1/360) \times (19 \times 10^6 \text{ PRI}_{\text{usec}})\}$	60%	30
		Test B: 15 unique PRI values randomly selected within the range of 518-3066 usec. With a minimum increment of 1 usec, excluding PRI values selected in Test A			
2	1-5	150-230	23-29	60%	30
3	6-10	200-500	16-18	60%	30
4	11-20	200-500	12-16	60%	30
Aggregate (Radar Types 1-4)				80%	120
Note 1: Short Pulse Radar Type 0 should be used for the <i>Detection Bandwidth</i> test, <i>Channel Move Time</i> , and <i>Channel Closing Time</i> tests.					

Table 6 – Long Pulse Radar Test Signal

Radar Waveform Type	Pulse Width (μsec)	Chirp Width (MHz)	PRI (μsec)	Pulses per Burst	Number of Bursts	Minimum Percentage of Successful Detection	Minimum Trials
5	50-100	5-20	1000-2000	1-3	8-20	80%	30

Table 7 – Frequency Hopping Radar Test Signal

Radar Waveform Type	Pulse Width (μsec)	PRI (μsec)	Pulses per Hop	Hopping Rate (kHz)	Hopping Sequence Length (msec)	Minimum Percentage of Successful Detection	Minimum Trials
6	1	333	9	0.333	300	70%	30

14.1.1. TEST AND MEASUREMENT SYSTEM

CONDUCTED METHOD SYSTEM BLOCK DIAGRAM

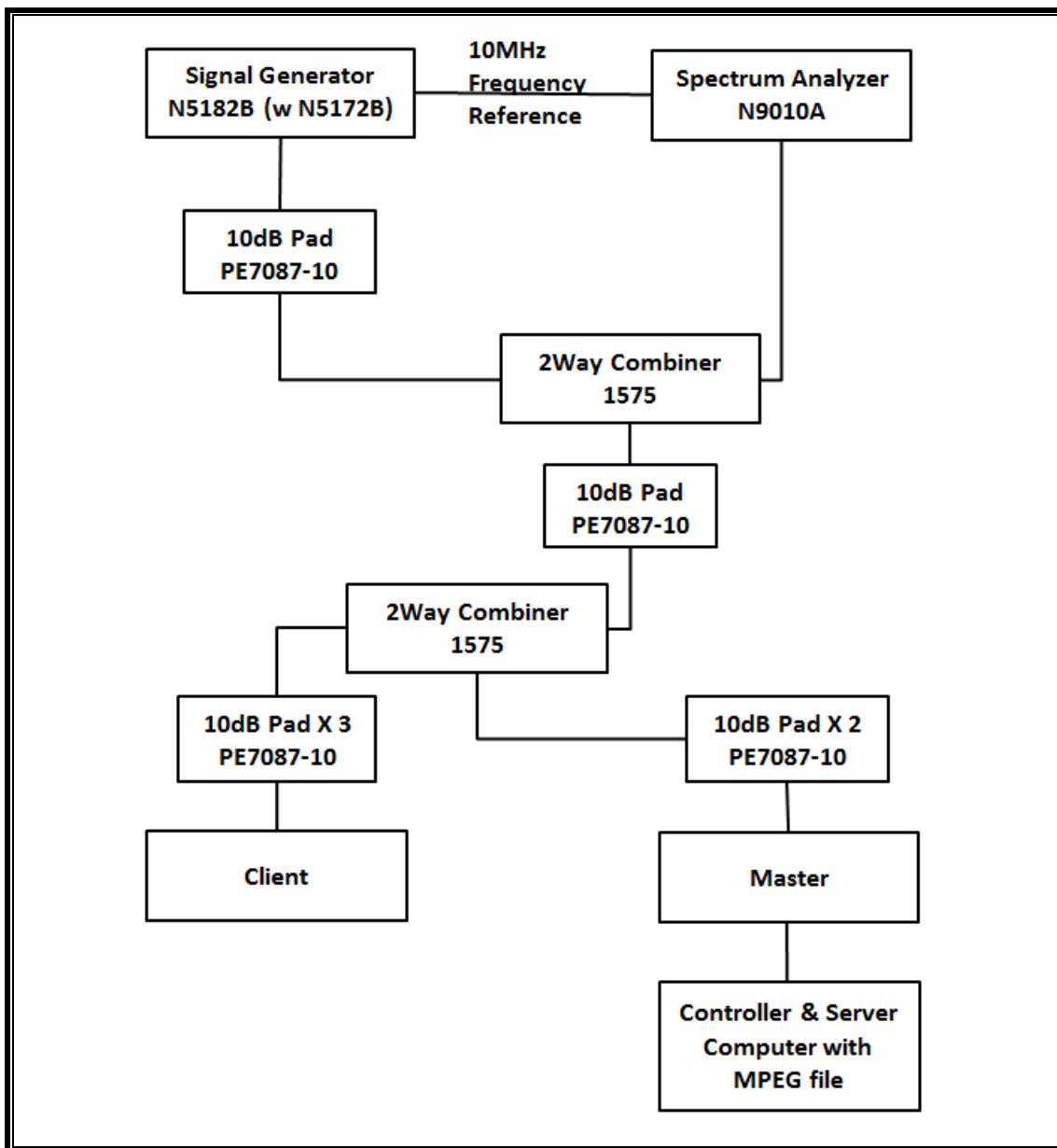

SYSTEM OVERVIEW

The short pulse and long pulse signal generating system utilizes the Keysite Signal Studio for Pulse Building as N5172B. The Vector Signal Generator has been validated by the NTIA. The hopping signal generating system utilizes the CCS simulated hopping method and system, which has been validated by the DoD, FCC and NTIA. The software selects waveform parameters from within the bounds of the signal type on a random basis using uniform distribution.

The short pulse types 1, 2, 3 and 4, and the long pulse type 5 parameters are randomized at run-time.

The hopping type 6 pulse parameters are fixed while the hopping sequence is based on the August 2005 NTIA Hopping Frequency List. The initial starting point randomized at run-time and each subsequent starting point is incremented by 475. Each frequency in the 100-length segment is compared to the boundaries of the EUT Detection Bandwidth and the software creates a hopping burst pattern in accordance with Section 7.4.1.3 Method #2 Simulated Frequency Hopping Radar Waveform Generating Subsystem of KDB 905462 D02. The frequency of the signal generator is incremented in 1 MHz steps from F_L to F_H for each successive trial. This incremental sequence is repeated as required to generate a minimum of 30 total trials and to maintain a uniform frequency distribution over the entire Detection Bandwidth.

The signal monitoring equipment consists of a spectrum analyzer. The aggregate ON time is calculated by multiplying the number of bins above a threshold during a particular observation period by the dwell time per bin, with the analyzer set to peak detection and max hold.

SYSTEM CALIBRATION

A 50-ohm load is connected in place of the spectrum analyzer, and the spectrum analyzer is connected to a horn antenna via a coaxial cable, with the reference level offset set to (horn antenna gain – coaxial cable loss). The signal generator is set to CW mode. The amplitude of the signal generator is adjusted to yield a level of –64 dBm as measured on the spectrum analyzer.

Without changing any of the instrument settings, the spectrum analyzer is reconnected to the Common port of the Spectrum Analyzer Combiner/Divider. The Reference Level Offset of the spectrum analyzer is adjusted so that the displayed amplitude of the signal is –64 dBm.

The spectrum analyzer displays the level of the signal generator as received at the antenna ports of the Master Device. The interference detection threshold may be varied from the calibrated value of –64 dBm and the spectrum analyzer will still indicate the level as received by the Master Device.

ADJUSTMENT OF DISPLAYED TRAFFIC LEVEL

A link is established between the Master and Slave and the distance between the units is adjusted as needed to provide a suitable received level at the Master and Slave devices. The video test file is streamed to generate WLAN traffic. The monitoring antenna is adjusted so that the WLAN traffic level, as displayed on the spectrum analyzer, is at lower amplitude than the radar detection threshold.

TEST AND MEASUREMENT EQUIPMENT

The following test and measurement equipment was utilized for the DFS tests documented in this report:

TEST EQUIPMENT LIST				
Description	Manufacturer	Model	S/N	Cal Due
Spectrum Analyzer, 7 GHz	Agilent / HP	N9010A	MY54200580	08-07-18
Vector Signal Generator, 6GHz	Agilent / HP	N5182B	MY53051241	08-07-18

SETUP OF EUT

CONDUCTED METHOD EUT TEST SETUP

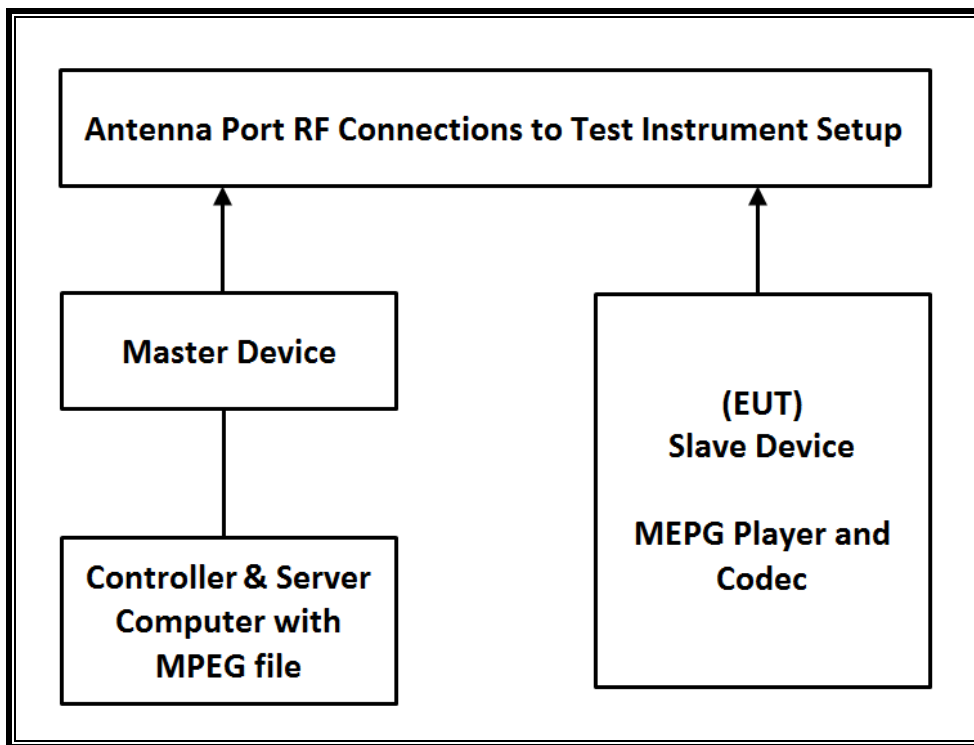

SUPPORT EQUIPMENT

The following support equipment was utilized for the DFS tests documented in this report:

PERIPHERAL SUPPORT EQUIPMENT LIST				
Description	Manufacturer	Model	Serial Number	FCC ID
Wireless Access Point	Cisco	AIR-CAP3702E-A-K9	FTX182276QX	LDK102087
PC (Controller/Server)	HP	HP EliteDesk 800 G1 TWR	CZC4125J25	DoC

14.1.2. DESCRIPTION OF EUT

The EUT operates over the 5250-5350 MHz and 5470-5725 MHz ranges.

The EUT is a Slave Device without Radar Detection.

The highest power level within these bands is 10.01 dBm in the 5250-5350 MHz band and 13.15 dBm in the 5470-5725 MHz band.

The antenna gain assembly utilized with the EUT are -2.01 dBi in the 5250-5350 MHz band and -1.41 dBi in the 5470-5725 MHz band.

The rated output power of the Master unit is > 23dBm (EIRP). Therefore the required interference threshold level is -64 dBm. After correction for procedural adjustments, the required conducted threshold at the antenna port is $-64 + 1 = -63$ dBm.

The calibrated radiated DFS Detection Threshold level is set to -64 dBm. The tested level is lower than the required level hence it provides a margin to the limit.

The EUT uses one transmitter/receiver chain connected to an antenna to perform radiated tests.

WLAN traffic that meets or exceeds the minimum required loading was generated by transferring a data stream from the controller/server PC to the EUT using iPerf version 2.0.5 software package.

TPC is not required since the maximum EIRP is less than 500 mW (27 dBm).

The EUT utilizes the 802.11a/n architecture. Three nominal channel bandwidths are implemented: 20 MHz, 40 MHz.

The software installed in the access point is 12.4(25d)JA1.

UNIFORM CHANNEL SPREADING

This requirement is not applicable to Slave radio devices.

OVERVIEW OF MASTER DEVICE WITH RESPECT TO §15.407 (h) REQUIREMENTS

The Master Device is a Cisco Access Point, FCC ID: LDK102087. The minimum antenna gain for the Master Device is 6 dBi.

The rated output power of the Master unit is > 23dBm (EIRP). Therefore the required interference threshold level is -64 dBm. After correction for procedural adjustments, the required radiated threshold at the antenna port is $-64 + 1 = -63$ dBm.

The calibrated radiated DFS Detection Threshold level is set to -64 dBm. The tested level is lower than the required level hence it provides a margin to the limit.

14.2. RESULTS FOR 20 MHz BANDWIDTH

14.2.1. TEST CHANNEL

All tests were performed at a channel center frequency of 5500 MHz.

14.2.2. RADAR WAVEFORM AND TRAFFIC

RADAR WAVEFORM

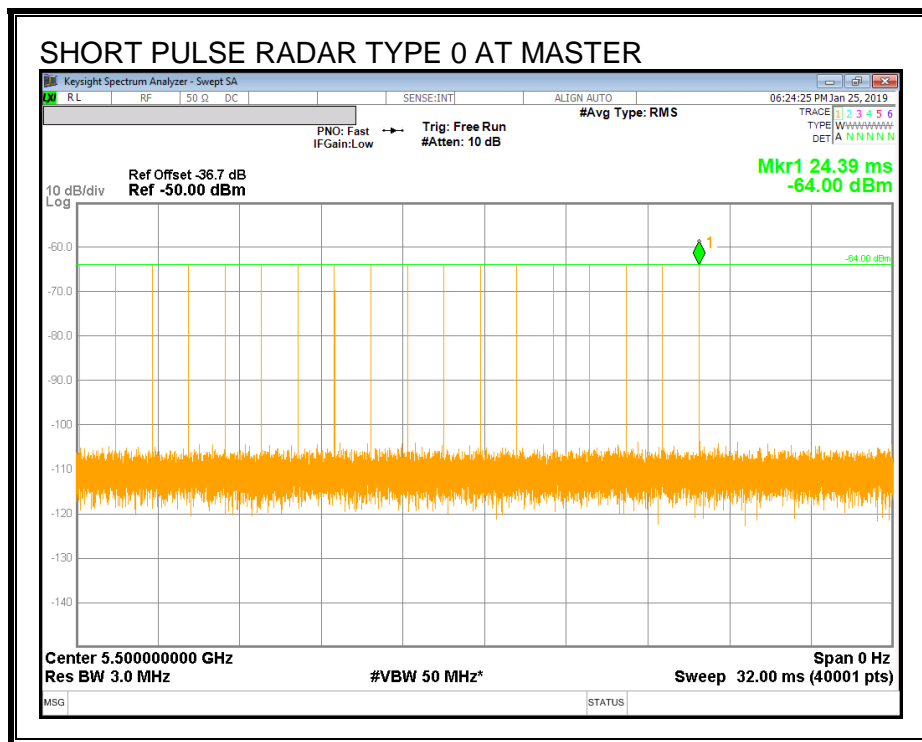

TRAFFIC

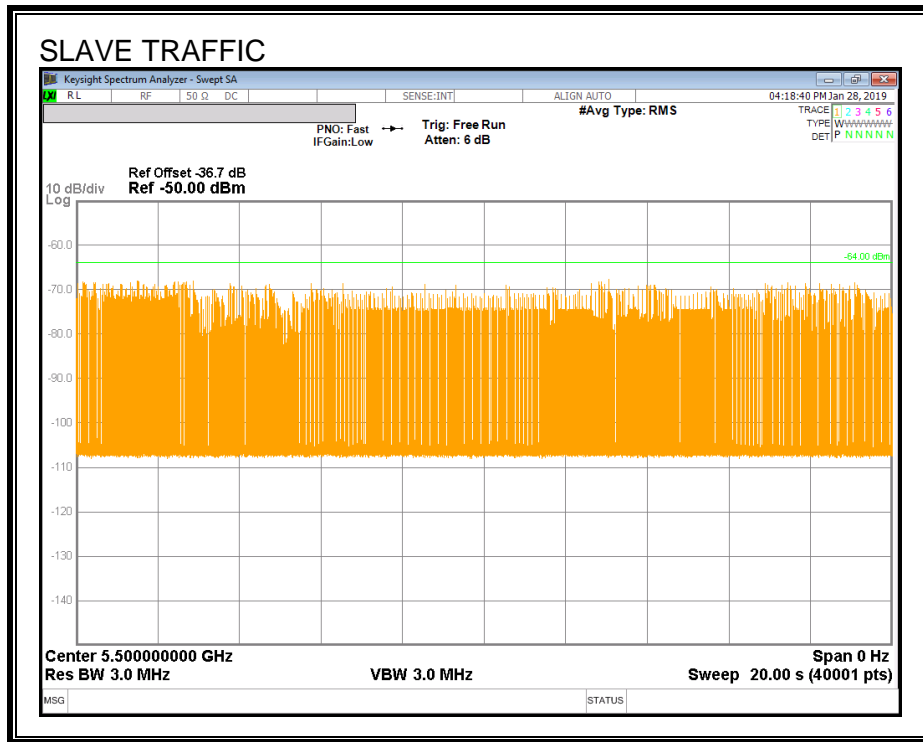

OVERLAPPING CHANNEL TESTS

RESULTS

These tests are not applicable.

14.2.3. MOVE AND CLOSING TIME

REPORTING NOTES

The reference marker is set at the end of last radar pulse.

The delta marker is set at the end of the last WLAN transmission following the radar pulse. This delta is the channel move time.

The aggregate channel closing transmission time is calculated as follows:

Aggregate Transmission Time =
(Number of analyzer bins showing transmission) * (dwell time per bin)

The observation period over which the aggregate time is calculated begins at (Reference Marker + 200 msec) and ends no earlier than (Reference Marker + 10 sec).

RESULTS

Channel Move Time (sec)	Limit (sec)
0.642	10

Aggregate Channel Closing Transmission Time (msec)	Limit (msec)
3.750	60

MOVE TIME & CHANNEL CLOSING TIME

AGGREGATE CHANNEL CLOSING TRANSMISSION TIME

No transmissions are observed during the aggregate monitoring period.

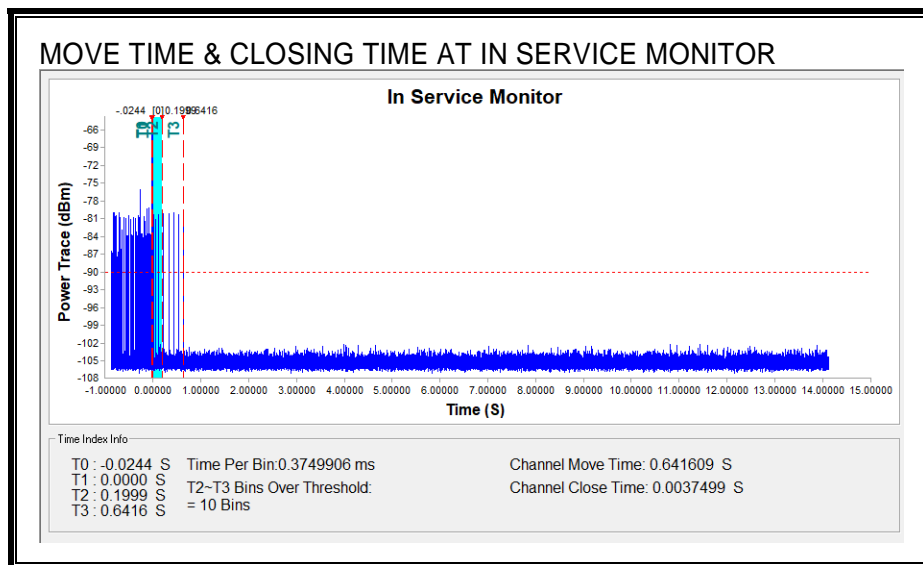
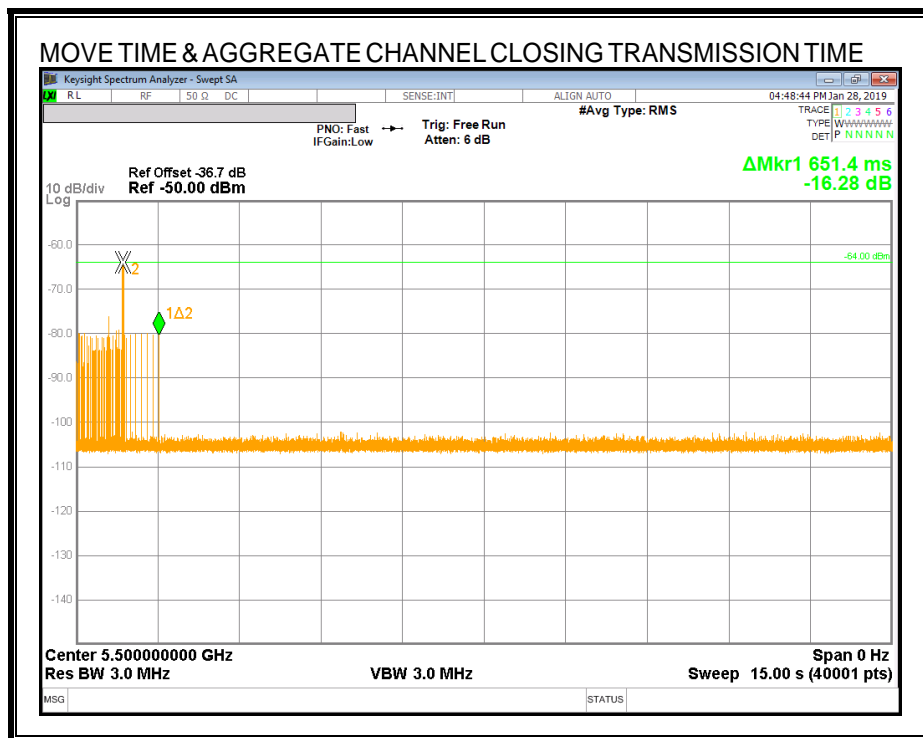

NON-OCCUPANCY PERIOD

RESULTS

No EUT transmissions were observed on the test channel during the 10-minute observation time.

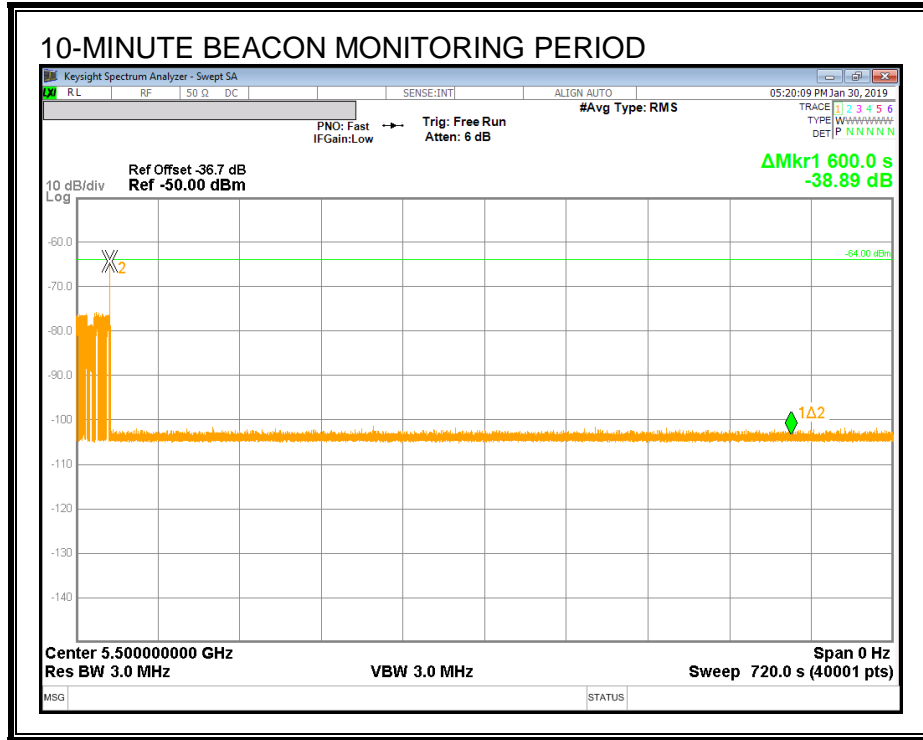

14.3. RESULTS FOR 40 MHz BANDWIDTH

14.3.1. TEST CHANNEL

All tests were performed at a channel center frequency of 5510 MHz.

14.3.2. RADAR WAVEFORM AND TRAFFIC

RADAR WAVEFORM

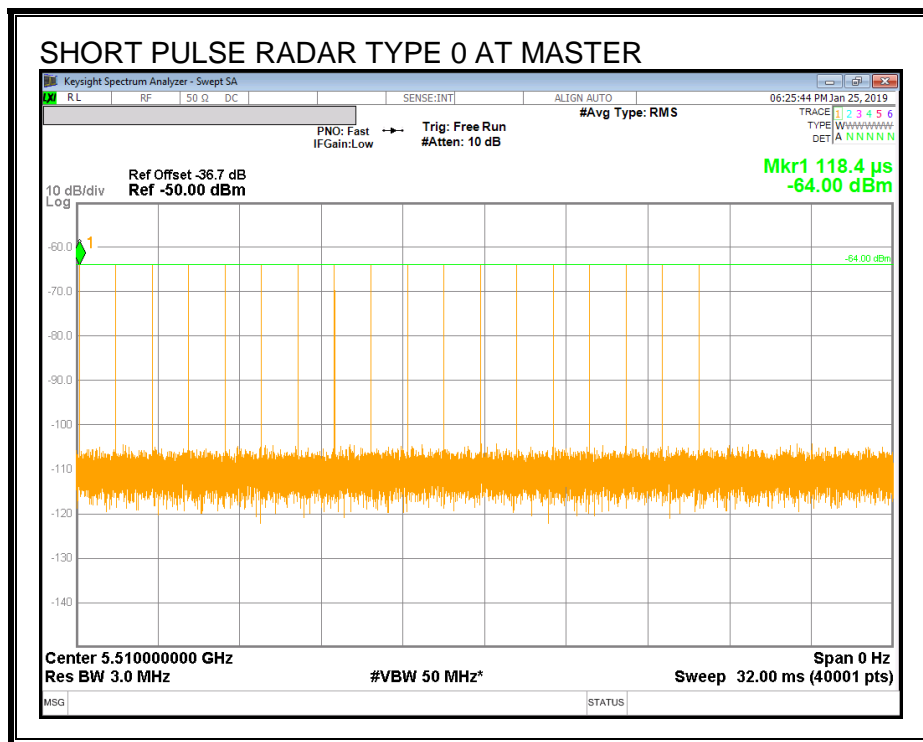

TRAFFIC

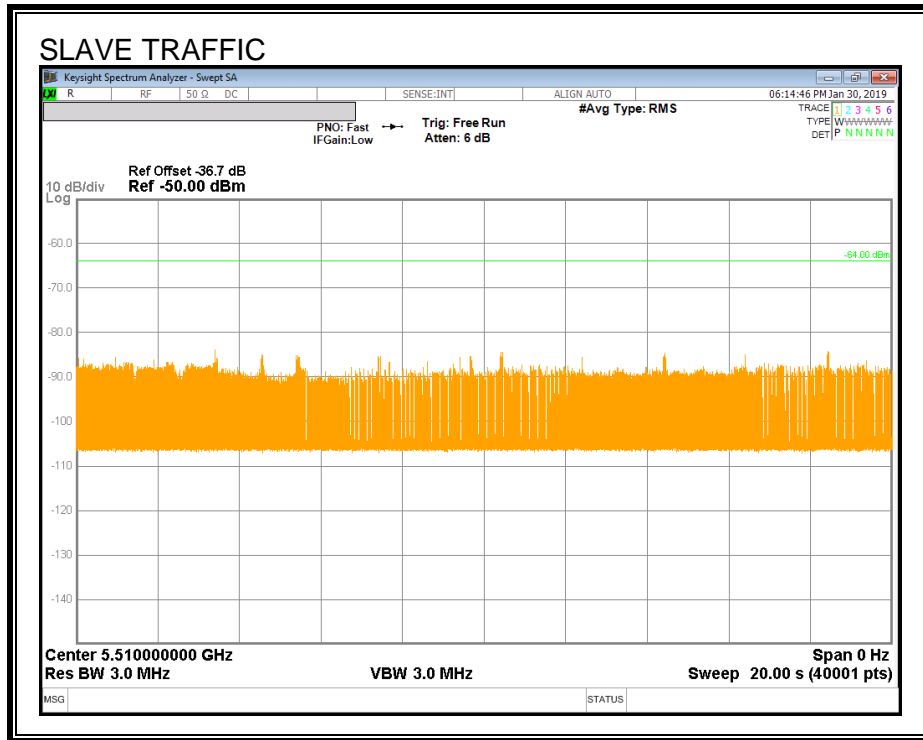

14.3.3. OVERLAPPING CHANNEL TESTS

RESULTS

These tests are not applicable.

14.3.4. MOVE AND CLOSING TIME

REPORTING NOTES

The reference marker is set at the end of last radar pulse.

The delta marker is set at the end of the last WLAN transmission following the radar pulse. This delta is the channel move time.

The aggregate channel closing transmission time is calculated as follows:

Aggregate Transmission Time =
(Number of analyzer bins showing transmission) * (dwell time per bin)

The observation period over which the aggregate time is calculated begins at (Reference Marker + 200 msec) and ends no earlier than (Reference Marker + 10 sec).

RESULTS

Channel Move Time (sec)	Limit (sec)
0.649	10

Aggregate Channel Closing Transmission Time (msec)	Limit (msec)
3.750	60

MOVE TIME & CHANNEL CLOSING TIME

AGGREGATE CHANNEL CLOSING TRANSMISSION TIME

No transmissions are observed during the aggregate monitoring period.

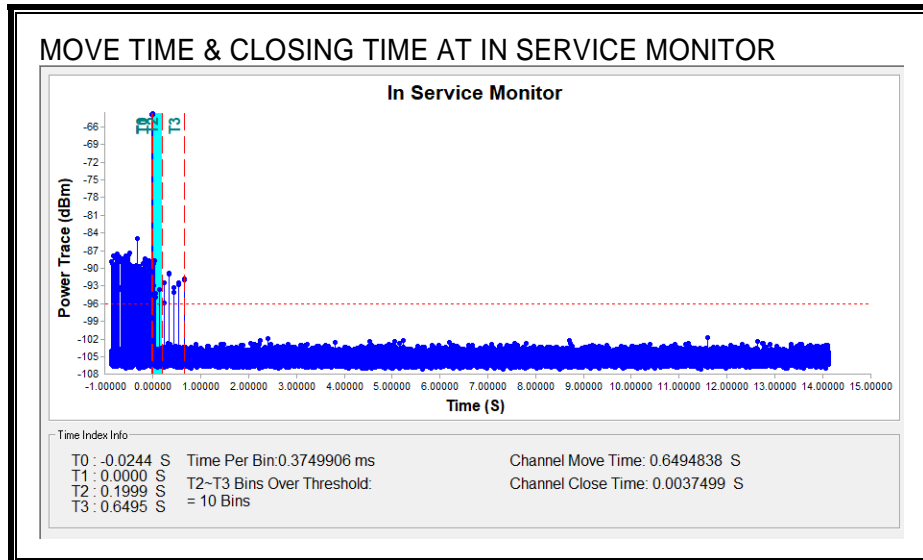
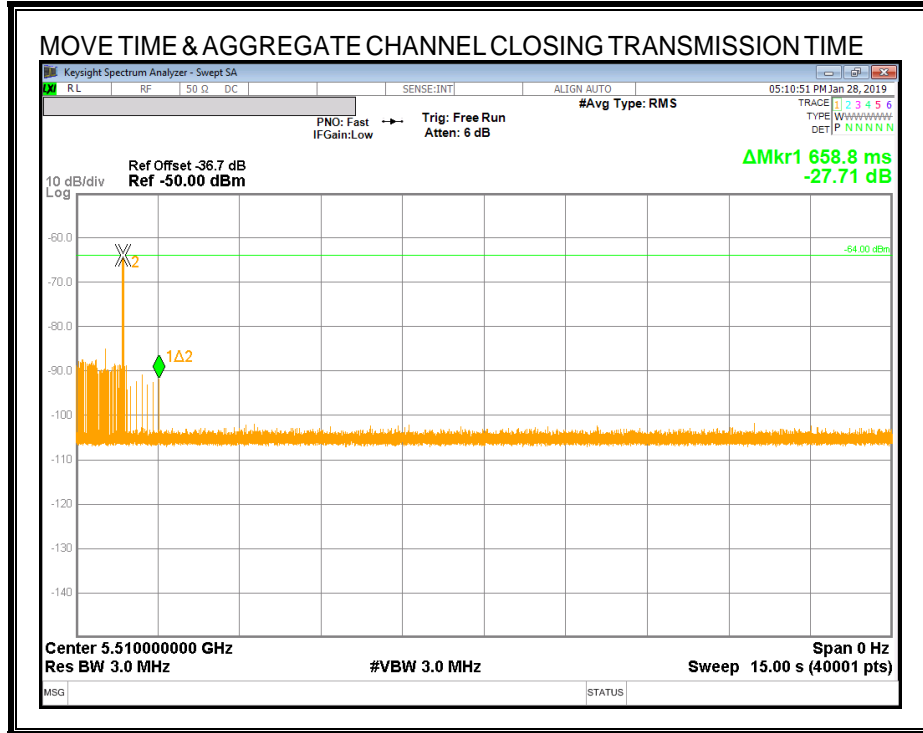

NON-OCCUPANCY PERIOD

RESULTS

No EUT transmissions were observed on the test channel during the 10-minute observation time.

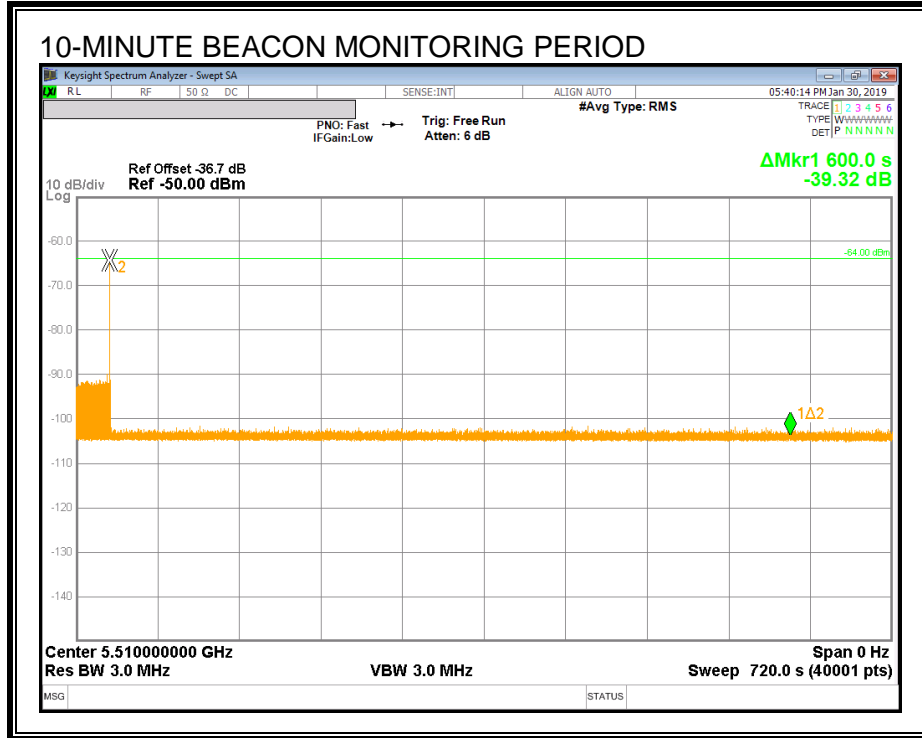

14.4. RESULTS FOR 80 MHz BANDWIDTH

14.4.1. TEST CHANNEL

All tests were performed at a channel center frequency of 5530 MHz.

14.4.2. RADAR WAVEFORM AND TRAFFIC

RADAR WAVEFORM

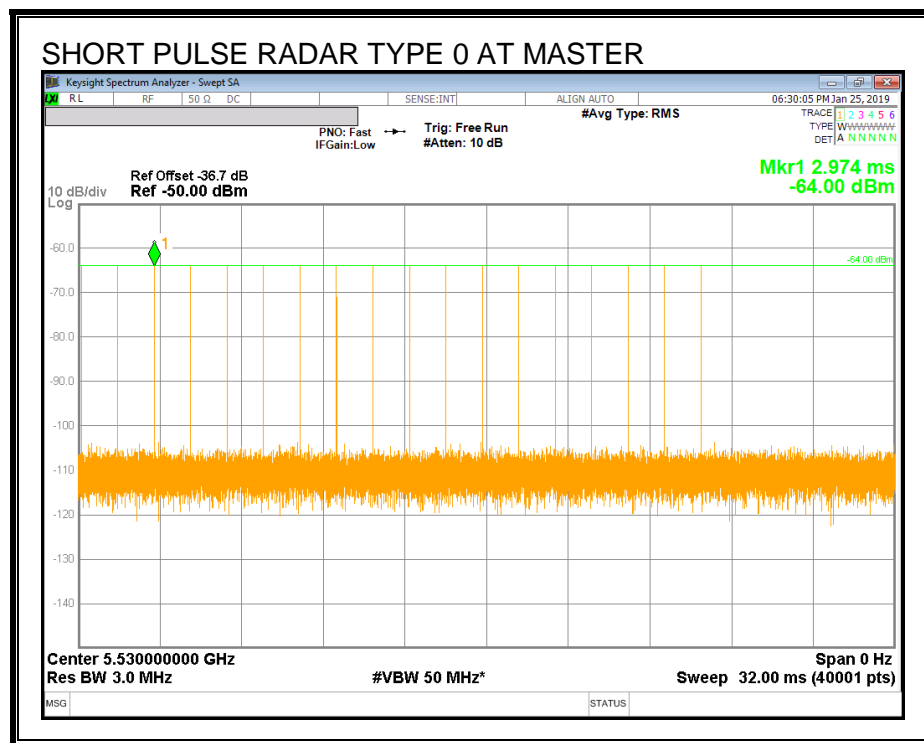

TRAFFIC

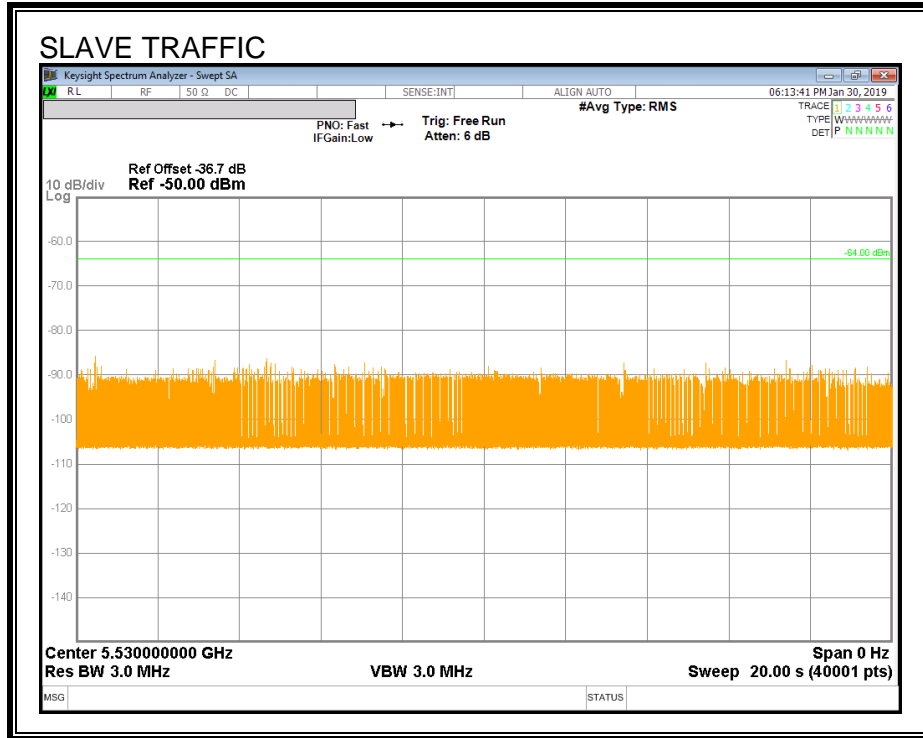

14.4.3. OVERLAPPING CHANNEL TESTS

RESULTS

These tests are not applicable.

14.4.4. MOVE AND CLOSING TIME

REPORTING NOTES

The reference marker is set at the end of last radar pulse.

The delta marker is set at the end of the last WLAN transmission following the radar pulse. This delta is the channel move time.

The aggregate channel closing transmission time is calculated as follows:

Aggregate Transmission Time =
(Number of analyzer bins showing transmission) * (dwell time per bin)

The observation period over which the aggregate time is calculated begins at (Reference Marker + 200 msec) and ends no earlier than (Reference Marker + 10 sec).

RESULTS

Channel Move Time (sec)	Limit (sec)
0.413	10

Aggregate Channel Closing Transmission Time (msec)	Limit (msec)
0.375	60

MOVE TIME & CHANNEL CLOSING TIME

AGGREGATE CHANNEL CLOSING TRANSMISSION TIME

No transmissions are observed during the aggregate monitoring period.

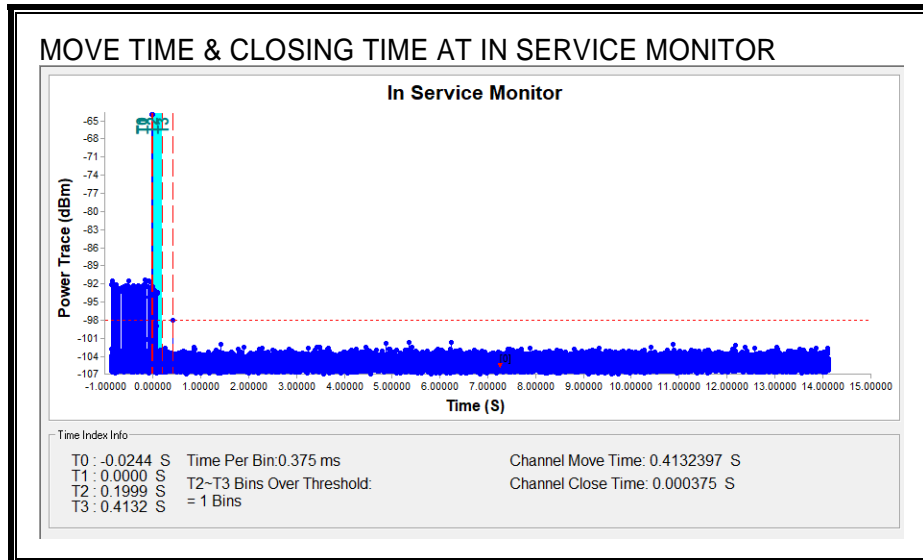
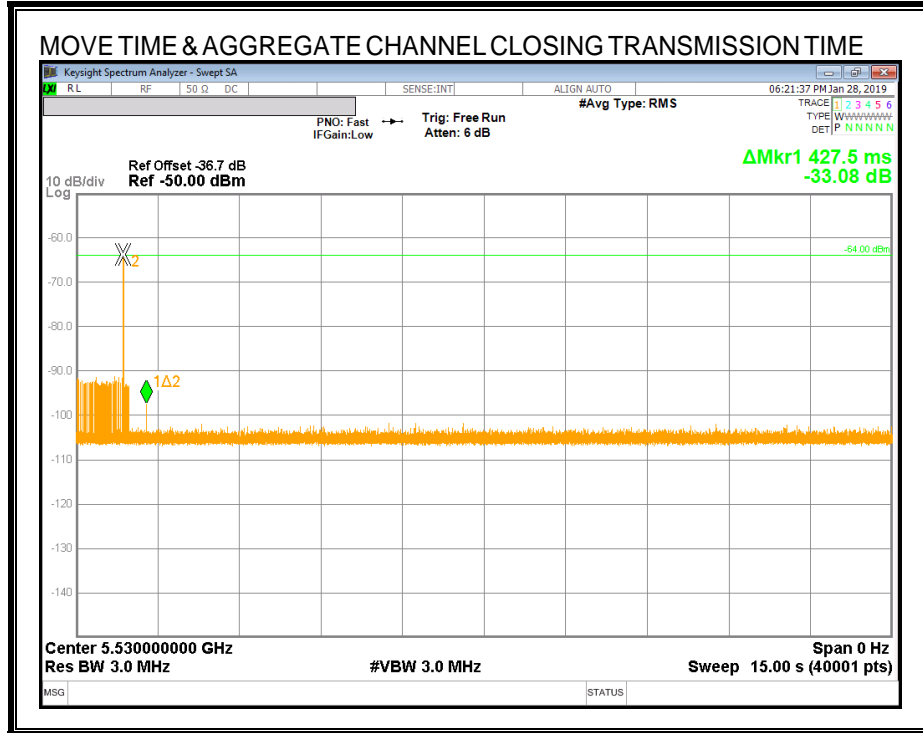

NON-OCCUPANCY PERIOD

RESULTS

No EUT transmissions were observed on the test channel during the 10-minute observation time.

